



Furniture Fittings & Architectural Hardware Price list*

February , 2019

Technik für Möbel





Hettich Forum at Kirchlengern, Germany



The company's origins date back to 1888, when Karl Hettich began making the new clock component he had invented. By 1930, his descendants had diversified into furniture fittings, setting up production in East Westphalia – a centre of the German furniture industry. Today, Hettich, still family owned, has become an industry leader with a worldwide reputation.

We're one of the world's largest manufacturers of high-quality furniture fittings, with over 6,000 employees in more than 100 countries. The company's success has been built on four enduring values: quality, innovation, close cooperation with customers and absolute reliability.

We work to inspire our customers with our ideas and our passion.

Praised by experts. Loved by customers.



Sensys



Sensys wide-angle hinge



Sensys thick door hinge



Sensys thin door hinge



Easys



ArciTech



AvanTech



Push to open silent



InLine S



InnoTech Atira



Hettinject



Cargo Wire Products





Quality

Hettich products stand for high quality. Once assembled, our fittings function perfectly day in, day out. High quality products and processes confirm our sense of value, our self confidence and our image. The way to our quality goal is for each one of us to cultivate an intense quality awareness.

Innovation

The right balance of continuity and innovation generates trust in the Hettich brand. We offer timely, high-value solutions for today's furniture; at the same time, we identify and shape the trends of tomorrow. We review and improve existing solutions ready for the future. Driving innovation is our capacity for looking at things from new angles.

Closeness to customers

For us closeness to customers implies sharpened awareness, attention to detail, a grasp of complex challenges, and efficiency in production and logistics. We know our customers. We're there when our customers need us! The keynote of our partnership with our customers is direct, person-to-person communication.

Reliability

Quality, innovation, closeness to customers – they're nothing without reliability! Reliability encompasses the durability of our products and the reliability of Hettich people – each and every one of us. The solid basis for reliability is robust and stable processes.



Warranty

For Warranty please refer to website.
www.hettich.com/in

* Refer Website



Free Design Service:

Looking for Designs to liven up your Living Room, Bedroom, Bathroom & Kitchen. A dedicated team of highly qualified Interior Designers is at your service to provide customised design solution to suit every taste and budget at zero cost to you.

Free Consultation at your doorstep:

Looking for perfect Furniture Fittings solution. A dedicated team of highly qualified professionals is at your service to provide the perfect furniture fittings solution to suit your need and budget at zero cost to you.

Hettich Customer Care Service:

In today's fast paced and technologically advanced era, most of the organizations succumb to the pressure of staying ahead in the competition and often, end up neglecting the most critical aspect of business i.e. CUSTOMERS. Hettich, being a CUSTOMER CENTRIC organization, is very sensitive towards this tendency; hence, we constantly try to provide the best and quality driven products and services.

For Enquiry & Customer Services

Toll Free : 1800 209 2096 (office hours)
 Email: sales_enquiry@in.hettich.com
customer_services@in.hettich.com
www.hettich.com

INDEX



Furniture Fittings	
Hinges	08-12
Flap Fittings	13-15
Sliding & folding systems	16-32
Drawer Runners (Quadro, KA & FR)	33-37
Drawer System: InnoTech	38-52
Drawer System: ArciTech	53-76
Cargo Series	
CargoTech	77-80
CargoPlus	81
CargoTech M	82-83
Kitchen Accessories	84-87
Wardrobe Accessories	88 - 89
Connecting Fitting & Locks	90-93
Handles	94-96
Aluminium Profiles	97-100
Screws	101
Lights	102-105

Architectural Hardware	
Hinge Technology	107-109
Door Closer	110-1113
Mortise Locking Solution	114-126
Panic Solution	127
ProLock Infinity	128-129
Cylindrical Knobs & Handle Sets	130-131
Floor Spring	132-133
Glass Patch Fittings	134-135
Glass Sliding	135
Pull Handles	136-138
Shower Fitting	139-140
Shower Header Bar & Connecting Fitting	141-142
Shower Seals	143
PVC Door Seals & Automatic Drop Seals	144
Door Accessories	145-147
Appendix	148-160

* Company reserves the right to change the product's prices at any time without further notice.





Product	Article No.	SAP	Item Description	Qty.	Unit	PU	MRP	HS Code
Slide On Hinges								
	Slide On 2333 Hinge - T42 for 14-25 mm thick doors; Opening angle 95°							
	9242867	9242867	Base 12.5 (Crank 0°) with Mounting Plate (D 1.5 mm)	1	Pair	100	94	83021090
	9242868	9242868	Base 5 (Crank 9.5°) with Mounting Plate (D 1.5 mm)	1	Pair	100	99	83021090
	9242869	9242869	Base -1.5 (Crank 16°) with Mounting Plate (D 1.5 mm)	1	Pair	100	104	83021090
	9242870	9242870	Base 12.5 (Crank 0°) with Mounting Plate (D 1.5 mm) & with Dampener	1	Pair	100	247	83021090
	Accessories for Slide On Hinge							
	9042758	9042758	Dampener for Hinge Cup overlay doors	1	Pc	100	153	83024200
	9077364	9077364	Slide On Mounting Plate system 2006 (D 1.5 mm)	100	Pc	100	1,250	83021000
Intermat Hinges								
	Intermat 9943 Hinge - TH42 for 15-25 mm thick doors; Opening angle 110°							
	9242871	9242871	Base 12.5 (Crank 0°) with Mounting Plate (D 0 mm)	1	Pair	100	229	83021090
	9242872	9242872	Base 3 (Crank 9.5°) with Mounting Plate (D 0 mm)	1	Pair	100	252	83021090
	9242873	9242873	Base -3.5 (Crank 16°) with Mounting Plate (D 0 mm)	1	Pair	100	258	83021090
	Intermat 9936 Hinge - TH42 for 14-32 mm thick doors; Opening angle 95°							
	9242874	9242874	Base 12.5 (Crank 0°) with Mounting Plate (D 0 mm)	1	Pair	100	241	83021090
	9242876	9242876	Base 3 (Crank 9.5°) with Mounting Plate (D 0 mm)	1	Pair	100	265	83021090
	9242877	9242877	Base -3.5 (Crank 16°) with Mounting Plate (D 0 mm)	1	Pair	100	271	83021090
	Intermat 9935 Hinge - TH22/L for 16-43 mm thick doors; Opening angle 95°							
	9242878	9242878	Base 18 (Crank -5°) with Mounting Plate (D 0 mm)	1	Pair	100	778	83021090
	9242883	9242883	Base 8 (Crank 5°) with Mounting Plate (D 0 mm)	1	Pair	100	802	83021090
	9242885	9242885	Base -3 (Crank 16°) with Mounting Plate (D 0 mm)	1	Pair	100	807	83021090
	Intermat 9956 Hinge - TH42 16-24 mm thick doors; Opening angle 165°							
	9242890	9242890	Base 12.5 (Crank 0°) with Intermat Mounting plate	1	Pair	50	809	83021090
	Intermat 9930 Hinge- TH52 16-21 mm thick doors; Opening angle 50/65°							
	9243042	9243042	Corner unit folding door with Intermat Mounting Plate (D 0 mm); cup in sensys design	1	Pair	100	761	83021090
	9242888	9242888	Corner unit folding door with Intermat Mounting Plate (D 0 mm); cup in Intermat design	1	Pair	100	741	83021090

Product	Article No.	SAP	Item Description	Qty.	Unit	PU	MRP	HS Code
Intermat 9936 Hinge W90 - TH42 14-28 mm thick doors; face angle 90°, Opening Angle 95°								
	9242895	9242895	Blind corner (W 90°)	1	Pair	100	722	83021090
Intermat 9936 Hinge TA22 19 mm Aluminium Profile doors; Opening angle 95°								
	9242896	9242896	Base 13.5 (Crank 0°) with Mounting Plate (D 0 mm)	1	Pair	10	443	83021090
Accessories for Intermat Hinge								
	72983	1071605	Intermat Cross Mounting Plate (System 9000) (D 0 mm)	1	Pc	100	16	83021000
	9071575	9071575	Sensys Cross Mounting Plate (System 8099) (D 0 mm)	1	Pc	100	24	83021000
Push to Open (P20) Opening System Screw on								
	60233	9051925	P20 Universal Maxi	1	Set	25	415	39263000



Product	Article No.	SAP	Item Description	Qty.	Unit	PU	MRP	HS Code
Sensys Hinge								
	Sensys 8645i Hinge - TH52 for 15-24 mm thick doors; Opening angle 110°							
	9242917	9242922	Base 12.5 (Crank 0°) with Mounting Plate (D 0 mm)	1	Pair	100	511	83021090
	9242919	9242923	Base 3 (Crank 9.5°) with Mounting Plate (D 0 mm)	1	Pair	100	545	83021090
	9242921	9242924	Base -4 (Crank 16°) with Mounting Plate (D 0 mm)	1	Pair	100	579	83021090
	Sensys 8631i Hinge - TH52 for 15-32 mm thick doors; Opening angle 95°							
	9242902	9242902	Base 12.5 (Crank 0°) with Mounting Plate (D 0 mm)	1	Pair	100	551	83021090
	9242905	9242905	Base 3 (Crank 9.5°) with Mounting Plate (D 0 mm)	1	Pair	100	585	83021090
	9242906	9242906	Base-4 (Crank 16°) with Mounting Plate (D 0 mm)	1	Pair	100	619	83021090
	Sensys 8657i Hinge - TH52 for 15-32 mm thick doors; Opening angle 165° (Zero Protrusion Hinge)							
	9243040	9243040	Base 12.5 (Crank 0°) with Mounting Plate (D 0 mm)	1	Pair	50	1,255	83021090
	Sensys 8638i Hinge - TA32 for 19 mm Aluminium Profile; Opening angle 95°							
	9243057	9243057	Base 12.5 (Crank 0°) with Mounting Plate (D 0 mm)	1	Pair	50	833	83021090
	Sensys 8639i W90 Hinge - TH52 for 90° Face Angle Application; Opening angle 95°							
	9243043	9243043	Base 4 (Crank 4) with Mounting Plate	1	Pair	50	1,217	83021090
	Accessories of Sensys Hinge							
	9199822	9199822	Sensys Cover Cap "Made in Germany"	1	Pc	50	13	83024200
	9082614	9082614	Sensys Cover Cap for Hinge Cup T52/53	1	Pc	50	16	83024200
	9071575	9071575	Sensys Mount Plate D 0	1	Pc	100	24	83021000
	9075095	9075095	Sensys Screw-on Linear Mount Plate D 0.5	1	Pc	100	118	83021000
	9088242	9088242	Sensys Press-in Linear Mount Plate D 0.5	1	Pc	50	93	83021000
	9046472	9046472	Dampener for Overlay Hinges - Screw On	1	Pc	50	310	83024200
	46695	46695	Door Buffer Self-Adhesive	1000	Pc	1000	6,461	39269097
	1001097	1001097	T43 Hinge Screws (45169a)	1	Pc	5000	3	73181558
	1058613	1058613	T43 Hinge Sockets 10mm Dia	1	Pc	10000	6	39269097

Product	Article No.	SAP	Item Description	Qty.	Unit	PU	MRP	HS Code
Assorted Hinges								
	Glass Door hinge Opening angle 105°							
	20870	20870	Glass Door hinge ET 150 nickel matt for inset door	1	Pair	20	1,316	83021000
	20873	20873	Magnetic catch D7/GP9 black	1	Pc	20	149	83021000
	Butt Hinges SS 304							
	142381	142381	SS 304 (4" x 3" x 3") with 8 fixing screws	1	Set	20	771	83021000
	1129304	1129304	SS 304 (5" x 3" x 3") with 8 fixing screws	1	Set	20	882	83021000
	9230906	9230906	SS 304 (4" x 3" x 3") without screws - Bulk pack	1	Set	100	635	83021000
	9230907	9230907	SS 304 (5" x 3" x 3") without screws - Bulk pack	1	Set	100	729	83021000
	9230908	9230908	Fixing Screw 4.8 X 31 SS for Butt Hinge	1	Pc	200	4	83021000
	Centre Hinge for Folding Doors Opening angle 180°							
	1069932	1069932	Centre hinge 625	1	Pc	10	35	83021000



Flap Fittings

▶ HF / HK / HL / HS / FYL



Product	Article No.	SAP	Item Description	Qty.	Unit	PU	MRP	HS Code
---------	-------------	-----	------------------	------	------	----	-----	---------

Lift Ups & Flap Stays



Lift Advanced HF (Order Gas Spring Sets Separately)

9079605	9079605	Lift Advanced HF (Inside Carcass Height 440-550 mm)	1	Set	1	7,874	83024900
9079607	9079607	Lift Advanced HF (Inside Carcass Height 551-610 mm)	1	Set	1	7,874	83024900
9079610	9079610	Lift Advanced HF (Inside Carcass Height 611-700 mm)	1	Set	1	7,874	83024900
9079601	9079601	Lift Advanced HF 19mm Alu. Frame Adapter	1	Set	1	458	83024900

(Order Hinges Separately)

Gas Spring Sets for Lift Advanced HF

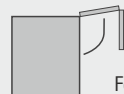

Folding flap fitting

Inside carcass height mm 450 - 550	Inside carcass height mm 551 - 610	Inside carcass height mm 611 - 700	Spring force N	Article No.	SAP	PU	HS Code
4.4 - 5.8 kg	4.0 - 6.0 kg	-	300	9079624	9079624	1 set	83024200
5.1 - 6.6 kg	4.5 - 6.7 kg	3.8 - 5.8 kg	350	9079626	9079626	1 set	83024200
6.0 - 8.0 kg	5.3 - 7.6 kg	4.6 - 7.0 kg	400	9079628	9079628	1 set	83024200
6.8 - 9.2 kg	6.2 - 8.6 kg	5.9 - 8.0 kg	450	9079630	9079630	1 set	83024200
7.8 - 10.2 kg	7.0 - 9.3 kg	6.9 - 8.9 kg	500	9079632	9079632	1 set	94039010
8.9 - 11.2 kg	8.0 - 10.3 kg	8.0 - 9.9 kg	550	9079635	9079635	1 set	83024200
10.5 - 12.6 kg	9.1 - 11.4 kg	8.8 - 10.8 kg	600	9079637	9079637	1 set	83024200
12.2 - 14.2 kg	10.5 - 12.6 kg	10.1 - 12.0 kg	650	9079644	9079644	1 set	83024200
13.2 - 15.0 kg	11.7 - 13.6 kg	11.1 - 12.9 kg	700	9079645	9079645	1 set	83024200
13.8 - 15.4 kg	12.3 - 14.1 kg	11.6 - 13.5 kg	750	9079647	9079647	1 set	83024200
-	13.3 - 14.6 kg	12.6 - 14.4 kg	800	9079650	9079650	1 set	83024200
-	-	13.4 - 15.2 kg	850	9079651	9079651	1 set	83024200



Lift Advanced HK (Order Gas Spring Sets Separately)

9079603	9079603	Lift Advanced HK (Inside Carcass Height 276 - 720 mm)	1	Set	1	6,296	83024900
9079709	9079709	Lift Advanced HK 19mm Alu. Frame Adapter	1	Set	1	616	83024200

(Order Hinges Separately)

Gas Spring Sets for Lift Advanced HK

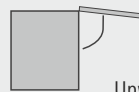

Upward opening flap fitting

Inside carcass height mm 276 - 360	Inside carcass height mm 361 - 480	Inside carcass height mm 481 - 540	Inside carcass height mm 541 - 600	Inside carcass height mm 601 - 720	Spring force N	Article No.	SAP	PU	HS Code
2.1 - 4.7 kg *	2.0 - 3.8 kg	-	-	-	150	9079618	907961802	1 set	83024200
4.1 - 7.0 kg *	3.3 - 5.4 kg	2.4 - 4.9 kg	-	-	200	9079619	907961903	1 set	83024200
6.1 - 8.9 kg *	4.5 - 6.3 kg	3.8 - 6.2 kg	3.8 - 5.6 kg	3.8 - 5.0 kg	250	9079622	907962203	1 set	83024200
7.8 - 10.7 kg *	5.7 - 7.9 kg	5.2 - 7.6 kg	4.9 - 6.7 kg	4.4 - 5.9 kg	300	9079624	907962403	1 set	83024200
9.7 - 12.4 kg *	7.1 - 9.3 kg	6.6 - 9.0 kg	6.1 - 7.7 kg	5.4 - 6.8 kg	350	9079626	907962603	1 set	83024200
11.5 - 14.3 kg	8.6 - 10.7 kg	8.1 - 10.3 kg	7.2 - 8.8 kg	6.3 - 7.8 kg	400	9079628	907962803	1 set	83024200
13.3 - 16.0 kg	10.2 - 12.1 kg	9.7 - 11.6 kg	8.4 - 10.0 kg	7.3 - 8.7 kg	450	9079630	907963003	1 set	94039010
15.2 - 17.9 kg	11.7 - 13.4 kg	11.0 - 12.8 kg	9.6 - 11.0 kg	8.2 - 9.6 kg	500	9079632	907963203	1 set	83024200
-	12.9 - 14.3 kg	12.4 - 14.1 kg	10.7 - 12.2 kg	9.1 - 10.4 kg	550	9079635	907963503	1 set	83024200
-	14.2 - 15.5 kg	13.7 - 15.4 kg	12.0 - 13.2 kg	10.1 - 11.4 kg	600	9079637	907963703	1 set	83024200
-	15.4 - 16.8 kg	15.0 - 16.7 kg	13.1 - 14.3 kg	11.1 - 12.4 kg	650	9079644	907964403	1 set	83024200

Flap Fittings

▶ HF / HK / HL / HS / FYL



Product	Article No.	SAP	Item Description	Qty.	Unit	PU	MRP	HS Code
	Lift Advanced HL (Order Gas Spring Sets Separately)							
	9079595	9079595	Lift Advanced HL (Inside Carcass Height 277-312 mm)	1	Set	1	7,874	83024900
	9079597	9079597	Lift Advanced HL (Inside Carcass Height 313-342 mm)	1	Set	1	7,874	83024900
	9079598	9079598	Lift Advanced HL (Inside Carcass Height 343-372 mm)	1	Set	1	7,874	83024900
	9079599	9079599	Lift Advanced HL (Inside Carcass Height 373-402 mm)	1	Set	1	7,874	83024900
	9079600	9079600	Lift Advanced HL (Inside Carcass Height 403-462 mm)	1	Set	1	7,874	83024900
	9079653	9079653	Lift Advanced Shortenable Rod 600	1	Set	1	931	83024900
	9079658	9079658	Lift Advanced Shortenable Rod 1200	1	Set	1	1,563	83024900
	9079664	9079664	Lift Advanced Shortenable Rod 1800	1	Set	1	2,194	83024900
	9079601	9079601	19mm Alu. Frame Adapter (Order Hinges Separately)	1	Set	1	458	83024900

Gas Spring Sets for Lift Advanced HL

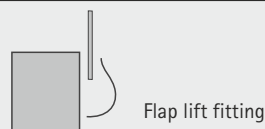

Inside carcass height mm 277 - 312	Inside carcass height mm 313 - 342	Inside carcass height mm 343 - 372	Inside carcass height mm 373 - 402	Inside carcass height mm 403 - 462	Spring force N	Article No.	SAP	PU	HS Code
2.1 - 3.8 kg	2.3 - 3.8 kg	-	-	-	150	9079618	9079618	1 set	83024200
3.8 - 5.4 kg	3.6 - 5.3 kg	2.1 - 4.8 kg	1.7 - 3.8 kg	-	200	9079619	9079619	1 set	83024900
5.6 - 7.1 kg	5.2 - 7.1 kg	3.3 - 6.0 kg	2.6 - 5.0 kg	3.2 - 4.9 kg	250	9079622	9079622	1 set	83024900
7.3 - 8.8 kg	6.5 - 8.7 kg	4.3 - 7.2 kg	3.8 - 6.3 kg	4.4 - 5.9 kg	300	9079624	9079624	1 set	83024900
8.9 - 10.5 kg	7.9 - 10.2 kg	5.5 - 8.6 kg	4.9 - 7.5 kg	5.4 - 6.8 kg	350	9079626	9079626	1 set	83024900
10.6 - 12.1 kg	9.1 - 11.7 kg	6.6 - 9.7 kg	6.0 - 8.7 kg	6.3 - 7.8 kg	400	9079628	9079628	1 set	83024900
-	10.5 - 13.2 kg	7.8 - 10.9 kg	7.1 - 9.9 kg	7.3 - 8.7 kg	450	9079630	9079630	1 set	83024900
-	11.6 - 14.7 kg	8.9 - 12.2 kg	8.2 - 11.1 kg	8.2 - 9.6 kg	500	9079632	9079632	1 set	83024900
-	12.8 - 16.2 kg	10.0 - 13.4 kg	9.3 - 12.4 kg	9.1 - 10.4 kg	550	9079635	9079635	1 set	83024900
-	14.2 - 17.6 kg	11.2 - 14.6 kg	10.5 - 13.6 kg	10.1 - 11.4 kg	600	9079637	9079637	1 set	83024900
-	-	12.5 - 15.9 kg	11.7 - 14.9 kg	11.1 - 12.4 kg	650	9079644	9079644	1 set	83024900

	Lift Advanced HS (Order Gas Spring Sets Separately)							
	9079617	907961702	Lift Advanced HS (Inside Carcass Height 372-688 mm)	1	Set	1	7,874	83024200
	9079653	907965300	Lift Advanced Shortenable Rod 600	1	Set	1	931	83024900
	9079658	907965800	Lift Advanced Shortenable Rod 1200	1	Set	1	1,563	83024900
	9079664	907966400	Lift Advanced Shortenable Rod 1800	1	Set	1	2,194	83024900
	9079601	907960100	19mm Alu. Frame Adapter (Order Hinges Separately)	1	Set	1	458	83024900

Gas Spring Sets for Lift Advanced HS



Inside carcass height mm 372 - 408	Inside carcass height mm 409 - 508	Inside carcass height mm 509 - 568	Inside carcass height mm 569 - 688	Spring force N	Article No.	SAP	PU	HS Code
3.0 - 4.4 kg	3.2 - 4.3 kg	2.5 - 3.9 kg	-	200	9079619	9079619	1 set	83024200
4.0 - 5.4 kg	4.2 - 5.4 kg	3.4 - 5.2 kg	3.2 - 4.8 kg	250	9079622	9079622	1 set	83024200
5.3 - 6.7 kg	5.2 - 6.5 kg	4.4 - 6.4 kg	4.0 - 6.1 kg	300	9079624	9079624	1 set	83024200
6.3 - 7.9 kg	6.3 - 7.4 kg	5.4 - 7.4 kg	4.9 - 7.1 kg	350	9079626	9079626	1 set	83024200
7.7 - 9.1 kg	7.3 - 8.6 kg	6.5 - 8.4 kg	5.8 - 8.2 kg	400	9079628	9079628	1 set	83024200
8.8 - 10.3 kg	8.4 - 9.9 kg	7.5 - 9.5 kg	6.8 - 9.1 kg	450	9079630	9079630	1 set	83024200
10.0 - 11.5 kg	9.4 - 10.9 kg	8.6 - 10.5 kg	7.7 - 10.0 kg	500	9079632	9079632	1 set	94039010
11.0 - 12.6 kg	10.5 - 12.1 kg	9.6 - 11.6 kg	8.6 - 11.6 kg	550	9079635	9079635	1 set	83024200
12.1 - 13.8 kg	11.6 - 13.2 kg	10.7 - 12.6 kg	9.6 - 12.6 kg	600	9079637	9079637	1 set	83024200
13.3 - 14.9 kg	12.6 - 14.2 kg	11.7 - 13.7 kg	10.5 - 13.5 kg	650	9079644	9079644	1 set	83024200
-	13.6 - 15.3 kg	12.8 - 14.7 kg	11.4 - 14.3 kg	700	9079645	9079645	1 set	83024200

Flap Fittings

▶ HF / HK / HL / HS / FYL



Product	Article No.	SAP	Item Description	Qty.	Unit	PU	MRP	HS Code
	Gas Spring sets for Advanced Lift-Up (HF, HK, HL & HS)							
	9079618	9079618	Spring Force 150N	1	Set	1	3,002	83024200
	9079619	9079619	Spring Force 200N	1	Set	1	3,002	83024200
	9079622	9079622	Spring Force 250N	1	Set	1	3,002	83024200
	9079624	9079624	Spring Force 300N	1	Set	1	3,002	83024200
	9079626	9079626	Spring Force 350N	1	Set	1	3,002	83024200
	9079628	9079628	Spring Force 400N	1	Set	1	3,002	83024200
	9079630	9079630	Spring Force 450N	1	Set	1	3,002	83024200
	9079632	9079632	Spring Force 500N	1	Set	1	3,002	94039010
	9079635	9079635	Spring Force 550N	1	Set	1	3,002	83024200
	9079637	9079637	Spring Force 600N	1	Set	1	3,002	83024200
	9079644	9079644	Spring Force 650N	1	Set	1	3,002	83024200
	9079645	9079645	Spring Force 700N	1	Set	1	3,002	83024200
	9079647	9079647	Spring Force 750N	1	Set	1	3,708	83024200
	9079650	9079650	Spring Force 800N	1	Set	1	3,708	83024200
	9079651	9079651	Spring Force 850N	1	Set	1	3,708	83024200
	Lift Up FLY (Opening angle 90°) (Order Hinges Separately)							
	9111155	9111155	Grey 450N	1	Pc	1	6,280	83024200
	Lift Up - Top Box Lift 90 (Order Hinges Separately)							
	10921 L	1077875	Flap Lift Exact 90 (4.6 kg) Left	1	Pc	30	465	83024200
	10921 R	1077876	Flap Lift Exact 90 (4.6 kg) Right	1	Pc	30	465	83024200
	Flap Stay KLS 30 (Order Hinge Separately)							
	16179	16179	KLS 30 Flap Support (4kg weight carrying capacity with 2 fittings ; Max Flap Dimensions: Width 600 mm Et Height 500 mm)	1	Pc	10	1,337	83024200
	Flap Stay Lift Basic (Order Hinge Separately)							
	9079593	9079593	Lift Basic Flap Stay (3.2kg weight carrying capacity with 2 fittings ; Max Flap Dimensions: Width 600 mm Et Height 400 mm)	1	Pc	10	314	83024200
	Klassik D with magnetic stay close function							
	21579	21579	Klassik D Magnetic 4 kg Left	1	Pc	10	906	85051100
	21700	21700	Klassik D Magnetic 4 kg Right	1	Pc	10	906	85051100

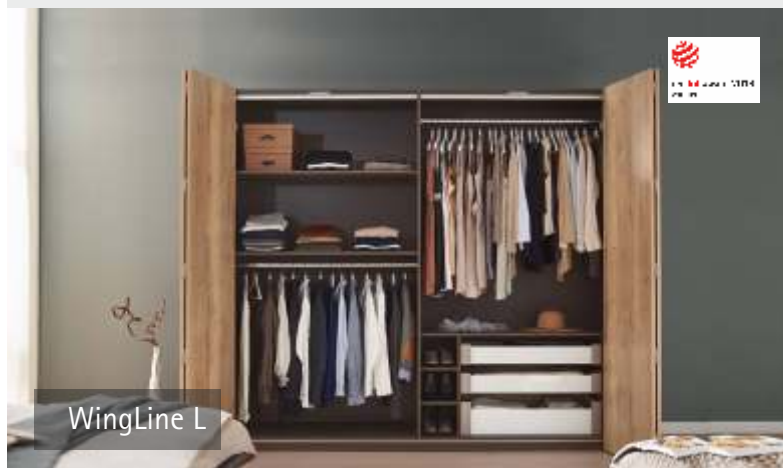

Product	Article No.	SAP	Item Description	Qty.	Unit	PU	MRP	HS Code
---------	-------------	-----	------------------	------	------	----	-----	---------

Top Running & Flush Fitted Wardrobe Door Sliding Fittings

InLineXL

**InLine XL - Weight 60 Kg per Door; Max. Dimensions: Height- 2600 mm & Width - 1799 mm
(Pre-order Form required for ordering)**



9148180	9148180	Door width 750 -819 mm (max. door height 2000 mm)	1	Set	1	1,09,846	83024200
9148201	9148201	Door width 820 -909 mm (max. door height 2000 mm)	1	Set	1	1,09,833	83024200
9148202	9148202	Door width 910 -1044 mm (max. door height 2200 mm)	1	Set	1	1,09,887	83024200
9148203	9148203	Door width 1045 -1199 mm (max. door height 2200 mm)	1	Set	1	1,00,971	83024200
9148204	9148204	Door width 1200 -1299 mm (max. door height 2400 mm)	1	Set	1	1,04,127	83024200
9148205	9148205	Door width 1300 -1499 mm (max. door height 2400 mm)	1	Set	1	1,07,283	83024200
9148206	9148206	Door width 1500 -1599 mm (max. door height 2600 mm)	1	Set	1	1,10,439	83024200
9116581	9116581	Door width 1600 -1799 mm (max. door height 2600 mm)	1	Set	1	1,13,595	83024200

Top Running & Overlay & Inset Wardrobe Door Sliding Fittings

TopLineXL

**TopLine XL 2 Door Advanced - Weight 80 Kg per Door with Soft Closing
& Soft Opening; Max. Door Dimensions: Height-2600 mm & Width- (1500) 2000 mm**





9181742	9181742	Frontmost Door Set for 19 mm max. door thickness EB 30	1	Set	1	12,611	83024200
9183613	9183613	Frontmost Door Set for 22 mm max. door thickness EB 33	1	Set	1	12,611	83024200
9183615	9183615	Frontmost Door Set for 28 mm max. door thickness EB 39	1	Set	1	12,611	83024200
9183616	9183616	Frontmost Door Set for 40 mm max. door thickness EB 51	1	Set	1	19,591	83024200
9181744	9181744	Rearmost Door Set Left side	1	Set	1	7,571	83024200
9169548	9169548	Soft Opening & Closing System	1	Set	1	9,928	39263000
9135004	9135004	4000 mm Predrilled Runner profile , Guide Profile and Cover Profile	1	Set	1	23,516	83024200
9135002	9135002	3000 mm Predrilled Runner profile , Guide Profile and Cover Profile	1	Set	1	18,637	83024200

**TopLine XL 3 Door Advanced - Weight 80 Kg per Door with Soft Closing & Soft Opening;
Max. Door Dimensions: Height-2600 mm & Width-2000 mm**



9181742	9181742	Frontmost Door Set for 19 mm max. door thickness EB 30	1	Set	1	12,611	83024200
9183613	9183613	Frontmost Door Set for 22 mm max. door thickness EB 33	1	Set	1	12,611	83024200
9183615	9183615	Frontmost Door Set for 28 mm max. door thickness EB 39	1	Set	1	12,611	83024200
9183616	9183616	Frontmost Door Set for 40 mm max. door thickness EB 51	1	Set	1	19,951	83024200
9181744	9181744	Rearmost Door Set Left side for Doors	1	Set	1	7,571	83024200
9183533	9183533	Rearmost Door Set Right side for Doors	1	Set	1	7,571	83024200
9154933	9154933	Soft Opening & Closing System	1	Set	1	18,143	83024200
9135004	9135004	4000 mm Predrilled Runner profile, Guide Profile and Cover Profile	1	Set	1	23,516	83024200

Product	Article No.	SAP	Item Description	Qty.	Unit	PU	MRP	HS Code
TopLine XL 4 Door Synchronised – Weight 80 Kg per Door with Soft Closing & Soft Opening; Max. Door Dimensions: Height-2600 mm & width-1000 mm								
	9181742	9181742	Frontmost Door Set for 19 mm max. door thickness EB 30	1	Set	1	12,611	83024200
	9196841	9196841	Front most door set for synchronisation EB 30	1	Set	1	25,675	83024200
	9183613	9183613	Frontmost Door Set for 22 mm max. door thickness EB 33	1	Set	1	12,611	83024200
	9199006	9199006	Front most door set for synchronisation EB 33	1	Set	1	25,675	83024200
	9183615	9183615	Frontmost Door Set for 28 mm max. door thickness EB 39	1	Set	1	12,611	83024200
	9199007	9199007	Front most door set for synchronisation EB 39	1	Set	1	25,675	83024200
	9183616	9183616	Frontmost Door Set for 40 mm max. door thickness EB 51	1	Set	1	19,591	83024200
	9199009	9199009	Front most door set for synchronisation EB 51	1	Set	1	28,418	83024200
	9181744	9181744	Rearmost Door Set Left side	1	Set	1	7,571	83024200
	9183533	9183533	Rearmost Door Set Right side	1	Set	1	7,571	83024200
	9185664	9185664	Soft Opening & Closing System for 4 Doors	1	Set	1	25,266	83024200
	9191156	9191156	3000 mm Reinforced & Predrilled Runner profile, Guide Profile and Cover Profile	1	Set	1	34,089	83024200
	9191157	9191157	4000 mm Reinforced & Predrilled Runner profile, Guide Profile and Cover Profile	1	Set	1	44,269	83024200
	TopLine XL Accessories							
	9137352	9137352	2000 mm Cover Profile for Frontmost Door	1	Set	1	1,424	39263000



Product	Article No.	SAP	Item Description	Qty.	Unit	PU	MRP	HS Code
TopLine 22								
	TopLine 22: 2 Door with STB 11 (Frontmost Door on Right) for Wooden & Aluminium Profile Doors Weight 50 kg per door; Max Door Dimensions: H-2500 & Width-1500 for 21 mm thickness							
	13431	13431	Set 2-Door for thickness 21 mm	1	Set	1	5,096	83024200
	45080	45080	STB 11 Set 2-Doors	1	Set	1	1,659	83024200
	71111	71111	Runner profile 3000 mm Silver Alu.	1	Pc	4	1,678	76042990
	71117	71117	STB 11 Guide profile 3000 mm Alu.	1	Pc	4	1,595	76042990
		Total Set					10,028	
	TopLine 22: 2 Door with STB 12 (Frontmost Door on Right) for Wooden & Aluminium Profile Doors Weight 50 kg per door; Max Door Dimensions: H-2500 mm & Width-1500 mm for 21 mm thickness							
	13431	13431	Set 2-Door for thickness 21 mm	1	Set	1	5,096	83024200
	45082	45082	STB 12 Set 2-Doors	1	Set	1	1,773	83024200
	71111	71111	Runner profile 3000 mm Silver Alu.	1	Pc	4	1,678	76042990
	71116	71116	STB 12 Guide profile 3000 mm Alu.	1	Pc	4	1,717	76042990
		Total Set					10,264	
	TopLine 22: 2 Door with STB 15 (Frontmost Door on Right) for Wooden & Aluminium Profile Doors Weight 50kg per door; Max Door Dimensions: H-2500 mm & Width-1500 mm for 21 mm Thickness							
	13431	13431	Set 2-Door for thickness 21 mm	1	Set	1	5,096	83024200
	45199	45199	STB 15 Set 2-Doors	1	Set	1	2,033	83024200
	71111	71111	Runner profile 3000 mm Silver Alu.	1	Pc	4	1,678	76042990
	71115	71115	STB 15 Guide profile 3000 mm Alu.	1	Pc	4	2,023	76042990
		Total Set					10,830	
	TopLine 22: 3 Door with STB 11 for Wooden & Aluminium Profile Doors- Weight 50kg per door; Max Door Dimensions: H-2500 mm & Width-1500 mm for 21 mm Thickness							
	13433	13433	Set 3-Door for thickness 21 mm	1	Set	1	6,449	83024200
	45081	45081	STB 11 Set 3-Doors	1	Set	1	1,974	83024200
	71111	71111	Runner profile 3000mm Silver Alu.	1	Pc	4	1,678	76042990
	71117	71117	STB 11 Guide profile 3000mm Alu.	1	Pc	4	1,595	76042990
		Total Set					11,696	
	TopLine 22: 3 Door with STB 12 for Wooden & Aluminium Profile Doors - Weight 50kg per door; Max Door Dimensions: H-2500 mm & Width-1500 mm for 21 mm Thickness							
	13433	13433	Set 3-Door for thickness 21 mm	1	Set	1	6,449	83024200
	45083	45083	STB 12 Set 3-Doors	1	Set	1	2,212	83024200
	71111	71111	Runner profile 3000mm Silver Alu.	1	Pc	4	1,678	76042990
	71116	71116	STB 12 Guide profile 3000 mm Alu.	1	Pc	4	1,717	76042990
		Total Set					12,056	
	Top Line 22, 50 Kg/ Door , Wodden & Aluminium (Other Options)							
	13432	13432	Set Front Door on left for thickness 21 mm	1	Set	1	5,097	83024200
	9080202	9080202	Set Front Door on left for thickness 28 mm	1	Set	1	5,616	83024200
	46418	46418	Profile 1000 mm brown	1	Pc	4	689	39169090

Product	Article No.	SAP	Item Description	Qty.	Unit	PU	MRP	HS Code
TopLine 22 Advanced								
	TopLine 22 2 Door Advanced with STB 11 (Frontmost Door on Right) for Wooden & Aluminium Profile Doors - Weight 50 kg per door; Max Door Dimensions: Height -2500 mm & Width -1500 mm for 28 mm thickness							
	9080201	9080201	Top Door Runner set for Door Thickness 28 mm (Max.)	1	Set	1	5,616	83024200
	45080	45080	STB 11 Guide Set	1	Set	1	1,659	83024200
	71111	71111	Runner profile 3000 mm Silver Alu.	1	Pc	4	1,678	76042990
	71117	71117	STB 11 Guide profile 3000 mm Alu.	1	Pc	4	1,595	76042990
			Total Set				10,548	
	TopLine 22: 2 Door Advanced with STB 12 (Frontmost Door on Right) for Wooden & Aluminium Profile Doors - Weight 50 kg per door; Max Door Dimensions: Height -2500 mm & Width -1500 mm for 28 mm thickness							
	9080201	9080201	Top Door Runner set for Door Thickness 28 mm (Max.)	1	Set	1	5,616	83024200
	45082	45082	STB 12 Guide Set	1	Set	1	1,773	83024200
	71111	71111	Runner profile 3000 mm Silver Alu.	1	Pc	4	1,678	76042990
	71116	71116	STB 12 Guide profile 3000 mm Alu.	1	Pc	4	1,717	76042990
			Total Set				10,784	
	TopLine 22: 2 Door Advanced with STB 15 (Frontmost Door on Right) for Wooden & Aluminium Profile Doors - Weight 50 kg per door; Max Door Dimensions: Height -2500 mm & Width -1500 mm for 28 mm thickness							
	9080201	9080201	Top Door Runner set for Door Thickness 28 mm (Max.)	1	Set	1	5,616	83024200
	45199	45199	STB 15 Guide Set	1	Set	1	2,033	83024200
	71111	71111	Runner profile 3000 mm Silver Alu.	1	Pc	4	1,678	76042990
	71115	71115	STB 15 Guide profile 3000 mm Alu.	1	Pc	4	2,023	76042990
			Total Set				11,350	
	TopLine 22: 3 Door Advanced with STB 11 for Wooden & Aluminium Profile Doors - Weight 50 kg per door; Max Door Dimensions: Height -2500 mm & Width -1500 mm for 28 mm Thickness							
	9080203	9080203	Top Door Runner set for Door Thickness 28 mm (Max.)	1	Set	1	7,416	83024200
	45081	45081	STB 11 Guide Set	1	Set	1	1,974	83024200
	71111	71111	Runner profile 3000 mm Silver Alu.	1	Pc	4	1,678	76042990
	71117	71117	STB 11 Guide profile 3000 mm Alu.	1	Pc	4	1,595	76042990
			Total Set				12,663	
	TopLine 22: 3 Door Advanced with STB 12 for Wooden & Aluminium Profile Doors - Weight 50kg per door; Max Door Dimensions: Height -2500 mm & Width -1500 mm for 28 mm Thickness							
	9080203	9080203	Top Door Runner set for Door Thickness 28 mm (Max.)	1	Set	1	7,416	83024200
	45083	45083	STB 12 Guide Set	1	Set	1	2,212	83024200
	71111	71111	Runner profile 3000 mm Silver Alu.	1	Pc	4	1,678	76042990
	71116	71116	STB 12 Guide profile 3000 mm Alu.	1	Pc	4	1,717	76042990
			Total Set				13,023	
	TopLine 22 Silent System soft closing set & Cover Profile							
	9084432	9084432	Silent System soft closing set-2 Door	1	Set	1	6,243	39263000
	9096761	9096761	Silent System soft closing set-3 Door	1	Set	1	6,603	39263000
	46418	46418	Cover Profile 1000 mm	1	Pc	1	689	39169090

Product	Article No.	SAP	Item Description	Qty.	Unit	PU	MRP	HS Code
---------	-------------	-----	------------------	------	------	----	-----	---------

Top Running & Inset Wardrobe/Cabinet Sliding Fittings







TopLine 110



**Topline 110: 2 Door for Wooden & Aluminium Profile Doors - Weight 20kg per door;
Max Door Dimensions: Height 2000 mm & Width 500-1500 mm**

9040230	9040230	Aluminium Runner Profile 3000 mm for gluing in	1	Pc	1	1,832	76042990
45317	45317	Topline 110 Set for 2 Door Cabinet (for 16-19 mm door thickness)	1	Set	1	2,770	83024200
9079731	9079731	Silent System for Wooden Door only (Max door weight 20kg)	1	Set	1	3,880	39263000



Product	Article No.	SAP	Item Description	Qty.	Unit	PU	MRP	HS Code
TopLine 1								
	Topline 1: 2 Door for Wooden Doors with STB 11- Weight 50 kg per door; Max Door Dimensions : Height 1500-2500 mm & Width 500-1500 mm							
	45076	45076	Top Door Runner Set for 2 Doors	1	Set	1	2,712	83024200
	71113	71113	Aluminium Runner Profile 3000 mm	1	Pc	4	2,422	76042990
	71117	71117	STB 11 Aluminium Guide profile 3000 mm	1	Pc	4	1,595	76042990
	45080	45080	STB 11 Guide Set for 2-Doors	1	Set	1	1,659	83024200
			Total Set				8,388	
	Topline 1: 2 Door for Wooden Doors with STB 12- Weight 50 kg per door; Max Door Dimensions : Height 1500-2500 mm & Width 500-1500 mm							
	45076	45076	Top Door Runner Set for 2 Doors	1	Set	1	2,712	83024200
	71113	71113	Aluminium Runner Profile 3000 mm	1	Pc	4	2,422	76042990
	71116	71116	STB 12 Aluminium Guide profile 3000 mm	1	Pc	4	1,717	76042990
	45082	45082	STB 12 Guide Set for 2-Doors	1	Set	1	1,773	83024200
			Total Set				8,624	
	Topline 1: 2 Door for Wooden Doors with STB 35- Weight 50 kg per door; Max Door Dimensions : Height 1500-2500 mm & Width 500-1500 mm							
	45076	45076	Top Door Runner Set for 2 Doors	1	Set	1	2,712	83024200
	71113	71113	Aluminium Runner Profile 3000 mm	1	Pc	4	2,422	76042990
	46790	46790	STB 35 plastic guide profile 3500 mm	2	Pc	25	442	39169090
	25119	25119	STB 35 Guide Set for 2-Doors	2	Set	100	58	39263000
			Total Set				5,634	
	Topline 1: 2 Door for Wooden Doors with STB 11- Weight 75 kg per door; Max Door Dimensions : Height 1500-2500 mm & Width 500-1500 mm							
	45078	45078	Top Door Runner Set for 2 Doors	1	Set	1	4,633	83024200
	71113	71113	Aluminium Runner Profile 3000 mm	1	Pc	4	2,422	76042990
	71117	71117	STB 11 Aluminium Guide profile 3000 mm	1	Pc	4	1,595	76042990
	45080	45080	STB 11 Guide Set for 2-Doors	1	Set	1	1,659	83024200
			Total Set				10,309	
	Topline 1: 2 Door for Wooden Doors with STB 12 - Weight 75 kg per door; Max Door Dimensions: Height 1500-2500 mm & Width 500-1500 mm							
	45078	45078	Top Door Runner Set for 2 Doors	1	Set	1	4,633	83024200
	71113	71113	Aluminium Runner Profile 3000 mm	1	Pc	4	2,422	76042990
	71116	71116	STB 12 Aluminium Guide profile 3000 mm	1	Pc	4	1,717	76042990
	45082	45082	STB 12 Guide Set for 2-Doors	1	Set	1	1,773	83024200
			Total Set				10,545	
	Topline 1: 2 Door for Wooden Doors with STB 35 - Weight 75 kg per door; Max Door Dimensions: Height 1500-2500 mm & Width 500-1500 mm							
	45078	45078	Top Door Runner Set for 2 Doors	1	Set	1	4,633	83024200
	71113	71113	Aluminium Runner Profile 3000 mm	1	Pc	4	2,422	76042990
	46790	46790	STB 35 plastic guide profile 3500 mm	2	Pc	25	442	39169090
	25119	25119	STB 35 Guide Set for 2-Doors	2	Set	100	58	39263000
			Total Set				7,555	

Product	Article No.	SAP	Item Description	Qty.	Unit	PU	MRP	HS Code
	Topline 1: 3 Door for Wooden Doors with STB 11 - Weight 50 kg per door; Max Door Dimensions: Height 1500-2500 mm & Width 500-1500 mm							
	45077	45077	Top Door Runner Set for 3 Doors	1	Set	1	3,585	83024200
	71113	71113	Aluminium Runner Profile 3000 mm	1	Pc	4	2,422	76042990
	71117	71117	STB 11 Aluminium Guide profile 3000 mm	1	Pc	4	1,595	76042990
	45081	45081	STB 11 Guide Set for 3-Doors	1	Set	1	1,974	83024200
			Total Set				9,576	
	Topline 1: 3 Door for Wooden Doors with STB 12 - Weight 50 kg per door; Max Door Dimensions: Height 1500-2500 mm & Width 500-1500 mm							
	45077	45077	Top Door Runner Set for 3 Doors	1	Set	1	3,585	83024200
	71113	71113	Aluminium Runner Profile 3000 mm	1	Pc	4	2,422	76042990
	71116	71116	STB 12 Aluminium Guide profile 3000 mm	1	Pc	4	1,717	76042990
	45083	45083	STB 12 Guide Set for 3-Doors	1	Set	1	2,212	83024200
			Total Set				9,936	
	Topline 1: 3 Door for Wooden Doors with STB 35 - Weight 50 kg per door; Max Door Dimensions: Height 1500-2500 mm & Width 500-1500 mm							
	45077	45077	Top Door Runner Set for 3 Doors	1	Set	1	3,585	83024200
	71113	71113	Aluminium Runner Profile 3000 mm	1	Pc	4	2,422	76042990
	46790	46790	STB 35 plastic guide profile 3500 mm	2	Pc	25	442	39169090
	25119	25119	STB 35 Guide Set for 3-Doors	3	Set	100	87	39263000
			Total Set				6,536	
	Topline 1: 3 Door for Wooden Doors with STB 11 - Weight 75 kg per door; Max Door Dimensions: Height 1500-2500 mm & Width 500-1500 mm							
	45079	45079	Top Door Runner Set for 3 Doors	1	Set	1	6,561	83024200
	71113	71113	Aluminium Runner Profile 3000 mm	1	Pc	4	2,422	76042990
	71117	71117	STB 11 Aluminium Guide profile 3000 mm	1	Pc	4	1,595	76042990
	45081	45081	STB 11 Guide Set for 3-Doors	1	Set	1	1,974	83024200
			Total Set				12,552	
	Topline 1: 3 Door for Wooden Doors with STB 12 - Weight 75 kg per door; Max Door Dimensions: Height 1500-2500 mm & Width 500-1500 mm							
	45079	45079	Top Door Runner Set for 3 Doors	1	Set	1	6,561	83024200
	71113	71113	Aluminium Runner Profile 3000 mm	1	Pc	4	2,422	76042990
	71116	71116	STB 12 Aluminium Guide profile 3000 mm	1	Pc	4	1,717	76042990
	45083	45083	STB 12 Guide Set for 3-Doors	1	Set	1	2,212	83024200
			Total Set				12,952	
	Topline 1: 3 Door for Wooden Doors with STB 35 - Weight 75 kg per door; Max Door Dimensions: Height 1500-2500 mm & Width 500-1500 mm							
	45079	45079	Top Door Runner Set for 3 Doors	1	Set	1	6,561	83024200
	71113	71113	Aluminium Runner Profile 3000 mm	1	Pc	4	2,422	76042990
	46790	46790	STB 35 plastic guide profile 3500 mm	2	Pc	25	442	39169090
	25119	25119	STB 35 Guide Set for 3-Doors	3	Set	100	87	39263000
			Total Set				9,512	

Product	Article No.	SAP	Item Description	Qty.	Unit	PU	MRP	HS Code
---------	-------------	-----	------------------	------	------	----	-----	---------

Bottom Running & Overlay & Inset Cabinet Door Sliding Fittings

SlideLine M

**SlideLine M: 1 Door for Wooden & Aluminium framed Doors – Weight 30 kg per door;
Max Door Dimensions: Height 2000 mm & Width 300–1800 mm**



9156338	9156338	Set fitting SlideLine M with Silent system for Wooden & 55 mm Alu. Profile Doors (Min. Width 450 mm; Weight Max. 30kg; Self Thickness 16–25 mm)	1	Set	1	7,457	83024200
9156339	9156339	Set fitting SlideLine M, for Wooden & 55mm Alu. Profile Doors (Min. Width 300 mm; Weight Max. 30 kg; Self Thickness 16–25 mm)	1	Set	1	4,361	83024200
9184626	9184626	Upgrade set for 19mm Alu. framed doors with Silent System	1	Set	1	10,922	83024200
9209225	9209225	Profile Set SL-M 18/2500 mm 1 Profile	1	Set	1	5,833	76042990
9209226	9209226	Profile Set SL-M 18/4000 mm 1 Profile	1	Set	1	8,341	76042990
9209228	9209228	Profile Set SL-M 22/2500 mm 1 Profile	1	Set	1	6,155	76042990
9209229	9209229	Profile Set SL-M 22/4000 mm 1 Profile	1	Set	1	8,985	76042990
9209230	9209230	Profile Set SL-M 25/2500 mm 1 Profile	1	Set	1	6,380	76042990
9209231	9209231	Profile Set SL-M 25/4000 mm 1 Profile	1	Set	1	8,978	76042990
9209277	9209277	Decorative Silver Cover for 18 mm /2500 mm	1	Set	1	2,248	39199080
9209278	9209278	Decorative Silver Cover for 18 mm /4000 mm	1	Set	1	3,214	39269097
9209287	9209287	Decorative Silver Cover for 22 mm /4000 mm	1	Set	1	3,366	39269097
9209399	9209399	Decorative Silver Cover for 25 mm /2500 mm	1	Set	1	2,362	39269097
9209400	9209400	Decorative Silver Cover for 25 mm /4000 mm	1	Set	1	3,218	39269097

SlideLine 66



**SlideLine 66: 1 Door for Wooden & Alu.framed Doors– Weight 10 kg per door;
Max Door Dimensions: Height 800 mm & Width 400–1500 mm**

20143	9125955	Cover Profile 3000 mm Silver	1	Pc	4	215	39169090
20142	20142	Aluminium Runner Profile 3000 mm Silver	1	Pc	4	1,937	76042990
20145	20145	Slide-Line 66 Set for Wooden and Aluminium Profile doors (for 16–19 mm thick door)	1	Set	1	1,533	83024200

SlideLine 55



**SlideLine 55: 2 Door for Wooden Doors – Weight 15 kg per door with Plastic Runner Profile;
Max Door Dimensions: Height 1500 mm & Width 400–2000 mm**

25121	1010501	Profile 4000mm Brown	1	Pc	20	256	39169090
25122	1006347	Running Component for 15kg door (For 16–19mm thick door)	1	Pc	100	56	39263000
25123	1006263	Guide Component with Spring loaded bolt (For 16–19mm thick door)	1	Pc	100	69	39263000
47392	47392	Door Stopper Press-In for 15kg door	1	Pc	100	16	39263000
9079731	9079731	Add-On Silent System (max door weight 20 kg)	1	Pc	1	3,880	39263000

SlideLine 55 Plus



**SlideLine 55 Plus: 2 Door for Wooden Doors – Weight 15–30 kg per door;
Max Door Dimensions: Height 1500 mm & Width 400–2000 mm**

1079090	1057668	Runner & guide profile Alu 4000 mm	1	Pc	4	1,104	76042990
9115217	9115217	Guiding part STB 55 plus	1	Pc	100	117	83024200
9115219	9115219	SL 55 plus running part	1	Pc	100	267	39263000
9115216	9115216	Spacer STB 55 plus	1	Pc	100	51	39269097
9119584	9119584	Silent system SL 55plus left	1	Pc	30	1,048	83024200
9119585	9119585	Silent system SL 55plus right	1	Pc	30	1,048	83024200
9118477	9118477	Assembly activator SISY SL 55	1	Pc	300	93	39263000

Product	Article No.	SAP	Item Description	Qty.	Unit	PU	MRP	HS Code
---------	-------------	-----	------------------	------	------	----	-----	---------

SlideLine 56



**SlideLine 56: 2 Door for Wooden Doors- Weight 40 kg per door;
Max Door Dimensions: Height 2000 mm & Width 500-1000 mm**

1015936	49764	Aluminium Runner Profile 2000 mm Silver	1	Pc	16	296	76042990
71110	49765	Aluminium Runner Profile 3000 mm Silver	1	Pc	4	1,064	76042990
45234	45234	2 Door Kit for 1 cabinet (16-19 mm thick door)	1	Set	1	1,617	39263000
45235	45235	3 Door Kit for 1 cabinet (16-19 mm thick door)	1	Set	1	2,661	39263000
9079731	9079731	Add-On Silent System (max door weight 20kg)	1	Set	1	3,880	39263000

SlideLine 97



**SlideLine 97: 2 Door glass fitting All round Frame - Weight 25/50 kg per door;
Max Door Dimensions: Height 2500 mm & Width 250-1250 mm**

48965	48965	Slide-Line 97 Guide profile 2500 mm	1	Pc	4	6,059	76042990
48966	48966	Slide-Line 97 Running Shoe 2500 mm	1	Pc	4	4,694	76042990
76472	76472	Slide-Line 97 Running part	4	Pc	4	2,936	83024200
76475	76475	Slide-Line 97 Stop & Securing Device	4	Pc	10	1,136	83024200
48970	48970	Slide-Line 97 Dust Prevention Profile 2500 mm	2	Pc	40	5,512	83024200
48971	9082726	Frame Runner Profile	1	Pc	30	4,369	76042990
76480	76480	Slide-Line 97 End Plate, Chrome	4	Pc	10	1,112	83024200
76481	76481	Slide-Line 97 Running component handle	2	Pc	10	1,892	83024200
48969	48969	Slide-Line 97 Frame 2500 mm	4	Pc	4	16,796	76042990
48968	48968	Slide in profile for 6 mm	1	Pc	4	1,000	83024200
76484	76484	Slide-Line 97 Special Fitting Tool	1	Pc	1	4,612	83024200

Optional Accessories Slide-Line 97 (Push Lock)



76482	76482	Slide-Line 97 Adapter, Chrome	1	Set	1	1,617	83024200
76483	76483	Slide-Line 97 Pressure Plug Lock	1	Set	1	5,473	83013000

Vertically running Door Sliding Fittings

Vertico Synchro

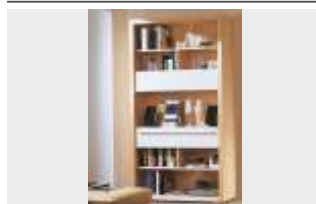

**Vertico Synchro: 2 Door for Wooden and Aluminium Profile Doors - Weight 15 kg per door;
Max Door Dimensions: Height 400-600 mm & Width 1500 mm max.**

20386	20386	Vertico Synchro Set 400 for Overlay Door height 400-600 mm	1	Set	1	24,313	83024200
20400	20400	Cover Profile 2500 mm Aluminium Silver anodised	2	Pc	1	3,484	76042990

Vertico Mono



**Vertico Mono: 1 Door for Wooden and Aluminium Profile Doors - Weight 15 kg per door;
Max Door Dimensions: Height 400-700 mm & Width 1500 mm max.**

45315	45315	Set Vertico Mono for inset door	1	Set	1	20,475	83024200
20400	20400	Cover Profile 2500 mm Aluminium Silver anodised	2	Pc	1	3,484	76042990





Swivel system

HorizonPlus Swivel system







**Horizon Plus: Sliding Door for Wooden & Aluminium Profile Door - Weight 20 kg per door;
max door Dimensions: Height 2600 mm & Width 400-700 mm**

9080210	9080210	Horizon Plus Single Door Kit for internal height 2570 mm and Door Width 400-515 mm	1	Set	1	44,012	94039010
48078	48078	Horizon Plus Single Door Kit for internal height 2570 mm and Door Width 475-700 mm	1	Set	1	41,659	83024200

Product	Article No.	SAP	Item Description	Qty.	Unit	PU	MRP	HS Code
Folding Door System for Wardrobe / Cabinet								
WingLine								
	Wingline L Push to move - Weight 5 kg to 12 kg per wing ; Max Door Dimensions : 2400 mm Height & 600 mm Door Wing Width (Order Hinges Separately)							
	9237901	9237901	Wing Line L Kit - Left	1	Pc	1	2,044	83024200
	9237900	9237900	Wing Line L Kit - Right	1	Pc	1	2,044	83024200
	9238051	9238051	Push to Move Mechanisms Medium- Left	1	Pc	1	8,133	83024200
	9238101	9238101	Push to Move Mechanisms Medium- Right	1	Pc	1	8,133	83024200
	9237917	9237917	Runner Profile - 2400 mm	1	Pc	1	2,256	76042990
9237758	9237758	Profile Mounting Clip	2	Pc	1	188	39269097	
	Wingline L Push to move - Weight 12 kg to 25 Kg per wing ; Max Door Dimensions : 2400 mm Height & 600 mm Door Wing Width (Order Hinges Separately)							
	9237880	9237880	Wing Line L Kit - Left	1	Pc	1	3,414	83024200
	9237881	9237881	Wing Line L Kit - Right	1	Pc	1	3,414	83024200
	9238052	9238052	Push to Move Mechanisms Heavy - Left	1	Pc	1	7,976	83024200
	9238053	9238053	Push to Move Mechanisms Heavy - Right	1	Pc	1	7,976	83024200
	9239310	9239310	Runner Profile - 2400 mm	1	Pc	1	3,764	76042990
	Wingline L Pull to move - Weight 5 kg to 12 kg per wing ; Max Door Dimensions : 2400 mm Height & 600 mm Door Wing Width (Order Hinges Separately)							
	9237901	9237901	Wing Line L Kit - Left	1	Pc	1	2,044	83024200
	9237900	9237900	Wing Line L Kit - Right	1	Pc	1	2,044	83024200
	9238115	9238115	Pull to move Mechanisms Medium- Left	1	Pc	1	8,133	83024200
	9238116	9238116	Pull to move Mechanisms Medium- Right	1	Pc	1	8,133	83024200
	9237917	9237917	Runner Profile - 2400 mm	1	Pc	1	2,256	76042990
9237758	9237758	Profile Mounting Clip	2	Pc	1	188	39269097	
	Wingline L Pull to move - Weight 12 kg to 25 Kg per wing ; Max Door Dimensions : 2400 mm Height & 600 mm Door Wing Width (Order Hinges Separately)							
	9237880	9237880	Wing Line L Kit - Left	1	Pc	1	3,414	83024200
	9237881	9237881	Wing Line L Kit - Right	1	Pc	1	3,414	83024200
	9238125	9238125	Pull to move Mechanisms Heavy - Left	1	Pc	1	7,976	83024200
	9238114	9238114	Pull to move Mechanisms Heavy - Right	1	Pc	1	7,976	83024200
	9239310	9239310	Runner Profile - 2400 mm	1	Pc	1	3,764	76042990
	Wingline L Pull to move Silent - Weight 5 kg to 12 kg per wing ; Max Door Dimensions : 2400 mm Height & 600 mm Door Wing Width (Order Hinges Separately)							
	9237903	9237903	Wing Line L Kit - Left	1	Pc	1	2,044	83024200
	9237902	9237902	Wing Line L Kit - Right	1	Pc	1	2,044	83024200
	9238121	9238121	Pull to move Silent Mechanisms Medium- Left	1	Pc	1	6,577	83024200
	9238124	9238124	Pull to move Silent Mechanisms Medium- Right	1	Pc	1	6,577	83024200
	9237917	9237917	Runner Profile - 2400 mm	1	Pc	1	2,256	76042990
9237758	9237758	Profile Mounting Clip	2	Pc	1	188	39269097	
	Wingline L Pull to move Silent - Weight 12 kg to 25 Kg per wing ; Max Door Dimensions : 2400 mm Height & 600 mm Door Wing Width (Order Hinges Separately)							
	9237852	9237852	Wing Line L Kit - Left	1	Pc	1	3,414	83024200
	9237890	9237890	Wing Line L Kit - Right	1	Pc	1	3,414	83024200
	9238123	9238123	Pull to move Silent Mechanisms Heavy - Left	1	Pc	1	7,341	39269097
	9238122	9238122	Pull to move Silent Mechanisms Heavy - Right	1	Pc	1	7,341	39269097
	9239310	9239310	Runner Profile - 2400 mm	1	Pc	1	3,764	76042990







Product	Article No.	SAP	Item Description	Qty.	Unit	PU	MRP	HS Code
	WingLine 230: 2 Doors with 4 Wings for Wooden Doors – Weight 20–25 kg per door; Max Door Dimensions: Height 3000mm & Door wing Width 600 mm (Order Hinges Separately)							
	79013	1079849	Runner profile Aluminium White 2400 mm	1	Pc	4	7,285	76042990
	79015	9225395	WingLine 230 Set of 4 Wings (Left & Right) (16–25 mm Door thickness)	1	Set	1	23,498	83024200
	Wing 77: for 2 or 4 Door Wings for Wooden Doors– Weight up to 20 kg (25 kg) with 4 (2) Wings Max Door Dimensions: Height 2400 mm & Width 400 mm (500) with 4 (2) Wings (Order Hinges Separately)							
	70986	70986	Set 2 Wings 25 kg / door	1	Set	1	8,700	83024200
	70987	70987	Set 4 Wings 20 kg / door	1	Set	1	15,765	83024200
	70985	70985	Guide profile 3200 mm Aluminium Silver Anodised	1	Pc	4	4,103	76042990
	9193574	919357400	Runner Profile 3200 mm Aluminium Silver Anodised	1	Pc	4	4,619	76042990
	Wingline 170: 1 Door with 2 Wings for Wooden/Aluminium Profile Doors – Weight depends on hinges used; Max Door Dimensions: Height 2200 mm & Door wing Width 300 mm (Order Hinges Separately)							
	74658	74658	Wingline 170 set	1	Set	1	1,289	83024200
	71648	1069932	Centre Folding Door Hinge 625 (Nickel plated Steel)	1	Pc	4	35	83021000
	Accessories for Sliding & Folding Doors							
	45198	9189775	Door Bend Adjustment Rod Fitting - Plastic	1	Set	1	1,086	83024200
	9117303	9117303	Door Bend Adjustment Rod Fitting - Aluminium	1	Set	2	7,474	83024200
	26453	26453	Brush Sealing Strip 2500mm (27 mm height.; Screw on Brown)	1	Pc	40	1,289	39269097
	9200386	9200386	Self Adhesive Brush Sealing Strip 2500 mm (8 mm height.)	1	Pc	1	227	39269097
	9073662	9073662	Sensys 8675 Hinge ; Opening Angle 110° for Push to move and Pull to Move Mechanisms	1	Pc	1	228	83021000
	9071205	9071205	Sensys 8645i Hinges ; Opening angle 110° for Pull to Move Silent Mechanisms	1	Pc	1	232	83021000
	9071575	9071575	Sensys Mount Plate	1	Pc	1	24	83021000
9237758	9237758	Profile Mounting Clip	1	Pc	1	94	39269097	







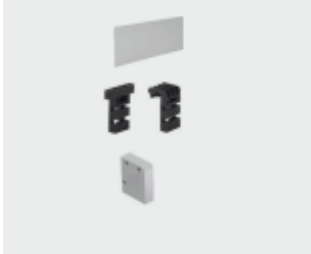

Product	Article No.	SAP	Item Description	Qty.	Unit	PU	MRP	HS Code
Top Running Sliding & Folding Door System as Space Dividers								
Sliding								
	Topline 80: Single profile Top Running Door – Weight 80 kg/door; Max Door Dimensions: Width1000/1500 mm (Max.)							
	14005	9089915	Kit for 1 Door (Door Thickness : 25 mm upwards)	1	Set	1	3,143	76042990
	14006	9089914	Runner profile anodised aluminium profile 2000 mm	1	Pc	4	1,580	76042990
	9083102	9083102	Runner profile anodised aluminium profile 3000 mm	1	Pc	4	2,206	76042990
	Slideline 16: 2 Door for Wooden doors with 2 m screw on track –Weight 60 kg per door; thickness 16–24 mm							
	9226025	9226025	SL 16- Fitting Set	1	Set	1	1,460	83024200
	9239411	9239411	SL 16- Profile Set Screw 2000 mm	1	Set	1	1,745	76169990
	9226028	9226028	Silent System	1	Set	1	893	83024200
	Total Set							4,098
	Slideline 16: 2 Door for Wooden doors with 3 m screw on track –Weight 60 kg per door; thickness 16–24 mm							
	9226025	9226025	SL 16- Fitting Set	1	Set	1	1,460	83024200
	9226026	9226026	SL 16- Profile Set Screw 3000 mm	1	Set	1	3,030	76169990
	9226028	9226028	Silent System	1	Set	1	893	83024200
	Total Set							5,383
	Grant 1230 with 3000 mm Runner, 147 Kg / Door, max. height 3000 mm & min. thickness 25.5 mm							
	50125	50125	Runner profile, 3000 mm	1	Pc	4	4,321	76042990
	1133278	1133278	Kit for 1 door	1	Set	1	5,920	83024190
	50140	50140	TopLine 1230 Bumper stop	1	Pc	2	1,021	83024200
	50562	50562	Floor Guide Tab Steel	1	Pc	10	373	83024200
	Total Set							11,635
	Grant 1230 with 3600 mm Runner, 147 Kg / Door, max. height 3000 mm & min. thickness 25.5 mm							
	50126	50126	Runner profile, 3600 mm	1	Pc	4	6,324	76042990
	1133278	1133278	Kit for 1 door	1	Set	1	5,920	83024190
	50140	50140	TopLine 1230 Bumper stop	1	Pc	2	1,021	83024200
	50562	50562	Floor Guide Tab Steel	1	Pc	10	373	83024200
	Total Set							13,638
	Grant 1230 with 4800 mm Runner, 147 Kg / Door, max. height 3000 mm & min. thickness 25.5 mm							
	50127	50127	Runner profile, 4800 mm	1	Pc	4	8,482	76042990
	1133278	1133278	Kit for 1 door	1	Set	1	5,920	83024190
	50140	50140	TopLine 1230 Bumper stop	1	Pc	2	1,021	83024200
	50562	50562	Floor Guide Tab Steel	1	Pc	10	373	83024200
	Total Set							15,796

Product	Article No.	SAP	Item Description	Qty.	Unit	PU	MRP	HS Code
	Grant 1260 with 3000 mm Runner (For Heavy Duty Folding Doors) - 80 Kg / Door							
	1133284	1133284	Kit for 1 fold	1	Set	1	10,376	83024200
	50146	50146	Guide profile, 3000 mm	1	Pc	4	2,298	76041090
	50125	50125	Runner profile, 3000 mm	1	Pc	4	4,321	76042990
	50141	50141	Guide rollers	1	Pc	1	859	83024190
			Total Set				17,854	
	Grant 1260 with 3600 mm Runner (For Heavy Duty Folding Doors) - 80 Kg / Door							
	1133284	1133284	Kit for 1 fold	1	Set	1	10,376	83024200
	50147	50147	Guide profile, 3600 mm	1	Pc	4	2,461	76041090
	50126	50126	Runner profile, 3600 mm	1	Pc	4	6,324	76041090
	50141	50141	Guide rollers	1	Pc	1	859	83024190
			Total Set				20,020	
	Grant 1260 with 4800 mm Runner (For Heavy Duty Folding Doors) - 80 Kg / Door							
	1133284	1133284	Kit for 1 fold	1	Set	1	10,376	83024200
	50148	50148	Guide profile, 4800 mm	1	Pc	4	3,579	76041090
	50127	50127	Runner profile, 4800 mm	1	Pc	4	8,482	76041090
	50141	50141	Guide Rollers	1	pc	1	859	83024190
			Total Set				23,296	
	SlideLine Grant 400 (40 Kg / Door) for 1 Door / 2 Door, Wardrobe							
	9215175	9215175	Set of fittings for 1 door Choose two sets for a two door wardrobe.	1	Set	1	51,276	39269097
	9215220	9215220	Additional set for 3rd door.	1	Set	1	51,553	39269097



Product	Article No.	SAP	Item Description	Qty.	Unit	PU	MRP	HS Code
Grand SD for door weight 68 kg								
	TopLine Grant SD Set Standard 10 feet with Silent System							
	9199839	9199839	Single Track 10 feet	1	Pc	1	15,748	83024190
	9191124	9191124	Standard Hardware Set	1	Set	1	7,136	83024190
	9235608	9235608	Silent System SD	1	Pc	1	13,786	83024190
			Total Set				36,670	
	TopLine Grant SD Set Low Profile 10 feet with Silent System							
	9199839	9199839	Single Track 10 feet	1	Pc	1	15,748	83024190
	9203725	9203725	Low profile Hardware Set	1	Set	1	25,053	83024190
	9235608	9235608	Silent System SD	1	Pc	1	13,786	83024190
			Total Set				54,587	
	TopLine Grant SD Set Standard 12 feet with Silent System							
	9199840	9199840	Single Track 12 feet	1	Pc	1	18,897	83024190
	9191124	9191124	Standard Hardware Set	1	Set	1	7,136	83024190
	9235608	9235608	Silent System SD	1	Pc	1	13,786	83024190
			Total Set				38,819	
	TopLine Grant SD Set Low Profile 12 feet with Silent System							
	9199840	9199840	Single Track 12 feet	1	Pc	1	18,897	83024190
	9203725	9203725	Low profile Hardware Set	1	Set	1	25,053	83024190
	9235608	9235608	Silent System SD	1	Pc	1	13,786	83024190
			Total Set				57,736	
	TopLine Grant SD Set Standard 16 feet with Silent System							
	9199841	9199841	Single Track 16 feet	1	Pc	1	25,196	83024190
	9191124	9191124	Standard Hardware Set	1	Set	1	7,136	83024190
	9235608	9235608	Silent System SD	1	Pc	1	13,786	83024190
			Total Set				46,118	
	TopLine Grant SD Set Low Profile 16 feet with Silent System							
	9199841	9199841	Single Track 16 feet	1	Pc	1	25,196	83024190
	9203725	9203725	Low profile Hardware Set	1	Set	1	25,053	83024190
	9235608	9235608	Silent System SD	1	Pc	1	13,786	83024190
			Total Set				64,035	
	Accessories							
	9203746	9203746	Fascia 16 feet	1	Pc	1	14,503	83024190
	9203751	9203751	Header mount Fascia Clip	1	Pc	1	1,109	83024190
	9202941	9202941	End cap without fascia	1	Pc	1	2,176	83024190

Product	Article No.	SAP	Item Description	Qty.	Unit	PU	MRP	HS Code
Grand HD for door weight 147 kg								
	TopLine Grant HD Set Standard 10 feet with Silent System							
	9201461	9201461	Single Track 10 feet	1	Pc	1	14,472	83024190
	9191125	9191125	Standard Hardware Set	1	Set	1	7,879	83024190
	9235621	9235621	Silent System HD	1	Pc	1	16,575	83024190
			Total Set				38,926	
	TopLine Grant HD Set Low Profile 10 feet with Silent System							
	9201461	9201461	Single Track 10 feet	1	Pc	1	14,472	83024190
	9203729	9203729	Low profile Hardware Set	1	Set	1	25,072	83024190
	9235621	9235621	Silent System HD	1	Pc	1	16,575	83024190
			Total Set				56,119	
	TopLine Grant HD Set Standard 12 feet with Silent System							
	9201462	9201462	Single Track 12 feet	1	Pc	1	17,349	83024190
	9191125	9191125	Standard Hardware Set	1	Set	1	7,879	83024190
	9235621	9235621	Silent System HD	1	Pc	1	16,575	83024190
			Total Set				41,803	
	TopLine Grant HD Set Low Profile 12 feet with Silent System							
	9201462	9201462	Single Track 12 feet	1	Pc	1	17,349	83024190
	9203729	9203729	Low profile Hardware Set	1	Set	1	25,072	83024190
	9235621	9235621	Silent System HD	1	Pc	1	16,575	83024190
			Total Set				58,996	
	TopLine Grant HD Set Standard 16 feet with Silent System							
	9201463	9201463	Single Track 16 feet	1	Pc	1	21,692	83024190
	9191125	9191125	Standard Hardware Set	1	Set	1	7,879	83024190
	9235621	9235621	Silent System HD	1	Pc	1	16,575	83024190
			Total Set				46,146	
	TopLine Grant HD Set Low Profile 16 feet with Silent System							
	9201463	9201463	Single Track 16 feet	1	Pc	1	21,692	83024190
	9203729	9203729	Low profile Hardware Set	1	Set	1	25,072	83024190
	9235621	9235621	Silent System HD	1	Pc	1	16,575	83024190
			Total Set				63,339	
	Accessories							
	9203746	9203746	Fascia 16 feet	1	Pc	1	14,503	83024190
	9203751	9203751	Header mount Fascia Clip	1	Pc	1	1,109	83024190
	9202942	9202942	End cap without fascia	1	Pc	1	1,990	83024190

Product	Article No.	SAP	Item Description	Qty.	Unit	PU	MRP	HS Code
---------	-------------	-----	------------------	------	------	----	-----	---------

Grand XHD for door weight 227 kg



TopLine Grant XHD Set Standard 12 feet without Silent System								
9199513	9199513		Single Track 12 feet	1	Pc	1	32,140	83024190
9191126	9191126		Standard Hardware Set	1	Set	1	15,468	83024190
			Total Set				47,608	



Quadro



Telescopic Runner



InnoTech

Drawer Runners

▸ Quadro



Product	Article No.	SAP	Item Description	Qty.	Unit	PU	MRP	HS Code
	Quadro- 25 Partial Extension 25 Kg							
	72904.S	9243213	250 mm with catches	1	Set	10	1,020	83021090
	72905.S	9243214	300 mm with catches	1	Set	10	764	83021090
	73210.S	9243215	350 mm with catches	1	Set	10	805	83021090
	73211.S	9243216	400 mm with catches	1	Set	10	844	83021090
	73212.S	9243217	450 mm with catches	1	Set	10	884	83021090
	33687.S	9243218	500 mm with catches	1	Set	10	923	83021090
	73214.S	9243219	550 mm with catches	1	Set	10	964	83021090
	73215.S	9243220	600 mm with catches	1	Set	10	1,003	83021090
	73216.S	9243221	650 mm with catches	1	Set	10	1,003	83021090
	Quadro-25 Partial Extension with Silent System 25 Kg							
	9135931.S	9243222	250 mm with catches	1	Set	10	1,234	83021090
	9135939.S	9243223	300 mm with catches	1	Set	10	1,234	83021090
	9135943.S	9243224	350 mm with catches	1	Set	10	1,270	83021090
	9135933.S	9243225	400 mm with catches	1	Set	10	1,309	83021090
	9135935.S	9243226	450 mm with catches	1	Set	10	1,346	83021090
	9135937.S	9243227	500 mm with catches	1	Set	10	1,383	83021090
	9135941.S	9243228	550 mm with catches	1	Set	10	1,490	83021090
	Quadro-V6 Full Extension 30 Kg with Silent System							
	45285.S	9243229	300 mm with catches	1	Set	10	2,153	83024200
	45287.S	9243230	350 mm with catches	1	Set	10	2,153	83024200
	45289.S	9243231	400 mm with catches	1	Set	10	2,340	83024200
	45291.S	9243232	450 mm with catches	1	Set	10	2,433	83024200
	45293.S	9243233	500 mm with catches	1	Set	10	2,526	83024200
	45295.S	9243234	550 mm with catches	1	Set	10	2,715	83024200
	45297.S	9243235	600 mm with catches	1	Set	10	2,995	83024200
	Quadro 25 Partial Extension with P20 25 Kg							
	9135958.S	9243236	300 mm with catches	1	Set	10	1,307	83021090
	9135960.S	9243237	350 mm with catches	1	Set	10	1,383	83021090
	9135962.S	9243238	400 mm with catches	1	Set	10	1,459	83021090
	9135964.S	9243239	450 mm with catches	1	Set	10	1,533	83021090
	9135966.S	9243240	500 mm with catches	1	Set	10	1,646	83021090
	Quadro V6 Full Extension with P20 30 Kg							
	9135984.S	9243241	250 mm with catches	1	Set	10	2,253	83021090
	9135985.S	9243242	300 mm with catches	1	Set	10	2,253	83021090
	9135987.S	9243243	350 mm with catches	1	Set	10	2,417	83021090
	9135989.S	9243244	400 mm with catches	1	Set	10	2,543	83021090
	9135991.S	9243245	450 mm with catches	1	Set	10	2,666	83021090
	9135993.S	9243246	500 mm with catches	1	Set	10	2,870	83021090
	9135995.S	9243247	550 mm with catches	1	Set	10	3,078	83021090

Drawer Runners

▸ Quadro



Product	Article No.	SAP	Item Description	Qty.	Unit	PU	MRP	HS Code
	Quadro- 4D Full Extension 30 Kg (EB 20) *							
	9181290	9181290	300 mm with catches	1	Set	10	3,730	83021090
	9181292	9181292	350 mm with catches	1	Set	10	3,808	83021090
	9181294	9181294	400 mm with catches	1	Set	10	3,959	83021090
	9181296	9181296	450 mm with catches	1	Set	10	4,110	83021090
	9181298	9181298	500 mm with catches	1	Set	10	4,406	83021090
	9181300	9181300	550 mm with catches	1	Set	10	4,703	83021090
	9181302	9181302	600 mm with catches	1	Set	10	5,142	83021090
	Quadro Catches for wooden drawers							
	9144830	9144830	Left	1	Pc	10	57	39263000
	9144841	9144841	Right	1	Pc	10	57	39263000
	Quadro- V6+ Full Extension 50 Kg *							
	9119167	9119167	350 mm with catches - Left	1	Set	10	1,477	83021090
	9119168	9119168	350 mm with catches - Right	1	Set	10	1,477	83021090
	9115506	9115506	400 mm with catches - Left	1	Set	10	1,558	83021090
	9115507	9115507	400 mm with catches - Right	1	Set	10	1,558	83021090
	9119148	9119148	450 mm with catches - Left	1	Set	10	1,782	83021090
	9119149	9119149	450 mm with catches - Right	1	Set	10	1,782	83021090
	9115580	9115580	500 mm with catches - Left	1	Set	10	1,913	83021090
	9115581	9115581	500 mm with catches - Right	1	Set	10	1,913	83021090
	9119162	9119162	550 mm with catches - Left	1	Set	10	1,922	83021090
	9119164	9119164	550 mm with catches - Right	1	Set	10	1,922	83021090
	9115538	9115538	600 mm with catches - Left	1	Set	10	2,165	83021090
	9115539	9115539	600 mm with catches - Right	1	Set	10	2,165	83021090
	Quadro Catches for wooden drawers							
	9117483	9117483	Left	1	Pc	10	95	39263000
	9117485	9117485	Right	1	Pc	10	95	39263000

NOTE: Available from request



Drawer Runners

► KA





Product	Article No.	SAP	Article No.	SAP	Item Description	Qty.	Unit	PU	MRP	HS Code
	KA 5632 45 kg Zinc / Black									
	Zinc		Black							
	73276	9215435	44916	9215445	250 mm	1	Set	10	409	83024200
	73277	9215436	44915	9215446	300 mm	1	Set	10	443	83024200
	73278	9215437	44914	9215447	350 mm	1	Set	10	477	83024200
	73279	9209240	44913	9215448	400 mm	1	Set	10	511	83024200
	73280	9209239	44912	9215449	450 mm	1	Set	10	528	83024200
	73281	9193319	44911	9215450	500 mm	1	Set	10	545	83024200
	73282	9215441	44909	9215451	550 mm	1	Set	10	597	83024200
	73283	9215442	44908	9215452	600 mm	1	Set	10	682	83024200
	73284	9215443	44907	9215453	650 mm	1	Set	10	767	83024200
	41355	9215444	44906	9215454	700 mm	1	Set	10	852	83024200
	KA 5632 30 kg Zinc Silent System									
	9221400	9221400			300 mm	1	Set	10	886	83024200
	9221467	9221467			350 mm	1	Set	10	906	83024200
	9221468	9221468			400 mm	1	Set	10	926	83024200
	9221499	9221499			450 mm	1	Set	10	956	83024200
	9221500	9221500			500 mm	1	Set	10	986	83024200
	9221503	9221503			550 mm	1	Set	10	1,016	83024200
	KA 5632 30 kg Black Silent System									
	9221513	9221513			300 mm	1	Set	10	886	83021090
	9221525	9221525			350 mm	1	Set	10	906	83021090
	9221526	9221526			400 mm	1	Set	10	926	83021090
	9221527	9221527			450 mm	1	Set	10	956	83021090
	9221528	9221528			500 mm	1	Set	10	986	83024200
	9221539	9221539			550 mm	1	Set	10	1,016	83021090
	KA 4532, 35 kg Silent System / P20 Zinc									
	Silent System		Push To Open							
	9114271	9114271	9114281	9114281	300 mm	1	Set	10	937	83024200
	9114273	9114273	9114282	9114282	350 mm	1	Set	10	971	83024200
	9114274	9114274	9114283	9114283	400 mm	1	Set	10	1,005	83024200
	9114275	9114275	9114284	9114284	450 mm	1	Set	10	1,022	83024200
	9114276	9114276	9114285	9114285	500 mm	1	Set	10	1,039	83024200
	9114277	9114277	9114286	9114286	550 mm	1	Set	10	1,091	83024200
	9114278	9114278	9114288	9114288	600 mm	1	Set	10	1,176	83024200
	9114279	9114279	9114289	9114289	650 mm	1	Set	10	1,262	83024200
	9114280	9114280	9114290	9114290	700 mm	1	Set	10	1,347	83024200
	KA 4620 90 Kg									
	41392	41392			400 mm	1	Set	5	1,419	83024200
	41393	41393			450 mm	1	Set	5	1,419	83024200
	41394	41394			500 mm	1	Set	5	1,577	83024200
	41395	41395			550 mm	1	Set	5	1,595	83024200
	41396	41396			600 mm	1	Set	5	1,734	83024200
	41397	41397			650 mm	1	Set	5	2,177	83024200
	41398	41398			700 mm	1	Set	5	2,358	83024200

Drawer Runners

► KA / FR



Product	Article No.	SAP	Item Description	Qty.	Unit	PU	MRP	HS Code
	KA 3320 136 Kg							
	73296	9018568	760 mm	1	Set	5	8,153	83024200
	41367	9018570	810 mm	1	Set	3	8,736	83024200
	41368	9018572	860 mm	1	Set	3	9,318	83024200
	41369	9018574	910 mm	1	Set	3	9,706	83024200
	FR 302, 20 kg with stop control							
	75993	75993	250 mm	1	Set	20	95	83024200
	75994	1083317	300 mm	1	Set	20	103	83024200
	75995	1083318	350 mm	1	Set	20	115	83024200
	75996	1083319	400 mm	1	Set	20	129	83024200
	75997	1083320	450 mm	1	Set	20	143	83024200
	13089	1083321	500 mm	1	Set	20	157	83024200
	9006351	9006351	550 mm	1	Set	20	173	83024200



Drawer System InnoTech



InnoTech



InnoTech





InnoTech

Drawer System InnoTech

- ▶ Drawer, height 70 mm
- ▶ Silver



Product	Article No.	SAP	Item Description	Qty.	Unit	PU	HS Code
	InnoTech- 350 mm (30 Kg) Full Extn. Silent						
	1062015	9019693	Drawer side profile, L	1	Pc	1	94039010
	1062016	9019694	Drawer side profile, R	1	Pc	1	94039010
	1065191	1065191	Screw-On Front Connector	2	Pc	2	39263000
	45310-L	9126554	Quadro-V6	1	Pc	1	83024200
	45310-R	9126555	Quadro-V6	1	Pc	1	83024200
	1062501	1062501	Rear panel Connector, L	1	Pc	1	83024200
	1062502	1062502	Rear panel Connector, R	1	Pc	1	83024200
	9194646	9194646	Cover Cap Grey	2	Pc	2	39269097
BOM-code	9243083	Total Set	MRP: 4,456				83021090
	InnoTech- 420 mm (30 Kg) Full Extn. Silent						
	1062017	9015786	Drawer side profile, L	1	Pc	1	94039010
	1062018	9015787	Drawer side profile, R	1	Pc	1	94039010
	1065191	1065191	Screw-On Front Connector	2	Pc	2	39263000
	45311-L	9126558	Quadro-V6	1	Pc	1	83024200
	45311-R	9126559	Quadro-V6	1	Pc	1	83024200
	1062501	1062501	Rear panel Connector, L	1	Pc	1	83024200
	1062502	1062502	Rear panel Connector, R	1	Pc	1	83024200
	9194646	9194646	Cover Cap Hettich logo Grey Background	2	Pc	2	39269097
BOM-code	9243084	Total Set	MRP: 4,456				83021090
	InnoTech- 470 mm (30 Kg) Full Extn. Silent						
	1062019	9015793	Drawer side profile, L	1	Pc	1	94039010
	1062020	9015794	Drawer side profile, R	1	Pc	1	94039010
	1065191	1065191	Screw-On Front Connector	2	Pc	2	39263000
	45312-L	9126556	Quadro-V6	1	Pc	1	83024200
	45312-R	9126557	Quadro-V6	1	Pc	1	83024200
	1062501	1062501	Rear panel Connector, L	1	Pc	1	83024200
	1062502	1062502	Rear panel Connector, R	1	Pc	1	83024200
	9194646	9194646	Cover Cap Grey	2	Pc	2	39269097
BOM-code	9243085	Total Set	MRP: 4,040				83021090
	InnoTech- 520 mm (30 Kg) Full Extn. Silent						
	1062521	9015811	Drawer side profile, L	1	Pc	1	94039010
	1062522	9015812	Drawer side profile, R	1	Pc	1	94039010
	1065191	1065191	Screw-On Front Connector	2	Pc	2	39263000
	45313-L	9126562	Quadro-V6	1	Pc	1	83024200
	45313-R	9126563	Quadro-V6	1	Pc	1	83024200
	1062501	1062501	Rear panel Connector, L	1	Pc	1	83024200
	1062502	1062502	Rear panel Connector, R	1	Pc	1	83024200
	9194646	9194646	Cover Cap Grey	2	Pc	2	39269097
BOM-code	9243086	Total Set	MRP: 4,251				83021090

Drawer System InnoTech

- ▶ Drawer, height 70 mm
- ▶ Silver



Product	Article No.	SAP	Item Description	Qty.	Unit	PU	HS Code
	InnoTech- 420 mm (50 Kg) Full Extn. Silent						
	1062017	9015786	Drawer side profile, L	1	Pc	1	94039010
	1062018	9015787	Drawer side profile, R	1	Pc	1	94039010
	1065191	1065191	Screw-On Front Connector	2	Pc	2	39263000
	48360-L	9102862	Quadro-V6+	1	Pc	1	83024200
	48360-R	9102864	Quadro-V6+	1	Pc	1	83024200
	1062501	1062501	Rear panel Connector, L	1	Pc	1	83024200
	1062502	1062502	Rear panel Connector, R	1	Pc	1	83024200
	9194646	9194646	Cover Cap Grey	2	Pc	2	39269097
BOM-code	9243087	Total Set	MRP: 5,286				
	InnoTech- 470 mm (50 Kg) Full Extn. Silent						
	1062019	9015793	Drawer side profile, L	1	Pc	1	94039010
	1062020	9015794	Drawer side profile, R	1	Pc	1	94039010
	1065191	1065191	Screw-On Front Connector	2	Pc	2	39263000
	48361-L	9133792	Quadro-V6+	1	Pc	1	83024200
	48361-R	9133793	Quadro-V6+	1	Pc	1	83024200
	1062501	1062501	Rear panel Connector, L	1	Pc	1	83024200
	1062502	1062502	Rear panel Connector, R	1	Pc	1	83024200
	9194646	9194646	Cover Cap Grey	2	Pc	2	39269097
BOM-code	9243088	Total Set	MRP: 4,872				
	InnoTech- 520 mm (50 Kg) Full Extn. Silent						
	1062521	9015811	Drawer side profile, L	1	Pc	1	94039010
	1062522	9015812	Drawer side profile, R	1	Pc	1	94039010
	1065191	1065191	Screw-On Front Connector	2	Pc	2	39263000
	48362-L	9102868	Quadro-V6+	1	Pc	1	83024200
	48362-R	9102870	Quadro-V6+	1	Pc	1	83024200
	1062501	1062501	Rear panel Connector, L	1	Pc	1	83024200
	1062502	1062502	Rear panel Connector, R	1	Pc	1	83024200
	9194646	9194646	Cover Cap Grey	2	Pc	2	39269097
BOM-code	9243089	Total Set	MRP: 5,079				
	InnoTech- 620 mm (50 Kg) Full Extn. Silent						
	1077781	1077781	Drawer side profile, L	1	Pc	1	94039010
	1077782	1077782	Drawer side profile, R	1	Pc	1	94039010
	1065191	1065191	Screw-On Front Connector	2	Pc	2	39263000
	40271-L	9126394	Quadro-V6+	1	Pc	1	83024200
	40271-R	9126395	Quadro-V6+	1	Pc	1	83024200
	1062501	1062501	Rear panel Connector, L	1	Pc	1	83024200
	1062502	1062502	Rear panel Connector, R	1	Pc	1	83024200
	9194646	9194646	Cover Cap Grey	2	Pc	2	39269097
BOM-code	9243090	Total Set	MRP: 5,697				

Drawer System InnoTech

- ▶ Pot & pan drawer with railing, height 144 mm
- ▶ Silver





Product	Article No.	SAP	Item Description	Qty.	Unit	PU	HS Code
	InnoTech- 350 mm (30 Kg) Full Extn. Silent						
	1062015	9019693	Drawer side profile H70 mm, L	1	Pc	1	94039010
	1062016	9019694	Drawer side profile H70 mm, R	1	Pc	1	94039010
	1065191	1065191	Screw-On Front Connector	2	Pc	2	39263000
	45310-L	9126554	Quadro-V6	1	Pc	1	83024200
	45310-R	9126555	Quadro-V6	1	Pc	1	83024200
	1070630	1070630	Longitudinal Railing	2	Pc	2	83024200
	9002503	9002503	Railing Connector	2	Pc	2	83024200
	9007355	9007355	Rear panel Connector 144 mm, L	1	Pc	1	83024200
	9007356	9007356	Rear panel Connector 144 mm, R	1	Pc	1	83024200
	9194646	9194646	Cover Cap Grey	2	Pc	2	39269097
BOM-code	9243091	Total Set	MRP: 5,079				
	InnoTech- 420 mm (30 Kg) Full Extn. Silent						
	1062017	9015786	Drawer side profile H70 mm, L	1	Pc	1	94039010
	1062018	9015787	Drawer side profile H70 mm, R	1	Pc	1	94039010
	1065191	1065191	Screw-On Front Connector	2	Pc	2	39263000
	45311-L	9126558	Quadro-V6	1	Pc	1	83024200
	45311-R	9126559	Quadro-V6	1	Pc	1	83024200
	1063675	1063675	Longitudinal Railing	2	Pc	2	83024200
	9002503	9002503	Railing Connector	2	Pc	2	83024200
	9007355	9007355	Rear panel Connector 144 mm, L	1	Pc	1	83024200
	9007356	9007356	Rear panel Connector 144 mm, R	1	Pc	1	83024200
	9194646	9194646	Cover Cap Grey	2	Pc	2	39269097
BOM-code	9243092	Total Set	MRP: 5,079				
	InnoTech- 470 mm (30 Kg) Full Extn. Silent						
	1062019	9015793	Drawer side profile H70 mm, L	1	Pc	1	94039010
	1062020	9015794	Drawer side profile H70 mm, R	1	Pc	1	94039010
	1065191	1065191	Screw-On Front Connector	2	Pc	2	39263000
	45312-L	9126556	Quadro-V6	1	Pc	1	83024200
	45312-R	9126557	Quadro-V6	1	Pc	1	83024200
	1062394	1062394	Longitudinal Railing	2	Pc	2	83024200
	9002503	9002503	Railing Connector	2	Pc	2	83024200
	9007355	9007355	Rear panel Connector 144 mm, L	1	Pc	1	83024200
	9007356	9007356	Rear panel Connector 144 mm, R	1	Pc	1	83024200
	9194646	9194646	Cover Cap Grey	2	Pc	2	39269097
BOM-code	9243093	Total Set	MRP: 4,663				
	InnoTech- 520 mm (30 Kg) Full Extn. Silent						
	1062521	9015811	Drawer side profile H70 mm, L	1	Pc	1	94039010
	1062522	9015812	Drawer side profile H70 mm, R	1	Pc	1	94039010
	1065191	1065191	Screw-On Front Connector	2	Pc	2	39263000
	45313-L	9126562	Quadro-V6	1	Pc	1	83024200
	45313-R	9126563	Quadro-V6	1	Pc	1	83024200
	1063677	1063677	Longitudinal Railing	2	Pc	2	83024200
	9002503	9002503	Railing Connector	2	Pc	2	83024200
	9007355	9007355	Rear panel Connector 144 mm, L	1	Pc	1	83024200
	9007356	9007356	Rear panel Connector 144 mm, R	1	Pc	1	83024200
	9194646	9194646	Cover Cap Grey	2	Pc	2	39269097
BOM-code	9243094	Total Set	MRP: 4,874				

Drawer System InnoTech

- ▶ Pot & pan drawer with railing, height 144 mm
- ▶ Silver



Product	Article No.	SAP	Item Description	Qty.	Unit	PU	HS Code
	InnoTech- 420 mm (50 Kg) Full Extn.Silent						
	1062017	9015786	Drawer side profile H70 mm, L	1	Pc	1	94039010
	1062018	9015787	Drawer side profile H70 mm, R	1	Pc	1	94039010
	1065191	1065191	Screw-On Front Connector	2	Pc	2	39263000
	48360-L	9102862	Quadro-V6+	1	Pc	1	83024200
	48360-R	9102864	Quadro-V6+	1	Pc	1	83024200
	1063675	1063675	Longitudinal Railing	2	Pc	2	83024200
	9002503	9002503	Railing Connector	2	Pc	2	83024200
	9007355	9007355	Rear panel Connector 144 mm, L	1	Pc	1	83024200
	9007356	9007356	Rear panel Connector 144 mm, R	1	Pc	1	83024200
	9194646	9194646	Cover Cap Grey	2	Pc	2	39269097
BOM-code	9243095	Total Set	MRP: 5,909				
	InnoTech- 470 mm (50 Kg) Full Extn. Silent						
	1062019	9015793	Drawer side profile H70 mm, L	1	Pc	1	94039010
	1062020	9015794	Drawer side profile H70 mm, R	1	Pc	1	94039010
	1065191	1065191	Screw-On Front Connector	2	Pc	2	39263000
	48361-L	9133792	Quadro-V6+	1	Pc	1	83024200
	48361-R	9133793	Quadro-V6+	1	Pc	1	83024200
	1062394	1062394	Longitudinal Railing	2	Pc	2	83024200
	9002503	9002503	Railing Connector	2	Pc	2	83024200
	9007355	9007355	Rear panel Connector 144 mm, L	1	Pc	1	83024200
	9007356	9007356	Rear panel Connector 144 mm, R	1	Pc	1	83024200
	9194646	9194646	Cover Cap Grey	2	Pc	2	39269097
BOM-code	9243096	Total Set	MRP: 5,495				
	InnoTech- 520 mm (50 Kg) Full Extn. Silent						
	1062521	9015811	Drawer side profile H70 mm, L	1	Pc	1	94039010
	1062522	9015812	Drawer side profile H70 mm, R	1	Pc	1	94039010
	1065191	1065191	Screw-On Front Connector	2	Pc	2	39263000
	48362-L	9102868	Quadro-V6+	1	Pc	1	83024200
	48362-R	9102870	Quadro-V6+	1	Pc	1	83024200
	1063677	1063677	Longitudinal Railing	2	Pc	2	83024200
	9002503	9002503	Railing Connector	2	Pc	2	83024200
	9007355	9007355	Rear panel Connector 144 mm, L	1	Pc	1	83024200
	9007356	9007356	Rear panel Connector 144 mm, R	1	Pc	1	83024200
	9194646	9194646	Cover Cap Grey	2	Pc	2	39269097
BOM-code	9243097	Total Set	MRP: 5,702				
	InnoTech- 620 mm (50 Kg) Full Extn. Silent						
	1077781	1077781	Drawer side profile H70 mm, L	1	Pc	1	94039010
	1077782	1077782	Drawer side profile H70 mm, R	1	Pc	1	94039010
	1065191	1065191	Screw-On Front Connector	2	Pc	2	39263000
	40271-L	9126394	Quadro-V6+	1	Pc	1	83024200
	40271-R	9126395	Quadro-V6+	1	Pc	1	83024200
	1077931	1077931	Longitudinal Railing	2	Pc	2	83024200
	9002503	9002503	Railing Connector	2	Pc	2	83024200
	9007355	9007355	Rear panel Connector 144 mm, L	1	Pc	1	83024200
	9007356	9007356	Rear panel Connector 144 mm, R	1	Pc	1	83024200
	9194646	9194646	Cover Cap Grey	2	Pc	2	39269097
BOM-code	9243098	Total Set	MRP: 6,320				

Drawer System InnoTech

- ▶ Internal drawer 70 mm & 144 mm, 30 Kg
- ▶ Silver





Product	Article No.	SAP	Item Description	Qty.	Unit	PU	MRP	HS Code
Internal InnoTech 100- 470 mm (30 Kg) Full Extn. Silent. Alu Front								
	1062019	9015793	Drawer side profile, L	1	Pc	1	689	94039010
	1062020	9015794	Drawer side profile, R	1	Pc	1	689	94039010
	45312-L	9126556	Quadro-V6	1	Pc	1	1,106	39263000
	45312-R	9126557	Quadro-V6	1	Pc	1	1,106	83024200
	1062501	1062501	Rear panel Connector, L	1	Pc	1	205	83024200
	1062502	1062502	Rear panel Connector, R	1	Pc	1	205	83024200
	9194646	9194646	Cover Cap Grey	2	Pc	2	28	83024200
	44925	9025970	Aluminium front 2000 mm	1	Pc	1	6,452	76042990
	44926	44926	Connector for aluminium front	1	Set	1	372	39269097
Internal Pot-N-Pan InnoTech 100- 470 mm (30 Kg) Full Extn. Silent. Aluminium Front								
	1062019	9015793	Drawer side profile, L	1	Pc	1	689	94039010
	1062020	9015794	Drawer side profile, R	1	Pc	1	689	94039010
	45312-L	9126556	Quadro-V6	1	Set	1	1,106	83024200
	45312-R	9126557	Quadro-V6	1	Set	1	1,106	83024200
	9194646	9194646	Cover Cap Grey	2	Pc	2	28	39269097
	44925	9025970	Aluminium front 2000 mm	1	Pc	1	6,452	76042990
	77924	1074009	Railing for aluminium front	1	Pc	1	886	73063011
	46733-L	9022284	Corner Connector H144 mm, L	1	Pc	1	370	39263000
	46733-R	9022285	Corner Connector H144 mm, R	1	Pc	1	370	39263000
	1062394	1062394	Innotech Gallery, 470 mm (Silver)	2	Pc	2	524	83024200
	9007355	9007355	Rear panel Connector 144 mm, L	1	Pc	1	234	83024200
	9007356	9007356	Rear panel Connector 144 mm, R	1	Pc	1	234	83024200
	Internal InnoTech 200- 470 mm (30 Kg) Full Extn. Silent (Order Glass Front separately)							
	1062019	9015793	Drawer side profile, L	1	Pc	1	689	94039010
	1062020	9015794	Drawer side profile, R	1	Pc	1	689	94039010
	45312-L	9126556	Quadro-V6	1	Pc	1	1,106	83024200
	45312-R	9126557	Quadro-V6	1	Pc	1	1,106	83024200
	1062501	1062501	Rear panel Connector, L	1	Pc	1	205	83024200
	1062502	1062502	Rear panel Connector, R	1	Pc	1	205	83024200
	9194646	9194646	Cover Cap Grey	2	Pc	2	28	39269097
	9079115	9079115	Connector for glass front	1	Pc	1	4,425	94039010



Drawer System InnoTech

- ▶ Drawer, height 70 / 144 mm
- ▶ White



Product	Article No.	SAP	Item Description	Qty.	Unit	PU	HS Code
	InnoTech White- 350 mm (30 Kg) Full Extn. Silent						
	1062511	1062511	Drawer side profile H70 mm, L	1	Pc	1	94039010
	1062512	1062512	Drawer side profile H70 mm, R	1	Pc	1	94039010
	1065191	1065191	Screw-On Front Connector	2	Pc	2	39263000
	45310-L	9126554	Quadro-V6	1	Pc	1	83024200
	45310-R	9126555	Quadro-V6	1	Pc	1	83024200
	1062503	1062503	Rear Panel Connector, L	1	Pc	1	83024200
	1062504	1062504	Rear Panel Connector, R	1	Pc	1	83024200
	9194647	9194647	Cover Cap White	2	Pc	2	39269097
			Total Set				MRP: 4,414
	InnoTech White, Pot & Pan- 350 mm (30 Kg) Full Extn. Silent						
	1062511	1062511	Drawer side profile H70 mm, L	1	Pc	1	94039010
	1062512	1062512	Drawer side profile H70 mm, R	1	Pc	1	94039010
	1065191	1065191	Screw-On Front Connector	2	Pc	2	39263000
	45310-L	9126554	Quadro-V6	1	Pc	1	83024200
	45310-R	9126555	Quadro-V6	1	Pc	1	83024200
	1070628	1070628	Longitudinal Railing	2	Pc	2	73269098
	9002503	9002503	Railing Connector	2	Pc	2	39269097
	9060648	9060648	Rear panel Connector 144 mm, L	1	Pc	1	83024200
	9060649	9060649	Rear panel Connector 144 mm, R	1	Pc	1	83024200
9194647	9194647	Cover Cap White	2	Pc	2	39269097	
		Total Set				MRP: 5,145	
	InnoTech White- 420 mm (30 Kg) Full Extn. Silent						
	1062513	1062513	Drawer side profile, L	1	Pc	1	94039010
	1062514	1062514	Drawer side profile, R	1	Pc	1	94039010
	1065191	1065191	Screw-On Front Connector	2	Pc	2	39263000
	45311-L	9126558	Quadro-V6	1	Pc	1	83024200
	45311-R	9126559	Quadro-V6	1	Pc	1	83024200
	1062503	1062503	Rear Panel Connector, L	1	Pc	1	83024200
	1062504	1062504	Rear Panel Connector, R	1	Pc	1	83024200
	9194647	9194647	Cover Cap White	2	Pc	2	39269097
		Total Set				MRP: 4,648	
	InnoTech White, Pot & Pan- 420 mm (30 Kg) Full Extn. Silent						
	1062513	1062513	Drawer side profile, L	1	Pc	1	94039010
	1062514	1062514	Drawer side profile, R	1	Pc	1	94039010
	1065191	1065191	Screw-On Front Connector	2	Pc	2	39263000
	45311-L	9126558	Quadro-V6	1	Pc	1	83024200
	45311-R	9126559	Quadro-V6	1	Pc	1	83024200
	1063676	1063676	Longitudinal Railing	2	Pc	2	73269098
	9002503	9002503	Railing Connector	2	Pc	2	39269097
	9060648	9060648	Rear panel Connector 144 mm, L	1	Pc	1	83024200
	9060649	9060649	Rear panel Connector 144 mm, R	1	Pc	1	83024200
99194647	9194647	Cover Cap White	2	Pc	2	39269097	
		Total Set				MRP: 5,451	

Drawer System InnoTech

- ▶ Drawer, height 70 / 144 mm
- ▶ White







Product	Article No.	SAP	Item Description	Qty.	Unit	PU	HS Code
	InnoTech White- 470 mm (30 Kg) Full Extn. Silent						
	1062454	1062454	Drawer side profile, L	1	Pc	1	94039010
	1062455	1062455	Drawer side profile, R	1	Pc	1	94039010
	1065191	1065191	Screw-On Front Connector	2	Pc	2	39263000
	45312-L	9126556	Quadro-V6	1	Pc	1	83024200
	45312-R	9126557	Quadro-V6	1	Pc	1	83024200
	1062503	1062503	Rear Panel Connector, L	1	Pc	1	83024200
	1062504	1062504	Rear Panel Connector, R	1	Pc	1	83024200
	9194647	9194647	Cover Cap White	2	Pc	2	39269097
	BOM-code	9243104	Total Set	MRP: 4,252			
	InnoTech White, Pot & Pan- 470 mm (30 Kg) Full Extn. Silent						
	1062454	1062454	Drawer side profile, L	1	Pc	1	94039010
	1062455	1062455	Drawer side profile, R	1	Pc	1	94039010
	1065191	1065191	Screw-On Front Connector	2	Pc	2	39263000
	45312-L	9126556	Quadro-V6	1	Pc	1	83024200
	45312-R	9126557	Quadro-V6	1	Pc	1	83024200
	1062549	1062549	Longitudinal Railing	2	Pc	2	73269098
	9002503	9002503	Railing Connector	2	Pc	2	39269097
	9060648	9060648	Rear panel Connector 144 mm, L	1	Pc	1	83024200
	9060649	9060649	Rear panel Connector 144 mm, R	1	Pc	1	83024200
9194647	9194647	Cover Cap White	2	Pc	2	39269097	
BOM-code	9243105	Total Set	MRP: 4,853				
	InnoTech White- 520 mm (30 Kg) Full Extn. Silent						
	1062515	1062515	Drawer side profile H70 mm, L	1	Pc	1	94039010
	1062516	1062516	Drawer side profile H70 mm, R	1	Pc	1	94039010
	1065191	1065191	Screw-On Front Connector	2	Pc	2	39263000
	45313-L	9126562	Quadro-V6	1	Pc	1	83024200
	45313-R	9126563	Quadro-V6	1	Pc	1	83024200
	1062503	1062503	Rear Panel Connector, L	1	Pc	1	83024200
	1062504	1062504	Rear Panel Connector, R	1	Pc	1	83024200
	9194647	9194647	Cover Cap White	2	Pc	2	39269097
			Total Set	MRP: 4,442			
	InnoTech White, Pot & Pan- 520 mm (30 Kg) Full Extn. Silent						
	1062515	1062515	Drawer side profile H70 mm, L	1	Pc	1	94039010
	1062516	1062516	Drawer side profile H70 mm, R	1	Pc	1	94039010
	1065191	1065191	Screw-On Front Connector	2	Pc	2	39263000
	45313-L	9126562	Quadro-V6	1	Pc	1	83024200
	45313-R	9126563	Quadro-V6	1	Pc	1	83024200
	1063678	1063678	Longitudinal Railing	2	Pc	2	73269098
	9002503	9002503	Railing Connector	2	Pc	2	39269097
	9060648	9060648	Rear panel Connector 144 mm, L	1	Pc	1	83024200
	9060649	9060649	Rear panel Connector 144 mm, R	1	Pc	1	83024200
9194647	9194647	Cover Cap White	2	Pc	2	39269097	
		Total Set	MRP: 5,243				

Drawer System InnoTech

- ▶ Drawer, height 70 / 144 mm
- ▶ Sliver, White





Product	Article No.	SAP	Item Description	Qty.	Unit	PU	HS Code
	InnoTech Silver- 470 mm (30 Kg) Part Extn. Silent						
	1062019	9015793	Drawer side profile, L	1	Pc	1	94039010
	1062020	9015794	Drawer side profile, R	1	Pc	1	94039010
	1065191	1065191	Screw-On Front Connector	2	Pc	2	39263000
	9159027	9159027	Quadro 25 - L	1	Pc	1	83024200
	9159028	9159028	Quadro 25 - R	1	Pc	1	83024200
	1062501	1062501	Rear panel Connector, L	1	Pc	1	83024200
	1062502	1062502	Rear panel Connector, R	1	Pc	1	83024200
	9194646	9194646	Cover Cap Grey	2	Pc	2	39269097
	BOM-code	9243102	Total Set	MRP: 3,314			
	InnoTech Silver, Pot & Pan- 470 mm (30 Kg) Part Extn. Silent						
	1062019	9015793	Drawer side profile, L	1	Pc	1	94039010
	1062020	9015794	Drawer side profile, R	1	Pc	1	94039010
	1065191	1065191	Screw-On Front Connector	2	Pc	2	39263000
	9159027	9159027	Quadro 25 - L	1	Pc	1	83024200
	9159028	9159028	Quadro 25 - R	1	Pc	1	83024200
	1062394	1062394	Longitudinal Railing	2	Pc	2	73269098
	9002503	9002503	Railing Connector	2	Pc	2	39269097
	9007355	9007355	Rear panel Connector 144mm, L	1	Pc	1	83024200
	9007356	9007356	Rear panel Connector 144mm, R	1	Pc	1	83024200
9194646		Cover Cap Grey	2	Pc	2	39269097	
BOM-code	9243103	Total Set	MRP: 3,938				
	InnoTech White- 470 mm (30 Kg) Part Extn. Silent						
	1062454	1062454	Drawer side profile, L	1	Pc	1	94039010
	1062455	1062455	Drawer side profile, R	1	Pc	1	94039010
	1065191	1065191	Screw-On Front Connector	2	Pc	2	39263000
	9159027	9159027	Quadro 25 - L	1	Pc	1	83024200
	9159028	9159028	Quadro 25 - R	1	Pc	1	83024200
	1062503	1062503	Rear panel Connector, L	1	Pc	1	83024200
	1062504	1062504	Rear panel Connector, R	1	Pc	1	83024200
	9104095	9194647	Cover cap White	2	Pc	2	39269097
BOM-code	9243108	Total Set	MRP: 3,527				
	InnoTech White, Pot & Pan- 470 mm (30 Kg) Part Extn. Silent						
	1062454	1062454	Drawer side profile, L	1	Pc	1	94039010
	1062455	1062455	Drawer side profile, R	1	Pc	1	94039010
	1065191	1065191	Screw-On Front Connector	2	Pc	2	39263000
	9159027	9159027	Quadro 25 - L	1	Pc	1	83024200
	9159028	9159028	Quadro 25 - R	1	Pc	1	83024200
	9060648	9060648	Rear panel Connector 144 mm, L	1	Pc	1	83024200
	9060649	9060649	Rear panel Connector 144 mm, R	1	Pc	1	39269097
	9104095	9194647	Innotech cover cap White "Hettich"	2	Pc	2	39269097
	9002503	9002503	Screw on railing connectors	2	Pc	2	39269097
	1062549	1062549	Longitudinal Railing 470mm - White	2	Pc	2	39269097
	BOM-code	9243109	Total Set	MRP: 4,146			

Drawer System InnoTech

- ▶ Drawer, height 70 / 144 mm
- ▶ Anthracite



Product	Article No.	SAP	Item Description	Qty.	Unit	PU	HS Code
	InnoTech Anthracite- 470 mm (30 Kg) Full Extn. Silent						
	9068042	9068042	Drawer side profile, L	1	Pc	1	94039010
	9068043	9068043	Drawer side profile, R	1	Pc	1	94039010
	1065191	1065191	Screw-On Front Connector	2	Pc	2	39263000
	45312-L	9126556	Quadro-V6	1	Pc	1	83024200
	45312-R	9126557	Quadro-V6	1	Pc	1	83024200
	9080219	9080219	Rear Panel Connector H70 LEFT	1	Pc	1	83024200
	9080220	9080220	Rear Panel Connector H70 RIGHT	1	Pc	1	83024200
	9079223	9079223	Cover Cap Anthracite	2	Pc	2	39269097
	BOM-code	9243110	Total Set	MRP: 4,252			
	InnoTech Anthracite, Pot & Pan- 470 mm (30 Kg) Full Extn. Silent						
	9068042	9068042	Drawer side profile, L	1	Pc	1	9068042
	9068043	9068043	Drawer side profile, R	1	Pc	1	9068043
	1065191	1065191	Screw-On Front Connector	2	Pc	2	1065191
	45312-L	9126556	Quadro-V6	1	Pc	1	9126556
	45312-R	9126557	Quadro-V6	1	Pc	1	9126557
	9080192	9080192	Longitudinal Railing	2	Pc	2	9080192
	9002503	9002503	Railing Connector	2	Pc	2	9002503
	9080197	9080197	Rear panel Connector 144 mm, L	1	Pc	1	9080197
	9080199	9080199	Rear panel Connector 144 mm, R	1	Pc	1	9080199
9079223	9079223	Cover Cap Anthracite	2	Pc	2	9079223	
BOM-code	9243111	Total Set	MRP: 4,874				
	InnoTech Anthracite - 470 mm (30 Kg) Part Extn. Silent						
	9068042	9068042	Drawer side profile, L	1	Pc	1	94039010
	9068043	9068043	Drawer side profile, R	1	Pc	1	94039010
	1065191	1065191	Screw-On Front Connector	2	Pc	2	39263000
	9159027	9159027	Quadro 25 - L	1	Pc	1	83024200
	9159028	9159028	Quadro 25 - R	1	Pc	1	83024200
	9080219	9080219	Rear Panel Connector H70 LEFT	1	Pc	1	83024200
	9080220	9080220	Rear Panel Connector H70 RIGHT	1	Pc	1	83024200
	9079223	9079223	Cover Cap Anthracite	2	Pc	2	39269097
	BOM-code	9243112	Total Set	MRP: 3,527			
	InnoTech Anthracite, Pot & Pan- 470 mm (30 Kg) Part Extn. Silent						
	9068042	9068042	Drawer side profile, L	1	Pc	1	94039010
	9068043	9068043	Drawer side profile, R	1	Pc	1	94039010
	1065191	1065191	Screw-On Front Connector	2	Pc	2	39263000
	9159027	9159027	Quadro 25 - L	1	Pc	1	83024200
	9159028	9159028	Quadro 25 - R	1	Pc	1	83024200
	9080197	9080197	Rear panel Connector 144 mm, L	1	Pc	1	83024200
	9080199	9080199	Rear panel Connector 144 mm, R	1	Pc	1	83024200
	9079223	9079223	Cover Cap Anthracite	1	Pc	1	39269097
	9080192	9080192	Innotech Gallery 470 Anthracite	2	Pc	2	73269098
9002503	9002503	Screw on railing connectors	2	Pc	2	39269097	
BOM-code	9243113	Total Set	MRP: 4,149				

Drawer System InnoTech

► Accessories



Product	Article No.	SAP	Item Description	Qty.	Unit	PU	MRP	HS Code
InnoTech TopSide								
	9004315	9004315	H144/470 Silver	1	Set	1	1,366	94039010
	9005411	9005411	H144/520 Silver	1	Set	1	1,190	83024200
	9079648	9079648	Universal Adapter Topside H144 Grey	1	Set	1	689	94039010
InnoTech DesignSide								
	9100889	9100889	Grey, Float Glass+Adapters 470 mm	1	Set	1	2,934	94039000
	9100890	9100890	Grey, Float Glass+Adapters 520 mm	1	Set	1	2,734	94039000
	9100878	9100878	Innotech Adapter for DesignSide	1	Set	1	1,523	70200080
	9194648	9194648	Hettich Logo Cover Cap Anthracite	1	Pc	1	25	39269097
InnoTech Rear Panel, Silver								
	1061907	1061907	70mm / 600 mm	1	Pc	1	425	94039010
	1062961	1062961	70mm / 900 mm	1	Pc	1	757	94039010
	9004072	9004072	144mm / 600 mm	1	Pc	1	845	94039010
	9004075	9004075	144mm / 900 mm	1	Pc	1	1,307	94039010
InnoTech Design Profile (Chrome)								
	9068242	9068242	Design Rail 470 mm	1	Pc	20	329	39169090
	9068244	9068244	Design Rail 520 mm	1	Pc	20	355	39169090



Product	Article No.	SAP	Item Description	Qty.	Unit	PU	MRP	HS Code
	OrgaTray 440 Trimmable							
	9194924	9194924	Tray width 501-600 mm, Nominal width 600 mm	1	Pc	1	679	39249000
	9194934	9194934	Tray width 351-400 mm, Nominal width 450 mm	1	Pc	1	511	39249000
	9194935	9194935	Tray width 401-450 mm, Nominal width 500 mm	1	Pc	1	540	39249000
	9194936	9194936	Tray width 451-500 mm, Nominal width 550 mm	1	Pc	1	591	39249000
	9194937	9194937	Tray width 501-600 mm, Nominal width 600 mm	1	Pc	1	704	39249000
	9194939	9194939	Tray width 701-800 mm, Nominal width 800 mm	1	Pc	1	1,349	39249000
9194940	9194940	Tray width 801-900 mm, Nominal width 900 mm	1	Pc	1	1,417	39249000	
	OrgaTray 560							
	13304	9002439	For 470 mm depth, cab width 450 mm	1	Set	1	1,809	39269097
	13306	9002441	For 470 mm depth, cab width 600 mm	1	Set	1	2,126	39269097
	13307	9005806	For 470 mm depth, cab width 800 mm	1	Set	1	4,054	39269097
	13308	9004427	For 470 mm depth, cab width 900 mm	1	Set	1	4,106	39269097
	13317	9005651	For 520 mm depth, cab width 600 mm	1	Set	1	2,235	39269097
13319	9005671	For 520 mm depth, cab width 900 mm	1	Set	1	4,458	39269097	
	OrgaTray 590							
	9194891	9194891	For 470 mm depth, cab width 600 mm	1	Set	1	1,789	39269097
9194893	9194893	For 470 mm depth, cab width 900 mm	1	Set	1	3,451	39269097	
	OrgaTray 490							
9207241	9207241	For 470 mm depth, for cab width ≥ 450 mm	1	Set	1	1,415	3924900	
	OrgaTray 610							
9194881	9194881	For 470 mm depth, for cab width ≥ 450 mm	1	Set	1	5,043	73239900	
	Orga Stripe Profile							
	9203466	9203466	Orga Profile 1100 mm Grey	1	Pc	1	401	39169090
9203469	9203469	Orga Clip Grey	1	Pc	1	77	39263000	
	OrgaFlag Advanced							
	9194869	9194869	For 470 mm depth, cab width 600 mm	1	Set	1	7,547	3924900
	9194870	9194870	For 470 mm depth, cab width 900 mm	1	Set	1	10,545	3924900
	9194872	9194872	For 520 mm depth, cab width 600 mm	1	Set	1	8,185	3924900
9194873	9194873	For 520 mm depth, cab width 900 mm	1	Set	1	11,502	3924900	

Drawer System InnoTech

► Internal Accessories



Product	Article No.	SAP	Item Description	Qty.	Unit	PU	MRP	HS Code
	Lengthwise railing for wooden rear panel (Add on kit)							
	1081333	1081333	470 mm	1	Set	8	589	73269098
	1081335	1081335	520 mm	1	Set	8	707	73269098
	9002503	9002503	Front connector with Expanding socket	2	Pc	2	31	39269097
	Anti-slip mat (5 m roll)							
	9209533	9209533	Anti-slip Mat 470 Silver	1	Set	1	6,706	3924900
	9209536	9209536	Anti-slip Mat 520 Silver	1	Set	1	6,829	3924900
	9209568	9209568	Anti-slip Mat 620 Silver	1	Set	1	9,251	3924900
	9209580	9209580	Anti-slip Mat 500 Antracite	1	Set	1	6,772	3924900
	Crosswise railing for Pot & Pan drawer							
	10016	10016	Double railing kit 470 mm	1	Set	1	2,153	73239900
	10017	10017	Double railing kit 520 mm	1	Set	1	2,263	73239900
	77924	1074009	Crosswise railing 1100 mm Silver	1	Pc	1	886	73063011
	77925	1070632	Mount for crosswise railing	1	Pc	20	27	39263000
	9014651	9014651	IT Orgastore flag gray	1	Pc	20	297	39269097
	Plate Rack, for storage of plates up to 29 cm diameter							
	9132496	9132496	Plate rack white	1	Pc	1	2,149	39263000
	9132497	9132497	Set of end caps white	1	Set	1	1,206	39263000
	9132521	9132521	Plate rack Silver	1	Pc	1	2,219	39263000
	9132522	9132522	Set of end caps Silver	1	Set	1	1,245	39263000
	OrgaStore 240							
	9209900	9209900	For 470 mm depth, cab width 900 mm	1	Pc	1	6,565	44219999
	9209908	9209908	Divider	1	Pc	4	4,728	44219999
	Innoplus Tray with AntiSlip Mat							
	1069955	1069955	470 Nominal Length x 450 Carcase Width	1	Pc	1	4,590	94039000
	1069956	1069956	470 Nominal Length x 500 Carcase Width	1	Pc	1	4,934	94039000
	1081997	1081997	470 Nominal Length x 800 Carcase Width	1	Pc	1	9,960	94039010

Drawer System InnoTech

► Internal Accessories



Product	Article No.	SAP	Item Description	Qty.	Unit	PU	MRP	HS Code
Innotech Drawer Side Profile								
	Finish : Silver							
	1062015	9019693	InnoTech- 350 mm-Drawer side profile, L -Silver	1	Pc	1	773	94039010
	1062016	9019694	InnoTech- 350 mm-Drawer side profile, R -Silver	1	Pc	1	773	94039010
	1062017	9015786	InnoTech- 420 mm-Drawer side profile, L -Silver	1	Pc	1	782	94039010
	1062018	9015787	InnoTech- 420 mm-Drawer side profile, R -Silver	1	Pc	1	782	94039010
	1062019	9015793	InnoTech- 470 mm-Drawer side profile, L -Silver	1	Pc	1	689	94039010
	1062020	9015794	InnoTech- 470 mm-Drawer side profile, R -Silver	1	Pc	1	689	94039010
	1062521	9015811	InnoTech- 520 mm-Drawer side profile, L -Silver	1	Pc	1	722	94039010
	1062522	9015812	InnoTech- 520 mm-Drawer side profile, R -Silver	1	Pc	1	722	94039010
	1077781	1077781	InnoTech- 620 mm-Drawer side profile, L -Silver	1	Pc	1	868	94039010
1077782	1077782	InnoTech- 620 mm-Drawer side profile, R -Silver	1	Pc	1	868	94039010	
	Finish : White							
	1062511	1062511	InnoTech- 350 mm-Drawer side profile, L -White	1	Pc	1	717	94039010
	1062512	1062512	InnoTech- 350 mm-Drawer side profile, R -White	1	Pc	1	717	94039010
	1062513	1062513	InnoTech- 420 mm-Drawer side profile, L -White	1	Pc	1	834	94039010
	1062514	1062514	InnoTech- 420 mm-Drawer side profile, R -White	1	Pc	1	834	94039010
	1062454	1062454	InnoTech- 470 mm-Drawer side profile, L -White	1	Pc	1	752	94039010
	1062455	1062455	InnoTech- 470 mm-Drawer side profile, R -White	1	Pc	1	752	94039010
	1062515	1062515	InnoTech- 520 mm-Drawer side profile, L -White	1	Pc	1	788	94039010
1062516	1062516	InnoTech- 520 mm-Drawer side profile, R -White	1	Pc	1	788	94039010	
	Finish : Anthracite							
	9068042	9068042	InnoTech - 470 mm-Drawer side profile, L - Anthracite	1	Pc	1	752	94039010
9068043	9068043	InnoTech - 470 mm-Drawer side profile, R - Anthracite	1	Pc	1	752	94039010	
Longitudinal railing								
	Finish : Silver							
	1070630	1070630	InnoTech- 350 mm-Longitudinal Railing -Silver	1	Pc	1	262	73269098
	1063675	1063675	InnoTech- 420 mm-Longitudinal Railing -Silver	1	Pc	1	262	73269098
	1062394	1062394	InnoTech- 470 mm-Longitudinal Railing -Silver	1	Pc	1	262	83024200
	1063677	1063677	InnoTech- 520 mm-Longitudinal Railing -Silver	1	Pc	1	267	73269098
1077931	1077931	InnoTech- 620 mm-Longitudinal Railing -Silver	1	Pc	1	262	73269098	
	Finish : White							
	1070628	1070628	InnoTech- 350 mm-Longitudinal Railing -White	1	Pc	1	296	73269098
	1063676	1063676	InnoTech- 420 mm-Longitudinal Railing -White	1	Pc	1	334	73269098
	1062549	1062549	InnoTech- 470 mm-Longitudinal Railing -White	1	Pc	1	231	83024200
1063678	1063678	InnoTech- 520 mm-Longitudinal Railing -White	1	Pc	1	331	73269098	
	Finish : Anthracite							
	9080192	9080192	InnoTech - 470 mm - Longitudinal Railing - Anthracite	1	Pc	1	209	73269098
	Connector							
	9002503	9002503	Railing Connector	2	Pc	2	30	39269097
1065191	1065191	Screw-On Front Connector	2	Pc	2	40	39263000	

Drawer System InnoTech

► Internal Accessories



Product	Article No.	SAP	Item Description	Qty.	Unit	PU	MRP	HS Code
Rear Panel Connector								
	Finish : Silver							
	1062501	1062501	Rear panel Connector 70 mm, L -Silver	1	Pc	1	205	83024200
	1062502	1062502	Rear panel Connector 70 mm, R -Silver	1	Pc	1	205	83024200
	9007355	9007355	Rear panel Connector 144 mm, L -Silver	1	Pc	1	234	83024200
9007356	9007356	Rear panel Connector 144 mm, R -Silver	1	Pc	1	234	83024200	
	Finish : White							
	1062503	1062503	Rear Panel Connector, L -White	1	Pc	1	223	83024200
	1062504	1062504	Rear Panel Connector, R -White	1	Pc	1	223	83024200
	9060648	9060648	Rear panel Connector 144 mm, L -White	1	Pc	1	277	83024200
9060649	9060649	Rear panel Connector 144 mm, R -White	1	Pc	1	277	83024200	
	Finish : Anthracite							
	9080219	9080219	Rear Panel Connector H70 LEFT - Anthracite	1	Pc	1	223	83024200
	9080220	9080220	Rear Panel Connector H70 RIGHT - Anthracite	1	Pc	1	223	83024200
	9080197	9080197	Rear panel Connector 144 mm, L - Anthracite	1	Pc	1	309	83024200
9080199	9080199	Rear panel Connector 144 mm, R - Anthracite	1	Pc	1	309	83024200	
	Cover Cap							
	9194646	9194646	Cover Cap Grey	2	Pc	2	28	39269097
	9194647	9194647	Cover Cap White	2	Pc	2	50	39269097
9079223	9079223	Cover Cap Anthracite	2	Pc	2	36	39269097	
	Quadro V6							
	45310-L	9126554	Innotech 350 mm - Quadro-V6	1	Pc	1	1,222	83024200
	45310-R	9126555	Innotech 350 mm - Quadro-V6	1	Pc	1	1,222	83024200
	45311-L	9126558	InnoTech- 420 mm - Quadro-V6	1	Pc	1	1,222	83024200
	45311-R	9126559	InnoTech- 420 mm - Quadro-V6	1	Pc	1	1,222	83024200
	45312-L	9126556	InnoTech- 470 mm - Quadro-V6	1	Pc	1	1,106	83024200
	45312-R	9126557	InnoTech- 470 mm - Quadro-V6	1	Pc	1	1,106	83024200
	45313-L	9126562	InnoTech- 520 mm - Quadro-V6	1	Pc	1	1,165	83024200
45313-R	9126563	InnoTech- 520 mm - Quadro-V6	1	Pc	1	1,165	83024200	
	Quadro V6+							
	48360-L	9102862	InnoTech- 420 mm - Quadro-V6+	1	Pc	1	1,628	83024200
	48360-R	9102864	InnoTech- 420 mm - Quadro-V6+	1	Pc	1	1,628	83024200
	48361-L	9133792	InnoTech- 470 mm - Quadro-V6+	1	Pc	1	1,514	83024200
	48361-R	9133793	InnoTech- 470 mm - Quadro-V6+	1	Pc	1	1,514	83024200
	48362-L	9102868	InnoTech- 520 mm - Quadro-V6+	1	Pc	1	1,578	83024200
	48362-R	9102870	InnoTech- 520 mm - Quadro-V6+	1	Pc	1	1,578	83024200
	40271-L	9126394	InnoTech- 620 mm - Quadro-V6+	1	Pc	1	1,748	83024200
	40271-R	9126395	InnoTech- 620 mm - Quadro-V6+	1	Pc	1	1,748	83024200
	Partial Extension							
	9159027	9159027	InnoTech- 470 mm - Quadro 25 - L	1	Pc	1	753	83024200
9159028	9159028	InnoTech- 470 mm - Quadro 25 - R	1	Pc	1	753	83024200	
	PTO Full Extension 30 Kg							
	9143499	9143499	InnoTech- 470 mm - Quadro V6 EB 9.5	1	Set	1	3,257	83024200
9143500	9143500	InnoTech- 520 mm - Quadro V6 EB 9.5	1	Set	1	3,292	83024200	



Drawer System ArciTech

► Drawer, height 94 & 186 mm



Product	Article No.	SAP	Item Description	Qty.	Unit	PU	HS Code
	ArciTech Silver 450 mm, Height 94 mm, 40 kg						
	9121205	9121205	Drawer side profile, L	1	Pc	1	94039010
	9121206	9121206	Drawer side profile, R	1	Pc	1	94039010
	9123005	9123005	Cover Cap	2	Pc	2	39269097
	9121827	9121827	Rear panel Connector, L	1	Pc	1	83024200
	9121828	9121828	Raer panel Connector, R	1	Pc	1	83024200
	9123011	9123011	Screw-On Front Connector	2	Pc	2	83024200
	9239283	9239283	Actro runner, L	1	Pc	1	83024200
	9239284	9239284	Actro runner, R	1	Pc	1	83024200
BOM-code	9243114	Total Set	MRP: 5,579				83021090
	ArciTech Silver 500 mm, Height 94 mm, 40 kg						
	9121207	9121207	Drawer side profile, L	1	Pc	1	94039010
	9121208	9121208	Drawer side profile, R	1	Pc	1	94039010
	9123005	9123005	Cover Cap	2	Pc	2	39269097
	9121827	9121827	Rear panel Connector, L	1	Pc	1	83024200
	9121828	9121828	Raer panel Connector, R	1	Pc	1	83024200
	9123011	9123011	Screw-On Front Connector	2	Pc	2	83024200
	9239287	9239287	Actro runner, L	1	Pc	1	83024200
	9239288	9239288	Actro runner, R	1	Pc	1	83024200
BOM-code	9243115	Total Set	MRP: 5,579				83021090
	ArciTech Silver 550 mm, Height 94 mm, 40 kg						
	9121209	9121209	Drawer side profile, L	1	Pc	1	94039010
	9121210	9121210	Drawer side profile, R	1	Pc	1	94039010
	9123005	9123005	Cover Cap	2	Pc	2	39269097
	9121827	9121827	Rear panel Connector, L	1	Pc	1	83024200
	9121828	9121828	Raer panel Connector, R	1	Pc	1	83024200
	9123011	9123011	Screw-On Front Connector	2	Pc	2	83024200
	9239293	9239293	Actro runner, L	1	Pc	1	83024200
	9239294	9239294	Actro runner, R	1	Pc	1	83024200
BOM-code	9243116	Total Set	MRP: 5,804				83021090
	ArciTech Silver 450 mm, Height 94 mm, 60 kg						
	9121205	9121205	Drawer side profile, L	1	Pc	1	94039010
	9121206	9121206	Drawer side profile, R	1	Pc	1	94039010
	9123005	9123005	Cover Cap	2	Pc	2	39269097
	9121827	9121827	Rear panel Connector, L	1	Pc	1	83024200
	9121828	9121828	Raer panel Connector, R	1	Pc	1	83024200
	9123011	9123011	Screw-On Front Connector	2	Pc	2	83024200
	9239285	9239285	Actro runner, L	1	Pc	1	83024200
	9239286	9239286	Actro runner, R	1	Pc	1	83024200
BOM-code	9243117	Total Set	MRP: 6,472				83021090

Drawer System ArciTech

► Drawer, height 94 & 186 mm





Product	Article No.	SAP	Item Description	Qty.	Unit	PU	HS Code
	ArciTech Silver 500 mm, Height 94 mm, 60 kg						
	9121207	9121207	Drawer side profile, L	1	Pc	1	94039010
	9121208	9121208	Drawer side profile, R	1	Pc	1	94039010
	9123005	9123005	Cover Cap	2	Pc	2	39269097
	9121827	9121827	Rear panel Connector, L	1	Pc	1	83024200
	9121828	9121828	Raer panel Connector, R	1	Pc	1	83024200
	9123011	9123011	Screw-On Front Connector	2	Pc	2	83024200
	9239289	9239289	Actro runner, L	1	Pc	1	83024200
	9239290	9239290	Actro runner, R	1	Pc	1	83024200
BOM-code	9243118	Total Set				MRP: 6,472	83021090
	ArciTech Silver 550 mm, Height 94 mm, 60 kg						
	9121209	9121209	Drawer side profile, L	1	Pc	1	94039010
	9121210	9121210	Drawer side profile, R	1	Pc	1	94039010
	9123005	9123005	Cover Cap	2	Pc	2	39269097
	9121827	9121827	Rear panel Connector, L	1	Pc	1	83024200
	9121828	9121828	Raer panel Connector, R	1	Pc	1	83024200
	9123011	9123011	Screw-On Front Connector	2	Pc	2	83024200
	9239295	9239295	Actro runner, L	1	Pc	1	83024200
	9239296	9239296	Actro runner, R	1	Pc	1	83024200
BOM-code	9243119	Total Set				MRP: 6,695	83021090
	ArciTech Silver 650 mm, Height 94 mm, 60 kg						
	9121211	9121211	Drawer side profile, L	1	Pc	1	94039010
	9121212	9121212	Drawer side profile, R	1	Pc	1	94039010
	9123005	9123005	Cover Cap	2	Pc	2	39269097
	9121827	9121827	Rear panel Connector, L	1	Pc	1	83024200
	9121828	9121828	Raer panel Connector, R	1	Pc	1	83024200
	9123011	9123011	Screw-On Front Connector	2	Pc	2	83024200
	9239301	9239301	Actro runner, L	1	Pc	1	83024200
	9239302	9239302	Actro runner, R	1	Pc	1	83024200
BOM-code	9243120	Total Set				MRP: 7,143	83021090
	ArciTech Silver 500 mm, Height 94 mm, 80 kg						
	9121207	9121207	Drawer side profile, L	1	Pc	1	94039010
	9121208	9121208	Drawer side profile, R	1	Pc	1	94039010
	9123005	9123005	Cover Cap	2	Pc	2	39269097
	9121827	9121827	Rear panel Connector, L	1	Pc	1	83024200
	9121828	9121828	Raer panel Connector, R	1	Pc	1	83024200
	9123011	9123011	Screw-On Front Connector	2	Pc	2	83024200
	9239291	9239291	Actro runner, L	1	Pc	1	83024200
	9239292	9239292	Actro runner, R	1	Pc	1	83024200
BOM-code	9243121	Total Set				MRP: 7,363	83021090

Drawer System ArciTech

► Drawer, height 94 & 186 mm





Product	Article No.	SAP	Item Description	Qty.	Unit	PU	HS Code
	ArciTech Silver 550 mm, Height 94 mm, 80 kg						
	9121209	9121209	Drawer side profile, L	1	Pc	1	94039010
	9121210	9121210	Drawer side profile, R	1	Pc	1	94039010
	9123005	9123005	Cover Cap	2	Pc	2	39269097
	9121827	9121827	Rear panel Connector, L	1	Pc	1	83024200
	9121828	9121828	Raer panel Connector, R	1	Pc	1	83024200
	9123011	9123011	Screw-On Front Connector	2	Pc	2	83024200
	9239297	9239297	Actro runner, L	1	Pc	1	83024200
	9239298	9239298	Actro runner, R	1	Pc	1	83024200
BOM-code	9243122	Total Set	MRP: 7,590				83021090
	ArciTech White 450 mm, Height 94 mm, 40 kg						
	9121247	9121247	Drawer side profile, L	1	Pc	1	94039010
	9121248	9121248	Drawer side profile, R	1	Pc	1	94039010
	9123006	9123006	Cover Cap	2	Pc	2	39269097
	9121829	9121829	Rear panel Connector, L	1	Pc	1	83024200
	9121830	9121830	Raer panel Connector, R	1	Pc	1	83024200
	9123011	9123011	Screw-On Front Connector	2	Pc	2	83024200
	9239283	9239283	Actro runner, L	1	Pc	1	83024200
	9239284	9239284	Actro runner, R	1	Pc	1	83024200
BOM-code	9243124	Total Set	MRP: 5,804				83021090
	ArciTech White 500 mm, Height 94 mm, 40 kg						
	9121249	9121249	Drawer side profile, L	1	Pc	1	94039010
	9121250	9121250	Drawer side profile, R	1	Pc	1	94039010
	9123006	9123006	Cover Cap	2	Pc	2	39269097
	9121829	9121829	Rear panel Connector, L	1	Pc	1	83024200
	9121830	9121830	Raer panel Connector, R	1	Pc	1	83024200
	9123011	9123011	Screw-On Front Connector	2	Pc	2	83024200
	9239287	9239287	Actro runner, L	1	Pc	1	83024200
	9239288	9239288	Actro runner, R	1	Pc	1	83024200
BOM-code	9243125	Total Set	MRP: 5,804				83021090
	ArciTech White 550 mm, Height 94 mm, 40 kg						
	9121251	9121251	Drawer side profile, L	1	Pc	1	94039010
	9121252	9121252	Drawer side profile, R	1	Pc	1	94039010
	9123006	9123006	Cover Cap	2	Pc	2	39269097
	9121829	9121829	Rear panel Connector, L	1	Pc	1	83024200
	9121830	9121830	Raer panel Connector, R	1	Pc	1	83024200
	9123011	9123011	Screw-On Front Connector	2	Pc	2	83024200
	9239293	9239293	Actro runner, L	1	Pc	1	83024200
	9239294	9239294	Actro runner, R	1	Pc	1	83024200
BOM-code	9243126	Total Set	MRP: 6,030				83021090

Drawer System ArciTech

► Drawer, height 94 & 186 mm







Product	Article No.	SAP	Item Description	Qty.	Unit	PU	HS Code
	ArciTech White 450 mm, Height 94 mm, 60 kg						
	9121247	9121247	Drawer side profile, L	1	Pc	1	94039010
	9121248	9121248	Drawer side profile, R	1	Pc	1	94039010
	9123006	9123006	Cover Cap	2	Pc	2	39269097
	9121829	9121829	Rear panel Connector, L	1	Pc	1	83024200
	9121830	9121830	Raer panel Connector, R	1	Pc	1	83024200
	9123011	9123011	Screw-On Front Connector	2	Pc	2	83024200
	9239285	9239285	Actro runner, L	1	Pc	1	83024200
	9239286	9239286	Actro runner, R	1	Pc	1	83024200
BOM-code	9243127	Total Set	MRP: 6,698				83021090
	ArciTech White 500 mm, Height 94 mm, 60 kg						
	9121249	9121249	Drawer side profile, L	1	Pc	1	94039010
	9121250	9121250	Drawer side profile, R	1	Pc	1	94039010
	9123006	9123006	Cover Cap	2	Pc	2	39269097
	9121829	9121829	Rear panel Connector, L	1	Pc	1	83024200
	9121830	9121830	Raer panel Connector, R	1	Pc	1	83024200
	9123011	9123011	Screw-On Front Connector	2	Pc	2	83024200
	9239289	9239289	Actro runner, L	1	Pc	1	83024200
	9239290	9239290	Actro runner, R	1	Pc	1	83024200
BOM-code	9243128	Total Set	MRP: 6,698				83021090
	ArciTech White 550 mm, Height 94 mm, 60 kg						
	9121251	9121251	Drawer side profile, L	1	Pc	1	94039010
	9121252	9121252	Drawer side profile, R	1	Pc	1	94039010
	9123006	9123006	Cover Cap	2	Pc	2	39269097
	9121829	9121829	Rear panel Connector, L	1	Pc	1	83024200
	9121830	9121830	Raer panel Connector, R	1	Pc	1	83024200
	9123011	9123011	Screw-On Front Connector	2	Pc	2	83024200
	9239295	9239295	Actro runner, L	1	Pc	1	83024200
	9239296	9239296	Actro runner, R	1	Pc	1	83024200
BOM-code	9243129	Total Set	MRP: 6,921				83021090
	ArciTech White 500 mm, Height 94 mm, 80 kg						
	9121249	9121249	Drawer side profile, L	1	Pc	1	94039010
	9121250	9121250	Drawer side profile, R	1	Pc	1	94039010
	9123006	9123006	Cover Cap	2	Pc	2	39269097
	9121829	9121829	Rear panel Connector, L	1	Pc	1	83024200
	9121830	9121830	Raer panel Connector, R	1	Pc	1	83024200
	9123011	9123011	Screw-On Front Connector	2	Pc	2	83024200
	9239291	9239291	Actro runner, L	1	Pc	1	83024200
	9239292	9239292	Actro runner, R	1	Pc	1	83024200
BOM-code	9243131	Total Set	MRP: 7,589				83021090

Drawer System ArciTech

► Drawer, height 94 & 186 mm







Product	Article No.	SAP	Item Description	Qty.	Unit	PU	HS Code
	ArciTech White 550 mm, Height 94 mm, 80 kg						
	9121251	9121251	Drawer side profile, L	1	Pc	1	94039010
	9121252	9121252	Drawer side profile, R	1	Pc	1	94039010
	9123006	9123006	Cover Cap	2	Pc	2	39269097
	9121829	9121829	Rear panel Connector, L	1	Pc	1	83024200
	9121830	9121830	Raer panel Connector, R	1	Pc	1	83024200
	9123011	9123011	Screw-On Front Connector	2	Pc	2	83024200
	9239297	9239297	Actro runner, L	1	Pc	1	83024200
	9239298	9239298	Actro runner, R	1	Pc	1	83024200
BOM-code	9243132	Total Set	MRP: 7,816				83021090
	ArciTech Anthracite 450 mm, Height 94 mm, 40 kg						
	9121289	9121289	Drawer side profile, L	1	Pc	1	94039010
	9121290	9121290	Drawer side profile, R	1	Pc	1	94039010
	9123005	9123005	Cover Cap	2	Pc	2	39269097
	9121831	9121831	Rear panel Connector, L	1	Pc	1	83024200
	9121832	9121832	Raer panel Connector, R	1	Pc	1	83024200
	9123011	9123011	Screw-On Front Connector	2	Pc	2	83024200
	9239283	9239283	Actro runner, L	1	Pc	1	83024200
	9239284	9239284	Actro runner, R	1	Pc	1	83024200
BOM-code	9243134	Total Set	MRP: 5,804				83021090
	ArciTech Anthracite 500 mm, Height 94 mm, 40 kg						
	9121291	9121291	Drawer side profile, L	1	Pc	1	94039010
	9121292	9121292	Drawer side profile, R	1	Pc	1	94039010
	9123005	9123005	Cover Cap	2	Pc	2	39269097
	9121831	9121831	Rear panel Connector, L	1	Pc	1	83024200
	9121832	9121832	Raer panel Connector, R	1	Pc	1	83024200
	9123011	9123011	Screw-On Front Connector	2	Pc	2	83024200
	9239287	9239287	Actro runner, L	1	Pc	1	83024200
	9239288	9239288	Actro runner, R	1	Pc	1	83024200
BOM-code	9243135	Total Set	MRP: 5,804				83021090
	ArciTech Anthracite 550 mm, Height 94 mm, 40 kg						
	9121293	9121293	Drawer side profile, L	1	Pc	1	94039010
	9121294	9121294	Drawer side profile, R	1	Pc	1	94039010
	9123005	9123005	Cover Cap	2	Pc	2	39269097
	9121831	9121831	Rear panel Connector, L	1	Pc	1	83024200
	9121832	9121832	Raer panel Connector, R	1	Pc	1	83024200
	9123011	9123011	Screw-On Front Connector	2	Pc	2	83024200
	9239293	9239293	Actro runner, L	1	Pc	1	83024200
	9239294	9239294	Actro runner, R	1	Pc	1	83024200
BOM-code	9243136	Total Set	MRP: 6,028				83021090

Drawer System ArciTech

► Drawer, height 94 & 186 mm



Product	Article No.	SAP	Item Description	Qty.	Unit	PU	HS Code
	ArciTech Anthracite 450 mm, Height 94 mm, 60 kg						
	9121289	9121289	Drawer side profile, L	1	Pc	1	94039010
	9121290	9121290	Drawer side profile, R	1	Pc	1	94039010
	9123005	9123005	Cover Cap	2	Pc	2	39269097
	9121831	9121831	Rear panel Connector, L	1	Pc	1	83024200
	9121832	9121832	Raer panel Connector, R	1	Pc	1	83024200
	9123011	9123011	Screw-On Front Connector	2	Pc	2	83024200
	9239285	9239285	Actro runner, L	1	Pc	1	83024200
	9239286	9239286	Actro runner, R	1	Pc	1	83024200
BOM-code	9243137	Total Set	MRP: 6,698				83021090
	ArciTech Anthracite 500 mm, Height 94 mm, 60 kg						
	9121291	9121291	Drawer side profile, L	1	Pc	1	94039010
	9121292	9121292	Drawer side profile, R	1	Pc	1	94039010
	9123005	9123005	Cover Cap	2	Pc	2	39269097
	9121831	9121831	Rear panel Connector, L	1	Pc	1	83024200
	9121832	9121832	Raer panel Connector, R	1	Pc	1	83024200
	9123011	9123011	Screw-On Front Connector	2	Pc	2	83024200
	9239289	9239289	Actro runner, L	1	Pc	1	83024200
	9239290	9239290	Actro runner, R	1	Pc	1	83024200
BOM-code	9243138	Total Set	MRP: 6,698				83021090
	ArciTech Anthracite 550 mm, Height 94 mm, 60 kg						
	9121293	9121293	Drawer side profile, L	1	Pc	1	94039010
	9121294	9121294	Drawer side profile, R	1	Pc	1	94039010
	9123005	9123005	Cover Cap	2	Pc	2	39269097
	9121831	9121831	Rear panel Connector, L	1	Pc	1	83024200
	9121832	9121832	Raer panel Connector, R	1	Pc	1	83024200
	9123011	9123011	Screw-On Front Connector	2	Pc	2	83024200
	9239295	9239295	Actro runner, L	1	Pc	1	83024200
	9239296	9239296	Actro runner, R	1	Pc	1	83024200
BOM-code	9243139	Total Set	MRP: 6,920				83021090
	ArciTech Anthracite 500 mm, Height 94 mm, 80 kg						
	9121291	9121291	Drawer side profile, L	1	Pc	1	94039010
	9121292	9121292	Drawer side profile, R	1	Pc	1	94039010
	9123005	9123005	Cover Cap	2	Pc	2	39269097
	9121831	9121831	Rear panel Connector, L	1	Pc	1	83024200
	9121832	9121832	Raer panel Connector, R	1	Pc	1	83024200
	9123011	9123011	Screw-On Front Connector	2	Pc	2	83024200
	9239291	9239291	Actro runner, L	1	Pc	1	83024200
	9239292	9239292	Actro runner, R	1	Pc	1	83024200
BOM-code	9243141	Total Set	MRP: 7,590				83021090

Drawer System ArciTech

► Drawer, height 94 & 186 mm



Product	Article No.	SAP	Item Description	Qty.	Unit	PU	HS Code
	ArciTech Anthracite 550 mm, Height 94 mm, 80 kg						
	9121293	9121293	Drawer side profile, L	1	Pc	1	94039010
	9121294	9121294	Drawer side profile, R	1	Pc	1	94039010
	9123005	9123005	Cover Cap	2	Pc	2	39269097
	9121831	9121831	Rear panel Connector, L	1	Pc	1	83024200
	9121832	9121832	Raer panel Connector, R	1	Pc	1	83024200
	9123011	9123011	Screw-On Front Connector	2	Pc	2	83024200
	9239297	9239297	Actro runner, L	1	Pc	1	83024200
	9239298	9239298	Actro runner, R	1	Pc	1	83024200
	BOM-code	9243142	Total Set	MRP: 7,813			
	ArciTech Stainless steel 450 mm, Height 94 mm, 40 kg						
	9121325	9121325	Drawer side profile, L	1	Pc	1	94039010
	9121326	9121326	Drawer side profile, R	1	Pc	1	94039010
	9123007	9123007	Cover Cap	2	Pc	2	39269097
	9132252	9132252	Rear panel Connector, L	1	Pc	1	83024200
	9132253	9132253	Raer panel Connector, R	1	Pc	1	83024200
	9123011	9123011	Screw-On Front Connector	2	Pc	2	83024200
	9239283	9239283	Actro runner, L	1	Pc	1	83024200
	9239284	9239284	Actro runner, R	1	Pc	1	83024200
	BOM-code	9243144	Total Set	MRP: 9,708			
	ArciTech Stainless steel 500 mm, Height 94 mm, 40 kg						
	9121327	9121327	Drawer side profile, L	1	Pc	1	94039010
	9121328	9121328	Drawer side profile, R	1	Pc	1	94039010
	9123007	9123007	Cover Cap	2	Pc	2	39269097
	9132252	9132252	Rear panel Connector, L	1	Pc	1	83024200
	9132253	9132253	Raer panel Connector, R	1	Pc	1	83024200
	9123011	9123011	Screw-On Front Connector	2	Pc	2	83024200
	9239287	9239287	Actro runner, L	1	Pc	1	83024200
	9239288	9239288	Actro runner, R	1	Pc	1	83024200
	BOM-code	9243145	Total Set	MRP: 9,708			
	ArciTech Stainless steel 550 mm, Height 94 mm, 40 kg						
	9121329	9121329	Drawer side profile, L	1	Pc	1	94039010
	9121330	9121330	Drawer side profile, R	1	Pc	1	94039010
	9123007	9123007	Cover Cap	2	Pc	2	39269097
	9132252	9132252	Rear panel Connector, L	1	Pc	1	83024200
	9132253	9132253	Raer panel Connector, R	1	Pc	1	83024200
	9123011	9123011	Screw-On Front Connector	2	Pc	2	83024200
	9239293	9239293	Actro runner, L	1	Pc	1	83024200
	9239294	9239294	Actro runner, R	1	Pc	1	83024200
	BOM-code	9243146	Total Set	MRP: 9,933			

Drawer System ArciTech

► Drawer, height 94 & 186 mm







Product	Article No.	SAP	Item Description	Qty.	Unit	PU	HS Code
	ArciTech Stainless steel 450 mm, Height 94 mm, 60 kg						
	9121325	9121325	Drawer side profile, L	1	Pc	1	94039010
	9121326	9121326	Drawer side profile, R	1	Pc	1	94039010
	9123007	9123007	Cover Cap	2	Pc	2	39269097
	9132252	9132252	Rear panel Connector, L	1	Pc	1	83024200
	9132253	9132253	Raer panel Connector, R	1	Pc	1	83024200
	9123011	9123011	Screw-On Front Connector	2	Pc	2	83024200
	9239285	9239285	Actro runner, L	1	Pc	1	83024200
	9239286	9239286	Actro runner, R	1	Pc	1	83024200
BOM-code	9243147	Total Set				MRP: 10,601	83021090
	ArciTech Stainless steel 500 mm, Height 94 mm, 60 kg						
	9121327	9121327	Drawer side profile, L	1	Pc	1	94039010
	9121328	9121328	Drawer side profile, R	1	Pc	1	94039010
	9123007	9123007	Cover Cap	2	Pc	2	39269097
	9132252	9132252	Rear panel Connector, L	1	Pc	1	83024200
	9132253	9132253	Raer panel Connector, R	1	Pc	1	83024200
	9123011	9123011	Screw-On Front Connector	2	Pc	2	83024200
	9239289	9239289	Actro runner, L	1	Pc	1	83024200
	9239290	9239290	Actro runner, R	1	Pc	1	83024200
BOM-code	9243148	Total Set				MRP: 10,601	83021090
	ArciTech Stainless steel 550 mm, Height 94 mm, 60 kg						
	9121329	9121329	Drawer side profile, L	1	Pc	1	94039010
	9121330	9121330	Drawer side profile, R	1	Pc	1	94039010
	9123007	9123007	Cover Cap	2	Pc	2	39269097
	9132252	9132252	Rear panel Connector, L	1	Pc	1	83024200
	9132253	9132253	Raer panel Connector, R	1	Pc	1	83024200
	9123011	9123011	Screw-On Front Connector	2	Pc	2	83024200
	9239295	9239295	Actro runner, L	1	Pc	1	83024200
	9239296	9239296	Actro runner, R	1	Pc	1	83024200
BOM-code	9243149	Total Set				MRP: 10,824	83021090
	ArciTech Stainless steel 500 mm, Height 94 mm, 80 kg						
	9121327	9121327	Drawer side profile, L	1	Pc	1	94039010
	9121328	9121328	Drawer side profile, R	1	Pc	1	94039010
	9123007	9123007	Cover Cap	2	Pc	2	39269097
	9132252	9132252	Rear panel Connector, L	1	Pc	1	83024200
	9132253	9132253	Raer panel Connector, R	1	Pc	1	83024200
	9123011	9123011	Screw-On Front Connector	2	Pc	2	83024200
	9239291	9239291	Actro runner, L	1	Pc	1	83024200
	9239292	9239292	Actro runner, R	1	Pc	1	83024200
BOM-code	9243151	Total Set				MRP: 11,492	83021090

Drawer System ArciTech

► Drawer, height 94 & 186 mm



Product	Article No.	SAP	Item Description	Qty.	Unit	PU	HS Code
	ArciTech Stainless steel 550 mm, Height 94 mm, 80 kg						
	9121329	9121329	Drawer side profile, L	1	Pc	1	94039010
	9121330	9121330	Drawer side profile, R	1	Pc	1	94039010
	9123007	9123007	Cover Cap	2	Pc	2	39269097
	9132252	9132252	Rear panel Connector, L	1	Pc	1	83024200
	9132253	9132253	Raer panel Connector, R	1	Pc	1	83024200
	9123011	9123011	Screw-On Front Connector	2	Pc	2	83024200
	9239297	9239297	Actro runner, L	1	Pc	1	83024200
	9239298	9239298	Actro runner, R	1	Pc	1	83024200
	BOM-code	9243152	Total Set	MRP: 11,719			
	ArciTech Silver 450 mm pot & pan with railing, Height 186 mm, 40 kg						
	9121205	9121205	Drawer side profile, L	1	Pc	1	94039010
	9121206	9121206	Drawer side profile, R	1	Pc	1	94039010
	9123005	9123005	Cover Cap	2	Pc	2	39269097
	9121843	9121843	Rear panel Connector, L	1	Pc	1	83024200
	9121844	9121844	Raer panel Connector, R	1	Pc	1	83024200
	9123011	9123011	Screw-On Front Connector	2	Pc	2	83024200
	9239283	9239283	Actro runner, L	1	Pc	1	83024200
	9239284	9239284	Actro runner, R	1	Pc	1	83024200
	9121993	9121993	Lengthwise Railing, L	1	Pc	1	73269098
	9121994	9121994	Lengthwise Railing, R	1	Pc	1	73269098
	9127011	9127011	Screw-On Railing Connector	2	Pc	2	39263000
	BOM-code	9243154	Total Set	MRP: 6,694			
	ArciTech Silver 500 mm pot & pan with railing, Height 186 mm, 40 kg						
	9121207	9121207	Drawer side profile, L	1	Pc	1	94039010
	9121208	9121208	Drawer side profile, R	1	Pc	1	94039010
	9123005	9123005	Cover Cap	2	Pc	2	39269097
	9121843	9121843	Rear panel Connector, L	1	Pc	1	83024200
	9121844	9121844	Raer panel Connector, R	1	Pc	1	83024200
	9123011	9123011	Screw-On Front Connector	2	Pc	2	83024200
	9239287	9239287	Actro runner, L	1	Pc	1	83024200
	9239288	9239288	Actro runner, R	1	Pc	1	83024200
	9122003	9122003	Lengthwise Railing, L	1	Pc	1	73269098
	9122004	9122004	Lengthwise Railing, R	1	Pc	1	73269098
	9127011	9127011	Screw-On Railing Connector	2	Pc	2	39263000
	BOM-code	9243155	Total Set	MRP: 6,694			
	ArciTech Silver 550 mm pot & pan with railing, Height 186 mm, 40 kg						
	9121209	9121209	Drawer side profile, L	1	Pc	1	94039010
	9121210	9121210	Drawer side profile, R	1	Pc	1	94039010
	9123005	9123005	Cover Cap	2	Pc	2	39269097
	9121843	9121843	Rear panel Connector, L	1	Pc	1	83024200
	9121844	9121844	Raer panel Connector, R	1	Pc	1	83024200
	9123011	9123011	Screw-On Front Connector	2	Pc	2	83024200
	9239293	9239293	Actro runner, L	1	Pc	1	83024200
	9239294	9239294	Actro runner, R	1	Pc	1	83024200
	9122013	9122013	Lengthwise Railing, L	1	Pc	1	73269098
	9122014	9122014	Lengthwise Railing, R	1	Pc	1	73269098
	9127011	9127011	Screw-On Railing Connector	2	Pc	2	39263000
	BOM-code	9243156	Total Set	MRP: 6,920			

Drawer System ArciTech

► Drawer, height 94 & 186 mm



Product	Article No.	SAP	Item Description	Qty.	Unit	PU	HS Code
	ArciTech Silver 450 mm pot & pan with railing, Height 186 mm, 60 kg						
	9121205	9121205	Drawer side profile, L	1	Pc	1	94039010
	9121206	9121206	Drawer side profile, R	1	Pc	1	94039010
	9123005	9123005	Cover Cap	2	Pc	2	39269097
	9121843	9121843	Rear panel Connector, L	1	Pc	1	83024200
	9121844	9121844	Raer panel Connector, R	1	Pc	1	83024200
	9123011	9123011	Screw-On Front Connector	2	Pc	2	83024200
	9239285	9239285	Actro runner, L	1	Pc	1	83024200
	9239286	9239286	Actro runner, R	1	Pc	1	83024200
	9121993	9121993	Lengthwise Railing, L	1	Pc	1	73269098
	9121994	9121994	Lengthwise Railing, R	1	Pc	1	73269098
	9127011	9127011	Screw-On Railing Connector	2	Pc	2	39263000
BOM-code	9243157	Total Set	MRP: 7,587				83021090
	ArciTech Silver 500 mm pot & pan with railing, Height 186 mm, 60 kg						
	9121207	9121207	Drawer side profile, L	1	Pc	1	94039010
	9121208	9121208	Drawer side profile, R	1	Pc	1	94039010
	9123005	9123005	Cover Cap	2	Pc	2	39269097
	9121843	9121843	Rear panel Connector, L	1	Pc	1	83024200
	9121844	9121844	Raer panel Connector, R	1	Pc	1	83024200
	9123011	9123011	Screw-On Front Connector	2	Pc	2	83024200
	9239289	9239289	Actro runner, L	1	Pc	1	83024200
	9239290	9239290	Actro runner, R	1	Pc	1	83024200
	9122003	9122003	Lengthwise Railing, L	1	Pc	1	73269098
	9122004	9122004	Lengthwise Railing, R	1	Pc	1	73269098
	9127011	9127011	Screw-On Railing Connector	2	Pc	2	39263000
BOM-code	9243158	Total Set	MRP: 7,587				83021090
	ArciTech Silver 550 mm pot & pan with railing, Height 186 mm, 60 kg						
	9121209	9121209	Drawer side profile, L	1	Pc	1	94039010
	9121210	9121210	Drawer side profile, R	1	Pc	1	94039010
	9123005	9123005	Cover Cap	2	Pc	2	39269097
	9121843	9121843	Rear panel Connector, L	1	Pc	1	83024200
	9121844	9121844	Raer panel Connector, R	1	Pc	1	83024200
	9123011	9123011	Screw-On Front Connector	2	Pc	2	83024200
	9239295	9239295	Actro runner, L	1	Pc	1	83024200
	9239296	9239296	Actro runner, R	1	Pc	1	83024200
	9122013	9122013	Lengthwise Railing, L	1	Pc	1	73269098
	9122014	9122014	Lengthwise Railing, R	1	Pc	1	73269098
	9127011	9127011	Screw-On Railing Connector	2	Pc	2	39263000
BOM-code	9243159	Total Set	MRP: 7,812				83021090
	ArciTech Silver 650 mm pot & pan with railing, Height 186 mm, 60 kg						
	9121211	9121211	Drawer side profile, L	1	Pc	1	94039010
	9121212	9121212	Drawer side profile, R	1	Pc	1	94039010
	9123005	9123005	Cover Cap	2	Pc	2	39269097
	9121843	9121843	Rear panel Connector, L	1	Pc	1	83024200
	9121844	9121844	Raer panel Connector, R	1	Pc	1	83024200
	9123011	9123011	Screw-On Front Connector	2	Pc	2	83024200
	9239301	9239301	Actro runner, L	1	Pc	1	83024200
	9239302	9239302	Actro runner, R	1	Pc	1	83024200
	9122033	9122033	Lengthwise Railing, L	1	Pc	1	73269098
	9122034	9122034	Lengthwise Railing, R	1	Pc	1	73269098
	9127011	9127011	Screw-On Railing Connector	2	Pc	2	39263000
BOM-code	9243160	Total Set	MRP: 8,258				83021090

Drawer System ArciTech

► Drawer, height 94 & 186 mm



Product	Article No.	SAP	Item Description	Qty.	Unit	PU	HS Code
	ArciTech Silver 500 mm pot & pan with railing, Height 186 mm, 80 kg						
	9121207	9121207	Drawer side profile, L	1	Pc	1	94039010
	9121208	9121208	Drawer side profile, R	1	Pc	1	94039010
	9123005	9123005	Cover Cap	2	Pc	2	39269097
	9121843	9121843	Rear panel Connector, L	1	Pc	1	83024200
	9121844	9121844	Raer panel Connector, R	1	Pc	1	83024200
	9123011	9123011	Screw-On Front Connector	2	Pc	2	83024200
	9239291	9239291	Actro runner, L	1	Pc	1	83024200
	9239292	9239292	Actro runner, R	1	Pc	1	83024200
	9122003	9122003	Lengthwise Railing, L	1	Pc	1	73269098
	9122004	9122004	Lengthwise Railing, R	1	Pc	1	73269098
	9127011	9127011	Screw-On Railing Connector	2	Pc	2	39263000
BOM-code	9243161	Total Set	MRP: 8,480				83021090
	ArciTech Silver 550 mm pot & pan with railing, Height 186 mm, 80 kg						
	9121209	9121209	Drawer side profile, L	1	Pc	1	94039010
	9121210	9121210	Drawer side profile, R	1	Pc	1	94039010
	9123005	9123005	Cover Cap	2	Pc	2	39269097
	9121843	9121843	Rear panel Connector, L	1	Pc	1	83024200
	9121844	9121844	Raer panel Connector, R	1	Pc	1	83024200
	9123011	9123011	Screw-On Front Connector	2	Pc	2	83024200
	9239297	9239297	Actro runner, L	1	Pc	1	83024200
	9239298	9239298	Actro runner, R	1	Pc	1	83024200
	9122013	9122013	Lengthwise Railing, L	1	Pc	1	73269098
	9122014	9122014	Lengthwise Railing, R	1	Pc	1	73269098
	9127011	9127011	Screw-On Railing Connector	2	Pc	2	39263000
BOM-code	9243162	Total Set	MRP: 8,705				83021090
	ArciTech Silver 650 mm pot & pan with railing, Height 186 mm, 80 kg						
	9121211	9121211	Drawer side profile, L	1	Pc	1	94039010
	9121212	9121212	Drawer side profile, R	1	Pc	1	94039010
	9123005	9123005	Cover Cap	2	Pc	2	39269097
	9121843	9121843	Rear panel Connector, L	1	Pc	1	83024200
	9121844	9121844	Raer panel Connector, R	1	Pc	1	83024200
	9123011	9123011	Screw-On Front Connector	2	Pc	2	83024200
	9121113	9121113	Actro runner, L	1	Pc	1	83024200
	9121114	9121114	Actro runner, R	1	Pc	1	83024200
	9122033	9122033	Lengthwise Railing, L	1	Pc	1	73269098
	9122034	9122034	Lengthwise Railing, R	1	Pc	1	73269098
	9127011	9127011	Screw-On Railing Connector	2	Pc	2	39263000
BOM-code	9243163	Total Set	MRP: 9,153				83021090
	ArciTech White 450 mm pot & pan with railing, Height 186 mm, 40 kg						
	9121247	9121247	Drawer side profile, L	1	Pc	1	94039010
	9121248	9121248	Drawer side profile, R	1	Pc	1	94039010
	9123006	9123006	Cover Cap	2	Pc	2	39269097
	9121845	9121845	Rear panel Connector, L	1	Pc	1	83024200
	9121846	9121846	Raer panel Connector, R	1	Pc	1	83024200
	9123011	9123011	Screw-On Front Connector	2	Pc	2	83024200
	9239283	9239283	Actro runner, L	1	Pc	1	83024200
	9239284	9239284	Actro runner, R	1	Pc	1	83024200
	9121997	9121997	Lengthwise Railing, L	1	Pc	1	73269098
	9121998	9121998	Lengthwise Railing, R	1	Pc	1	73269098
	9127011	9127011	Screw-On Railing Connector	2	Pc	2	39263000
BOM-code	9243164	Total Set	MRP: 6,917				83021090

Drawer System ArciTech

► Drawer, height 94 & 186 mm



Product	Article No.	SAP	Item Description	Qty.	Unit	PU	HS Code
	ArciTech White 500 mm pot & pan with railing, Height 186 mm, 40 kg						
	9121249	9121249	Drawer side profile, L	1	Pc	1	94039010
	9121250	9121250	Drawer side profile, R	1	Pc	1	94039010
	9123006	9123006	Cover Cap	2	Pc	2	39269097
	9121845	9121845	Rear panel Connector, L	1	Pc	1	83024200
	9121846	9121846	Raer panel Connector, R	1	Pc	1	83024200
	9123011	9123011	Screw-On Front Connector	2	Pc	2	83024200
	9239287	9239287	Actro runner, L	1	Pc	1	83024200
	9239288	9239288	Actro runner, R	1	Pc	1	83024200
	9122007	9122007	Lengthwise Railing, L	1	Pc	1	73269098
	9122008	9122008	Lengthwise Railing, R	1	Pc	1	73269098
	9127011	9127011	Screw-On Railing Connector	2	Pc	2	39263000
BOM-code	9243165	Total Set	MRP: 6,917				83021090
	ArciTech White 550 mm pot & pan with railing, Height 186 mm, 40 kg						
	9121251	9121251	Drawer side profile, L	1	Pc	1	94039010
	9121252	9121252	Drawer side profile, R	1	Pc	1	94039010
	9123006	9123006	Cover Cap	2	Pc	2	39269097
	9121845	9121845	Rear panel Connector, L	1	Pc	1	83024200
	9121846	9121846	Raer panel Connector, R	1	Pc	1	83024200
	9123011	9123011	Screw-On Front Connector	2	Pc	2	83024200
	9239293	9239293	Actro runner, L	1	Pc	1	83024200
	9239294	9239294	Actro runner, R	1	Pc	1	83024200
	9122017	9122017	Lengthwise Railing, L	1	Pc	1	73269098
	9122018	9122018	Lengthwise Railing, R	1	Pc	1	73269098
	9127011	9127011	Screw-On Railing Connector	2	Pc	2	39263000
BOM-code	9243166	Total Set	MRP: 7,143				83021090
	ArciTech White 450 mm pot & pan with railing, Height 186 mm, 60 kg						
	9121247	9121247	Drawer side profile, L	1	Pc	1	94039010
	9121248	9121248	Drawer side profile, R	1	Pc	1	94039010
	9123006	9123006	Cover Cap	2	Pc	2	39269097
	9121845	9121845	Rear panel Connector, L	1	Pc	1	83024200
	9121846	9121846	Raer panel Connector, R	1	Pc	1	83024200
	9123011	9123011	Screw-On Front Connector	2	Pc	2	83024200
	9239285	9239285	Actro runner, L	1	Pc	1	83024200
	9239286	9239286	Actro runner, R	1	Pc	1	83024200
	9121997	9121997	Lengthwise Railing, L	1	Pc	1	73269098
	9121998	9121998	Lengthwise Railing, R	1	Pc	1	73269098
	9127011	9127011	Screw-On Railing Connector	2	Pc	2	39263000
BOM-code	9243167	Total Set	MRP: 7,810				83021090
	ArciTech White 500 mm pot & pan with railing, Height 186 mm, 60 kg						
	9121249	9121249	Drawer side profile, L	1	Pc	1	94039010
	9121250	9121250	Drawer side profile, R	1	Pc	1	94039010
	9123006	9123006	Cover Cap	2	Pc	2	39269097
	9121845	9121845	Rear panel Connector, L	1	Pc	1	83024200
	9121846	9121846	Raer panel Connector, R	1	Pc	1	83024200
	9123011	9123011	Screw-On Front Connector	2	Pc	2	83024200
	9239289	9239289	Actro runner, L	1	Pc	1	83024200
	9239290	9239290	Actro runner, R	1	Pc	1	83024200
	9122007	9122007	Lengthwise Railing, L	1	Pc	1	73269098
	9122008	9122008	Lengthwise Railing, R	1	Pc	1	73269098
	9127011	9127011	Screw-On Railing Connector	2	Pc	2	39263000
BOM-code	9243168	Total Set	MRP: 7,810				83021090

Drawer System ArciTech

► Drawer, height 94 & 186 mm



Product	Article No.	SAP	Item Description	Qty.	Unit	PU	HS Code
	ArciTech White 550 mm pot & pan with railing, Height 186 mm, 60 kg						
	9121251	9121251	Drawer side profile, L	1	Pc	1	94039010
	9121252	9121252	Drawer side profile, R	1	Pc	1	94039010
	9123006	9123006	Cover Cap	2	Pc	2	39269097
	9121845	9121845	Rear panel Connector, L	1	Pc	1	83024200
	9121846	9121846	Raer panel Connector, R	1	Pc	1	83024200
	9123011	9123011	Screw-On Front Connector	2	Pc	2	83024200
	9239295	9239295	Actro runner, L	1	Pc	1	83024200
	9239296	9239296	Actro runner, R	1	Pc	1	83024200
	9122017	9122017	Lengthwise Railing, L	1	Pc	1	73269098
	9122018	9122018	Lengthwise Railing, R	1	Pc	1	73269098
9127011	9127011	Screw-On Railing Connector	2	Pc	2	39263000	
BOM-code	9243169	Total Set	MRP: 8,035				83021090
	ArciTech White 500 mm pot & pan with railing, Height 186 mm, 80 kg						
	9121249	9121249	Drawer side profile, L	1	Pc	1	94039010
	9121250	9121250	Drawer side profile, R	1	Pc	1	94039010
	9123006	9123006	Cover Cap	2	Pc	2	39269097
	9121845	9121845	Rear panel Connector, L	1	Pc	1	83024200
	9121846	9121846	Raer panel Connector, R	1	Pc	1	83024200
	9123011	9123011	Screw-On Front Connector	2	Pc	2	83024200
	9239291	9239291	Actro runner, L	1	Pc	1	83024200
	9239292	9239292	Actro runner, R	1	Pc	1	83024200
	9122007	9122007	Lengthwise Railing, L	1	Pc	1	73269098
	9122008	9122008	Lengthwise Railing, R	1	Pc	1	73269098
9127011	9127011	Screw-On Railing Connector	2	Pc	2	39263000	
BOM-code	9243171	Total Set	MRP: 8,701				83021090
	ArciTech White 550 mm pot & pan with railing, Height 186 mm, 80 kg						
	9121251	9121251	Drawer side profile, L	1	Pc	1	94039010
	9121252	9121252	Drawer side profile, R	1	Pc	1	94039010
	9123006	9123006	Cover Cap	2	Pc	2	39269097
	9121845	9121845	Rear panel Connector, L	1	Pc	1	83024200
	9121846	9121846	Raer panel Connector, R	1	Pc	1	83024200
	9123011	9123011	Screw-On Front Connector	2	Pc	2	83024200
	9239297	9239297	Actro runner, L	1	Pc	1	83024200
	9239298	9239298	Actro runner, R	1	Pc	1	83024200
	9122017	9122017	Lengthwise Railing, L	1	Pc	1	73269098
	9122018	9122018	Lengthwise Railing, R	1	Pc	1	73269098
9127011	9127011	Screw-On Railing Connector	2	Pc	2	39263000	
BOM-code	9243172	Total Set	MRP: 8,928				83021090
	ArciTech Anthracite 450 mm pot & pan with railing, Height 186 mm, 40 kg						
	9121289	9121289	Drawer side profile, L	1	Pc	1	94039010
	9121290	9121290	Drawer side profile, R	1	Pc	1	94039010
	9123005	9123005	Cover Cap	2	Pc	2	39269097
	9121847	9121847	Rear panel Connector, L	1	Pc	1	83024200
	9121848	9121848	Raer panel Connector, R	1	Pc	1	83024200
	9123011	9123011	Screw-On Front Connector	2	Pc	2	83024200
	9239283	9239283	Actro runner, L	1	Pc	1	83024200
	9239284	9239284	Actro runner, R	1	Pc	1	83024200
	9121995	9121995	Lengthwise Railing, L	1	Pc	1	73269098
	9121996	9121996	Lengthwise Railing, R	1	Pc	1	73269098
9127011	9127011	Screw-On Railing Connector	2	Pc	2	39263000	
BOM-code	9243174	Total Set	MRP: 6,917				83021090

Drawer System ArciTech

► Drawer, height 94 & 186 mm



Product	Article No.	SAP	Item Description	Qty.	Unit	PU	HS Code
	ArciTech Anthracite 500 mm pot & pan with railing, Height 186 mm, 40 kg						
	9121291	9121291	Drawer side profile, L	1	Pc	1	94039010
	9121292	9121292	Drawer side profile, R	1	Pc	1	94039010
	9123005	9123005	Cover Cap	2	Pc	2	39269097
	9121847	9121847	Rear panel Connector, L	1	Pc	1	83024200
	9121848	9121848	Raer panel Connector, R	1	Pc	1	83024200
	9123011	9123011	Screw-On Front Connector	2	Pc	2	83024200
	9239287	9239287	Actro runner, L	1	Pc	1	83024200
	9239288	9239288	Actro runner, R	1	Pc	1	83024200
	9122005	9122005	Lengthwise Railing, L	1	Pc	1	73269098
	9122006	9122006	Lengthwise Railing, R	1	Pc	1	73269098
9127011	9127011	Screw-On Railing Connector	2	Pc	2	39263000	
BOM-code	9243175	Total Set	MRP: 6,917				83021090
	ArciTech Anthracite 550 mm pot & pan with railing, Height 186 mm, 40 kg						
	9121293	9121293	Drawer side profile, L	1	Pc	1	94039010
	9121294	9121294	Drawer side profile, R	1	Pc	1	94039010
	9123005	9123005	Cover Cap	2	Pc	2	39269097
	9121847	9121847	Rear panel Connector, L	1	Pc	1	83024200
	9121848	9121848	Raer panel Connector, R	1	Pc	1	83024200
	9123011	9123011	Screw-On Front Connector	2	Pc	2	83024200
	9239293	9239293	Actro runner, L	1	Pc	1	83024200
	9239294	9239294	Actro runner, R	1	Pc	1	83024200
	9122015	9122015	Lengthwise Railing, L	1	Pc	1	73269098
	9122016	9122016	Lengthwise Railing, R	1	Pc	1	73269098
9127011	9127011	Screw-On Railing Connector	2	Pc	2	39263000	
BOM-code	9243176	Total Set	MRP: 7,141				83021090
	ArciTech Anthracite 450 mm pot & pan with railing, Height 186 mm, 60 kg						
	9121289	9121289	Drawer side profile, L	1	Pc	1	94039010
	9121290	9121290	Drawer side profile, R	1	Pc	1	94039010
	9123005	9123005	Cover Cap	2	Pc	2	39269097
	9121847	9121847	Rear panel Connector, L	1	Pc	1	83024200
	9121848	9121848	Raer panel Connector, R	1	Pc	1	83024200
	9123011	9123011	Screw-On Front Connector	2	Pc	2	83024200
	9239285	9239285	Actro runner, L	1	Pc	1	83024200
	9239286	9239286	Actro runner, R	1	Pc	1	83024200
	9121995	9121995	Lengthwise Railing, L	1	Pc	1	73269098
	9121996	9121996	Lengthwise Railing, R	1	Pc	1	73269098
9127011	9127011	Screw-On Railing Connector	2	Pc	2	39263000	
BOM-code	9243177	Total Set	MRP: 7,812				83021090
	ArciTech Anhracite 500 mm pot & pan with railing, Height 186 mm, 60 kg						
	9121291	9121291	Drawer side profile, L	1	Pc	1	94039010
	9121292	9121292	Drawer side profile, R	1	Pc	1	94039010
	9123005	9123005	Cover Cap	2	Pc	2	39269097
	9121847	9121847	Rear panel Connector, L	1	Pc	1	83024200
	9121848	9121848	Raer panel Connector, R	1	Pc	1	83024200
	9123011	9123011	Screw-On Front Connector	2	Pc	2	83024200
	9239289	9239289	Actro runner, L	1	Pc	1	83024200
	9239290	9239290	Actro runner, R	1	Pc	1	83024200
	9122005	9122005	Lengthwise Railing, L	1	Pc	1	73269098
	9122006	9122006	Lengthwise Railing, R	1	Pc	1	73269098
9127011	9127011	Screw-On Railing Connector	2	Pc	2	39263000	
BOM-code	9243178	Total Set	MRP: 7,812				83021090

Drawer System ArciTech

► Drawer, height 94 & 186 mm



Product	Article No.	SAP	Item Description	Qty.	Unit	PU	HS Code
	ArciTech Anthracite 550 mm pot & pan with railing, Height 186 mm, 60 kg						
	9121293	9121293	Drawer side profile, L	1	Pc	1	94039010
	9121294	9121294	Drawer side profile, R	1	Pc	1	94039010
	9123005	9123005	Cover Cap	2	Pc	2	39269097
	9121847	9121847	Rear panel Connector, L	1	Pc	1	83024200
	9121848	9121848	Raer panel Connector, R	1	Pc	1	83024200
	9123011	9123011	Screw-On Front Connector	2	Pc	2	83024200
	9239295	9239295	Actro runner, L	1	Pc	1	83024200
	9239296	9239296	Actro runner, R	1	Pc	1	83024200
	9122015	9122015	Lengthwise Railing, L	1	Pc	1	73269098
	9122016	9122016	Lengthwise Railing, R	1	Pc	1	73269098
9127011	9127011	Screw-On Railing Connector	2	Pc	2	39263000	
BOM-code	9243179	Total Set				MRP: 8,032	83021090
	ArciTech Anthracite 500 mm pot & pan with railing, Height 186 mm, 80 kg						
	9121291	9121291	Drawer side profile, L	1	Pc	1	94039010
	9121292	9121292	Drawer side profile, R	1	Pc	1	94039010
	9123005	9123005	Cover Cap	2	Pc	2	39269097
	9121847	9121847	Rear panel Connector, L	1	Pc	1	83024200
	9121848	9121848	Raer panel Connector, R	1	Pc	1	83024200
	9123011	9123011	Screw-On Front Connector	2	Pc	2	83024200
	9239291	9239291	Actro runner, L	1	Pc	1	83024200
	9239292	9239292	Actro runner, R	1	Pc	1	83024200
	9122005	9122005	Lengthwise Railing, L	1	Pc	1	73269098
	9122006	9122006	Lengthwise Railing, R	1	Pc	1	73269098
9127011	9127011	Screw-On Railing Connector	2	Pc	2	39263000	
BOM-code	9243181	Total Set				MRP: 8,703	83021090
	ArciTech Anthracite 550 mm pot & pan with railing, Height 186 mm, 80 kg						
	9121293	9121293	Drawer side profile, L	1	Pc	1	94039010
	9121294	9121294	Drawer side profile, R	1	Pc	1	94039010
	9123005	9123005	Cover Cap	2	Pc	2	39269097
	9121847	9121847	Rear panel Connector, L	1	Pc	1	83024200
	9121848	9121848	Raer panel Connector, R	1	Pc	1	83024200
	9123011	9123011	Screw-On Front Connector	2	Pc	2	83024200
	9239297	9239297	Actro runner, L	1	Pc	1	83024200
	9239298	9239298	Actro runner, R	1	Pc	1	83024200
	9122015	9122015	Lengthwise Railing, L	1	Pc	1	73269098
	9122016	9122016	Lengthwise Railing, R	1	Pc	1	73269098
9127011	9127011	Screw-On Railing Connector	2	Pc	2	39263000	
BOM-code	9243182	Total Set				MRP: 8,926	83021090
	ArciTech Stainless steel 450 mm pot & pan with railing, Height 186 mm, 40 kg						
	9121325	9121325	Drawer side profile, L	1	Pc	1	94039010
	9121326	9121326	Drawer side profile, R	1	Pc	1	94039010
	9123007	9123007	Cover Cap	2	Pc	2	39269097
	9132256	9132256	Rear panel Connector, L	1	Pc	1	83024200
	9132257	9132257	Raer panel Connector, R	1	Pc	1	83024200
	9123011	9123011	Screw-On Front Connector	2	Pc	2	83024200
	9239283	9239283	Actro runner, L	1	Pc	1	83024200
	9239284	9239284	Actro runner, R	1	Pc	1	83024200
	9121999	9121999	Lengthwise Railing, L	1	Pc	1	73269098
	9122000	9122000	Lengthwise Railing, R	1	Pc	1	73269098
9127011	9127011	Screw-On Railing Connector	2	Pc	2	39263000	
BOM-code	9243184	Total Set				MRP: 13,275	83021090

Drawer System ArciTech

► Drawer, height 94 & 186 mm



Product	Article No.	SAP	Item Description	Qty.	Unit	PU	HS Code
	ArciTech Stainless steel 550 mm pot & pan with railing, Height 186 mm, 40 kg						
	9121329	9121329	Drawer side profile, L	1	Pc	1	94039010
	9121330	9121330	Drawer side profile, R	1	Pc	1	94039010
	9123007	9123007	Cover Cap	2	Pc	2	39269097
	9132256	9132256	Rear panel Connector, L	1	Pc	1	83024200
	9132257	9132257	Raer panel Connector, R	1	Pc	1	83024200
	9123011	9123011	Screw-On Front Connector	2	Pc	2	83024200
	9239293	9239293	Actro runner, L	1	Pc	1	83024200
	9239294	9239294	Actro runner, R	1	Pc	1	83024200
	9122019	9122019	Lengthwise Railing, L	1	Pc	1	73269098
	9122020	9122020	Lengthwise Railing, R	1	Pc	1	73269098
	9127011	9127011	Screw-On Railing Connector	2	Pc	2	39263000
BOM-code	9243186	Total Set				MRP: 13,502	83021090
	ArciTech Stainless steel 450 mm pot & pan with railing, Height 186 mm, 60 kg						
	9121325	9121325	Drawer side profile, L	1	Pc	1	94039010
	9121326	9121326	Drawer side profile, R	1	Pc	1	94039010
	9123007	9123007	Cover Cap	2	Pc	2	39269097
	9132256	9132256	Rear panel Connector, L	1	Pc	1	83024200
	9132257	9132257	Raer panel Connector, R	1	Pc	1	83024200
	9123011	9123011	Screw-On Front Connector	2	Pc	2	83024200
	9239285	9239285	Actro runner, L	1	Pc	1	83024200
	9239286	9239286	Actro runner, R	1	Pc	1	83024200
	9121999	9121999	Lengthwise Railing, L	1	Pc	1	73269098
	9122000	9122000	Lengthwise Railing, R	1	Pc	1	73269098
	9127011	9127011	Screw-On Railing Connector	2	Pc	2	39263000
BOM-code	9243187	Total Set				MRP: 14,170	83021090
	ArciTech Stainless steel 550 mm pot & pan with railing, Height 186 mm, 60 kg						
	9121329	9121329	Drawer side profile, L	1	Pc	1	94039010
	9121330	9121330	Drawer side profile, R	1	Pc	1	94039010
	9123007	9123007	Cover Cap	2	Pc	2	39269097
	9132256	9132256	Rear panel Connector, L	1	Pc	1	83024200
	9132257	9132257	Raer panel Connector, R	1	Pc	1	83024200
	9123011	9123011	Screw-On Front Connector	2	Pc	2	83024200
	9239295	9239295	Actro runner, L	1	Pc	1	83024200
	9239296	9239296	Actro runner, R	1	Pc	1	83024200
	9122019	9122019	Lengthwise Railing, L	1	Pc	1	73269098
	9122020	9122020	Lengthwise Railing, R	1	Pc	1	73269098
	9127011	9127011	Screw-On Railing Connector	2	Pc	2	39263000
BOM-code	9243189	Total Set				MRP: 14,393	83021090



Drawer System ArciTech

► Drawer, height 94 & 186 mm



Product	Article No.	SAP	Item Description	Qty.	Unit	PU	HS Code
ArciTech Stainless steel 550 mm pot & pan with railing, Height 186 mm, 80 kg							
	9121329	9121329	Drawer side profile, L	1	Pc	1	94039010
	9121330	9121330	Drawer side profile, R	1	Pc	1	94039010
	9123007	9123007	Cover Cap	2	Pc	2	39269097
	9132256	9132256	Rear panel Connector, L	1	Pc	1	83024200
	9132257	9132257	Raer panel Connector, R	1	Pc	1	83024200
	9123011	9123011	Screw-On Front Connector	2	Pc	2	83024200
	9239297	9239297	Actro runner, L	1	Pc	1	83024200
	9239298	9239298	Actro runner, R	1	Pc	1	83024200
	9122019	9122019	Lengthwise Railing, L	1	Pc	1	73269098
	9122020	9122020	Lengthwise Railing, R	1	Pc	1	73269098
	9127011	9127011	Screw-On Railing Connector	2	Pc	2	39263000
BOM-code	9243192	Total Set				MRP: 15,286	83021090



Drawer System ArciTech

► Accessories



Product	Article No.	SAP	Item Description	Qty.	Unit	PU	MRP	HS Code
	Accessories for ArciTech Silver 500 / 550 mm							
	9122920	9122920	ArciTech Topside- 500 mm	1	Set	1	2,658	73269098
	9122988	9122988	ArciTech DesignSide- 500 mm	1	Set	1	1,868	70200080
	9122989	9122989	ArciTech DesignSide- 550 mm	1	Set	1	1,902	70200080
	9122973	9122973	ArciTech DesignSide Adapter	1	Set	1	1,358	83024200
	ArciTech Silver, front panel, Internal Drawer height 94 / 186 mm							
	9122799	9122799	94 / 600 mm	1	Pc	15	2,768	94039010
	9122853	9122853	186 / 600 mm	1	Pc	15	3,728	94039010
	9122801	9122801	94 / 900 mm	1	Pc	15	4,060	94039010
	9122855	9122855	186 / 900 mm	1	Pc	15	5,020	83024200
	9192204	9192204	Aluminium front panel, L2000 mm	1	Pc	1	3,820	76042990
	9182706	9182706	Railing for Aluminium front panel	1	Pc	1	2,311	73066192
	9123083	9123083	Front connector H 94	1	Pc	15	1,358	83024200
	9123089	9123089	Front connector H 186	1	Pc	15	2,241	83024200
	Accessories for ArciTech White 500 / 550 mm							
	9122988	9122988	ArciTech DesignSide- 500 mm	1	Set	1	1,868	70200080
	9122989	9122989	ArciTech DesignSide- 550 mm	1	Set	1	1,902	70200080
	9122975	9122975	ArciTech DesignSide Adapter	1	Set	15	1,358	83024200
	ArciTech White 500 mm, front panel, Internal drawer height 94 / 186 mm							
	9122862	9122862	ArciTech front panel 186 / 600 mm	1	Set	15	3,728	94039010
	9123084	9123084	Front connector H 94	1	Set	15	1,358	83024200
	9123090	9123090	Front connector H 186	1	Set	15	2,241	83024200
	Accessories for ArciTech Anthracite 500 / 550 mm							
	9122921	9122921	ArciTech Topside- 500 mm	1	Set	1	2,658	73269098
	9122988	9122988	ArciTech DesignSide- 500 mm	1	Set	1	1,868	70200080
	9122989	9122989	ArciTech DesignSide- 550 mm	1	Set	1	1,902	70200080
	9122974	9122974	ArciTech DesignSide Adapter	1	Set	1	1,358	83024200
	ArciTech Anthracite, front panel, Internal drawer height 94 / 186 mm							
	9140089	9140089	94 / 600 mm	1	Set	15	2,768	94039010
	9140107	9140107	186 / 600 mm	1	Set	15	3,728	94039010
	Accessories for ArciTech Stainless steel 500 / 550 mm							
	9122988	9122988	ArciTech DesignSide- 500 mm	1	Set	1	1,868	70200080
	9122989	9122989	ArciTech DesignSide- 550 mm	1	Set	1	1,902	70200080
	9122976	9122976	ArciTech DesignSide Adapter	1	Set	15	3,566	83024200

Drawer System ArciTech

► Accessories







Product	Article No.	SAP	Item Description	Qty.	Unit	PU	MRP	HS Code
	ArciTech Stainless steel , front panel, Internal drawer height 94 / 186 mm							
	9122817	9122817	94 / 600 mm	1	Pc	15	3,008	94039010
	9122871	9122871	186 / 600 mm	1	Pc	15	3,968	94039010
	9192207	9192207	Aluminium front panel, Length 2000mm	1	Pc	15	3,821	76042990
	9123085	9123085	Front connector H 94	1	Pc	15	1,346	83024200
	OrgaTray 570 Silver							
	9134992	9134992	For NL 500 mm depth, cab width 600 mm	1	Set	1	2,126	39149000
	9134994	9134994	For NL 500 mm depth, cab width 900 mm	1	Set	1	3,791	39149000
	OrgaTray 440 Trimmable							
	9194924	9194924	Tray width 501-600 mm, depth 380-440 mm	1	Pc	1	679	39249000
	9194934	9194934	Tray width 351-400 mm, depth 441-520 mm	1	Pc	1	511	39249000
	9194935	9194935	Tray width 401-450 mm, depth 441-520 mm	1	Pc	1	540	39249000
	9194936	9194936	Tray width 451-500 mm, depth 441-520 mm	1	Pc	1	591	39249000
	9194937	9194937	Tray width 501-600 mm, depth 441-520 mm	1	Pc	1	704	39249000
	9194939	9194939	Tray width 701-800 mm, depth 441-520 mm	1	Pc	1	1,349	39249000
	9194940	9194940	Tray width 801-900 mm, depth 441-520 mm	1	Pc	1	1,417	39249000
	OrgaTray 600 Silver Advanced							
	9123112	9123112	For carcass width 450 mm (Type 1)	1	Pc	1	4,426	73239900
	9132689	9132689	For carcass width 500-1200 mm (Type 2) (Type2: 2 can be fitted in carcasses in widths >_ 800 mm) (Anti-slip mat must be ordered separately)	1	Pc	1	5,531	73239900
	OrgaStore 400 customised width							
	9182706	9182706	Crosswise railing 2000 mm silver	1	Pc	1	2,311	73066192
	9182222	9182222	Adapter anthracite	1	Pc	1	141	39269097
	9182225	9182225	Lengthwise divider anthracite	1	Pc	1	313	39269097
	9182714	9182714	Crosswise railing 2000 mm white	1	Pc	1	2,311	73066192
	9182223	9182223	Adapter white	1	Pc	1	141	39269097
	9182227	9182227	Lengthwise divider white	1	Pc	1	313	39269097
	9182712	9182712	Crosswise railing 2000 mm anthracite	1	Pc	1	2,311	73066192
	Anti-slip mat (5 m roll)							
9209580	9209580	500 mm NL PVC, antracite	1	Pc	1	6,772	39269097	
	OrgaStore 230 Oak							
	9199647	9199647	OrgaStore 230 B600 T500 Oak	1	Pc	1	6,112	44199090
	9190578	9190578	OrgaStore 230 Separator Oak	1	Pc	1	2,981	44199090
	9190577	9190577	OrgaStore 230 Separating Angle Oak	1	Pc	1	4,291	44199090

Drawer System ArciTech

► Accessories

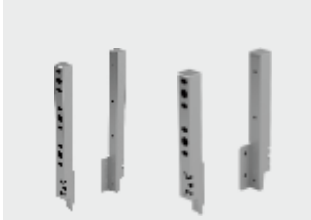

Product	Article No.	SAP	Item Description	Qty.	Unit	PU	MRP	HS Code
Orga tray 610								
	9194883	9194883	OrgaTray 610 frame Anthracite for 450 mm	1	Pc	1	5,043	73239900
	9194882	9194882	OrgaTray 610 Frame White for 450 mm	1	Pc	1	5,043	73269098
Arcitech Support Materials								
	9123080	9123080	Front Stabiliser	1	Pc	1	274	39263000
	9122998	9122998	Designside Connectors	1	Pc	1	1,189	83024200
Connector for front								
	9140123	9140123	Connector for Front - Antracite	1	Set	1	2,241	83024200
	9123091	9123091	Connector for Front - Champagne	1	Set	1	2,462	83024200
ArciTech Back Panel								
	9121362	9121362	Back Panel - Silver - 94 mm 600 W	1	Pc	1	425	94039010
	9121518	9121518	Back Panel - Silver - 186 mm 600 W	1	Pc	1	849	94039010
	9121524	9121524	Back Panel - Silver - 186 mm 900 W	1	Pc	1	1,329	94039010
	9121544	9121544	Back Panel - White - 186 mm 600 W	1	Pc	1	849	94039010
	9121550	9121550	Back Panel - White - 186 mm 900 W	1	Pc	1	1,329	94039010
	9121414	9121414	Back Panel - Antracite - 94 mm 600 W	1	Pc	1	425	94039010
	9121420	9121420	Back Panel - Antracite - 94 mm 900 W	1	Pc	1	775	94039010
	9121570	9121570	Back Panel - Antracite - 186 mm 600 W	1	Pc	1	849	94039010
	9121576	9121576	Back Panel - Antracite - 186 mm 900 W	1	Pc	1	1,329	94039010
ArciTech Back Panel Connector								
	9121851	9121851	Back panel connector Silver Left--218 mm	1	Pc	1	396	83024200
	9121852	9121852	Back panel connector Silver Right--218 mm	1	Pc	1	396	83024200
	9121867	9121867	Back panel connector Silver Left--282 mm	1	Pc	1	585	83024200
	9121868	9121868	Back panel connector Silver Right--282 mm	1	Pc	1	585	83024200
	9132258	9132258	Back panel connector Stainless Steel Left--218 mm	1	Pc	1	396	83024200
	9132259	9132259	Back panel connector Stainless Steel Right--218 mm	1	Pc	1	396	83024200



Drawer System ArciTech

► Accessories



Product	Article No.	SAP	Item Description	Qty.	Unit	PU	MRP	HS Code
ArciTech Drawer Side Profile								
	Finish : Silver							
	9121205	9121205	Arcitech - 450 mm-Drawer side profile, L - Silver	1	Pc	1	862	94039010
	9121206	9121206	Arcitech - 450 mm-Drawer side profile, R - Silver	1	Pc	1	862	94039010
	9121207	9121207	Arcitech - 500 mm-Drawer side profile, L - Silver	1	Pc	1	862	94039010
	9121208	9121208	Arcitech - 500 mm-Drawer side profile, R - Silver	1	Pc	1	862	94039010
	9121209	9121209	Arcitech - 550 mm-Drawer side profile, L - Silver	1	Pc	1	969	94039010
	9121210	9121210	Arcitech - 550 mm-Drawer side profile, R - Silver	1	Pc	1	969	94039010
	9121211	9121211	Arcitech - 650 mm-Drawer side profile, L - Silver	1	Pc	1	1,005	94039010
9121212	9121212	Arcitech - 650 mm-Drawer side profile, R - Silver	1	Pc	1	1,005	94039010	
	Finish : White							
	9121247	9121247	Arcitech - 450 mm-Drawer side profile, L-White	1	Pc	1	917	94039010
	9121248	9121248	Arcitech - 450 mm-Drawer side profile, R-White	1	Pc	1	917	94039010
	9121249	9121249	Arcitech - 500 mm-Drawer side profile, L-White	1	Pc	1	917	94039010
	9121250	9121250	Arcitech - 500 mm-Drawer side profile, R-White	1	Pc	1	917	94039010
	9121251	9121251	Arcitech - 550 mm-Drawer side profile, L-White	1	Pc	1	1,025	94039010
9121252	9121252	Arcitech - 550 mm-Drawer side profile, R-White	1	Pc	1	1,025	94039010	
	Finish : Anthracite							
	9121289	9121289	Arcitech-450 mm-Drawer side profile, L-Anthracite	1	Pc	1	923	94039010
	9121290	9121290	Arcitech-450 mm-Drawer side profile, R-Anthracite	1	Pc	1	923	94039010
	9121291	9121291	Arcitech-500 mm-Drawer side profile, L-Anthracite	1	Pc	1	923	94039010
	9121292	9121292	Arcitech-500 mm-Drawer side profile, R-Anthracite	1	Pc	1	923	94039010
	9121293	9121293	Arcitech-550 mm-Drawer side profile, L-Anthracite	1	Pc	1	1,029	94039010
9121294	9121294	Arcitech-550 mm-Drawer side profile, R-Anthracite	1	Pc	1	1,029	94039010	
	Finish : Stainless Steel							
	9121325	9121325	Arcitech - 450 mm - Drawer side profile, L - SS	1	Pc	1	2,868	94039010
	9121326	9121326	Arcitech - 450 mm - Drawer side profile, R - SS	1	Pc	1	2,868	94039010
	9121327	9121327	Arcitech - 500 mm - Drawer side profile, L - SS	1	Pc	1	2,868	94039010
	9121328	9121328	Arcitech - 500 mm - Drawer side profile, R - SS	1	Pc	1	2,868	94039010
	9121329	9121329	Arcitech - 550 mm - Drawer side profile, L - SS	1	Pc	1	2,974	94039010
9121330	9121330	Arcitech - 550 mm - Drawer side profile, R - SS	1	Pc	1	2,974	94039010	
Lengthwise railing								
	Finish : Silver							
	9121993	9121993	Lengthwise Railing, L - 450 mm - Silver	1	Pc	1	375	73269098
	9121994	9121994	Lengthwise Railing, R - 450 mm - Silver	1	Pc	1	375	73269098
	9122003	9122003	Lengthwise Railing, L - 500 mm - Silver	1	Pc	1	375	73269098
	9122004	9122004	Lengthwise Railing, R - 500 mm - Silver	1	Pc	1	375	73269098
	9122013	9122013	Lengthwise Railing, L - 550 mm - Silver	1	Pc	1	375	73269098
	9122014	9122014	Lengthwise Railing, R - 550 mm - Silver	1	Pc	1	375	73269098
	9122033	9122033	Lengthwise Railing, L - 650 mm - Silver	1	Pc	Pc	375	73269098
9122034	9122034	Lengthwise Railing, R - 650 mm - Silver	1	Pc	Pc	375	73269098	

Drawer System ArciTech

► Accessories



Product	Article No.	SAP	Item Description	Qty.	Unit	PU	MRP	HS Code
	Finish : White							
	9121997	9121997	Lengthwise Railing, L - 450 mm - White	1	Pc	1	454	73269098
	9121998	9121998	Lengthwise Railing, R - 450 mm - White	1	Pc	1	454	73269098
	9122007	9122007	Lengthwise Railing, L - 500 mm - White	1	Pc	1	454	73269098
	9122008	9122008	Lengthwise Railing, R - 500 mm - White	1	Pc	1	454	73269098
	9122017	9122017	Lengthwise Railing, L - 550 mm - White	1	Pc	1	454	94039010
	Finish : Anthracite							
	9121995	9121995	Lengthwise Railing, L - 450 mm - Anthracite	1	Pc	1	454	73269098
	9121996	9121996	Lengthwise Railing, R - 450 mm - Anthracite	1	Pc	1	454	73269098
	9122005	9122005	Lengthwise Railing, L - 500 mm - Anthracite	1	Pc	1	454	73269098
	9122006	9122006	Lengthwise Railing, R - 500 mm - Anthracite	1	Pc	1	454	73269098
	9122015	9122015	Lengthwise Railing, L - 550 mm - Anthracite	1	Pc	1	454	73269098
	Finish : Stainless Steel							
	9121999	9121999	Lengthwise Railing, L - 450 mm - Stainless Steel	1	Pc	1	1,502	73269098
	9122000	9122000	Lengthwise Railing, R - 450 mm - Stainless Steel	1	Pc	1	1,502	73269098
	9122019	9122019	Lengthwise Railing, L - 550 mm - Stainless Steel	1	Pc	1	1,502	73269098
Rear Panel Connector								
	Finish : Silver							
	9121827	9121827	Rear panel Connector, L - 94 mm - Silver	1	Pc	1	241	83024200
	9121828	9121828	Raer panel Connector, R - 94 mm - Silver	1	Pc	1	241	83024200
	9121843	9121843	Rear panel Connector, L - 186 mm - Silver	1	Pc	1	380	83024200
	Finish : White							
	9121829	9121829	Rear panel Connector, L - 94 mm - White	1	Pc	1	292	83024200
	9121830	9121830	Raer panel Connector, R - 94 mm - White	1	Pc	1	292	83024200
	9121845	9121845	Rear panel Connector, L - 186 mm - White	1	Pc	1	351	83024200
	Finish : Anthracite							
	9121831	9121831	Rear panel Connector, L - 94 mm - Anthracite	1	Pc	1	292	83024200
	9121832	9121832	Raer panel Connector, R - 94 mm - Anthracite	1	Pc	1	292	83024200
	9121847	9121847	Rear panel Connector, L - 186 mm - Anthracite	1	Pc	1	351	83024200
	Finish : Stainless Steel							
	9132252	9132252	Rear panel Connector, L - 94 mm - SS	1	Pc	1	275	83024200
	9132253	9132253	Raer panel Connector, R - 94 mm - SS	1	Pc	1	275	83024200
	9132256	9132256	Rear panel Connector, L - 186 mm - SS	1	Pc	1	511	83024200
	9132257	9132257	Raer panel Connector, R - 186 mm - SS	1	Pc	1	511	83024200

Drawer System ArciTech

► Accessories



Product	Article No.	SAP	Item Description	Qty.	Unit	PU	MRP	HS Code
ArciTech Cover Cap								
	9123005	9123005	Cover Cap - Silver	2	Pc	2	64	39269097
	9123006	9123006	Cover Cap - White	2	Pc	2	76	39269097
	9123005	9123005	Cover Cap - Anthracite	2	Pc	2	64	39269097
	9123007	9123007	Cover Cap - Stainless Steel	2	Pc	2	116	39269097

Push to open Silent opening system for ArciTech								
	9241050	9241050	PTO Silent System Set up to 10 Kg - 40 Kg	1	Set	1	3,884	39263000
	9241051	9241051	PTO Silent System Set up to 20 Kg - 80 Kg	1	Set	1	3,884	39263000

Synchronisation Mechanism for 600 mm and above drawer carcass widths								
	9236718	9236718	Synchronisation Bar - 2000 mm	1	Pc	100	698	83024200
	9221295	9221295	Mid Connector	1	Pc	20	99	39269097

Actro Runners								
	Actro Runners 40 kg							
	9239283	9239283	Actro runner, 450 mm L - 40 Kg	1	Pc	1	1,514	83024200
	9239284	9239284	Actro runner, 450 mm R - 40 Kg	1	Pc	1	1,514	83024200
	9239287	9239287	Actro runner, 500 mm L - 40 Kg	1	Pc	1	1,514	83024200
	9239288	9239288	Actro runner, 500 mm R - 40 Kg	1	Pc	1	1,514	83024200
	9239293	9239293	Actro runner, 550 mm L - 40 Kg	1	Pc	1	1,520	83024200
	9239294	9239294	Actro runner, 550 mm R - 40 Kg	1	Pc	1	1,520	83024200
	Actro Runners 60 kg							
	9239285	9239285	Actro runner, 450 mm L - 60 Kg	1	Pc	1	1,960	83024200
	9239286	9239286	Actro runner, 450 mm R - 60 Kg	1	Pc	1	1,960	83024200
	9239289	9239289	Actro runner, 500 mm L - 60 Kg	1	Pc	1	1,960	83024200
	9239290	9239290	Actro runner, 500 mm R - 60 Kg	1	Pc	1	1,960	83024200
	9239295	9239295	Actro runner, 550 mm L - 60 Kg	1	Pc	1	1,965	83024200
	9239296	9239296	Actro runner, 550 mm R - 60 Kg	1	Pc	1	1,965	83024200
	9239301	9239301	Actro runner, 650 mm L - 60 Kg	1	Pc	1	2,150	83024200
9239302	9239302	Actro runner, 650 mm R - 60 Kg	1	Pc	1	2,150	83024200	
	Actro Runners 80 kg							
	9239291	9239291	Actro runner, 500 mm L - 80 Kg	1	Pc	1	2,406	83024200
	9239292	9239292	Actro runner, 500 mm R - 80 Kg	1	Pc	1	2,406	83024200
	9239297	9239297	Actro runner, 550 mm L - 80 Kg	1	Pc	1	1,773	83024200
9239298	9239298	Actro runner, 550 mm R - 80 Kg	1	Pc	1	1,773	83024200	







Pull Out Shelf











Moving Corner







Cargo IQ 200

Product	Article No.	SAP	Item Description	Qty.	Unit	PU	MRP	HS Code	
CargoTech Plain Wire Basket (For 500 mm depth)									
 <p>Height- 100 mm</p>	9156381	9156381	(386 x 500 x 100) Cab.450 mm (15" x 20" x 4")	1	Pc	6	2,830	73239390	
	9156383	9156383	(386 x 500 x 150) Cab.450 mm (15" x 20" x 6")	1	Pc	4	3,334	73239390	
	9156384	9156384	(386 x 500 x 200) Cab.450 mm (15" x 20" x 8")	1	Pc	3	3,842	73239390	
	9156385	9156385	(436 x 500 x 100) Cab.500 mm (17" x 20" x 4")	1	Pc	6	3,072	73239390	
	9156386	9156386	(436 x 500 x 150) Cab.500 mm (17" x 20" x 6")	1	Pc	4	3,530	73239390	
	9156387	9156387	(436 x 500 x 200) Cab.500 mm (17" x 20" x 8")	1	Pc	3	4,065	73239390	
	9159547	9159547	(486 x 500 x 100) Cab.550 mm (19" x 20" x 4")	1	Pc	6	3,169	73239390	
	9159548	9159548	(486 x 500 x 150) Cab.550 mm (19" x 20" x 6")	1	Pc	4	3,728	73239390	
	9159549	9159549	(486 x 500 x 200) Cab.550 mm (19" x 20" x 8")	1	Pc	3	4,287	73239390	
	9156388	9156388	(536 x 500 x 100) Cab.600 mm (21" x 20" x 4")	1	Pc	6	3,338	73239390	
	9156389	9156389	(536 x 500 x 150) Cab.600 mm (21" x 20" x 6")	1	Pc	4	3,921	73239390	
	9156390	9156390	(536 x 500 x 200) Cab.600 mm (21" x 20" x 8")	1	Pc	3	4,504	73239390	
	 <p>Height- 150 mm</p>	9156391	9156391	(836 x 500 x 100) Cab.900 mm (33" x 20" x 4")	1	Pc	6	4,519	73239390
9156392		9156392	(836 x 500 x 150) Cab.900 mm (33" x 20" x 6")	1	Pc	4	5,279	73239390	
9156393		9156393	(836 x 500 x 200) Cab.900 mm (33" x 20" x 8")	1	Pc	3	6,040	73239390	
CargoTech Plain Wire Basket (For 550 mm depth)									
 <p>Height- 200 mm</p>		9156394	9156394	(386 x 550 x 100) Cab.450 mm (15" x 22" x 4")	1	Pc	6	3,002	73239390
	9156395	9156395	(386 x 550 x 150) Cab.450 mm (15" x 22" x 6")	1	Pc	4	3,521	73239390	
	9156396	9156396	(386 x 550 x 200) Cab.450 mm (15" x 22" x 8")	1	Pc	3	4,039	73239390	
	9156398	9156398	(436 x 550 x 100) Cab.500 mm (17" x 22" x 4")	1	Pc	6	3,317	73239390	
	9156399	9156399	(436 x 550 x 150) Cab.500 mm (17" x 22" x 6")	1	Pc	4	3,737	73239390	
	9156400	9156400	(436 x 550 x 200) Cab.500 mm (17" x 22" x 8")	1	Pc	3	4,286	73239390	
	9159550	9159550	(486 x 550 x 100) Cab.550 mm (19" x 22" x 4")	1	Pc	6	3,390	73239390	
	9159551	9159551	(486 x 550 x 150) Cab.550 mm (19" x 22" x 6")	1	Pc	4	3,924	73239390	
	9159552	9159552	(486 x 550 x 200) Cab.550 mm (19" x 22" x 8")	1	Pc	3	4,492	73239390	
	9156401	9156401	(536 x 550 x 100) Cab.600 mm (21" x 22" x 4")	1	Pc	6	3,995	73239390	
	9156402	9156402	(536 x 550 x 150) Cab.600 mm (21" x 22" x 6")	1	Pc	4	4,149	73239390	
	9156403	9156403	(536 x 550 x 200) Cab.600 mm (21" x 22" x 8")	1	Pc	3	4,806	73239390	
	9156404	9156404	(836 x 550 x 100) Cab.900 mm (33" x 22" x 4")	1	Pc	6	4,761	73239390	
9156405	9156405	(836 x 550 x 150) Cab.900 mm (33" x 22" x 6")	1	Pc	4	5,526	73239390		
9156406	9156406	(836 x 550 x 200) Cab.900 mm (33" x 22" x 8")	1	Pc	3	6,291	73239390		











Product	Article No.	SAP	Item Description	Qty.	Unit	PU	MRP	HS Code	
CargoTech Inlets (for 500 mm depth)									
 Thali Inlet	9156342	9156342	Thali Inlet, height-200 mm	1	Pc	5	1,153	73239390	
	9156343	9156343	Plate Inlet, height-200 mm	1	Pc	5	1,274	73239390	
	9156344	9156344	Cup & Saucer Inlet, height 150 mm	1	Pc	5	1,213	73239390	
	9156345	9156345	Saucer Inlet, height 100 mm	1	Pc	10	970	73239390	
	9156346	9156346	Cup Inlet, height 100 mm	1	Pc	10	848	73239390	
	9156347	9156347	Bottle Separator Inlet, height 200 mm	1	Pc	3	479	73239390	
	9156408	9156408	Basket Divider Inlet, height 100 mm	1	Pc	5	666	73239390	
	9156409	9156409	Basket Divider Inlet, height 150 mm	1	Pc	5	727	73239390	
	9156410	9156410	Basket Divider Inlet, height 200 mm	1	Pc	5	848	73239390	
	9190416	9190416	CT Inlet for 500 mm depth- 100 mm	1	Pc	10	848	73239390	
9190417	9190417	CT Inlet for 500 mm depth- 144 mm	1	Pc	10	910	73239390		
 Plate Inlet	CargoTech Inlets (for 550 mm depth)								
	9156411	9156411	Thali Inlet, height-200 mm	1	Pc	5	1,213	73239390	
	9156412	9156412	Plate Inlet, height-200 mm	1	Pc	5	1,396	73239390	
	9156413	9156413	Cup & Saucer Inlet, height 150 mm	1	Pc	5	1,274	73239390	
	9156414	9156414	Saucer Inlet, height 100 mm	1	Pc	10	1,032	73239390	
	9156415	9156415	Cup Inlet, height 100 mm	1	Pc	10	848	73239390	
	9156416	9156416	Bottle Separator Inlet, height 200 mm	1	Pc	3	540	73239390	
	9156417	9156417	Basket Divider Inlet, height 100 mm	1	Pc	5	727	73239390	
	9156419	9156419	Basket Divider Inlet, height 150 mm	1	Pc	5	848	73239390	
	9156420	9156420	Basket Divider Inlet, height 200 mm	1	Pc	5	910	73239390	
 Cup & Saucer Inlet	9190418	9190418	CT Cutlery Inlet-550 mm/100 mm width	1	Pc	10	910	73239390	
	9190419	9190419	CT Cutlery Inlet-550 mm/144 mm width	1	Pc	10	970	73239390	
 Saucer Inlet									
 Cup Inlet									
 Bottle Separator Inlet									
 Basket Divider Inlet									
 Cutlery Inlet									

Product	Article No.	SAP	Item Description	Qty.	Unit	PU	MRP	HS Code
Under Sink Basket Cargo Series								
	9190451	9190451	UnderSink Basket- 900 mm	1	Pc	1	6,665	73239390
Detergent Holder Cargo Series								
	9197058	9197058	Detergent Holder Cargo Series (Recommended shutter width 450 mm)	1	Set	1	1,838	73239390
Dish Drainer Set Cargo Series								
	9206160	9206160	Dish Drainer Set- 600 mm	1	Set	1	4,131	73239390
	9206161	9206161	Dish Drainer Set- 900 mm	1	Set	1	5,751	73239390
Pull Out Shelf - wall unit								
	9209343	9209343	W 536 mm x D 250 mm x H 41 Cab.600 mm	1	Set	2	2,222	73239390
	9210437	9210437	W 686 mm x D 250 mm x H 41 mm Cab.750 mm	1	Set	2	2,889	73239390
	9209346	9209346	W 836 mm x D 250 mm x H 41 Cab.900 mm	1	Set	2	3,458	73239390
CargoTech Accessories								
	1180142	1180142	Clamps for KA	1	Set	1	48	83024200
	9160975	9160975	Clamps for Quadro	1	Set	1	48	94039000
	9200681	9200681	Cargo IQ 200 Series Clamp for Quadro Left Set	1	Set	1	140	94039000
	9200682	9200682	Cargo IQ 200 Series Clamp for Quadro Right Set	1	Set	1	140	94039000
	9162315	9162315	End Connector for inlets	1	Set	1	29	94039000



Product	Article No.	SAP	Item Description	Qty.	Unit	PU	MRP	HS Code	
	CargoPlus (CP)								
	9216602	9216602	CP Plain W 312-470 NL IT Cab.450 mm	1	Pc	4	1,865	73239390	
	9216603	9216603	CP Plain W 462-470 NL IT Cab.600 mm	1	Pc	4	2,237	73239390	
	9216604	9216604	CP Plain W 762-470 NL IT Cab.900 mm	1	Pc	4	3,298	73239390	
	9216605	9216605	CP Plain W 312-520 NL IT Cab.450 mm	1	Pc	4	1,967	73239390	
	9216606	9216606	CP Plain W 462-520 NL IT Cab.600 mm	1	Pc	4	2,384	73239390	
	9216607	9216607	CP Plain W 762-520 NL IT Cab.900 mm	1	Pc	4	3,375	73239390	
	CargoPlus (Thali Inlets)								
	9216608	9216608	CP Thali W 312-470 NL IT Cab.450 mm	1	Pc	3	2,166	73239390	
	9216611	9216611	CP Thali W 312-520 NL IT Cab.450 mm	1	Pc	3	2,236	73239390	
	9216614	9216614	CP Thali W 462-470 NL IT Cab.600 mm	1	Pc	3	2,450	73239390	
	9216617	9216617	CP Thali W 462-520 NL IT Cab.600 mm	1	Pc	3	2,590	73239390	
	CargoPlus (Plate Inlets)								
	9216609	9216609	CP Plate W 312-470 NL IT Cab.450 mm	1	Pc	4	2,237	73239390	
	9216612	9216612	CP Plate W 312-520 NL IT Cab.450 mm	1	Pc	4	2,307	73239390	
	9216615	9216615	CP Plate W 462-470 NL IT Cab.600 mm	1	Pc	4	2,690	73239390	
	9216618	9216618	CP Plate W 462-520 NL IT Cab.600 mm	1	Pc	4	2,826	73239390	
	CargoPlus (Cup & Saucer Inlets)								
	9216610	9216610	CP Cup & Saucer W 312-470 NL IT Cab.450 mm	1	Pc	6	2,130	73239390	
	9216613	9216613	CP Cup & Saucer W 312-520 NL IT Cab.450 mm	1	Pc	6	2,227	73239390	
	9216616	9216616	CP Cup & Saucer W 462-470 NL IT Cab.600 mm	1	Pc	6	2,563	73239390	
	9216619	9216619	CP Cup & Saucer W 462-520 NL IT Cab.600 mm	1	Pc	6	2,695	73239390	
	CargoPlus (Thali/Plate Inlets)								
	9216620	9216620	CP Thali/Plate W 762-470 NLIT Cab.900 mm	1	Pc	3	3,556	73239390	
	9216621	9216621	CP Thali/Plate W 762-520 NL IT Cab.900 mm	1	Pc	3	3,731	73239390	

Product	Article No.	SAP	Item Description	Qty.	Unit	PU	MRP	HS Code
CargoTech M (Plain Wire Basket - 500 mm depth) with KA clamps								
	9190382	9190382	CTM Plain (386x500x100) Cab.450 mm	1	Pc	6	1,865	73239390
	9190383	9190383	CTM Plain (386x500x150) Cab.450 mm	1	Pc	4	2,261	73239390
	9190384	9190384	CTM Plain (386x500x200) Cab.450 mm	1	Pc	3	2,571	73239390
	9190385	9190385	CTM Plain (436x500x100) Cab.500 mm	1	Pc	6	1,950	73239390
	9190386	9190386	CTM Plain (436x500x150) Cab.500 mm	1	Pc	4	2,303	73239390
	9190387	9190387	CTM Plain (436x500x200) Cab.500 mm	1	Pc	3	2,814	73239390
	9190388	9190388	CTM Plain (486x500x100) Cab.550 mm	1	Pc	6	2,051	73239390
	9190389	9190389	CTM Plain (486x500x150) Cab.550 mm	1	Pc	4	2,477	73239390
	9190390	9190390	CTM Plain (486x500x200) Cab.550 mm	1	Pc	3	2,942	73239390
	9190401	9190401	CTM Plain (536x500x100) Cab.600 mm	1	Pc	6	1,897	73239390
	9190402	9190402	CTM Plain (536x500x150) Cab.600 mm	1	Pc	4	2,277	73239390
	9190403	9190403	CTM Plain (536x500x200) Cab.600 mm	1	Pc	3	2,657	73239390
	9190404	9190404	CTM Plain (836x500x100) Cab.900 mm	1	Pc	6	2,805	73239390
	9190405	9190405	CTM Plain (836x500x150) Cab.900 mm	1	Pc	4	3,389	73239390
	9190406	9190406	CTM Plain (836x500x200) Cab.900 mm	1	Pc	3	4,018	73239390
CargoTech M (Thali Inlet)								
	9194315	9194315	CTM Thali (386x500x200) Cab.450 mm	1	Pc	3	2,798	73239390
	9194317	9194317	CTM Thali (436x500x200) Cab.500 mm	1	Pc	3	3,029	73239390
	9194319	9194319	CTM Thali (486x500x200) Cab.550 mm	1	Pc	3	3,299	73239390
CargoTech M (Cup & Saucer Inlet)								
	9194314	9194314	CTM Cup & Saucer (386x500x100) Cab.450 mm	1	Pc	6	2,333	73239390
CargoTech M (Saucer/Jar Inlet)								
	9194316	9194316	CTM Cup & Saucer/Jar (436x500x100) Cab.500 mm	1	Pc	6	2,611	73239390
	9194318	9194318	CTM Cup & Saucer/Jar (486x500x100) Cab.550 mm	1	Pc	6	3,173	73239390
	9194320	9194320	CTM Cup & Saucer/Jar (536x500x100) Cab.600 mm	1	Pc	6	3,173	73239390
CargoTech M (Thali/Jar Inlet)								
	9194321	9194321	CTM Thali/Jar (536x500x200) Cab.600 mm	1	Pc	3	3,373	73239390
CargoTech M (Thali/Plate/Jar Inlet)								
	9194322	9194322	CTM Thali/Plate/Jar (836x500x200) Cab.900 mm	1	Pc	3	4,773	73239390

Product	Article No.	SAP	Item Description	Qty.	Unit	PU	MRP	HS Code
CargoTech M (Plain Wire Basket - 550 mm depth) with KA clamps								
	9206742	9206742	CTM Plain (386x550x100) Cab.450 mm	1	Pc	6	2,045	73239390
	9206743	9206743	CTM Plain (386x550x150) Cab.450 mm	1	Pc	4	2,421	73239390
	9206744	9206744	CTM Plain (386x550x200) Cab.450 mm	1	Pc	3	2,850	73239390
	9206745	9206745	CTM Plain (436x550x100) Cab.500 mm	1	Pc	6	2,146	73239390
	9206746	9206746	CTM Plain (436x550x150) Cab.500 mm	1	Pc	4	2,535	73239390
	9206747	9206747	CTM Plain (436x550x200) Cab.500 mm	1	Pc	3	2,998	73239390
		9206778	9206778	CTM Plain (486x550x100) Cab.550 mm	1	Pc	6	2,248
9206779		9206779	CTM Plain (486x550x150) Cab.550 mm	1	Pc	4	2,643	73239390
9206780		9206780	CTM Plain (486x550x200) Cab.550 mm	1	Pc	3	3,133	73239390
9206982		9206982	CTM Plain (536x550x100) Cab.600 mm	1	Pc	6	2,283	73239390
9206985		9206985	CTM Plain (536x550x150) Cab.600 mm	1	Pc	4	2,766	73239390
	9206987	9206987	CTM Plain (536x550x200) Cab.600 mm	1	Pc	3	3,256	73239390
	9206988	9206988	CTM Plain (836x550x100) Cab.900 mm	1	Pc	6	2,979	73239390
	9206990	9206990	CTM Plain (836x550x150) Cab.900 mm	1	Pc	4	3,615	73239390
	9206991	9206991	CTM Plain (836x550x200) Cab.900 mm	1	Pc	3	4,240	73239390
CargoTech M (Thali Inlet)								
	9206841	9206841	CTM Thali (386x550x200) Cab.450 mm	1	Pc	3	3,078	73239390
	9206843	9206843	CTM Thali (436x550x200) Cab.500 mm	1	Pc	3	3,253	73239390
	9206845	9206845	CTM Thali (486x550x200) Cab.550 mm	1	Pc	3	3,575	73239390
CargoTech M (Cup & Saucer Inlet)								
	9206840	9206840	CTM Cup & Saucer (386x550x100) Cab.450 mm	1	Pc	6	2,611	73239390
CargoTech M (Saucer/Jar Inlet)								
	9206842	9206842	CTM Cup & Saucer/Jar (436x550x100) Cab.500 mm	1	Pc	6	2,892	73239390
	9206844	9206844	CTM Cup & Saucer/Jar (486x550x100) Cab.550 mm	1	Pc	6	3,453	73239390
	9207004	9207004	CTM Cup & Saucer/Jar (536x550x100) Cab.600 mm	1	Pc	6	3,548	73239390
CargoTech M (Thali/Jar Inlet)								
	9207007	9207007	CTM Thali/Jar (536x550x200) Cab.600 mm	1	Pc	3	3,732	73239390
CargoTech M (Thali/Plate/Jar Inlet)								
	9207010	9207010	CTM Thali/Plate/Jar (836x550x200) Cab.900 mm	1	Pc	3	5,574	73239390







Product	Article No.	SAP	Item Description	Qty.	Unit	PU	MRP	HS Code
	Moving Corner for blind corner cabinet, 900 / 1000 mm width							
	9221242	9221242	Moving Corner Cargo Series set of 4 baskets	1	Set	1	6,952	73239390
	9221243	9221243	Moving Corner Cargo Series Right mechanism	1	Pc	1	26,507	94039010
	9221244	9221244	Moving Corner Cargo Series Left mechanism	1	Pc	1	26,507	94039010
	Carousel							
	70549	9083464	Carousel D-1/2 for Ø750 Arena Classic	1	Set	1	34,513	94039010
	70550	9083480	Carousel D-1/2 for Ø850 Arena Classic	1	Set	1	37,161	94039010
	Carousel cargo series							
	9219462	9219462	Cargo 3/4 Carousel 2 Shelves 2 Flat Chrome White Base	1	Set	1	23,653	94039010
	9219465	9219465	Cargo 3/4 Carousel M 2 Shelves 1 Round Chrome White Base	1	Set	1	20,498	94039010
	CargoMan for Blind corner cabinet, 900/1000 mm width							
	9161971	9161971	450 LH (Double layer)	1	Set	1	30,154	94039010
	9161972	9161972	450 RH (Double layer)	1	Set	1	30,154	94039010
	9161973	9161973	500 LH (Double layer)	1	Set	1	33,129	94039010
	9161974	9161974	500 RH (Double layer)	1	Set	1	33,129	94039010
	Cargoman Soft Close for Blind corner cabinet, 900/1000 mm width							
	9218025	9218025	450 LH (Double layer)	1	Set	1	33,538	94039010
	9218026	9218026	450 RH (Double layer)	1	Set	1	33,538	94039010
	9218027	9218027	500 LH (Double layer)	1	Set	1	34,707	94039010
	9218028	9218028	500 RH (Double layer)	1	Set	1	34,707	94039010
	Cargoman M for Blind corner cabinet, 900/1000 mm width							
	9218021	9218021	450 LH (Double layer)	1	Set	1	24,308	94039010
	9218022	9218022	450 RH (Double layer)	1	Set	1	24,308	94039010
	9218023	9218023	500 LH (Double layer)	1	Set	1	29,188	94039010
	9218024	9218024	500 RH (Double layer)	1	Set	1	29,188	94039010
	Waste-Bin.It Classic							
	9154601	9154601	Body Stainless steel with Black plastic Bin, 13 litres capacity (Min. cabinet width 400 mm)	1	Set	1	3,349	73239990
	9218233	9218233	Body White lacquered with White plastic Bin, 13 litres capacity (Min. cabinet width 400 mm)	1	Set	1	2,566	73239990

Product	Article No.	SAP	Item Description	Qty.	Unit	PU	MRP	HS Code
Cleaning Utensil Pull-out								
	73549	9148880	Pull-out basket (1 x 96) + (1 x 185) width	1	Set	1	10,916	94039010
Cargo IQ 200 (Bottle Pull out - 2 tier)								
	9161045	9161045	For Cabinet width 150 mm	1	Pc	4	6,571	73239390
	9161046	9161046	For Cabinet width 200 mm	1	Pc	3	7,725	73239390
	9161047	9161047	For Cabinet width 300 mm	1	Pc	2	8,875	73239390
	9160975	9160975	Quadro clamps (as per requirement)	1	set	1	48	94039000
	1180142	1180142	Telescopic clamps (as per requirement)	1	set	1	48	83024200
	73280	73280	KA 5632, Zinc 450 mm	1	set	1	528	83024200
	9114275	9114275	KA 4532, Silent 450 mm	1	set	1	1,022	83024200
	45291-L	9099124	Quadro full Extn.Silent System 450 mm 30 kg	1	Pc	1	1,160	83024200
	45291-R	9099125	Quadro full Extn.Silent System 450 mm 30 kg	1	Pc	1	1,160	83024200
Cargo IQ 300 (Bottle Pull out - 2 tier) - Compatible with KA runners only								
	9191703	9191703	For Cabinet width 150 mm	1	Pc	4	3,652	73239390
	9191708	9191708	For Cabinet width 200 mm	1	Pc	3	4,335	73239390
	9191711	9191711	For Cabinet width 300 mm	1	Pc	2	5,019	73239390
	1180142	1180142	Telescopic clamps (as per requirement)	1	Set	1	48	83024200
	73280	73280	KA 5632, Zinc 450 mm	1	Set	1	528	83024200
	9114275	9114275	KA 4532, Silent 450 mm	1	Set	1	1,022	83024200
	Spice Pull Out 3 tier - Compatible with KA runners only							
	9210439	9210439	For Cabinet width 150 mm	1	Pc	4	4,346	73239390
	9210441	9210441	For Cabinet width 200 mm	1	Pc	3	4,950	73239390
	9210442	9210442	For Cabinet width 300 mm	1	Pc	2	5,426	73239390
Cosario								
	9062032	9062032	600 mm width	1	Set	1	55,840	94039010
	9062035	9062035	900 mm width	1	Set	1	62,426	94039010
TopFlex worktop extension								
	43733	9207632	TopFlex worktop extension Variable in width for cabinet 450-900 mm	1	Pc	1	30,678	94039010
Parallel Swing-out Mechanism for slicer								
	49144	9083572	Parallel Swivel Mechanism 2 Springs (Inside cabinet width 410-570 mm)	1	Pc	1	17,829	94039010













Product	Article No.	SAP	Item Description	Qty.	Unit	PU	MRP	HS Code		
	Waterproof mat									
	9079862	9079862	1200X580 Polystyrene, aluminium look	1	Pc	1	3,447	94039090		
	Wicker Baskets with wooden Runner									
	41895	41895	320 x 500 x 120 (cabinet width 400 mm)	1	Pc	1	7,416	46021091		
	41898	41898	320 x 500 x 210 (cabinet width 400 mm)	1	Pc	1	7,194	46021091		
	41902	41902	320 x 500 x 300 (cabinet width 400 mm)	1	Pc	1	7,541	46021091		
	41896	41896	420 x 500 x 120 (cabinet width 500 mm)	1	Pc	1	7,783	46021091		
	41899	41899	420 x 500 x 210 (cabinet width 500 mm)	1	Pc	1	7,349	46021091		
	41903	41903	420 x 500 x 300 (cabinet width 500 mm)	1	Pc	1	7,961	46021091		
	41897	41897	520 x 500 x 120 (cabinet width 600 mm)	1	Pc	1	8,272	46021091		
	41901	41901	520 x 500 x 210 (cabinet width 600 mm)	1	Pc	1	7,809	46021091		
	41904	41904	520 x 500 x 300 (cabinet width 600 mm)	1	Pc	1	9,210	46021091		
	41906	41906	Beech Runner for cabinet side 18-19 mm (Order Beech runners separately)	1	Set	1	1,340	94039030		
	Round Bin Holder									
	9210443	9210443	Cargo Round Bin Holder 100 Series	1	Pc	1	711	73239390		
	9210444	9210444	Cargo Round Bin Holder 200 Series (Recommended shutter width 450 mm)	1	Pc	1	1,202	73239390		
	Cargo Cylinder Trolley									
	9210445	9210445	Cylinder Trolley (Minimum cabinet width 400 mm)	1	Pc	1	1,396	73239390		
	Cargo Duo		For outer cabinet width (mm)	For inside carcase width (mm)	Min. inside carcase height (mm)					
	9236364	9236364	450	410	1215 4-tier	1	Set	1	48,900	94039010
	9236366	9236366	450	410	1800 6-tier	1	Set	1	50,477	94039010
	9236365	9236365	600	560	1215 4-tier	1	Set	1	48,900	94039010
	9236367	9236367	600	560	1800 6-tier	1	Set	1	50,477	94039010
	Pull out basket & Door shelf									
	9235979	9235979	For 450 mm cabinet width Pull Out Basket (360 x 220 x 90 mm) Door Shelf Basket (335 x 110 x 90 mm)	1	Set	2	1,841	73239390		
	9235980	9235980	For 600 mm cabinet width Pull Out Basket (510 x 220 x 90 mm) Door Shelf Basket (485 x 110 x 90 mm)	1	Set	2	2,307	73239390		

Product	Article No.	SAP	Item Description	Qty.	Unit	PU	MRP	HS Code	
	Cargo Larder Basket Holder								
	9236391	9236391	For 450 mm cabinet width	1	Set	1	315	94039010	
	Carcase outer width (mm) Full extension Runner 80 kg								
	9236381	9236381	300	1	Set	1	22,549	94039010	
	9236382	9236382	400	1	Set	1	22,549	94039010	
	9236383	9236383	450	1	Set	1	22,549	94039010	
	Carcase outer width (mm) Full extension Runner 120 kg								
	9236386	9236386	300	1	Set	1	24,916	94039010	
	9236387	9236387	400	1	Set	1	24,916	94039010	
	9236388	9236388	450	1	Set	1	24,916	94039010	
	Stainless Steel Baskets W x D x H (mm)								
	9235981	9235981	300 (230 x 435 x 115)	4	Pc	4	10,440	94039010	
	9235982	9235982	400 (330 x 435 x 115)	4	Pc	4	11,136	94039010	
	9235983	9235983	450 (380 x 435 x 115)	4	Pc	4	11,828	94039010	
	Cargo Larder (Frame)		Min. inside carcase width	Carcase outer width					
	For Inside carcase height 1615 -1915 mm for 5 layers								
	9236379	9236379	262 (mm)	300 (mm)	1	Set	1	11,362	94039010
			362 (mm)	400 (mm)	1	Set	1	11,362	94039010
			412 (mm)	450 (mm)	1	Set	1	11,362	94039010
	For Inside carcase height 1880 -2180 mm for 6 layers								
	9236380	9236380	262 (mm)	300 (mm)	1	Set	1	11,362	94039010
			362 (mm)	400 (mm)	1	Set	1	11,362	94039010
			412 (mm)	450 (mm)	1	Set	1	11,362	94039010
									

Product	Article No.	SAP	Item Description	Qty.	Unit	PU	MRP	HS Code
	Garment Lift							
	9079878	9079878	Duo Lift 10 (10Kg) Inside cabinet width 750-1170 mm	1	Pc	1	5,629	83024200
	42507	42507	Duo Lift 15 (15Kg) Inside cabinet width 750-1150 mm	1	Pc	1	6,582	83024200
	9079882	9079882	Duo Lift 18 (18Kg) Inside cabinet width 750-1150 mm	1	Pc	1	9,342	83024200
	Wardrobe Tube & Wardrobe Tube Support							
	47615	47615	Oval cabinet rail 2000 mm Chrome Gloss	1	Pc	10	1,095	73066990
	70664	9056579	Cabinet rail Support SL 322 (3 screw holes)	1	Pc	10	30	83024200
	70666	9056573	Cabinet rail Support SL 323 (2 pins+1 screw hole)	1	Pc	10	35	83024200
	Built-in Ironing Board							
45541	45541	Ironing Board Extension (Minimum inside cabinet width 360 - 468 mm)	1	Set	1	19,566	94039090	
	Cargo Pull Out Shoe Rack (Vertical)							
9209340	9209340	Cargo Pull Out Shoe Rack with accessory plate. For internal cabinet height 750 mm (W X D X H) - 279 x 500 x 580 mm (KA runner & clamps to be ordered separately)	1	Set	1	5,226	73262090	
	Cargo Pull Out Shoe Rack (Horizontal)							
	9217067	9217067	For 600 mm cabinet width with accessory plate.	1	Set	1	4,320	73262090
	9211635	9211635	For 900 mm cabinet width with accessory plate. (KA / Quadro runner & clamps to be ordered separately)	1	Set	1	5,409	73262090
	Pull Out Shelf							
	9209345	9209345	W 536 x D 500 x H 41, Cabinet 600 mm	1	Set	1	5,197	73262090
	9210438	9210438	W 686 mm x D 500 mm x H 41 mm Cab.750 mm	1	Set	1	5,839	73262090
	9209348	9209348	W 836 x D 500 x H 41, Cabinet 900 mm	1	Set	1	6,487	73262090

Product	Article No.	SAP	Item Description	Qty.	Unit	PU	MRP	HS Code
	Cargo Trousler Pull Out							
	9221098	9221098	Cargo trouser pull out (W X D X H) - 536 x 500 x 120 mm	1	Pc	1	7,264	73262090
	9236898	9236898	Cargo trouser pull out (W X D X H) - 836 x 500 x 120 mm (KA runner & clamps to be ordered separately)	1	Pc	1	8,277	73262090
	Cargo Trousler Pull Out M							
	9243990	9243990	Cargo trouser pull out (W X D X H) - 320 x 500 x 142 mm (KA runner & clamps to be ordered separately)	1	Pc	1	6,286	73262090
	Cargo Tie & Belt Pull Out							
	9221099	9221099	Cargo tie & belt pull out (W X D X H) - 125 x 500 x 100 mm (KA runner & clamps to be ordered separately)	1	Pc	1	6,216	73262090
	Cargo Tie & Belt Pull Out M							
	9243991	9243991	Cargo tie & belt pull out M (W X D X H) - 110 x 500 x 68 mm (KA runner & clamps to be ordered separately)	1	Pc	1	5,238	73262090
	Cargo wall shoe rack (M)							
	9243992	9243992	Cargo wall shoe rack (M) (W X D X H) - 500 x 210 x 238 mm (KA runner & clamps to be ordered separately)	1	Pc	1	3,452	73262090
	Cargo Laundry							
	9241012	9241012	Cargo Laundry (W X D X H) - 220 x 500 x 580 mm (KA runner & clamps to be ordered separately)	1	Pc	1	5,110	73262090

Product	Article No.	SAP	Item Description	Qty.	Unit	PU	MRP	HS Code
Shelf Supports								
	16180	16180	Safety 5 mm Translucent.	100	Pc	1000	277	83024200
	25090	9127419	Safety 5 mm White	100	Pc	1000	277	83024200
	53012	1011027	Sekura7 Nickel	100	Pc	1000	1,039	83024200
	22737	1006203	Universal D Nickel	100	Pc	1000	554	83024200
	25100	9010111	Sekura2 Nickel	100	Pc	1000	600	83024200
	79707	9005558	Support Sekura6 Nickel	100	Pc	1000	1,014	83024200
	19557	9010110	Sekura1.1 Nickel	100	Pc	1000	662	83021090
	79709	1056163	PVC/Steel 5 mm for Glass shelf	100	Pc	1000	277	83024200
	47609	1010564	Sekura8 Nickel for Glass shelf	100	Pc	1000	1,234	83024200
	47661	1069728	Titan min. shelf thickness 24 mm	1	Pc	20	91	83024200
Suspension Brackets								
	79724-L	1066278	SAH 130 Steel/PVC White Left	1	Pc	25	62	83024200
	79724-R	1066279	SAH 130 Steel/PVC White Right	1	Pc	25	62	83024200
	79725-L	1066339	Cover Cap Left For SAH 130 White	100	Pc	25	916	39269097
	79725-R	1066338	Cover Cap Right For SAH 130 White	100	Pc	25	916	39269097
	9007651	9000169	Rail B 3000 mm Zinc	1	Pc	1	857	83024200
	9208678	9208678	Rail L 130 mm Zinc	1	Pc	1	79	83024200
	46103	46103	Suspension Hook Ø6 X 50 mm + Wall pulg Ø8 X 40 mm	100	Pc	100	1,893	83024200
	65480	65480	Special screw Ø5.5 x 50 mm + Wall pulg Ø8 X 40 mm	100	Pc	100	2,020	83024200
Rastex- 3 Part Set								
	13958	9056601	Rastex 15/18 Zinc/Nickel Cam	100	Pc	2000	600	83024200
	20157	9047865	Twister screw in Dowel DU644 - M6 x 7.8 mm	100	Pc	2000	500	73181499
	79539	1004928	Socket No.33 - 10 mm, Plastic	100	Pc	2,000	300	39269097

Product	Article No.	SAP	Item Description	Qty.	Unit	PU	MRP	HS Code
	Rastex- 2 Part Set							
	13958	9056601	Rastex 15/18 Zinc/Nickel Cam	100	Pc	2000	600	83024200
	20058	9047861	Twister screw in Dowel DU 232T - Ø 5 mm	100	Pc	2000	500	73181499
	Rastex Cover Cap for Rastex 15 without rim							
	71054	1008524	Cover Cap Rastex 15 White	100	Pc	5000	92	39269097
	71055	1008525	Cover Cap Rastex 15 Brown	100	Pc	5000	92	39269097
	79490	1009563	Cover Cap Rastex 15 Black	100	Pc	5000	92	39269097
	Rastex Misc.							
	40005	1004925	Socket (Plastic) NR 49 - 8 mm	100	Pc	10000	200	39269097
	79458	9064684	Rastex (Cam) 15/15 nickel plated.	100	Pc	2000	600	83024200
	79568	1079580	Double Dowel Du853 chrome with seeger circle ring	1	Pc	2000	27	83024200
	48578	48578	Expanding Socket M4 Brass 5 mm	100	Pc	2000	560	83024200
	Rapid Dowels							
	45758	9046182	Rapid S DU 332-8mm stern 30 mm	100	Pc	200	629	73182900
	44758	9046184	Rapid S DU 332-10mm stern 20mm	100	Pc	200	567	73181499
	44759	9046186	Rapid S DU 332-10mm stern 30mm	100	Pc	200	623	73182900
	VB Connectors							
	47454	47454	VB 21 for 19 - 20 mm shelves, without rib.	1	Pc	200	58	83024200
	25052	9039828	Screw in dowel DU 327 Steel Bright, Drill dia 5 mm	100	Pc	2000	579	73181499
	65515	9116929	VB 35 / 19 for 19 mm shelves, without rib. White	1	Pc	200	14	94039010
	74688	74688	Screw in dowel DU 321, Drill dia 5 mm	100	Pc	2000	628	83024200
	Connectors Misc.							
	65523	9129805	VB 36M/19 White	100	Pc	2000	1,662	83024200
	9039828	9039828	DU 265 Dowel Steel Bright	100	Pc	2000	579	73181499
	79650	79650	Screw in dowel DU 648, M6 x 7.8 mm thread	100	Pc	2000	755	73181900
	48586	48586	Cone-Shaped Plug Ø5 white	100	Pc	2000	92	39263000
	1996097	1996097	Socket M6 WZ.LJ205A	100	Pc	2000	500	73181500
	Fanke Fittings							
	9060089	9060089	Franko-Flex 90°, 10 Positions (44745)	1	Pc	100	600	83024200
	9130900	9130900	Cover Cap Chrome for Round Link Vario-Flex	1	Pc	100	155	83024200
	9125137	9125137	Vario-Flex 0-90° with Round Link Chromed	1	Pc	100	718	83024200
	9125138	9125138	Vario-Flex 270-360° with Round Link Chromed	1	Pc	100	718	83024200

Product	Article No.	SAP	Item Description	Qty.	Unit	PU	MRP	HS Code
Cabinet Connector								
	79659	1072394	VHS 32/35 28-36 mm	100	Pc	1000	432	73181692
	79660	1072393	VHS 32/35 36-44 mm	100	Pc	1000	556	73181900
	1058986	1058986	VHS Screw SMG M4x15	100	Pc	2000	185	73181558
Misc Fittings								
	46080	1009684	Multi-Clip PVC Black	100	Pc	200	1,925	39263000
	79665	9113735	Universal angle 31x31 mm	100	Pc	1000	1,477	83024200
Plastic Socket								
	48577	1004932	Expanding Socket 43 Ø5 L13 PL	100	Pc	10000	106	39269097
	48576	1004933	Expanding Socket 66 Ø5 L9 PL	100	Pc	10000	144	39269097
	45169	1001097	T43 Hinge Screws Ø10 x 11 mm	100	Pc	1000	329	39269097
	1058613	1058613	T43 Hinge Sockets Ø10 mm	100	Pc	1000	556	39269097
Wooden Dowel								
	69241	9102465	Ø8.0x 40 mm	100	Pc	2000	92	44219999
Magnetic Catches								
	13142	13142	M72/GP2, 4 kg holding force, Brown	1	Pc	50	53	85051100
Locks								
	43635	43635	Multi-Purpose Square Lock 22mm - 200 KC	1	Set	100	195	83013000
	9110389	9110389	Multi-Purpose Square Lock 32mm - 200 KC	1	Set	100	205	83013000
	9219182	9219182	Multi-Purpose Square Lock 32mm - 400 KC	1	Set	100	196	83013000
	43637	43637	Multi-drawer Pedestal Lock 600mm - 200 KC	1	Set	100	323	83013000
	9219491	9219491	Multi-drawer Pedestal Lock 600mm - 400 KC	1	Set	100	317	83013000
	9236413	9236413	MD Lock 200KC, Foldable key	1	Set	100	301	83013000
	9236415	9236415	MD Lock 400KC, Foldable key	1	Set	100	326	83013000
	9236417	9236417	MP Lock 400KC, Foldable key	1	Set	100	279	83013000
	9246395	9246395	MP Lock 400K with Foldable Et Master key	1	Set	100	238	83013000
	9246396	9246396	MD Lock 400KC with Foldable Et Master key without Rod	1	Set	100	275	83013000
	30125	30125	Stop bracket Type-3011	10	Pc	100	330	83024200
Cylinder Cam Lock								
	9227175	9227175	Cylinder cam lock Fix Barrel 200KC - 2 mm crank	1	Set	200	155	83013000
	9227176	9227176	Cylinder cam lock Fix Barrel 200KC - Flat cam	1	Set	200	155	83013000
	9227177	9227177	Cylinder cam lock Fix Barrel 200KC -11 mm crank	1	Set	200	155	83013000
Push Lock								
	9180613	9180613	Push-Lock 22mm 200 KC with Master Key	1	Set	200	175	83013000
	9182732	9182732	Push-Lock 32mm 200 KC with Master Key	1	Set	200	213	83013000

Product	Article No.	SAP	Item Description	Qty.	Unit	PU	MRP	HS Code
	Espagnolette Cabinet Lock For 20 mm Doors Upto 8 ft							
	9136128	9136128	Prestige 2000 Set Z23 Dia 18 mm - 20 mm	1	Set	10	1,328	83013000
	72251	72251	Espagnolette rod 1000 mm length	1	Set	10	212	83013000
	72253	72253	Espagnolette rod 1500 mm length	1	Set	10	321	83013000
	9078861	9078861	Lock Barrel+Keys Z23 18001-18050	1	Set	10	404	83013000
			Total				2,265	
	Espagnolette Cabinet Lock For 26 mm Doors Upto 8 ft							
	9154261	9154261	Prestige 2000 Set Z23 Dia 18 mm - 26 mm	1	Set	10	1,366	83013000
	72251	72251	Espagnolette rod 1000 mm length	1	Set	10	212	83013000
	72253	72253	Espagnolette rod 1500 mm length	1	Set	10	321	83013000
	9078861	9078861	Lock Barrel+Keys Z23 18001-18050	1	Set	10	527	83013000
			Total				2,426	
	Cylinder Lock Set for 3-Door Sliding-Door Cabinets (Max Door Width=1200 mm; Thickness 20-22 mm)							
	9133927	9133927	3 Door Sliding Lock Set Z23 Dia 18 mm	1	Set	10	1,963	83013000
	9078861	9078861	Lock Barrel+Keys Z23 18001-18050	1	Set	10	527	83013000
			Total				2,490	
	Cylinder Lock Set for 2-Door Sliding-Door Cabinets (Max Door Width=1500 mm; Thickness 20-28 mm)							
	9133926	9133926	2 Door Sliding Lock Set Z23 Dia 18 mm	1	Set	10	1,374	83013000
	9078861	9078861	Lock Barrel+Keys Z23 18001-18050	1	Set	10	527	83013000
			Total				1,901	
	Automatic Door Bolt Nickel							
48259	48259	Automatic Door Bolt Nickel	1	Pc	10	632	83013000	
	Euro Adjustable Legs							
	40438	40438	Base Adjustable Stop 60-80 A	1	Pc	100	386	39263000
	71840	71840	Euro-Base Adjustable 100 mm	1	Pc	100	36	39263000
	71841	71841	Euro-Base Adjustable 130 mm	1	Pc	100	51	39263000
	71842	71842	Euro-Base Adjustable 150 mm	100	Pc	100	4,300	39263000
	71847	71847	Euro-PC Fixing Block Screw-On.	1	Pc	100	30	39263000
	71845	71845	Euro-PC Clips Screw-On	100	Pc	100	739	39263000
9020484	9020484	Euro-Base Plinth Plate Screw-On Self Colour	100	Pc	100	295	39263000	
	Blue Max Mini Machine							
	20264	20264	Blue Max Mini T2/6 230V 50 HZ 1 PH 53,951	1	Pc	1	53,951	84651010
	20485	20485	Fence Extension with Scale	1	Set	1	2,742	84669200
	20486	20486	Holder For Fence Extension	1	Set	1	1,842	84669200
	20487	20487	Set Of Fixed Stop	1	Set	1	720	84669200
	20488	20488	Pendulum Stop For Fence- 61265	2	Set	2	1,234	84669200
	20490	20490	Set Of Drill Bits For Hinges	1	Set	1	4,108	82075060
	20492	20492	Set Of Drill Bits For VB 18/19/20/21	2	Set	2	6,742	82075060
	20498	20498	Drill Bit D. 5 mm Left Hand	2	Pc	2	1,236	82075060
	20499	20499	Drill Bit D. 2 mm Left Hand	2	Pc	2	2,014	82075060
	9242840		Total				74,589	



Ispani





















Lupia

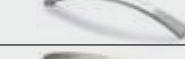

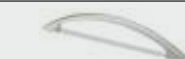
Soria



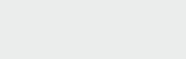

Luro

Product	Article No.	SAP	Hole Distance	Finish	Qty.	Unit	PU	MRP	HS Code
Econ Handle									
Adonia 	1180122	1180122	96	Nickel Matt	1	Pc	200	87	83024200
	1180121	1180121	128	Nickel Matt	1	Pc	150	135	83024200
Alano 	1180167	1180167	96	Nickel Matt	1	Pc	200	92	83024200
	1180166	1180166	128	Nickel Matt	1	Pc	125	136	83024200
Ancona 	9995081	1161173	96	Nickel Matt	1	Pc	200	82	83024200
	9995077	1161167	128	Nickel Matt	1	Pc	150	122	83024200
Agacia 	9220976	9220976	96	Nickel Matt	1	Pc	50	69	83024200
	9220978	9220978	128	Nickel Matt	1	Pc	50	108	83024200
Agacia 	9220975	9220975	96	Bright Chrome	1	Pc	50	62	83024200
	9220977	9220977	128	Bright Chrome	1	Pc	50	99	83024200
Andera 	9220980	9220980	96	Nickel Matt	1	Pc	50	64	83024200
	9220982	9220982	128	Nickel Matt	1	Pc	50	112	83024200
Andera 	9220979	9220979	96	Bright Chrome	1	Pc	50	58	83024200
	9220981	9220981	128	Bright Chrome	1	Pc	50	103	83024200
ProDecor Handles									
Baldone 	9995780	1161398	160	Bright Chrome	1	Pc	30	204	83024200
	9995781	1161399	160	Stainless steel	1	Pc	30	456	83024200
Evisa 	9113502	9113502	128	Stainless steel	1	Pc	30	456	83024200
	9113501	9113501	128	Bright Chrome	1	Pc	30	212	83024200
Nidum 	9071071	9071071	128	Aluminium	1	Pc	25	645	94039000
	9071073	9071073	160	Aluminium	1	Pc	25	494	83024200
Neapolis 	115122	9160301	96	Bright chrome	1	Pc	25	768	83024200
Parma 	9113468	9113468	96	Bright chrome	1	Pc	50	475	83024200
Salona 	1170155	1170155	160	Stainless steel	1	Pc	30	282	83024200
Tolfo 	9097900	9097900	32	Bright chrome	1	Pc	25	1,156	83024200
Tolosa 	9113514	9113514	128	Nickel Matt	1	Pc	25	252	83024200
Calisia 	9125758	9125758	128	Aluminium	1	Pc	50	688	83024200
Intra 	9113800	9113800	192	Bright Chrome	1	Pc	25	1,033	83024200
Messana 	115157	9211117	32	Bright Chrome	1	Pc	50	574	83024200
Clivia 	115218	9125428	2x664	Aluminium	1	Pc	25	3,780	83024200
Riol 	9145716	9145716	32	Bright Chrome	1	Pc	50	692	83024200

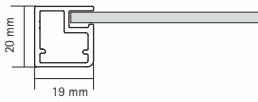
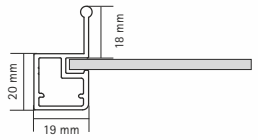
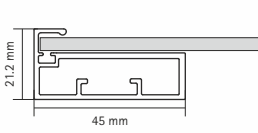
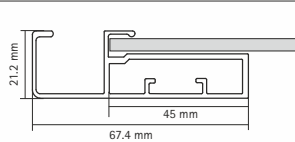
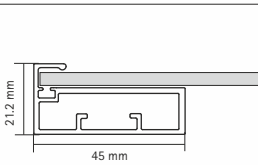
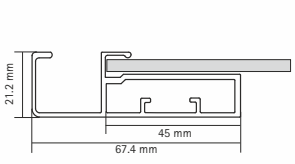
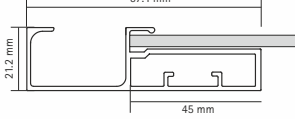
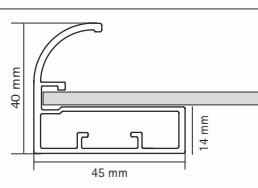
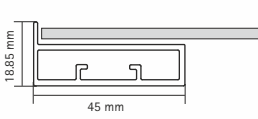
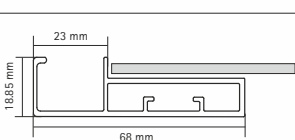



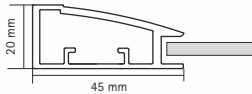
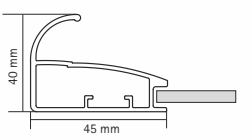
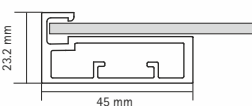
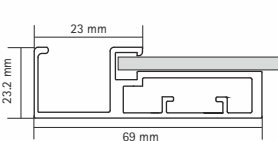
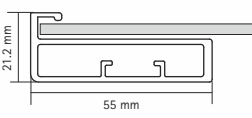
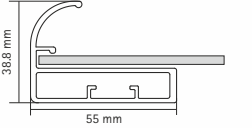
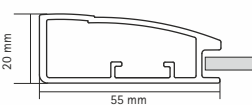
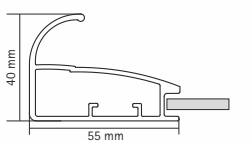
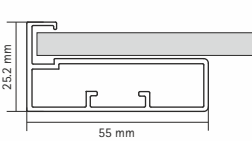
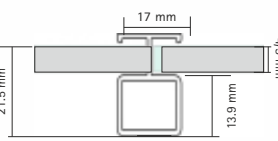

Product	Article No.	SAP	Hole Distance	Finish	Qty.	Unit	PU	MRP	HS Code
 <p>Lamezia</p>	9247827	9247827	145	Bright chrome	1	Pc	25	476	83024200
	9247828	9247828	195	Bright chrome	1	Pc	25	588	83024200
	9105801	9105801	295	Bright chrome	1	Pc	25	1,462	83024200
	9105802	9105802	345	Bright chrome	1	Pc	25	1,608	83024200
	9105803	9105803	395	Bright chrome	1	Pc	25	1,898	83024200
	9105805	9105805	445	Bright chrome	1	Pc	25	2,082	83024200
	9105806	9105806	495	Bright chrome	1	Pc	25	2,299	83021090
	9105807	9105807	595	Bright chrome	1	Pc	25	2,743	83024200
	9105809	9105809	795	Bright chrome	1	Pc	25	3,441	83024200
	9105810	9105810	895	Bright chrome	1	Pc	25	1,811	83024200
	9105811	9105811	995	Bright chrome	1	Pc	25	1,957	83024200
	9105813	9105813	1195	Bright chrome	1	Pc	25	2,139	83024200
	9248726	9248726	145	Stainless steel	1	Pc	25	344	83024200
	9248727	9248727	195	Stainless steel	1	Pc	25	428	83024200
	9105815	9105815	295	Stainless steel	1	Pc	25	1,243	83024200
	9105816	9105816	345	Stainless steel	1	Pc	25	1,302	83024200
	9105819	9105819	395	Stainless steel	1	Pc	25	1,448	83024200
	9105820	9105820	445	Stainless steel	1	Pc	25	1,536	83024200
	9105821	9105821	495	Stainless steel	1	Pc	25	1,770	83021090
	9105822	9105822	595	Stainless steel	1	Pc	25	1,974	83024200
	9105823	9105823	795	Stainless steel	1	Pc	25	2,502	83024200
	9105824	9105824	895	Stainless steel	1	Pc	25	2,910	83024200
	9105825	9105825	995	Stainless steel	1	Pc	25	1,957	83024200
	9105826	9105826	1195	Stainless steel	1	Pc	25	2,139	83024200
	9247829	9247829	145	Anodised aluminium	1	Pc	25	314	83024200
	9247830	9247830	195	Anodised aluminium	1	Pc	25	392	83024200
	9105827	9105827	295	Anodised aluminium	1	Pc	25	893	83024200
	9105828	9105828	345	Anodised aluminium	1	Pc	25	951	83024200
	9105829	9105829	395	Anodised aluminium	1	Pc	25	1,097	83024200
	9105830	9105830	445	Anodised aluminium	1	Pc	25	738	83024200
	9105831	9105831	495	Anodised aluminium	1	Pc	25	1,419	83021090
	9105832	9105832	595	Anodised aluminium	1	Pc	25	992	83024200
	9105833	9105833	795	Anodised aluminium	1	Pc	25	1,320	83024200
	9105834	9105834	895	Anodised aluminium	1	Pc	25	2,530	83024200
	9105835	9105835	995	Anodised aluminium	1	Pc	25	1,721	83024200
	9105836	9105836	1195	Anodised aluminium	1	Pc	25	1,866	83024200

Product	Product Section	Glass Thickness	Width	Finish	Article No.	SAP	Unit	PU	MRP	HS Code
19 mm Straight Frame Profile 3000 mm		4 mm	19 mm	SA	9113071	9113071	Pc	04	1,186	76042990
19 mm Straight Frame Profile with handle 3000 mm		4 mm	19 mm	SA	9113914	9113914	Pc	04	1,390	76042990
45 mm (Econ) Straight Frame Profile for small shutters 3000 mm		4 mm	45 mm	SA	9224276	9224276	Pc	04	1,402	76042990
45 mm (Econ) Straight Frame Profile with L Handle for small shutters 3000 mm		4 mm	45 mm	SA	9224277	9224277	Pc	04	1,876	76042990
45 mm Straight Frame Profile 3000 mm		4 mm	45 mm	SA	9113915	9113915	Pc	04	1,673	76042990
				CP	9154640	9154640	Pc	04	2,152	
				SS	9119040	9119040	Pc	04	2,969	
				CH	9223365	9223365	Pc	04	2,504	
45 mm Straight Frame Profile with L Handle 3000 mm		4 mm	45 mm	SA	9135075	9135075	Pc	04	2,193	76042990
				CP	9154641	9154641	Pc	04	2,820	
				SS	9153794	9153794	Pc	04	3,599	
				CH	9223366	9223366	Pc	04	3,154	
45 mm Straight Frame Profile with G Handle 3000 mm		4 mm	45 mm	SA	9135077	9135077	Pc	04	3,042	76042990
45 mm Straight Frame Profile with C Handle 3000 mm		4 mm	45 mm	SA	9113916	9113916	Pc	04	2,207	76042990
45 mm Straight Stick-On Frame Profile 3000 mm		4 mm	45 mm	SA	9148108	9148108	Pc	04	1,390	76042990
				SS	9148110	9148110	Pc	04	1,576	76042990
45 mm Straight Stick-On Frame Profile with L handle 3000 mm		4 mm	45 mm	SA	9148090	9148090	Pc	04	2,003	76042990

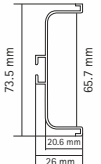
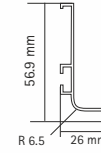

• CP - Chrome finish • SS - Stainless steel finish • SA - Silver finish • CH - Champagne Finish

Product	Product Section	Glass Thickness	Width	Finish	Article No.	SAP	Unit	PU	MRP	HS Code
45 mm Curved Frame Profile 3000 mm		4 & 5 mm	45 mm	SA	9113917	9113917	Pc	04	2,003	76042990
45 mm Curved Frame Profile with C Handle 3000 mm		4 & 5 mm	45 mm	SA	9113918	9113918	Pc	04	2,411	76042990
45 mm Straight Frame Profile for 6mm glass 3000 mm		6 mm	45 mm	SA	9148112	9148112	Pc	04	1,799	76042990
45 mm Straight Frame Profile with L Handle for 6mm glass 3000 mm		6 mm	45 mm	SA	9148132	9148132	Pc	04	2,356	76042990
55 mm Straight Frame Profile 3000 mm		4 mm	55 mm	SA	9113070	9113070	Pc	04	2,099	76042990
55 mm Straight Frame Profile with C Handle 3000 mm		4 mm	55 mm	SA	9113912	9113912	Pc	04	2,541	76042990
55 mm Curved Frame Profile 3000 mm		4 & 5 mm	55 mm	SA	20035	20035	Pc	04	2,300	76042990
				SS	9119033	9119033	Pc	04	2,699	76042990
55 mm Curved Frame Profile with C Handle 3000 mm		4 & 5 mm	55 mm	SA	9113913	9113913	Pc	04	2,802	76042990
55 mm Straight Frame Profile for 8 mm glass 3000 mm		8 mm	55 mm	SA	9148114	9148114	Pc	04	1,966	76042990
Mid Way Joining profile 3000 mm		4 & 5 mm	17 mm	SA	9148138	9148138	Pc	08	1,019	76042990
					Connector set	9153818	9153818	Pc	10	106
Angle Connector Set (For all aluminum profiles)		1 Set Consists of 4 connectors & 8 screws			13684	13684	Set	20	110	83024200

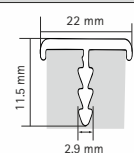
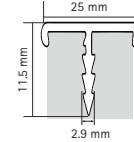
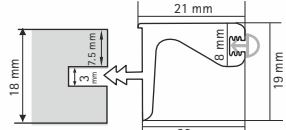
• CP - Chrome finish • SS - Stainless steel finish • SA - Silver finish • CH - Champagne Finish

Product	Product Section	Length (mm)	Finish	Article No.	SAP	Unit	PU	MRP	HS Code	
Gola Profile										
Gola profile C Type		3000	SA	9212797	9212797	Pc	10	1,205	76042990	
			CP	9212559	9212559	Pc	10	1,576	76042990	
			SS	9212560	9212560	Pc	10	1,576	76042990	
Gola profile L Type		3000	SA	9212828	9212828	Pc	10	1,001	76042990	
			CP	9212561	9212561	Pc	10	1,372	76042990	
			SS	9212562	9212562	Pc	10	1,279	76042990	
Item Description	Product	Compatible with	Side	Article No.	SAP	Unit	PU	MRP	HS Code	
Gola Profile Accessories										
Gola Profile End Cap for C Type with screws		SA & CP	Left	9212563	9212563	Pc	20	277	76042990	
			Right	9212564	9212564	Pc	20	277	76042990	
		SS	Left	9218244	9218244	Pc	20	278	76042990	
			Right	9218245	9218245	Pc	20	278	76042990	
Gola Profile End Cap for L Type with screws		SA & CP	Left	9212565	9212565	Pc	20	277	76042990	
			Right	9212566	9212566	Pc	20	277	76042990	
		SS	Left	9218246	9218246	Pc	20	278	76042990	
			Right	9218247	9218247	Pc	20	278	76042990	
Gola Outer Angle Profile Connector with screws		SA & CP		9212567	9212567	Pc	20	277	76042990	
		SS		9218248	9218248	Pc	20	278	76042990	
Gola Inner Angle Profile Connector with screws		SA & CP		9212568	9212568	Pc	20	376	76042990	
		SS		9218269	9218269	Pc	20	376	76042990	
Gola L Connector set with screws		-		9220600	9220600	Pc	20	46	76042990	
Item Description	Profile Section	Suitable for (mm)	Width (mm)	Finish	Article No.	SAP	Unit	PU	MRP	HS Code
Edge Profile										
Edge Profile (22 mm) 3000 mm		19 mm board thickness	22	SA	9148140	9148140	Pc	08	444	76042990
				CP	9154644	9154644	Pc	08	593	76042990
				SS	9148141	9148141	Pc	08	510	76042990
Edge Profile (25 mm) 3000 mm		22 mm board thickness	25	SA	9148142	9148142	Pc	08	472	76042990
				CP	9154645	9154645	Pc	08	611	76042990
				SS	9148143	9148143	Pc	08	543	76042990
Edge Profile for Wall cabinet 3000 mm		18 mm board thickness onwards	-	SA	9212831	9212831	Pc	12	1,001	76042990
				SS	9212832	9212832	12	12	1,242	76042990

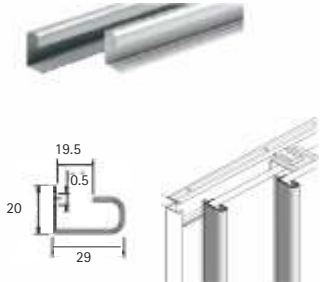
• CP - Chrome finish • SS - Stainless steel finish • SA - Silver finish • CH - Champagne Finish

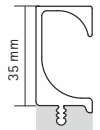
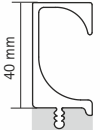
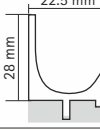
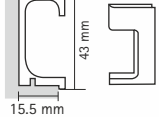
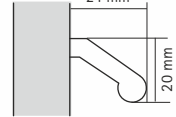
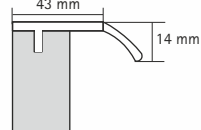
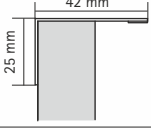
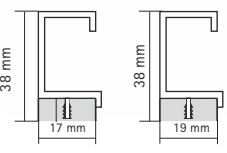
Product	Product Section	Details	Article No.	SAP	Unit	PU	MRP	HS Code
Aluminum Door Profiles for 2/3 Sliding Door Carcases								
Door Profile for door thick (18-19 mm)		Aluminum Silver Anodised Door Profile : 2500 mm (3 nos. for 2 door carcase ; 4 nos. for 3 door carcase)	9136121	9136121	Pc	04	2,089	76042990
Product	Product Section	Details	Article No.	SAP	Unit	PU	MRP	HS Code
Handle Eslinga (G Profile)		Profile height 40 mm & Length 3000 mm	SA 9149982	9149982	Pc	04	2,240	76042990
			CP 9216235	9216235	Pc	04	2,709	76042990
			SS 9216237	9216237	Pc	04	2,802	76042990
			CH 9223362	9223362	Pc	04	2,950	76042990
Eslinga Econ (G Profile)		Profile height 35 mm & Length 3000 mm	SA 9153797	9153797	Pc	04	1,631	76042990
			CP 9216236	9216236	Pc	04	1,967	76042990
			SS 9216238	9216238	Pc	04	2,041	76042990
Eslinga M (G Profile)		Profile height 40 mm & Length 3000 mm	SA 9224278	9224278	Pc	04	1,993	76042990
Lutetia		Profile height 28 mm & Length 3000 mm	SA 9133756	9133756	Pc	04	1,409	76042990
Spira		Profile Ht- 43 mm & Length 2000 mm	SA 115314	9126106	Pc	04	1,515	76042990
			End Cap	-	115298	9126165	Pc	20
Calisia		Length 1950 mm	SA 115105	9125763	Pc	08	2,219	76042990
Lindavia		for 19 mm board & Length 2000 mm	SA 115115	9125832	Pc	12	1,559	94039000
Ticinum		Length 2000 mm	SA 9131455	9131455	Pc	12	3,284	76042990
Seveso		Profile height 38 for 17 mm thickness & Length 2400 mm	SA 9995122	1161199	Pc	06	982	76042990
		for 19 mm thickness & Length 3000 mm	SA 9995123	1161200	Pc	06	1,001	76042990

HETTICH – Countersunk Saw Thread

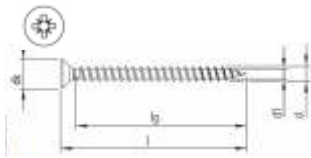

Material: Steel
 Finish: Zinc Coated
 Head: Countersunk
 Drive: Pozi Drive
 Thread: Saw
 Packing: Small/Retail

Dimension	Gauge	Article no.	SAP	Unit	PU	MRP/100	HS Code
Ø3.5 x 20	6	9153820	9153820	Pc	1000	72	73181200
Ø3.5 x 25	6	9162379	9162379	Pc	1000	82	73181200
Ø3.5 x 30	6	9162380	9162380	Pc	1000	95	73181200
Ø3.5 x 35	6	9169371	9169371	Pc	1000	103	73181200
Ø3.5 x 40	6	9162381	9162381	Pc	500	115	73181200
Ø4.0 x 12	8	9169372	9169372	Pc	1000	72	73181200
Ø4.0 x 16	8	9137992	9137992	Pc	1000	82	73181200
Ø4.0 x 20	8	9137991	9137991	Pc	1000	86	73181200
Ø4.0 x 25	8	9137993	9137993	Pc	1000	97	73181200
Ø4.0 x 30	8	9140272	9140272	Pc	1000	112	73181200
Ø4.0 x 35	8	9140274	9140274	Pc	500	131	73181200
Ø4.0 x 40	8	9140275	9140275	Pc	500	142	73181200
Ø4.0 x 45	8	9140276	9140276	Pc	500	152	73181200
Ø4.0 x 50	8	9169373	9169373	Pc	500	165	73181200
Ø5.0 x 50	10	9148093	9148093	Pc	200	297	73181200
Ø5.0 x 60	10	9153821	9153821	Pc	200	342	73181200
Ø5.0 x 70	10	9153822	9153822	Pc	200	408	73181200
Ø5.0 x 80	10	9169376	9169376	Pc	100	489	73181200
Ø5.0 x 90	10	9169378	9169378	Pc	100	588	73181200
Ø5.0 x 100	10	9169380	9169380	Pc	100	685	73181200

HETTICH – Pan head Saw Thread



Material: Steel
 Finish: Zinc Coated
 Head: Pan head
 Drive: Pozi Drive
 Thread: Saw
 Packing: Retail

Dimension	Gauge	Article no.	SAP	Unit	PU	MRP/100	HS Code
Ø4.0 x 16	8	9137999	9137999	Pc	1000	82	73181200
Ø4.0 x 30	8	9169386	9169386	Pc	500	131	73181200

HETTICH – Stainless Steel CounterSunk Saw thread

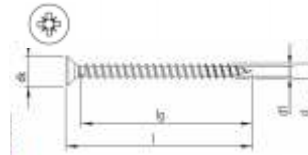

Material: Magnetic
 Finish: -
 Head: Countersunk
 Drive: Pozi Drive
 Thread: Saw
 Packing: Retail

Dimension	Gauge	Article no.	SAP	Unit	PU	MRP/100	HS Code
Ø3.5 x 12	6	9162382	9162382	Pc	1000	108	73181200
Ø3.5 x 16	6	9154452	9154452	Pc	1000	112	73181200
Ø3.5 x 20	6	9162383	9162383	Pc	1000	138	73181200
Ø3.5 x 25	6	9162384	9162384	Pc	1000	169	73181200
Ø3.5 x 30	6	9162385	9162385	Pc	1000	183	73181200
Ø3.5 x 35	6	9162386	9162386	Pc	1000	214	73181200
Ø4.0 x 16	8	9162388	9162388	Pc	1000	154	73181200
Ø4.0 x 20	8	9154453	9154453	Pc	1000	163	73181200
Ø4.0 x 25	8	9154454	9154454	Pc	1000	192	73181200
Ø4.0 x 30	8	9154455	9154455	Pc	1000	242	73181200
Ø4.0 x 35	8	9154456	9154456	Pc	500	265	73181200
Ø4.0 x 40	8	9162389	9162389	Pc	500	315	73181200
Ø5.0 x 50	10	9154459	9154459	Pc	200	546	73181200
Ø5.0 x 60	10	9169394	9169394	Pc	200	726	73181200
Ø5.0 x 70	10	9154461	9154461	Pc	200	760	73181200

HETTICH – Zinc Countersunk Industrial Packing

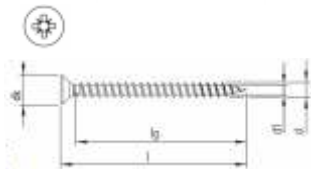

Material: Steel
 Finish: Zink
 Head: Countersunk
 Drive: Pozi Drive
 Thread: Saw
 Packing: Industrial

Dimension	Gauge	Article no.	SAP	Unit	PU	MRP/100	HS Code
Ø3.5 x 12	6	9200221	9200221	Pc	28000	51	73181200
Ø3.5 x 16	6	9200222	9200222	Pc	25000	51	73181200
Ø3.5 x 20	6	9200223	9200223	Pc	20000	55	73181200
Ø4.0 x 16	8	9200224	9200224	Pc	17000	62	73181200
Ø4.0 x 20	8	9200225	9200225	Pc	15000	65	73181200
Ø4.0 x 25	8	9200226	9200226	Pc	13000	75	73181200
Ø4.0 x 30	8	9200227	9200227	Pc	10000	86	73181200
Ø4.0 x 35	8	9200228	9200228	Pc	9000	95	73181200
Ø5.0 x 50	10	9200252	9200252	Pc	4500	194	73181200







HETTICH – Handle Fixing Screws

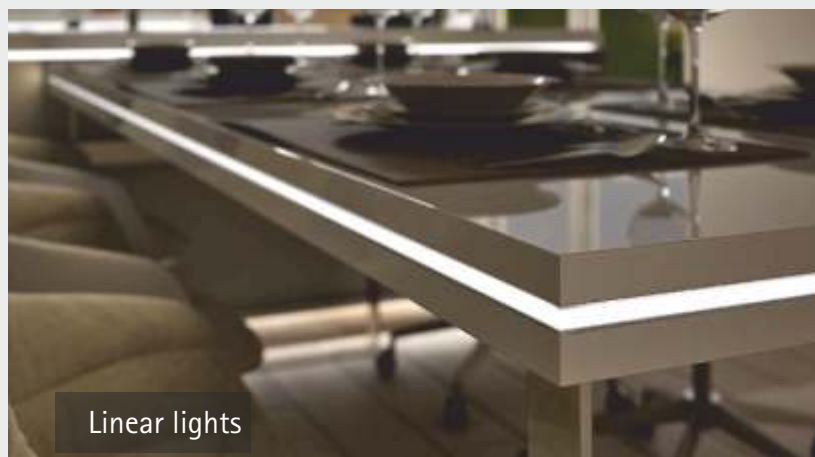
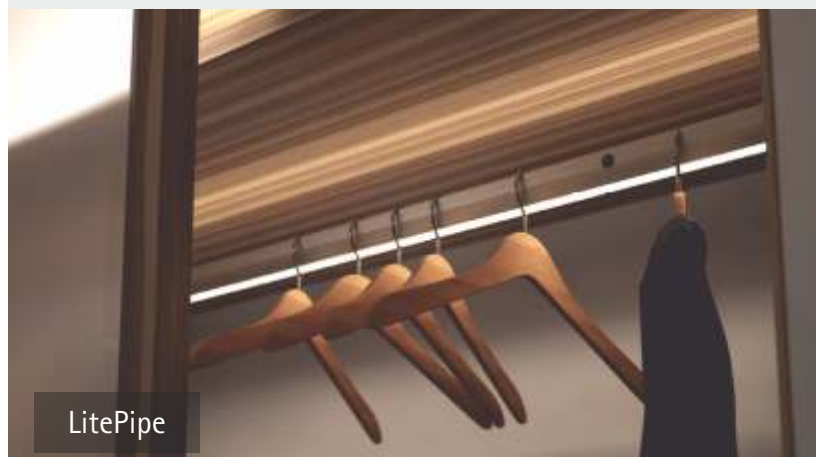
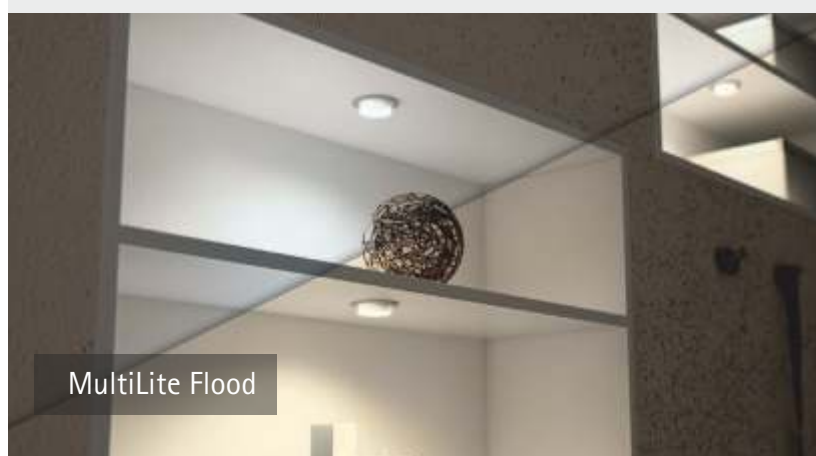

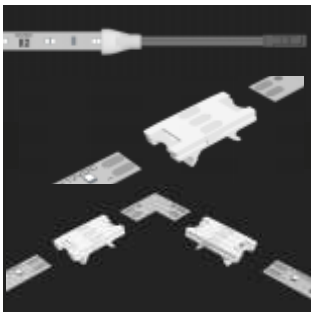



Material: Steel
 Finish: Zinc Coated
 Head: Pan head
 Drive: Cross recessed
 Thread: M4
 Packing: Retail

S.no.	Description Et Dimension	Qty.	Article No.	SAP	Unit	PU	MRP	HS Code
1	Handle Fixing Screw M4 x 22	100	71549	71549	Pc	1000	143	73181200
2	Handle Fixing Screw M4 x 24	100	71555	71555	Pc	1000	143	73181200
3	Handle Fixing Screw M4 x 26	100	71556	71556	Pc	1000	154	73181200
4	Handle Fixing Screw M4 x 28	100	71557	71557	Pc	500	165	73181200
5	Handle Fixing Screw M4 x 30	100	71558	71558	Pc	500	165	73181200
6	Handle Fixing Screw M4 x 32	100	71559	71559	Pc	500	175	73181200
7	Handle Fixing Screw M4 x 34	100	71560	71560	Pc	500	188	73181200
8	Handle Fixing Screw M4 x 36	100	71561	71561	Pc	500	198	73181200
9	Handle Fixing Screw M4 x 38	100	71562	71562	Pc	500	209	73181200



Product	Article No.	SAP	Item Description	Qty.	Unit	PU	MRP	HS Code
Lights								
	Linear Light							
	5580113	9243905	LED Versa Inside 60,12VDC, WW, L=5m, 4.8W/m LTG 1.8m, M1	1	Pc	1	5,259	94054039
	5580513	9243901	LED Versa Inside 90,12VDC, WW, L=5m, 7.2W/m LTG 1.8m, M1	1	Pc	1	6,843	94054039
	Linear Light Accessories							
	3633002	9243892	Feeder 1700 mm for sections (max. 36 W), 12 V DC	1	Pc	1	283	85444290
	3633401	9254412	Direct Connector (max. 36 W)[Strip to strip connector]	1	Pc	1	182	85366990
	3633501	9258311	Direct Connector 90° (max. 36W)	1	Pc	1	173	94059200
Profiles								
	ChannelLine B							
	5566002	9162612	ChannelLine B, Opal Cover, Aluminium / plastic profile 3000 mm, Depth = 13.5 mm	1	Pc	1	4,563	94054039
	ChannelLine F							
	556402	9162630	ChannelLine F, Opal Cover, Plastic profile 3000 mm, Depth =8mm	1	Pc	1	3,063	94054039
	ChannelLine H (Corner Profile)							
	5570602	9244566	ChannelLine H, Opal Cover, Aluminium / plastic profile 3000 mm, Depth =11mm	1	Pc	1	3,790	94054039
	2555901	9244567	End cap (Set of 2)	1	Set	1	105	94059200
	ChannelLine G2							
	5570502	9244282	Channelline G2, Aluminium / plastic profile 3000 mm, Opal cover, Depth = 9.6mm	1	Pc	1	4,706	94059900
	2555601	9244283	End cap (2 units per set, left + right)	1	Set	1	129	94059200
	ChannelLine C Recessed Profile							
	5566102	9162617	ChannelLine C, Aluminium / plastic profile 3000 mm, Opal cover, Depth = 7.5mm	1	Pc	1	4,524	94054039
	2556901	9242650	End cap (2 units per set)	1	Set	1	143	39269097
	ChannelLine D, Recessed and Surface Mounted Profile							
	5566202	9162620	Channelline Versa D - L=3000mm, opal cover, Depth = 10mm	1	Pc	1	4,657	94054039
	2557001	9244279	End cap (2 units per set)	1	Set	1	143	94059200

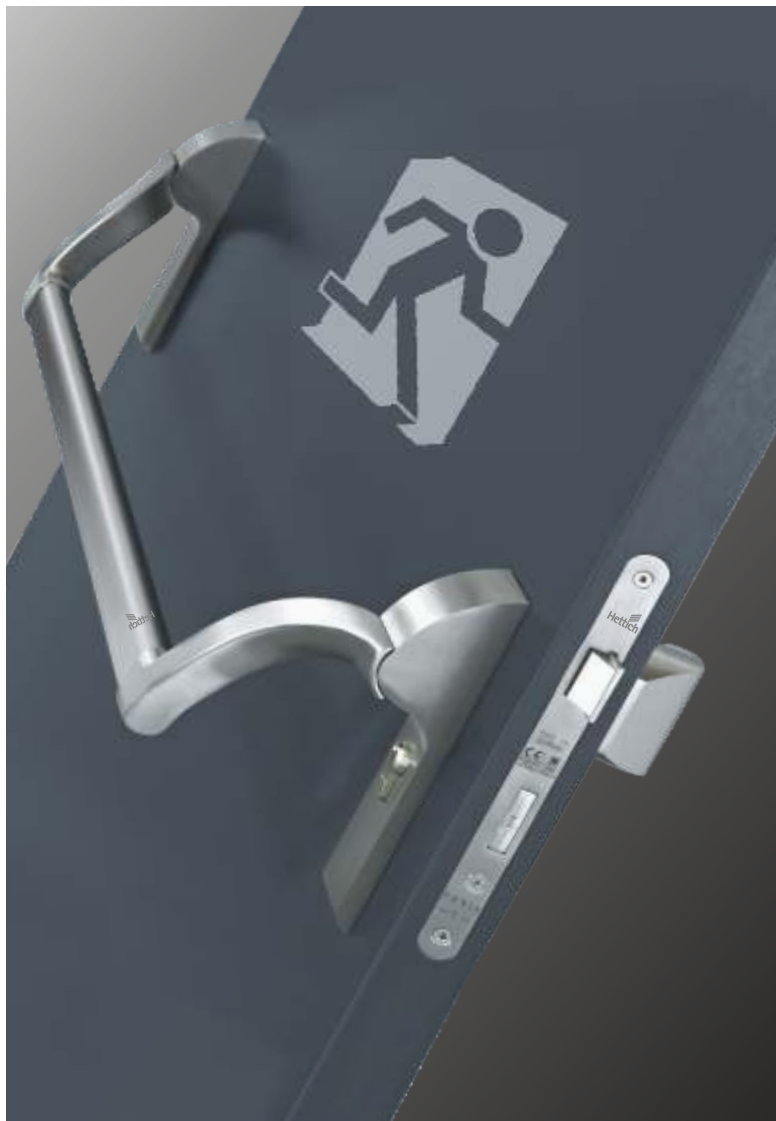

Product	Article No.	SAP	Item Description	Qty.	Unit	PU	MRP	HS Code
Spot Light and special Light								
	Powerlite Plus							
	3206319	9246819	PowerLite Plus round stainless steel look,12 V DC, WW, 3.5 W	1	Pc	1	2,066	94054039
	MultiLite Flood							
	3215011	9245068	MultiLite Flood, Al look, WW, 12V DC (Light without outer ring)	1	Pc	1	2,415	94054039
	Power Square Long (Used below wall unit)							
	3461717	9162644	600 mm,12VDC, Al, WW, 3.6W	1	Pc	1	7,416	94054090
	3461817	9162646	900 mm,12VDC, Al, WW, 5.4W	1	Pc	1	10,650	94054090
	3461917	9162648	1200 mm,12VDC, Al, WW, 7.2W	1	Pc	1	13,881	94054090
Special Light								
	GlasLine (Back glass profile), Set							
	5580112	9243903	Versa Inside 60, 1.2 m strip in WW, L=1200mm, 12VDC, 5W	1	Pc	1	1,566	94054039
	1872001	9162721	U-profile for flexible strip 14 x 11.2 x 3000 mm	1	Pc	1	4,252	94059900
	Drawer Light with integrated IR sensor							
	5516804	9162748	LED InnoLine Plus NW 12V DC L=501-600 mm, 3 W	1	Pc	1	4,969	94054090
	5516807	9162751	LED InnoLine Plus NW 12V DC L=801-900 mm, 4.5 W	1	Pc	1	5,916	94054090
	5516808	9162752	LED InnoLine Plus NW 12V DC L=901-1000 mm, 5 W	1	Pc	1	6,273	94054090
	Wardrobe Light with inbuilt motion sensor							
	9150406	9150406	LED Lite Pipe 12V 1000 mm WW, 5W	1	Pc	1	9,955	94054090
	9150407	9150407	LED Lite Pipe 12V 1200 mm WW, 5W	1	Pc	1	10,787	94054090
	9150408	9150408	LED Lite Pipe 12V 1000 mm CW, 5.5W	1	Pc	1	9,955	94054090
	9150409	9150409	LED Lite Pipe 12V 1200 mm CW, 5.5W	1	Pc	1	10,787	94054090
	9162787	9162787	LED - Transformer 12VDC 6W HIN	1	Pc	1	1,518	85365080

Product	Article No.	SAP	Item Description	Qty.	Unit	PU	MRP	HS Code
Sensor								
	IR Sensor (Surface mounting)							
	3076401	9152784	Master unit 12 V DC	1	Pc	1	1,769	85365007
	3064201	9152785	IR-Sensor for surface mounting	1	Pc	1	1,158	85365007
	IR Sensor (Drill Hole mounting)							
	3076401	9152784	Master unit 12 V DC	1	Pc	1	1,769	85365007
	3076751	9245711	IR Sensor for Drill hole mounting	1	Pc	1	791	85365005
	Motion Sensor							
	3076401	9152784	Master unit 12 V DC	1	Pc	1	1,769	85365007
	3063801	9152786	IR Sensor for Drill hole mounting	1	Pc	1	1,895	85365007
	Multiswitch Push button							
	3076401	9152784	Master unit 12 V DC	1	Pc	1	1,769	85365007
	3064801	9152787	Push button with dimming function	1	Pc	1	971	85365090
	Extension Wire For Sensor							
	1823803	9259373	Extension lead sensor cable - 2.5 mm jack - 2000 mm	1	Pc	1	490	85444290
Ballasts								
	3022602	9162787	LED - Ballast 12V DC 6W with flat euro plug	1	Pc	1	1,518	85365080
	3101601	9244918	LED ballast 12V DC 20 W with flat Euro plug and 6- way distributor	1	Pc	1	2,335	85044082
	3100207	9248604	LED ballast 12V DC 30 W with flat Euro plug and 6- way distributor	1	Pc	1	3,757	85365080
	3099801	9162794	LED ballast 12V DC 50 W with flat Euro plug and 6- way distributor	1	Pc	1	4,890	85365080
Accessories								
	3685201	9244295	LED 3way Distributer M1, 12V DC	1	Pc	1	367	85444290
	3612501	9084272	LED 6 way Distributer=M1 2m, 12V DC	1	Pc	1	589	85444290
	3676801	9104773	LED Extension M1, 12 V DC	1	Pc	1	286	85444290



Architectural
Hardware



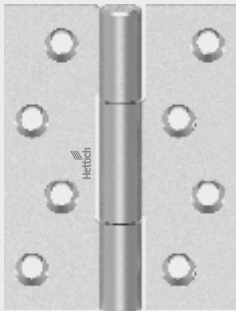





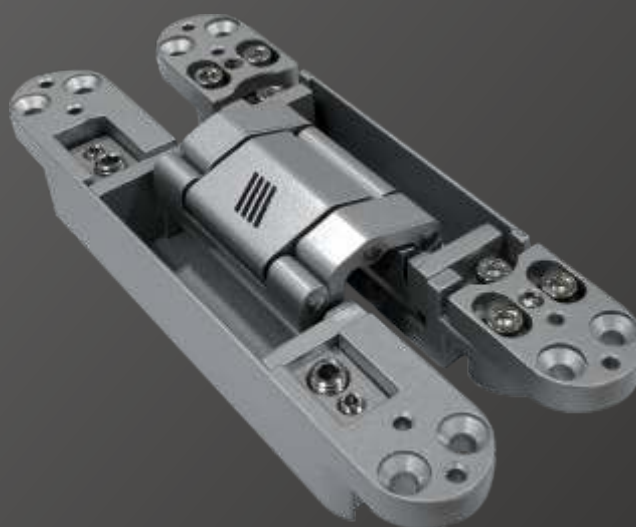

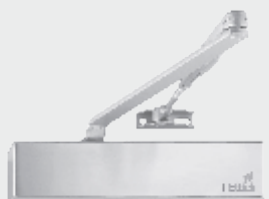

Product	Article No.	SAP	Item Description	Qty.	Unit	PU	MRP	HS Code
	Mortise flush Door Hinge: HBN 20 Series							
	9228227	9228227	HBN-20 4141/160: 6.3x3.8x3.5, SS 304, Heavy duty hinge, Patented grease free ball bearing technology, Loading capacity 300kg/pair, EN1935 certified, Fire Rated; 200,000 cycles tested	01	Pair	01	7,319	83024110
	Mortise flush Door Hinge: HBN 18 Series							
	9228228	9228228	HBN -18 4141/160: 6.3x3.8x3.5, SS 304, Heavy duty hinge, Patented grease free ball bearing technology, Loading capacity 180kg/pair, EN1935 certified, Fire Rated; 200,000 cycles	01	Pair	01	5,425	83024110
	Mortise flush Door Hinge: HBN 14 Series							
	9228734	9228734	HBN-14 4x3x3 Square edge Z shape drilling pattern for timber doors, CAPACITY 160KG EN 1935 Grade14, Finish SS	1	Pair	1	1,485	83021090
	9228736	9228736	HBN-14 4x3x3 Round edge Z shape drilling pattern for timber doors, CAPACITY 160KG EN 1935 Grade14, Finish SS	1	Pair	1	1,500	83021090
	9250396	9250396	HBN-14 4x3.5x3 Square edge Z shape drilling pattern for timber doors, CAPACITY 160KG EN 1935 Grade14, Finish SS	1	Pair	1	1,500	83021090
	9250398	9250398	HBN-14 4x3.5x3 Round edge Z shape drilling pattern for timber doors, CAPACITY 160KG EN 1935 Grade14, Finish SS	1	Pair	1	1,500	83021090
	9250407	9250407	HBN-14 4x4x3 Square edge Z shape drilling pattern for timber doors, CAPACITY 160KG EN 1935 Grade14, Finish SS	1	Pair	1	1,500	83021090
	9250409	9250409	HBN-14 4x4x3 Round edge Z shape drilling pattern for timber doors, CAPACITY 160KG EN 1935 Grade14, Finish SS	1	Pair	1	1,500	83021090
	9250446	9250446	HBN-14 4.5x4x3 Square edge Z shape drilling pattern for timber doors, CAPACITY 160KG EN 1935 Grade14, Finish SS	1	Pair	1	1,690	83021090
	9250448	9250448	HBN-14 4.5x4x3 Round edge Z shape drilling pattern for timber doors, CAPACITY 160KG EN 1935 Grade14, Finish SS	1	Pair	1	1,690	83021090
	9228745	9228745	HBN-14 5x3x3 Square edge Z shape drilling pattern for timber doors, CAPACITY 160KG EN 1935 Grade14, Finish SS	1	Pair	1	1,593	83021090
	9228747	9228747	HBN-14 5x3x3 Round edge Z shape drilling pattern for timber doors, CAPACITY 160KG EN 1935 Grade14, Finish SS	1	Pair	1	1,593	83021090
	9250457	9250457	HBN-14 5x3.5x3 Square edge Z shape drilling pattern for timber doors, CAPACITY 160KG EN 1935 Grade14, Finish SS	1	Pair	1	1,670	83021090
	9250459	9250459	HBN-14 5x3.5x3 Round edge Z shape drilling pattern for timber doors, CAPACITY 160KG EN 1935 Grade14, Finish SS	1	Pair	1	1,670	83021090
	9250468	9250468	HBN-14 5x4x3 Square edge Z shape drilling pattern for timber doors, CAPACITY 160KG EN 1935 Grade14, Finish SS	1	Pair	1	1,740	83021090
	9250510	9250510	HBN-14 5x4x3 Round edge Z shape drilling pattern for timber doors, CAPACITY 160KG EN 1935 Grade14, Finish SS	1	Pair	1	1,740	83021090

Product	Article No.	SAP	Item Description	Qty.	Unit	PU	MRP	HS Code
Flag Hinge								
	9228243	9228243	HBN-18-127/102-FLG: Flag Hinge, 5"x4"x3, butterfly type, loading capacity 50 kg/pair	01	Pair	01	1,194	83021090
Spring Hinge								
	9228242	9228242	HBN-18-102/102-SPR: Spring Hinge, 4"x4"x3, SS304, 4"x4"x3, loading capacity 40kg/pair	01	Pair	01	1,901	83021090
Lift off Hinge								
	9228245	9228245	HBN-13-4353C/102 SS L: Lift Off Hinge, 4"x3.5"x3, loading capacity 40kg/pair, DIN left	01	Pair	01	1,043	83021090
	9228764	9228764	HBN-13-4353C/102 SS R: Lift Off Hinge, 4"x3.5"x3, loading capacity 40kg/Pair SS DIN right	01	Pair	01	1,043	83021090
	9228731	9228731	HBN-13-4353C/102 AB L: Lift Off Hinge, 4"x3.5"x3, loading capacity 40kg/pair, DIN left	01	Pair	01	1,461	83021090
	9228763	9228763	HBN-13-4353C/102 AB R: Lift Off Hinge, 4"x3.5"x3, loading capacity 40kg/PAIR SS DIN right	01	Pair	01	1,461	83021090
Rising Hinge								
	9228244	9228244	HBN-13-102/76-RSN DIN Left: Rising Hinge, 4"x3"x3, loading capacity 26kg/pair, DIN Left	01	Pair	01	1,026	83021090
	9228720	9228720	HBN-13-102/76-RSN DIN Right: Rising Hinge, 4"x3"x3, loading capacity 26kg/pair, DIN Right	01	Pair	01	1,026	83021090
Security Hinge								
	9228246	9228246	HBN-13-Square C: Security Hinge, 4"x4"x3, loading capacity 50 kg/pair	01	Pair	01	1,368	83021090
Flush Hinge								
	9228247	9228247	HBN- 13-4325ZM/102: Flush Hinge, 4"x3"x2.5 loading capacity 40kg/pair	01	Pair	01	816	83021090

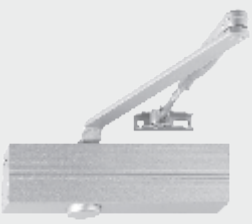
Product	Article No.	SAP	Item Description	Qty.	Unit	PU	MRP	HS Code	
	Concealed Hinges (Hinge Material:: Base: Zinc Alloy; Connector: SS 304)								
	9228248	9228248	HBC-25-1835/117: Concealed Hinge for min door thickness: 29 mm, loading capacity: 50 kg/pair	1	Pair	1	3,833	83021090	
	9228249	9228249	HBC-28-2245/117: Concealed Hinge for min door thickness: 35 mm, loading capacity: 50 kg/pair	1	Pair	1	6,117	83021090	
	9228250	9228250	HBC-35-2650/139: Concealed Hinge for min door thickness: 45 mm, loading capacity: 50 kg/pair	1	Pair	1	7,672	83021090	
	3D Concealed Hinges (Hinge Material:: Base: Zinc Alloy; Connector: Aluminum Alloy)								
	9228474	9228474	HBC-25-1440/150Z-3D: 3D-Concealed Hinge Min Door Thickness: 35 mm Loading Capacity: 40 kg/pair, Finish Silver	1	Pair	1	3,447	83021090	
	9228475	9228475	HBC-28-1640/150Z-3D: 3D-Concealed Hinge Min Door Thickness: 40 mm Loading Capacity: 80 kg/pair, Finish Silver	1	Pair	1	4,589	83021090	
	9228476	9228476	HBC-34-1845/246Z-3D: 3D-Concealed Hinge Min Door Thickness: 45 mm Loading Capacity: 120 kg/pair, Finish Silver	1	Pair	1	7,571	83021090	
	9250145	9250145	HBC-28-1640/177Z-3D: 3D-Concealed Hinge Min Door Thickness: 40 mm Loading Capacity: 80 kg/pair, Finish Satin Gold	1	Pair	1	4,589	83021090	
	9250191	9250191	HBC-34-1845/246Z-3D: 3D-Concealed Hinge Min Door Thickness: 45mm Loading Capacity: 120 kg/pair Finish Satin Gold	1	Pair	1	7,571	83021090	
	9228756	9228756	HBC-34-1845/246Z-3D: 3D-Concealed Hinge Min Door Thickness: 45mm Loading Capacity: 120 kg/pair Finish Chrome	1	Pair	1	10,399	83021090	





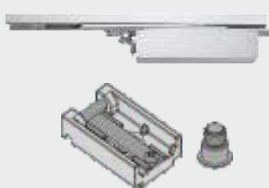



Product	Article No.	SAP	Item Description	Qty.	Unit	PU	MRP	HS Code
Surface Mounted Door Closer with Slide rail								
	HSS 61							
	9227802	9227802	HSS 61 B: EN 5-6, For Door Width 1250-1400 mm and Door Weight 100-250 kg; Adjustable Back-check; EN1154 certified, Fire Rated; 500,000 cycles tested. (For hinge side mounting only)	1	Set	1	20,707	83024110
	HSS 41							
	9227808	9227808	HSS 41: EN 1-4, With slide rail B; For Door Width 750-1100 mm and Door Weight 20-120 kg; Fixed Back-check; EN1154 certified, Fire Rated; 500,000 cycles tested.	1	Set	1	14,053	83024110
	HSS 31							
	9227810	9227810	HSS 31: EN 1-3, With slide rail B; For Door Width 750-950 mm and Door Weight 20-100 kg; Fixed Back-check; EN1154 certified, Fire Rated; 500,000 cycles tested.	1	Set	1	11,426	83024110
	HSS 33							
	9227812	9227812	HSS 33: EN 3, With slide rail K; For Door Width 750-950 mm and Door Weight 20-80 kg; EN1154 certified, Fire Rated; 500,000 cycles tested. (Cannot be made hold open door closer)	1	Set	1	8,284	83024110
Surface Mounted Door Closer with Standard Arm								
	HSA 50							
	9227813	9227813	HSA 50: EN 1-5, For Door Width 750-1250 mm and Door Weight 20-150 kg; Fixed Back-check; Continuous power adjustment; EN1154 certified, Fire Rated; 500,000 cycles tested.	1	Set	1	12,309	83024110
	HSA 20							
	9227814	9227814	HSA 20: EN 2/3/5, For Door Width 850-1250 mm and Door Weight 20-150 kg; Fixed Back-check; EN1154 certified, Fire Rated; 500,000 cycles tested.	1	Set	1	7,343	83024110













Product	Article No.	SAP	Item Description	Qty.	Unit	PU	MRP	HS Code
Surface Mounted Door Closer with Standard Arm								
	HSA 15							
	9227815	9227815	HSA 15: EN 2/3/4/5, For Door Width 850-1250 mm and Door Weight 40-100 kg.	1	Set	1	6,498	83024110
	HSA 14							
	9228418	9228418	HSA 14: EN 1/2/3/4, For Door Width 750-1100 mm and Door Weight 40-80 kg.	1	Set	1	4,935	83024110
	HSA 10 D EN							
	9227817	9227817	HSA 10 D EN: EN 2/3/4, For Door Width 850-1100 mm and Door Weight 40-80 kg; with standard arm; EN 1154 Certified; Fire Rated.	1	Set	1	3,024	83024110
	9228767	9228767	HSA 10 D EN HO: EN 2/3/4, For Door Width 850-1100 mm and Door Weight 40-80 kg; With Hold Open Arm, EN 1154 Certified; Fire Rated.	1	Set	1	3,707	83024110
	HSA 10 F							
	9227816	9227816	HSA 10 F: EN 2/3/4, For Door Width 850-1100 mm and Door Weight 40-80 kg; Fire Rated; with standard arm	1	Set	1	2,688	83024110
	9228766	9228766	HSA 10 F HO: EN 2/3/4, For Door Width 850-1100 mm and Door Weight 40-80 kg, with Hold Open Arm, Fire Rated	1	Set	1	3,371	83024110
	HSA 10							
	9227818	9227818	HSA 10: EN 2/3/4, For Door Width 850-1100 mm and Door Weight 40-80 kg. with standard arm;	1	Set	1	2,592	83024110
	9228765	9228765	HSA 10 HO: EN 2/3/4, For Door Width 850-1100 mm and Door Weight 40-80 kg, With Hold Open Arm	1	Set	1	2,988	83024110
Concealed Door Closer with hold open Slide rail								
	HCS Multi G Body							
	9227820	9227820	HCS Multi G (Body): EN 2-5, For Door Width 850-1250 mm and Door Weight 40-150 kg; EN1154 Certified; Fire rated; 500,000 cycle tested (Min. Door Thickness - 40 mm).	1	Set	1	31,636	83024110
	9227825	9227825	Slide rail for HCS Multi G 21x31, with hold open, Fire Rated. (Please order Slide rail separately)	1	Set	1	8,207	83024110
	HCS 400							
	9227822	9227822	HCS 400: EN 2-4, For Door Width 850-1100 mm and Door Weight 40-120 kg; EN1154 Certified; Fire rated; 500,000 cycle tested (Min. Door Thickness - 40 mm)	1	Set	1	12,617	83024110
	9228460	9228460	Hold open device for HCS 400 (Please order Hold open device separately)	1	Pc	1	765	83024110



Product	Article No.	SAP	Item Description	Qty.	Unit	PU	MRP	HS Code
	HCS 385							
	9227823	9227823	HCS 385: EN 2-4, With Hold Open Slide rail; For Door Width 850-1100 mm and Door Weight 40-80 kg (Min. Door Thickness - 45 mm).	1	Set	1	7,895	83024110
	HCS 380							
	9227824	9227824	HCS 380: EN 3, With Hold Open Slide rail; For Door Width 950 mm and Door Weight 60 kg (Min. Door Thickness - 40 mm).	1	Set	1	5,952	83024110
Door Coordinator								
	Door Coordinator (For DIN Left Active Door only)							
	9228441	9228441	HSR Closing Sequence Selector For HSS 61 and 41 body, Fire Rated (For Hinge Side)	1	Set	1	27,046	83024110
	9228442	9228442	HSR BG Closing Sequence Selector For HSS 61 and 41 body , Fire Rated (For Hinge Opposite Side) (Please order HSS 61 and 41 (body) separately)	1	Set	1	31,306	83024110
	Basic Door Coordinator							
	9250395	9250395	HSR Basis 2: Basic Door Coordinator for door closers for doors up to 200 kg , EN 1158 Certified	1	Set	1	2,900	83024110
Door Closer Accessories								
	Hold Open Arm							
	9227829	9227829	Hold open arm (70-130 deg) for all standard arm model	1	Set	1	1,769	83024110
	Opening Angle Limiter							
	9227830	9227830	Opening Angle Limiter for slide rail B for Models: HSS 61/51/41/31 Not to be used with HSS 33	1	Set	1	2,391	83024110
	Hold open device							
	9227831	9227831	FKL Hold Open device for slide rail B for Models: HSS 61/51/41/31 (not to be used with HSS 33)	1	Set	1	2,391	83024110

Product	Article No.	SAP	Item Description	Qty.	Unit	PU	MRP	HS Code
	Angle Bracket							
	9227839	9227839	Angle Bracket for Standard Arm Door Closer	1	Set	1	1,087	83024110
	Under Lintel Angle							
	9227836	9227836	Under Lintel Angle for Slide rail B (For HSS 61/41/31)	1	Pc	1	3,632	83024110
	9227837	9227837	Under Lintel Angle For Slide rail K (For HSS 33 only)	1	Pc	1	3,632	83024110
	Glass Clamping Device							
	9228295	9228295	HGL GC: Glass Clamping Device For Door closer HSS-41, Finish: Aluminium	1	Pc	1	3,823	83024110



















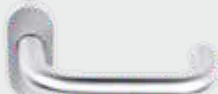

Product	Article No.	SAP	Item Description	Qty.	Unit	PU	MRP	HS Code
Mortise Handles-ProLock 2 (Hollow) SS 304, Satin finish, EN1906 certified; 200,000 cycles tested; 5 years Functional Warranty								
	Prolock 2 HH 110 as per EN 1906 (Hollow)							
	9228066	9228066	ProLock 2 HH 110 Handle + Handle set SS	1	Set	1	2,397	83024110
	9228068	9228068	ProLock 2 HH 110 Handle + WC Bathroom set SS (Please order only Bathroom Lock along with WC version set)	1	Set	1	3,417	83024110
	Prolock 2 HH 120 as per EN 1906 (Hollow)							
	9228069	9228069	ProLock 2 HH 120 Handle + Handle set SS	1	Set	1	2,399	83024110
	9228071	9228071	ProLock 2 HH 120 Handle + WC Bathroom set SS (Please order only Bathroom Lock along with WC version set)	1	Set	1	3,419	83024110
	Prolock 2 HH 210 as per EN 1906 (Hollow)							
	9228072	9228072	ProLock 2 HH 210 Handle + Handle set SS	1	Set	1	2,397	83024110
	9228074	9228074	ProLock 2 HH 210 Handle + WC Bathroom set SS (Please order only Bathroom Lock along with WC version set)	1	Set	1	3,417	83024110
	Prolock 2 HH 310 as per EN 1906 (Hollow)							
	9228075	9228075	ProLock 2 HH 310 Handle + Handle set SS	1	Set	1	2,397	83024110
	9228077	9228077	ProLock 2 HH 310 Handle + WC Bathroom set SS (Please order only Bathroom Lock along with WC version set)	1	Set	1	3,417	83024110
	Prolock 2 HH 410 as per EN 1906 (Hollow)							
	9228078	9228078	ProLock 2 HH 410 Handle + Handle set SS	1	Set	1	2,967	83024110
	9228080	9228080	ProLock 2 HH 410 Handle + WC Bathroom set SS (Please order only Bathroom Lock along with WC version set)	1	Set	1	3,986	83024110
	Prolock 2 HH 510 as per EN 1906 (Hollow)							
	9228081	9228081	ProLock 2 HH 510 Handle + Handle set SS	1	Set	1	2,967	83024110
	9228083	9228083	ProLock 2 HH 510 Handle + WC Bathroom set SS (Please order only Bathroom Lock along with WC version set)	1	Set	1	3,986	83024110





Product	Article No.	SAP	Item Description	Qty.	Unit	PU	MRP	HS Code
Mortise Handles-ProLock 1 SS 304, Satin finish; 200,000 cycles tested in-house lab.; 5 years Functional Warranty								
 	Prolock 1 HH 2110 (Hollow)							
	9228099	9228099	ProLock 1 HH 2110 Handle + Handle set SS	1	Set	1	1,334	83024110
	9228101	9228101	ProLock 1 HH 2110 Handle + WC Bathroom set SS (Please order only Bathroom Lock along with WC version set)	1	Set	1	1,934	83024110
 	Prolock 1 HH 2210 (Hollow)							
	9250321	9250321	ProLock 1 HH 2210 Handle + Handle set SS	1	Set	1	1,193	83024110
	9250322	9250322	ProLock 1 HH 2210 Handle + WC Bathroom set SS (Please order only Bathroom Lock along with WC version set)	1	Set	1	1,790	83024110
 	Prolock 1 HH 2310 (Hollow)							
	9228102	9228102	ProLock 1 HH 2310 Handle + Handle set SS	1	Set	1	1,334	83024110
	9228104	9228104	ProLock 1 HH 2310 Handle + WC Bathroom set SS (Please order only Bathroom Lock along with WC version set)	1	Set	1	1,934	83024110
 	Prolock 1 HH 2250 (Hollow)							
	9228105	9228105	ProLock 1 HH 2250 Handle + Handle set SS	1	Set	1	1,326	83024110
	9228107	9228107	ProLock 1 HH 2250 Handle + WC Bathroom set SS (Please order only Bathroom Lock along with WC version set)	1	Set	1	1,934	83024110
 	Prolock 1 HH 2340 (Hollow)							
	9228108	9228108	ProLock 1 HH 2340 Handle + Handle set SS	1	Set	1	1,307	83024110
	9228110	9228110	ProLock 1 HH 2340 Handle + WC Bathroom set SS (Please order only Bathroom Lock along with WC version set)	1	Set	1	1,934	83024110
 	Prolock 1 HH 2410 (Hollow)							
	9228111	9228111	ProLock 1 HH 2410 Handle + Handle set SS	1	Set	1	1,767	83024110
	9228113	9228113	ProLock 1 HH 2410 Handle + WC Bathroom set SS (Please order only Bathroom Lock along with WC version set)	1	Set	1	2,188	83024110





Product	Article No.	SAP	Item Description	Qty.	Unit	PU	MRP	HS Code	
	ProLock 1 HH 2730 (Hollow)								
	9228114	9228114	ProLock 1 HH 2730 Handle + Handle set SS	1	Set	1	1,702	83024110	
	9228116	9228116	ProLock 1 HH 2730 Handle + WC Bathroom set SS (Please order only Bathroom Lock along with WC version set)	1	Set	1	2,134	83024110	
	ProLock 1 HH 2610 (SS 304 Solid Die cast) (Suitable for door thickness of 40-66 mm)								
	9228768	9228768	ProLock 1 HH 2610 Handle + Handle set SS	1	Set	1	2,556	83024110	
	9228769	9228769	ProLock 1 HH 2610 Handle + WC Bathroom set SS (Please order only Bathroom Lock along with WC version set)	1	Set	1	3,169	83024110	
	ProLock 1 HH 2620 (SS 304 Solid Die cast) (Suitable for door thickness of 40-66 mm)								
	9228770	9228770	ProLock 1 HH 2620 Handle + Handle set SS	1	Set	1	2,556	83024110	
	9228771	9228771	ProLock 1 HH 2620 Handle + WC Bathroom set SS (Please order only Bathroom Lock along with WC version set)	1	Set	1	3,169	83024110	
	ProLock 1 HH 2630 (SS 304 Solid Die cast) (Suitable for door thickness of 40-66 mm)								
	9228772	9228772	ProLock 1 HH 2630 Handle + Handle set SS	1	Set	1	2,556	83024110	
	9228773	9228773	ProLock 1 HH 2630 Handle + WC Bathroom set SS (Please order only Bathroom Lock along with WC version set)	1	Set	1	3,169	83024110	
	ProLock 1 HH 2640 (SS 304 Solid Die cast) (Suitable for door thickness of 40-66 mm)								
	9228774	9228774	ProLock 1 HH 2640 Handle + Handle set SS	1	Set	1	2,556	83024110	
	9228775	9228775	ProLock 1 HH 2640 Handle + WC Bathroom set SS (Please order only Bathroom Lock along with WC version set)	1	Set	1	3,289	83024110	
	ProLock 1 HH 2650 (SS 304 Solid Die cast) (Suitable for door thickness of 40-66 mm)								
	9228776	9228776	ProLock 1 HH 2650 Handle + Handle set SS	1	Set	1	2,670	83024110	
	9228777	9228777	ProLock 1 HH 2650 Handle + WC Bathroom set SS (Please order only Bathroom Lock along with WC version set)	1	Set	1	3,270	83024110	

Product	Article No.	SAP	Item Description	Qty.	Unit	PU	MRP	HS Code
	ProLock 1 HH 2660 (SS 304 Solid Die cast) (Suitable for door thickness of 40-66 mm)							
	9228778	9228778	ProLock 1 HH 2660 Handle + Handle set SS	1	Set	1	2,670	83024110
	9228779	9228779	ProLock 1 HH 2660 Handle + WC Bathroom set SS (Please order only Bathroom Lock along with WC version set)	1	Set	1	3,390	83024110
	ProLock 1 HH 2670 (SS 304 Solid Die cast) (Suitable for door thickness of 40-66 mm)							
	9228780	9228780	ProLock 1 HH 2670 Handle + Handle set SS	1	Set	1	2,670	83024110
	9228781	9228781	ProLock 1 HH 2670 Handle + WC Bathroom set SS (Please order only Bathroom Lock along with WC version set)	1	Set	1	3,390	83024110
	ProLock 1 HH 2680 (SS 304 Solid Die cast) (Suitable for door thickness of 40-66 mm)							
	9228782	9228782	ProLock 1 HH 2680 Handle + Handle set SS	1	Set	1	2,556	83024110
	9228783	9228783	ProLock 1 HH 2680 Handle + WC Bathroom set SS (Please order only Bathroom Lock along with WC version set)	1	Set	1	3,169	83024110
	ProLock 1 HH 2690 (SS 304 Solid Die cast) (Suitable for door thickness of 40-66 mm)							
	9228784	9228784	ProLock 1 HH 2690 Handle + Handle set SS	1	Set	1	3,001	83024110
	9228785	9228785	ProLock 1 HH 2690 Handle + WC Bathroom set SS	1	Set	1	3,602	83024110
	ProLock 1 HH 2710 (SS 304 Solid Die cast) (Suitable for door thickness of 40-66 mm)							
	9228786	9228786	ProLock 1 HH 2710 Handle + Handle set SS	1	Set	1	2,556	83024110
	9228787	9228787	ProLock 1 HH 2710 Handle + WC Bathroom set SS (Please order only Bathroom Lock along with WC version set)	1	Set	1	3,169	83024110
	ProLock 1 HH 2720 (SS 304 Solid Die cast) (Suitable for door thickness of 40-66 mm)							
	9228788	9228788	ProLock 1 HH 2720 Handle + Handle set SS	1	Set	1	2,556	83024110
	9228789	9228789	ProLock 1 HH 2720 Handle + WC Bathroom set SS (Please order only Bathroom Lock along with WC version set)	1	Set	1	3,289	83024110

Product	Article No.	SAP	Item Description	Qty.	Unit	PU	MRP	HS Code	
 	ProLock 1 HH 2740 (Hollow) (Suitable for door thickness of 40-66 mm)								
	9228790	9228790	ProLock 1 HH 2740 Handle + Handle set SS	1	Set	1	1,658	83024110	
	9228791	9228791	ProLock 1 HH 2740 Handle + WC Bathroom set SS (Please order only Bathroom Lock along with WC version set)	1	Set	1	2,341	83024110	
 	ProLock 1 HH 2750 (Hollow) (Suitable for door thickness of 40-66 mm)								
	9228792	9228792	ProLock 1 HH 2750 Handle + Handle set SS	1	Set	1	1,578	83024110	
	9228793	9228793	ProLock 1 HH 2750 Handle + WC Bathroom set SS (Please order only Bathroom Lock along with WC version set)	1	Set	1	2,181	83024110	
 	ProLock 1 HH 2760 (Hollow) (Suitable for door thickness of 40-66 mm)								
	9228794	9228794	ProLock 1 HH 2760 Handle + Handle set SS	1	Set	1	1,644	83024110	
	9228795	9228795	ProLock 1 HH 2760 Handle + WC Bathroom set SS (Please order only Bathroom Lock along with WC version set)	1	Set	1	2,242	83024110	
 	ProLock 1 HH 2770 (Hollow) (Suitable for door thickness of 40-66 mm)								
	9228796	9228796	ProLock 1 HH 2770 Handle + Handle set SS	1	Set	1	1,658	83024110	
	9228797	9228797	ProLock 1 HH 2770 Handle + WC Bathroom set SS (Please order only Bathroom Lock along with WC version set)	1	Set	1	2,341	83024110	
Mortise handle Prolock 1 SS 304, Satin finish; 200,000 cycles tested in-house lab.; 5 years Functional Warranty									
 	Prolock 1 HH 2110 (Oval Rose Hollow Handles)								
	9228117	9228117	ProLock 1 HH 2110/O Handle + Handle set SS (Please order Profile Sash Lock with this handles)	1	Set	1	1,431	83024110	
 	Prolock 1 HH 2210 (Oval Rose Hollow Handles)								
	9228119	9228119	ProLock 1 HH 2210/O Handle + Handle set SS (Please order Profile Sash Lock with this handles)	1	Set	1	1,407	83024110	

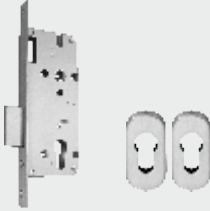

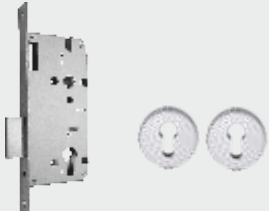



Product	Article No.	SAP	Item Description	Qty.	Unit	PU	MRP	HS Code
	Prolock 1 HH 2310 (Oval Rose Hollow Handles)							
	9228121	9228121	ProLock 1 HH 2310/O Handle + Handle set SS (Please order Profile Sash Lock with this handles)	1	Set	1	1,407	83024110
Spare Escutcheons								
  	Round PZ Escutcheon (For Dead bolt / Roller Latch / Single Dead Bolt Lock Only)							
	9228459	9228459	Round PZ Escutcheon 1	1	Set	1	259	83014090
	9228434	9228434	Square PZ Escutcheon	1	Set	1	278	83014090
	9250390	9250390	Oval PZ Escutcheon	1	Set	1	256	83014090
  	Round WC Escutcheon (For single bathroom lock only)							
	9228706	9228706	Round WC Escutcheon 1	1	Set	1	813	83014090
	9227805	9227805	Round WC Escutcheon 2	1	Set	1	720	83014090
	9227803	9227803	Square WC Escutcheon	1	Set	1	840	83014090





Product	Article No.	SAP	Item Description	Qty.	Unit	PU	MRP	HS Code
Lock Body (72 mm Centre to Centre Distance)								
	Sash Locks (For Main and Internal doors)							
	9228136	9228136	HBS 31 FSL: Sash Lock DIN Left/Right CTC 72 & Backset 55	1	Set	1	1,354	83014090
	9228137	9228137	HBS 31 FSL: Sash Lock DIN Left/Right CTC 72 & Backset 60	1	Set	1	1,354	83014090
	Latch Lock (With Mortise Handle only)							
	9228138	9228138	HBS 31 FLL: Latch Lock DIN Left/Right CTC 72 & Backset 55	1	Set	1	1,293	83014090
	9228139	9228139	HBS 31 FLL: Latch Lock DIN Left/Right CTC 72 & Backset 60	1	Set	1	1,293	83014090
	Dead Bolt Lock (Without Mortise handle)							
	9228140	9228140	HBS 31 FDL: Dead Lock DIN Left/Right CTC 72 & Backset 55	1	Set	1	1,263	83014090
	9228141	9228141	HBS 31 FDL: Dead Lock DIN Left/Right CTC 72 & Backset 60	1	Set	1	1,263	83014090
	9228459	9228459	Round PZ Escutcheon 1 (Please Order Escutcheon separately)	1	Set	1	259	83014090
	Bathroom Lock (For use in bathroom doors with WC version handles)							
	9228142	9228142	HBS 31 FBL: Bathroom Lock DIN Left/Right CTC 78 & Backset 55	1	Set	1	1,478	83014090
	9228143	9228143	HBS 31 FBL: Bathroom Lock DIN Left/Right CTC 78 & backset 60 (Only to be used with WC version handles)	1	Set	1	1,478	83014090
	Night Latch Lock (For use on main door only)							
	9228144	9228144	HBS 31 FNL: Night Latch Lock DIN Left/Right CTC 72 & Backset 55	1	Set	1	1,666	83014090
	9228145	9228145	HBS 31 FNL: Night Latch Lock DIN Left/Right CTC 72 & Backset 60	1	Set	1	1,666	83014090
	Roller latch (For two way opening doors)							
	9228146	9228146	HBS 31 FRL: Roller Latch Lock DIN Left/Right CTC 72 & Backset 55	1	Set	1	1,820	83014090
	9228147	9228147	HBS 31 FRL: Roller Latch Lock DIN Left/Right CTC 72 & Backset 60	1	Set	1	1,820	83014090
	9228459	9228459	Round PZ Escutcheon 1 (Please order escutcheon separately)	1	Set	1	259	83014090

Product	Article No.	SAP	Item Description	Qty.	Unit	PU	MRP	HS Code
Lock Body (85/92 mm Centre to Centre Distance)								
	Profile Sash Lock (For use in Steel and Aluminum Profile doors)							
	9228151	9228151	HBS 31 FSL: Sash Profile Lock DIN Left/Right CTC 92 & Backset 30	1	Set	1	1,407	83014090
	9250116	9250116	HBS 31 FSL: Sash Profile Lock DIN Left/Right CTC 85 & Backset 30	1	Set	1	937	83014090
	9228575	9228575	HBS 31 FSL: Profile sash lock DIN Left/Right CTC 85 & Backset 35	1	Set	1	983	83014090
	Profile Latch Lock (For use in Steel and Aluminum Profile doors)							
	9228580	9228580	HBS 31 FLL: Profile Latch Lock DIN Left/Right CTC 85 & Backset 30	1	Pc	1	923	83024110
	9228581	9228581	HBS 31 FLL: Profile Latch Lock DIN Left/Right CTC 85 & Backset 35	1	Pc	1	956	83024110
	Profile Dead Bolt lock (For use in Steel and Aluminum Profile doors)							
	9228586	9228586	HBS 31 FDL: Profile Dead Lock DIN Left/Right CTC 85 & Backset 30	1	Pc	1	894	83014090
	9228587	9228587	HBS 31 FDL: Profile Dead Lock DIN Left/Right CTC 85 & Backset 35	1	Pc	1	923	83014090
	9250390	9250390	Oval PZ Escutcheon	1	Pc	1	256	83014090
	Profile Roller Latch lock (For use in Steel and Aluminum Profile doors)							
	9228152	9228152	HBS 31 FRL: Roller Latch Profile Lock DIN Left/Right CTC 92 & Backset 30	1	Set	1	1,594	83014090
	9250390	9250390	Oval PZ Escutcheon	1	Set	1	256	83014090
	Sash Lock (For Main and Internal doors)							
	9228576	9228576	HBS 31 FSL: Sash Lock DIN Left/Right CTC 85 & Backset 45	1	Set	1	1,317	83014090
	9228577	9228577	HBS 31 FSL: Sash Lock DIN Left/Right CTC 85 & Backset 50	1	Set	1	1,292	83014090
	9228578	9228578	HBS 31 FSL: Sash Lock DIN Left/Right CTC 85 & Backset 55	1	Set	1	1,292	83014090
	9228579	9228579	HBS 31 FSL: Sash Lock DIN Left/Right CTC 85 & Backset 60	1	Set	1	1,436	83014090
	Dead Bolt Lock (Without Mortise Handle)							
	9228588	9228588	HBS 31 FDL: Dead Lock DIN Left/Right CTC 85 & Backset 45	1	Set	1	1,203	83014090
	9228589	9228589	HBS 31 FDL: Dead Lock DIN Left/Right CTC 85 & Backset 50	1	Set	1	1,216	83014090
	9228590	9228590	HBS 31 FDL: Dead Lock DIN Left/Right CTC 85 & Backset 55	1	Set	1	1,216	83014090
	9228591	9228591	HBS 31 FDL: Dead Lock DIN Left/Right CTC 85 & Backset 60	1	Set	1	1,247	83014090
	9228459	9228459	Round PZ Escutcheon 1 (Plz Order Escutcheon separately)	1	Set	1	259	83014090
	Latch Lock (With Mortise Handle only)							
	9228582	9228582	HBS 31 FLL: Latch Lock DIN Left/Right CTC 85 & Backset 45	1	Set	1	1,203	83014090
	9228583	9228583	HBS 31 FLL: Latch Lock DIN Left/Right CTC 85 & Backset 50	1	Set	1	1,216	83014090
	9228584	9228584	HBS 31 FLL: Latch Lock DIN Left/Right CTC 85 & Backset 55	1	Set	1	1,216	83014090
	9228585	9228585	HBS 31 FLL: Latch Lock DIN Left/Right CTC 85 & Backset 60	1	Set	1	1,247	83014090

Product	Article No.	SAP	Item Description	Qty.	Unit	PU	MRP	HS Code
Lock Body EN 12209 Series (72 mm CTC locks) SS 304: Latch and Dead Bolt; 200,000 cycles tested ; 5 years Functional Warranty								
	Sash Lock (For fire rated Main and Internal doors)							
	9228154	9228154	HBS 31 FESL: Sash Lock DIN Left/Right CTC 72 & Backset 60 EN 12209, Fire Rated	1	Set	1	2,263	83014090
	Latch Lock (With Mortise Handle only)							
	9228156	9228156	HBS 31 FELL: Latch Lock DIN Left/Right CTC 72 & Backset 60 EN 12209, Fire Rated	1	Set	1	2,052	83014090
	Dead Bolt Lock (Without Mortise handle)							
	9228158	9228158	HBS 31 FEDL: Dead Lock DIN Left/Right CTC 72 & Backset 60 EN 12209, Fire Rated	1	Set	1	1,877	83014090
	9228459	9228459	Round PZ Escutcheon 1 (Please Order Escutcheon separately)	1	Set	1	259	83014090
	Bathroom Lock (For use in bathroom doors with WC version handles)							
	9228160	9228160	HBS 31 FEFL: Bathroom Lock DIN Left/Right CTC 78 & Backset 60 EN 12209, Fire Rated (Only to be used with WC version handles)	1	Set	1	2,353	83014090
	Night Latch Lock (For use on main door only)							
	9228162	9228162	HBS 31 FENL: Night Latch Lock DIN Left/Right CTC 72 & Backset 60 EN 12209, Fire Rated	1	Set	1	2,111	83014090
	Panic Lock (for use on fire rated Main door only)							
	9228164	9228164	HBS 31 FEPL: Panic Lock DIN Left/Right CTC 72 & Backset 60 EN 12209, EN 179	1	Set	1	3,442	83014090

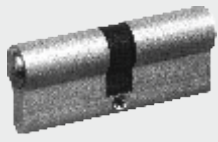
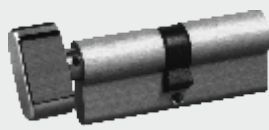
Product	Article No.	SAP	Item Description	Qty.	Unit	PU	MRP	HS Code
Special locks								
	Security Lock							
	9250585	9250585	HBS 31 SL: Security Tribolt Lock DIN Left/Right CTC 85 Et Backset 60	1	Set	1	1,385	83014090
	Single Dead Bolt Lock							
	9228148	9228148	HBS 31 FSDL: Single Dead Lock DIN Left/Right Backset 55	1	Set	1	1,047	83014090
	9228459	9228459	Round PZ Escutcheon 1 (Please Order Escutcheon separately)	1	Set	1	259	83014090
	Single Latch Lock							
	9228149	9228149	HBS 31 FSSL: Single Latch Lock DIN Left/Right Backset 55	1	Set	1	1,079	83014090
	Single Bathroom Lock							
	9228150	9228150	HBS 31 FSBL: Single Bathroom Lock DIN Left/Right Backset 45	1	Set	1	1,018	83014090
	9228706	9228706	Round WC Escutcheon 1 (Please order WC escutcheon separately)	1	Set	1	813	83014090
	Roller Catch Lock							
	9228716	9228716	Roller ball Catch	1	Set	1	980	83014090
	Allen key Tubewell Lock							
	9250584	9250584	Allen key Tubewell Lock SS	1	Set	1	650	83014090

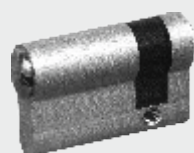
Product	Article No.	SAP	Item Description	Qty.	Unit	PU	MRP	HS Code
Wooden Sliding Locks and Handles / Escutcheons								
	Sliding PZ Lock							
	9228481	9228481	Hettich Sliding Lock PZ DIN Left/Right backset 50 mm (Please order Sliding Handle or Escutcheon Et also cylinder according to door thickness)	1	Set	1	987	83014090
	Sliding Handles with PZ hole							
	9228483	9228483	Hettich Sliding Handles For Timber Doors of Thickness 40-50Mm SS304 Satin Finish (Please order Euro Profile cylinder as per door thickness)	1	Set	1	1,231	83014090
	Sliding door Escutcheons with PZ hole							
	9228484	9228484	Sliding Door Escutcheons For Timber Doors SS304 Satin Finish (Please order Euro Profile cylinder as per door thickness)	1	Set		1,231	83014090
	Sliding WC Lock							
	9228482	9228482	Hettich Sliding Lock WC DIN Left/Right backset 50 mm (Please order WC sliding Handle or Escutcheon)	1	Set	1	987	83014090
	Sliding door WC handle with knob							
	9228712	9228712	WC Sliding Door Handle For Timber Doors SS 304 Satin Finish	1	Set	1	1,264	83014090
	Sliding WC Escutcheon with knob							
	9228713	9228713	WC Sliding Door Escutcheons For Timber Doors SS304 Satin Finish	1	Set	1	1,207	83014090

Product	Article No.	SAP	Item Description	Qty.	Unit	PU	MRP	HS Code
Euro profile cylinder								
	HSCL - Standard Double Cylinder							
	9228171	9228171	HSCL 60: Both side key 60 mm, for max door thickness - 40 mm	1	Set	1	1,019	83014090
	9228172	9228172	HSCL 70: Both side key 70 mm, for max door thickness - 50 mm	1	Set	1	1,080	83014090
	9228173	9228173	HSCL 75: Both side key 75 mm, for max door thickness - 55 mm	1	Set	1	1,125	83014090
	9228174	9228174	HSCL 80: Both side key 80 mm, for max door thickness - 60 mm	1	Set	1	1,169	83014090
	9228175	9228175	HSCL 90: Both side key 90 mm, for max door thickness - 70 mm	1	Set	1	1,259	83014090
	9250323	9250323	HSCL 100: Both side key 100 mm, for max door thickness - 80 mm	1	Set	1	1,426	83014090
	HTCL - Thumb Turn Cylinder							
	9228176	9228176	HTCL 60: One side key and one side knob 60 mm, for max door thickness - 40 mm	1	Set	1	1,139	83014090
	9228177	9228177	HTCL 70: One side key and one side knob 70 mm, for max door thickness - 50 mm	1	Set	1	1,199	83014090
	9228178	9228178	HTCL 75: One side key and one side knob 75 mm, for max door thickness - 55 mm	1	Set	1	1,244	83014090
	9228179	9228179	HTCL 80: One side key and one side knob 80 mm, for max door thickness - 60 mm	1	Set	1	1,289	83014090
	9228180	9228180	HTCL 90: One side key and one side knob 90 mm, for max door thickness - 70 mm	1	Set	1	1,380	83014090
	9250324	9250324	HTCL 100: One side key and one side knob 100 mm, for max door thickness - 80 mm	1	Set	1	1,567	83014090
	HBCL - Bathroom Cylinder							
	9228181	9228181	HBCL 60: One side knob and one side coin slot 60 mm, for max door thickness-40 mm	1	Set	1	959	83014090
	9228182	9228182	HBCL 70: One side knob and one side coin slot 70 mm, for max door thickness-50 mm	1	Set	1	1,051	83014090
	9228183	9228183	HBCL 75: One side knob and one side coin slot 75 mm, for max door thickness-55 mm	1	Set	1	1,110	83014090
	HHCL - Half Cylinder							
	9228184	9228184	HHCL 40: One side key only 40 mm, for max door thickness-40 mm	1	Set	1	960	83014090
	9228185	9228185	HHCL 45: One side key only 45 mm, for max door thickness-45 mm	1	Set	1	989	83014090
	HHTL- Half Thumb Turn Cylinder							
	9228729	9228729	HHTL 40: One side thumb turn only 40 mm, for max door thickness-40 mm		Set	1	856	83014090
	9228730	9228730	HHTL 45: One side thumb turn only 45 mm, for max door thickness-45 mm		Set	1	888	83014090

Master Key System

- ▶ Below are the standard prices for master key system.
- ▶ These prices are of single cylinder only.
- ▶ For your query/requirement please multiply prices by number of cylinder needed.
- ▶ If any query please ask the technical team.

Example:





Master key system with 5 master keys for 20 locks cylinders

i.e. 10 cylinders of HSCL 60 & 10 cylinder HSCL 70

Then total pricing will be 10x price of HSCL 60 master cylinder + 10x price of HSCL 70 master cylinder

Price of whole set = 10x1565 + 10x1628 = 31930 only

Master key system Mechanical Key	For Set Quantity < 50 Cylinders		For Set Quantity > 50 Cylinders	
	Description (Cylinder Set with 3 individual cylinder keys and 5 master keys)	5 MK MRP	6MK MRP	5 MK MRP
HSCL 60: Both side key 60 mm, for max door thickness - 40 mm	2,191	2,258	1,565	1,613
HSCL 70: Both side key 70 mm, for max door thickness - 50 mm	2,279	2,346	1,628	1,676
HSCL 75: Both side key 75 mm, for max door thickness - 55 mm	2,341	2,408	1,672	1,720
HSCL 80: Both side key 80 mm, for max door thickness - 60 mm	2,404	2,470	1,717	1,764
HSCL 90: Both side key 90 mm, for max door thickness - 70 mm	2,528	2,596	1,806	1,854
HSCL 100: Both side key 100 mm, for max door thickness - 80 mm	2,780	2,848	1,986	2,034
HTCL 60: One side key and one side knob 60 mm, for max door thickness - 40 mm	2,062	2,128	1,473	1,520
HTCL 70: One side key and one side knob 70 mm, for max door thickness - 50 mm	2,145	2,212	1,532	1,580
HTCL 75: One side key and one side knob 75 mm, for max door thickness - 55 mm	2,208	2,275	1,577	1,625
HTCL 80: One side key and one side knob 80 mm, for max door thickness - 60 mm	2,272	2,338	1,623	1,670
HTCL 90: One side key and one side knob 90 mm, for max door thickness - 70 mm	2,400	2,467	1,714	1,762
HTCL 100: One side key and one side knob 100 mm, for max door thickness - 80 mm	2,671	2,738	1,908	1,956
HHCL 40: One side key only 40 mm, for max door thickness-40 mm	1,810	1,876	1,293	1,340
HHCL 45: One side key only 45 mm, for max door thickness-45 mm	1,645	1,712	1,175	1,223

Product	Article No.	SAP	Item Description	Qty.	Unit	PU	MRP	HS Code
Panic Bar Solution								
	HPN 3000 RIM (Touch Bar Panic Device)							
	9228616	9228616	HPN 3000 RIM: 1 Point Locking, Touch bar, Steel Silver Painted, Fire Rated	1	Set	1	7,928	83014090
	9228258	9228258	HPN 3000 RIM: 1 Point Locking, Touch bar, Stainless Steel, Fire Rated	1	Set	1	12,042	83014090
	9228617	9228617	HPN 3000 Vertical: 2 Point Locking, Touch bar, Steel Silver Painted, Fire Rated	1	Set	1	11,450	83014090
	9228259	9228259	HPN 3000 Vertical: 2 Point Locking, Touch bar, Stainless Steel, Fire Rated.	1	Set	1	13,297	83014090
	HPN 500 IN RIM (Push Bar Panic Device)							
	9228622	9228622	HPN 500 IN RIM: 1 Point Locking, Push bar, Steel Silver Painted, Fire Rated	1	Set	1	8,130	83014090
	9228623	9228623	HPN 500 IN RIM: 1 Point Locking, Push bar, Stainless Steel, Fire Rated	1	Set	1	10,664	83014090
	9228624	9228624	HPN 500 IN Vertical RIM: 2 Point Locking, Push bar, Steel Silver Painted, Fire Rated	1	Set	1	14,800	83014090
	9228625	9228625	HPN 500 IN Vertical: 2 Point Locking, Push bar, Stainless Steel, Fire Rated.	1	Set	1	12,096	83014090
Panic Accessories for HPN 3000 and 500 IN								
	Counter Handle On Short plate							
	9228704	9228704	Counter handle for HPN on Short Plate Silver	1	Set	1	7,012	83014090
	9228260	9228260	Counter handle for HPN on Short Plate SS	1	Set	1	8,232	83014090
	Counter Handle On Rose							
	9228705	9228705	Counter handle for HPN on Rose Silver	1	Set	1	4,395	83014090
	9228261	9228261	Counter handle for HPN on Rose SS	1	Set	1	5,182	83014090



ProLock Infinity : The Complete Main Door Solution



ProLock Infinity Lock System: Main Door locking solution having a combination of mortise and night latch lock system.

Technical detail in brief:

Handle:

- ▶ Movable handle both side
- ▶ Manual locking
- ▶ Cylinder Protection (anti drill protection for 10 pin cylinder)
- ▶ Returning Spring
- ▶ DIN Left/Right different model
- ▶ Door Thickness 35-50 mm
- ▶ Material: Stainless Steel 304

Lock Body:

- ▶ Centre to centre distance 68 mm
- ▶ Back Set 60 mm
- ▶ Life time cycle: 200,000 cycles tested
- ▶ Material: Stainless Steel 304 (faceplate)

Euro Profile Cylinder:

- ▶ ProLock Infinity High security thumb turn 70 mm cylinder with computerized snake key way and anti drill pins
- ▶ Supplied with Five Main Keys & Two Construction Key

Available finishes :

- ▶ Stainless Steel, Antique Brass, Champagne & Black

ProLock Infinity Lock System handles



Handle design 1



Handle design 2



Handle design 3



Handle design 4

Other Available finishes

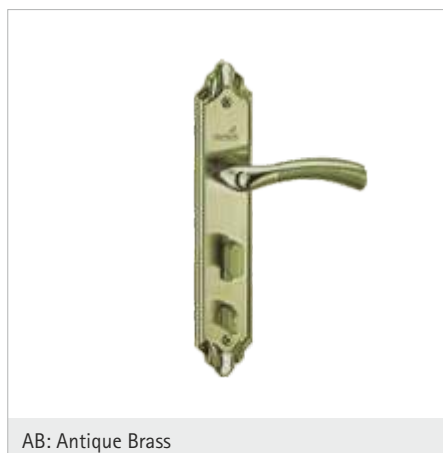

AB: Antique Brass

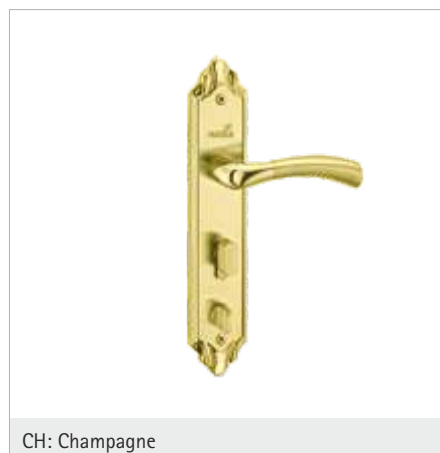









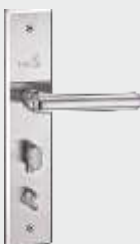









CH: Champagne

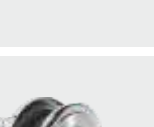

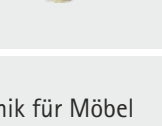

BL: Black

* Against Special Order

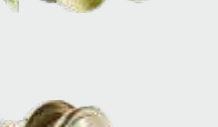
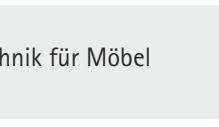
Product	Article No.	SAP	Item Description	Qty.	Unit	PU	MRP	HS Code
Prolock Infinity : The Complete Main Door Solution								
	Prolock Infinity Handles Design 1							
	9228485	9228485	Prolock Infinity 1 SS DIN Left	1	Set	1	4,606	83024110
	9228501	9228501	Prolock Infinity 1 SS DIN Right	1	Set	1	4,606	83024110
	Prolock Infinity Handles Design 2							
	9228489	9228489	Prolock Infinity 2 SS DIN Left	1	Set	1	4,606	83024110
	9228505	9228505	Prolock Infinity 2 SS DIN Right	1	Set	1	4,606	83024110
	Prolock Infinity Handles Design 3							
	9228493	9228493	Prolock Infinity 3 SS DIN Left	1	Set	1	4,606	83024110
	9228509	9228509	Prolock Infinity 3 SS DIN Right	1	Set	1	4,606	83024110
	Prolock Infinity Handles Design 4							
	9228497	9228497	Prolock Infinity 4 SS DIN Left	1	Set	1	4,606	83024110
	9228513	9228513	Prolock Infinity 4 SS DIN Right	1	Set	1	4,606	83024110
	Prolock Infinity Lock body with 5 point locking system							
	9228517	9228517	HBS 21 FSL: Sash Lock DIN Left/Right CTC 68 & Backset 60 with 3 Bolt, Latch And 1 Manual Bolt SS Finish	1	Set	1	1,998	83014090
	Prolock Infinity Cylinder with 5 Main keys & 2 construction keys							
	9228518	9228518	Prolock Infinity Euro Profile Cylinder with 2 Row Pin, Anti-Drill Pin & Reversible AB Key SS Finish	1	Set	1	2,085	83014090

Product	Article No.	SAP	Item Description	Qty.	Unit	PU	MRP	HS Code
HCK 01 (Backset 60 mm & Door thickness 30 to 45 mm)								
        	9228335	9228335	HCK 01 SS: One side Key and one side knob (For Room Doors) (For Room Doors), with 3 keys, dia 65 mm	1	Set	1	827	83024110
	9228336	9228336	HCK 01 SS WC: One side Knob and other side emergency release slot, without key (for Washroom doors), dia 65 mm	1	Set	1	750	83024110
	9250827	9250827	HCK 01 SS BD: One side knob and other side Dead Knob(for Balcony doors), dia 65 mm	1	Set	1	783	83024110
	9228337	9228337	HCK 01 PB: One side Key and one side knob (For Room Doors) (For Room Doors), with 3 keys, dia 65 mm	1	Set	1	1,004	83024110
	9228338	9228338	HCK 01 PB WC: One side Knob and other side emergency release slot, without key (for Washroom doors), dia 65 mm	1	Set	1	927	83024110
	9250583	9250583	HCK 01 PB BD: One side knob and other side Dead Knob(for Balcony doors), dia 65 mm	1	Set	1	937	83024110
	9228339	9228339	HCK 01 AB: One side Key and one side knob (For Room Doors) (For Room Doors), with 3 keys, dia 65 mm	1	Set	1	1,004	83024110
	9228340	9228340	HCK 01 AB WC: One side Knob and other side emergency release slot, without key (for Washroom doors), dia 65 mm	1	Set	1	927	83024110
	9250582	9250582	HCK 01 AB BD: One side knob and other side Dead Knob(for Balcony doors), dia 65 mm	1	Set	1	937	83024110
HCK 02 (Backset 60 mm & Door thickness 30 to 45 mm)								
     	9228341	9228341	HCK 02 SS: One side Key and one side knob (For Room Doors), with 3 keys, dia 75 mm	1	Set	1	949	83024110
	9228342	9228342	HCK 02 SS WC: One side Knob and other side emergency release slot, without key (for bathroom doors), dia 75 mm	1	Set	1	872	83024110
	9228343	9228343	HCK 02 PB: One side Key and one side knob (For Room Doors), with 3 keys, dia 75 mm	1	Set	1	1,453	83024110
	9228344	9228344	HCK 02 PB WC: One side Knob and other side emergency release slot, without key (for bathroom doors), dia 75 mm	1	Set	1	1,378	83024110
	9228345	9228345	HCK 02 AB: One side Key and one side knob (For Room Doors), with 3 keys, dia 75 mm	1	Set	1	1,484	83024110
	9228346	9228346	HCK 02 AB WC: One side Knob and other side emergency release slot, without key (for bathroom doors), dia 75 mm	1	Set	1	1,407	83024110
HCH 01 (Adjustable Backset 60/70 mm & Door thickness 35 to 45 mm)								
   	9228347	9228347	HCH 01 SS: One side Key and one side knob (For Room Doors), with 3 keys, dia 75 mm	1	Set	1	1,683	83024110
	9228348	9228348	HCH 01 SS WC: One side Knob and other side emergency release slot, without key (for bathroom doors), dia 75 mm	1	Set	1	1,607	83024110
	9228349	9228349	HCH 01 PB: One side Key and one side knob (For Room Doors), with 3 keys, dia 75 mm	1	Set	1	1,989	83024110
	9228350	9228350	HCH 01 PB WC: One side Knob and other side emergency release slot, without key (for bathroom doors), dia 75 mm	1	Set	1	1,912	83024110
	9228351	9228351	HCH 01 AB: One side Key and one side knob (For Room Doors), with 3 keys, dia 75 mm	1	Set	1	1,989	83024110
	9228352	9228352	HCH 01 AB WC: One side Knob and other side emergency release slot, without key (for bathroom doors), dia 75 mm	1	Set	1	1,912	83024110

Product	Article No.	SAP	Item Description	Qty.	Unit	PU	MRP	HS Code
HCH 02 (Adjustable Backset 60/70 mm & Door thickness 35 to 45 mm)								
	9228353	9228353	HCH 02 SS: One side Key and one side knob (For Room Doors), with 3 keys, dia 65 mm	1	Set	1	1,958	83024110
	9228354	9228354	HCH 02 SS WC: One side Knob and other side emergency release slot, without key (for bathroom doors), dia 65 mm	1	Set	1	1,882	83024110
	9228355	9228355	HCH 02 PB: One side Key and one side knob (For Room Doors), with 3 keys, dia 65 mm	1	Set	1	2,263	83024110
	9228356	9228356	HCH 02 PB WC: One side Knob and other side emergency release slot, without key (for bathroom doors), dia 65 mm	1	Set	1	2,188	83024110
	9228357	9228357	HCH 02 AB: One side Key and one side knob (For Room Doors), with 3 keys, dia 65 mm	1	Set	1	2,263	83024110
	9228358	9228358	HCH 02 AB WC: One side Knob and other side emergency release slot, without key (for bathroom doors), dia 65 mm	1	Set	1	2,188	83024110



SS: Stainless Steel

PB: Polished Brass





AB: Antique Brass









Product	Article No.	SAP	Item Description	Qty.	Unit	PU	MRP	HS Code
Floor Spring								
	960 Series (Door Weight 300 kg)							
	9227859	9227859	HTS FS960: For Door Width 950-1400 mm, Hold open at 90°, without accessories; EN1154 Certified; 500,000 cycle tested; Fire rated.	1	Set	1	33,950	83024110
	840 Series (Door Weight 150 Kg)							
	9227843	9227843	HTS FS843: For Door Width 950 mm, No Hold open, without accessories; EN1154 Certified; 500,000 cycle tested; Fire rated.	1	Set	1	7,845	83024110
	9227844	9227844	HTS FS843: For Door Width 950 mm, Hold open at 90°, without accessories; EN1154 Certified; 500,000 cycle tested; Fire rated.	1	Set	1	7,845	83024110
	9227846	9227846	HTS FS844: For Door Width 1100 mm, No Hold open, without accessories; EN1154 Certified; 500,000 cycle tested; Fire rated.	1	Set	1	7,845	83024110
	9227847	9227847	HTS FS844 (Body): For Door Width 1100 mm, Hold open at 90° without accessories; EN1154 Certified; 500,000 cycle tested; Fire rated.	1	Set	1	7,845	83024110
	650 Series (Door Weight 100 Kg)							
	9227850	9227850	HTS FS652: For Door Width 850 mm, Hold open at 90°, without accessories; 200,000 cycle in-house lab tested.	1	Set	1	6,433	83024110
	9227853	9227853	HTS FS653: For Door Width 950 mm, Hold open at 90°, without accessories; 200,000 cycle in-house lab tested.	1	Set	1	6,433	83024110
	9227856	9227856	HTS FS654: For Door Width 1100 mm, Hold open at 90°, without accessories; 200,000 cycle in-house lab tested.	1	Set	1	6,433	83024110
	463 Series (Door Weight 80 Kg)							
	9228444	9228444	HTS FS463: For Door Width 950 mm, Hold open at 90°, without accessories; 200,000 cycle in-house lab tested.	1	Set	1	4,637	83024110
	Floor Spring Accessories for Wooden and Steel Profile doors							
	9227863	9227863	Top & Bottom Pivot for Wooden and Profile doors (For door weight up to 150 kg)	1	Set	1	1,339	83024110
	9228715	9228715	Heavy duty Top and bottom pivot for floor pivot (For door weight up to 350 kg)	1	Set	1	4,060	83024110
	Floor Spring Spare cover							
	9227861	9227861	Spare Cover for Floor spring 840 series.	1	Set	1	1,257	83024110
	9227862	9227862	Spare Cover for Floor spring 650 series.	1	Set	1	1,207	83024110

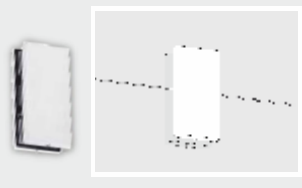

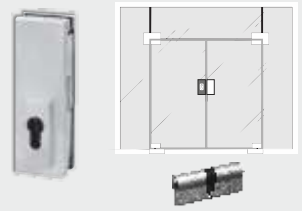
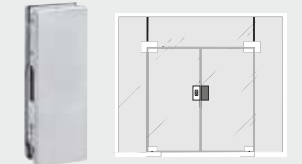
Product	Article No.	SAP	Item Description	Qty.	Unit	PU	MRP	HS Code
	Floor pivot/ Hinge							
	9250826	9250826	Floor pivot/hinge with loading capacity of 150 Kg doors	1	Set	1	1,460	83024110
	9228714	9228714	Floor pivot/hinge with loading capacity of 350 Kg doors	1	Set	1	3,602	83024110
	Offset Arm for Floor Springs							
	9228717	9228717	Offset arms for Floor Springs (DIN Left)	1	Pc	1	2,991	83024110
	9228718	9228718	Offset arms for Floor Springs (DIN Right)	1	Pc	1	2,991	83024110



Product	Article No.	SAP	Item Description	Qty.	Unit	PU	MRP	HS Code
Glass Patch Fittings (SS 304 satin finish cover; For 8-12 mm Glass thickness)								
 	Bottom Patch							
	9228265	9228265	HGF 100 : Bottom Patch	1	Set	1	1,083	83024110
 	Top Patch							
	9228266	9228266	HGF 200 : Top Patch	1	Set	1	1,083	83024110
 	Overpanel Patch							
	9228267	9228267	HGF 300: Overpanel Patch	1	Set	1	1,066	83024110
 	Overpanel side Patch							
	9228268	9228268	HGF 400 : Overpanel side Patch	1	Set	1	1,778	83024110
 	Overpanel Patch with Fixing Plate							
	9228275	9228275	HGF 930 : Overpanel Patch with Fixing Plate	1	Set	1	1,112	83024110
 	Wall to glass one panel							
	9228272	9228272	HGF 900: Wall to glass one panel	1	Set	1	1,033	83024110
 	Wall to glass two panels							
	9228273	9228273	HGF 910: Wall to glass two panels	1	Set	1	1,299	83024110



Product	Article No.	SAP	Item Description	Qty.	Unit	PU	MRP	HS Code
Glass to Glass two panels Connector								
	9228274	9228274	HGF 920: Glass to glass two panels	1	Set	1	1,131	83024110
Connector for over panel								
	9228276	9228276	HGF 940: Connector for over panel	1	Set	1	1,516	83024110
Corner Patch lock								
	9228269	9228269	HGF 500 : Corner Patch lock	1	Set	1	1,754	83024110
	9228171	9228171	HSCL 60: Both side key 60 mm, for max door thickness - 40 mm	1	Set	1	1,019	83024110
Centre Patch lock								
	9228270	9228270	HGF 600 : Centre patch Lock	1	Set	1	2,215	83024110
	9228171	9228171	HSCL 60: Both side key 60 mm, for max door thickness - 40 mm (Please order Euro Profile cylinder 60 mm separately)	1	Set	1	1,019	83024110
Counter Lock for Centre Patch Lock								
	9228271	9228271	HGF 700 : Counter Lock for Centre Patch Lock	1	Set	1	988	83024110
Top pivot for Top patch								
	9228458	9228458	HGF 800: Fixed top pivot for top patch	1	Set	1	362	83024110
Glass Sliding (Partition)								
Glass Sliding Kit and Track for 8-12 mm Glass thickness								
	9228477	9228477	HR SL80-G: Glass Sliding for loading capacity 80 kg	1	Set	1	3,791	83024110
	9228478	9228478	HR SL80-G: Glass Sliding track length 3000 mm	1	Set	1	4,176	83024110
	9228479	9228479	HR SL120-G: Glass Sliding for loading capacity 120 kg	1	Set	1	5,127	83024110
	9228480	9228480	HR SL120-G: Glass Sliding track length 3000 mm	1	Set	1	4,833	83024110

Product	Article No.	SAP	Item Description	Qty.	Unit	PU	MRP	HS Code	
	HPH 2110 Back to Back Handles Dia: 19 mm								
	9228525	9228525	HPH 2110 : Back to Back Pull Handles Dia. 19mm, CTC Length 150mm, SS Finish	1	Set	1	1,274	83024110	
	9228526	9228526	HPH 2110 : Back to Back Pull Handles Dia. 19mm, CTC Length 150mm, PSS Finish	1	Set	1	1,397	83024110	
	9228527	9228527	HPH 2110 : Back to Back Pull Handles Dia. 19mm, CTC Length 200mm, SS Finish	1	Set	1	1,336	83024110	
	9228528	9228528	HPH 2110 : Back to Back Pull Handles Dia. 19mm, CTC Length 200mm, PSS Finish	1	Set	1	1,459	83024110	
	HPH 2110 Back to Back Handles Dia: 25 mm								
	9228529	9228529	HPH 2110 : Back to Back Pull Handles Dia. 25mm, CTC Length 300mm, SS Finish	1	Set	1	1,761	83024110	
	9228530	9228530	HPH 2110 : Back to Back Pull Handles Dia. 25mm, CTC Length 300mm, PSS Finish	1	Set	1	1,942	83024110	
	9228531	9228531	HPH 2110 : Back to Back Pull Handles Dia. 25mm, CTC Length 400mm, SS Finish	1	Set	1	2,003	83024110	
	9228532	9228532	HPH 2110 : Back to Back Pull Handles Dia. 25mm, CTC Length 400mm, PSS Finish	1	Set	1	2,187	83024110	
	HPH 2110 Back to Back Handles Dia: 30 mm								
	9228533	9228533	HPH 2110 : Back to Back Pull Handles Dia. 30mm, CTC Length 600mm, SS Finish	1	Set	1	3,523	83024110	
	9228534	9228534	HPH 2110 : Back to Back Pull Handles Dia. 30mm, CTC Length 600mm, PSS Finish	1	Set	1	3,887	83024110	
	9228535	9228535	HPH 2110 : Back to Back Pull Handles Dia. 30mm, CTC Length 900mm, SS Finish	1	Set	1	4,919	83024110	
	9228536	9228536	HPH 2110 : Back to Back Pull Handles Dia. 30mm, CTC Length 900mm, PSS Finish	1	Set	1	5,588	83024110	
	HPH 2110 Back to Back Handles Dia: 32 mm								
9228537	9228537	HPH 2110 : Back to Back Pull Handles Dia. 32mm, CTC Length 1200mm, SS Finish	1	Set	1	5,342	83024110		
9228538	9228538	HPH 2110 : Back to Back Pull Handles Dia. 32mm, CTC Length 1200mm, PSS Finish	1	Set	1	6,256	83024110		
	HPH 2110 Bolt Through Pull Handles Dia: 19 mm								
	9228539	9228539	HPH 2110: Bolt Through Pull Handles Dia. 19mm, CTC Length 150mm, SS Finish	1	Set	1	607	83024110	
	9228540	9228540	HPH 2110: Bolt Through Pull Handles Dia. 19mm, CTC Length 150mm, PSS Finish	1	Set	1	668	83024110	
	9228541	9228541	HPH 2110: Bolt Through Pull Handles Dia. 19mm, CTC Length 200mm, SS Finish	1	Set	1	637	83024110	
	9228542	9228542	HPH 2110: Bolt Through Pull Handles Dia. 19mm, CTC Length 200mm, PSS Finish	1	Set	1	699	83024110	
	9228543	9228543	HPH 2110: Bolt Through Pull Handles Dia. 19mm, CTC Length 250mm, SS Finish	1	Set	1	668	83024110	
9228544	9228544	HPH 2110: Bolt Through Pull Handles Dia. 19mm, CTC Length 250mm, PSS Finish	1	Set	1	729	83024110		

Product	Article No.	SAP	Item Description	Qty.	Unit	PU	MRP	HS Code	
	HPH 2330 Back To Back Pull Handles Dia: 19 mm								
	9228545	9228545	HPH 2330: Back to Back Pull Handles Dia. 19mm, CTC Length 200, SS Finish O/A 300	1	Set	1	1,459	83024110	
	9228546	9228546	HPH 2330: Back to Back Pull Handles Dia. 19mm, CTC Length 200, PSS Finish O/A 300	1	Set	1	1,639	83024110	
	HPH 2330 Back To Back Pull Handles Dia: 25 mm								
	9228547	9228547	HPH 2330: Back to Back Pull Handles Dia. 25mm, CTC Length 200, SS Finish O/A 300	1	Set	1	1,700	83024110	
	9228548	9228548	HPH 2330: Back to Back Pull Handles Dia. 25mm, CTC Length 200, PSS Finish O/A 300	1	Set	1	2,003	83024110	
	9228549	9228549	HPH 2330: Back to Back Pull Handles Dia. 25mm, CTC Length 300, SS Finish O/A 400	1	Set	1	1,884	83024110	
	9228550	9228550	HPH 2330: Back to Back Pull Handles Dia. 25mm, CTC Length 300, PSS Finish O/A 400	1	Set	1	2,187	83024110	
	9228551	9228551	HPH 2330: Back to Back Pull Handles Dia. 25mm, CTC Length 400, SS Finish O/A 550	1	Set	1	2,307	83024110	
	9228552	9228552	HPH 2330: Back to Back Pull Handles Dia. 25mm, CTC Length 400, PSS Finish O/A 550	1	Set	1	2,671	83024110	
	9250424	9250424	HPH 2330: Back to Back Pull Handles Dia. 25mm, CTC Length 500, SS Finish O/A 600	1	Set	1	2,579	83024110	
	9250508	9250508	HPH 2330: Back to Back Pull Handles Dia. 25mm, CTC Length 500, PSS Finish O/A 600	1	Set	1	2,869	83024110	
	9228553	9228553	HPH 2330: Back to Back Pull Handles Dia. 25mm, CTC Length 900, SS Finish O/A 1200	1	Set	1	3,766	83024110	
	9228554	9228554	HPH 2330: Back to Back Pull Handles Dia. 25mm, CTC Length 900, PSS Finish O/A 1200	1	Set	1	4,251	83024110	
	HPH 2330 Back to Back Pull Handle Dia: 32 mm								
	9228555	9228555	HPH 2330: Back to Back Pull Handles Dia. 32mm, CTC Length 1200, SS Finish O/A 1500	1	Set	1	5,648	83024110	
	9228556	9228556	HPH 2330: Back to Back Pull Handles Dia. 32mm, CTC Length 1200, PSS Finish O/A 1500	1	Set	1	6,681	83024110	
	9228557	9228557	HPH 2330: Back to Back Pull Handles Dia. 32mm, CTC Length 1500, SS Finish O/A 1800	1	Set	1	6,498	83024110	
	9228558	9228558	HPH 2330: Back to Back Pull Handles Dia. 32mm, CTC Length 1500, PSS Finish O/A 1800	1	Set	1	7,529	83024110	
	HPH 2310 Back to Back Pull Handle Dia: 25 mm								
	9228559	9228559	HPH 2310: Back to Back Pull Handles Dia. 25mm, CTC Length 300, SS Finish	1	Set	1	2,003	83024110	
	9228560	9228560	HPH 2310: Back to Back Pull Handles Dia. 25mm, CTC Length 300, PSS Finish	1	Set	1	2,307	83024110	
	9228561	9228561	HPH 2310: Back to Back Pull Handles Dia. 25mm, CTC Length 400, SS Finish	1	Set	1	2,187	83024110	
	9228562	9228562	HPH 2310: Back to Back Pull Handles Dia. 25mm, CTC Length 400, PSS Finish	1	Set	1	2,490	83024110	







Product	Article No.	SAP	Item Description	Qty.	Unit	PU	MRP	HS Code	
	HPH 2310 Bolt Through Pull Handle Dia: 19 mm								
	9228563	9228563	HPH 2310: Bolt Through Pull Handles Dia. 19mm, CTC Length 150mm, SS Finish	1	Set	1	637	83024110	
	9228564	9228564	HPH 2310: Bolt Through Pull Handles Dia. 19mm, CTC Length 150mm, PSS Finish	1	Set	1	699	83024110	
	9228565	9228565	HPH 2310: Bolt Through Pull Handles Dia. 19mm, CTC Length 200mm, SS Finish	1	Set	1	668	83024110	
	9228566	9228566	HPH 2310: Bolt Through Pull Handles Dia. 19mm, CTC Length 200mm, PSS Finish	1	Set	1	729	83024110	
	9228567	9228567	HPH 2310: Bolt Through Pull Handles Dia. 19mm, CTC Length 250mm, SS Finish	1	Set	1	699	83024110	
	9228568	9228568	HPH 2310: Bolt Through Pull Handles Dia. 19mm, CTC Length 250mm, PSS Finish	1	Set	1	760	83024110	
	HPH 2420 Back to Back Pull Handle								
	9228569	9228569	HPH 2420: Back to Back Pull Handles Section 30*30mm, CTC Length 450mm SS Finish	1	Set	1	3,158	83024110	
	9228570	9228570	HPH 2420: Back to Back Pull Handles Section 30*30mm, CTC Length 450mm PSS Finish	1	Set	1	4,068	83024110	
	9228571	9228571	HPH 2420: Back to Back Pull Handles Section 30*30mm, CTC Length 600mm SS Finish	1	Set	1	3,949	83024110	
	9228572	9228572	HPH 2420: Back to Back Pull Handles Section 30*30mm, CTC Length 600mm PSS Finish	1	Set	1	4,919	83024110	
	9228573	9228573	HPH 2420: Back to Back Pull Handles Section 30*30mm, CTC Length 900mm SS Finish	1	Set	1	5,162	83024110	
9228574	9228574	HPH 2420: Back to Back Pull Handles Section 30*30mm, CTC Length 900mm PSS Finish	1	Set	1	6,193	83024110		
	Stainless Steel Lock-able Pull Handle Dia: 35 mm								
	9228223	9228223	HLH S350 1200: 2 fixing points, diameter 35mm, center to center 925mm, end to end 1200mm, material thickness 1.35mm SS finish	1	Set	1	27,377	83024110	
	9228224	9228224	HLH S350 1800: 3 fixing points, diameter 35mm, center to center bottom (C1) 925mm, center to center upper (C2) 725mm, end to end 1800mm, material thickness	1	Set	1	32,117	83024110	
	9228225	9228225	HLH S350 2000: 3 fixing points, diameter 35mm, center to center bottom (C1) 925mm, center to center upper (C2) 925mm, end to end 2000mm, material thickness 1.35 mm SS finish	1	Set	1	34,870	83024110	
9228226	9228226	HLH S350 2400: 3 fixing points, diameter 35mm, center to center bottom (C1) 1125mm, center to center upper (C2) 1125mm, end to end 2400mm, material thickness 1.35 mm SS finish	1	Set	1	40,681	83024110		

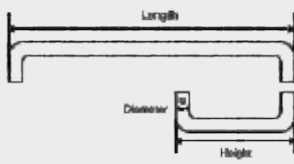

Product	Article No.	SAP	Item Description	Qty.	Unit	PU	MRP	HS Code
Connectors (Material: Brass with Chrome plating; For 8-10 mm Glass thickness) (96 hours salt spray tested)								
	HGC01							
	9228297	9228297	HGC 01: 90° Wall to Glass / Floor to Glass Connector	1	Pc	1	612	83024110
	HGC02							
	9228298	9228298	HGC 02: 90° Wall to Glass / Floor to Glass Connector	1	Pc	1	873	83024110
	HGC03							
	9228299	9228299	HGC 03: 90° Glass to Glass Connector	1	Pc	1	1,242	83024110
	HGC04							
	9228300	9228300	HGC 04: 180° Glass to Glass Connector	1	Pc	1	1,242	83024110
Pro-Series Hinges (Material: Brass with Chrome plating; For 8-12 mm Glass thickness) (96 hours salt spray tested)								
	HSH-OWNO							
	9228309	9228309	HSH-OWNO: 90° Glass to Wall Hinge (standard base plate) Loading Capacity 40 kg/pair, Max door width: 750 mm	1	Pc	1	2,549	83024110
	HSH-OWFO							
	9228311	9228311	HSWOWFO: 90° Glass to Wall Hinge (Essentric base plate) Loading Capacity 40 kg/pair, Max door width: 750 mm	1	Set	1	2,549	83024110
	HSH-OGAO							
	9228312	9228312	HSHOGAO: 90° Glass to Glass Hinge brass Loading Capacity 40 kg/pair, Max door width: 750 mm	1	Set	1	4,081	83024110

Product	Article No.	SAP	Item Description	Qty.	Unit	PU	MRP	HS Code
	HSH-OGCD							
	9228313	9228313	H SOGCO: 135° Glass to Glass Hinge Loading Capacity 40 kg/pair, Max door width: 750 mm	1	Pc	1	4,081	83024110
	HSH-OGDO							
	9228314	9228314	HSHOGDO: 180° Glass to Glass Hinge Loading Capacity 40 kg/pair, Max door width: 750 mm	1	Pc	1	4,081	83024110

Shower Handles

Stainless Steel Shower handles, Finish: Stainless steel Satin								
	9228315	9228315	HSH 1540/20: Height 150mm, Length 400mm, diameter 20mm Satin SS	1	Set	1	2,982	83024110
	9228316	9228316	HSH 1545/20: Height 150mm, Length 450mm, diameter 20mm Satin SS	1	Set	1	3,060	83024110
	9228317	9228317	HSH 2040/20: Height 200mm, Length 400mm, diameter 20mm Satin SS	1	Set	1	3,060	83024110
	9228318	9228318	HSH 2045/20: Height 200mm, Length 450mm, diameter 20mm Satin SS	1	Set	1	3,448	83024110
	9228319	9228319	HSH 1540/25: Height 150mm, Length 400mm, diameter 25mm Satin SS	1	Set	1	3,366	83024110
	9228320	9228320	HSH 1545/25: Height 150mm, Length 450mm, diameter 25mm Satin SS	1	Set	1	3,467	83024110
	9228321	9228321	HSH 2040/25: Height 200mm, Length 400mm, diameter 25mm Satin SS	1	Set	1	3,467	83024110
	9228322	9228322	HSH 2045/25: Height 200mm, Length 450mm, diameter 25mm Satin SS	1	Set	1	3,569	83024110
Stainless Steel Shower handles, Finish: Stainless steel Polished								
	9250416	9250416	HSH 1540/20: Height 150mm, length 400mm, diameter 20mm polished SS	1	Set	1	3,662	83024110
	9250417	9250417	HSH 1545/20: Height 150mm, length 450mm, diameter 20mm polished SS	1	Set	1	3,740	83024110
	9250418	9250418	HSH 2040/20: Height 200mm, length 400mm, diameter 20mm polished SS	1	Set	1	3,740	83024110
	9250419	9250419	HSH 2045/20: Height 200mm, length 450mm, diameter 20mm polished SS	1	Set	1	3,822	83024110
	9250420	9250420	HSH 1540/25: Height 150mm, length 400mm, diameter 25mm polished SS	1	Set	1	4,394	83024110
	9250421	9250421	HSH 1545/25: Height 150mm, length 450mm, diameter 25mm polished SS	1	Set	1	4,475	83024110
	9250422	9250422	HSH 2040/25: Height 200mm, length 400mm, diameter 25mm polished SS	1	Set	1	4,475	83024110
	9250423	9250423	HSH 2045/25: Height 200mm, length 450mm, diameter 25mm polished SS	1	Set	1	4,594	83024110

Product	Article No.	SAP	Item Description	Qty.	Unit	PU	MRP	HS Code
Shower cubicle header bar and accessories								
	Header Bar							
	9228609	9228609	HSHAC-Tube: Header Bar Length 1200 mm Dia Φ 19 mm Polished Stainless Steel	1	Pc	1	2,907	83024110
	9228610	9228610	HSHAC-Tube: Header Bar Length 1200 mm Dia Φ 19 mm Satin Stainless Steel	1	Pc	1	2,600	83024110
	9228611	9228611	HSHAC-Tube: Header Bar Length 2000 mm Dia Φ 19 mm Polished Stainless Steel	1	Pc	1	4,894	83024110
	9228612	9228612	HSHAC-Tube: Header Bar Length 2000 mm Dia Φ 19 mm Satin Stainless Steel	1	Pc	1	4,283	83024110
	9228613	9228613	HSHAC-Tube: Header Bar Length 3000 mm Dia Φ 19 mm Polished Stainless Steel	1	Pc	1	7,341	83024110
	9228614	9228614	HSHAC-Tube: Header Bar Length 3000 mm Dia Φ 19 mm Satin Stainless Steel	1	Pc	1	6,423	83024110
	Wall Support To Header Bar (Base Material: Brass)							
	9228593	9228593	HSHAC-827: Wall Support To Header Bar Brass, For Φ 19 mm Polished Stainless Steel	1	Pc	1	750	83024110
	9228594	9228594	HSHAC-827: Wall Support To Header Bar Brass, For Φ 19 mm Satin Stainless Steel	1	Pc	1	796	83024110
	Glass End Connector For Header Bar (Base Material: Brass)							
	9228595	9228595	HSHAC-826: Glass End Connector For Header Bar Brass, For Φ 19 mm Polished Stainless Steel	1	Pc	1	794	83024110
	9228596	9228596	HSHAC-826: Glass End Connector For Header Bar Brass, For Φ 19 mm Satin Stainless Steel	1	Pc	1	842	83024110
	Glass Middle Support For Header Bar (Base Material: Brass)							
	9228597	9228597	HSHAC-825: Glass Middle Support For Header Bar Brass, For Φ 19 mm Polished Stainless Steel	1	Pc	1	858	83024110
	9228598	9228598	HSHAC-825: Glass Middle Support For Header Bar Brass, For Φ 19 mm Satin Stainless Steel	1	Pc	1	918	83024110
	90° Connector For Header Bar (Base Material: Brass)							
	9228599	9228599	HSHAC-327: 90° Connector For Header Bar Brass, For Φ 19 mm Polished Stainless Steel	1	Pc	1	1,286	83024110
	9228600	9228600	HSHAC-327: 90° Connector For Header Bar Brass, For Φ 19 mm Satin Stainless Steel	1	Pc	1	1,163	83024110
	Universal connector for Header Bar (With Adjustable Angle) (Base Material: Brass)							
	9228601	9228601	HSHAC-828: Universal Rail Connector Brass, For Φ 19 mm Polished Stainless Steel	1	Pc	1	1,530	83024110
	9228602	9228602	HSHAC-828: Universal Rail Connector Brass, For Φ 19 mm Satin Stainless Steel	1	Pc	1	1,591	83024110
	T-Connector For Header Bar (Base Material: Brass)							
	9228603	9228603	HSHAC-825: Glass Middle Support For Header Bar Brass, For Φ 19 mm Polished Stainless Steel	1	Pc	1	1,223	83024110
	9228604	9228604	HSHAC-825: Glass Middle Support For Header Bar Brass, For Φ 19 mm Satin Stainless Steel	1	Pc	1	1,286	83024110

Product	Article No.	SAP	Item Description	Qty.	Unit	PU	MRP	HS Code
	Straight Connector For Header Bar (Base Material: Brass)							
	9228605	9228605	HSHAC-832: Straight Connector For Header Bar Brass, For Φ 19 mm Polished Stainless Steel	1	Pc	1	551	83024110
	9228606	9228606	HSHAC-832: Straight Connector For Header Bar Brass, For Φ 19 mm Satin Stainless Steel	1	Pc	1	612	83024110
	135° Connector For Header Bar (Base Material: Brass)							
	9228607	9228607	HSHAC-326: 135° Connector For Header Bar Brass, For Φ 19 mm Polished Stainless Steel	1	Pc	1	1,316	83024110
	9228608	9228608	HSHAC-326: 135° Connector For Header Bar Brass, For Φ 19 mm Satin Stainless Steel	1	Pc	1	1,223	83024110

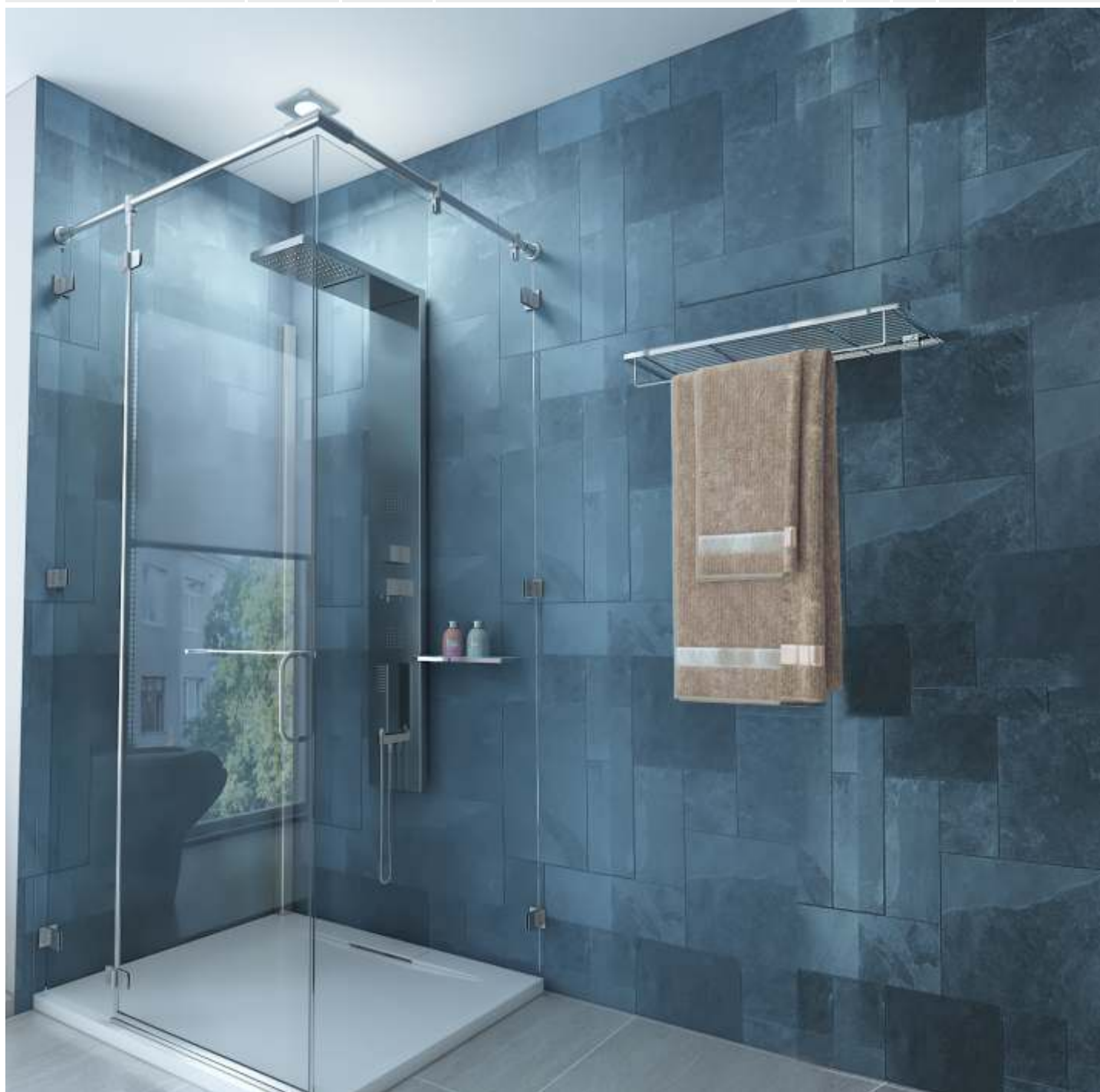

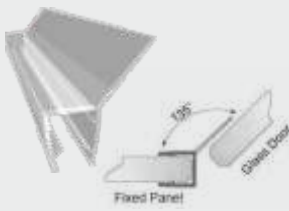
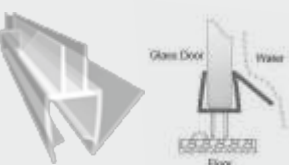
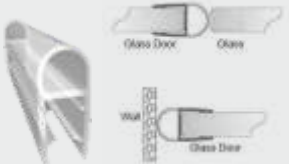
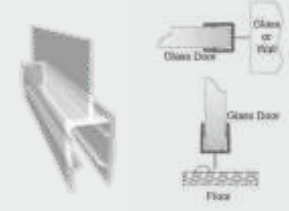
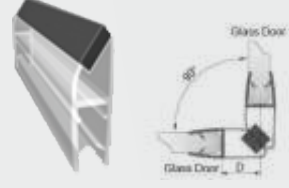
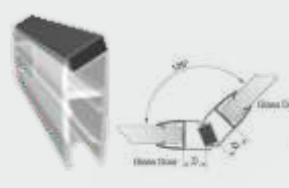
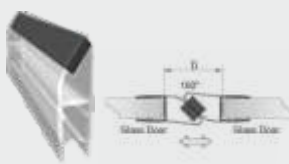
Product	Article No.	SAP	Item Description	Qty.	Unit	PU	MRP	HS Code
Shower Seals (Material: PVC; For 8 & 10 mm Glass thickness)								
	Wall seal for Soft Lip for Glass							
	9228440	9228440	HSDS8-005: For 8 mm glass, 2400 mm length, soft whisker	1	Pc	1	320	83024110
	9228445	9228445	HSDS10-005: For 10 mm glass, 2400 mm length, soft whisker	1	Pc	1	328	83024110
	Wall and Bottom seal for Glass Extruded with water run-off plate							
	9228446	9228446	HSDS8-009: For 8 mm glass, 2400 mm length, soft whisker	1	Pc	1	338	83024110
	9228447	9228447	HSDS10-009: For 10 mm glass, 2400 mm length, soft whisker	1	Pc	1	347	83024110
	Weather Seal used between Door & Side panel opposite the hinge							
	9228448	9228448	HDS8-007: For 8 mm glass, 2400 mm length, soft whisker	1	Pc	1	338	83024110
	9228449	9228449	HDS10-007: For 10 mm glass, 2400 mm length, soft whisker	1	Pc	1	347	83024110
	Central Glass seal for sealing double action Door & wall							
	9228450	9228450	HSDS8-001: For 8 mm glass, 2400 mm length, soft whisker	1	Pc	1	338	83024110
	9228451	9228451	HSDS10-001: For 10 mm glass, 2400 mm length, soft whisker	1	Pc	1	347	83024110
	90° Magnetic Seal							
	9228454	9228454	HSDS8-90M: For 8 mm glass, 2400 mm length, soft whisker, Magnet 90°	1	Set	1	1,471	83024110
	9228455	9228455	HSDS10-90M: For 10 mm glass, 2400 mm length, soft whisker, Magnet 90°	1	Set	1	1,530	83024110
	135° Magnetic Seal							
	9228452	9228452	HSDS8-135M: For 8 mm glass, 2400 mm length, soft whisker, Magnet 135°	1	Set	1	1,471	83024110
	9228453	9228453	HSDS10-135M: For 10 mm glass, 2400 mm length, soft whisker, Magnet 135°	1	Set	1	1,530	83024110
	180° Magnetic Seal							
	9228456	9228456	HSDS8-180M: For 8 mm glass, 2400 mm length, soft whisker, Magnet 180°	1	Set	1	1,471	83024110
	9228457	9228457	HSDS10-180M: For 10 mm glass, 2400 mm length, soft whisker, Magnet 180°	1	Set	1	1,530	83024110

Product	Article No.	SAP	Item Description	Qty.	Unit	PU	MRP	HS Code
---------	-------------	-----	------------------	------	------	----	-----	---------

Conventional/ Intumescent seals

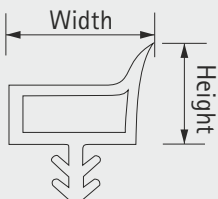
		Wedge Shape						
9228363	9228363	HSQ1-RC01E: Wedge Shape Door Seal 10*4.5mm, 150metre/box Dark Brown	1	Box	1	11,748	39269099	
9228463	9228463	HSQ1-RC01E: Wedge Shape Door Seal 10x4.5 mm, 150 metre/box White	1	Box	1	11,748	39269099	

Self adhesive seals

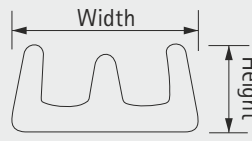
		E shape						
9228376	9228376	HSQ1-11: E- shape Adhesive Seal 9x3.5mm, 50 metre/box Dark Brown	1	Box	1	5,847	39269099	
9228462	9228462	HSQ1-11: E- shape Adhesive Seal 9x3.5 mm, 50 metre/box White	1	Box	1	5,847	39269099	

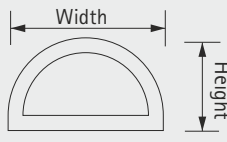





		D shape						
9228378	9228378	HSQ1-26: D-Shape Adhesive Seal 9x4.5mm, 50 metre/box Dark Brown	1	Box	1	4,196	39269099	
9228461	9228461	HSQ1-26: D-Shape Adhesive Seal 9x4.5mm, 50 metre/box White	1	Box	1	4,196	39269099	







Automatic Drop Bottom Seals for Wooden Doors

		Automatic Drop Bottom Seals for Wooden Doors						
9228383	9228383	HDS1-25: Automatic Drop Seal 250-330 mm	1	Set	1	2,122	83024110	
9228384	9228384	HDS1-66: Automatic Drop Seal 330-660 mm	1	Set	1	1,962	83024110	
9228386	9228386	HDS1-100: Automatic Drop Seal 660-1000 mm	1	Set	1	1,854	83024110	
9228387	9228387	HDS1-120: Automatic Drop Seal 1000-1200 mm	1	Set	1	2,121	83024110	
9228388	9228388	HDS1-150: Automatic Drop Seal 1200-1500 mm	1	Set	1	2,969	83024110	
9228389	9228389	HDS1-185: Automatic Drop Seal 1500-1850 mm	1	Set	1	3,499	83024110	



Product	Article No.	SAP	Item Description	Qty.	Unit	PU	MRP	HS Code
	Flush Bolt for timber doors							
	9228397	9228397	HFB 1: Flushbolt for Timber Door (200 mm)	1	Pc	1	506	83024110
	9228424	9228424	HFB 1: Flushbolt for Timber Door (300 mm)	1	Pc	1	624	83024110
	Flush Bolt for Metal doors							
	9228398	9228398	HFB 2: Flushbolt for Metal Doors	1	Set	1	610	83024110
	Centre flush Bolt for steel doors							
	9228399	9228399	HFB 3: Center flush bolt for steel doors	1	Set	1	2,686	83024110
	Automatic Flush Bolt							
	9228400	9228400	HFB 4: Automatic flush bolt	1	Pc	1	848	83024110
	Dust Proof Socket							
	9228401	9228401	HFBA1: dust socket for FB	1	Pc	1	254	83024110
Magnetic Wall Stop								
	HWS75							
	9228402	9228402	HWS 75: magnetic wall stop	1	Set	1	1,121	83024110
	HWS 45							
	9228707	9228707	HWS 45: magnetic wall stop	1	Set	1	762	83024110

Product	Article No.	SAP	Item Description	Qty.	Unit	PU	MRP	HS Code
Pull/Push								
	Pull Plate							
	9228403	9228403	HPP 1: Pull plate	1	Pc	1	706	83024110
	Push Plate							
	9228404	9228404	HPP2: Push Plate for Door	1	Pc	1	417	83024110
Door Chain/Guard								
	Door Chain							
	9228405	9228405	HDC 1: Door Chain	1	Pc	1	817	83024110
	Door Guard							
	9228708	9228708	HDC 2: Door Guard	1	Pc	1	947	83024110
Pull on Rose								
	Flush Pull on Rose							
	9228406	9228406	HFP 1: Flush Pull-on Rose for Door	1	Pc	1	439	83024110
Door Stopper								
	Door Stopper Floor Mounted							
	9228407	9228407	HDS 44: Door Stopper	1	Pc	1	264	83024110
	Door Stopper Floor Mounted							
	9228408	9228408	HDS 45: Door Stopper	1	Pc	1	352	83024110

Product	Article No.	SAP	Item Description	Qty.	Unit	PU	MRP	HS Code
	Door Drop Stop							
	9228709	9228709	HDS 46: door drop stop	1	Pc	1	632	83024110
	Door Drop Stop							
	9228710	9228710	HDS 47: door drop stop	1	Pc	1	1,040	83024110
	Door Stopper Wall Mounted							
	9228409	9228409	HWS 76: wall stop	1	Pc	1	219	83024110
Door Viewer								
	Door Viewer							
	9228410	9228410	HDV 1: Door viewer 180° view (for door thick-35- 55mm)	1	Pc	1	783	83024110
	Door Viewer							
	9228439	9228439	HDV 2: Door viewer 140° view (for door thick-35-55mm)	1	Pc	1	431	83024110
	9250664	9250664	HDV 2: Door viewer 140° view (for door thick-35-60mm)	1	Pc	1	461	83024110
	Catalogue							
	9254294	9254294	Architectural Hardware Et Applications Catalogue	1	Pc	1	On Request Only	



* Refer Website

Warranty Clause

For Warranty Regarding Architectural Hardware please refer to below site.
www.hettich.com/in



Conformité Européenne, meaning "European Conformity"



Fire Protection Certification



European Norms for Door Closing Devices



European Norms for Lever Handles & Knob furniture



European Norms for Emergency Exit Locks with Door Handles



European Norms for Panic Exit Devices



European Norms for Mechanically operated Locks, Latches & Locking Plates



European Norms for Hinges

Most of the Hettich hardware are in accordance with the following European standards:

- DIN EN 1154 A: Door Closing Devices
- DIN EN 1906 : Lever Handles & Knob furniture
- DIN EN 179 : Emergency Exit Locks with Door Handles
- DIN EN 1125 : Panic Exit Devices operated by horizontal bar
- DIN EN 12209 : Locks & Latches
- DIN EN 1935 : Hinges

EN STANDARDS		
EN Value	Recommended Door Width (MM)	Recommended Door Weight (KG)
EN 1	750	20
EN 2	850	40
EN 3	950	60
EN 4	1100	80
EN 5	1250	100
EN 6	1400	120
EN 7	1600	160

Factors to consider when specifying hinges

- ▶ Is it a fire, smoke or emergency escape door?
- ▶ How heavy is the door and what are the door dimensions (height, width and thickness)?
- ▶ What is the door's construction and are there any unusual features that could affect the hinges?
- ▶ Where is the door situated e.g. internal or external; is it near the coast or in a swimming pool?
- ▶ What level of use/abuse will the door be subject to e.g. office, hospital or school corridor?
- ▶ What other items of hardware are to be fitted, that may affect the hinge performance, typically door closers or door stops?

Forces operating on a door

Two main forces are influencing the performance of the hinge (vertical and the horizontal load).

The vertical load is a result of the gross door weight.

The horizontal load is created by:

- ▶ The door weight
- ▶ The door height to width ratio
- ▶ Where the hinges are positioned.

The wider the door is in relation to its height, the greater the side load that the hinges and their fixings have to support.

Hinges for use with doors of excess width

Wider doors increase the stresses exerted on the hinge. This must be allowed for by a reduction in the maximum mass of the door leaf supported by each class of hinge. The factors by which the door mass has to be adjusted for wider widths are calculated by dividing the door height by its width. For a factor of 2 or greater, no allowance has to be made. The percentage leaf mass increases are shown in the Side Loading calculations in the table:

Side Loading Calculations			
Door Size		Factor	Normal increase of mass of door leaf %
Door Height (mm)	Door Width (mm)		
2000	1000	2.0	0
2000	1050	1.9	10
2000	1100	1.82	18
2000	1150	1.74	26
2000	1200	1.66	33
2000	1250	1.6	40

Example

Door Height = 2100mm

Door Width = 1100mm

Door Weight = 65kg

Factor (Door Height/Door Width) 2100/1100 = 1.9 this implies increase of door leaf mass by 10%

Adjusted Door Weight

Different factors like a door closer or extra heavy usage are influencing the door weight. Some details for the calculation of the adjusted door weight can be found here:

Adjusted Door Weight Calculation		
Actual Door Weight	Doors of excess width, please refer to Side Loading Calculation table	
	Door closer	+20%
	Door closer (Backcheck)	+75%
	Extra Heavy Use	+10%
	Light Use	- 10%
		= Adjusted Door Weight

Example

height = 2100mm

width = 1100mm

weight = 65kg

+ increase of door leaf mass of 10%

+ installed door closer with back-check = increase of door leaf mass of +75%

= 65kg + 10% +75% = 125 kg (adjusted door leaf weight)

Simply selecting the hinge by door weight alone is very common and not 100% correct. There are many factors influencing the correct number or model of hinges. Hettich is taking the most important factors into consideration to make the choice for the right number of hinges even easier.

Follow our HBN 14 guidelines to correct hinge specification.

1. The right number of hinges and maximum door weight

The correct number of hinges is influenced by different factors such as:

- the door type
- the door weight
- the door height / width ratio (excess width side load)
- the frequency of use
- other door hardware used on the door

In order to make the choice for the right number of hinges easier, the following overview summarizes the maximum door weight with reference to the door width at a height between 2.100 to 2.300 mm.

In many cases two hinges per door will be sufficient to guarantee a smooth performance of the door system. In some cases three hinges per door are used to minimize warping in extremes of temperature or humidity. Hettich also recommends three hinges per door if the actual door weight is very close to the indicated maximum door weight for 2 hinges per door.

Width (in mm)	Max. door weight w/o door closer		Max. door weight w/ door closer		Max. door weight w/ door closer (incorporating back-check and / or hold open device)	
	2 hinges per door	3 hinges per door	2 hinges per door	3 hinges per door	2 hinges per door	3 hinges per door
max. 750	144 kg	187 kg	120 kg	142 kg	82 kg	97 kg
max. 850	144 kg	187 kg	120 kg	142 kg	82 kg	97 kg
max. 950	144 kg	187 kg	120 kg	142 kg	82 kg	97 kg
max. 1.100	131 kg	170 kg	109 kg	129 kg	75 kg	88 kg
max. 1.250	108 kg	141 kg	90 kg	107 kg	62 kg	73 kg
max. 1.400	96 kg	125 kg	80 kg	95 kg	55 kg	65 kg
max. 1.600	85 kg	111 kg	71 kg	84 kg	49 kg	58 kg

Please note: Above maximum door weight indications are based on a perfectly installed and adjusted door system as per EN 1935 test parameters and requirements. Actual values may vary in individual cases. The door system and number of hinges (incl. maximum door weight) may also be influenced by additional hardware installed with the door, the general usage, the correct installation and maintenance. In general, Hettich recommends a trial testing of the door to guarantee an adequate performance.

2. The installation position

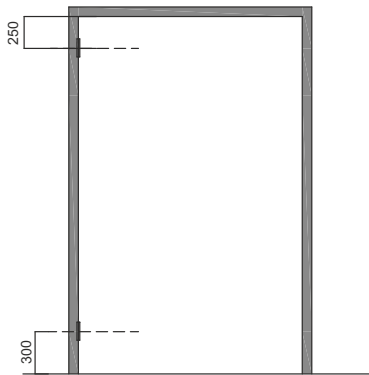

Fig. 1 2 hinges per door

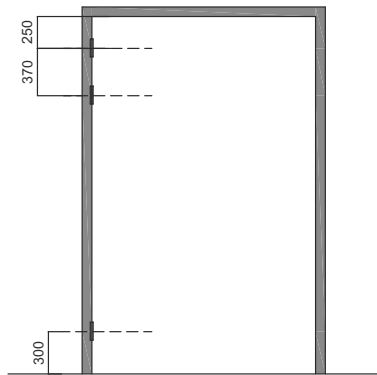

Fig. 2 3 hinges per door

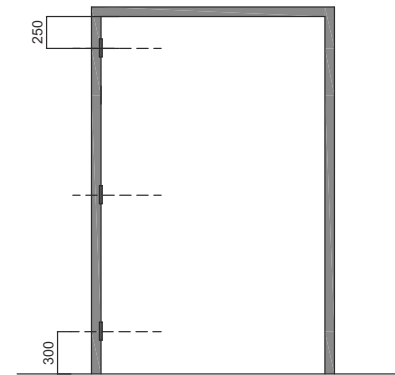
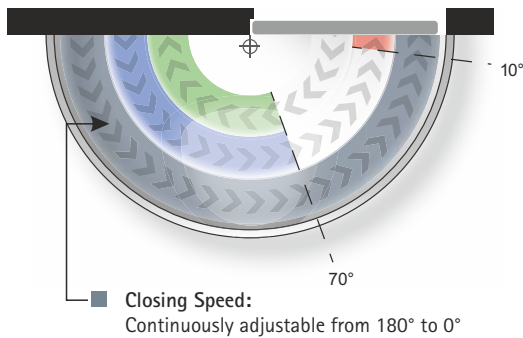

Fig. 3 3 hinges per door

Fig. 1	The new Hettich practice where only two hinges are installed on the door. Hettich recommends to space the hinges as shown. A proper testing is recommended for an adequate door performance as explained in chapter 1.
Fig. 2	Where overhead door closers are used, additional lateral forces are applied to the top hinge. Whilst this is taken into consideration within the design calculation, to reduce the lateral force on the top hinge, it is recommended that the hinges are spaced as shown.
Fig. 3	The standard practice and most common, providing maximum resistance to 'warping' of doors, hinges are spaced as shown.

3. The definition of low, medium and high frequency doors

Building / door type	Daily usage	Frequency
Department store entrance	5,000	High
Hospital corridor doors	5,000	High
Office Building Entrance	4,000	High
School Entrance	1,500	High
School Toilet	1,500	High
Apartment Entrance (Main Door)	500	High
Office Stairwell	500	High
Office Building Toilet	500	High
School Corridor	100	Medium
Hospital Consultation Room	100	Medium
Office Building Corridor	100	Medium
Storage Room	50	Medium
Residential Entrance	30	Low
Interior Residential	20	Low



- ▶ **Closing Moment and Closing Speed:** The force generated by a door closing device which acts upon during the closing operation. It helps to adjust closing force according to width & weight of the door
- ▶ **Adjustable Closing Power:** By turning the Hex Notch clockwise or anticlockwise spring strength changes.
- ▶ **Adjustable Closing Speed:** By turning Valve Screw the flow of Liquid can be altered for adjustment of Closing speed.

Valve Adjustment

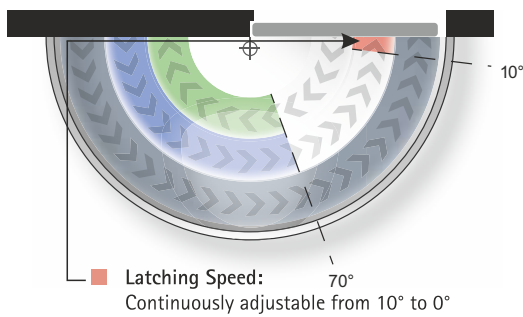

- ▶ **Latching Speed:** A speed control operable to increase the closing speed and thus the safe closing of the door, for example to overcome door seals, door locks and high air pressure. Continuously Adjustable Latching speed ensures perfect latching of all kind of locks.
- ▶ **Latching speed valve:** By turning Valve Screw the flow of Liquid can be further altered for adjustment of Latching speed.

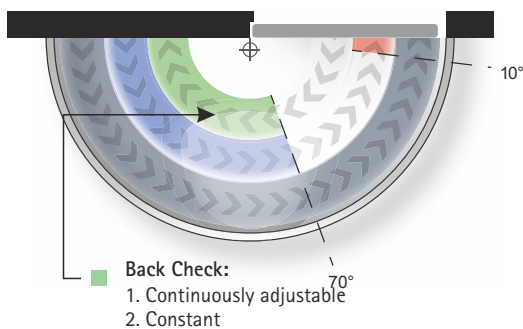

- ▶ **Back Check:** An inbuilt buffer which helps to prevent a door leaf being flung wide open by providing cushioning effect when the door is thrown open. Reduces the opening speed starting at 70° and avoids the slamming of the door.
- Two variants in back check
1. Continuously Adjustable
 2. Constant

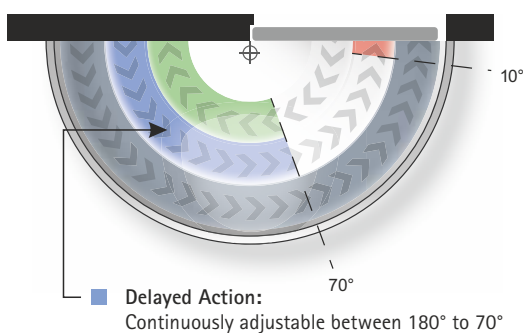

- ▶ **Delayed Action:** An inbuilt function that allows delay in closing door for an adjustable period of time allowing the disabled, elderly people or long trolleys, stretchers to pass through the door unhindered.
- Reduces the closing speed and allows a safer passing for people and transports. Especially suitable for the use in nursing homes and hospitals

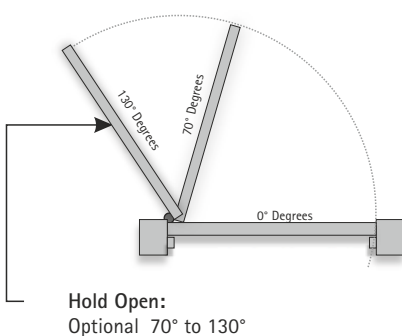

- ▶ **Hold Open:** Additional Feature which ensure self stopping of doors at a certain angle i.e. 70° to 130°. To achieve this additional Component to be added in Slide rail or Standard Arm to be replaced by Hold Open Arm

1. Hold Open Device for Slide Rail

2. Hold Open Arm

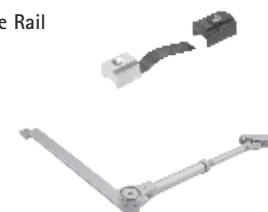

Appendix

Hettich Door Closers for every Door width & Usage



SL No	Door Closer Type	Door Closer Description	Image	Article Nos.	Warranty	MRP (Rs.)	Exclusive Features
950 mm (3 ft 2 inches) EN 3							
1	Slide Rail Door Closer	HSS 33 with Slide Rail K (Short Slide Rail)		9227812	5 Years	8,284	Corrosion Resistant Stainless Steel cover, Suitable for outdoor use, 500,000 cycle tested, EN1154 Certified and Fire rated
		HSS 31 with Slide rail B (Long slide rail)		9227810	5 Years	11,426	Corrosion Resistant Stainless Steel cover, Suitable for outdoor use, With Fixed back check, 500,000 cycle tested, EN1154 Certified and Fire rated
	Concealed Door Closer	HCS 380		9227824	3 Years	5,952	Suitable for indoor use, Integrated Hold open function, 500,000 cycle tested, For 40 mm thick door
	Standard Arm Door Closer	Standard Arm Door Closer have Power size in range of 2-4 so we can suggest any EN4 (1100 mm) Door Closer					
1100 mm (3 ft 8 inches) EN 4							
2	Slide Rail Door Closer	HSS 41 with slide rail B (Long Slide rail)		9227808	5 Years	14,053	Corrosion Resistant Stainless Steel cover, Suitable for outdoor use, With Fixed back check, 500,000 cycle tested, EN1154 Certified and Fire rated
	Concealed Door Closer	HCS 385		9227823	3 Years	7,895	Suitable for indoor use, Integrated Hold open function, 500,000 cycle tested, For 40 mm thick door
		HCS 400 (w/o hold open)		9227822	5 Years	12,617	Suitable for indoor use, 500,000 cycle tested, EN 1154 Certified and Fire rated, For 40 mm thick door; For Hold open please order device (extra)
	Standard Arm Door Closer	HSA 10 F		9227816	3 Years	2,688	Suitable for outdoor use, Fixing Position of Door closer to be changed according to Door size (EN2/3/4), 200,000 cycle tested, Fire rated
		HSA 10 D EN		9227817	5 Years	3,024	Suitable for outdoor use, Fixing Position of Door closer to be changed according to Door size (EN2/3/4), 500,000 cycle tested, EN1154 Certified and Fire rated
		HSA 10		9227818	3 Years	2,592	Suitable for outdoor use, Fixing Position of Door closer to be changed according to Door size (EN2/3/4), 200,000 cycle tested
		HSA 14		9228418	3 Years	4,935	Sliding Removable Ribbed Protective Aluminum cover, Fixing Position of Door closer to be changed according to Door size (EN1/2/3/4) 200,000 cycle tested
	1250 mm (4 ft 2 inches) EN 5						
3	Slide Rail Door Closer	HSS 61 with Slide Rail B (Long Slide rail)		9227802	5 Years	20,707	Corrosion Resistant Stainless Steel Cover, Suitable for outdoor use, Adjustable back check, 500,000 cycle tested EN1154 Certified and Fire rated
	Standard Arm Door Closer	HSA 15		9227815	3 Years	6,498	Sliding Removable Ribbed Protective Aluminum Cover, Fixing Position of Door closer to be changed according to Door size (EN 1/2/3/4), 200,000 cycle tested
		HSA 20		9227814	5 Years	7,343	Corrosion Resistant Stainless Steel Cover, Suitable for outdoor use, Fixed back check, 500,000 cycle tested, EN1154 Certified and Fire rated
		HSA 50		9227813	5 Years	12,309	Corrosion Resistant Stainless Steel Cover, Suitable for outdoor use, Fixed back check, 500,000 cycle tested, EN1154 Certified and Fire rated
1400 mm (4 ft 8 inches) EN 6							
4	Slide Rail Door Closer	HSS 61 with Slide Rail B (Long Slide rail)		9227802	5 years	20,707	Corrosion Resistant Stainless Steel Cover, Suitable for outdoor use, Adjustable back check, 500,000 cycle tested, EN1154 Certified and Fire rated

Appendix Maximum Door Mass for Standard Arm Door Closer



Standard Arm Door closer for single leaf doors (Hinge and hinge opposite side)

Maximum Door Width 950 mm

Door closer	Fire rated	Size acc.to EN 1154 A	Adjustable Latching Speed	Adjustable Closing Speed	Back-Check	Delay Action	Max. Door Weight
HSA50	Yes	1-5	✓	✓	✓	-	150 kg
HSA20	Yes	2/3/5	✓	✓	✓	-	150 kg
HSA15	No	2/3/4/5	✓	✓	-	-	100 kg
HSA14	No	1/2/3/4	✓	✓	-	-	80 kg
HSA10 D EN	Yes	2/3/4	✓	✓	-	-	80 kg
HSA10 F	Yes	2/3/4	✓	✓	-	-	80 kg
HSA10	No	2/3/4	✓	✓	-	-	80 kg

Maximum Door Width 1100 mm

Door closer	Fire rated	Size acc.to EN 1154 A	Adjustable Latching Speed	Adjustable Closing Speed	Back-Check	Delay Action	Max. Door Weight
HSA50	Yes	1-5	✓	✓	✓	-	140 kg
HSA20	Yes	2/3/5	✓	✓	✓	-	140 kg
HSA15	No	2/3/4/5	✓	✓	-	-	100 kg
HSA14	No	1/2/3/4	✓	✓	-	-	80 kg
HSA10 D EN	Yes	2/3/4	✓	✓	-	-	80 kg
HSA10 F	Yes	2/3/4	✓	✓	-	-	80 kg
HSA10	No	2/3/4	✓	✓	-	-	80 kg

Maximum Door Width 1250 mm

Door closer	Fire rated	Size acc.to EN 1154 A	Adjustable Latching Speed	Adjustable Closing Speed	Back-Check	Delay Action	Max. Door Weight
HSA50	Yes	1-5	✓	✓	✓	-	110 kg
HSA20	Yes	2/3/5	✓	✓	✓	-	110 kg
HSA15	No	2/3/4/5	✓	✓	-	-	100 kg

Note: The door closer power size has to be adjusted to the highest level for any door weight that exceeds the test door weight of EN1154 standard

Appendix Maximum Door Mass for Slide Rail Door Closer



Slide Rail Door closer for single leaf doors (Hinge and hinge opposite side)

Maximum Door Width 950 mm

Door closer	Fire rated	Size acc.to EN 1154 A	Adjustable Latching Speed	Adjustable Closing Speed	Back-Check	Delay Action	Max. Door Weight
HSS-61	Yes	5-6	✓	✓	✓	opt.	250 kg
HSS-61	Yes	2-5	✓	✓	✓	opt.	200 kg
HSS-51	Yes	1-4	✓	✓	✓	-	140 kg
HSS-41	Yes	1-4	✓	✓	✓	-	120 kg
HSS-31	Yes	1-3	✓	✓	✓	-	100 kg
HSS-33	Yes	3	✓	✓	-	-	80 kg

Maximum Door Width 1100 mm

Door closer	Fire rated	Size acc.to EN 1154 A	Adjustable Latching Speed	Adjustable Closing Speed	Back-Check	Delay Action	Max. Door Weight
HSS-61	Yes	5-6	✓	✓	✓	opt.	220 kg
HSS-61	Yes	2-5	✓	✓	✓	opt.	170 kg
HSS-51	Yes	1-4	✓	✓	✓	-	140 kg
HSS-41	Yes	1-4	✓	✓	✓	-	120 kg

Maximum Door Width 1250 mm

Door closer	Fire rated	Size acc.to EN 1154 A	Adjustable Latching Speed	Adjustable Closing Speed	Back-Check	Delay Action	Max. Door Weight
HSS-61	Yes	5-6	✓	✓	✓	opt.	190 kg
HSS-61	Yes	2-5	✓	✓	✓	opt.	140 kg

Maximum Door Width 1400 mm

Door closer	Fire rated	Size acc.to EN 1154 A	Adjustable Latching Speed	Adjustable Closing Speed	Back-Check	Delay Action	Max. Door Weight
HSS-61	Yes	5-6	✓	✓	✓	opt.	160 kg

Note: The door closer power size has to be adjusted to the highest level for any door weight that exceeds the test door weight of EN1154 standard

Appendix Maximum Door Mass for Concealed Door Closer



Concealed Door closer for single leaf doors (Hinge and hinge opposite side)

Maximum Door Width 950 mm

Door closer	Fire rated	Size acc.to EN 1154 A	Adjustable Latching Speed	Adjustable Closing Speed	Back-Check	Delay Action	Max. Door Weight
Multi G	Yes	2-5	✓	✓	-	-	150 kg
Multi G	Yes	1-4	✓	✓	-	-	120 kg
HCS 400	Yes	2-4	✓	✓	-	-	120 kg
HCS 385	No	2-4	✓	✓	-	-	80 kg
HCS 380	No	3	✓	✓	-	-	60 kg

Maximum Door Width 1100 mm

Door closer	Fire rated	Size acc.to EN 1154 A	Adjustable Latching Speed	Adjustable Closing Speed	Back-Check	Delay Action	Max. Door Weight
Multi G	Yes	2-5	✓	✓	✓	-	120 kg
Multi G	Yes	1-4	✓	✓	✓	-	100 kg
HCS 400	Yes	2-4	✓	✓	✓	-	100 kg
HCS 385	No	2-4	✓	✓	✓	-	80 kg

Maximum Door Width 1250 mm

Door closer	Fire rated	Size acc.to EN 1154 A	Adjustable Latching Speed	Adjustable Closing Speed	Back-Check	Delay Action	Max. Door Weight
Multi G	Yes	2-5	✓	✓	-	-	100 kg

Note: The door closer power size has to be adjusted to the highest level for any door weight that exceeds the test door weight of EN1154 standard

Utilization Categories of Door Locks & Handle



Class 1: HOME

Moderate utilization by persons motivated to exercise great care and from whom there is a low risk of improper use. Typical areas of application: interior doors of residential buildings.



Class 2: OFFICE

Moderate utilization by persons motivated to exercise care but from whom there is a certain risk of improper use. Typical areas of application: interior doors of office buildings.



Class 3: PUBLIC PLACES

High utilization by the general public or other persons with low motivation to exercise care and from whom there is a high risk of improper use. Typical areas of application: interior doors of office buildings open to the general public.



Class 4: STADIUM / PUBLIC TOILETS

For use in doors that are frequently subjected to violence or damage. Typical areas of application are Cricket & Football stadium, barracks or public toilets.

Technology Behind Handles

ProLock 4 - Premium handles with ball-bearing technology

ProLock 4

ProLock 4 -bearing

These high-end project handles are characterized by an industrial ball bearing. The precise and maintenance free ball bearing technology ensures a well-balanced system. Additionally the flex-bearing, lying inside the ball bearing unit, balances uneven door surfaces for up to 3 degree. This premium and innovative solution will meet all standards for private or public doors.

- ▶ EN 1906, class 4
- ▶ With spring and 90 degree carrier
- ▶ Patented flex-bearing unit
- ▶ 1 million cycle tested

ProLock 3 - Handles with friction bearing technology

ProLock 3

ProLock 3-bearing

The main characteristic of this handle is a maintenance free nylon bearing that is floating on the steel base rose and balancing radial and axial free-play. This class 4 handle bearing can be used on doors with high frequency and a potential for violent usage such as in schools or Cricket & Football stadium.

- ▶ EN 1906, class 4
- ▶ Unsprung
- ▶ 200,000 cycle tested

ProLock 2 - Handles with standard friction bearing technology

ProLock 2

ProLock 2 -bearing

The bearing made of glass fiber reinforced nylon is guiding the handle axial as well as radial. A wave spring is compensating angular tolerances. A perfect and certified price/performance ratio for frequently used handles in all kind of buildings.

- ▶ EN 1906, class 3
- ▶ With spring
- ▶ 200,000 test cycles

ProLock 1 - Handles with standard friction bearing technology

ProLock 1

ProLock 1 -bearing

The steel base rose and return spring ensure a proper and stable fixing on the door. The economic bearing is perfect for interior doors in public buildings or private houses.

- ▶ With spring
- ▶ 200,000 internal test cycles

Prolock handles: PZ and WC Sets

As mentioned in the Price List, each handle is having two versions with two Article codes as per below :

		Prolock 1 HH 2110 (Hollow)							
		Article Code 1	Article Code 2	Description	Quantity	Unit	Quantity	Price	Article Code
		9228099	9228099	ProLock 1 HH 2110 Handle + Handle set SS	1	Set	1	1,334	83024110
		9228101	9228101	ProLock 1 HH 2110 Handle + WC Bathroom set SS (Please order only Bathroom Lock along with WC version set)	1	Set	1	1,934	83024110

What is Handle + handle set and Handle + WC bathroom Set?

The PZ version handles are used for all the locking solutions in which Euro profile cylinders are used for key Locking

PZ version Mortise handle

- For use with Sash Lock, Latch Lock, Night Latch Lock and Panic Lock bodies
- Set comprises of set of Handles, Set f PZ escutcheon and fixing material
- Widely used version of handle
- Available in all handle shapes



The WC version handles are used for bathroom or privacy doors with bathroom handles

WC version Mortise handle

- For use with **only** Bathroom Lockbody
- Set comprises of set of Handles, Set of WC escutcheon with indicator and fixing material
- Less used version of handle mostly where WC escutcheon with indicator is required
- Available in all handle shapes

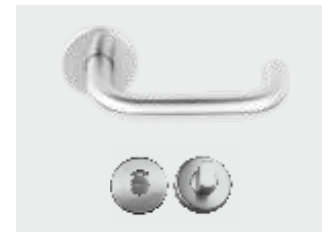

Handing of doors for Lift Off Hinge

Lift Off Hinge illustration for DIN Right & DIN Left hinge and for ordering

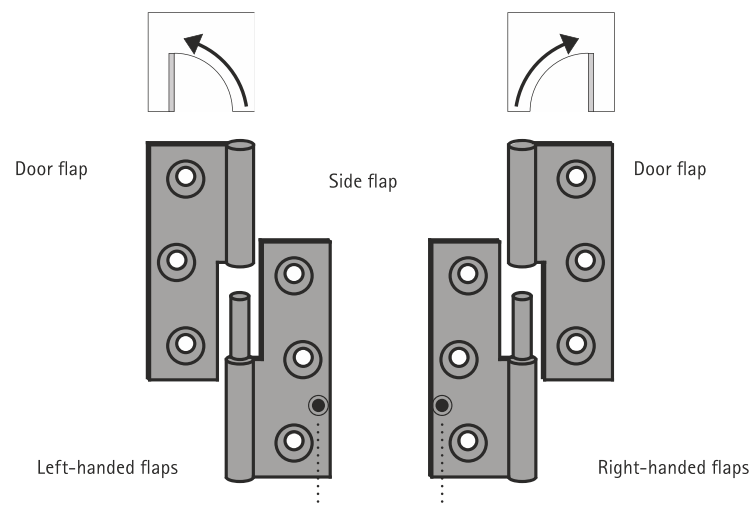

How to determine if the door is DIN Left or DIN Right

What is DIN Left And Right: DIN Right/Left denotes the direction of the opening of the door

DIN Left: When the hinges are placed to the left of the door leaf, then the door is opened DIN left.

DIN Right: When the hinges are placed to the right of the door leaf, then the door is opened DIN right.

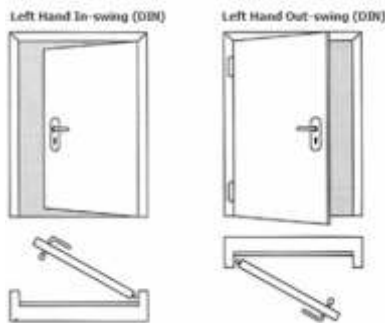
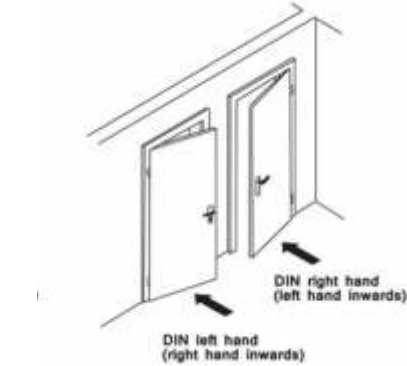

DIN left means Hinge barrel is visible on Left side that means a person will use left hand to operate the door

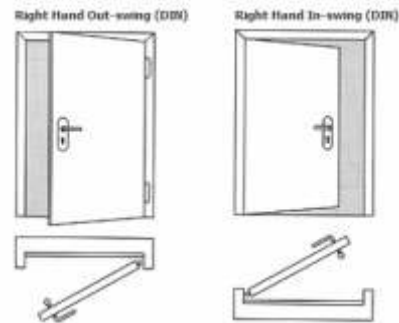
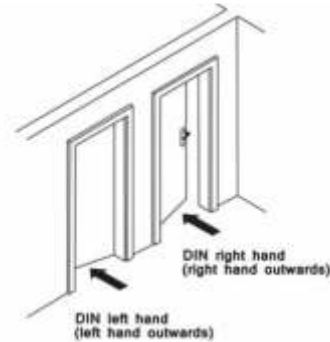

DIN Right means Hinge barrel is visible on right side that means a person will use Right hand to operate the door.

Why we need DIN Left/Right versions?

It is required as the outer handle is fixed and only operable with key that means only inside handle will be moving and hence we need to have different handles motion for DIN Left/Right opening Doors from inside.

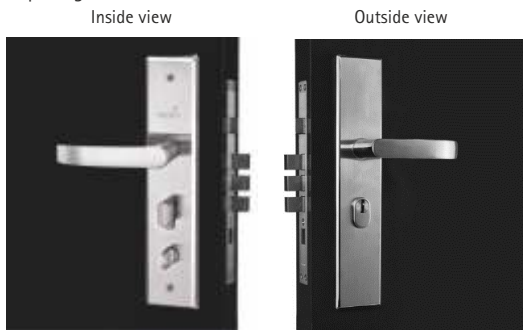

DIN Left set

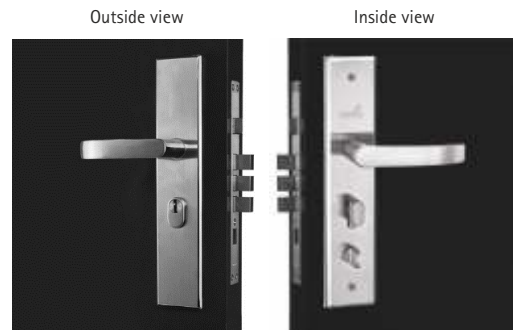

DIN Right set

NOTE: There is no need to order both DIN left and DIN right for a single door.

How to decide article no. while placing Order?

If a person will be using leftward opening door then DIN left will be used. Article no: 9228485 (For SS Finish only)

If a person will be using rightward opening door then DIN right will be used. Article no : 9228501 (For SS Finish only)

Prolock Infinity : The Complete Main Door Solution

	Prolock Infinity Handles Design 1 (HSN Code - 83024110)		Qty.	Unit	PU	MRP
	9228485	Prolock Infinity 1 SS DIN Left	01	Set	01	4,606
	9228501	Prolock Infinity 1 SS DIN Right	01	Set	01	4,606







Same concept applies to all ProLock Infinity Handles Design.

NOTE: There is no need to order both DIN left and DIN right for a single door.

Appendix

Hettich Floor Springs for every door width and weight



Loading Capacity	Floor Spring Description	Image	Article Nos.	Warranty	MRP (Rs.)	Exclusive Features	Ready Reckoner: Glass Door Weight (kg)				
							Thickness (mm)	Height 2100 mm	Height 2400 mm	Height 2700 mm	Height 3000 mm
Door Width: 850 mm (34 inches) EN 2											
150 kg	HTS FS842 (Body):EN2, adjustable closing/ latching speed, HO 90 , without acc., EN1154		9227841	5 years	7,845	Protective Rust proof Stainless Steel cover; Specially made for commercial glass, wooden & profile 850 mm Doors; Door Weight 150 kg; EN 1154 certified; 500,000 cycle tested; For small sized, high traffic doors	10	46	53	60	67
100 kg	HTS FS652 (Body):EN2, adjustable closing/ latching speed, HO 90, without acc.		9227850	3 years	6,433	Protective Rust proof Stainless Steel cover; Specially made for commercial glass, wooden & profile 850 mm Doors; Door Weight 100 kg; 200,000 cycle tested; For small sized, medium traffic doors	12	56	64	72	80
Door Width: 950 mm (38 inches) EN 3											
150 kg	HTS FS843 (Body):EN3, adjustable closing/ latching speed, HO 90, without acc., EN1154		9227844	5 years	7,845	Protective Rust proof Stainless Steel cover; Specially made for commercial and residential glass, wooden & profile 950 mm Doors; Door Weight 150 kg; EN 1154 certified; 500,000 cycle tested; For medium sized, high traffic doors	10	52	60	70	75
100 kg	HTS FS653 (Body):EN3, adjustable closing/ latching speed, HO 90, without acc.		9227853	3 years	6,433	Protective Rust proof Stainless Steel cover; Specially made for commercial and residential glass, wooden & profile 950 mm Doors; Door Weight 100 kg; 200,000 cycle tested; For medium sized, moderate traffic doors	12	63	72	80	88
80 kg	HTS FS463 (Body):EN3, adjustable closing/ latching speed, HO 90 , without acc.		9228444	3 years	4,637	Protective Rust proof Stainless Steel cover; Specially made for commercial and residential glass, wooden & profile 950 mm Doors; Door Weight 80 kg; 200,000 cycle tested; For medium sized, moderate traffic doors					
Door Width: 1100 mm (44 inches) EN 4											
150 kg	HTS FS844 (Body):EN4, adjustable closing/ latching speed, HO 90, without acc., EN1154		9227847	5 years	7,845	Protective Rust proof Stainless Steel cover; Specially made for commercial and residential glass, wooden & profile 1100 mm Doors; Door Weight 150 kg; EN 1154 certified; 500,000 cycle tested; For large high traffic doors	10	60	69	73	86
100 kg	HTS FS654 (Body):EN4, adjustable closing/ latching speed, HO 90, without acc.		9227856	3 years	6,433	Protective Rust proof Stainless Steel cover; Specially made for commercial and residential glass, wooden & profile 1100 mm Doors; Door Weight 100 kg; 200,000 cycle tested; For Large sized, high traffic doors	12	72	83	93	102
For Fitting with Glass doors, please order patch fittings (extra)											
For Fitting with wooden and steel/aluminum profile doors, please order "top and bottom pivot (922786300)" extra.											
No hold open version is generally used for ATM and Restaurant doors where closing is must (mostly to conserve AC, ensure privacy and protection from outside dust)											



Registered & Head Office:
Hettich India Private Limited
302, Duro-lite House,
Opp. SAB TV, New Link Road,
Andheri (West), Mumbai - 400 053
Phone: +91 22 2674 3289/3356/4089
Fax: +91 22 2674 3267

Delhi Office:
Hettich India Private Limited
A-26/4, 1st floor,
Mohan Co-operative Industrial Estate,
New Delhi - 110 044
Phone: +91 11 4889 4000, 4889 4005
Fax: +91 11 4889 4044

Vadodara Factory:
Plot No. 304, Dhanora,
Nandesari Road,
Near ECPL,
Village - Dhanora - 391 346
Dist. - Vadodara
Tel: + 91 26 5656 9003

02.2019

Application Centres:

New Delhi:
61, Panchkuian Road,
New Delhi - 110 001
Ph. No. : +91 11 2358 0713,
2358 4603

Kolkata:
2nd Floor, Unit Number 2A,
Tirumala 22,
East Topsia Road,
Kolkata - 700 046
Ph. No. : +91 85850 44725

Bangalore:
Adventz Center, Ground Floor 28,
Cubbon Road, Shivaji Nagar,
Bangalore - 560 001
Ph. No. : +91 80 4530 0400,
4530 0401

Chandigarh:
2nd Floor, Aspire Tower,
Plot no. 55, Industrial
& Business park, Phase 1,
Chandigarh - 160 002
Ph. No. : +91 93 1755 7195

Training Center Address:
Hettich Poddar Wood Work Institute
Plot No.2, 1st Floor, DLF Industrial Estate-1
Near NHPC Metro Station,
Faridabad- Haryana
Ph: 0129 - 4203888
Email: info@hpwwi.com

Mumbai:
202, Duro-lite House, Opp. SAB TV,
New Link Road, Andheri (West),
Mumbai - 400 053
Ph.No. : +91 22 2639 9707

Hyderabad:
" Sai Krishna "
797 - A, Road No. 36,
Jubilee Hills,
Hyderabad - 500 034
Ph. No. : +91 40 2355 8994

Kochi:
41/2062D, 2nd Floor
Palarivattom signal
junction, NH 47 By-pass,
Kochi - 682 028
Ph. No. : +91 93 4900 3909

Indore:
Office No.106 and 107-A,
"Brilliant Titanium",
Plot No.9, Scheme No.78, Part-II,
Indore - 452 010, Madhya Pradesh,
Ph. No. : +91 93 0171 7343

Chennai:
"Heavitree", Ground Floor,
47, Spur Tank Road,
Chetpet, Chennai - 600 031
Ph. No. : +91 44 4263 7227

Pune:
Ishanya Speciality Mall,
C G 00-01, 2nd floor,
Arcade-2, Opp.Golf Course,
Yerwada, Pune - 411 006,
Ph. No. : +91 20 4132 2638

Ahmedabad:
1st Floor, Unit No. 102,
Safal Pegasus,
Anand Nagar,
Ahmedabad - 380 015,
Ph. No. : +91 79 4032 2824

Enquiry & Customer Services
Toll Free : 1800 209 2096 (office hours)
Email: sales_enquiry@in.hettich.com
customer_services@in.hettich.com
www.hettich.com

Technik für Möbel

Hettich