

# WESTMARK

MONOPOL  
M  
GERMANY



no. 60

Lieber Kunde und Interessent,

wir freuen uns, Ihnen den aktuellen vier-sprachigen Katalog präsentieren zu dürfen.

Das umfangreiche Gesamt-Sortiment folgt dem Anspruch, die Tätigkeiten rund um Küche, Kochen, und Genießen zu vereinfachen.

Besonders auf das **Thema »Backen«** möchten wir Ihre Aufmerksamkeit lenken. Diese Kategorie wurde mit einer Vielzahl von interessanten Produkten komplettiert und zu einem Westmark-Kompetenzbereich ausgebaut.

Benötigen Sie auch Tischsets oder lebensmittelechte, spülmaschinenfeste Flechtkörbe aus synthetischem Spezialmaterial? Dann empfehlen wir einen Blick in den aktuellen Saleen-Katalog.

Die Waren all unserer Marken, Saleen, Monopol und Westmark, können gemeinsam bestellt und geliefert werden.

Herzlichen Dank für Ihr Interesse.



*Dear Customer,*

*We are delighted to present our current catalogue in four languages.*

*The extensive product range aspires to simplify activities involving the kitchen and cooking, and to make them more enjoyable.*

*We would like to focus particularly on the theme of "Baking". This category consists of a wide range of interesting products, and has been expanded into one of Westmark's specialist areas.*

*Do you also need placemats or food-safe, dishwasher-safe baskets, made of specialised synthetic materials? Then take a look at the current Saleen catalogue.*

*Products from all of our brands (Saleen, Monopol, and Westmark) can be ordered and delivered together.*

*Thank you for your interest!*



Christian Deimel  
Geschäftsführender  
Gesellschafter  
Managing Director



Alfred Habel  
Geschäftsführer  
General Manager



Cher client et prospect,

Nous nous réjouissons de pouvoir vous présenter le dernier catalogue en quatre langues.

La gamme complète correspond à notre désir de simplifier les activités autour de la cuisine, de la cuisson et des saveurs.

Nous souhaitons attirer votre attention tout particulièrement sur le thème de la « cuisson au four ». De nombreux produits intéressants sont venus compléter cette catégorie. Elle a été développée pour devenir le domaine de compétence Westmark.

Vous avez besoin de sets de table ou de corbeilles tressées, en matériau synthétique spécial, qui conviennent pour les aliments et qui passent au lave-vaisselle ? Nous vous conseillons de jeter un œil dans le dernier catalogue Saleen.

Les produits de toutes nos marques, Saleen, Monopol et Westmark peuvent être commandés et livrés ensemble.

Nous vous remercions pour votre intérêt.



*Estimado cliente e interesado:*

*Nos alegramos de presentarle el nuevo catálogo en cuatro idiomas.*

*Toda esta gran gama de productos pretende facilitar las tareas relacionadas con la cocina y pasarlo bien.*

*Nos gustaría centrar su atención en el tema «hornear». Esta categoría se ha completado con un gran número de productos interesantes y se ha construido para formar un ámbito de competencia de Westmark.*

*¿Necesita manteles individuales o cestas de mimbre en material sintético especial aptos para alimentos y resistentes para el lavavajillas? Entonces le recomendamos que eche un vistazo a nuestro catálogo Saleen.*

*Los productos, todos de nuestras marcas Saleen, Monopol y Westmark se pueden pedir y suministrar conjuntamente.*

*¡Muchas gracias por su interés!*



Christian Deimel  
PDG  
Socio Director



Alfred Habel  
Gérant  
Gerente

## Piktogramme

Viele Informationen - wie die Hauptmaterialien der Artikel, Garantie, Hitzebeständigkeit etc. - werden Sie über Piktogramme dargestellt vorfinden.

## Pictograms

A lot of information - such as the main materials used in the products, heat-resistance, warranty, etc – is represented by pictograms.

## Pictogrammes

Vous trouverez de nombreuses informations (comme les matériaux principaux des articles, la garantie, la résistance à la chaleur, etc.) représentées sous la forme de pictogrammes.

## Pictogramas

Mucha información, como los materiales principales de los artículos, la garantía, la resistencia al calor, etc., se encuentra representada mediante pictogramas.

	artikel lose • <i>article bulk</i> • article en vrac • <i>artículo suelto</i>
	artikel mit illustr. karte/aufkleber • <i>article with illustr. card / sticker</i> • article avec carte illustrée/autocollant • <i>artículo con tarjeta ilustrada/pegatina</i>
	artikel im karton • <i>article in sales carton</i> • article en carton • <i>artículo en caja de cartón</i>
	artikel im geschenkkarton • <i>article in sales carton</i> • article en carton • <i>artículo en caja de cartón</i>
	polybeutel mit header • <i>polybag with header</i> • poly-sac avec header • <i>polibolsa con header</i>
	display mit stückzahl • <i>display with qty. of pieces</i> • présentoir avec nombre de pièces • <i>expositor con cantidad de piezas</i>
	polybeutel oder verschrumpft ohne illustr. verkaufsförderung • <i>polybag or shrink foil without illustr. promotion</i> • poly-sac ou film étirable sans promotion illustrée • <i>polibolsa o zunchdo sin ilustración. promoción de venta</i>

	edelstahl rostfrei • <i>stainless steel</i> • acier inoxydable • <i>acero inoxidable</i>
	spülmaschinengeeignet • <i>suitable for the dishwasher</i> • passe au lave-vaisselle • <i>apto para lavavajillas</i>
	nicht spülmaschinengeeignet • <i>not suitable for the dishwasher</i> • ne passe pas au lave-vaisselle • <i>inadecuado para lavavajillas</i>
	garantie • <i>guarantee</i> • garantie • <i>garantía</i>
	retro-serie
	ursprungsland • <i>country of origin</i>
	linkshandvariante • <i>left handers</i> • gauchers • <i>zurdos</i>
	beschichtung für backformen • <i>coating for bakeware</i>
	beschichtung für backformen • <i>coating for bakeware</i>
	frei von perfluorooctansäure • <i>perfluorooctanoic acid free</i>

ABS	acrylnitril-butadien-styrol • <i>acrylonitrile butadiene styrene</i>
AL	aluminium • <i>aluminum</i>
FE	eisen • <i>iron</i>
GLAS	glas • <i>glass</i>
INOX	edelstahl • <i>stainless steel</i>
PA	polyamid • <i>polyamide</i>
PC	polycarbonat • <i>polycarbonate</i>
PP	polypropylen • <i>polypropylene</i>
PS	polystyrol • <i>polystyrene</i>
SAN	styrol-acrylnitril • <i>Styrene-acrylonitrile</i>
SI	silikon • <i>silicone</i>
ST	stahl • <i>steel</i>
TPE	thermoplastische elastomere • <i>thermoplastic elastomeric</i>
ZD	zinkdruckguss • <i>zinc die-cast</i>

alle angegebenen maße sind circa maße. drucktechnisch bedingt sind eventuelle farbabweichungen möglich. • *all dimensions are approx. variations in colour due to printing process.* • toutes les dimensions indiquées sont approximatives. d'éventuelles variations de couleur sont possibles en raison du processus d'impression. • *todas las medidas indicadas son aproximadas. son posibles diferencias eventuales en los colores debidas a la técnica de impresión*



	westmark	04	
schälen, schneiden & teilen • <i>peeling, dividing &amp; cutting</i> éplucher, couper & diviser • <i>pelar, cortar &amp; partir</i>		09	01
garnieren, dekorieren • <i>garnishing &amp; decorating</i> décorer et garnir • <i>guarnición y decoración</i>		31	02
nudeln & spätzle • <i>pasta &amp; spätzle</i> les pâtes et les spätzles • <i>pasta y spätzle</i>		37	03
zubereiten • <i>seasoning</i> cuisiner • <i>preparación</i>		43	04
zerkleinern, reiben & hobeln • <i>cutting, grating &amp; slicing</i> couper, râper & émincer • <i>picar, rallar &amp; tajar</i>		81	05
öffnen & verschließen • <i>opening &amp; closing</i> ouvrir & fermer • <i>abrir &amp; cerrar</i>		97	06
frischhalten & aufbewahren • <i>storing food &amp; keeping fresh</i> garder au frais & conserver • <i>mantener fresco &amp; guardar</i>		111	07
kaffee & tee • <i>coffee &amp; tea</i> café & thé • <i>café &amp; té</i>		125	08
backstube • <i>bakery</i> pâtisserie • <i>pastelería</i>		135	09
entkernen & einkochen • <i>stoning &amp; preserving</i> dénoyer & mettre en conserve • <i>deshuesar &amp; conservar</i>		173	10
	Retro-Serie	193	11
gastro-zubehör • <i>catering-equipment</i> accessoires de restauration • <i>accesorios para la gastronomía</i>		197	12
ausgießer, portionierer & dosierer • <i>measure pourers, dispensers &amp; pourers</i> becs verseurs, distributeurs & doseurs • <i>vertedores, porcionadores &amp; dosificadores</i>		216	13
spezielles & ersatzteile • <i>for special purposes &amp; spare parts</i> spécial & pièces détachées • <i>para cosas especiales &amp; piezas de repuesto</i>		223	14
	Monopol	231	15
verkaufsförderung • <i>merchandising</i> promotion • <i>fomento de las ventas</i>		244	
	index	246	

historie • history • histoire • historia



**1956**

Hubert Deimel gründet das Unternehmen unter dem Namen ‚Hubert Deimel Haushaltwarenfabrik‘ - gefertigt und verkauft wird der »Famos«-Kartoffelschäler.

Hubert Deimel fonde l'entreprise sous le nom „Hubert Deimel Haushaltwarenfabrik“ - fabrication et vente du fameux épilucheur de pommes de terre »Famos«.

Dieser wird später für lange Zeit zum Namensgeber des Unternehmens - **Famos GmbH**.

C'est lui, qui va donner son nom à la société Famos GmbH pour longtemps.



*Hubert Deimel founds the company under the name "Hubert Deimel Haushaltwarenfabrik" - manufactures and markets the »Famos« potato peeler which will later give its name to the company Famos GmbH for a long time.*

*Hubert Deimel constitue la empresa dándose el nombre de „Hubert Deimel Haushaltwarenfabrik“ - se fábrica y se vende el pelador de patatas »Famos«, que será el epónimo para la empresa Famos GmbH para mucho tiempo.*

**1988**

Christian Deimel (Sohn) übernimmt die Geschäftsführung  
*Christian Deimel (son) takes over the company management*

Christian Deimel (fils) prend la direction de l'entreprise  
*Christian Deimel (hijo) asume la gerencia de la empresa*

**2001**

Zukauf der Firma Westmark (heutiger Namensgeber)  
*Acquisition of the Westmark Company (present name)*

Achat de la société Westmark (nom actuel)  
*Compra de la compañía Westmark (nombre actual)*

**2005  
-07**

Zukauf der Firmen Monopol und Sieger  
*Acquisition of the Monopol and Sieger companies*

Achat des sociétés Monopol et Sieger  
*Compra de las compañías Monopol y Sieger*

**2008**

Zertifizierung nach ISO 9001  
*Certification under ISO 9001*

Certification ISO 9001  
*Certificación según ISO 9001*

**2012**

Zukauf der Firma Saleen  
*Acquisition of the Saleen Company*

Achat de la société Saleen  
*Compra de la compañía Saleen*





## fertigung • production • fabrication • fabricación

Seit einigen Jahrzehnten bereits erfolgreich in der Haushaltswarenbranche tätig, freuen wir uns, dass wir als Fertigungsunternehmen auch heute noch einen Großteil der Produkte selbst in Deutschland herstellen.

Hierauf sind wir sehr stolz.

*We have operated successfully in the household goods industry for several decades, and we are pleased that as a manufacturer, we still produce a large proportion of the products ourselves in Germany.*

*We are very proud of this.*

Nous exerçons notre activité avec succès dans le secteur des articles ménagers, depuis quelques décennies déjà. En tant que fabricants, nous nous réjouissons encore aujourd'hui de produire nous-mêmes une grosse partie de nos articles en Allemagne.

Nous en sommes très fiers.

*Nuestra presencia en el sector de los productos para el hogar viene siendo exitosa desde hace algunas décadas y nos alegramos de que como empresa manufacturera sigamos aún hoy en gran parte fabricando productos en Alemania.*

*Es algo de lo que nos enorgullecemos.*



fertigung • *production* • fabrication • *fabricación*

In unseren Abteilungen Kunststoffspritzguss und -extrusion, Aluminiumdruckguss, Zinkdruckguss und Metallverarbeitung wird ein breites und zum Teil tiefes Sortiment verschiedenster Küchenhelfer sowie Tischsets und Korbwaren produziert.

*In our plastic injection moulding and extrusion, aluminium die-casting, zinc die-casting and metal processing departments, we produce a broad, and sometimes deep, range of kitchen equipment, such as placemats and basketry.*

Dans nos sections Plastique injecté et Extrusion plastique, Aluminium injecté, Zinc moulé sous pression et Traitement du métal, nous produisons une large gamme, parfois variée, d'ustensiles de cuisine très divers tels que les sets de table et la vannerie.

*En nuestros departamentos de modelado de plástico por inyección y extrusión, fundición de aluminio inyectado, zinc modelado a presión y mecanización de metales se produce una amplia gama de productos con los accesorios de cocina más diversos, manteles individuales y cestería.*





fertigung • production • fabrication • fabricación

Alle Prozesse im Unternehmen werden regelmäßig überprüft. Seit Jahren schon sind wir ein gem. ISO 9001:2008 zertifiziertes Unternehmen.

*All processes used by the company are monitored on a regular basis. For many years, we have been an ISO 9001:2008 -certified company.*

Tous les processus de l'entreprise sont régulièrement contrôlés. Nous sommes une entreprise certifiée ISO 9001:2008 depuis des années.

*Todos los procesos de la empresa se verifican con regularidad. Somos una empresa certificada según ISO 9001:2008 desde hace años.*



Wir sind von der Qualität unserer Produkte überzeugt und sicher, dass sie über lange Zeit ihre Funktion erfüllen. Daher geben wir – ab sofort - auf nahezu alle Artikel 5 Jahre Garantie.



*We have every confidence in the quality of our products, and we make sure that they fulfil their purpose for a long time. We therefore now offer a 5 year warranty on almost all of our products.*

Nous sommes convaincus de la qualité de nos produits et sûrs qu'ils remplissent leur fonction pendant longtemps. Par conséquent, presque tous nos articles sont désormais garantis 5 ans.

*Estamos convencidos de la calidad de nuestros productos y seguros de que cumplen su función por un prolongado periodo de tiempo. Por eso ofrecemos de forma inmediata 5 años de garantía en casi todos los artículos.*







# 01

schälen, schneiden, teilen • *peeling, dividing, cutting*  
éplucher, couper, diviser • *pelar, cortar, partir*

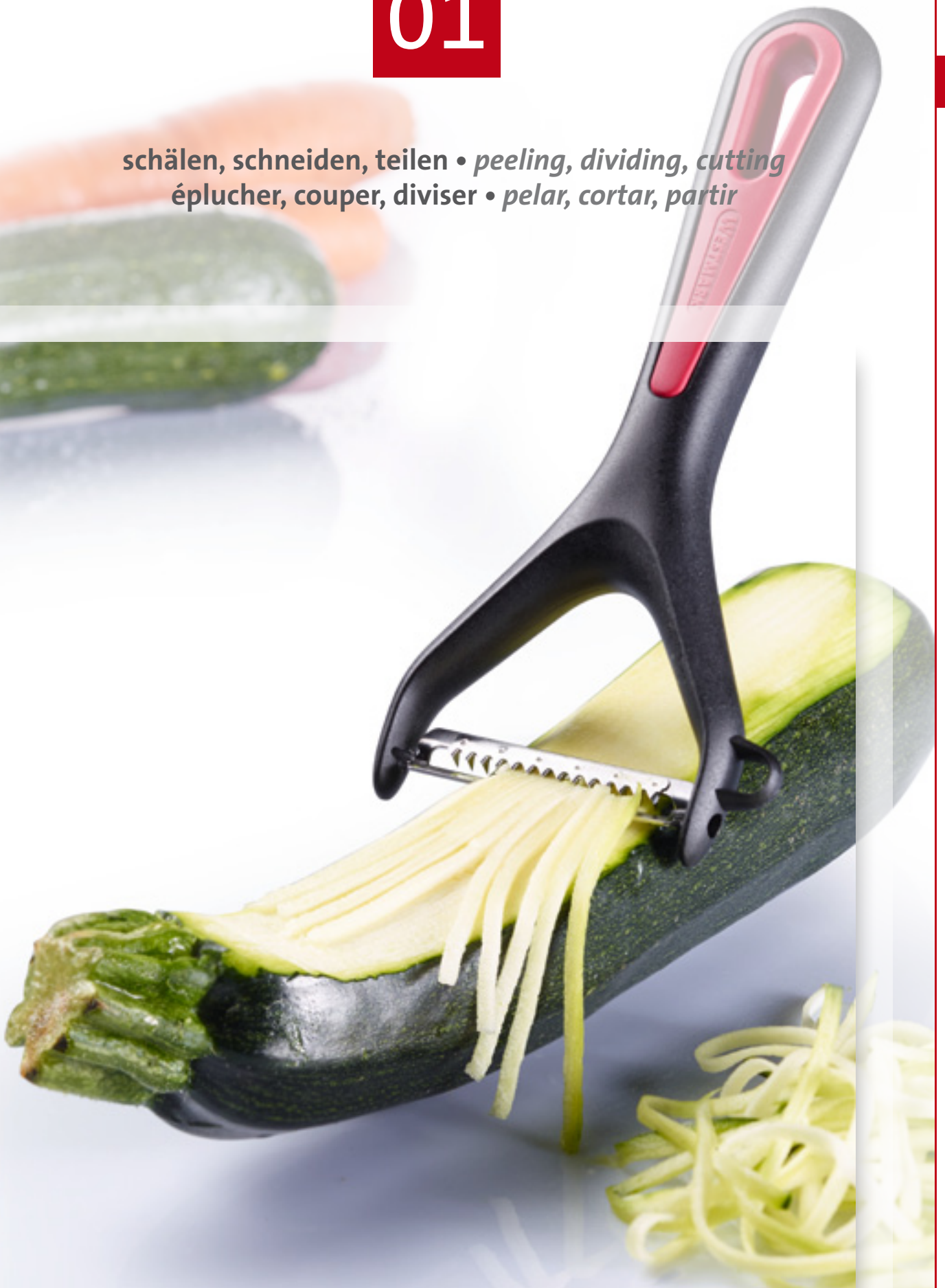

01

schälen, schneiden & teilen • *peeling, dividing & cutting* • éplucher, couper & diviser • *pelar, cortar & partir*



171 x 100 x 18 mm

**Krautschneider »Universal«**  
 • schneidet schnell kleinere Mengen Rot- und Weißkohl oder Salat

**Cabbage slicer »Universal«**  
 • quick cutting of small quantities of red and white cabbage or salad

**Coupe-chou »Universal«**  
 • coupe rapidement de petites quantités de chou rouge ou blanc et de salade

**Cortador de repollo »Universal«**  
 • corta rápidamente pequeñas cantidades de lombarda o repollo y lechuga

Art-Nr. / Art.-No.	VE / SU	EAN
1069 2270	6	4 004094 106972



115 x 65 x 13 mm

**Gemüse- und Spargelschäler »Steel«**  
 • klassischer U-Schäler aus pflegeleichtem Edelstahl  
 • mit geschliffenem ‚Aushöher‘ für Schadstellen

**Vegetable-/ asparagus peeler »Steel«**  
 • classic U-peeler from easy-care stainless steel  
 • with sharpened ‘corer’ for damaged spots

**Eplucheur de légumes et d’asperges »Steel«**  
 • économe classique de forme U en acier inoxydable  
 • avec ergot affûté pour les parties endommagées

**Pelador de verduras y espárragos »Steel«**  
 • cortador clásico en U de acero inoxidable  
 • con ahuecador afilado para manchas

Art-Nr. / Art.-No.	VE / SU	EAN
6090 2260	5	4 004094 609060



107 x 66 x 12 mm

**Spargel- und Gemüseschäler »U-Typ«**  
 • ergonomisch geformt mit Fingergriffmulden für sicheren Halt  
 • mit extrem scharfer Federstahlklinge  
 • wird farbig sortiert geliefert

**Asparagus-/vegetable peeler »U-Typ«**  
 • ergonomic handle with finger grips for secure hold  
 • with extremely sharp blade from spring steel  
 • comes in assorted colours

**Eplucheur de légumes et d’asperges »U-Typ«**  
 • manche ergonomique avec grip pour les doigts pour une prise sûre  
 • avec lame extrêmement coupante d’acier à ressort  
 • couleurs assorties

**Pelador de espárragos y verduras »U-Typ«**  
 • forma ergonómica con huellas para los dedos para agarrar con seguridad  
 • con hoja muy afilada en acero de muelle  
 • se suministra en varios colores

Art-Nr. / Art.-No.	VE / SU	EAN
1057 2210	100	
1057 2611	1	4 004094 105722



128 x 77 x 15 mm

**Gemüse- und Spargelschäler »Quick«**  
 • besonders leicht und doch enorm robust  
 • mit gebogener Klinge für breiten und sparsamen Schnitt

**Vegetable-/asparagus swivel peeler »Quick«**  
 • extremely light but nevertheless very sturdy  
 • with curved blade for an extra wide and economical cut

**Eplucheur de légumes et d’asperges »Quick«**  
 • particulièrement léger et pourtant très solide  
 • avec lame courbée pour une coupe large et économique

**Pelador de verduras y espárragos »Quick«**  
 • especialmente ligero, no obstante muy robusto  
 • con hoja curvada para un corte extra ancho y económico

Art-Nr. / Art.-No.	VE / SU	EAN
6095 2270	10	4 004094 609572
6095 2610	1	4 051734 609515



128 x 77 x 15 mm

**Julienne-Schneider »Quick-Spezial«**  
 • mit grob gezackter Klinge  
 • schneidet feine Gemüwestreifen zum Dekorieren von Suppen oder für Wok-Gerichte

**Julienne-cutter »Quick-Spezial«**  
 • with coarsely serrated blade  
 • cuts fine stripes for garnishing soups or preparing wok-meals

**Couteau à julienne »Quick-Spezial«**  
 • avec lame grossièrement dentée  
 • coupe de fines lanières de légumes pour décorer soupes ou plats au wok

**Cortador Juliana »Quick-Spezial«**  
 • con hoja dentada gruesa  
 • corta finas tiras de verduras para decorar sopas o para platos de wok

Art-Nr. / Art.-No.	VE / SU	EAN
6096 2270	10	4 004094 609671
6096 2610	1	4 051734 609614

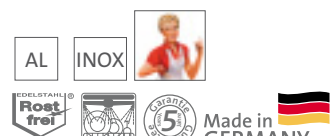







- Sparschäler »Trio«**
- 3 Klingen in einem Schäler
  - 1x Julienneklinge, 1x Kiwi-/ Tomaten-/ Paprika- Klinge, 1x glatte Klinge (z.B. für Gurken/ Möhren etc.)
- Peeler »Trio«**
- 3 blades in a single peeler
  - 1 x julienne blade, 1 x kiwi/tomato/paprika blade, 1 x smooth blade (eg for cucumbers/carrots, etc.)

- Éplucheur »Trio«**
- 3 lames sur un seul éplucheur
  - 1 x lame à julienne, 1 x lame à kiwis / tomates/ poivrons, 1 x lame lisse (pour concombres, carottes, etc.)
- Pelador »Trio«**
- 3 hojas en un pelador
  - 1hoja para cortar en juliana, 1hoja para pelar kiwis/ tomates/pimientos, 1hoja lisa (p. ej. para pepinos/zanahorias)



144 x 75 x 30 mm

Art-Nr. / Art.-No.	VE / SU	EAN
1058 2280 	6	 4 004094 105883
1058 2611 	1	 4 051734 003184



- Julienne-Schneider »Gentle«**
- mit grob gezackter Klinge
  - schneidet feine Gemüsestreifen



- Couteau à julienne »Gentle«**
- avec lame grossièrement dentée
  - coupe de fines lanières de légumes

- Julienne cutter »Gentle«**
- with coarsely serrated blade
  - cuts fine vegetable stripes

- Cortador Juliana »Gentle«**
- con hoja dentada gruesa
  - corta finas tiras de verduras



150 x 69 x 18 mm

Art-Nr. / Art.-No.	VE / SU	EAN
2805 2270 	6	 4 004094 280573



- Julienne-Schneider »Gallant«**
- mit grob gezackter Klinge
  - schneidet feine Gemüsestreifen
  - Komfort-Soft-Touch-Griff



- Couteau à julienne »Gallant«**
- avec lame grossièrement dentée
  - coupe de fines lanières de légumes
  - poignée confort-soft-touch

- Julienne cutter »Gallant«**
- with coarsely serrated blade
  - cuts fine vegetable stripes
  - comfort-soft-touch handle

- Cortador Juliana »Gallant«**
- con hoja dentada gruesa
  - corta finas tiras de verduras
  - con mango cómodo soft-touch



150 x 69 x 18 mm

Art-Nr. / Art.-No.	VE / SU	EAN
2905 2270 	6	 4 004094 290572







- Gemüse-/Spargelschäler »Gentle«**
- Metallteile zum Teil galvanisch beschichtet
  - mit aufgeschraubter Klinge aus Edelstahl

- Eplucheur de légumes et d'asperges »Gentle«**
- éléments métalliques en partie avec revêtement galvanisé
  - avec lame vissée
- Pelador de verduras y espárragos »Gentle«**
- elementos metálicos en parte con revestimiento galvanizado
  - con hoja enroscada

- Vegetable/ asparagus peeler »Gentle«**
- metal elements in parts with plated coating
  - screwed on blade from stainless steel



150 x 69 x 18 mm

Art-Nr. / Art.-No.	VE / SU	EAN
2802 2210 	25	
2802 2270 	6	 4 004094 280276
2811 2270 	6	 4 004094 281174



- Gemüse-/Spargelschäler »Gallant«**
- alle Metallteile aus Edelstahl
  - mit aufgeschraubter Klinge
  - Komfort-Soft-Touch-Griff





- Eplucheur de légumes et d'asperges »Gallant«**
- tous les éléments métalliques en acier inox
  - avec ergot pour les parties endommagés
  - poignée confort-soft-touch

- Vegetable/ asparagus peeler »Gallant«**
- all metal parts from stainless steel
  - with screwed-on blade
  - comfort-soft-touch handle

- Pelador de verduras y espárragos »Gallant«**
- todos elementos metálicos de acero inoxidable
  - con ahuecador para manchas
  - con mango cómodo soft-touch



150 x 69 x 18 mm

Art-Nr. / Art.-No.	VE / SU	EAN
2907 2270 	6	 4 004094 290770
2911 2270 	6	 4 004094 291173





157 x 41 x 7 mm



- Sparschäler »Famos«**
- das Original mit verchromtem Griff
  - mit aufgeschraubter Klinge
  - mit geschärftem ‚Ausstecher‘ für Schadstellen
- Swivel peeler »Famos«**
- the original with chrome-plated handle
  - with screwed on blade
  - with sharpened 'corer' for damaged spots

- Econome »Famos«**
- l'original avec manche chromé
  - avec lame vissée
  - avec ergot affûté pour les parties endommagées
- Pelador ahorrativo »Famos«**
- el original con mango cromado
  - con hoja enroscada
  - con ahuecador afilado para manchas

Art-Nr. / Art.-No.	VE / SU	EAN
1061 2210	90	
1061 2270	10	4 004094 106170
1061 2611	1	4 051734 000114



157 x 41 x 7 mm

- Sparschäler »Steel«**
- grau-beschichteter Griff
  - mit aufgeschweisster Klinge

- Econome »Steel«**
- manche révetu en gris
  - avec lame soudée

- Swivel peeler »Steel«**
- grey-coated handle
  - with welded on blade

- Pelador ahorrativo »Steel«**
- mango recubierto en gris
  - con hoja soldada

Art-Nr. / Art.-No.	VE / SU	EAN
1610 2210	90	
1610 2270	10	4 004094 161070
1610 2610	1	4 004094 161025



155 x 30 x 10 mm

- Sparschäler »Simple«**
- hochwertiger Kunststoff-Griff
  - mit aufgeschweißter Klinge

- Econome »Simple«**
- manche en plastique de qualité
  - avec lame soudée

- Swivel peeler »Simple«**
- quality plastic handle
  - with welded on blade

- Pelador ahorrativo »Simple«**
- mango en plástico de calidad
  - con hoja soldada

Art-Nr. / Art.-No.	VE / SU	EAN
1067 2210	25	
1067 2270	10	4 004094 106774



165 x 37 x 18 mm

- Sparschäler »Gentle«**
- Metallteile zum Teil galvanisch beschichtet
  - mit aufgeschraubter Klinge aus Edelstahl
  - mit geschärftem Ausstecher für Schadstellen
- Swivel peeler »Gentle«**
- metal elements in parts with plated coating
  - screwed on blade from stainless steel
  - with sharpened corer for damaged spots

- Econome »Gentle«**
- éléments métalliques en partie avec revêtement galvanisé
  - avec lame vissée
  - avec ergot affûté pour les parties endommagées
- Pelador ahorrativo »Gentle«**
- elementos metálicos en parte con revestimiento galvánico
  - con hoja enroscada
  - con ahuecador afilado para manchas

Art-Nr. / Art.-No.	VE / SU	EAN
2803 2210	25	
2803 2270	6	4 004094 280375
2804 2210	25	
2804 2270	6	4 004094 280474



165 x 37 x 20 mm

- Sparschäler »Gallant«**
- alle Metallteile aus Edelstahl
  - mit aufgeschraubter Klinge
  - mit geschärftem Ausstecher für Schadstellen
  - Komfort-Soft-Touch-Griff
- Swivel peeler »Gallant«**
- all metal parts from stainless steel
  - with screwed-on blade
  - with sharpened corer for damaged spots
  - comfort-soft-touch handle

- Econome »Gallant«**
- tous les éléments métalliques en acier inox
  - avec lame vissée
  - avec ergot affûté pour les parties endommagées
  - poignée confort-soft-touch
- Pelador ahorrativo »Gallant«**
- todos elementos metálicos de acero inoxidable
  - con hoja enroscada
  - con ahuecador afilado para manchas
  - con mango cómodo soft-touch

Art-Nr. / Art.-No.	VE / SU	EAN
2903 2270	6	4 004094 290374
2909 2270	6	4 004094 290978





**Schäler & Messer - Set**  
 • besteht aus Sparschäler »Steel« (Art. 1610) und Küchenmesser »Techno« (Art. 1351)

**Peeler & Knife Set**  
 • consists of swivel peeler »Steel« (Art. 1610) and kitchen knife »Techno« (Art. 1351)

**Ensemble éplucheur & couteau**  
 • ce compose de economie »Steel« (Art. 1610) et couteau de cuisine »Techno« (Art. 1351)

**Pelador con cuchillo**  
 • consta de pelador ahorrativo »Steel« (Art. 1610) y cuchillo »Techno« (Art. 1351)

Art-Nr. / Art.-No.	VE / SU	EAN
1616 2280 	6	4 004094 161681

PP INOX METAL





157 x 41 x 7 mm

**Sparschäler mit feststehender Klinge »Gentle«**  
 • beidseitig geschliffene Klinge

**Eplucheur 2 tranchants »Gentle«**  
 • lame fixe à double tranchant

**Peeler with fixed blade »Gentle«**  
 • two-side sharpened blade

**Pelador con hoja fija »Gentle«**  
 • hoja fija afilada por ambos lados

Art-Nr. / Art.-No.	VE / SU	EAN
2806 2210 	25	
2806 2270 	6	4 004094 280672

PP INOX



185 x 27 x 20 mm

**Sparschäler mit feststehender Klinge »Gallant«**  
 • feststehende, beidseitig geschliffene Klinge  
 • geschliffene Klingenspitze als Ausstecher für Schadstellen  
 • Komfort-Soft-Touch-Griff

**Eplucheur 2 tranchants »Gallant«**  
 • lame fixe à double tranchant  
 • pointe aiguisée pour les parties endommagées  
 • poignée confort-soft-touch

**Peeler with fixed blade »Gallant«**  
 • two-side sharpened blade  
 • sharpened blade top serves as corer for damaged spots  
 • comfort-soft-touch handle

**Pelador con hoja fija »Gallant«**  
 • hoja fija afilada por ambos lados  
 • con punta afilada para manchas  
 • con mango cómodo soft-touch

Art-Nr. / Art.-No.	VE / SU	EAN
2906 2270 	6	4 004094 290671

PP TPE INOX



185 x 27 x 20 mm

**Sparschäler »Pomfix Gallant«**  
 • sehr langlebig durch auswechselbare Klinge  
 • gebogene Klinge für besonders breiten und sparsamen Schnitt  
 • Klinge umsteckbar für Rechts- und Linkshänder  
 • Komfort-Soft-Touch-Griff

**Economie »Pomfix Gallant«**  
 • produit de longue vie à cause de lame remplaçable  
 • lame courbée pour une coupe large et économique  
 • lame réversible pour droitiers et gauchers  
 • poignée confort-soft-touch

**Swivel peeler »Pomfix Gallant«**  
 • long-life product due to replaceable blade  
 • bended blade for an extra wide and economical cut  
 • blade reversible for right and left handed use  
 • comfort-soft-touch handle

**Pelador ahorrativo »Pomfix Gallant«**  
 • pelador de larga duracion para hoja cambiabile  
 • hoja curvada para un corte extra ancho y económico  
 • hoja reversible para diestros y zurdos  
 • con mango cómodo soft-touch

Art-Nr. / Art.-No.	VE / SU	EAN
2945 2270 	6	4 004094 294570

PP TPE AL





195 x 27 x 20 mm

**Tomaten- und Kiwischäler »Tomfix«**  
 • mit gezackter, extrem scharfer Klinge  
 • zum Schälen von Tomaten, Paprika, Pflirsichen, Kiwis etc.  
 • für Rechts- und Linkshänder

**Eplucheur de tomates et de kiwis »Tomfix«**  
 • lame dentée et super tranchante  
 • permet d'éplucher les tomates, les poivrons, les pêches, les kiwis etc.  
 • pour droitiers et gauchers

**Tomato- /kiwi fruit peeler »Tomfix«**  
 • with serrated, super-sharp blade  
 • for peeling tomatoes, peppers, peaches, kiwi-fruit etc. • for right and left handed use

**Pelador de tomates y kiwis »Tomfix«**  
 • con hoja dentada y superafilada  
 • por pelar los tomates, los pimientos, los melocotones, los kiwis etc.  
 • para diestros y zurdos

Art-Nr. / Art.-No.	VE / SU	EAN
6046 2270 	10	4 004094 604676
6046 2610 	1	4 051734 604619

PP TPE AL



NEU ab Ende 2016

185 x 22 x 18 mm







192 x 50 x 31 mm

**Gemüse- und Doppelschäler »Peel-Star Alu«**

- Spezierschäler mit Zwei-Klingen Prinzip, so wird das Gemüse von zwei Seiten gleichzeitig geschält
- ideal für Langgemüse wie Spargel, Möhren etc.

**Double peeler »Peel-Star Alu«**

- peeler with two-blade principle • peels the vegetable from two sides at the same time
- ideal for long vegetables like asparagus, carrots etc.

Art-Nr. / Art.-No.	VE / SU	EAN
6050 2260 	5	4 004094 605062 
6050 2660 	1	4 051734 001739 







192 x 50 x 31 mm

**Gemüse- und Doppelschäler »Peel-Star KS«**

- der Spezierschäler mit dem Zwei-Klingen Prinzip (Beschreibung siehe oben) aus sehr hochwertigem Kunststoff

**Double peeler »Peel-Star KS«**

- the special peeler with the two-blade principle (description see above) from very high quality plastic

Art-Nr. / Art.-No.	VE / SU	EAN
6060 2260 	5	4 004094 606069 
6060 2660 	1	4 051734 001746 



**Double éplucheur de légumes »Peel-Star Alu«**

- le légume est épluché uniformément des deux côtés
- idéal pour légumes longs tels que les asperges, les carottes etc.

**Pelador doble de verduras »Peel-Star Alu«**

- pelador especial con el principio de dos hojas
- pela la verdura por dos lados al mismo tiempo
- ideal para verduras como espárragos, zanahorias, etc.

**Double éplucheur de légumes »Peel-Star KS«**

- l'économe spécial avec le principe deux lames (description ci-dessus) en plastique de très grande qualité

**Pelador doble de verduras »Peel-Star KS«**

- el pelador especial con el principio de dos hojas (descripción véase arriba) de plástico de altísima calidad







173 x 55 x 15 mm

**Spargelschäler »Peel-Master«**

- die zangenähnliche Konstruktion sorgt dafür, dass die empfindliche Spargelstange beim Schälen nicht bricht
- geschliffenes Messer für Spargelenden

**Asparagus peeler »Peel-Master«**

- the tong-like construction makes sure that the delicate asparagus stem does not break when being peeled
- the sharpened knife cuts the hard ends

Art-Nr. / Art.-No.	VE / SU	EAN
6070 2260 	5	4 004094 607066 
6070 2660 	1	4 051734 001661 



**Eplucheur d'asperges »Peel-Master«**

- construction semblable à une pince
- permet de ne pas casser la tige délicate de l'asperge lors de l'épluchage
- couteau affûté coupe les extrémités

**Pelador de espárragos »Peel-Master«**

- gracias a la construcción similar a la de unas pinzas, hace que no se parta el sensible cuerpo del espárrago al pelarlo
- con cuchilla afilada





**Pellkartoffelgabel »Gentle«**

- ca. 27 mm lange Zinken halten die Kartoffel sicher in Position

**Potato fork »Gentle«**

- ca. 27 mm long prongs - hold the potato in a secure position

Art-Nr. / Art.-No.	VE / SU	EAN
2814 2210	25	
2814 2270	6	4 004094 281471

**Fourchette à pommes de terre »Gentle«**

- des dents de ca. 27 mm maintiennent la pomme de terre en position

**Tenedor para pelar patatas cocidas »Gentle«**

- el tridente de ca. 27 mm mantiene la patata en posición



159 x 27 x 20 mm

01

**Pellkartoffelgabel »Gentle« & Messer, Set**

- besteht aus Pellkartoffelgabel »Gentle« (Art. 2814) und Küchenmesser »Techno« (Art. 1351)

**Jacket potato fork »Gentle« and knife, set**

- consists of jacket potato fork »Gentle« (Art. 2814) and kitchen knife »Techno« (Art. 1351)

**Fourchette à pommes de terre »Gentle« & couteau, set**

- se compose de Fourchette à pommes de terre »Gentle« (Art. 2814) et couteau de cuisine »Techno« (Art. 1351)

**Tenedor para patatas cocidas con piel »Gentle« & cuchillo, set**

- Se compone de Tenedor para patatas cocidas con piel »Gentle« (Art. 2814) y cuchillo »Techno« (Art. 1351)



159 x 27 x 20 mm

Art-Nr. / Art.-No.	VE / SU	EAN
2815 2280	6	4 004094 281587

**Pellkartoffelgabel »Gallant«**

- besonders lange Zinken - ca. 37 mm - halten die Kartoffel sicher in Position
- Komfort-Soft-Touch-Griff

**Potato fork »Gallant«**

- especially long prongs- ca. 37 mm - hold the potato in a secure position
- comfort-soft-touch handle

**Fourchette à pommes de terre »Gallant«**

- des dents particulièrement longues - ca. 37 mm - maintiennent la pomme de terre en position
- poignée confort-soft-touch

**Tenedor para pelar patatas cocidas »Gallant«**

- el tridente de ca. 37 mm mantiene la patata en posición
- con mango cómodo soft-touch



163 x 27 x 20 mm

Art-Nr. / Art.-No.	VE / SU	EAN
2914 2270	6	4 004094 291470

**Zestenreißer/ Zitronenschaber »Gentle«**

- Fadenschaber schneidet feine Streifen aus Fruchtschalen, Schokolade etc.
- geschärfte Lochklingen

**Zester »Gentle«**

- for cutting fine stripes from fruit peel, chocolate etc.
- sharpened hole-blades

**Zesteur »Gentle«**

- pour couper de fines bandes d'écorces de fruits, chocolat etc.
- lames de trou affûtées

**Raspador para limones »Gentle«**

- para cortar tiras finas de la piel de frutas, de chocolate etc.
- perforaciones afiladas



165 x 27 x 20 mm

Art-Nr. / Art.-No.	VE / SU	EAN
2830 2270	6	4 004094 283079

**Zestenreißer/ Zitronenschaber »Gallant«**

- Fadenschaber schneidet feine Streifen aus Fruchtschalen, Schokolade etc.
- speziell geschärfte Lochklingen
- mit Kanneliermesser
- Komfort-Soft-Touch-Griff

**Zester with cannele »Gallant«**

- for cutting fine stripes from fruit peel, chocolate etc.
- specially sharpened hole-blades
- with channel-knife
- comfort-soft-touch handle

**Zesteur et canneleur »Gallant«**

- pour couper de fines bandes d'écorces de fruits, chocolat etc.
- lames de trou affûtées
- avec couteau canneleur
- poignée confort-soft-touch

**Raspador para limones »Gallant«**

- para cortar tiras finas de la piel de frutas, de chocolate etc.
- perforaciones especialmente afiladas
- con cuchillo acanalador
- mango cómodo soft-touch



165 x 27 x 20 mm

Art-Nr. / Art.-No.	VE / SU	EAN
2930 2270	6	4 004094 293078



schälen, schneiden &amp; teilen • peeling, dividing &amp; cutting • éplucher, couper &amp; diviser • pelar, cortar &amp; partir

15



190 x 27 x 20 mm

- Orangenschäler »Gentle«**
- zum Schälen von Zitrusfrüchten
  - sehr scharf geschliffene Klingen
  - mit Kanneliermesser



*Orange peeler with channel knife »Gentle«*

- for peeling citrus fruit
- very sharply ground blades
- with channel knife

- Eplucheur d'orange avec cannelure »Gentle«**
- pour peler les agrumes
  - des lames très aiguisées
  - avec couteau cannelure

*Pelador de naranjas y cuchillo acanalador »Gentle«*

- para pelar los cítricos
- hojas muy afiladas
- con cuchillo acanalador

Art-Nr. / Art.-No.	VE / SU	EAN
2834 2270 	6	4 004094 283475 



190 x 27 x 20 mm

- Orangenschäler »Gallant«**
- zum Schälen von Zitrusfrüchten
  - sehr scharf geschliffene Klingen
  - mit Kanneliermesser
  - Komfort-Soft-Touch-Griff



*Orange peeler with channel knife »Gallant«*

- for peeling citrus fruit
- very sharply ground blades
- with channel knife
- comfort-soft-touch handle

- Eplucheur d'orange avec cannelure »Gallant«**
- pour peler les agrumes
  - des lames très aiguisées
  - avec couteau cannelure
  - poignée confort-soft-touch

*Pelador de naranjas y cuchillo acanalador »Gallant«*

- para pelar los cítricos
- hojas muy afiladas
- con cuchillo acanalador
- mango cómodo soft-touch

Art-Nr. / Art.-No.	VE / SU	EAN
2934 2270 	6	4 004094 293474 



198 x 27 x 20 mm

- Apfelkernausstecher »Gentle«**
- ermöglicht ein schnelles, sauberes Ausstechen des Kerngehäuses
  - Ausstech-ø 17 mm



*Apple core remover »Gentle«*

- enables quick and clean coring
- coring-ø 17 mm

- Vide-pomme »Gentle«**
- retrait rapide et propre du trognon
  - tige-ø 17 mm

*Descorazonador de manzanas »Gentle«*

- sacar rápida y limpiamente el corazón de la manzana
- descorazonador-ø 17 mm

Art-Nr. / Art.-No.	VE / SU	EAN
2818 2210 	25	
2818 2270 	6	4 004094 281877 



210 x 27 x 20 mm

- Apfelkernausstecher »Gallant«**
- sehr stabile Konstruktion
  - ermöglicht ein schnelles, sauberes Ausstechen des Kerngehäuses
  - Ausstech-ø 19 mm
  - Komfort-Soft-Touch-Griff



*Apple core remover »Gallant«*

- very solid construction
- enables quick and clean coring
- coring-ø 19 mm
- comfort-soft-touch handle

- Vide-pomme »Gallant«**
- construction très solide
  - retrait rapide et propre du trognon
  - tige-ø 19 mm
  - poignée confort-soft-touch

*Descorazonador de manzanas »Gallant«*

- version muy solida
- sacar rápida y limpiamente el corazón de la manzana
- descorazonador-ø 19 mm
- con mango cómodo soft-touch

Art-Nr. / Art.-No.	VE / SU	EAN
2918 2270 	6	4 004094 291876 



195 x 43 x 23 mm

- Apfelausstecher »Kernfix«**
- schnelles, sauberes Ausstechen des Kerngehäuses
  - durch die Zangenform wird die Herausnahme des Kerngehäuses besonders einfach

*Apple corer »Kernfix«*

- easy and clean coring
- the tong shape of the corer makes it especially easy to remove the core

- Vide-pomme »Kernfix«**
- retrait rapide et propre du trognon
  - grâce à la forme en pince, le retrait du trognon est particulièrement simple

*Descorazonador de manzanas »Kernfix«*

- sacar rápida y limpiamente el corazón de la manzana
- gracias a la forma de pinzas se puede sacar el corazón de la manzana con suma facilidad

Art-Nr. / Art.-No.	VE / SU	EAN
1319 2260 	6	4 004094 131967 





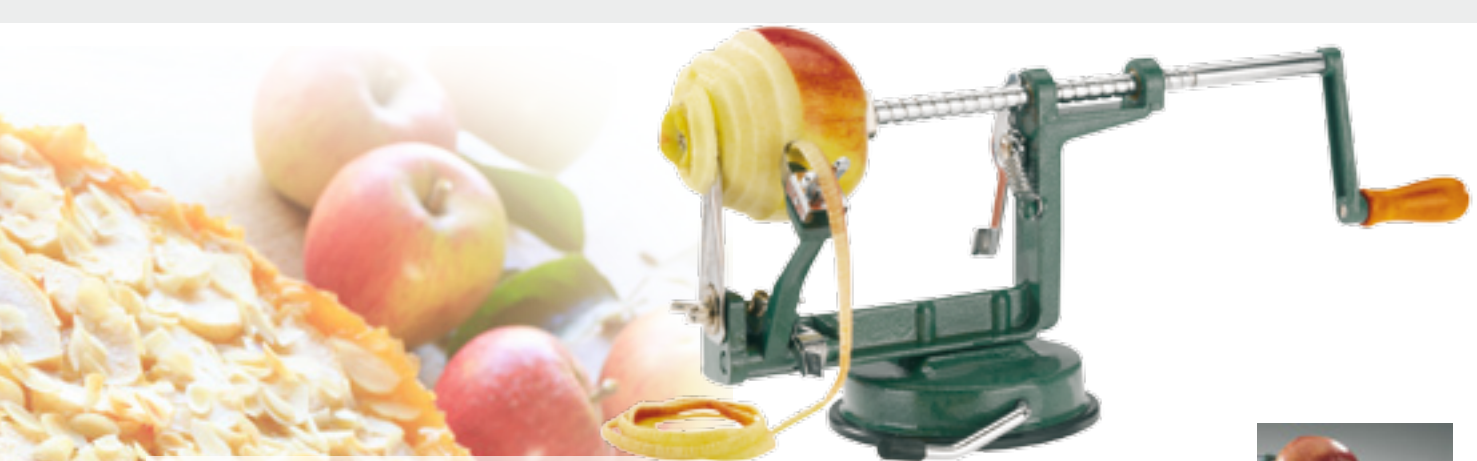

**Apfelraum mit Saugfuß**

- schält, schneidet und entkernt den Apfel in einem Arbeitsgang
- auch ideal für Kartoffeln
- sicheres, rutschfreies Arbeiten dank starkem Saugfuß

**Apple dream with suction pad**

- peels, cuts and cores the apple at the same time
- also ideal for potatoes
- secure non-slip working thanks to the strong suction pad

**Pèle-pomme avec pied-ventouse**



- évide, épluche et coupe la pomme en une opération
- aussi idéal pour les pommes de terre
- travail sûr et antidérapant grâce au pied-ventouse

**Sueño de manzanas con pata de succión**

- pela, corta y saca el corazón de la manzana en una operación
- anche ideal para pelar los patatas
- trabajo seguro antideslizante debido a la fuerte base de succión



305 x 105 x 130 mm

Art-Nr. / Art.-No.	VE / SU	EAN
1144 2260 	3	 4 004094 114465



**Apfelraum mit Schraubzwinde**

- schält, schneidet und entkernt den Apfel in einem Arbeitsgang
- auch ideal für Kartoffeln
- mit Schraubzwinde

**Apple dream with screw clamp**

- peels, cuts and cores the apple at the same time
- also ideal for potatoes
- with screw clamp

**Pèle-pomme avec serre-joint**



- évide, épluche et coupe la pomme en une opération
- aussi idéal pour les pommes de terre
- avec serre-joint

**Sueño de manzanas con tornillo de apriete**

- pela, corta y saca el corazón de la manzana en una operación
- anche ideal para pelar los patatas
- con tornillo de apriete



310 x 53 x 210 mm

Art-Nr. / Art.-No.	VE / SU	EAN
1143 2260 	3	 4 004094 114366



**Fruchtteiler »Vitamino«**

- 6 gleiche Teile in einem Arbeitsgang
- sternförmiger, spitz zulaufender Messereinsatz
- klarer Deckel schützt vor Spritzern

**Fruit divider »Vitamino«**

- 6 equal parts in one action
- star-shaped, pointed blade-assembly
- the clear cover makes sure that possible juice splashes stay within the tool

**Coupe-fruits »Vitamino«**

- 6 portions identiques en une opération
- assemblage de lames affûtées en forme d'étoile
- le couvercle transparent protège des éclaboussures

**Partidor de frutas »Vitamino«**

- 6 partes iguales en una operación
- cuchillas en forma de estrella, puntiagudo
- tapa transparente contra las posibles salpicaduras de zumo



Art-Nr. / Art.-No.	VE / SU	EAN
1154 2260 	4	 4 004094 115462



109 x 109 x 133 mm







86 x 98 x 239 mm

**Ananasschneider**  
 • entkernt, schält und schneidet in einem Arbeitsgang - sofort verzehrfertige Scheiben  
 • schnelle und bequeme Handhabung

**Pineapple slicer**  
 • cores, peels and slices in a single operation - immediately provides ready-to-eat juicy slices  
 • fast and comfortable handling

**Coupe-ananas**  
 • évide, épiluche et tranche en une opération des tranches immédiatement prêtes à être mangées  
 • maniement rapide et agréable

**Cortador de piña**  
 • descorazona, pela y corta en una operación - rodajas que se pueden consumir inmediatamente  
 • manejo rápido y cómodo

Art.-Nr. / Art.-No.	VE / SU	EAN
5167 2270 	5	 4 004094 516771
5167 2670 	1	 4 051734 003283

ABS PP





245 x 105 x 85 mm

**Ananasschneider Edelstahl**  
 • entkernt, schält und schneidet in einem Arbeitsgang - sofort verzehrfertige Scheiben  
 • schnelle und bequeme Handhabung

**Pineapple slicer stainless steel**  
 • cores, peels and slices in a single operation - immediately provides ready-to-eat juicy slices  
 • fast and comfortable handling

**Coupe-ananas acier inoxydable**  
 • évide, épiluche et tranche en une opération des tranches immédiatement prêtes à être mangées  
 • maniement rapide et agréable

**Cortador de piña en acero inoxidable**  
 • descorazona, pela y corta en una operación - rodajas que se pueden consumir inmediatamente  
 • manejo rápido y cómodo

Art.-Nr. / Art.-No.	VE / SU	EAN
5169 2260 	3	 4 004094 516962

PP INOX





**Erdbeerentkroner »Zupfi«**  
 • entfernt die Erdbeerkrone schnell und sicher mit geschärften Zangenenden  
 • nur im Display erhältlich - einzeln mit EAN ausgezeichnet

**Strawberry huller tongs »Zupfi«**  
 • takes off the center with its sharpened tong edges  
 • only available in display unit - each article barcoded

**Equetteur à fraise »Zupfi«**  
 • retire rapidement et en toute sécurité la queue des fraises grâce aux extrémités dentées affûtées  
 • disponible uniquement en présentoir - chaque article possède un code-barres

**Descorazonador de fresas »Zupfi«**  
 • con sus extremos de tenazas afiladas descorazona las fresas de un modo rápido y seguro  
 • obtenible solo en expositor - individualmente disponen de EAN

Art.-Nr. / Art.-No.	VE / SU	EAN
4044 2610 	1	 4 051734 404417

INOX





86 x 41 x 22 mm



- Apfel- und Birnenteiler »Divisorex«**
- das robuste Original aus Aluminium
  - 10 gleiche Stücke und Entfernen des Kerngehäuses in einem Arbeitsgang
  - speziell geschliffenes Messereinheit

- Apple- and pear slicer »Divisorex«**
- the sturdy original from aluminium
  - coring of the fruit and 10 even segments in one action
  - specially sharpened blade assembly



Art-Nr. / Art.-No.	VE / SU	Größe / Size	EAN
5110 2260 	5	ø 90 mm	4 004094 511066
5110 2660 	1		4 051734 001708



170 x 111 x 43 mm

- Apfelteiler »8P«**
- 8 gleichförmige Segmente und Entfernen des Kerngehäuses in einem Arbeitsgang
  - gummierte Griffe

- Apple slicer »8P«**
- coring of the fruit and 8 equal segments in one action
  - rubber handles



Art-Nr. / Art.-No.	VE / SU	Größe / Size	EAN
5162 2270 	6	ø 90 mm	4 004094 516276
5162 2670 	1		4 051734 001623
5163 2670 	1		4 051734 001630



175 x 105 x 65 mm

- Mangoteiler**
- entfernt den Kern und teilt die Frucht in zwei Hälften
  - gummierte Griffe

- Mango slicer**
- the stable blade unit removes the seed and cuts the fruit into two segments
  - rubber handles

Art-Nr. / Art.-No.	VE / SU	Größe / Size	EAN
5164 2270 	6	ø 90 mm	4 004094 516474
5164 2670 	1		4 051734 001647
5163 2670 	1		4 051734 001630



200 x 105 x 65 mm

- Fruchtteiler »Universal«**
- die verstellbare Messereinheit ermöglicht das Schneiden in 2 oder 4 Teile
  - auch geeignet für Pfirsiche
  - gummierte Griffe

- Fruit corer »Universal«**
- the adjustable slicing unit cuts the fruit into 2 or 4 segments
  - also for coring peaches
  - rubber handles

Art-Nr. / Art.-No.	VE / SU	Größe / Size	EAN
5165 2270 	6	ø 105 mm	4 004094 516573



210 x 133 x 55 mm

- Melonenteiler »Jumbo«**
- teilt Melonen bis zu einem ø von 19 cm in 12 gleichförmige Segmente
  - scharf gezackte Messer für sauberen Schnitt
  - gummierte Griffe
  - mit Klingenschutz

- Melon slicer »Jumbo«**
- divides melons up to ø 19 cm in 12 even segments
  - sharp, serrated knives for clean cut
  - rubber handles
  - with blade protection

Art-Nr. / Art.-No.	VE / SU	Größe / Size	EAN
5160 2270 	3	ø 190 mm	4 004094 516078



297 x 215 x 38 mm

- Coupe-pomme et poire »Divisorex«**
- l'original robuste en aluminium
  - 10 morceaux identiques et retrait du trognon en une opération
  - unité de coupe spécialement affûtée

- Partidor de manzanas y peras »Divisorex«**
- el original robusto de aluminio
  - 10 partes iguales y descorazonado en una operación
  - unidad de corte afilada especialmente

- Coupe-pomme »8P«**
- 8 segments de forme identique et retrait du trognon en une opération
  - poignée caoutchoutée

- Partidor de manzanas »8P«**
- 8 partes iguales y descorazonado en una operación
  - mangos engomados

- Coupe-mangue**
- cet outil permet de retirer le noyau proprement et coupe le fruit en deux
  - poignée caoutchoutée

- Partidor de mangos**
- este partidor ayuda a extraer el hueso limpiamente y corta la fruta en dos
  - mangos engomados

- Coupe-fruits »Universal«**
- l'unité de tranchage réglable permet de couper 2 ou 4 parts
  - aussi pour les pêches
  - poignée caoutchoutée

- Partidor de frutas »Universal«**
- la unidad de corte regulable corta las frutas en 2 o 4 segmentos
  - también deshuesar melocotones
  - mangos engomados

- Coupe-melon »Jumbo«**
- coupe les melons jusqu'à 19 cm de ø en 12 parts
  - lames tranchantes et dentelées coupent facilement le fruit
  - avec protection de lame

- Partidor de melones »Jumbo«**
- parte melones hasta de un diámetro de 19 cm en 12 partes iguales
  - cuchillas dentadas puntiagudas cortan fácil la fruta
  - con protección de las hojas



**Käseschneider »Fromarex«**

- der Käseschneider mit der Klinge
- Vorteil: gegenüber üblichen Geräten, die mit Draht arbeiten, schneidet der Fromarex mit seiner Klinge auch Hartwurst, Parmesan-Käse, Schinken, Paprika, Gurken, Rettich, Eisbergsalat etc.
- mit Skala zum Einstellen der gewünschten Schnittstärke

**Cheese slicer »Fromarex«**

- the cheese slicer with the blade
- advantage: compared with common appliances which work with a wire - the Fromarex with its blade does not shy away from hard cured sausage, parmesan cheese, peppers, cucumbers, radishes, lettuce and much more
- with scale for adjusting the desired slicing thickness

**Coupe-fromage »Fromarex«**

- le coupe-fromage avec lame
- avantage : à l'inverse des appareils traditionnels fonctionnant avec un fil, le Fromarex coupe aussi grâce à sa lame le saucisson, le parmesan, le jambon, les poivrons, les concombres, les radis, la salade Eisberg etc.
- avec graduation pour régler l'épaisseur de coupe souhaitée

**Cortador de queso »Fromarex«**

- el cortador de queso con la hoja
- ventaja: en comparación con los aparatos corrientes, que trabajan con alambre, el Fromarex puede cortar con UV hoja también embutidos duros, queso de parmesano, jamón, pimientos, pepinos, rábanos, lechuga iceberg, etc
- con escala para ajustar el grueso de corte

230 x 228 x 53 mm

Art.-Nr. / Art.-No.	VE / SU	EAN
7000 2260	3	4 004094 700064



7100 2270  
139 x 109 x 10 mm

**Käseschneider »Rollschnitt«**

- für alle gängigen Schnittkäse
- Scheibendicke variabel je nach Schrägstellung des Schneiders

**Cheese slicer »Rollschnitt«**

- for semi-hard cheeses
- thickness of slices varies with the angle at which the slicer is held

**Coupe-fromage »Rollschnitt«**

- pour les fromages à pâte demi-dure courants
- l'épaisseur des tranches peut être modifiée en fonction de l'inclinaison de l'outil

**Cortador de queso »Rollschnitt«**

- para todos los quesos de corte corrientes
- el grueso de las lonchas se varia por inclinación del partidor



7110 2260  
163 x 120 x 17 mm

**Käseschneider »Rollschnitt-Spezial«**

- Schneiddraht auswechselbar
- 2 zusätzliche Drähte im Lieferumfang enthalten

**Cheese slicer »Rollschnitt-Spezial«**

- wire can be exchanged
- 2 spare wires included

**Coupe-fromage »Rollschnitt-Spezial«**

- fil tranchant peut être changé
- 2 fils supplémentaires fournis

**Cortador de queso »Rollschnitt-Spezial«**

- la posibilidad de cambiar l'alambre de cortar
- 2 alambres adicionales incluidos en el suministro

Art.-Nr. / Art.-No.	VE / SU	EAN
7100 2270	5	4 004094 710070
7100 2611	1	4 051734 710013
7110 2260	5	4 004094 711060



210 x 74 x 33 mm

**Käsehobel »Gentle«**

- mit geschärfter Schneide

**Cheese slicer »Gentle«**

- with sharpened blade

**Coupe-fromage »Gentle«**

- avec coupe affûté

**Tajador de queso »Gentle«**

- con filo afilado

Art.-Nr. / Art.-No.	VE / SU	EAN
2826 2270	6	4 004094 282676



245 x 74 x 30 mm

**Käsehobel »Gallant«**

- sehr stabile Ausführung
- speziell geschärfte Schneide
- Komfort-Soft-Touch-Griff

**Cheese slicer »Gallant«**

- very solid design
- specially sharpened blade
- comfort-soft-touch handle

**Coupe-fromage »Gallant«**

- version très solide
- avec coupe spécialement affûté
- poignée confort-soft-touch

**Tajador de queso »Gallant«**

- version muy solida
- con filo afilado especialmente
- con mango cómodo soft-touch

Art.-Nr. / Art.-No.	VE / SU	EAN
2926 2270	6	4 004094 292675







### Eierteiler »Duplex«

- schneidet runde oder ovale Scheiben
- nach oben gebogener Griff für leichtes Handling
- sehr langlebig durch einzeln gespannte Schneiddrähte

### Egg slicer »Duplex«

- for round and oval slices
- bent up handle provides easy grip
- especially long lasting due to individually mounted wires

Art-Nr. / Art.-No.	VE / SU	EAN
1020 2260 	5	4 004094 102066 



### Coupe-œuf »Duplex«

- coupe des tranches rondes ou ovales
- poignée courbée vers le haut pour un maniement facile
- très durable grâce aux fils de coupe tendus séparément

### Cortahuevos »Duplex«

- corta rodajas redondas u ovaladas
- mango curvado para un manejo sencillo
- muy larga duración gracias a los alambres de corte tendidos individualmente



135 x 79 x 29 mm

### Eierteiler »Maximus«

- wie Duplex
- sehr gut zu fassender Griff ermöglicht schnelles Arbeiten
- besonders für den Einsatz in der Profi-Küche zu empfehlen

### Egg slicer »Maximus«

- like Duplex
- very easy to hold handle enables quick action
- especially recommended for being used in professional kitchens

Art-Nr. / Art.-No.	VE / SU	EAN
1042 2260 	5	4 004094 104268 



### Coupe-œuf »Maximus«

- comme Duplex
- la poignée très facile à saisir permet une action rapide
- version recommandée pro pour la restauration

### Cortahuevos »Maximus«

- como Duplex
- gracias al mango de excelente agarre se puede trabajar rápidamente
- variante profesional para la gastronomía



160 x 90 x 41 mm

### Kombi-Eierteiler

- Eierteiler und Eierstückler aus höchst strapazierfähigem Kunststoff
- 2 Bügel ermöglichen beide Funktionen in einem Gerät

### Combined egg slicer

- egg slicer and wedger from highly durable plastics
- 2 frames provide two functions in one tool

Art-Nr. / Art.-No.	VE / SU	EAN
1075 2260 	5	4 004094 107566 



### Coupe-œuf combiné

- coupe-œuf et trancheur en plastique extrêmement résistants
- 2 cadres pour deux fonctions

### Cortahuevos combinado

- cortahuevos y troceador de plástico extra resistente
- gracias a los 2 marcos se consiguen dos funciones en el mismo utensilio





139 x 85 x 40 mm

### Eierteiler »Famos«

- Design mit zwei vorgegebenen Griffpunkten gewährleistet optimale Handhabung

### Egg slicer »Famos«

- design with two molded holding points for optimal operation

Art-Nr. / Art.-No.	VE / SU	EAN
1168 2270 	5	4 004094 116872 



### Coupe-œuf »Famos«

- le design avec deux points de préhension prédéterminés permet un parfait maniement

### Cortahuevos »Famos«

- el diseño con dos puntos de agarre predeterminados garantizan un manejo óptimo



179 x 86 x 35 mm

### Eierteiler »Traditionell«

- funktionales Basismodell

### Egg slicer »Traditionell«

- economy model

Art-Nr. / Art.-No.	VE / SU	EAN
1166 2250 	50	

Art-Nr. / Art.-No.	VE / SU	EAN
1166 2270 	5	4 004094 116674 



### Coupe-œuf »Traditionell«

- modèle d'entrée fonctionnel

### Cortahuevos »Traditionell«

- modelo funcional para principiantes



139 x 82 x 31 mm





**Eierstückler »Columbus«**  
 • das Original aus Alu  
 • teilt hartgekochte Eier mit einem Druck in 6 gleiche Teile

**Egg cutter »Columbus«**  
 • the original from aluminium  
 • divides hard boiled eggs into 6 equal segments in one action

**Coupe-œuf dur »Columbus«**  
 • l'original en alu  
 • coupe en une pression les œufs durs en 6 parties égales

**Troceador de huevos »Columbus«**  
 • el original de aluminio  
 • con un solo apriete parte huevos duros en 6 partes iguales

181 x 64 x 26 mm

Art-Nr. / Art.-No.	VE / SU	EAN
1060 2260 	5	4 004094 106064 





**Butterteiler »Portionetto«**  
 • teilt ein Stück Butter mit einem Druck in gleichmäßige Scheiben  
 • Tipp: Butter an die Tischkante legen, Portionetto mit der flachen Seite ansetzen und mit gleichmäßigem Druck schneiden

**Butter portioner »Portionetto«**  
 • divides a piece of butter into equal slices  
 • tip: Put the butter on the edge of the worktop, put the Portionetto with the flat surface on top and slowly slide through the butter with constant pressure

**Coupe-beurre »Portionetto«**  
 • coupe en une pression un morceau de beurre en tranches uniformes  
 • conseil: placer le beurre au bord du plan de travail, mettre le Portionetto sur la surface plate et couper avec une pression uniforme

**Porcionador de mantequilla »Portionetto«**  
 • con un solo apriete, parte un trozo de mantequilla en lonchas uniformes  
 • consejo: colocar la mantequilla en el borde de la mesa, con el lado plano aplicar el Portionetto y partir con un apriete homogéneo

258 x 115 x 13 mm

Art-Nr. / Art.-No.	VE / SU	EAN
3200 2260 	5	4 004094 320064 





**Pellkartoffel-/Mozzarella-Schneider »Rondex«**  
 • schneidet gekochte Kartoffeln oder Mozzarella schnell in Scheiben  
 • Tipp: Der Profi hält das Gerät leicht schräg und drückt die gekochte Kartoffel mit der flachen Hand durch die Schneiddrähte

**Jacket potato and mozzarella slicer »Rondex«**  
 • cuts boiled potatoes or mozzarella easily into evenly thick slices  
 • tip: the professional user holds the tool in a slightly slanted angle and presses the boiled potato with the flat hand through the cutting wires

**Coupe-pommes de terre et mozzarella »Rondex«**  
 • coupe les pommes de terre cuites en tranches  
 • conseil: le pro maintient l'outil dans un angle légèrement incliné et presse la pomme de terre cuite avec le plat de la main à travers les fils de coupe

**Cortador de patatas cocidas / mozzarella »Rondex«**  
 • corta rápidamente en rodajas patatas cocidas  
 • Consejo: el experto mantiene el utensilio ligeramente inclinado y presiona la patata cocida con la palma de la mano por los alambres cortantes

258 x 114 x 12 mm

Art-Nr. / Art.-No.	VE / SU	EAN
6080 2260 	5	4 004094 608063 





**Mozzellaschneider**  
 • für Mozzarella, Champignons, Erdbeeren, Kiwis etc.

**Mozzarella slicer**  
 • for mozzarella, mushrooms, strawberry, kiwi, etc.

**Coupe-mozzarella**  
 • pour mozzarella, champignons, fraises, kiwis etc.

**Cortador de mozzarella**  
 • para mozzarella, champiñones, fresas, kiwis, etc.

170 x 130 x 31 mm

Art-Nr. / Art.-No.	VE / SU	EAN
1164 2260 	6	4 004094 116469 





- Tomatenzange »Tomatex«**
- auch für Zwiebeln, Zitronen etc.
  - hilft gleichmäßige Scheiben zu schneiden

- Pince à tomates »Tomatex«**
- également pour les oignons, les citrons etc.
  - aide à couper des tranches uniformes

- Slicing aid »Tomatex«**
- also for onions, citrus fruit etc.
  - helps to cut very even slices

- Pinzas para cortar tomates »Tomatex«**
- también para cebollas, limones, etc.
  - ayuda a cortar uniformemente rodajas



185 x 85 x 47 mm

Art-Nr. / Art.-No.	VE / SU	EAN
5140 2260 	3	4 004094 514067



- Vielweckschneider »Champion«**
- ideal für Pilze, Erdbeeren, Kiwis etc.
  - sieben Klingen schneiden gleichmäßig in Scheiben



- Coupeur multi-usages »Champion«**
- idéal pour les champignons, les fraises, les kiwis etc.
  - les sept lames coupent des tranches uniformes

- Multi purpose slicer »Champion«**
- ideal for mushrooms, strawberries, kiwi fruit etc.
  - seven blades cut fast and evenly in slices

- Cortador multiuso »Champion«**
- ideal para setas, fresas, kiwis, etc.
  - siete hojas cortan uniformemente rodajas



195 x 72 x 29 mm

Art-Nr. / Art.-No.	VE / SU	EAN
5170 2260 	5	4 004094 517068
5170 2660 	1	4 051734 001722



- Pilz- und Gemüse-Reinigungsbürste »Champy«**
- mit abgerundeten Spezialborsten für schonendes und gründliches Reinigen
  - dichtes Bürstenbild
  - aus hygienischem Kunststoff - gut zu reinigen

- Brosse de nettoyage pour champignons et légumes »Champy«**
- avec des poils arrondis pour un nettoyage soigné et en profondeur
  - brosse compacte
  - en plastique hygiénique - facile à nettoyer

- Mushroom cleaning brush »Champy«**
- with round-tip bristles for careful and thorough cleaning
  - close bristle stand
  - from hygienic plastics - easy to clean

- Cepillo para limpiar setas y verduras »Champy«**
- con cerdas de puntas redondeadas para la limpieza cuidadosa y esmerada
  - cerdas dispuestas densamente
  - de plástico higiénico - fácil de limpiar



78 x 60 x 27 mm

Art-Nr. / Art.-No.	VE / SU	EAN
5180 2260 	5	4 004094 518065



- Kräuterschere mit Reinigungskämmchen**
- 5 Klingen aus geschliffenem Edelstahl schneiden schnell und exakt durch Kräuter aller Art
  - mit Reinigungskämmchen



- Ciseaux à herbes avec peigne de nettoyage**
- les 5 lames affûtées en acier inoxydable coupent rapidement et précisément tous les types d'herbes
  - avec peigne de nettoyage

- Herb scissors with cleaning comb**
- 5 blades from ground stainless steel cut thoroughly through herbs of all kind
  - with cleaning comb

- Tijeras para hierbas con peine limpiador**
- 5 hojas de acero inoxidable afilado pican las hierbas de todo tipo rápida y exactamente
  - con peine limpiador



200 x 76 x 19 mm

Art-Nr. / Art.-No.	VE / SU	EAN
1175 2280 	6	4 004094 117589
1175 2611 	1	4 004094 117565



- Kräuterschere »Herby«**
- Abstreifkerben erleichtern das Abziehen von Kräuterblättchen vom Stiel
  - zur gründlichen Reinigung kann die Schere in zwei Teile zerlegt werden



- Ciseaux à herbes aromatiques »Herby«**
- l'encoche facilite le détachement des feuilles de la tige
  - pour les nettoyer soigneusement, les ciseaux peuvent être démonté en deux parties

- Herb scissors »Herby«**
- stripping notches enable easy removal of herb leaves from their stems
  - scissors can be dismantled into two parts for cleaning

- Tijeras para las hierbas »Herby«**
- gracias a las hendiduras se retira más fácilmente el tallo de las hojas
  - para el lavado las tijeras pueden desmontarse en dos piezas



193 x 95 x 13 mm

Art-Nr. / Art.-No.	VE / SU	EAN
1178 2280 	6	4 004094 117886
1178 2680 	1	





207 x 83 x 15 mm

**Universelle Haushaltsschere**

- angenehm große Griffe ermöglichen sichere Schnittführung
- mit gezahntem Öffnungselement für Tuben und Drehverschlüsse

*All purpose household scissors*

- comfortable, easy to hold handles enable secure handling
- with serrated opening element for screw caps

**Ciseaux ménagers universels**

- les deux grandes poignées agréables assurent une bonne stabilité de coupe
- avec élément d'ouverture denté pour les tubes ou les fermetures tournantes

*Tijeras universales para el hogar*

- con los mangos confortables se logra un manejo seguro
- con el elemento dentado para abrir tubos o cierres de bayoneta

Art.-Nr. / Art.-No.	VE / SU	EAN
1375 2280	6	4 004094 137587



230 x 69 x 58 mm

**Salatschere**

- die Salatschere zerteilt Tomaten, Salat, Gurken etc. direkt über oder in der Salatschüssel

*Salad scissors*

- the salad scissors cut tomatoes, lettuce, cucumbers etc. directly over or in the bowl

**Ciseaux à salade**

- les ciseaux coupent les tomates, la salade, les concombres etc. directement sur ou dans le saladier

*Tijeras para hierbas*

- las tijeras pican los tomates, la ensalada, el pepino etc.

Art.-Nr. / Art.-No.	VE / SU	EAN
2094 2270	3	4 004094 209475
2094 2611	1	4 051734 001777



291 x 63 x 12 mm

**Salatmesser**

- um braune Anschnitte am Salat zu vermeiden
- auch ideal, um z.B. Kuchen auf beschichteten Backblechen zu schneiden
- Klinge: 185 mm

*Salad knife*

- in order to prevent brown cutting edges on lettuce
- also ideal for cutting pastry on coated baking dishes
- blade: 185 mm

**Couteau à salade**

- pour éviter les entailles brunes sur la salade
- également idéal pour couper par ex. des gâteaux sur les plaques de cuisson
- lame: 185 mm

*Cuchillo para ensaladas*

- para evitar bordes pardos de la ensalada
- también ideal para cortar, p.ej., pasteles en bandejas antiadhesivas
- hoja: 185 mm

Art.-Nr. / Art.-No.	VE / SU	EAN
2093 2270	6	4 004094 209376



170 x 126 x 38 mm

**Wiegemesser »Uno«, 1 Klinge**

- der ideale Helfer, um schnell Kräuter, Knoblauch oder Zwiebeln zu zerkleinern
- rund-geformte Kunststoffgriffe sorgen für sichere Handhabung

*Mincing knife »Uno«, 1 knife*

- the ideal helper when it comes to chopping garlic, herbs or onions
- round-shaped handles ensure a secure grip

**Couteau hachoir »Uno«, 1 lame**

- l'assistant idéal pour émincer rapidement les herbes, l'ail ou les oignons
- les poignées arrondies en plastique assurent un maniement sûr

*Tajadera »Uno«, 1 cuchilla*

- el ayudante ideal para picar rápidamente hierbas, ajo o cebollas
- con los mangos de plástico de forma redonda se consigue un manejo seguro

Art.-Nr. / Art.-No.	VE / SU	EAN
1293 2270	4	4 004094 129377



170 x 126 x 38 mm

**Wiegemesser »Due«, 2 Klingen**

- der ideale Helfer, um schnell Kräuter, Knoblauch oder Zwiebeln zu zerkleinern
- rund-geformte Kunststoffgriffe sorgen für eine sichere Handhabung

*Mincing knife »Due«, 2 knives*

- the ideal helper when it comes to chopping garlic, herbs or onions
- round-shaped handles ensure a secure grip

**Couteau hachoir »Due«, 2 lames**

- l'assistant idéal pour émincer rapidement les herbes, l'ail ou les oignons
- les poignées en plastique assurent un maniement sûr

*Tajadera »Due«, 2 hojas*

- el ayudante ideal para picar rápidamente hierbas, ajo o cebollas
- con los mangos de plástico se consigue un manejo seguro

Art.-Nr. / Art.-No.	VE / SU	EAN
1294 2270	4	4 004094 129476





### Pizzarad »Easy«

- das Kunststoffrad schneidet Pizzen auf beschichteten Backblechen, ohne dass die empfindliche Blechoberfläche zerkratzt wird

### Pizza wheel »Easy«

- the plastic wheel cuts pizza on coated baking trays without scratching the delicate surface

### Roulette à pizza »Easy«

- la roulette en plastique coupe les pizzas sur les plaques de cuisson sans rayer la surface sensible

### Rueda cortadora de pizzas »Easy«

- con la rueda de plástico se cortan las pizzas sobre bandejas antiadhesivas sin arañar la sensible superficie de chapa



159 x 100 x 23 mm

Art-Nr. / Art.-No.	VE / SU	EAN
1327 2270	6	4 004094 132773



### Pizzaschneider »Gentle«

- mit geschärftem Schneidrad - ø 69 mm
- ergonomisch geformter Fingerschutz

### Pizza cutter »Gentle«

- with sharpened cutting wheel - ø 69 mm
- ergonomically shaped finger protection element

### Coupe-pizza »Gentle«

- avec roulette affûtée - ø 69 mm
- avec protège-doigts en forme ergonomique

### Cortador de pizzas »Gentle«

- con la rueda afilada - ø 69 mm
- con protección para los dedos ergonómica



212 x 76 x 20 mm

Art-Nr. / Art.-No.	VE / SU	EAN
2828 2270	6	4 004094 282874



Made in GERMANY

### Pizzaschneider »Gallant«

- mit extra-großem Schneidrad - ø 76 mm
- speziell geschärft
- sehr solider, ergonomisch geformter Fingerschutz
- Komfort-Soft-Touch-Griff

### Pizza cutter »Gallant«

- with extra large cutting wheel - ø 76 mm
- specially sharpened
- very solid - ergonomically shaped - finger protection element
- comfort-soft-touch handle

### Coupe-pizza »Gallant«

- avec roulette extra grande - ø 76 mm
- spécialement affûtée
- avec protège-doigts en forme ergonomique et très solide
- poignée confort-soft-touch

### Cortador de pizzas »Gallant«

- con la rueda extra grande - ø 76 mm
- especialmente afilada
- con protección para los dedos muy sólida y ergonómica
- con mango cómodo soft-touch



205 x 81 x 20 mm

Art-Nr. / Art.-No.	VE / SU	EAN
29282270	6	4 004094 292873



Made in GERMANY

### Frühstücksmesser

- mit Wellenschliffklinge (Klinge 100mm)

### Breakfast knife

- with serrated blade (blade length: 100 mm)

### Couteau petit-déjeuner

- avec lame dentelée (lame: 100 mm)

### Cuchillo para desayuno

- con hoja de afilado ondulado (hoja: 100 mm)



220 x 33 x 16 mm

Art-Nr. / Art.-No.	VE / SU	EAN
1359 2260	6	4 004094 135965



Bitte beachten Sie auch:  
Monopol Vespermesser  
Seite 233

Please see as well:  
Monopol Universal knife  
page 233



156 x 20 x 8 mm

**Küchenmesser »Techno«**  
 • erhältlich lose, unverpackt (1351 2210) oder als Set mit 2 Messern (1351 2280)  
 • Klingenlänge: ca. 65 mm

**Kitchen knife »Techno«**  
 • available as single item, bulk (1351 2210) or as set of 2 knives (1351 2280)  
 • blade length: ca. 65 mm

**Couteau de cuisine »Techno«**  
 • disponible individuellement en vrac (1351 2210) ou comme ensemble de 2 couteaux (1351 2280)  
 • longueur de lame: ca. 65 mm

**Cuchillos de cocina »Techno«**  
 • disponible como cuchillo individual, suelto (1351 2210) o como set con 2 cuchillos (1351 2280)  
 • longitud de la hoja: ca. 65 mm

Art-Nr. / Art.-No.	VE / SU	EAN
1351 2210	50	
1351 2280	10	



**Messer-Serie »Domesticus«**  
 • Küchenmesser  
 • mit gut geformten Griffen für sichere Handhabung  
 • solide Klengen aus Solingen

**Knife series »Domesticus«**  
 • kitchen knife  
 • with well shaped handles for secure grip  
 • solid blades from Solingen

**Série de couteaux »Domesticus«**  
 • couteau de cuisine  
 • avec manches de belle forme pour un maniement sûr  
 • lames solides de Solingen

**Serie de cuchillos »Domesticus«**  
 • buen cuchillo para la cocina  
 • con mangos bien moldeados para un manejo seguro  
 • hojas sólidas de Solingen

**Gemüsemesser »Domesticus«, gerade**  
 • Klingenlänge: 75 mm

**Couteau à légumes »Domesticus«, droit**  
 • longueur de lame: 75 mm



177 x 20 x 8 mm

**Vegetable knife »Domesticus«, straight**  
 • blade length: 75 mm

**Cuchillo para verduras »Domesticus«, recto**  
 • longitud de la hoja: 75 mm

Art-Nr. / Art.-No.	VE / SU	EAN
1352 2270	10	



**Gemüsemesser »Domesticus«, gebogen**  
 • Klingenlänge: 60 mm

**Couteau à légumes »Domesticus«, courbé**  
 • longueur de lame: 60 mm



159 x 22 x 11 mm

**Vegetable knife »Domesticus«, straight**  
 • blade length: 60 mm

**Cuchillo para verduras »Domesticus«, curvado**  
 • longitud de la hoja: 60 mm

Art-Nr. / Art.-No.	VE / SU	EAN
1353 2270	10	



**Fleischmesser »Domesticus«**  
 • Klingenlänge: 180 mm

**Couteau à viande »Domesticus«**  
 • longueur de lame: 180 mm



317 x 28 x 18 mm

**Meat knife »Domesticus«**  
 • blade length: 180 mm

**Cuchillo para carne »Domesticus«**  
 • longitud de la hoja: 180 mm

Art-Nr. / Art.-No.	VE / SU	EAN
1354 2270	5	



**Brotmesser »Domesticus«**  
 • Klingenlänge: 185 mm

**Couteau à pain »Domesticus«**  
 • longueur de lame: 185 mm



303 x 28 x 18 mm

**Bread knife »Domesticus«**  
 • blade length: 185 mm

**Cuchillo para pan »Domesticus«**  
 • longitud de la hoja: 185 mm

Art-Nr. / Art.-No.	VE / SU	EAN
1355 2270	5	





**Messer**

- mit Klingenschutz
- mit antihafbeschichteter Klinge
- dank des Klingenschutzes ist die Schneide in der Schublade vor Beschädigungen geschützt
- ergonomisch geformter und rutschfester Griff

**Knife**

- with blade protection
- with non-stick blade
- blade is protected against damage in drawer thanks to blade protection
- ergonomically shaped and non-slip handle

**Couteau**

- avec protection de lame
- avec lame anti-adhésive
- grâce à la protection de lame, celle-ci est protégée des dommages dans le tiroir
- manche de forme ergonomique et antidérapant

**Cuchillo**

- con protección de la hoja
- hoja con revestimiento antiadherente
- gracias a la protección de la hoja, esta no puede dañarse en el cajón
- mango de forma ergonómica, antiresbalante

**Schälmesser**

- Klingenlänge: 80 mm

**Peeling knife**

- blade length: 80 mm

**Couteau à peler**

- longueur de lame: 80 mm

**Cuchillo para peler**

- longitud de la hoja: 80 mm

Art-Nr. / Art.-No.	VE / SU	EAN
1452 2280	6	4 004094 145285



204 x 30 x 17 mm

**Allzweckmesser**

- Klingenlänge: 120 mm

**Multi-purpose knife**

- blade length: 120mm

**Couteau multi-usages**

- longueur de lame: 120 mm

**Cuchillo multiuso**

- longitud de la hoja: 120 mm

Art-Nr. / Art.-No.	VE / SU	EAN
1453 2280	6	4 004094 145384



235 x 30 x 17 mm

**Chefmesser**

- Klingenlänge: 200 mm

**Kitchen knife**

- blade length: 200 mm

**Couteau de chef**

- longueur de lame: 200 mm

**Cuchillo chef**

- longitud de la hoja: 200 mm

Art-Nr. / Art.-No.	VE / SU	EAN
1454 2280	6	4 004094 145483



330 x 51 x 20 mm

**Brotmesser**

- Klingenlänge: 200 mm

**Bread knife**

- blade length: 200 mm

**Couteau à pain**

- longueur de lame: 200 mm

**Cuchillo para pan**

- longitud de la hoja: 200 mm

Art-Nr. / Art.-No.	VE / SU	EAN
1455 2280	6	4 004094 145582



327 x 36 x 20 mm

**Santokumesser**

- Klingenlänge: 170 mm

**Santoku knife**

- blade length: 170 mm

**Couteau Santoku**

- longueur de lame: 170 mm

**Cuchillo Santoku**

- longitud de la hoja: 170 mm

Art-Nr. / Art.-No.	VE / SU	EAN
1456 2280	6	4 004094 145681



300 x 53 x 20 mm

schälen, schneiden & teilen • peeling, dividing & cutting • éplucher, couper & diviser • pelar, cortar & partir



110 x 110 x 222 mm

- Messerblock**
- mit Kunststoffborsten (PET)
  - der Einsatz ist herausnehmbar und kann abgespült oder in die Spülmaschine gegeben werden
  - maximale Klinglänge 8" = ca. 20,3 cm

- Bloc porte-couteaux**
- bloc porte-couteaux universel à poils en matière plastique (en PET)
  - l'insert peut être retiré et rincé ou va au lave-vaisselle
  - longueur de lame maximale: 8" = env. 20,3 cm

- Knife block**
- with hygienic plastic bristles (PET) blade
  - the insert is removable and can be rinsed or even placed in the dishwasher
  - maximum blade length: 8" = 20.3 cm

- Bloque para cuchillos**
- bloque para cuchillos universal con cerdas de material sintético (PET)
  - la pieza insertada puede extraerse y enjuagarse incluso lavarse en el lavavajillas
  - largo máximo de cuchillo: 8" = aprox. 20,3cm



Art-Nr. / Art.-No.	VE / SU	EAN
1450 2260 	2	 4 004094 145063

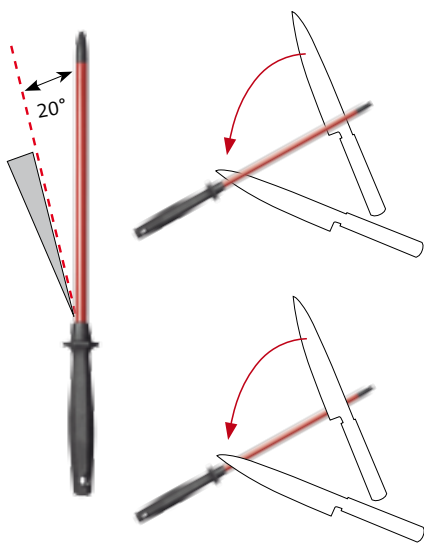

- Wetzstab »Sieger-Long-Life« aus Sinterrubin**
- der Sieger-Longlife besteht aus Keramik. Einem dichtgesinternten, bindemittelfreiem Material, das aufgrund seiner Kristallstruktur folgende Eigenschaften besitzt:
  - ausgezeichnete Oberflächengüte
  - beste Profil- und Kantenbeständigkeit
  - beste Abnutzungsresistenz
  - äußerst hohe Härte (fast diamanthart)
  - scharfes, schartenfreies Schlibfbild

- Fusil à aiguiser »Sieger-Long-Life« en rubis fritté**
- le Sieger-Longlife est en céramique. Une matière densément frittée et sans liant, qui en raison de sa structure cristalline, possède les propriétés suivantes:
  - remarquable finition de surface
  - excellente stabilité des profils et des bords
  - grande résistance à l'usure
  - extrême dureté (presque celle du diamant)

- Knife sharpener »Sieger-Long-Life« from sintered ruby**
- the Sieger-Long Life is made from ceramics. A densely sintered material without any binder, which contains the following properties due to the crystalline structure:
  - outstanding surface finish
  - excellent stability of profiles and edges
  - great wear resistance
  - extreme hardness (almost diamond-hard)
  - sharp, even grinding pattern

- Afilador de cuchillos »Sieger-Long-Life« de rubí sinterizado**
- el Sieger-Longlife está hecho de cerámica. Un material sinterizado densamente sin ligante, que tiene las características siguientes, debido a UV estructura cristalina:
  - calidad extraordinaria de la superficie
  - máxima resistencia del perfil y de los cantos
  - excelente resistencia al desgaste
  - dureza extrema (casi duro como el diamante)
  - micrografía nítida, sin mellas

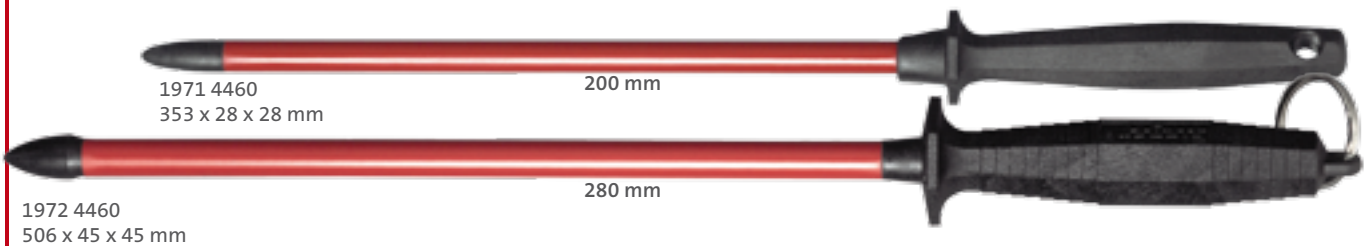





1971 4460  
353 x 28 x 28 mm

200 mm

1972 4460  
506 x 45 x 45 mm

280 mm

Art-Nr. / Art.-No.	VE / SU	EAN
1971 4460 	1	 4 004094 197161
1972 4460 	1	 4 004094 197260



Made in GERMANY 



- Schleifstein**
- Kombi-Schleifstein aus Korund
  - für Reparatur- und Grundschliff
  - mit rutschfester Ablage aus Silikon
  - Körnung: 400 (rot) Reparaturschliff / 1000 (blau) Grundschliff

**Sharpening stone**

- combined sharpening stone from corundum
- for repair and basic sharpening
- with anti-slip tray from silicone
- grain: 400 (red) repair sharpening / 1000 (blue) basic sharpening

Art-Nr. / Art.-No.	VE / SU	EAN
1015 2260 	4	4 004094 101564 



- Pierre à affûter**
- pierre à affûter combinée de corindon
  - pour l'affûtage de base et de réparation
  - avec support antidérapant de silicone
  - grain: 400 (rouge) /1000 (bleu)

**Piedra de amolar**

- piedra de amolar combinada de corindón
- para el afilado de reparación y básico
- con base de goma contra el resbalamiento
- granulación: 400 (rojo) y 1.000 (azul)



185 x 67 x 31 mm

- Messer- und Scherenschärfer**
- für gewöhnliche Klingen mit Glattschliff
  - sicherer Halt durch speziell geformten Griff

**Knife- and scissors sharpener**



- for usual straight edge blades
- secure hold due to specially shaped handle

- Aiguiseur de couteaux et de ciseaux**
- pour lames ordinaires à tranchant lisse
  - maintien sûr grâce au manche de forme spéciale

**Afilador de cuchillos y tijeras**

- para hojas corrientes con afilado liso
- apoyo seguro gracias al mango de moldeo especial



Art-Nr. / Art.-No.	VE / SU	EAN
1021 2270 	5	4 004094 102172 



183 x 29 x 49 mm

- Messerschärfer »Deluxe«**
- in 3 Stufen zu wieder scharfen Klingen
  - mit ergonomischem Griff und Antirutsch-Gummierung für sicheren Halt

**Knife sharpener »Deluxe«**

- just 3 steps to sharp blades
- with ergonomic handle and non-slip rubber pads for control

- Aiguiseur de couteaux »Deluxe«**
- des lames plus aiguisées en 3 étapes
  - avec une poignée ergonomique et un revêtement antidérapant pour une excellente prise en main

**Afilador de cuchillos »Deluxe«**

- hojas afiladas de nuevo en 3 pasos
- con mango ergonómico y goma antideslizante para una sujeción segura



200 x 46 x 72 mm

Art-Nr. / Art.-No.	VE / SU	EAN
1017 2260 	4	4 004094 101762 



- Ceranfeld-/Reinigungsschaber**
- mit einer Reinigungsklinge
  - mit Klingenschutz und Verriegelungsklammer
- Cleaning scraper**
- with one cleaning blade
  - with blade cover and locking device

**Ersatzklingen für Reinigungsschaber**





- 5 Klingen
- Spare blades for cleaning scraper
- 5 blades

- Racleur pour plaques vitrocéramiques/de nettoyage**
- avec une lame de nettoyage
  - avec couverture de lame et dispositif de verrouillage
- Rascador para vitrocerámica / de limpieza**
- con una hoja limpiadora
  - con función de protección

**Lames de rechange pour racleur de nettoyage**

- 5 lames
- Hojas de recambio por el rascador de limpieza
- 5 hojas

1084 2280

Art-Nr. / Art.-No.	VE / SU	Größe / Size	EAN
1084 2280 	5	138 x 46 x 16 mm	4 004094 108488 
1085 2280 	5	46 x 25 x 0,3 mm	4 004094 108587 



1085 2280





380 x 305 x 1 mm

- Flexible Schneidmatten**
- Set mit 2 flexiblen Schneidmatten
  - schnittfeste Oberfläche
  - mit rutschfester Unterseite

- Cutting mats**
- set of 2 flexible cutting boards
  - cut resistant surface
  - with non-slip underside

- Tapis de coupe flexibles**
- ensemble de 2 tapis de coupe flexibles
  - surface résistant aux coupures
  - avec dessous antidérapant

- Esterillas flexibles de corte**
- set de 2 esterillas flexibles de corte
  - superficie resistente al corte
  - lado inferior antiresbalante

Art-Nr. / Art.-No.	VE / SU	EAN
1177 2250 	6	 4 004094 117756



- Schneidbrett**
- praktisch mit umlaufender Saftrille
  - die roten Randelemente sind aus rutschfestem Material, an den Enden verstärkt
  - liegt sicher auf der Arbeitsfläche auf
  - hygienisch
  - leicht zu reinigen
  - schont die Klengen







- Cutting board**
- with circumferential groove to catch the juice
  - red elements are from anti-slip material, strengthened at the ends
  - hygienical
  - easy to clean
  - protects blades

- Planche à découper**
- pratique avec rainure circéférentielle pour capter le jus
  - les bordures rouges sont en matière antidérapante, renforcées aux extrémités
  - parfait maintien sur le plan de travail
  - hygiénique
  - facile à nettoyer
  - ménage les lames

- Tabla de corte**
- práctica con ranura circunferencial para recoger el jugo
  - los elementos marginales rojos son de material antiresbalante y están reforzados mañosamente en sus extremos
  - se apoya de un modo seguro sobre la encimera
  - higiénica
  - fácil de limpiar
  - protege las hojas



**in 3 Größen erhältlich!  
available in 3 sizes!**

Art-Nr. / Art.-No.	VE / SU	Größe / Size	EAN
6215 224G 	4	300 x 210 x 14 mm	 4 004094 000638
6216 224G 	4	370 x 255 x 14 mm	 4 004094 000645
6217 224G 	4	430 x 305 x 14 mm	 4 004094 000652



- Allerschneider »Traditionell«**
- mit starkem Saugfuß
  - mit geschliffenem Rundmesser aus Edelstahl
  - Schlitten und Resthalter für sicheres Arbeiten
  - platzsparend zusammenklappbar

- Universal slicer »Traditionell«**
- with strong suction pad
  - with sharpened stainless steel circular blade
  - sliding unit and hand guard for secure work
  - space-saving fold away design

- Coupeur universel »Traditionell«**
- avec fort pied-ventouse
  - avec lame circulaire affûtée en acier inox
  - unité coulissante et pousse-restes pour un travail sûr
  - design compact pliant

- Cortador universal »Traditionell«**
- con potente pata de succión
  - con cuchilla redonda afilada de acero inox
  - patín y sujetador de alimentos para un trabajo seguro
  - plegable

Art-Nr. / Art.-No.	VE / SU	EAN
9700 2260 	1	 4 004094 970061





# 02

**garnieren, dekorieren • *garnishing & decorating*  
décorer et garnir • *guarnición y decoración***



02

garnieren, dekorieren • *garnishing & decorating* • décorer et garnir • *guarnición y decoración*



150 x 38 x 20 mm

**Mehrzweckgarnierer »Decorex-Spezial«**  
 • zum Formen von Streifen, Würfeln, Kugeln aus Butter, Käse, Früchten etc. für dekorative Butterröllchen  
 • Dorn zum Dosenlochen

**Multi-purpose garnishing tool »Decorex-Spezial«**  
 • for forming stripes, cubes, stripes, curls from butter, cheese, fruit etc.  
 • with spike - as can punch

**Outil de décoration multi-usages »Decorex-Spezial«**  
 • outils de cuisine multi-usages pour former des bandes, des dés, des billes de beurre, de fromage, de fruits etc.  
 • avec perce-boite

**Guarnecedor multiuso »Decorex-Spezial«**  
 • para moldear tiras, cubos, bolas de mantequilla, queso, frutas etc.,  
 • púa para perforar latas

Art-Nr. / Art.-No.	VE / SU	EAN
3110 2270	10	4 004094 311079



215 x 68 x 52 mm

**Buntschneider »Garnetta«**  
 • Spezialklinge für besonders ausgeprägten Wellenschliff  
 • schneidet Käse, Gemüse, Obst etc.

**Crinkle cutter »Garnetta«**  
 • special blade for pronounced crinkle cut  
 • cuts cheese, vegetables, fruit etc.

**Couteau à lame ondulée »Garnetta«**  
 • lame spéciale pour une coupe particulièrement ondulée  
 • coupe le fromage, les légumes, les fruits etc.

**Cuchilla de corte ondulado »Garnetta«**  
 • hoja especial para cortes ondulados pronunciados  
 • corta queso, verduras, frutas etc.

Art-Nr. / Art.-No.	VE / SU	EAN
3120 2260	5	4 004094 312069



181 x 52 x 32 mm

**Radieschenverzierer »Decoretto«**  
 • Radieschen einlegen und zudrücken - fertig ist das dekorative Röschen  
 • zusätzlicher ‚Zackenschneider‘ z.B. für Cocktail-Zitrushälften

**Radishrose cutter »Decoretto«**  
 • simply put the radish into the tongs and press - voilà: a nice radish rose appears  
 • extra: a zig-zag cutter clips triangles in orange and citrus fruit shells

**Coupe-radis »Decoretto«**  
 • il suffit de mettre le radis et de presser pour qu'une jolie rose en radis apparaisse  
 • avec coupeur à dents pour des triangles par ex. dans des moitiés de citron

**Decorador de rabanitos »Decoretto«**  
 • colocar el rabanito y prensar - en un instante se obtiene una rosita decorativa  
 • la punta delantera del Decoretto es un cortador zigzag, para cortar encajes en medias naranjas o limones

Art-Nr. / Art.-No.	VE / SU	EAN
5120 2260	5	4 004094 512063



243 x 30 x 15 mm

**Kartoffelspirale »Spiro«**  
 • für Kartoffeln und Gemüse  
 • als Spirale werden Kartoffeln, Möhren, Gurken etc. appetitlicher

**Potato spiral »Spiro«**  
 • for potatoes and vegetables  
 • potatoes, carrots, cucumbers etc. are even more appetizing in shape of a spiral

**Spirale à pommes de terre »Spiro«**  
 • pour pommes de terre et légumes  
 • en spirales, les pommes de terre, les carottes, les concombres etc. ont l'air encore plus appétissants

**Espiral para patatas »Spiro«**  
 • para patatas y verduras  
 • patatas, zanahorias, pepinos, etc. son mucho más apetitosos en forma de una espiral

Art-Nr. / Art.-No.	VE / SU	EAN
5122 2270	5	4 004094 512278



150 x 35 x 40 mm

**Deko-Hobel »Möhrfix«**  
 • ob Blume oder Tierkörper - der Möhrfix verwandelt Langgemüse in interessante Deko-Varianten

**Deco-grater »Möhrfix«**  
 • flower or body of an animal - the Möhrfix deco-grater turns long vegetables into nice decorations

**Eminceur déco »Möhrfix«**  
 • que se soit une fleur ou le corps d'un animal, le Möhrfix transforme les longs légumes en décorations

**Tajador decorador »Möhrfix«**  
 • si se trata de una flor o del cuerpo de un animal - el Möhrfix transforma la verdura larga en interesantes decoraciones

Art-Nr. / Art.-No.	VE / SU	EAN
5125 2270	6	4 004094 512575
5125 2610	1	4 051734 512518





- Gurkenverzierer »Dekofix«**
- sieben Klingen schneiden schnell und effizient
  - Gewürzgurken lassen sich mit einem Schnitt in einen dekorativen Fächer verwandeln

- Décorateur à cornichon »Dekofix«**
- les sept lames coupent rapidement et efficacement
  - les cornichons sont tranchés de façon décorative

- Gherkin decorator »Dekofix«**
- seven blades allow quick and efficient cutting
  - gherkins are sliced ready for fanning out decoratively with one simple cut

- Decorador para pepinos »Dekofix«**
- siete hojas cortan rápida y eficientemente
  - los pepinillos en vinagre pueden convertirse rápidamente en un abanico decorativo



163 x 29 x 17 mm

Art-Nr. / Art.-No.	VE / SU	EAN
5124 2260	6	4 004094 512469



- Rettichschneider »Radimax«**
- Spiralschneider für Rettich, Gurken, Zucchini, Möhren etc.
  - der extra-lange Zentrierstab ermöglicht einen sauberen, durchgehenden Spiralschnitt

- Coupe-radis »Radimax«**
- coupe en spirale les radis, les concombres, les courgettes, les carottes etc.
  - la tige extra-longue permet une coupe en spirale propre et continue

- Spiral cutter »Radimax«**
- for long radishes, cucumbers, carrots and other lengthy vegetables
  - the extra long central stem ensures a continuously clean cut

- Cortador de rábanos »Radimax«**
- cortador de espirales para rábanos, pepinos, zucchini etc.
  - gracias a la larga varilla de centraje se consigue un corte espiral continuo muy limpio



240 x 120 x 42 mm

Art-Nr. / Art.-No.	VE / SU	EAN
5130 2260	5	4 004094 513060

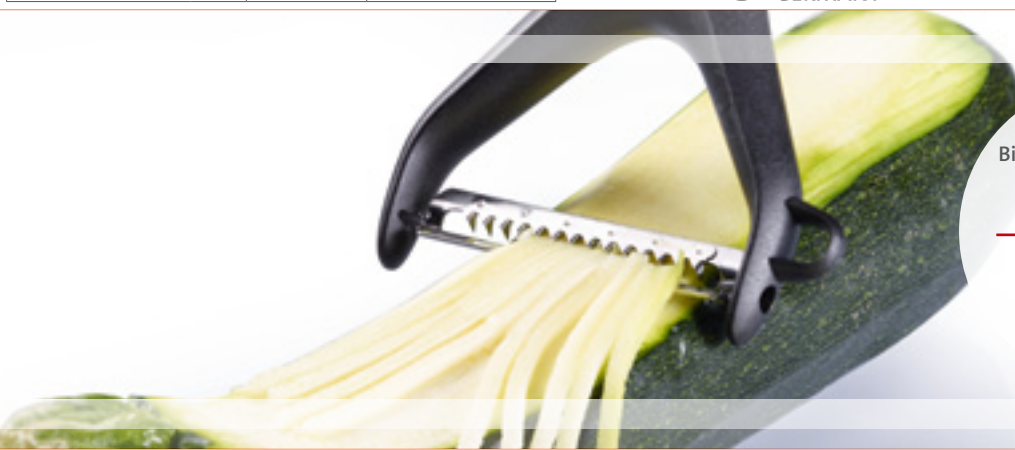

Bitte beachten Sie auch:  
Julieneschneider  
Seite 11

Please see as well:  
Julienne cutter  
page 11

- Aushöhlöffel/ Tomatenstrunkentferner »Gentle«**
- spitz gezackter Löffel
  - entfernt den Tomatenstrunk
  - auch ideal zum Aushöhlen von Gemüse oder Obst für anschließende Füllungen

- Evideur de tomates »Gentle«**
- évideur très denté
  - retir proprement le pédoncule de la tomate
  - aussi idéal pour vider légumes et fruits afin de les farcir

- Baller/ tomato corer »Gentle«**
- sharply serrated coring bowl
  - removes the tomato stem
  - also ideal for coring vegetables and fruits for subsequent fillings

- Sacapedúnculos de tomate »Gentle«**
- ahuecador dentado puntiagudo
  - quita el pedúnculo
  - anche ideal para ahuecar verduras y frutas para rellenos seguidamente

Art-Nr. / Art.-No.	VE / SU	Größe / Size	EAN
2820 2210	25	ø 21 mm	
2820 2270	6	ø 21 mm	4 004094 282072



166 x 27 x 20 mm

- Aushöhlöffel/ Tomatenstrunkentferner »Gallant«**
- spitz gezackter Löffel
  - entfernt den Tomatenstrunk
  - auch ideal zum Aushöhlen von Gemüse oder Obst für anschließende Füllungen
  - Komfort-Soft-Touch-Griff

- Evideur de tomates »Gallant«**
- videur très denté
  - retir proprement le pédoncule de la tomate
  - aussi idéal pour vider légumes et fruits afin de les farcir
  - poignée confort-soft-touch

- Baller/ tomato corer »Gallant«**
- sharply serrated coring bowl
  - removes the tomato stem
  - also ideal for coring vegetables and fruits for subsequent fillings
  - comfort-soft-touch handle

- Sacapedúnculos de tomate »Gallant«**
- ahuecador dentado puntiagudo
  - quita el pedúnculo
  - anche ideal para ahuecar verduras y frutas para rellenos seguidamente
  - con mango cómodo soft-touch

Art-Nr. / Art.-No.	VE / SU	Größe / Size	EAN
2920 2270	6	ø 21 mm	4 004094 292071



166 x 27 x 20 mm



173 x 27 x 20 mm





**Aushöhlhöffel »Gentle«**  
 • zum Formen von Kugeln aus Butter, Obst oder Gemüse  
 • mit angeschliffenem Rand für schnelles, sauberes Arbeiten

**Baller, »Gentle«**  
 • for molding balls from butter, fruit and vegetables  
 • with sharpened rim for quick and clean coring

**Cuillère à pomme parisienne »Gentle«**  
 • pour former des billes de beurre, de fruits ou de légumes  
 • bord affûté pour un travail efficace et propre

**Sacabolas »Gentle«**  
 • para moldear bolas de matequilla, frutas o verduras  
 • el borde afilado para un trabajo limpio y rapido

Art-Nr. / Art.-No.	VE / SU	Größe / Size	EAN
2822 2210 	25	ø 26 mm	
2822 2270 	6	ø 26 mm	4 004094 282270



173 x 27 x 20 mm



**Aushöhlhöffel »Gallant«, ø 26 mm**  
 • zum Formen von Kugeln aus Butter, Obst oder Gemüse  
 • mit angeschliffenem Rand für schnelles, sauberes Arbeiten  
 • Komfort-Soft-Touch-Griff

**Baller »Gallant«**  
 • for molding balls from butter, fruit and vegetables  
 • with sharpened rim for quick and clean coring  
 • comfort-soft-touch handle

**Cuillère à pomme parisienne »Gallant«**  
 • pour former des billes de beurre, de fruits ou de légumes  
 • bord affûté pour un travail efficace et propre  
 • poignée confort-soft-touch

**Sacabolas »Gallant«**  
 • para moldear bolas de matequilla, frutas o verduras  
 • el borde afilado para un trabajo limpio y rapido  
 • con mango cómodo soft-touch

Art-Nr. / Art.-No.	VE / SU	Größe / Size	EAN
2922 2270 	6	ø 26 mm	4 004094 292270



1630 2260



**Dessert-/Speisenformer**  
 • zum Ausstechen von Teig  
 • zum Portionieren von Vorspeisen und Beilagen  
 • zum Anrichten von Desserts, Sandwiches und Gebäck

**Dessert/food**  
 • for cutting out pastry  
 • for serving up starters and side dishes  
 • for serving up desserts, sandwiches and pastries



**Emporte-pièces pour desserts et hors**  
 • pour découper de la pâte  
 • pour former des portions de hors d'oeuvre et garnitures  
 • pour présenter des desserts, sandwiches et petits gateaux

**Moldes para postres / comidas**  
 • para hacer moldes de masa  
 • para porcionar aperitivos y acompa amientos  
 • para acabar postres, bocadillos y bolleria

1631 2260



**Dessert-/Speisenformer Rund**  
 Dessert/food Round

Art-Nr. / Art.-No.	VE / SU	EAN
1630 2260 	6	4 004094 163067
1631 2260 	6	4 004094 163166





**Emporte-pièces pour desserts et hors d'œuvre**  
 Moldes para postres / comidas Rond

1632 2260



**Dessert-/Speisenformer Herzform**  
 Dessert/food Heart

Art-Nr. / Art.-No.	VE / SU	EAN
1632 2260 	6	4 004094 163265
1633 2260 	6	4 004094 163364





**Emporte-pièces pour desserts et hors d'œuvre**  
 Moldes para postres / comidas Cœur

1634 2260



**Dessert-/Speisenformer Eckig**  
 Dessert/food Square

Art-Nr. / Art.-No.	VE / SU	EAN
1634 2260 	6	4 004094 163463
1635 2260 	6	4 004094 163562



**Emporte-pièces pour desserts et hors d'œuvre**  
 Moldes para postres / comidas Carré

1635 2260



67 x 67 x 55 mm







**Speisenformer »Herz« & »Blume«**

- 2-er Set
- zum dekorativen Anrichten von Speisen
- mit praktischem Griffelement

**Food moulds »Herz« & »Blume«**

- 2-piece set
- for decorative food presentation
- with convenient grip-element

Art-Nr. / Art.-No.	VE / SU	EAN
1257 2260 	6	 4 004094 125768
1258 2260 	6	 4 004094 125867

**Emporte-pièces »Herz« & »Blume«**

- ensemble de 2 pièces
- pour le dressage décoratif de plats
- avec manche pratique

**Set de moldes para comidas »Herz« & »Blume«**

- set de 2 piezas
- para la presentación decorativa de comidas
- con mango práctico

Blume  
1258 2260  
136 x 100 x 15 mm

Herz  
1257 2260  
135 x 98 x 15 mm



02

**Ausstechformen-Set »Füße«**

- 3-er Set
- der Party-Spaß
- nicht nur für das Formen von Plätzchen, sondern auch für die Zubereitung ansprechender Sandwiches zu verwenden

**Shape cutters »Füße«**

- 3-piece set
- the party fun
- they are not just cookie cutters - but do also give shape to fancy sandwiches

**Ensemble d'emporte-pièces »Füße«**



- ensemble de 3 pièces
- le party fun
- à utiliser non seulement comme emporte-pièces, mais également pour préparer des sandwiches attrayants

**Set de moldes cortadores »Füße«**

- set de 3 piezas
- divertido para la fiesta
- no solo para moldear galletas, sino también sandwiches decorativos



70 / 90 / 110 mm H= 25 mm

Art-Nr. / Art.-No.	VE / SU	EAN
3138 2280 	6	 4 004094 313882

**Ausstechformen-Set »Hände«**

- 3-er Set
- der Party-Spaß
- nicht nur für das Formen von Plätzchen, sondern auch für die Zubereitung ansprechender Sandwiches zu verwenden

**Shape cutters »Hände«**

- 3-piece set
- the party fun
- they are not just cookie cutters - but do also give shape to fancy sandwiches

**Ensemble d'emporte-pièces »Hände«**



- ensemble de 3 pièces
- le party fun
- à utiliser non seulement comme emporte-pièces, mais également pour préparer des sandwiches attrayants

**Set de moldes cortadores »Hände«**

- set de 3 piezas
- divertido para la fiesta
- no solo para moldear galletas, sino también sandwiches decorativos



65 / 80 / 110 mm H= 25 mm

Art-Nr. / Art.-No.	VE / SU	EAN
3139 2280 	6	 4 004094 313981

**Nestbacklöffel**

- für die Herstellung von attraktiven Kartoffelkörnchen, Zucchini- oder Möhren-Nestern aus hauchdünnen Scheiben »oder Gemüsestreifen

**Nest frying spoon**

- for creating attractive nests from thin slices or stripes of potatoes, courgette (zucchini) and carrots

**Nid à friture**



- pour préparer des petits paniers de pommes de terre, des nids de courgettes et de carottes attrayants

**Molde para hacer nidos de patatas**

- para preparar cestitas atractivas de patatas, nidos de zuchini o de zanahorias de finisimas rodajas o de tiras de verduras



350 x 100 x 45 mm

Art-Nr. / Art.-No.	VE / SU	EAN
1243 2270 	3	 4 004094 124372

**Zahnstocher**

- Set mit 300 Zahnstochern / Spießchen
- beidseitig gespitzt
- auch für die Zubereitung kleiner Häppchen zu verwenden
- geschmacksneutral aus Birkenholz

**Toothpicks**

- set of 300 toothpicks / skewers
- pointed at both ends
- also for the preparation of appetizers or finger food
- neutral to taste from birchwood

**Cure-dents**



- ensemble de 300 cure-dents / piques à brochettes
- taillés en pointe des deux côtés
- aussi pour la préparation de petites collations
- sans goût de bois de bouleau

**Palillos de dientes**

- set de 300 palillos de dientes / pinchitos
- puntiagudos por ambos lados
- pueden usarse estupendamente para preparar bocaditos
- de sabor nouveautro de madera de abedul



65 x 2 x 2 mm

Art-Nr. / Art.-No.	VE / SU	EAN
1047 2270 	10	 4 004094 104770





03

nudeln & spätzle • *pasta & spätzle*  
les pâtes et les spätzles • *pasta y spätzle*

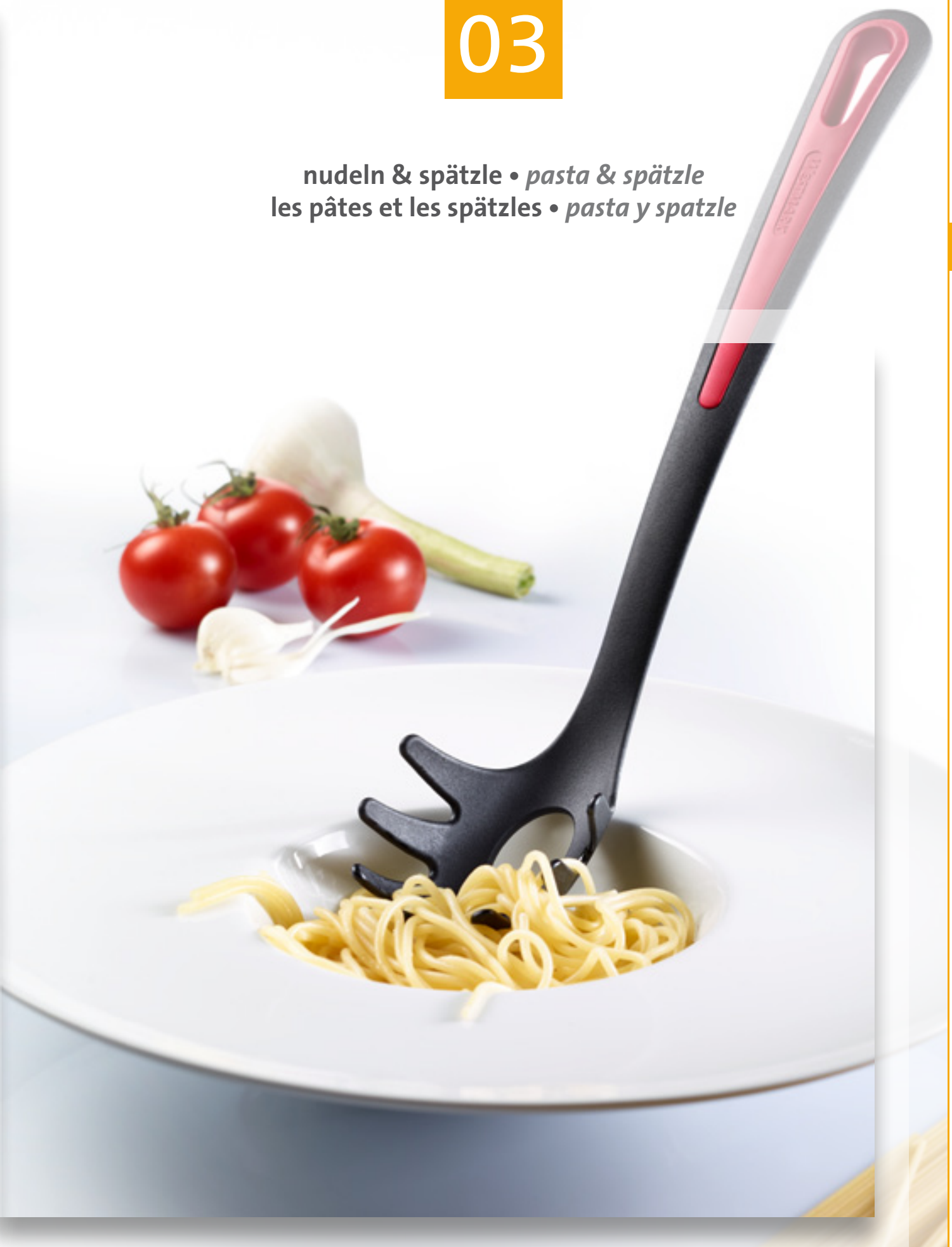

03

nudeln & spätzle • *pasta & spätzle* • les pâtes et les spätzles • *pasta y spätzle*



**Spätzle Presse »Spätzlepress« & »Spätzlechef«**  
 • ideal auch für die Zubereitung von Kartoffelpüree, Obstsaften, Spaghetti-Eis etc.  
 • der Griff ist unten abgeflacht und bietet mit den drei Auflagerasten vorne sicheren Halt auf verschieden großen Töpfen

*Press for noodles and potatoes*  
 »Spätzlepress« & »Spätzlechef«  
 • can also be used for purees, spaghetti-ice, mashed potatoes and as fruitpress  
 • the handle is flattened and ensures with the three grooves at the front a safe hold on pots of different sizes

**Presse à spätzles »Spätzlepress« & »Spätzlechef«**  
 • s'utilise également pour la préparation de jus de fruits, de glace spaghetti, les pommes de terre et bien plus encore  
 • le manche aplati offre avec les trois pattes à l'avant un maintien sûr sur des casseroles de différentes tailles

*Prensa para Spätzle*  
 »Spätzlepress« & »Spätzlechef«  
 • también puede usarse para preparar zumos de frutas, helado spaghetti, patatas y muchas otras cosas  
 • el mango está aplanado por abajo y con las tres acanaladuras ofrece un apoyo seguro sobre ollas de diferentes tamaños



Art.-Nr. 6110  
 Spätzlepress  
 410 x 93 x 110 mm

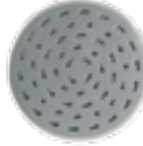

Art.-Nr. 6120  
 Spätzlechef  
 410 x 93 x 110 mm



Art-Nr. / Art.-No.	VE / SU	EAN	Art-Nr. / Art.-No.	VE / SU	EAN
6110 2260	2	4 004094 611063	6120 2260	2	4 004094 612060
6110 2230	1	4 004094 611032	6120 2230	1	4 004094 612039
6110 223R	1	4 004094 000782	6120 223R	1	4 004094 000829
6110 223V	1	4 004094 000799	6120 223V	1	4 004094 000812
6110 223W	1	4 004094 000805	6120 223W	1	4 004094 000836



**Spätzle-Kartoffelpresse »Quadro«**  
 • mit 4 Lochscheiben für Stampfkartoffeln, Kartoffelpüree, Spaghetti-Eis, Spätzle etc.  
 • Auflagerasten und Wellenrelief im Griff geben festen Halt auf Töpfen

*Spätzle and potato press »Quadro«*  
 • with 4 interchangeable discs for mashed potatoes, potato purée, ice cream, spaghetti, 'Spätzle'-noodles etc.  
 • with notched handle for placing on the pot

**Presse à pommes de terre et spätzles »Quadro«**  
 • avec 4 grilles pour pommes mousseline, purée de pommes de terre, glace spaghetti, spätzles etc.  
 • la poignée crantée permet un parfait maintien sur les casseroles

*Prensa para Spätzle y patatas »Quadro«*  
 • con 4 insertos para patatas machacadas, puré de patatas, helado spaghetti, Spätzle, etc.  
 • las acanaladuras y el relieve ondulado en el mango proporcionan un apoyo sobre las ollas

Art-Nr. / Art.-No.	VE / SU	EAN
6117 2260	3	4 004094 611766



350 x 90 x 165 mm



**Spätzle-/Topfaufsatz + Schaber, 2teiliges Set**  
 • geeignet für Töpfe von Ø 24 - 28 cm  
 • inklusive Kunststoffschaber

*Spätzle top + scraper*  
 • suitable for all pots from Ø 24 - 28 cm  
 • plastic scraper included

**Dispositif à spätzles pour casserole + grattoir**  
 • pour des casseroles de Ø 24 - 28 cm  
 • grattoir en plastique inclus

*Suplemento para Spätzle + rasqueta*  
 • apropiado para ollas de Ø de 24 - 28 cm  
 • incluido rascador de plástico

Art-Nr. / Art.-No.	VE / SU	EAN
6111 2240	6	4 004094 611148



327 x 272 x 18 mm



### Spätzleobel »Knöpfe«

- mit Auflagerasten
- Anwendung: der Schlitten wird mit Teig befüllt und in den Schienen sanft über den Hobel gezogen

### Spätzle plane »Knöpfe«

- with grooved section in frame for safe hold on pots
- use: fill the batter box with dough and slide it back and forth to create uniform 'Spätzle'

Art-Nr. / Art.-No.	VE / SU	EAN
6112 2270	6	4 004094 611278



### Eminceur de spätzles »Knöpfe«

- les crans maintiennent l'éminceur en position sur la casserole
- utilisation: remplir le chariot de pâte et le tirer doucement

### Rallador para Spätzle »Knöpfe«

- las ranuras de engrane sujetan el rallador perfectamente en posición
- utilización: se llena el patín con masa y se le mueve de aquí para allá sobre el rallador



320 x 108 x 68 mm

### Spätzleobel »Fädle«

- mit Auflagerasten
- Anwendung: der Schlitten wird mit Teig befüllt und in den Schienen sanft über den Hobel gezogen

### Spätzle plane »Fädle«

- with grooved section in frame for safe hold on pots
- use: fill the batter box with dough and slide it back and forth to create uniform 'Spätzle'

Art-Nr. / Art.-No.	VE / SU	EAN
6122 2270	6	4 004094 612275



### Eminceur de spätzles »Fädle«

- les crans maintiennent l'éminceur en position sur la casserole
- utilisation: remplir le chariot de pâte et le tirer doucement

### Rallador para Spätzle »Fädle«

- las ranuras de engrane sujetan el rallador perfectamente en posición
- utilización: se llena el patín con masa y se le mueve de aquí para allá sobre el rallador



320 x 108 x 68 mm

### Spätzlebrett »Öko«, aus Holz

- mit abgeschrägter Kante
- für die Zubereitung handgeschabter schwäbischer Spätzle
- auch als Schneidbrett verwendbar

### Spätzle board »Öko«, from wood

- with bevelled edge
- for the preparation of handmade 'Spätzle'
- also suitable as cutting board

Art-Nr. / Art.-No.	VE / SU	EAN
6114 2240	6	4 004094 611445



### Planche à spätzles »Öko«, de bois

- avec bord biseauté
- pour la préparation de spätzles faits main
- s'utilise également comme planche à découper

### Tabla para Spätzle »Öko«, de madeira

- con borde achaflanado
- para preparar Spätzle de Suaba a mano
- puede usarse también como tabla de corte



320 x 140 x 10 mm

### Spätzleschaber

- für die klassische Art der Zubereitung - direkt über dem Topf
- stabiler Edelstahlschaber mit typisch schrägem Schnitt

### Spätzle scraper

- for the classic preparation - directly over the pot
- strong stainless steel scraper with typical diagonal blade

Art-Nr. / Art.-No.	VE / SU	EAN
6115 2270	6	4 004094 611575



### Grattoir à spätzles

- pour la préparation classique - directement au-dessus de la casserole
- grattoir stable en acier inoxydable avec coupe diagonale typique

### Rasqueta para Spätzle

- para la preparación clásica - directamente por encima de la olla
- rasqueta estable de acero inoxidable con corte inclinado típico



122 x 113 x 21 mm

### Spätzlebrett + Schaber-Set

- Spätzlebrett Nr. 6114 und Schaber Nr. 6115 im Set

### Spätzle board + scraper

- Spätzle-board no. 6114 and scraper no. 6115 as a set

Art-Nr. / Art.-No.	VE / SU	EAN
6116 2240	3	4 004094 611643



### Ensemble planche à spätzles + grattoir

- ensemble planche à spätzles n°6114 et grattoir n°6115

### Set de tabla para Spätzle + rasqueta

- Tabla para Spätzle No 6114 y rasqueta No 6115 como un set



320 x 140 x 31 mm



**Ravioliformer**

- Set mit 3 Klapp-Formen für die Zubereitung von Maultaschen, Ravioli, Mini-Calzone, Apfeltaschen etc.
- mit attraktivem Rezeptheft

**Ravioli formers**



- set with 3 formers for the preparation of pasta pockets, ravioli, mini calzone, apple pies etc.
- with attractive recipe booklet

**Moule à raviolis**

- set avec 3 moules pour préparer des maultaschen, des raviolis, des mini calzone, des tartes aux pommes etc.
- avec livre de recettes captivant

**Moldes para raviolis**

- set con 3 moldes plegables para preparar empanadas, ravioli, mini calzone, empanadas de manzana etc.
- con cuaderno atractivo de recetas

Art-Nr. / Art.-No.	VE / SU	EAN
6134 2260 	6	 4 004094 613463

PP



**Pastamaschine**

- für Lasagne, Tagliolini, Tagliatelle
- höchste Standfestigkeit durch rutschfesten Sockel sowie Schraubzwinge
- leicht zu bedienen

**Pasta maker**

- for home-made pasta – lasagne, tagliolini, tagliatelle
- maximum stability ensured by non-slip base and screw clamp
- easy handling

**Machine à pâtes**

- pour pâtes, lasagnes, tagliolinis, tagliatelles faits maison
- très grande stabilité grâce au socle antidérapant et au serre-joint
- facile à utiliser

**Máquina de pasta**

- para lasaña, tagliolini, tagliatella
- máxima estabilidad garantizada gracias a la base antiresbalante así como gato
- fácil manejo

Art-Nr. / Art.-No.	VE / SU	EAN
6130 2260 	1	 4 004094 613067

ST

INOX



195 x 200 x 155 mm

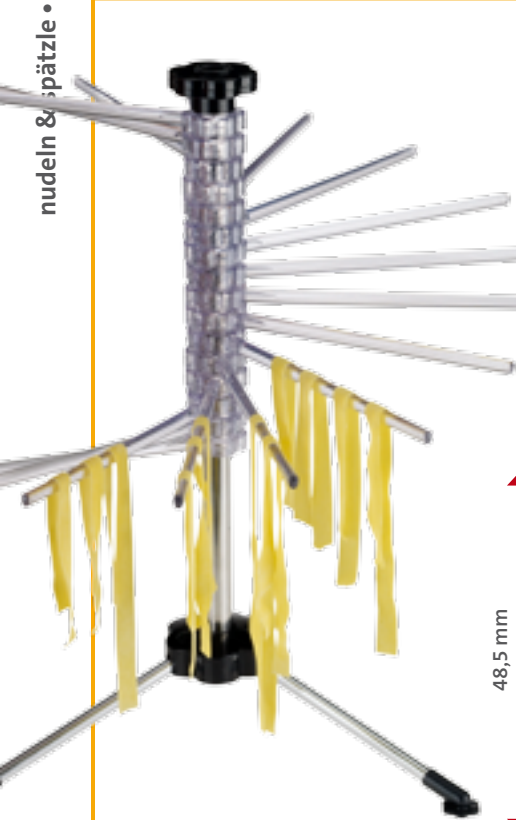

**Nudeltrockner »Pasta-Tree«**

- platzsparend zusammenklappbar
- mit ‚Transport-Stab‘ für den Weg zwischen Maschine und Trockner
- Stab wird im Innern des Pasta-Trees aufbewahrt

**Pasta drying rack »Pasta-tree«**

- folds up to save space
- with ‚transfer rod‘ for transferring pasta from machine to rack
- rod conveniently stores in the centre of the pasta-tree

**Séchoir à pâtes »Pasta-Tree«**

- repliable - peu encombrant
- avec ‚tige de transfert‘ se rangeant facilement dans le séchoir à pâtes pour transférer la pâte de la machine au séchoir

**Secador de pasta »Pasta-tree«**

- rebatible para guardar el secador ahorrando sitio
- con „varilla de transferencia“ que puede guardarse convenientemente en el interior del secador

Art-Nr. / Art.-No.	VE / SU	EAN
6133 2260 	1	 4 004094 613364

PC

INOX



48,5 mm



450 x 450 x 470 mm



- Schaumlöffel »Gentle«**
- aus hochwertigem Polyamid
  - ideal für beschichtete Töpfe und Pfannen

- Skimmer »Gentle«**
- from high quality polyamide
  - ideal for coated pots and pans

Art-Nr. / Art.-No.	VE / SU	EAN
2850 2270	6	4 004094 285073



- Ecumoire »Gentle«**
- en polyamide de haute qualité
  - idéal pour les casseroles et les poêles anti-adhésives

- Espumadera »Gentle«**
- de poliamida de alta calidad
  - ideales para ollas y sartenes con revestimiento antiadherente



322 x 118 x 80 mm

- Schaumlöffel »Gallant«**
- aus hochwertigem Polyamid
  - ideal für beschichtete Töpfe und Pfannen
  - Komfort-Soft-Touch-Griff

- Skimmer »Gallant«**
- from high quality polyamide
  - ideal for coated pots and pans
  - comfort-soft-touch handle

Art-Nr. / Art.-No.	VE / SU	EAN
2950 2270	6	4 004094 295072



- Ecumoire »Gallant«**
- en polyamide de haute qualité
  - idéal pour les casseroles et les poêles anti-adhésives
  - poignée confort-soft-touch

- Espumadera »Gallant«**
- de poliamida de alta calidad
  - ideales para ollas y sartenes con revestimiento antiadherente
  - con mango cómodo soft-touch



322 x 118 x 80 mm

- Spaghettilöffel »Gentle«**
- aus hochwertigem Polyamid
  - ideal für beschichtete Töpfe und Pfannen

- Spaghetti server »Gentle«**
- from high quality polyamide
  - ideal for coated pots and pans

Art-Nr. / Art.-No.	VE / SU	EAN
2860 2270	6	4 004094 286070



- Cuillère à spaghettis »Gentle«**
- en polyamide de haute qualité
  - idéal pour les casseroles et les poêles anti-adhésives

- Cuchara para spaghetti »Gentle«**
- de poliamida de alta calidad
  - ideales para ollas y sartenes con revestimiento antiadherente



305 x 62 x 63 mm

- Spaghettilöffel »Gallant«**
- aus hochwertigem Polyamid
  - ideal für beschichtete Töpfe und Pfannen
  - Komfort-Soft-Touch-Griff

- Spaghetti server »Gallant«**
- from high quality polyamide
  - ideal for coated pots and pans
  - comfort-soft-touch handle

Art-Nr. / Art.-No.	VE / SU	EAN
2960 2270	6	4 004094 296079



- Cuillère à spaghettis »Gallant«**
- en polyamide de haute qualité
  - idéal pour les casseroles et les poêles anti-adhésives
  - poignée confort-soft-touch

- Cuchara para spaghetti »Gallant«**
- de poliamida de alta calidad
  - ideales para ollas y sartenes con revestimiento antiadherente
  - con mango cómodo soft-touch



305 x 62 x 63 mm

- Schaumlöffel/Blanchierheber**
- zum Abschöpfen, Abseihen und Herausheben von Gemüse, Kartoffelknödeln, Spätzle etc.
  - sehr stabile Ausführung

- Slotted spoon/blanching**
- for skimming, straining and lifting out vegetables, potato dumplings, spätzle etc.
  - very solid version

Art-Nr. / Art.-No.	VE / SU	EAN
1237 2270	3	4 004094 123771



- Ecumoire à blanchir et à spätzles**
- pour égoutter, écumer et retirer légumes, knödel de pommes de terre, spätzles etc.
  - version très stable

- Espumadera / Paleta**
- para extraer la espuma, colar y sacar verduras, albóndigas de patatas, Spätzle, etc.
  - versión muy estable



435 x 150 x 120 mm





04

zubereiten • *seasoning*  
cuisiner • *preparación*

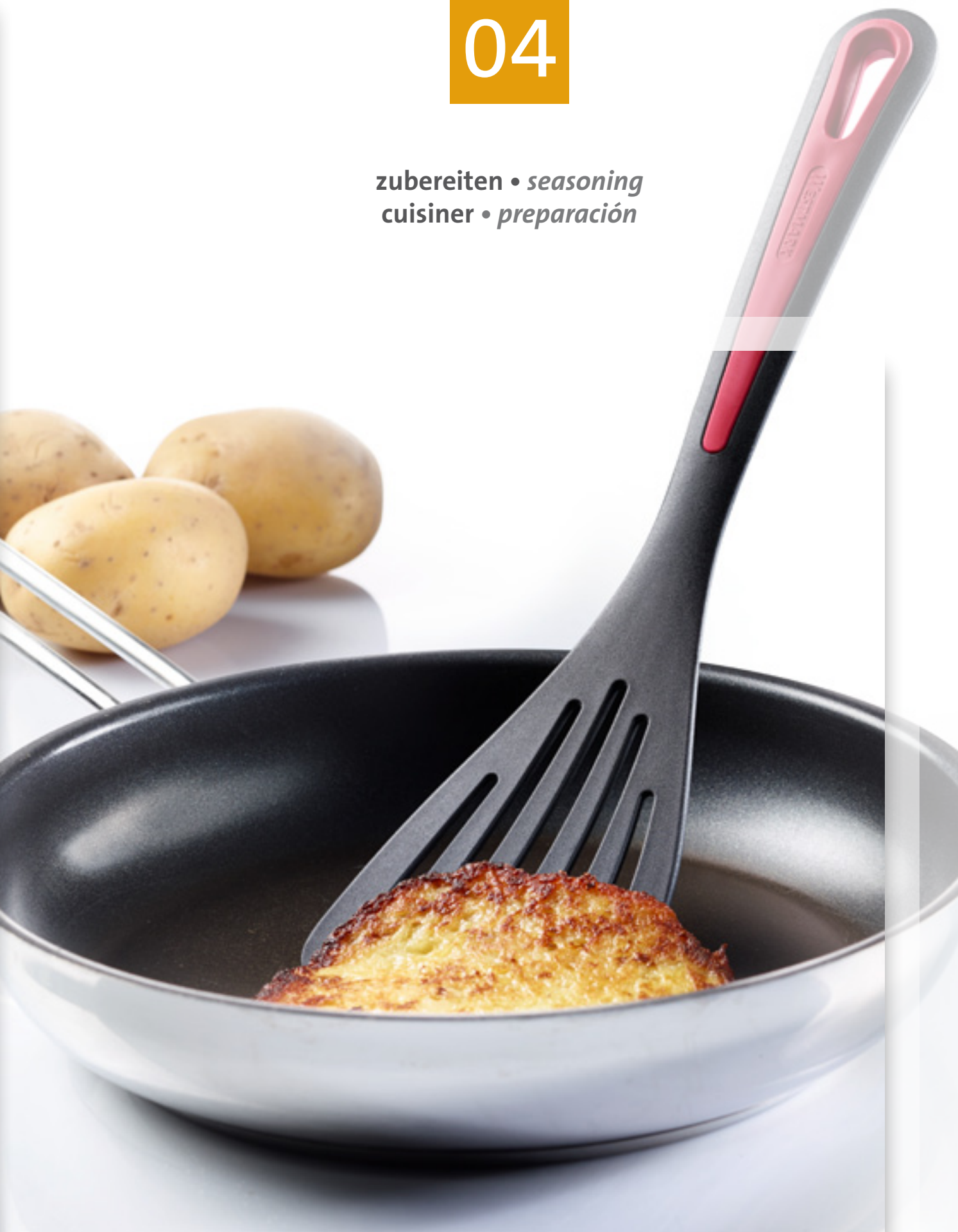

04

zubereiten • *seasoning* • cuisiner • *preparación*

2935 2270



2950 2270



2954 2270



2956 2270



zubereiten • seasoning • cuisiner • preparación

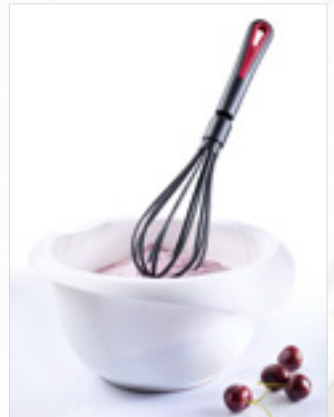
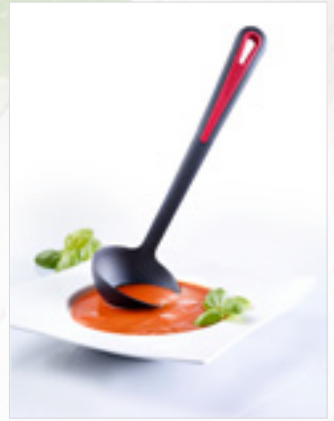



2960 2270



2965 2270



2966 2270



2968 2270



**Küchenhelfer Serie »Gallant«**  
**Kitchen gadgets »Gallant«**

NEU ab  
Juni 2016



Made in  GERMANY

Art-Nr. / Art.-No.	Bezeichnung / Description	Größe / Size	VE / SU	EAN
2935 2270	Pfannenwender / <i>Spatula</i> / Spatule / <i>Espátula</i>	300 x 87 x 30 mm	6	4 004094 293573
2950 2270	Schaumlöffel / <i>Skimmer</i> / <i>Ecumoire</i> / <i>Espumadera</i>	322 x 118 x 80 mm	6	4 004094 295072
2954 2270	Soßenlöffel / <i>Sauce spoon</i> / <i>Cuillère à sauce</i> / <i>Cuchara para salsas</i>	290 x 79 x 60 mm	6	4 004094 295478
2956 2270	Suppenkelle / <i>Soup ladle</i> / <i>Louche</i> / <i>Cazo</i>	315 x 92 x 83 mm	6	4 004094 295676
2960 2270	Spaghettilöffel / <i>Spaghetti server</i> / <i>Cuillère à spaghettis</i> / <i>Cuchara para spaghetti</i>	305 x 62 x 63 mm	6	4 004094 296079
2965 2270	Gemüse-/Woklöffel / <i>Vegetable/wokspoon</i> / <i>Cuillère à légumes</i> / <i>Cuchara para verduras</i>	315 x 72 x 25 mm	6	4 004094 296574
2966 2270	Crêpes-Spatel / <i>Crêpes spatula</i> / <i>Spatule à crêpes</i> / <i>Espátula para crepes</i>	330 x 35 x 65 mm	6	4 004094 296673
2968 2270	Schneebeesen / <i>Whisk</i> / <i>Fouet</i> / <i>Batidor</i>	310 x 72 x 72 mm	6	4 004094 296871



2903 2270



EDELSTAHL  
Rost  
frei  
Stainless steel

2905 2270



EDELSTAHL  
Rost  
frei  
Stainless steel

2906 2270



EDELSTAHL  
Rost  
frei  
Stainless steel

2907 2270



EDELSTAHL  
Rost  
frei  
Stainless steel

2908 2270



poliert

2918 2270



ø 19 mm  
EDELSTAHL  
Rost  
frei  
Stainless steel

2920 2270



ø 21 mm  
poliert  
EDELSTAHL  
Rost  
frei  
Stainless steel

2922 2270



ø 26 mm  
poliert  
EDELSTAHL  
Rost  
frei  
Stainless steel

2926 2270



poliert  
EDELSTAHL  
Rost  
frei  
Stainless steel

2928 2270



ø 76 mm  
poliert  
EDELSTAHL  
Rost  
frei  
Stainless steel

Art.-Nr. / Art.-No.	Bezeichnung / Description	Größe / Size	VE / SU	EAN
2903 2270	 Linkshand-Sparschäler / Swivel peeler for left handed people / Econome pour gauchers / Pelador ahorrativo para zurdas	165 x 37 x 18 mm	6	4 004094 290374
2905 2270	Julienne-Schneider / Julienne cutter / Couteau à julienne / Cortador Juliana	150 x 69 x 18 mm	6	4 004094 290572
2906 2270	Sparschäler / Swivel peeler / Econome / Pelador ahorrativo	185 x 27 x 20 mm	6	4 004094 290671
2907 2270	Gemüse-/Spargelschäler / Vegetable/asparagus peeler / Eplucheur de légumes et d'asperges / Pelador de verduras y espárragos	150 x 69 x 18 mm	6	4 004094 290770
2908 2270	Flaschenöffner / Bottle opener / Décapsuleur / Abrebotellas	170 x 40 x 20 mm	6	4 004094 290879
2909 2270	Sparschäler / Swivel peeler / Econome / Pelador ahorrativo	165 x 37 x 20 mm	6	4 004094 290978
2910 2270	Dosenlocher / Tin pincher / Perce-boîte / Agujereador de latas	140 x 27 x 20 mm	6	4 004094 291074
2911 2270	Spargel-/Gemüeschäler / Vegetable/asparagus peeler / Eplucheur de légumes et d'asperges / Pelador de verduras y espárragos	150 x 69 x 18 mm	6	4 004094 291173
2914 2270	Pellkartoffelgabel / Potato fork / Fourchette à pommes de terre / Tenedor para pelar patatas cocidas	163 x 27 x 20 mm	6	4 004094 291470
2916 2270	Brat-/Backpinsel / Basting-/baking brush / Pinceau à viande/pâtisserie / Pincel para asado y horneado	205 x 27 x 20 mm	6	4 004094 291678



2909 2270



ROSTFREI  
Stainless steel

2910 2270



ROSTFREI  
Stainless steel

2911 2270



Keramik-Klinge  
ceramic-blade

2914 2270



ROSTFREI  
Stainless steel

2916 2270



2930 2270



poliert  
ROSTFREI  
Stainless steel

2932 2270



ø 39 mm  
poliert  
ROSTFREI  
Stainless steel

2934 2270



poliert  
ROSTFREI  
Stainless steel

2945 2270



ROSTFREI  
Stainless steel

2958 2270



Hochglanz  
poliert

## Küchenhelfer Serie »Gallant«

### Kitchen gadgets »Gallant«



Art-Nr. / Art.-No.	Bezeichnung / Description	Größe / Size	VE / SU	EAN
2918 2270	Apfelnukausstecher / Apple core remover / Vide-pomme / Descorazonador de manzanas	210 x 27 x 20 mm	6	4 004094 291876
2920 2270	Aushöhlhöffel/Tomatenstrunkentferner / Baller/ Échoppe à cuiller / Sacapedúnculos de tomate	166 x 27 x 20 mm	6	4 004094 292071
2922 2270	Aushöhlhöffel / Baller / Evideur / Sacabolas	173 x 27 x 20 mm	6	4 004094 292279
2926 2270	Käsehobel / Cheese slicer / Coupe-fromage / Tajador de queso	245 x 74 x 30 mm	6	4 004094 292675
2928 2270	Pizzaschneider / Pizza cutter / Coupe-pizza / Cortador de pizzas	205 x 81 x 20 mm	6	4 004094 292873
2930 2270	Zitronenschaber / Zester / Zesteur / Raspador para limones	165 x 27 x 20 mm	6	4 004094 293078
2932 2270	Teigrad / Dough cutter / Roulette à pâte / Rueda para pastas	180 x 40 x 20 mm	6	4 004094 293276
2934 2270	Orangenschäler / Orange peeler / Eplucheur à orange / Pelanaranjas con cuchillas	190 x 27 x 20 mm	6	4 004094 293474
2945 2270	Sparschäler / Swivel peeler / Econome / Pelador ahorrativo	195 x 27 x 20 mm	6	4 004094 294570
2958 2270	Eislöffel / Ice-cream scoop / Cuiller à glace / Cuchara para helado	215 x 44 x 34 mm	6	4 004094 295874



2835 2270



2850 2270



2854 2270



2856 2270



1363 2270



NEU ab  
Juni 2016



1367 2270



NEU ab  
Juni 2016





2860 2270



2865 2270



2866 2270



1368 2270



## Küchenhelfer Serie »Gentle« Kitchen gadgets »Gentle«



Art-Nr. / Art.-No.	Bezeichnung / Description	Größe / Size	VE / SU	EAN
2835 2270	Pfannenwender / <i>Spatula</i> / <i>Spatule</i> / <i>Espátula</i>	300 x 87 x 30 mm	6	4 004094 283574
2850 2270	Schaumlöffel / <i>Skimmer</i> / <i>Ecumoire</i> / <i>Espumadera</i>	322 x 118 x 80 mm	6	4 004094 285073
2854 2270	Soßenlöffel / <i>Sauce spoon</i> / <i>Cuillère à sauce</i> / <i>Cuchara para salsas</i>	290 x 79 x 60 mm	6	4 004094 285479
2856 2270	Suppenkelle / <i>Soup ladle</i> / <i>Louche</i> / <i>Cazo</i>	315 x 92 x 83 mm	6	4 004094 285677
2860 2270	Spaghettilöffel / <i>Spaghetti server</i> / <i>Cuillère à spaghettis</i> / <i>Cuchara para spaghetti</i>	305 x 62 x 63 mm	6	4 004094 286070
2865 2270	Gemüse-/Woklöffel / <i>Vegetable/wokspoon</i> / <i>Cuillère à légumes</i> / <i>Cuchara para verduras</i>	315 x 72 x 25 mm	6	4 004094 286575
2866 2270	Crêpes-Spatel / <i>Crêpes spatula</i> / <i>Spatule à crêpes</i> / <i>Espátula para crepes</i>	330 x 35 x 65 mm	6	4 004094 286674
1363 2270	Kartoffelstampfer / <i>Potato masher</i> / <i>Presse-purée</i> / <i>Mazo para patatas</i>	245 x 77 x 87 mm	6	4 004094 136375
1367 2270	Kochlöffel / <i>Cooking spoon</i> / <i>Cuillère</i> / <i>Paleta para cocinar</i>	300 x 50 x 7 mm	6	4 004094 136771
1368 2270	Schneebeesen / <i>Whisk</i> / <i>Fouet</i> / <i>Batidor</i>	275 x 70 x 70 mm	6	4 004094 136870



2802 2270 \*



2803 2270 \*



2804 2270 \*



2805 2270



2818 2270 \*



ø 17 mm  
  
 Stainless steel

2820 2270 \*



ø 21 mm  
  
 Stainless steel

2822 2270 \*



ø 26 mm  
  
 Stainless steel

2826 2270



## Küchenhelfer Serie »Gentle«



PP



Made in GERMANY

Art.-Nr. / Art.-No.	Bezeichnung / Description	Größe / Size	VE / SU	EAN
2802 2270*	Gemüse-/Spargelschäler / Vegetable/asparagus peeler / Eplucheur de légumes et d'asperges / Pelador de verduras y espárragos	150 x 69 x 18 mm	6	4 004094 280276
2803 2270*	Linkshand-Sparschäler / Swivel peeler for left handed people / Econome pour gauchers / Pelador ahorrativo para zurdos	165 x 37 x 18 mm	6	4 004094 280375
2804 2270*	Sparschäler / Swivel peeler / Econome / Pelador ahorrativo	165 x 37 x 18 mm	6	4 004094 280474
2805 2270	Julienne-Schneider / Julienne cutter / Couteau à julienne / Cortador Juliana	150 x 69 x 18 mm	6	4 004094 280573
2806 2270*	Sparschäler / Swivel peeler / Econome / Pelador ahorrativo	185 x 27 x 20 mm	6	4 004094 280672
2808 2270*	Flaschenöffner / Bottle opener / Décapsuleur / Abrebotellas	170 x 40 x 20 mm	6	4 004094 280870
2810 2270*	Dosenlocher / Tin pincher / Perce-boîte / Agujereador de latas	140 x 27 x 20 mm	6	4 004094 281075
2811 2270	Spargel-/Gemüseschäler / Vegetable/asparagus peeler / Eplucheur de légumes et d'asperges / Pelador de verduras y espárragos	150 x 69 x 18 mm	6	4 004094 281174
2814 2270*	Pellkartoffelgabel / Potato fork / Fourchette à pommes de terre / Tenedor para pelar patatas cocidas	159 x 27 x 20 mm	6	4 004094 281471

\* auch lose erhältlich (2210) / also available bulk (2210) / disponible en vrac (2210) / también disponible suelto (2210)



2806 2270 \*



2808 2270 \*



2810 2270 \*



2811 2270

Keramik-Klinge  
ceramic-blade

2814 2270 \*



2828 2270



ø 69 mm



2830 2270



2832 2270



ø 36 mm



2834 2270



## Küchenhelfer Serie »Gentle«

Made in  GERMANY

Art-Nr. / Art.-No.	Bezeichnung / Description	Größe / Size	VE / SU	EAN
2818 2270*	Apfelkernausstecher / Apple core remover / Vide-pomme / Descorador de manzanas	198 x 27 x 20 mm	6	4 004094 281877
2820 2270*	Aushöhlöffel/Tomatenstrunkentferner / Baller / Evideur / Sacabolas	166 x 27 x 20 mm	6	4 004094 282072
2822 2270*	Aushöhlöffel / Baller / Evideur / Sacabolas	173 x 27 x 20 mm	6	4 004094 282270
2826 2270	Käsehobel / Cheese slicer / Coupe-fromage / Tajador de queso	210 x 74 x 33 mm	6	4 004094 282676
2828 2270	Pizzaschneider / Pizza cutter / Coupe-pizza / Cortador de pizzas	212 x 76 x 20 mm	6	4 004094 282874
2830 2270	Zitronenschaber / Zester / Zesteur / Raspador para limones	165 x 27 x 20 mm	6	4 004094 283079
2832 2270	Teigrad / Dough cutter / Roulette à pâte / Rueda para pastas	176 x 36 x 20 mm	6	4 004094 283277
2834 2270	Orangenschäler / Orange peeler / Eplucheur à orange / Pelanaranjas con cuchillas	190 x 27 x 20 mm	6	4 004094 283475



1802 2270



1804 2270



1806 2270



1808 2270



1814 2270



1826 2270



1827 2270



1830 2270



1832 2270



1834 2270



ø 38 mm

INOX

ROSTFREI  
Stainless steel

Art.-Nr. / Art.-No.	Bezeichnung / Description	Größe / Size	VE / SU	EAN
1802 2270	Spargel-/Gemüseschäler / Vegetable-/asparagus swivel peeler / Eplucheur d'asperges/de légumes / Pelador de espárragos / verduras	186 x 57 x 23 mm	6	4 004094 180279
1804 2270	Schäler mit Pendelklinge / Swivel Peeler / Econome à lame pivotante / Pelador con hoja pendular	223 x 22 x 23 mm	6	4 004094 180477
1806 2270	Sparschäler / Swivel Peeler / Econome / Pelador ahorrativo	200 x 23 x 23 mm	6	4 004094 180675
1808 2270	Kapselheber / Bottle opener / Décapsuleur / Abrebotellas	198 x 42 x 23 mm	6	4 004094 180873
1814 2270	Pellkartoffelgabel / Jacket potato fork / Fourchette à pommes de terre / Tenedor para pelar patatas cocidas	173 x 23 x 23 mm	6	4 004094 181474
1818 2270	Apfelentkerner / Apple-corer / Vide-pomme / Descorazonador de manzanas	220x 23 x 23 mm	6	4 004094 181870
1822 2270	Aushöhlöffel / Baller / Evideur / Sacabolas	186 x 30 x 23 mm	6	4 004094 182273
1824 2270	Butterrollmesser / Butter curler / Couteau à beurre / Cuchillo para mantequilla	200 x 23 x 44 mm	6	4 004094 182471
1836 2270	Knoblauchpresse / Garlic press / Presse-ail / Prensa de ajos	200 x 51 x 33 mm	6	4 004094 183676



1818 2270



ø 20 mm

1822 2270



ø 30 mm

1824 2270



1836 2270



1828 2270



ø 68 mm

1838 2270

verchromt  
chrome-plated

1839 2270

verchromt  
chrome-plated

1858 2270

verchromt  
chrome-plated

INOX

EDELSTAHL®  
Rost  
frei  
Stainless steel

Art-Nr. / Art.-No.	Bezeichnung / Description	Größe / Size	VE / SU	EAN
1826 2270	Käsehobel / Cheese slicer / Coupe-fromage / Tajador de queso	254 x 73 x 23 mm	6	4 004094 182679
1827 2270	Käseschneider / Cheese slicer / Coupe-fromage / Cortador de queso	280 x 23 x 23 mm	6	4 004094 182778
1828 2270	Pizzaschneider / Pizza cutter / Coupe-pizza / Cortador de pizzas	207 x 81 x 23 mm	6	4 004094 182877
1830 2270	Zitronenschaber / Zester / Zesteur / Raspador para limones	175 x 26 x 23 mm	6	4 004094 183072
1832 2270	Teig- und Pizzarad / Dough and pizza cutter / Roulette à pâte et à pizza / Rueda para pastas y pizzas	187 x 68 x 23 mm	6	4 004094 183270
1834 2270	Orangenschäler / Orange peeler / Eplucheur d'orange / Pelador de naranjas	196 x 23 x 23 mm	6	4 004094 183478
1838 2270	Deckelöffner / Cap opener / Ouvre-bocal / Abretapas	263 x 88 x 14 mm	6	4 004094 183874
1839 2270	Dosenöffner / Can opener / Ouvre-boîte / Abrelatas	213 x 49 x 43 mm	6	4 004094 183973
1858 2270	Eislöffel / Ice-cream scoop / Cuillère à glace / Cuchara para helados	225 x 44 x 30 mm	6	4 004094 185878



1842 2270



1843 2270



1844 2270



1801 2270



1846 2270



1848 2270



1835 2270



1852 2270



1855 2270



1851 2270



1854 2270



1856 2270







Art-Nr. / Art.-No.	Bezeichnung / Description	Größe / Size	VE / SU	EAN
1842 2270	Schneebeesen, 20 cm / Whisk, 20 cm / Fouet, 20 cm / Batidor, 20 cm	214 x 43 x 43 mm	6	4 004094 184277
1843 2270	Schneebeesen, 25 cm / Whisk, 25 cm / Fouet, 25 cm / Batidor, 25 cm	265 x 59 x 59 mm	6	4 004094 184376
1844 2270	Schneebeesen, 30 cm / Whisk, 30 cm / Fouet, 30 cm / Batidor, 30 cm	319 x 70 x 70 mm	6	4 004094 184475
1801 2270	Torteneheber mit Sägekante / Cake slice with serrated edge / Pelle à tarte à bord dentelé / Paleta para tartas con arista cortante	280 x 60 x 28 mm	6	4 004094 180170
1846 2270	Fleischgabel / Meat fork / Fourchette à viande / Tenedor para carne	352 x 30 x 23 mm	6	4 004094 184673
1848 2270	Kartoffelstampfer / Potato masher / Presse-purée / Aplastador de patatas	257 x 81 x 85 mm	6	4 004094 184871



Art-Nr. / Art.-No.	Bezeichnung / Description	Größe / Size	VE / SU	EAN
1835 2270	Wender / Turner / Spatule / Espátula	338 x 70 x 26 mm	6	4 004094 183577
1851 2270	Schaumlöffel / Skimmer / Ecumoire / Espumadera	354 x 109 x 50 mm	6	4 004094 185175
1852 2270	Gemüselöffel / Vegetable spoon / Cuillère à légumes / Cuchara para verduras	342 x 70 x 40 mm	6	4 004094 185274
1854 2270	Soßenlöffel / Sauce spoon / Cuillère à sauce / Cuchara para salsas	322 x 81 x 55 mm	6	4 004094 185472
1855 2270	Spaghettilöffel / Spaghetti server / Cuillère à spaghettis / Cuchara para spaghetti	325 x 79 x 53 mm	6	4 004094 185571
1856 2270	Schöpfkelle / Soup ladle / Louche / Cazo	308 x 89 x 74 mm	6	4 004094 185670



260 x 74 x 16 mm

**Pfannenwender »Küchenfreund«**

- ein Westmark-Klassiker
- mit einer Einkerbung an der Unterseite, die das Abrutschen des Wenders vom Pfannenrand verhindert

**Turner »Küchenfreund«**



- a Westmark classic
- grooves on the underside of the handle prevent the turner from sliding into the pan

**Spatule à poêle »Küchenfreund«**

- un classique Westmark
- encoche à la base empêche la spatule de glisser du bord de la poêle

**Espátula »Küchenfreund«**

- un clásico de Westmark
- con una acanaladura en el lado inferior, que evita que se escurre la espátula del borde del sartén

Art-Nr. / Art.-No.	VE / SU	EAN
2015 2270 	10	4 004094 201578 

AL

Made in  GERMANY

275 x 75 x 20 mm

**Doppelwender und Grillzange »Duetto«**

- als Zange oder Einzelwender nutzbar
- beide Wenderelemente sind mit einem Einsteckgelenk verbunden und lassen sich beliebig voneinander trennen

**Double turner and barbecue tongs »Duetto«**



- two in one
- the two parts of the turner are connected with a joint; the turners can be detached easily for separate use

**Double spatule et pince à barbecue »Duetto«**

- deux en un
- les deux éléments réversibles sont reliés par une articulation et se détachent facilement pour être utilisées séparément

**Espátula doble y pinzas para barbacoa »Duetto«**

- dos en un
- ambas partes de la espátula están unidas por una articulación de encaje; se pueden desarmar fácilmente para usarlas individualmente

Art-Nr. / Art.-No.	VE / SU	EAN
2110 2260 	5	4 004094 211065 

AL

Made in  GERMANY

283 x 70 x 20 mm

**Pfannenwender »Flonal«**

- Daumenmulde im Griff für sicheren Halt
- die Laffe ist an einer Seite stärker abgerundet, um Bratgut in der Pfanne zerteilen zu können

**Turner »Flonal«**



- thumb recess
- one side is shaped especially rounded for easy separating of food in the pan

**Spatule à poêle »Flonal«**

- creux pour le pouce dans le manche pour un maintien sûr
- l'embout est spécialement arrondi sur un côté pour couper les aliments dans la poêle

**Espátula »Flonal«**

- huella para el pulgar en el mango para un buen agarre
- cabeza cóncava especialmente redondeada por un lado, para poder partir el asado en la sartén

Art-Nr. / Art.-No.	VE / SU	EAN
2035 2270 	10	4 004094 203572 

PA

Made in  GERMANY

289 x 72 x 20 mm

**Doppelwender und Servierzange »Duetto Flonal«**

- zum praktischen Wenden und Servieren von Fleisch, Fisch und Gemüse

**Double turner and kitchen tongs »Duetto Flonal«**



- for turning and serving meat, fish, vegetables etc.

**Double spatule et pince de service »Duetto Flonal«**

- pour retourner et servir de façon pratique viande, poisson et légumes

**Espátula doble y pinzas para servir »Duetto Flonal«**

- para dar la vuelta y servir de un modo práctico carne, pescado y verdura

Art-Nr. / Art.-No.	VE / SU	EAN
2100 2260 	5	4 004094 210068 

PA

Made in  GERMANY**Wender »Silicone«**

- stabiler Edelstahlwender mit Silikonlaffe
- praktisch im Einsatz mit allen Pfannen

**Spatule »Silicone«**

- spatule robuste en acier inoxydable avec embout en silicone
- s'utilise avec toutes les poêles

**Turner »Silicone«**



- solid stainless steel turner with silicone
- for all types of pans

**Espátula »Silicone«**

- espátula estable en inox con cabeza cóncava de silicona
- práctica para ser usada con todas las sartenes



352 x 79 x 35 mm

Art-Nr. / Art.-No.	VE / SU	EAN
1540 2270 	5	4 004094 154072 

SI

INOX

Made in  GERMANY



- Pfannenwender »Gentle«**
- aus hochwertigem Polyamid
  - ideal für beschichtete Töpfe und Pfannen

- Spatula/turner »Gentle«**
- from high quality polyamide
  - ideal for coated pots and pans

Art-Nr. / Art.-No.	VE / SU	EAN
2835 2270	6	4 004094 283574



300 x 87 x 30 mm

- Pfannenwender »Gallant«**
- aus hochwertigem Polyamid
  - ideal für beschichtete Töpfe und Pfannen
  - Komfort-Soft-Touch-Griff

- Spatula/turner »Gallant«**
- from high quality polyamide
  - ideal for coated pots and pans
  - comfort-soft-touch handle

Art-Nr. / Art.-No.	VE / SU	EAN
2935 2270	6	4 004094 293573



300 x 87 x 30 mm

- Pfannenwender-/schaber »Flexi«**
- Wender und Schaber in einem
  - verfügt über eine starre schwarze und eine flexible rote Seite

- Turner / scraper »Flexi«**
- turner and scraper in one
  - it consists of a rigid black and a flexible red side

Art-Nr. / Art.-No.	VE / SU	EAN
1570 2270	5	4 004094 157073



310 x 86 x 10 mm

- Pfannenwender »Profi«**
- besonders breite Laffe für großes Bratgut
  - eine speziell gerundete, abgeschrägte Seite zum einfachen Zerteilen in der Pfanne

- Heavy duty turner »Profi«**
- extra wide blade
  - one side specially shaped for easy separating of food in the pan

Art-Nr. / Art.-No.	VE / SU	EAN
2065 2270	5	4 004094 206573



290 x 95 x 45 mm

- Raclette-Schaber »Gourmetta«**
- 4er Set von kleinen, schlanken Wendern
  - ideal für den Einsatz am Raclette - Pfännchen

- Raclette-scrapers »Gourmetta«**
- 4-piece set of small, slim turners
  - ideal for being used with gourmet raclette grills

Art-Nr. / Art.-No.	VE / SU	EAN
2045 2270	5	4 004094 204579



166 x 39 x 10 mm

- Spatule à poêle »Gentle«**
- en polyamide de haute qualité
  - idéal pour les casseroles et les poêles anti-adhésives

- Espátula »Gentle«**
- de poliamida de alta calidad
  - ideales para ollas y sartenes con revestimiento antiadherente

- Spatule à poêle »Gallant«**
- en polyamide de haute qualité
  - idéal pour les casseroles et les poêles anti-adhésives
  - poignée confort-soft-touch

- Espátula »Gallant«**
- de poliamida de alta calidad
  - ideales para ollas y sartenes con revestimiento antiadherente
  - con mango cómodo soft-touch

- Spatule à poêle-/grattoir »Flexi«**
- à la fois une spatule et un grattoir
  - dispose d'un côté fixe noir et d'un côté rouge flexible

- Espátula y rascador »Flexi«**
- espátula y rascador
  - consiste de un lado negro rígido y otro lado rojo flexible

- Spatule à poêle »Profi«**
- embout extra large
  - un côté spécialement arrondi pour faciliter la découpe de la nourriture dans la poêle

- Espátula »Profi«**
- cabeza cóncava muy ancha para grandes asados
  - un lado redondo y achaflanado especial para partir fácilmente en la sartén

- Spatule à raclette »Gourmetta«**
- ensemble de 4 petites spatules minces
  - idéale pour les petites poêles à raclette

- Rasquetas de raclette »Gourmetta«**
- set de 4 espátulas pequeñas y esbeltas
  - ideal para usarlas en las pequeñas sartenes de raclette

58 x 30 x 4 mm

**Spatel »Natur Pur«**

- dieses Set umfasst zwei hochwertige Buchenholzspatel
- bestens geeignet für den Einsatz in beschichteten Pfannen

**Spatula »Natur Pur«**

- this set contains 2 high quality beech wood spatulas
- ideal for coated pots and pans

Art-Nr. / Art.-No.	VE / SU	EAN
1381 2210	20	
1380 2270	6	4 004094 138072

**Spatule »Natur Pur«**

- cet ensemble comprend deux spatules en hêtre de haute qualité
- idéale pour les poêles anti-adhésives

**Espátula »Natur Pur«**

- este set está compuesto de 2 espátulas de madera de haya de alta calidad
- ideal para sartenes revestidas



282 x 47 x 13 mm

**Kochlöffel »Silicone«**

- stabiler Eisenkern - ummantelt mit Silikon
- schont die Oberfläche von Töpfen und Pfannen
- sehr hygienisch

**Cooking spoon »Silicone«**

- solid iron-core - surrounded with silicone
- protects the surface of coated pots and pans
- very hygienic

**Cuillère de cuisine »Silicone«**

- solide noyau en fer entouré de silicone
- ménage la surface des casseroles et des poêles
- très hygiénique

**Cuchara para guisar »Silicone«**

- núcleo de hierro estable revestido de silicona
- protege la superficie de ollas y sartenes
- muy higiénica

Art-Nr. / Art.-No.	VE / SU	EAN
1566 2270	5	4 004094 156670



NEU ab Juni 2016

**Kochlöffel**

- aus hochwertigem Polyamid
- ideal für beschichtete Töpfe und Pfannen

**Cooking spoon**

- from high quality polyamide
- ideal for coated pots and pans

**Cuillère de cuisine**

- en polyamide de haute qualité
- idéal pour les casseroles et les poêles anti-adhésives

**Cuchara para guisar**

- de poliamida de alta calidad
- ideales para ollas y sartenes con revestimiento antiadherente

300 x 50 x 7 mm



Art-Nr. / Art.-No.	VE / SU	EAN
1367 2270	6	4 004094 136771

**Crêpes-Spatel »Gentle« & »Gallant«**

- aus hochwertigem Polyamid
- ideal für beschichtete Töpfe und Pfannen
- Komfort-Soft-Touch-Griff (2966 2270)

**Crêpes-spatula »Gallant«**

- from high quality polyamide
- ideal for coated pots and pans
- comfort-soft-touch handle (2966 2270)

**Spatule à crêpes »Gallant«**

- en polyamide de haute qualité
- idéal pour les casseroles et les poêles anti-adhésives

- poignée confort-soft-touch (2966 2270)

**Espátula para crepes »Gallant«**

- de poliamida de alta calidad
- ideales para ollas y sartenes con revestimiento antiadherente
- con mango cómodo soft-touch (2966 2270)

330 x 35 x 65 mm



Art-Nr. / Art.-No.	VE / SU	EAN
2866 2270	6	4 004094 286674
2966 2270	6	4 004094 296673

**Pfannkuchen-/Omelettwender »Flic-Flac«**

- praktischer Helfer, der sicherstellt, dass die Pfannkuchen beim Wenden nicht auseinanderfallen
- wird gern auch für die Zubereitung von Tortillas eingesetzt

**Pancake-/omelette turner »Flic-Flac«**

- practical helper which ensures that the pancakes will not fall apart when being turned
- is also recommended for being used with tortillas

**Retourneur de crêpes épaisses et omelettes »Flic-Flac«**

- l'assistant pratique pour que les crêpes ne se démontent pas lorsque vous les retournez
- s'utilise également pour la préparation de tortillas

**Volador de sartén para crepes y panqueques »Flic-Flac«**

- un ayudante práctico que garantiza que los panqueques no se despedacen al darlos la vuelta
- se recomienda que se use el volador también para tortillas

Art-Nr. / Art.-No.	VE / SU	Größe / Size	EAN
1526 2270	5	ø 26 cm	4 004094 152672





### Spritzschutz »Picante«

- engmaschiges Netz
- einsetzbar für alle Pfannen und Töpfe bis zu einem max. ø von 300 mm

### Splatter screen »Picante«

- fine-grid mesh
- suitable for all pots and pans up to a diameter of max ø 300 mm

### Protection contre les éclaboussures »Picante«

- belle grille à mailles fines
- s'utilise avec toutes les poêles et casseroles jusqu'à un ø de 300 mm

### Protector contra salpicaduras »Picante«

- mallas finas extraordinarias
- puede usarse para todas las sartenes y ollas hasta un ø máx. de 300 mm



455 x 300 x 7 mm

Art-Nr. / Art.-No.	VE / SU	EAN
1218 2270	6	4 004094 121876



### Haushaltssiebe »Picante«

- mit breiter Edelstahlkrempe
- langer Griff und breiter Auflagerahmen sorgen für sicheren Halt auf Töpfen und Schüsseln

### Strainer »Picante«

- with wide stainless steel brim
- the long handle and the well-worked out wire loop make sure that the sieve sits well on pots and bowls

### Passoire »Picante«

- avec large bord en acier inox
- le long manche et le large cadre permettent à la passoire d'être bien positionnée sur la casserole ou le bol

### Coladores domésticos »Picante«

- con ancho reborde de acero inoxidable
- el mango largo y el marco de apoyo ancho que se puede colocar el colador de forma segura



Art-Nr. / Art.-No.	VE / SU	Größe / Size	EAN
1210 2270	6	ø 7 / 210 x 70 x 42 mm	4 004094 121074
1212 2270	6	ø 12 / 297 x 124 x 70 mm	4 004094 121272
1214 2270	6	ø 16 / 355 x 159 x 80 mm	4 004094 121470
1216 2270	6	ø 20 / 400 x 200 x 100 mm	4 004094 121678



### Spritzschutz »Traditionell«

- für alle Pfannen und Töpfe bis zu einem max. ø von 290 mm
- mit Aufhängöse im Griff

### Splatter screen »Traditionell«

- for all pots and pans up to a diameter of 290 mm
- with hanging loop for convenient storage

### Protection contre les éclaboussures »Traditionell«

- pour toutes les poêles et casseroles jusqu'à 290 mm de diamètre
- avec trou d'accrochage dans le manche

### Protector contra salpicaduras »Traditionell«

- puede usarse para todos los sartenes y ollas hasta un ø máx. de 290 mm
- con ojete en el mango para colgar



444 x 297 x 5 mm

Art-Nr. / Art.-No.	VE / SU	EAN
1286 2270	6	4 004094 128677



### Haushaltssieb »Traditionell«

- praktisches Haushaltssieb mit zwei Auflagerasten
- mit Aufhängöse im Griff

### Strainer »Traditionell«

- strainer with two wire loops for rest on pots and bowls
- with hanging loop for convenient storage

### Passoire »Traditionell«

- passoire domestique pratique à deux crans
- avec trou d'accrochage dans le manche

### Coladores domésticos »Traditionell«

- colador doméstico práctico con dos acanaduras para apoyar sobre ollas y bols
- con ojete en el mango para colgar



Art-Nr. / Art.-No.	VE / SU	Größe / Size	EAN
1281 2270	6	ø 7 / 205 x 70 x 30 mm	4 004094 128172
1282 2270	6	ø 10 / 260 x 112 x 35 mm	4 004094 128271
1283 2270	6	ø 16 / 308 x 160 x 75 mm	4 004094 128370
1284 2270	6	ø 18 / 327 x 178 x 70 mm	4 004094 128479
1285 2270	6	ø 20 / 347 x 197 x 75 mm	4 004094 128578











**Haushaltssieb »Spezial«**  
 • leichtes Kunststoffsieb mit zwei praktischen Auflagern für sicheren Halt auf Tassen, Töpfen und Schüsseln  
 • mit resistantem Nylon-Gewebe

**Strainer »Special«**  
 • light mesh strainer with two hooks for safe hold on cups, pots and bowls  
 • made with durable and long lasting nylon

**Passoire »Spezial«**  
 • passoire domestique légère avec deux crochets pratiques pour un maintien en toute sécurité sur les tasses, les casseroles et les bols  
 • avec du tissu en nylon résistant

**Coladores domésticos »Special«**  
 • colador ligero de plástico con dos soportes prácticos para un apoyo seguro sobre tazas, ollas y fuentes  
 • con tejido de nylon resistente

Art-Nr. / Art.-No.	VE / SU	Größe / Size	EAN
1287 2270 	6	ø 8 / 195 x 89 x 31 mm	 4 004094 128776
1288 2270 	6	ø 14 / 265 x 138 x 57 mm	 4 004094 128875
1289 2270 	6	ø 18 / 325 x 178 x 70 mm	 4 004094 128974





310 x 72 x 72 mm

**Schneebeesen »Gallant«**  
 • aus hochwertigem Polyamid  
 • ideal für beschichtete Töpfe und Pfannen  
 • Komfort-Soft-Touch-Griff

**Whisk »Gallant«**  
 • from high quality polyamide  
 • ideal for coated pots and pans  
 • comfort-soft-touch handle

**Fouet »Gallant«**  
 • en polyamide de haute qualité  
 • idéal pour les casseroles et les poêles anti-adhésives  
 • poignée confort-soft-touch  
**Batidor »Gallant«**  
 • de poliamidia de alta calidad  
 • ideales para ollas y sartenes con revestimiento antiadherente  
 • con mango cómodo soft-touch

Art-Nr. / Art.-No.	VE / SU	EAN
2968 2270 	6	 4 004094 296871





275 x 70 x 70 mm

**Schneebeesen**  
 • aus hochwertigem Polyamid  
 • ideal für beschichtete Töpfe und Pfannen

**Whisk**  
 • from high quality polyamide  
 • ideal for coated pots and pans

**Fouet**  
 • en polyamide de haute qualité  
 • idéal pour les casseroles et les poêles anti-adhésives

**Batidor**  
 • de poliamidia de alta calidad  
 • ideales para ollas y sartenes con revestimiento antiadherente

Art-Nr. / Art.-No.	VE / SU	EAN
1368 2270 	6	 4 004094 136870











**Schneebeesen**  
 • aus Edelstahl

**Whisk**  
 • from stainless steel

**Fouet**  
 • en acier inox

**Batidor**  
 • en acero inox

Art-Nr. / Art.-No.	VE / SU	Größe / Size	EAN
1250 2211 	6	170 x 35 x 35 mm	 4 004094 125010
1251 2211 	6	230 x 45 x 42 mm	 4 004094 125119
1252 2211 	6	280 x 62 x 62 mm	 4 004094 125218
1253 2211 	6	320 x 62 x 62 mm	 4 004094 125317





### Abgießhilfe Edelstahl

- geeignet für alle Topfgrößen bis 26 cm Durchmesser
- die eingeformten Griffmulden garantieren sicheren Halt

### Pan strainer stainless steel

- suitable for all pot sizes to 26 cm diameter
- the recessed grips on either side keep hands away from hot water

### Couvercle passoire acier inoxydable



- convient à toutes les tailles de casseroles jusqu'à 26 cm de diamètre
- les poignées encastrées de chaque côté garantissent un parfait maintien

### Escurridor semiesférico acero inoxidable

- se apropia para ollas de todos los tamaños hasta de 26 cm de diámetro
- las agarraderas moldeadas garantizan un agarre seguro



337 x 130 x 9 mm

Art-Nr. / Art.-No.	VE / SU	EAN
1639 2260 	6	 4 004094 163968



### Dünsteinsatz

- für Töpfe von ø 14 bis 23 cm beliebig verstellbar
- zum Dämpfen, wasserarmen Garen, Blanchieren etc.

### Panier vapeur

- ajustable ø de 14 à 23 cm
- pour étuver, cuire sans eau, blanchir etc.

### Steaming basket



- from ø 14 to 23 cm freely adjustable
- for steaming, less-water cooking, blanching etc.

### Inserto para vapor

- ø 14 hasta 23 cm, ajustable libremente
- para guisar al vapor, cocer con menos agua, escaldar, etc.



140 x 140 x 70 mm

Art-Nr. / Art.-No.	VE / SU	EAN
1259 2270 	4	 4 004094 125973



### Crème Brûlée/Flambier Brenner

- zum Karamellisieren und Gratiniere
- Größe der Flamme einstellbar
- Einhandbedienung
- Kindersicherung
- Gasfüllung nicht im Lieferumfang enthalten

### Chalumeau à gaz pour crème brûlée

- pour caraméliser et gratiner
- taille de la flamme ajustable
- utilisation d'une seule main
- avec sécurité enfants
- remplissage de gaz non inclus

### Culinary Torch



- for caramelizing and gratins
- adjustable flame size
- one-handed operation
- with child safety device
- gas filling not included in delivery

### Soplete culinario

- para caramelizar y gratinar
- tamaño de la llama ajustable
- operación con una mano
- con seguro a prueba de niños
- llenado de gas no incluido en el suministro



80 x 60 x 142 mm

Art-Nr. / Art.-No.	VE / SU	EAN
1239 2280 	3	 4 004094 123986



### Porzellanschälchen

- Set mit 4 Porzellanschälchen
- ideal für die Zubereitung von Crème Brûlée oder das Anrichten von anderen Süßspeisen

### Couppelles en porcelaine

- ensemble de 4 coupelles en porcelaine
- idéales pour préparer de la crème brûlée ou d'autres desserts

### Porcelain dishes



- set of 4 porcelain dishes
- ideal for preparing Crème Brûlée or desserts in general

### Fuentecitas de porcelana

- set con 4 fuentecitas de porcelana
- ideal para preparar crema catalana u otros postres



135 x 81 x 27 mm

Art-Nr. / Art.-No.	VE / SU	EAN
2330 2260 	4	 4 004094 233067









- Mehrzweckpresse »Extracta«**
- für Zwiebeln und Knoblauch (mit Einlegesieb)
  - mit Funktionselementen am Griff auch als Kirschkernzer, Nussknacker, Fischschuppe nutzbar

**All purpose press »Extracta«**

- ideal for onions and garlic (with insert)
- with functional elements at the handles also helpful as cherry pitter, nutcracker and fish scaler

Art-Nr. / Art.-No.	VE / SU	EAN
3000 2260 	5	 4 004094 300066



- Presse multi-usages »Extracta«**
- pour les oignons et l'ail (avec insert)
  - éléments fonctionnels au manche utilisables comme dénoyauteur à cerises, casse-noix, écailleur à poisson

**Prensa multiuso »Extracta«**

- ideal para cebollas y ajo con tamiz de inserción
- con elementos funcionales en los mangos para deshuesar cerezas, cascar nueces y descamar pescado





160 x 50 x 33 mm

- Knoblauchpresse »Biopress«**
- die kompakte Knoblauchpresse
  - konsequente Funktionalität

**Garlic press »Biopress«**

- the compact garlic press
- consequent functionality

Art-Nr. / Art.-No.	VE / SU	EAN
3010 2260 	5	 4 004094 301063



- Presse-ail »Biopress«**
- le presse-ail compact
  - fonctionnalité cohérente

**Prensa de ajos »Biopress«**

- la prensa de ajos compacta
- funcionalidad consecuente





152 x 25 x 31 mm

- Knoblauchpresse »Novapress«**
- mit präzise gefrästem Pressbecher und Pressstempel für höchste Ergiebigkeit

**Garlic press »Novapress«**

- with precision milled bowl and press piston for best results

Art-Nr. / Art.-No.	VE / SU	EAN
3030 2260 	5	 4 004094 303067



- Presse-ail »Novapress«**
- avec chambre précisément fraisée et poussoir pour un rendement maximal

**Prensa de ajos »Novapress«**

- con copa y pistón de prensado fresados con precisión se consiguen máximos rendimientos





165 x 40 x 32 mm

- Knoblauchscheider und Schäler-Set »Knofix«**
- besteht aus 1x Schälrolle aus Silikon & 1x Knoblauchscheider mit 20 Messern
  - zerkleinert mit wenigen Drehungen Knoblauch, Zwiebeln oder Kräuter

**Garlic cutter and peeler-set »Knofix«**

- comprises 1 peeling roller from silicone & 1 garlic cutter with 20 knives
- chops garlic, onions or herbs with just a couple of turns

Art-Nr. / Art.-No.	VE / SU	EAN
1194 2260 	6	 4 004094 119460



- Coupe-ail et ensemble d'éplucheurs »Knofix«**
- se compose de 1x tube épluche-ail en silicone & 1x coupe-ail avec 20 couteaux
  - écrase en quelques tours ail, oignons ou herbes

**Set pelador y picador de ajos »Knofix«**

- se compone de 1x rollo pelador de silicona & 1x picador de ajos con 20 cuchillas
- tritura ajo, cebollas o hierbas con pocos giros



130 x 90 x 90 mm

- Knoblauchscheider »Peel-Fix«**
- befreit die Knoblauchzehen schnell von ihrer Haut
  - schützt die Hände vor Geruch

**Garlic peeler »Peel-Fix«**

- helps to remove skin from garlic cloves
- hands stay free from odour



- Epluche-ail »Peel-Fix«**
- la peau se retire rapidement de la gousse d'ail
  - ainsi les mains ne sentent pas l'ail

**Pelador de ajos »Peel-Fix«**

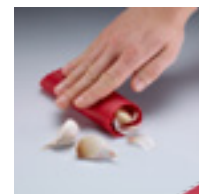
- se quita rápidamente la piel de los dientes de ajo
- así se protegen las manos del olor



133 x 34 x 34 mm

Art-Nr. / Art.-No.	VE / SU	EAN
1192 2280 	6	 4 004094 119286



**Brat- und Backmatte »Crispy«**

- die strukturierte Oberfläche sorgt für eine gleichmäßige Wärmeverteilung
- ideal für die gesund fettarme Zubereitung - austretendes Fett läuft nach unten ab
- hochgezogener umlaufender Rand, damit der Ofen sauber bleibt



**Baking mat »Crispy«**

- the structured surface ensures uniform heat distribution
- ideal for healthy, low-fat cooking - any oil that emerges runs away downwards
- the circumferential rim is drawn up extra-high so that the baking tray remains clean

**Tapis de cuisson »Crispy«**

- la surface structurée garantit une répartition uniforme de la chaleur
- idéal pour une cuisson saine - pauvre en matières grasses
- bord périphérique relevé pour que la plaque de cuisson reste propre

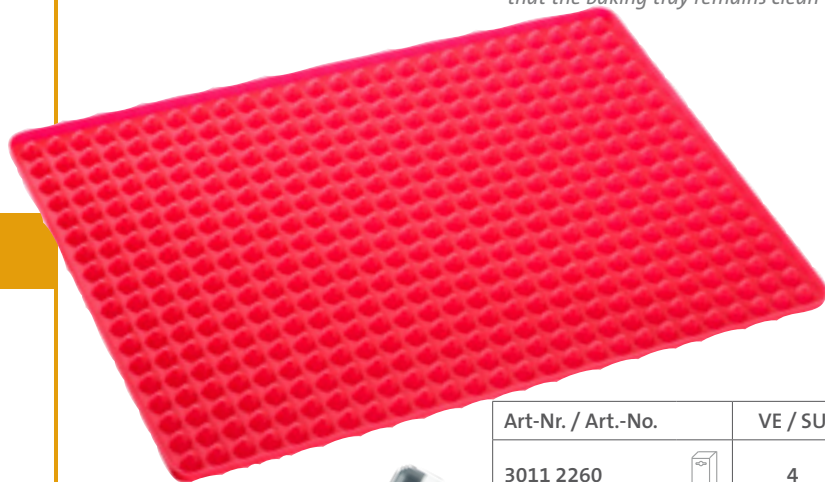

**Esterilla horno »Crispy«**

- la superficie estructurada proporciona un reparto homogéneo del calor
- ideal para la preparación sana de poca grasa - la grasa que se produce sale hacia abajo
- borde circundante extremadamente alto para que la bandeja de horno permanezca limpia



280 x 400 x 10 mm



Art-Nr. / Art.-No.	VE / SU	EAN
3011 2260 	4	 4 004094 301162



247 x 52 x 40 mm

**Fleischhammer »Famos«**

- mit Eisenkern
- zwei unterschiedliche Schlagflächen (grob und fein)

**Attendrisseur de viande »Famos«**



- avec noyau de fer
- deux surfaces de frappe différentes (grosse et fine)

**Meat hammer »Famos«**

- with iron core
- two different surfaces (coarse and fine)

**Mazo para carne »Famos«**

- con núcleo de hierro
- con dos diferentes superficies de impacto (grueso y fino)

Art-Nr. / Art.-No.	VE / SU	EAN
1074 2270 	5	 4 004094 107474



240 x 64 x 45 mm

**Fleischhammer »Robusto-Spezial«**

- besonders schwere Ausführung
- zwei unterschiedliche Schlagflächen - eine mit feinem Relief, um das Fleisch zu plätten - ohne die Faser zu verletzen; eine zweite Schlagfläche mit grober Struktur

**Attendrisseur de viande »Robusto-Spezial«**



- version particulièrement lourde
- deux surfaces de frappe différentes – une à structure fine pour aplatir la viande sans couper les fibres et une deuxième à structure grossière

**Meat hammer »Robusto-Spezial«**

- extra large and heavy version
- two different hitting surfaces - one with a fine structure for simply flattening the meat without cutting into the fibre; a second hitting surface with coarse structure

**Mazo para carne »Robusto-Spezial«**

- versión especialmente pesada
- dos diferentes superficies de impacto – una con un relieve suave, para planchar la carne – sin lesionar la fibra; otra superficie de impacto con una estructura gruesa

Art-Nr. / Art.-No.	VE / SU	EAN
6200 2260 	3	 4 004094 620065

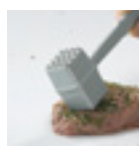

215 x 60 x 35 mm

**Fleischhammer »Robusto«**

- sehr stabil und ausgewogen
- zwei unterschiedliche Schlagflächen (grob und fein) zur Fleischmürbung

**Attendrisseur de viande »Robusto«**



- très solide et équilibré
- deux surfaces de frappe différentes (grosse et fine) pour attendrir la viande

**Meat hammer »Robusto«**

- solid and well balanced
- two different surfaces for tenderizing meat (coarse and fine pyramid shaped points)

**Mazo para carne »Robusto«**

- muy estable y equilibrado
- dos diferentes superficies de impacto (grueso y fino) para mango ancho – bien modelado

Art-Nr. / Art.-No.	VE / SU	EAN
6210 2260 	5	 4 004094 621062





### Steakhammer »Steakmaster«

- mit 2 Schlagflächen
- eine grob strukturierte Seite zum Fleischmürben und Einklopfen von Gewürzen
- eine mit Messern gespikete Seite zum Steaken

### Meat- and steakhammer »Steakmaster«

- with 2 hitting surfaces
- one coarsely structured for tenderizing meat and for bringing in herbs
- one spiked with knives

Art-Nr. / Art.-No.	VE / SU	EAN
6220 2260 	3	4 004094 622069



### Attendrisseur à steak »Steakmaster«

- avec 2 surfaces de frappe
- une grossièrement structurée pour attendrir la viande et introduire des épices
- et une surface dotée de couteaux

### Mazo para bistec »Steakmaster«

- con 2 diferentes superficies de impacto
- una de estructura gruesa para ablandar la carne e integrar especias
- y una dotada de cuchillas



238 x 74 x 45 mm

### Fleischhammer »Fatty«

- besonders schwere Ausführung: 620 g
- zwei unterschiedliche Schlagflächen (ø 75 mm) - eine mit sanftem Relief; eine Zweite mit glatter Oberfläche

### Meat hammer »Fatty«

- extra large and heavy version: 620 g
- two different hitting surfaces (ø 75 mm) - one with a fine structure; a second one with a flat surface

Art-Nr. / Art.-No.	VE / SU	EAN
6212 2270 	3	4 004094 621277



### Attendrisseur »Fatty«

- Modèle particulièrement lourd : 620 g
- deux surfaces de frappe - une à structure fine; l'autre à surface lisse pour aplatir

### Mazo para carne »Fatty«

- extra modelo especialmente pesado: 620g
- dos superficies de golpeo diferentes - una con unrelieve suave - otra de impacto lisa para planchar



280 x 107 x 75 mm

### Küchenbeil und Fleischhammer »Friomaster«

- Spezial-Küchenwerkzeug
- eine Schlagfläche zur Fleischmürbung
- ein gehärtetes, geschliffenes Hackbeil zum Trennen - auch für tiefgefrorenes Fleisch
- bitte per Hand reinigen

### Combined cleaver and meat hammer »Friomaster«

- the kitchen-tool for the specialist
- one hammer-surface for tenderizing meat
- and a specially hardened blade for cleaving - also for frozen meat
- please wash by hand

Art-Nr. / Art.-No.	VE / SU	EAN
6230 2260 	3	4 004094 623066



### Couperet et attendrisseur de viande »Friomaster«

- outil de cuisine spécial
- une surface de frappe pour attendrir la viande
- un couperet trempé pour couper - également pour la viande surgelée
- à nettoyer à la main

### Hacha de cocina y mazo para carne »Friomaster«

- el útil de cocina especial
- una superficie de impacto para ablandar la carne
- un hacha templado y afilado para separar - también en carne congelada
- lavado a mano



273 x 110 x 41 mm



### Fleischklopfer »Patscher«

- extra groß und schwer
- mit glatter Schlagfläche
- zum Flachklopfen von Fleischstücken - ohne die Faser zu verletzen
- Handwäsche empfohlen

### Meat pounder »Patscher«

- extra large and heavy
- with even surface for flattening meat without cutting into the fibre
- hand wash recommended

### Aplatisseur de viande »Patscher«

- extrêmement grand et lourd
- avec surface de frappe lisse
- pour aplatir la viande sans couper les fibres
- lavage à la main recommandé

### Aplastador de carne »Patscher«

- extra grande y pesado
- con superficie de impacto lisa
- para aplastar trozos de carne - sin lesionar la fibra
- se recomienda lavarlo a mano



290 x 94 x 34 mm

Art-Nr. / Art.-No.	VE / SU	EAN
6214 2270 	6	4 004094 621475





135 x 66 x 19 mm

**Restehalter / Schneidhilfe**

- schützt die Finger vor Verletzungen
- für das Schneiden von Braten, Zwiebeln etc.
- 10 spitze Edelstahladeln halten das Schneidgut sicher fest

**Slicing aid**



- helps to protect the fingers from injuries
- for holding roast meat, onions etc. whilst slicing
- 10 sharp stainless steel prongs hold the food

**Assistant de coupe**

- pour protéger les doigts des blessures
- pour couper la viande, les oignons etc.
- 10 aiguilles pointues en inox maintiennent fermement l'aliment

**Sujetador de restos / auxiliar de corte**

- ideal para proteger los dedos contra lesiones
- para cortar asados, cebollas etc.
- 10 agujas puntiagudas de inox sujetan el alimento

Art-Nr. / Art.-No.	VE / SU	EAN
6299 2260 	6	 4 004094 629969



255 x 65 x 75 mm

**Tranchierhilfe »Tranchetta«**

- zum Schneiden von Braten, Wurst etc.
- gleichmäßige Scheiben, kein Verletzungsrisiko
- platzsparende Aufbewahrung durch Scharniersperre

**Carving aid »Tranchetta«**



- for slicing roast meat, sausage etc.
- fast action, equal slices, no injury risk
- space saving locking spring

**Aide au tranchage »Tranchetta«**

- pour couper la viande, les saucisses etc.
- coupe uniforme, pas de risque de blessure
- rangement peu encombrant grâce à la charnière de verrouillage

**Utensilio auxiliar para trincar »Tranchetta«**

- para cortar asados, embutidos, etc.
- lonjas uniformes, ningún riesgo de lesiones
- gracias al muelle de bloqueo se puede ahorrar sitio al guardarlo

Art-Nr. / Art.-No.	VE / SU	EAN
6300 2260 	3	 4 004094 630064



252 x 50 x 15 mm

**Geflügelschere »Classic«**

- stabile Schere mit Federmechanismus
- Scherenblätter geschmiedet und geschliffen
- mit Verriegelung für sichere Aufbewahrung in der Schublade

**Poultry shears »Classic«**



- strongly constructed shears with spring mechanism
- forged and professionally ground cutting blades
- locking device for secure storage in the drawer

**Ciseaux à volaille »Classic«**

- ciseaux solides avec mécanisme à ressort
- lames forgées et affûtées
- avec dispositif de verrouillage pour une conservation sécurisée dans le tiroir

**Tijeras de aves »Classic«**

- tijeras estables con mecanismo de muelle
- hojas están forjadas y afiladas
- con bloqueo para guardar las tijeras de un modo seguro en el cajón

Art-Nr. / Art.-No.	VE / SU	EAN
1371 2260 	3	 4 004094 137167



255 x 50 x 15 mm

**Geflügelschere »Modern«**

- mit Innenfeder
- geschliffene Klinge
- mit Verriegelung für sichere Aufbewahrung in der Schublade

**Poultry shears »Modern«**



- with inner spring
- ground blades
- with locking device for save storage in the drawer

**Ciseaux à volaille »Modern«**

- avec ressort intérieur
- lame affûtée
- avec dispositif de verrouillage pour une conservation sécurisée dans le tiroir

**Tijeras de aves »Modern«**

- con muelle interno
- hoja afilada
- con bloqueo para guardar las tijeras de un modo seguro en el cajón

Art-Nr. / Art.-No.	VE / SU	EAN
1373 2280 	6	 4 004094 137389





### Hähnchengriller

- röstet das Hähnchen aufrecht stehend - lässt Fett somit abtropfen
- Teller antihaft-beschichtet
- für platzsparende Aufbewahrung auseinander zu nehmen

### Vertical chicken roaster

- roasts poultry standing up to allow fats to drip off
- plate with non-stick coating
- disassembles for space saving storage

### Rôtissoire vertical à poulet



- rôtit le poulet en position verticale et permet ainsi à la graisse de s'égoutter
- plateau à revêtement anti-adhésif
- démontable pour rangement facile

### Asador de pollo

- se asa el pollo en posición erguida goteando la grasa
- platillo con revestimiento antiadherente
- puede desarmarse para guardarlo ahorrando sitio



207 x 207 x 196 mm

Art-Nr. / Art.-No.	VE / SU	EAN
1515 2260 	3	 4 004094 151569



### Hamburgermaker »Uno«

- für perfekte Hamburger ø 11 cm
- mit Rillen – für den typischen Burger-Look

### Hamburger maker »Uno«

- for perfect hamburgers ø 11 cm
- with grooves – for the typical burger look



### Machine à hamburgers »Uno«

- pour de parfaits hamburgers ø 11 cm
- avec rainures pour retrouver l'aspect typique du hamburger

### Molde para hamburguesas »Uno«

- para hamburguesas perfectas ø de 11 cm
- con ranuras, para conseguir el auténtico aspecto de la hamburguesa



Art-Nr. / Art.-No.	VE / SU	EAN
6231 2260 	6	 4 004094 623165



115 x 115 x 80 mm

### Hamburgermaker

- die Burger-Presse formt wohldimensionierte, gleichförmige Fleischfrikadellen mit den typischen Rillen
- mit Hebevorrichtung für leichte Entnahme

### Hamburger press



- the burger press delivers perfectly shaped burgers complete with grooves for the authentic burger look
- with practical lifting aid for easy removal

### Presse-hamburger

- permet de confectionner des steaks à hamburger bien dimensionnés aux rainures typiques
- avec mécanisme de levage pour un retrait facile

### Prensa para hamburguesas

- con esta prensa se forman hamburguesas uniformes bien dimensionadas con las ranuras típicas
- con extractor para poder sacarlas fácilmente

Art-Nr. / Art.-No.	VE / SU	EAN
6233 2260 	4	 4 004094 623363

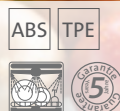

160 x 148 x 57 mm





207 x 117 x 125 mm

- Fett-Trenn-Kanne**
- trennt Fett von Bratensäften oder Saucen
  - mit Skala für das Abmessen von bis zu 1000 ml

- Fat-/Gravy separator**
- separates fat from gravies and sauces
  - with scale for measuring up to 1000 ml

- Séparateur de graisse**
- sépare la graisse des jus de cuisson et des sauces
  - avec graduations pour mesurer jusqu'à 1000 ml

- Jarra separadora de grasa**
- separa la grasa de salsas y jugos del asado
  - con escala para medir hasta 1000 ml

Art-Nr. / Art.-No.	VE / SU	EAN
3071 2260 	3	 4 004094 307164

SAN

Made in GERMANY 



225 x 139 x 160 mm

- Fett-Trenn-Kanne mit Sieb**
- trennt Fett von Bratensäften und Saucen
  - verfügt über ein nützliches Sieb
  - mit Skala für das Abmessen von bis zu 1000 ml

- Fat-separation jug with strainer**
- separates fat from gravies and sauces
  - has a practical strainer
  - with scale for measuring up to 1000 ml

- Séparateur de graisse avec passoire**
- sépare la graisse des jus de cuisson et des sauces
  - dispose d'une passoire
  - avec graduations pour mesurer jusqu'à 1000 ml

- Jarra separadora de grasa con colador**
- separa la grasa de salsas y jugos del asado
  - dispone de un colador muy práctico
  - con escala para medir hasta 1000 ml

Art-Nr. / Art.-No.	VE / SU	EAN
3075 2260 	6	 4 004094 307560

SAN

PE

Made in GERMANY 



190 x 10 x 10 mm

- Spicknadel**
- mit gezahntem Endstück zum Festklemmen des Speckstreifens

- Larding needle**
- with dented part for holding bacon

- Aiguille à larder**
- à extrémité dentée pour coincer le lard

- Aguja para mechar**
- con parte dentada para sujetar el bacón

Art-Nr. / Art.-No.	VE / SU	EAN
1267 2270 	5	 4 004094 126772

INOX





180 x 6 x 4 mm

- Dressiernadel**
- gerade Form
  - angespitzt
  - für das Verschließen von gefülltem Braten und Geflügel
  - mit großem Nadelöhr

- Trussing needle**
- straight shape
  - pointed
  - for lacing up stuffed poultry or roast
  - with easy to thread eye

- Aiguille à brider**
- forme droite
  - pointue
  - pour fermer les rôtis farcis et les volailles
  - grand trou d'aiguille

- Aguja para coser**
- forma recta
  - puntiaguda
  - para cerrar asados rellenos y aves
  - con ojo de aguja grande

Art-Nr. / Art.-No.	VE / SU	EAN
1268 2270 	10	 4 004094 126871

INOX





280 x 62 x 62 mm

- Bratensaftrispritze »Kunststoff«**
- mit Skaleneinteilung, max. 30 ml
  - zum Benetzen des Bratguts von außen

- Baster »Kunststoff«**
- with scale, max. 30 ml
  - for easy basting of roast meat on the surface

- Seringue à jus »Kunststoff«**
- avec graduations, max. 30 ml
  - pour arroser facilement le rôti de l'extérieur

- Humectador de carne con jugos de asados »Kunststoff«**
- con escala, max. 30 ml
  - para humectar el asado de fuera

Art-Nr. / Art.-No.	VE / SU	EAN
1525 2270 	5	 4 004094 152573

PP

SI





### Bratenspritzze 3tlg. »Edelstahl«

- Set bestehend aus Edelstahl-Saugrohr mit Silikonbalg, Injektionsnadel und Reinigungsbürste
- zum Verfeinern des Bratguts von innen und außen

### Baster set, 3pcs »Edelstahl«

- set consisting of stainless suction pipe with silicone bulb, injection needle and cleaning brush
- for easy basting on the surface and from inside

### Seringue à jus »Edelstahl«, 3pièces

- se composant d'un tube d'aspiration en inox avec soufflet en silicone, d'une aiguille d'injection et d'une brosse de nettoyage
- pour arroser facilement

### Humectador de carne con jugos de asados »Edelstahl«, 3 piezas

- set compuesto de tubo aspirante de acero inoxidable con fuelle de silicona y cepillo limpiador
- así se puede mejorar el asado desde fuera y dentro

Art-Nr. / Art.-No.	VE / SU	EAN
6140 2260	3	4 004094 614064



275 x 56 x 56 mm

### Marinierspritze

- abnehmbare Nadel mit Schnellverschluss
- mit Skala
- Maßeinheit bis 50 ml / 1 1/2 OZ

### Seringue à marinade

- aiguille en acier inox facile à démonter
- avec graduations
- capacité: 50 ml / 1 1/2 OZ

### Marinating syringe

- with easy-take-off needle
- with scale
- unit up to 50 ml / 1 1/2 OZ

### Jeringa para escabechar

- aguja de la jeringa se desmonta con rapidez
- con escala de medición
- cabida: 50 ml / 1 1/2 OZ

Art-Nr. / Art.-No.	VE / SU	EAN
6142 2280	4	4 004094 614286



225 x 78 x 41 mm

### Kartoffel-Thermometer-Set »Pommi«

- zeigt an, wann die Folienkartoffel im Innern perfekt durchgegart ist
- aus pflegeleichtem Edelstahl

### Thermomètre à pommes de terre »Pommi«

- montre quand la pomme de terre parfaitement cuite
- en acier facile d'entretien

### Potato thermometer-Set »Pommi«

- shows when your jacket potato is cooked through nicely inside
- made of easy-care stainless steel

### Termómetro para patatas »Pommi«

- indica quando la patata esta perfectamente cocida
- de acero inoxidable fácil de limpiar

Art-Nr. / Art.-No.	VE / SU	EAN
1242 2280	6	4 004094 124280



70 x 36 x 30 mm

### Bratenthermometer

- zeigt die Temperatur im Innern des Gargutes an
- mit Symbolen für das einfache Ablesen der richtigen Temperatur bei unterschiedlichen Fleischsorten

### Thermomètre à viande

- indique la température à l'intérieur de l'aliment cuit
- avec symboles pour lire facilement la bonne température de tous les types de viande

### Roasting thermometer

- shows the temperature inside the cooked food
- with symbols for the correct roast-temperature for different types of meat

### Termómetro para asados

- indica la temperatura en el interior del asado
- con símbolos para la fácil lectura de la temperatura correcta para diferentes clases de carne

Art-Nr. / Art.-No.	VE / SU	EAN
1269 2270	5	4 004094 126970



140 x 55 x 55 mm

### Steakthermometer-Set, 2tlg.

- zur Kontrolle der gewünschten Kerntemperatur
- Thermometer leicht zu unterscheiden durch verschiedene Farben
- Messbereich: Rare, Medium und Well

### Ensemble de thermomètres à steak, 2 pièces

- pour contrôler la température désirée
- thermomètres sont faciles à différencier grâce aux différentes couleurs
- plage de mesure: rare, medium et well

### Steakthermometer set, 2 pc

- to control the desired core-temperature
- thermometers can easily be distinguished by the different colours
- measuring range: rare - medium - well

### Set de termómetros para bistec, 2 piezas

- para comprobar la temperatura deseada
- fácil de distinguir gracias a los diversos colores
- gama de medición: Rare - poco hecho, Medium - al punto y Well - muy hecho



Art-Nr. / Art.-No.	VE / SU	EAN
1248 2280	6	4 004094 124884



weitere Informationen

70 x 27 x 27 mm



- Einstichthermometer**
- Temperaturfühler aus Edelstahl
  - Wechsel zwischen °C und °F möglich
  - Messbereich: 0° C bis +200°C
  - automatische Ausschaltfunktion nach 5 Min.
  - inklusive Batterie 1 x CR 2032, 3V



- Probe thermometer**
- temperature sensor from stainless steel
  - switch between °C and °F possible
  - measuring range: 0° C to +200° C / 32° C to 392° F
  - automatic switch-off function after 5 minutes
  - Includes batterie 1 x CR 2032, 3V

- Thermomètre à sonde**
- sonde de température en acier inoxydable
  - changement possible entre °C et °F
  - plage de mesure: 0° C à +200° C
  - mise hors tension automatique après 5 minutes
  - pile incluse 1 x CR 2032, 3V

- Termómetro pincha carne**
- sonda térmica de acero inoxidable
  - es posible el cambio entre °C y °F
  - gama de medición: 0° C hasta +200° C
  - desconexión automática (5 minutos)
  - incluida pila 1 x CR 2032, 3V



277 x 25 x 11 mm

Art-Nr. / Art.-No.	VE / SU	EAN
1278 2280 	6	 4 004094 127885





85 x 75 x 34 mm

- Ofenthermometer**
- zur Kontrolle der Ofentemperatur
  - zum Einhängen am Rost oder Backblech
  - Messbereich: 50° C bis +300°C

- Oven thermometer**
- to control the set oven temperature
  - can be hooked into the baking tray or grid
  - measuring range: 50° C to +300° C / 122° C to 572° F

- Thermomètre à four**
- pour contrôler la température du four
  - peut être accroché à la grille ou à la plaque du four
  - plage de mesure: 50° C à +300°C

- Termómetro para horno**
- con este ayudante, se tiene a la vista
  - puede colgarse en la parrilla o chapa de hornear
  - gama de medición: 50° C hasta +300° C

Art-Nr. / Art.-No.	VE / SU	EAN
1290 2260 	6	 4 004094 129063



80 x 80 x 15 mm

- Digitales Bratenthermometer**
- zum Aufstellen oder Hängen (mit Magnet)
  - Alarmfunktion bei Erreichen der festgesetzten Kerntemperatur, Messbereich: 0° C bis +250°C
  - Umschaltbar auf Zeitmesser
  - inklusive Batterie AAA, 1,5 V
- Digital cooking thermometer**
- the thermometer can stand upright or hang (with magnet)
  - alarm function when the set core temperature is reached, measuring range: 0° C to +250° C / 32° C to 482° F
  - can switch to timer function
  - incl. battery AAA, 1,5 V

- Thermomètre à viande digital**
- à poser ou à accrocher (avec aimant)
  - fonction alarme lorsque la température à cœur programmée est atteinte, plage de mesure: 0° C à +250°C
  - commutable sur chronomètre
  - pile incluse AAA, 1,5 V
- Termómetro digital para asados**
- para poner de pie o colgar (con imán)
  - emite una alarma al alcanzar la temperatura del núcleo ajustada, gama de medición: 0° C hasta +250° C
  - conmutable a cronómetro
  - incluida pila AAA, 1,5 V

Art-Nr. / Art.-No.	VE / SU	EAN
1291 2280 	6	 4 004094 129186





**Digitales Funk-Bratenthermometer**

- mit einer Vielzahl von voreingestellten Kerntemperaturen
- tragbarer Empfänger sorgt für Mobilität - Reichweite bis 30 m
- beleuchtetes Display
- Timer-/Stoppuhr Funktion
- Temperaturanzeige in °C oder °F
- Messbereich von 0°C bis 250°C
- inkl. 4 Batterien, AAA, 1,5V

*Digital wireless roasting thermometer*

- features many pre-set core temperatures
- mobile receiver for great mobility - range up to 30 m
- illuminated display
- timer/stopwatch function
- temperature shows in °C or °F
- temperature range: 0°C - 250°C
- incl. 4 batteries (wire: 105 mm), AAA, 1,5V

**Thermomètre à rôtir digital et sans fil**



- avec une multitude de températures à cœur préprogrammées
- récepteur portable pour plus de mobilité - portée jusqu'à 30 m
- écran illuminé
- fonction Timer/chrono
- affichage de la température en °C ou °F
- plage de mesure: 0° C - 250° C
- 4 piles incluses (cordon: 105 mm), AAA, 1,5V

*Radio termómetro digital para asados*

- con un sinnúmero de temperaturas del núcleo preajustadas
- el receptor portátil proporciona movilidad - alcance hasta 30 m
- display iluminado
- función de reloj/cronómetro
- visualización de la temperatura en °C o °F
- gama de medición: 0° C - 250° C
- incluidas 4 pilas (cordel: 105 mm), AAA, 1,5V



130 x 76 x 55 mm

Art-Nr. / Art.-No.	VE / SU	EAN
1292 2260 	3	 4 004094 129261



Bitte beachten Sie auch:  
weitere Thermometer  
Seite 225

---

Please see as well:  
more thermometers  
page 225

**Kurzzeitmesser**

- mit Magnet auf der Rückseite
- sekundengenaue Einstellung bis 99 Minuten und 59 Sekunden
- inklusive Batterie, 1 x LR 1130, 1,5V

*Timer*

- with magnet on reverse
- exact to the second setting up to 99 minutes and 59 seconds
- includes batterie, 1 x LR 1130, 1,5V

**Chronomicromètre**



- avec aimant au dos
- réglage à la seconde près jusqu'à 99 minutes et 59 secondes
- pile incluse, 1 x LR 1130, 1,5V

*Contador de tiempo corto*

- con imán en el dorso
- ajuste con precisión de segundo hasta 99 minutos y 59 segundos
- incluida pila, 1 x LR 1130, 1,5V



70 x 53 x 8 mm

Art-Nr. / Art.-No.	VE / SU	EAN
1088 2280 	6	 4 004094 108884



**Timer »Futura«**

- 60 Minuten-Timer
- mit Magnet auf der Rückseite

*Timer »Futura«*

- 60 minutes-timer
- with magnet on the back



**Minuteur »Futura«**

- 60 minutes - minuteur
- avec aimant à l'arrière

*Temporizador »Futura«*

- 60 minutos-temporizador
- con imán en la parte trasera



Art-Nr. / Art.-No.	VE / SU	EAN
1090 2260 	6	 4 004094 109065



60 x 60 x 36 mm

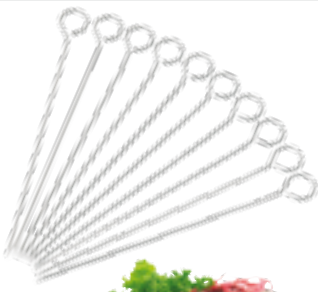

**Rouladennadeln**  
 • Set mit 10 Rouladennadeln  
 • angespitzt

**Aiguilles à roulade**  
 • ensemble de 10 aiguilles à roulade  
 • pointues

*Meat roll skewers*  
 • set of 10 meat roll skewers  
 • pointed

*Agujas para rollos de carne asada*  
 • set de 10 agujas para rollos de carne asada  
 • puntiagudas



100 x 10 x 1 mm

Art-Nr. / Art.-No.	VE / SU	EAN
1022 2270	10	4 004094 102271



**Rouladenringe**  
 • Set mit 6 Rouladenringen  
 • flexibel verstellbar

**Anneaux à roulade**  
 • ensemble de 6 anneaux à roulade  
 • ajustables

*Meat roll rings*  
 • set of 6 meat roll rings  
 • individually adjustable

*Aros metálicos para rollos de carne asada*  
 • set de 6 aros metálicos para rollos de carne asada  
 • ajustables flexiblemente



55 x 52 x 9 mm

Art-Nr. / Art.-No.	VE / SU	Größe / Size	EAN
1023 2280	10	ø 45 - 53 mm	4 004094 102387



1519



**Grill- und Bratenschnur**  
 • 60 Meter

**Ficelle de rôtir**  
 • 60 mètres

*Barbecue and roast string*  
 • 60 metres

*Hilo para asado*  
 • 60 metros



1521



58 x 58 x 43 mm

Art-Nr. / Art.-No.	VE / SU	EAN
1519 2270	5	4 004094 151972
1521 2270	5	4 004094 152177



**Grill- und Bratenschnur**  
 • hitzebeständiges Spezialgarn  
 • 60 m, ø 35 mm

**Ficelle à grillades et rôtis**  
 • ficelle spéciale résistant à la chaleur  
 • 60 m, ø 35 mm

*Barbecue and roast string*  
 • heat resistant special roast string  
 • 60 m, ø 35 mm

*Cordel para barbacoa y asados*  
 • hilo especial termorresistente  
 • 60 m, ø 35 mm



70 x 38 x 38 mm

Art-Nr. / Art.-No.	VE / SU	EAN
1523 2270	5	4 004094 152375

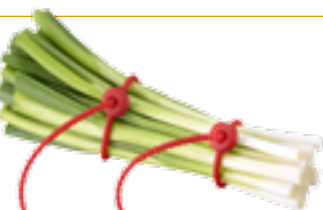

**Koch- und Bratschnüre**  
 • Set mit 6 Schnüren  
 • helfen Fleisch, Fisch oder Gemüse für die weitere Zubereitung in Form zu bringen  
 • mikrowellentauglich, für Topf, Pfanne oder Ofen

**Liens de cuisson**  
 • set de 6 liens  
 • permettent de mettre en forme la viande ou les légumes  
 • adaptés au micro-ondes, s'utilisent dans les casseroles, les poêles, au four

*Cook and roast strings*  
 • set of 6 strings  
 • these practical ties hold meat, fish or vegetables in shape for further preparation  
 • suitable for microwave, for pots, pans or the oven

*Cordeles para guisar y asar*  
 • set des 6 cuerdas  
 • ayudan a mantener la forma de la carne y de la verdura para la preparación sucesiva  
 • aptas para microondas, pueden usarse en la olla, la sartén o el horno



405 x 20 x 9 mm

Art-Nr. / Art.-No.	VE / SU	EAN
1524 2280	6	4 004094 152481





**Salat- und Servierzange**

- Gabel- und Löffelelement in einer Zange
- aus einem Stück gefertigt - besonders gut zu reinigen

*Salad- and serving tongs*

- fork and spoon element in a set of tongs
- crafted from one piece - especially easy to clean

**Pince à salade et de service**

- fourchette et cuillère combinée en une pince
- fabriquée d'une pièce - très facile à nettoyer

*Pinzas para ensaladas y servir*

- tenedor y cuchara en unas pinzas
- hechas de una sola pieza - fácil de limpiar



220 x 58 x 21 mm

Art-Nr. / Art.-No.	VE / SU	EAN
1277 2270	5	4 004094 127779



**Salat- und Spaghettizange**

- mit breiten, nach unten gezahnten, Laffen
- aus einem Stück gefertigt - besonders gut zu reinigen

*Salad- and pasta serving tongs*

- with the wide, dented blades
- crafted from one piece - especially easy to clean

**Pince à salade et spaghettis**

- avec les larges dents du bas
- fabriquée d'une pièce - très facile à nettoyer

*Pinzas para ensaladas y spaghetti*

- con las cabezas cóncavas, dentadas abajo
- hechas de una sola pieza - fácil de limpiar



238 x 52 x 22 mm

Art-Nr. / Art.-No.	VE / SU	EAN
1279 2270	5	4 004094 127977



**Spargel- und Servierzange**

- mit breiter Auflagefläche, damit der Spargel nicht bricht
- aus einem Stück gefertigt - besonders gut zu reinigen

*Asparagus- and serving tong*

- with wide support surface preventing the asparagus from breaking
- crafted from one piece - especially easy to clean

**Pince à asperges et de service**

- avec large surface portante pour que les asperges restent intactes
- fabriquée d'une pièce - très facile à nettoyer

*Pinzas para espárragos y servir*

- estas pinzas con una lata superficie de contacto sujetan bien los espárragos
- hechas de una sola pieza - fácil de limpiar



242 x 108 x 22 mm

Art-Nr. / Art.-No.	VE / SU	EAN
1280 2270	5	4 004094 128073



**Küchen- und Servierzangen**

- mit geriffelten Greifenden für festen Halt
- ideal für Gebäck, Fleischwaren etc.

*Kitchen tongs*

- with corrugated surface at the ends for secure hold
- ideal for pastry, meat etc.

**Pince de cuisine**

- avec surface ondulée aux extrémités
- idéale pour la pâtisserie, les viandes, etc.

*Pinzas para cocina y servir*

- con extremos corrugados de agarre
- ideal para repostería, carne, etc.

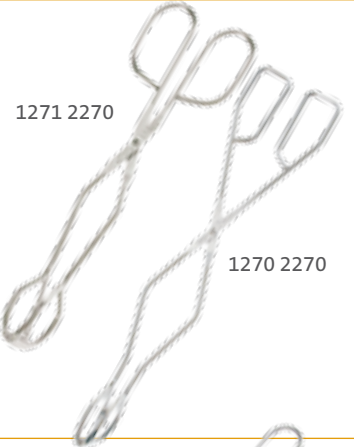

1271 2270

1270 2270

Art-Nr. / Art.-No.	VE / SU	Größe / Size	EAN
1270 2270	5	321 x 86 x 46 mm	4 004094 127076
1271 2270	5	215 x 72 x 40 mm	4 004094 127175



**Grillzange**

- mit geriffelten, gebogenen Greifenden

*Barbecue tongs*

- with corrugated, bent ends

**Pince à barbecue**

- avec extrémités ondulées et courbées

*Pinzas para barbacoa*

- con extremos corrugados, curvados

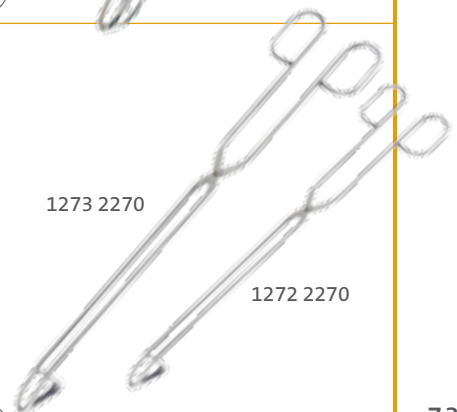

1273 2270

1272 2270

Art-Nr. / Art.-No.	VE / SU	Größe / Size	EAN
1272 2270	5	240 x 70 x 50 mm	4 004094 127274
1273 2270	5	372 x 77 x 51 mm	4 004094 127373





306 x 55 x 17 mm

#### Brat- und Servierpinzette

- zum Wenden von Bratgut, Entnehmen von Gurken, Würstchen aus Gläsern, zum Servieren etc.
- mit Wellenprofil an den Spitzen für sicheren Halt

#### Kitchen tweezers

- for turning food in the pan, removing gherkins, sausages from jars, serving food
- ridged profile at the ends for safe holding

#### Pince de cuisine

- pour retourner les aliments, saisir les cornichons, saucisses des bocaux, servir etc.
- forme ondulée aux extrémités pour une bonne prise

#### Pinzas de cocina

- para coger los alimentos en la barbacoa, sacar pepinillos de botes, servir etc.
- con perfil ondulado en las puntas para una sujeción segura

Art-Nr. / Art.-No.	VE / SU	EAN
1369 2270	10	4 004094 136979

PA



Made in GERMANY



304 x 78 x 35 mm

#### Servierzange »Standard«

- mit gebogenen Enden
- verchromt

#### Serving tongs

- with curved ends
- chrome-plated

#### Pince à servir »Standard«

- avec extrémités courbées
- chromé

#### Pinzar para servir

- con extremos redondeados
- cromado

Art-Nr. / Art.-No.	VE / SU	EAN
1510 2270	10	4 004094 151071

PP

ST



#### Grillserie »Futura«

- sehr solide Ausführung
- kunststoffummantelte Griffe schützen vor Hitze

#### Grill series »Futura«

- very solid version
- plastic-coated handles protect from heat

#### Série à barbecue »Futura«

- version très stable
- des poignées gainées en plastique protègent contre la chaleur

#### Serie para barbacoa »Futura«

- versión muy estable
- los mangos revestidos de plástico protegen contra el calor

1500 2270



1501 2270



1502 2270



1503 2270



Art-Nr. / Art.-No.	VE / SU	Größe / Size	EAN
1500 2270	6	485 x 55 x 45 mm	4 004094 150074
1501 2270	6	455 x 100 x 35 mm	4 004094 150173
1502 2270	6	405 x 42 x 20 mm	4 004094 150272
1503 2270	6	455 x 33 x 20 mm	4 004094 150371

TPE INOX





### Brat- und Servierpinzette

- für punktgenaues Festhalten von Fleisch/Fisch beim Tranchieren
- zum Wenden von empfindlichem Bratgut
- ideal zum Anrichten von Beilagen auf dem Teller

### Frying and serving pincers

- for precise holding of meat or fish while slicing
- for turning food while frying
- ideal also for arranging food decoratively on a plate

Art-Nr. / Art.-No.	VE / SU	EAN
1276 2270	6	4 004094 127670



### Pincette

- pour tenir précisément les viandes pour les trancher
- pour tourner les aliments délicats
- pour arranger les aliments décorativement sur l'assiette

### Pinzas para asados y servir

- se puede sujetar puntualmente la carne al trincharlo
- para dar la vuelta al asado sensible
- para colocar decorativamente los piscochablis en un plato



290 x 65 x 22 mm

### Wurstzange

- aus einem Stück geformt
- die gewellten Enden sorgen für sicheren Halt beim Wenden und Transportieren
- optional: mit gebogenen oder geraden Greifenden
- *Sausage tongs*
- *high quality tongs - crafted from one piece*
- *corrugated ends for safe hold when turning and lifting*
- *option: with bended or straight ends*

### Pince à saucisses

- en une pièce
- extrémités ondulées assurent un parfait maintien pour lever et retourner les saucisses
- option: avec extrémités courbées ou droites
- *Pinzas para embutidos*
- *pinzas de una pieza*
- *extremos corrugados proporcionan un agarre seguro al levantar y transportar el embutido*
- *opción: con extremos curvados o rectos*

Art-Nr. / Art.-No.	VE / SU	Größe / Size	EAN
1274 2270	5	339 x 50 x 60 mm	4 004094 127472
1275 2270	5	354 x 68 x 24 mm	4 004094 127571



### Grillzange »Classic Spezial«

- mit Edelstahlaffen - ideal für den Grill
- die gummierten Griffe schützen vor Hitze
- mit Feststellmechanismus und Aufhängeöse für die Aufbewahrung

### Pince à barbecue »Classic Spezial«

- avec embouts en inox - idéal pour le barbecue
- manches caoutchoutés protègent de la chaleur
- avec mécanisme de verrouillage et boucle d'accrochage

### Barbecue tongs »Classic Spezial«

- with stainless steel blades ideal for the barbecue
- rubber coated handles protect from heat
- with hanging loop for convenient storage

### Pinzas para barbacoa »Classic Spezial«

- con cabeza cóncava de acero inox - ideal para la barbacoa
- las agarraderas engomadas protegen del calor
- con mecanismo de retención y ojete para colgar

Art-Nr. / Art.-No.	VE / SU	EAN
1516 2270	5	4 004094 151675



377 x 35 x 38 mm

### Servierzange »Classic Mini« & »Classic«

- universelle Haushaltszange mit Nylon-Laffen
- ideal für Töpfe und Pfannen mit Antihafbeschichtung
- mit Feststellmechanismus und Aufhängeöse
- *Serving tongs »Classic Mini« & »Classic«*
- *universal tongs with nylon blade*
- *ideal for pots and pans with non-stick coating*
- *with locking device and hanging loop*

### Pince de service »Classic Mini« & »Classic«

- pince universelle avec embout en nylon
- idéale pour les casseroles/ poêles anti-adhésives
- avec mécanisme de verrouillage et boucle d'accrochage
- *Pinzas para servir »Classic Mini« & »Classic«*
- *pinzas universales con cabezas cóncavas de nylon*
- *ideales para ollas y sartenes con revestimiento antiadherente*
- *con mecanismo de retención*

Art-Nr. / Art.-No.	VE / SU	Größe / Size	EAN
1517 2270	5	272 x 35 x 40 mm	4 004094 151774
1518 2270	5	350 x 35 x 40 mm	4 004094 151873



### Servierzange »Comfort«

- mit breiteren Laffen für größeres Bratgut
- ideal für Töpfe und Pfannen mit Antihafbeschichtung
- mit Feststellmechanismus und Aufhängeöse

### Pince de service »Comfort«

- pince à embouts larges
- idéale pour les casseroles et poêles anti-adhésives
- avec mécanisme de verrouillage et boucle d'accrochage

### Serving tongs »Comfort«

- with wide blades for burgers etc.
- ideal for pots and pans with non-stick coating
- with locking device and hanging loop

### Pinzas para servir »Comfort«

- con cabezas más anchas para asados más grandes
- ideales para ollas y sartenes con revestimiento antiadherente
- con mecanismo de retención

Art-Nr. / Art.-No.	VE / SU	EAN
1512 2270	5	4 004094 151279



340 x 30 x 55 mm



1260 2270

1261 2270

1262 2270

**Schaschlikspieße**

- Set aus je 3 hochwertigen Schaschlikspießen
- geschmiedet und gespitzt
- die speziell flache Form verhindert das ungewünschte Drehen der Fleischstücke

*Shish kebab skewer*

- set of 3 classy, high quality shish kebab skewers
- forged and pointed
- the special - flat - shape prevents the meat pieces from twisting

**Pique à brochettes**

- ensemble de 3 piques à brochettes
- forgées et taillées en pointe
- la forme spécialement plate empêche les morceaux de viande de tourner

*Pinchos para carne*

- set de 3 pinchos para carne de alta calidad
- forjados y puntiagudos
- la forma plana especial evita los giros indeseados de los trozos de carne



Art-Nr. / Art.-No.	VE / SU	Größe / Size	EAN
1260 2270	3	236 x 25 x 4 mm	4 004 094 126079
1261 2270	3	312 x 25 x 4 mm	4 004 094 126178
1262 2270	3	370 x 25 x 4 mm	4 004 094 126277



**Grillspieße »Twister«**

- Set mit 2 Grillspießen aus flexiblem Edelstahlgeflecht
- platzsparend auf dem Grill
- Fleisch/Gemüwestücke lassen sich auf dem Grillspieß marinieren

*Grilling skewer »Twister«*

- set of 2 skewers from flexible stainless steel wire
- can be placed on the grill space savingly
- meat/vegetable cubes can be marinated while on skewer

**Pique à barbecue »Twister«**

- set de 2 piques en fil d'acier inox flexible
- peut être facilement placé sur le barbecue
- les dés de viande/légumes peuvent mariner sur le pique

*Pinchos para barbacoa »Twister«*

- set de 2 pinchos de cable trenzado flexible en acero inox
- ahorrando espacio sobre la barbacoa
- el pincho puede fácilmente escabecharse con los trozos de carne



740 x 4 x 4 mm



Art-Nr. / Art.-No.	VE / SU	EAN
1263 2270	6	4 004 094 126376



**Schaschlikspieße**

- Set mit 4 stabilen Schaschlikspießen
- angespitzt für einfaches Aufspießen der Fleischstücke
- der flache Querschnitt verhindert das ungewünschte Drehen

*Shish kebab skewers*

- set of 4 solid kebab skewers
- pointed for easy skewering of food chunks
- the special - flat - shape prevents the meat pieces from twisting

**Pique à brochettes**

- ensemble de 4 piques à brochettes solides
- pour embrocher facilement des morceaux de viande
- la forme plate empêche la viande de tourner

*Pinchos para carne*

- set de 4 pinchos estables
- puntiagudos para pinchar fácilmente los trozos de carne
- la forma plana evita los giros indeseados de los trozos de carne

Art-Nr. / Art.-No.	VE / SU	EAN
1024 2270	10	4 004 094 102479



210 x 24 x 4 mm



### Schashlikspieße »Schwert«

- Set mit 3 Spießsen
- mit Schwertgriff aus Messing
- geschmiedet und gespitzt
- speziell flache Form verhindert das ungewünschte Drehen der Fleischstücke

### Shish kebab skewer »Schwert«

- set of 3 skewers
- with decorative handle from brass
- forged and pointed
- the special - flat - shape prevents the meat pieces from twisting

Art-Nr. / Art.-No.	VE / SU	EAN
1264 2270	3	4 004094 126475

### Pique à brochettes »Schwert«

- ensemble de 3 brochettes
- avec poignée décorative de laiton
- forgé et taillé en pointe
- la forme spécialement plate empêche les morceaux de viande de tourner

### Pinchos para carne »Schwert«

- set de 3 pinchos
- con mango decorativo de latón
- forjados y puntiagudos
- la forma plana especial evita los giros indeseados de los trozos de carne



320 x 47 x 9 mm

### Schashlikspieße »Lilie«

- Set mit 3 Spießsen
- mit dekorativem Griff aus Messing
- geschmiedet und gespitzt
- speziell flache Form verhindert das ungewünschte Drehen der Fleischstücke

### Shish kebab skewer »Lilie«

- set of 3 skewers
- with decorative handle from brass
- forged and pointed
- the special - flat - shape prevents the meat pieces from twisting

### Pique à brochettes »Lilie«

- ensemble de 3 brochettes
- avec poignée décorative de laiton
- forgé et taillé en pointe
- la forme spécialement plate empêche les morceaux de viande de tourner

### Pinchos para carne »Lilie«

- set de 3 pinchos
- con mango decorativo de latón
- forjados y puntiagudos
- la forma plana especial evita los giros indeseados de los trozos de carne

1265 2270



1266 2270



Art-Nr. / Art.-No.	VE / SU	Größe / Size	EAN
1265 2270	3	245 x 25 x 8 mm	4 004094 126574
1266 2270	3	312 x 25 x 8 mm	4 004094 126673



### Schashlikspieße »Natur pur«

- Set mit 100 Schashlikspießsen
- gespitzt für einfaches Aufstecken der Fleisch- und Gemüsestücke
- geschmacksneutral aus Birkenholz

### Shish kebab skewers »Natur pur«

- set of 100 shish kebab skewers
- pointed for easy skewering of food cubes
- neutral to taste

### Pique à brochettes »Natur pur«

- ensemble de 100 piques à brochettes
- taillé en pointe pour faciliter l'embrochage des morceaux de viande et de légumes
- sans goût

### Pinchos para carne »Natur pur«

- set de 100 pinchos para carne
- puntiagudos para pinchar fácilmente los trozos de carne y verduras
- de sabor neutro

Art-Nr. / Art.-No.	VE / SU	EAN
1046 2280	10	4 004094 104688



200 x 3 x 3 mm

### Maiskolbenhalter »Spiky«

- Set mit 4 Maiskolbenhaltern
- mit Softgriffen für guten Halt
- je 2 Edelstahlspitzen halten den Maiskolben gut in Position

### Corn cob holders »Spiky«

- set of 4 corn cob holders
- with soft grips
- with every little helper 2 stainless steel spikes hold the corn cob in good position

### Brochette à maïs »Spiky«

- ensemble de 4 brochettes
- avec poignées souples
- 2 piques en acier inox dans chaque brochette maintiennent les épis de maïs en bonne position

### Soportes para mazorcas de maíz »Spiky«

- set de 4 soportes
- con mangos blandos para una buena sujeción
- sendas 2 agujas de acero inox sujetan la mazorca de maíz bien en posición



75 x 20 x 15 mm

Art-Nr. / Art.-No.	VE / SU	EAN
1514 2280	10	4 004094 151484





210 x 59 x 53 mm

**Fischentschupper »Scalex«**

- breite Spezialklinge für schnelles und effizientes Entschuppen
- Schuppenauffangschale mit Deckel verschließbar für sauberes Arbeiten

**Fish scaler »Scalex«**



- rapid and efficient de-scaling of fish by means of a wide special blade
- the waste scale container can be closed with a lid for clean working

**Ecailleur à poisson »Scalex«**

- la large lame spéciale écaille rapidement et efficacement
- le bac collecteur à écailles se ferme avec un couvercle pour un travail propre

**Desescamador »Scalex«**

- la hoja ancha especial desescama rápida y eficientemente
- el platillo de recogida de escamas puede cerrarse con tapa para un trabajo limpio

Art-Nr. / Art.-No.	VE / SU	EAN
6500 2260 	5	4 004094 650062 



138 x 26 x 32 mm

**Fischgrätenpinzette**

- mit breitem, angeschrägtem Pinzettenende für sicheres Greifen von Gräten oder einzelnen Schuppen
- auch zum Entfernen von Federkielen bei Geflügel

**Fish bone tweezers**



- with wide, slanted grip surface for secure removal of bones and individual fish scales
- also suitable for the removal of poultry quills

**Pincette à arêtes de poisson**

- avec surface de préhension large et inclinée pour retirer les arêtes ou écailles de poisson
- également pour retirer les plumes des volailles

**Pinzas para espinas de pescado**

- con superficie de agarre ancha, achafianada para quitar con seguridad espinas o escamas
- se apropia también para quitar cañones de pluma de aves

Art-Nr. / Art.-No.	VE / SU	EAN
6608 2280 	6	4 004094 660887 



144 x 61 x 13 mm

**Hummerknacker »Cracky«**

- das Original
- öffnet Hummer und andere Schalentiere

**Lobster cracker »Cracky«**



- the original
- opens lobsters and other shellfishes

**Casse-homard »Cracky«**

- l'original
- ouvre les homards et autres fruits de mer

**Casca langostas »Cracky«**

- el original
- abre langostas y otros crustáceos

Art-Nr. / Art.-No.	VE / SU	EAN
6600 2270 	5	4 004094 660078 



212 x 61 x 13 mm

**Hummerknacker mit Pinzette »Cracky-Spezial«**

- öffnet Hummer und andere Schalentiere
- die speziell gezahnte Pinzette hilft, das schwer zugängliche Fleisch herauszuziehen

**Lobster cracker with pincers »Cracky-Spezial«**



- opens lobsters and other shellfishes
- the pincers with the especially dented ends are great when it comes to pulling out the difficult to reach lobster meat

**Casse-homard avec pincette »Cracky-Spezial«**

- ouvre les homards et autres fruits de mer
- la pincette spécialement dentée permet de retirer la chair difficilement accessible

**Casca langostas con pinza »Cracky-Spezial«**

- abre langostas y otros crustáceos
- la pinza dentada ayuda a sacar la carne de difícil acceso

Art-Nr. / Art.-No.	VE / SU	EAN
6610 2270 	5	4 004094 661075 



188 x 42 x 10 mm

**Hummerzange »Cammarus«**

- elegante Zänge mit Innenfeder und Verriegelung
- zum Öffnen des Hummerpanzers und der Scheren
- auch zum Zerlegen von Langusten

**Lobster tongs »Cammarus«**



- elegant tongs with inner spring and locking device
- opens effortlessly the lobster carapace and pinchers
- also good for crayfishes

**Pince à homard »Cammarus«**

- pince élégante avec ressort intérieur et dispositif de verrouillage
- pour ouvrir la carapace et les pinces du homard
- également adaptée pour couper les langoustines

**Tenazas para langostas »Cammarus«**

- tenazas elegantes con muelle interior y cierre
- para abrir el caparazón y las pinzas
- también para partir bogavantes

Art-Nr. / Art.-No.	VE / SU	EAN
6613 2280 	6	4 004094 661389 





#### Hummergabeln

- Set mit 2 Hummergabeln
- lange, schlanke Form
- massive Ausführung mit feiner Prägung
- gespitzte Zinken, um das Fleisch gut greifen zu können

#### Lobster forks

- set with 2 lobster forks
- long, slim shape
- strong construction with fine embossing
- dented fork-ends for easy pulling out of the meat

#### Fourchettes à homard

- ensemble de 2 fourchettes à homard
- forme longue et mince
- version massive avec gaufrage fin
- dents pointues pour bien saisir la chair

#### Tenedores para langostas

- set de 2 tenedores para langostas
- forma alargada, esbelta
- versión maciza con troquelado fino
- dientes puntiagudos para poder agarrar bien la carne

Art-Nr. / Art.-No.	VE / SU	EAN
6616 2280	6	4 004094 661686

INOX



185 x 17 x 4 mm



04

zubereiten • seasoning • cuisiner • preparación

#### Austernbrecher

- sehr massives Küchenwerkzeug
- geschmiedete und geschliffene Klinge
- mit umlaufend hohem Rand als Fingerschutz

#### Oyster opener

- very robust kitchentool
- forged and ground blade
- with circumferential guard as finger protection

#### Couteau à huîtres

- outil de cuisine très solide
- lame forgée et polie
- avec rebord circonférentiel haut pour protéger les doigts

#### Cuchillo abre ostras

- utensilio de cocina muy macizo
- hoja forjada y afilada
- con alto borde circunferencial para proteger los dedos



Art-Nr. / Art.-No.	VE / SU	EAN
6615 2270	6	4 004094 661570

PP

INOX



197 x 55 x 43 mm

79





177 x 177 x 5 mm

- Untersetzer »Silicone«**
- zum Topf abstellen
  - so flexibel - auch als Topflappen nutzbar

- Coasters »Silicone«**
- hereon a hot pot may be placed safely
  - so flexible that they could also be used as potholders

- Dessous de plat »Silicone«**
- pour poser une casserole chaude
  - si flexible qu'il peut également être utilisé comme manique

- Salvamanteles »Silicone«**
- sobre este puede colocarse una olla caliente
  - tan flexibles que pueden servir excelentemente también como manopla de cocina

Art-Nr. / Art.-No.	VE / SU	EAN
1558 2270 	6	 4 004094 155871

SI





195 x 200 x 10 mm

- 2 Topflappen**
- aus Baumwolle mit rutschfestem Neopren zum sicheren Halten von glatten Auflaufformen, Glasbehältern etc.
  - mit praktischer Aufhängöse

- 2 Pot holders**
- made of cotton with slip-resistant neoprene for holding slippery baking dishes safely
  - with practical hang-up-loop

- 2 Manique**
- en coton avec néoprène antidérapant pour une bonne prise en main des plats à gratin lisses etc.
  - avec accroche de suspension pratique

- 2 Agarradores**
- de algodón con neopreno antideslizante para un agarre seguro de moldes lisos etc.
  - con enganche

Art-Nr. / Art.-No.	VE / SU	EAN
1562 2270 	6	 4 004094 156274





265 x 160 x 23 mm

- 2 Küchen-/Ofenhandschuhe**
- aus Baumwolle mit rutschfestem Neopren zum sicheren Halten von glatten Auflaufformen, Glasbehältern etc.
  - mit praktischer Aufhängöse

- 2 Kitchen/oven glove**
- made of cotton with slip-resistant neoprene for holding slippery baking dishes safely
  - with practical hang-up-loop

- 2 Gant de cuisine et de four**
- en coton avec néoprène antidérapant pour une bonne prise en main des plats à gratin lisses etc.
  - avec accroche de suspension pratique

- 2 Guantes de cocina/para horno**
- de algodón con neopreno antideslizante para un agarre seguro de moldes lisos etc.
  - con enganche

Art-Nr. / Art.-No.	VE / SU	EAN
1560 2270 	6	 4 004094 156076



255 x 215 x 85 mm

- Untersetzer »Flexi«**
- variabel ausziehbar (180 - 420 mm)
  - ideal für Töpfe, Auflaufformen etc.

- Trivet »Flexi«**
- can be extended to various lengths (180 - 420 mm)
  - ideal for pots, casserole dishes etc.

- Dessous de plat »Flexi«**
- étirable (180 - 420 mm)
  - idéal pour les casseroles, les cocottes etc.

- Salvamanteles »Flexi«**
- extensible variablemente (180 - 420 mm)
  - ideal para ollas, cacerolas, etc.

Art-Nr. / Art.-No.	VE / SU	EAN
1641 2260 	3	 4 004094 164163

INOX





# 05

zerkleinern, reiben & hobeln • *cutting, grating & slicing*  
couper, râper & émincer • *picar, rallar & tajar*



05

zerkleinern, reiben & hobeln • *cutting, grating & slicing* • couper, râper & émincer • *picar, rallar & tajar*

### Technicus

Diese Reibenserie bietet Schneidtechnologie für höchste Ansprüche. Im Rahmen eines speziellen Fertigungsverfahrens wird die Oberfläche des Edelstahl mit einer professionellen Ätztechnik so bearbeitet, dass außergewöhnlich scharfe und langlebige Klingen entstehen. Früchte und Gemüse werden somit nicht „zerquetscht“ oder „zerrieben“ sondern sauber geschnitten - für vollen Aroma-Genuss.

Der rutschfeste Fuß ermöglicht ein sicheres Arbeiten, und der praktische Klingenschutz stellt sicher, dass man die Reibe auch gut geschützt in der Schublade verstauen kann.

### Technicus

This series of graters offers cutting technology for the most discerning. In a very special manufacturing process, the surface of the stainless steel is treated with a professional etching technique in such a way that creates extraordinarily sharp and long-lived blades. Fruit and vegetables are therefore no longer „squashed“ or „shredded“, but cut cleanly to preserve their full flavour.

The non-slip foot enables you to work safely and the practical blade protector makes sure that you can also store the grater well protected in the drawer.

### Technicus

Cette série de râpes offre une technologie de coupe pour les plus exigences les plus élevées. Dans le cadre d'un processus de fabrication particulier, la surface de l'acier inoxydable est traitée avec une technique de gravure professionnelle de façon à obtenir des lames extraordinairement tranchantes et durables. Ainsi, les fruits et les légumes ne sont plus „écrasés“ ou „déchiquetés“ mais proprement découpés pour préserver toute leur saveur.

Le pied antidérapant permet un travail sûr et la protection de lame pratique veille à ce que la râpe soit bien protégée pour la ranger dans le tiroir.

### Technicus

Esta serie ralladores ofrece una tecnología de corte para máximas exigencias. En el marco de un proceso de fabricación especial se mecaniza la superficie del acero inoxidable con una técnica de mordido de tal modo que se generan hojas extraordinariamente duras y de larguísima duración. Así no se estrujan ni machacan las frutas y verduras, sino se cortan limpiamente - para un deleite total del aroma. Gracias a la pata antiresbalante se puede trabajar de un modo seguro y la práctica protección de las hojas asegura que se puede guardar el rallador bien protegido en el cajón de la cocina.

### Fingerschutz für »Technicus Square«

- für Reiben 1410-1418

### Hand guard for »Technicus Square«

- for graters 1410-1418

### Protège-doigts pour »Technicus Square«



- pour les râpes 1410-1418

### Protector de dedos para »Technicus Square«

- para los ralladores 1410-1418



69 x 67 x 45 mm

Art-Nr. / Art.-No.	VE / SU	EAN
1438 2270 	6	 4 004094 143878

PP



### Fingerschutz für »Technicus Pro«

- für Reiben 1420-1426

### Hand guard for »Technicus Pro«

- for graters 1420-1426

### Protège-doigts pour »Technicus Pro«



- pour les râpes 1420-1426

### Protector de dedos para »Technicus Pro«

- para los ralladores 1420-1426



60 x 41 x 40 mm

Art-Nr. / Art.-No.	VE / SU	EAN
1439 2270 	6	 4 004094 143977

PP



### Technicus Info

- Informationsheft für den Konsumenten
- mit 16 Seiten, DIN A6 (Postkartenformat)
- 20 Stück in einer Box zum Aufstellen oder zum Aufhängen

### Technicus Info

- Consumer Information-brochure
- languages: German, English, French, Dutch
- 20 pcs in a cdu (can be put onto the shelf or hung onto a hook)

### Technicus Info

- livret d'information pour consommateurs
- langues: allemand, anglais, français, hollandais
- 20 pièces dans une boîte à installer ou à accrocher

### Technicus Info

- folleto informativo para el consumidor
- idiomas: alemán, inglés, francés, holandés
- 20 ejemplares en una caja para colocar o colgar



Art-Nr. / Art.-No.	VE / SU	EAN
1437 2260	1	 4 004094 143762



1410 2270  
Reibe, fein  
Grater, fine  
Râpe, fin  
Rallador, fino



1412 2270  
Reibe, mittel  
Grater, medium  
Râpe, moyen  
Rallador, mediano



1414 2270  
Reibe, grob  
Grater, coarse  
Râpe, gros  
Rallador, grueso



1416 2270  
Raspel  
Rasp  
Râpe  
Raspa



1418 2270  
Hobel  
Slicer  
Eminceur  
Cortador



320 x 65 x 28 mm

**Reibe »Technicus-Square«**  
*Grater »Technicus-Square«*  
**Râpe »Technicus-Square«**  
*Rallador »Technicus-Square«*

Art-Nr. / Art.-No.	VE / SU	EAN
1410 2270	6	4 004094 141072
1412 2270	6	4 004094 141270
1414 2270	6	4 004094 141478
1416 2270	6	4 004094 141676
1418 2270	6	4 004094 141874



05

1420 2270  
Reibe, fein  
Grater, fine  
Râpe, fin  
Rallador, fino



1421 2270  
Kombireibe  
Combi-grater  
Râpe, moyen  
Rallador, mediano



1424 2270  
Reibe, grob  
Grater, coarse  
Râpe, gros  
Rallador, grueso

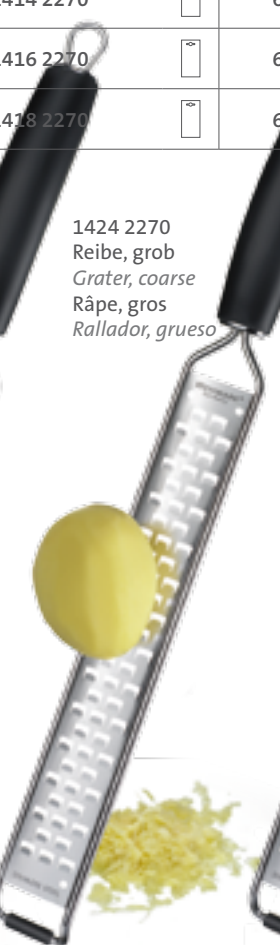

1426 2270  
Raspel  
Rasp  
Râpe  
Raspa



399 x 36 x 28 mm

**Reibe »Technicus-Pro«**  
*Grater »Technicus-Pro«*  
**Râpe »Technicus-Pro«**  
*Rallador »Technicus-Pro«*

Art-Nr. / Art.-No.	VE / SU	EAN
1420 2270	6	4 004094 142079
1421 2270	6	4 004094 142178
1424 2270	6	4 004094 142475
1426 2270	6	4 004094 142673



zerkleinern, reiben & hobeln • cutting, grating & slicing • couper, râper & émincer • picar, rallar & tajar

83



»Trio«  
1433 2270

»Duo«  
1434 2270

130 x 65 x 235 mm

**Technicus Turmreibe »Trio«, fein, mittel, grob**  
**Technicus Turmreibe »Duo«, extra grob + Gurkenhobel**

- sicherer Stand durch gummierten Ring
- Vorteil : Auffangen des Reibguts und gezieltes Entleeren über der Schüssel
- mit abnehmbarem Bodenelement

*Technicus grater »Trio«, fine, medium, coarse*  
*Technicus grater »Duo«, extra coarse + cucumber slicer*





- non-slip base for safe stand
- the bottom lid can be taken off
- advantage: food can be caught in the grater and let off over the bowl

**Râpe tour Technicus »Trio«, fin, moyen, gros**  
**Râpe tour Technicus »Duo«, extra gros + coupe-concombre**

- base caoutchoutée pour un maintien sûr
- le fond peu être retiré
- avantage : la nourriture peut être collectée dans la râpe et vidée au-dessus du bol

*Rallador torre Technicus »Trio«, fino, mediano, grueso*  
*Rallador torre Technicus »Duo«, extra grueso + cortador de pepino*

- apoyo seguro gracias al anillo engomado
- con fondo de quita y pon
- ventaja: recogida del alimento rallado en el rallador y vaciado directo en el recipiente

Art.-Nr. / Art.-No.	VE / SU	EAN
1433 2270 	6	 4 004094 143373
1434 2270 	6	 4 004094 143472



240 x 95 x 85 mm

**Reibenset »Technicus Quadro«**

- mit Rahmen für den Einsatz von vier unterschiedlichen Reiben
- Reibeneinsätze: fein, mittel, extra grob, Gurkenhobel
- mit Anti-Rutsch-Füßen

*Grater Set »Technicus Quadro«*



- with lid-frame for four different grating inserts
- grating inserts: fine, medium, extra coarse, cucumber slicer
- with non-slip feet

**Ensemble de râpes »Technicus Quadro«**

- avec cadre pour l'utilisation de quatre grilles différentes
- grilles: fin, moyen, extra gros, coupe-concombre
- avec pied antidérapant

*Set de ralladores »Technicus Quadro«*

- con marco para cuatro diferentes ralladores
- insertos ralladores: fino, mediano, extra grueso, cortador de pepinos
- con patitas antiresbalantes

Art.-Nr. / Art.-No.	VE / SU	EAN
1435 2260 	3	 4 004094 143564



76 x 76 x 150 mm

**Käsereiber »Technicus«**

- mit drei unterschiedlichen Einsätzen (grob, fein, Hobel)
- pfiffig: die nicht genutzten Reibeinsätze können in dem Deckel des Druckstempels untergebracht werden

*Cheese Grater »Technicus«*



- with three different grating discs (fine, coarse, shaving)
- cute: discs that are not in use can be stored in the plunger lid

**Râpe à fromage »Technicus«**

- avec trois grilles différentes (gros, fin, éminceur)
- futé: les grilles non utilisées peuvent être placées dans le couvercle

*Rallador de queso »Technicus«*

- con tres diferentes discos de rallado (grueso, fino, cortador)
- inteligente: los discos de rallado que no se usan pueden depositarse en la tapa del punzón de agujerear

Art.-Nr. / Art.-No.	VE / SU	EAN
1440 2260 	6	 4 004094 144066



96 x 67 x 31 mm

**Muskatreibe »Technicus Nut«**

- mit Auffangbehälter
- mit praktischem Deckel/Klingenschutz für die Lagerung

*Nutmeg grater »Technicus Nut«*



- with collection container
- with blade protection for safe storage

**Râpe à muscade »Technicus Nut«**

- avec bac collecteur
- avec couvercle pratique/protection de lame pour le rangement

*Rallador de nuez moscada »Technicus Nut«*

- con recipiente colector
- con tapa/protección de la hoja práctica para guardar el utensilio

Art.-Nr. / Art.-No.	VE / SU	EAN
1444 2260 	6	 4 004094 144462





- Klassische Muskatreibe**
- mit praktischem Aufhängeloch
  - Vorratsfach für Muskatnüsse

- Classic nutmeg grater**
- with practical rack-hole
  - storage space for whole nutmegs

- Râpe à muscade**
- râpe à muscade classique avec trou d'accrochage pratique
  - avec bac compartiment pour les noix de muscade
- Ralladora para nuez moscada**
- clásica ralladora para nuez moscada con práctico agujero para colgar
  - con recipiente de reserva para nueces moscadas



Art-Nr. / Art.-No.	VE / SU	EAN
1153 2270	5	4 004094 115370



- Muskatmühle**
- mit Vorratsfläche
  - der sich selbst regulierenden Federmechanismus drückt die Muskatnuss mit gleichmäßiger Kraft gegen die untenliegende Messereinheit

- Nut meg grinder**
- with storage section
  - the self-adjusting spring-loaded mechanism holds the nutmeg against the blade with consistent force

- Moulin à muscade**
- avec surface de stockage
  - le mécanisme à ressort auto-ajustable maintient la noix de muscade contre la lame avec une pression constante

- Molino de nuez moscada**
- con área para guardar
  - el mecanismo de resorte de autoajuste presiona la nuez moscada con fuerza uniforme contra la hoja ubicada debajo



Art-Nr. / Art.-No.	VE / SU	EAN
6957 2260	4	4 004094 695766



- Ingwerreibe**
- mit umlaufendem Rand zum Auffangen des Reibgutes
  - ideal für Ingwer, Nüsse, Muskatnuss, etc.

- Ginger grater**
- with a circumferential edge to catch grated food
  - ideal for ginger, nuts, nutmeg, etc.

- Mini-râpe universelle**
- avec bord sur le pourtour pour récupérer le râpé
  - idéale pour le gingembre, les noix, les noix de muscade, etc.

- Mini-rallador universal**
- con borde perimétrico para captar el material rallado
  - ideal para jengibre, nueces y avellanas, nuez-moscada, etc.



Art-Nr. / Art.-No.	VE / SU	EAN
1156 2260	4	4 004094 115660



- Kronenreibe**
- ideal für Kartoffeln (z.B. Reibekuchen), Äpfel (z.B. Kartoffelsalat), Zwiebeln, Gurken etc.
  - sehr scharf
  - mit großen Öffnungen

- Crown grater**
- ideal for potatoes (e.g. potato pancakes), apples (e.g. potato salad), onions, cucumbers etc.
  - very sharp
  - with large holes

- Râpe couronne**
- idéal pour les pommes de terre (par exemple les galettes de pomme de terre), oignons, concombres etc.
  - râpe très coupante
  - gros trous
- Ralladora a coronas**
- ideal para las patatas (por ejemplo para las tortillas alemanas), las cebollas, los pepinos etc.
  - muy afilado
  - hoyos grandes



Art-Nr. / Art.-No.	VE / SU	EAN
1135 2270	5	4 004094 113574



1002 2270  
 Universalreibe »Steel«  
 Universal grater »Steel«  
 Râpe universelle »Steel«  
 Raspador universal »Steel«



1003 2270  
 Gemüsereibe »Steel«  
 Vegetable grater »Steel«  
 Râpe à légumes »Steel«  
 Rallador de verduras »Steel«



1004 2270  
 Gemüse-/Rohkostreibe »Steel«  
 Raw fruit and vegetable grater »Steel«  
 Râpe à légumes/crudités »Steel«  
 Rallador de verduras/ alimentos crudos »Steel« »Steel«



1005 2270  
 Kartoffel-/Apfelreibe »Steel«  
 Potato/apple grater »Steel«  
 Râpe à pommes/pommes de terre »Steel«  
 Rallador de patatas / manzanas »Steel«



1006 2270  
 Gurkenhobel »Steel«  
 Cucumber slicer »Steel«  
 Coupe-concombres »Steel«  
 Tajador de pepinos »Steel«





Art.-Nr. / Art.-No.	VE / SU	EAN
1002 2270	6	4 004094 100277
1003 2270	6	4 004094 100376
1004 2270	6	4 004094 100475
1005 2270	6	4 004094 100574
1006 2270	6	4 004094 100673





- Gemüseschneider »Küchenmaid«**
- klein und handlich
  - mit beidseitig schneidender Klinge
  - mit Kronenreibfläche für Käse, Gewürze oder Früchte

- Vegetable slicer »Küchenmaid«**
- small and handy
  - with two-sided slicing blade
  - with crown-grating surface for cheese, spices and fruit

Art-Nr. / Art.-No.	VE / SU	EAN
1066 2250 	50	
1066 2270 	10	 4 004094 106675

PS INOX

EDELSTAHL® Rostfrei Stainless steel  Made in GERMANY 



174 x 70 x 9 mm

- Universalreibe**
- Reibe fein, grob und Hobel
  - rutschfeste Kante für sicheres Arbeiten bei verschiedenen Neigungswinkeln
  - Auflagerasten oben geben Halt am Schüsselrand

**Universal grater**



- fine, coarse grater and slicer
- non-slip edge for safe working in different angles
- grooves in the upper part offer hold at the bowl rim

**Râpe universelle**

- râpe fine, grosse et éminceur
- bordure antidérapante pour travailler en toute sécurité
- les crans en haut offrent un maintien au rebord du bol

**Rallador universal**

- rallador fino, grueso y cortador
- borde antiresbalante para un trabajo seguro
- acanaladuras en la parte superior ofrecen apoyo en el borde de la fuente

Art-Nr. / Art.-No.	VE / SU	EAN
1131 2270 	6	 4 004094 113178

ABS TPE INOX

EDELSTAHL® Rostfrei Stainless steel 



279 x 124 x 31 mm

05

**Küchenreiben »Famos«**

- breite Auflagefläche
- rutschfeste GummifüÙe
- Auflagerasten für sicheren Halt auf Schüsseln und Töpfen

**Kitchen grater »Famos«**

- wide slicing plate
- non-slip rubber feet
- grooves for safe hold on bowls and pots

**Râpes de cuisine »Famos«**

- large surface de coupe
- pieds en caoutchouc antidérapants
- crans pour un maintien sûr sur les bols et casseroles

**Ralladores de cocina »Famos«**

- patas de goma antiresbalantes
- las acanaladuras sirven para un apoyo seguro sobre bols y ollas

1132 2270  
Gemüsehobel »Famos«  
Vegetable slicer  
Mandoline  
Tajador de verduras









1134 2270  
Fruchtreibe »Famos«  
Fruit grater  
Râpe à fruits  
Rallador de frutas



1136 2270  
Rohkostschneider »Famos«  
Vegetable and fruit slicer  
Râpe à crudités  
Cortador de verduras  
y frutas crudas



Art-Nr. / Art.-No.	VE / SU	EAN
1132 2250 	5	
1132 2270 	5	 4 004094 113277
1134 2270 	5	 4 004094 113475
1136 2270 	5	 4 004094 113673

PS TPE INOX

EDELSTAHL® Rostfrei Stainless steel  Made in GERMANY 

267 x 120 x 38 mm

zerkleinern, reiben & hobeln • cutting, grating & slicing • couper, râper & émincer • picar, rallar & tajar

87





148 x 61 x 84 mm

- Kräuterschneider »Schneidfix«**
- klein, handlich, schnell in der Schublade verstaut
  - die 6 beidseitig geschliffenen Schneidrollen zerkleinern im Nu frische Kräuter

- Herbs chopper »Schneidfix«**
- small, handy, easily stored away in the drawer
  - 6 wheel blades - sharpened from both sides - cut fresh herbs in an instant

- Coupe-herbes »Schneidfix«**
- petit, pratique et rapide à ranger
  - les 6 roulettes de coupe affûtées des deux côtés cisellent en un tour de main les herbes fraîches

- Cortador de hierbas »Schneidfix«**
- manejable, guardado rápidamente en el cajón de cocina
  - los 6 discos cortantes afilados por ambos lados pican en un instante las hierbas frescas

Art-Nr. / Art.-No.	VE / SU	EAN
1068 4460 	1	 4 004094 106866





232 x 118 x 23 mm

- Gemüseschneider**
- Schnittstärke verstellbar (4 Einstellungen)
  - die scharfe Wellenschliffklinge schneidet auch Tomaten

- Vegetable slicer**
- this slicer has an individually adjustable blade (4-different thicknesses)
  - the sharp wavy edge blade even cuts through tomatoes effortlessly

- Mandoline**
- permet d'ajuster l'épaisseur de coupe (4 différentes)
  - la lame ondulée tranchante coupe aussi les tomates sans effort
- Cortador de verduras**
- este cortador de verduras tiene una hoja ajustable individualmente (4 diferentes gruesos)
  - la hoja ondulada muy afilada corta fácilmente también por tomates



Art-Nr. / Art.-No.	VE / SU	EAN
1065 2270 	5	 4 004094 106576



220 x 110 x 11 mm

- Gemüsehobel**
- mit beidseitig schneidender Klinge
  - der hochgezogene Rahmen bildet die Begrenzung für die Hobelfläche und verhindert ein seitliches Abrutschen
- Vegetable slicer**
- with two-sided blade
  - the at the edges torn up frame acts as safe limitation to the slicing surface and prevents side-wise skidding

- Mandoline**
- avec lame à double
  - le cadre relevé sur l'extérieur forme la limite de sécurité de la surface de tranchage et empêche un glissement latéral
- Tajador de verduras**
- con hoja cortante bilateral
  - un marco levantado por fuera forma el límite seguro para el área de tajado y evita el escurrimiento hacia los lados



Art-Nr. / Art.-No.	VE / SU	EAN
1076 2250 	50	
1076 2270 	10	 4 004094 107672



304 x 105 x 50 mm

- Gemüseschneider »V-Hobel«**
- sehr scharfe V-förmige Klinge
  - über das Rädchen im Griff wird die gewünschte Schnittstärke eingestellt (1 - 3 mm)
  - mit Resthalter
- Vegetable slicer »V-Hobel«**
- very sharp V-tapered blade
  - freely adjustable from 1 - 3 mm over the small wheel in the handle
  - with matching finger protection

- Mandoline »V-Hobel«**
- lame effilée en forme de V très tranchante
  - la roulette dans le manche permet d'ajuster l'épaisseur de coupe (1 à 3 mm)
  - avec protège-doigts
- Tajador de verduras »V-Hobel«**
- hoja muy afilada en forma de V
  - con la ruedecita en el mango se puede ajustar el grueso de tajado (1 a 3 mm)
  - con empujador

Art-Nr. / Art.-No.	VE / SU	EAN
1147 2260 	3	 4 004094 114762



reiben & hobeln • cutting, grating & slicing • couper, râper & émincer • picar, rallar & tajar



- Gemüsehobel »6 in 1«**
- mit 4 Einsätzen zum Schneiden, Reiben, Hobeln und Schnitzeln
  - mit eingesetztem Buntschneider für Wellenschnitt
  - mit Auffangschale & Fingerschutz
- Vegetable slicer »6 in 1«*
- with 4 different plates for grating, shredding, cutting etc.
  - with crinkle cutter
  - collection container
  - with finger protection for safe work

Art-Nr. / Art.-No.	VE / SU	EAN
1139 2260	1	4 004094 113963

ABS PP INOX



- Mandoline »6 in 1«**
- avec 4 grilles différentes pour couper, râper, émincer etc.
  - couteau à lame ondulée
  - avec bac collecteur
  - avec protège-doigts
- Tajador de verduras »6 in 1«*
- con 4 insertos para picar, rallar y tajar, etc.
  - con cortador en zigzag
  - con platillo colector
  - con protección de los dedos



307 x 145 x 95 mm

- Turmreibe**
- mit 3 Reibeflächen (fein, mittel, grob)

- Tower grater*
- with 3 grating surfaces (fine, medium, coarse)

Art-Nr. / Art.-No.	VE / SU	EAN
1148 2270	4	4 004094 114878

PP TPE INOX



- Râpe tour**
- avec 3 surfaces de coupe (fine, moyenne et grossière)

- Rallador de base redonda*
- con 3 superficies de rallado (fino, mediano, grande)



126 x 126 x 260 mm

- Rohkostreibe »Quattro«**
- sehr solide
  - 4 unterschiedlichen Reibe-/Schneidflächen
  - über einen Schieber verschließbar zum Auffangen des Reibgutes

- Grater »Quattro«*
- very solid box grater
  - with 4 different grating/slicing surfaces
  - a slide closes the grater for collecting the food inside

Art-Nr. / Art.-No.	VE / SU	EAN
1138 2270	4	4 004094 113871

INOX



- Râpe à crudités »Quattro«**
- très solide
  - avec 4 surfaces de râpe/coupe différentes
  - une glissière collecte la nourriture à l'intérieur

- Rallador de verduras y frutas crudas »Quattro«*
- muy robusto
  - con cuatro diferentes superficies de rallado / tajado
  - en la gavetita corrediza puede coleccionarse el producto rallado



264 x 115 x 82 mm

- Rohkostreibe**
- mit 4 unterschiedlichen Reibe-/Schneidflächen
  - mit handlichem Kunststoffgriff

- Grater*
- with 4 different grating/slicing surfaces
  - with plastic handle

Art-Nr. / Art.-No.	VE / SU	EAN
1142 2270	6	4 004094 114274

PP INOX



- Râpe à crudités**
- avec 4 surfaces de râpe/coupe différentes
  - avec poignée maniable en plastique

- Rallador de verduras y frutas crudas*
- con cuatro diferentes superficies de rallado / tajado
  - con práctico mango de plástico



157 x 106 x 80 mm

- Vierkantreibe**
- 4 unterschiedliche Reibeflächen
  - integrierter Auffangbehälter mit Deckel - umgedreht verschwindet er platzsparend im Inneren der Reibe

- Square grater*
- 4 different grating surfaces
  - integrated food collector with lid - turned upside down the collector is stored space-savingly inside the grater

Art-Nr. / Art.-No.	VE / SU	EAN
1188 2260	4	4 004094 118869

ABS PP INOX



- Râpe carrée**
- avec 4 surfaces de râpe différentes
  - bac collecteur intégré avec couvercle - le tournant, il disparaît pour se conserver à l'intérieur de la râpe

- Rallador de cuatro caras*
- 4 diferentes superficies de rallado
  - recipiente colector con tapa - dándole la vuelta desaparece en el interior del rallador para ahorrar sitio



130 x 136 x 250 mm

**Gemüseschneider »Vario«**

- mehrere Schneidvarianten in einem Gerät
- einfach die gewünschte Schneidvariante über den Drehknopf an der Seite auswählen
- möglich sind grobe und feine Julienne sowie unterschiedliche Scheibenstärken
- mit Fingerschutz für sicheres Arbeiten

**Mandolin »Vario«**

- multiple slicing options in one device
- simply turn the setting knob to choose the desired slicing option
- possible are thick and thin julienne as well as slices of various thicknesses
- food-holder for safe work

**Mandoline »Vario«**



- plusieurs versions de coupe dans un appareil
- choisir simplement la version de coupe souhaitée avec le bouton rotatif sur le côté
- des juliennes fines ou grosses ainsi que différentes épaisseurs de tranches sont possibles
- avec protège-doigts pour un travail en toute sécurité

**Tajador de verduras »Vario«**

- diversas variantes de tajado en un utensilio
- elegir simplemente la variante de tajado deseada con el botón giratorio al lado
- se pueden hacer tajadas Juliana gruesos y finos así como rodajas de diferentes gruesos
- con protección de dedos para trabajar con seguridad



370 x 175 x 180 mm

Art-Nr. / Art.-No.	VE / SU	EAN
1129 2260 	1	 4 004094 112966

TPE ABS INOX

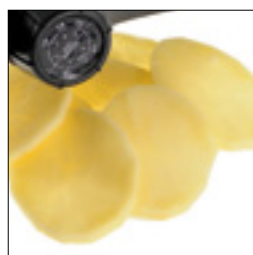

**Gemüseschneider »V-PLUS«**

- mit 5 unterschiedlichen Schneideinsätzen
- möglich sind Scheiben mit Dicken in 1,5; 2,5 und 3,5 mm sowie Streifen à 3,5 oder 7 mm
- mit Fingerschutz für sicheres Arbeiten
- sehr leichte Handhabung und Reinigung

**Vegetable slicer »V-PLUS«**

- with 5 different inserts
- possible are slices in thicknesses of: 1,5; 2,5 and 3,5 mm as well as julienne stripes of 3,5 or 7 mm
- food-holder for safe work included
- very easy handling and cleaning

**Mandoline »V-PLUS«**



- avec 5 lames différentes
- permet des tranches d'1,5, 2,5 et 3,5 mm d'épaisseur ainsi que des tranches de 3,5 ou 7 mm
- avec protège-doigts pour un travail en toute sécurité
- maniement et nettoyage très faciles

**Tajador de verduras »V-PLUS«**

- con 5 insertos de corte diferentes
- se pueden hacer rodajas de gruesos de 1,5; 2,5 y 3,5 mm así como tiras de 3,5 o 7 mm
- con protección de dedos para trabajar con seguridad
- manejo y limpieza muy fáciles



415 x 150 x 120 mm

Art-Nr. / Art.-No.	VE / SU	EAN
1130 2260 	1	 4 004094 113062

TPE ABS INOX





**Spiralschneider »Triolo«**

- mit 3 Schneidkegeln
- schneidet Spiralen, Julienne fein & grob
- ideal zur Verarbeitung von Zucchini, Möhren, Gurken, Salat, länglichen Gemüsearten, etc.
- mit Resthalter

**Vegetable slicer »Triolo«**

- with 3 blades
- slices into spirals and julienne fine & coarse
- ideal for carrots, zucchini, cucumbers, cabbages, salad etc.
- with rest holder



**Coupe-légumes spirale »Triolo«**

- avec 3 lames
- découpe en spirales, en julienne fin & grossier
- idéal pour découper courgettes, carottes, concombres etc.
- avec pousse-restes



**Cortador en espiral »Triolo«**

- con 3 cuchillas
- corta en espiral, en juliana fina y gruesa
- ideal para trabajar con calabacines, zanahorias, pepinos, etc.
- con empujador

**3 verschiedene Klingen  
3 different blades**



188 x 68 x 93 mm

Art-Nr. / Art.-No.	VE / SU	EAN
1165 2260 	6	 4 004094 116568



05



**Kräutermühle Edelstahl**

- scharfe Edelstahlzähne ziehen die Kräuter in das Innere der Mühle und zerkleinern diese
- zur Reinigung leicht auseinanderzunehmen

**Herb mill stainless steel**

- sharp stainless steel teeth tear the herbs inside the mill and cut them in an instant
- for cleaning - simply detach the tool

**Moulin à herbes acier inoxydable**



- les dents affûtées en acier inoxydable arrachent les herbes à l'intérieur du moulin et les broient
- facile à démonter pour le nettoyage

**Molino de hierbas de acero inoxidable**

- los dientes agudos de acero inoxidable tiran de las hierbas al interior del molino y las pican
- se puede desmontar fácilmente para la limpieza



185 x 160 x 58 mm

Art-Nr. / Art.-No.	VE / SU	EAN
1176 2260 	6	 4 004094 117664



zerkleinern, reiben & hobeln • cutting, grating & slicing • couper, râper & émincer • picar, rallar & tajar

91



**Gemüseschneider »Spiromat«**

- Obst und Gemüse mal anders geschnitten
- 3 sehr scharfe Klingen-Einsätze sorgen für Abwechslung
- praktisch: die jeweils nicht genutzten Schneideinsätze werden schubladenförmig in das Gerät eingesteckt
- 4 Gummi-Saugfüße für festen Halt

**Mandoline »Spiromat«**

- couper les fruits et les légumes autrement
- 3 unités de lames très tranchantes assurent la variété
- particulièrement pratique: les unités de coupe non utilisées peuvent être rangées dans les tiroirs de l'appareil
- 4 pieds-ventouses en caoutchouc pour un parfait maintien

**Vegetable slicer »Spiromat«**

- fruit and vegetables cut in a different way
- 3 very sharp blade units ensure variety
- very practical: the cutting units which are not in use can be stored away drawer-wise in the appliance
- 4 rubber suction-feet for secure hold

**Cortador de verduras »Spiromat«**

- frutas y verduras cortadas de otra manera
- 3 unidades de hojas muy agudas aseguran variedad
- especialmente práctico: las unidades de hojas que no se están usando se meten como cajitas en el aparato
- 4 patas de goma para un apoyo seguro



275 x 140 x 220 mm

Art-Nr. / Art.-No.	VE / SU	EAN
1133 2260	1	4 004094 113369

ABS INOX



**Reibemaschine mit 4 Trommeln**

- mit 4 Schneidtrommeln aus Edelstahl zum groben und feinen Reiben, Hobeln und Raspeln von Obst, Gemüse, Nüssen, Schokolade, Käse etc.
- mit Fingerschutz
- starker Saugfuß für hohe Standfestigkeit

**Machine à râper avec 4 trémies**

- avec 4 trémies de coupe en acier inoxydable pour râper finement ou grossièrement, émincer et broyer fruits, légumes, noix, chocolat, fromages etc.
- avec protège-doigts
- le fort pied-ventouse assure la stabilité

**Grater with 4 drums**

- with 4 cutting drums from stainless steel for coarse and fine grating, cutting and shredding of fruit, vegetables, nuts, cheese, chocolate etc.
- with finger protection
- the secure suction-foot ensures safe hold

**Ralladora con 4 tambores**

- con 4 tambores cortadores de acero inoxidable para el rallado grueso y fino, el tajo y raspado de frutas, verduras, nueces, chocolate, queso etc.
- con protección para los dedos
- con pata de succión fuerte

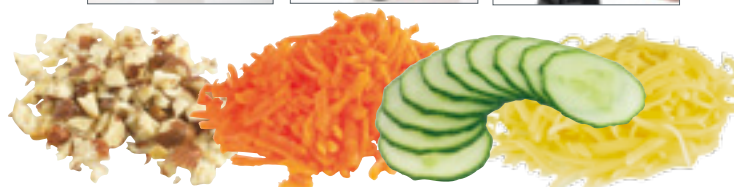

190 x 115 x 280 mm

Art-Nr. / Art.-No.	VE / SU	EAN
9760 2260	1	4 004094 976063

ABS TPE INOX







**Gemüseschneider »Schnitzel Mouli«**

- 3 Schneidscheiben aus Edelstahl
- kompakt zusammenlegbar -> wenig Stauraum
- 3 GummifüÙe geben sicheren Halt auf der Arbeitsfläche

**Râpe à légumes »Schnitzel Mouli«**

- 3 disques de coupe en acier inoxydable
- appareil est pliable -> peu d'espace de rangement
- 3 pieds en caoutchouc assurent un parfait maintien

**Rotary grater »Schnitzel Mouli«**

- 3 blade discs from stainless steel
- the appliance can be fold away space savingly
- three rubber feet ensure secure hold on the work-surface

**Cortador de verduras »Schnitzel Mouli«**

- 3 discos cortadores de acero inoxidable
- el aparato puede plegarse, de modo que se ahorra sitio
- 3 patas de goma proporcionan un apoyo seguro

Art-Nr. / Art.-No.	VE / SU	EAN
1171 2260	1	4 004094 117169

ABS ST INOX



320 x 245 x 245 mm

**Trommelreibe »Trio«**

- mit 3 Trommeln zum groben und feinen Reiben und Raspeln von Mandeln, Nüssen, Früchten, Gemüse, Schokolade und Hartkäse

**Râpe rotative »Trio«**

- avec 3 trémies différentes pour râper et couper grossièrement ou finement les amandes, les noix, les fruits, les légumes, le chocolat et le fromage à pâte dure

**Drum grater »Trio«**

- with 3 grating drums for coarse and fine grating and cutting of almonds, nuts, fruit, vegetables, chocolate and hard cheese

**Rallador de tambor »Trio«**

- con 3 tambores para el rallado grueso y fino y para picar almendras, nueces, frutas, verduras, chocolate y queso duro



Art-Nr. / Art.-No.	VE / SU	EAN
1172 2260	3	4 004094 117268

ABS INOX



190 x 105 x 97 mm



**Küchenhexe**  
 • manuelle Küchenmaschine für verschiedenste Anwendungen  
 • bis auf den Funktionsdeckel sind alle Teile spülmaschinengeeignet

**Kitchen witch**  
 • nearly like „witchcraft“ - this manual kitchen machine does almost everything  
 • except for the functional lid all parts are dishwasher safe

**Robot de cuisine**  
 • le „sorcier“ – le robot manuel qui peut presque tout faire  
 • toutes les pièces vont au lave-vaisselle, sauf le couvercle de fonction

**Mago de cocina**  
 • casi “magia” – el aparato de cocina manejado a mano que hace casi todo  
 • todas las piezas se apropian para el lavavajillas- excepción: la tapa funcional



264 x 168 x 244 mm

Art-Nr. / Art.-No.	VE / SU	EAN
1140 2260	1	 4 004094 114069



**Zwiebelwürfler**  
 • Schneidgitter 6 x 6 mm  
 • Gummifüße für sicheren Stand  
 • zusätzlicher, dichtschießender Deckel verwandelt den Auffangbehälter in eine Vorratsdose

**Onion dicer**  
 • cutting grid 6 x 6 mm  
 • rubber feet ensure a safe hold  
 • an additional tightly closing lid transfers the collector into a storage box

**Coupe-oignon**  
 • grille de coupe 6 x 6 mm  
 • avec pieds en caoutchouc pour un maintien parfait  
 • un couvercle hermétique supplémentaire transforme le bac collecteur en boîte de stockage

**Cortador de ebollas en cubitos**  
 • rejilla cortadora 6 x 6 mm  
 • gracias a las patas de goma se consigue un apoyo seguro  
 • una tapa adicional que cierra fijamente transforma el recipiente de recogida en un colector



275 x 112 x 153 mm

Art-Nr. / Art.-No.	VE / SU	EAN
1141 2260	1	 4 004094 114168





**Universalhacker »Kompakt«**

- mit Rotationsmechanismus
- für Zwiebeln, Gemüse, Nüsse etc.
- durch einen zusätzlichen Deckel verwandelt sich der klare Hackzylinder in eine Vorratsdose

**Universal chopper »Kompakt«**

- with rotating mechanism
- for onions, vegetables, nuts etc.
- with the additionally provided lid the clear chopping cylinder turns into a storage box



**Hachoir universel »Kompakt«**

- avec mécanisme de rotation
- pour les oignons, noix etc.
- grâce à un couvercle supplém., le cylindre de hachage se transforme en boîte de stockage

**Picador universal »Kompakt«**

- con mecanismo automático rotatorio
- para cebollas, nueces etc.
- gracias a una tapa adicional, el cilindro picador se transforma en un colector



Art-Nr. / Art.-No.	VE / SU	EAN
1145 2260 	6	 4 004094 114564



175 x 91 x 91 mm

05



**Edelstahlhacker »500«**

- mit Rotationsmechanismus
- Besonderheit: ein sich bei jedem Hub mitdrehender Abstreifer löst das Hackgut von der Wand des Hackzylinders

**Stainless steel chopper »500«**

- with rotating mechanism
- special feature: a wiper removes chopped food from the sides of the chopping cylinder with every push

**Hachoir en acier inoxydable »500«**



- avec mécanisme de rotation
- particularité: un racloir tournant à chaque pression décolle les aliments hachés de la paroi du cylindre de hachage

**Picador de acero inoxidable »500«**

- con mecanismo rotatorio
- particularidad: un rascador que gira al mismo tiempo separa el producto picado de la pared del cilindro cada vez que se levante



165 x 70 x 70 mm

Art-Nr. / Art.-No.	VE / SU	EAN
1151 2260 	3	 4 004094 115165



**Edelstahlhacker »1000«**

- mit Rotationsmechanismus
- Besonderheit: ein sich bei jedem Hub mitdrehender Abstreifer löst das Hackgut von der Wand des Hackzylinders

**Stainless steel chopper »1000«**

- with rotating mechanism
- special feature: a wiper removes chopped food from the sides of the chopping cylinder with every push

**Hachoir en acier inoxydable »1000«**



- avec mécanisme de rotation
- particularité: un racloir tournant à chaque pression décolle les aliments hachés de la paroi du cylindre de hachage

**Picador de acero inoxidable »1000«**

- con mecanismo rotatorio
- particularidad: un rascador que gira al mismo tiempo separa el producto picado de la pared del cilindro cada vez que se levante



220 x 94 x 94 mm

Art-Nr. / Art.-No.	VE / SU	EAN
1149 2260 	3	 4 004094 114960



zerkleinern, reiben & hobeln • cutting, grating & slicing • couper, râper & émincer • picar, rallar & tajar

95

zerkleinern, reiben & hobeln • cutting, grating & slicing • couper, râper & émincer • picar, rallar & tajjar



340 x 115 x 85 mm

**Kartoffelstampfer Edelstahl**  
 • der Klassiker  
 • robuster Helfer für die Zubereitung von Kartoffelpüree

*Potato masher stainless steel*  
 • the classic  
 • robust helper for mashing potatoes

**Presse-purée acier inoxydable**  
 • le classique  
 • l'assistant robuste pour préparer des purées de pommes de terre

*Aplastador de patatas en acero inoxidable*  
 • el clásico  
 • el ayudante robusto para preparar puré de patatas

Art-Nr. / Art.-No.	VE / SU	EAN
6127 2270	5	4 004094 612770



260 x 102 x 120 mm

**Kartoffelpresse**  
 • die kompakte Form und die ergonomisch geformten runden Griffe sorgen für ein gutes Handling

*Potato press*  
 • a strong tool with sophisticated look  
 • very convincing functionality

**Presse à pommes de terre**  
 • la forme compacte et les manches ergonomiques arrondis garantissent une bonne prise en main

*Prensa patatas*  
 • la forma compacta y los mangos redondo moldeados ergonómicamente, garantizan un buen manejo

Art-Nr. / Art.-No.	VE / SU	EAN
6124 2270	5	4 004094 612473



300 x 117 x 140 mm

**Kartoffelpresse »Triangel«**  
 • robustes Gerät mit filigranem Look  
 • sehr überzeugende Funktionalität  
 • leicht zu reinigen

*Potato press »Triangel«*  
 • a strong tool with sophisticated look  
 • very convincing functionality  
 • easy to clean

**Presse à pommes de terre »Triangel«**  
 • un appareil performant au look filigrané  
 • fonctionnalité très impressionnante  
 • facile à nettoyer

*Prensa patatas »Triangel«*  
 • un aparato fuerte con look afiligranado  
 • funcionalidad muy convincente  
 • fácil de limpiar

Art-Nr. / Art.-No.	VE / SU	EAN
6126 2260	3	4 004094 612664



240 x 85 x 110 mm

**Pommes-frites Schneider**  
 • 3 geschliffene Messereinsätze und Stempel (12x12 / 10x10 / 9x9 mm)  
 • auch zum Schneiden von Obst- und Gemüsestiften für Fingerfood-Variationen  
 • mit sicherem Saugfuß für festen Halt

*Potato chipper*  
 • 3 sharpened knife units and indentors (12x12 / 10x10 / 9x9 mm)  
 • also for cutting fruit and vegetable sticks for finger food creations  
 • the safe suction pad enables a secure hold

**Coupe-frites**  
 • 3 grilles affûtées (12x12 / 10x10 / 9x9 mm)  
 • également pour couper de bâtonnets de fruits et de légumes à manger avec les doigts  
 • le pied-ventouse assure un parfait maintien

*Cortador de patatas*  
 • 3 unidades de cuchillas afiladas y de presión (12x12 / 10x10 / 9x9 mm)  
 • también para cortar barritas sabrosas de frutas y verduras para variaciones de finger food  
 • con pata de succión fuerte

Art-Nr. / Art.-No.	VE / SU	EAN
1180 2260	3	4 004094 118067



248 x 95 x 128 mm

**Pommes-frites Schneider »Pomfri-Perfect«**  
 • 3 geschliffene Messereinsätze und Stempel (12x12 / 10x10 / 9x9 mm)  
 • auch zum Schneiden von Obst- und Gemüsestiften für Fingerfood-Variationen  
 • mit sicherem Saugfuß für festen Halt

*Potato chipper »Pomfri-Perfect«*  
 • 3 sharpened knife units and indentors (12x12 / 10x10 / 9x9 mm)  
 • also for cutting fruit and vegetable sticks for finger food creations  
 • the safe suction pad enables a secure hold

**Coupe-frites »Pomfri-Perfect«**  
 • 3 grilles affûtées (12x12 / 10x10 / 9x9 mm)  
 • également pour couper de bâtonnets de fruits et de légumes à manger avec les doigts  
 • le pied-ventouse assure un parfait maintien

*Cortador de patatas »Pomfri-Perfect«*  
 • 3 unidades de cuchillas afiladas y de presión (12x12 / 10x10 / 9x9 mm)  
 • también para cortar barritas sabrosas de frutas y verduras para variaciones de finger food  
 • con pata de succión fuerte

Art-Nr. / Art.-No.	VE / SU	EAN
1181 2260	3	4 004094 118166





# 06

öffnen & verschließen • *opening & closing*  
ouvrir & fermer • *abrir & cerrar*

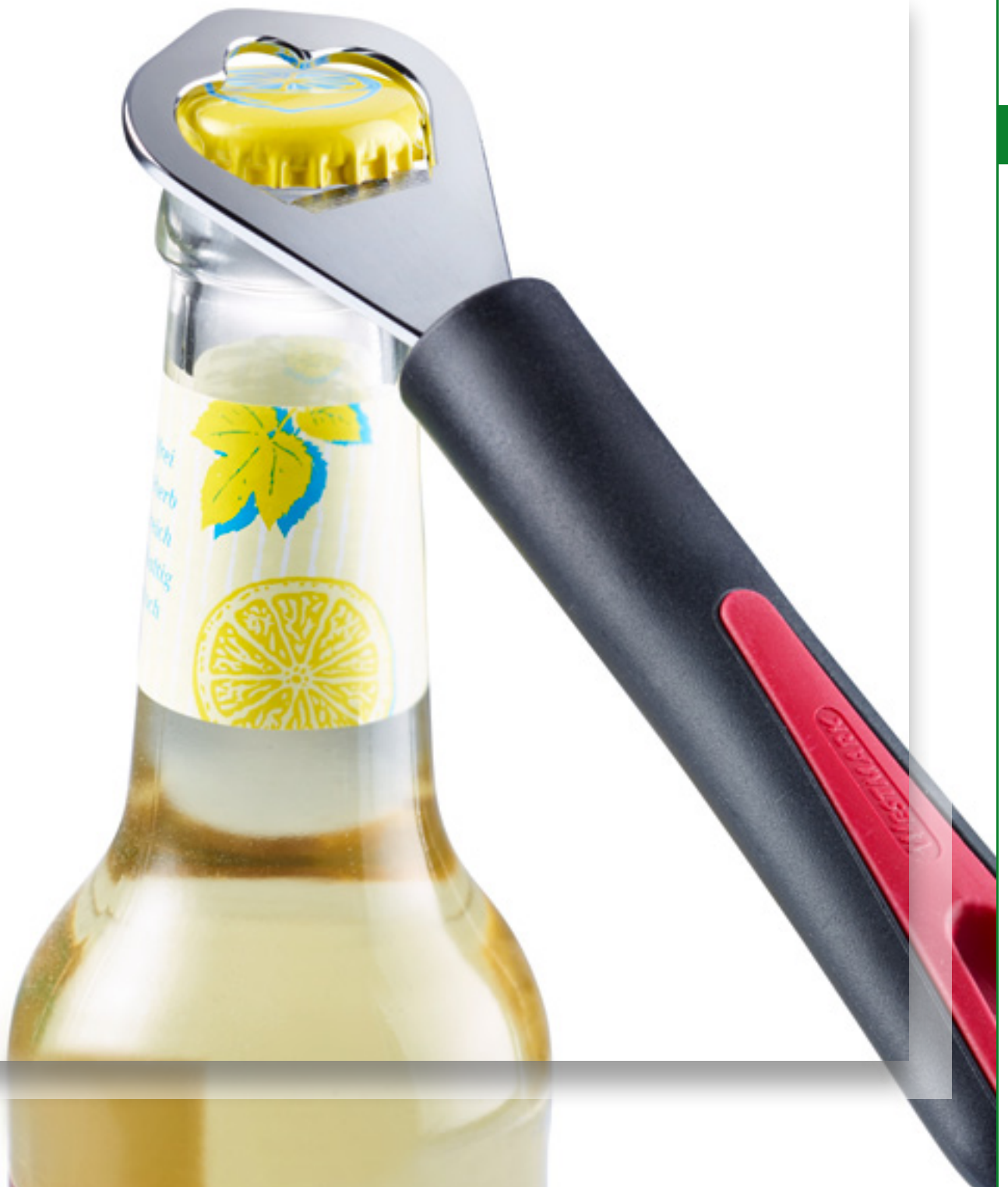

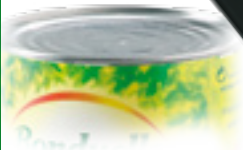

149 x 31 x 32 mm



**SIEGER**

**Hebeldosenöffner »Original Sieger«**

- Schneidmesser-Prinzip
- mit Kapselheber
- schwarz lackiert

*Lever can opener »Original Sieger«*





- cutting knife principle
- with cap lifter
- black lacquered

**Ouvre-boîte à levier »Original Sieger«**

- principe à lame de coupe
- avec décapsuleur
- laqué noir

*Abrelatas de palanca »Original Sieger«*

- principio de cuchilla de corte
- con abre cápsulas
- laqueado negro

Art-Nr. / Art.-No.	VE / SU	EAN
1121 4460 	5	 4 004094 112164
1121 4470 	5	 4 004094 112171



Made in GERMANY 



149 x 32 x 24 mm

**SIEGER**

**Hebeldosenöffner »Eminent«**

- Schneidmesser-Prinzip
- mit besonders robustem Kapselheber im Gehäuse
- wird farbig sortiert geliefert

*Lever can opener »Eminent«*



- cutting knife principle
- with especially robust cap lifter in the housing
- comes in assorted colours

**Ouvre-boîte à levier »Eminent«**

- principe à lame de coupe
- avec décapsuleur particulièrement robuste
- en couleurs assorties

*Abrelatas de palanca »Eminent«*

- principio de cuchilla de corte
- con abre cápsulas extra robusto en la caja
- se suministra en colores surtidos

Art-Nr. / Art.-No.	VE / SU	EAN
1125 4470 	5	 4 004094 112577

ST



Made in GERMANY 



162 x 28 x 28 mm

**Hebeldosenöffner »Columbus«**

- Schneidmesser-Prinzip
- mit Kapselheber
- farbig sortiert

*Lever can opener »Columbus«*



- cutting knife principle
- with cap lifter
- comes in assorted colours

**Ouvre-boîte à levier »Columbus«**

- principe à lame de coupe
- avec décapsuleur
- couleurs assorties

*Abrelatas de palanca »Columbus«*

- principio de cuchilla de corte
- con abre cápsulas
- en colores surtidos

Art-Nr. / Art.-No.	VE / SU	EAN
1025 2210 	70	
1025 2270 	10	 4 004094 102578

ST



Made in GERMANY 



155 x 85 x 40 mm

**SIEGER**

**Zangendosenöffner »Zangen-Sieger«**

- der Sieger-Klassiker
- Schneidmesser-Prinzip
- mit Kapselheber

*Pincer can opener »Zangen-Sieger«*



- the Sieger-Classic
- cutting knife principle
- with cap lifter

**Ouvre-boîte à pince »Zangen-Sieger«**

- le classique Sieger
- principe à lame de coupe
- avec décapsuleur

*Abrelatas de tenazas »Zangen-Sieger«*

- el clásico de Sieger
- con principio de cuchilla de corte
- con abre cápsulas

Art-Nr. / Art.-No.	VE / SU	EAN
1031 4470 	5	 4 004094 103179

ST

PA



Made in GERMANY 



148 x 63 x 35 mm

**Zangendosenöffner »Standard«**

- Schneidmesser Prinzip
- mit Kapselheber im Griff
- gehärtetes Messer und Zahnrad

*Pincer can opener »Standard«*



- cutting knife principle
- with cap lifter in the handle
- hardened knife and transport wheel

**Ouvre-boîte à pince »Standard«**

- principe à lame de coupe
- avec décapsuleur dans le manche
- couteau trempé et roue dentée

*Abrelatas de tenazas »Standard«*

- principio de cuchilla de corte
- con abre cápsulas en el mango
- cuchill y rueda dentada templadas

Art-Nr. / Art.-No.	VE / SU	EAN
1030 2210 	25	
1030 2270 	10	 4 004094 103070

ST



Made in GERMANY 





### Dosenöffner »Sieger Boy«

- klein, kompakt, gut in der Schublade zu verstauen
- hochfein verchromt
- Transportrad und Schneidmesser aus gehärtetem Spezialstahl

### Can opener »Sieger Boy«

- *small, compact, easy to store in the drawer*
- *fine chrome-plating*
- *transport wheel and knife from special, tempered steel*

Art-Nr. / Art.-No.	VE / SU	EAN
1228 4470 	5	 4 004094 122873

ST PA



### Ouvre-boîte »Sieger Boy«

- petit, compact, facile à ranger dans un tiroir
- chromage fin
- roue de transport et lame de coupe en acier spécial trempé

### Abrelatas »Sieger Boy«

- *pequeño, compacto, fácil de guardar en el cajón*
- *cromado muy fino*
- *rueda transportadora y cuchilla de corte de acero especial templado*

**SIEGER**







78 x 50 x 54 mm

### Dosenöffner »Automatic«

- klein, kompakt, gut in der Schublade zu verstauen
- hochfein verchromt
- Transportrad und Schneidmesser aus gehärtetem Spezialstahl

### Can opener »Automatic«

- *small, compact, easy to store in the drawer*
- *fine chrome-plating*
- *transport wheel and knife from special, tempered steel*

Art-Nr. / Art.-No.	VE / SU	EAN
1222 2270 	5	 4 004094 122279
1222 5560 	5	 4 004094 122262

ST PA



### Ouvre-boîte »Automatic«

- petit, compact, facile à ranger dans un tiroir
- chromage fin
- roue de transport et lame de coupe en acier spécial trempé

### Abrelatas »Automatic«

- *pequeño, compacto, fácil de guardar en el cajón*
- *cromado muy fino*
- *rueda transportadora y cuchilla de corte en acero especial templado*



78 x 50 x 54 mm

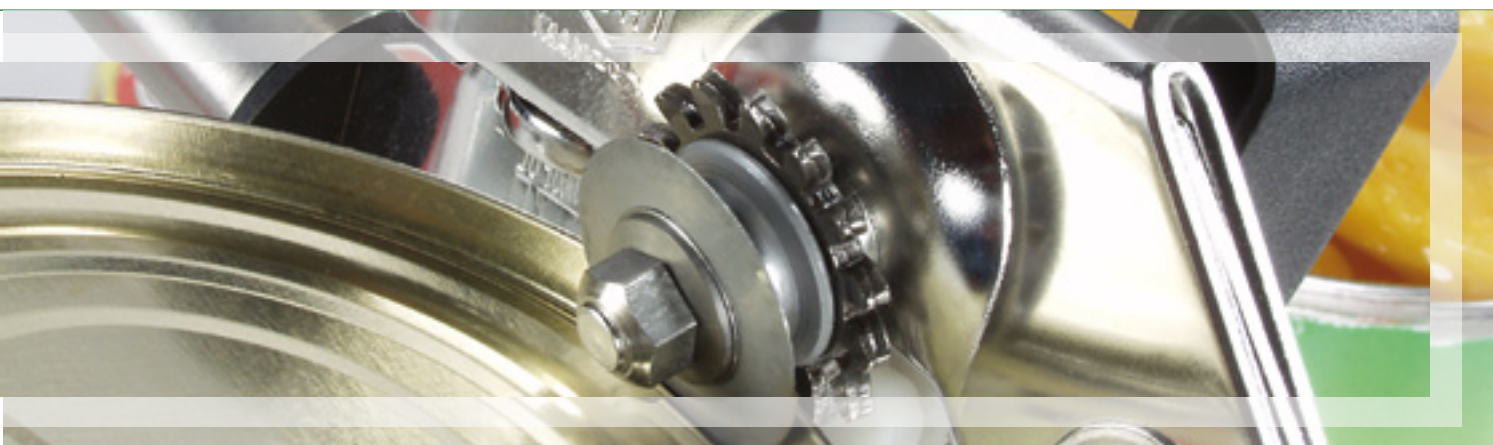

### Profidosenöffner »Titan«

- für den gewerblichen Gebrauch
- konzipiert für Dosen in Gastronomiegröße
- Schneidmesser Prinzip
- Messer und Transportrad stahlgehärtet und verzinkt

### Multipurpose opener »Titan«

- *for commercial use*
- *designed for cans in catering size*
- *cutting-knife-principle*
- *knife and traction wheel specially hardened and tin-plated*



### Ouvre-boîte professionnel »Titan«



- à usage commercial
- conçu pour les grandes boîtes dans la restauration
- principe à lame de coupe
- lame et roue de transport en acier trempé et étamé

### Abrelatas profesional »Titan«

- *para el uso comercial*
- *diseñado para latas de tamaño para gastronomía*
- *principio de cuchilla de corte*
- *cuchilla y rueda transportadora templadas y estañadas*



**MONOPOL**  
**M**  
GERMANY

Art-Nr. / Art.-No.	VE / SU	EAN
1224 2260 	5	 4 004094 122477
1224 5560 	5	 4 004094 122460

ST



91 x 60 x 91 mm



**Dosenöffnermaschine**

- zuverlässiges Werkzeug für die Gastronomie
- Stange, Messer und Transportrad aus hochwertigem, rostfreiem Edelstahl
- maximale Dosenhöhe 550 mm
- Auflagefläche für Tischbefestigung: 230 x 80 mm
- Abmessungen: Stange mit Funktionsteil - 840 mm lang

*Can opener unit*

- reliable tool for professional users in food service
- bar, knife and transport wheel from high grade stainless steel
- maximum can height 550 mm
- table base element: 230 x 80 mm
- dimensions: bar with functional part - 840 mm long

**Machine ouvre-boîte**

- fiable outil pour la restauration
- barre, lame et roue de transport en acier inoxydable de haute qualité
- hauteur de boîte maximale de 550 mm
- surface d'appui pour fixation sur la table: 230 x 80 mm
- dimensions: barre avec partie fonctionnelle 840 mm de long

*Máquina abrelatas robusta*



- herramienta fiable para la gastronomía
- barra, cuchilla y rueda transportadora hechos de acero inoxidable de alta calidad
- altura máxima de las latas 550 mm
- encimera para sujeción a la mesa: 230 x 80 mm
- dimensiones: barra con parte funcional - 840 mm de largo

**Dosenöffnermaschine »Clou 30«, lackiert**  
• Druckgusselemente hellgrau-lackiert

*Can opener unit »Clou 30«, painted*  
• cast elements painted light-grey

**Machine ouvre-boîte »Clou 30«, peinte**  
• éléments en fonte peints en gris clair

*Máquina abrelatas robusta »Clou 30«, revestida*  
• elementos de fundición a presión laqueados en gris claro

Art-Nr. / Art.-No.	VE / SU	EAN
1980 4460 	1	 4 004094 198069





**Dosenöffnermaschine »Clou 40«, vernickelt**  
• Druckgusselemente vernickelt

*Can opener unit »Clou 40«, nickel-plated*  
• cast elements nickel-plated

**Machine ouvre-boîte »Clou 40«, nickelée**  
• éléments en fonte nickelés

*Máquina abrelatas robusta »Clou 40«, niquelada*  
• elementos de fundición a presión niquelados

Art-Nr. / Art.-No.	VE / SU	EAN
1985 4460 	1	 4 004094 198564





**Dosenöffnermaschine »Clou 50«, Edelstahl**  
• alle Metallteile aus hochwertigem, rostfreiem Edelstahl

*Can opener unit »Clou 50«, stainless steel*  
• all metal parts from high grade stainless steel

**Machine ouvre-boîte »Clou 50«, inox**  
• toutes les pièces métalliques en acier inoxydable de haute qualité

*Máquina abrelatas robusta »Clou 50«, acero inox*  
• todas las piezas metálicas están hechas en acero inoxidable de alta calidad

Art-Nr. / Art.-No.	VE / SU	EAN
1990 4460 	1	 4 004094 199066







### Zangendosenöffner

- mit Schneidrollen-Prinzip
- mit Kapsel- und Deckelheber
- wird sortiert geliefert - schwarze & weiße Griffe
- auch als Linkshandvariante verfügbar (Art-Nr. 1127)

### Pincer can opener

- on cutting wheel principle
- with cap and lid lifter
- comes in assorted colours - black and white handles
- also available for left-handers (ref. 1127)

Art-Nr. / Art.-No.	VE / SU	EAN
1126 4470 	10	4 004094 112676
1127 4470  	5	4 004094 112775

### Ouvre-boîte à pince

- principe à roue de coupe
- avec décapsuleur et ouvre-bocal
- couleurs assorties – manches noirs & blancs
- également en version pour gauchers (art. 1127)

### Abrelatas de tenazas

- con principio de rodillo cortante
- con abre cápsulas y abre tapas
- en colores surtidos, mangos negros & blancos
- también como variante para zurdos (Art° 1127)



185 x 74 x 53 mm



06

### Zangendosenöffner »Techno«

- Schneidrollen Prinzip
- gehärtetes Messer und Zahnrad
- mit Kapsel- und Deckelheber
- großer Drehknopf für angenehmes Handling

### Pincer can opener »Techno«

- cutting wheel principle
- hardened knife and traction wheel
- with cap and lid lifter
- big turning knob for good handling

### Ouvre-boîte à pince »Techno«

- principe à molette
- couteau trempé et roue dentée
- avec décapsuleur et lève-couvercle
- grande poignée tournante pour une manipulation agréable

### Abrelatas de tenazas »Techno«

- principio de rodillo cortante
- cuchilla y rueda dentada templadas
- con abre cápsulas y abre tapas
- gran pomo giratorio para un manejo agradable

Art-Nr. / Art.-No.	VE / SU	EAN
1340 2270 	5	4 004094 134074



187 x 57 x 54 mm

### Sicherheitsdosenöffner »Bravo«

- „keine-scharfen-Kanten-Schneidsystem“
- schneidet die Dose am Rand ein - Deckel kann so wieder aufgesetzt werden
- ergonomischer Griff
- großer Drehknopf

### Profi can opener »Bravo«

- „no-sharp-edges-cutting-principle“
- cuts the can at the side - lid can thus be put on again
- ergonomic handle

### Ouvre-boîte de sécurité »Bravo«

- „système de coupe sans bords affûtés“
- coupe la boîte sur le côté – le couvercle peut ainsi être replacé
- manche ergonomique

### Abrelatas de seguridad »Bravo«

- sistema de corte - ningunas aristas agudas
- corta la lata por el borde – de modo que se puede poner la tapa otra vez
- mango ergonómico

Art-Nr. / Art.-No.	VE / SU	EAN
1032 4470 	5	4 004094 103278



185 x 80 x 42 mm



180 x 82 x 71 mm

### Sicherheitsdosenöffner »Klu«

- „keine-scharfen-Kanten-Schneidsystem“
- der Deckel wird am seitlichen Dosenrand sauber eingeschnitten
- mit Zange zum leichten Abnehmen des Deckels

### Safety can opener »Klu«



- „no-sharp-edges-cutting-principle“
- the lid is cut cleanly sideways underneath the rim
- built-in tongs for taking off the lid easily

### Ouvre-boîte de sécurité »Klu«

- „système de coupe sans bords affûtés“
- coupe la boîte sur le côté
- avec pince pour retirer facilement le couvercle

### Abrelatas de seguridad »Klu«

- sistema de corte - ningunas aristas agudas
- se corta la tapa por el borde
- con pinza para sacar la tapa fácilmente

Art-Nr. / Art.-No.	VE / SU	EAN
1033 2260 	5	 4 004094 103360

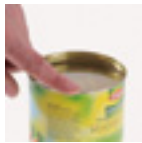

175 x 55 x 60 mm

### Sicherheitsdosenöffner »Klu 2«

- „keine-scharfen-Kanten-Schneidsystem“
- der Deckel wird am seitlichen Dosenrand sauber eingeschnitten
- mit Zange zum leichten Abnehmen des Deckels
- mit Hebel-Ratschen Funktion

### Safety can opener »Klu 2«



- „no-sharp-edges-cutting-principle“
- the lid is cut cleanly sideways underneath the rim
- built-in tongs for taking off the lid easily
- with lever-handle

### Ouvre-boîte de sécurité »Klu 2«

- „système de coupe sans bords affûtés“
- coupe la boîte sur le côté
- avec pince pour retirer facilement le couvercle
- avec long manche à levier

### Abrelatas de seguridad »Klu 2«

- sistema de corte - ningunas aristas agudas
- se corta la tapa por el borde
- con pinza para sacar la tapa fácilmente
- con función palanca-carracase

Art-Nr. / Art.-No.	VE / SU	EAN
1038 2260 	5	 4 004094 103865



170 x 98 x 15 mm

### Vielwecköffner »Sieger-Twist«

- mit Gummilippe für festen, sicheren Griff
- hilft, Gläser, Drehverschlüsse und Tuben mühelos zu öffnen
- auch ideal als Dosenlocher und Kapselheber
- wird farbig sortiert geliefert

### Universal opener »Sieger-Twist«



- with the rubber band the opener gets a good grip on the lid
- that way jars, bottles and tubes can be opened easily
- also ideal as can puncher/cap lifter
- comes in assorted colours

### Ouvre-boîte universel »Sieger-Twist«

- la bande caoutchoutée s'accroche bien au couvercle
- idéal pour ouvrir facilement les canettes, les bocaux et les tubes
- aussi comme perce-boîte/décapsuleur
- en couleurs assorties

### Abridor universal »Sieger-Twist«

- el labio de goma se arrima fijamente a la tapa
- así se pueden abrir fácilmente recipientes y cierres giratorios
- también como abre cápsulas
- se suministra en colores surtidos

Art-Nr. / Art.-No.	VE / SU	EAN
1049 4470 	5	 4 004094 104978



### Vielwecköffner »Twist«

- mit Gummilippe für festen, sicheren Griff
- hilft, Gläser, Drehverschlüsse und Tuben mühelos zu öffnen
- auch ideal als Dosenlocher und Kapselheber

### Universal opener »Twist«

- with the rubber band the opener gets a good grip on the lid
- that way jars, bottles and tubes can be opened easily
- also ideal as can puncher/cap lifter



### Ouvre-universel »Twist«

- la bande caoutchoutée s'accroche bien au couvercle
- idéal pour ouvrir facilement les canettes, les bocaux et les tubes
- aussi comme perce-boîte/décapsuleur

### Abridor universal »Twist«

- el labio de goma se arrima fijamente a la tapa
- así se pueden abrir fácilmente recipientes y cierres giratorios
- también como abre cápsulas



Art-Nr. / Art.-No.	VE / SU	EAN
1050 2210 	100	
1050 2270 	5	 4 004094 105074





170 x 98 x 15 mm



- Dosenlocher »Gentle«**
- mit gespitztem Edelstahlhorn
  - sehr robust

- Tin pincher »Gentle«**
- with pointed stainless steel spike
  - strong design

Art-Nr. / Art.-No.	VE / SU	EAN
2810 2210 	25	
2810 2270 	6	 4 004094 281075



- Perce-boîte »Gentle«**
- avec pointe en acier inox pointue
  - très robuste



- Agujereador de latas »Gentle«**
- con púa de acero inoxidable aguzada
  - muy robusto



140 x 27 x 20 mm

- Dosenlocher »Gallant«**
- mit gespitztem rostfreien Edelstahldorn
  - sehr robust
  - Komfort-Soft-Touch-Griff

- Tin pincher »Gallant«**
- with pointed stainless steel spike
  - strong design
  - comfort-soft-touch handle

Art-Nr. / Art.-No.	VE / SU	EAN
2910 2270 	6	 4 004094 291074



- Perce-boîte »Gallant«**
- avec pointe en acier inox pointue
  - très robuste
  - poignée confort-soft-touch

- Agujereador de latas »Gallant«**
- con púa de acero inoxidable aguzada
  - muy robusto
  - con mango cómodo soft-touch



140 x 27 x 20 mm



06





104 x 80 x 21 mm

- Korkenzieher »Woody«**
- traditioneller 'Korkenzieher'
  - Wendel mit Seele

- Corkscrew »Woody«**
- a traditional corkscrew
  - thread with axial centre

- Tire-bouchon »Woody«**
- un tire-bouchon traditionnel
  - mèche avec âme

- Sacacorchos »Woody«**
- un „sacacorchos“ tradicional
  - espiral con alma

Art-Nr. / Art.-No.	VE / SU	EAN
1012 2210 	50	
1012 2270 	10	 4 004094 101274

ST





72 x 44 x 155 mm

- Korkenzieher »Spezi«**
- Wendel mit Seele, mit Antihaft-Beschichtung
  - exakter Sitz auf jedem Flaschenhals

- Corkscrew »Spezi«**
- thread with axial centre, with non-stick coating
  - precise fit on the bottle neck

- Tire-bouchon »Spezi«**
- mèche avec âme et revêtement anti-adhésif
  - ajustement précis sur le goulot de la bouteille

- Sacacorchos »Spezi«**
- espiral con alma, con revestimiento antiadhesivo
  - asiento exacto sobre todos los cuellos de botellas

Art-Nr. / Art.-No.	VE / SU	EAN
6024 2270 	5	 4 004094 602474

PP

PA

ST



87 x 44 x 149 mm





**SIEGER**

- Korkenzieher »Avanti«**
- Wendel mit Seele, mit Antihaft-Beschichtung
  - robust gefertigt
  - seidig glänzende Oberfläche
  - auch als Linkshand-Version

- Cork screw »Avanti«**
- thread with axial centre, with non-stick coating
  - robust design
  - satin-shine surface
  - also as left-hand-version

- Tire-bouchon »Avanti«**
- mèche avec âme et revêtement anti-adhésif
  - robuste
  - surface brillante et soyeuse
  - aussi pour gauchers

- Sacacorchos »Avanti«**
- espiral con alma, con revestimiento antiadhesivo
  - fabricación robusta
  - superficie de brillo sedoso
  - también como variante para zurdos

Art-Nr. / Art.-No.	VE / SU	EAN
6025 4470 	5	 4 004094 602573
6028 4470  	5	 4 004094 602870

ABS

ST



160 x 70 x 39 mm

- Korkenzieher »Bardolino«**
- antihafbeschichteter Wendel mit Seele
  - formschöner, sehr wertig anmutender Korkenzieher
  - robust gefertigt
  - seidig glänzende Oberfläche

- Cork screw »Bardolino«**
- coated thread with axial centre
  - esthetically pleasing, good quality feeling
  - robust design
  - satin-shine surface

- Tire-bouchon »Bardolino«**
- mèche revêtue avec âme
  - tire-bouchon plaisant et de bonne qualité
  - robuste
  - surface brillante et soyeuse

- Sacacorchos »Bardolino«**
- espiral revestida con alma
  - sacacorchos de bella forma, sugiere alta calidad
  - fabricación robusta
  - superficie de brillo sedoso



Art-Nr. / Art.-No.	VE / SU	EAN
6027 2270 	5	 4 004094 602771
6027 2610 	1	 4 051734 602714

ABS

ST







- Glockenkorkenzieher**
- verchromt
  - Wendel mit Seele

- Tire-bouchon**
- chromé
  - mèche avec âme

- Bell corkscrew**
- chrome-plated
  - thread with axial centre

- Sacacorchos de campana**
- cromado
  - espiral con alma

Art-Nr. / Art.-No.	VE / SU	EAN
6018 2270 	5	4 004094 601873 

ST





39 x 39 x 148 mm

- Hebelkorkenzieher**
- verchromt
  - Wendel mit Seele

- Tire-bouchon à levier**
- chromé
  - mèche avec âme

- Lever corkscrew**
- chrome-plated
  - thread with axial centre

- Sacacorchos de palanca**
- cromado
  - espiral con alma

Art-Nr. / Art.-No.	VE / SU	EAN
6020 2270 	5	4 004094 602078 

ST





173 x 63 x 37 mm

- Hebelkorkenzieher »Sieger«**
- verchromt

- Tire-bouchon à levier »Sieger«**
- chromé

- Lever corkscrew »Sieger«**
- chrome-plated

- Sacacorchos de palanca »Sieger«**
- cromado

Art-Nr. / Art.-No.	VE / SU	EAN
6023 2270 	5	4 004094 602375 

ST

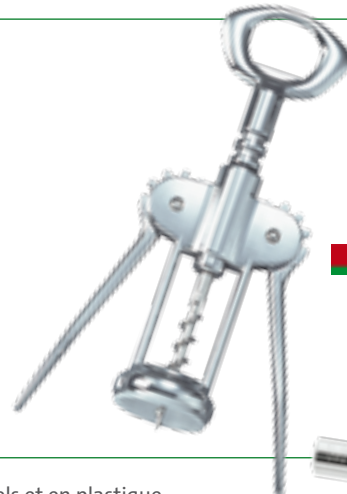

**SIEGER**





67 x 40 x 191 mm

- Glockenkorkenzieher »Chianti«**
- geeignet für Natur- und Kunststoffkorken
  - mit Korkabstreifer
  - hochglänzend verchromt

- Tire-bouchon à cloche »Chianti«**
- adapté pour les bouchons naturels et en plastique
  - avec extracteur de bouchon
  - version chromée

- Bell corkscrew »Chianti«**
- suitable for plastic and natural cork
  - with cork remover
  - highgloss chrome-version

- Sacacorchos de campana »Chianti«**
- idóneo para corchos de materiales naturales y plásticos
  - con rascacorchos
  - cromado en cajea

Art-Nr. / Art.-No.	VE / SU	EAN
6255 2270 	5	4 004094 625572 
6255 556C  	5	4 004094 625565 

ZD



Made in  GERMANY







150 x 68 x 35 mm

- Hebelkorkenzieher »Pedro«**
- ein Klassiker der Marke Monopol
  - mit dem Original-Monopol Scharfgewinde
  - verfügbar in Westmark- und Monopol-Aufmachung

- Tire-bouchon à levier »Pedro«**
- un classique de la marque Monopol
  - avec le filetage de coupe original Monopol
  - en emballage Westmark ou Monopol

- Lever corkscrew »Pedro«**
- a classic from the Monopol-assortment
  - with the original Monopol cutting thread
  - available in Westmark- and Monopol-packaging

- Sacacorchos de palanca »Pedro«**
- un clásico de Monopol
  - con la rosca afilada original Monopol
  - disponible en embalaje Westmark o Monopol

Art-Nr. / Art.-No.	VE / SU	EAN
6155 2270 	3	4 004094 615573 
6155 556C  	5	4 004094 615566 

ZD



Made in  GERMANY



73 x 38 x 205 mm





- Kellnerbesteck »Exclusiv«**
- Wendel mit Seele
  - Kapselheber
  - Klinge zum Abschneiden der Weinkapsel

- Waiter's bottle opener »Exclusiv«*
- thread with axial centre
  - with cap opener
  - with foil cutter

- Tire-bouchon de sommelier »Exclusiv«**
- mèche avec âme
  - avec décapsuleur
  - lame pour couper la capsule de la bouteille de vin
- Sacacorchos de camarero »Exclusiv«**
- espiral con alma
  - con abre cápsulas incorporado
  - cuchillo para cortar la cápsula

142 x 37 x 8 mm

Art-Nr. / Art.-No.	VE / SU	EAN
6016 2270 	5	 4 004094 601675

ST INOX





- Kellnerbesteck**
- Wendel mit Seele
  - Kapselheber
  - Klinge zum Abschneiden der Weinkapsel

- Waiter's bottle opener*
- thread with axial centre
  - with cap opener
  - with foil cutter

- Tire-bouchon de sommelier**
- mèche avec âme
  - avec décapsuleur
  - lame pour couper la capsule de la bouteille de vin
- Sacacorchos de camarero**
- espiral con alma
  - con abrecápsulas
  - cuchillo para cortar la cápsula

111 x 22 x 14 mm

Art-Nr. / Art.-No.	VE / SU	EAN
6015 2270 	5	 4 004094 601576

INOX





- Kellnerbesteck »Profi«**
- Wendel mit Seele
  - Besonderheit: der 2-Stufen Hebel erleichtert das Herausziehen des Korkens
  - mit Kapselheber für Kronkorken
  - gezackte - äußerst scharfe - Klinge

- Waiter's bottle opener »Profi«*
- thread with axial centre
  - special feature: the hinged double-lever system helps to pull out the cork very easily
  - with cap lifter for crown corks
  - serrated - very sharp - blade

- Tire-bouchon de sommelier »Profi«**
- mèche avec âme
  - particularité: le levier double étage facilite le retrait du bouchon
  - avec décapsuleur
  - lame dentée, extrêmement coupante

- Sacacorchos de camarero »Profi«**
- espiral con alma
  - particularidad: la palanca de 2 escalones facilita la extracción del corcho
  - con abrecápsulas para corchos corona
  - cuchillo dentado - afiladísimo

120 x 20 x 20 mm

Art-Nr. / Art.-No.	VE / SU	EAN
6017 2270 	5	 4 004094 601774

INOX



**SIEGER**



- Tischentkorkmaschine »Sieger-Profi«**
- Tischkorkenzieher in Profi-Qualität
  - durch die Bauweise mit dem großen Hebel lässt sich die Weinflasche mühelos mit zwei schnellen Handbewegungen öffnen
  - mit Korkabstreifer



- Uncorking machine »Sieger-Profi«*
- table-mount corkscrew in professional quality
  - the lever system helps to uncork the bottle with simply two quick movements
  - with cork-ejector

- Déboucheur de table »Sieger-Profi«**
- tire-bouchon de table de qualité professionnelle
  - le grand levier permet de déboucher la bouteille de vin en seulement deux mouvements
  - avec extracteur de bouchon

- Descorchadora de mesa »Sieger-Profi«**
- en calidad profesional
  - gracias a la construcción con la palanca grande puede abrirse la botella fácilmente con dos movimientos de la mano
  - con rascacorchos



280 x 85 x 288 mm

Art-Nr. / Art.-No.	VE / SU	EAN
6038 4460 	1	 4 004094 603860



ZD PS INOX





- Flaschenöffner »Gentle«**
- Funktionsteil aus starkem Stahl gefertigt
  - vernickelt
  - sehr robust

- Bottle opener »Gentle«*
- functional element from strong steel
  - nickel-plated
  - heavy-duty

Art-Nr. / Art.-No.	VE / SU	EAN
2808 2210 	25	
2808 2270 	6	4 004094 280870

PP ST



- Décapsuleur »Gentle«**
- élément fonctionnel fabriqué d'un acier épais
  - nickelé
  - très robuste

- Abrebotellas »Gentle«*
- componente funcional en acero espeso
  - niquelado
  - muy robusto



170 x 40 x 20 mm

- Flaschenöffner »Gallant«**
- Funktionsteil aus starkem Stahl gefertigt
  - sorgfältig verchromt
  - sehr robust
  - mit Komfort-Soft-Touch-Griff

- Bottle opener »Gallant«*
- functional element from strong steel
  - chrome-plated
  - heavy-duty
  - with comfort-soft-touch handle

Art-Nr. / Art.-No.	VE / SU	EAN
2908 2270 	6	4 004094 290879

PP TPE ST



- Décapsuleur »Gallant«**
- élément fonctionnel fabriqué d'un acier épais
  - soigneusement chromé
  - très robuste
  - avec poignée confort-soft-touch



- Abrebotellas »Gallant«*
- componente funcional en acero espeso
  - cromado
  - muy robusto
  - con mango cómodo soft-touch



170 x 40 x 20 mm

- Flaschenöffner »Metall«**
- klassischer Flaschenöffner für Kronkorken
  - verfügbar in lose, als 2-er Set auf Karte oder 10 Stück im Polybeutel mit Header

- Bottle opener »Metall«*
- classic bottle opener for crown corks
  - available in bulk, as a set of 2 on a card or as a set of 10 in a polybag

Art-Nr. / Art.-No.	VE / SU	EAN
1094 2210 	100	
1094 2270 	10	4 004094 109478
1094 2230 	6	4 004094 109430

ST



- Ouvre-bouteille »Metall«**
- ouvre-bouteille classique pour capsules
  - disponible au détail, par ensemble de 2 sur carte ou comme set de 10 dans un sachet



- Abrebotellas »Metall«*
- el clásico para corchos de corona
  - disponible suelto, en sets de 2 piezas en tarjeta o en set de 10 eu polibolsa



80 x 41 x 6 mm

- Kapselheber**
- aus einem Stück gefertigt
  - sehr robust
  - Oberfläche veredelt

- Cap opener*
- made from a single piece
  - a heavy-duty tool
  - surface refined

Art-Nr. / Art.-No.	VE / SU	EAN
6177 2210 	10	
6177 2270 	6	4 004094 617775

ST



- Décapsuleur**
- fabriqué à d'une pièce
  - très robuste
  - surface traitée

- Abrechapas*
- hecho de una sola pieza
  - muy robusto
  - superficie afinada





133,5 x 40 x 2,5 mm



- Flaschenöffner »Woody«**
- klassisch - mit Buchenholz
  - angenehm im Handling

- Bottle opener »Woody«*
- a classic - with beech wood
  - comfortable to hold

Art-Nr. / Art.-No.	VE / SU	EAN
1008 2210 	100	
1008 2270 	10	4 004094 100871

ST



- Ouvre-bouteille »Woody«**
- classique - avec bois de hêtre
  - manipulation agréable

- Abrebotellas »Woody«*
- clásico - con madera de haya
  - manejo agradable



141 x 44 x 19 mm



86 x 37 x 15 mm

**Flaschenöffner/-verschießer »Hermetus«**

- Kapselheber, Schraubverschlussöffner und Flaschenverschluss in einem
- die gummierte Fläche ermöglicht ein luftdichtes Verschließen der Flasche

**Bottle opener and sealer »Hermetus«**

- cap lifter, screw cap opener and bottle sealer - all in one
- the rubberised surface permits an air-tight sealing of the bottle

**Ouvre/ferme-bouteille »Hermetus«**

- décapsuleur, ouvreur de couvercles vissés et bouchon en un
- la surface caoutchoutée permet une obturation hermétique de la bouteille

**Abrebotellas y taponador »Hermetus«**

- abrebotellas, abridor para cierres roscados y cierre de botellas en uno
- la superficie engomada permite un cierre hermético

Art-Nr. / Art.-No.	VE / SU	EAN
6183 2270	6	4 004094 618376



53 x 53 x 80 mm

**Flaschenöffner »Push & Pull«**

- automatischer Kapselheber mit federgelagertem Öffnungssystem
- öffnet die Flasche durch einfaches Herunterdrücken

**Cap lifter »Push & Pull«**

- automatic cap opener with spring-loaded opening system
- opens the bottle by simple downward movement through a spring-loaded mechanism

**Décapsuleur »Push & Pull«**

- décapsuleur automatique avec système d'ouverture à ressort
- il faut simplement appuyer pour ouvrir la bouteille

**Abrebotellas »Push & Pull«**

- abrebotellas automático con sistema de apertura alojado en muelles

Art-Nr. / Art.-No.	VE / SU	EAN
6188 2260	6	4 004094 618864
6188 2660	1	4 004094 618864



147 x 45 x 31 mm

**Kombiöffner »Propeller 4 in 1«**

- hilft, Schraubkappen- und Kronkorkenflaschen zu öffnen
- löst das Vakuum von Konservengläsern
- assistiert beim Öffnen von Getränkedosen

**Combi opener »Propeller 4 in 1«**

- helps opening screw cap and crown cap bottles
- releases the vacuum of jars
- is a great assistant for opening beverage cans

**Ouvre combiné »Propeller 4 in 1«**

- aide à ouvrir les bouchons vissés et les capsules de bouteilles
- libère le vide des bocaux
- assistant idéal pour ouvrir les canettes

**Abridor combinado »Propeller 4 in 1«**

- ayuda a abrir botellas con tapa roscada y corcho corona
- alivia el vacío de los tarros de conserva
- asiste al abrir latas de bebidas



Art-Nr. / Art.-No.	VE / SU	EAN
1051 2280	6	4 004094 105180



**Schraubdeckelöffner »Vacumex«**

- verchromt
- mit Kapselheber
- löst das Vakuum ohne den Deckel zu zerstören
- für Deckelhöhen bis 19 mm

**Lid opener »Vacumex«**

- chrome-plated
- with cap lifter
- releases the vacuum without destroying the lid
- for lids up to 19 mm height

**Ouvre-bocal »Vacumex«**

- chromé
- avec décapsuleur
- libère le vide sans détruire le couvercle
- pour des hauteurs de couvercle jusqu'à 19 mm

**Abridor de tapas roscadas »Vacumex«**

- cromado
- con abrechapas
- alivia el vacío sin destruir la tapa
- para alturas de tapa hasta de 19 mm



131 x 87 x 20 mm

Art-Nr. / Art.-No.	VE / SU	EAN
1056 2270	5	4 004094 105678





- Flaschenverschlüsse mit Hebel**
- Set aus 3 Flaschenverschlüssen
  - mit Silikondichtung
  - wird farbig sortiert geliefert



- Bottle sealers with lever*
- set of 3 bottle sealers
  - with silicone sealing
  - comes in assorted colours

- Bouchons à levier**
- ensemble de 3 bouchons
  - avec joint en silicone
  - couleurs assorties

- Cierres de botellas con palanca*
- set con 3 cierres de botellas
  - con junta de silicona
  - se suministra en colores surtidos



59 x 40 x 19 mm

Art-Nr. / Art.-No.	VE / SU	EAN
4440 2280 	6	 4 004094 444081



- Flaschenverschlüsse »Universal«**
- 2 Stück im Set - hiervon ein Verschluss mit Kapselheber
  - durch seitliches Umklappen des Verschlussoberteils wird die Flasche luftdicht verschlossen



- Bottle sealers »Universal«*
- 2 pieces in a set - hereof one with cap opener
  - by pushing down the closing top the bottle is hermetically sealed

- Bouchons de bouteille »Universal«**
- ensemble de 2 bouchons – dont un avec décapsuleur
  - en pressant vers le bas le levier, la bouteille est fermée hermétiquement

- Cierres de botellas »Universal«*
- 2 piezas en set – de aquí un cierre con abrechapas
  - plegando lateralmente la parte superior del cierre, se cierra la botella de un modo hermético al aire



39 x 39 x 72,5 mm

Art-Nr. / Art.-No.	VE / SU	EAN
4444 2280 	6	 4 004094 444487

ABS



- Flaschenverschlüsse**
- »Basic«
  - »Glocke Colour Edition«
  - »Glocke«
  - durch seitliches Umklappen des Oberteils wird die Flasche luftdicht verschlossen
  - mit Kapselheber

- Bottle stoppers*
- »Basic«
  - »Glocke Colour Edition«
  - »Glocke«
  - by pushing down the closing top the bottle is hermetically sealed
  - with cap opener

- Bouchons de bouteille**
- »Basic«
  - »Clocke Colour Edition«
  - »Glocke«
  - en rabattant latéralement la partie supérieure, la bouteille se ferme hermétiquement
  - avec décapsuleur

- Cierres de botellas*
- »Basic«
  - »Glocke Colour Edition«
  - »Glocke«
  - plegando lateralmente la parte superior se cierra la botella herméticamente al aire
  - con abrebotellas



4445 2280



4446 2611











4445 2611



4446 2270



Art-Nr. / Art.-No.	VE / SU	Größe / Size	EAN
4445 2280 	6	33 x 33 x 81 mm	 4 004094 444586
4445 2611 	1		 4 051734 444512
4446 2611 	1		 4 051734 444611
4446 2270 	6	43 x 43 x 92,5 mm	 4 004094 444678

ABS



Made in EUROPE 





- Sektflaschenverschluss**
- einfaches Verschließen der geöffneten Flasche
  - verchromt

- Bouchon à champagne**
- fermeture simple de la bouteille ouverte
  - chromé

- Champagne bottle stopper*
- easy closing of the open bottle
  - chrome-plated

- Cierre de botellas de cava*
- modo de cerrar fácilmente la botella abierta
  - cromado

56 x 38 x 38 mm

Art-Nr. / Art.-No.	VE / SU	EAN
6010 2280 	5	 4 004094 601088



6002

6000







64 x 35 x 62 mm

- Sektflaschenverschluss »Casco«**
- die Besonderheit: Während des Ausgießens kann der Casco auf der Flasche verbleiben

- Bouchon à champagne »Casco«**
- la particularité: le Casco peut rester sur la bouteille lorsque vous servez le champagne

- Champagne bottle stopper »Casco«*
- special feature: the Casco can remain on the bottle while pouring

- Cierre de botella de cava »Casco«*
- la particularidad: al verter, el Casco puede permanecer puesto en la botella

Art-Nr. / Art.-No.	VE / SU	EAN
6000 2280 	6	 4 004094 600081
6002 2280 	6	 4 004094 600289
6002 2611 	1	 4 051734 003603



Made in  GERMANY







89 x 39 x 44 mm

- Sektflaschenverschleißer »Tappa«**
- durch die federgelagerte Klemmfunktion mit einer Hand zu bedienen
  - die Flasche kann auch liegend gelagert werden
  - verchromt

- Bouchon à champagne »Tappa«**
- s'utilise d'une main grâce au mécanisme de ressort
  - la bouteille peut être conservée allongée
  - en version chromée

- Champagne bottle sealer »Tappa«*
- the spring-loaded clamp-system can be operated with one hand
  - the bottle may also be stored horizontally
  - in chrome-plated

- Cierre de botellas de cava »Tappa«*
- gracias a la función de sujeción de suspensión elástica, puede manejarse el cierre con una sola mano
  - la botella puede tumbarse también en la estantería
  - en versión cromada

Art-Nr. / Art.-No.	VE / SU	EAN
6013 228C 	5	 4 004094 601385
6013 556C  	6	 4 004094 601361



Made in  GERMANY







31 x 31 x 82,5 mm

- Weinflaschenverschluss »Vino«**
- massive Ausführung
  - matt, gebürstet
  - mit Silikondichtfläche

- Bouchon de bouteille de vin »Vino«**
- version massive
  - satiné et brossé
  - avec élément hermétique en silicone

- Wine bottle stopper »Vino«*
- solid version
  - matt, brushed finish
  - with silicone sealing element

- Cierre de botellas de vino »Vino«*
- versión sólida
  - mateado y cepillado
  - con superfi cie hermetizante de silicona

Art-Nr. / Art.-No.	VE / SU	EAN
6196 2280 	4	 4 004094 619670
6196 5580  	2	 4 004094 619687





07

frischhalten & aufbewahren • *storing food & keeping fresh*  
garder au frais & conserver • *mantener fresco & guardar*



garder au frais & conserver • *mantener fresco & guardar*

07

frischhalten & aufbewahren • *storing food & keeping fresh*

Schüsselserie »Olympia«

- zum Aufbewahren, Transportieren und Servieren
- sehr schick, auch auf dem Tisch
- massive, hochwertige Qualität
- alle Schüsseln »Olympia« und Seiher »Olympia« ineinander stapelbar
- Material: PP

Bowl series »Olympia«

- for keeping food fresh, transport and serving
- looks nice on the table
- excellent quality
- all bowls and the strainer of series »Olympia«
- could be nested for space-saving storage
- material: PP

Série de bols »Olympia«

- pour conserver, transporter et servir
- très chic, même sur la table
- excellente qualité
- tous les bols et passoire »Olympia« s'empilent
- matière: PP

Serie de bols »Olympia«

- para conservar, transportar y servir
- muy bonitos, también puestos sobre la mesa
- alta calidad masiva
- todos los bols y coladores "Olympia" apilables entre sí
- material: PP





Schüssel »Olympia«, Fassungsvermögen 0,6 l  
Bowl »Olympia«, capacity: 0,6 l

Bol »Olympia«, capacité: 0,6 l  
Bol »Olympia«, cabida: 0,6 l

Art-Nr. / Art.-No.	VE / SU	EAN
2410 221A 	5	 4 004094 241024
2410 221R 	5	 4 004094 241017

PP







Made in  GERMANY



138 x 138 x 86 mm

Schüssel »Olympia«, Fassungsvermögen 1,3 l  
Bowl »Olympia«, capacity: 1,3 l

Bol »Olympia«, capacité: 1,3 l  
Bol »Olympia«, cabida: 1,3 l

Art-Nr. / Art.-No.	VE / SU	EAN
2412 221A 	5	 4 004094 241222
2412 221R 	5	 4 004094 241215

PP



Made in  GERMANY



180 x 174 x 106 mm

Schüssel »Olympia«, Fassungsvermögen 2,5 l  
Bowl »Olympia«, capacity: 2,5 l

Bol »Olympia«, capacité: 2,5 l  
Bol »Olympia«, cabida: 2,5 l

Art-Nr. / Art.-No.	VE / SU	EAN
2414 221A 	5	 4 004094 241420
2414 221R 	5	 4 004094 241413

PP





Made in  GERMANY



218 x 213 x 128 mm

Schüssel »Olympia«, Fassungsvermögen 4,3 l  
Bowl »Olympia«, capacity: 4,3 l

Bol »Olympia«, capacité: 4,3 l  
Bol »Olympia«, cabida: 4,3 l

Art-Nr. / Art.-No.	VE / SU	EAN
2416 221A 	5	 4 004094 241628
2416 221R 	5	 4 004094 241611

PP



Made in  GERMANY



263 x 255 x 147 mm

Seiher »Olympia«, Fassungsvermögen 4,3 l, ø 23 cm  
Strainer »Olympia«, capacity: 4,3 l, ø 23 cm

Passoire »Olympia«, capacité: 4,3 l, ø 23 cm  
Colador »Olympia«, cabida: 4,3 l, ø 23 cm

Art-Nr. / Art.-No.	VE / SU	EAN
2417 221A 	5	 4 004094 241727
2417 221R 	5	 4 004094 241710

PP







Made in  GERMANY



250 x 250 x 138 mm

Schüssel »Olympia«, Fassungsvermögen 6,5 l  
Bowl »Olympia«, capacity: 6,5 l

Bol »Olympia«, capacité: 6,5 l  
Bol »Olympia«, cabida: 6,5 l

Art-Nr. / Art.-No.	VE / SU	EAN
2419 221A 	5	 4 004094 005374
2419 221R 	5	 4 004094 241918

PP



Made in  GERMANY



318 x 310 x 163 mm





263 x 255 x 147 mm

**3er Set »Olympia«**  
 • bestehend aus einer Schüssel 4,3 l mit dicht schließendem Deckel und einem Seiher ø 230 mm

**3pc Set »Olympia«**  
 • consisting of a bowl 4.3 l with a tightly closing lid and one strainer ø 230 mm

**Ensemble 3 pièces »Olympia«**  
 • se compose d'un bol 4,3 l avec couvercle hermétique et d'une passoire ø 230 mm

**Set de 3 piezas »Olympia«**  
 • compuesto de un bol de 4,3 l con tapa de cierre estanco y un colador de ø 230 mm

Art-Nr. / Art.-No.	VE / SU	EAN
2418 227A 	5	4 004094 000232
2418 227R 	5	4 004094 241871





263 x 255 x 147 mm

**9er Set »Olympia«**  
 • die Grundausrüstung  
 • bestehend aus je einer Schüssel 0,6; 1,3; 2,5 und 4,3 l mit jeweils passendem Deckel und einem Seiher

**9pc Set »Olympia«**  
 • the basic equipment  
 • consisting of one bowl with each 0.6, 1.3, 2.5 and 4.3 l - always with matching lid plus one strainer

**Ensemble 9 pièces »Olympia«**  
 • l'équipement de base  
 • se compose à chaque fois d'un bol de 0,6, 1,3, 2,5 et 4,3 l avec couvercle adapté et d'une passoire

**Set de 9 piezas »Olympia«**  
 • el equipo base  
 • compuesto de sendos un bol 0,6; 1,3; 2,5 y 4,3 l con senda tapa idónea y un colador

Art-Nr. / Art.-No.	VE / SU	EAN
2420 226A 	4	4 004094 000959
2420 226R 	4	4 004094 242069



ø 31 cm



307 x 307 x 125 mm

**Salatschüssel, 5,5 l**  
 • besonders massive und hochwertige Qualität  
 • glänzende Oberfläche

**Saladier, 5,5 l**  
 • excellente qualité  
 • surface brillante

**Salad bowl, 5,5 l**  
 • especially solid and high-quality design  
 • glossy surface

**Bol para ensaladas, 5,5 l**  
 • especialmente sólido y de alta calidad  
 • superficie brillante

Art-Nr. / Art.-No.	VE / SU	EAN
2437 227A 	6	4 004094 000287
2437 227R 	6	4 004094 243776





310 x 277 x 109 mm

**Seiher**  
 • formschön und griffig  
 • für die moderne Küche

**Passoire**  
 • bien faite et pratique  
 • pour la cuisine moderne

**Strainer**  
 • shapely and handy  
 • for modern kitchens

**Colador**  
 • de bonita forma y buen agarre  
 • para la cocina moderna

Art-Nr. / Art.-No.	VE / SU	EAN
2424 227A 	10	4 004094 000751
2424 227R 	10	4 004094 242472





290 x 260 x 120 mm

**Seiher**  
 • 4 Aufsatzrasten sorgen dafür, dass der Seiher fest und ein Stück erhoben auf einem ø 240 mm Topf sitzt. So bleibt viel Platz zum Abtropfen.

**Passoire**  
 • 4 empreintes permettent à la passoire d'être bien positionnée sur une casserole (ø 240 mm) tout en laissant suffisamment de place pour l'égouttage

**Strainer**  
 • 4 indentations make sure that the strainer sits securely on a ø 240 mm pot rim and comes out enough to leave sufficient space for dripping

**Colador**  
 • 4 acanaladuras garantizan que el colador pueda colocarse bien algo erigido sobre una olla de un ø de 240mm quedando mucho espacio para escurrir

Art-Nr. / Art.-No.	VE / SU	EAN
2126 221A 	10	4 004094 000379
2126 221R 	10	4 004094 212611





**Salatbutler, 6,5 l »Praktika«**

- 4 sichere Verschlüsse halten den Deckel fest auf der Schüssel
- mit praktischem Tragegriff
- integrierter Behälter (ca. 0,3 l) für Dressing

**Salad butler, 6,5 l »Praktika«**

- 4 clip locks hold the lid securely on the container
- with practical carrying handle
- with integrated container for dressings (approx. 0.3 l)





**Récipient à salade, 6,5 l »Praktika«**

- 4 clips de fermeture gardent le couvercle sur le saladier
- avec poignée de transport
- réservoir intégré (env. 0,3 l) pour la vinaigrette

**Butler para ensaladas, 6,5 l »Praktika«**

- 4 cierres seguros capturan la tapa firmemente en el tazón
- con asa práctico
- contenedor de transporte integrado para las salsas



Art-Nr. / Art.-No.	VE / SU	EAN
2422 227A 	4 	4 004094 000614
2422 227R 	4 	4 004094 242274



305 x 305 x 188 mm

garder au frais & conserver • maintenir fresco & guardar

07

frischhalten & aufbewahren • storing food & keeping fresh

**Salatschleuder »Fortuna«, 5 l**

- sehr solide
- leichtgängige, zuverlässige Mechanik
- mit praktischem Ausgießer
- 4 Gummifüße für rutschfesten Halt (2432 2260/A)

**Essoreuse à salade »Fortuna«, 5 l**

- très solide
- facile à tourner, reliable système mécanique
- bec verseur pratique
- 4 pieds en caoutchoucs pour un maintien parfait (2432 2260/A)



**Salat spinner »Fortuna«, 5 l**









- very solid
- easy-spin, reliable mechanism
- practical pouring spout
- 4 non-slip feet for safe hold (2432 2260/A)

**Centrifugadora de lechuga »Fortuna«, 5 l**

- muy sólida
- una mecánica de marcha suave y confiable
- con surtidor práctico
- 4 pies de goma para apoly antideslizante (2432 2260/A)



2432 224A/R  
ohne Gummifüße, transparenter Deckel  
without non-slip-feet, transparent lid  
sans pieds anti-dérapant, couvercle transparent  
sin patitas de goma, tapa transparente

Art-Nr. / Art.-No.	VE / SU	EAN
2432 226A 	4 	4 004094 000980
2432 2260 	4 	4 004094 243264
2432 224A 	6 	4 004094 000218
2432 224R 	6 	4 004094 243240



290 x 252 x 215 mm

115







266 x 68 x 25 mm

**Salatbesteck »Traditionell«**  
 • solides Salatbesteck mit klassischer Form  
 • farbig sortiert

**Salad servers »Traditionell«**  
 • salad servers in classic shape  
 • assorted colours

**Couverts à salade »Traditionell«**  
 • solides couverts à salade de forme classique  
 • couleurs assortis

**Cubierto para ensalada »Traditionell«**  
 • cubierto sólido de ensalada de un diseño clásico  
 • colores surtidos

Art-Nr. / Art.-No.	VE / SU	EAN
2090 2270 	10	4 004094 209079 

PP SAN



Made in  GERMANY







101 x 93 x 197 mm

**Dressingshaker »Mixery«, 0,5 l**  
 • mit eingepprägter Messskala  
 • herausnehmbare Mixscheibe  
 • Ausgießer im Deckel ermöglicht gezieltes Schütten

**Dressingshaker »Mixery«, 0,5 l**  
 • with embossed scale  
 • with removable mixing disc  
 • the spout in the lid allows an exact pouring

**Shaker à vinaigrette »Mixery«, 0,5 l**  
 • avec graduations en relief  
 • disque de mélange amovible  
 • le bec verseur dans le couvercle permet un versement ciblé

**Dressing shaker »Mixery«, 0,5 l**  
 • con escala de medición estampada  
 • disco mezclador de quita y pon  
 • gracias al vertedor en la tapa se puede verter de un modo exacto

Art-Nr. / Art.-No.	VE / SU	EAN
2435 227A 	12	4 004094 000362 
2435 227R 	12	4 004094 243578 

PP PE



Made in  GERMANY







87 x 87 x 128 mm

**Schüttelbecher »Mix-Ei«, 0,25 l**  
 • mit Mixscheibe  
 • fest schließender Schraubdeckel  
 • die Vertiefungen im Becher geben die sichere Halteposition vor

**Shaker »Mix-Ei«, 0,25 l**  
 • with mixing insert  
 • tightly closing lid  
 • the grooves in the beaker indicate the right position where to hold the shaker

**Mélangeur »Mix-Ei«, 0,25 l**  
 • avec disque de mélange  
 • couvercle hermétique  
 • les rainures indiquent la bonne position pour tenir le mélangeur

**Copa shaker »Mix-Ei«, 0,25 l**  
 • con disco mezclador  
 • tapa de cierre fijo  
 • los ahondamientos en la copa sirven para un apoyo seguro

Art-Nr. / Art.-No.	VE / SU	EAN
3089 227A 	12	4 004094 006029 
3089 2270 	12	4 004094 308970 

PP PE SAN



Made in  GERMANY

**Mixbecher, 0,25 l**  
 • mit Zitronenpresse im Deckel

**Shaker, 0,25 l**  
 • avec presse-citron dans le couvercle



**Mixing beaker, 0,25 l**  
 • with lemon press in the lid

**Vaso para mezclar, 0,25 l**  
 • con exprimidor de limones en la tapa

Art-Nr. / Art.-No.	VE / SU	EAN
3087 2291 	5	4 004094 308796 

PS SAN



Made in  GERMANY

79 x 79 x 109 mm



### Frischhaltedeckel

- Frischdeckel aus Silikon sind vielseitig einsetzbare praktische Helfer für die Zubereitung und Aufbewahrung von Speisen
- während des Kochens werden ungewünschte Spritzer zurückgehalten
- für die Aufbewahrung, den Frischdeckel leicht andrücken - der Deckel saugt sich fest

### Fresh lid

- fresh lids from silicone are practical, multi-use aids for food preparation and storage
- during cooking, they prevent unwanted splashes
- for storage, the lid is simply pressed down slightly to create a vacuum effect

### Couvercle fraîcheur

- les couvercles fraîcheur en silicone sont des aides pratiques et multi-usages pour préparer et conserver des plats
- pendant la cuisson, ils empêchent les projections indésirables
- pour la conservation, presser légèrement le couvercle fraîcheur afin de créer un effet de vide



### Tapa para mantener fresco

- ayudantes prácticos, de múltiple aplicación para preparar y guardar las comidas
- se retienen las salpicaduras indeseadas que se producen al guisar
- para mantener los productos frescos, hay que ejercer una ligera presión sobre la tapa - la tapa produce un efecto de vacío y queda fija



### Frischhaltedeckel Silikon »Mini«

ø 100 mm

- zum Abdecken von Getränken
- farbig sortiert

### Fresh lid silicone »Mini«

ø 100 mm

- for covering drinks
- assorted colours

### Couvercle fraîcheur silicone »Mini«

ø 100 mm

- pour couvrir les boissons
- couleurs assortis

### Tapa para mantener fresco, silicona »Mini«

ø 100 mm

- para tapar bebidas
- colores surtidos

Art-Nr. / Art.-No.	VE / SU	EAN
2337 2270	6	4 004094 233777

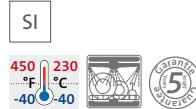

100 x 100 x 16 mm

### Frischhaltedeckel Silikon »Midi«

ø 250 mm

- ideal für Schüsseln oder Töpfe

### Midi fresh lid silicone »Midi«

ø 250 mm

- ideal for pots and bowls

### Couvercle fraîcheur silicone »Midi«

ø 250 mm

- idéal pour casseroles et bols

### Tapa para mantener fresco, silicona »Midi«

ø 250 mm

- ideal para las ollas y los bols

Art-Nr. / Art.-No.	VE / SU	EAN
2335 2270	4	4 004094 233579

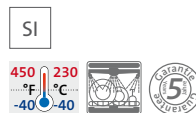

257 x 250 x 20 mm

### Frischhaltedeckel Silikon »Maxi«

ø 320 mm

- ideal für Schüsseln oder Töpfe

### Midi fresh lid silicone »Maxi«

ø 320 mm

- ideal for pots and bowls

### Couvercle fraîcheur silicone »Maxi«

ø 320 mm

- idéal pour casseroles et bols

### Tapa para mantener fresco, silicona »Maxi«

ø 320 mm

- deal para las ollas y los bols

Art-Nr. / Art.-No.	VE / SU	EAN
2334 2270	4	4 004094 233470

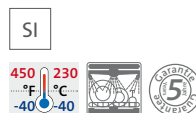

330 x 320 x 20 mm

### Frischhaltedeckel, Silikon »Eckig«

- ideal für Auflaufformen

### Fresh lid, silicone »Eckig«

- ideal for casserole dishes

### Couvercle fraîcheur, silicone »Eckig«

- idéal pour les plats

### Tapa para mantener fresco, silicona »Eckig«

- ideal para moldes de gratinado

Art-Nr. / Art.-No.	VE / SU	EAN
2333 2270	4	4 004094 233371

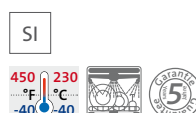

415 x 300 x 20 mm



ø 9

ø 7

90 x 90 x 80 mm

- Frischhaltekügelchen-2er-Set**
- zum Aufbewahren von Knoblauch, Zwiebeln etc.
  - hält Gerüche im Innern der Kugel
  - stapelbar für platzsparende Aufbewahrung im Kühlschrank



*Storage ball, 2piece-set*

- for storage of garlic, onions etc.
- keeps the odour inside
- space-savingly stackable one on top of the other in the fridge

- Ensemble de 2 boules fraîcheur**
- pour conserver l'ail, les oignons etc.
  - maintient les odeurs à l'intérieur
  - peuvent être mise l'une sur l'autre pour gagner de la place

*Set de 2 bolas para mantener fresco*

- para guardar ajos, cebollas, etc.
- los olores quedan dentro de la bola
- apilable una dentro de la otra a ahorrar espacio

Art-Nr. / Art.-No.	VE / SU	EAN
2572 2260 	6	 4 004094 257261



240 x 155 x 95 mm

- Aufschnittschalen-Set, 3tlg »Fresh«**
- zum getrennten und geruchssicheren Frischhalten und Servieren von Wurst und Käse bestehend aus:

- 1 x Schale ca. 65 mm hoch
- 1 x Schale ca. 38 mm hoch

*Storage set, 3pc »Fresh«*



- for separate and odour-free fresh-keeping and serving of cold cuts and cheese consisting of:
- 1 x container ca. 65 mm high
- 1 x container ca. 38 mm high

- Ensemble de conservation, 3pièces »Fresh«**
- pour maintenir au frais et servir la charcuterie et le fromage séparément et sans odeur comprenant:

- 1 boîte ca. 65 mm d'hauteur
- 1 boîte ca. 38 mm d'hauteur

*Set de bandejas, 3 piezas »Fresh«*

- para conservar fresco por separado y seguro contra olores y para servir fiambres y queso compuesto de:
- 1 bandeja ca. 65 mm de alta
- 1 bandeja ca. 38 mm de alta

Art-Nr. / Art.-No.	VE / SU	EAN
2348 2270 	5	 4 004094 234873



2351 2270  
»Mini«



2352 2270  
»Maxi«



- Snack-box »Mini & Maxi«**
- zum Frischhalten, Aufbewahren und Transportieren
  - ideal für Schule und Beruf
  - mit Filmscharnier - besonders komfortabel
  - farbige sortiert: rot und grün





*Snackbox »Mini & Maxi«*

- for fresh-keeping, storage and transport
- ideal for school and work
- with film-hinge - especially comfortable
- assorted colours: red and green

- Boîte à snack »Mini & Maxi«**
- pour maintenir au frais et transporter
  - idéale pour l'école et le travail
  - avec film-charnière - très confortable
  - couleurs assort.: rouge et vert

*Snack-box »Mini & Maxi«*

- para mantener fresco y transportar
- ideal para el colegio y la profesión
- con bisagra de film - especialmente comfortable
- colores surt.: rojo y verde

Art-Nr. / Art.-No.	VE / SU	Größe / Size	EAN
2351 2270 	10	174 x 137 x 37 mm	 4 004094 235177
2352 2270 	10	174 x 137 x 74 mm	 4 004094 235276



3102 2270  
»Midi«



3103 2270  
»Maxi«



- Proviantbox »Midi & Maxi«**
- klassisches Modell - Box bestehend aus zwei Teilen
  - ideal für Schule und Beruf





*Sandwich box »Midi & Maxi«*

- classic model - box consisting of two pieces
- ideal for school and work

- Boîte à sandwich »Midi & Maxi«**
- modèle classique - boîte en deux parties
  - idéale pour l'école et le travail

*Caja para sándwiches »Midi & Maxi«*

- modelo clásico - la caja se compone de dos partes
- ideal para el colegio y la profesión

Art-Nr. / Art.-No.	VE / SU	Größe / Size	EAN
3102 2270 	6	168 x 128 x 48 mm	 4 004094 310270
3103 2270 	4	198 x 138 x 63 mm	 4 004094 310379





- Gefrierdosen »Trio«**
- zum Einfrieren und Frischhalten
  - geschmacksneutral
  - erhältlich in Sets von 3 bis 4 Dosen pro Größe

- Deep freezing containers »Trio«*
- for freezing and keeping food fresh
  - neutral to taste
  - available as sets of 3 to 4 containers

- Boîtes de congélation »Trio«**
- pour congeler et maintenir au frais
  - sans goût
  - disponible en ensemble de 3 à 4 boîtes par taille

- Contenedor para congelación »Trio«*
- para congelar y mantener fresco
  - de sabor neutro
  - obtenible en sets de 3 a 4 contenedores por tamaño



Art-Nr. / Art.-No.	VE / SU	Größe / Size	EAN
1 2504 2270	10	4 x 0,25 l / 113 x 113 x 36 mm	4 004094 250477
2 2514 2270	10	4 x 0,5 l / 113 x 113 x 64 mm	4 004094 251474
3 2523 2270	10	3 x 0,75 l / 113 x 113 x 84,5 mm	4 004094 252372
4 2533 2270	6	3 x 1,25 l / 113 x 113 x 124 mm	4 004094 253379
5 2543 2270	10	3 x 1 l / 212 x 112 x 64 mm	4 004094 254376
6 2553 2270	5	3 x 1,5 l / 212 x 112 x 83 mm	4 004094 255373



- Kräuterdosen »Trio«**
- ideal zum Aufbewahren und Einfrieren von Kräutern
  - geschmacksneutral
  - erhältlich in Sets von 4 Dosen pro Größe

- Herb boxes »Trio«*
- ideal for keeping and deep-freezing of herbs
  - neutral to taste
  - available as sets of 4 containers

- Boîtes à herbes »Trio«**
- idéales pour conserver et congeler les herbes
  - sans goût
  - disponible en ensemble de 4 boîtes par taille

- Pote para hierbas »Trio«*
- ideal para guardar y congelas hierbas
  - sabor neutro
  - obtenible en sets de 4 potes por tamaño



Art-Nr. / Art.-No.	VE / SU	Größe / Size	EAN
2574 2270	6	4 x 0,1 l / 83 x 83 x 39 mm	4 004094 257476
2584 2270	8	4 x 0,2 l / 83 x 83 x 69 mm	4 004094 258473



- Knäckebspender**
- mit Krümmeluntersatz
  - spendet Stück für Stück knuspriges Knäckebrötchen und hält es lange frisch

- Crispbread dispenser*
- with crumb catcher dish
  - offers crusty crispbread piece by piece and keeps it fresh for a long time

- Distributeur de pain suédois**
- avec ramasse-miettes
  - délivre du pain suédois morceau par morceau et lui conserve sa fraîcheur pendant longtemps

- Expendedora de pan en láminas*
- con base para migajas
  - expende pieza por pieza las láminas de pan crujientey las mantiene frescas por largo tiempo



Art-Nr. / Art.-No.	VE / SU	EAN
2118 2260	5	4 004094 211867



195 x 90 x 175 mm

**Mikrowellen Starter-Set 5tlg.**

- bestehend aus:
- 1 x Kasserolle 0,75 l
- 1 x Kasserolle 1 l
- 1 x Kasserolle 1,5 l
- 1 x Menüeller
- 1 x Abdeckhaube
- Behälter zum Einfrieren, Auftauen und Erwärmen geeignet

**Microwave starter kit 5 pieces**

- containing:
- 1 x casserole of 0.75 l
- 1 x casserole of 1 l
- 1 x casserole of 1.5 l
- 1 x micro wave plate
- 1 x cover
- the containers are suitable for freezing, defrosting and warming up

**Ensemble pour micro-ondes 5 pièces**

- contenant:
- 1 récipient 0,75 l
- 1 récipient 1 l
- 1 récipient 1,5 l
- 1 assiette à compartiments
- 1 couvercle
- les récipients sont adaptés pour congeler, décongeler et réchauffer

**Set inicio para horno microondas 5 piezas**

- compuesto de:
- 1 contenedor 0,75 l
- 1 contenedor 1 l
- 1 contenedor 1,5 l
- 1 plato de menú
- 1 tapa
- contenedores idóneos para congelar, descongelar y calentar



Art-Nr. / Art.-No.	VE / SU	EAN
2203 2260	3	4 004094 220364

PP



Made in GERMANY

**Mikrowellen-Kasserolle**

- zum Einfrieren, Auftauen und Erwärmen
- bruchstark, geschmacksneutral

**Récipients à micro-ondes**

- pour congeler, décongeler et réchauffer
- incassable, sans goût

**Casserole**

- for freezing, defrosting and warming up
- break-proof, neutral to taste

**Contenedor para horno microondas**

- para congelar, descongelar y calentar
- irrompible, sabor neutro



Art-Nr. / Art.-No.	VE / SU	Größe / Size	EAN
2210 2270	16	0,75 l / 157 x 157 x 54 mm	4 004094 221071
2215 2270	14	1 l / 157 x 157 x 74 mm	4 004094 221576
2220 2270	12	1,5 l / 190 x 190 x 77 mm	4 004094 222078
2225 2270	9	2 l / 190 x 190 x 100 mm	4 004094 222573

PP



Made in GERMANY

2245 2270

**Mikrowellen-Menüeller ø 250 mm**

- mit 3 Einteilungen
- Microwave dinnerplate ø 250 mm*
- with 3 divided sections

**Assiette à compartiments pour micro-ondes ø 250 mm**

- avec 3 compartiments
- Plato de menú para horno microondas ø 250 mm*
- con tres compartimentos



**Mikrowellen-Teller-Abdeckhaube ø 250 mm**

*Microwave plate cover ø 250 mm*

**Couvercle d'assiette pour micro-ondes ø 250 mm**

*Tapa para plato para horno microonda ø 250 mm*

Art-Nr. / Art.-No.	VE / SU	Größe / Size	EAN
2240 2270	5	250 x 250 x 25 mm	4 004094 224072
2245 2270	5	255 x 255 x 63 mm	4 004094 224577

PP



Made in GERMANY



- Kühlschrankbutterdose »Exklusiv«**
- erhobene Ablagefläche - erleichtert das portionsweise Abtrennen der Butter mit dem Messer
  - passt in die üblichen Halterungen der Kühlschranktüren

- Refrigerator butter dish »Exklusiv«**
- elevated base to place the butter - makes it easy to cut off the desired portion
  - box fits into the common fridge-door storage compartments

Art-Nr. / Art.-No.	VE / SU	EAN
2086 2270 	6	4 004094 208676

PP SAN



- Beurrier de réfrigérateur »Exklusiv«**
- plateau un peu surélevé - facilite de couper le beurre avec le couteau
  - convient à tous les compartiments habituels des portes de réfrigérateur

- Mantequillera para refrigerador »Exklusiv«**
- una base un pocosubida - para cortar fácilmente la mantequilla con el cuchillo
  - cabe en los soportes corrientes en las puertas de refrigeradores



143 x 94 x 64 mm

- Kühlschrankbutterdose »Traditionell«**
- handlich
  - passt in die üblichen Halterungen der Kühlschranktüren

- Refrigerator butter dish »Traditionell«**
- handy
  - fits into the common fridge door storage compartments

Art-Nr. / Art.-No.	VE / SU	EAN
2088 2241 	6	4 004094 208843

PS



- Beurrier de réfrigérateur »Traditionell«**
- maniable
  - convient à tous les compartiments habituels des portes de réfrigérateur

- Mantequillera para refrigerador »Traditionell«**
- manejable
  - cabe en los soportes corrientes en las puertas de los refrigeradores



130 x 90 x 46 mm

- Tischbutterdose mit Skala**
- erhobene Ablagefläche - erleichtert das portionsweise Abtrennen der Butter mit dem Messer
  - Besonderheit: mit Gewichtsskala

- Butter dish with scale**
- elevated base to place the butter - makes it easy to cut off the desired portion
  - speciality: the dish comes with a weight scale (grams)

Art-Nr. / Art.-No.	VE / SU	EAN
2116 2270 	6	4 004094 211676

PP SAN



- Beurrier de table avec échelle**
- plateau un peu surélevé - facilite de couper le beurre avec le couteau
  - particularité: avec échelle de poids (gramme)

- Mantequillera de mesa con escala**
- una base un pocosubida - para cortar fácilmente la mantequilla con el cuchillo
  - particularidad: con escala de pesos



157 x 110 x 55 mm

- Speisehaube, 34 x 34 cm**
- zum Schutz vor Insekten

- Food cover, 34 x 34 cm**
- for protection against insects

Art-Nr. / Art.-No.	VE / SU	EAN
2328 2230 	6	4 004094 232831

PA

- Cloche à nourriture, 34 x 34 cm**
- pour se protéger des insectes

- Cubierta para comidas, 34 x 34 cm**
- para proteger contra insectos



325 x 100 x 16 mm

- Topfhauben**
- mit Gummizug
  - Set mit 5 Stück in verschiedenen Größen: ø 9, 14, 17, 19 und 25 cm

- Food covers**
- with rubber string
  - set with 5 pcs in different sizes: ø 9, 14, 17, 19 and 25 cm

Art-Nr. / Art.-No.	VE / SU	EAN
2329 2260 	6	4 004094 232961

PE

- Housse pour casserole**
- avec élastique caoutchouté
  - ensemble de 5 pièces de différentes tailles: ø 9,14, 17, 19 et 25 cm

- Cubiertas para cacerolas**
- con goma
  - set con 5 piezas en diversos tamaños: ø 9, 14, 17, 19 y 25 cm





7607

7945







**Einzelne Küchenschütte, 1l, »Milano«**  
 • mit Muschelgriff  
 • Farbe: glasklar  
*Single Scoop, 1l, »Milano«*  
 • with shell-shaped handle  
 • colour: clear

**Schüttengehäuse »Milano«**  
 • komplett mit 3 Küchenschütten à 1 l  
*Dispenser unit »Milano«*  
 • complete with 3 scoops each 1 l

**Distributeur de cuisine individuel, 1l, »Milano«**  
 • avec poignée concave  
 • couleur: transparent  
*Cajón de cocina suelto, 1l, »Milano«*  
 • con agarradera cóncava  
 • color: transparente

**Unité de distribution »Milano«**  
 • complet avec 3 distributeurs de cuisine de chacun 1 l  
*Carcasa de cajones »Milano«*  
 • completa con 3 cajones de cocina de 1 l

Art-Nr. / Art.-No.	VE / SU	Größe / Size	EAN
7607 2240 	4	355 x 170 x 110 mm	
7945 2240 	4	172 x 118 x 105 mm	



7305

7950







**Einzelne Küchenschütte, 1l, »Roma«**  
 • mit senkrecht offenem Griff  
 • Farbe: glasklar  
*Single Scoop, 1l, »Roma«*  
 • with vertically open handle  
 • colour: clear

**Schüttengehäuse »Roma«**  
 • komplett mit 3 Küchenschütten à 1 l  
*Scoop dispenser »Roma«*  
 • complete with 3 scoops each 1 l

**Distributeur de cuisine individuel, 1l, »Roma«**  
 • avec poignée verticale ouverte  
 • couleur: transparent  
*Cajón de cocina suelto, 1l, »Roma«*  
 • con agarradera vertical abierta  
 • color: transparente

**Unité de distribution »Roma«**  
 • complet avec 3 distributeurs de cuisine de chacun 1 l  
*Carcasa de cajones »Roma«*  
 • completa con 3 cajones de cocina de 1 l

Art-Nr. / Art.-No.	VE / SU	Größe / Size	EAN
7305 2260 	3	255 x 178 x 144 mm	
7950 2240 	14	175 x 81 x 127 mm	



7805

7925







**Einzelne Küchenschütte, 1l, »Venezia«**  
 • mit geschwungenem Griff  
 • Farbe: glasklar  
*Single Scoop, 1l, »Venezia«*  
 • with curved handle  
 • colour: clear

**Schüttengehäuse »Venezia«**  
 • komplett mit 6 Küchenschütten à 1 l  
*Dispenser unit »Venezia«*  
 • complete with 6 scoops each 1 l

**Distributeur de cuisine individuel, 1l, »Venezia«**  
 • avec poignée incurvée  
 • couleur: transparent  
*Cajón de cocina suelto, 1l, »Venezia«*  
 • con agarradera arqueada  
 • color: transparente

**Unité de distribution »Venezia«**  
 • complet avec 6 distributeurs de cuisine de chacun 1 l  
*Carcasa de cajones »Venezia«*  
 • completa con 6 cajones de cocina de 1 l

Art-Nr. / Art.-No.	VE / SU	Größe / Size	EAN
7805 2240 	6	265 x 166 x 268 mm	
7925 2240 	14	170 x 122 x 85 mm	





**Folienspender**  
 • mit gezahnter Abrisskante

*Cling film / foil dispenser*  
 • with serrated edge for easy tearing

**Distributeur de film alimentaire**  
 • avec bord de coupe denté

*Expendedor de láminas*  
 • con borde dentado para rasgar



Art-Nr. / Art.-No.	VE / SU	EAN	PP
5234 2260 	6		





- Gewürzregal »Parato«**
- für Gewürzgläser und Dosen
  - extra tiefe Abstellflächen
  - für Wand- und Innentürbefestigung
  - inkl. Befestigungsmaterial

- Rack »Parato«**
- for spice jars and cans
  - extra deep storage shelves
  - for fixing on walls and on the inside of cupboard doors
  - includes mounting material

Art-Nr. / Art.-No.	VE / SU	EAN
5220 2260 	4	 4 004094 522062

PS



- Étagère à épices »Parato«**
- pour pots à épices et boîtes
  - surfaces de rangement profondes
  - fixation murale ou à l'intérieur des portes de placard
  - matériel de fixation inclus



- Esteras para especias »Parato«**
- para pots de especias y latas
  - entrepaños extra profundas
  - para sujetar a la pared y a puertas interiores
  - incluido material de sujeción



379 x 69 x 349 mm

- Küchenrollenhalter**
- einfach zu montieren
  - schwerer, rutschfester Sockel für sicheren Stand
  - für alle gängigen Haushaltsrollen geeignet
  - Abmessungen: ø 150

- Kitchen roll holder**
- easy to assemble
  - especially heavy, non-slip base for secure stand
  - suitable for all usual kitchen rolls
  - dimensions: ø 150 mm

Art-Nr. / Art.-No.	VE / SU	EAN
5236 2260 	4	 4 004094 523663

INOX



- Support d'essuie-tout**
- simple à monter
  - particulièrement lourd, socle antidérapant pour un maintien sûr
  - convient à tous les types d'essuie-tout
  - dimensions: ø 150 mm

- Portarrollos de cocina**
- fácil de montar
  - zócalo antirresbalante, especialmente pesado para una estabilidad segura
  - apropiado para todos los rollos corrientes
  - dimensiones: ø 150 mm





150 x 150 x 365 mm

**Blitzbinder, 50er Set**

*Food bag cable tie, 50pc-set*

**Attache rapide, set 50 pièces**

*Atadores rápidos, set 50 piezas*

Art-Nr. / Art.-No.	VE / SU	EAN
1539 2230 	6	 4 004094 153938

PE







122 x 7 x 4 mm

- Beutelclips »Mini« & »Maxi«**
- Set mit je 2 Stück Maxi / oder je 3 Stück Mini
  - farbig sortiert

- Bag clips »Mini« & »Maxi«**
- set with each 2 pcs Maxi / or 3 pcs Mini
  - assorted colours

- Clips à sachet »Mini« & »Maxi«**
- ensemble de 2 pièces Maxi / ou 3 pièces Mini
  - couleurs assorties

- Pinzas para bolsas »Mini« & »Maxi«**
- Set con 2 unidades Maxi / o 3 unidades Mini
  - en colores surtidos

Art-Nr. / Art.-No.	VE / SU	Größe / Size	EAN
5218 2230 »Mini« 	12	70 x 35 x 23 mm	 4 004094 521836
5216 2230 »Maxi« 	12	100 x 50 x 35 mm	 4 004094 521638

ABS



5218 »Mini«

5216 »Maxi«



- Beutelclips, 10er Set**
- wird farbig sortiert geliefert
  - ca. 10 cm, 8 cm, 6 cm

- Bag clips, 10pc-set**
- comes in assorted colours
  - ca. 10 cm, 8 cm, 6 cm

- Clips à sachet, set 10 pièces**
- livrée en couleurs assorties
  - ca. 10 cm, 8 cm, 6 cm

- Clips para bolsas, set 10 piezas**
- se suministran surtidos en colores
  - ca. 10 cm, 8 cm, 6 cm



Art-Nr. / Art.-No.	VE / SU	EAN
5205 2280 	6	 4 004094 520587

PP





# 08

kaffee & tee • coffee & tea  
café & thé • café & té







110 x 35 x 35 mm

**Kaffee-Dosierlöffel**  
 • klein - handlich  
 • für gleichmäßiges Dosieren

*Coffee-measure-spoon*  
 • small - handy  
 • for an exact dosage

**Cuillère doseuse à café**  
 • petite - pratique  
 • pour un dosage uniforme

*Cuchara dosificadora de café*  
 • pequeña - manejable  
 • para dosificar homogéneamente

Art-Nr. / Art.-No.	VE / SU	EAN
1528 2210 	25	
1528 2270 	10	





191 x 38 x 23 mm

**Kaffee-Dosierlöffel**  
 • mit extra langem Griff  
 • für gleichmäßiges Dosieren

*Coffee-measure-spoon*  
 • with extra long handle  
 • for an exact dosage

**Cuillère doseuse à café**  
 • avec manche extra long  
 • pour un dosage uniforme

*Cuchara dosificadora de café*  
 • con mango extra largo  
 • para dosificar homogéneamente

Art-Nr. / Art.-No.	VE / SU	EAN
1529 2270 	6	





176 x 38 x 24 mm

**Kaffee-Dosierlöffel mit Verschlussklemme**  
 • immer griffbereit  
 • der Kaffee- oder Teebeutel wird mit der praktischen Klemmschiene verschlossen  
 • so bleibt der Inhalt frisch und aromatisch

*Coffee measuring spoon with sealing clip*  
 • always at hand when needed  
 • the coffee- and tea-bag is easily closed with the practical sealing clip  
 • thus the contents stay fresh and aromatic

**Cuillère doseuse à café avec pince de fermeture**  
 • toujours à portée de main  
 • le sachet de café ou de thé se ferme avec le rail de serrage pratique  
 • le contenu reste ainsi toujours frais et aromatique

*Cuchara dosificadora de café con clip para cerrar*  
 • así está siempre a mano  
 • el sobre de café o de té se cierra con la práctica pinza desplazable  
 • así el contenido permanece bien fresco y aromático

Art-Nr. / Art.-No.	VE / SU	EAN
1538 2270 	6	









2442 2261 »Two«  
 2444 2261 »Four«  
 2446 2261 »Six«

**Kaffeefilter »Two«, »Four«, »Six«**  
 • für Filtergröße 2, 4, 6

*Coffee filter »Two«, »Four«, »Six«*  
 • for filter size 2, 4, 6

**Porte-filtre à café »Two«, »Four«, »Six«**  
 • pour taille de filtre 2, 4, 6

*Filtro de café »Two«, »Four«, »Six«*  
 • para el tamaño de filtro 2, 4, 6

Art-Nr. / Art.-No.	VE / SU	Größe / Size	EAN
2442 2261 	12	2 132 x 110 x 88 mm	
2444 2261 	12	4 157 x 132 x 110 mm	
2446 2261 	6	6 185 x 161 x 137 mm	





160 x 134 x 135 mm

**Stutzen-Kaffeefilter**  
 • für Filtergröße 4  
 • bietet durch den langen Einfüllstutzen sicheren Halt  
 • besonders für Isolierkannen und -flaschen geeignet

*Coffee filter cone*  
 • for filter size 4  
 • long filling spout provides a secure fit  
 • especially suitable for insulated jugs and pitchers

**Porte-filtre à café**  
 • pour taille de filtre 4  
 • offre un maintien sûr sur les pots grâce à la longue goulotte de remplissage  
 • idéal pour pichets isothermes

*Portafiltro de café*  
 • para el tamaño de filtro 4  
 • gracias a su larga tubuladura de llenado, estabilidad segura en la cafetera  
 • ideal para termosjarra y botella

Art-Nr. / Art.-No.	VE / SU	EAN
2445 2270 	6	





- Dauerfilter »Tee«**
- mit Edelstahlgewebe
  - aromatreu, geschmacksneutral
  - der Deckel kann als Abtropfschale verwendet werden und als Abdeckung während der Ziehzeit



- Permanent filter »Tee«**
- with stainless steel mesh
  - preserves aroma, taste-neutral
  - the lid can be used as a drip tray

- Filtre permanent »Tee«**
- avec tamis en acier fin
  - préserve l'arôme, neutre du point de vue goût
  - le couvercle peut être utilisé comme support d'égouttage

- Filtro perdurable para infusiones »Tee«**
- con tamiz de acero fino
  - preserva el aroma, de sabor neutro
  - la tapa puede emplearse como platillo para el goteo



110 x 72 x 80 mm

Art-Nr. / Art.-No.	VE / SU	EAN
1575 2260 	5	 4 004094 157561



- Dauerfilter »Kaffee«**
- für alle gängigen Kaffeemaschinen oder Hand-Kaffeefilter - für 8 bis 12 Tassen
  - praktisch am Bügel zu entnehmen

- Permanent filter »Kaffee«**
- for all common coffee machines or manual coffee filters - for 8 to 12 cups
  - easily removable using the attached handle



- Filtre permanent »Kaffee«**
- pour toutes les cafetières automatiques ou manuelles courantes - pour 8 à 12 tasses
  - prélèvement aisé grâce à l'étrier mis en place

- Filtro perdurable para el café »Kaffee«**
- para todas las cafeteras convencionales o para hacer café vertiendo agua a mano; para 8 a 12 tazas
  - el filtro puede tomarse fácilmente gracias al asa

Größe / Size 4



112 x 119 x 83 mm

Art-Nr. / Art.-No.	VE / SU	EAN
2443 2260 	5	 4 004094 244360



08

- Teebox aus Bambus**
- mit 8 Fächern zur übersichtlichen Aufbewahrung und ansprechenden Präsentation von Teebeuteln
  - mit Magnetverschluss
  - (Lieferung: ohne Inhalt)



- Tea box from bamboo**
- with 8 compartments for the arrangement and appealing presentation of tea bags
  - with magnetic seal
  - (delivery without contents)

- Boîte à thé en bambou**
- avec 8 compartiments pour conserver et présenter de belle manière les sachets de thé
  - à fermeture magnétique
  - (fournie sans contenu)

- Caja para tes en bambú**
- con 8 compartimentos para guardar con claridad y correspondiente presentación las bolsitas de té
  - con cierre magnético
  - (suministro: caja vacía)



280 x 160 x 90 mm

Art-Nr. / Art.-No.	VE / SU	EAN
1574 2260 	4	 4 004094 157462







Tee-Ei oval  
• leicht zu verschließen

Oeuf à thé ovale  
• facile à fermer

Tea infuser ball  
• easy to close

Huevo para té, ovalado  
• fácil de cerrar

40 x 40 x 53 mm

Art-Nr. / Art.-No.	VE / SU	EAN
1536 2280 	5	 4 004094 153686





Tee-Ei oval mit Untersatz  
• mit Ablage für saubere Aufbewahrung

Oeuf à thé ovale avec base  
• avec base adaptée

Tea infuser ball oval with base  
• with matching drip-cup

Huevo para té, ovalado con base  
• con soporte para un asiento limpio

43 x 43 x 53 mm

Art-Nr. / Art.-No.	VE / SU	EAN
1577 2280 	5	 4 004094 157783





Tee-Ei zylindrisch  
• leicht zu verschließen

Oeuf à thé cylindrique  
• facile à fermer

Tea infuser ball cylindrical  
• easy to close

Huevo para té, cilíndrico  
• fácil de cerrar

40 x 40 x 40 mm

Art-Nr. / Art.-No.	VE / SU	EAN
1578 2280 	5	 4 004094 157882





Schwenksieb  
• mit Untersatz zum Auffangen von Tropfen

Passette à thé basculante  
• avec base pour les gouttes

Tip tea strainer  
• with dish for catching drips

Colador oscilante  
• con base para las gotas

95 x 57 x 65 mm

Art-Nr. / Art.-No.	VE / SU	EAN
1582 2260 	6	 4 004094 158261







Teenetz  
• aus Baumwolle

Filtre à thé  
• en coton

Tea net  
• from cotton

Redecilla para té  
• en algodón



Art-Nr. / Art.-No.	VE / SU	Größe / Size	EAN
1530 2230 	10	ø 70 mm / 2 Tassen	 4 004094 153051
1531 2230 	10	ø 90 mm / 4 Tassen	 4 004094 153150
1532 2230 	10	ø 110 mm / 6-7 Tassen	 4 004094 153259



- Sieb »Picante«, ø 70 mm**
- ideal als Kaffee-/Teesieb
  - mit breiter Edelstahlkrempe
  - langer Griff und breiter Auflagerahmen sorgen für sicheren Halt auf Tassen

- Strainer »Picante«, ø 70 mm**
- ideal as coffee/tea strainer
  - with wide stainless steel brim
  - the long handle and the well-worked out wire loop ensure a safe hold on cups

Art-Nr. / Art.-No.	VE / SU	EAN
1210 2270	6	4 004094 121074



- Passette »Picante«, ø 70 mm**
- idéal comme passette à café/thé
  - avec large bord en acier inoxydable
  - long manche et large bord assurent un parfait maintien sur la tasse

- Colador »Picante«, ø 70 mm**
- ideal como colador café/té
  - con ancho rebor de acero inoxidable
  - el largo mango y el marco de apoyo proporcionan al colador una estabilidad segura



210 x 70 x 42 mm

- Sieb »Traditionell«, ø 70 mm**
- praktisches Kaffee-/Teesieb mit Auflageraste
  - Aufhängöse im Griff

- Strainer »Traditionell«, ø 70 mm**
- useful coffee/tea strainer with wire loop for safe rest on cups
  - hanging hole in handle

Art-Nr. / Art.-No.	VE / SU	EAN
1281 2270	6	4 004094 128172



- Passette »Traditionell«, ø 70 mm**
- passette à café/thé pratique avec cran
  - avec trou d'accrochage dans le manche

- Colador »Traditionell«, ø 70 mm**
- el práctico colador para café/ té con encaje de apoyo
  - con ojete en el mango para colgar



205 x 70 x 30 mm

- Sieb »Spezial«, ø 80 mm**
- mit zwei praktischen Auflagehaken für sicheren Halt auf Tassen

- Strainer »Spezial«, ø 80 mm**
- with two hooks for safe hold on cups

Art-Nr. / Art.-No.	VE / SU	EAN
1287 2270	6	4 004094 128776



- Passette »Spezial«, ø 80 mm**
- avec deux crochets d'accrochage pratiques pour un parfait maintien sur les tasses

- Colador »Spezial«, ø 80 mm**
- con dos prácticos ganchos de apoyo para una estabilidad segura de la taza



195 x 89 x 31 mm

- Brühlöffel »Teatime«**
- gut aufeinander abgestimmte Zangenfunktion
  - mit Federklappmechanismus
  - einfach zu befüllen

- Brewing spoon »Teatime«**
- well harmonized tong-function
  - with spring clap mechanism
  - easy to fill

Art-Nr. / Art.-No.	VE / SU	EAN
1537 2270	6	4 004094 153778



- Cuillère à infuser »Teatime«**
- fonction pince bien adaptée
  - avec mécanisme de clapet à ressort
  - simple à remplir

- Cuchara para preparar té »Teatime«**
- función de tenazas bien armonizada entre sí
  - con mecanismo plegable de muelle
  - fácil de llenar



155 x 36 x 30 mm

- Klappsieb »Teatime«**
- ideal für Tee oder Gewürze, sehr feinmaschig
  - mit Federklappmechanismus für einfaches Befüllen

- Strainer »Teatime«**
- ideal for use with tea or spices, fine-meshed
  - with spring clap mechanism for easy filling

Art-Nr. / Art.-No.	VE / SU	Größe / Size	EAN
1533 2270	6	ø 50 mm / 160 x 51 x 40 mm	4 004094 153372
1534 2270	6	ø 65 mm / 175 x 66 x 54 mm	4 004094 153471
1535 2270	6	ø 75 mm / 182 x 76 x 61 mm	4 004094 153570



- Passette »Teatime«**
- idéal pour le thé ou pour les épices, à mailles fines
  - avec mécanisme de clapet à ressort pour un remplissage simple

- Colador plegable »Teatime«**
- ideal para té o especias, de malla fina
  - con mecanismo plegable de muelle para un llenado fácil







**Zitronenausgießer**  
• zum einfachen Eindrehen in die Zitrone

**Trompette à citron**  
• à tourner simplement dans le citron

*Lemon pourer*  
• simply to be pushed into the lemon

*Vertedor de zumo de limón*  
• introducir girando simplemente en el limón

41 x 41 x 68 mm

Art-Nr. / Art.-No.	VE / SU	EAN
6298 2280 	6	 4 004094 629884





**Zitronenschnitzelpresse**  
• solide Ausführung

**Presse à pulpe de citron**  
• modèle solide

*Lemon slice squeezer*  
• solid construction

*Exprimidor de rodajas de limón*  
• versión sólida

85 x 71 x 19 mm

Art-Nr. / Art.-No.	VE / SU	EAN
9088 2280 	6	 4 004094 908880



**Tropfenfänger »Butterfly«**  
• für sicheres, tropfenfreies Ausgießen



**Pare-gouttes »Butterfly«**  
• pour un versement sûr et sans goutte

*Drip catcher »Butterfly«*  
• for safe, drip-free pouring

*Recogegotas »Butterfly«*  
• vertido seguro, sin goteo



54 x 35 x 21 mm

Art-Nr. / Art.-No.	VE / SU	EAN
1527 2280 	12	 4 004094 152788



### Süßstoffspender

- dezent matter Edelstahlspender
- zum Befüllen einfach den aufgesteckten Deckel abnehmen
- eine Süßstofftablette pro Tastendruck

### Sweetener pill dispenser



- unobtrusive mat stainless steel dispenser
- for easy filling – just take off the lid
- one push – one tablet

### Distributeur d'édulcorant

- distributeur mat en acier inox
- pour remplir, retirer simplement le couvercle
- une sucrète par pression

### Dispensador de edulcorantes

- decente dispensador mate de acero inoxidable
- para llenarlo se quita sencillamente la tapa
- pulsando la tecla – sale una pildorita edulcorante

Art-Nr. / Art.-No.	VE / SU	EAN
6517 2260 	6	 4 004094 651762

ABS INOX



50 x 50 x 86 mm

### Dekorier-/Kakaostreuer

- zum Verzieren von Cappuccino, Kakao etc.
- beinhaltet 4 verschiedene Motivscheiben
- platzsparende Aufbewahrung der Scheiben im Deckel

### Garnishing/Cocoa Castor

- for garnishing cappuccino, cocoa etc.
- includes 4 separate decorating plates
- easy storage of the plates in the lid

### Saupoudreuse pour décoration/cacao

- pour la décoration de cappuccino, cacao etc.
- comprend 4 disques de différents motifs
- rangement facile des disques dans le couvercle

### Espolvoreador decorador / de cacao



- para adornar capuchino, cacao, etc.
- incluidos 4 discos con distintos motivos
- los discos se guardan en la tapa sujetos - para ahorrar sitio



dreheren / turn



75 x 75 x 107 mm

Art-Nr. / Art.-No.	VE / SU	EAN
6284 2260 	6	 4 004094 628467

PP INOX



### 3 Dekorierschablonen »Cappuccino«

- zum Erstellen dekorativer Motive auf Milchschaum
- extra groß im Durchmesser
- praktisch in der Anwendung durch Halte- und Aufhängeelement

### 3 decorative templates »Cappuccino«

- for the simple creation of motifs on foamed milk
- extra-large diameter
- especially practical to use thanks to the holding element



### Kit de 3 pochoirs de décoration »Cappuccino«

- pour réaliser des motifs décoratifs sur la mousse de lait
- diamètre extra-grand
- particulièrement pratique à utiliser grâce à l'élément de maintien

### Juego con tres plantillas para decorar »Cappuccino«

- para crear motivos decorativos sobre espuma de leche
- diámetro extra-grande
- especialmente práctico en el uso gracias al elemento de sujeción



Art-Nr. / Art.-No.	VE / SU	EAN
6286 2260 	4	 4 004094 628665

INOX



130 x 106 x 0,7 mm

**Eidorn Kunststoff**  
• mit Sicherheitsverriegelung



**Pique-oeuf plastique**  
• avec verrouillage de sécurité

**Egg-pricker plastic**  
• with safety closing mechanism

**Agujereador de huevos en plástico**  
• con bloqueo de seguridad



48 x 48 x 30 mm

Art-Nr. / Art.-No.	VE / SU	EAN
1080 2210 	50	
1080 2280 	5	 4 004094 108082



**Eidorn Edelstahl**  
• edler Look



**Pique-oeuf acier inoxydable**  
• aspect élégant

**Egg-pricker stainless steel**  
• elegant look

**Agujereador de huevos en acero inoxidable**  
• noble look



57 x 57 x 29 mm

Art-Nr. / Art.-No.	VE / SU	EAN
1081 2260 	6	 4 004094 108167



**Eierköpfer**  
• durch Zusammendrücken der beiden Kunststoffelemente zu bedienen



**Coupe-oeuf**  
• à opérer en pressant les deux éléments en plastique

**Egg cutter**  
• to be worked by pushing both plastic elements

**Cortacabezas de huevos**  
• a manejar por apretando los dos elementos de plástico



91 x 81 x 11 mm

Art-Nr. / Art.-No.	VE / SU	EAN
1089 2280 	6	 4 004094 108983



**Eierbecher »Punto«, rund, 3er-Set**  
*Egg cups »Punto« round, 3pc-set*





**Coquetier »Punto«, rond, set 3 pièces**  
*Huevo »Punto« redondo, set 3 piezas*



2062 2270

**Eierbecher »Tri« dreieckig, 6er-Set**  
*Egg cups »Tri« triangular, 6pc-set*

**Coquetier »Tri« triangulaire, set 6 pièces**  
*Huevo »Tri« triangular, set 6 piezas*

Art-Nr. / Art.-No.	VE / SU	Größe / Size	EAN
2062 2270 	5	100 x 100 x 21 mm	 4 004094 206276
2070 2241 	22	106 x 106 x 21 mm	 4 004094 207044

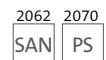

**Eierlöffel**  
• erhältlich als 6er Set auf Blisterkarte (2084 2280) oder lose als Einzelartikel



**Cuillère à oeuf**  
• disponible en set de 6 pièces sur carte de vente (2084 2280) ou au détail en vrac

**Egg spoons**  
• available as a set of 6 pieces on sales card (2084 2280) or bulk as single item

**Cuchara para huevos**  
• disponible como set de 6 piezas (2084 2280) o como artículo individual



143 x 27 x 6 mm

Art-Nr. / Art.-No.	VE / SU	EAN
2084 2210 	50	
2084 2280 	10	 4 004094 208478







- Cocktail-/Limo-/Joghurtlöffel**
- extra lang
  - farbig sortiert
  - erhältlich als 6er Set auf Blisterkarte (2082 2270) oder lose als Einzelartikel
- Cocktail-/lemonade/yoghurt spoons*
- extra long
  - assorted colours
  - available as a set of 6 pieces on sales card (2082 2270) or bulk as single item

- Cuillère à cocktail/limonade/yaourt**
- extra longue
  - couleurs assorties
  - disponible en set de 6 pièces sur carte de vente (2082 2270) ou au détail en vrac
- Cuchara para cócteles / limonada / yogures*
- extra larga
  - colores surtidos
  - disponible como set de 6 piezas (2082 2270) o como artículo individual



224 x 27 x 15 mm

Art-Nr. / Art.-No.	VE / SU	EAN
2082 2210 	100	
2082 2270 	10	 4 004094 208270



Made in  GERMANY

- Henkeltasse, 0,3 l**
- unzerbrechlich, besonders gut geeignet für Kinder, Camping etc.
  - farbig sortiert



- Tasse à hanse large, 0,3 l**
- incassable – particulièrement bien adapté aux enfants, au camping etc.
  - couleurs assorties

- Large cup, 0,3 l*
- unbreakable - especially suitable for children, camping etc.
  - assorted colours

- Taza con asa, 0,3 l*
- irrompible – se apropia especialmente bien para los niños, camping, etc.
  - colores surtidos



104 x 78 x 87 mm

Art-Nr. / Art.-No.	VE / SU	EAN
2104 2291 	5	 4 004094 210495



Made in  GERMANY

- Trinkbecher »Trend«, 0,3 l**
- unzerbrechlich, besonders gut geeignet für Kinder, Camping etc.
  - farbig sortiert

- Gobelet »Trend«, 0,3 l**
- incassable – particulièrement bien adapté aux enfants, au camping etc.
  - couleurs assorties

- Beaker »Trend«, 0,3 l*
- unbreakable - especially suitable for children, camping etc.
  - assorted colours

- Vaso »Trend«, 0,3 l*
- irrompible – se apropia especialmente bien para los niños, camping, etc.
  - colores surtidos



73 x 73 x 108 mm

Art-Nr. / Art.-No.	VE / SU	EAN
5108 2291 	10	 4 004094 510892



Made in  GERMANY

- Trinkbecher »Klipp-Klapp«, 24er-Display**
- für Wanderer, Kurgäste, Reiselustige etc.
  - praktisch zusammenklappbarer Trinkbecher - findet Platz in jeder Jackentasche
  - Fassungsvermögen: 0,125 l



- Gobelet »Klipp-Klapp«, display 24 pièces**
- idéal pour les randonneurs, les curistes, les voyageurs etc.
  - gobelet pliable pour être facilement transporté dans une poche
  - capacité: 0,125 l

- Drinking cups »Klipp-Klapp«, 24pc-display*
- ideal for hikers, cure guests, people enjoying travelling etc.
  - collapses into a small round box for easy transport in the pocket
  - capacity: 0,125 l

- Vaso »Klipp-Klapp«, display 24 piezas*
- para senderistas, huéspedes de balnearios, etc.
  - vaso práctico plegable – cabe en cualquier bolsillo de la chaqueta
  - cabida: 0,125 l



75 x 49 x 24 mm

Art-Nr. / Art.-No.	VE / SU	EAN
5118 2610 	1	 4 051734 511818



Made in  GERMANY

- Tischabfallbehälter, 1 l**
- porzellanartig glänzende Oberfläche
  - Deckelelement zum leichten Entleeren und Reinigen abnehmbar



- Poubelle de table, 1 l**
- surface de type porcelaine, finition brillante
  - couvercle amovible pour vider et nettoyer facilement la poubelle

- Table bin, 1 l*
- elegant porcelain-look, shiny finish
  - lid comes off for easy emptying and cleaning

- Recipiente para desperdicios de mesa, 1 l*
- superficie con brillo similar a porcelana
  - tapa de quita y pon para vaciar y limpiar fácilmente



124 x 124 x 142 mm

Art-Nr. / Art.-No.	VE / SU	EAN
2120 2270 	5	 4 004094 212079



Made in  GERMANY





# 09

backstube • *bakery*  
pâtisserie • *pastelería*











**Springform**  
 • hochwertige Antihafbeschichtung  
 • zuverlässige Qualität für langes Backvergnügen

**Moule à charnières**  
 • revêtement anti-adhésif de haute qualité  
 • qualité éprouvée pour un plaisir de cuisson durable

**Spring-form**  
 • high-quality non-stick coating  
 • reliable quality for long-term baking pleasure

**Molde desmontable**  
 • revestimiento antiadherente de alta calidad  
 • calidad fiable para que su diversión al hornear dure mucho tiempo

Art-Nr. / Art.-No.	VE / SU	Größe / Size	EAN
3166 2240 	3	ø 26 cm	4 004094 316647 
3168 2240 	3	ø 28 cm	4 004094 316845 



**Offensives Preis-/Leistungs-Verhältnis**  
**Material:** kaltgewalzter Stahl  
**Beschichtung:** hochwertige Antihaf-Beschichtung

*Intriguing price/performance ratio*  
*Material: cold-rolled steel*  
*Coating: high-quality non-stick coating*

**Rapport qualité-prix offensif**  
**Matière:** acier laminé à froid  
**Revêtement:** anti-adhésif de haute qualité

*Relación precio-calidad ofensiva*  
*Material: acero laminada frío*  
*Revestimiento antiadherente de alta calidad*







**Springform, Set mit 2 Böden**  
 • 2 Böden (Flachboden & Rohrboden)  
 • hochwertige Antihafbeschichtung  
 • zuverlässige Qualität für langes Backvergnügen

**Moule à charnières, set avec 2 fonds**  
 • 2 fonds (fond plat et fond cannelé)  
 • revêtement anti-adhésif de haute qualité  
 • qualité éprouvée pour un plaisir de cuisson durable

**Spring-form, set with 2 bases**  
 • 2 bases (flat base & base with tube)  
 • high-quality non-stick coating  
 • reliable quality for long-term baking pleasure

**Molde desmontable, set con 2 bases**  
 • 2 bases (base plana y base con chimenea)  
 • revestimiento antiadherente de alta calidad  
 • calidad fiable para que su diversión al hornear dure mucho tiempo

Art-Nr. / Art.-No.	VE / SU	Größe / Size	EAN
3167 2240 	3	ø 26 cm	4 004094 316746 
3169 2240 	3	ø 28 cm	4 004094 316944 

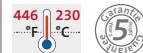



#### Gugelhupfform

- hochwertige Antihafbeschichtung
- gute Wärmeleitung sorgt für gleichmäßiges Bräunen

#### Moule à kouglof

- revêtement anti-adhésif de haute qualité
- la bonne conduction de la chaleur assure un brunissage uniforme



#### Fluted tube cake pan

- high-quality non-stick coating
- good thermal conductivity ensures uniform browning

#### Molde Gugelhupf

- revestimiento antiadherente de alta calidad
- la buena conducción del calor proporciona un dorado homogéneo



Art-Nr. / Art.-No.	VE / SU	Größe / Size	EAN
3180 2270 	3	ø 22 cm	 4 004094 318078



#### Königskuchenform

- hochwertige Antihafbeschichtung
- zuverlässige Qualität für langes Backvergnügen

#### Moule à cake

- revêtement anti-adhésif de haute qualité
- qualité éprouvée pour un plaisir de cuisson durable





#### King's cake tin

- high-quality non-stick coating
- reliable quality for long-term baking pleasure

#### Molde para pasteles rectangulares

- revestimiento antiadherente de alta calidad
- calidad fiable para que su diversión al hornear dure mucho tiempo



Art-Nr. / Art.-No.	VE / SU	Größe / Size	EAN
3184 2270 	6	25 cm	 4 004094 318474
3186 2270 	6	30 cm	 4 004094 318672







- Springform**
- für anspruchsvolle Vielnutzer
  - sehr gute Antihafbeschichtung
  - leichte Reinigung
  - gleichmäßiges Bräunen

- Spring-form*
- for demanding frequent users
  - very good non-stick coating
  - easy to clean
  - uniform browning

- Moule à charnières**
- pour utilisateurs exigeants
  - très bon revêtement anti-adhésif
  - nettoyage facile
  - brunissement uniforme

- Molde desmontable*
- para el multiusuario exigente
  - bonísimo revestimiento antiadherente
  - fácil de limpiar
  - dorado homogéneo

Art-Nr. / Art.-No.	VE / SU	Größe / Size	EAN
3258 2270	3	ø 18 cm	4 004094 325878
3264 2270	3	ø 24 cm	4 004094 326479
3266 2270	3	ø 26 cm	4 004094 326677
3268 2270	3	ø 28 cm	4 004094 326875



**Back-Meister**

Für anspruchsvolle Vielnutzer  
Gute Qualität zu fairen Preisen  
Material: kaltgewalzter Stahl  
Beschichtung: hochwertige Antihaf-Beschichtung

*For demanding frequent users  
Great quality at fair prices  
Material: cold-rolled steel  
Coating: high-quality non-stick coating*

Pour utilisateurs exigeants  
Une bonne qualité à des prix équitables  
Matière: acier laminé à froid  
Revêtement: anti-adhésif de haute qualité

*Para el multiusuario exigente  
Buena calidad a precios equitativos  
Material: acero laminada frío  
Revestimiento antiadherente de alta calidad*



**Back-Meister**

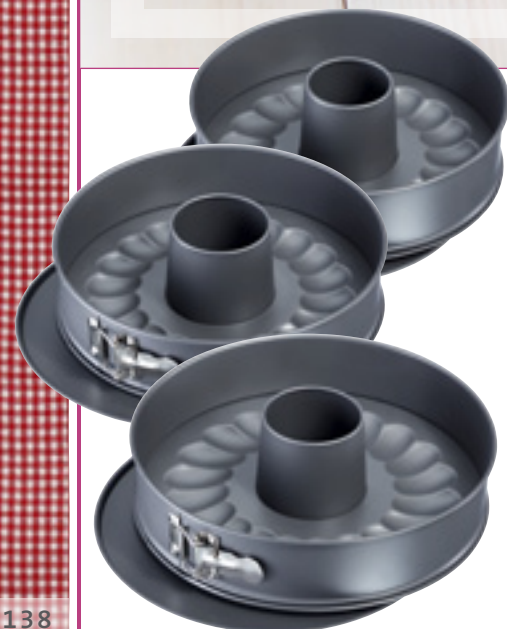

- Springform, Set mit 2 Böden**
- 2 Böden (Flachboden & Rohrboden)
  - für anspruchsvolle Vielnutzer
  - sehr gute Antihafbeschichtung
  - leichte Reinigung
  - gleichmäßiges Bräunen

- Spring-form, set with 2 bases*
- 2 bases (flat base & base with tube)
  - for demanding frequent users
  - very good non-stick coating
  - easy to clean
  - uniform browning

- Moule à charnières, set avec 2 fonds**
- 2 fonds (fond plat et fond cannelé)
  - pour utilisateurs exigeants
  - très bon revêtement anti-adhésif
  - nettoyage facile
  - brunissement uniforme

- Molde desmontable, set con 2 bases*
- 2 bases (base plana y base con chimenea)
  - para el multiusuario exigente
  - bonísimo revestimiento antiadherente
  - fácil de limpiar
  - dorado homogéneo

Art-Nr. / Art.-No.	VE / SU	Größe / Size	EAN
3265 2270	3	ø 24 cm	4 004094 326578
3267 2270	3	ø 26 cm	4 004094 326776
3269 2270	3	ø 28 cm	4 004094 326974





### Gugelhupfform

- für anspruchsvolle Vielnutzer
- sehr gute Antihafbeschichtung
- leichte Reinigung
- gleichmäßiges Bräunen

### Fluted tube cake pan

- for demanding frequent users
- very good non-stick coating
- easy to clean
- uniform browning



### Moule à kouglof

- pour utilisateurs exigeants
- très bon revêtement anti-adhésif
- nettoyage facile
- brunissement uniforme

### Molde Gugelhupf

- para el multiusuario exigente
- bonísimo revestimiento antiadherente
- fácil de limpiar
- dorado homogéneo



Art-Nr. / Art.-No.	VE / SU	Größe / Size	EAN
3280 2270 	3	ø 22 cm	 4 004094 328077



### Königskuchenform

- für anspruchsvolle Vielnutzer
- sehr gute Antihafbeschichtung
- leichte Reinigung
- gleichmäßiges Bräunen

### King's cake tin

- for demanding frequent users
- very good non-stick coating
- easy to clean
- uniform browning





### Moule à cake

- pour utilisateurs exigeants
- très bon revêtement anti-adhésif
- nettoyage facile
- brunissement uniforme

### Molde para pasteles rectangulares

- para el multiusuario exigente
- bonísimo revestimiento antiadherente
- fácil de limpiar
- dorado homogéneo



Art-Nr. / Art.-No.	VE / SU	Größe / Size	EAN
3284 2270 	5	25 cm	 4 004094 328473
3286 2270 	5	30 cm	 4 004094 328671







- Obstbodenform**
- sehr gute Antihafbeschichtung
  - leichte Reinigung
  - gleichmäßiges Bräunen

- Fruit tart tin*
- very good non-stick coating
  - easy to clean
  - uniform browning

- Moule à charnières**
- revêtement anti-adhésif de haute qualité
  - facile à nettoyer
  - brunissement uniforme

- Molde desmontable*
- revestimiento antiadherente de alta calidad
  - fácil de limpiar
  - dorado homogéneo



Art-Nr. / Art.-No.	VE / SU	Größe / Size	EAN
3294 2270 	5	ø 28 cm	 4 004094 329470

Made in GERMANY

PFOA FREE

446 / 230 °F / °C

**ILAG**  
NON STICK  
SPECIAL

5  
YEARS  
WARRANTY

Back-  
Meister







- Brat-/Backform**
- hochwertige Antihafbeschichtung
  - für Herzhaftes oder Süßes
  - Aufläufe, Gemüsepfannen oder süße Obstkuchen lassen sich aufgrund der praktischen Höhe von 4 cm sehr gut in dieser Form zubereiten

- Roasting/baking tin*
- high quality non-stick coating
  - for savoury or sweet eatables
  - casseroles, soufflés, stir-fries or sweet fruitcakes can be prepared excellently in this tin thanks to its practical height of 4 cm

- Plat à gratin/moule à pâtisserie**
- revêtement anti-adhésif de haute qualité
  - pour salé ou sucré
  - grâce à la hauteur pratique de 4 cm, ce moule permet de préparer de délicieux ragoûts, des poêlées de légumes ou des tartes aux fruits sucrées

- Molde para asar/hornear*
- revestimiento antiadherente de alta calidad
  - para lo sabroso o dulce
  - en este molde, gracias a su práctica altura de 4 cm, pueden prepararse excelentemente gratinados, verduras a la sartén o dulces pasteles de frutas



Art-Nr. / Art.-No.	VE / SU	Größe / Size	EAN
3295 2270 	5	28,5 x 23 x 4 cm	 4 004094 329579
3296 2270 	5	42 x 29 x 4 cm	 4 004094 329678

Made in GERMANY

PFOA FREE

482 / 250 °F / °C

**ILAG**  
NON STICK  
SPECIAL

5  
YEARS  
WARRANTY



- Backblech, ausziehbar**
- hochwertige Antihafbeschichtung
  - ausziehbar von 33 bis 53 cm
  - mit extra abgeflachter Abrutschkante
  - fruchtsäurebeständig

- Baking pan, extendable*
- high quality non-stick coating
  - extendable from 33 up to 53 cm
  - with extra-wide flat lip
  - resistant to fruit acids

- Plaque (à gateaux, étirable**
- revêtement anti-adhésif de haute qualité
  - étirable de 33 à 53 cm
  - à bord extrêmement plat pour éviter tout glissement
  - résiste à l'acidité des fruits

- Bandeja de horno, extensible*
- revestimiento antiadherente de alta calidad
  - extensible de 33 a 53 cm
  - con canto deslizante extra aplanado
  - resistente al ácido de frutas



Art-Nr. / Art.-No.	VE / SU	Größe / Size	EAN
3297 2270	3	33-53 x 33 x 3,3 cm	4 004094 329777



- Muffinbackform**
- zum Backen von CupCakes oder Muffins
  - Art.-Nr. 3288 für 6 Muffins
  - Art.-Nr. 3290 für 12 Muffins

- Muffin baking tin*
- for baking delicious CupCakes or muffins
  - Art.-No. 3288 for 6 muffins
  - Art.-No. 3290 for 12 muffins

- Moule de cuisson pour muffins**
- pour cuire de délicieux CupCakes et muffins
  - Art.-n°. 3288 pour 6 muffins
  - Art.-n°. 3290 pour 12 muffins

- Molde para muffins*
- para ahornar CupCakes o muffins deliciosos
  - Art.-n°. 3288 para 6 muffins
  - Art.-n°. 3290 para 12 muffins

Art-Nr. / Art.-No.	VE / SU	Größe / Size	EAN
3288 2270	6	26,5 x 18,5 x 3 cm	4 004094 328879
3290 2270	6	35 x 26,5 x 3 cm	4 004094 329074



- 12er Mini-Muffin-Backform**
- zum Backen von CupCakes oder Muffins

- Mini-muffin baking tin, for 12 muffins*
- for baking delicious CupCakes or muffins

- Moule de cuisson pour 12 mini-muffins**
- pour cuire de délicieux CupCakes et muffins

- Molde para 12 mini muffins*
- para ahornar CupCakes o muffins deliciosos

Art-Nr. / Art.-No.	VE / SU	Größe / Size	EAN
3291 2270	6	25 x 19 x 2 cm	4 004094 329173



- Brotbackform, ausziehbar**
- ausziehbar von 22 bis 35 cm
  - aus extra starkem Stahl mit hochwertiger Beschichtung für hervorragende Backeigenschaften
  - saureteigbeständig

- Bread tin, extendable*
- extendable from 22 up to 35 cm
  - of extra-thick steel with a high quality coating to give outstanding baking properties
  - sourdough resistant

- Moule à pain, étirable**
- étirable de 22 à 35 cm
  - en acier épais avec un revêtement de haute qualité pour garantir d'excellentes propriétés de cuisson
  - résistant au levain

- Molde para horno de pan, extensible*
- extensible de 22 a 35 cm
  - en acero extra fuerte con un revestimiento de alta calidad para obtener propiedades de horneado excelentes
  - resistente al fermento

Art-Nr. / Art.-No.	VE / SU	Größe / Size	EAN
3293 2270	3	22 - 35 x 12 x 9 cm	4 004094 329371



- Pizzablech**
- mit Thermolochung für knusprige Böden
  - mit Antihafbeschichtung
  - leicht zu reinigen
  - für frische und tiefgekühlte Pizza bis ø 33 cm

- Pizza baking plate*
- with thermo holes for crispy bases
  - with non-stick coating
  - easy to clean
  - for freshly made and deep-frozen pizzas up to ø 33 cm

- Plaque à pizza**
- avec fond perforée pour une pâte croustillante
  - avec revêtement anti-adhésif
  - facile à nettoyer
  - pour pizzas fraîches et congelées jusqu'au ø 33 cm

- Bandeja de horno para pizza*
- con perforaciones térmicas para fondos bien crujientes
  - con revestimiento antiadherente
  - fácil de limpiar
  - para pizzas recién hechas y congeladas hasta ø 33 cm

Art-Nr. / Art.-No.	VE / SU	Größe / Size	EAN
3292 2270	6	ø 35 cm	4 004094 329272













- Springform, auslaufsicher**
- hochwertige Springform mit auslaufsicherem Flachboden
  - ideal für sehr flüssigen Teig
  - sehr gute Antihafbeschichtung
  - leichte Reinigung
  - gleichmäßiges Bräunen

- Spring-form, leak-proof*
- high-quality spring-form baking tin with leak-proof base
  - ideal for very runny dough
  - very good non-stick coating
  - easy to clean
  - uniform browning

- Moule à charnières, anti-écoulement**
- moule à charnière de haute qualité avec fond plat anti-écoulement
  - idéal pour les pâtes très liquides
  - très bon revêtement anti-adhésif
  - nettoyage facile
  - brunissement uniforme

- Molde desmontable, a prueba de derrame*
- molde desmontable de alta calidad con base plana a prueba de derrame
  - ideal para masa muy líquida
  - bonísimo revestimiento antiadherente
  - fácil de limpiar
  - dorado homogéneo

Art-Nr. / Art.-No.	VE / SU	Größe / Size	EAN
3358 2260 	3	ø 18 cm	 4 004094 335860
3364 2260 	3	ø 24 cm	 4 004094 336461
3366 2260 	3	ø 26 cm	 4 004094 336669
3368 2260 	3	ø 28 cm	 4 004094 336867



PFOA FREE



Made in EUROPE 

**Back-profi**

Qualität für höchste Ansprüche  
Material: kaltgewalzter Stahl  
Beschichtung: hochwertige Antihaf-Beschichtung

*Quality for highest demands*  
Material: cold-rolled steel  
Coating: high-quality non-stick coating

Une qualité qui répond aux plus hautres exigences  
Matière: acier laminé à froid  
Revêtement: anti-adhésif de haute qualité

*Calidad para las más altas exigencias*  
Material: acero laminada frío  
Revestimiento antiadherente de alta calidad



**Back-profi**







- Springform, Set mit 2 Böden**
- 2 Böden (auslaufsicherer Flachboden & Rohrboden)
  - ideal für sehr flüssigen Teig
  - sehr gute Antihafbeschichtung
  - leichte Reinigung

- Spring-form, set with 2 bases*
- 2 bases (leak-proof flat base & base with tube)
  - ideal for very runny dough
  - very good non-stick coating
  - easy to clean

- Moule à charnières, set avec 2 fonds**
- 2 fonds (fond plat anti-écoulement et fond cannelé)
  - idéal pour les pâtes très liquides
  - très bon revêtement anti-adhésif
  - nettoyage facile

- Molde desmontable, set con 2 bases*
- 2 bases (base plana a prueba de derrame y base con chimenea)
  - ideal para masa muy líquida
  - bonísimo revestimiento antiadherente
  - fácil de limpiar

Art-Nr. / Art.-No.	VE / SU	Größe / Size	EAN
3367 2260 	3	ø 26 cm	 4 004094 336768
3369 2260 	3	ø 28 cm	 4 004094 336966



PFOA FREE



Made in EUROPE 



- Obstbodenform**
- sehr gute Antihafbeschichtung
  - leichte Reinigung
  - gleichmäßiges Bräunen

*Fruit tart tin*



- high quality non-stick coating
- easy to clean
- uniform browning

- Moule à tarte**
- revêtement anti-adhésif de haute qualité
  - facile à nettoyer
  - brunissement uniforme

*Base para tartas de frutas*

- revestimiento antiadherente de alta calidad
- fácil de limpiar
- dorado homogéneo



Art-Nr. / Art.-No.	VE / SU	Größe / Size	EAN
3394 2260 	3	ø 28 cm	 4 004094 339462



Back-profi

- Quicheform**
- mit Hebeboden
  - hochwertige Antihafbeschichtung
  - gleichmäßiges Bräunen
  - für herzhaftes Quiches oder süße Tartes

*Spring-form baking tin*



- with lift-out base
- high-quality non-stick coating
- uniform browning
- for savoury quiches or sweet tarts

- Moule à quiche**
- avec fond amovible
  - revêtement anti-adhésif de haute qualité
  - brunissement uniforme
  - pour quiches salées ou tartes sucrées

*Molde para quiches*

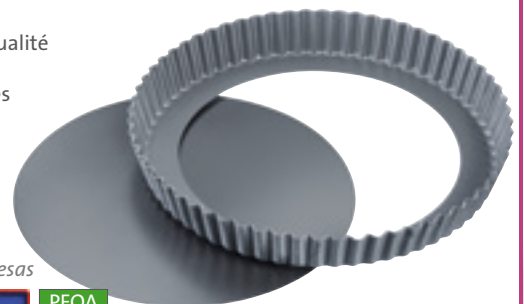
- con base desmontable
- revestimiento antiadherente de alta calidad
- dorado homogéneo
- para sabrosos quiches o tartas francesas



Art-Nr. / Art.-No.	VE / SU	Größe / Size	EAN
3393 2260 	3	ø 28 cm	 4 004094 339363







185 x 165 x 85 mm

- Tortenring**
- zum Backen, Füllen und Schichten
  - Durchmesser verstellbar (160-300 mm)
  - extra hoch 85 mm
  - die praktischen Griffen helfen bei der Einstellung der richtigen Größe

- Cake setting ring**
- for baking, filling and layering
  - diameter adjustable (160-300 mm)
  - extra high 85 mm
  - with practical handles which help to get just the size you want everytime

- Cercle à gâteau**
- pour la cuisson, le remplissage et la superposition
  - diamètre ajustable (160 à 300 mm)
  - extra haut 85 mm
  - les poignées pratiques permettent de régler labonne taille

- Aro para tartas**
- para hornear, llenar y preparar capas
  - el diámetro puede regularse (160-300 mm)
  - extra alto 85 mm
  - las prácticas agarraderas ayudan al ajustar el tamaño correcto

Art-Nr. / Art.-No.	VE / SU	EAN
3131 2260 	5	4 004094 313165 



275 x 185 x 50 mm

- Kuchen-/Pizzarahmen mit Teiler**
- um zwei unterschiedliche Pizzen oder Kuchen zu backen
  - die Trennwand kann frei eingesetzt werden
  - Grundmaße des Rahmens stufenlos verstellbar : Länge von 275 mm bis 525 mm; Breite von 185 bis 340 mm; Höhe 50 mm

- Cake-/pizza-baking frame with separator**
- simply bake two different pizzas or cakes
  - the separating device can freely be placed in
  - ground mass variable: length from 275 mm to 525 mm; width from 185 to 340 mm; height: 50 mm

- Cadre à gâteau et à pizza avec séparateur**
- pour cuire simplement deux pizzas ou gâteaux différents
  - le dispositif de séparation peut être librement placé
  - les dimensions du cadre sont ajustables: longueur de 275 mm à 525 mm; largeur de 185 à 340 mm; hauteur 50 mm

- Marco para pasteles/pizzas (con divisor)**
- hacer sencillamente dos pizzas o pasteles distintos
  - la pared separadora puede ponerse libremente
  - la medida base del marco es regulable sin escalones: longitud de 275 mm hasta 525 mm; anchura de 185 hasta 340 mm, altura 50 mm

Art-Nr. / Art.-No.	VE / SU	EAN
3132 2260 	3	4 004094 313264 

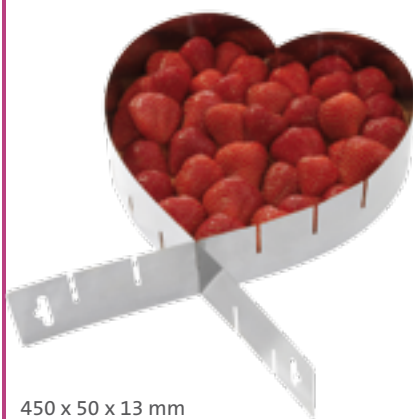



450 x 50 x 13 mm

- Herzbackform**
- Form ohne Boden - zum Backen, Formen und Schichten
  - variabel verstellbar

- Heart-shaped baking frame**
- mould without base - for baking, shaping and layering
  - freely adjustable

- Moule à pâtisserie en forme de coeur**
- moule sans fond - pour la cuisson, le remplissage et la superposition
  - ajustable

- Molde en forma de corazón**
- molde sin fondo - para hornear, moldear y preparar capas
  - regulable de un modo variable

Art-Nr. / Art.-No.	VE / SU	EAN
3134 2270 	6	4 004094 313479 

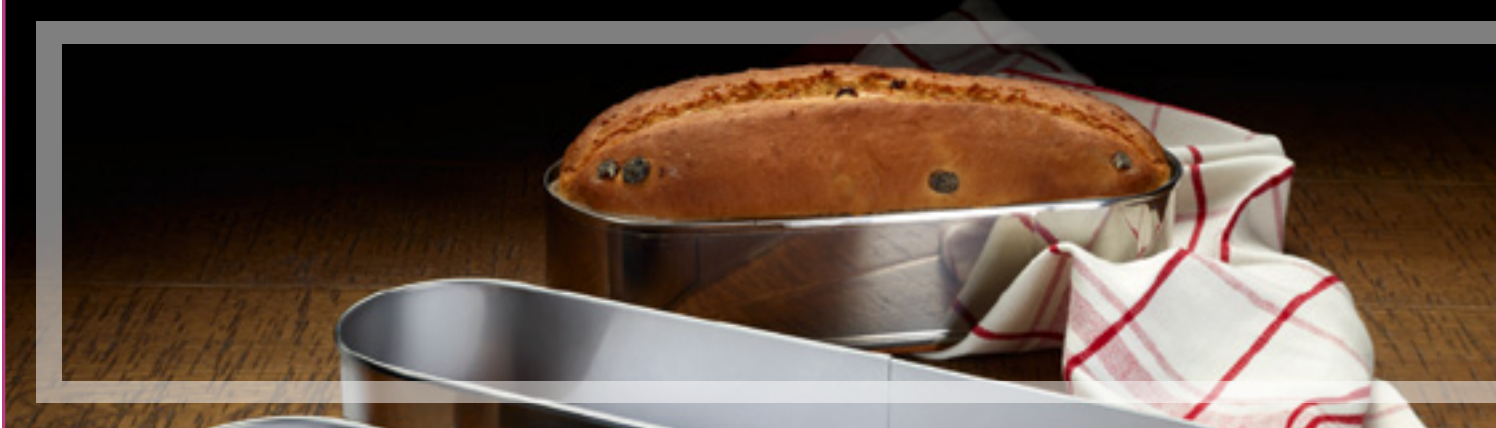

270 x 100 x 70 mm

- Ovale Backform**
- ohne Boden
  - ausziehbar von ca. 27 bis 40 cm
  - für schön geformte Brote, Strudel, Stollen etc.

- Oval baking tin**
- without base
  - extends from approx. 27 to 40 cm
  - for perfectly formed bread, cakes etc.

- Moule à pâtisserie ovale**
- sans fond
  - étirable de 27 à 40 cm
  - pour des pains, des cakes etc. parfaitement formés

- Molde ovalado**
- sin fondo
  - extraíble de aprox. 27 a 40 cm
  - para panes de bellas formas, pasteles de Navidad, etc.

Art-Nr. / Art.-No.	VE / SU	EAN
3135 2260 	4	4 004094 313561 





- 200 Muffin Papier-Backförmchen, weiß
- ø 7 cm
  - für Muffins und CupCakes



- 200 Petits moules en papier, blanc
- ø 7 cm
  - pour de parfaits muffins et CupCakes

- 200 Paper muffin baking cups, white
- ø 7 cm
  - for muffins and CupCakes

- 200 Moldecitos de papel para muffins, blanco
- ø 7 cm
  - para muffins y CupCakes



70 x 70 x 27 mm

Art-Nr. / Art.-No.	VE / SU	EAN
3027 2260 	6	 4 004094 302763



- 150 Muffin Papier-Backförmchen, farbig
- ø 7 cm
  - 4-farbig sortiert
  - für Muffins und CupCakes



- 150 Petits moules en papier, en couleurs
- ø 7 cm
  - 4 couleurs assorties
  - pour de parfaits muffins et CupCakes

- 150 Paper muffin baking cups, coloured
- ø 7 cm
  - in four different colours
  - for perfect muffins and CupCakes

- 150 Moldecitos de papel para muffins, en colores
- ø 7 cm
  - surtido en 4 colores
  - para muffins y CupCakes



70 x 70 x 27 mm

Art-Nr. / Art.-No.	VE / SU	EAN
3028 2260 	6	 4 004094 302862



- 6 Silikon Muffinformen
- 1,2 mm stark, ø 7 cm
  - mit Antihaft-Effekt
  - zum Backen von CupCakes, Muffins - auch für die Zubereitung von Eistörtchen, Pudding etc.



- 6 moules à muffin en silicone
- 1,2 mm d'épaisseur, ø 7 cm
  - avec effet anti-adhésif
  - pour cuire de CupCakes ou muffins - également pour la préparation de tartelettes glacées, pudding etc.

- 6 Silicone muffin cups
- 1,2 mm thick, ø 7 cm
  - with non-stick effect
  - for baking CupCakes or muffins - also for the preparation of ice-cream cakes, puddings etc.

- 6 moldes para muffins de silicona
- 1,2 mm d'el espesor, ø 7 cm
  - con efecto antiadherente
  - para ahornar sabrosos CupCakes y muffins
  - también para preparar tortitas heladas, flanes, etc.



70 x 70 x 30 mm

Art-Nr. / Art.-No.	VE / SU	EAN
3014 2260 	4	 4 004094 301469

SI



- 6er Silikon-Muffin-Backform**
- mit Antihaft-Effekt
  - zum Backen von CupCakes oder Muffins
  - auch für die Zubereitung von Eistörtchen, Pudding etc.

*Silicone muffin cups, for 6 muffins*

- with non-stick effect
- for baking delicious CupCakes or muffins
- also for the preparation of ice-cream cakes, puddings etc.







- Moule de cuisson en silicone pour 6 muffins**
- avec effet anti-adhésif
  - pour cuire de CupCakes ou muffins
  - également pour la préparation de tartelettes glacées, pudding etc.

*Molde en silicona para 6 muffins*

- con efecto antiadherente
- para ahornar CupCakes o muffins
- también para preparar tortitas heladas, flanes, etc.



293 x 175 x 39 mm

Art.-Nr. / Art.-No.	VE / SU	EAN
3015 2270  	4	4 004094 301575
3015 227G  	4	4 004094 002359
3015 227Y  	4	4 004094 002342

SI



- 6er Silikon-Küchlein-Backform »Classic«**
- mit Antihaft-Effekt
  - zum Backen von CupCakes oder Muffins
  - auch für die Zubereitung von Eistörtchen, Pudding etc.

*Silicone baking mould for 6 small cakes »Classic«*

- with non-stick effect
- for baking delicious CupCakes or muffins
- also for the preparation of ice-cream cakes, puddings etc.







- Moule à gâteaux en silicone pour 6 muffins »Classic«**
- avec effet anti-adhésif
  - pour cuire de CupCakes ou muffins
  - également pour la préparation de tartelettes glacées, pudding etc.

*Molde en silicona para 6 pastelitos »Classic«*

- con efecto antiadherente
- para ahornar CupCakes o muffins
- también para preparar tortitas heladas, flanes, etc.



293 x 175 x 30 mm

Art.-Nr. / Art.-No.	VE / SU	EAN
3016 2270  	4	4 004094 301674
3016 227G  	4	4 004094 002373
3016 227Y  	4	4 004094 002366

SI



3015 2270/G/Y



3016 2270/G/Y



3017 2270/G/Y



- 6er Silikon-Küchlein-Backform »Trio«**
- mit unterschiedlichen Formen
  - mit Antihaft-Effekt
  - zum Backen von CupCakes oder Muffins
  - auch für die Zubereitung von Eistörtchen, Pudding etc.

*Silicone baking mould for 6 small cakes »Trio«*

- with non-stick effect
- for baking delicious CupCakes or muffins
- also for the preparation of ice-cream cakes, puddings etc.







- Moule à gâteaux en silicone pour 6 muffins »Trio«**
- avec effet anti-adhésif
  - pour cuire de CupCakes ou muffins
  - également pour la préparation de tartelettes glacées, pudding etc.

*Molde en silicona para 6 pastelitos »Trio«*

- con efecto antiadherente
- para ahornar CupCakes o muffins
- también para preparar tortitas heladas, flanes, etc.



293 x 175 x 30 mm

Art.-Nr. / Art.-No.	VE / SU	EAN
3017 2270  	4	4 004094 301773
3017 227G  	4	4 004094 002397
3017 227Y  	4	4 004094 002380

SI







- 12er CakePop-Silikonform**
- mit Antihaft-Effekt
  - angenehm flexibel zum leichten Herauslösen
  - auch mikrowellen- und gefriergeeignet

- Moule en silicone pour 12 CakePops**
- avec effet anti-adhésif
  - très flexible pour un retrait facile
  - passe au micro-ondes et au congélateur

- Silicone CakePop mould, for 12 CakePops*
- with non-stick effect
  - pleasantly flexible for easy removing
  - also suitable for microwaves and freezing

- Molde de silicona para 12 CakePops*
- con efecto antiadherente
  - agradablemente flexible para el desmolde sencillo
  - tambien apropiado para microondas y congelados



Art-Nr. / Art.-No.	VE / SU	EAN
3024 2260 	4	4 004094 302466
3024 226G 	4	4 004094 002410
3024 226Y 	4	4 004094 002403



267 x 98 x 40 mm



- 48 CakePop-Stäbchen**
- aus Papier

- 48 Bâtons pour CakePops**
- de papier

- 48 CakePop sticks*
- from paper

- 48 Palitos para CakePops*
- de papel



Art-Nr. / Art.-No.	VE / SU	Größe / Size	EAN
3023 2260 	6	150 mm	4 004094 302367

150 x 3,5 mm

- CakePop Butler**
- zum Auskühlen, Dekorieren und Servieren von CakePops
  - bietet Platz für 20 Stück

- Présentoir à CakePops**
- pour refroidir, décorer et servir CakePops
  - permet de placer 20 pièces

- CakePop butler*
- for cooling, decorating and serving CakePops
  - provides space for 20 pieces

- CakePop Butler*
- para enfriar, decorar y servir CakePops
  - en el Butler caben 20 piezas



Art-Nr. / Art.-No.	VE / SU	EAN
3025 2260 	4	4 004094 302565



220 x 160 x 60 mm

3020 2260 »Classic«

**Silikon-Pralinenform**

- aus Silikon mit Antihaft-Effekt
- flexibel zum leichten Herauslösen
- für selbstgemachte Schokopralinen
- Tipp: auch für die Herstellung von Eiswürfeln, Eiskonfekt, Puddingformen oder Butterstücken

**Silicone chocolate mould**

- of silicone with non-stick effect
- flexible to make removing the chocolates easy
- for home-made chocolates
- tip: Can also be used for making ice cubes and ice delicacies, as pudding moulds or for butter cubes

**Moule à pralines en silicone**

- avec effet antiadhésif
- flexible pour un retrait facile
- pour pralines en chocolat faites maison
- conseil: s'utilise également pour la confection de glaçons, confiseries glacées, puddings ou petits morceaux de beurre



**Molde de silicona para bombones**

- con efecto antiadherente
- flexible para el desmolde sencillo
- para bombones de chocolate de fabricación propia
- consejo: También puede usarse para hacer cubitos de hielo, confeti de hielo, flanecitos o trocitos de mantequilla

3021 2260 »Herz«

3022 2260 »Trio«

120 x 220 x 19 mm

Art.-Nr. / Art.-No.	VE / SU	EAN
3020 2260 	4	4 004094 302060
3021 2260 	4	4 004094 302169
3022 2260 	4	4 004094 302268

SI



464 240  
°F °C  
-40 -40



**4tlg. Pralinen-Set**

- bestehend aus 2 Pralinentauchgabeln, 1 Pralinentauchspirale, 1 Abtropfgitter und Rezeptheft

**4 part chocolate-making set**

- consisting of 2 forks and 1 spiral for immersing in the chocolate mixture and 1 drip grid and booklet with recipes

**Ensemble 4 pièces pour pralines**

- se composant de 2 fourchettes à tremper, d'1 broche à tremper en spirale, d'1 grille égouttoir et un livre de recettes

**Set de 4 piezas para bombones**

- consta de 2 tenedores para sumergirlos bombones, de 1 espiral para sumergirlos bombones, de 1 rejilla para escurrir los bombones y un recetario

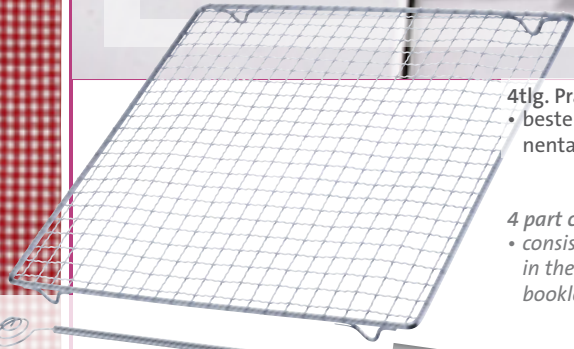

Art.-Nr. / Art.-No.	VE / SU	EAN
3147 2260 	4	4 004094 314766

ST

INOX



300 x 300 x 19 mm







Bitte beachten Sie unsere separate Broschüre mit einer Vielzahl von Ausstechförmchen.

*Please see our separate brochure for a wide range of pastry cutters.*

Veillez noter que nous disposons de différentes brochures présentant une multitude d'emporte-pièces.

*Tenga en cuenta nuestro folleto individual que contiene un gran número de moldes de cocina.*





3078

**Messkanne**

- Messskala in DE, NL, FR
- Maßeinheiten: Gramm für Zucker und Mehl, Liter und ccm für Flüssigkeiten

**Measuring jug**

- scale in DE, NL, FR
- measuring units: grams for sugar and flour, liter and ccm for liquids

**Pichet mesureur**

- graduations en DE, NL, FR
- unités de mesure: gramme pour le sucre et la farine, litre et ccm pour les liquides

**Jarra medidora**

- escala de medición en DE, NL, FR
- unidades de medida: gramos para harina y azúcar

**Messkanne**

- Messskala in DE, GB, FR, NL, IT, ES
- Maßeinheiten: Gramm Mehl, Zucker, Grieß, Reis; Liter, ml Flüssigkeiten
- mit rutschfestem Standfuß

**Measuring jug**

- with scale in DE, GB, FR, NL, IT, ES
- measuring units: grams for flour, sugar, semolina, rice; liters /ml for liquids
- with non-slip base

**Pichet mesureur**



- escala de medición en DE, GB, FR, NL, IT, ES
- unidades de medida: gramos para azúcar y harina

**Jarra medidora**

- escala de medición en DE, GB, FR, NL, IT, ES
- unidades de medida: gramos harina, azúcar, sémola, arroz; litro/ml, con líquidos
- con pata anti resbalante

3068  
»Gerda«



Art-Nr. / Art.-No.	VE / SU	Größe / Size	EAN
3078 2211 	5	0,5 l / 141 x 94 x 130 mm	4 004094 307812
3068 2270 	6	1,0 l / 180 x 124 x 165 mm	4 004094 306877



Made in GERMANY



3079

**Messkanne**

- Messskala in DE, FR, NL
- Maßeinheiten: Gramm für Zucker und Mehl, Liter und ccm für Flüssigkeiten

**Measuring jug**

- scale in DE, FR, NL
- measuring units: grams for sugar and flour, liter and ccm for liquids

**Pichet mesureur**

- graduations en DE, FR, NL
- unités de mesure: gramme pour le sucre et la farine, litre et ccm pour les liquides

**Bol para batir**

- escala de medición en DE, FR, NL
- unidades de medida: gramos para azúcar y harina

**Messkanne**

- mit aufgedruckter Messskala DE
- Maßeinheiten: Gramm für Zucker und Mehl, Liter und ccm für Flüssigkeiten

**Measuring jug**

- Besonderheit: auch geeignet für die Mikrowelle
- scale in DE
- measuring units: grams for sugar and flour; liter and ccm for liquids
- also suitable for being used in the microwave

**Pichet mesureur**



- graduations imprimées en DE
- unités de mesure: gramme pour le sucre et la farine, litre et ccm pour les liquides

**Bol para mezclar**

- escala de medición en DE
- unidades de medida: gramos para azúcar y harina, litro y ccm para líquidos
- particularidad: también idónea para horno microonda

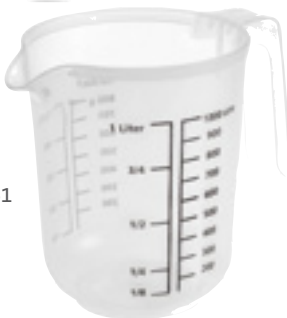
3061



Art-Nr. / Art.-No.	VE / SU	Größe / Size	EAN
3079 2211 	5	0,5 l / 137 x 92 x 129 mm	4 004094 307911
3061 2211 	5	1,0 l / 184 x 120 x 150 mm	4 004094 306112



Made in GERMANY



133 x 133 x 165 mm

**Messbecher »Famos«, 0,5 l**

- mit aufgedruckter Messskala in DE, GB, FR
- Maßeinheiten: Gramm für Mehl, Zucker, Speisestärke; ml für Flüssigkeiten
- wir empfehlen Handwäsche

**Measuring beaker »Famos«, 0,5 l**

- with printed scale in DE, GB, FR
- measuring units: grams for flours, sugar, starch; ml for liquids
- we recommend handwash

**Verre mesureur »Famos«, 0,5 l**

- avec graduations imprimées en DE, GB, FR
- unités de mesure: gramme pour la farine, le sucre, la féculé; ml pour les liquides
- lavage à la main recommandé

**Vaso medidor »Famos«, 0,5 l**

- con escala de medición impresa en DE, GB, FR
- unidades de medida: gramos de harina, azúcar, almidón; ml para líquidos
- recomendamos lavar a mano

Art-Nr. / Art.-No.	VE / SU	EAN
3074 2270 	6	4 004094 307478



Made in GERMANY

**Messbecher, 0,5 l**

- Messskala in DE, GB, FR, NL, IT, ES
- Maßeinheiten: Gramm für Salz, Zucker, Mehl etc.; ccm/Liter für Flüssigkeiten
- Besonderheit: mit Feinmesskegel - misst bereits ab 10 g oder 10 ccm/ml

**Measuring beaker, 0,5 l**

- scale in DE, GB, FR, NL, IT, ES
- measuring units: grams for salt, sugar, flour etc.; ccm/liter for liquids
- special feature: with fine measuring cone - measures already from 10 grams or 10 ccm/ml

**Verre mesureur, 0,5 l**

- graduations en DE, GB, FR, NL, IT, ES
- unités de mesure: gramme pour le sel, le sucre, la farine etc.; ccm/litre pour les liquides
- particularité: avec cône de mesure fin - mesure dès 10 g ou 10 ccm/ml

**Vaso medidor, 0,5 l**

- escala de medición en DE, GB, FR, NL, IT, ES
- unidades de medida: gramos para sal, azúcar, harina etc.; ccm/litro para líquidos
- particularidad: con cono de medida de alta precisión - mide ya a partir de 10 g o 10 ccm/ml

Art-Nr. / Art.-No.	VE / SU	EAN
3076 2270 	6	4 004094 307676



Made in GERMANY



120 x 120 x 160 mm



#### Küchenwaage »Elegance«

- Wiegebereich: bis 5000 g
- Anzeige: 1 g / 0.01 oz / 0.001 lb / 1 ml
- Einheiten: g / oz / lb / ml
- Tara –Funktion (=Zuwiege-Funktion)
- Abschaltautomatik (nach 2 Minuten)
- Überladungsanzeige
- benötigt 2 x Knopfzellen CR2032 (im Lieferumfang enthalten)

#### Kitchen scales „Elegance“

- weighing range: up to 5000 g
- Display: 1 g / 0.01 oz / 0.001 lb / 1 ml
- units : g / oz / lb / ml
- tara function (= added weighing function)
- with automatic switch-off (after 2 minutes)
- overload display
- 2 x CR2032 button cells are required (included)



#### Balance de cuisine »Elegance«

- plage de pesée: jusqu'à 5000 g
- Affichage: 1 g / 0.01 oz / 0.001 lb / 1 ml
- unités: g / oz / lb / ml
- fonction de tare
- avec dispositif automatique de coupure
- affichage de surcharge
- nécessite 2 x piles de type bouton CR2032 (comprises dans la fourniture)

#### Balanza de cocina »Elegance«

- gama de pesaje: hasta 5000 g
- indicación: 1 g / 0.01 oz / 0.001 lb / 1 ml
- unidades: g / oz / lb / ml • función de tara (=función peso adicional)
- con desconexión automática (transcurridos 2 minutos)
- indicación de sobrecarga
- se necesitan 2 pilas de botón CR2032 (incluidas en el suministro)



Art-Nr. / Art.-No.	VE / SU	EAN
3033 2260 	4	 4 004094 303364

230 x 180 x 18 mm



Made in   
GERMANY





**Quirltopf ohne Deckel, 1 l**

- weiß
- mit dunkelrotem Gummiring im Boden

*Mixing bowl (without lid), 1 l*

- white
- with dark red non-slip ring in the bottom

**Pichet de mélange sans couvercle, 1 l**

- avec anneau caoutchouté rouge foncé dans le bas

*Bol para batir (sin tapa), 1 l*

- con anillo de goma de color rojo oscuro en la base



170 x 158 x 163 mm

Art-Nr. / Art.-No.	VE / SU	EAN
3150 227W	5	4 004094 315077



**Quirltopf mit zweigeteiltem Deckel, 1 l**

- der Rand dient als Spritzschutz - mit dem weißen Innenteil wird daraus ein vollständiger Deckel
- mit Ausgießer
- mit Gummiring im Boden

*Mixing bowl with two piece lid splatter guard, 1 l*

- dividable lid serves as splatter guard - and with the center seal as storage lid
- with pouring spout
- with non-slip ring at the bottom

**Pichet de mélange avec couvercle deux parties, 1 l**

- bordure sert de protection contre les éclaboussures
- avec verseur
- anneau caoutchouté dans le bas

*Bol para batir (con tapa dividida en dos partes), 1 l*

- el borde sirve de protección contra salpicaduras
- con vertedor
- con anillo de goma en la base



170 x 158 x 173 mm

Art-Nr. / Art.-No.	VE / SU	EAN
3151 227R	6	4 004094 315176
3151 227A	6	4 004094 000683



**Rührschüssel ohne Deckel**

- mit Ausgießer
- mit dunkelrotem Gummiring im Boden

*Mixing bowl without lid*

- with pouring spout
- with dark red non-slip ring at the bottom

**Bol de mélange sans couvercle**

- avec verseur
- avec anneau caoutchouté rouge foncé dans le fond

*Bol para mezclar sin tapa*

- con vertedor
- con anillo de goma de color rojo oscuro en la base



Art-Nr. / Art.-No.	VE / SU	Größe / Size	EAN
3152 227W	3	2,5 l / 253 x 238 x 125 mm	4 004094 315275
3154 227W	3	3,5 l / 285 x 278 x 125 mm	4 004094 315473



**Rührschüssel mit zweigeteiltem Deckel**

- der Rand dient als Spritzschutz - mit dem weißen Innenteil wird daraus ein vollständiger Deckel
- mit Ausgießer
- mit Gummiring im Boden

*Mixing bowl with two piece lid*

- dividable lid serves as splatter guard - and with the center seal as storage lid
- with pouring spout
- with non-slip ring at the bottom

**Bol de mélange avec couvercle deux parties**

- bordure sert de protection contre les éclaboussures
- avec verseur
- anneau caoutchouté dans le bas

*Bol para mezclar (con tapa dividida en dos partes)*

- el borde sirve de protección contra salpicaduras
- con vertedor
- con anillo de goma en la base



Art-Nr. / Art.-No.	VE / SU	Größe / Size	EAN
3153 227R	6	2,5 l / 245 x 225 x 142 mm	4 004094 315374
3153 227A	6	2,5 l / 245 x 225 x 142 mm	4 004094 000720
3155 227R	6	3,5 l / 280 x 270 x 145 mm	4 004094 315572
3155 227A	6	3,5 l / 280 x 270 x 145 mm	4 004094 000706



**Teigportionierer, 900 ml**

- ideal zum Dosieren von Rührteig für Muffins, CakePops, Donuts, Pfannkuchen und Co.
- Einhandbedienung durch Druckfunktion im Griff

**Portioner, 900 ml**

- ideal for measuring out the mixture for muffins, CakePops, doughnuts, pancakes & Co.
- one-hand-principle due to press function in the handle

**Diviseuse de pâte, 900 ml**



- idéal pour doser la pâte à muffins, CakePops, donuts, crêpes etc.
- utilisation à une main grâce au bouton dans le manche

**Porcionador de masa, 900 ml**

- ideal para dosificar masa de bizcocho para muffins, CakePops, donuts, crêpes y demás
- principio de una sola mano mediante función de presión en el asa



170 x 114 x 188 mm

Art-Nr. / Art.-No.	VE / SU	EAN
3012 2260 	4	 4 004094 301261

PS



**Rührbecher mit Deckel, »Helena«, 1,4 l**

- zweigeteilter Deckel und Ausgießer (Sieb-Funktion)
- Messkala in DE, GB, FR
- Maßeinteilung: ml, Liter, Gramm
- rutschfester Gummiring im Boden

**Bol de mélange avec couvercle »Helena«, 1,4 l**

- avec couvercle en deux parties et verseur (fonction passoire)
- graduations en DE, GB, FR: ml, litre, gramme
- anneau antidérapant dans le bas

**Mixing jug with lid, »Helena«, 1,4 l**







- two piece lid and pouring spout (strainer-function)
- scale in DE, GB, FR
- measures: ml, liter, pints for liquids and grams
- non-skid ring at the bottom

**Vaso para mezclar (con tapa) »Helena«, 1,4 l**

- con tapa dividida en dos partes y vertedor (función de tamiz)
- escala en DE, GB, FR
- graduación: ml, litro, gramos
- con anillo de goma en la base



195 x 150 x 148 mm

Art-Nr. / Art.-No.	VE / SU	EAN
3105 227R  	4	 4 004094 310577
3105 227A  	4	 4 004094 000409

PP



Made in GERMANY 

**Modelliererset, 8-tlg.**

- zum Verzieren und Dekorieren von Torten und Gebäck mit Fondant, Marzipan etc.
- zum Gestalten von Salzteig

**Ebauchoirs, set 8 pièces**

- pour embellir et décorer tarte set gâteaux avec du fondant, de la pâte d'amande etc.
- pour la conception de pâte à sel



**Modelling set, 8-pcs**

- for the adorning and decorating of cakes and pastries with fondant, marzipan etc.
- as well as for the modelling of salt dough

**Set para modelar de 8 piezas**

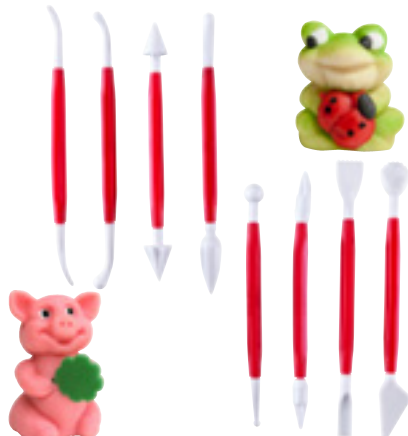
- para adornar y decorar tartas y pasteles con fondant, mazapán, etc.
- para configurar masa de sal



Art-Nr. / Art.-No.	VE / SU	Größe / Size	EAN
3036 2280 	4	140 - 160 mm	 4 004094 303685

PP





**Ausstechformen »Sonnenblume«, 3er Set**  
 • mit Auswerfer  
 • für das Formen von Sonnenblumen, Gerbera oder Gänseblümchen aus Fondant, Marzipan, Salzteig und Co.

*Biscuit cutters »Sonnenblume«, 3pc set*  
 • with ejector  
 • conjures up sunflowers, gerbera or dandelions of fondant, marzipan, salt dough and Co.

**Découpoir »Sonnenblume«, set 3 pièces**  
 • avec poussoir  
 • réalise de décorations de tournesol, gerbera ou pâquerettes fondant, pâte d'amande, pâte à sel etc.

*Cortapastas »Sonnenblume«, set 3 piezas*  
 • con expulsador  
 • haga girasoles, gerbera o margaritas de fondant, mazapán, masade sal y demás como por arte de magia

Art-Nr. / Art.-No.	VE / SU	EAN
3038 2280	4	4 004094 303883



6 x 5,5 cm / 6,5 x 5,0 cm / 7 x 5,5 cm

**Ausstechformen »Rosenblätter«, 3er Set**  
 • mit Auswerfer  
 • für das Formen von Rosenblättern aus Fondant, Marzipan, Salzteig und Co.

*Biscuit cutters »Rosenblätter«, 3pc set*  
 • with ejector  
 • conjures up rose leaves of fondant, marzipan, salt dough and Co.

**Découpoir »Rosenblätter«, set 3 pièces**  
 • avec poussoir  
 • réalise de magnifiques décorations de pétales de rose en fondant, pâte d'amande, pâte à sel etc.

*Cortapastas »Rosenblätter«, set 3 piezas*  
 • con expulsador  
 • haga pétalos de rosa de fondant, mazapán, masa de sal y demás como por arte de magia

Art-Nr. / Art.-No.	VE / SU	EAN
3040 2280	4	4 004094 304088



3,5 x 5,5 / 4 x 5 / 5 x 5



**Ausstechformen »Schmetterlinge«, 3er Set**  
 • mit Auswerfer  
 • für das Formen von Schmetterlingen aus Fondant, Marzipan, Salzteig und Co.

*Biscuit cutters »Schmetterlinge«, 3-pc set*  
 • with ejector  
 • conjures up butterflies of fondant, marzipan, salt dough and Co.

**Découpoir »Schmetterlinge«, set 3 pièces**  
 • avec poussoir  
 • réalise de décorations de papillons en fondant, pâte d'amande, pâte à sel etc.

*Cortapastas »Schmetterlinge«, set 3 piezas*  
 • con expulsador  
 • haga mariposas de fondant, mazapán, masa de sal y demás como por arte de magia

Art-Nr. / Art.-No.	VE / SU	EAN
3042 2280	4	4 004094 304286



6x5cm / 6,5x5,5cm / 7x5,5cm

**Ausstechformen »Blüte«, 4er Set**  
 • mit Auswerfer  
 • für das Formen von Blüten aus Fondant, Marzipan, Salzteig und Co.

*Biscuit cutters »Blüte«, 4-pc set*  
 • with ejector  
 • conjures up flowers of fondant, marzipan, salt dough and Co.

**Découpoir »Blüte«, set 4 pièces**  
 • avec poussoir  
 • réalise de magnifiques décorations de fleurs en fondant, pâte d'amande, pâte à sel etc.

*Cortapastas »Blüte«, set 4 piezas*  
 • con expulsador  
 • haga flores de fondant, mazapán, masa de sal y demás como por arte de magia

Art-Nr. / Art.-No.	VE / SU	EAN
3044 2280	4	4 004094 304484





148 x 25 x 25 mm

- Dekorierstift Silikon**
- für Dekorationen auf Gebäck, Torten oder Desserts
  - auch für Verzierungen auf Tellerrändern

*Silicone decorating pen*

- for decorations on biscuits, cakes or desserts
- also for adorning the edges of plates

- Stylo de décoration en silicone**
- pour réaliser de décorations sur les gâteaux, les tartes et les desserts
  - permet également de réaliser de décorations sur le rebord des assiettes

*Lápiz de silicona para decoración*

- para hacer decoraciones sobre galletas o pastas, tartas o postres
- también para refinados adornos en los bordes de los platos

Art-Nr. / Art.-No.	VE / SU	EAN
3111 2280	4	4 004094 311185

SI PP



53 x 53 x 116 mm

- 2er Set Dekorierflaschen**
- mit 4 Edelstahl-Tüllen
  - ideal zum Garnieren, Verzieren und Dekorieren von Kuchen, Torten und Gebäck

*2 Decorating bottles*

- with 4 stainless steel nozzles
- ideal for the garnishing, adorning and decorating of cakes, gateaux and pastries

- Ensemble de 2 flacons de décoration**
- avec 4 douilles en acier inoxydable
  - idéal pour fourrer, décorer et garnir facilement vos gâteaux, tartes et pâtisseries

*Set de 2 frascos decoradores*

- con 4 boquillas de acero inoxidable
- ideal para guarnecer, adornar y decorar pasteles, tartas, galletas y pastas



Art-Nr. / Art.-No.	VE / SU	EAN
3114 2260	4	4 004094 311468

PE PP INOX



- Geburts- und Partykerzen, Set**
- Set mit 24 Partykerzen und 12 Halterungen
  - Abmessung der Kerzen ca. 65 x 5 x 5 mm

*Birthday and party candles, set*

- set with 24 party candles and 12 holders
- dimensions of the candles: ca. 65 x 5 x 5mm

- Bougies d'anniversaire et de fête, set**
- ensemble de 24 bougies avec 12 bobèches
  - dimension des bougies env. 65 x 5 x 5 mm

*Velas para cumpleaños y guateques, set*

- set de 24 velas para guateque y 12 soportes
- dimensiones de las velas aprox. 65 x 5 x 5 mm



Art-Nr. / Art.-No.	VE / SU	EAN
5209 2280	12	4 004094 520983

74 x 15 x 15 mm



### Spritzbeutel Leinen, 7-tlg. Set

- bestehend aus Spritzbeutel, Adapter und 5 Tüllen
- Spritzbeutel aus beschichtetem Leinen in Konditorqualität - kochfest

### Icing bag linen, 7-pc set

- consists of icing bag, adapter and 5 nozzles
- icing bag from coated linen -boil proof

### Poche à douille, set 7 pièces

- se compose d'une poche à douille, un adaptateur et 5 douilles
- poche à douilles de lin revêtu en qualité pâtisserie - peut être bouillit

### Manga pastelera, set 7 piezas

- consta de una manga pastelera, un adaptador y 5 boquillas
- manga pastelera en calidad profesional de tejido de hilo con recubrimiento - resistente a la cocción

Art-Nr. / Art.-No.	VE / SU	Größe / Size	EAN
3086 2260 	5	28 cm	4 004094 308666



Made in GERMANY



310 x 105 x 105 mm

### Spritzbeutel

- Konditorqualität - beschichtete Baumwolle
- kochfest

### Icing bag



- Pastry chef quality - coated cotton
- boil proof

### Poche à douille

- qualité pâtisserie - coton revêtu
- peut être bouillit

### Manga pastelera

- en calidad profesional - algodón revestido
- resistente a la cocción

Art-Nr. / Art.-No.	VE / SU	Größe / Size	EAN
3096 2270 	6	30 cm	4 004094 309670
3097 2270 	6	35 cm	4 004094 309779
3098 2270 	6	40 cm	4 004094 309878



### Garnierset »Maxi Steel«, 7-tlg.

- bestehend aus Spritzbeutel, Adapter und 5 Tüllen
- Spritzbeutel aus beschichteter Baumwolle in Konditorqualität - kochfest

### Garnishing set »Maxi Steel«, 7-pcs.

- consists of icing bag, adapter and 5 nozzles
- icing bag from coated cotton in professional quality -boil proof

### Poche à douille »Maxi Steel«, set 7 pièces

- se compose d'une poche à douille, un adaptateur et 5 douilles
- poche à douilles de coton revêtu en qualité pâtisserie- peut être bouillit

### Manga pastelera »Maxi Steel«, set 7 piezas

- consta de una manga pastelera, un adaptador y 5 boquillas
- manga pastelera de algodón revestido en calidad profesional - resistente a la cocción

Art-Nr. / Art.-No.	VE / SU	Größe / Size	EAN
3099 2260 	4	40 cm	4 004094 309960



Stainless steel



480 x 150 x 150 mm

### Garnierset »Steel«, 8-tlg.

- bestehend aus Spritzbeutel, Adapter und 6 Tüllen
- Spritzbeutel aus beschichteter Baumwolle in Konditorqualität - kochfest

### Garnishing set »Steel«, 8-pcs.

- consists of icing bag, adapter and 6 nozzles
- icing bag from coated cotton in professional quality -boil proof

### Poche à douille »Steel«, 8 pièces

- se compose d'une poche à douille, un adaptateur et 6 douilles
- poche à douilles de coton revêtu en qualité pâtisserie- peut être bouillit

### Manga pastelera »Steel«, 8 piezas

- consta de una manga pastelera, un adaptador y 6 boquillas
- manga pastelera de algodón revestido en calidad profesional - resistente a la cocción

Art-Nr. / Art.-No.	VE / SU	Größe / Size	EAN
3100 2260 	4	30 cm	4 004094 310065



Stainless steel



250 x 115 x 115 mm

### Garnierset »Easy«, 15-tlg.

- 10 Einwegspritzbeutel und 5 Garniertüllen

### Poche à douille »Easy«

- 10 poches à douille perdues avec 5 douilles

### Garnishing set »Easy«, 15-pcs.

- 10 disposable icing bags with 5 nozzles

### Manga pastelera »Easy«

- 10 mangas de sentido único y 5 boquillas

Art-Nr. / Art.-No.	VE / SU	Größe / Size	EAN
3101 2260 	6	30 cm	4 004094 310164



250 x 120 x 120 mm



**Backformroller aus Buchenholz**

- konisch
- für runde Backformen

*Baking tin roller from beechwood*

- conical
- for circular baking tins

**Rouleau pour moule à pâtisserie en bois de hêtre**

- conique
- pour moules ronds

*Rodillo de molde de horno de madera de haya*

- cónico
- para moldes de horno redondos

3004 2270

3003 2270

**Backblechroller aus Buchenholz**

*Baking tray roller from beechwood*

**Rouleau pour plaque de cuisson en bois de hêtre**

*Rodillo de bandeja de horno de madera de haya*

Art-Nr. / Art.-No.	VE / SU	Größe / Size	EAN
3003 2270	4	180 x 84 x 53 mm	4 004094 300370
3004 2270	4	178 x 84 x 54 mm	4 004094 300479



**Backformwalze**

- konische Form - ideal für runde Backformen

*Cake tin roller*

- ideal for round tins due to the conical shape of the roller

**Roulette à pâtisserie**

- forme conique – idéale pour les moules à pâtisserie ronds

*Rodillo para moldes de horno*

- forma cónica – ideal para moldes de horno redondos



195 x 86 x 46 mm

Art-Nr. / Art.-No.	VE / SU	EAN
3140 2270	5	4 004094 314070



Made in GERMANY

**Stipproller**

- die ideale Hilfe, um den Teigboden mit Löchern zu versehen, vermeidet Blasenbildung beim Backen

*Dough docker*

- the ideal tool for putting holes in rolled-out dough, prevents bubble formation during baking

**Rouleau pique-pâte**

- idéal pour trouser la pâte, empêche la formation de cloques à la cuisson

*Agujereador de pasta*

- el accesorio ideal para hacer agujeros en la pasta, evita que se formen burbujas al hornearla

3217 2270



**Gitterroller**

- die ideale Hilfe, um schnell ein gleichmäßiges Gitter aus Teig zu formen z.B. für Linzer Torte, gedeckte Blechkuchen, Pasteten

*Decorative dough docker*

- the ideal tool for shaping a uniform dough pattern, e.g. for Linzer-Tortes, covered sheet cakes, pastries

**Rouleau à croisillons**

- idéal pour former rapidement un grillage régulier de pâte, ex. pour la tarte de Linz, les gâteaux sur plaque, les pâtés

*Rodillo para hacer rejilla en la pasta*

- el accesorio ideal para formar rápidamente una rejilla uniforme de pasta p. ej. para pastelería

3218 2270



**Teigstreifenschneider**

- mit 7 Rädchen, schneidet gleichförmige Streifen aus Teig, ideal für Verziermassen wie Fondant, etc.

*Dough-strip cutter*

- with 7 little wheels, cuts uniform strips from dough, also ideal for decorative foods such as fondant or marzipan

**Découpe-pâte**

- à 7 roulettes, coupe des lamelles régulières de pâtes, idéal aussi pour les masses de décoration comme le fondant ou la frangipane

*Cortador de tiras de pasta*

- con 7 ruedecillas, corta tiras uniformes de pastas, idóneo también para masa tipo fondant o mazapán

3219 2270



Art-Nr. / Art.-No.	VE / SU	Größe / Size	EAN
3217 2270	4	200 x 125 x 55 mm	4 004094 321771
3218 2270	4	195 x 125 x 45 mm	4 004094 321870
3219 2270	4	195 x 125 x 45 mm	4 004094 321979









### Spekulatiuswalze

- einmal Ausrollen und 7 unterschiedliche Motive erscheinen im Teig
- Tipp: der Griff hat oben eine Verlängerung, um die korrekte Teigdicke zu bestimmen

### Cooky roller

- simply roll and 7 different Christmas cookie shapes appear in the dough
- tip: the handle holds a device to determine the right thickness of the dough

Art-Nr. / Art.-No.	VE / SU	EAN
3216 2270 	5	 4 004094 321672
3216 2611 	1	 4 051734 006734

PP ABS

 Made in GERMANY



172 x 140 x 54 mm

### Teigrolle aus Buchenholz

- mit Leichtlauf-Gleitlager

### Rouleau à pâtisserie en bois de hêtre



- avec roulement à billes de précision

### Rolling pin from beechwood

- with easy-running sleeve bearing

### Rodillo de amasar de madera de haya

- con cojinete de deslizamiento de rodadura fácil

Art-Nr. / Art.-No.	VE / SU	EAN
3001 2270 	4	 4 004094 300172

 Made in EUROPE



460 x 64 x 64 mm

### Teig-Ausrollmatte

- mit Antihaft-Effekt
- unterschiedliche Kreis-Reliefs helfen passgenaue Kuchenböden auszurollen
- mit Maßeinheiten (cm & inch)

### Tapis pour abaisser la pâte



- avec effet anti-adhésif
- différents reliefs circulaires aident à abaisser la pâte avec précision
- avec unités de mesure (cm & pouce)

### Dough rolling-out mat

- with non-stick effect
- different circles in relief aid in rolling out cake bases to the exact size required
- with dimension scales (cm & inch)

### Esterilla para extender la masa

- con efecto antiadherente
- los diversos relieves de circunferencias ayudan a extender con el rodillo bases para pasteles de medida exacta
- con unidades de medidas (cm y pulgadas)

Art-Nr. / Art.-No.	VE / SU	EAN
3018 2260 	3	 4 004094 301865

SI 



615 x 420 x 1 mm

### Teigrad »Gentle«

- mit 36 mm ø gewelltem Rädchen
- sehr stabiles Funktionselement aus rostfreiem Edelstahl
- Komfort-Soft-Touch-Griff

### Roulette à pâte »Gentle«



- avec roulette ondulée de 36 mm ø
- très solide partie fonctionnelle d'acier inox
- poignée confort-soft-touch

### Pastry wheel »Gentle«

- with 36 mm ø wavy-edge-wheel
- very strong functional part from stainless steel
- comfort-soft-touch handle

### Rueda para pastas »Gentle«

- ruedecilla ondulada de 36 mm ø
- con parte funcional en acero inox muy stable
- mango cómodo soft-touch

Art-Nr. / Art.-No.	VE / SU	EAN
2832 2270 	6	 4 004094 283277

PP INOX  Made in GERMANY



176 x 36 x 20 mm

### Teigrad »Gallant«

- mit 39 mm ø gewelltem Rädchen
- sehr stabiles Funktionselement aus rostfreiem Edelstahl
- Komfort-Soft-Touch-Griff

### Roulette à pâte »Gallant«



- avec roulette ondulée de 39 mm ø
- très solide partie fonctionnelle d'acier inox
- poignée confort-soft-touch

### Pastry wheel »Gallant«

- with 39 mm ø wavy-edge-wheel
- very strong functional part from stainless steel
- comfort-soft-touch handle

### Rueda para pastas »Gallant«

- ruedecilla ondulada de 39 mm ø
- con parte funcional en acero inox muy stable
- mango cómodo soft-touch

Art-Nr. / Art.-No.	VE / SU	EAN
2932 2270 	6	 4 004094 293276

PP TPE INOX  Made in GERMANY



180 x 40 x 20 mm

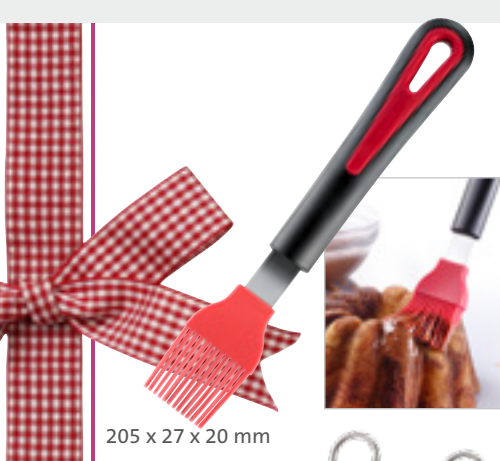



205 x 27 x 20 mm

- Brat-/Backpinsel »Gallant«**
- aus pflegeleichtem Silikon
  - sehr hygienisch
  - Komfort-Soft-Touch-Griff

- Basting-/baking brush »Gallant«**
- from easy-care silicone
  - very hygienic
  - comfort-soft-touch handle

- Pinceau à badigeonner et à pâtisserie »Gallant«**
- en silicone facile à nettoyer
  - très hygiénique
  - poignée confort-soft-touch

- Pincel para asado y horneado »Gallant«**
- de silicona de fácil cuidado
  - muy higiénico
  - con mango cómodo soft-touch

Art-Nr. / Art.-No.	VE / SU	EAN
2916 2270 	6	4 004094 291678 









- Brat- und Backpinsel »Silicone«**
- hygienisch & pflegeleicht
  - einzeln auf Karte oder zu 20 Stück in Messkanne

- Basting- and pastry brush »Silicone«**
- hygienic & easy to clean
  - single on sales card or 20 pcs in a jug

- Pinceau à badigeonner et à pâtisserie »Silicone«**
- hygiénique & facile à nettoyer
  - seul sur carte de vente ou 20 pcs en bol

- Pincel para asado y horneado »Silicone«**
- higiénico & fácil a limpiar
  - individualmente o como 20 piezas en bol

Art-Nr. / Art.-No.	VE / SU	Größe / Size	EAN
1543 2270 	10	200 x 34 x 14 mm	4 004094 154379 
1544 2270 	10	220 x 45 x 14 mm	4 004094 154478 
1544 2610 	1	220 x 45 x 14 mm	4 051734 009483 







- Kuchenpinsel »Natur Pur«, 1' + 1,5'**
- der Klassiker mit Holzgriff aus Birke

- Pastry brush »Natur Pur«, 1' + 1,5'**
- the classic with wooden handle

- Pinceau à pâtisserie »Natur Pur«, 1' + 1,5'**
- le classique avec manche en bois

- Espátula »Natur Pur«, 1' + 1,5'**
- el clásico con mango de madera

Art-Nr. / Art.-No.	VE / SU	Größe / Size	EAN
3220 2270 	10	1' / 185 x 26 x 9 mm	4 004094 322075 
3222 2270 	10	1,5' / 195 x 39 x 9 mm	4 004094 322273 















- Brat-/Backpinsel »Silicone«**
- fusselfrei und hygienisch
  - aus pflegeleichtem Silikon

- Basting- and pastry brush »Silicone«**
- lint-free and hygienic
  - from easy-care silicone

- Pinceau à badigeonner et à pâtisserie »Silicone«**
- sans peluche et hygiéniques
  - en silicone facile à nettoyer

- Pincel para asado y horneado »Silicone«**
- carece de hilachas y higiénico
  - de silicona de fácil cuidado



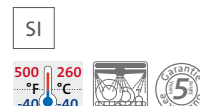

Art-Nr. / Art.-No.	VE / SU	EAN
1556 227B  	6	4 004094 155673 
1556 227G  	6	4 004094 002571 
1556 227P  	6	4 004094 002588 
1556 227Y  	6	4 004094 002564 



260 x 46 x 16 mm



- Schaber- und Kuchengarnierer-Set**
- Set bestehend aus handlichem Teigschaber & Kuchengarnierer mit zwei unterschiedlichen Zahnungen
  - Teigschaber auch einzeln, lose erhältlich (3852)
- Scraper and garnish comb*
- set consisting of handy dough scraper & dough garnisher with two different denting structures
  - dough scraper also available individually, bulk (3852)

Art-Nr. / Art.-No.	VE / SU	EAN
3085 2270 	10	4 004094 308574
3852 2211 	10	4 004094 385216

PP



Made in GERMANY

- Ensemble raclette à pâte et peigne de glaçage**
- ensemble se composant d'une raclette à pâte maniable & d'un peigne de glaçage à deux dentitions différentes
  - raclette à pâte aussi disponible en individuel, en vrac (3852)

- Set de rasquetas y adornador de cocina*
- set compuesto de la manejable rasqueta para masa y adornador de pasteles con dos dentados distintos
  - rasqueta para masa también disponible suelta (3852)



3085 2270

3852 2211

- Schaber/Kuchenlöser**
- einsetzbar als Schaber und Kuchenlöser für beschichtete Backformen
  - schmales - messerähnliches - Design hilft, den Kuchen aus der Form zu lösen

- Scraper/cake loosener*
- spatula serves as scraper and cake loosener
  - ideal for non-stick cake tins
  - the narrow shape enables easy loosening of the cake from the mould frame

- Racleur/détacheur à gâteau**
- utilisable comme racleur/détacheur à gâteau
  - idéal pour les moules anti-adhésifs
  - le design effilé permet de détacher facilement le gâteau du moule

- Rasqueta/desprendedor de pasteles*
- utilizable como rasqueta y desprendedor
  - ideal para moldes para hornear
  - el diseño estrecho – es ideal para desprender el pastel del molde



Art-Nr. / Art.-No.	VE / SU	EAN
3084 2270 	10	4 004094 308475

PP



Made in GERMANY



220 x 35 x 6 mm

- Koch- und Teigschaber »Silicone«**
- aus pflegeleichtem Silikon
  - für den gewohnten Einsatz beim Backen - aber auch beim Kochen zu verwenden

- Dough- and cooking scraper »Silicone«*
- from easy-care silicone
  - for normal use when baking - but also suitable for being used while cooking

- Spatule de cuisine et à pâte »Silicone«**
- en silicone facile à nettoyer
  - pour une utilisation normale lors de la cuisson mais également pour la cuisine

- Rasqueta desprendedora para guisar y masa »Silicone«*
- de silicona fácil de cuidar
  - para el uso corriente al hornear – pero también al guisar

Art-Nr. / Art.-No.	VE / SU	Größe / Size	EAN
1546 2270 	10	285 x 60 x 11 mm	4 004094 154676
1547 2270 	10	227 x 34 x 11 mm	4 004094 154775

SI INOX

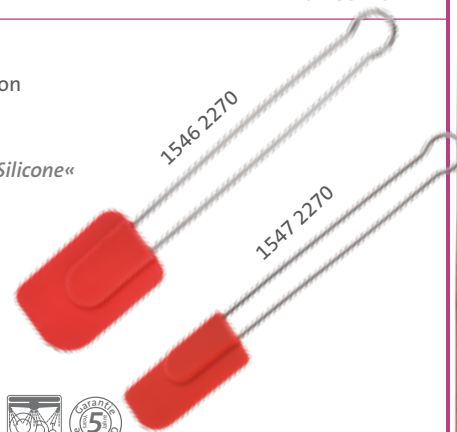

1546 2270

1547 2270

- Teigschaber »Natur Pur«**
- der Klassiker mit Holzgriff
  - langer Stiel aus Buche
  - Naturkautschuklaffe

- Dough scraper »Natur Pur«*
- the classic one
  - long beech wood handle
  - blade natural rubber

- Spatule à pâte »Natur Pur«**
- le classique avec manche en bois
  - manche extra long
  - embout en caoutchouc naturel

- Rasqueta para masa »Natur Pur«*
- la clásica con mango de madera
  - mango muy largo
  - cabeza de caucho natural

Art-Nr. / Art.-No.	VE / SU	EAN
3083 2270 	6	4 004094 308376







274 x 53 x 10 mm

- Koch-/Teigschaber »Silicone«**
- für den gewohnten Einsatz beim Backen - aber auch beim Kochen zu verwenden

- Dough- and cooking scraper »Silicone«*
- for normal use when baking - but also for being used while cooking

- Spatule de cuisine et à pâte »Silicone«**
- pour une utilisation normale lors de la cuisson mais également pour la cuisine

- Rasqueta desprendedora para guisar y masa »Silicone«*
- para el uso corriente al hornear – pero también al guisar

Art-Nr. / Art.-No.	VE / SU	EAN
1554 227B 	6	4 004094 155475
1554 227G 	6	4 004094 002632
1554 227P 	6	4 004094 002649
1554 227Y 	6	4 004094 002625

SI



277 x 54 x 16 mm



#### Rührlöffel »Natur Pur«

- hochwertige Buchenholzlöffel in unterschiedlichen Längen
- verfügbar als 3er Set (1382 2270) auf Karte oder lose als Einzelartikel

#### Mixing spoons »Natur Pur«

- high quality beech wood spoons in different sizes
- available as set of 3 on sales card (1382 2270) or bulk as single items





#### Spatule »Natur Pur«

- choix de cuillères en hêtre de différentes longueurs
- disponible en ensemble de 3 pièces sur carte de vente (1382 2270) ou au détail en vrac

#### Espátula »Natur Pur«

- selección de cucharas de madera de haya de diferentes longitudes
- disponible como set de 3 piezas (1382 2270) o como artículo individual



Art-Nr. / Art.-No.	VE / SU	Größe / Size	EAN
1382 2270 	6	25 / 28 / 35 cm	 4 004094 138270
1383 2210 	20	250 x 43 x 9 mm	
1384 2210 	20	280 x 47 x 11 mm	
1385 2210 	20	350 x 53 x 13 mm	



#### Holz Rührlöffel-Set »Natur Pur«, 2-tlg.

- Rührlöffel und Spitzlochlöffel
- zum Kochen und Backen

#### Jeu de 2 cuillères à mélange en bois »Natur Pur«



- cuillère à mélange et cuillère pointue trouée
- pour la cuisine et la pâtisserie

#### Wooden mixing-spoon set, 2 pcs. »Natur Pur«

- mixing spoon and pointed spoon with hole
- for cooking and baking

#### Set de cucharas de madera, 2 piezas »Natur Pur«

- cuchara para remover y cuchara con agujero
- para asar y cocer

Art-Nr. / Art.-No.	VE / SU	Größe / Size	EAN
1392 2270 	6	28 / 30 cm	 4 004094 139277
1387 2210 	20	300 x 50 x 12 mm	



#### Waffelbäckerei mit 3 Motiven

- zum einfachen Zubereiten von Rosettenwaffeln
- mit Rezeptheft und bebildeter Anwendungsbeschreibung
- Formengröße: 7 - 9 cm

#### Moules à gaufres avec 3 motifs

- pour la préparation de rosettes de gaufres
- avec livre de recettes et description d'utilisation détaillée
- taille des moules: 7 - 9 cm

#### Waffle moulds with 3 different designs

- for easy preparation of deep-fried rosettes (Northern European cookies sprinkled with sugar)
- with recipe booklet and illustrated how-to-use description
- each form is approx: 7 - 9 cm

#### Moldes para gofres con 3 motivos

- para preparar fácilmente gofres en forma de rosetón
- con cuaderno de recetas y descripción gráfica del uso
- tamaño de moldes: 7 - 9 cm



Art-Nr. / Art.-No.	VE / SU	EAN
3224 2260 	5	 4 004094 322464

ST





### Handquirl »Quickstep«

- Handquirl mit Rotationsmechanik
- für die Zubereitung von Sahne, Eischnee, zum Aufschäumen von Milch etc.

### Handheld »Quickstep«

- hand held whisk with rotating mechanism
- for the preparation of cream, egg whites and for frothing milk

### Fouet à main »Quickstep«



- fouet à main avec le mécanisme de rotation
- pour la préparation de crème, de blanc en neige ou pour faire mousser du lait

### Molinillo de mano »Quickstep«

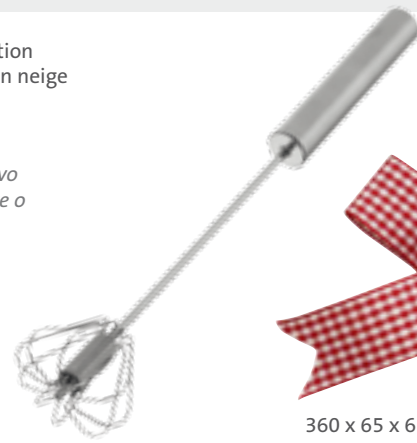
- molinillo de mano con mecanismo rotativo
- para preparar nata, clara a punto de nieve o para espumar leche



360 x 65 x 65 mm

Art-Nr. / Art.-No.	VE / SU	EAN
1249 2260 	3	 4 004094 124969



### Eidottertrenner

- gebogen - sitzt fest auf Tassen und Schälchen
- mit Aufschlaghilfe

### Egg separator

- bent - sits securely on cups and small bowls
- with egg-break-help

### Séparateur de jaune d'oeuf



- courbé – maintient fixe sur les tasses et les petits bols
- avec casse-oeuf

### Separador de yemas de huevos

- bella curvatura – se asienta fijamente sobre tazas y bols
- con útil para cascar



167 x 70 x 28 mm

Art-Nr. / Art.-No.	VE / SU	EAN
1086 2260 	6	 4 004094 108662



### Streichpalette

- universeller Helfer zum Verteilen von Creme, Sahne, Glasur und Zuckerguss auf Torten und Kuchen
- mit Maßeinheit (18 cm)

### Spatula

- universal aid for spreading butter cream, whipped cream, icing and glacé icing on gateaux and cakes
- with measure (18 cm)

### Spatule

- ustensile universel pour étaler la crème, une couche de sucre ou un glaçage sur les tartes et les gâteaux
- avec mensuration (18 cm)

### Espátula extendedora

- yudante universal para extender crema, nata, cobertura y glaseado sobre tartas y pasteles
- con medida (18 cm)



387 x 35 x 19 mm

Art-Nr. / Art.-No.	VE / SU	EAN
3006 2270 	4	 4 004094 300677



### Winkelpalette

- zum Verstreichen von Creme, Sahne, Glasur etc. auf Torten und Gebäck
- auch geeignet zum Heben und Zerteilen von Böden
- mit Maßeinheit (18 cm)

### Angled spatula

- for spreading of butter cream, whipped cream etc. on gateaux and pastries
- also for lifting and dividing flan cases/bases
- with measure (18 cm)

### Spatule coudée

- pour étaler crème, glaçage etc. sur les gâteaux et les pâtisseries
- également pour lever et couper en plusieurs parties
- avec mensuration (18 cm)

### Espátula acodada

- para extender crema, nata, cobertura y glaseadosobre tartas, galletas etc.
- también se apropia para levantar y partir bases de masa
- con medida (18 cm)



387 x 35 x 33 mm

Art-Nr. / Art.-No.	VE / SU	EAN
3007 2270 	4	 4 004094 300776





**Garnierspritze, 100 ml**  
 • mit Kunststoffkolben  
 • mit 5 Tüllen

**Seringue de glaçage, 100 ml**  
 • avec piston en plastique  
 • avec 5 douilles

*Icing syringe, 100 ml*  
 • with plastic piston  
 • with 5 nozzles

*Jeringa para decorar, 100 ml*  
 • con émbolo de plástico  
 • con 5 boquillas



Art-Nr. / Art.-No.	VE / SU	EAN
3077 2270 	5	 4 004094 307775

PS PE PP



Made in  GERMANY

165 x 87 x 43 mm

**Mix- und Garniergerät, 280 ml**  
 • nicht nur zum Dekorieren, auch zum Mixen  
 • mit Standfuß für die Mixfunktion  
 • mit Kunststoffkolben  
 • mit 6 Tüllen

**Seringue de mélange et de glaçage, 280 ml**  
 • pour glacer mais également pour mélanger  
 • avec pied de maintien pour la fonction mélange  
 • avec piston en plastique  
 • avec 6 douilles

*Mix- and icing set, 280 ml*  
 • not only for icing - but also for mixing  
 • with firm base for mixing purposes  
 • with plastic piston  
 • with 6 nozzles

*Jeringa para mezclar y adornar, 280 ml*  
 • no solo para adornar sino también para mezclar  
 • con pata estándar para función de mezcla  
 • con émbolo de plástico  
 • con 6 boquillas



Art-Nr. / Art.-No.	VE / SU	EAN
3238 2260 	5	 4 004094 323867

PS PP SAN



Made in  GERMANY

222 x 60 x 60 mm

**Garnierkünstler, 180 ml**  
 • mit Edelstahl-Kolben  
 • ideal auch für festere Cremes  
 • mit 5 Tüllen

**Seringue de décoration, 180 ml**  
 • piston en acier inoxydable  
 • également pour des crèmes plus fermes  
 • avec 5 douilles

*Decorating artist, 180 ml*  
 • with stainless steel piston  
 • suitable also for stiffer icings  
 • with 5 nozzles

*Artista del adorno, 180 ml*  
 • con émbolo de acero inoxidable  
 • ideal para elaborar también cremas más espesas  
 • con 5 boquillas



Art-Nr. / Art.-No.	VE / SU	EAN
3115 2260 	5	 4 004094 311567

SAN PP INOX



Made in  GERMANY

190 x 55 x 55 mm



- Garnier- und Krappenspritze, 180 ml**
- mit Edelstahl Kolben für festere Cremes
  - bequeme Einhandbedienung - gleichmäßiges Garnieren per Knopfdruck
  - mit 5 verschiedenen Formtüllen

- Garnishing- and doughnut filling-syringe, 180 ml**
- with stainless steel piston for stiffer icings
  - convenient thumb-push-button system
  - with 5 different nozzles



- Seringue de décoration, 180 ml**
- avec piston en acier inox pour des crèmes plus fermes
  - utilisation facile d'une main – décoration uniforme en appuyant sur le bouton
  - avec 5 douilles
- Jeringa para adornar y decorar buñuelos, 180 ml**
- con émbolo de acero inox para cremas más espesas
  - gracias al manejo con una sola mano se consigue un adornado uniforme apretando un botón
  - con 5 boquillas



Art-Nr. / Art.-No.	VE / SU	EAN
3116 2260 	5	 4 004094 311666

PE PP PS SAN



220 x 97 x 53 mm

**Gebäckpresse und Dekorierspritze**

- »Luxus«, 225 ml**
- toll für gemeinsames Backen mit Kindern
  - ein Hebeldruck = ein Plätzchen
  - mit 6 Formscheiben, 6 Deko-Tüllen und 1 Adapter

**Cookie press and icing syringe**

- »Luxus«, 225 ml**
- super for baking with kids
  - one press action = one cookie
  - with 6 shape discs, 6 nozzles and 1 adapter



**Presse à biscuits et seringue de décoration**

- »Luxus«, 225 ml**
- super pour faire des biscuits avec les enfants
  - une pression = un biscuit
  - avec 6 disques, 6 douilles de décoration et 1 adaptateur

**Prensa para pasteles y jeringa para adornar**

- »Luxus«, 225 ml**
- magnífica para hornear con niños
  - apretar una vez = una galletita
  - con 6 discos moldeadores, 6 boquillas para adornar y 1 adaptador



Art-Nr. / Art.-No.	VE / SU	EAN
3230 2260 	5	 4 004094 323065

ABS PP POM



150 x 58 x 208 mm

**Gebäckpresse und Garnierspritze, 250 ml**

- mit 8 Formscheiben, 8 Dekorations-Tüllen aus Edelstahl sowie 1 Adapter
- für die Zubereitung von Churros geeignet
- mit Rezepten

**Cookie press and piping gun, 250 ml**

- with 8 stainless steel cutter templates and 8 piping nozzles as well as 1 adapter
- suitable for preparing Churros
- recipes included



**Presse à gâteaux et seringue de garniture, 250 ml**

- avec 8 moules et 8 embouts de décoration en inox ainsi qu'un adaptateur
- con vient pour la préparation des Churros
- avec des recettes

**Pistola pastelera e inyección para guarnecer, 250 ml**

- con 8 discos demoldeado y 8 boquillas para decoración de acero fino así como con un adaptador
- apropiado para la preparación de churros!
- con recetas



Art-Nr. / Art.-No.	VE / SU	EAN
3233 2260 	4	 4 004094 323362

INOX ABS PP



217 x 58 x 145 mm



60 x 60 x 62 mm

#### CupCake-Aushöler

- zum praktischen Aushöhlen von CupCakes, Muffins und Küchlein für das anschließende Befüllen mit Crèmes, Kirschen etc.

#### CupCake corer

- the practical way of making a hole in CupCakes, muffins and small cakes prior to filling with cream, cherries etc.

#### Evidoir à CupCake

- pour évider de façon pratique CupCakes, muffins et petits gâteaux pour les fourrer ensuite de crèmes, de cerises etc.

#### Ahuecador de CupCakes

- para el ahuecador práctico de CupCakes, muffins y pastelitos para ser rellenos después con cremas, cerezas, etc.

Art-Nr. / Art.-No.	VE / SU	EAN
3013 2270	4	4 004094 301377

PP



#### 2 Dauerbackfolien

- individuell zuschneidbar
- wiederverwendbar
- Antihaft-Effekt - kein zusätzliches Einfetten
- leicht zu reinigen

#### 2 Long-life baking films

- can be cut to individual size
- can be used again and again
- with non-stick effect
- easy to clean

#### 2 rouleaux de papier de cuisson réutilisable

- à découper selon les besoins
- réutilisable
- anti-adhésif
- facile à nettoyer

#### 2 folios reutilizables para horneado

- para cortar a la medida individualmente
- reutilizable
- efecto antiadherente - no hace falta engrasarlo adicionalmente
- fácil de limpiar

400 x 500 x 1 mm

Art-Nr. / Art.-No.	VE / SU	EAN
3019 2260	4	4 004094 301964



#### Tortenbodenteiler »Simplex« & »Simplex-Duo«

- Besonderheit: gezackter Schneiddraht
- einfache Höhenverstellung

#### Coupe-gâteau à fil »Simplex« & »Simplex-Duo«

- particularité: fil de coupe dentelé
- réglage simple de la hauteur

#### Horizontal cake cutter »Simplex« & »Simplex-Duo«

- speciality: serrated wire
- easy height adjustment

#### Cortador horizontal para pasteles

- »Simplex« & »Simplex-Duo«
- particularidad: alambre de corte dentado
- regulación sencilla en altura



7120 2270 »Simplex«

7160 2270 »Simplex-Duo«

Art-Nr. / Art.-No.	VE / SU	Größe / Size	EAN
7120 2270	5	320 x 135 x 5 mm	4 004094 712074
7160 2270	5	320 x 135 x 5 mm	4 004094 716072

INOX



#### Kuchenschneider und -heber

- ideal für das Schneiden auf beschichteten Backböden
- die breite Messerform erlaubt das einfache Herausheben und Servieren von Backwaren

#### Couteau à gâteau et pelle-à tarte

- idéal pour couper sur les plaques de cuisson revêtues
- la large forme du couteau permet de retirer facilement les pâtisseries et de les servir

#### Cake cutter and lifter

- ideal for gentle cutting on coated baking trays,
- the wide shape of the blade makes the lifting up and serving of cake etc. an easy matter

#### Cortador y paleta para tartas

- ideal para cortar sobre bases de varias bandejas de horno
- la forma ancha del cortador permite levantar y servir fácilmente los productos de horneado



290 x 59 x 12 mm

Art-Nr. / Art.-No.	VE / SU	EAN
3031 2270	6	4 004094 303173

PP





- Puderzuckerstreuer**
- mit Frischhaltedeckel
  - der dicht schließende Frischhaltedeckel schützt vor Feuchtigkeit und Aromaverlust



- Powdered sugar sifter**
- mit Frischhaltedeckel
  - der dicht schließende Frischhaltedeckel schützt vor Feuchtigkeit und Aromaverlust

- Saupoudreuse à sucre glace**
- avec couvercle hermétique
  - le couvercle hermétique évite l'humidité et la perte d'arôme

- Azucarero de azúcar en polvo**
- con tapa con cierre hermético
  - la tapa con cierre hermético protege contra la humedad y pérdida de aroma



62 x 62 x 82 mm

Art-Nr. / Art.-No.	VE / SU	EAN
6950 2260 	4	 4 004094 695063



- Mehl- und Puderzuckersieb**
- klassisches Siebprinzip
  - Einhandbedienung durch Druckfunktion im Griff



- Flour- and icing sifter**
- classic sifter
  - one-hand-principle due to press function in the handle stainless steel

- Tamis à farine et sucre en poudre**
- principe classique du tamis
  - utilisation à une main grâce au bouton dans le manche

- Tamiz para harina y azúcar en polvo**
- principio clásico de tamizado
  - principio de una sola mano mediante función de presión en el asa



157 x 104 x 95 mm

Art-Nr. / Art.-No.	VE / SU	EAN
3215 2270 	6	 4 004094 321573



- Mehl- und Puderzuckersieb**
- praktisches Einhandprinzip durch Druckfunktion im Griff



- Flour- and icing sifter**
- practical one-hand principle due to press function in the handle

- Tamis à farine et sucre en poudre**
- utilisation à une main grâce au bouton dans le manche

- Tamiz para harina y azúcar en polvo**
- principio de una sola mano mediante función de presión en el asa



156 x 108 x 110 mm

Art-Nr. / Art.-No.	VE / SU	EAN
3214 2270 	4	 4 004094 321474





365 x 282 x 3 mm

### Kuchen- und Tortenheber

- mit abgeschrägtem Rand zum einfachen Lösen der Kuchen vom Backblech
- Funktion auch als Verzier Schablone

### Cake- and gateaux lifter



- with slanted edge for easy loosening of freshly baked cakes and gateaux
- also suitable for icing and decorating

### Lève gâteaux et tartes

- à bord incliné pour détacher facilement le gâteau de la plaque de cuisson
- s'utilise également pour glacer et décorer

### Paleta para pasteles y tartas

- con borde sesgado para separar más fácilmente los pasteles de la bandeja
- función también como patrón adornador

Art-Nr. / Art.-No.	VE / SU	EAN
3141 2270 	10	 4 004094 314179

PS



Made in GERMANY 

### Kuchenkühler und Torteneinteiler

- Doppelfunktion
- Kuchengitter: zum Auskühlen von frisch gebackenen Kuchen und Torten
- Torteneinteiler: als ‚Schnittmuster‘ zum gleichmäßigen Einteilen des Kuchens in 16 gleich große Stücke

### Cake cooling rack and gateaux portioner

- double function: cooling rack: for cooling down freshly baked cakes and gateaux
- portioner: as gateaux portioner for creating 16 equal pieces

### Refroidisseur et diviseur à gâteau

- double fonction: grille à gâteau: pour refroidir les gâteaux et les tartes
- diviseur à gâteau: comme diviseur pour créer 16 parts égales

### Enfriador de pasteles y partidor de tartas

- doble función: rejilla para pasteles: para enfriar pasteles y tartas recién hechas
- partidor de tartas: como ‚patrón‘ para partir el pastel en 16 partes iguales

Art-Nr. / Art.-No.	VE / SU	EAN
3143 2270 	10	 4 004094 314377

PS



Made in GERMANY 

### Kuchenauskühler

- sehr stabil, verformt sich nicht
- zum Auskühlen von Kuchen, Gebäck etc.
- verchromt

### Cake/gateaux cooler



- very rigid, does not get distorted
- for allowing gateaux, cakes etc. to cool down
- chromed

### Grille avec pieds

- qualité éprouvée, très stable, ne se déforme pas
- pour refroidir les gâteaux, les pâtisseries etc.
- chromé

### Enfriador para pasteles

- calidad fiable, muy estable, no se deforma
- para enfriar pasteles, galletas y pastas, etc.
- cromado

Art-Nr. / Art.-No.	VE / SU	EAN
3144 2270 	6	 4 004094 314476

ST



### Stollen- und Kuchenplatte

- sieht aus wie Glas
- bruch-unempfindlich
- zum Servieren von Kasten Kuchen, Gebäck, Snacks und Stollen

### Stollen- and cake plate

- looks like glass
- break resistant
- for serving Christmas stollen, square cake, pastry and snacks

### Plat à Stollen et à gâteau

- ressemble au verre
- moins cassable
- pour servir des cakes, des pâtisseries, des snacks et des Stollen

### Bandeja para pastel navideño y pasteles

- parecerse de cristal
- pero es menos sensible a la ruptura
- para servir pasteles de molde, galletas, snacks y pastel navideño

Art-Nr. / Art.-No.	VE / SU	EAN
3440 2211 	10	 4 004094 344015

PS



Made in GERMANY 

### Tortenplatte

- sieht aus wie Glas
- bruch-unempfindlich
- glatte Form zum Servieren von Kuchen, Torten, Gebäck, Aufschnitt und Snacks

### Cakeplate

- looks like glass
- break resistant
- flat shape for serving cake, gateaux, cold cuts and snacks

### Plat à gâteau

- ressemble au verre
- moins cassable
- forme lisse pour servir des gâteaux, des tartes, des pâtisseries, de la charcuterie en tranches etc.

### Plato para tartas

- parecerse de cristal
- pero es menos sensible a la ruptura
- forma lisa para servir pasteles, tartas, galletas, fiambres y snacks

Art-Nr. / Art.-No.	VE / SU	EAN
3455 2211 	10	 4 004094 345517

PS



Made in GERMANY 



315 x 315 x 17 mm



### Nussmühle

- Grob- oder Feinkörnung durch Rechts- oder Linksdrehung der Kurbel
- robustes Mahlwerk aus Edelstahl
- rutschfester Fuß

### Nut chopper

- coarse and fine grating achieved by left- or right turning of the handle
- very solid grinding unit from stainless steel
- non-slip bottom

### Moulin à noix

- noix finement ou grossièrement moulues en tournant la manivelle à droite ou à gauche
- broyeur robuste en acier inoxydable
- pied antidérapant

### Molino de nueces

- granulación gruesa o fina según giro a la derecha o izquierda de la manivela
- mecanismo de molienda robusto de acero inoxidable
- pata antiresbalante



142 x 85 x 205 mm

Art-Nr. / Art.-No.	VE / SU	EAN
9770 2270	3	4 004094 977077



### Mohnmühle

- mit stufenlos einstellbarem Mahlgrad
- ideal für ölhaltiges Mahlgut wie Mohn und Leinsamen
- auch für andere Getreidesorten
- mit Schraubzwinge

### Poppy seed mill

- with infinitely variable coarseness setting
- ideal for oil-containing grains such as poppy and flaxseed
- also suitable for other grains
- with screw clamp

### Moulin à pavot

- mouture réglable
- idéal pour les graines contenant de l'huile telles que de pavot et de lin
- aussi pour d'autres sortes de céréales
- avec serre-joint

### Molino de adormidera

- con grado de molienda ajustable
- ideal para granos con aceite, como semillas de adormidera o de lino
- también para otras clases de cereales
- con gato



210 x 185 x 55 mm

Art-Nr. / Art.-No.	VE / SU	EAN
1179 2260	4	4 004094 117961



### Mandelmühle

- zum Feinreiben von Mandeln, Nüssen, Schokolade, Hartkäse etc.
- Schneidtrommel aus Edelstahl
- starker Saugfuß
- mit Füllstößel für sicheres Arbeiten

### Almond grater

- for fine grating of almonds, nuts, chocolate, hard cheese etc.
- stainless steel cutting drum
- strong suction pad
- red food pusher for safe working

### Moulin à amandes

- pour râper finement les amandes, les noix, le chocolat, le fromage dur etc.
- tambour de coupe en inox
- fort pied-ventouse
- avec poussoir

### Molino de almendras

- para rallar finamente almendras, chocolate, queso duro, etc.
- con tambor cortador de acero inox
- con pata de succión
- con empujador de llenado



180 x 98 x 189 mm

Art-Nr. / Art.-No.	VE / SU	EAN
9715 2260	3	4 004094 971563



### Mandelmühle »Exklusiv« aus Edelstahl

- mit 2 Schneidtrommeln
- für Mandeln, Nüsse, Schokolade, Parmesan etc.
- starker Saugfuß
- mit Füllstößel für sicheres Arbeiten

### Almond grater »Exklusiv«

- with two cutting drums
- for almonds, nuts, chocolate, hard cheese etc.
- strong suction pad
- food pusher for safe working

### Moulin à amandes »Exklusiv«

- deux tambours de coupe
- pour amandes, noix, chocolat, parmesan etc.
- avec fort pied-ventouse
- avec poussoir de remplissage

### Molino de almendras »Exklusiv«

- con 2 tambores cortadores
- para almendras, nueces, chocolate, parmesano etc.
- con pata de succión muy fuerte
- con empujadores



210 x 110 x 196 mm

Art-Nr. / Art.-No.	VE / SU	EAN
9717 2260	3	4 004094 971761





230 x 133 x 245 mm

**Fleischwolf »New Style«**

- mit 2 Lochscheiben (Lochgrößen 4 mm und 8 mm  $\phi$ ), Gebäckvorsatz und Füllstößel
- starker Saugfuß
- Vorteil: die komplette obere Funktionseinheit lässt sich zur Reinigung abnehmen

**Meat Mincer »New Style«**

- with 2 mincing plates (hole-sizes 4 mm and 8 mm  $\phi$ ), baking attachment and pusher
- strong suction pad
- advantage: complete upper function unit can be taken off for easy cleaning

Art-Nr. / Art.-No.	VE / SU	EAN
9745 2260	1	4 004094 974564

ABS	PP	INOX
-----	----	------



**Hachoir à viande »New Style«**

- avec 2 disques perforés (taille des trous  $\phi$  4 mm et 8 mm), adaptateur à biscuits et pousoir
- fort pied-ventouse
- avantage: l'unité fonctionnelle se retire pour le nettoyage facile

**Máquina de picar carne »New Style«**

- con 2 discos perforados (agujero  $\phi$  4 mm y 8 mm), suplemento para galletas y empujador
- pata de succión
- ventaja: se puede quitar la unidad funcional para una limpieza facile

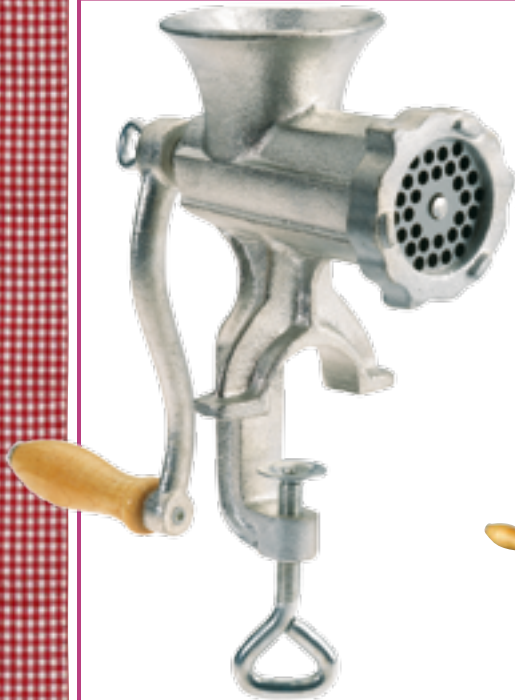

9750, Größe / Size 5

9752, Größe / Size 8

9754, Größe / Size 10

**Fleischwolf**

- aus verzinnemtem Stahlguss
- mit 4-flügeligem Messer und Scheibe Lochgröße  $\phi$  4,5 mm
- Schutzelement aus Kunststoff verhindert Verkratzen des Tisches

**Meat Mincer**

- from tinned cast steel
- with 4-wing knife and mincing plate hole  $\phi$  4,5 mm
- with protection element from plastics for the work-top

**Hachoir à viande**

- en fonte d'acier étamée
- avec couteau à 4 pâles et disque à trous de  $\phi$  4,5 mm
- un élément de protection en plastique protège la surface de la table

**Máquina de picar carne en acero inoxidable**

- en fundición de acero estañado
- con cuchilla de 4 alas y disco perforado -  $\phi$  4,5 mm
- con elemento protector de plástico para la superficie de la mesa



Art-Nr. / Art.-No.	VE / SU	Größe / Size	EAN
9750 2260	3	225 x 90 x 245 mm	4 004094 975066
9752 2260	2	250 x 100 x 265 mm	4 004094 975264
9754 2260	2	285 x 118 x 280 mm	4 004094 975462

ST



**Fleischwolf aus Edelstahl**

- mit 3 Lochscheiben (Lochgrößen 4 mm, 5 mm und 8 mm  $\phi$ ), Wurstfülltrichter & Gebäckvorsatz
- der starke Saugfuß sorgt für festen Halt

**Stainless steel mincer**

- with 3 mincing plates (hole-sizes 4 mm, 5 mm and 8 mm  $\phi$ ), funnel for making sausages and baking attachment
- the strong suction food ensures secure hold

**Hachoir à viande en acier inoxydable**

- avec 3 disques perforés (taille des trous  $\phi$  4 mm, 5 mm et 8 mm), entonnoirs à saucisses et adaptateur à biscuits
- avec pied-ventouse

**Máquina de picar carne**

- con 3 discos perforados (agujero  $\phi$  4 mm, 5 mm y 8 mm), embudo embudidor y suplemento para galletas
- con fuerte pata de succión



Größe / Size 8

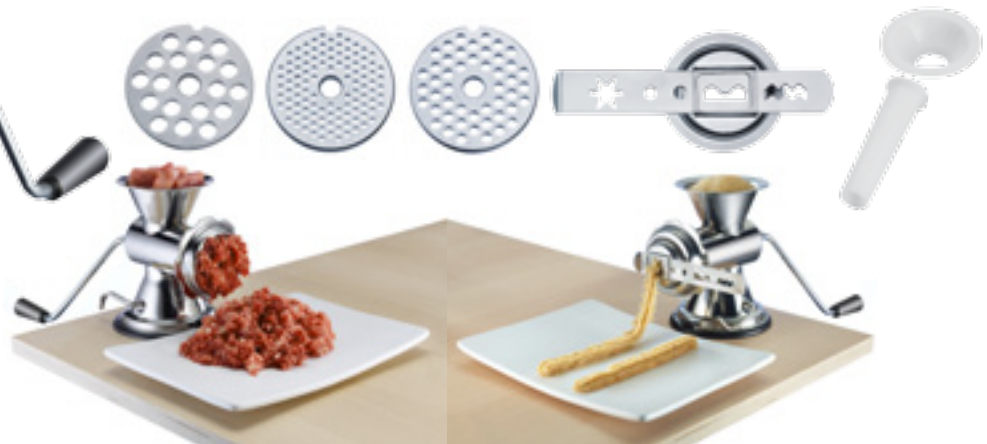

Art-Nr. / Art.-No.	VE / SU	EAN
9777 2260	1	4 004094 977763

TPE	PP	INOX
-----	----	------



290 x 120 x 157 mm



Ersatz- und Ergänzungsteile zu dem klassischen Fleischwolf Nr. 9750 2260 - 9754 2260  
 Spare parts and additional equipment for the classic meat mincers nos. 9750 2260 - 9754 2260  
 Pièces de rechange et accessoires pour le hachoir à viande classique n°9750 2260 - 9754 2260  
 Recambios y suplementos para la máquina de picar carne clásica No 9750 2260 - 9754 2260

Spritzgebäckvorsatz    Adaptateur à biscuits  
 Baking attachment    Suplemento para galletas

Art-Nr. / Art.-No.	VE / SU	Größe / Size	EAN
1470 2270	6	5	4 004094 147074
1471 2270	6	8	4 004094 147173
1472 2270	6	10	4 004094 147272

INOX



Lochscheibe 4,5 mm    Disque perforé 4,5 mm  
 Mincing Plate 4,5 mm    Disco perforado 4,5 mm

Art-Nr. / Art.-No.	VE / SU	Größe / Size	EAN
1476 2250	5	5	4 004094 147654
1477 2250	5	8	4 004094 147753
1478 2250	5	10	4 004094 147852

ST



Lochscheibe 6 mm    Disque perforé 6 mm  
 Mincing Plate 6 mm    Disco perforado 6 mm

Art-Nr. / Art.-No.	VE / SU	Größe / Size	EAN
1479 2250	5	5	4 004094 147951
1480 2250	5	8	4 004094 148057
1481 2250	5	10	4 004094 148156

ST



Lochscheibe 8 mm    Disque perforé 8 mm  
 Mincing Plate 8 mm    Disco perforado 8 mm

Art-Nr. / Art.-No.	VE / SU	Größe / Size	EAN
1482 2250	5	5	4 004094 148255
1483 2250	5	8	4 004094 148354
1484 2250	5	10	4 004094 148453

ST



Wurstfülltrichter  
 • bestehend aus 3 Wurstfülltrichtern unterschiedlicher Durchmesser und ein Adapter

Funnel for making sausages  
 • containing 3 funnels with different diameters and one adaptor

Entonnoirs à saucisses  
 • avec 3 entonnoirs à saucisse de différents diamètres et un adaptateur

Embudo embutidor  
 • compuesto de 3 embudos de diferentes diámetros y de un adaptador

Art-Nr. / Art.-No.	VE / SU	Größe / Size	EAN
1493 2230	6	5	4 004094 149337
1494 2230	6	8	4 004094 149436
1495 2230	6	10	4 004094 149535

PE



Messer 4-flügelig    Couteau 4 pâles  
 4-wing knife    Cuchilla de 4 alas

Art-Nr. / Art.-No.	VE / SU	Größe / Size	EAN
1485 2250	5	5	4 004094 148552
1486 2250	5	8	4 004094 148651
1487 2250	5	10	4 004094 148750

ST



Kurbelschraube    Vis manivelle  
 Screw for crank    Tornillo de manivela

Art-Nr. / Art.-No.	VE / SU	Größe / Size	EAN
1488 2250	5	5	4 004094 148859
1489 2250	5	8	4 004094 148958
1490 2250	5	10	4 004094 149054

ST







150 x 33 x 15 mm

**Nussknacker »Herkules«**  
 • der Klassiker aus Alu  
 • nicht nur zum Knacken von Nüssen - wird auch gern als Hummerknacker verwendet

**Nutcracker »Herkules«**  
 • the classic from aluminium  
 • ideal not only for cracking nuts but also well liked as lobster cracker

**Casse-noix »Herkules«**  
 • le classique en alu  
 • idéal non seulement pour casser des noix mais aussi comme casse-homard

**Cascanueces »Herkules«**  
 • el clásico de aluminio  
 • no solo para cascar nueces – se usa también para partir langostas

Art-Nr. / Art.-No.	VE / SU	EAN
3300 2270 	5	4 004094 330070
3300 2610 	1	4 051734 002330





200 x 78 x 46 mm

**Nussknacker »Coco«**  
 • knackt die Schale - nicht den Kern  
 • kein Verstreuen von Nusschalen  
 • mit Federmechanismus  
 • Achtung: die Griffe nicht auseinanderbiegen

**Nutcracker »Coco«**  
 • cracks the shell - not the kernel  
 • no scattering of shells  
 • spring-loaded opening mechanism  
 • attention: please do not force open

**Casse-noix »Coco«**  
 • casse la coquille mais pas l'intérieur  
 • pas de dispersion des coquilles  
 • avec mécanisme à ressort  
 • attention: ne pas forcer l'ouverture

**Cascanueces »Coco«**  
 • casca la cáscara – no el núcleo  
 • no se esparcen las cáscaras de las nueces  
 • con mecanismo de muelle  
 • atención: no separe los mangos a fuerza

Art-Nr. / Art.-No.	VE / SU	EAN
3320 2260 	5	4 004094 332067
3320 2660 	1	4 051734 001692





180 x 78 x 58 mm

**Nussknacker »Nussprofi«**  
 • Nussknacker und Sektzange in einem  
 • mit federgelagertem Zangensystem

**Nutcracker »Nussprofi«**  
 • a nutcracker and champagne opener in one  
 • spring-loaded tong-system

**Casse-noix »Nussprofi«**  
 • casse-noix et pince à champagne  
 • système de pince à ressort

**Cascanueces »Nussprofi«**  
 • cascanueces y tenazas para descorchar botellas de cava  
 • con sistema de tenazas alojado en muelle

Art-Nr. / Art.-No.	VE / SU	EAN
3325 4470 	10	4 004094 332579
3325 4610 	1	4 051734 000183



180 x 78 x 58 mm

**Nussknacker »Nussprofi«**  
 • Nussknacker und Sektzange in einem  
 • mit federgelagertem Zangensystem

**Nutcracker »Nussprofi«**  
 • a nutcracker and champagne opener in one  
 • spring-loaded tong-system

**Casse-noix »Nussprofi«**  
 • casse-noix et pince à champagne  
 • système de pince à ressort

**Cascanueces »Nussprofi«**  
 • cascanueces y tenazas para descorchar botellas de cava  
 • con sistema de tenazas alojado en muelle

Art-Nr. / Art.-No.	VE / SU	EAN
3327 4470 	10	4 004094 332777





168 x 76 x 60 mm

**Nussknacker »Nussprofi«**  
 • Nussknacker und Sektzange in einem  
 • mit federgelagertem Zangensystem

**Nutcracker »Nussprofi«**  
 • a nutcracker and champagne opener in one  
 • spring-loaded tong-system

**Casse-noix »Nussprofi«**  
 • casse-noix et pince à champagne  
 • système de pince à ressort

**Cascanueces »Nussprofi«**  
 • cascanueces y tenazas para descorchar botellas de cava  
 • con sistema de tenazas alojado en muelle

Art-Nr. / Art.-No.	VE / SU	EAN
3326 4470 	10	4 004094 332678
3326 4610 	1	4 051734 002231





10

entkernen & einkochen • *stoning & preserving*  
dénoyer & mettre en conserve • *deshuesar & conservar*









140 x 40 x 25 mm

**Kirschkernentzucker »Kernex«**

- funktionaler Bestseller
- robuster sternförmiger Entkernstößel
- entkernt Kirschen auch mit Stiel (einfach mit dem Stiel nach unten einlegen)

**Cherry stoner »Kernex«**

- functional bestseller
- strong, star-shaped stone-ejector
- possibility to eject pit and stem at the same time (just place cherry stem downwards)

Art-Nr. / Art.-No.	VE / SU	EAN
4000 2260 	5	 4 004094 400063
4000 2660 	1	 4 004094 400025

**Dénoyauteur à cerises »Kernex«**

- best-seller super fonctionnel
- fort éjecteur de noyau en forme d'étoile
- queue et noyau peuvent être retirés en même temps

**Deshuesador de cerezas »Kernex«**

- el clásico superfuncional
- punzón deshuesador en forma de estrella
- la cereza puede deshuesarse con el rabillo







167 x 32 x 38 mm

**Pflaumentzucker »Steinex«**

- entsteint Zwetschgen kuchen- und konservengerecht
- speziell gehärtetes Messer

**Plum stoner »Steinex«**

- stones and cuts plums ready for cakes and preserving recipes
- specially hardened knife

Art-Nr. / Art.-No.	VE / SU	EAN
4010 2260 	5	 4 004094 401060
4010 2660 	1	 4 004094 401022

**Dénoyauteur à prunes »Steinex«**

- dénoyaute les prunes pour en faire des gâteaux ou des conserves
- lame spécialement trempée

**Deshuesador de ciruelas »Steinex«**

- deshuesa ciruelas pudiendo usarlas para hacer pasteles y conservas
- cuchilla templada especialmente





131 x 89 x 25 mm

**Kirschkernentzucker »Kernetto«**

- aus hochwertigem Polyamid
- mit Funktionselementen aus rostfreiem Edelstahl

**Cherry stoner »Kernetto«**

- from high quality polyamide
- functional elements from stainless steel

Art-Nr. / Art.-No.	VE / SU	EAN
4001 2270 	10	 4 004094 400179

**Dénoyauteur »Kernetto«**

- en polyamide de haute qualité
- éléments fonctionnels d'acier inox

**Deshuesador de cerezas »Kernetto«**

- en poliamida de alta calidad
- partes funcionales en acero inox





169 x 105 x 27 mm

**Olivenentzucker »Olivus«**

- zuverlässiges und sauberes Entkernen durch den besonders langen, gebogenen Entkernstößel
- speziell geformte Mulde für große und kleine Früchte

**Olive stoner »Olivus«**

- reliable and neat removal of the stone because of the especially long, curved stone-ejector
- special bowl for big and small olives

Art-Nr. / Art.-No.	VE / SU	EAN
4040 2270 	5	 4 004094 404078

**Dénoyauteur à olives »Olivus«**

- dénoyautage fiable et propre grâce à l'éjecteur de noyau courbé et particulièrement long
- creux spécial pour les petits et les gros fruits

**Deshuesador de aceitunas »Olivus«**

- deshuesado fiable y limpio gracias al punzón-curvado especialmente largo
- parte cóncava de forma especial para frutas-grandes y pequeñas





106 x 83 x 230 mm

**Kirschen- und Pflaumentzucker »Steinex-Combi«**

- entsteint Kirschen und Pflaumen kuchen- und konservengerecht
- auch für tiefgefrorene Früchte geeignet

**Cherry and plum stoner »Steinex-Combi«**

- stones cherries and plums for cakes and preserving recipes
- also for preserved and deep-frozen fruit

Art-Nr. / Art.-No.	VE / SU	EAN
4020 2260 	7	 4 004094 402067

**Dénoyauteur à cerises et à prunes »Steinex-Combi«**

- dénoyaute les cerises et les prunes pour en faire des gâteaux ou des conserves
- convient également aux fruits surgelés

**Deshuesador de cerezas y ciruelas »Steinex-Combi«**

- deshuesa cerezas y ciruelas pudiendo usarlas-para hacer pasteles y conservas
- idóneo también para frutas congeladas







**Pflaumentsteiner »Prunus«**

- für küchenfertig entsteinte Pflaumen
- auch für konservierte und tiefgefrorene Früchte
- mit rutschfesten Gummifüßen
- sehr leicht zu reinigen

**Plum stoner »Prunus«**

- leaves plums ready for cooking and preserving recipes
- also for preserved and deep frozen fruit
- with non-slip rubber feet
- very easy to clean

Art-Nr. / Art.-No.	VE / SU	EAN
4023 2260 	3	4 004094 402364 



**Dénoyateur à prunes »Prunus«**

- pour prunes prêtes pour la cuisine
  - également pour les fruits en conserve et surgelés
  - avec pieds antidérapants
  - très facile à nettoyer
- Deshuesador de ciruelas »Prunus«**
- para ciruelas deshuesadas listas para la cocina
  - también para frutas conservadas y congeladas
  - con patas anti-resbalantes
  - muy fácil de limpiar





109 x 67 x 265 mm

**Kirschkernker**

- großes Fassungsvermögen von Schütte und Kernkassette
- mit Saugfuß
- für frische und konservierte Früchte
- leicht zu reinigen

**Cherry stoner**

- large capacity chute and stone collector
- with suction pad
- for fresh and preserved cherries
- easy to clean

Art-Nr. / Art.-No.	VE / SU	EAN
4030 2260 	6	4 004094 403064 



**Dénoyateur à cerises**

- goulotte de grande capacité et bac collecteur
- avec pied-ventouse
- pour fruits frais ou en conserves
- facile à nettoyer

**Deshuesador de cerezas**

- gran cubida del vertedero y recogedor de huesos
- para sujetar con pata de succión
- para frutas frescas y conservadas
- fácil de limpiar



190 x 115 x 220 mm

**Kirschkernker »Kirschomat«**

- hohe Entkernleistung (bis zu 15 kg/h)
- schräggestellte Schütte, damit die Kirschen gut nachrutschen
- große Kernkassette
- optimaler Spritzschutz

**Cherry stoner »Kirschomat«**

- high efficiency (stones up to 15 kg/h)
- slanted chute - so that the stoner is fed easily
- spacious stone collector
- optimum splash protection



**Dénoyateur à cerises »Kirschomat«**

- efficace dénoyautage (jusqu'à 15 kg/h)
- goulotte inclinée pour que les cerises glissent
- bac collecteur spacieux
- protection contre les éclaboussures

**Deshuesador de cerezas »Kirschomat«**

- alto rendimiento de deshuesado (hasta de 15 kg/h)
- vertedero inclinándolo
- gran recogedor de huesos
- protección contra salpicaduras



Art-Nr. / Art.-No.	VE / SU	EAN
4070 2260 	5	4 004094 407062 



Made in  GERMANY

240 x 100 x 333 mm

**Doppeltkernker & Pflaumentsteiner »Steinomat«**

- hier rutschen immer gleich zwei Kirschen in die Entkerneinheit
- so lassen sich bis zu 20 kg/h Früchte verarbeiten
- Kernkassette umsteckbar

**Double-cherry- and plum stoner »Steinomat«**

- two cherries are pitted simultaneously in the double pitting-unit
- stones up to 20 kg/h
- the stone collector can be put on the one or other side

**Double dénoyateur cerises & prunes »Steinomat«**



- prend deux cerises en même temps
- dénoyauté jusqu'à 20 kg/h
- le bac collecteur peut être placé d'un côté ou de l'autre

**Deshuesador doble de cerezas y de ciruelas »Steinomat«**

- dos cerezas a la vez
- así pueden elaborarse hasta 20 kg/h de frutas
- el recogedor de huesos puede cambiarse de sitio



325 x 98 x 310 mm

Art-Nr. / Art.-No.	VE / SU	EAN
4060 2260 	3	4 004094 406065 



Made in  GERMANY



**Pflaumen- und Zwetschgenentsteiner »Steinfix«**

- entsteht kuchen- und konservengerecht
- bis zu 15 kg/h
- geschliffenes Kreuzmesser aus Edelstahl
- fester Stand durch 4 GummifüÙe
- mit Rezeptheft

**Plum Stoner »Steinfix«**

- stones and cuts fruits ready for cakes and preserves
- up to 15 kg/h
- sharpened stainless steel blades
- with 4 non-slip rubber feet
- with recipes



**Dénoyauteur à prunes et quetsches »Steinfix«**

- dénoyaute et coupe les fruits pour des gâteaux ou conserves
- lames spécialement trempées en acier inox
- 4 pieds antidérapants
- avec recettes

**Deshuesador de ciruelas »Steinfix«**

- deshuesa y corta las frutas para pasteles y conservas
- cuchilla en cruz afilada en acero inox
- con 4 patas de goma
- con recetas

175 x 110 x 337 mm

Art-Nr. / Art.-No.	VE / SU	EAN
4025 2260 	3	 4 004094 402562



**Kirschkernentsteiner »Kernfix«**

- entsteint Kirschen kuchen- und konservengerecht
- ca. 12 kg/h
- auch für konservierte / tiefgefrorene Früchte mit Rezepten

**Cherry Stoner »Kernfix«**

- stones cherries ready for cakes and preserves
- approx. 12 kg/h
- also for preserved or deep-frozen fruit
- with recipes

**Dénoyauteur à cerises »Kernfix«**

- dénoyaute les cerises pour en faire des gâteaux ou des conserves
- env. 12 kg/h
- aussi pour les fruits en conserve et surgelés
- avec recettes

**Deshuesador de cerezas »Kernfix«**

- deshuesa cerezas para poder ser usadas para pasteles y conservas
- hasta de 12/kg
- también para frutas conservadas y congeladas
- con recetas

205 x 118 x 300 mm

Art-Nr. / Art.-No.	VE / SU	EAN
4035 2260 	3	 4 004094 403562





### Bohenschneider Aluminium

- ideal, um Schnippelbohnen für Suppen und Salate zuzubereiten
- mit 3 gehärteten und geschliffenen Messern
- mit Schraubzwinde

### Bean slicer aluminium

- ideal for slicing beans for soups and salads
- with 3 hardened and sharpened knives
- very solid with screw clamp

### Coupe-haricots aluminium

- idéal pour trancher les haricots pour les soupes et les salades
- avec 3 couteaux trempés et affûtés
- avec serre-joint

### Cortador de judías verdes en aluminio

- ideal para cortar judías verdes para ensaladas o potajes
- con 3 cuchillas templadas y afiladas
- con tornillo de apriete

Art-Nr. / Art.-No.	VE / SU	EAN
1182 2260	5	4 004094 118265



123 x 140 x 265 mm

### Bohenschneider Kunststoff

- gleichmäßig geschnittene Bohnen für Suppen und Salate
- 3 gehärtete und geschliffene Messer
- sehr stabiles Kunststoffgehäuse
- mit Saugfuß

### Bean slicer plastic

- equally long cut beans for soups and salads
- 3 hardened and sharpened knives
- very robust plastic body
- with suction pad

### Coupe-haricots plastique

- des haricots coupés uniformément pour des soupes et salades
- 3 couteaux trempés et affûtés
- corps en plastique très robuste
- avec pied-ventouse

### Cortador de judías verdes en plástico

- judías verdes cortadas a longitudes uniformes para potajes y ensaladas
- 3 cuchillas afiladas
- carcasa muy estable de plástico
- con pata de succión

Art-Nr. / Art.-No.	VE / SU	EAN
1184 2260	3	4 004094 118463



122 x 141 x 220 mm

### Bohnenlangschneider

- die Messerrolle mit 6 Klingen schneidet die Bohnen sehr effizient der Länge nach auf
- mit Schraubzwinde für festen Halt an der Arbeitsplatte

### Lengthwise bean slicer

- the slicing wheel unit with 6 blades slices beans lengthwise in no time
- with screw clamp for secure hold at the worktop

### Coupe-haricots dans la longueur

- la roue de tranchage à 6 lames coupe très efficacement les haricots dans le sens de la longueur
- avec serre-joint pour un parfait maintien

### Cortador de judías verdes en sentido longitudinal

- el rodillo cortador con 6 hojas corta las judías verdes eficientemente en sentido longitudinal
- con tornillo de apriete para un apoyo fijo

Art-Nr. / Art.-No.	VE / SU	EAN
1186 2260	4	4 004094 118661



105 x 150 x 102 mm







310 x 280 x 104 mm

**Soft- und Beerenpresse »Starke Else«**

- idealer Helfer für die Herstellung von Säften, Marmeladen, Gelees und Fruchtmarmelade aus rohen oder gekochten Früchten
- Holunderbeeren, Brombeeren etc. werden mühelos entsaftet, Kerne werden von dem vorhandenen Sieb zurückgehalten und mit dem ausgedrückten Fruchtfleisch nach vorne transportiert
- mit Stampfer zum sicheren Befüllen
- die Schraubzwinge sorgt für festen Halt, die mitgelieferte Gummiunterlage dafür, dass der Tisch nicht zerkratzt wird

**Juice- and Berrypress »Starke Else«**

- this is the ideal helper for producing juices, jams, jellies and fruit pulp from raw and cooked fruit
- ideal for processing grapes, elderberries, blackberries etc.
- any seeds are held back by the sieve and are transported to the front
- with pusher for safe filling
- the screw clamp ensures a safe hold, the supplied rubber pad prevents the table from being scratched



**Presse à jus et à fraises »Starke Else«**

- c'est l'assistant idéal pour préparer des jus, des confitures, des gelées et des pâtes de fruit à base de fruits crus ou cuits
- idéale pour préparer sans effort des jus de raisin, de baies de sureau, de mûres etc.
- les noyaux sont retenus par le tamis et transportés vers l'avant avec le jus de fruit pressé
- avec poussoir pour un remplissage en toute sécurité
- le serre-joint assure un parfait maintien, la semelle caoutchoutée fournie évite de rayer la table

**Exprimidor de zumo y bayas »Starke Else«**

- este exprimidor es un ayudante ideal para preparar zumos, mermeladas, jaleas y pulpa de frutas de frutas frescas y cocidas
- uvas, bayas de saúco, moras, etc. se exprimen en un instante, en el tamiz existente se retienen las pipas y se transportan hacia adelante con la carne de las frutas exprimidas
- con empujador para el llenado seguro
- gracias al gato se consigue un apoyo seguro. la base de goma evita que se arañe la mesa



Art-Nr. / Art.-No.	VE / SU	EAN	ST
9748 2260 	1	 4 004094 974861	

**Tomaten-Passierer und Entsafter**

- für Tomaten, Äpfel, Erdbeeren, Kiwis, Aprikosen, Pfirsiche, Kirschen etc.
- idealer Helfer für die Zubereitung von Tomatensauce, Suppen, Babynahrung

**Tomato strainer and Juicer**

- for tomatoes, apples, strawberries, kiwis, apricots, peaches, cherries etc.
- ideal for the preparation of pasta sauce, soups, baby food etc.

**Presse-tomates et extracteur de jus**



- pour tomates, fraises, kiwis, abricots, pêches, cerises etc.
- idéal pour préparer des sauces pour les pâtes, des soupes, des plats pour bébés etc.

**Tamizador de tomates y exprimidor**

- para tomates, fresas, kiwis, albaricoques, melocotones, cerezas, etc.
- por preparar frescas salsas para pasta, sopas, alimentos para bebés etc,



350 x 135 x 285 mm

Art-Nr. / Art.-No.	VE / SU	EAN	PP INOX
1199 2260 	1	 4 004094 119965	

**Milch und Vorratseimer**

- mit dicht schließendem Deckel
- angespritzte Griffmulde im Deckel erlaubt leichtes Öffnen

**Milk and storage bucket**

- with tightly closing lid
- moulded grip at the lid allows easy opening





**Seau à lait et de stockage**

- avec couvercle hermétique
- poignée moulée sur le couvercle permettant une ouverture facile

**Cubo de leche y contenedor**

- con tapa de cierre hermético
- la concavidad de agarre inyectada en la tapa, permite que se levante la tapa fácilmente



Art-Nr. / Art.-No.	VE / SU	Größe / Size	EAN
2378 2270 	3	2 l 180 x 163 x 170 mm	 4 004094 237874
2379 2270 	3	3 l 183 x 177 x 200 mm	 4 004094 237973





- Passiersieb »Standard«, ø 20 cm**
- mit feinmaschigem Sieb für die Zubereitung von Pürees, Saucen, Babynahrung etc.
  - Auflagerasten für sicheren Halt auf Töpfen und Schüsseln

*Strainer/ puree sieve »Standard«, ø 20 cm*

- with fine-meshed screen for preparing purees, fruit coulis, sauces, baby food etc.
- loops for safe rest on pots and bowls

Art-Nr. / Art.-No.	VE / SU	EAN
1197 2270	3	4 004094 119774

ABS INOX



- Moulin à légumes/presse-purée »Standard«, ø 20 cm**
- passoire à mailles fines pour la préparation de purées, sauces, plats pour bébés etc.
  - crans pour un maintien sûr sur les bols et les casseroles

*Tamiz pasador »Standard«, ø 20 cm*

- con tamiz de malla fina para preparar purés, salsas, alimentos para bebés etc.
- encaje de apoyo para una sujeción segura sobre las cacerolas y bols



368 x 203 x 170 mm

- Passiersieb »Freches Früchtchen«, ø 20 cm**
- sehr wertige, robuste Verarbeitung
  - mit feinmaschigem Sieb für die Zubereitung von Pürees, Saucen, Babynahrung etc.
  - Auflagerasten für sicheren Halt auf Töpfen und Schüsseln

*Strainer/ puree sieve »Freches Früchtchen«, ø 20 cm*

- high quality, robust craftsmanship
- with fine-meshed screen for preparing purees, fruit coulis, sauces, baby food etc.
- loops for safe rest on pots and bowls

Art-Nr. / Art.-No.	VE / SU	EAN
1198 2260	1	4 004094 119866

ABS INOX



- Moulin à légumes/presse-purée »Freches Früchtchen«, ø 20 cm**
- finition robuste et de très belle qualité
  - passoire à mailles fines pour la préparation de purées, sauces, plats pour bébés etc.
  - crans pour un maintien sûr sur les bols et les casseroles

*Tamiz pasador »Freches Früchtchen«, ø 20 cm*

- elaboración robusta de mucho valor
- con tamiz de malla fina para preparar purés, salsas, alimentos para bebés etc.
- encaje de apoyo para una sujeción segura sobre las cacerolas y bols



390 x 200 x 170 mm

- Passiermaschine, ø 23 cm**
- 2 Lochscheiben
  - 3 stabile Auflagearme für festen Halt auf unterschiedlichen Behältnissen
  - besonderer Vorteil: klein zusammenlegbar und somit platzsparend zu verstauen

*Food mill, ø 23 cm*

- with 2 grinding discs
- 3 robust non-slip pot rests for safe hold
- special advantage: disassembles for easy storage

Art-Nr. / Art.-No.	VE / SU	EAN
1196 2260	1	4 004094 119668

ABS INOX



- Moulin à légumes, ø 23 cm**
- avec 2 disques perforés
  - 3 bras supports stables pour un maintien fixe sur les récipients
  - avantage particulier: se démonte pour un rangement facile

*Máquina pasadora, ø 23 cm*

- con 2 discos perforados
- 3 brazos de apoyo estables por una sujeción fija sobre recipientes
- ventaja especial: puede plegarse a un pequeño tamaño ahorrando así espacio al guardarlo



355 x 210 x 238 mm

- Passiermaschine »Finoletta«**
- sehr stabile Qualität
  - mit 3 Lochscheiben
  - zum Entsaften / Pürieren von Obst und Gemüse
  - ideal für die Herstellung von Babynahrung

*Straining mill »Finoletta«*

- very solid stainless steel constructio
- with 3 straining discs
- for juicing and pureeing fruit /vegetables
- ideal for fresh baby food

- Moulin à légumes »Finoletta«**
- qualité très stable
  - 3 disques perforés
  - pour extraire les jus et faire des purées de fruits/ légumes
  - idéal pour préparerdes repas pour bébés

*Máquina pasadora »Finoletta«*

- calidad muy estable para grandes exigencias
- con 3 discos perforado
- para exprimir y hacer puré de frutas y verduras, para mejorar salsas, para hacer alimentos frescos para bebés



Art-Nr. / Art.-No.	VE / SU	EAN
1195 2260	1	4 004094 119569

INOX



395 x 205 x 199 mm



ø 125 mm / ø 37 mm



199 x 126 x 50 mm

**Einmachtrichter**  
• Durchlass groß genug für Früchte

**Canning funnel**  
• wide mouth - big enough for fruits

**Entonnoir**  
• passage assez grand pour des fruits

**Embudo para conservas**  
• paso lo suficientemente grande para frutas

Art-Nr. / Art.-No.	VE / SU	EAN
1150 2270	5	4 004094 115073

PP



ø 130 mm / ø 70 mm

ø 75 mm / ø 37 mm

168 x 147 x 69 mm

**Einmachtrichter »Twix«**  
• 2 Einmachtrichter - 3 Funktionen  
• beide Trichter einzeln nutzbar oder zusammen-  
gesteckt

**Canning funnel »Twix«**  
• 2 funnel elements - 3 functions  
• both funnels can be used separately or put  
together as one

**Entonnoir »Twix«**  
• 2 entonnoirs - 3 fonctions  
• on peut utiliser le petit ou le grand entonnoir-  
séparément ou on peut les assembler

**Embudo para conservas »Twix«**  
• 2 embudos - 3 funciones  
• use por separado el embudo pequeño ogran-  
de o meta el uno en el otro juntándolos

Art-Nr. / Art.-No.	VE / SU	EAN
1155 2270	12	4 004094 115578

PP



ø 130 mm / ø 40 mm

170 x 130 x 68 mm

**Einmachtrichter »Edelstahl«**  
• mit langem Einfüllstutze  
• erleichtert das Umfüllen von flüssigen und  
festen Lebensmitteln wie z.B. Marmeladen,  
Zucker, Reis etc.

**Preserving funnel »Edelstahl«**  
• with long filling spout  
• makes it easy to transfer both liquids and solids  
between containers such as jams, sugar, rice etc.

**Entonnoir »Edelstahl«**  
• avec longue tubulure de remplissage  
• facilite le passage d'une multitude d'aliments  
liquides et solides tels que marmelades, sucres,  
riz etc.

**Embudo para conservas »Edelstahl«**  
• con boca de llenado larga  
• facilita el transvase de un sinnúmero de  
combustibles líquidos y sólidos tales como  
mermeladas, azúcar, arroz, etc.

Art-Nr. / Art.-No.	VE / SU	EAN
1245 2260	6	4 004094 124563

INOX



ø 120 mm / ø 40-13 mm

147 x 128 x 120 mm

**Flaschentrichter mit herausnehmbarem Sieb**  
• ideal für Flüssigkeiten - aber auch, um z.B.  
Zucker in Streuer zu füllen  
• langer Einfüllstutzen bietet guten Halt

**Funnel with strainer**  
• ideal for liquids - but also suitable for filling sugar  
in dispensers  
• the long stem offers excellent hold

**Entonnoir à bouteille avec tamis amovible**  
• idéal pour les liquides mais aussi pour remplir  
par ex. une saupoudreuse de sucre  
• la longue tubulure de remplissage offre un bon  
maintien

**Embudo para botellas con tamiz quita y pon**  
• ideal para líquidos - pero también idóneo  
par llenar con azúcar el azucarero  
• la boca de llenado larga ofrece una buena  
sujeción

Art-Nr. / Art.-No.	VE / SU	EAN
1246 2270	6	4 004094 124679

INOX



125 x 103 x 115 mm

**Trichter-Satz**  
• 3-teiliges Set  
• Größen: ø 70, 90, 105 mm

**Funnel set**  
• 3-piece set  
• Sizes: ø 70, 90, 105 mm

**Ensemble d'entonnoirs**  
• ensemble de 3 pièces  
• ø 70, 90, 105 mm

**Set de embudos**  
• et de 3 piezas  
• ø 70, 90, 105 mm

Art-Nr. / Art.-No.	VE / SU	EAN
5117 2211	6	4 004094 511714

PE





- Universal Konservenglasöffner**
- löst das Vakuum
  - für alle Flachrand- und Rillen-Einmachgläser

- Ouvre-bocal universel**
- libère le vide
  - pour différentes formes de bocaux

- Universal preserve-glass opener*
- releases the vacuum
  - for different glass-shapes

- Abretarros de cristal universal*
- relaja el vacío
  - para todos los tarros de cristal de borde plano con hendiduras



315 x 120 x 23 mm

Art-Nr. / Art.-No.	VE / SU	EAN
1052 2260	6	4 004094 105265

PP INOX



- Glasheber, verchromt**
- zum sicheren Entnehmen heißer Gläser aus dem Einkoch-Kessel
  - durch die praktische 4-Punkt-Technik für unterschiedliche Glasformen und -durchmesser geeignet

- Pince à bocal, chromé**
- pour retirer facilement des bocaux chauds du cuiseur
  - adapté à différentes formes et diamètres de bocaux grâce à la technique pratique des 4 points

- Glass lifter, chrome-plated*
- for safe removal of hot preserving jars from the canner
  - suitable for different jar shapes and diameters thanks to practical 4-point technique

- Levantatarros, cromado*
- para sacar con seguridad los tarros de cristal-calientes del agua caliente o de la caldera
  - gracias a la práctica técnica de 4 puntos, se apropia para diversas formas y diámetros de los tarros de cristal



190 x 81 x 77 mm

Art-Nr. / Art.-No.	VE / SU	EAN
1053 2270	5	4 004094 105371

PE ABS ST



- Einkochthermometer**
- unverzichtbarer Klassiker für das Einkochen
  - Messskala von 60 bis 110 °C
  - aus Weißblech

- Thermomètre à bocaux**
- un classique indispensable pour la mise en bocaux
  - échelle de mesure de 60 à 110°C
  - de fer-blanc

- Canning thermometer*
- indispensable classic for canning
  - measure scale from 60 to 110 °C
  - from tinplate

- Termómetro para conservas*
- clásico indispensable para conservas
  - escala de medición: de 60 a 110 °C
  - de hojalata



420 x 40 x 40 mm

Art-Nr. / Art.-No.	VE / SU	EAN
4076 2270	5	4 004094 407673

BL



Made in GERMANY





**Gradhalsflaschen**  
 • rund  
 • mit 28 mm Schraubdeckel

*Straight-neck bottle*

• round  
 • with 28 mm screw-top

**Bouteille**  
 • rond  
 • à col droit à 28 mm

*Botella de cuello recto*

• redondo  
 • 28 mm

Art-Nr. / Art.-No.	VE / SU	Inhalt / capacity	EAN
6634 2270	12	500 ml	4 004094 663475
6636 2270	12	350 ml	4 004094 663673
6638 2270	12	250 ml	4 004094 663871

GLAS

Made in GERMANY



**Bügelverschlussflaschen**  
 • eckig

*Swing-top bottle*

• square

**Bouteille à fermeture**  
 • angulaire

*Botella de cangrejo giartorio*

• anguloso

Art-Nr. / Art.-No.	VE / SU	Inhalt / capacity	EAN
6620 2270	6	1 l	4 004094 662072
6624 2270	6	500 ml	4 004094 662478
6628 2270	12	250 ml	4 004094 662874

PP ST GLAS

Made in EUROPE



**Bügelverschlussflaschen**  
 • rund

*Swing-top bottle*

• round

**Bouteille à fermeture**  
 • rond

*Botella de cangrejo giartorio*

• redondo

Art-Nr. / Art.-No.	VE / SU	Inhalt / capacity	EAN
6621 2270	12	200 ml	4 004094 662171
6622 2270	12	100 ml	4 004094 662270
6623 2270	12	50 ml	4 004094 662379

PP ST GLAS

Made in EUROPE



**Drahtbügelgläser**  
 • mit Gummiring  
 Flip-top jar  
 • with rubbering

**Bocal à étrier**  
 • y compris bague caoutchouc  
 Tarro de cristal con cierre de alambre  
 • incluida arandela de goma

Art-Nr. / Art.-No.	VE / SU	Inhalt / capacity	EAN
6664 2270	6	200 ml, ø 80 mm	4 004094 666476
6668 2270	6	500 ml, ø 90 mm	4 004094 666872
6660 2270	6	1 l, ø 90 mm	4 004094 666070
6662 2270	6	2 l, ø 90 mm	4 004094 666278

PP ST GLAS

Made in EUROPE







Sturzgläser  
• mit Schraubdeckel

Pot à renverser  
• y compris couvercle

Flat jars  
• with screw-top

Tarro para desmoldar  
• incluida tapa

Art-Nr. / Art.-No.	VE / SU	Inhalt / capacity	EAN
6695 2270 	6	440 ml, ø 82 mm	 4 004094 669576
6698 2270 	12	230 ml, ø 66 mm	 4 004094 669873

GLAS

Made in  GERMANY





Glas  
• mit Schraubdeckel

Bocal en verre  
• y compris couvercle

Glass  
• with screw-top

Tarro redondo  
• incluida tapa

Art-Nr. / Art.-No.	VE / SU	Inhalt / capacity	EAN
6652 2270 	12	720 ml, ø 82 mm	 4 004094 665271

GLAS

Made in  GERMANY







6 Gläser »Eckig«  
• mit Schraubdeckeln

6 Bocalux »Eckig«  
• y compris couvercle

6 glasses »Eckig«  
• with screw-top

6 Tarros »Eckig«  
• incluida tapa

Art-Nr. / Art.-No.	VE / SU	Inhalt / capacity	EAN
6643 2270 	8	288 ml, ø 63 mm	 4 004094 664373
6645 2270 	6	191 ml, ø 58 mm	 4 004094 664571

GLAS

Made in  GERMANY







8 Gläser »Eckig«  
• mit Schraubdeckeln

8 Bocalux »Eckig«  
• y compris couvercle

8 glasses »Eckig«  
• with screw-top

8 Tarros »Eckig«  
• incluida tapa

Art-Nr. / Art.-No.	VE / SU	Inhalt / capacity	EAN
6647 2270 	4	110 ml, ø 48 mm	 4 004094 664779
6649 2270 	4	45 ml, ø 43 mm	 4 004094 664977

GLAS

Made in  GERMANY





**6 Sturzgläser »Weck«**  
 • mit Glasdeckel  
 • mit 8 Deckelklammern und 4 Gummiringen

**6 Verres »Weck«**  
 • y compris couvercle  
 • y compris 4 bagues caoutchouc & 8 crochets couvercles

**6 flat jars »Weck«**  
 • with glass-lid  
 • with 8 canning claps and 4 rubberings

**6 Tarros »Weck«**  
 • incluida tapa  
 • incluida 4 arandelas de goma & 8 clips para tarros



Art-Nr. / Art.-No.	VE / SU	Inhalt / capacity	EAN
6680 2270	8	165 ml, ø 80 mm	4 004094 668074

ST GLAS  
 Made in  GERMANY



**4 Sturzgläser »Weck«**  
 • mit Glasdeckel  
 • mit 8 Deckelklammern und 4 Gummiringen

**4 Verres »Weck«**  
 • y compris couvercle  
 • y compris 4 bagues caoutchouc & 8 crochets couvercles

**4 flat jars »Weck«**  
 • with glass-lid  
 • with 8 canning claps and 4 rubberings

**4 Tarros »Weck«**  
 • incluida tapa  
 • incluida 4 arandelas de goma & 8 clips para tarros



Art-Nr. / Art.-No.	VE / SU	Inhalt / capacity	EAN
6682 2270	8	290 ml, ø 80 mm	4 004094 668272

ST GLAS  
 Made in  GERMANY



**6 Sturzgläser »Weck«**  
 • mit Glasdeckel  
 • mit 12 Deckelklammern und 6 Gummiringen

**6 Verres »Weck«**  
 • y compris couvercle  
 • y compris 6 bagues caoutchouc & 12 crochets couvercles

**6 flat jars »Weck«**  
 • with glass-lid  
 • with 12 canning claps and 6 rubberings

**6 Tarros »Weck«**  
 • incluida tapa  
 • incluida 6 arandelas de goma & 12 clips para tarros



Art-Nr. / Art.-No.	VE / SU	Inhalt / capacity	EAN
6691 2270	8	80 ml, ø 60 mm	4 004094 669170

ST GLAS  
 Made in  GERMANY



**4 Gläser »Tulpe«**  
 • mit Glasdeckel  
 • mit 8 Deckelklammern und 4 Gummiringen

**4 Verres »Tulpe«**  
 • y compris couvercle  
 • y compris 4 bagues caoutchouc & 8 crochets couvercles

**4 glasses »Tulpe«**  
 • with glass-lid  
 • with 8 canning claps and 4 rubberings

**4 Tarros »Tulpe«**  
 • incluida tapa  
 • incluida 4 arandelas de goma & 8 clips para tarros



Art-Nr. / Art.-No.	VE / SU	Inhalt / capacity	EAN
6674 2270	6	1/2 l, ø 100 mm	4 004094 667473

ST GLAS  
 Made in  GERMANY



**4 Sturzgläser »Weck«**  
 • mit Glasdeckel  
 • mit 8 Deckelklammern und 4 Gummiringen

**4 Verres »Weck«**  
 • y compris couvercle  
 • y compris 4 bagues caoutchouc & 8 crochets couvercles

**4 flat jars »Weck«**  
 • with glass-lid  
 • with 8 canning claps and 4 rubberings

**4 Tarros »Weck«**  
 • incluida tapa  
 • incluida 4 arandelas de goma & 8 clips para tarros



Art-Nr. / Art.-No.	VE / SU	Inhalt / capacity	EAN
6688 2270	8	1/4 l, ø 100 mm	4 004094 668876

ST GLAS  
 Made in  GERMANY



**Pflückeimer**

- mit 14 Gläsern »Eckig« á 191 ml, ø 58 mm

*Picking bucket*

- inkl. 14 jars á 191 ml, ø 58 mm



**Seau de cueillette**

- avec 14 verres hexagonaux á 191 ml, ø 58 mm

*Cubo para recolectar*

- con 14 tarros hexagonales de 191 ml, ø 58 mm



Art-Nr. / Art.-No.	VE / SU	Inhalt / capacity	EAN
6646 2260 	1	5,6 l	 4 004094 664663

PP GLAS

Made in  GERMANY

**Pflückeimer**

- mit 12 Sturzgläsern »Rund« á 262 ml, ø 82 mm

*Picking bucket*

- inkl. 12 flat jars á 262 ml, ø 82 mm



**Seau de cueillette**

- avec 12 verres á 262 ml, ø 82 mm

*Cubo para recolectar*

- con 12 tarros de 262 ml, ø 82 mm



Art-Nr. / Art.-No.	VE / SU	Inhalt / capacity	EAN
6656 2260 	1	6,2 l	 4 004094 665660

PP GLAS

Made in  GERMANY













Schraubdeckel  
• 10 Stück im Beutel

Screw-tops  
• bag with 10 pieces

Couvercles à visser  
• sachet de 10 pièces

Tapas a rosca  
• bolsa con 10 piezas

Art-Nr. / Art.-No.	VE / SU	Größe / Size	EAN
4090 2230 	10	ø 82 mm	 4 004094 409035
4091 2230 	10	ø 66 mm	 4 004094 409134
4092 2230 	10	ø 63 mm	 4 004094 409233
4093 2230 	10	ø 58 mm	 4 004094 409332

Made in   
GERMANY



Schraubdeckel  
• 10 Stück  
• passend für Gradhalsflaschen

Screw-tops  
• 10 pieces  
• suitable for straight-neck bottles

Vissages  
• 10 pièces  
• convient à toutes les bouteilles à col droit

Atornilladuras  
• 10 piezas  
• adecuados para todas las botellas de cuello recto



Art-Nr. / Art.-No.	VE / SU	Größe / Size	EAN
4088 2230 	10	ø 28 mm	 4 004094 408830

Made in   
GERMANY



Etiketten und Gummibänder  
• Set mit 48 Tiefkühl-Etiketten und Gummiringen

Self-adhesive labels & rubber bands  
• Set with 48 freezer labels and bands

Étiquettes et élastiques  
• ensemble de 48 étiquettes de congélation et élastiques

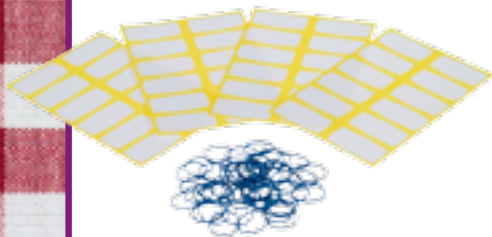
Etiquetas y gomas  
• set de 48 etiquetas para congelados y gomas



Art-Nr. / Art.-No.	VE / SU	EAN
4084 2230 	10	 4 004094 408434

Made in   
GERMANY



Deko-Anhänger  
• 6 Stück  
• mit 6 Gummiringen

Decorative tags  
• 6 pieces  
• incl. 6 rubber rings

Pendentifs déco  
• 6 pièces  
• avec 6 bagues en caoutchouc

Colgantes decorativos  
• 6 piezas  
• incluidas 6 arandelas de goma



Art-Nr. / Art.-No.	VE / SU	EAN
4086 2230 	10	 4 004094 408632



Deko-Etiketten  
• 24 Stück  
• selbstklebend, festhaftend, rückstandsfrei  
wasserlöslich

Decorative labels  
• 24 pieces  
• self-adhesive, bonded, residue-free, water-soluble

Étiquettes déco  
• 24 pièces  
• autocollantes, autoadhésives, solubles dans  
l'eau sans effet de dépôt

Etiquetas decorativas  
• 24 piezas  
• autoadhesivas, fijamente adherentes, no dejan  
residuos, solubles en agua



Art-Nr. / Art.-No.	VE / SU	EAN
4085 2230 	10	 4 004094 408533







- Deckelklammern »Weck«**
- 4074: 20 Stück
  - 4075: 8 Stück
  - passend für alle Weck-Gläser

- Crochets couvercles »Weck«**
- 4074: 20 pièces
  - 4075: 8 pièces
  - convient à tous les bocaux Weck

- Canning clamps »Weck«**
- 4074: 20 pieces
  - 4075: 8 pieces
  - suitable for all Weck preserving jars

- Clips para tarros »Weck«**
- 4074: 20 piezas
  - 4075: 8 piezas
  - adecuados para todos los tarros Weck



Art-Nr. / Art.-No.	VE / SU	EAN
4074 2251 	5	 4 004520 106224
4075 2230 	10	 4 004094 407536

ST

Made in  GERMANY



- Universalbügel**
- Beutel mit 10 Universalbügeln
  - zum Verschließen von Einmachgläsern

- Clips universels**
- sachet de 10 clips universels
  - pour fermer les bocaux

- Universal clips**
- bag with 10 universal clips
  - for tightly closing canning jars

- Clips universales**
- bolsa con 10 clips universales
  - para cerrar tarros de conservas



Art-Nr. / Art.-No.	VE / SU	EAN
4050 2251 	10	 4 004520 106125

ST

Made in  GERMANY





- Einkoch-Gummiringe »Weck«**
- 10 Einkoch-Gummiringen

- Bagues caoutchouc »Weck«**
- 10 pièces

- Rubber jar rings »Weck«**
- bag with 10 rubber jar rings

- Arandelas de goma para tarros »Weck«**
- 10 piezas



Art-Nr. / Art.-No.	VE / SU	Größe / Size	EAN
4021 2230 	10	94 x 108 mm	 4 004094 402135
4024 2251 	50	112 x 128 mm	 4 002731 112010

Made in  GERMANY





- Flaschenscheiben**
- 4078: Beutel mit 20 Flaschenscheiben
  - 4079: Beutel mit 10 Flaschenscheiben

- Rondelles de bouteille**
- 4078: sachet de 20 rondelles de bouteille
  - 4079: sachet de 10 rondelles de bouteille

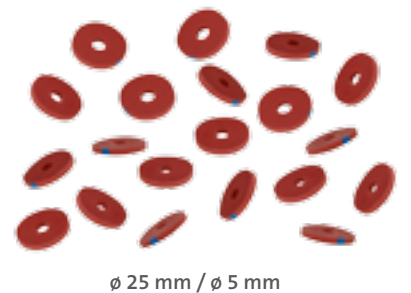
- Bottle seals**
- 4078: bag with 20 bottle seals
  - 4079: bag with 10 bottle seals

- Juntas para botellas**
- 4078: bolsa con 20 juntas para botellas
  - 4079: bolsa con 10 juntas para botellas



Art-Nr. / Art.-No.	VE / SU	EAN
4078 2251 	10	 9 006272 710075
4079 2230 	10	 4 004094 407932

Made in  GERMANY





- Süßmostkappen**
- Beutel mit je 10 Süßmostkappen
  - zum luftdichten Verschließen der Flasche
  - erhältlich in zwei Größen

- Capuchons**
- sachet de 10 capuchons
  - pour fermer hermétiquement la bouteille
  - disponible en deux tailles

- Fruit juice stoppers**
- bag with each 10 fruit juice stoppers
  - for airtight sealing of the bottle
  - available in two sizes

- Tapas para mosto**
- bolsa con 10 tapas para mosto
  - para cerrar las botellas herméticamente al aire
  - obtenible en 2 tamaños



Art-Nr. / Art.-No.	VE / SU	Größe / Size	EAN
4046 2251 	5	Gr. 1, 0,3-0,5 l Flaschen / bottles	 4 002731 201011
4048 2251 	5	Gr. 2, 0,7-1,0 l Flaschen / bottles	 4 002731 202018



Zitrus- & Orangenpresse, 0,2 l  
• mit glasklarem Sieb



Presse-citron & orange, 0,2 l  
• avec tamis transparent



Lemon & orange press, 0,2 l  
• with clear sieve

Exprimidor de limones y naranjas, 0,2 l  
• con tamiz transparente

152 x 118 x 90 mm

Art-Nr. / Art.-No.	VE / SU	EAN
3092 2291 	3	 4 004094 309298

PS



Zitrus- & Orangenpresse »Limetta«, 0,5 l  
• scharf ausgearbeitete Lamellen am Presskegel sorgen für ein besonders gutes Pressergebnis  
• mit rutschfestem Gummiring im Boden







Presse-citron & orange »Limetta«, 0,5 l  
• avec des lamelles bien définies au cône pour un bon résultat de pressage  
• l'anneau caoutchouté antidérapant dans le fond

Lemon & orange press »Limetta«, 0,5 l  
• with well defined sharp ribs at the press cone so that even the last drop of juice is well pressed out  
• non-slip ring at the bottom

Exprimidor de limones y naranjas »Limetta«, 0,5 l  
• con laminillas sobresalientes pronunciadas en el cono exprimidor por un buen resultado  
• anillo de goma en el fondo para una retención fija



187 x 170 x 105 mm

Art-Nr. / Art.-No.	VE / SU	EAN
3091 227A  	3	 4 004094 000898
3091 227R  	3	 4 004094 309175

PP SAN



Zitruspresse, 0,5 l  
• aus pflegeleichtem Edelstahl



Presse-citron, 0,5 l  
• en acier inoxydable facile à nettoyer

Citrus juicer, 0,5 l  
• from easy-to-care stainless steel

Exprimidor de limones, 0,5 l  
• de acero inoxidable fácil de cuidar e higiénico



169 x 138 x 93 mm

Art-Nr. / Art.-No.	VE / SU	EAN
3094 2260 	6	 4 004094 309465

INOX





### Zitrus-/Limettenpresse »Juicy«

- keine klebrigen Finger
- maximale Saftausbeute
- Auspressen direkt über dem gewünschten Behältnis

### Citrus/lime juicer »Juicy«

- no sticky fingers
- maximum amount of juice
- juicing directly above the container

### Presse-agrumes »Juicy«



- les doigts ne collent pas
- le rendement de jus est optimal
- le pressage est effectué directement au-dessus du récipient souhaité

### Exprimidor de limón/lima »Juicy«

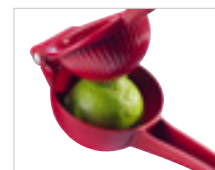
- los dedos no quedan pegajosos
- extracción máxima del jugo
- exprimir directamente sobre el recipiente deseado



217 x 74 x 60 mm

Art-Nr. / Art.-No.	VE / SU	EAN
3095 2270 	4	 4 004094 309571

AL



### Fruchtpresse »Limona«

- für Zitronen, Apfelsinen und Grapefruits
- Besonderheit: die Lamellen des Presstrichters sind extra stark ausgeformt, damit sie in die Fruchtschale eindringen können

### Fruit press »Limona«

- for lemons, oranges and grape fruits
- the lamellas of the press enter the skin of the fruit and make sure that the juice contains many vitamins

### Presse-fruits »Limona«



- pour citrons, oranges et pamplemousses
- particularité: les lamelles de la presse pénètrent dans la peau du fruit pour un maximum de vitamines

### Exprimidor de frutas »Limona«

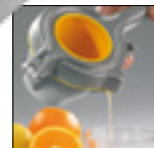
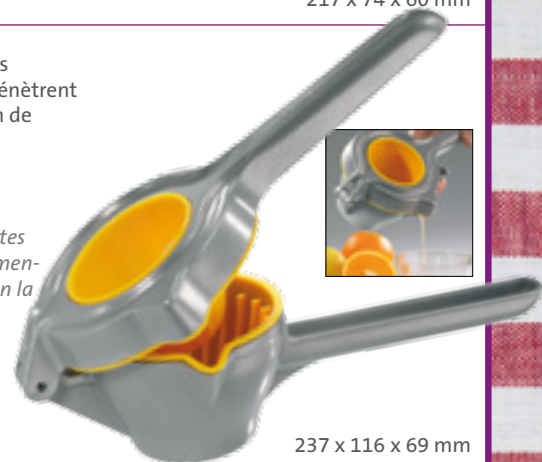
- para limones, naranjas y pomelos
- particularidad: las laminillas sobresalientes delembudo exprimidor están magníficamente formadas para que puedan penetrar en la piel de la fruta



237 x 116 x 69 mm

Art-Nr. / Art.-No.	VE / SU	EAN
5000 2260 	3	 4 004094 500060

PP

AL



Made in GERMANY 



Bitte beachten Sie auch:  
weitere Fruchtweiler  
Seite 18, 19

Please see as well:  
more fruit corers  
page 18, 19







# Vorspeisegläser/Nachspeisegläser

*Starter jars/dessert jars*

*Bocaux hors-d'oeuvre/bocaux dessert*

*Tarros para entremeses / postres*



6 Sturzgläser  
• inkl. Glasdeckel

6 Verres  
• y compris couvercle

6 flat jars  
• incl. glass lid

6 Tarros  
• incluidas tapas



Art-Nr. / Art.-No.	VE / SU	Inhalt / capacity	EAN
6689 2270	3	160 ml, ø 60 mm	4 004094 668975

GLAS



Made in GERMANY

6 Gläser »Tulpe«  
• inkl. Glasdeckel

6 Verres »Tulpe«  
• y compris couvercle

6 Jars »Tulpe«  
• incl. glass lid

6 Tarros »Tulpe«  
• incluidas tapas



Art-Nr. / Art.-No.	VE / SU	Inhalt / capacity	EAN
6676 2270	3	220 ml, ø 60 mm	4 004094 667671

GLAS



Made in GERMANY



4 Gläser »Tulpe«  
• inkl. Glasdeckel

4 Verres »Tulpe«  
• y compris couvercle

4 Jars »Tulpe«  
• incl. glass lid

4 Tarros »Tulpe«  
• incluidas tapas



Art-Nr. / Art.-No.	VE / SU	Inhalt / capacity	EAN
6675 2270	3	1/2 l, ø 100 mm	4 004094 667572

GLAS



Made in GERMANY





# WESTMARK



Made in Germany

11



11

»Retro-Serie«



**Sonderedition »Retro«:**

- Auswahl von 30 klassischen Küchenwerkzeugen  
**Made in Germany**
- Retro ist zeitgemäß => abverkaufsstark
- höhere Wertigkeit durch liebevolle Aufmachung  
=> Geschenkcharakter

**Special Edition »Retro«:**

- choice of 30 classic kitchen tools  
**Made in Germany**
- Retro is up-to-date => well-selling
- higher value because of lovely presentation => gift-character

**L'édition special »Retro«:**

- sélection de 30 ustensiles de cuisine classiques  
**Made in Germany**
- Retro est actuel => fort dans les ventes
- une valeur plus importante à cause d'emballage 'cadeaux'

**La edición especial »Retro«:**

- una selección de 30 productos de cocina clásicos  
**Made in Germany**
- Retro es moderno => fácil de vender
- los artículos adquieren una mejor calidad siendo fabricados con cariño => característica de regalos

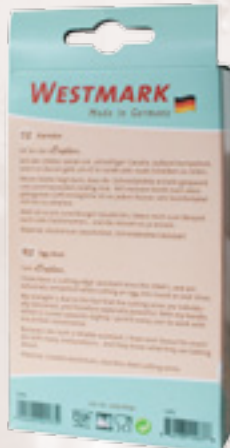

- Verpackungstexte 4-sprachig (deutsch, englisch, französisch, spanisch)
- direkte Ansprache des Endverbraucher
- packaging in 4 languages (German, English, French, Spanish)
- information on packaging addresses the consumer directly
- packaging en 4 langues (allemand, anglais, français, espagnol)
- textes packaging qui s'adressent directement au consommateur
- embalaje en 4 idiomas (alemán, inglés, francés, español)
- textos de embalaje que se dirigen directamente al consumidor

Art.-Nr. WP003122  
Display »Retro«



- Extra Einleger, der die Wertigkeit der Ware unterstreicht
- Extra insert which underlines the value of the product
- Extra: Fiche info qui souligne la valeur du produit
- Una carta extra informativa sobre la calidad de la mercancía



- \* RT60 Karton
- \* RT70 Karte
- \* 2611 Display

Art.-Nr. 00008070  
»Greta«







Art-Nr. / Art.-No.	Bezeichnung / Description	Name	VE / SU	EAN	Seite / Page
1020RT60	Eierteiler / <i>Egg slicer / Coupe-œuf / Cortahuevos</i>	»Duplex«	4	4 004094 001772	21
1050RT60	Universalöffner / <i>Universal opener / Ouvre-boîte universel / Abridor universal</i>	»Twist«	4	4 004094 001901	102
1060RT60	Eierstückler / <i>Egg cutter / Coupe-œuf dur / Troceador de huevos</i>	»Columbus«	4	4 004094 001833	22
1061RT60	Sparschäler / <i>Swivel peeler / Econome / Pelador ahorrativo</i>	»Famos«	4	4 004094 002069	12
10612611	dito 30 in display	»Famos«	1	4 051734 000114	12
1121RT60	Hebeldosenöffner / <i>Lever can opener / Ouvre-boîte à levier / Abrelatas de palanca</i>	»Original Sieger«	4	4 004094 002014	98
1184RT60	Bohnschneider / <i>Bean slicer / Coupe-haricots / Cortador de judías verdes</i>	»Haricot«	4	4 004094 002045	177
1222RT60	Dosenöffner / <i>Can opener / Ouvre-boîte / Abrelatas</i>	»Automatic«	3	4 004094 002021	102
2035RT70	Pfannenwender / <i>Turner / Spatule à poêle / Espátula</i>	»Flonal«	10	4 004094 002052	56
2110RT60	Doppelwender / <i>Double turner / Double spatule / Espátula doble y pinzas</i>	»Duetto«	4	4 004094 001895	56
3000RT60	Mehrzweckpresse / <i>All purpose press / Presse multi-usages / Prensa multiuso</i>	»Extracta«	4	4 004094 001970	63
3010RT60	Knoblauchpresse / <i>Garlic press / Presse-ail / Prensa de ajos</i>	»Biopress«	4	4 004094 002007	63
3110RT60	Mehrzweckgarnierer / <i>Multi-purpose tool / Outil de décoration / Guarnecedor multiuso</i>	»Decorex-Spezial«	4	4 004094 002038	32
4000RT60	Kirschentkerner / <i>Cherry stoner / Dénoyauteur à cerises / Deshuesador de cerezas</i>	»Kernex«	4	4 004094 001925	174
4010RT60	Pflaumentsteiner / <i>Plum stoner / Dénoyauteur à prunes / Deshuesador de ciruelas</i>	»Steinex«	4	4 004094 001932	174
4020RT60	Kirschen- und Pflaumentsteiner / <i>Cherry and plum stoner / Dénoyauteur à cerises et à prunes / Deshuesador de cerezas y ciruelas</i>	»Steinex-Combi«	4	4 004094 001949	174
4040RT60	Olivenentsteiner / <i>Olive stoner / Dénoyauteur à olives / Deshuesador de aceitunas</i>	»Olivus«	4	4 004094 001918	174
5110RT60	Apfel- und Birnenteiler / <i>Apple- and pear slicer / Coupe-pomme et poire / Partidor de manzanas y peras</i>	»Divisorex«	3	4 004094 001789	19
5120RT60	Radischenverzierer / <i>Radishrose cutter / Coupe-radis / Decorador de rabinitos</i>	»Decoretto«	4	4 004094 001819	32
5170RT60	Vielzweckschneider / <i>Multi purpose slicer / Coupeur multi-usages / Cortador multiuso</i>	»Champion«	4	4 004094 001826	23
6046RT60	Tomaten- und Kiwischäler / <i>Tomato-/kiwi fruit peeler / Eplucheur de tomates / Pelador de tomates y kiwis</i>	»Tomfix«	4	4 004094 001802	13
6080RT60	Pellkartoffel-/Mozzarella-Schneider / <i>Jacket potato and mozzarella slicer / Coupe-pommes de terre et mozzarella / Cortador de patatas cocidas/ mozzarella</i>	»Rondex«	4	4 004094 001840	22
6096RT60	Julienne-Schneider / <i>Julienne-cutter / Couteau à julienne / Cortador Juliana</i>	»Quick-Spezial«	4	4 004094 001796	10
6110RT60	Spätzle Presse / <i>Press for spätzle / Presse à spätzles / Prensa para Spätzle</i>	»Spätzlepress«	4	4 004094 001987	38
6183RT60	Kapselheber / <i>Can opener / Décapsuleur / Abrechapas</i>	»Hermetus«	4	4 004094 001994	108
6200RT60	Fleischhammer / <i>Meat hammer / Attendrisseur de viande / Mazo para carne</i>	»Robusto-Spezial«	3	4 004094 001888	64
6300RT60	Tranchierhilfe / <i>Carving aid / Aide au tranchage / Utensilio auxiliar para trinchar</i>	»Tranchetta«	3	4 004094 001871	66
6500RT60	Fischentschupper / <i>Fish scaler / Ecailleur à poisson / Desescamador</i>	»Scalex«	3	4 004094 001864	78
6600RT60	Hummerkacker / <i>Lobster cracker / Casse-homard / Casca langostas</i>	»Cracky«	4	4 004094 001857	78
7000RT60	Käseschneider / <i>Cheese slicer / Coupe-fromage / Cortador de queso</i>	»Fromarex«	4	4 004094 001963	20
7100RT60	Käseschneider / <i>Cheese slicer / Coupe-fromage / Cortador de queso</i>	»Rollschnitt«	4	4 004094 001956	20





# 12

**gastro-zubehör • catering-equipment**  
**accessoires de restauration • accesorios para la gastronomía**





73 x 73 x 116 mm

**Zuckerdosierer »Paris-Stainless«**  
• Fassungsvermögen: 150 ml

**Distributeur de sucre »Paris-Stainless«**  
• capacité: 150 ml

*Sugar dispenser »Paris-Stainless«*  
• capacity: 150 ml

*Dosificador de azúcar »Paris-Stainless«*  
• cabida: 150 ml

Art-Nr. / Art.-No.	VE / SU	EAN
6344 2261	9	4 004094 634468



49 x 49 x 63 mm

**Universalstreuer »Paris-Snap«**  
• mit praktischem Klappdeckel  
• eingearbeitete Noppen im Deckel verhindern ein Verstopfen des Streukopfes  
• Fassungsvermögen: 40 ml  
• erhältlich als Einzelartikel, im Set oder als Display

**Saupoudreuses universelles »Paris-Snap«**  
• avec couvercle rabattable pratique  
• des bosses moulées dans le couvercle évitent à la tête de la saupoudreuse de se boucher  
• capacité: 40 ml  
• disponibles séparément, ensemble ou en Display

*Universal shaker »Paris-Snap«*  
• with practical snap-lid  
• moulded studs in the lid prevent the shaker from blocking up  
• capacity: 40 ml  
• available as single article set or display

*Salero & pimentero »Paris-Snap«*  
• con práctica tapa plegable  
• las motas incorporadas en la tapa evitan que seatasque la cabeza dispersora  
• cabida: 40 ml  
• obtenibles como artículo suelto, en set o en display



Art-Nr. / Art.-No.	VE / SU	EAN
6305 2261	8	4 004094 630569
6305 2270	10	4 004094 630576
6305 2611	1	4 051734 002354



6304 2261



6314 2261

**Salz- & Pfefferstreuer »Paris-Standard«**  
• Fassungsvermögen: je 40 ml  
• erhältlich als Einzelartikel oder im Set  
• Art 6304 - Salzstreuer  
• Art 6314 - Pfefferstreuer  
• Art 6306 - Set

**Salière & poivrière »Paris-Standard«**  
• capacité: chacun 40 ml  
• disponibles séparément ou ensemble  
• art 6304 - salière  
• art 6314 - poivrière shaker  
• art 6306 - set

*Salt & pepper shaker »Paris-Standard«*  
• capacity: each 40 ml  
• available as single article or as set  
• art 6304 - salt shaker  
• art 6314 - pepper shaker  
• Art 6306 - set

*Salero & pimentero »Paris-Standard«*  
• cabida: sendos 40 ml  
• obtenibles como artículo suelto o en set  
• art 6304 - salero  
• art 6314 - pimentero shaker  
• art 6306 - set

Art-Nr. / Art.-No.	VE / SU	EAN
6304 2261	10	4 004094 630460
6314 2261	10	4 004094 631467
6306 2270	10	4 004094 630675



49 x 49 x 65 mm



6303 2261



6313 2261

**Salz- und Pfefferstreuer »Paris-Chrome«**  
• Fassungsvermögen: je 40 ml  
• erhältlich als Einzelartikel oder im Set  
• Art 6303 - Salzstreuer  
• Art 6313 - Pfefferstreuer  
• Art 6316 - Set

**Salière & poivrière »Paris-Chrome«**  
• capacité: chacun 40 ml  
• disponible séparément ou ensemble  
• art 6303 - salière  
• art 6313 - poivrière  
• art 6316 - set

*Salt/Pepper shaker »Paris-Chrome«*  
• capacity: each 40 ml  
• available as single article or as set  
• art 6303 - salt shaker  
• art 6313 - pepper shaker  
• art 6316 - set

*Salero & pimentero »Paris-Chrome«*  
• cabida: sendos 40 ml  
• obtenibles como artículo suelto o en set  
• art 6303 - salero  
• art 6313 - pimentero  
• art 6316 - set

Art-Nr. / Art.-No.	VE / SU	EAN
6303 2261	10	4 004094 630361
6313 2261	10	4 004094 631368
6316 2270	10	4 004094 631672



49 x 49 x 65 mm



Sahnespender »Paris-Standard«  
Cream dispenser »Paris-Standard«

Distributeur de crème »Paris-Standard«  
Expendedor de nata »Paris-Standard«

Zuckerdosierer »Paris-Standard«  
Sugar dispenser »Paris-Standard«



Distributeur de sucre »Paris-Standard«  
Azucarero »Paris-Standard«

Mehrzweckgießer »Paris-Standard«  
Multi dispenser »Paris-Standard«

Distributeur polyvalent »Paris-Standard«  
Expendedor multiuso »Paris-Standard«

- Fassungsvermögen: 150 ml
- capacity: 150 ml

- capacité: 150 ml chacun
- cabida: sendos 150 ml

Art-Nr. / Art.-No.	VE / SU	Größe / Size	EAN
6342 2261 	9	95 x 73 x 117 mm	4 004094 634260
6346 2261 	9	73 x 73 x 10 mm	4 004094 634666
6348 2261 	9	73 x 73 x 124 mm	4 004094 634864

ABS GLAS



Sahnespender »Paris-Chrome«  
Cream dispenser »Paris-Chrome«

Distributeur de crème »Paris-Chrome«  
Expendedor de nata »Paris-Chrome«

Zuckerdosierer »Paris-Chrome«  
Sugar dispenser »Paris-Chrome«



Distributeur de sucre »Paris-Chrome«  
Azucarero »Paris-Chrome«

Mehrzweckgießer »Paris-Chrome«  
Multi dispenser »Paris-Chrome«

Distributeur polyvalent »Paris-Chrome«  
Expendedor multiuso »Paris-Chrome«

- Fassungsvermögen: 150 ml
- capacity: 150 ml

- capacité: 150 ml chacun
- cabida: sendos 150 ml

Art-Nr. / Art.-No.	VE / SU	Größe / Size	EAN
6340 2261 	9	95 x 73 x 117 mm	4 004094 634062
6343 2261 	9	73 x 73 x 130 mm	4 004094 634369
6349 2261 	9	73 x 73 x 124 mm	4 004094 634963

ABS GLAS







86 x 55 x 114 mm

**Menage Salz & Pfeffer »Wien«, 2-tlg.**  
 • bestehend aus Salz- und Pfefferstreuer sowie Ständer mit Tragegriff  
 • Fassungsvermögen: je 40 ml

*Cruet Stand salt & pepper »Wien«, 2pcs*  
 • consisting of salt- and pepper shaker as well as stand with carrying  
 • handel capacity: each 40 ml

**Service salière & poivrière »Wien«, 2 pièces**  
 • se compose d'une salière et d'une poivrière et d'un support avec poignée  
 • capacité: 40 ml chacun

*Menaje Salero & Pimentero »Wien«, 2 piezas*  
 • compuesto de salero y pimentero, así como de soporte con asa  
 • cabida: sendos 40 ml

Art-Nr. / Art.-No.	VE / SU	EAN
6502 2260 	6	 4 004094 650260





32 x 32 x 91 mm

**Universalstreuer »Wien«**  
 • Fassungsvermögen: je 40 ml

*Universal shaker »Wien«*  
 • capacity: each 40 ml

**Saupoudreur universel »Wien«**  
 • capacité: 40 ml

*Dispensur universal »Wien«*  
 • cabida: sendos 40 ml

Art-Nr. / Art.-No.	VE / SU	EAN
6507 2291 	12	 4 004094 650710





121 x 73 x 187 mm

**Menage Essig & Öl »Wien«, 2-tlg.**  
 • bestehend aus Essig- und Öldosierer sowie Ständer mit Tragegriff  
 • Fassungsvermögen: je 160 ml

*Cruet Stand oil & vinegar »Wien«, 2pcs*  
 • consisting of oil- and vinegar dispenser as well as stand with carrying handel  
 • capacity: each 160 ml

**Service vinaigre & huile »Wien«, 2 pièces**  
 • se compose d'un doseur de vinaigre et d'huile et d'un support avec poignée  
 • capacité: 160 ml chacun

*Menaje Vinagrera & Aceitera »Wien«, 2 piezas*  
 • compuesto de dosificador de vinagre y aceite, así como de soporte con asa  
 • cabida: sendos 160 ml

Art-Nr. / Art.-No.	VE / SU	EAN
6504 2260 	6	 4 004094 650468





49 x 49 x 160 mm

**Essig- / Ölflasche »Wien«**  
 • Fassungsvermögen: je 160 ml

*Oil / vinegar bottle »Wien«*  
 • capacity: each 160 ml

**Bouteille à vinaigre / huile »Wien«**  
 • capacité: 160 ml chacun

*Vinagrera / aceitera »Wien«*  
 • cabida: sendos 160 ml

Art-Nr. / Art.-No.	VE / SU	EAN
6509 2291 	6	 4 004094 650918







**Menage Salz, Pfeffer, Essig & Öl »Wien«, 4-tlg.**  
 • bestehend aus Salz-, Pfefferstreuer, Essig- und Öldosierer sowie Ständer mit Tragegriff  
 • Fassungsvermögen: 2 x 40 ml & 2 x 160 ml

**Service sel, poivre, vinaigre & huile »Wien«, 4 pièces**  
 • se compose d'une salière, d'une poivrière, d'un doseur de vinaigre et d'un doseur d'huile ainsi que d'un support avec poignée  
 • capacité: 2 x 40 ml & 2 x 160 ml

**Cruet Stand salt, pepper, oil & vinegar »Wien«, 4pcs**  
 • consisting of salt and pepper pots as well as oil and vinegar bottles with pourers and stand with handle  
 • capacity: 2 x 40 ml & 2 x 160 ml

**Menaje Salero, Pimentero, Vinagrera & Aceitera »Wien«, 4 piezas**  
 • compuesto de dosificadores de sal, pimienta, vinagre y aceite, así como de soporte con asa  
 • cabida: 2 x 40 ml & 2 x 160 ml

Art-Nr. / Art.-No.	VE / SU	EAN
6505 2260 	6	 4 004094 650567



123 x 112 x 187 mm



Serie  
**»Wien«**



**Parmesan-/Zuckertopf »Wien«**  
 • bestehend aus Parmesan-/Zuckertopf und Löffel sowie Ständer mit Tragegriff  
 • Fassungsvermögen: 150 ml

**Pot à parmesan/sucre »Wien«**  
 • se compose d'un pot à parmesan/sucre, d'une cuillère et d'un support avec poignée  
 • capacité: 150 ml

**Parmesan-/sugar-pot »Wien«**  
 • consisting of parmesan-/sugar-pot and spoon as well as stand with carrying handle  
 • capacity: 150 ml

**Recipiente para parmesano/azúcar »Wien«**  
 • compuesto de recipiente para parmesano/azúcar y cucharilla, así como de soporte con asa  
 • cabida: 150 ml



Art-Nr. / Art.-No.	VE / SU	EAN
6511 2260 	6	 4 004094 651168



124 x 105 x 130 mm

Serie

# »New York«





50 x 50 x 111 mm

Salz- & Pfefferstreuerset »New York«, 2-tlg.  
• Fassungsvermögen: je 40 ml

Ensemble salière & poivrière »New York«, 2 pièces  
• capacité: 40 ml chacun

Set salt & pepper shaker »New York«, 2 pcs  
• capacity: each 40 ml

Set de salero & pimentero »New York«, 2 piezas  
• cabida: sendos 40 ml

Art-Nr. / Art.-No.	VE / SU	EAN
6526 2270 	6	 4 004094 652677

INOX GLAS





50 x 50 x 111 mm

Universalstreuer »New York«  
• Fassungsvermögen: 40 ml

Saupoudreur universel »New York«  
• capacité: 40 ml

Salt & pepper shaker »New York«  
• capacity: 40 ml

Dispensor universal »New York«  
• cabida: 40 ml

Art-Nr. / Art.-No.	VE / SU	EAN
6527 2291 	12	 4 004094 652714

INOX GLAS





76 x 76 x 133 mm

Zuckerstreuer »New York«  
• Fassungsvermögen: 300 ml

Sucrier verseur »New York«  
• capacité: 300 ml

Sugar dispenser »New York«  
• capacity: 300 ml

Azucarero »New York«  
• cabida: 300 ml

Art-Nr. / Art.-No.	VE / SU	EAN
6520 2260 	6	 4 004094 652066

INOX GLAS



76 x 76 x 170 mm

Zuckerdosierer »New York«  
• Fassungsvermögen: 300 ml

Doseur à sucre »New York«  
• capacité: 300 ml

Sugar dispenser »New York«  
• capacity: 300 ml

Dosificador de azúcar »New York«  
• cabida: 300 ml

Art-Nr. / Art.-No.	VE / SU	EAN
6524 2260 	6	 4 004094 652462

INOX GLAS





Salz- & Pfefferstreuer »Berlin«, 2-tlg.  
• Fassungsvermögen: je 50 ml



Ensemble salière & poivrière »Berlin«, 2 pièces  
• capacité: 50 ml chacun



50 x 50 x 70 mm

Set salt & pepper shaker »Berlin«, 2 pcs  
• capacity: each 50 ml

Set de salero & Pimentero »Berlin«, 2 piezas  
• cabida: sendos 50 ml

Art-Nr. / Art.-No.	VE / SU	EAN
6536 2270 	6	 4 004094 653674







Serie  
»Berlin«

Salz- & Pfefferstreuer »Berlin«  
• Fassungsvermögen: je 50 ml

Salière & poivrière »Berlin«  
• capacité: 50 ml chacun

Salt & pepper shaker »Berlin«  
• capacity: each 50 ml

Salero & pimentero »Berlin«  
• cabida: sendos 50 ml

Art-Nr. / Art.-No.	VE / SU	EAN
6537 2291 	12	 4 004094 653711
6538 2291 	12	 4 004094 653810





49 x 49 x 67 mm

Sahnegießer/Honigspender »Berlin«  
• Fassungsvermögen: 250 ml

Distributeur de crème/miel »Berlin«  
• capacité: 250 ml

Cream/honey dispenser »Berlin«  
• capacity: 250 ml

Vertedor de nata/Dispensador de miel »Berlin«  
• cabida: 250 ml

Art-Nr. / Art.-No.	VE / SU	EAN
6530 2260 	6	 4 004094 653063





123 x 80 x 118 mm

Zuckerdosierer »Berlin«  
• Fassungsvermögen: 250 ml

Doseur à sucre »Berlin«  
• capacité: 250 ml

Sugar dispenser »Berlin«  
• capacity: 250 ml

Dosificador de azúcar »Berlin«  
• cabida: 250 ml

Art-Nr. / Art.-No.	VE / SU	EAN
6534 2260 	6	 4 004094 653469



80 x 80 x 150 mm

Serie

# »Roma«





54 x 54 x 58 mm

Salz- & Pfefferstreuerset »Roma«, 2-tlg.  
• Fassungsvermögen: je 50 ml

Set salt & pepper shaker »Roma«, 2 pcs  
• capacity: each 50 ml

Ensemble salière & poivrière »Roma«, 2 pièces  
• capacité: 50 ml chacun

Set de salero & pimentero »Roma«, 2 piezas  
• cabida: sendos 50 ml

Art-Nr. / Art.-No.	VE / SU	EAN
6546 2270 	6	 4 004094 654671



6547 2291

6548 2291





54 x 54 x 58 mm

Salz- & Pfefferstreuer »Roma«  
• Fassungsvermögen: je 50 ml

Salt & pepper shaker »Roma«  
• capacity: each 50 ml

Salière & poivrière »Roma«  
• capacité: 50 ml chacun

Salero & pimentero »Roma«  
• cabida: sendos 50 ml

Art-Nr. / Art.-No.	VE / SU	EAN
6547 2291 	12	 4 004094 654718
6548 2291 	12	 4 004094 654817





114 x 86 x 107 mm

Sahnegießer/Honigspender »Roma«  
• Fassungsvermögen: 250 ml

Cream/honey dispenser »Roma«  
• capacity: 250 ml

Distributeur de crème/miel »Roma«  
• capacité: 250 ml

Vertedor de nata/Dispensador de miel »Roma«  
• cabida: 250 ml

Art-Nr. / Art.-No.	VE / SU	EAN
6540 2260 	6	 4 004094 654060





86 x 86 x 120 mm

Zuckerdosierer »Roma«  
• Fassungsvermögen: 250 ml

Sugar dispenser »Roma«  
• capacity: 250 ml

Doseur à sucre »Roma«  
• capacité: 250 ml

Dosificador de azúcar »Roma«  
• cabida: 250 ml

Art-Nr. / Art.-No.	VE / SU	EAN
6544 2260 	6	 4 004094 654466





- Honigbirne »Deluxe«
- praktisches Einhand-Bedienprinzip
  - mit Glas-Untersatz
  - Fassungsvermögen: 200 ml



- Honey dispenser »Deluxe«
- practical one-hand-operation-principle
  - with glass-saucer
  - capacity: 200 ml

- Distributeur de miel »Deluxe«
- utilisation pratique à une main
  - avec base adaptée en verre
  - capacité: 200 ml

- Pera para miel »Deluxe«
- principio práctico al manejo de una sola mano
  - con base en cristal
  - cabida: 200 ml



## Serie »Deluxe«

Art-Nr. / Art.-No.	VE / SU	EAN
6513 2260 	6	 4 004094 651366



83 x 83 x 144 mm



## Serie »Traditionell«

Set mit 2 Mini-Streuern

Ensemble de 2 mini-distributeurs

Set with 2 mini-shakers

Set con 2 mini-expendedores

Art-Nr. / Art.-No.	VE / SU	EAN
6307 2260 	10	 4 004094 630767



29 x 29 x 49 mm

Salz- & Pfefferstreuer »Traditionell«

- Fassungsvermögen: je 50 ml

Salière & poivrière »Traditionell«

- capacité: 50 ml

Salt & Pepper shaker »Traditionell«

- capacity: je 50 ml

Saleros y pimenteros »Traditionell«





- cabida: 50 ml



6301 2260

6310 2260

37 x 37 x 70 mm

Art-Nr. / Art.-No.	VE / SU	EAN
6310 2260 	10	 4 004094 631061
6301 2260 	10	 4 004094 630163



Made in GERMANY



- Salz- und Pfeffermühle »Classic«**
- aus Buchenholz
  - mit Keramikmahlwerk
  - Zentrierring zum genauen Führen der Mahlachse
  - stufenloses Verstellen des Mahlgrades am Drehknopf

- Salt- and peppermill »Classic«**
- from beechwood
  - with ceramic grinder
  - centering element assures precise control of grinding spindle • variable grinding setting at rotary knob







- Moulin à sel et à poivre »Classic«**
- en hêtre
  - avec broyeur en céramique
  - l'axe de broyage guidé précisément par une bague de centrage
  - réglage continu à l'aide du bouton tournant

- Molinillos de sal y pimienta »Classic«**
- de madera de haya
  - mecanismo molidor de cerámica
  - anillo de centrage
  - la finura de la molienda puede ajustarse en el botón giratorio



inklusive:  
1 Drehknopf „S“ = Salz  
1 Drehknopf „P“ = Pfeffer



Art-Nr. / Art.-No.	VE / SU	Größe / Size	EAN
6360 2260 	4	18 cm / 56 x56 x 203 mm	 4 004094 636066
6362 2260 	4	24 cm / 55 x55 x 250 mm	 4 004094 636264
6364 2260 	4	28 cm / 61 x 61 x 300 mm	 4 004094 636462



- Salz- und Pfeffermühle**
- aus Holz, lackiert
  - mit Keramikmahlwerk
  - Zentrierring zum genauen Führen der Mahlachse
  - stufenloses Verstellen des Mahlgrades am Drehknopf

- Salt- and peppermill**
- wood, varnished
  - with ceramic grinder
  - centering element assures precise control of grinding spindle
  - variable grinding setting at rotary knob

- Moulin à sel et à poivre**
- bois, verni
  - avec broyeur en céramique
  - l'axe de broyage guidé précisément par une bague de centrage
  - réglage continu à l'aide du bouton tournant

- Molinillos de sal y pimienta**
- madera barnizada
  - mecanismo molidor de cerámica
  - anillo de centrage
  - la finura de la molienda puede ajustarse en el botón giratorio

inklusive:  
1 Drehknopf „S“ = Salz  
1 Drehknopf „P“ = Pfeffer



Art-Nr. / Art.-No.	VE / SU	Größe / Size	EAN
6366 2260  	4	24 cm / 55 x 55 x 250 mm	 4 004094 636660
6368 2260  	4	24 cm / 55 x 55 x 250 mm	 4 004094 636868







- Salz- und Pfeffermühle »Traditionell«**
- mit Keramikmahlwerk
  - auch für Salz oder andere Gewürze
  - Verstellen des gewünschten Mahlgrades am untenliegenden Einstellring

- Moulin à sel et à poivre »Traditionell«**
- avec broyeur en céramique
  - convient aussi pour le sel ou d'autres épices
  - réglage continu à la bague située en bas

- Salt- and peppermill »Traditionell«**
- with ceramic grinder
  - also suitable for salt or other spices
  - adjusting ring provides variable grinding grade

- Molinillos de sal y pimienta »Traditionell«**
- con mecanismo molidor de cerámica
  - idóneo también para sal u otras especias
  - regulación sin escalones en el anillo de ajuste ubicado abajo

**Auslaufartikel • Discontinued article**  
**Fin de série • Artículo discontinuado**

Art-Nr. / Art.-No.	VE / SU	EAN
6356 2260 	6	 4 004094 635663

INOX



65 x 65 x 215 mm



- Salz- und Pfeffermühle »Automatic«**
- elektrische Mühle mit Keramikmahlwerk
  - auch für Salz oder andere Gewürze
  - praktische Einhandbedienung
  - mit Beleuchtung
  - benötigt 6 x AAA-Batterien (Nicht im Lieferumfang.)



- Moulin à sel et à poivre »Automatic«**
- moulin électrique avec broyeur en céramique
  - convient aussi pour le sel ou d'autres épices
  - utilisation pratique d'une seule main
  - avec éclairage
  - nécessite 6 piles AAA (non comprises)

- Salt- and peppermill »Automatic«**
- electric mill with ceramic grinder
  - also suitable for salt or other spices
  - practical one-hand operation
  - with light
  - 6 x AAA-batteries are required (not included)

- Molinillos de sal y pimienta »Automatic«**
- molinillo eléctrico con mecanismo molidor de cerámica
  - idóneo también para sal u otras especias
  - práctico manejo con una sola mano
  - con alumbrado
  - se necesitan 6 pilas AAA (no incluidas)

**Auslaufartikel • Discontinued article**  
**Fin de série • Artículo discontinuado**



Art-Nr. / Art.-No.	VE / SU	EAN
6358 2260 	6	 4 004094 635861

INOX



65 x 65 x 215 mm



40 x 40 x 73 mm



**Universalmühle »Acrylic«**

- handliche Tischmühle für Pfeffer, Salz und andere Gewürze
- mit Keramikmahlwerk

**Moulin universel »Acrylic«**



- moulin de table pratique pour poivre, sel et autres épices
- avec broyeur en céramique

**Universal mills »Acrylic«**

- handy table mill for pepper, salt and other spices
- with ceramic grinder

**Molino universal »Acrylic«**

- práctico molino de mesa para pimienta, sal y otras especias
- con molturador de cerámica

Art-Nr. / Art.-No.	VE / SU	EAN
6352 2660 	1	 4 051734 001906

PC



51 x 51 x 139 mm

**Salz- und Pfeffermühle »Acryl«**

- für Pfeffer, Salz und andere Gewürze
- mit Keramikmahlwerk

**Moulin à sel et à poivre »Acryl«**



- pour poivre, sel et autres épices
- avec broyeur en céramique

**Salt- and peppermill »Acryl«**

- for pepper, salt and other spices
- with ceramic grinder

**Molinillos de sal y pimienta »Acryl«**

- para pimienta, sal y otras especias
- con mecanismo molturador de cerámica

Art-Nr. / Art.-No.	VE / SU	EAN
6353 2260 	6	 4 004094 635366

PC



68 x 68 x 132 mm

**Gewürzmühle mit Keramikmahlwerk**

- elegante Tischmühle für Pfeffer, Salz usw.
- stufenlose Regulierung des Mahlgrades durch Drehen der Einstellschraube

**Moulin à épices avec broyeur en céramique**



- élégant moulin de table pour poivre, sel etc.
- réglage continu du niveau de mouture en tournant la vis de réglage

**Spice mill with ceramic grinder**

- elegant spice mill for pepper, salt etc.
- smooth regulation of grinding level by turning the setting screw

**Molino de especias con molturador de cerámica**

- elegante molino de mesa para pimienta, sal etc.
- regulación continua del grado de molienda girando el tornillo de ajuste

Art-Nr. / Art.-No.	VE / SU	EAN
6354 2260 	6	 4 004094 635465

GLAS

PS





PP





- Gewürzstreuer »Grob« & »Fein«**
- mit Frischhaltedeckel (transparent)
  - z.B. für Kräutermischungen, Schoko- oder Deko-Streusel, braunen Zucker etc.

- Spice shaker »Grob« & »Fein«**
- with keep-fresh lid (transparent)
  - for example for spice mixtures, icing sugar, chocolate or decorative crumbles, brown sugar etc.

Art-Nr. / Art.-No.	VE / SU	EAN
6952 2260 	4	 4 004094 695261
6954 2260 	4	 4 004094 695469

- Saupoudreuse à épices grossières »Grob« & »Fein«**
- avec couvercle hermétique
  - par ex. pour des mélanges d'herbes, sucre glace, vermicelles de chocolat ou de décoration, cassonade etc.
- Esparcidor de especias basto »Grob« & »Fein«**
- con tapa con cierre hermético
  - p.ej., para mezclas de hierbas, azúcar glas, pepitas de chocolate o de decoración, azúcar moreno, etc.



6954 2260



62 x 62 x 82 mm



- Gewürzdosenset**
- 4 Gewürzdosens mit Magnetboden auf Edelstahlboard
  - mit 2 verschiedenen Öffnungen zum perfekten Dosieren

- Spice rack**
- 4 seasoning pots with magnetic bases on a stainless steel rack
  - with 2 different openings for perfect dispensing

- Ensemble de boîtes à épices**
- 4 boîtes à épices à fond aimanté sur tablette en acier inoxydable
  - avec 2 orifices différents pour un parfait dosage

- Set de cajas de especias**
- 4 cajas para especias con fondo magnético sobre estante de acero inoxidable
  - con 2 aberturas distintas para la dosificación perfecta



Art-Nr. / Art.-No.	VE / SU	EAN
6515 2260 	6	 4 004094 651564



275 x 84 x 80 mm

- Mörser**
- mit Stößel
  - aus Natur-Granit
  - zum Zerstoßen und Zermahlen von Kräutern und Gewürzen

- Mortar**
- with pestle
  - made from natural granite
  - for crushing and grinding herbs and spices



- Mortier**
- avec pilon
  - en granit nature pour broyer et piler des herbes et épices

- Mortero**
- con maja
  - de granito natural
  - para picar y triturar hierbas y especias, para hacer sabrosos patés sazonados, pesto, etc.

Natur-Granit  
natural granite



130 x 130 x 70 mm

Art-Nr. / Art.-No.	VE / SU	EAN
6960 2260 	3	 4 004094 696060



- Mörser mit Stößel »Gourmet«**
- mit Stößel
  - aus Marmor
  - zum Zerstoßen und Zermahlen von Kräutern und Gewürzen



- Mortar »Gourmet«**
- with pestle
  - made from fine marble
  - for crushing and grinding herbs and spices

- Pilon avec poussoir »Gourmet«**
- avec pilon
  - de marbre
  - pour broyer et piler des herbes et épices

- Mortero con mano »Gourmet«**
- con maja
  - en marble
  - para picar y triturar hierbas y especias, para hacer sabrosos patés sazonados, pesto, etc.



102 x 102 x 75 mm

Art-Nr. / Art.-No.	VE / SU	EAN
6959 2260 	3	 4 004094 695964



- Essig- und Ölsprüher-Set**
- elegantes Duo aus Glas und Edelstahl
  - zum gezielten - sparsamen - Dosieren von Essig und Öl



- Oil and vinegar spray set**
- elegant duo from glass and stainless steel
  - for the targeted and - if wished - sparingly applied dosage of vinegar and oil

- Ensemble de vaporisateurs de vinaigre et d'huile**
- duo élégant en verre et acier inoxydable
  - pour le dosage ciblé et si nécessaire avec parcimonie du vinaigre et de l'huile

- Set pulverizador aceite / vinagre**
- elegante dúo de cristal y acero inoxidable
  - para dosificar exactamente y - si se desea, de modo ahorrativo vinagre y aceite



42 x 42 x 180 mm

Art-Nr. / Art.-No.	VE / SU	EAN
2436 2260 	6	 4 004094 243660



gastro-zubehör • catering-equipment • accessories para la gastronomía



81 x 47 x 14 mm

**Partyglashalter »Clipper«**

- funktioniert mit Stielgläsern
- mit gummierter Rutschsicherung für festen Halt
- als 8er Set im Verkaufskarton oder lose

*Party-glass-holders »Clipper«*



- functions with stemware
- rubber-coating at the plate touching side for secure grip
- available as set with 8 pcs in a sales carton or bulk

**Porte-verre à pied »Clipper«**

- fonctionne avec les verres à pied
- revêtement antidérapant caoutchouté pour un maintien fixe
- disponible en carton de 8 pièces ou au détail

*Portavasos de guateque »Clipper«*

- funciona con vasos con asa
- con anti-resbalador engomado para una buena sujeción
- como set de 8 piezas caja de cartón para ventas o sueltos

Art-Nr. / Art.-No.	VE / SU	EAN
5155 2260 	5	 4 004094 515569
5155 2210 	100	



79 x 50 x 160 mm

**Bierwärmer**

- hilft, kaltes Bier zu erwärmen, um es bekömmlicher zu machen
- zum Abtropfen in den mitgelieferten Halter stellen

*Beer warmer*



- helps to make your beer warmer - so that it becomes more agreeable
- comes with a drain-off stand

**Chauff e-bière**

- aide à réchauffer de la bière froide pour la rendre plus agréable
- avec support anti-gouttes

*Calentador de cerveza*

- ayuda a calentar la cerveza fría para hacerla más digestiva
- colocarle en el soporte que se adjunta para que gotee

Art-Nr. / Art.-No.	VE / SU	EAN
6328 2260 	3	 4 004094 632860

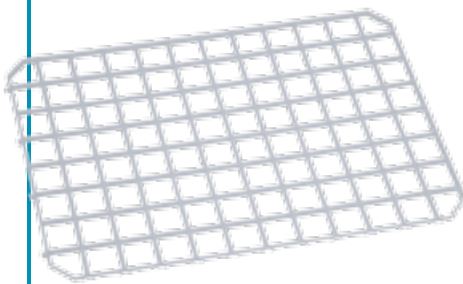

314 x 210 x 19 mm

**Gläserabtropfmatten**

- Set mit 4 Matten
- beliebig zusammensteckbar durch Steckvorrichtungen an den Enden
- verbessert die Luftzirkulation und läßt die Gläser somit besser trocknen

*Glass-clipper mats*



- set of 4 mats
- optionally interlocking because of plug devices at the edges
- will improve the air circulation and thus help the glass to dry quicker

**Tapis égouttoir à verres**

- ensemble de 4 tapis
- pliable grâce aux dispositifs aux extrémités
- améliore la circulation de l'air et permet aux verres de mieux sécher

*Bases para goteo de vasos*

- set con 4 bases
- pueden juntarse cuantas se quiera gracias a los enchufes existente en los extremos
- mejora la circulación de aire, por lo que se secan mejor los vasos

Art-Nr. / Art.-No.	VE / SU	EAN
6430 2250 	5	 4 004094 643057

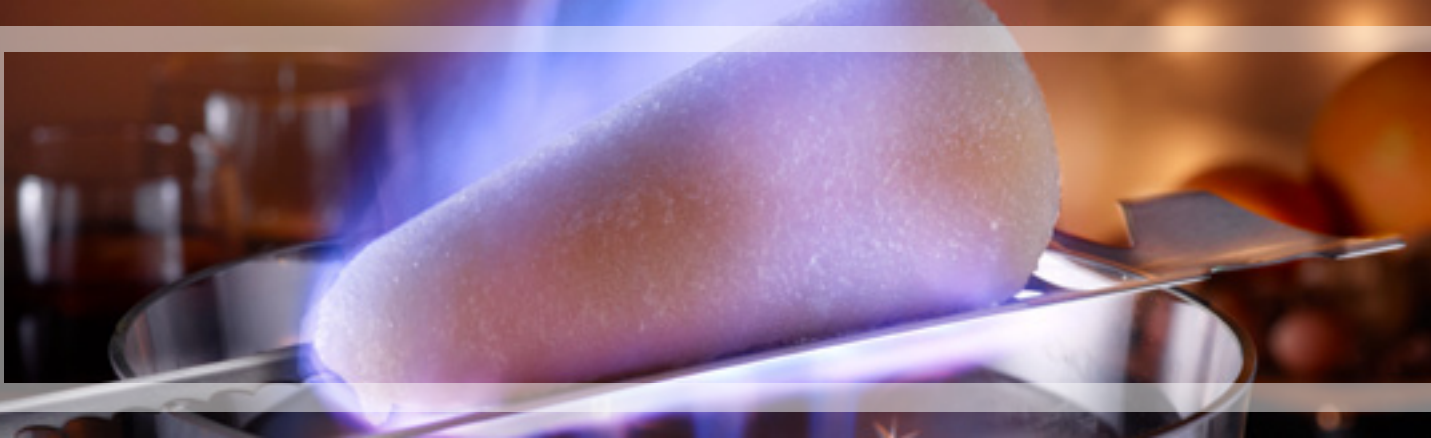

305 x 60 x 5 mm

**Zuckerzange**

- mit einer Länge von 30,5 cm für unterschiedliche Bowlgefäße geeignet
- die Lochung sorgt für ein optimales Abfließen des erhitzten Zuckers

*Tongs for burnt punch*



- with a length of 30,5 cm suitable for punch bowls of different sizes
- the holes allow an easy flow of the heated sugar

**Pince à sucre pour le punch**

- avec une longueur de 30,5 cm, elle convient à différents récipients
- la perforation permet un écoulement optimal du sucre chauffé

*Oporte para azúcar del ponche alemán*

- con una longitud de 30,5 cm, adecuado para diversos recipientes para ponche
- el cono de azúcar se apoya bien sobre el soporte

Art-Nr. / Art.-No.	VE / SU	EAN
6330 2260 	6	 4 004094 633065





**Caipirinha-Stößel**  
• aus Buchenholz



**Pilon Caipirinha**  
• en hêtre

**Caipirinha Pestle**  
• from beechwood

**Mano para Caipirinha**  
• de madera de haya



200 x 27 x 27 mm

Art-Nr. / Art.-No.	VE / SU	EAN
6280 2270 	6	 4 004094 628078



**Eiszerkleinerer »Cuby«**  
• ideal, um schnell und einfach eine kleine Menge Eis für Cocktails, Longdrinks etc. zu zerkleinern

**Broyeur à glace »Cuby«**  
• idéal pour réduire rapidement et simplement de petite quantité de glace pour des cocktails, longdrinks etc.

**Ice crusher »Cuby«**  
• ideal for crushing a small portion of ice quickly and easily for cocktails, long drinks etc.

**Desmenizador de hielo »Cuby«**  
• ideal para desmenuzar de un modo rápido y sencillo una pequeña cantidad de hielo para cócteles, long drinks, etc.



173 x 65 x 45 mm

Art-Nr. / Art.-No.	VE / SU	EAN
1200 2260 	5	 4 004094 120060



**Cocktailshaker »Casablanca«, 0,5 l**  
• mit 6 interessanten Cocktailrezepten (für jeweils 3 und 6 Cocktails)  
• der Deckel dient gleichzeitig als Messbecher



**Shaker à cocktail »Casablanca«, 0,5 l**  
• avec 6 recettes intéressantes de cocktails (pour à chaque fois 3 et 6 cocktails)  
• le couvercle sert également de bol mesureur

**Cocktailshaker »Casablanca«, 0,5 l**  
• with 6 interesting cocktail recipes (for each 3 and 6 cocktails)  
• lid doubles up as measuring cup

**Shaker para cócteles »Casablanca«, 0,5 l**  
• con 6 interesantes recetas de cócteles (para 3 y 6 cócteles, respectivamente)  
• la tapa sirve al mismo tiempo de vaso medidor



84 x 84 x 210 mm

Art-Nr. / Art.-No.	VE / SU	EAN
6289 2260 	6	 4 004094 628962







**Barmaß**  
• ein praktisches Hilfsmittel zum Cocktail-Mixen  
• zwei Funktionsseiten - einfach Umdrehen für eine andere Maßeinheit

**Mesure de bar**  
• un outil pratique pour mélanger les cocktails  
• deux côtés fonctionnels – retourner simplement pour une autre unité de mesure

**Double jigger**  
• a handy tool to have when mixing cocktails  
• two functional sides - simply flip for different measurements

**Medida para bares**  
• un ayudante práctico para mezclar cócteles  
• dos lados funcionales – dar sencillamente la vuelta para obtener otra unidad de medida



Art-Nr. / Art.-No.	VE / SU	Größe / Size	EAN
6277 2260 	3	2/4 cl - 85 x ø 45 mm	 4 004094 627767
6278 2260 	3	2/3 cl - 75 x ø 40 mm	 4 004094 627866







**3-teiliger Cocktailshaker**  
• in gebürstetem Look  
• mit eingearbeitetem Sieb  
• erhältlich in 2 Größen

**Shaker à cocktails 3 parties**  
• aspect brossé  
• avec passoire  
• disponible en 2 tailles

**3-piece Cocktailshaker**  
• brushed finish  
• built-in ice strainer  
• available in 2 sizes

**Shaker para cócteles, de 3 piezas**  
• en look cepillado  
• con tamiz integrado  
• obtenible en 2 tamaños



Art-Nr. / Art.-No.	VE / SU	Größe / Size	EAN
6281 2260 	3	0,5 l / 205 x ø 90 mm	 4 004094 628160
6283 2260 	3	0,75 l / 235 x ø 90 mm	 4 004094 628368









- Eislöffel/-portionierer »Gallant«**
- aus Metallguss - hochwertig verchromt
  - zum Formen gleichförmiger Eiskugeln
  - Komfort-Soft-Touch-Griff

- Ice-cream scoop »Gallant«**
- from die-cast metal - with high-quality chrome-plating
  - for scooping out equal-sized portions of ice-cream
  - comfort-soft-touch handle

Art-Nr. / Art.-No.	VE / SU	EAN
2958 2270 	6	 4 004094 295874



215 x 44 x 34 mm

- Eisportionierer »Profi«**
- formt schnell und einfach gleichförmige Eiskugeln
  - auch als Speisenportionierer für das Anrichten von Reis und Püree zu empfehlen

- Ice-cream scoop »Profi«**
- scoops out equal-sized portions of ice-cream quickly and easily
  - recommended as well for making attractive portions of rice and puree

Art-Nr. / Art.-No.	VE / SU	EAN
6294 2280 	5	 4 004094 629488



- Cuillère à glace »Profi«**
- confectionne des boules de glace de manière rapide et uniforme
  - également recommandée comme cuillère pour le dressage élégant du riz et de la purée

- Cuchara para helado »Profi«**
- hace bolas de helado uniformes de forma rápida y sencilla
  - también se puede utilizar para la presentación de comida, por ejemplo, al arroz o al puré





218 x 63 x 31 mm



- Speisekarten- und Eiskartenständer**
- Tischkartenaufsteller aus Edelstahl
  - sicherer Halt für verschiedene Kartenstärken
  - als 2er Set oder lose als Einzelartikel erhältlich

- Menu holder**
- card holder from stainless steel
  - safe stand for various thicknesses of menu-cards
  - available as a set of 2 pieces or bulk as single item

Art-Nr. / Art.-No.	VE / SU	EAN
6410 2210 	10	
6410 2230 	5	 4 004094 641039



- Porte-menus**
- porte-menus en acier inoxydable
  - maintien sûr pour différentes épaisseurs de cartes
  - disponible en set de 2 pièces ou au détail en vrac

- Sujetacartas de platos y helados**
- sujetacartas de mesa de acero inoxidable
  - sujeción segura para distintos gruesos de las cartas
  - disponible como set de 2 piezas o como artículo individual



ohne Karte  
without plastic card

80 x 75 x 24 mm

- Tisch-/Kellnerglocke**
- mit achteckigem Buchenholzfuß
  - Glocke hochglanzverchromt
  - reiner Klang

- Table waiter bell**
- with octagonal beech wood base
  - bell high-polish chrome-plated
  - clear sound

Art-Nr. / Art.-No.	VE / SU	EAN
6320 2230 	4	 4 004094 632020
6320 2250 	3	



- Cloche de table et de service**
- avec pied en hêtre octogonal
  - cloche chromé brillant
  - son pur

- Timbre de sobremesa/para llamar al camarero**
- con pata de madera de haya octogonal
  - timbre cromado a alto brillo
  - sonido puro



91 x 91 x 58 mm

**Kunststoffschaufel**

- ideal für trockene, stückige Lebensmittel wie Backzutaten, Gewürze etc.

*Plastic scoop*

- ideal for dry, chunky foodstuffs such as baking ingredients, spices etc.

**Pelle en plastique**

- idéale pour les aliments secs, en morceaux telsque les ingrédients de cuisson et les épices

*Cogedor de plástico*

- ideal para comestibles secos, en trozos tales como ingredientes para panificar, especias, etc.



Art-Nr. / Art.-No.	VE / SU	ml (ca.)	Mehl / flour (ca.)	Größe / Size	EAN
9091 2291	12	110 ml	100 g	185 x 63 x 31 mm	4 004094 909191
9093 2291	12	230 ml	250 g	250 x 90 x 41 mm	4 004094 909399
9095 2291	6	470 ml	430 g	310 x 112 x 53 mm	4 004094 909597
9097 2291	3	725 ml	660 g	345 x 145 x 75 mm	4 004094 909795
9099 2291	3	1390 ml	1265 g	400 x 170 x 85 mm	4 004094 909993

PP



Made in GERMANY



**Innenstiel-/Sackschaufel »Magazin«**

- konzipiert für den täglichen Einsatz
- als Back-, Abwiege-, Abfüll- oder Futterschaufel für trockene, körnige oder stückige Lebensmittel wie Mehl, Zucker, Gewürze etc.
- im Druckgussverfahren gefertigt
- wegen der optimalen Schwerpunktpositionierung durch den nach vorn gerichteten Griff - besonders angenehm im Handling bei schweren Befüllungen
- Wichtig: Reinigung per Handwäsche

*Scoop with inside handle / Sack scoops »Magazin«*

- heavy duty tool
- suitable as scoop for baking ingredients or animal feed for dry, grainy or chunky foodstuffs such as flour, sugar, spices etc.
- crafted in cast aluminium
- because of the ideal positioning of the centre of gravity due to the front handle this tool eases the handling of weighty loads
- important: hand wash only

**Pelle avec manche vers l'intérieur »Magazin«**

- conçu pour un usage quotidien
- peut être utilisée pour les aliments secs, en grains ou en morceaux tels que la farine, le sucre, les épices etc.
- fabriqué en une pièce coulée sous pression
- grâce à la position optimale du centre de gravité lié au manche dirigé vers l'avant, cet outil permet de prendre plus facilement des charges lourdes
- important: nettoyage à la main

*Cogedor con mango interior/para sacos »Magazin«*

- concebido para la aplicación diaria
- como cogedores para panificación, pesaje, llenado o forraje para comestibles secos, granulados o de trozos tales como harina, azúcar, especias, etc.
- fabricado por el proceso de colada a presión
- debido al óptimo posicionado del centro de gravedad por la empuñadura dirigida hacia delante - especialmente agradable en la manipulación de cargas pesadas
- importante: limpie a mano



Art-Nr. / Art.-No.	VE / SU	ml (ca.)	Mehl / flour (ca.)	Größe / Size	EAN
9031 2291	2	2600 ml	2000 g	320 x 165 x 165 mm	4 004094 903199

AL





**Haushaltsschaufel »Hygia«**

- geeignet als Back-, Abwiege oder Abfüllschaufel für trockene, körnige oder stückige Lebensmittel wie Mehl, Zucker, Gewürze etc.
- im Druckgussverfahren in einem Stück gefertigt - besonders stabil
- jeweils mit praktischem Aufhängerloch im Griff
- Wichtig: Reinigung per Handwäsche

**Scoop »Hygia«**

- suitable as scoop for baking ingredients or animal feed for dry, grainy or chunky foodstuffs such as flour, sugar, spices etc.
- crafted from cast aluminium
- with practical hanging hole in the handle
- important: hand wash only

**Pelle de cuisine »Hygia«**

- s'utilise pour les aliments secs, en grains ou en morceaux tels que la farine, le sucre, les épices etc.
- fabriqué en une pièce coulée sous pression - particulièrement stable
- à chaque fois avec trou d'accrochage pratique dans le manche
- Important: nettoyage à la main

**Cogedor »Hygia«**

- idóneo como cogedor para panificación, pesaje o envasado para comestibles secos, granulados o de trozos tales como harina, azúcar, especias, etc.
- hechos de una sola pieza por el proceso de colada a presión - especialmente estables
- con un práctico agujero en el asa para colgar
- importante: límpiense a mano



Art-Nr. / Art.-No.	VE / SU	ml (ca.)	Mehl / flour (ca.)	Größe / Size	EAN
9101 2291	10	37 ml	35 g	130 x 48 x 38 mm	4 004094 910197
9111 2291	10	48 ml	45 g	145 x 53 x 38 mm	4 004094 911194
9121 2291	10	75 ml	63 g	160 x 58 x 45 mm	4 004094 912191
9131 2291	10	113 ml	110 g	185 x 65 x 42 mm	4 004094 913198
9141 2291	10	210 ml	170 g	210 x 72 x 55 mm	4 004094 914195
9151 2291	10	300 ml	290 g	250 x 90 x 59 mm	4 004094 915192
9161 2291	10	410 ml	335 g	265 x 98 x 67 mm	4 004094 916199

AL



Art-Nr. / Art.-No.	VE / SU	ml (ca.)	Mehl / flour (ca.)	Größe / Size	EAN
9171 2291	5	650 ml	575 g	310 x 108 x 75 mm	4 004094 917196
9181 2291	5	1100 ml	1000 g	347 x 118 x 90 mm	4 004094 918193
9191 2291	5	1870 ml	1650 g	400 x 150 x 105 mm	4 004094 919190
9201 2291	2	2580 ml	2350 g	430 x 180 x 120 mm	4 004094 920196





30 x 24/18 mm

**Silikonkorken**

- sehr weich und flexibel
- passt sich hervorragend an den Flaschenhals an
- leicht zu reinigen - spülmaschinenfest (wir empfehlen jedoch Handwäsche)
- säurebeständig
- Farbe: immer weiß-transluzent - wie abgebildet - eine Ausnahme bildet der Artikel 4730 aus optischen Gründen

*Silicone cork*

- very smooth and flexible
- adjusts ideally to the inner bottle neck
- easy to clean - dishwasher safe (we recommend handwash though)
- acid resistant
- colour: always white-translucent - as shown - the only exception is ref. 4730 because of optical reasons

**Bouchon en silicone**

- très souple et flexible
- s'ajuste parfaitement au goulot de la bouteille
- facile à nettoyer – résiste au lave-vaisselle (un lavage à la main est cependant recommandé)
- résistant à l'acide
- couleur: toujours blanc translucide - comme illustré - la seule exception est l'article 4730 pour des raisons optiques

*Tapones de silicona*

- muy blandos y flexibles
- se adaptan excelentemente al cuello de la botella o del frasco
- fáciles de limpiar – a prueba de lavavajillas (recomendamos, sin embargo, lavarlos a mano)
- resistente a los ácidos
- color: siempre blanco-translúcido – como en la ilustración – una excepción es el artículo 4730 por razones ópticas.



27 x 22/17 mm (0,7 - 1l)  
 26 x 29/32 mm (3 - 5l)

**Naturkorken**

- der Klassiker
- um eine gleichbleibende Qualität - mit einer geschlossenen Oberfläche bieten zu können, verwenden wir in der Regel Presskorken
- Naturkorken nehmen im Gegensatz zu den leicht zu reinigenden Kunststoffkorken das Aroma der Flüssigkeiten an und müssen demnach gelegentlich ersetzt werden
- säurebeständig
- weitere Korken auf Anfrage

*Natural cork*

- The classic
- In order to offer a constant quality - with an even surface, we usually use agglomerated cork
- Instead of the easy-to-clean plastic corks - natural corks pick up the flavor of the liquids and have to be replaced from time to time
- Acid resistant
- further corks on request

**Bouchon naturel**

- le classique
- pour obtenir une qualité constante avec une surface fermée, nous utilisons généralement des bouchons en liège
- à l'inverse des bouchons en plastique faciles à nettoyer, les bouchons naturels captent l'arôme des liquides et doivent être remplacés de temps en temps
- résistant à l'acide
- plus de bouchons à la demande

*Tapones naturales*

- los clásicos
- para poder ofrecer una calidad uniforme con una superficie homogénea, por regla general usamos corchos prensados
- por el contrario que los corchos de plástico fáciles de lavar, los corchos naturales toman el gusto de los líquidos, por lo que tienen que cambiarse ocasionalmente
- resistente a los ácidos
- otros corchos a petición

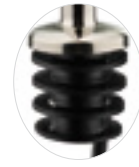

23 x 22,5/21 mm

**Kunststoffkorken aus PE**

- elastisch
- leicht zu reinigen - spülmaschinenfest (wir empfehlen jedoch Handwäsche)
- säurebeständig
- Kunststoffkork der Eco-Pour-Serie: 29 x 25/18 mm (Angabe ohne Luft-röhrchen)

*Plastic cork from PE*

- elastic
- easy to clean - dishwasher safe (we recommend handwash though)
- acid resistant
- Plastic cork from Eco-Pour: 29 x 25/18 mm (without airing tube)

**Bouchon plastique en PE**

- élastique
- facile à nettoyer - résiste au lave-vaisselle (nous recommandons néanmoins un nettoyage à la main)
- résistant à l'acide
- bouchon plastique de la série Eco-Pour: 29 x 25/18 mm (sans tube d'aération)

*Tapones de plástico de PE*

- elásticos
- fáciles de lavar – a prueba de lavavajillas (recomendamos, sin embargo, lavarlos a mano)
- resistentes a los ácidos
- Corcho de plástico de la serie Eco-Pour: 29 x 25/18 mm (datos sin tubitos de aire)



**Ersatzkorken 'Natur'**

- 4800 für die mit markierten Ausgießer
- 4810 für die mit markierten Ausgießer
- 4830 für den mit markierten Ausgießer

*Spare corks 'nature'*

- 4800 for the pourers marked
- 4810 for the pourers marked
- 4830 for the pourers marked

**Bouchon de rechange 'Natur'**

- 4800 pour les becs verseurs avec un point
- 4810 pour les becs verseurs avec un point
- 4830 pour les becs verseurs avec un point

*Tapones de recambio 'nature'*

- 4800 para vertedores marcados con
- 4810 para vertedores marcados con
- 4830 para vertedores marcados con



- Hier Abbildungen der verschiedenen Verpackungsformen für Ausgießer
- Einzelheiten zu den Artikeln entnehmen Sie bitte unserer Preisliste.

- Here examples of the different packagings for pourers
- For details concerning the articles please refer to our price list.

- Ici différents exemples de conditionnement pour becs verseurs.
- Pour plus d'informations concernant nos produits, veuillez consulter notre liste de prix.

- Aquí, ilustraciones de la diversas clases de empaques para vertedores
- Vea de nuestra lista de precios los detalles sobre los artículos.



12 Stück im Graukarton  
12 pcs in a grey cardboard box  
12 pièces dans un carton gris  
12 piezas en caja de cartón gris



12 Stück in einem Display  
12 pcs in a counter display unit  
12 pièces dans un présentoir  
12 piezas en un expositor

illustrierte Karte  
illustrated sales card  
carte illustrée  
tarjeta ilustrada



# Classic Serie

Made in  GERMANY

- Ausgießer aus Messing, silberfarbene Spezialbeschichtung, nickelfrei
- geeignet für alle üblichen Spirituosen - jedoch nicht für saure Getränke oder Essig
- in der Regel passend für 0,7 - 1 l Flaschen

- becs verseurs en laiton, revêtement spécial argenté, sans nickel
- convient à tous les spiritueux courants – mais pas pour les boissons acides ou le vinaigre
- convient généralement aux bouteilles de 0,7 à 1 l

- Pourers from brass, silvercoloured special coating, nickel-free
- suitable for all common spiritis - but not for acid containing drinks or vinegar
- fit usually on 0.7 - 1 l bottles

- vertedores de latón, revestimiento especial de color plata, sin níquel
- idóneo para toda clase de bebidas alcohólicas corrientes, pero no para bebidas ácidas ni vinagre
- por regla general valen para botellas de 0,7 a 1 l

## Standard



## Gastro



# Inox Serie

- Ausgießer aus hochwertigem Edelstahl
- geeignet für alle üblichen Spirituosen - besonders auch für saure Getränke und Essig
- in der Regel passend für 0,7 - 1 l Flaschen

- becs verseurs en acier inoxydable de haute qualité
- convient à tous les spiritueux courants - mais également aux boissons acides ou le vinaigre
- convient généralement aux bouteilles de 0,7 à 1 l

- pourers from high quality stainless steel
- suitable for all common spirits - especially also for acid containing drinks and vinegar
- fit usually on 0.7 - 1 l bottles

- vertedores de acero inoxidable de primera calidad
- idóneos para todas las bebidas alcohólicas corrientes - especialmente también para bebidas ácidas y vinagre
- por regla general valen para botellas de 0,7 a 1 l



## Standard

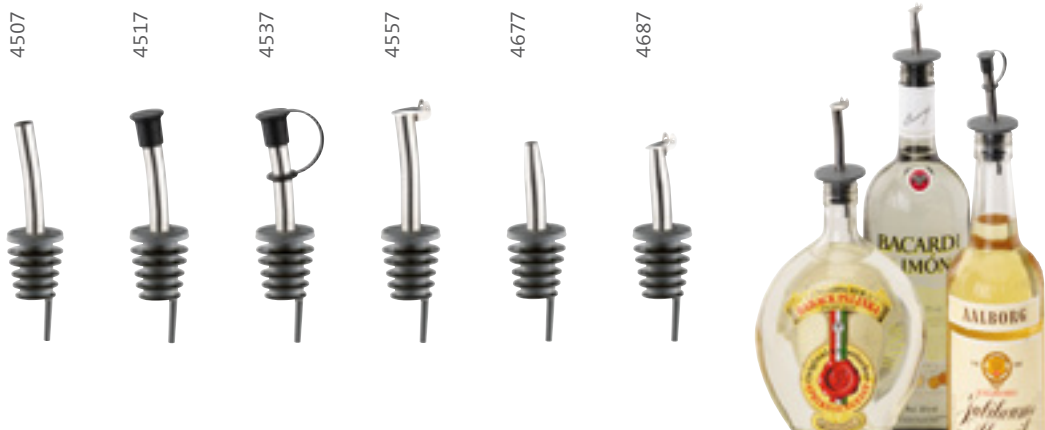

## Eco-Pour



## Gastro



## Essig-Spezial

## Öl-Spezial

ausgießer, portionierer & dosierer • measure pourers, dispensers & pourers  
becs verseurs, distributeurs & doseurs • vertedores, porcionadores & dosificadores



# Kunststoff Serie

Made in   
GERMANY

- Ausgießer gefertigt aus unterschiedlichen hochwertigen Kunststoffen
- geeignet für alle üblichen Spirituosen - auch für saure Getränke
- Hinweis: die Dosierausgießer funktionieren nur einwandfrei mit klaren alkoholischen Getränken - süße, klebrige Getränke beeinträchtigen die Funktion
- *pourers manufactured from various high quality plastics*
- *suitable for all common spirits - also for acid containing drinks*
- *information: the measure pourers function flawlessly with clear alcoholic drinks - sweet, pasty liquors though have a negative affect on the functionality*
- becs verseurs fabriqués en différents plastiques de haute qualité
- convient à tous les types de spiritueux courants – également pour les boissons acides
- Indication: les becs verseurs de dosage fonctionnent uniquement parfaitement avec des boissons clairement alcoolisées – les boissons douces et collantes ont en effet négatif sur le fonctionnement
- *vertedores fabricados de diversos plásticos de primera calidad*
- *idóneos para todas las bebidas alcohólicas corrientes – también para bebidas ácidas*
- *advertencia: los vertedores dosificadores funcionan solo perfectamente con bebidas alcohólicas claras – las bebidas dulces, pegajosas dificultan la función*

**Spritzkorken für Dash-Bottles oder Essigflaschen**  
• zum „Spritz“-Dosieren von Essig oder für Dash-Bottles mit Aromen wie Angostura, Orange Bitter etc. im Barbereich

**Dash-bottle pourer**

• for exact dosage of vinegar or for Dash-Bottles with flavours like Angostura, Orange Bitter etc.

**Becs verseurs pour dash bottles ou bouteilles de vinaigre**  
• pour le dosage précis de vinaigre ou dash bottles avec des arômes tels que Angostura, orange amère etc. dans les bars

**Tapones con vertedores para Dash-Bottles o botellas de vinagre**

• para dosificar “pulverizando” vinagre o para Dash-Bottles con aromas tales como angostura, tubo vertedero extra grande Orange Bitter, etc., en el sector de bares

4130



22 x 17/14 mm

4140

Extra großes Gießrohr extra big tube



8050



8052



Moritz

1 sec. = 1 cl

4110

NEON (leuchten bei Schwarzlicht)  
NEON (glow in black light)  
NEON (s'illuminent dans la lumière noire)  
NEON (alumbra con luz negra)



4122

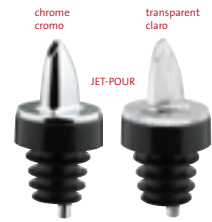

Jet-Pour

9910-9950



Maß / measure	Art.-Nr.	Farbe oben / top colour
1 cl	9910	○
2 cl	9920	○ ● ● ● ●
2,5 cl	9925	○
3 cl	9930	○ ●
4 cl	9940	○ ● ● ● ●
5 cl	9950	○ ●

Auto-Pour



8120 2,0cl  
8130 3,0cl

Auto-Pour-Plus

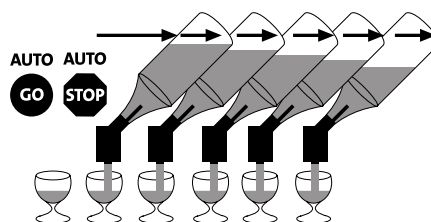

8215 1,5cl  
8220 2,0cl  
8221 2,1cl  
8225 2,5cl  
8230 3,0cl  
8235 3,5cl  
8240 4,0cl  
8250 5,0cl  
8260 6,0cl

Bottle-Pilot

ausgießer, portionierer & dosierer • measure pourers, dispensers & pourers  
becs verseurs, distributeurs & doseurs • vertedores, porcionadores & dosificadores

# Spirituosen-Dosiergeräte

## Spirit dispensers

Made in   
EUROPE

### Standard

- mit Kunststoffkorken
- für 0,7 - 1,0 l Flaschen
- with plastic cork
- for 0,7 - 1,0l bottles
- avec bouchons en plastique
- pour bouteilles de 0,7 à 1,0 l
- con tapones de plástico
- para botellas de 0,7-1,0 l

9220: 2 cl  
9225: 2,5 cl  
9230: 3 cl  
9240: 4 cl  
9250: 5 cl



9420: 2 cl  
9430: 3 cl  
9440: 4 cl  
9450: 4 cl



9220  
auch anisfest lieferbar  
also available in anise-resistant version  
également disponible en version résistante à l'anis  
suministrable también resistente al anís

mit Zählwerk  
with counter  
avec compteur  
con contador

### Professional

- Metallausführung
- mit Kunststoffkorken
- für 0,7 - 1,0 l Flaschen
- metal version
- with plastic cork
- for 0,7 - 1,0l bottles
- modèle métallique
- avec bouchons en plastique
- pour bouteilles de 0,7 à 1,0 l
- versión metálica
- con tapones de plástico
- para botellas de 0,7-1,0 l

9520: 2,0 cl  
9525: 2,5 cl  
9530: 3,0 cl  
9540: 4,0 cl  
9550: 5,0 cl



9620: 2 cl  
9640: 4 cl  
mit Zählwerk  
with counter  
avec compteur  
con contador





# Flaschen- und Wandhalterungen

## Shelf- and wall-brackets

### Standard

- mit Schraubzwinge
- für 0,7 - 1,0 l Flaschen
- with screw clamp
- for 0,7 - 1,0l bottles
- avec serre-joint
- pour bouteilles de 0,7 à 1,0 l
- con tornillo de apriete
- para botellas de 0,7-1,0 l



8811  
für 1 Flasche  
for 1 bottle

8831  
für 1 Flasche  
for 1 bottle

ohne Schraubzwinge  
without screw clamp  
sans serre-joint  
sin tornillo de apriete



### Professional

- mit Schraubzwinge und sehr stabilem Metall-Clip
- für 0,7 - 1,0 l und 3 l Flaschen
- with screw clamp and very solid metal clip
- for 0,7 - 1,0l and 3 l bottles
- métallique très stable avec serre-joint et clip
- pour bouteilles de 0,7 à 1,0 litre
- muy sólido con gato y clip metálico
- para botellas de 0,7-1,0 l

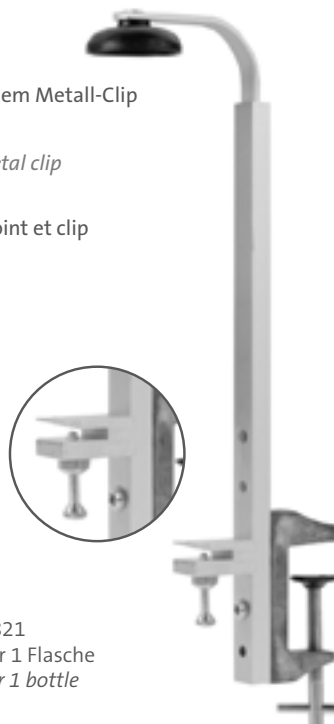

8821  
für 1 Flasche  
for 1 bottle

8861  
für 1 Flasche  
for 1 bottle  
für 3 Liter Flaschen  
for 3 litre bottles

sehr stabile, profilierte Ausführung  
very solid version  
très stable, modèle profilé  
muy sólido, versión perfilada

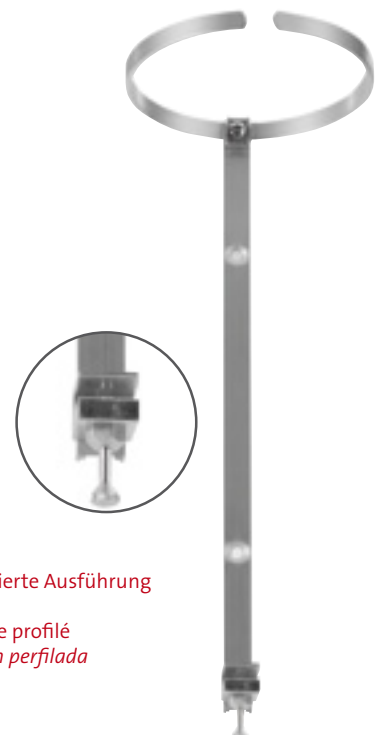



78 x 76 x 0,6 mm

**Weinausgießer »Safety«**

- aus PET
- 3 Stück im Set
- ermöglicht ein sauberes und tropfenfreies Ausgießen

*Wine pourer »Safety«*





- from PET
- set of 3
- allows tidy and drip free pouring

**Bec verseur à vin »Safety«**

- de PET
- ensemble de 3 pièces
- pour verser proprement et sans goutte

*Vertedores para vinos »Safety«*

- en PET
- set de 3 piezas
- hace posible un vertido limpio y sin goteo

Art-Nr. / Art.-No.	VE / SU	EAN
4448 2280 	6	 4 004094 444883
4448 2680 	1	 4 004094 444869



57,5 x 37,5 x 76 mm

**Dekantierausgießer**

- mit Verschlusskappe
- ideal zum Ausgießen von Wein

*Decanting pourer*



- with closing cap
- ideal for pouring out wine

**Bec verseur à décantation**

- avec clapet de fermeture
- idéal pour verser le vin

*Vertedores decantadores*

- con tapa de cierre
- ideal para echar vino

Art-Nr. / Art.-No.	VE / SU	EAN
4420 2280 	6	 4 004094 442087



**Griffkorken**

- Set mit 10 Griffkorken
- für 0,7-1,0 l Flaschen

*Spare corks*

- set of 10 spare corks
- for 0,7-1 l bottles

**Bouchon à tête**



- ensemble de 10 bouchons à tête
- pour bouteilles de 0,7 à 1,0 l

*Tapones agarraderos*

- set de 10 tapones agarraderos
- para botellas de 0,7-1,0 l



29 x 29 x 28,5 mm

Art-Nr. / Art.-No.	VE / SU	EAN
4820 2080 	10	 4 004094 482083

Bitte beachten Sie auch:  
 Entkorkmaschine,  
 Seite 106

Please see as well:  
 Uncorking machine  
 page 106





# 14

spezielles & ersatzteile • *for special purposes & spare parts*  
spécial & pièces détachées • *para cosas especiales & piezas de repuesto*









485 x 132 x 5 mm

**Fliegenklatsche »Blume«**  
 • sehr stabiler Stiel in Form eines Blumenstengels  
 • mit farbig sortierten Blüten  
 • lose oder im mehrfarbigen Display erhältlich

**Fly swatter »Blume«**  
 • solid handle in shape of a flower stem  
 • with flower in assorted colours  
 • available either bulk or in a colourful display

**Tapette à mouche »Blume«**  
 • manche très stable en forme de tige avec des fleur  
 • en couleurs assorties  
 • disponibles au détail ou dans un présentoir coloré

**Matamoscas »Blume«**  
 • mango muy sólido en forma de un tallo de flor con flores  
 • en diversos colores  
 • sueltas o en expositor en colores vistosos

Art.-Nr. / Art.-No.	VE / SU	EAN
5095 2251 	25	 4 004094 509551
5095 2610 	1	 4 004094 509568

PP PE

Made in  GERMANY

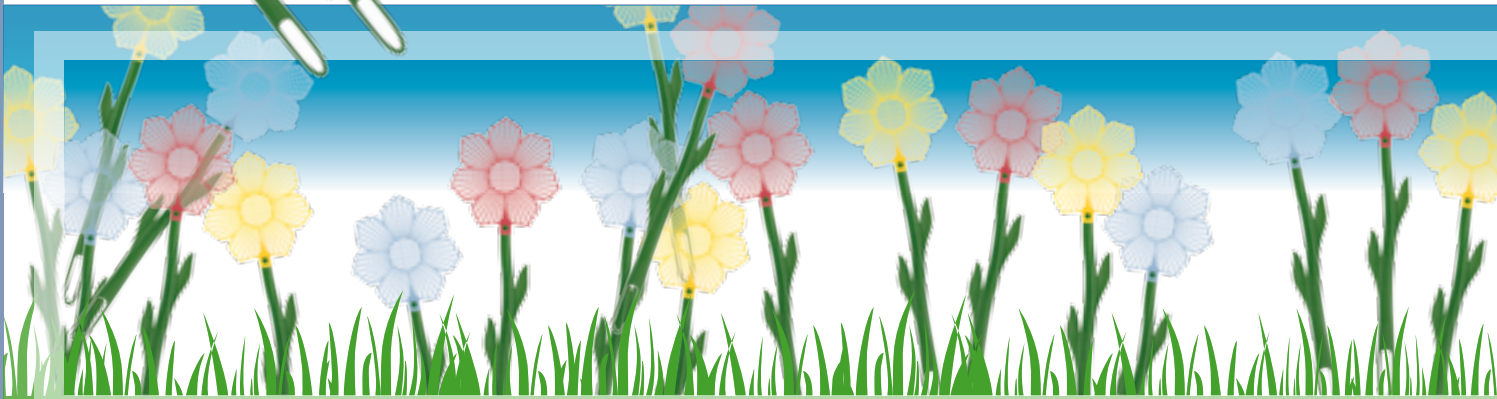

460 x 140 x 8 mm

**Fliegenklatsche »Frosch«**  
 • Stiele farbig sortiert

**Fly swatter »Frosch«**  
 • handles in assorted colours

**Tapette à mouche »Frosch«**  
 • manches en couleurs assorties

**Matamoscas »Frosch«**  
 • mangos en colores surtidos

Art.-Nr. / Art.-No.	VE / SU	EAN
5087 2250 	25	

PP PE

Made in  GERMANY





455 x 82 x 7 mm

**Fliegenklatsche »Traditionell«**  
 • Stiele farbig sortiert  
 • erhältlich lose oder im Display

**Fly swatter »Traditionell«**  
 • handles in assorted colours  
 • available in bulk or in a display

**Tapette à mouche »Traditionell«**  
 • manches en couleurs assorties  
 • disponible au détail ou dans un présentoir

**Matamoscas »Traditionell«**  
 • mangos en colores surtidos  
 • obtenible suelto o en expositor blanquinegro

Art.-Nr. / Art.-No.	VE / SU	EAN
5081 2250 	25	
5081 2610 	1	 4 051735 508114

PP PE

Made in  GERMANY



475 x 148 x 7 mm

**Fliegenklatsche »Fliege«**  
 • Stiele farbig sortiert

**Fly swatter »Fliege«**  
 • handles in assorted colours

**Tapette à mouche »Fliege«**  
 • manches en couleurs assorties

**Matamoscas »Fliege«**  
 • mangos en colores surtidos

Art.-Nr. / Art.-No.	VE / SU	EAN
5085 2250 	25	

PP PE

Made in  GERMANY



- Fensterthermometer**
- von außen an der Scheibe zu befestigen
  - Messbereich von -50°C bis +50°C

- Thermomètre de fenêtre**
- à fixer à la vitre depuis l'extérieur
  - plage de mesure de -50°C à +50°C

- Window thermometer**
- to be attached to the windowpane from outside
  - measurement range from -50°C to +50°C / -55°F to +122°F

- Termómetro de ventana**
- a sujetar por fuera a la luna de la ventana
  - gama de medición de -50°C a +50°C



Art-Nr. / Art.-No.	VE / SU	EAN
5212 2280	12	4 004094 521287

PS

76 x 76 x 23 mm

- Digitales / Kühlschrankthermometer**
- zur Messung der Raum- oder Kühlschranktemperatur
  - Clip zum Hängen oder Aufstellen
  - mit Magnet
  - Messbereich: -20°C bis + 50°C

- Thermomètre digital / de réfrigérateur**
- pour mesurer la température ambiante ou du réfrigérateur
  - clip pour l'accrocher ou le poser
  - avec aimant
  - plage de mesure: -20°C à + 50°C

- Digital / Refrigerator thermometer**
- for measuring room or refrigerator temperature
  - clip for hanging or standing upright
  - additional magnet
  - total temperature measurement range: -20°C - +50°C / -4°F - 122°F

- Termómetro digital / para refrigerador**
- para medir la temperatura ambiente o en el refrigerador
  - clip para colgar o poner de pie
  - con un imán
  - gama de medición: de -20°C a + 50°C



Art-Nr. / Art.-No.	VE / SU	EAN
5215 2280	6	4 004094 521584

ABS

PC

GLAS

68 x 60 x 14 mm



- Schuhrost / Schuhablage**
- stapelbar und miteinander zu verbinden
  - quer geeignet, um z.B. zwei Paar Schuhe bis Gr. 38 oder längs, um ein paar Schuhe bis Größe 49 abzustellen

- Porte-chaussures**
- empilable et fiable
  - pour par ex. deux paires de chaussures de taille 38 ou plus (maximum taille 49)

- Shoe and boot tray**
- stackable, connectable
  - holds square two pairs of shoes up to size UK 5 / US M 6 and lengthwise one pair up to size UK 13 ½ / US M 14 ½

- Rejilla y chapa para poner zapatos**
- apilable y para unir entre sí
  - transversalmente pueden colocarse dos pares de zapatos hasta el número 38 o, longitudinalmente un par de zapatos hasta el número 49



Art-Nr. / Art.-No.	VE / SU	EAN
5250 2270	5	4 004094 525070

PE Made in GERMANY

378 x 275 x 27 mm

- Schlauch- und Kabelhalter**
- praktischer Ordnungshelfer
  - aus pflegeleichtem, bruchsicherem Kunststoff
  - anschraubbar (Befestigungsmaterial nicht im Lieferumfang enthalten)

- Cache-câbles**
- un organisateur pratique
  - en plastique facile à nettoyer et incassable
  - peut être vissé au mur (matériaux de fixation non fournis)

- Hose- and cable holder**
- this practical device helps to keep things tidy
  - from easy-care, break-resistant plastic
  - can be screwed on to the wall (mounting set not included)

- Porta mangueras y cables**
- el ayudante práctico para guardar orden
  - de plástico fácil de cuidar y seguro contra rotura
  - atornillable (el material de sujeción no está incluido en el suministro)



Art-Nr. / Art.-No.	VE / SU	EAN
5201 2210	10	

PS Made in GERMANY

132 x 66 x 56 mm



**Saug- und Klebehaken**  
 • praktische Lösung, um Handtücher, Waschlappen oder anderes aufzuhängen

**Crochet-ventouse**  
 • solution pratique pour accrocher des serviettes, lavettes etc.

*Suction hooks*  
 • practical solution for hanging up towels, wash cloths etc.

*Ganchos de ventosas*  
 • solución práctica para colgar toallas, mantas para baño u otros



**Saughaken, 3er Set / 10er Set**  
*Suction hooks, 3pc-set / 10pc-set*

**Crochet-ventouse, set 3 pièces / set 10 pièces**  
*Ganchos de ventosas, set 3 piezas / set 10 piezas*

Art-Nr. / Art.-No.	VE / SU	Größe / Size	EAN
5318 2280	10	10er Set ø 20 mm	4 004094 531880
5319 2380	10	3er Set ø 40 mm	4 004094 531989

PVC ST

Made in GERMANY

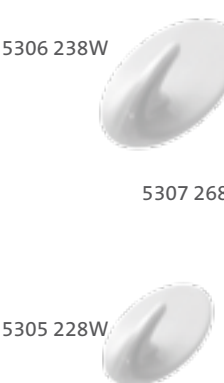

**Klebehaken oval, 2er Set / 3er Set / 6er Set**  
*Adhesive hooks, 2pc-set / 3pc-set / 6pc-set*

**Crochet adhésif, set 2 / set 3 / set 6 pièces**  
*Gancho para pegar, set 2 / set 3 / set 6 piezas*

Art-Nr. / Art.-No.	VE / SU	Größe / Size	EAN
5305 228W	10	2er Set 56 x 34 x 21 mm	4 004094 530586
5306 238W	10	3er Set 43,5 x 26,5 x 17 mm	4 004094 530685
5307 268W	10	6er Set 32 x 19 x 12 mm	4 004094 530784

PS

Made in GERMANY

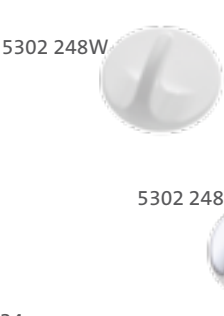

**Klebehaken rund, 4er Set**  
*Adhesive hooks, 4pc-set*

**Crochet adhésif, set 4 pc**  
*Gancho para pegar, set 4 pz*

Art-Nr. / Art.-No.	VE / SU	EAN
5302 248W	10	4 004094 530289
5302 248C	10	4 004094 530272

PS

Made in GERMANY

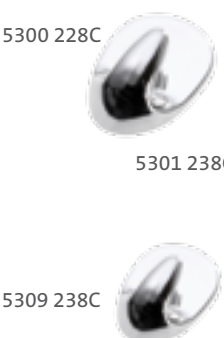

**Klebehaken Trapez, 2er Set / 3er Set**  
*Adhesive hooks, 2pc-set / 3pc-set*

**Crochet adhésif, set 2 pc / set 3 pc**  
*Gancho para pegar, set 2 pz / set 3 pz*

Art-Nr. / Art.-No.	VE / SU	Größe / Size	EAN
5300 228C	10	2er Set 56,5 x 39,5 x 23,5 mm	4 004094 530081
5301 238C	10	3er Set 44 x 31 x 19 mm	4 004094 530180
5309 238C	10	3er Set 37 x 26 x 16 mm	4 004094 530982

PS

Made in GERMANY



**Abfluss-Siebe, 2-er Set**  
 • 5207 2270 aus Kunststoff  
 • 5208 2270 aus Edelstahl

**Tamis d'évier, set 2 pièces**  
 • 5207 2270 en plastique  
 • 5208 2270 en acier inox

*Kitchen sink strainers, 2-pc set*  
 • 5207 2270 from plastics  
 • 5208 2270 from stainless steel

*Tamices para desagüe, set 2 piezas*  
 • 5207 2270 de plástico  
 • 5208 2270 de acero inox

Art-Nr. / Art.-No.	VE / SU	EAN
5207 2270	10	4 004094 520778
5208 2270	10	4 004094 520877

PP INOX

Made in EUROPE



Seifendose »Beauty«  
• für alle gängigen Seifengrößen

Soap box »Beauty«  
• for all current soap-sizes

Boîte à savon »Beauty«  
• pour toutes les tailles de savon ordinaires 5104 2291



Jabonera »Beauty«  
• para todos los tamaños corrientes de jabones



Trink- und Zahnpfutzbecher »Beauty«  
Drink- and tooth brush beaker »Beauty«

Verre à dents »Beauty«  
Vaso para beber y para el cepillo de dientes »Beauty«



Art-Nr. / Art.-No.	VE / SU	Größe / Size	EAN
5104 2291	5	112 x 79 x 47 mm	
5109 2291	5	72 x 72 x 100 mm	

PS PP

 Made in GERMANY 

5109 2291



Tischtuchklammern, 4er-Set  
• mit Federmechanismus

Pincas à nappe, set 4 pièces  
• avec mécanisme à ressort

Table cloth clips, 4pc-set  
• with spring mechanism

Clips para sujetar manteles, set 4 piezas  
• con mecanismo de muelle



Art-Nr. / Art.-No.	VE / SU	EAN
6428 2280 	6	

ABS METAL

62 x 56 x 16 mm



Schlüsselanhänger, 6er Set  
• Set mit 6 Schlüsselanhängern  
• farblich sortiert  
• mit Beschriftungsfeld

Key tags, 6pc-set  
• set of 6 key tags  
• assorted colours  
• with title block

Porte-clés, set de 6 pièces  
• ensemble de 6 porte-clés  
• couleurs assorties  
• avec plage d'écriture

Llaveros, set 6 piezas  
• set de 6 llaveros  
• surtido de diversos colores  
• con recuadro para rotulación



Art-Nr. / Art.-No.	VE / SU	EAN
5206 2280 	12	

PP PVC NI PAPIER

67 x 23 x 20 mm



Flizgleiter, 25 mm  
• Set mit 16 Flizgleitern  
• zur Befestigung an Stuhl- und Tischbeinen  
• schützt empfindlichen Bodenbelag

Felt pads, 25 mm  
• set of 16 felt pads  
• for table and chair legs  
• protects delicate grounds

Patin en feutre, 25 mm  
• ensemble de 16 patins en feutre  
• pour les pieds de chaise et de table  
• protège les revêtements de sol délicats

Deslizantes de fieltro, 25 mm  
• set de 16 deslizantes de fieltro  
• para sujetar debajo de la pata de la silla o mesa  
• protege los revestimientos de suelos delicados



Art-Nr. / Art.-No.	VE / SU	EAN
5204 2280 	6	



Flizgleiter, 19 x 19 mm  
• Set mit 32 Flizgleitern  
• zur Befestigung an Stuhl- und Tischbeinen  
• schützt empfindlichen Bodenbelag

Felt pads, 19 x 19 mm  
• set of 32 felt pads  
• for table and chair legs  
• protects delicate grounds

Patin en feutre, 19 x 19 mm  
• ensemble de 32 patins en feutre  
• pour les pieds de chaise et de table  
• protège les revêtements de sol délicats

Deslizantes de fieltro, 19 x 19 mm  
• set de 32 deslizantes de fieltro  
• para sujetar debajo de la pata de la silla o mesa  
• protege los revestimientos de suelos delicados



Art-Nr. / Art.-No.	VE / SU	EAN
5203 2280 	6	

## Ersatzteile

## Spare parts

für/for Art.	Art.-Nr.	Beschreibung / Description	VE / SU
1060 2260	0010 5050	Beutel mit 10 Winkelfedern / Bag with 10 angle springs	1
1061 2270	1106 0210	Ersatzklingen / Spare blades	50
	1106 0250	10 Ersatzklingen / 10 Spare blades	1
1084 2280	1085 2280	5 Ersatzklingen für Ceranfeld-/Reinigungsschaber / 5 Spare blades for cleaning scraper	5
1133 2260	1133 0100	Ersatzmesser Hobel / Spare knife for slices	1
	1133 0200	Ersatzmesser fein / Spare knife for fine stripes	1
	1133 0300	Ersatzmesser grob / Spare knife for rough stripes	1
1143 2260	1144 0200	Messer klein / Knife, small	1
	1144 0300	Messer groß / Knife, big	1
1144 2260	1144 0200	Messer klein / Knife, small	1
	1144 0300	Messer groß / Knife, big	1
1180 2260	1180 0100	Ersatzmesser 9 x 9 mm / Spare knife 9 x 9 mm	1
	1180 0200	Ersatzmesser 10 x 10 mm / Spare knife 10 x 10 mm	1
	1180 0300	Ersatzmesser 12 x 12 mm / Spare knife 12 x 12 mm	1
1181 2260	1181 0100	Ersatzmesser 9 x 9 mm / Spare knife 9 x 9 mm	1
	1181 0200	Ersatzmesser 10 x 10 mm / Spare knife 10 x 10 mm	1
	1181 0300	Ersatzmesser 12 x 12 mm / Spare knife 12 x 12 mm	1
1224 2260	1224 150z	Messer / Knife	1
	1224 160n	Transportrad / Transport wheel	1
1224 5560	1224 150z	Messer / Knife	1
	1224 160n	Transportrad / Transport wheel	1
1302 2270	1106 0210	Ersatzklingen / Spare blades	50
	1106 0250	10 Ersatzklingen / 10 Spare blades	1
1304 2270	1106 0210	Ersatzklingen / Spare blades	50
	1106 0250	10 Ersatzklingen / 10 Spare blades	1
1971 4460	1971 0400	Rubinrohr 10 x 5,5 x 200 mm Wetzstahl / Tube from sinter ruby 10 x 5,5 x 200 mm	1
1972 4460	1972 0400	Rubinrohr 14 x 6 x 280 mm / Tube from sinter ruby 14 x 6 x 280 mm	1
1980 4460	1980 4455	Ersatzteil-Set „Kurbel komplett für Clou 30“ / Spare part set „Complete crank for Clou 30“	1
	1980 4456	Ersatzteil-Set „Verschleißteile für Clou 30/40“ / Spare part set „Wear and tear elements for Clou 30/40“	1
	1980 4457	Ersatzteil-Set „Messerhalter kompl. für Clou 30“ / Spare part set „Knife holder complete for Clou 30“	1
	1983 4460	Tischbefestigung für „Clou 30“ / Table clamp for „Clou 30“, painted light grey	1
	1984 4460	Stange komplett für „Clou 30“ / „Clou 30“ without table clamp, complete bar unit	1
	1995 4480	Schneidmesser + 2 Schrauben für Clou / Knife + 2 screws for Clou	5
	1996 4480	Transportrad für Clou / Transport wheel for Clou	5
1985 4460	1980 4456	Ersatzteil-Set „Verschleißteile für Clou 30/40“ / Spare part set „Wear and tear elements for Clou 30/40“	1
	1985 4455	Ersatzteil-Set „Kurbel komplett für Clou 40“ / Spare part set „Crank complete for Clou 40“	1
	1985 4457	Ersatzteil-Set „Messerhalter kpl. für Clou 40“ / Spare part set „Knife holder complete, for Clou 40“	1
	1988 4460	Tischbefestigung für „Clou 40“ / Table clamp for „Clou 40“	1
	1989 4460	Stange komplett für „Clou 40“ / „Clou 40“ without table clamp, complete bar unit	1
	1995 4480	Schneidmesser + 2 Schrauben für Clou / Knife + 2 screws for Clou	5
	1996 4480	Transportrad für Clou / Transport wheel for Clou	5
	1990 4460	1990 4455	Ersatzteil-Set „Kurbel komplett für Clou 50“ / Spare part set „Complete crank for Clou 50“
1990 4457		Ersatzteil-Set „Messerhalter kpl. für Clou 50“ / Spare part set „Knife holder for Clou 50“	1
1993 4460		Tischbefestigung für „Clou 50“ / Table clamp for „Clou 50“, stainless steel	1
1994 4460		Stange komplett für „Clou 50“ / „Clou 50“ without table clamp, complete bar unit	1
1995 4480		Schneidmesser + 2 Schrauben für Clou / Knife + 2 screws for Clou	5
1996 4480		Transportrad für Clou / Transport wheel for Clou	5

für/for Art.	Art.-Nr.	Beschreibung / Description	VE / SU
2802 2270	1106 0210	Ersatzklingen / Spare blades	50
	1106 0250	10 Ersatzklingen / 10 Spare blades	1
2803 2270	1106 0210	Ersatzklingen / Spare blades	50
	1106 0250	10 Ersatzklingen / 10 Spare blades	1
2804 2270	1106 0210	Ersatzklingen / Spare blades	50
	1106 0250	10 Ersatzklingen / 10 Spare blades	1
2945 2270	6047 2250	Beutel mit 10 Ersatzklingen / Bag with 10 spare blades	1
4000 2260	0010 5050	Beutel mit 10 Winkelfedern / Bag with 10 angle springs	1
4001 2270	0010 5050	Beutel mit 10 Winkelfedern / Bag with 10 angle springs	1
4010 2260	0010 5050	Beutel mit 10 Winkelfedern / Bag with 10 angle springs	1
4020 2260	4020 990s	Messerträger mit Kreuzmesser / Knife holder with cross knives	1
4025 2260	4027 2250	Beutel mit 2 Federn / Bag with 2 springs	1
4030 2260	4030 9900	Handstößel kompl.mit Klinge / Pusher complete with blade	1
	4032 2250	Set 10 Abstreifplättchen / Set 10 rubber strips	1
	4033 2250	Set 3 Abstreifplättchen + 1 Feder / Set 3 rubber strips + 1 spring	1
4035 2260	4037 2250	Set 10 Abstreifplättchen / Set 10 rubber strips	1
	4038 2250	Set 3 Abstreifplättchen + 1 Feder / Set 3 rubber strips + 1 spring	1
	4062 2250	Set 30 Abstreifplättchen / Set 30 rubber strips	1
4060 2260	4037 2250	Set 10 Abstreifplättchen / Set 10 rubber strips	1
	4062 2250	Set 30 Abstreifplättchen / Set 30 rubber strips	1
4070 2260	4072 2250	Set 30 Abstreifplättchen / Set 30 rubber strips	1
	4073 2250	Set 3 Abstreifplättchen + 1 Feder / Set 3 rubber strips + 1 spring	1
5120 2260	0010 5050	Beutel mit 10 Winkelfedern / Bag with 10 angle springs	1
5140 2260	0010 5050	Beutel mit 10 Winkelfedern / Bag with 10 angle springs	1
5170 2260	0010 5050	Beutel mit 10 Winkelfedern / Bag with 10 angle springs	1
6038 4460	1998 4450	Krätzer für Entkorkmaschine / Thread for uncorking machine	1
6045 2270	6047 2250	Beutel mit 10 Ersatzklingen / Bag with 10 spare blades	1
6050 2260	6050 0450	Beutel mit 10 Winkelfedern / Bag with 10 angle springs	1
	6052 2250	Beutel mit 10 Ersatzklingen / Bag with 10 spare blades	1
6060 2260	6050 0450	Beutel mit 10 Winkelfedern / Bag with 10 angle springs	1
	6052 2250	Beutel mit 10 Ersatzklingen / Bag with 10 spare blades	1
6070 2260	6070 0200	Beutel mit 10 Ersatzklingen / Bag with 10 spare blades	1
6071 2260	6070 0200	Beutel mit 10 Ersatzklingen / Bag with 10 spare blades	1
6072 2260	6070 0200	Beutel mit 10 Ersatzklingen / Bag with 10 spare blades	1
6095 2270	6047 2250	Beutel mit 10 Ersatzklingen / Bag with 10 spare blades	1
6110 2260	6110 0600	Steckachse / Shaft	1
6120 2260	6110 0600	Steckachse / Shaft	1
7110 2260	7118 2250	2 Ersatzdrähte / 2 Replacement wires	1
7120 2270	7122 2250	2 Ersatzdrähte / 2 Replacement wires	1
7160 2270	7122 2250	2 Ersatzdrähte / 2 Replacement wires	1
5430 GE6S	5430 1800	Zylinderschloss + 2 Schlüssel / Barrel lock + 2 keys	1
4800 2080	4800 2080	10 Ersatzkorken Standard für Serie 42 + Edelstahl-ausgießer / 10 spare corks standard for series 42 + pourer from inox	10
	4810 2080	10 Ersatzkorken natur für Serien 43 und 46 / 10 spare corks, natural, for series 43 and 46	10
	4810 2210	Ersatzkorken natur für Serien 43 und 46 / Spare cork natural for series 43 and 46	25
	4832 2210	Kunststoffkorken Lamelle 3 l für Dosierer / Plastic cork lamelle 3 l for dispenser	5
	4842 2210	Kunststoffkorken Lamelle 0,7-1 l für Dosierer / Plastic cork lamelle 0,7-1 l for dispenser	10



## Touring comfort



### Fahrrad Wandhalter für ein Fahrrad

- ermöglicht das platzsparende Anbringen von bis zu drei Fahrrädern übereinander bei einer Raumhöhe von 2,10 m
- inkl. Befestigungsmaterial

### Wall support for one bike

- space-saving way to store up to three bikes on top of each other within a ceiling height of 2,10 m
- includes mounting material

### Fixation murale pour un vélo

- permet de suspendre jusqu'à trois vélos les uns sur les autres pour une pièce d'une hauteur de 2,10 m
- matériel de fixation inclus

### Soporte de pared para bicicletas

- permite el almacenamiento de hasta tres bicicletas super puestas, en una habitación de 2,10 m de altura permitiendo un gran ahorro de espacio
- incluido material de sujeción



350 x 75 x 32 mm

Art-Nr. / Art.-No.	VE / SU	EAN
5402 GE60 	6	 4 004094 540264

PP ST  
Made in   
GERMANY

### Touring-Tresor aus stabilem Kunststoff

- Fahrradkoffer für alle gebräuchlichen Gepäckträger, diebstahlsicheres Befestigungssystem, abschließbar, kratzunempfindliche Lederstruktur, wetterfest, Metallteile korrosionsschutz
- Volumen 14 l

### Touring-tresor from solid plastic

- bicycle case for all standard luggage racks, pilfer-proof attachment, lockable, scratchresistant surface, weatherproof, corrosionproof metal parts
- capacity 14 l

### Coffre-fort tourisme de plastique solide

- malle pour bicyclette pour tous les portebagages habituels, système de fixation à l'épreuve des voleurs, verrouillage, structure de cuir insensible aux éraflures, résistant aux intempéries, pièces métalliques protégées contre la rouille
- capacité 14 l

### Touring tresor en plástico resistente

- maleta para bicicletas, adaptable a todos los portabultos más usuales. Sistema de fijación antirobo, con cerradura. Estructura de cuero resistente a ralladuras e impermeable, piezas metálicas anticorrosivas
- capacidad 14 l



Art-Nr. / Art.-No.	VE / SU	EAN
5430 GE6S 	5	 4 004094 543067

PP ST  
Made in   
GERMANY

367 x 273 x 205 mm

### Kühlbox mit Deckel

- Zubehör zum „Touring-Tresor“ 5430
- Füllvolumen 9 l
- für Kühlakkus aller Art
- EPS-Schaum, FCKW frei

### Cool box with cover

- accessory for „touring-tresor“ 5430
- capacity 9 l
- all types of refrigerating accumulators
- EPS foam, no FCC

### Glacière avec couvercle

- adaptée au „coffre-fort tourisme“ 5430
- volume de remplissage 9 l
- pour accumulateurs frigorifiques de toutes sortes
- mousse EPS, sans fluorocarbones

### Nevera portátil con tapa

- para „touring-tresor“ ref. 5430
- capacidad hasta 9 lts
- conserva el frío por mediación de acumuladores pudiendo utilizar cualquier modelo de venta en el mercado



Art-Nr. / Art.-No.	VE / SU	EAN
5425 GE60 	6	

Made in   
GERMANY

340 x 260 x 205 mm

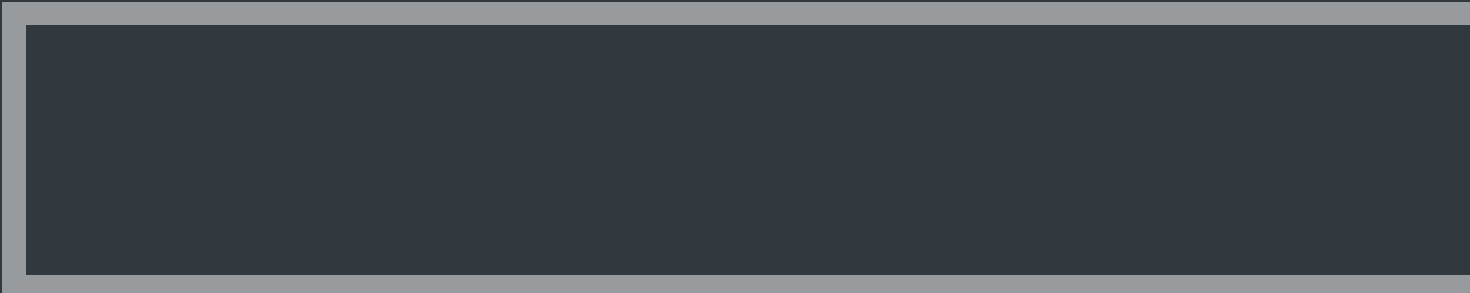



15

MONOPOL®





187 x 40 x 16 mm

**Sparschäler »Ceramico«**

- mit Keramik Klinge
- alle Metallteile aus Edelstahl
- langer, formschöner Monopol-Griffmit Aufhängeloch

**Vegetable peeler »Ceramico«**





- with ceramic blade
- all metal parts stainless steel
- long, well-shaped Monopol-handle with hanging hole

**Econome »Ceramico«**

- avec lame céramique
- toutes les parties métalliques en acier inoxydable
- long manche Monopol de belle forme avec trou d'accrochage

**Pelador ahorrativo »Ceramico«**

- con hojas de cerámica
- todas las partes metálicas son de acero inoxidable
- con mango largo de bella forma Monopol con agujero para colgar

Art-Nr. / Art.-No.	VE / SU	EAN
1784 5560 	5	 4 004094 178467
1784 5660 	1	 4 004941 1784292



175 x 51 x 15 mm

**Spargelschäler »Asparago«**

- die zangenähnliche Konstruktion sorgt dafür, dass die empfindliche Spargelstange beim Schälen nicht bricht
- mit geschliffenem Messer für die Spargelenden

**Swivel peeler »Asparago«**





- the tong-like construction makes sure that the delicate asparagus stem does not break when being peeled
- the sharpened knife cuts the hard ends

**Eplucheur d'asperges »Asparago«**

- la construction semblable à une pince permet à la tige de l'asperge de ne pas casser lors de l'épluchage
- la lame affûtée coupe les extrémités dures

**Pelador de espárragos »Asparago«**

- la construcción similar a tenazas hace que los delicados cuerpos de los espárragos no se partan al pelarlos
- la cuchilla afilada corta los duros extremos

Art-Nr. / Art.-No.	VE / SU	EAN
6071 5560 	5	 4 004094 607165
6071 5660 	1	 4 051734 607160



175 x 61 x 15 mm

**Spargelschäler »Asparago Due«**

- Zwei-Klingen-Prinzip -> doppelt so schnell
- für Langgemüse geeignet
- mit geschliffenem Messer z.B. für die Spargelenden

**Asparagus peeler »Asparago Due«**





- with two-blade principle -> twice as quick
- suitable for long vegetables sharpened knife cuts the hard ends of asparagus

**Eplucheur d'asperges »Asparago Due«**

- avec principe deux lames -> deux fois plus rapide
- convient aux légumes longs
- lame affûtée coupe les extrémités dures des asperges

**Pelador de espárragos »Asparago Due«**

- con el principio de dos hojas -> al mismo tiempo el doble de rápido
- idóneo para verduras largas
- la cuchilla afilada corta los duros extremos de los espárragos

Art-Nr. / Art.-No.	VE / SU	EAN
6072 5560 	5	 4 004094 607264
6072 5660 	1	 4 051734 003320



115 x 65 x 13 mm

**Spargel- und Gemüseschäler »Verdura«**

- aus hochwertigem Edelstahl
- ergonomischer Griff mit Fingergriffmulden für sicheren Halt
- geeignet für Rechts- und Linkshänder
- mit Ausstecher

**Vegetable swivel peeler »Verdura«**





- from high quality stainless steel
- ergonomic handle with finger grips for secure hold
- right- and left-handed use
- with corer for potato eyes

**Eplucheur d'asperges et de légumes »Verdura«**

- en acier inox
- manche ergonomique avec emplacement des doigts pour un maintien sûr
- pour droitiers et gauchers
- avec ergot

**Pelador de espárragos y verduras »Verdura«**

- en acero inoxidable
- agarrador ergonómico con huellas para los dedos para una sujeción segura
- idóneo para diestros y zurdos
- con ahuecador

Art-Nr. / Art.-No.	VE / SU	EAN
6091 5560 	10	 4 004094 609169
6091 5660 	1	 4 004094 609121







- Tomaten- und Kiwischäler »Pomodoro«**
- scharfe, gezackte Klinge zum Schälen von Tomaten, Paprika, Kiwis etc., mit Ausstecher
  - für Rechts- und Linkshänder

- Tomato- /kiwi fruit peeler »Pomodoro«**
- very sharp serrated blade for tomatoes, peppers, kiwis, peaches etc., with corer
  - for right- and left-handed use

- Eplucheur de tomates et de kiwis »Pomodoro«**
- lame dentée très coupante pour tomates, poivrons, kiwis, pêches etc., avec ergot
  - pour droitiers et gauchers

- Pelador de tomates y kiwis »Pomodoro«**
- una hoja dentada, muy afilada, así pueden pelarse fácilmente tomates, pimientos, kiwis, melocotones etc., con ahuecador
  - para diestros y zurdos

Art-Nr. / Art.-No.	VE / SU	EAN
6093 5560 	10	4 004094 609367
6093 5660 	1	4 051734 609362

INOX

Rostfrei  
Stainless steel



Made in EUROPE 



115 x 65 x 13 mm

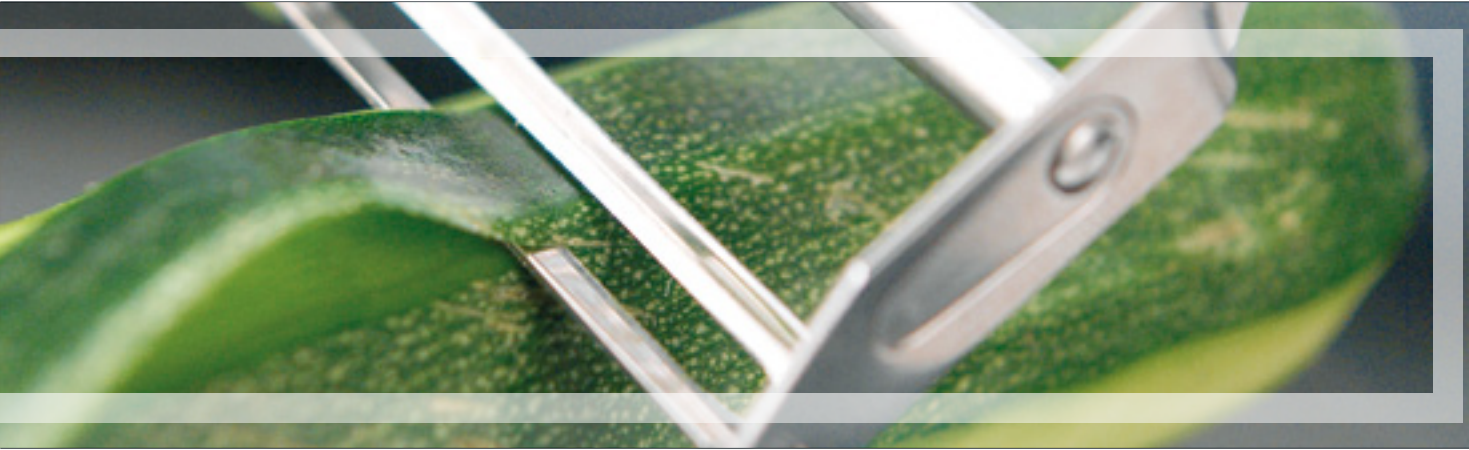

- Knoblauch- und Zwiebelpresse »Nero«**
- mit 2 Presseinsätzen (grob und fein)
  - Pressstempel aus Polyamid
  - Presseinsatz herausnehmbar für besonders leichte Reinigung

- Garlic and onion press »Nero«**
- with 2 press sieves (coarse and fine)
  - press plunger from polyamide
  - sieve removable for easy cleaning

- Presse-ail et oignon »Nero«**
- avec 2 presses (gros et fin)
  - piston en polyamide
  - presse retirable pour un nettoyage particulièrement facile

- Prensa de ajos y cebollas »Nero«**
- con dos insertos de prensado (grueso y fino)
  - prensador de poliamida
  - el inserto de prensado puede extraerse para una limpieza especialmente fácil

Art-Nr. / Art.-No.	VE / SU	EAN
1255 5560 	6	4 004094 125560

PP

INOX

EDELSTAHL  
Rostfrei  
Stainless steel



Made in GERMANY 





172 x 50 x 27 mm

- Gabel »Profi«**
- die hochwertige Monopol-Gabel - passend zu dem nachfolgenden Messer

- Fork »Profi«**
- the high quality Monopol-fork - matching the Monopol knife

- Fourchette »Profi«**
- la fourchette haute qualité Monopol - adapté-eau couteau suivant

- Tenedor »Profi«**
- el tenedor Monopol de primera calidad - idó-neo para usar con el cuchillo que sigue

Art-Nr. / Art.-No.	VE / SU	EAN
1691 5511 	6	4 004094 169113
1691 5611 	1	4 051735 003039

ABS

INOX

EDELSTAHL  
Rostfrei  
Stainless steel





Made in GERMANY 



207 x 24 x 17 mm

- Vespermesser »Profi«**
- sehr scharfe Wellenschliff-Klinge
  - ideal als Frühstück-, Obst-, Fleisch- & Steak-messer
- Universal knife »Profi«**
- very sharp serrated-edge-blade
  - ideal as breakfast, fruit, meat and steak knife

- Couteau universel »Profi«**
- lame ondulée très coupante
  - comme couteau à petit déjeuner, à fruits, à viande et à steak
- Cuchillo merienda »Profi«**
- hoja muy aguda con afilado ondulado
  - ideal como cuchillo para el desayuno, para pelar frutas, para cortar carne

Art-Nr. / Art.-No.	VE / SU	EAN
1692 5560 	6	4 004094 169267
1692 5511 	6	4 004094 169212
1692 5611 	1	4 051735 003022

ABS

INOX

EDELSTAHL  
Rostfrei  
Stainless steel



Made in GERMANY 



230 x 20 x 13 mm





78 x 50 x 54 mm

- Dosenöffner »Automatic«**
- klein, kompakt, gut in der Schublade zu verstauen
  - hochfein verchromt
  - Transportrad und Schneidmesser aus gehärtetem Spezialstahl

- Can opener »Automatic«**
- small, compact, easy to store in the drawer
  - fine chrome-plating
  - transport wheel and knife from special, tempered steel

- Ouvre-boîte »Automatic«**
- petit, compact, facile à ranger dans un tiroir
  - chromage fin
  - roue de transport et lame de coupe en acier spécial trempé

- Abrelatas »Automatic«**
- pequeño, compacto, fácil de guardar en el cajón
  - cromado muy fino
  - rueda transportadora y cuchilla de corte en acero especial templado

Art-Nr. / Art.-No.	VE / SU	EAN
1222 5560 	5	 4 004094 122262

ST PA



91 x 60 x 91 mm

- Profidosenöffner »Titan«**
- für den gewerblichen Gebrauch
  - konzipiert für Dosen in Gastronomiegröße
  - Schneidmesser-Prinzip
  - Messer und Transportrad stahlgehärtet und verzinkt

- Profi can opener »Titan«**
- for commercial use
  - designed for cans in catering size
  - cutting-knife-principle
  - knife and traction wheel specially hardened and tin-plated

- Ouvre-boîte professionnel »Titan«**
- à usage commercial
  - conçu pour les grandes boîtes dans la restauration
  - principe à lame de coupe
  - lame et roue de transport en acier trempé et étamé

- Abrelatas profesional »Titan«**
- para el uso comercial
  - diseñado para latas de tamaño para gastronomía
  - principio de cuchilla de corte
  - cuchilla y rueda transportadora templadas y estañadas



Art-Nr. / Art.-No.	VE / SU	EAN
1224 5560 	5	 4 004094 122460

ST





### Zangendosenöffner »Super«

- komfortables Ansetzen am Dosenrand durch vollständig zu öffnende Zange
- Schneidrad wird durch zwei gefederte Zahnräder angetrieben und passt sich somit optimal jedem Rand an

#### Can opener »Super«

- comfortable to place on the can by wide opening tongs
- the cutting wheel is driven by two spring mounted cog wheels and adjusts ideally to each rim

Art-Nr. / Art.-No.	VE / SU	EAN
1236 5560 	3	 4 004094 123665

ST ABS PP



### Ouvre-boîte à pince »Super«

- mise en place facile au bord de la boîte grâce à la pince s'ouvrant totalement
- la molette est entraînée par deux roues dentées à ressorts et s'ajuste de façon optimale à tous les bords

#### Abrelatas de tenazas »Super«

- colocación confortable en el borde de la lata gracias a las tenazas que se abren del todo
- la rueda cortante es impulsada por dos ruedas dentadas suspendidas en muelles y, por tanto, se adapta óptimamente a cualquier borde





200 x 46 x 63 mm

### Zangendosenöffner »Exquisit«

- alle Metallteile aus Edelstahl
- komfortables Ansetzen am Dosenrand durch vollständig zu öffnende Zange
- Schneidrad wird durch zwei gefederte Zahnräder angetrieben

#### Can opener »Exquisit«

- all metal parts stainless steel
- comfortable to place on the can by wide opening tongs
- the cutting wheel is driven by two spring mounted cog wheels

Art-Nr. / Art.-No.	VE / SU	EAN
1238 5560 	3	 4 004094 123863

ABS PP INOX



### Ouvre-boîte à pince »Exquisit«

- toutes les pièces métalliques d'inox
- mise en place facile au bord de la boîte grâce à la pince s'ouvrant totalement
- la molette est entraînée par deux roues dentées à ressorts

#### Abrelatas de tenazas »Exquisit«

- todas las partes metálica en inox
- colocación confortable en el borde de la lata gracias a las tenazas que se abren del todo
- la rueda cortante es impulsada por dos ruedas dentadas suspendidas en muelles





200 x 46 x 63 mm

### Zangendosenöffner »Safety«

- „Keine-scharfen-Kanten-Schneidsystem“
- Deckel wird am seitlichen Dosenrand sauber eingeschnitten
- mit Zange für leichtes Abnehmen des Deckels

#### Can opener »Safety«

- „no-sharp-edges-cutting-principle“
- the lid is cut cleanly sideways underneath the rim
- built-in tongs for taking off the lid easily

Art-Nr. / Art.-No.	VE / SU	EAN
1240 5560 	3	 4 004094 124068

ABS INOX



### Ouvre-boîte à pince »Safety«

- „système de coupe sans bords affûtés“
- coupe la boîte sur le côté
- avec petite pince pour retirer facilement le couvercle

#### Abrelatas de tenazas »Safety«

- ningún sistema de corte de bordes agudos
- la tapa se corta de un modo limpio en el borde lateral de la lata
- con tenacitas para quitar la tapa



198 x 50 x 60 mm





### Dosenöffner »Safety left« für Linkshänder

- „Keine-scharfen-Kanten-Schneidsystem“
- Deckel wird am seitlichen Dosenrand sauber eingeschnitten
- mit Zange für leichtes Abnehmen des Deckels

#### Can opener »Safety left« for left handed people

- „no-sharp-edges-cutting-principle“
- the lid is cut cleanly sideways underneath the rim
- built-in tongs for taking off the lid easily

Art-Nr. / Art.-No.	VE / SU	EAN
1235 5570 	5	 4 004094 123573

ABS INOX



### Ouvre-boîte »Safety left« pour gauchers

- „système de coupe sans bords affûtés“
- coupe la boîte sur le côté
- avec petite pince pour retirer facilement le couvercle

#### Abrelatas »Safety left« para zurdos

- ningún sistema de corte de bordes agudos
- la tapa se corta de un modo limpio en el borde lateral de la lata
- con tenacitas para quitar la tapa



167 x 110 x 83 mm





167 x 30 x 11 mm

**Nussknacker**

- Struktur-Relief an den Seitenflügeln
- verchromt
- wird einzeln im Polybeutel geliefert - empfohlen als Nachbestückung für das Display s. Art-No. 1679 5611

**Nut cracker**

- elegant relief design at the side of the wings
- chrome
- comes single in a polybag - recommended as refill for display s. article no. 1679 5611

Art-Nr. / Art.-No.	VE / SU	EAN
1670 5511 	5	 4 004094 167010

ST



**Casse-noix**

- design en relief élégant aux ailes latérales
- chromée
- livré séparément en poly-sacs - recommandé pour remplir le présentoir - voir. Art-No. 1679 5611

**Cascanueces**

- relieve estructural en las aletas laterales
- cromado
- en polibolsas individuales – se recomienda como equipamiento posterior para el expositor art. 1679 5611





167 x 30 x 11 mm

**Nussknacker**

- Struktur-Relief an den Seitenflügeln
- edelmattiert
- wird einzeln im Polybeutel geliefert - empfohlen als Nachbestückung für das Display s. Art-No. 1679 5611

**Nut cracker**

- elegant relief design at the side of the wings
- satin finish
- comes single in a polybag - recommended as refill for display s. article no. 1679 5611

Art-Nr. / Art.-No.	VE / SU	EAN
1671 5511 	5	 4 004094 167119

ST



**Casse-noix**

- design en relief élégant aux ailes latérales
- finition satinée
- livré séparément en poly-sacs - recommandé pour remplir le présentoir - voir. Art-No. 1679 5611

**Cascanueces**

- relieve estructural en las aletas laterales
- mateado
- en polibolsas individuales – se recomienda como equipamiento posterior para el expositor art. 1679 5611





178 x 44 x 13 mm

**Nussknacker »Triangolo«**

- klare Linienführung in solidem Druckguss
- polierte, glänzende Oberfläche
- das schwere Material unterstreicht die hochwertige Anmutung

**Nut cracker »Triangolo«**

- clear contours for a solid zinc diecast construction
- polished, shiny surface
- the weighty feeling underlines the high quality impression

Art-Nr. / Art.-No.	VE / SU	EAN
1672 5560 	5	 4 004094 167263

ZD



**Casse-noix »Triangolo«**

- contour clair en construction en zinc solide
- poli, surface brillante
- la matière lourde et brillante souligne l'apparence de haute qualité

**Cascanueces »Triangolo«**

- claro contorno en sólida colada a presión
- pulido, superficie brillante
- el material brillante, compacto, subraya la impresión de alta calidad







178 x 40 x 12 mm

**Nussknacker »Adesso«**

- in kantigem, kräftigem Design
- aus solidem Druckguss
- edelmattiert
- in Geschenkbox oder lose als Nachbestückung für Display No. 1679 5611

**Nut cracker »Adesso«**

- in square-edged, strong design
- crafted from zinc diecast material
- satin finish
- in gift box or bulk as refill for display no. 1679 5611

Art-Nr. / Art.-No.	VE / SU	EAN
1673 5511 	5	 4 004094 167317
1673 5580 	1	 4 004094 167386

ZD



**Casse-noix »Adesso«**

- design fort à arêtes vives
- de zinc moulé sous pression
- finition satinée
- en boîte cadeau ou au détail pour remplir le présentoir No. 1679 5611

**Cascanueces »Adesso«**

- en un diseño canteado
- de una sólida colada a presión
- mateado
- en estuche de regalo o suelto como equipamiento para el expositor no. 1679 5611







**Nussknacker »Elegante«**

- aus solidem Druckguss
- edelmattiert
- in Geschenkbox oder lose als Nachbestückung für Display No. 1679 5611

**Nut cracker »Elegante«**

- crafted from zinc diecast material
- satin finish
- in gift box or bulk as refill for display no. 1679 5611

Art-Nr. / Art.-No.	VE / SU	EAN
1674 5511 	5	 4 004094 167416
1674 5580 	2	 4 004094 167485



**Casse-noix »Elegante«**

- de zinc moulé sous pression
- finition satinée
- en boîte cadeau ou au détail pour remplir le présentoir No. 1679 5611

**Cascanueces »Elegante«**

- de una sólida colada a presión
- mateado
- en estuche de regalo o suelto como equipamiento para el expositor no. 1679 5611





181 x 33 x 17 mm

**Nussknacker »Prezioso«**

- ausgestattet mit Federmechanismus öffnet sich der Nussknacker automatisch nach jedem Zudrücken
- aus solidem Druckguss
- edelmattiert

**Nut cracker »Prezioso«**

- featuring a spring-mechanism this nutcracker opens up automatically after each squeeze
- crafted from zinc diecast material
- satin finish

Art-Nr. / Art.-No.	VE / SU	EAN
1675 5580 	2	 4 004094 167584



**Casse-noix »Prezioso«**

- pourvu d'un mécanisme à ressort, ce casse-noix s'ouvre automatiquement à chaque pression
- de zinc moulé sous pression
- finition satinée

**Cascanueces »Prezioso«**

- equipado con un mecanismo de muelle, este cascanueces se abre automáticamente cada vez que se ha apretado
- de una sólida colada a presión
- mateado



181 x 33 x 17 mm







**Nussknacker »Estetico«**

- warme Holzgriffe bilden einen schönen Kontrast zu dem kühlen hochglänzenden Metall
- aus solidem Druckguss
- in Geschenkbox und in Faltschachtel

**Nut cracker »Estetico«**

- warm wooden handles form a nice contrast to the cool high-polished metal
- crafted from zinc diecast material
- in giftbox and sales carton

Art-Nr. / Art.-No.	VE / SU	EAN
1680 5560 	5	 4 004094 168062
1680 5580 	2	 4 004094 168086



**Casse-noix »Estetico«**

- les manches chauds en bois forment un beau contraste avec le métal froid hautement brillant
- de zinc moulé sous pression
- en boîte cadeau et carton

**Cascanueces »Estetico«**

- las agarraderas de madera cálidas forman un bello contraste con el metal de alto brillo frío
- de una sólida colada a presión
- en estuche de regalo o encartonar





181 x 46 x 18 mm

**Nussknacker Display**

- Zusammenstellung der gängigsten Monopol-Nussknacker in einem Display
- Inhalt: insgesamt 20 Stück aufgeteilt in je 5 Stück der folgenden Artikel 1670, 1673, 1674 und 1680

**Nut cracker display**

- a choice of the most popular Monopol nutcrackers in a display
- contents: total of 20 pcs split into 5 pcs of each of the following articles 1670, 1673, 1674 and 1680

Art-Nr. / Art.-No.	VE / SU	EAN
1679 5611 	1	 4 004094 167911

**Présentoir casse-noix**

- assortiment des casse-noix Monopol les plus populaires dans un présentoir
- contenu: total de 20 pièces divisées à chaque fois en 5 pièces des articles suivants: 1670, 1673, 1674 et 1680

**Expositor para cascanueces**

- un surtido de cascanueces Monopol más corrientes en un expositor
- contenido: 20 piezas en total subdivididas en sendas 5 piezas de los siguientes artículos 1670, 1673, 1674 y 1680





6255 5580

6255 556C

150 x 68 x 35 mm

**Glockenkorkenzieher »Chianti«**

- mit Original-Monopol Scharfgewinde
- geeignet für Natur- und Kunststoffkorken
- mit Korkabstreifer
- optimal abgestimmte Mechanik
- edelmattiert in Geschenkbox oder hochglänzend verchromt in Verkaufskarton

**Bell corkscrew »Chianti«**





- with the original Monopol cutting thread
- suitable for plastic and natural cork
- with cork remover
- excellently finished mechanism
- satin-finished in gift-box or highgloss chrome-version in sales carton

**Tire-bouchon à cloche »Chianti«**

- avec le filet de coupe original Monopol
- adapté pour les bouchons naturels et en plastique
- avec extracteur de bouchon
- mécanisme parfaitement fini
- satinée en boîte cadeau ou en version chromée en carton

**Sacacorchos de campana »Chianti«**

- con la rosca cortante original Monopol
- idóneo para corchos de materiales naturales y plásticos
- con rascacorchos
- mecanismo excelentemente armonizado
- mateado noble en estuche de regalo o cromado en cajade cartón para ventas

Art-Nr. / Art.-No.	VE / SU	EAN
6255 556 C 	5	 4 004094 625565
6255 5580 	2	 4 004094 625589



147 x 68 x 38 mm

**Glockenkorkenzieher »Barolo«**

- mit vollflächigen Elementen - sehr massiv
- Original-Monopol Scharfgewinde
- für Natur- und Kunststoffkorken
- mit Korkabstreifer
- edelmattiert

**Bell corkscrew »Barolo«**



- high class look with generous, solid elements
- original Monopol cutting thread
- for plastic and natural cork
- with cork remover
- satin-finished

**Tire-bouchon à cloche »Barolo«**

- design avec des éléments très massifs
- filet de coupe original Monopol
- pour les bouchons naturels et en plastique
- extracteur de bouchon
- satiné

**Sacacorchos de campana »Barolo«**

- efecto muy sólido
- rosca cortante original Monopol
- idóneo para corchos de materiales naturales y plásticos
- con rascacorchos
- mateado

Art-Nr. / Art.-No.	VE / SU	EAN
6260 5580 	2	 4 004094 626081



154 x 90 x 38 mm

**Glockenkorkenzieher »Bacchus«**

- interessante Doppelspindel-Funktion
- Original-Monopol-Scharfgewinde
- für Natur- und Kunststoffkorken
- optimal abgestimmte Mechanik
- edelmattiert

**Bell corkscrew »Bacchus«**



- interesting double-spindle engineering
- original Monopol cutting thread
- for plastic and natural cork
- precisely crafted
- satin-finished

**Tire-bouchon à cloche »Bacchus«**

- fonction intéressante du double axe
- filet de coupe original Monopol
- adapté pour les bouchons naturels et en plastique
- conçu avec précision
- satiné

**Sacacorchos de campana »Bacchus«**

- interesante función de husillo doble
- rosca cortante original Monopol
- para corchos de materiales naturales y plásticos
- elaboración exacta
- mateado

Art-Nr. / Art.-No.	VE / SU	EAN
6240 5580 	2	 4 004094 624087







- Glockenkorkenzieher »Monopull«**
- Original-Monopol Scharfgewinde
  - geeignet für Natur- und Kunststoffkorken
  - mit Korkabstreifer
  - durch Zangenform sehr leicht auf Flaschenhals aufzusetzen
  - edelmattiert

- Bell corkscrew »Monopull«**
- original Monopol cutting thread
  - suitable for plastic and natural cork
  - cork remover
  - tong shape makes it very easy to put the corkscrew on the bottle neck
  - satin-finished

- Tire-bouchon à cloche »Monopull«**
- filet de coupe original Monopol
  - pour les bouchons naturels et en plastique
  - extracteur de bouchon
  - extra facile à placer sur le goulot de la bouteille
  - satinée

- Sacacorchos de campana »Monopull«**
- rosca cortante original Monopol
  - idóneo para corchos de materiales naturales y plásticos
  - rascacorchos
  - puede poner fácilmente sobre el cuello de la botella
  - mateado



Art-Nr. / Art.-No.	VE / SU	EAN
6275 5580 	2	 4 004094 627583

ZD ST



154 x 90 x 40 mm



Monopol

- Ent- und Verkorker »Ah-So«**
- zwei gehärtete Stahlfedern umfassen den Korken ohne ihn zu beschädigen
  - perfekt für brüchige Korken
  - mit dekorativer Schutzhülle
  - mit Kapselheber
  - edelmattiert in Geschenkbox oder hochglänzend verchromt in Verkaufskarton

- Bottle opener and corker »Ah-So«**
- two hardened steel prongs embrace the cork, without damaging it
  - ideal for brittle corks
  - with decorative casing
  - with cap opener
  - satin-finished in gift-box or highgloss chrome-version in sales carton





- Déboucheur et emboucheur »Ah-So«**
- deux lames en acier trempé entourent le bouchon sans l'endommager
  - idéal pour les bouchons fragiles
  - enveloppe de protection décorative
  - décapsuleur
  - satinée en boîte cadeau ou en version chromée en carton

6285 556C

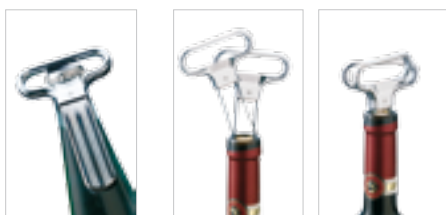
- Destaponador y taponador »Ah-So«**
- dos muelles de acero templado abrazan el corcho sin dañarlo
  - ideal para los corchos que bradizos
  - con funda protectora decorativa
  - con levantachapas
  - mateado noble en estuche de regalo o cromado en cajade cartón para ventas

6285 5580



Art-Nr. / Art.-No.	VE / SU	EAN
6285 556C 	5	 4 004094 628566
6285 5580 	2	 4 004094 628580

ZD ST



110 x 65 x 10 mm

15

239



73 x 38 x 205 mm

- Hebelkorkenzieher »Pedro«**
- Original-Monopol Scharfgewinde
  - für Natur- und Kunststoffkorken
  - mit Korkabstreifer & Kapselheber
  - edelmattiert in Geschenkbox oder hochglänzend verchromt im Verkaufskarton
  - Art-No. 6157 Wendel mit Seele







- Lever corkscrew »Pedro«**
- original Monopol cutting thread
  - for plastic and natural cork
  - with cork & cap remover
  - satin-finished in gift-box or as chrome-version in a sales carton
  - art-no. 6157 contains thread with axial centre

- Tire-bouchon à levier »Pedro«**
- filet de coupe original Monopol
  - pour les bouchons naturels et en plastique
  - avec extracteur de bouchon & décapsuleur
  - satinée en boîte cadeau ou en version chromée en carton
  - art-no. 6157 contient la mèche avec âme

- Sacacorchos de palanca »Pedro«**
- rosca cortante original Monopol
  - para corchos de materiales naturales y plásticos
  - con rascacorchos y levantachapas
  - mateado en estuchede regalo o cromado en cajade cartón para ventas
  - art-no. 6157 tiene espiral con alma

6157 5580



Art-Nr. / Art.-No.	VE / SU	EAN
6155 556C 	5	4 004094 615566 
6155 5580 	2	4 004094 615580 
6157 556C 	5	4 004094 615764 

ZD ST





203 x 75 x 41 mm

- Hebelkorkenzieher »Fino«**
- sehr massive Ausführung
  - Original-Monopol Scharfgewinde
  - für Natur- und Kunststoffkorken
  - mit Korkabstreifer & Kapselheber
  - edelmattiert in Geschenkbox

- Lever corkscrew »Fino«**
- very solid version
  - original Monopol cutting thread
  - for plastic and natural cork
  - with cork & cap remover
  - satin-finished in gift-box

- Tire-bouchon à levier »Fino«**
- modèle très massif
  - filet de coupe original Monopol
  - pour les bouchons naturels et en plastique
  - avec extracteur de bouchon & décapsuleur
  - satinée en boîte cadeau

- Sacacorchos de palanca »Fino«**
- versión muy sólida
  - rosca cortante original Monopol
  - para corchos de materiales naturales y plásticos
  - con rascacorchos y levantachapas
  - mateado en estuchede regalo

Art-Nr. / Art.-No.	VE / SU	EAN
6160 5580 	2	4 004094 616082 

ZD ST





- Hebelkorkenzieher »Brunello«**
- Original-Monopol Scharfgewinde
  - für Natur- und Kunststoffkorken
  - mit Korkabstreifer & Kapselheber
  - edelmattiert in Geschenkbox

- Lever corkscrew »Brunello«**
- original Monopol cutting thread
  - for plastic and natural cork
  - with cork & cap remover
  - satin-finished in gift-box

- Tire-bouchon à levier »Brunello«**
- filet de coupe original Monopol
  - pour les bouchons naturels et en plastique
  - avec extracteur de bouchon & décapsuleur
  - satinée en boîte cadeau

- Sacacorchos de palanca »Brunello«**
- rosca cortante original Monopol
  - para corchos de materiales naturales y plásticos
  - con rascacorchos y levantachapas
  - mateado en estuchede regalo

Art-Nr. / Art.-No.	VE / SU	EAN
6165 5580 	2	4 004094 616587 

ZD ST



210 x 75 x 47 mm



- Kapselheber »Puro«**
- edles puristisches Design
  - die schwere Druckgussqualität unterstreicht die Wertigkeit
  - dezente matte Oberfläche
  - edelmattiert in Geschenkbox
- Cap opener »Puro«**
- *classy puristic design*
  - *the heavy diecasted quality underlines the value*
  - *unobtrusive matt finish*
  - *satin-finished in gift-box*

Art-Nr. / Art.-No.	VE / SU	EAN
6179 5580	2	4 004094 617980

ZD



- Décapsuleur »Puro«**
- design pur et élégant
  - la qualité lourde du zinc moulé sous pression souligne la valeur
  - surface légèrement mate
  - satinée en boîte cadeau
- Levantachapas »Puro«**
- *diseño purístico noble*
  - *la buena calidad de la colada a presión subraya el alto valor*
  - *superficie mate decente*
  - *mateado en estuchede regalo*



153 x 16 x 23 mm

- Kapselheber »Rotondo«**
- klassisch elegant
  - aus einem Stück Stahl gefertigt
  - edelmattiert in Geschenkbox

- Cap opener »Rotondo«**
- *classic elegant*
  - *crafted from one piece steel*
  - *satin-finished in gift-box*

Art-Nr. / Art.-No.	VE / SU	EAN
6180 5580	2	4 004094 618086

ST



- Décapsuleur »Rotondo«**
- un classique élégant
  - fabriqué à partir d'une pièce acier
  - satinée en boîte cadeau
- Levantachapas »Rotondo«**
- *clásico elegante*
  - *fabricado de una sola pieza acero*
  - *mateado en estuchede regalo*



140 x 45 x 5 mm

- Kapselheber »Linea«**
- schöne Linienführung
  - schwere Druckgussqualität
  - angenehme Haptik
  - edelmattiert in Geschenkbox

- Cap opener »Linea«**
- *nicely shaped*
  - *heavy diecasted quality*
  - *very agreeable to hold*
  - *satin-finished in gift-box*

Art-Nr. / Art.-No.	VE / SU	EAN
6181 5580	2	4 004094 618185

ZD



- Décapsuleur »Linea«**
- de belles lignes
  - qualité lourde du zinc moulé
  - très agréable en main
  - satinée en boîte cadeau
- Levantachapas »Linea«**
- *bello trazado*
  - *buena calidad de la colada a presión*
  - *muy agradable en la mano*
  - *mateado en estuchede regalo*



139 x 41 x 8 mm

- Ausgießer »Versa«**
- aus gebürstetem Edelstahl
  - dezente matt
  - mit Silikondichtfläche
  - edelmattiert in Geschenkbox

- Pourer »Versa«**
- *from brushed stainless steel*
  - *unobtrusive matt-design*
  - *with silicone sealing element*
  - *satin-finished in gift-box*

Art-Nr. / Art.-No.	VE / SU	EAN
4450 5580	2	4 004094 445088

SI INOX



- Verseur »Versa«**
- en acier inoxydable brossé
  - légèrement mat
  - avec surface en silicone
  - satinée en boîte cadeau
- Vertedor »Versa«**
- *de acero inoxidable, cepillado*
  - *mate decente*
  - *con superficie hermetizante de silicona*
  - *mateado en estuchede regalo*



28 x 28 x 102 mm

- Kapselschneider »Mondo«**
- ermöglicht einfaches und sicheres Öffnen der Weinkapsel
  - federgelagert
  - durch die Zangenform flexible Anpassung an unterschiedliche Flaschenhälse
  - edelmattiert in Geschenkbox
- Foil cutter »Mondo«**
- *enables easy and secure foil cutting*
  - *spring loaded*
  - *the tong-like shape offers flexible adjustment to different size bottle necks*
  - *satin-finished in gift-box*

Art-Nr. / Art.-No.	VE / SU	EAN
6296 5580	2	4 004094 629686

ZD



- Coupe-capsule »Mondo«**
- pour une ouverture simple des capsules
  - mécanisme suspendu
  - la forme en pince permet une adaptation à différentes épaisseurs de goulots de bouteille
  - satinée en boîte cadeau
- Cortachapas »Mondo«**
- *abertura fácil de chapas de botellas de vino*
  - *suspensión elástica*
  - *gracias a la forma de tenazas, adaptación flexible a cuellos de botellas*
  - *mateado en estuchede regalo*



68 x 57 x 16 mm





41 x 41 x 67 mm

- Sektflaschenverschließer »Vermo«**
- dicht schließend
  - Besonderheit: der elastische Gummiring drückt die Metallflügel fest an
  - die Flasche kann auch liegend gelagert werden

- Champagne bottle stopper »Vermo«**
- tightly closing
  - speciality: the elastic rubber ring gives pressure to the metal wings
  - the bottle may also be stored horizontally

- Bouchon à champagne »Vermo«**
- fermeture hermétique
  - particularité: l'anneau élastique presse les ailes métalliques autour du goulot
  - la bouteille peut être conservée allongée

- Cierre de botellas de cava »Vermo«**
- cierra herméticamente
  - particularidad: el anillo elástico ejerce una presión y sujeta fijamente las alas metálicas
  - la botella puede tumbarse también en la estantería

Art.-Nr. / Art.-No.	VE / SU	EAN
6012 556C 	5	 4 004094 601262

ST ABS



6013 5580

- Sektflaschenverschließer »Tappa«**
- durch die federbelagte Klemmfunktion mit einer Hand zu bedienen
  - die Flasche kann auch liegend gelagert werden
  - verchromt oder edelmattiert

- Champagne bottle sealer »Tappa«**
- the spring-loaded clamp-system can be operated with one hand
  - the bottle may also be stored horizontally
  - in chrome-plated or satin-finished version







- Bouchon à champagne »Tappa«**
- s'utilise d'une main grâce au mécanisme de ressort
  - la bouteille peut être conservée allongée
  - en version chromée ou satinée

- Cierre de botellas de cava »Tappa«**
- gracias a la función de sujeción de suspensión elástica, puede manejarse el cierre con una sola mano
  - la botella puede tumbarse también en la estantería
  - en versión cromada o mateada

6013 556C  
6013 566C



89 x 39 x 44 mm

Art.-Nr. / Art.-No.	VE / SU	EAN
6013 556C 	6	 4 004094 601361
6013 566C 	1	 4 051734 001043
6013 5580 	2	 4 004094 601385

ST ABS





31 x 31 x 82,5 mm

- Weinflaschenverschluss »Vino«**
- aus hochwertigem Edelstahl – massive Ausführung
  - mit Silikondichtfläche
  - edelmattiert in Geschenkbox

- Wine bottle stopper »Vino«**
- from high quality stainless steel – solid version
  - with silicone sealing element
  - satin-finished in gift-box

- Obturbateur de bouteille de vin »Vino«**
- en acier inoxydable de grande qualité – modèle massif
  - avec surface en silicone
  - satinée en boîte cadeau

- Cierre de botellas de vino »Vino«**
- de acero inoxidable
  - con superficie hermetizante de silicona
  - mateado en estuche de regalo

Art.-Nr. / Art.-No.	VE / SU	EAN
6196 5580 	2	 4 004094 619687

SI INOX





198 x 92 x 20 mm

- Barsieb**
- für die Zubereitung von Cocktails
  - hält Eiswürfel und größere Fruchtfleisch-Stücke zurück
  - zwei Auflagen für sicheren Halt auf dem Shaker

- Bar strainer**
- indispensable for preparing cocktails
  - keeps ice and bigger size pulp from splashing into the drink
  - two prongs for a secure fit on top of a shaker

- Passoire à shaker**
- indispensable pour préparer des cocktails
  - filtre les glaçons et les grands morceaux de fruits
  - deux pattes pour un maintien sûr sur le shaker

- Tamiz para bares**
- para mezclar cócteles
  - retiene los cubitos de hielo y trozos más grande de la carne de la fruta
  - dos soportes para una retención segura sobre el shaker

Art.-Nr. / Art.-No.	VE / SU	EAN
6279 5560 	6	 4 004094 627965

INOX









## Systemes de présentation • *Sistemas de presentación*



Showroom

Vorschläge für Wand- oder Gondelpräsentationen erstellen wir gern individuell - nach Kundenwunsch.

*Proposals for presentations are being made according to the individual demands of our customers.*





# WESTMARK

Gebündelte Markenpräsenz = starke Wahrnehmung  
 Unser modulares Gondelsystem bietet Ihnen die folgenden Präsentationsflächen:

*Combined brand presence = increased perception  
 Our modular shelving system offers the following presentation surface areas:*

Présence concentrée des marques = perception plus forte  
 Notre système modulaire en gondoles vous propose les surfaces de présentation suivantes :

*Presencia de marca agrupada = mayor percepción  
 Nuestro sistema de góndola modular le ofrece las siguientes superficies de presentación.*

Art.-Nr. 0990 3400 080

Kopfgondel	End gondola	Gondole de fin	Góndola de fin
inkl. Lochwand	incl. perforated panel	incl. plaque perforée	incl. panel perforado
inkl. 1 Glasboden	incl. 1 glass shelf	incl. 1 étagère en verre	incl. 1 soporte de vidrio
inkl. 1 Topschild	incl. crowner	incl. panneau	incl. placa

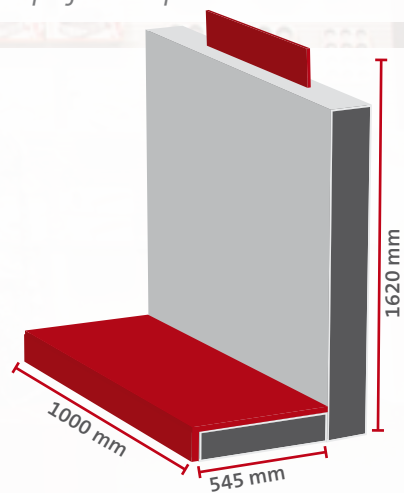

Art.-Nr. 0990 3390 080

Anbaugondel	Extension gondola	Gondole d'extension	Góndola de extension
inkl. 2 Lochwände	incl. 2 peg panels	incl. 2 plaques perforées	incl. 2 paneles
inkl. 2 Glasböden	incl. 2 glass shelves	incl. 2 étagères en verre	incl. 2 soportes de vidrio
inkl. 1 Topschild	incl. crowner	incl. panneau	incl. placa

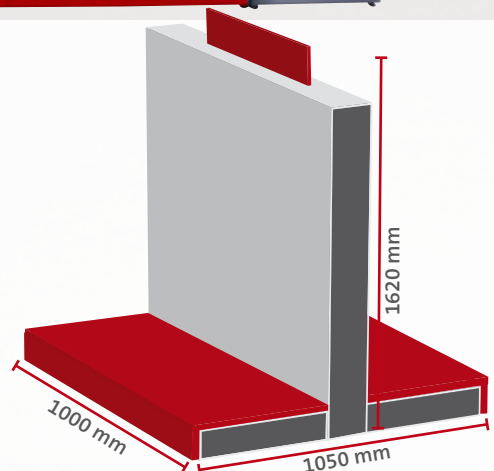

Abrebotellas	46/47, 50-53, 99, 102, 104-109, 238-241	Copa shaker	116	Escurredor semiesférico acero inoxidable	61
Abrebotellas	46, 50-53, 107/108, 241	Cordel para barbacoa y asados	72	Esparcidor de especias basto	209
Abrechapas	107	Cordeles para guisar y asar	72	Espátula	44/45, 48/49, 54-58, 160, 162 195
Abrechapas »Hermetus«	108	Cortacabezas de huevos	132	Espátula acodada	163
Abrelatas	53, 98-102, 195, 234/235	Cortador de cebollas en cubitos	94	Espátula doble	56, 195
Abrelatas	53, 98-102, 195, 234/235	Cortador de hierbas	88	Espátula extendedora	163
Abrelatas de palanca	98, 101, 195	Cortador de judías verdes	177, 195	Espátula para crepes	45, 49, 58
Abrelatas de seguridad	99, 102, 235	Cortador de mozzarella	22, 195	Espátula y rascador	57
Abrelatas de tenazas	98/99, 101/102, 235	Cortador de patatas	22, 96, 195	Espiral para patatas	32
Abrelatas profesional	99, 234	Cortador de piña	18	Espolvoreador decorador / de cacao	131
Abretapas	53	Cortador de pizzas	53	Espumadera	41, 44/45, 48/49, 54/55
Abretarros de cristal universal	181	Cortador de pizzas	25, 46/47, 51-53	Paleta	41, 44/45, 48/49, 54/55
Abridor combinado	99, 102, 108, 195	Cortador de queso	20, 32, 52/53, 195	Estanterías para especias	123, 209
Abridor de tapas roscadas	99, 102, 108, 181, 195	Cortador de rábanos	33	Esterilla horno	64
Abridor universal	99, 102, 108, 181, 195	Cortador de repollo	10	Esterilla para extender la masa	159
Afilador de cuchillos	28/29	Cortador de tiras de pasta	158	Esterillas flexibles de corte	30
Agarradores	80	Cortador de verduras	86-96	Etiquetas decorativas	186
Aguja para coser	68	Cortador en espiral	91/92	Etiquetas y gomas	186
Aguja para mechar	68	Cortador horizontal para pasteles	166	Expendedor de láminas	122
Agujas para rollos de carne asada	72	Cortador Juliana	10/11, 46, 50, 91, 195	Expendedor de nata	199, 203/204
Agujereador de huevos	132	Cortador multiuso	23, 195	Expendedor multiuso	199
Agujereador de latas	46/47, 103,	Cortador universal	30	Expendedora de pan en láminas	119
Agujereador de pasta	158	Cortador y paleta para tartas	166	Expositor para cascanueces	237
Ahucador de CupCakes	166	Cortahuevos	21/22, 195	Exprimidor de frutas	188/189
Aplastador de carne	65	Cortapastas	149/155	Exprimidor de rodajas de limón	130
Aplastador de patatas	96	Cubierta para comidas	121	Exprimidor de zumo y bayas	178
Aplastador de patatas	48/49, 54/55, 96	Cubiertas para cacerolas	121	Filtro de café	126
Arandelas de goma para tarros »Weck«	187	Cubierto para ensalada	116	Filtro perdurable para el café	127
Aro para tartas	144	Cubo de leche y contenedor	178	Filtro perdurable para infusiones	127
Aros metálicos para rollos de carne asada	72	Cubo para recolectar	185	Folios reutilizables para horneado	166
Artista del adorno	164	Cuchara dosificadora de café	126	Frasco decorador	156
Asador de pollos	67	Cuchara para cócteles / limonada / yogures	133	Fuentecitas de porcelana	61
Atadores rápidos	123	Cuchara para guisar	58	Ganchos de ventosas	226
Atornilladuras	186	Cuchara para helado	53, 213	Guantes de cocina/para horno	80
Azucarero	199, 202	Cuchara para huevos	132	Guarnecedor multiuso	32, 195
Azucarero de azúcar en polvo	167	Cuchara para preparar té	129	Hacha de cocina y mazo para carne	65
Balanza de cocina	151	Cuchara para salsas	49, 55	Hilo para asado	72
Bandeja de horno	141	Cuchara para spaghetti	41, 49, 55	Hojas de recambio por el rascador de limpieza	29
Bandeja de horno para pizza	141	Cuchara para verduras	45, 48/49, 54/55	Huevero	132
Bandeja para pastel navideño y pasteles	168	Cuchilla de 4 alas	171	Huevo para té	128
Base para tartas de frutas	141, 143	Cuchilla de corte ondulado	32	Humectador de carne con jugos de asados	68/69
Bases para goteo de vasos	210	Cuchillo	13, 15, 24-27, 52, 171, 233	Inserto para vapor	61
Batidor	45, 49, 54/55, 60	Cuchillo abre ostras	79	Jabonera	227
Bloque para cuchillos	28	Cuchillo chef	27	Jarra medidora	150
Bol »Olympia«	112-114	Cuchillo merienda	233	Jarra separadora de grasa	68
Bol para batir	150, 153	Cuchillo multiuso	27	Jeringa para adornar y decorar buñuelos	164/165
Bol para ensalada	114	Cuchillo para carne	26	Jeringa para decorar	164/165
Bol para mezclar	153	Cuchillo para desayuno	25	Jeringa para mezclar y adornar	164/165
Botella de cangrejo giartorio	182	Cuchillo para ensaladas	24	Juego con tres plantillas para decorar	131
Botella de cuello recto	182	Cuchillo para mantequilla	52	Juntas para botellas	187
Buena calidad a precios equitativos	138	Cuchillo para pan	26/27	Lápiz de silicona para decoración	156
Butler para ensaladas	115	Cuchillo para pelar	27	Levantachapas	46, 50-53, 107/108, 241
Caja para sándwiches	118	Cuchillo para verduras	26	Levantatarros	181
Caja para tes	127	Cuchillo Santoku	27	Llaveros	227
Cajón de cocina suelto	122	Cuchillos de cocina	26	Mago de cocina	94
CakePop Butler	147	Decorador de rabanitos	32, 195	Manga pastelera	157
Calentador de cerveza	210	Decorador para pepinos	33	Mano para Caipirinha	211
Calidad para las más altas exigencias	142	Descorazonador de fresas	18	Mantequillera de mesa con escala	121
Carcasa de cajones	122	Descorchadora de manzanas	16, 46/47, 50-53	Mantequillera para refrigerador	121
Casca langostas	78, 195	Desorchadora de mesa	106	Máquina abrelatas robusta »Clou«	100
Cascanueces	63, 172, 236/237	Desescamador	63, 78, 195	Máquina de pasta	40
Cazo	55	Deshuesador de aceitunas	174, 195	Máquina de picar carne	170
Centrifugadora de lechuga	115	Deshuesador de cerezas	174-176, 195	Máquina pasadora	179
Cepillo para limpiar setas y verduras	23	Deshuesador de ciruelas	174-176, 195	Marco para pasteles/pizzas	144
Cierre de botella de cava	110, 242	Deshuesador doble	174/175, 195	Matamoscas	224
Cierres de botellas	109	Deslizantes de fieltro	227	Mazo para bistec/carne	64/65, 195
Clips para bolsas	123, 126	Desmenuzador de hielo	211	Mazo para patatas	48/49, 54/55, 96
Clips para sujetar manteles	227	Destaponador y taponador	239	Medida para bares	211
Clips para tarros »Weck«	187	Disco perforado	171	Menaje Salero, Pimentero, Vinagrera & Aceitera	200/201
Clips universales	187	Dispensador de edulcorantes	131	Mini-rallador universal	85
Cogedor	214/215	Dispensador de miel	203-205	Molde de silicona	146-148
Colador	59/60, 113/114, 128/129, 167, 179, 227, 242	Dispensador universal	199, 203/204	Molde de silicona para bombones	148
Colador plegable	129	Dosificador de azúcar	198, 202-204	Molde desmontable	136, 138, 140, 142
Colgantes decorativos	186	Embudo embutidor	171	Molde en forma de corazón	144
Contador de tiempo corto	71	Embudo para botellas con tamiz quita y pon	180	Molde Gugelhupf	137, 139
Contenedor para congelación	119	Embudo para conservas	180	Molde ovalado	144
Contenedor para horno microondas	120	Enfriador de pasteles y partidador de tartas	168		



Molde para muffins	141, 145/146	Prensa para hamburguesas	67	Soportes para mazorcas de maíz	77
Molde para asar/hornear	140	Prensa para pasteles y jeringa para adornar	165	Sueño de manzanas	17
Molde para hacer nidos de patatas	35	Prensa para Spätzle	38, 195	Sujetacartas de platos y helados	213
Molde para hamburguesas	67	Prensa patatas	38, 96, 195	Sujetador de restos / auxiliar de corte	66
Molde para horno de pan	141, 144	Protector contra salpicaduras	59	Suplemento para galletas	171
Molde para pasteles rectangulares	137, 139	Protector de dedos	82	Suplemento para Spätzle + rasqueta	38
Molde para quiches	143	Radio termómetro digital para asados	71	Tabla de corte	30
Moldecitos de papel para muffins	145	Rallador	83-87, 89, 92	Tabla para Spätzle	39
Moldes para gofres	162	Rallador a coronas	85	Tajadera	24
Moldes para postres / comidas	34/35, 149	Rallador de base redonda	89	Tajador de queso	20, 46/47, 50, 52/53
Moldes para raviolis	40	Rallador de cuatro caras	89	Tajador de verduras	86-90
Molinillo de mano	163	Rallador de frutas	87	Tajador decorador	32
Molinillos de sal y pimienta	206-208	Rallador de nuez moscada	84/85	Tamices para desagüe	227
Molino de adormidera	169	Rallador de queso	83/84, 87, 92/93, 169	Tamiz para bares	242
Molino de almendras	169	Rallador de tambor	93	Tamiz para harina y azúcar en polvo	167
Molino de especias con		Rallador de verduras yf		Tamiz pasador	179
molturador de cerámica	208	rutas crudas	86/87, 89/90, 92/93	Tamizador de tomates y exprimidor	178
Molino de hierbas	91	Rallador para Spätzle	39	Tapa para mantener fresco	117
Molino de nueces	169	Rallador torre	84, 89	Tapa para plato para horno microonda	120
Molino de nuez moscada	85	Rallador universal	86/87, 89, 92/93	Tapas a rosca	186
Molino universal	208	Ralladora con 4 tambores	92	Tapas para mosto	187
Mortero	209	Ralladora para nuez moscada	85	Tapones agarraderos	222
Nevera portátil con tapa	228	Rascador para vitrocerámica / de limpieza	29	Tapones con vertedores para Dash-Bottles	219
Oporte para azúcar del ponche alemán	210	Raspador para limones	15, 47, 51-53	Tapones de recambio ,nature'	216
Paleta para cocinar	44, 48/49, 58, 162	Rasqueta desprendedora para guisar y masa	161	Tarro de cristal con cierre de alambre	182
Paleta para pasteles y tartas	168	Rasqueta para masa	161	Tarros	182-185, 191
Paleta para tartas con arista cortante	55	Rasqueta para Spätzle	39	Tarros para entremeses / postres	191
Palillos de dientes	35	Rasqueta/desprendedor de pasteles	161	Taza con asa	133
Palitos de papel para CakePops	147	Rasquetas de raclette	57	Technicus Info	82
Para el multiusuario exigente	138	Recambios y suplementos para		Temporizador	71
Partidor de frutas	17, 19, 195	la máquina de picar carne clásica	171	Tenazas para langostas	78
Partidor de mangos	19	Recipiente para desperdicios de mesa	133	Tenedor	233
Partidor de manzana	19, 195	Recipiente para parmesano/azúcar	201	Tenedor para carne	54/55, 74
Partidor de peras	19, 195	Recogegotas	130	Tenedor para pelar patatas cocidas	15, 46/47, 50-52
Partidor de melones	19	Redecilla para té	128	Tenedores para langostas	79
Pelador	10-14, 46/47, 50-52, 63, 195, 232	Rejilla y chapa para poner zapatos	225	Termómetro de ventana	225
Pelador ahorrativo	12/13, 52, 46/47, 50-52, 195, 232	Rodillo de amasar	159	Termómetro digital / para refrigerador	225
Pelador con hoja fija	13, 46, 50-52	Rodillo de bandeja de horno	158	Termómetro digital para asados	70
Pelador con hoja pendular	52	Rodillo de molde de horno	158	Termómetro para asados	69
Pelador de ajos	63	Rodillo para hacer rejilla en la pasta	158	Termómetro para conservas	181
Pelador de espárragos	10/11, 14, 46/47, 50/51, 52, 232	Rodillo para molques de horno	158	Termómetro para hornos	70
Pelador de verduras	10-14, 46/47, 50/51, 52, 232	Rodillo para Spekulatius	159	Termómetro para patatas	69
Pelador de naranjas	16, 47, 51-53	Rueda cortadora de pizzas	25, 46/47, 51-53	Termómetro para pincha carne	70
Pelador de tomates y kiwis	11, 13, 195, 233	Rueda para pastas	47, 51-53, 159	Tijeras de aves	66
Pelador doble	14, 232	Rueda para pizza	25, 46/47, 51-53	Tijeras para las hierbas	23
Pera para miel	205	Sacabolos	33/34, 46/47, 50-53	Tijeras universales para el hogar	24
Picador	95	Sacacorchos	104-106, 238-240	Timbre de sobremesa/para	
Piedra de amolar	29	Sacacorchos de camarero	106	llamar al camarero	213
Pincel para asado y horneado	46/47, 160	Sacacorchos de campana	105, 238/239	Tornillo de manivela	171
Pinchos para barbacoa	76	Sacacorchos de palanca	105, 240	Touring-tresor	228
Pinchos para carne	76/77	Sacapedúnculos de tomate	33/34, 46/47, 50/51	Troceador de huevos	22, 195
Pinzar para servir	56, 73-75	Salero	198, 202-205	Utensilio auxiliar para trinchar	66, 195
Pinzas de cocina	73-75	Pimentero	198, 202-205	Vaso	133
Pinzas para asados y servir	75	Salvamanteles	80	Vaso medidor	150
Pinzas para barbacoa	56, 73, 75	Secador de pasta	40	Vaso para beber y para el cepillo de dientes	133, 227
Pinzas para bolsas	123, 126	Separador de yemas de huevos	163	Vaso para mezclar	116, 154
Pinzas para cocina y servir	73-75	Serie de cuchillos	26/27	Velas para cumpleaños y guateques	156
Pinzas para cortar tomates	23	Serie para barbacoa »Futura«	74	Vertedor	216-219, 241
Pinzas para embutidos	75	Mini-expendedores	205	Vertedor de nata	203/204
Pinzas para ensaladas y servir	73	Bolas para mantener fresco	118	Vertedor de zumo de limón	130
Pinzas para spaghetti	73	Frascos decoradores	156	Vertedores decantadores	222
Pinzas para espárragos y servir	73	Set para bombones	148	Vertedores para vinos	222
Pinzas para espaldas de pescado	78	Set de bandejas apilables para embutidos	118	Vinagrera / aceitera	200
Pinzas para servir	56, 73-75, 195	Set de cajas de especias	209	Volvedor de sartén para crepes y panqueques	58
Pistola pastelera e inyección para guarnecer	165	Embudos	180		
Plato de menú para horno microondas	120	Moldes cortadores	34/35, 149		
Plato para tartas	168	Moldes para comidas	35		
Porcionador de mantequilla	22	Set de ralladores	84		
Porcionador de masa	154	Set de rasquetas y adornador de cocina	161		
Porta mangueras y cables	225	Tabla para Spätzle + rasqueta	39		
Portafiltro de café	126	Termómetros para bistec	69		
Portarrollos de cocina	123	Set inicio para horno microondas	120		
Portavasos de guateque	210	Set para modelar de 8 piezas	154		
Pote para hierbas »Trio«	119	Pelador y picador de ajos	63		
Prensa de ajos	52/53, 63, 195, 233	Set pulverizador aceite / vinagre	209		
Prensa multiuso	63, 195	Shaker para cócteles	211		
		Snack-box	118		
		Soplete culinario	61		
		Soporte de pared para bicicletas	229		

Adaptateur à biscuits	171	Coupe-haricots	177, 195	Diviseuse de pâte	154
Aide au tranchage	66, 195	Coupe-herbes	88	Doseur à sucre	202-204
Aiguille à brider	68	Coupe-légumes spirale	91/92	Double dénoyauteur	174/175, 195
Aiguille à larder	68	Coupe-mangue	19	Double éplucheur de légumes	14, 232
Aiguilles à roulade	72	Coupe-melon	19	Double spatule et pince à barbecue	56, 195
Aiguiseur de couteaux et de ciseaux	29	Coupe-mozzarella	22, 195	Double spatule et pince de service	56
Anneaux à roulade	72	Coupe-oeuf	21/22, 132, 195	Ebauchoirs	154
Aplatisseur de viande	65	Coupe-oignon	94	Ecailleur à poisson	63, 78, 195
Assiette à compartiments pour micro-ondes	120	Coupe-pizza	25, 46/47, 51-53	Econome	12/13, 41, 49, 52, 55, 195, 232
Assistant de coupe	66	Coupe-poire	19, 195	Ecumoire	41, 44/45, 48/49, 54/55
Attache rapide	123	Coupe-pomme	19, 195	Ecumoire à blanchir et à spätzles	41
Attendrisseur	64/65, 195	Coupe-pommes de terre	22, 195	Eminceur de spätzles	39
Bagues caoutchouc »Weck«	187	Coupe-radis	32/33, 195	Eminceur déco	32
Balance de cuisine	151	Couppelles en porcelaine	61	Emporte-pièces	34/35, 149
Bâtons pour CakePops	147	Couperet et attendrisseur de viande	65	Ensemble de conservation	118
Bec verseur à décantation	222	Coupeur multi-usages	23, 195	Ensemble de râpes	84
Bec verseur à vin	222	Coupeur universel	30	Ensemble pour micro-ondes	120
Becs verseurs	216-219, 241	Couteau	27	Ensemble pour pralines	148
Beurrer de réfrigérateur	121	Couteau à beurre	52	Ensemble raclette à pâte et peigne de glaçage	161
Beurrer de table avec échelle	121	Couteau à gâteau et pelle-à tarte	55, 166	Entonnoir	180
Bloc porte-couteaux	28	Couteau à huîtres	79	Entonnoirs à saucisses	171
Bocal à étrier	182	Couteau à julienne	10/11, 46, 50, 91, 195	Epluche-ail	63
Bocal en verre	183	Couteau à lame ondulée	32	Éplucheur	10-14, 46/47, 50-52, 63, 195, 232
Bocaux	183	Couteau à légumes courbé	26	Eplucheur d'orange	16, 47, 51-53
Bocaux hors-d'oeuvre/bocaux dessert	191	Couteau à légumes droit	26	Eplucheur d'asperges	10/11, 14, 46/47, 50/51, 52, 232
Boîte à sandwich	118	Couteau à pain	26/27	Eplucheur de légumes	10-14, 46/47, 50/51, 52, 232
Boîte à savon	227	Couteau à peler	27	Eplucheur de tomates et de kiwis	13, 195, 195, 233
Boîte à snack	118	Couteau à salade	24	Equetteur à fraise	18
Boîte à thé	127	Couteau à viande	26	Essoreuse à salade	115
Boîtes à épices	209	Couteau de chef	27	Étagère à épices	123, 209
Boîtes à herbes	119	Couteau de cuisine	26	Étiquettes déco	186
Boîtes de congélation	119	Couteau hachoir	24	Étiquettes et élastiques	186
Bol de mélange	153/154	Couteau multi-usages	27	Evideur de tomates	33/34, 46/47, 50/51
Bol-serie »Olympia«	113	Couteau petit-déjeuner	25	Evidoir à CupCake	166
Bouchon	109	Couteau pour hachoir à viande	171	Ficelle à grillades	72
Bouchon à tête	222	Couteau Santoku	27	Ficelle de rôti	72
Bouchon de bouteille	110, 242	Couteau universel	233	Filtre à thé	128
Bouchon de rechange »Natur‘	216	Couteaux	13, 15, 24-27, 52, 171, 233	Filtre permanent	127
Bouchons à levier	109	Couvercle d'assiette pour micro-ondes	120	Fixation murale pour un vélo	228
Bouchons de bouteille	109	Couvercle fraîcheur	117	Flacon de décoration	156
Bougies d'anniversaire et de fête	156	Couvercle passoire	61	Fouet	45, 49, 54/55, 60
Boules fraîcheur	118	Couvercles à visser	186	Fouet à main	163
Bouteille à fermeture	182	Couverts à salade	116	Fourchette	233
Bouteille à vinaigre / huile	200	Crêpes-Spatel	45, 49, 58	Fourchette à pommes de terre	15, 46/47, 50-52
Brochette à maïs	77	Crochet-ventouse	226	Fourchette à viande	54/55, 74
Brosse de nettoyage	23	Crochets couvercles »Weck«	187	Fourchettes à homard	79
Broyeur à glace	211	Cuillère	49	Fusil à aiguiser	28
Cache-câbles	225	Cuillère à glace	53, 213	Gant de cuisine et de four	80
Cadre à gâteau et à pizza	144	Cuillère à infuser	129	Glacière avec couvercle	228
Canneleur	15	Cuillère à légumes	45, 48/49, 54/55	Gobelet	133, 227
Capuchons	187	Cuillère à oeuf	132	Grattoir à spätzles	39
Casse-homard	78, 195	Cuillère à sauce	49, 55	Hachoir à viande	170
Casse-noix	63, 172, 236/237	Cuillère à spaghettis	41, 49, 55	Hachoir en acier inoxydable	95
Cercle à gâteau	144	Cuillère de cuisine	58	Hachoir universel	95
Chalumeau à gaz pour crème brûlée	61	Cuillère doseuse à café	126	Housse pour casserole	121
Chauffe-bière	210	Cuillère à pomme parisienne	33/34, 46/47, 50-53	Lames de rechange pour racleur de nettoyage	29
Chronomètre	71	Cure-dents	35	Lève gâteaux et tartes	168
Ciseaux à herbes	23	Déboucheur de table	106	Liens de cuisson	72
Ciseaux à salade	24	Déboucheur et emboucheur	239	Louche	44/45, 48/49, 55
Ciseaux à volaille	66	Décapsuleur	46, 50-53, 107/108, 241	Machine à hamburgers	67
Ciseaux ménagers universels	24	Décorateur à cornichon	33	Machine à pâtes	40
Clips à sachet	123, 126	Découpe-pâte	158	Machine à râper	92
Clips universels	187	Découpoir	155	Machine ouvre-boîte »Clou«	100
Cloche à nourriture	121	Dénoyauteur à cerises	174-176, 195	Mandoline	89/90, 92
Cloche de table et de service	213	Dénoyauteur à olives	174, 195	Manique	80
Coffre-fort tourisme	228	Dénoyauteur à prunes	174-176, 195	Mélangeur	116
Coquetier	132	Dessous de plat	80	Mesure de bar	211
Coupe-ail et ensemble d'éplucheur	63	Dispositif à spätzles pour casserole + grattoir	38	Mini-distributeur	205
Coupe-ananas	18	Disque perforé	171	Mini-râpe universelle	85
Coupe-beurre	22	Distributeur d'édulcorant	131	Minuteur	71
Coupe-capsule	241	Distributeur de crème/miel	199, 203/204	Mortier	209
Coupe-chou	10	Distributeur de cuisine individuel	122	Moule à cake	137, 139
Coupe-frites	96	Distributeur de film alimentaire	122	Moule à charnières	136, 138, 142
Coupe-fromage	20, 32, 46/47, 50, 52/53, 195	Distributeur de miel	199, 203-205		
		Distributeur de pain suédois	119		
Coupe-fruits	17, 19, 195	Distributeur de sucre	198/199		
Coupe-gâteau à fil	166	Distributeur polyvalent	199		



Moule à gâteaux en silicone	146	Plaque à gateaux	141	Seringue à jus	68/69
Moule à kouglof	137, 139	Plaque à pizza	141	Seringue à marinade	69
Moule à pain	141, 144	Plat à gâteau	168	Seringue de décoration et de garniture	164/165
Moule à pâtisserie en forme de coeur	144	Plat à gratin/moule à pâtisserie	140	Seringue de glaçage	164
Moule à pâtisserie ovale	144	Plat à Stollen et à gâteau	168	Seringue de mélange	164
Moule à pralines en silicone	148	Poche à douille	157	Service sel, poivre, vinaigre & huile	200/201
Moule à quiche	143	Pochoirs de décoration	131	Shaker à cocktail	211
Moule à raviolis	40	Poivrière	198, 202-205	Shaker à vinaigrette	116
Moule à tarte	143	Porte-chaussures	225	Spatule	49, 55/56, 58, 162/163
Moule de cuisson pour muffins	141, 145/146	Porte-clés	227	Spatule à crêpes	45, 49, 58
Moule en silicone pour CakePops	147	Porte-filtre à café	126	Spatule à pâte	161
Moules à gaufres	162	Porte-menus	213	Spatule à poêle-/grattoir	56/57, 195
Moules à muffin en silicone	145	Porte-verre à pied	210	Spatule à raclette	57
Moulin à amandes	169	Pot à parmesan/sucre	201	Spatule coudée	163
Moulin à herbes	91	Pot à renverser	183	Spatule de cuisine et à pâte	161
Moulin à légumes	179	Poubelle de table	133	Spirale à pommes de terre	32
Moulin à muscade	85	Présentoir à CakePops	147	Spiraliseur	91/92
Moulin à noix	169	Présentoir casse-noix	237	Stylo de décoration	156
Moulin à pavot	169	Presse à biscuits et gâteaux	165	Sucrier verseur	202
Moulin à sel et à poivre	206-208	Presse à jus et à fraises	178	Support d'essuie-tout	123
Moulin universel »Acrylic«	208	Presse à pommes de terre	38, 96, 195	Tamis à farine et sucre en poudre	167
Nid à friture	35	Presse à pulpe de citron	130	Tamis d'évier	227
Obturbateur de bouteille de vin	242	Presse à spätzles	38, 195	Tapette à mouche	224
Oeuf à thé	128	Presse multi-usages	63, 195	Tapis de coupe flexibles	30
Outil de décoration multi-usages	32, 195	Presse-agrumes	188/189	Tapis de cuisson	64
Ouvre-bocal	53, 102, 108, 181, 195	Presse-ail	52/53, 63, 195, 233	Tapis égouttoir à verres	210
Ouvre-bocal universel	181	Presse-citron & orange	188/189	Tapis pour abaisser la pâte	159
Ouvre-boîte	53, 98-102, 195, 234/235	Presse-hamburger	67	Tasse à hanse large	133
Ouvre-boîte à levier	98, 101, 195	Presse-purée	179	Technicus Info	82
Ouvre-boîte à pince	98/99, 101/102, 235	Presse-purée	48/49, 54/55, 96	Thermomètre à bocaux	181
Ouvre-boîte de sécurité	99, 102, 235	Presse-tomates et extracteur de jus	178	Thermomètre à four	70
Ouvre-boîte professionnel	99, 234	Protection contre les éclaboussures	59	Thermomètre à pommes de terre	69
Ouvre-boîte universel	99, 102, 108, 181, 195	Protège-doigts	82	Thermomètre à rôti digital	71
Ouvre-bouteille	46/47, 50-53, 99, 102, 104-109, 238-241	Racleur pour plaques vitrocéramiques/ de nettoyage	29	Thermomètre à sonde	70
Ouvreur combiné	99, 102, 108, 195	Racleur/détacheur à gâteau	161	Thermomètre à viande	69
Panier vapeur	61	Râpe	83-87, 89, 92	Thermomètre à viande digital	70
Pare-gouttes	130	Râpe à crudités	86/87, 89/90, 92/93	Thermomètre de fenêtre	225
Paslette	129	Râpe à fromage	84	Thermomètre digital / de réfrigérateur	225
Paslette à thé	128/129	Râpe à fruits	87	Thermomètres à steak	69
Passoire	59/60, 128/129, 167, 179, 227, 242	Râpe à légumes	93	Tire-bouchon	104-106, 238-240
Passoire à shaker	242	Râpe à muscade	84/85	Tire-bouchon à cloche	105, 238/239
Patin en feutre	227	Râpe carrée	89	Tire-bouchon à levier	105, 240
Pèle-pomme	17	Râpe carrée	89	Tire-bouchon de sommelier	106
Pelle	214/215	Râpe couronne	85	Trompette à citron	130
Pelle à tarte	55, 166	Râpe rotative	93	Unité de distribution	122
Pendentifs déco	186	Râpe tour	84, 89	Vaporisateurs de vinaigre et d'huile	209
Perce-boîte	46/47, 103,	Râpe universelle	86/87, 89, 92/93	Verre à dents	227
Petits moules en papier	145	Réceptif à salade	115	Verre mesureur	150
Pichet de mélange	153	Réceptifs à micro-ondes	120	Verres	182-185, 191
Pichet mesureur	150	Refrigidisseur et diviseur à gâteau	168	Verseur	241
Pièces de rechange	228	Retourneur de crêpes épaisses et omelettes	58	Vide-pomme	16, 46/47, 50-53
Pièces de rechange et accessoires pour le hachoir à viande	171	Robot de cuisine	94	Vis manivelle	171
Pierre à affûter	29	Rondelles de bouteille	187	Vissages	186
Pilon avec pousoir	209	Rôtissoire vertical à poulet	67	Zesteur	15, 47, 51-53
Pilon Caipirinha	211	Rouleau à croisillons	158		
Pince à asperges et de service	73	Rouleau à pâtisserie	159		
Pince à barbecue	73-75	Rouleau à pique-pâte	158		
Pince à bocal	181	Rouleau pour moule à pâtisserie	158		
Pince à homard	78, 195	Rouleau pour plaque de cuisson	158		
Pince à salade	73	Rouleaux de papier de cuisson réutilisable	166		
Pince à saucisses	74/75	Roulette à pâte	47, 51-53, 159		
Pince à servir	73-75	Roulette à pâtisserie	158		
Pince à spaghetti	73	Roulette à pâtisserie traditionnelle	159		
Pince à sucre pour le punch	210	Roulette à pizza	25, 46/47, 51-53		
Pince à tomates	23	Saladier	114		
Pince de cuisine	73-75	Salière & poivrière	198, 202-205		
Pinceau à badigeonner et à pâtisserie	46/47, 160	Saupoudreur universel	198, 200, 202		
Pinces à nappe	227	Saupoudreuse à épices grossières	209		
Pincette	75	Saupoudreuse à sucre glace	167		
Pincette à arêtes de poisson	78	Saupoudreuse pour décoration/cacao	131		
Pique à barbecue	76	Seau à lait et de stockage	178		
Pique à brochettes	76/77	Seau de cueillette	185		
Pique-oeuf	132	Séchoir à pâtes »Pasta-Tree«	40		
Planche à découper	30	Séparateur de graisse	68		
Planche à spätzles + grattoir	39	Séparateur de jaune d'oeuf	163		
		Série à barbecue »Futura«	74		
		Série de bols »Olympia«	112		

All purpose household scissors	24	Cocktailshaker	211	Fruit tart tin	140, 143
All purpose press	63, 195	Cocoa castor	131	Frying and serving pincers	75
Almond grater	169	Coffee filter	126	Funnel	180
Angled spatula	163	Coffee filter cone	126	Funnel for making sausages	171
Apple corer	16, 46/47, 50-53	Coffee-measure-spoon	126	Garlic and onion press	233
Apple dream	17	Combi opener	99, 102, 108, 195	Garlic cutter and peeler-set	63
Apple slicer	17, 19, 195	Combined egg slicer	21	Garlic peeler	63
Asparagus peeler	10/11, 14, 46/47, 50, 52, 232	Cook and roast strings	72	Garlic press	52/53, 63, 195, 233
Asparagus tong	73	Cookie press	165	Garnishing- and doughnut filling-syringe	165
Bag clips	123, 126	Cooking spoon	44/45, 48/49, 58, 162	Garnishing biscuit cutters	34/35, 149
Baking attachment	171	Cooky roller	159	Garnishing castor	131
Baking films	166	Cool box with cover	229	Garnishing set	157
Baking mat	64	Cork screw	104-106, 238-240	Gateaux cooler	168
Baking pan	141	Corn cob holders	77	Gateaux lifter	168
Baking tin	140/141	Cream dispenser	199, 203/204	Gateaux portioner	168
Baking tin roller	158	Crêpes-spatula »Gallant«	58	Gherkin decorator	33
Baking tray roller	158	Crinkle cutter »Garnetta«	32	Ginger grater	85
Baller	33/34, 46/47, 50-53	Crispbread dispenser	119	Glass lifter	181
Bar strainer	242	Crown grater	85	Glass-clipper mats	210
Barbecue string	72	Cruet stand salt, pepper, oil & vinegar	201	Glasses	182-185, 191
Barbecue tongs	56, 73, 75	Culinary torch	61	Grater	83-87, 89, 92
Baster	68/69	CupCake corer	166	Gravy separator	68
Basting brush	46/47, 74, 160	Cutting board	30	Grill series »Futura«	74
Beaker	133	Cutting mats	30	Grilling skewer	76
Bean slicer	177, 195	Dash-bottle pourer	219	Hamburger maker	67
Beer warmer	210	Decanting pourer	222	Hand guard for Technicus Pro	82
Bell corkscrew	105, 238/239	Deco-grater	32	Handheld	163
Berrypress	178	Decorating artist	164	Heart-shaped bakingframe	144
Birthday and party candles	156	Decorating bottle	156	Heavy duty turner	57
Bottle corker	239	Decorating pen	156	Herb boxes	119
Bottle opener	46, 50-53, 99, 102, 104-109, 238-241	Decorative dough docker	158	Herb mill	91
Bottle sealers	108-110, 187, 222, 242	Decorative labels	186	Herb scissors	23
Bottle sealers with lever	109	Decorative tags	186	Herbs chopper	88
Bottle stoppers	109	Decorative templates	131	Honey dispenser	205
Bowl series »Olympia«	112-114	Deep freezing containers	119	Hooks	226
Bread knife	26/27	Dessert jars	191	Horizontal cake cutter	166
Bread tin	141	Dessert/food	34/35, 149	Hose- and cable holder	225
Breakfast knife	25	Digital thermometer	70/71, 225	Ice crusher	211
Brewing spoon	129	Digital wireless roasting thermometer	71	Ice-cream scoop	53, 213
Butter curler	52	Dispenser unit	122	Icing bag	157
Butter dish	121	Double jigger	211	Icing set	164
Butter portioner	22	Double peeler	14, 232	Icing syringe	164/165
Cabbage slicer	10	Double stoner	174/175, 195	Jacket potato fork	15, 46/47, 50-52
Caipirinha pestle	211	Double turner	56, 195	Jacket potato slicer	22, 195
Cake baking frame	144	Dough- and cooking scraper	161	Jars	182-185, 191
Cake cooler	168	Dough cutter	47, 51-53, 159	Jigger	211
Cake cooling rack	168	Dough docker	158	Juicepress	178
Cake cutter and lifter	166	Dough rolling-out mat	159	Julienne cutter	10/11, 46, 50, 91, 195
Cake lifter	168	Dough scraper	161	Key tags	227
Cake loosener	161	Dough-strip cutter	158	King's cake tin	137, 139
Cake plate	168	Dressingshaker	116	Kitchen glove	80
Cake setting ring	144	Drink beaker	227	Kitchen knife	26/27
Cake slicer	54/55, 166	Drinking cups	133	Kitchen roll holder	123
Cake tin roller	158	Drip catcher	130	Kitchen scales	151
Cakeplate	168	Drum grater	93	Kitchen sink strainers	226
CakePop butler	147	Egg cups	132	Kitchen tongs	56
CakePop mould	147	Egg cutter	132	Kitchen tongs	73-75
CakePop sticks	147	Egg separator	163	Kitchen tweezers	74
Can opener	53, 98-102, 195, 234/235	Egg slicer	21/22, 195	Kitchen witch	94
Can opener unit »Clou«	100	Egg spoons	132	Kiwi fruit peeler	11, 13, 195, 233
Canning clamps »Weck«	187	Egg-pricker	132	Knife block	28
Canning funnel	180	Fat-separation jug	68	Knife for meat mincer	171
Canning thermometer	181	Felt pads	227	Knife series	26/27
Cap lifter	108	Fish bone tweezers	78	Knife sharpener	29
Cap opener	46, 50-53, 107/108, 241	Fish scaler	63, 78, 195	Knife sharpener »Sieger-Long Life«	28
Carving aid	66	Flat jars	183/184, 191	Knives	13, 15, 24-27, 52, 171, 233
Casserole	120	Flip-top jar	182	Larding needle	68
Champagne bottle sealer	110, 242	Flour- and icing sifter	167	Large cup	133
Cheese Grater	83/84, 87, 92/93, 169	Fluted tube cake pan	137, 139	Lemon pourer	130
Cheese slicer	20, 32, 52/53, 195	Fly swatter	224	Lemon press	188/189
Cherry stoner	174-176, 195	Foil cutter	241	Lemon slice squeezer	130
Chocolate mould	148	Food bag cable tie	123	Lemonade spoons	133
Chocolate-making set	148	Food cover	121	Lengthwise bean slicer	177
Citrus juicer	188/189	Food mill	179	Lever can opener	98, 101, 195
Classic nutmeg grater	85	Food moulds	35	Lever corkscrew	105, 240
Cleaning scraper	29	Fork	233	Lid opener	53, 99, 102, 108, 181, 195
Cleaver and meat hammer	65	Fresh lid	117	Lime juicer	188/189
Cling film / foil dispenser	122	Fruit corer	16/19, 174-176, 195	Lobster cracker	78, 195
Coasters	80	Fruit divider	17, 19, 52/53, 63, 174-176, 195	Lobster forks	79
Cocktail spoons	133	Fruit juice stoppers	187	Lobster tongs	78
		Fruit press	189	Long-life baking films	166



Mandolin	88, 90	Pot holders	80	Spring-form baking tin	143
Mango slicer	19	Potato chipper	96	Square grater	89
Marinating syringe	69	Potato fork	15, 46/47, 50-52	Stainless steel chopper	95
Measuring beaker	150, 154	Potato masher	48/49, 54/55, 96	Stainless steel mincer	170
Measuring jug	150	Potato press	38, 96, 195	Starter jars	191
Meat fork	54/55, 74	Potato spiral	32	Steakhammer	65
Meat hammer	64/65, 195	Potato thermometer	69	Steakthermometer	69
Meat knife	26	Poultry shears	66	Steaming basket	61
Meat mincer	170	Pourer	216-219, 241	Stollen- and cake plate	168
Meat pounder	65	Powdered sugar sifter	167	Storage ball	118
Meat roll rings	72	Preserving funnel	180	Storage bucket	178
Meat roll skewers	72	Press for noodles and potatoes	38	Storage set	118
Melon slicer	19	Probe thermometer	70	Straight-neck bottle	182
Menu holder	213	Profi can opener	99, 234	Strainer	59/60, 113/114, 128/129, 167, 179, 227, 242
Microwave dinnerplate	120	Puree sieve	179	Straining mill	179
Microwave plate cover	120	Raclette-scrapers	57	Strawberry huller tongs	18
Microwave starter kit	120	Radishrose cutter	32, 195	Suction hooks	226
Milk bucket	178	Ravioli formers	40	Sugar dispenser	198/199, 202-204
Mincing knife	24	Refrigerator butter dish	121	Sugar pot	201
Mincing Plate	171	Refrigerator thermometer	225	Sweetener pill dispenser	131
Mini-shakers	205	Roast string	72	Swing-top bottle	182
Mix set	164	Roasting thermometer	69-71	Swivel peeler	12/13, 52, 195, 232
Mixing beaker	116	Roasting/baking tin	140	Table bin	133
Mixing bowl	153	Rolling pin	159	Table cloth clips	227
Mixing jug	154	Rotary grater	93	Table waiter bell	213
Mixing spoons	162	Rubber jar rings »Weck«	187	Tea box	127
Modelling set	154	Sack scoop	214	Tea infuser ball	128
Mortar	209	Safety can opener	99, 102, 235	Tea net	128
Mozzarella slicer	22, 195	Salad bowl	114	Tea-strainer	129
Muffin baking tin	141, 145/146	Salad butler	115	Technicus-serie	82-84
Muffin cups	145/146	Salad knife	24	Thermometer	69-71, 181, 225
Multi dispenser	199, 203/204	Salad scissors	24	Timer	71
Multi purpose garnishing tool	32, 195	Salad servers	116	Tin pincher	46/47, 103
Multi purpose knife	27	Salad tongs	73	Tip tea strainer	128
Multi purpose opener	99, 102, 108, 181, 195	Salat spinner	115	Tomato corer	33/34, 46/47, 50/51
Multi purpose slicer	20, 23, 195	Salt shaker	198, 202-205	Tomato peeler	13, 195, 233
Mushroom cleaning brush	23	Saltmill	206-208	Tomato strainer and Juicer	178
Natural cork	216	Sandwich box	118	Tongs for burnt punch	210
Nest frying spoon	35	Santoku knife	27	Tooth brush beaker	227
Nut chopper	169	Sauce spoon	48/49, 54/55	Toothpicker	35
Nut cracker	63, 172, 236, 237	Sausage tongs	75	Touring tresor	228
Nut meg grinder	84/85	Scissors	24	Tower grater	84, 89
Oil and vinegar spray set	209	Scissors sharpener	29	Trivet	80
Oil bottle	200	Scoop	122, 214/215	Trussing needle	68
Olive stoner	174, 195	Scoop dispenser	122	Turner	44/45, 48/49, 54-57, 195
Omelette turner	58	Scoop with inside handle	214	Uncorking machine	106
Onion dicer	94/95	Scraper	29, 57, 161	Universal chopper	95
Orange peeler	16, 47, 51-53	Scraper and garnish comb	161	Universal clips	187
Orange press	188/189	Screw for crank	171	Universal grater	86/87, 89, 92/93
Oval baking tin	144	Screw-tops	186	Universal knife	233
Oven glove	80	Self-adhesive labels & rubber bands	186	Universal mills	208
Oven thermometer	70	Serving tongs	56, 73-75	Universal opener	99, 102, 108, 181, 195
Oyster opener	79	Shaker	116, 211	Universal preserve-glass opener	181
Pan strainer	61	Shape cutters	34/35, 149	Universal shaker	198, 200
Pancake turner	58	Sharpening stone	29	Universal slicer	86/87, 89, 92/93
Paper muffin baking cups	145	Shish kebab skewer	76/77	Vegetable and fruit slicer	87
Parmesan pot	201	Shoe and boot tray	225	Vegetable knife	26
Party-glass-holders	210	Silicone baking accessories	145-148, 156, 159-161	Vegetable peeler	10-14, 46/47, 50/51, 52, 232
Pasta drying rack	40	Silicone cork	216	Vegetable slicer	87-92
Pasta maker	40	Skimmer	41, 44/45, 48/49, 54/55	Vegetable spoon	45, 48/49, 54/55
Pasta serving tongs	73	Slicer	84	Vertical chicken roaster	67
Pastry brush	46/47, 160	Slicing aid	23, 66	Vinegar and oil spray set	209
Pastry wheel	47, 51-53, 159	Slotted spoon/blanching	41	Vinegar bottle	200
Pear slicer	17, 19, 195	Snackbox	118	Waffle moulds	162
Peeler	10-14, 46/47, 50-52, 63, 232	Soap box	227	Waiter bell	213
Peeling knife	27	Soup ladle	44/45, 48/49, 55	Waiter's bottle opener	106
Pepper shaker	198, 202-205	Spaghetti server	41, 49, 55	Wall support for one bike	228
Peppermill	206-208	Spare blades for cleaning scraper	29	Whisk	45, 49, 54/55, 60
Permanent filter	127	Spare corks	222	Window thermometer	225
Picking bucket	185	Spare corks ,nature'	216	Wine bottle stopper	110, 242
Pincer can opener	98, 101/102, 235	Spare parts	228	Wine pourer	222
Pineapple slicer	18	Spare parts and additional equipment for the classic		Wok spoon	45, 48/49
Pizza baking frame	144	meat mincers nos. 9750 2260 - 9754 2260	171	Yoghurt spoons	133
Pizza baking plate	141	Spatula	45, 49, 57/58, 163	Zester	15, 47, 51-53
Pizza cutter	25, 46/47, 51-53	Spätzle accessories	38/39, 41, 195		
Pizza wheel	25, 46/47, 51-53	Spice mill	208		
Plastic scoop	214	Spice rack	123, 209		
Plum stoner	174-176, 195	Spice shaker	209		
Poppy seed mill	169	Spiral cutter	33		
Porcelain dishes	61	Splatter screen	59		
Portioner	154	Spring-form	136, 138, 142		

Art.	Seite	Art.	Seite	Art.	Seite	Art.	Seite	Art.	Seite	Art.	Seite	Art.	Seite	Art.	Seite
1002	86	1134	87	1242	69	1369	74	1514	77	1801	54	2245	120	2832	51, 159
1003	86	1135	85	1243	35	1371	66	1515	67	1802	52	2328	121	2834	16, 51
1004	86	1136	87	1245	180	1373	66	1516	75	1804	52	2329	121	2835	48/49, 57
1005	86	1138	89	1246	180	1375	24	1517	75	1806	52	2330	61	2850	41, 48/49
1006	86	1139	89	1248	69	1380	58	1518	75	1808	52	2333	117	2854	48/49
1008	107	1140	94	1249	163	1381	58	1519	72	1814	52	2334	117	2856	48/49
1012	104	1141	94	1250	60	1382	162	1521	72	1818	52	2335	117	2860	41, 48/49
1015	29	1142	89	1251	60	1383	162	1523	72	1822	52	2337	117	2865	48/49
1017	29	1143	17	1252	60	1384	162	1524	72	1824	52	2348	118	2866	48/49, 58
1020	21, 195	1144	17	1253	60	1385	162	1525	68	1826	52	2351	118	2903	12, 46
1021	29	1145	95	1255	233	1387	162	1526	58	1827	52	2352	118	2905	11, 46
1022	72	1147	88	1257	35	1392	162	1527	130	1828	53	2378	178	2906	13, 46
1023	72	1148	89	1258	35	1410	83	1528	126	1830	52	2379	178	2907	11, 46
1024	76	1149	95	1259	61	1412	83	1529	126	1832	52	2410	113	2908	46, 107
1025	98	1150	180	1260	76	1414	83	1530	128	1834	52	2412	113	2909	12, 46/47
1030	98	1151	95	1261	76	1416	83	1531	128	1835	54	2414	113	2910	46/47, 103
1031	98	1153	85	1262	76	1418	83	1532	128	1836	52	2416	113	2911	11, 46/47
1032	101	1154	17	1263	76	1420	83	1533	129	1838	53	2417	113	2914	15, 46/47
1033	102	1155	180	1264	77	1421	83	1534	129	1839	53	2418	114	2916	46/47, 160
1038	102	1156	85	1265	77	1424	83	1535	129	1842	54	2419	113	2918	16, 46/47
1042	21	1164	22	1266	77	1426	83	1536	128	1843	54	2420	114	2920	33, 46/47
1046	77	1165	91	1267	68	1433	84	1537	129	1844	54	2422	115	2922	34, 46/47
1047	35	1166	21	1268	68	1434	84	1538	126	1846	54	2424	114	2926	20, 46/47
1049	102	1168	21	1269	69	1435	84	1539	123	1848	54	2432	115	2928	25, 46/47
1050	102, 195	1171	93	1270	73	1437	82	1540	56	1851	54	2435	116	2930	15, 46/47
1051	108	1172	93	1271	73	1438	82	1543	160	1852	54	2436	209	2932	46/47, 159
1052	181	1175	23	1272	73	1439	82	1544	160	1854	54	2437	114	2934	16, 47
1053	181	1176	91	1273	73	1440	84	1546	161	1855	54	2442	126	2935	44/45, 57
1056	108	1177	30	1274	75	1444	84	1547	161	1856	54	2443	127	2945	13, 47
1057	10	1178	23	1275	75	1450	28	1554	161	1858	53	2444	126	2950	41, 44/45
1058	11	1179	169	1276	75	1452	27	1556	160	1971	28	2445	126	2954	44/45
1060	22, 195	1180	96	1277	73	1453	27	1558	80	1972	28	2446	126	2956	44/45
1061	12, 195	1181	96	1278	70	1454	27	1560	80	1980	100	2504	119	2958	47, 213
1065	88	1182	177	1279	73	1455	27	1562	80	1985	100	2514	119	2960	41, 44/45
1066	87	1184	177, 195	1280	73	1456	27	1566	58	1990	100	2523	119	2965	44/45
1067	12	1186	177	1281	59, 129	1470	171	1570	57	2015	56	2533	119	2966	44/45, 58
1068	88	1188	89	1282	59	1471	171	1574	127	2035	56, 195	2543	119	2968	44/45, 60
1069	10	1192	63	1283	59	1472	171	1575	127	2045	57	2553	119	3000	63, 195
1074	64	1194	63	1284	59	1476	171	1577	128	2062	132	2572	118	3001	159
1075	21	1195	179	1285	59	1477	171	1578	128	2065	57	2574	119	3003	158
1076	88	1196	179	1286	59	1478	171	1582	128	2070	132	2584	119	3004	158
1080	132	1197	179	1287	60, 129	1479	171	1610	12	2082	133	2588	119	3006	163
1081	132	1198	179	1288	60	1480	171	1616	13	2084	132	2802	11, 50	3007	163
1084	29	1199	178	1289	60	1481	171	1630	34	2086	121	2803	12, 50	3010	63, 195
1085	29	1200	211	1290	70	1482	171	1631	34	2088	121	2804	12, 50	3011	64
1086	163	1210	59, 129	1291	70	1483	171	1632	34	2090	116	2805	11, 50	3012	154
1088	71	1212	59	1292	71	1484	171	1633	34	2093	24	2806	13, 50/51	3013	166
1089	132	1214	59	1293	24	1485	171	1634	34	2094	24	2808	50/51, 107		
1090	71	1216	59	1294	24	1486	171	1635	34	2094	24	2810	50/51, 103		
1094	107	1218	59	1319	16	1487	171	1639	61	2100	56	2811	11, 50/51		
1121	98, 195	1222	99, 195, 234	1327	25	1488	171	1641	80	2104	133	2811	11, 50/51		
1125	98	1224	99, 234	1340	101	1489	171	1670	236	2110	56, 195	2814	15, 50/51		
1126	101	1228	99	1351	26	1490	171	1671	236	2116	121	2815	15		
1127	101	1235	235	1352	26	1493	171	1672	236	2118	119	2818	16, 50/51		
1129	90	1236	235	1353	26	1494	171	1673	236	2120	133	2820	33, 50/51		
1130	90	1237	41	1354	26	1495	171	1674	237	2126	114	2822	34, 50/51		
1131	87	1238	235	1355	26	1500	74	1675	237	2203	120	2826	20, 50/51		
1132	87	1239	61	1363	49	1501	74	1679	237	2210	120	2828	25, 51		
1133	92	1240	235	1367	49, 58	1502	74	1680	237	2215	120	2830	15, 51		
				1368	49, 60	1503	74	1691	233	2220	120				
						1510	74	1692	233	2225	120				
						1512	75	1784	232	2240	120				



Art.	Seite	Art.	Seite	Art.	Seite	Art.	Seite	Art.	Seite	Art.	Seite	Art.	Seite	Art.	Seite
3014	145	3140	158	3394	143	5110	19, 195	6027	104	6275	239	6526	202	7607	122
3015	146	3141	168	3440	168	5117	180	6028	104	6277	211	6527	202	7805	122
3016	146	3143	168	3455	168	5118	133	6038	106	6278	211	6530	203	7925	122
3017	146	3144	168	3852	161	5120	32, 195	6046	13, 195	6279	242	6534	203	7945	122
3018	159	3147	148	4000	174, 195	5122	32	6050	14	6280	211	6536	203	7950	122
3019	166	3150	153	4001	174	5124	33	6060	14	6281	211	6537	203	8050	219
3020	148	3151	153	4010	174, 195	5125	32	6070	14	6283	211	6538	203	8052	219
3021	148	3152	153	4020	174, 195	5130	33	6071	232	6284	131	6540	204	8120	219
3022	148	3153	153	4021	187	5140	23	6072	232	6285	239	6544	204	8130	219
3023	147	3154	153	4023	175	5155	210	6080	22, 195	6286	131	6546	204	8215-8260	219
3024	147	3155	153	4024	187	5160	19	6090	10	6289	211	6547	204	8811	221
3025	147	3166	136	4025	176	5162	19	6091	232	6294	213	6548	204	8821	221
3027	145	3167	136	4030	175	5163	19	6093	233	6296	241	6600	78, 195	8831	221
3028	145	3168	136	4035	176	5164	19	6095	10	6298	130	6608	78	8861	221
3030	63	3169	136	4040	174, 195	5165	19	6096	10, 195	6299	66	6610	78	9021	214
3031	166	3180	137	4044	18	5166	18	6110	38, 195	6300	66, 195	6613	78	9088	130
3033	151	3184	137	4046	187	5169	18	6111	38	6301	205	6615	79	9091	214
3036	154	3186	137	4048	187	5170	23, 195	6112	39	6303	198	6616	79	9093	214
3038	155	3200	22	4050	187	5180	23	6114	39	6304	198	6620	182	9095	214
3040	155	3214	167	4060	175	5201	225	6115	39	6305	198	6621	182	9097	214
3042	155	3215	167	4070	175	5203	227	6116	39	6306	198	6622	182	9099	214
3044	155	3216	159	4074	187	5204	227	6117	38	6307	205	6623	182	9101	215
3061	150	3217	158	4075	187	5205	123	6120	38	6310	205	6624	182	9111	215
3068	150	3218	158	4076	181	5206	227	6122	39	6313	198	6628	182	9121	215
3071	68	3219	158	4078	187	5207	226	6124	96	6314	198	6634	182	9131	215
3074	150	3220	160	4079	187	5208	226	6126	96	6316	198	6636	182	9141	215
3075	68	3222	160	4084	186	5209	156	6127	96	6320	213	6638	182	9151	215
3076	150	3224	162	4085	186	5212	225	6130	40	6328	210	6643	183	9161	215
3077	164	3230	165	4086	186	5215	225	6133	40	6330	210	6645	183	9171	215
3078	150	3233	165	4088	186	5216	123	6134	40	6340	199	6646	185	9181	215
3079	150	3238	164	4090	186	5218	123	6140	69	6342	199	6647	183	9191	215
3083	161	3258	138	4091	186	5220	123	6142	69	6343	199	6649	183	9201	215
3084	161	3264	138	4092	186	5223	122	6155	105, 240	6344	198	6652	183	9220	220
3085	161	3265	138	4093	186	5234	122	6157	240	6346	199	6656	185	9230	220
3086	157	3266	138	4110	219	5236	123	6160	240	6348	199	6660	182	9240	220
3087	116	3267	138	4122	219	5250	225	6165	240	6349	199	6662	182	9250	220
3089	116	3268	138	4130	219	5300	226	6177	107	6352	208	6664	182	9420	220
3091	188	3269	138	4140	219	5301	226	6179	241	6353	208	6668	182	9430	220
3092	188	3280	139	4144	219	5302	226	6180	241	6354	208	6674	184	9440	220
3094	188	3284	139	4200-4252	217	5305	226	6181	241	6356	207	6675	191	9450	220
3095	189	3286	139	4300-4390	217	5306	226	6183	108, 195	6358	207	6676	191	9520	220
3096	157	3288	141	4420	222	5307	226	6188	108	6360	206	6680	184	9525	220
3097	157	3290	141	4430	217	5309	226	6196	110, 242	6362	206	6682	184	9530	220
3098	157	3291	141	4440	109	5318	226	6200	64, 195	6364	206	6688	184	9540	220
3099	157	3292	141	4444	109	5319	226	6210	64	6366	206	6689	191	9550	220
3100	157	3293	141	4445	109	5402	229	6212	65	6368	206	6691	184	9620	220
3101	157	3294	140	4446	109	5425	229	6214	65	6410	213	6695	183	9640	220
3102	118	3295	140	4448	222	5430	229	6215	30	6428	227	6698	183	9700	30
3103	118	3296	140	4450	241	6000	110	6216	30	6430	210	6950	167	9715	169
3105	154	3297	141	4500-4793	218	6002	110	6217	30	6500	78, 195	6952	209	9717	169
3110	32, 195	3300	172	4820	222	6010	110	6220	65	6502	200	6954	209	9745	170
3111	156	3320	172	5000	189	6012	242	6230	65	6504	200	6957	85	9748	178
3114	156	3325	172	5081	224	6013	110, 242	6231	67	6505	201	6959	209	9750	170
3115	164	3326	172	5085	224	6015	106	6233	67	6507	200	6960	209	9752	170
3116	165	3327	172	5087	224	6016	106	6240	238	6509	200	7000	20, 195	9754	170
3120	32	3358	142	5095	224	6017	106	6255	105, 238	6511	201	7100	20, 195	9760	92
3131	144	3364	142	5104	227	6018	105	6260	238	6513	205	7110	20	9770	169
3132	144	3366	142	5108	133	6020	105			6515	209	7120	166	9777	170
3133	144	3367	142	5109	227	6023	105			6517	131	7160	166	9910-9950	219
3134	144	3368	142			6024	104			6520	202				
3135	144	3369	142			6025	104			6524	202				
3138	35	3393	143												
3139	35														

Art.	Seite	Art.	Seite	Art.	Seite
Abdeckhaube	120/121	Dauerbackfolien	166	Fensterthermometer	225
Abfluss-Siebe	226	Dauerfilter	127	Fett-Trenn-Kanne	68
Abgießhilfe	61	Deckelklammern »Weck«	187	Filzgleiter	227
Allesschneider	30	Deckelöffner	53, 102, 108, 181, 195	Fingerschutz	82
Allzweckmesser	27	Dekantierausgießer	222	Fischentschupper	63, 78, 195
Ananasschneider	18	Deko-Anhänger	186	Fischgrätenpinzette	78
Apfelkernausstecher	16, 46/47, 50-53	Deko-Etiketten	186	Flaschenöffner	46, 50-53, 99, 102, 104-109, 238-241
Apfelschälmaschine	17	Deko-Hobel	32	Flaschenscheiben	187
Apfelteiler	17, 19, 195	Dekorierflaschen	156	Flaschentrichter	180
Apfeltraum	17	Dekorierschablonen	131	Flaschenverschluss	108-110, 222, 242
Aufschnittschalen	118	Dekorierspritze	156, 164/165	Fleischgabel	54/55, 74
Ausgießer	216-219, 241	Dekorierstift Silikon	156	Fleischhammer	64/65, 195
Aushöhlöffel	33/34, 46/47, 50-53	Dekorierstreuer	131	Fleischmesser	26
Ausrollmatte	159	Dessertformer	34/35, 149	Fleischwolf	170
Ausstechformen	35, 149, 155	Dessertgläser	191	Fleischwolf-Zubehör	171
Austernbrecher	79	Digitalthermometer	70/71, 225	Flexible Schneidmatten	30
Backblech	141	Doppellentkerner	174/175, 195	Fliegenklatsche	224
Backblechroller	158	Doppelschäler	14, 232	Folienspender	122
Backfolie	166	Doppelwender	56, 195	Fondantausstecher	155
Backform	136-148	Dosenlocher	46/47, 103	Frischhaltedeckel	117
Backformroller	158	Dosenöffner	53, 98-102, 195, 234/235	Frischhaltekügel	118
Backmatte	64	Dosenöffnermaschine »Clou«	100	Fruchtpresse	178, 189
Backpinsel	46/47, 160	Dosiergerät	220	Fruchtteiler	17, 19, 195
Backzubehör	134-172	Dosierlöffel	126	Frühstücksmesser	25, 233
Barmaß	211	Drahtbügelgläser	182	Funk-Bratenthermometer	71
Barsieb	242	Dressiernadel	68	Gabel	233
Becher	133, 227	Dressingshaker	116	Garnier-Ausstechformen	149
Beerenpresse	178	Dünsteinsatz	61	Garnierset	157, 164/165
Beutelclip	123, 126	Edelstahl-Vorlegeserie	52-55	Garnierspritze	164/165
Bierwärmer	210	Edelstahlhacker	95	Gasbrenner	61
Birnteiler	17, 19, 195	Eidorn	132	Gebäckpresse	165
Blanchierheber	41, 44/45, 48/49, 54/55	Eidottertrenner	163	Geburtstagskerzen	156
Blitzbinder	123	Eierbecher	132	Geflügelschere	66
Bohenschneider	177, 195	Eierköpfer	132	Gefrierdosen	119
Bratensafteinspritzer	68-69	Eierlöffel	132	Gemüsebürste	23
Bratenschnur	72	Eierstückler	21/22, 195	Gemüsehobel	86-90
Bratenthermometer	69-71	Eierteiler	21/22, 195	Gemüselöffel	45, 48/49, 54/55
Bratform	140	Eieruhr	71	Gemüsemesser	26
Bratmatte	64	Eimer	178	Gemüseschäler	10-14, 46/47, 50-52, 232
Bratpinsel	46/47, 74, 160	Einkoch-Zubehör	173-191	Gemüseschneider	86-96
Bratpinzette	73-75	Einstichthermometer	70	Gemüsestiftler	94, 96
Brotbackform	141, 144	Eiskartenständer	213	Gewürzdosen	209
Brotmaschine	30	Eislöffel	53, 213	Gewürzregal	123, 209
Brotmesser	26/27	Eisportionierer	53, 213	Gewürzsieb	129
Brühlöffel	129	Eiszerkleinerer	211	Gewürzstreuer	209
Bügelverschlussflaschen	182	Entkerner	52/53, 63, 174-176, 195	Gitterroller	158
Buntschneider	32	Entkorker	239	Gläser	182-185, 191
Butterbrotdose	118	Entschupper	63, 78, 195	Gläserabtropfmatten	210
Butterdose	121	Erdbeerkroner	18	Glasheber	181
Butterrollmesser	52/53	Ersatz- und Ergänzungsteile Fleischwolf	171	Glockenkorkenzieher	105, 238/239
Butterteiler	22	Ersatzklängen für Reinigungsschaber	29	Gradhalsflaschen	182
Caipirinha-Stößel	211	Ersatzkorken »Natur«	216	Griffkorken	222
CakePop Butler	147	Ersatzteile	228	Grillschnur	72
CakePop-Silikonform	147	Essigflasche	200	Grillserie »Futura«	74
CakePop-Stäbchen	147	Essigsprüher	209	Grillspieß	76
Ceranfeldschaber	29	Etiketten und Gummibänder	186	Grillzange	56, 73, 75
Chefmesser	27	Fahrrad-Zubehör	229	Gugelhupfform	137, 139
Cocktailöffel	133			Gummibänder und Etiketten	186
Cocktailshaker	211			Gurkenverzierer	33
CupCake-Aushöher	166				



Art.	Seite	Art.	Seite	Art.	Seite
Hähnchengriller	67	Kräuterschere	23	Mixgerät	164
Haken	226	Kräuterschneider	23/24, 88	Mixbecher	116
Hamburgermaker	67	Krautschneider	10	Modellierset	154
Handquirl	163	Kronenreibe	85	Mohnmühle	169
Haushaltsschaufel	214/215	Kuchenauskühler	168	Mörser	209
Haushaltssieb	59/60	Küchenbeil	65	Mozzarellaschneider	22, 195
Hebeldosenöffner	98, 101, 195	Kuchengarnierer	161	Muffin Papier-Backförmchen	145
Hebelkorkenzieher	105, 240	Küchenhandschuhe	80	Muffinbackform	141, 145/146
Henkeltasse	133	Kuchenheber	54/55, 166, 168	Muskatmühle	85
Herzbackform	144	Küchenhelfer-Serien	44-55	Muskatreibe	84
Hobel	20, 32, 39, 46/47, 50-53, 83/84, 86-90	Küchenhexe	94	Nachspeisegläser	191
Honigbirne	205	Küchenlöser	161	Naturkorken	216
Honigspender	203-205	Küchenmesser	26	Nestbacklöffel	35
Hummergabeln	79	Kuchenpinsel	46/47, 160	Nudelholz	159
Hummerknacker/-Zange	78, 195	Kuchenrahmen	144	Nudeltrockner	40
Ingwerreibe	85	Küchenreiben	87	Nussknacker	63, 172, 236/237
Innenstielschaufel	214	Küchenrollenhalter	123	Nussmühle	169
Joghurtlöffel	133	Kuchenschneider und -heber	54/55, 166	Obstbodenform	140, 143
Julienne-Schneider	10/11, 46, 50, 91, 195	Küchenschütte	122	Ofenhandschuhe	80
Kabelbinder	123	Küchenwaage	151	Ofenthermometer	70
Kabelhalter	225	Küchenzangen	73-75	Ölflasche	200, 209
Kaffee-Dosierlöffel	126	Küchlein-Backform	146	Olivenentsteiner	174, 195
Kaffeefilter	126/127	Kühlbox mit Deckel	229	Ölsprüher	209
Kakaostreuer	131	Kühlschrankbutterdose	121	Omelettwender	58
Kapselheber	46, 50-53, 106-108, 195, 241	Kühlschrankthermometer	225	Orangenpresse	188
Kapselschneider	241	Kunststoffschaufel	214	Orangenschäler	16, 47, 51-53
Kartoffel-Thermometer	69	Kurbelschraube	171	Ovale Backform	144
Kartoffelpresse	38, 96, 195	Kurzzeitmesser	71	Parmesantopf	201
Kartoffelspirale	32	Limettenpresse	188/189	Partyglashalter	210
Kartoffelstampfer	48/49, 54/55, 96	Limonadenlöffel	133	Partykerzen	156
Käsehobel	20, 46/47, 50-53	Linkshandprodukte	46, 50, 235	Passiermaschine	179
Käserreibe	83/84, 87, 92/93, 169	Lochscheibe für Fleischwolf	171	Passiersieb	179
Käseschneider	20, 32, 52/53, 195	Löffel	132/133	Pastamaschine	40
Kasserolle	120	Maiskolbenhalter	77	Pellkartoffel-Schneider	22, 195
Kellnerbesteck	106	Mandelmühle	169	Pellkartoffelgabel	15, 46/47, 50-52
Kellnerlocke	213	Mandoline	88, 90	Pendelklingenschäler	52
Keramikschäler	11, 46/47, 50/51, 232	Mangoteiler	19	Pfannenwender	44/45, 48/49, 54-57, 195
Kirschkerner	174-176, 195	Marinierspritze	69	Pfannkuchenwender	58
Kiwischäler	11, 13, 195, 233	Maultaschenformer	40	Pfeffermühle	206-208
Klappsieb	129	Mehlsieb	167	Pfefferstreuer	198, 202-205
Klassische Muskatreibe	85	Mehrzweckgarnierer	32, 195	Pfirsichteiler	19
Klebehaken	226	Mehrzweckgießer	199, 203/204	Pflaumentsteiner	174-176, 195
Knäckebrotspender	119	Mehrzweckpresse	63, 195	Pflückeimer	185
Knoblauchpresse	52/53, 63, 195, 233	Melonenteiler	19	Pilzreinigungsbürste	23
Knoblauchschäler	63	Menage	200/201	Pinsel	46/47, 160
Knoblauchschneider	63	Messbecher	150, 154	Pinzette	74-75, 78
Kochlöffel	44/45, 48/49, 58, 162	Messer	13, 15, 24-27, 52, 171, 233	Pizzablech	141
Kochschaber	57, 161	Messer für Fleischwolf	171	Pizzarad	25, 46/47, 51, 53
Kochschnur	72	Messerblock	28	Pizzarahmen	144
Kombi-Eierteiler	21	Messerschärfer	29	Pommes-frites Schneider	96
Kombiöffner	99, 102, 108, 195	Messkanne	150	Porzellanschälchen	61
Königskuchenform	137, 139	Mikrowellen Starter-Set	120	Pralinen-Set	148
Konservenglasöffner	102, 108, 181, 195	Mikrowellen-Kasserolle	120	Pralinenform	148
Korkenzieher	104-106, 238-240	Mikrowellen-Menüteller	120	Profidosenöffner	99, 234
Krapfenspritze	164/165	Mikrowellen-Teller-Abdeckhaube	120	Proviantbox	118
Kräuterdosen	119	Milcheimer	178	Puderzuckersieb	167
Kräutermühle	91	Milchthermometer	70	Puderzuckerstreuer	167
		Mini-Muffin-Backform	141	Quicheform	143
		Mini-Streuer	205	Quirltopf	153
				Raclette-Schaber	57

Art.	Seite	Art.	Seite	Art.	Seite
Radieschenverzierer	32, 195	Silikon-Korke	216	Tortenheber	54/55, 166, 168
Ravioliformer	40	Snack-Box	118	Tortenplatte	168
Reibe	83-89, 92	Soßenlöffel	48/49, 54/55	Tortenring	144
Reibemaschine	92	Spaghettilöffel	41, 49, 54/55	Touring-Tresor	229
Reibenset	84	Spaghettizange	73	Tranchierhilfe	66, 195
Reinigungsschaber	29	Spargelschäler	10/11, 14, 46/47, 50/51, 52, 232	Trichter	180
Restehalter	66, 82	Spargelzange	73	Trinkbecher	133, 227
Retroserie	192-195	Sparschäler	12/13, 46/47, 50-52, 195, 232	Trommelreibe	93
Rettichschneider	33	Spatel	45, 49, 58	Tropfenfänger	130
Rohkostreibe	86/87, 89/90, 92/93	Spätzle-Zubehör	38/39, 41, 195	Turmreibe	84, 89
Rouladennadeln/-Ringe	72	Speisehaube	121	Universal Konservenglas- öffner	181
Rührbecher	153/154	Speisekartenständer	213	Universalbügel	187
Rührschüssel	153	Speisenformer	34/35, 149	Universalhacker	95
Sackschaufel	214	Spekulatiuswalze	159	Universalmühle	208
Saftpresse	178, 188/189	Spicknadel	68	Universalöffner	102, 108, 181, 195
Sahnegießer	199/203/204	Spiralenschneider	91/92	Universalreibe	86/87, 89, 92/93
Salatbesteck	116	Springform	136, 138, 142	Universalstreuer	198, 200, 202
Salatbutler	115	Spritzgebäckvorsatz	171	Universelle Haushaltsschere	24
Salatmesser	24	Spritzbeutel	157	Untersetzer	80
Salatschere	24	Spritzkorken	219	V-Hobel	88, 90
Salatschleuder	115	Spritzschutz	59	Verkorker	239
Salatschüssel	114	Steakhammer	65	Vespermesser	233
Salatzange	73	Steakthermometer	69	Vielzwecköffner	102, 108, 195
Salzmühle	206-208	Stipproller	158	Vielzweckschneider	20, 23, 195
Salzstreuer	198, 202-205	Stollenplatte	168	Vierkantreibe	89
Santokumesser	27	Streichpalette	163	Vorlege-Serien	44/45, 48/49, 54/55
Saughaken	226	Sturzgläser	183/184, 191	Vorratseimer	178
Schaber	29, 57, 161	Stutzen-Kaffeefilter	126	Vorspeisegläser	191
Schäler	10-14, 46/47, 50-52, 63, 232	Suppenkelle	44/45, 48/49, 54/55	Waffelbäckerei	162
Schälmaschine	17	Süßmostkappen	187	Wandhalterung	221, 225, 229
Schälmesser	27	Süßstoffspender	131	Weinausgießer	222
Schaschlikspieß	76/77	Technicus-Reiben-Serie	82-84	Weinflaschenverschluss	110, 242
Schaumlöffel	41, 44/45, 48/49, 54/55	Tee-Ei	128	Wender	44/45, 48/49, 54-58
Scherenschärfer	29	Teebox	127	Wetzstab Sieger-Long-Life	28
Schlauchhalter	225	Teenetz	128	Wiegemesser	24
Schleifstein	29	Teesieb	128/129	Winkelpalette	163
Schlüsselanhänger	227	Teig-Ausrollmatte	159	Woklöffel	45, 48/49
Schneebesen	45, 49, 54/55, 60	Teigportionierer	154	Wurstfülltrichter	171
Schneidbrett	30	Teigrad	47, 51-53, 159	Wurstzange	74/75
Schneidhilfe	66	Teigrolle	159	Zahnputzbecher	227
Schöpfkelle	44/45, 48/49, 54/55	Teigschaber	161	Zahnstocher	35
Schraubdeckel	186	Teigstreifenschneider	158	Zangendosenöffner	98, 101/102, 235
Schraubdeckelöffner	99, 102, 108, 195	Thermometer	69-71, 181, 225	Zestenreißer	15, 47, 51-53
Schuhrost/Schuhablage	225	Timer	71	Zitronenausgießer	130
Schüsselserie »Olympia«	112-114	Tischabfallbehälter	133	Zitronenschaber	15, 47, 51-53
Schüttelbecher	116	Tischbutterdose	121	Zitronenschnitzelpresse	130
Schüttengehäuse	122	Tischentkorkmaschine	106	Zitruspresse	188/189
Schwenksieb	128	Tischglocke	213	Zuckerdosierer/-Streuer	198/199, 202-204
Seifendose	227	Tischtuchklammern	227	Zuckertopf	201
Seiher	113/114	Tomaten-Passierer und Entsafter	178/179	Zuckerzange	210
Sektflaschenverschluss	110, 242	Tomatenschäler	11, 13, 195, 233	Zwetschgenentsteiner	174-176
Sektzange	172	Tomatenstrunkentferner	33, 46/47, 50/51	Zwiebelhacker/-würfler	94/95
Servierpinzette	74/75	Tomatenzange	23	Zwiebelpresse	233
Servierzange	56, 73-75	Topfhauben	121		
Shaker	116, 211	Topflappen/-Handschuhe	80		
Sicherheitsdosenöffner	101/102, 235	Topfuntersetzer	80		
Sieb	59/60, 128/129, 167, 179, 226, 242	Tortenbodenform	140, 143		
Silikon-Backaccessoires	145-148, 156, 159-161	Tortenbodenteiler	166		
		Torteneinteiler	168		



## Allgemeine Geschäftsbedingungen (AGB)

### I. Vertragsabschluss/Übertragung von Rechten u. Pflichten

#### 1. Maßgeblichkeit der AGB

a. Die Allgemeinen Geschäftsbedingungen der Verkäuferin gelten für alle - auch zukünftigen - Verträge zwischen den Vertragsschließenden. Bedingungen des Käufers sind nur verbindlich, wenn die Verkäuferin sie ausdrücklich u. in Schrift- o. Textform anerkannt hat. Die Unwirksamkeit einzelner Bestimmungen berührt die Gültigkeit dieser Bedingungen im Übrigen nicht.

b. Besondere von diesen Bedingungen abweichende Abmachungen gelten nur für das Geschäft, für das sie vereinbart sind, haben weder rückwirkende Kraft noch gelten sie für spätere Geschäfte.

c. Die Bestellung gilt als Anerkennung der Verkaufs- u. Lieferbedingungen der Verkäuferin.

d. Die Verkäuferin ist jederzeit berechtigt, die vorliegenden AGB zu ändern. Widerspricht der Käufer den geänderten Bedingungen nicht innerhalb von 2 Wochen nach Zugang der Änderungsmitteilung, so werden diese entsprechend der Ankündigung wirksam. Widerspricht der Käufer fristgemäß, so ist die Verkäuferin berechtigt, den Vertrag zu diesem Zeitpunkt zu kündigen, an dem die geänderten Bedingungen in Kraft treten. Diese AGB gelten auch für zukünftige Geschäfte, ohne dass es in jedem Einzelfall einer diesbezüglichen ausdrücklichen Vereinbarung bedarf.

#### 2. Beratung/Angebote/Vertragsabschluss

a. Die Bestellung ist für den Käufer verbindlich.

b. Alle Angebote sind freibleibend, falls nicht die Bindung an ein Angebot für eine bestimmte Frist ausdrücklich erklärt o. die Angebote ausdrücklich als Festangebote ausgewiesen werden.

c. Aufträge gelten erst dann als angenommen, wenn sie von der Verkäuferin schriftl. bestätigt sind (Auftragsbestätigung).

d. Die Verkäuferin behält sich den Rücktritt vom Vertrag vor, ohne dass Ansprüche irgendwelcher Art an sie gestellt werden können, wenn die Zahlungsfähigkeit des Käufers unsicher erscheint o. eine von der Verkäuferin gewünschte Vorkasse abgelehnt wird.

#### 3. Wirksamkeit des Auftrags, Vertretungsmacht

Für sämtliche Vereinbarungen einschließlich aller Nebenabreden, Zusicherungen, nachträgl. Vertragsänderungen, zur Auftragsannahme, -erweiterung, -änderung u. zur Erteilung von Angeboten sind grundsätzlich nur Geschäftsführer u. Prokuristen vertretungsberechtigt. Sämtl. Vereinbarungen, Nebenabreden, Zusicherungen, nachträgliche Vertragsänderungen, Auftragsannahmen, -erweiterungen u. -änderungen durch andere Personen bedürfen der schriftl. Bestätigung durch vertretungsberechtigte Personen.

#### 4. Schriftform

Sämtliche Vereinbarungen, Aufträge sowie einseitige Erklärungen des Käufers sind schriftl. o. in Textform niederzulegen.

#### 5. Umfang des Auftrages

Bestellt der Käufer eine Ware, die erst für ihn gesondert aufgrund von ihm mitge-

teilter Angaben für ihn angefertigt werden muss, ist er zur Abnahme u. Bezahlung der Ware von dem Zeitpunkt an verpflichtet, an dem die Ware seinen Wünschen gemäß modifiziert wurde.

### II. Lieferung

#### 1. Lieferkosten

Die Angebote der Verkäuferin sind freibleibend. Lieferung erfolgt zu den von ihr vor Versand o. Abholung der Ware zuletzt bekannt gegebenen Preisen u. Bedingungen.

#### 2. Verpackung

Die Verpackung ist im Preis enthalten.

#### 3. Gefahrtragung

a. Mit Verlassen des Lagers geht die Gefahr auf den Käufer über, auch wenn die Lieferung frachtfrei erfolgt und die Verkäuferin die Ware selbst transportiert oder an ein Transportunternehmen übergibt. Die Pflicht zur Entladung, die damit verbundenen Kosten u. Gefahr trägt der Käufer.

b. Wahl von Verpackung, Versandart u. Versandweg erfolgt nach Ermessen der Verkäuferin.

c. Für eine Versicherung sorgt die Verkäuferin nur auf besondere Anweisung u. auf Kosten des Käufers.

#### 4. Annahmeverzug, Schadensersatz

a. Nimmt der Käufer die Sache nicht gegen Bezahlung rechtzeitig an, so kann die Verkäuferin dem Käufer schriftl. eine Nachfrist von 2 Wochen mit Ablehnungsandrohung setzen. Der Setzung einer Nachfrist bedarf es nicht in den gesetzlich bestimmten Fällen. Nach erfolglosem Ablauf dieser Nachfrist ist die Verkäuferin berechtigt, die Erfüllung des Vertrages abzulehnen.

b. Hat der Käufer die Nichtannahme zu vertreten, so ist die Verkäuferin berechtigt, neben dem Rücktritt Schadensersatz zu verlangen. Der Schadensersatzanspruch der Verkäuferin beträgt pauschaliert 15 % des vereinbarten Kaufpreises. Der Schadensersatz ist höher o. niedriger anzusetzen, wenn die Verkäuferin einen höheren o. der Käufer einen geringeren Schaden nachweist.

### III. Lieferung / Lieferungsverzug

#### 1. Schriftform, Fristbeginn

Lieferfristen und Liefertermine sind unverbindlich. Teillieferungen sind zulässig. Zugesagte Lieferfristen beginnen erst nach endgültiger Klärung erteilter Aufträge, Eingang aller für die Auftragsabwicklung erforderlichen Unterlagen (Zeichnungen, Muster etc.) u. der Auftragsbestätigung durch die Verkäuferin.

#### 2. Nicht von der Verkäuferin zu vertretende Verzögerungen

a. Treten durch nicht von der Verkäuferin zu vertretende Umstände (z.B.: höhere Gewalt, Streik usw.), insbesondere durch Verzögerungen bei den Vormaterialwerken Verzögerungen ein, hat der Käufer kein Recht vom Kaufvertrag zurückzutreten u./o. Schadensersatz zu verlangen. Dies gilt hinsichtlich des Kündigungsrechts nicht für Fälle des § 322 Abs. 2 Nr. 2 BGB.

b. Vereinbarte Lieferfristen verlängern sich / der vereinbarte Liefertermin verschiebt sich angemessen wegen eines von der Verkäuferin nicht zu vertretenden vorübergehenden Leistungshindernisses. Der Liefertermin verschiebt sich entsprechend um den Zeitraum, um den sich die Klarstellung der Einzelheiten unplanmäßig verzögert.

c. Erhöht sich der Arbeitsumfang gegenüber dem ursprünglichen Auftrag, verlängert sich die Lieferfrist / verschiebt sich der Liefertermin entsprechend.

#### 3. Lieferverzug bei unverbindlicher Lieferfrist/Liefertermin

Der Käufer kann vier Wochen nach Überschreitung eines unverbindlichen Liefertermins o. einer unverbindlichen Lieferfrist die Verkäuferin schriftl. auffordern, binnen einer Frist von vier Wochen zu liefern, mit dem Hinweis, dass er die Abnahme nach Ablauf der Frist ablehne. Dies gilt nicht, soweit nach dem Gesetz eine Fristsetzung entbehrlich ist.

#### 4. Lieferverzug bei verbindlicher Lieferfrist/Liefertermin

Wird ein verbindlicher Liefertermin o. ein verbindliche Lieferfrist überschritten, bestehen die Rechte des Käufers ab dem Zeitpunkt des Verzugesintrittes.

#### 5. Schadensersatz

##### a. Verzögerungsschaden

Gerät die Verkäuferin in Verzug, beschränkt sich die Höhe des Schadensersatzes auf höchstens 5% des vereinbarten Kaufpreises, wenn sie leicht fahrlässig gehandelt hat.

##### b. Nichterfüllungsschaden

Tritt der Käufer nach dem Ablauf der Nachfrist zurück, kann er höchstens 10% des vereinbarten Kaufpreises als Schadensersatz bei einem leicht fahrlässigen Handeln der Verkäuferin verlangen.

### IV. Preise u. Zahlung

#### 1. Preise

a. Die Angebote sind freibleibend. Lieferung, Leistung u. Berechnung erfolgen zu den von der Verkäuferin vor Versand o. Abholung der Ware zuletzt bekannt gegebenen Preisen u. Bedingungen so lange der Vorrat reicht.

b. Die Preise verstehen sich grundsätzlich in EURO ab Lager bzw. Lieferwerk einschließlich Verpackungs- und ausschließlich Frachtkosten zzgl. Mehrwertsteuer in der jeweiligen gesetzlichen Höhe.

#### 2. Rechnungsstellung, Fälligkeit

Der Kaufpreis u. Preise für Nebenleistungen sind spätestens bei Erhalt der Ware u. Aushändigung o. Übersendung der Rechnung zur Zahlung fällig.

#### 3. Zahlungsweise

a. Die Zahlung hat bar o. durch Überweisung zu erfolgen. Maßgeblich für den Fristeinhalt ist der Eingang bei der Verkäuferin bzw. die Gutschrift auf deren Konto. Zahlungen an Angestellte o. Vertreter dürfen nur erfolgen, wenn diese eine gültige Inkassovollmacht vorweisen.

b. Eine andere Zahlungsweise muss ausdrücklich vereinbart sein. Schecks u. Wechsel werden nur nach Vereinbarung zahlungshalber angenommen. Die Hereinnahme von fremden o. eigenen Akzepten behält die Verkäuferin sich vor. Sämtliche hieraus entstehenden Kosten trägt der Käufer. Eine Gewähr für Vorlage u. Protesterhebung eigener Wechsel des Bestellers o. nicht sofortige Abdeckung protestierter fremder Wechsel ermächtigen die Verkäuferin, sämtliche noch laufenden Wechsel zurückzugeben. Gleichzeitig werden sämtlichen Forderungen der Verkäuferin fällig. Vordatierte Schecks werden nicht angenommen.

#### 4. Fälligkeit / Skonto

Die Zahlung hat ohne jeden Abzug innerhalb von 30 Tagen ab Rechnungsdatum zu erfolgen. Bei Zahlung innerhalb von 14 Tagen ab Rechnungsdatum gewährt die Verkäuferin 2 % Skonto; maßgebend ist der Eingang der Zahlung bei der Verkäuferin.

#### 5. Zurückbehaltung / Aufrechnung

Die Zurückbehaltung von Zahlungen o. Aufrechnungen etwaiger Gegenansprüche ist nur zulässig, wenn diese rechtskräftig festgestellt o. durch die Verkäuferin anerkannt sind.

### V. Zahlungsverzug

#### 1. Fristsetzung u. Rücktritt

a. Befindet sich der Käufer in Verzug, kann die Verkäuferin ihm eine Frist von zwei Wochen zur Zahlung des noch ausstehenden Betrages setzen. Mit Ablauf dieser Frist kann die Verkäuferin vom Vertrag zurücktreten u. zugleich Schadensersatz verlangen.

b. Tritt die Verkäuferin zurück, werden bereits erfolgte Kaufpreiszahlungen gegen Rückgabe der Ware nur noch anteilig in Höhe des noch vorhandenen Verkehrswertes der Ware zurückerstattet. Wertverluste gehen zu Lasten des Käufers.

#### 2. Verzugszinsen / Rabattwegfall

Im Verzugsfall schuldet der Käufer die gesetzlichen Verzugszinsen von 8 % über dem jeweiligen Basiszinssatz. Bei Zahlungsverzug entfällt jede Rabattgewährung. Der Ersatz weitergehender Schäden ist nicht ausgeschlossen.

#### 3. Fälligkeit aller Forderungen / Vorauszahlungen / Rücktritt / Schadensersatz

Nichteinhaltung der Zahlungsbedingungen o. Umstände, welche ernste Zweifel an der Kreditwürdigkeit des Käufers begründen, haben die sofortige Fälligkeit aller Forderungen der Verkäuferin zur Folge. Die Verkäuferin ist berechtigt, für noch offene stehende Lieferungen Vorauszahlungen o. Sicherheiten zu verlangen, nach angemessener Nachfrist vom Vertrag zurückzutreten, Schadensersatz wegen Nichterfüllung zu verlangen, die Weiterveräußerung der Ware zu untersagen u. die noch nicht bezahlte Ware zurückzuholen. Die damit verbundenen Kosten trägt der Käufer.

4. Gefahrtragung während des Verzuges  
Der Käufer trägt während seines Verzuges auch dann die Gefahr des Untergangs o. der Verschlechterung der Leistung, wenn sich die Ware noch bei der Verkäuferin befindet.

### VI. Sicherungsrechte - Eigentumsvorbehalt

#### 1. Umfang

a. Die gelieferte Ware bleibt bis zur vollen Bezahlung Eigentum der Verkäuferin, bei laufender Geschäftsbeziehung bleibt die gelieferte Ware so lange Eigentum der Verkäuferin, bis alle Forderungen aus der Kontokorrent- bzw. Geschäftsbeziehung vollständig bezahlt sind. Der Eigentumsvorbehalt bleibt auch dann bestehen, wenn einzelne Forderungen des Verkäufers in eine laufende Rechnung aufgenommen werden und der Saldo gezogen und anerkannt wird.

b. Auf Verlangen des Käufers ist die Verkäuferin zum Verzicht auf den Eigentumsvorbehalt verpflichtet, wenn der Käufer sämtliche mit dem Kaufgegenstand im Zusammenhang stehende Forderungen

erfüllt hat u. für die übrigen Forderungen aus der laufenden Geschäftsbeziehung anderweitig eine angemessene Sicherung besteht.

c. Übersteigt der Wert der Sicherheiten die Forderungen der Verkäuferin um 20 %, wird diese auf Verlangen des Käufers Sicherheiten nach ihrer Wahl der die 120% übersteigenden Werte freigeben.

#### 2. Geltendmachung / Befriedigung

Die Verkäuferin ist berechtigt, die sofortige Herausgabe der Vorbehaltsware zu fordern bzw. diese abzuholen, wenn die Ware nicht bezahlt wurde. Für Zurückbehaltungsrechte des Käufers gilt IV.5..

Nimmt die Verkäuferin aufgrund des Eigentumsvorbehalts die Ware zurück, so liegt nur dann ein Rücktritt vom Vertrag vor, wenn die Verkäuferin dies ausdrücklich erklärt. Die Verkäuferin kann sich aus der zurückgenommenen Vorbehaltsware durch freihändigen Verkauf befriedigen.

#### 3. Verbindung/Vermischung/Verarbeitung

Wird die Vorbehaltsware vom Käufer zu einer neuen beweglichen Sache verbunden, vermischt o. verarbeitet, so erfolgt dies für die Verkäuferin, ohne dass diese allerdings hierdurch verpflichtet wird. Durch die Verbindung, Vermischung o. Verarbeitung erwirbt der Käufer nicht das Eigentum gemäß den Vorschriften der §§ 947 ff. BGB an der neuen Sache. Bei Verbindung, Vermischung o. Verarbeitung mit nicht der Verkäuferin gehörenden Sachen erwirbt die Verkäuferin Miteigentum an der neuen Sache nach dem Verhältnis des Wertes ihrer Vorbehaltsware zum Gesamtwert.

#### 4. Veräußerung/Sicherungsübereignung/Verpfändung der Ware

a. Der Käufer darf die Vorbehaltsware nur im ordnungsgemäßen Geschäftsbetrieb veräußern o. verarbeiten u. sofern sich seine Vermögensverhältnisse nicht nachhaltig verschlechtern. Er ist verpflichtet, der Verkäuferin das Eigentum vorzubehalten. Die Befugnisse des Käufers, in ordnungsgem. Geschäftsverkehr Vorbehaltsware zu veräußern, enden mit dem Widerruf durch den Verkäufer infolge einer nachhaltigen Verschlechterung der Vermögenslage des Käufers, spätestens jedoch mit seiner Zahlungseinstellung oder mit der Beantragung bzw. Eröffnung des Insolvenzverfahrens über sein Vermögen.

b. Der Käufer tritt die Forderungen mit allen Rechten aus dem Weiterverkauf der Vorbehaltsware - einschließlich etwaiger Saldoforderungen - im Voraus an die Verkäuferin ab. Wurde die Ware verbunden, vermischt o. verarbeitet u. hat die Verkäuferin hieran Miteigentum erlangt, steht ihr die Kaufpreisforderung anteilig zum Wert ihrer Rechte an der Ware zu.

c. Der Käufer ist zur Einziehung der in dieser Regelung genannten Forderungen trotz der vorstehenden Abtretung ermächtigt. Die Einziehungsbefugnis der Verkäuferin bleibt jedoch von der Einziehungsermächtigung des Käufers unberührt. Die Verkäuferin wird die Forderungen so lange nicht einziehen, solange der Käufer seinen Zahlungsverpflichtungen nachkommt und keine wesentliche Verschlechterung der Vermögensverhältnisse des Käufers eintritt. In diesem Fall kann die Verkäuferin dem Käufer den Forderungseinzug durch sich oder beauftragte Dritte androhen. Nach Fristablauf ist die Verkäuferin vom

Käufer bevollmächtigt, die Abnehmer von der Abtretung zu unterrichten und die Forderungen selbst einzuziehen. Der Käufer ist verpflichtet, der Verkäuferin auf Verlangen alle Auskünfte für eine Geltendmachung der Rechte zu erteilen sowie die erforderlichen Unterlagen (Forderungsaufstellung mit Namen und Anschrift der Abnehmer, Höhe der einzelnen Forderungen, Rechnungsdaten usw.) auszuhändigen.

d. Der Käufer ist nicht berechtigt, die Ware o. die an ihre Stelle tretenden Forderungen zu verpfänden o. zur Sicherheit zu übereignen.

Hat der Käufer die Forderung im Rahmen des echten Factorings verkauft, wird die Forderung der Verkäuferin sofort fällig und der Käufer tritt die an ihre Stelle tretende Forderung gegen den Factor an die Verkäuferin ab und leistet seinen Verkaufserlös unverzüglich an die Verkäuferin weiter. Die Verkäuferin nimmt diese Abtretung an.

#### 5. Zugriffe Dritter

Bei Zugriffen Dritter, insbesondere bei Pfändungen des Kaufgegenstandes, hat der Käufer unter Hinweis auf den Eigentumsvorbehalt zu widersprechen u. die Verkäuferin unverzüglich schriftl. zu unterrichten. Eine schriftl. Information hat auch dann zu erfolgen, wenn von dritter Seite ein Werkunternehmerpfandrecht o. sonstige Sicherungsrechte geltend gemacht werden. Der Käufer ist verpflichtet, die Verkäuferin bei der Wahrnehmung ihrer Rechte zu unterstützen.

#### 6. Verwahrung der Vorbehaltsware / Versicherung

Der Käufer verwahrt die Ware für die Verkäuferin unentgeltlich. Er hat sie gegen die üblichen Gefahren wie z. B. Feuer, Diebstahl und Wasser in gebäulichem Umfang zu versichern. Der Käufer tritt hiermit seine Entschädigungsansprüche, die ihm aus Schäden der o. g. Art gegen Versicherungsgesellschaften oder sonstige Ersatzverpflichtete zustehen, an die Verkäuferin in Höhe des Fakturenwertes der Ware ab. Die Verkäuferin nimmt diese Abtretung an.

#### 7. Zurückbehaltungsrecht

Wegen aller gegen den Käufer gerichteten Forderungen, einschließlich solcher aus früheren Werk- u. Kaufverträgen steht der Verkäuferin an den in ihren Besitz gelangten Gegenständen u. Unterlagen des Käufers ein Zurückbehaltungsrecht zu.

#### VII. Sachmängelhaftung

##### 1. Soll-Beschaffenheit

a. Die Soll-Beschaffenheit der Ware bestimmt sich nach dem der Stand der Technik für vergleichbare Waren des Typs des Kaufgegenstandes bei Abschluss des Kaufvertrages. Geringfügige Abweichungen gelten nicht als Abweichung der Ist- von der Sollbeschaffenheit. Die Werbung eines anderen Herstellers ist für die Sollbeschaffenheit nur dann verbindlich, wenn die Verkäuferin sie sich zu Eigen gemacht hat.

b. Geringe, technisch nicht vermeidbare Abweichung der Qualität, Farbe, Breite, Gewicht der Ausrüstung o. des Designs dürfen nicht beanstandet werden u. gelten nicht als Mangel im Sinne des § 434 BGB. Dies gilt auch für handelsübliche Abweichungen, es sei denn, dass der Verkäufer eine mustergetreue Lieferung schriftl.

zugesagt hat.

##### 2. Untersuchungs- u. Rügepflicht

Der Käufer hat die Ware unverzüglich nach der Annahme o. innerhalb von acht Tagen nach der Übergabe zu untersuchen, u., wenn sich ein Mangel zeigt, der Verkäuferin unverzüglich schriftliche Anzeige unter Rücksendung des Lieferscheines zu machen. Unterlässt er die Anzeige, so gilt die Ware als genehmigt, es sei denn, dass es sich um einen Mangel handelt, der bei der Untersuchung nicht erkennbar war. Zeigt sich später ein solcher Mangel, so muss die Anzeige unverzüglich, spätestens aber eine Woche nach der Entdeckung gemacht werden; anderenfalls gilt die Ware auch in Ansehung dieses Mangels als genehmigt. Dies gilt nicht in den Fällen der § 444 bzw. § 639 BGB.

##### 3. Sachmängelhaftungsumfang

a. Bei berechtigten Mängelrügen kann der Käufer Nacherfüllung verlangen. Die Verkäuferin wird nach ihrer Wahl den Mangel beseitigen o. eine mangelfreie Sache liefern.

b. Schlägt der Versuch einer Mängelbeseitigung durch die Verkäuferin dreimal fehl o. ist sie mit einem unverhältnismäßigen Aufwand verbunden, so kann der Käufer nach seiner Wahl Rückgängigmachung des Vertrags o. Herabsetzung der Vergütung verlangen. Eine Nachbesserung gilt auch nach dem dritten erfolglosen Versuch nicht als endgültig fehlgeschlagen, wenn sich insbesondere aus der Art der Sache o. des Mangels o. den sonstigen Umständen, die die Nachbesserung erschweren, etwas anderes ergibt.

c. Für die bei der Nachbesserung ggf. eingebauten Teile wird bis zum Ablauf der Sachmängelhaftungspflicht des Kaufgegenstandes Gewähr aufgrund des Kaufvertrages geleistet. Ggf. ausgewechselte Ersatzteile werden Eigentum der Verkäuferin.

##### 4. Abwicklung / Kosten

a. Der Käufer kann Nachbesserungsansprüche bei der Verkäuferin geltend machen. Die Verkäuferin bestimmt Art u. Ort der Nachbesserung.

b. Bei Rückgängigmachung des Vertrages werden die empfangenen Leistungen zurückgewährt beziehungsweise bei Herabsetzung der Vergütung der vom Käufer gezahlte Mehrbetrag von der Verkäuferin erstattet u. die gezogenen Nutzungen herausgegeben. Sofern der Käufer Nutzungen entgegen den Regeln einer ordnungsmäßigen Wirtschaft nicht gezogen hat, ist er der Verkäuferin zum Wertersatz verpflichtet.

##### 5. Sachmängelhaftungsausschluss

a. Die Sachmängelhaftung erlischt, wenn nach Entdeckung des Mangels die Sache vom Käufer o. von jemand anderem als der Verkäuferin verändert o. instand gesetzt worden sind. Hiervon ausgenommen sind Notfälle u. Fälle, in denen die Veränderung o. Instandsetzung eindeutig keinen Einfluss auf den Mangel haben konnte.

b. Sachmängelhaftungsverpflichtungen der Verkäuferin erlöschen auch, wenn der Käufer die Vorschriften über die Behandlung, Wartung, Lagerung u. Pflege der Ware nicht befolgt hat.

##### 6. Verjährung

a. Sachmängelhaftungsfristen für erkennbare Mängel verjähren mit Ablauf von sechs Monaten seit Lieferung.

b. Für solche Sachmängel, die bei Abnahme nicht erkennbar sind, beträgt die Verjährungsfrist ein Jahr nach Abnahme.

#### VIII. Haftung

##### 1. Organe u. leitende Angestellte

Bei einem Handeln von Organen u. leitenden Angestellten ist die Haftung der Verkäuferin - gleich aus welchem Rechtsgrund - auf Vorsatz u. grobe Fahrlässigkeit beschränkt.

##### 2. Einfache Erfüllungsgehilfen

Bei einem Handeln von einfachen Erfüllungsgehilfen haftet die Verkäuferin bei der Verletzung vertragswesentlicher Pflichten umfassend. Bei der Verletzung nicht vertragswesentlicher Pflichten besteht die Haftung bei einfachen Erfüllungsgehilfen nur für Vorsatz u. grobe Fahrlässigkeit.

##### 3. Schadenshöhe

Für den Fall fahrlässig verursachter Schäden ist die Haftung auf die Höhe der vernünftigerweise vorhersehbaren Schäden begrenzt. Dies gilt nicht bei einem grob fahrlässigen Verhalten von Organen o. leitenden Angestellten.

##### 4. Personenschäden

Für Schäden an Leben, Körper o. Gesundheit haftet die Verkäuferin umfassend.

##### 5. Eigenhaftung der Arbeitnehmer

Eine persönliche Haftung der Organmitglieder u. Arbeitnehmer der Verkäuferin gegenüber dem Käufer besteht nur in dem Umfang, in dem die Verkäuferin selbst haftet.

##### 6. Versicherung

Soweit die Verkäuferin gegen die Haftung für die in den vorgenannten Absätzen versichert ist, kann sie einen etwaigen Versicherungsanspruch an den Geschädigten abtreten.

#### IX. Entwürfe, Zeichnungen, Muster

Alle Entwürfe, Zeichnungen u. Muster, die die Verkäuferin dem Angebot beifügt o. zur Erleichterung des Wiederverkaufs ihrer Erzeugnisse dem Käufer auf unbestimmte Zeit überlässt, bleiben unveräußerliches Eigentum der Verkäuferin u. sind auf Verlangen zurückzugeben. Eine Weitergabe o. Reproduktion von Zeichnungen u. Entwürfen, insbesondere an Konkurrenzunternehmen der Verkäuferin, ist nicht gestattet.

#### X. Erfüllungsort / Gerichtsstand

1. Erfüllungsort u. Gerichtsstand  
Erfüllungsort u. Gerichtsstand für alle sich aus dem Kaufvertrag ergebenden Ansprüche ist Lennestadt, auch wenn Verkäufe o. Lieferungen von einer Niederlassung vorgenommen worden sind.

Dieser Gerichtsstand gilt auch für Streitigkeiten über die Entstehung u. Wirksamkeit des Vertragsverhältnisses.

Die Verkäuferin behält sich jedoch das Recht vor, den Käufer auch vor dem für ihn zuständigen Gericht in Anspruch zu nehmen.

2. Maßgeblichkeit deutschen Rechts  
Auf die gesamte Geschäftsverbindung findet deutsches Recht Anwendung. Das UN-Kaufrecht findet keine Anwendung.



## Handelsagenturen

### Schleswig-Holstein/Niedersachsen/Bremen/Hamburg

Handelsagentur Jörg Weiland  
Am Wiesengrund 16  
22965 Todendorf  
Tel.: +49 4534 8676  
Fax: +49 4534 205248  
Mobil: +49 152 33752714  
E-Mail: joergweiland@handels-profi.de

### Mecklenburg-Vorpommern/ Berlin/Nördl. Brandenburg/Nördl. Sachsen-Anhalt

Handelsvertretung Volker Krüger  
Kisserower Straße 15  
17209 Walow  
Tel.: +49 39932 81990  
Fax: +49 39932 82843  
Mobil: +49 171 4834344  
E-Mail: krueger@walow-mv.de

### Sachsen/Südl. Sachsen-Anhalt/Thüringen/Südl. Brandenburg

Handelsvertretung Joachim Reißig  
Jacobsplatz 25  
04808 Wurzen  
Tel.: +49 34293 29614  
Fax: +49 34293 55579  
Mobil: +49 171 4505533  
E-Mail: handelsvertretung@joachim-reissig.de

### NRW-Nord

KST Köhler & Stock oHG  
Egon Köhler  
Wacholderhof 16  
33803 Steinhagen  
Tel.: +49 5204 9249968  
Fax: +49 5204 9249976  
Mobil: +49 160 5312891  
E-Mail: ekoehler@kst-handelsagentur.de

### Rheinland-Pfalz/Saarland/NRW-Süd

Handelagentur Karl-Heinz Mayer  
Mozartstraße 40  
67165 Waldsee  
Tel.: +49 6236 500166  
Fax: +49 6236 500148  
Mobil: +49 176 32735917  
E-Mail: karl-heinz.mayer@bm-handelsagenturen.com  
Web: www.bm-handelsagenturen.com

### Hessen

Handelsvertretung Hubert Usbeck  
Beethovenstrasse 9  
35043 Marburg  
Tel.: +49 6421 485111  
Fax: +49 6421 485122  
Mobil: +49 176 15501550  
E-Mail: hubert.usbeck@gmx.de

### Baden/Baden-Württemberg

Handelsagentur Anke Laufer  
Schönbergstraße 46B  
79227 Schallstadt  
Tel.: +49 7664 9625370  
Fax: +49 7664 9625380  
Mobil: +49 160 8863187  
E-Mail: contact@laufer-handelsagentur.de  
Web: www.wolfram-handelsagentur.de

### Bayern-Süd

Handelsagentur Stephan Herrmann  
Rodlbahn 13  
85614 Kirchseeon  
Tel.: +49 8091 5390001  
Fax: +49 8091 5390002  
Mobil: +49 170 7330735  
E-Mail: info@hv-agentur.de

### Bayern-Nord

Handelsagentur Manuela Pikalowa  
Am Rain 1  
85604 Zorneding  
Tel.: +49 08106 3489050  
Fax: +49 08106 3489277  
Mobil: +49 173 3733050  
E-Mail: manuela.pikalowa@gmx.net

#### Wir sind gerne für Sie da:

Telefon: +49 2721 9258-0  
Fax: +49 2721 9258-49  
E-Mail: info@westmark.de

#### Nous nous tenons volontiers à votre disposition:

Telefon: +49 2721 9258-717  
Fax: +49 2721 9258-49  
E-Mail: export@westmark.de

#### We will be pleased to help:

Phone: +49 2721 9258-30  
Fax: +49 2721 9258-49  
E-Mail: export@westmark.de

#### Estamos aquí para servirles:

Phone: +49 2721 9258-46  
Fax: +49 2721 9258-49  
E-Mail: export@westmark.de

Current information on trade partners/distributors can be found on our website at [www.westmark.de](http://www.westmark.de)  
Vous trouverez les dernières informations sur nos partenaires commerciaux/représentants sur notre page d'accueil:  
Encontrará información actual sobre los socios comerciales/representantes en nuestra página web:

# ***WESTMARK***

Westmark GmbH  
Bielefelder Straße 125  
57368 Lennestadt-Elspe / Germany

[info@westmark.de](mailto:info@westmark.de)  
[www.westmark.de](http://www.westmark.de)