

Nokia E60 User Guide



DECLARATION OF CONFORMITY



We, NOKIA CORPORATION declare under our sole responsibility that the product RM-49 is in conformity with the provisions of the following Council Directive: 1999/5/EC. A copy of the Declaration of Conformity can be found from http://www.nokia.com/phones/declaration_of_conformity/.



The crossed-out wheeled bin means that within the European Union the product must be taken to separate collection at the product end-of-life. This applies to your device but also to any enhancements marked with this symbol. Do not dispose of these products as unsorted municipal waste.

Copyright © 2006 Nokia. All rights reserved.

Reproduction, transfer, distribution or storage of part or all of the contents in this document in any form without the prior written permission of Nokia is prohibited.

Nokia, Nokia Connecting People, Xpress-on and Pop-Port are trademarks or registered trademarks of Nokia Corporation. Other product and company names mentioned herein may be trademarks or tradenames of their respective owners.

Nokia tune is a sound mark of Nokia Corporation.



This product includes software licensed from Symbian Software Ltd (c) 1998-2004. Symbian and Symbian OS are trademarks of Symbian Ltd.

US Patent No 5818437 and other pending patents. T9 text input software Copyright (C) 1997-2004. Tegic Communications, Inc. All rights reserved.



Includes RSA BSAFE cryptographic or security protocol software from RSA Security.



POWERED

Java and all Java-based marks are trademarks or registered trademarks of Sun Microsystems, Inc.

This product is licensed under the MPEG-4 Visual Patent Portfolio License (i) for personal and noncommercial use in connection with information which has been encoded in compliance with the MPEG-4 Visual Standard by a consumer engaged in a personal and noncommercial activity and (ii) for use in connection with MPEG-4 video provided by a licensed video provider. No license is granted or shall be implied for any other use. Additional information, including that related to promotional, internal, and commercial uses, may be obtained from MPEG LA, LLC. See <http://www.mpegla.com>.

Nokia operates a policy of ongoing development. Nokia reserves the right to make changes and improvements to any of the products described in this document without prior notice.

Under no circumstances shall Nokia be responsible for any loss of data or income or any special, incidental, consequential or indirect damages howsoever caused.

The contents of this document are provided "as is". Except as required by applicable law, no warranties of any kind, either express or implied, including, but not limited to, the implied warranties of merchantability and fitness for a particular purpose, are made in relation to the accuracy, reliability or contents of this document. Nokia reserves the right to revise this document or withdraw it at any time without prior notice.

The availability of particular products may vary by region. Please check with the Nokia dealer nearest to you.

EXPORT CONTROLS

This device may contain commodities, technology, or software subject to export laws and regulations from the US and other countries. Diversion contrary to law is prohibited.

9241264/Issue 4

Contents

For your safety	6
About your device.....	6
NETWORK SERVICES.....	6
Enhancements, batteries, and chargers.....	7
1. Get started	8
Insert the SIM card and battery.....	8
Insert a memory card.....	9
Charge the battery.....	9
Switch on your device.....	9
Enter basic settings.....	10
Keys and parts.....	10
Keypad lock (keyguard).....	10
Connectors.....	11
Antennas.....	11
About the display.....	11
Rotate the display.....	11
Standby modes.....	12
Active standby mode.....	12
Standby mode.....	12
Shortcuts in standby mode.....	12
Display indicators.....	13
Volume control.....	13
Write text.....	13
Traditional text input.....	13
Predictive text input.....	14
Copy text to the clipboard.....	14
Change writing language.....	14
Memory.....	14
Removable memory.....	14
Device memory.....	14
Monitor device memory.....	15
Memory card.....	15
RS-MMC.....	15
Use a memory card.....	15
Format a memory card.....	15
Memory card security.....	15
Unlock a memory card.....	15
CD-ROM.....	16
Nokia support and contact information.....	16
Transfer content between devices.....	16
Transfer data with Bluetooth or infrared.....	16
Synchronize data with another device.....	16
2. Your device	17
Menu.....	17
Help and tutorial.....	17
Device help.....	17
Tutorial.....	17
Scroll and make selections.....	17
Common actions in several applications.....	18
3. Make calls	19
Speed dial.....	19
Answer a call.....	19
Options during a call.....	19
Divert calls.....	20
Call barring.....	20
Net call barring.....	20
Send DTMF tones.....	20
Video calls.....	21
Log.....	21
Log settings.....	21
Push to talk.....	21
User settings.....	22
Connection settings.....	22
Log in to push to talk service.....	22
Push to talk calls.....	22
Callback requests.....	22
Contacts view.....	22
Create a channel.....	22
Register PTT channels.....	23
Join a channel.....	23
Push to talk log.....	23
Exit push to talk.....	23
Net calls.....	23
Preferred profile.....	23
Register profiles.....	24
Device security.....	24
Define security settings.....	24
Change the barring password.....	24
Fixed dialing.....	24
4. Contacts	26
Manage contact groups.....	26
Manage default information.....	26
Copy contacts between SIM and device memory.....	26
Select ringing tones for contacts.....	27
Business cards.....	27
5. Messages	28
Organize messages.....	28
Search for messages.....	28
Inbox.....	28
My folders.....	28
Draft messages.....	29
Sent messages.....	29
Outbox.....	29
Delivery reports.....	29
Messaging settings.....	29
Other settings.....	29
Text message center settings.....	30
Text messages.....	30
Write and send text messages.....	30
Sending options for text messages.....	30
Reply to received text messages.....	30
Text messages on the SIM card.....	30
Text message settings.....	31
Picture messages.....	31
Forward picture messages.....	31
Multimedia messages.....	31
Create and send multimedia messages.....	31
Create presentations.....	32
Receive and reply to multimedia messages.....	32
View presentations.....	33
View media objects.....	33
View and save multimedia attachments.....	33
Multimedia message settings.....	33
E-mail messages.....	34
Set up your e-mail.....	34
Connect to mailbox.....	34
View e-mail offline.....	35
Read and reply to e-mail.....	35
Delete messages.....	35
E-mail folders.....	35
Write and send e-mail.....	36
E-mail account settings.....	36
User settings.....	36
Retrieval settings.....	37
Automatic retrieval settings.....	37
Instant messaging.....	37
Connect to an IM server.....	37
Search IM users or IM groups.....	37
Conversations with a single IM user.....	37
IM groups.....	38
Group conversations.....	38
IM group settings.....	38
Group editing rights.....	39
Ban from groups.....	39
IM contacts.....	39
Blocked contacts.....	39
View invitations.....	40
Recorded messaging.....	40
Settings.....	40
IM server settings.....	40
Special messages.....	40

Contents

Send service commands.....	40
6. Connectivity.....	41
Internet access points.....	41
Set up an Internet access point for data calls.....	41
Advanced Internet access point settings for data calls.....	41
Set up an Internet access point for packet data (GPRS).....	42
Advanced Internet access point settings for packet data (GPRS).....	42
Set up an Internet access point for wireless LAN.....	42
Advanced Internet access point settings for wireless LAN.....	43
Cable connection.....	43
IP passthrough.....	43
Set up a data cable to use IP passthrough.....	43
Access point for IP passthrough.....	43
Advanced IP passthrough access point settings.....	43
Bluetooth.....	44
Start using Bluetooth.....	44
Settings.....	44
Security tips.....	44
Send data.....	44
Bluetooth connectivity indicators.....	45
Pair devices.....	45
Authorize a device.....	45
Receive data.....	45
End a Bluetooth connection.....	45
SIM access profile.....	46
Infrared.....	46
Data connections.....	46
Packet data.....	46
UMTS.....	47
Wireless local area network (WLAN).....	47
Connection manager.....	47
View and end active connections.....	47
Search for wireless LAN.....	48
Modem.....	48
Mobile VPN.....	48
VPN management.....	48
Manage VPN policies.....	48
View the VPN log.....	49
Email data roaming.....	49
Access point groups.....	49
Configure access point groups for mail and synchronization.....	50
7. Web.....	51
Access points.....	51
Browse the Web.....	51
Bookmarks.....	51
Download items.....	51
End a connection.....	52
Clear the cache.....	52
News feeds and blogs.....	52
Web settings.....	52
Services.....	53
8. Media applications.....	54
Gallery.....	54
Images.....	54
Manage image files.....	54
Organizing images.....	55
RealPlayer.....	55
Play video clips and stream links.....	55
Send audio files and video clips.....	55
Receive videos.....	55
View information about a media clip.....	56
Settings.....	56
Video settings.....	56
Connection settings.....	56
Proxy settings.....	56
Network settings.....	56
Advanced network settings.....	56
Music player.....	56
Listen to music.....	56
Adjust music volume.....	57
Track lists.....	57
Equalizer.....	57
Recorder.....	57
Play a voice recording.....	58
Flash player.....	58
9. Office applications.....	59
File manager.....	59
Manage files.....	59
Search for files.....	59
Documents.....	59
View objects in a document.....	59
Format documents.....	60
View document structure.....	60
Preview the page layout.....	60
Find text.....	60
Table editor.....	61
Sheet.....	61
Outline view.....	61
Work with worksheets.....	61
Work with cells.....	62
Insert functions.....	62
Web links.....	63
Create and modify charts.....	63
Find text.....	63
Presentation.....	63
View slide shows.....	63
Show slide shows with a data projector.....	63
Work with different views.....	64
Layout view.....	64
Outline view.....	64
Notes view.....	64
Master slide view.....	64
Edit presentations.....	64
Edit tables.....	65
Find text in a presentation.....	65
Screen export.....	65
Show screen content.....	66
Print.....	66
10. Settings.....	67
Phone settings.....	67
General settings.....	67
Standby mode settings.....	67
Display settings.....	67
Call settings.....	67
Connection settings.....	68
Access points.....	68
Access point groups.....	68
Packet data.....	69
Packet data settings.....	69
Net call settings.....	69
Session initiation protocol (SIP) settings.....	69
Edit SIP profiles.....	69
Edit SIP proxy servers.....	69
Edit registration servers.....	70
Data call settings.....	70
VPN.....	70
VPN access points.....	70
VPN access point settings.....	70
Wireless LAN.....	70
Advanced WLAN settings.....	70
Security settings for wireless LAN access points.....	71
Configurations.....	72
Date and time settings.....	72
Security settings.....	72
Network settings.....	72
Enhancement settings.....	72
Text phone settings.....	72
11. Organiser.....	73
Calendar.....	73
Create calendar entries.....	73
To-do.....	73
Calendar settings.....	73
Calendar views.....	74
Send calendar entries.....	74
Add a received calendar entry to your calendar.....	74

Contents

Notes.....	74
Calculator.....	74
Converter.....	75
Convert measurements.....	75
Set base currency and exchange rate.....	75
Voice mailbox.....	75
Clock.....	75
Clock settings.....	75
Add and delete cities.....	76

12. Tools.....77

Positioning.....	77
Navigator.....	77
Navigation view.....	77
Position view.....	77
Trip distance view.....	77
Manage locations.....	78
Navigator settings.....	78
Landmarks.....	78
Landmark categories.....	78
Edit landmark categories.....	78
Edit landmarks.....	79
Receive landmarks.....	79
Voice commands.....	79
Use a voice command to make a call.....	79
Use a voice command to launch an application.....	79
Use voice commands for profiles.....	79
Voice command settings.....	80
Voice aid.....	80
Sett. wizard.....	80
E-mail.....	80
Push to talk.....	80
Video sharing.....	80
Operator.....	81
Application manager.....	81
Install applications and software.....	81
View and remove software.....	81
View the installation log.....	81
Settings.....	81
Specify Java application security settings.....	82
Certificate manager.....	82
Manage personal certificates.....	82
Manage authority certificates.....	82
View certificate details.....	83
Certificate security settings.....	83
Nokia Catalogs.....	83
Open a catalog.....	83
Open a folder.....	83
Catalogs settings.....	84

13. Device management.....85

Server profile settings.....	85
Remote configuration network service.....	85
Remote configuration settings.....	85
Create a configuration profile.....	85
Data synchronization.....	86
Create a synchronization profile.....	86
Synchronization profiles.....	86
Synchronization connection settings.....	86
Define synchronization settings for Contacts.....	86
Define synchronization settings for Calendar.....	87
Define synchronization settings for Notes.....	87

14. Personalization.....88

Profiles.....	88
Select ringing tones.....	88
Change enhancement settings.....	88
Themes.....	88

Battery information.....90

Nokia battery authentication guidelines.....	90
Authenticate hologram.....	90
What if your battery is not authentic?.....	91

Care and maintenance.....92

Additional safety information.....93

Operating environment.....	93
Medical devices.....	93
Pacemakers.....	93
Hearing aids.....	93
Vehicles.....	93
Potentially explosive environments.....	93
Emergency calls.....	94
CERTIFICATION INFORMATION (SAR).....	94

Index.....95

For your safety

Read these simple guidelines. Not following them may be dangerous or illegal. Read the complete user guide for further information.



SWITCH ON SAFELY

Do not switch the device on when wireless phone use is prohibited or when it may cause interference or danger.



ROAD SAFETY COMES FIRST

Obey all local laws. Always keep your hands free to operate the vehicle while driving. Your first consideration while driving should be road safety.



INTERFERENCE

All wireless devices may be susceptible to interference, which could affect performance.



SWITCH OFF IN HOSPITALS

Follow any restrictions. Switch the device off near medical equipment.



SWITCH OFF IN AIRCRAFT

Follow any restrictions. Wireless devices can cause interference in aircraft.



SWITCH OFF WHEN REFUELLING

Do not use the device at a refueling point. Do not use near fuel or chemicals.



SWITCH OFF NEAR BLASTING

Follow any restrictions. Do not use the device where blasting is in progress.



USE SENSIBLY

Use only in the normal position as explained in the product documentation. Do not touch the antennas unnecessarily.



QUALIFIED SERVICE

Only qualified personnel may install or repair this product.



ENHANCEMENTS AND BATTERIES

Use only approved enhancements and batteries. Do not connect incompatible products.



WATER-RESISTANCE

Your device is not water-resistant. Keep it dry.



BACK-UP COPIES

Remember to make back-up copies or keep a written record of all important information.



CONNECTING TO OTHER DEVICES

When connecting to any other device, read its user guide for detailed safety instructions. Do not connect incompatible products.



EMERGENCY CALLS

Ensure the phone function of the device is switched on and in service. Press the end key as many times as needed to clear the display and return to the standby mode. Enter the emergency number, then press the call key. Give your location. Do not end the call until given permission to do so.

■ About your device

The wireless device described in this guide is approved for use on the EGSM900/1800/1900, UMTS 2100 networks. Contact your service provider for more information about networks.

When using the features in this device, obey all laws, and respect privacy and legitimate rights of others.



Warning: To use any features in this device, other than the alarm clock, the device must be switched on. Do not switch the device on when wireless device use may cause interference or danger.

■ NETWORK SERVICES

To use the phone you must have service from a wireless service provider. Many of the features in this device depend on features in the wireless network to function. These network services may not be available on all networks or you may have to make specific arrangements with your service provider before you can utilize network services. Your service provider may need to give you additional instructions for their use and explain what charges will apply. Some networks may have limitations that affect how you can use network services. For instance, some networks may not support all language-dependent characters and services.

For your safety

Your service provider may have requested that certain features be disabled or not activated in your device. If so, they will not appear on your device menu. Your device may also have been specially configured. This configuration may include changes in menu names, menu order and icons. Contact your service provider for more information.

This device supports WAP 2.0 protocols (HTTP and SSL) that run on TCP/IP protocols. Some features of this device, such as MMS, browsing, e-mail, and content downloading using the browser or over MMS, require network support for these technologies.

■ Enhancements, batteries, and chargers

Check the model number of any charger before use with this device. This device is intended for use when supplied with power from the LCH-12, ACP-12, and AC-1 chargers.



Warning: Use only batteries, chargers, and enhancements approved by Nokia for use with this particular model. The use of any other types may invalidate any approval or warranty, and may be dangerous.

For availability of approved enhancements, please check with your dealer. When you disconnect the power cord of any enhancement, grasp and pull the plug, not the cord.

Your device and its enhancements may contain small parts. Keep them out of reach of small children.

1. Get started



Note: Your service provider may have requested that certain features be disabled or not activated in your device. If so, they do not appear on your device menu. Your device may also have been specially configured for your network provider. This configuration may include changes in menu names, menu order and icons. Contact your service provider for more information.

Model number: Nokia E60-1

Hereinafter referred to as Nokia E60.

■ Insert the SIM card and battery

Keep all SIM cards out of the reach of small children. For availability and information on using SIM card services, contact your SIM card vendor. This may be the service provider, network operator, or other vendor.

1. Always switch the device off, and disconnect the charger before removing the battery.

With the back of the device facing you, press and slide the back cover in the direction of the arrow.

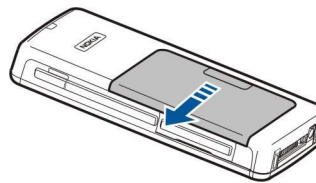

2. If the battery is installed, lift the battery from the battery compartment in the direction of the arrow to remove it.

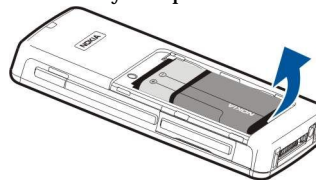

3. To release the SIM card holder, slide it in the direction of the arrow (1), and lift it (2). Insert the SIM card into the SIM card slot (3). Ensure that the beveled corner of the SIM card is pointing up and the contact area on the card is facing the device. Lower the SIM card holder (4), and slide it until it locks into place (5).

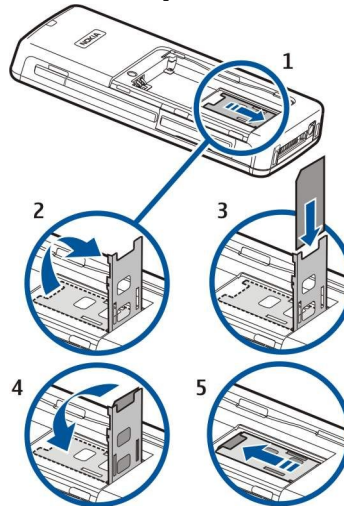

4. To insert the battery, align the contacts of the battery with the corresponding connectors on the battery compartment, insert in the direction of the arrow, and gently click the battery into place.

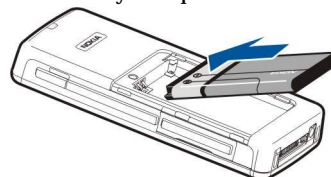

5. Insert the locking catches of the back cover into the corresponding slots, and slide the cover into place.

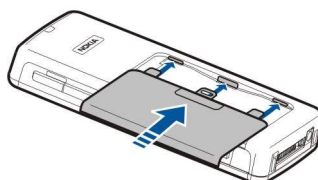

Instead of a SIM card, you may also have a USIM card, which is an enhanced version of the SIM card and is supported by UMTS (network service) mobile phones. Contact your service provider for more information and settings.

■ Insert a memory card

If you have a memory card, follow the instructions to insert it.

See "Memory," p. 14.

1. To open the memory card compartment, pull the door in the direction of the arrow (1).
2. Slide the memory card into the memory card slot (2). Ensure that the beveled corner of the memory card is pointing towards the device and the contact area is facing up.

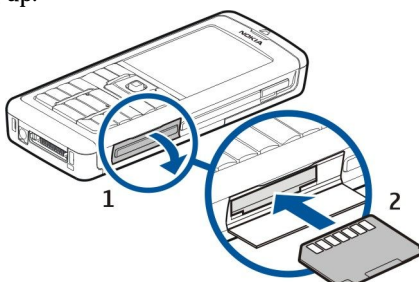

3. Close the memory card compartment door.



Important: Do not remove the MMC card in the middle of an operation when the card is being accessed. Removing the card in the middle of an operation may damage the memory card as well as the device, and data stored on the card may be corrupted.

■ Charge the battery

1. Connect the charger to a wall outlet.
2. Connect the power cord to the bottom of the device. The battery indicator bar starts scrolling on the display. If the battery is completely discharged, it may take a few minutes before the charging indicator is shown. The device can be used while charging.
3. When the battery is fully charged, the bar stops scrolling. Disconnect the charger from the device, then from the outlet.

■ Switch on your device

1. To switch the device on, press the power key.
2. If the device asks for a PIN code (or UPIN code, if you have a USIM card), lock code or security code, enter the code, and select **OK**.
3. To switch the device off, press the power key.



Tip: When you switch the device on, it may recognize the SIM card provider and configure the correct text message, multimedia message, and GPRS settings automatically. If not, contact your service provider for the correct settings, or use the **Sett. wizard** application.

The device can be used without the network dependant phone functions when a SIM card is not inserted or when the **Offline** profile is selected.

The picture shows the location of the power key.

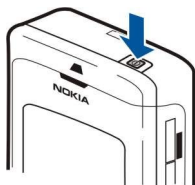

■ Enter basic settings

When you power on the device for the first time, and when you power on the device after the battery has been empty or removed for a longer period of time, your device asks for the city in which you are located, time, and date. You can change the settings later.

1. Select the city in which you are located from the list and **OK**. To browse for a city, start to type the name of the city, or scroll to a city. It is important to select the correct city, because scheduled calendar entries that you create can change if the new city is located on a different time zone.
2. Set the time, and select **OK**.
3. Set the date, and select **OK**.

■ Keys and parts

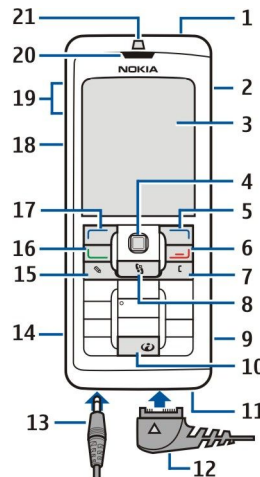

- 1 — Power key
- 2 — Integrated loudspeaker
- 3 — Display
- 4 — Joystick. Press the joystick to enter a selection. Use the joystick to scroll left, right, up, down, or to move around on the screen.
- 5 — Right selection key. Press either selection key to perform the function shown above it on the display.
- 6 — End key. Press the end key to reject a call, end active calls and held calls, close applications, and with a long keypress, end data connections (GPRS, data call).
- 7 — Clear key
- 8 — **Menu** key. Press the **Menu** key to access the applications installed in your device. With a long keypress, you can see a list of the active applications and switch between them. In this User Guide, "select **Menu**" refers to pressing this key.
- 9 — Memory card slot
- 10 — Internet key. Press and hold the key in the standby mode to browse the Web.
- 11 — Microphone. Do not cover the microphone with your hand during phone calls.
- 12 — Pop-Port™. Connector for the USB data cable, headset, and loopset.
- 13 — Charger connector
- 14 — Infrared port
- 15 — Edit key
- 16 — Call key
- 17 — Left selection key. Press either selection key to perform the function shown above it on the display.
- 18 — Voice key/Push to talk (PTT) key
- 19 — Volume keys
- 20 — Earpiece
- 21 — Light sensor

■ Keypad lock (keyguard)

When the keypad lock is on, calls may be possible to the official emergency number programmed into your device.

Get started

Use the keypad lock to prevent the keys on the device from being accidentally pressed.

To lock the keypad in the standby mode, press the left selection key and *. To unlock, press the left selection key and * again.



Tip: To lock the keypad in the **Menu** or in an open application, press the power key briefly, and select **Lock keypad**. To unlock, press the left selection key and *.

You can also lock the device in the standby mode using your lock code. Press the power key, select **Lock phone**, and enter your lock code. If your lock code contains numbers, press and hold # to switch to the number mode. The default lock code is 12345. To unlock, press the left selection key, enter your lock code, and press the joystick.

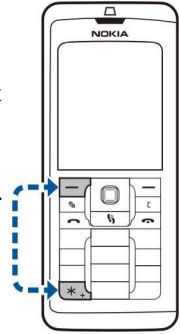

Connectors



Warning: When you use the headset, your ability to hear outside sounds may be affected. Do not use the headset where it can endanger your safety.

Pop-Port connector for headset and other enhancements

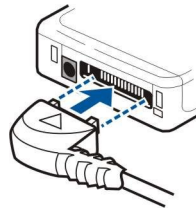

Battery charger connector

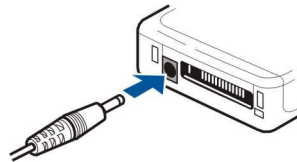

Antennas

Your device has two internal antennas.



Note: As with any other radio transmitting device, do not touch either of the antennas unnecessarily when the device is switched on. Contact with the antenna affects call quality and may cause the device to operate at a higher power level than otherwise needed. Not touching the antenna area during a phone call optimises the antenna performance and the talktime of your device.



The picture shows the normal use of the device at the ear for voice calls.



About the display

A small number of missing, discolored, or bright dots may appear on the screen. This is a characteristic of this type of display. Some displays may contain pixels or dots that remain on or off. This is normal, not a fault.

Rotate the display

You can rotate the display screen on your device from portrait to landscape.

Select **Menu** > **Rotate**. You can also rotate the screen by pressing and holding the menu key and then selecting **Rotate** from the application switching window.

The display screen rotates 90 degrees clockwise from portrait to landscape and back to portrait each time you select **Rotate**.

Get started



Tip: The application switching window displays **Rotate** until you switch off the phone or use the clear key to turn off the option and close the application.

■ Standby modes

Your device has two different standby modes: active standby mode and standby mode.

Active standby mode

After you have switched on your device and it is ready for use, but you have not entered any characters or made other selections, the device is in the active standby mode. In the active standby mode, you can view your service provider and network, different indicators such as indicators for alarms, and applications you want to access fast.

To select the applications that you want to access from active standby, select **Menu > Tools > Settings > Phone > Standby mode > Standby apps**. Scroll to the different shortcut settings, and press the joystick. Scroll to the desired application, and press the joystick.

To use the basic standby mode, select **Menu > Tools > Settings > Phone > Standby mode > Active standby > Off**.

You can see the messages in a messaging folder such as inbox or mailbox in the active standby mode. Select **Menu > Tools > Settings > Phone > Standby mode** and the folders in **Active standby mailbox**.



Tip: You can also see different notifications, such as missed calls, unread messages, or voice mails in the active standby mode. With these notifications, you can see the communication status of your device with one glance. Select the plug-ins in **Menu > Tools > Settings > Phone > Standby mode > Active standby plug-ins**. The available plug-ins may vary.

Standby mode

In the standby mode, you can see different information, such as your service provider, time, and different indicators, such as indicators for alarms.

The picture shows a the display in the standby mode.

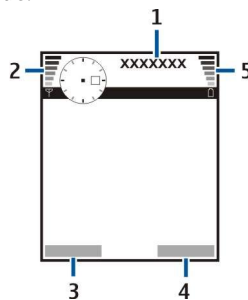

1 — Service provider

2 — Signal strength indicator

3 — Command for left selection key

4 — Command for right selection key

5 — Battery strength indicator

Shortcuts in standby mode

In the standby mode, you can use the following shortcuts. These shortcuts are usually not available in the active standby mode, where the joystick is used for normal scrolling.

To view the most recently dialed numbers, press the call key. Scroll to a number or name, and press the call key again to call the number.

To call your voice mailbox (network service), press and hold 1.

To view calendar information, scroll right.

To write and send text messages, scroll left.































To open the contacts list, press the joystick.

To change the profile, press the power key briefly, scroll to the profile you want, and press the joystick to activate the profile.

To open **Services** and connect to the Web, press 0.

To change these shortcuts, select **Menu > Tools > Settings > Phone > Standby mode**.

■ Display indicators

-  The device is being used in a GSM network. The bar next to the icon indicates the signal strength of the network at your current location. The higher the bar, the stronger the signal.
-  The device is being used in a UMTS network (network service). The bar next to the icon indicates the signal strength of the network at your current location. The higher the bar, the stronger the signal.
-  The battery charge level. The higher the bar, the stronger the charge in the battery.
-  You have one or more unread messages in the **Inbox** folder in **Messag.**
-  You have received new e-mail in the remote mailbox.
-  You have one or more missed phone calls.
-  An alarm is active.
-  You have selected the silent profile, and the device does not ring for an incoming call or message.
-  Bluetooth is activated.
-  An infrared connection is active. If the indicator blinks, your device is trying to connect to the other device, or the connection has been lost.
-  A GPRS or EGPRS packet data connection is available.
-  A GPRS or EGPRS packet data connection is active.
-  A GPRS or EGPRS packet data connection is on hold.
-  A UMTS packet data connection is available.
-  A UMTS packet data connection is active.
-  A UMTS packet data connection is on hold.
-  You have set the device to scan for wireless LANs, and a wireless LAN is available.
-  A wireless LAN connection is active in a network that does not have encryption.
-  A wireless LAN connection is active in a network that has encryption.
-  Your device is connected to a PC with a USB data cable.
-  A data call is active.
-  IP passthrough is active.
-  **1** and **2** Indicate the phone line that you have selected, if you have subscribed to two phone lines (network service).
-  All calls are forwarded to another number.
-  A headset is connected to the device.
-  The connection to a headset with Bluetooth connectivity has been lost.
-  A hands-free car kit is connected to the device.
-  A loopset is connected to the device.
-  A **Text phone** is connected to the device.
-  Your device is synchronizing.
-  You have an ongoing push to talk connection.

■ Volume control



Warning: Do not hold the device near your ear when the loudspeaker is in use, because the volume may be extremely loud.

To adjust the volume during a call, press the volume keys.

To adjust the volume when using the loudspeaker, press the volume keys.

■ Write text

Traditional text input

abc is shown on the top right of the display when you are writing text using traditional text input.

Get started

ABC and **abc** indicate the selected case. **Abc** indicates that the first letter of the sentence is written in uppercase and all the other letters will automatically be written in lowercase. **123** indicates number mode.

- Press a number key **1–9** repeatedly until the desired character appears. There are more characters available for a number key than are printed on the key.
- To insert a number, press and hold the number key.
- To switch between letter and number mode, press and hold **#**.
- If the next letter is located on the same key as the present one, wait until the cursor appears, and enter the letter.
- To erase a character, press the clear key. Press and hold the clear key to clear more than one character.
- To access the most common punctuation marks, press the **1** key. Press **1** repeatedly to reach the desired punctuation mark. Press ***** to open a list of special characters. Use the joystick to move through the list, and select a character.
- To insert a space, press **0**. To move the cursor to the next line, press **0** three times.
- To switch between the different character cases, press **#**.

Predictive text input

1. To activate predictive text input, press the edit key, and select **Predictive text on**. This activates predictive text input for all editors in the device. The indicator  is shown on the top right of the display when you are writing text using predictive text input.
2. To write the desired word, press **2–9**. Press each key only once for one letter.
3. When you have finished writing the word and it is correct, to confirm it, scroll right, or press **0** to add a space.
If the word is not correct, press ***** repeatedly to view the matching words the dictionary has found one by one.
If the **?** character is shown after the word, the word you intended to write is not in the dictionary. To add a word to the dictionary, select **Spell**, enter the word (up to 32 letters) using traditional text input, and select **OK**. The word is added to the dictionary. When the dictionary is full, a new word replaces the oldest added word.
4. Start writing the next word.

 **Tip:** To set predictive text input on or off, press **#** twice quickly.

Write the first half of a compound word; to confirm it, scroll right. Write the last part of the compound word. To complete the compound word, press **0** to add a space.

To turn predictive text input off for all editors in the device, press the edit key, and select **Predictive text > Off**.

Copy text to the clipboard

1. To select letters and words, press and hold the edit key. At the same time, scroll in the direction necessary to highlight the word, phrase, or line of text you want to copy. As the selection moves, the text is highlighted.
2. To copy the text to the clipboard, while still holding the edit key, select **Copy**. To insert the text into a document, press and hold the edit key, and select **Paste**.

■ Change writing language

If you are writing text, for example a note or a message, you can change the writing language. When you are writing and press a key several times to reach a specific character, changing the writing language gives you access to a different characters.

For example, if you are writing text using a non-Latin alphabet and want to write Latin characters for Web addresses, select **Options > Writing language** and the writing language to have access to a language that uses Latin characters.

■ Memory

There are two types of memory into which you can save data or install applications: device memory and removable memory.

Removable memory

Removable memory is data storage that is not built into your device, such as a SIM card or a memory card. A SIM card stores different information, such as information about the network operator and contacts. A memory card serves as external storage media for software applications, pictures, music, contacts, text, or any other form of electronic data. High-capacity memory cards are available.

Device memory

Memory that is built into your device is a dynamic memory pool shared by many applications. The amount of internal memory available varies but cannot be increased past the maximum factory setting. Data stored on the device, such as software applications, pictures, and music, consume on-device memory.

Monitor device memory

Select **Menu** > **Options** > **Memory details**.

You can see how much memory is currently in use, how much free memory remains, and how much memory is consumed by each data type. For example, you can see how much memory your e-mail messages, text documents, or calendar appointments consume.

To switch between device memory and memory card statistics, select **Memory details** > **Phone mem.** or **Memory details** > **Memory card**.



Tip: To ensure that you have adequate memory, you should regularly delete or transfer data to a memory card or PC.

Memory card

Your Nokia device supports the FAT12, FAT16, and FAT32 file systems for memory cards. If you format a memory card in your Nokia device, all data in the memory card is permanently deleted, and the file system will become FAT16.

It is recommended to back up device memory regularly to the memory card. The information can be restored to your device later. To back up information from device memory to a memory card, select **Menu** > **Tools** > **Memory card** > **Options** > **Backup phone mem.** To restore information from the memory card to the device memory, select **Menu** > **Tools** > **Memory card** > **Options** > **Restore from card**.

Do not remove a memory card when the card is being accessed. Removing the card in the middle of an operation may damage the memory card as well as the device, and data stored on the card may be corrupted.

If you cannot use a memory card in your device, you may have the wrong type of memory card, the card may not be formatted for your device, or the card has a corrupted file system.



Tip: You can install and remove a memory card without removing the battery or powering off the device.

RS-MMC

This device uses a reduced-size, dual-voltage (1.8/3.0V) MultiMediaCard (MMC).

To ensure interoperability, use only dual-voltage multimedia cards. Check the compatibility of a multimedia card with its manufacturer or provider. Use only compatible multimedia cards with this device. Other memory cards, such as full-size MMC or Secure Digital (SD) cards, do not fit in the MMC slot and are not compatible with this device. Using an incompatible memory card may damage the memory card as well as the device, and data stored on the incompatible card may be corrupted. Keep all memory cards out of the reach of small children.

Use a memory card

Select **Menu** > **Tools** > **Memory card** > **Options**, and from the following:

- **Remove mem. card** — Eject the memory card safely.
- **Backup phone mem.** — Back up important information such as your calendar entries or contacts to your memory card.
- **Restore from card** — Restore the backup from the memory card to your device.
- **Format mem. card** — Format a memory card for your device.
- **Memory card name** — Change the name of the memory card.
- **Set password** — Create a password for the memory card.
- **Memory details** — Monitor the memory consumption of applications and data.

Format a memory card

When a memory card is formatted, all data on the card is lost permanently. Consult your retailer to find out if you must format the memory card before you can use it. To format a memory card, select **Options** > **Format mem. card**. When formatting is complete, enter a name for the memory card.

Memory card security

You can protect a memory card with a password to prevent unauthorized access. To set a password, select **Options** > **Set password**. The password can be up to eight characters long and is case-sensitive. The password is stored in your device. You do not need to enter it again while you use the memory card on the same device. If you use the memory card on another device, you are asked for the password. Not all memory cards support password protection.

To remove the memory card password, select **Options** > **Remove password**. When you remove the password, the data on the memory card is not protected against unauthorized use.

Unlock a memory card

To open a locked memory card, select **Options** > **Unlock memory card**. Enter the password.

■ CD-ROM

The sales package CD-ROM is compatible with Windows 98SE, Windows ME, Windows 2000, and Windows XP. You can install Nokia PC Suite from the CD-ROM. Nokia PC Suite can be used only with Windows 2000 and Windows XP.

■ Nokia support and contact information

Check www.nokia.com/support or your local Nokia Web site for the latest version of this guide, additional information, downloads, and services related to your Nokia product.

On the Web site, you can get information on the use of Nokia products and services. If you need to contact customer service, check the list of local Nokia contact centers at www.nokia.com/customerservice.

For maintenance services, check your nearest Nokia service center at www.nokia.com/repair.

■ Transfer content between devices

You can transfer content, such as contacts, from a compatible Nokia device to your Nokia E60 using Bluetooth connectivity or infrared. The type of content that can be transferred depends on the phone model. If the other device supports synchronization, you can also synchronize data between the other device and your Nokia E60.

Transfer data with Bluetooth or infrared

To start transferring data from a compatible device, select **Menu > Tools > Transfer**.

Bluetooth connectivity

1. In the information view, select **Continue**.
2. Select **Via Bluetooth**. Both devices must support the selected connection type.
3. Activate Bluetooth in your other device, and select **Continue** in your Nokia E60 to start searching for devices with active Bluetooth connectivity.
4. Select **Stop** in your Nokia E60 after it has found your other device.
5. Select your other device from the list. You are asked to enter a passcode (1 to 16 digits) on your Nokia E60. The passcode is used only once to confirm this connection.
6. Enter the code on your Nokia E60, and select **OK**. Enter the passcode on your other device, and select **OK**. The devices are now paired. [See "Pair devices," p. 45.](#)

For some phone models, the **Transfer data** application is sent to your other device as a message. To install **Transfer data** on your other device, open the message, and follow the instructions on the display.

7. From your Nokia E60, select the content you want to transfer from your other device, and **OK**.

Infrared connectivity

1. In the information view, select **Continue**.
2. Select **Via infrared**. Both devices must support the selected connection type.
3. Connect the two devices. [See "Infrared," p. 46.](#)
4. From your Nokia E60, select the content you want to transfer from your other device, and **OK**.

Content is copied from the memory of the other device to the corresponding location in your device. Copying time depends on the amount of data to be transferred. You can also cancel and continue later.

The necessary steps for data transfer may vary depending on your device, and whether you have interrupted data transfer earlier. The items that you can transfer vary depending on the other device.

Synchronize data with another device

If you have previously transferred data to your Nokia E60, and your other device supports synchronization, you can use **Transfer** to keep the data of the two devices up to date.

1. Select **Phones**, and press the joystick.
2. Scroll to the device from which you transferred data, and press the joystick.
3. Select **Synchronise**, and press the joystick. The devices start synchronizing using the same connection type that you selected when you originally transferred data. Only the data that you originally selected for data transfer is synchronized.

To modify the data transfer and synchronization settings, select **Synchronise**, scroll to a device, press the joystick, and select **Edit**.

2. Your device

When you switch the device on, it may recognize the SIM card provider and configure the correct text message, multimedia message, and GPRS settings automatically. You may also receive the settings as a special text message from your service provider.

■ Menu

The **Menu** is a starting point from which you can open all applications in the device or on a memory card. The **Menu** contains applications and folders, which are groups of similar applications. Use the joystick to scroll up and down on the screen.

Applications that you install are saved in the **Installat.** folder by default.

To open an application, scroll to it, and press the joystick.

To view the applications in a list, select **Options > Change view > List**. To return back to the grid view, select **Options > Change view > Grid**.

To view the memory consumption of different applications and data stored on the device or memory card and to check the amount of free memory, select **Options > Memory details** and the memory.

To rearrange the folder, scroll to the application you want to move, and select **Options > Move**. A check mark is placed beside the application. Scroll to a new location, and select **OK**.

To move an application to a different folder, scroll to the application you want to move to another folder, and select **Options > Move to folder**, the new folder, and **OK**.

To download applications from the Web, select **Options > App. downloads**.

To create a new folder, select **Options > New folder**. You cannot create folders inside folders.

To rename a new folder, select **Options > Rename**.



Tip: To switch between several open applications, press and hold the menu key. The application-switching window opens and displays the open applications. Scroll to an application, and press the joystick to switch to it.

■ Help and tutorial

You can find answers to your questions while using the device even with no user guide present, because your device includes both a task-specific help and a tutorial.



Tip: Task-specific means you can access instructions from **Options** lists.

Device help

You can access the device help from an open application or from the **Menu**. When you have an application open, select **Options > Help** to read instructions for the current view.

To open help from **Menu**, select **Help > Help**. In **Help**, you can select categories for which you want to see instructions. Scroll to a category, such as Messaging, and press the joystick to see what instructions (help topics) are available. While you are reading the topic, scroll left or right to see the other topics in that category.

When you are reading the instructions, press and hold the menu key to switch between help and the application that is open in the background.

Tutorial

The tutorial provides you information about your device and shows you how to use it.

To access the tutorial in the menu, select **Menu > Help**, open **Tutorial** and the section you want to view.

■ Scroll and make selections

Use the joystick to move and make selections. With the joystick, you can move up, down, left and right in the **Menu** or in different applications or lists. You can also press the joystick to open applications, files, or edit settings.

To select text, press and hold the edit key, and scroll left or right until you have selected the text.

To select different items, such as messages, files, or contacts, scroll up, down, left or right to highlight the item you want to select. Select **Options > Mark/Unmark > Mark** to select one item or **Options > Mark/Unmark > Mark all** to select all items.



Tip: To select almost all items, first select **Options > Mark/Unmark > Mark all**, then select the items you do not want, and **Options > Mark/Unmark > Unmark**.

Your device

To select an object (for example, an attachment in a document) scroll to the object so that square markers appear on each side of the object.

■ Common actions in several applications

You can find the following actions in several applications:

To switch between open applications, press and hold the menu key to see a list of open applications. Select an application.

To change the profile or switch off or lock the device, press the power key briefly.

To save a file, select **Options** > **Save**. There are different save options depending on the application you use.

To send a file, select **Options** > **Send**. You can send a file in an e-mail or multimedia message, or using infrared or Bluetooth.

To print to a compatible printer, select **Options** > **Print**. You can preview items that you want to print, or edit the way printed pages look. Before you can print, you must define a compatible printer to your device. [See "Print," p. 66.](#)

To copy, press the edit key, and select the text with the joystick. Press and hold the edit key, and select **Copy**. To paste, scroll to where you want to paste the text, press and hold the edit key, and select **Paste**. This method may not work in applications such as **Documents** that have their own copy and paste commands.

To delete a file, press the clear key, or select **Options** > **Delete**.

To insert characters such as question marks or parentheses to text, press *.

3. Make calls

When the device is locked, calls still may be possible to the official emergency number programmed into your device.

In the offline profile, you may need to enter the lock code and change the device to a calling profile before making any call, including a call to an emergency number.

To make and receive calls, the device must be switched on, the device must have a valid SIM card installed, and you must be located in a service area of the cellular network. The GPRS connection is put on hold during voice calls unless the network supports dual transfer mode or you have a USIM card and are within the coverage of a UMTS network.

Enter the phone number, including the area code, and press the call key. If you enter an incorrect character, press the clear key.



Tip: For international calls, press the * key twice to add the + character that replaces the international access code, and enter the country code, area code (omit the leading 0, if necessary), and phone number.

To end the call or cancel the call attempt, press the end key.

To make a call using the saved contacts, press **Contacts** in standby mode. Enter the first letters of the name, scroll to the name, and press the call key. [See "Contacts," p. 26.](#)

Press the call key to view up to 20 numbers that you last called or attempted to call. Scroll to the desired number or name, and press the call key to dial the number. [See "Log," p. 21.](#)

Use the volume keys to adjust the volume of an active call.

To call your voice mailbox (network service) in standby mode, press and hold **1**, or press **1** then the call key.

■ Speed dial

Speed dialing allows you to make a call by pressing and holding a number key.

Before using speed dialing, select **Menu > Tools > Settings > Call > Speed dialing > On.**

To assign a number key to a phone number, select **Menu > Tools > Speed dial.** Scroll to the number key (2 - 9) on the screen, and select **Options > Assign.** Select the desired number from the **Contacts** directory.

To remove the phone number assigned to a number key, scroll to the speed dialing key, and select **Options > Remove.**

To change a phone number assigned to a number key, scroll to the speed dialing key, and select **Options > Change.**

■ Answer a call



Note: The actual invoice for calls and services from your service provider may vary, depending on network features, rounding off for billing, taxes, and so forth.

To answer a call, press the call key.

To reject the call, press the end key.

To mute a ringing tone instead of answering a call, select **Silence.**

To answer a new call during a call when the **Call waiting** function is activated, press the call key. The first call is put on hold. To end the active call, press the end key.

■ Options during a call

Select **Options** for the following options during a call:

- **Mute** — Listen to the active conversation, but your voice cannot be heard by the other parties of the call.
- **Unmute** — Your voice can be heard again by the other parties of the call.
- **Drop** — Drop a party from the active call.
- **End active call** — End the currently active call.
- **Menu** — View the applications menu of your device.
- **Hold** — Place the active call on hold.
- **Unhold** — Remove the active call from hold.
- **New call** — Place a new call while on a call, if conference calling (network service) is available.
- **Answer** — Answer an incoming call while on a call, if **Call waiting** is activated.
- **Reject** — Reject an incoming call while on a call, if **Call waiting** is activated.
- **Lock keypad** — Lock the device keypad while on a call.
- **Conference** — Merge an active and a held call into a conference call (network service).
- **Private** — Converse privately with a selected participant during a conference call (network service).
- **Swap** — Alternate between an active and a held call (network service).

Make calls

- **Send DTMF** — Send DTMF (dual tone multi-frequency) tone strings, for example, passwords. Enter the DTMF string or search for it in **Contacts**, and select **DTMF**.
- **Transfer** — Connect the held call to the active call and disconnect yourself from the call (network service).

The available options may vary.

■ Divert calls

Select **Menu** > **Tools** > **Settings** > **Call divert**.

Divert incoming calls to your voice mailbox or to another phone number. For details, contact your service provider.

1. Select a call type from the following:
 - **Voice calls** — Incoming voice calls.
 - **Data and video calls** — Incoming data and video calls.
 - **Fax calls** — Incoming fax calls.
2. Select one of the following call diverting options:
 - **All voice calls, All data and vid. calls, or All fax calls.** — Divert all incoming voice, data and video, or fax calls.
 - **If busy** — Divert incoming calls when you have an active call.
 - **If not answered** — Divert incoming calls after your device rings for a specified period of time. Define the time you let the device ring before diverting the call in the **Delay time:** field.
 - **If out of reach** — Divert calls when the device is switched off or out of network coverage.
 - **If not available** — Activate the last three settings at the same time. This option diverts calls if your device is busy, not answered, or out of reach.
3. Select **Activate**.

To check the current diverting status, scroll to the diverting option, and select **Options** > **Check status**.

To stop diverting voice calls, scroll to the diverting option, and select **Options** > **Cancel**.

■ Call barring

Call barring and call diverting cannot be active at the same time.

When calls are barred, calls still may be possible to certain official emergency numbers.

Select **Menu** > **Tools** > **Settings** > **Call barring**.

You can bar the calls that can be made or received with the device (network service). To change the settings, you need the barring password from your service provider. Call barring affects all calls, including data calls.

To bar calls, select **Cellular call barring** and select from the following options:

- **Outgoing calls** — Prevent making voice calls with your device.
- **Incoming calls** — Bar incoming calls.
- **International calls** — Prevent calling to foreign countries or regions.
- **Incoming if abroad** — Bar incoming calls when outside your home country.
- **Intern. except home** — Prevent calls to foreign countries or regions, but to allow calls to your home country.

To check the status of voice call barrings, scroll to the barring option, and select **Options** > **Check status**.

To stop all voice call barrings, scroll to a barring option, and select **Options** > **Cancel all barrings**.

Net call barring

To bar net calls, select **Menu** > **Tools** > **Settings** > **Call barring** > **Internet call barring**.

To reject net calls from anonymous callers, select **Anonymous calls** > **On**.

■ Send DTMF tones

You can send dual tone multi-frequency (DTMF) tones during an active call to control your voice mailbox or other automated phone services.

To send a DTMF tone sequence, make a call, and wait until the other end answers. Select **Menu** > **Options** > **Send DTMF**. Type the DTMF tone sequence, or select a predefined sequence.

To attach DTMF tone sequences to contact cards, select **Menu** > **Contacts**. Open a contact, and select **Options** > **Edit** > **Options** > **Add detail** > **DTMF**. Enter the tone sequence. Press * three times to insert **p**, a pause of about 2 seconds before or between DTMF tones. Select **Done**. To set the device to send the DTMF tones only after you select **Send DTMF** during a call, press * four times to insert **w**.

Make calls

■ Video calls

To be able to make a video call, you must be within the coverage of a UMTS network. For availability of and subscription to video call services, contact your network operator or service provider. While talking, you can send a still image to the recipient's compatible mobile phone and see a real-time video sent by the recipient, if the recipient has a compatible mobile phone with a video camera. A video call can only be made between two parties.



Warning: Do not hold the device near your ear when the loudspeaker is in use, because the volume may be extremely loud.

Select the still image to be sent in **Tools > Settings > Call settings > Image in video call**.

To make a video call, enter the phone number or select the recipient of the call from **Contacts**, and select **Options > Call > Video call**. You cannot convert the video call to a normal voice call.

During the call, select **Options** and from the following:

- **Audio** — Talk to the recipient of the call.
- **Use video** — See video without audio.
- **Loudsp.** — Select to use the loudspeaker for receiving audio.
- **Handset** — Mute the loudspeaker and use the handset.

■ Log

Select **Menu > Log**.

In the **Log**, you can view information about the communication history of the device.

To view the logs for recent voice calls, their approximate duration, and packed data connections, select **Recent calls**, **Call duration**, or **Packet data**; and press the joystick.

To sort the events by type or direction, scroll right to open the general log, and select **Options > Filter**. Scroll to a filter type, and press the joystick. Select the type or direction, and press the joystick.

To set the time how long all communication events are held in the log, select **Options > Settings > Log duration**, an option, and **OK**.

To clear missed and received calls and dialed numbers, select **Recent calls > Options > Clear recent calls**.

To reply to a caller with a message, select **Recent calls > Missed calls > Options > Create message**. You can send text messages and multimedia messages.

To add the caller or the sender of a message to **Contacts**, select the caller or sender of a message, and select **Recent calls > Missed calls > Options > Add to Contacts**.

To view the amount of data sent or received using GPRS, select **Packet data**.

To clear the GPRS counters, select **Options > Clear counters**. Enter your lock code, and select **OK**.

Log settings

To set the time for keeping all communication events in the **Log**, select **Options > Settings > Log duration**, an option from the list, and **OK**.

To see the call duration during the call, select **Options > Settings > Show call duration > Yes**.

■ Push to talk

Select **Menu > Connect > PTT**.

Push to talk (PTT) (network service) provides direct voice communication connected with the push of a key. With push to talk, you can use your device as you would use a walkie-talkie.

You can use push to talk to have a conversation with one person or with a group of people, or to join a channel. A channel is like a chat room: you can call the channel to see if anyone is online. The channel call does not alert the other participants; the participants just join the channel and start speaking with each other.

In push to talk communication, one person talks while the other participants listen through the built-in loudspeaker. Participants take turns responding to each other. Because only one participant can talk at a time, the maximum duration of a speech turn is limited. For details of the speech turn duration for your network, contact your network operator or service provider.

Remember to hold the device in front of you during a push to talk call so you can see the display. Speak towards the microphone, and do not cover the loudspeaker with your hands.

Phone calls always take priority over push to talk.

Before you can use push to talk, you must define the push to talk access point and push to talk settings. You may receive the settings in a special text message from the service provider that offers the push to talk service.

Make calls

User settings

Select **Options** > **Settings** > **User settings**.

Define the following:

- **Incoming PTT calls** — Select **Notify** if you want to see a notification of incoming calls. Select **Auto-accept** if you want push to talk calls to be answered automatically. Select **Not allowed** if you want push to talk calls to be rejected automatically.
- **PTT call alert tone** — Select **Set by profile** if you want the incoming call alert setting for push to talk to follow your profile settings. If your profile is silent, you are not available to others using push to talk, except for callback requests.
- **Callback request tone** — Define the ringing tone for callback requests.
- **Application start-up** — Select if you want to log in to the push to talk service when you switch on your device.
- **Default nickname** — Enter your default nickname (20 characters maximum) that is displayed to other users.
- **Show my PTT address** — Define if you want callers to see your push to talk address. You can let all callers see the address, show the address only to one-to-one callers or channel participants, or hide the address from all callers.
- **Show my login status** — Define whether your login to the push to talk server is shown or hidden from other users.

Connection settings

Select **Options** > **Settings** > **Connection settings**.

Define the following:

- **Domain** — Enter the domain name obtained from your service provider.
- **Access point name** — Select the push to talk access point.
- **Server address** — Enter the IP address or domain name of the push to talk server obtained from your service provider.
- **User name** — Enter your user name obtained from your service provider.
- **Password** — Enter a password, if required, to log into the push to talk service. The password is provided by the service provider.

Log in to push to talk service

If you have set **Application start-up** on in **User settings**, push to talk automatically logs in to the service when started. If not, you must log in manually.

To log in to a push to talk service, select **Options** > **Settings** > **Connection settings**, and enter your **User name**, **Password**, **Domain**, **Server address**, and **Access point name**. Select **Options** > **Switch PTT on**.

When the **Ringing type** setting of your device is set to **Beep once** or **Silent**, or there is an ongoing phone call, you cannot make or receive push to talk calls.

Push to talk calls



Warning: Do not hold the device near your ear when the loudspeaker is in use, because the volume may be extremely loud.

Select **Options** > **PTT contacts**.

To make a push to talk call, select one or several contacts from the list, and press the voice key. Remember to hold the device in front of you during a push to talk call so you can see the display. The display informs you when it is your turn to speak. Speak towards the microphone, and do not cover the loudspeaker with your hands. Press and hold the voice key the entire time you are talking. When you have finished talking, release the key.

To end the push to talk call, press the end key.

When you receive a push to talk call, press the call key to answer the call or the end key to dismiss the call.

Callback requests

To send a callback request, select **Options** > **PTT contacts**, scroll to the desired contact, and select **Options** > **Send callback request**.

To answer a callback request, select **Show** to open the callback request. To make a push to talk call to the sender, press the voice key.

Contacts view

To view, add, modify, delete, or call contacts, select **Options** > **PTT contacts**. A list of names from your device **Contacts** application is displayed with information about their login status.

To call a selected contact, select **Options** > **Talk 1 to 1**. To make a group call, select **Options** > **Make PTT group call**.

To send the contact a request to call you, select **Options** > **Send callback request**.

Create a channel

A channel is like a chat room: you can call the channel to see if anyone is online. The channel call does not alert the other participants; the participants just join the channel and start speaking with each other.

Make calls

To create a channel, select [Options](#) > [New channel](#) > [Create new](#).

Select [Options](#) and define the following:

- **Channel name** — Write the channel name.
- **Channel privacy** — Select [Private](#) or [Public](#).
- **Nickname in channel** — Enter your nickname (20 characters maximum) that is displayed to other users.
- **Channel thumbnail** — Insert a picture that describes the channel.

To delete a channel, press the clear key.

When you log in to push to talk, push to talk automatically connects to the channels that were active when the application was last closed.

Register PTT channels

To register a channel to the push to talk service, select [Options](#) > [Register](#).

To edit the channel details, select [Options](#) > [Edit](#).

Join a channel

To join a channel, select [Options](#) > [PTT channels](#). Select the channel you want to talk to, and press the voice key. Remember to hold the device in front of you during a push to talk call so you can see the display. The display informs you when it is your turn to speak. Speak towards the microphone, and do not cover the loudspeaker with your hands. Press and hold the voice key the entire time you are talking. When you have finished talking, release the key.

To switch between channels during multiple calls, select [Swap](#). The active channel is highlighted.

To view the currently active participants in the channel, select [Options](#) > [Active members](#).

To invite a participant to a channel, select [Options](#) > [Send invitation](#).

Push to talk log

To open the push to talk log, select [Options](#) > [PTT log](#). The log shows the date, time, duration, and other details of your push to talk calls.



Tip: To initiate a one-to-one call from [PTT log](#), select the desired log event and press the voice key.

Exit push to talk

Select [Options](#) > [Exit](#). Select [Yes](#) to log out and close the service. Press [No](#) if you want to keep the application active on the background.

■ Net calls

Your device supports voice calls over the Internet (Internet calls). Your device attempts emergency calls primarily over cellular networks. If an emergency call using cellular networks is not successful, then your device attempts an emergency call through your Internet call provider. Due to the established nature of cellular telephony, you should use cellular networks for emergency calls, if possible. If you have cellular network coverage available, please make sure that your cellular phone is switched on and ready to make calls before you attempt an emergency call. The capability for an emergency call using Internet telephony depends on the availability of a WLAN network and your Internet call provider's implementation of emergency call capabilities. Contact your Internet call provider to check the Internet telephony emergency call capability.

VoIP (voice over Internet protocol) technology is a set of protocols that facilitate phone calls over an IP network, such as the Internet. VoIP phone calls can be established between computers, between mobile phones, and between a VoIP device and a traditional telephone. To make or receive a VoIP call, your device must be within WLAN coverage, for example.

Before you can make net calls, you need to create a net telephone profile. When the profile is ready, you can make a net call from all applications where you can create a regular voice call. To make a net call to an address that does not start with a digit, press any number key when the device is in standby mode, then press # for a few seconds to clear the display and to switch the device from number mode to letter mode. Write the address and press the call key.

You must define session initiation protocols (SIP) settings in [Menu](#) > [Tools](#) > [Settings](#) > [Connection](#) > [SIP settings](#) and VoIP settings in [Menu](#) > [Tools](#) > [Settings](#) > [Connection](#) > [Internet tel. settings](#). Contact your service provider for more information and correct settings.

Preferred profile

Select [Menu](#) > [Connect](#) > [Internet tel.](#) to change settings.

Before you can select the default profile, you must create profiles in [Menu](#) > [Tools](#) > [Settings](#) > [Connection](#) > [Internet tel. settings](#).

Make calls

To select the profile that is used by default when you make net calls, select **Preferred profile**, and press the joystick. Scroll to the desired profile, and press the joystick.

Register profiles

Only those profiles where you have selected **Registration > When needed** setting in **Menu > Tools > Settings > Connection > SIP settings** are shown in the list.

To change the registration of your net telephone profiles, scroll to the profile that you want to register or unregister, and press the joystick. Press the joystick again to select **Registered** or **Not registered**.

To save your settings, select **Back**.

■ Device security

Select **Menu > Tools > Settings > Security > Phone and SIM**.

You can modify the security settings for the PIN code, automatic lock, and SIM card change, and change codes and passwords.

Avoid using codes that are similar to emergency numbers to prevent accidental dialing of the emergency number.

Codes are shown as asterisks. When you change a code, enter the current code, then the new code twice.

Define security settings

To define device and SIM card settings, select a setting and **Options > Change**.

When calls are limited to closed user groups, calls may be possible to the official emergency number programmed into your device.

Define the following settings:

- **PIN code request** — Select **On** to request that the PIN code is entered each time the device is switched on. This setting cannot be changed if the device is switched off. Some SIM cards do not allow turning off the PIN code request.
- **PIN code** — Change the PIN code. The PIN code must be 4 to 8 numbers long. The PIN code protects your SIM card against unauthorized use and is provided with the SIM card. After three consecutive incorrect PIN code entries, the PIN code is blocked, and you need to use the PUK code to unblock it before you can use the SIM card again.
- **PIN2 code** — Change the PIN2 code. The PIN2 code must be 4 to 8 numbers long. The PIN2 code is required to access some functions of the device and is provided with the SIM card. After three consecutive incorrect PIN2 code entries, the PIN2 code is blocked, and you need to use the PUK2 code to unblock it before you can use the SIM card again.
- **Autolock period** — Set a time-out after which the device is automatically locked and can be used only if the correct lock code is entered. Enter a number for the time-out in minutes, or select **None** to turn off the autolock period. When the device is locked, you can still answer incoming calls and calls may still be possible to the official emergency number programmed into your device.
- **Lock code** — The new code can be 4-255 characters long. Both alphabets and digits can be used, and both uppercase and lowercase alphabets are possible. The device notifies you if the lock code is not properly formatted.
- **Lock if SIM changed** — Set the device to ask for the lock code when an unknown, new SIM card is inserted into your device. The device maintains a list of SIM cards that are recognized as the owner's cards.
- **Allow remote lock** — If you set this option on, you can lock the device by sending a predefined text message from another phone. When you set this option on, you need to enter the remote lock message and confirm the message. The message must be at least 5 characters long.
- **Closed user group** (network service) — Specify a group of people to whom you can call and who can call you.
- **Confirm SIM services** (network service) — Set the device to display confirmation messages when you are using a SIM card service.

Change the barring password

To change the password used for barring voice, fax, and data calls, select **Menu > Tools > Settings > Call barring > Cellular call barring > Options > Edit barrings passw..** Enter the current code, then the new code twice. The barring password must be four digits long. For details, contact your service provider.

Fixed dialing

When fixed dialing is activated, calls may be possible to the official emergency number programmed into your device.

Select **Menu > Contacts > Options > SIM contacts > Fixed dialling contacts**.

With the fixed dialing service, you can restrict calls from your device to only certain phone numbers. Not all SIM cards support the fixed dialing service. Contact your service provider for more information.

Select **Options**, and select from the following options:

Make calls

- **Activ. fixed dialling** — Restrict calls from your device. To cancel the service, select **Deact. fixed dialling**. You need your PIN2 code to activate and deactivate fixed dialling or edit your fixed dialling contacts. Contact your service provider if you do not have the code.
- **New SIM contact** — Add a phone number to the list of numbers to which calls are allowed. Enter the contact name and phone number. To restrict calls by a country prefix, enter the country prefix in **New SIM contact**. All phone numbers to which calls are allowed must start with this country prefix.
- **Add from Contacts** — Copy a contact from **Contacts** to your fixed dialling list.



Tip: To send text messages to the SIM contacts while the fixed dialling service is active, you need to add the text message center number to the fixed dialling list.

To view or edit a phone number to which calls from your device are allowed, select **Options > SIM contacts > Fixed dialling contacts**.

To call the contact, press the call key.

To edit the phone number, select **Options > Edit**. You may need your PIN2 code to edit your fixed dialling numbers.

To delete the contact, press the clear key.

4. Contacts

Select **Menu** > **Contacts**.

Manage all of your contact information, such as phone numbers and addresses. Add a personal ringing tone, voice tag, or a thumbnail image to a contact. Send contact information to compatible devices or receive contact information as business cards from compatible devices, and add them to your own list of contacts.

To add a contact, select **Options** > **New contact**. Enter the contact information, and select **Done**.

To edit information in a contact card, scroll to the contact, and select **Options** > **Edit**. Select from the following options:

- **Add thumbnail** — Add a thumbnail image that will display when a contact calls you. The image must be previously saved to your device or memory card.
- **Remove thumbnail** — Remove the image from the contact card.
- **Add detail** — Add fields of information to a contact card, such as **Job title**.
- **Delete detail** — Delete any details that you added to a contact card.
- **Edit label** — Edit the field names of the contact card.

■ Manage contact groups

Create a contact group so that you can send text or e-mail messages to several recipients at the same time.

1. Scroll to the right, and select **Options** > **New group**.
2. Enter a name for the group or use the default name, and select **OK**.
3. Open the group, and select **Options** > **Add members**.
4. Scroll to each contact you want to add to the group, and press the joystick to mark it.
5. Select **OK** to add all marked contacts to the group.

The following options are available when you select **Options** in the contact groups view:

- **PTT options** — Make a push to talk call either to an individual or to a group, or send a callback request.
- **Open** — Open the contact group and view the group members.
- **Create message** — Send a message.
- **New group** — Create a new contact group.
- **Delete** — Delete a contact group.
- **Rename** — Rename the contact group.
- **Ringing tone** — Assign a ringing tone to a contact group.
- **Contacts info** — View the information for a contact group.
- **Settings** — Set the name display settings for contact group members.

To remove a contact from a contact group, open the contact group. Scroll to the contact you want to remove, and select **Options** > **Remove from group** > **Yes**.



Tip: To check the group in which a contact belongs, select **Menu** > **Contacts**. Scroll to the contact, and select **Options** > **Belongs to groups**.

To view or edit a contact within a contact group, open the contact group. Scroll to the contact you want to view or edit, and select **Options**. Select from the following options:

- **Open** — Opens the contact and displays contact information.
- **Call** — Select **Voice call** or **Video call**, and call the contact.
- **Create message** — Create and send a text message or multimedia message to the contact.
- **Remove from group** — Remove the contact from the contact group.
- **Belongs to groups** — View all contact groups that a contact belongs to.

■ Manage default information

Assign a default number or address to a contact so you can easily call or send a message to the default number or address, even if several numbers or addresses are saved to that contact.

To change default information for a contact, open the contact, and select **Options** > **Defaults**. Select the number or address you want to set as a default, and select **OK**.

The default number or address is underlined in the contact.

■ Copy contacts between SIM and device memory

For availability and information on using SIM card services, contact your SIM card vendor. This may be the service provider, network operator, or other vendor.

Contacts

To copy contacts from a SIM card to device memory, select **Options > SIM contacts > SIM directory** to open the SIM directory. Mark the contacts you want to copy, or select **Mark all** to copy all contacts. Select **Options > Copy to Contacts**.

To copy contacts from the device memory to a SIM card, select **Options > Copy to SIM direct..** Mark the contacts you want to copy, or select **Mark all** to copy all contacts. Select **Options > Copy to SIM direct..**

Select **Options > SIM contacts > SIM directory** to see the names and numbers stored on the SIM card. In SIM directory you can add, edit, or copy numbers to **Contacts**, and you can make calls.

■ Select ringing tones for contacts

Select a ringing tone for a contact or contact group. If the caller's phone number is sent with the call and your device recognizes the number, the ringing tone plays when the contact calls you.

To select a ringing tone for a contact or contacts group, open the contact or contact group, and select **Options > Ringing tone**. A list of ringing tones opens. Select the ringing tone you want to use, and select **OK**.

To remove the ringing tone, select **Default tone** from the list of ringing tones.

■ Business cards

Select **Menu > Contacts**.

You can send, receive, view, and save contact cards as business cards in vCard or Nokia Compact Business Card format.

You can send business cards to compatible devices using SMS, MMS, or e-mail, or an infrared or Bluetooth connection.

To send a business card, select the contact card from the contacts list, and select **Options > Send**. Select **Via text message, Via multimedia, Via e-mail, Via Bluetooth, or Via infrared**. Enter the phone number or address, or add a recipient from the contacts list. Select **Options > Send**. If you select SMS as the sending method, contact cards are sent without images.

To view a received business card, select **Open** from the displayed notification, or open the message from the inbox folder in **Messag..**

To save a business card, select **Options > Save business card** when the incoming message appears on the device.

To save a received business card, select **Options > Save business card**.

To delete a received business card, select **Options > Delete**.

5. Messages

Select **Menu** > **Message**.

Before sending or receiving messages, you may need to do the following:

- Insert a valid SIM card in the device and be located in a service area of the cellular network.
- Verify that the network supports the messaging features you want to use and that they are activated on your SIM card.
- Define Internet access point (IAP) settings on the device. See "[Access points](#)," p. 68.
- Define e-mail account settings on the device. See "[E-mail account settings](#)," p. 36.
- Define SMS settings on the device. See "[Text message settings](#)," p. 31.
- Define MMS settings on the device. See "[Multimedia message settings](#)," p. 33.

The device may recognize the SIM card provider and automatically configure some of the message settings. If not, you may need to define the settings manually, or contact your service provider, network operator, or Internet service provider to configure the settings.

The **Message** application displays each type of messaging folder in a list format with the newest message displayed first in each folder.

Select one of the following:

- **New message** — Create and send a new text, multimedia, or e-mail message.
- **Inbox** — View received messages, except e-mails and cell broadcast messages.
- **My folders** — Create your own folders to store messages and templates.
- **Mailbox** — View and reply to received e-mail.
- **Drafts** — Store messages that have not been sent.
- **Sent** — Store messages that have been sent.
- **Outbox** — View messages waiting to be sent.
- **Reports** — View information about the delivery of sent messages.

■ Organize messages

To create a new folder to organize your messages, select **My folders** > **Options** > **New folder**. Enter the folder name, and select **OK**.

To rename a folder, select the folder and **Options** > **Rename folder**. Enter the new folder name, and select **OK**. You can only rename folders that you have created.

To move a message to another folder, open the message, and select **Options** > **Move to folder**, the folder, and **OK**.

To sort messages in a specific order, select **Options** > **Sort by**. You can sort the messages by **Date**, **Sender**, **Subject**, or **Message type**.

To view the properties of a message, select the message and **Options** > **Message details**.

■ Search for messages

To search for a message, open the folder in which you want to search, select **Options** > **Find**. Enter the search term, and select **OK**.

■ Inbox

Select **Menu** > **Message** > **Inbox**.

To view a message, scroll to the message, and press the joystick.

To forward a sent or received message, open the message, and select **Options** > **Forward**. It may not be possible to forward some messages.

To reply to a received message, open the message, and select **Options** > **Reply**.

■ My folders

To view messages saved in your own folders or to use message templates, select **My folders**.

To view a message, scroll to it, and press the joystick.

To view, edit, create, or send message templates, select **Templates**, and press the joystick.

Select **Options** and from the following:

- **Create message** — Write and send a message.

Messages

- **Sort by** — Arrange your messages according to sender, type, or other info.
- **Move to folder** — Save a message in another folder. Scroll to the desired folder, and select **OK**.
- **New folder** — Create new folders.

The available options may vary.

To delete a message or folder, scroll to it, and press the clear key.

■ Draft messages

Messages that you have created, but not yet sent, are stored in the **Drafts** folder.

To view or edit a message, scroll to it, and press the joystick.

To send the message, select **Options** > **Send**.

To delete a message, scroll to it, and press the clear key.



Tip: To delete multiple messages, scroll to each message, and simultaneously press the edit key and joystick. A check mark appears next to these messages. Once you have marked the messages, press the clear key.

■ Sent messages

Your last 20 sent messages are automatically saved in the **Sent** folder. To change the number of saved messages, select **Message**, and select **Options** > **Settings** > **Other**.

Select **Options** and select from the following:

- **Create message** — Write and send a message.
- **Message details** — View information about the message.
- **Sort by** — Arrange your messages according to sender, type, or other info.
- **Move to folder** — Save a message in another folder. Scroll to the desired folder, and select **OK**.
- **New folder** — Create new folders.



Tip: To move multiple messages, scroll to each message, and simultaneously press the edit key and joystick to mark it. Once you have marked the desired messages, select **Options** > **Move to folder**.

The available options may vary.

To delete a message, scroll to it, and press the clear key.

■ Outbox

Select **Menu** > **Message** > **Outbox**.

To send a message from the **Outbox**, select the message, and **Options** > **Send**.

To cancel the sending of a message in the **Outbox**, select the message, and **Options** > **Defer sending**.

■ Delivery reports

To keep track of your text and multimedia messages after sending, select **Reports**.

You can receive or reject delivery reports in text message and multimedia message settings. Select **Options** > **Settings** > **Text msg**, or **Multimedia message** > **Receive report**.



Tip: To call a message recipient, scroll to the delivery report, and press the call key.

■ Messaging settings

Select **Options** > **Settings**.

To define or edit settings for different message types, select **Text message**, **Multimedia message**, **E-mail**, **Service message**, **Cell broadcast**, or **Other**.

See "[Text message settings](#)," p. 31.

See "[Multimedia message settings](#)," p. 33.

See "[E-mail account settings](#)," p. 36.

Other settings

Select **Menu** > **Message** > **Options** > **Settings** > **Other**.

Select from the following:

- **Save sent messages** — Select whether to store sent messages in the **Sent** folder.

Messages

- **No. of saved msgs.** — Enter the number of sent messages that you want to save. When the limit is reached, the oldest message is deleted.
- **Folder view** — Define how you want the messages in the inbox to be shown.
- **Memory in use** — Select where to save your received messages. You can save messages to memory card only if a memory card is inserted.

The settings available for editing may vary.

■ Text message center settings

Select **Options > Settings > Text msg. > Message centres**.

To edit message centers, select the message center, and **Options > Edit**.

To add new message centers, select **Options > New msg. centre**.

To delete message centers, select the message center, and press the clear key.

■ Text messages

Your device supports the sending of text messages beyond the character limit for a single message. Longer messages are sent as a series of two or more messages. Your service provider may charge accordingly. Characters that use accents or other marks, and characters from some language options like Chinese, take up more space limiting the number of characters that can be sent in a single message.

Write and send text messages

Select **Menu > Messag. > New message > Text message**.

1. In the **To** field, press the joystick to select recipients from **Contacts**, or enter the recipients' mobile phone numbers manually. If you enter more than one number, separate the numbers with a semicolon. To insert a semicolon, press *****.
2. Enter the text of the message. To use a template, select **Options > Insert > Template**.
3. Select **Options > Send** to send the message.



Note: When sending messages, your device may display Message Sent. This is an indication that the message has been sent by your device to the message center number programmed into your device. This is not an indication that the message has been received at the intended destination. For more details about messaging services, check with your service provider.

Sending options for text messages

To set sending options for the text message, select **Options > Sending options**.

Define the following:

- **Msg. centre in use** — Select a message center to send the message.
- **Character encoding** — Select **Reduced support** to use automatic character conversion to another encoding system when available.
- **Receive report** — Select **Yes** if you want that the network sends you delivery reports on your messages (network service).
- **Message validity** — Select how long the message center resends your message if the first attempt fails (network service). If the recipient cannot be reached within the validity period, the message is deleted from the message center.
- **Message sent as** — Convert the message to another format, such as **Text, Fax, Paging** or **E-mail**. Change this option only if you are sure that your message center is able to convert text messages into these other formats. Contact your network operator.
- **Reply via same ctr.** — Select whether you want the reply message to be sent using the same text message center number (network service).

Reply to received text messages

To reply to a text message, open the message from the **Inbox**. Select **Options > Reply**. Enter the text of the message, and select **Options > Send**.

To call the sender of a text message, open the message from the **Inbox**, and select **Options > Call**.

Text messages on the SIM card

Text messages may be stored on your SIM card. Before you can view SIM messages, you must copy the messages to a folder in the device. After copying the messages to a folder, you can view them in the folder or delete them from the SIM card.

Select **Options > SIM messages**.

1. Select **Options > Mark/Unmark > Mark** or **Mark all** to mark every message.
2. Select **Options > Copy**.
3. Select a folder and **OK** to begin copying.

Messages

To view SIM card messages, open the folder where you copied the messages, and open a message.

To delete a text message from the SIM card, select the message, and press the clear key.

Text message settings

Select **Options** > **Settings** > **Text msg.**

Define the following:

- **Message centres** — View the available message centers for your device.
- **Msg. centre in use** — Select a message center to send the message.
- **Character encoding** — Select **Reduced support** to use automatic character conversion to another encoding system when available.
- **Receive report** — Select **Yes** if you want that the network sends you delivery reports on your messages (network service).
- **Message validity** — Select how long the message center resends your message if the first attempt fails (network service). If the recipient cannot be reached within the validity period, the message is deleted from the message center.
- **Message sent as** — Convert the message to another format, such as **Text, Fax, Paging** or **E-mail**. Change this option only if you are sure that your message center is able to convert text messages into these other formats. Contact your network operator.
- **Preferred conn.** — Select the preferred method of connection when sending text messages from your device.
- **Reply via same ctr.** — Select whether you want the reply message to be sent using the same text message center number (network service).

Picture messages



Note: Picture message function can be used only if it is supported by your network operator or service provider. Only devices that offer picture message features can receive and display picture messages.

Select **Menu** > **Message**.

To view a picture message, open the message from the **Inbox** folder.

Select **Options** and select from the following:

- **Message details** — View information about the message.
- **Move to folder** — Save the message in a different folder.
- **Add to Contacts** — Add the sender of the message to your contacts.
- **Find** — Find phone numbers and addresses that the message may contain.

Forward picture messages

Copyright protections may prevent some images, ringing tones, and other content from being copied, modified, transferred or forwarded.

1. In the **Inbox**, open a picture message and select **Options** > **Forward**.
2. In the **To** field, enter a recipient's number, or press the joystick to add a recipient from **Contacts**. If you enter more than one number, separate the numbers with a semicolon. To insert a semicolon, press *.
3. Enter the text of your message. The text can have 120 characters. To use a template, select **Options** > **Insert** > **Template**.
4. To send the message, press the call key.



Tip: To remove the picture from the message, select **Options** > **Remove picture**.

Multimedia messages

A multimedia message (MMS) can contain text and objects such as images, sound clips, or video clips.



Note: Only devices that have compatible features can receive and display multimedia messages. The appearance of a message may vary depending on the receiving device.

Before you can send or receive multimedia messages on your device, you must define the multimedia message settings. Your device may have recognized the SIM card provider and automatically configured the multimedia message settings. If not, contact your service provider. See "[Multimedia message settings](#)," p. 33.

Create and send multimedia messages

The default setting of the multimedia message service is generally on.

Select **New message** > **Multimedia message**.

Copyright protections may prevent some images, ringing tones, and other content from being copied, modified, transferred or forwarded.

1. In the **To** field, press the joystick to select recipients from **Contacts**, or enter the recipients' mobile phone numbers or e-mail addresses manually.

Messages

2. In the **Subject** field, enter a subject for the message. To change the fields that are visible, select **Options > Address fields**.
3. Enter the text of the message, and select **Options > Insert object** to add media objects. You can add objects such as **Image**, **Sound clip**, or **Video clip**.

The wireless network may limit the size of MMS messages. If the inserted picture exceeds this limit, the device may make it smaller so that it can be sent by MMS.

4. Each slide of your message can contain only one video or audio clip. To add more slides to your message, select **Options > Insert new > Slide**. To change the order of slides in your message, select **Options > Move**.
5. To preview a multimedia message before sending it, select **Options > Preview**.
6. Press the joystick to send the multimedia message.



Tip: You can also create multimedia messages directly from several applications, such as **Contacts** and **Gallery**.

To delete an object from a multimedia message, select **Options > Remove**.

Sending options for multimedia messages

Select **Options > Sending options** and from the following options:

- **Receive report** — Select **Yes** if you want to receive a notification when the message has been successfully delivered to the recipient. Receiving a delivery report of a multimedia message that has been sent to an e-mail address may not be possible.
- **Message validity** — Select how long the messaging center tries to send the message. If the recipient of a message cannot be reached within the validity period, the message is removed from the multimedia messaging center. The network must support this feature. **Maximum time** is the maximum amount of time allowed by the network.

Create presentations

Select **New message > Multimedia message**.

1. In the **To** field, press the joystick to select recipients from **Contacts**, or enter the recipients' mobile phone numbers or e-mail addresses manually.
2. Select **Options > Create presentation** and a presentation template.



Tip: A template may define which media objects you can include in the presentation, where they appear, and which effects are displayed between images and slides.

3. Scroll to a text area and enter the text.
4. To insert images, sound, video, or notes in your presentation, scroll to the corresponding object area, and select **Options > Insert**.



Tip: To move between object areas, scroll up and down.

5. To add slides, select **Insert > New slide**.
6. Select **Options** and from the following:
 - **Preview** — See what your multimedia presentation looks like when it is opened. Multimedia presentations may only be viewed in compatible devices that support presentations. They may appear different in different devices.
 - **Backgrnd. settings** — Select the background color for the presentation and background images for different slides.
 - **Effect settings** — Select effects between images or slides.

Creating multimedia presentations is not possible if **MMS creation mode** is **Restricted**. To change **MMS creation mode**, select **Message. > Options > Settings > Multimedia message**.

The available options may vary.

To send your multimedia presentation, press the call key.



Tip: To save the message in **Drafts** without sending it, select **Done**.

Receive and reply to multimedia messages



Important: Multimedia message objects may contain viruses or otherwise be harmful to your device or PC. Do not open any attachment if you are not sure of the trustworthiness of the sender.

Before you can send or receive multimedia messages on your device, you must define the multimedia message settings. Your device may have recognized the SIM card provider and automatically configured the multimedia message settings. If not, contact your service provider. [See "Multimedia message settings," p. 33.](#)

If you receive multimedia messages containing objects unsupported by your device, you cannot open them.

1. To reply to a multimedia message, open the message from the **Inbox**, and select **Options > Reply**.
2. Select **Options > To sender** to reply to the sender with a multimedia message or **Options > Via text message** to reply to the sender with a text message.

Messages



Tip: To add recipients to your reply, select **Options > Add recipient** to select the recipients of the message from the contacts list, or enter the recipients' phone numbers or e-mail addresses manually in the **To** field.

3. Enter the text of the message, and press the joystick to send it.

View presentations

Open the **Inbox**, scroll to a multimedia message that contains a presentation, and press the joystick. Scroll to the presentation, and press the joystick.

To pause the presentation, press either selection key below the display.

After you pause the presentation or playing finishes, select **Options** and from the following:

- **Open link** — Open a Web link and browse the Web page.
- **Activate scrolling** — Scroll text or images too large to fit on the display.
- **Continue** — Resume playing the presentation.
- **Play** — Replay the presentation from the start.
- **Find** — Find phone numbers and e-mail or Web addresses the presentation may contain. You may use these numbers and addresses to make calls, send messages, or create bookmarks, for example.

The available options may vary.

View media objects

Open the **Inbox**, scroll to a received multimedia message and press the joystick. Select **Options > Objects**.

To view or play a media object, scroll to it, and press the joystick.

Media objects and message attachments may contain viruses or other harmful software. Do not open any objects or attachments unless you are sure of the trustworthiness of the sender.

To save a media object in its corresponding application, scroll to the object, select **Options > Save**.

To send a media object to compatible devices, scroll to it, and select **Options > Send**.



Tip: If you receive multimedia messages that contain media objects your device cannot open, you may be able to send these objects to another device such as a computer.

View and save multimedia attachments

To view multimedia messages as complete presentations, open the message, and select **Options > Play presentation**.



Tip: If you have selected a multimedia object in a multimedia message, to view or play them, select **View image**, **Play sound clip**, or **Play video clip**.

To view the name and size of an attachment, open the message, and select **Options > Objects**.

To save a multimedia object, select **Options > Objects**, the object, and **Options > Save**.

Multimedia message settings

Select **Options > Settings > Multimedia message**.

Define the following settings:

- **Image size** — Select **Small** or **Large** to scale images in multimedia messages. Select **Original** to maintain the original image size of multimedia messages.
- **MMS creation mode** — Select **Restricted** to have your device prevent you from including content in multimedia messages that may not be supported by the network or the receiving device. To receive warnings about including such content, select **Guided**. To create a multimedia message with no restrictions on attachment type, select **Free**. If you select **Restricted**, creating multimedia presentations is not possible.
- **Access point in use** — Select the default access point to connect to the multimedia message center. You may not be able to change the default access point if it is preset in your device by your service provider.
- **Multimedia retrieval** — Select **Always automatic** to always receive multimedia messages automatically, **Auto. in home network** to receive notification of a new multimedia message that you can retrieve from the message center (for example, when you are traveling abroad and are outside your home network), **Manual** to retrieve multimedia messages from the message center manually, or **Off** to prevent receipt of any multimedia messages.
- **Allow anon. msgsg.** — Select whether you want to receive messages from unknown senders.
- **Receive adverts** — Select whether you want to receive messages defined as advertisements.
- **Receive report** — Select **Yes** to have the status of the sent message to be shown in the log (network service). Receiving a delivery report of a multimedia message that has been sent to an e-mail address may not be possible.
- **Deny report sending** — Select **Yes** to not send delivery reports from your device for received multimedia messages.

Messages

- **Message validity** — Select how long the messaging center tries to send the message (network service). If the recipient of a message cannot be reached within the validity period, the message is removed from the multimedia messaging center. **Maximum time** is the maximum amount of time allowed by the network.

■ E-mail messages

To receive and send mail, you must have a remote mailbox service. This service may be offered by an Internet service provider, a network service provider, or your company. Your device is compliant with Internet standards SMTP, IMAP4 (revision 1), and POP3, and with different push e-mail solutions. Other e-mail providers may offer services with different settings or features than those described in this user guide. Contact your e-mail provider or service provider for more details.

Before you can send, receive, retrieve, reply to, and forward mail on your device, you must also do the following:

- Configure an Internet access point (IAP). [See "Access points," p. 68.](#)
- Set up an e-mail account, and define the e-mail settings correctly. [See "E-mail account settings," p. 36.](#)

Follow the instructions from your remote mailbox and Internet service providers. Contact your network and Internet service providers or operator for the correct settings.

Set up your e-mail

If you select **Mailbox** and have not set up your e-mail account, you are prompted to do so. To start setting up the e-mail account with the mailbox guide, select **Yes**.

1. To start entering the e-mail settings, select **Start**.
2. In **Mailbox type**, select **IMAP4** or **POP3**, and select **Next**.



Tip: POP3 is a version of the post office protocol that is used to store and retrieve e-mail or Internet mail messages. IMAP4 is a version of the Internet message access protocol that lets you access and manage e-mail messages while the messages are still on the e-mail server. You can then choose which messages to download to your device.

3. In **My e-mail address**, enter your e-mail address. To insert @ or other special characters, press *. To insert a full stop, press 1. Select **Next**.
4. In **Incoming mail serv.**, enter the name of the remote server that receives your e-mail, and select **Next**.
5. In **Outgoing mail serv.**, enter the name of the remote server that sends your e-mail, and select **Next**. Depending on your mobile operator, you might have to use your mobile operator's outgoing mail server instead of your e-mail provider's.
6. In **Access point**, select the Internet access point your device should use when it retrieves the e-mails. If you select **Always ask**, each time the device starts to retrieve e-mail, it asks which Internet access point it should use, but if you select an access point, the device makes the connection automatically. Select **Next**.



Tip: If you select **Select group**, the device makes the connection automatically using the best available Internet access point from the access point group. Select the access point group, and **Back** to save the selection.

7. Enter a name for your new mailbox, and select **Finish**.

When you create a new mailbox, the name you give to the mailbox replaces **Mailbox** in the **Messag.** main view. You can have up to six mailboxes.

Select your default mailbox

If you have defined several mailboxes, you can select one of them as your default mailbox. To define the default mailbox, select **Options > Settings > E-mail > Mailbox in use** and the mailbox.

If you have defined several mailboxes, you must select the mailbox that you want to use every time you start composing a new e-mail message.

Connect to mailbox

E-mail addressed to you is not automatically received by your device, but by your remote mailbox. To read your e-mail, you must first connect to the remote mailbox; then select the e-mails you wish to retrieve into your device. To receive and send e-mail, you need to register for an e-mail service. To set up a mailbox in your device, select **Messag. > Options > Settings > E-mail > Options > New mailbox**. Contact your service provider for the correct settings.

To retrieve received e-mail messages to your device and view them offline, select your mailbox in the **Messag.** main view. When the device asks **Connect to mailbox?**, select **Yes**.

To view e-mail messages in a folder, scroll to the folder, and press the joystick. Scroll to a message, and press the joystick.

To retrieve e-mail messages to your device, select **Options > Retrieve e-mail > New** to retrieve new messages that you have neither read nor retrieved, **Selected** to retrieve only messages you select from the remote mailbox, or **All** to retrieve all messages not previously retrieved.

To disconnect from a remote mailbox, select **Options > Disconnect**.

View e-mail offline

Working offline means that your device is not connected to a remote mailbox. Managing your e-mail offline enables you to save in connection costs and work in conditions that do not allow a data connection. Any changes you make in the remote mailbox folders while offline take effect in your remote mailbox the next time you go online and synchronize. For example, if you delete an e-mail from your device when offline, the e-mail is deleted from the remote mailbox the next time you connect to the mailbox.

1. Select **Message** > **Options** > **Settings** > **E-mail**. Select the e-mail account, and press the joystick. Select **Retrieval settings** > **E-mail to retrieve** > **Msgs. & attachs.** to retrieve entire messages with their attachments to your device.
2. Open your mailbox, and select **Options** > **Retrieve e-mail**. Select **New** to retrieve new messages that you have neither read nor retrieved, **Selected** to retrieve only messages you select from the remote mailbox, or **All** to retrieve all messages not previously retrieved. The device goes online and connects to the mailbox to retrieve the mails.
3. After retrieving the e-mails, select **Options** > **Disconnect** to return to the offline mode.
4. To view an e-mail message, scroll to it, and press the joystick.

Some options require you to connect to your remote mailbox.



Tip: To subscribe to other folders in your remote mailbox, select **E-mail settings** > **Retrieval settings** > **Folder subscriptions**. E-mail in all subscribed folders is updated when you retrieve e-mail from your remote mailbox.

Read and reply to e-mail



Important: E-mail messages may contain viruses or otherwise be harmful to your device or PC. Do not open any attachment if you are not sure of the trustworthiness of the sender.

To read a received e-mail, scroll to the e-mail, and press the joystick.

To search for an e-mail in your mailbox, select **Options** > **Find**. Enter the search term, and select **OK**.

To open an attachment, select **Options** > **Attachments**. Scroll to the attachment, and press the joystick.

To reply only to the sender of an e-mail, open the e-mail, and select **Options** > **Reply** > **To sender**.

To reply to all recipients of an e-mail, open the e-mail, and select **Options** > **Reply** > **To all**.

To delete an attachment from an e-mail that you are sending, select the attachment and **Options** > **Attachments** > **Remove**.



Tip: If you reply to an e-mail that contains attached files, the attachments are not included in the reply. If you forward the received e-mail, attachments are included.

To set the message priority, select **Options** > **Sending options** > **Priority** and from the available options.

To call the sender of the e-mail, open the e-mail, and select **Options** > **Call**.

To reply to the sender of the e-mail with a text message or multimedia message, open the e-mail, and select **Options** > **Create message**.

To forward an e-mail, open the e-mail, and select **Options** > **Forward**.

Delete messages

To free up memory space on your device, regularly delete messages from the **Inbox** and **Sent** folders, and delete retrieved e-mail messages.

To delete a message, scroll to it, and press the clear key.

You can select to delete local e-mail messages on the device and keep the original on the server, or you can delete both the local e-mail messages on the device and the original messages on the server.

To delete e-mails from the device only, select **Options** > **Delete** > **Phone only**.

To delete e-mail both from the device and from the remote server, open an e-mail, and select **Options** > **Delete** > **Phone and server**.

E-mail folders

If you create subfolders in your IMAP4 mailboxes on a remote server, you can view and manage these folders with your device. You can only subscribe to folders in your IMAP4 mailboxes. Subscribing to folders in a remote mailbox allows you to view those folders on your device.

To view folders in your IMAP4 mailbox, establish a connection, and select **Options** > **E-mail sett.** > **Retrieval settings** > **Folder subscriptions**.

To view a remote folder, select a folder and **Options** > **Subscribe**. Every time you go online, the subscribed folders are updated. This may take some time if the folders are large.

To update the list of folders, select a folder and **Options** > **Update folder list**.

Write and send e-mail

To write an e-mail, select **Options** > **Add recipient** to select the recipients' e-mail addresses from the contacts list, or enter the e-mail addresses in the **To** field. Use a semicolon to separate entries. Scroll down, and use the **Cc** field to copy other recipients, or the **Bcc** field to blind copy recipients. In the **Subject** field, enter the subject of the e-mail. Enter your e-mail message in the text area, and select **Options** > **Send**.

To attach a file to an e-mail, select **Options** > **Insert**, and select the attachment you want to add. For example, you can insert images, sound clips, notes and other files such as office files.

To set the sending time for an e-mail message, select **Options** > **Sending options** > **Send message**. Select **Immediately** or **During next conn.** if you are working offline.

E-mail messages are stored in the **Outbox** before sending. Unless the e-mail is sent immediately, you can open the **Outbox** and suspend and resume sending or view the e-mail.

E-mail account settings

Select **Menu** > **Messag.** > **Mailbox**.

The settings available for editing may vary. Some settings may be preset by your service provider.

If you try to edit mailbox settings but have not set up an e-mail account, the mailbox guide opens and helps you set up your e-mail account.

Settings for the received e-mail

Select **Incoming e-mail** and from the following settings:

- **User name** — Enter the user name for the e-mail service.
- **Password** — Enter the password for the e-mail service.
- **Incoming mail serv.** — Enter the IP address or host name of the server that receives your e-mail.
- **Access point in use** — Select the Internet access point that the device uses for retrieving the e-mail messages that you receive.
- **Default mailbox** — Enter a name for the mailbox.
- **Mailbox type** — Select the mailbox protocol that your remote mailbox service provider recommends. The options are **POP3** and **IMAP4**. This setting can be selected only once and cannot be changed if you have saved or exited from the mailbox settings. If you use the POP3 protocol, e-mail messages are not updated automatically when you are online. To see the latest e-mail messages, you must disconnect and make a new connection to your mailbox.
- **Security (ports)** — Select the security option used to increase the security of the connection.
- **Port** — Define a port for connection.
- **APOP secure login** (for POP3 only) — Use with the POP3 protocol to encrypt the sending of passwords to the remote e-mail server while connecting to the mailbox.

Settings for sent e-mail

Select **Outgoing e-mail** and from the following settings:

- **My e-mail address** — Enter the e-mail address given to you by your service provider. Replies to your messages are sent to this address.
- **User name** — Enter the user name for the e-mail service.
- **Password** — Enter the password for the e-mail service.
- **Outgoing mail serv.** — Enter the IP address or host name of the mail server that sends your e-mail. You may only be able to use the outgoing server of your network operator. Contact your service provider for more information.
- **Access point in use** — Select the Internet access point that the device uses for sending the e-mail messages that you send.
- **Security (ports)** — Select the security option used to secure the connection to the remote mailbox.
- **Port** — Define a port for connection.

User settings

Select **User settings** and from the following settings:

- **My name** — Enter a name to appear before your e-mail address when you send e-mail.
- **Reply-to** — Select whether you want replies to be redirected to a different address. Select **On**, and enter the e-mail address to which you want to direct the replies. You can only enter one address to which replies are directed.
- **Delete e-mails from** — Select whether you want to delete the e-mails only from the device or from both the device and the server. Select **Always ask** if you want to confirm from where the e-mail should be deleted every time you delete an e-mail.
- **Send message** — Select to send the e-mail as soon as possible, to send it the next time you retrieve e-mail, or to store the e-mail in the Outbox, from where you can send it later.
- **Send copy to self** — Select whether you want to save a copy of the e-mail to your remote mailbox and to the address defined in **My e-mail address** in the settings for **Outgoing e-mail**.
- **Include signature** — Select whether you want to attach a signature to your e-mail messages.
- **New e-mail alerts** — Select whether you want to receive the new e-mail indications, a tone and a note, when new mail is received to the mailbox.

Messages

- **Default encoding** — Select the preferred method for character encoding.

Retrieval settings

Select **Retrieval settings** and from the following settings:

- **E-mail to retrieve** (for POP3 mailboxes only) — Select whether you want to retrieve only the e-mail header information such as sender, subject and date, e-mail, or e-mail with attachments.
- **Retrieval amount** — Select the number of e-mails you want to retrieve from the remote server to your mailbox.
- **IMAP4 folder path** (for IMAP4 mailboxes only) — Define the folder path for folders to be subscribed.
- **Folder subscriptions** (for IMAP4 mailboxes only) — Subscribe to other folders in the remote mailbox and retrieve content from those folders.

Automatic retrieval settings

Select **Automatic retrieval** and from the following settings:

- **E-mail notifications** — Select whether you want to receive notifications when new e-mail is received in your remote mailbox. Select **Always enabled** to always automatically retrieve new e-mail messages from your remote mailbox, or **Only in home net.** to automatically retrieve new e-mail messages from your remote mailbox only when you are in your home network and not, for example, traveling.
- **Retrieval days** — Select the days on which e-mails are retrieved to your device.
- **Retrieval hours** — Define the hours between which the e-mails are retrieved.
- **Retrieval interval** — Select the time interval between retrieving new e-mails.

■ Instant messaging

Select **Menu > Connect > IM**.

Instant messaging (IM) (network service) allows you to converse with other people using instant messages and join discussion forums (IM groups) with specific topics. Various service providers maintain IM servers that you can log in to after you register to an IM service. Service providers may differ in their support of features.

If IM is not available from your wireless service provider, it may not appear in the menu of your device. Contact your service provider for more information about signing up for IM services and costs for services. For more information on the availability of IM settings, contact your network operator, service provider, or dealer.

You may receive the settings in a special text message from the network operator or service provider that offers the IM service. You must save the settings to access the service that you want to use. You can also enter the settings manually.

Connect to an IM server

To converse with an IM user or users, and to view and edit your IM contacts, you must log into the instant messaging server. Open **IM**, and select **Options > Login**. Enter your user ID and password, and press the joystick to log in. You can obtain the user name, password, and other settings to log in from your service provider when you register for the service.



Tip: To have instant messaging connect to the server automatically when you open the application, select **Options > Settings > Server settings > IM login type > On app. start-up**.

Search IM users or IM groups

To search for IM users and user IDs, select **IM contacts > Options > New IM contact > Search**. You can search by **User's name**, **User ID**, **Phone number**, and **E-mail address**.

To search for IM groups and group IDs, select **IM groups > Options > Search**. You can search by **Group name**, **Topic**, and **Members** (user ID).

Scroll to a found IM user or group, and select **Options** and from the following:

- **New search** — Conduct another search.
- **More results** — View the remaining found IM users or groups, if any.
- **Previous results** — View the IM users or groups that were found in the previous search.
- **Open conversation** — Start a conversation with the user if the user is online.
- **Add to IM contacts** — Save the user in one of your IM contacts lists.
- **Send invitation** — Invite the IM user to an IM group.
- **Blocking options** — Prevent or allow the reception of messages from the IM user.
- **Join** — Join the IM group.
- **Save** — Save the group.

Conversations with a single IM user

The **Conversations** view shows a list of the individual conversation participants with whom you have an ongoing conversation. Ongoing conversations are automatically closed when you exit IM.

Messages

To view a conversation, scroll to a participant, and press the joystick.

To continue the conversation, enter your message, and press the joystick.

To return to the conversations list without closing the conversation, select **Back**. To close the conversation, select **Options > End conversation**.

To start a new conversation, select **Options > New conversation**. You can start a new conversation with a different contact while you are inside another active conversation. However, you cannot have two active conversations with the same contact.

To insert an image to an instant message, select **Options > Send image**, and select the image you want to send.

To save a conversation participant to your IM contacts, select **Options > Add to IM contacts**.

To save a conversation, while in the conversation view, select **Options > Record chat**. The conversation is saved as a text file that can be opened and viewed in the **Notes** application.

To send automatic replies to incoming messages, select **Options > Set auto reply on**. You can still receive messages.

IM groups

The **IM groups** view shows a list of the IM groups that you have saved or to which you are currently joined.

IM groups is available only if you logged into an IM server when you opened the IM application, and the server supports IM groups.

To create an IM group, select **Options > Create new group**.

To join an IM group or to continue a group conversation, scroll to the group, and press the joystick. Enter a message, and press the call key to send it.

To join an IM group that is not on the list, but for which you know the group ID, select **Options > Join new group**.

To leave the IM group, select **Options > Leave IM group**.

You can also select **Options** and from the following:

- **Group** — Select **Save** to save the group to your IM groups, **View participants** to view the current members of the group, or **Settings** to edit the group settings. You can only select this option if you have editing rights to the group.
- **Login** — Connect to an instant messaging server if you did not log in when you opened the application.
- **Logout** — Disconnect from the IM server.
- **Settings** — Edit instant messaging application or server settings.

To remove an IM group, press the clear key.

Group conversations

To join the conversation, select a group.

Select **Options** and from the following:

- **Insert smiley** — Add a smiley in your message.
- **Send private msg.** — Send a private message to one or several, but not all, members of the IM group.
- **Reply** — Send a message only to the sender of the open message.
- **Forward** — Forward the open message to another IM group or contact.
- **Send invitation** — Invite an IM user to join the group.
- **Leave IM group** — End instant messaging in the group.
- **Group** — Select **Save** to save the group to your IM groups, **View participants** to view the current members of the group, or **Settings** to edit the group settings. You can only select this option if you have editing rights to the group.
- **Record chat** — Save a copy of the group conversation.

To send a message, enter the message, and press the call key.

IM group settings

Select **IM groups > Options > Group > Settings**.

You can only edit IM group settings if you have editing rights to that group.

Select from the following settings:

- **Group name:** — Enter a name for the IM group.
- **Group ID** — The group ID is created automatically and cannot be added or changed.
- **Group topic** — Enter a topic for the group conversation.
- **Welcome note** — Enter a note that greets IM users once they join the group.
- **Group size** — Enter the maximum number of IM users that can join the group.
- **Allow search** — Select whether you want to allow IM users to find the group when searching.

Messages

- **Editing rights** — To provide other members of the group with editing rights to the group, select **Selected > Options > Add editor**. IM users with editing rights can edit group settings and invite other users to join the group or ban them from it.
- **Group members** — To close the group and allow only selected IM users to join it, select **Selected only > Options > Add member**.
- **Banned list** — To prevent some IM users from joining the group, select **Options > Add to banned list**.
- **Allow private msgs.** — To prevent group members from sending private messages between themselves, select **No**.

Group editing rights

To add editing rights to or remove them from IM group members, scroll to the IM group, and select **Options > Group > Settings > Editing rights > Selected**.



Tip: IM users with editing rights can edit group settings and invite other users to join the group or ban them from the group.

To provide members with editing rights to the group, select **Options > Add editor** and from the following:

- **From IM contacts** — Add one or several of your IM contacts.
- **Enter user ID** — Enter the ID of the IM user.

To remove editing rights from a group member, select **Options > Remove**.

Ban from groups

Scroll to the IM group, and select **Options > Group > Settings > Banned list**.

To prevent IM users from joining the group, select **Options > Add to banned list** and from the following:

- **From IM contacts** — Ban one or several of your IM contacts.
- **Enter user ID** — Enter the ID of the IM user.

To allow a banned user to join the group, select **Options > Remove**.

IM contacts

When login to an IM service is complete, your contact list for the service provider is retrieved automatically. If your contact list is not available, wait a few minutes and try to retrieve your contacts list manually.



Tip: The online status of your IM contacts is shown by an indicator next to the contact name.

To create an IM contact card, select **Options > New IM contact**. Enter the user ID and a nickname, and select **Done**. The user ID can be up to 50 characters, and the IM service provider may require the user ID to be in the username@domain.com format. The nickname is optional.

To view a different list of your IM contacts, select **Options > Change contact list**.

Scroll to an IM contact, select **Options** and from the following:

- **Open conversation** — Start or continue instant messaging with the contact.
- **Contact details** — View the contact card.
- **Editing options** — Edit or delete the contact card, move it to another contact list, or receive a note when the contact's online status changes.
- **Belongs to groups** — See the IM groups the contact has joined.
- **New contact list** — Create a contact list for a specific group of IM contacts.
- **Reload users' availab.** — Update the online status of your IM contacts.
- **Blocking options** — Prevent or allow the reception of messages from the contact.
- **Login** — Connect to an instant messaging server if you did not log in when you opened the application.
- **Logout** — Disconnect from the IM server.
- **Settings** — Edit instant messaging application or server settings.

The available options may vary.

To delete an IM contact, press the clear key.

Blocked contacts

Select **IM contacts > Options > Blocking options > View blocked list**.

To find a blocked IM user, enter the first letters of the user's name. Matching names appear in a list.

To allow receiving messages from a blocked IM user, select **Options > Unblock**.

To prevent receiving messages from other IM users, select **Options > Block new contacts**. Select the IM user from your IM contacts, or enter the user ID.

Messages

View invitations

Select **Conversations**. Scroll to an invitation, and press the joystick.

Select **Options** and from the following:

- **Join** — Join the instant messaging group.
- **Reject** — Reject the invitation and send a message to its sender.
- **Delete** — Delete the invitation.
- **Blocking options** — Prevent the reception of invitations from this sender.

Recorded messaging

To view a recorded conversation, select **Record. chats**, scroll to a conversation, and press the joystick.

You can also scroll to a recorded conversation, and select **Options** and select from the following:

- **Send** — Send the IM session to a compatible device.
- **Login** — Connect to an instant messaging server if you did not log in when you opened the application. To disconnect, select **Logout**.
- **Settings** — Edit instant messaging application or server settings.

To delete an IM conversation, press the clear key.

Settings

Select **Options > Settings > IM settings**.

Select from the following settings:

- **Use screen name** — To change the name that identifies you in IM groups, select **Yes**.
- **Allow messages from** — Select to receive instant messages from all other IM users, your IM contacts only, or not to receive messages at all.
- **Allow invitations from** — Select to receive invitations to IM groups from all IM users, your IM contacts only, or not to receive invitations at all.
- **Msg. scrolling speed** — To decrease or increase the speed at which new messages are displayed, scroll left or right.
- **Sort IM contacts** — Select to list your IM contacts alphabetically or by their online status.
- **Availabil. reloading** — To update the online status of your IM contacts automatically, select **Automatic**.
- **Offline contacts** — Select if IM contacts with an offline status are shown in the IM contacts list.

The settings available for editing may vary. Contact your service provider for more information.

IM server settings

Select **Options > Settings > Server settings**.

Scroll to the following options, and press the joystick to configure your IM server:

- **Servers** — Add new, edit, or delete servers.
- **Default server** — Change the server to which your device automatically logs into, scroll to the desired server, and press the joystick.
- **IM login type** — To establish a connection between your device and the default server automatically, select **Automatic**. Select **Auto. in home network** to automate the connection when in your home network. Select **On app. start-up** to connect to the server when you open the messaging application. Select **Manual** to connect to the server manually at any time.

■ Special messages

Your device can receive many kinds of messages that contain data:

- **Operator logo** — To save the logo, select **Options > Save**.
- **Ringtone** — To save a ringtone, select **Options > Save**.
- **Configuration message** — You may receive settings from your network operator, service provider, or company information management department in a configuration message. To accept the settings, open the message, and select **Options > Save all**.
- **E-mail notification** — The note tells you how many new e-mails you have in your remote mailbox. An extended notification may list more detailed information.

Send service commands

Send a service request message to your service provider and request activation for certain network services.

To send a service request to your service provider, select **Options > Service command**. Enter the service request as a text message, and select **Options > Send**.

6. Connectivity

Copyright protections may prevent some images, music (including ringing tones), and other content from being copied, modified, transferred or forwarded.

Your device offers several options to connect to the Internet, a corporate intranet, or to another device or PC. Wireless methods include wireless LAN, Bluetooth, and infrared. Your device supports a wired solution with a USB (Universal Serial Bus) cable connection for Nokia PC Suite or IP passthrough. Your device also allows you to communicate using net calls (Voice over IP), push to talk, instant messaging (chat), and modem-based connections.

■ Internet access points

An access point is where your device connects to a network. To use e-mail and multimedia services or to connect to the Internet and browse web pages, you must first define Internet access points for these services. You may need to set up several Internet access points, depending on the sites you want to access. For example, browsing the Web may require one access point, and accessing your company intranet may require another. To connect to the Internet over GPRS, your device may have predefined, default Internet access point settings.

When you switch on your device for the first time, the access points may be configured automatically based on the service provider information in your SIM card. You can also receive the access points settings in a message from your service provider. This might reduce the number of settings you need to enter yourself.

The available options may vary. Some or all access points may be preset for your device by your service provider. You may not be able to add, edit, or delete access points.

Contact your service provider and e-mail service provider for more information on access points and their settings.

[See "Connection settings," p. 68.](#)

Set up an Internet access point for data calls

1. Select **Menu > Tools > Settings > Connection > Access points**.
2. Select **Options > New access point**. To use an existing access point as a basis for the new one, select **Use existing settings**. To start with an empty access point, select **Use default settings**.
3. Define the following settings.
 - **Connection name** — Enter a descriptive name for the connection.
 - **Data bearer** — Select **Data call** or **High speed data (GSM only)**.
 - **Dial-up number** — Enter the modem telephone number of the access point. Use + before international numbers.
 - **User name** — Enter your user name if required by the service provider. User names are often case-sensitive and provided by your service provider.
 - **Prompt password** — Select **Yes** to enter your password each time you log into a server or **No** to save the password in your device memory and automate the login.
 - **Password** — Enter your password if required by the service provider. The password is often case-sensitive provided by the service provider.
 - **Authentication** — Select **Secure** to always send your password encrypted or **Normal** to send your password encrypted when possible.
 - **Homepage** — Enter the Web address of the page you want to display as a home page when you use this access point.
 - **Data call type** — Select **Analogue** or **ISDN**.
 - **Max. data speed** — Select the limit to apply to the transfer speed. If you select **Automatic**, the data transfer rate is determined by the network and may be affected by network traffic. Some service providers may charge more for higher data rates.
4. After defining the basic settings, select **Options > Advanced settings** to define the advanced settings or **Back** to save the settings and exit.

Advanced Internet access point settings for data calls

After setting up a basic Internet access point for **Data call** or **High speed data (GSM only)**, select **Options > Advanced settings**, and define the following advanced settings.

- **IPv4 settings** — Enter the device IP and name server addresses for IPv4 Internet protocol.
- **IPv6 settings** — Enter the device IP and name server addresses for IPv6 Internet protocol.
- **Proxy serv. address** — Enter the proxy server address.
- **Proxy port number** — Enter the proxy server port number. Proxy servers are intermediate servers between a browsing service and its users, which are used by some service providers. These servers may provide additional security and speed up access to the service.
- **Use callback** — Select **Yes** if you have a service that dials back to your device when you establish an Internet connection.

Connectivity

- **Callback type** — Select **Use server no.** or **Use other no.**, according to instructions from your service provider.
- **Callback number** — Enter your data call phone number of your device, which the callback server uses.
- **Use PPP compress.** — Select **Yes** to speed up the data transfer, if it is supported by the remote PPP server.
- **Use login script** — Select **Yes**, if your Internet service provider requires a login script, or if you want to automate your login. A login script is a sequence of instructions that the system follows during the login process.
- **Login script** — Enter the login script. This setting is available only if you have selected **Use login script > Yes**.
- **Modem initialisation** — Enter a command string for the connection setup, if required by your service provider.

Set up an Internet access point for packet data (GPRS)

1. Select **Menu > Tools > Settings > Connection > Access points**.
2. Select **Options > New access point**. To use an existing access point as a basis for the new one, select **Use existing settings**. To start with an empty access point, select **Use default settings**.
3. Define the following settings.
 - **Connection name** — Enter a descriptive name for the connection.
 - **Data bearer** — Select **Packet data**.
 - **Access point name** — Enter the name for the access point. The name is usually provided by your service provider or network operator.
 - **User name** — Enter your user name if required by the service provider. User names are often case-sensitive and provided by your service provider.
 - **Prompt password** — Select **Yes** to enter your password each time you log into a server or **No** to save the password in your device memory and automate the login.
 - **Password** — Enter your password if required by the service provider. The password is often case-sensitive provided by the service provider.
 - **Authentication** — Select **Secure** to always send your password encrypted or **Normal** to send your password encrypted when possible.
 - **Homepage** — Enter the Web address of the page you want to display as a home page when you use this access point.
4. After defining the settings, select **Options > Advanced settings** to define the advanced settings or **Back** to save the settings and exit.

Advanced Internet access point settings for packet data (GPRS)

After setting up a basic Internet access point for packet data (GPRS), select **Options > Advanced settings**, and define the following advanced settings.

- **Network type** — Select **IPv4** or **IPv6** as the Internet protocol type. The Internet protocol defines how data is transferred to and from your device.
- **Phone IP address** — Enter the IP address of your device. Select **Automatic** to have the network provide the device IP address. This setting is shown only if you select **Network type > IPv4**.
- **DNS address** — Enter the IP addresses of the **Primary DNS address** and **Secondary DNS addr.** if required by your service provider or network operator. Otherwise, the name server addresses are provided automatically.
- **Proxy serv. address** — Enter the address of the proxy server. Proxy servers are intermediate servers between a browsing service and its users, which are used by some service providers. These servers may provide additional security and speed up access to the service.

Set up an Internet access point for wireless LAN

1. Select **Menu > Tools > Settings > Connection > Access points**.
2. Select **Options > New access point**. To use an existing access point as a basis for the new one, select **Use existing settings**. To start with an empty access point, select **Use default settings**.
3. Define the following settings.
 - **Connection name** — Enter a descriptive name for the connection.
 - **Data bearer** — Select **Wireless LAN**.
 - **WLAN netw. name** — To enter the service set identifier (SSID), that is, the name that identifies the specific wireless LAN, select **Enter manually**. To select the network from the wireless LANs in range, select **Search for netw.**
 - **Network status** — Select **Hidden** if the network you are connecting to is hidden, or **Public** if it is not hidden.
 - **WLAN netw. mode** — If you select **Infrastructure**, devices can communicate with each other and with wired LAN devices through a wireless LAN access point. If you select **Ad-hoc**, devices can send and receive data directly with each other, and no wireless LAN access point is needed.
 - **WLAN security mode** — You must select the same security mode that is used in the wireless LAN access point. If you select WEP (wired equivalent privacy), 802.1x, or WPA2 (Wi-Fi protected access), you must also configure the relevant additional settings.
 - **WLAN security sett.** — Edit the security settings for the selected **WLAN security mode**.

Connectivity

- **Homepage** — Enter the Web address of the page you want to display as a home page when you use this access point.

The settings available for editing may vary.

Advanced Internet access point settings for wireless LAN

Select **Menu** > **Tools** > **Settings** > **Connection** > **Access points**.

After setting up a basic Internet access point for wireless LAN, select **Options** > **Advanced settings**, and define the following advanced settings.

- **IPv4 settings** — Enter the device IP and name server addresses for the IPv4 Internet protocol.
- **IPv6 settings** — Select or enter the name server addresses for the IPv6 Internet protocol.
- **Ad-hoc channel** — If the selected network mode is ad-hoc, select **User defined** to manually enter a channel number (1-11).
- **Proxy serv. address** — Enter the proxy server address.
- **Proxy port number** — Enter the proxy server port number.

The settings available for editing may vary. Contact your service provider for more information.

■ Cable connection

Install the USB data cable driver to your PC before you use a cable connection. You can use the **Data transfer** without installing the USB data cable drivers.

Select **Menu** > **Connect** > **Data cbl.**

Using a USB data cable, you can connect your device to a compatible PC. Connect the USB data cable to the bottom of the device. To change the device type you normally connect to your device with the data cable, press the joystick.

Select from the following:

- **Ask on connection** — Select whether you want to be asked for the device type every time you connect the data cable to your device.
- **PC Suite** — Connect the PC Suite to your device with the data cable, and use your device as a modem.
- **Data transfer** — Access and transfer data such as music or image files from your computer using the data cable connection. To use the **Data transfer** mode, make sure that you have not selected USB as a connection type in the Manage connections settings in Nokia PC Suite. Insert a memory card to your device, connect the device to a compatible computer with the USB data cable, and select **Data transfer** when the device asks which mode is used. In this mode, your device acts as a mass storage device and you can see it as a removable hard drive in your computer. The device will switch into the **Offline** profile if this is selected. End the connection from the PC (for example, from an Unplug or Eject Hardware wizard in Windows) to avoid damaging the memory card. After you end the connection, the device returns to the profile in which it was before using the data transfer mode.
- **IP passthrough** — Select an access point through which to transfer data using the Internet protocol.

To save your selection, select **Back**.

■ IP passthrough

Select **Menu** > **Connect** > **Data cable** > **Options** > **Change** > **IP passthrough**.

The **IP passthrough** application allows you to obtain a network connection on your device from a compatible PC through a data cable.

Set up a data cable to use IP passthrough

Use IP passthrough as you use any Internet access point to browse or synchronize remotely. If a wireless network connection is unavailable, use IP passthrough to access the Internet or a LAN. You cannot use IP passthrough at the same time as Nokia PC Suite. You cannot activate the modem if you select IP passthrough in cable connection settings.

To prepare for an IP passthrough session, connect a data cable to your device, and select **IP passthrough** as the connection method. Connect the other end of the data cable to a compatible PC, and wait for the PC to recognize your device.

Access point for IP passthrough

Menu > **Tools** > **Settings** > **Connection** > **Access points**.

To configure IP passthrough basic settings, select **Options** > **New access point** > **Use default settings**. Enter a name for your IP passthrough connection in the **Connection name** field, select **IP passthrough** in the **Data bearer** field, and enter an address in the **Homepage** field.

Advanced IP passthrough access point settings

Menu > **Tools** > **Settings** > **Connection** > **Access points**.

Connectivity

To use advanced settings, open an IP passthrough access point, and select **Options > Advanced settings** and select from the following:

- **IPv4 settings** — Enter the **Phone IP address** and **DNS address** for the IPv4 Internet protocol.
- **IPv6 settings** — Enter the **DNS address** for the IPv6 Internet protocol.
- **Proxy serv. address** — Enter the proxy server address.
- **Proxy port number** — Enter the proxy server port number.

■ Bluetooth

There may be restrictions on using Bluetooth technology in some locations. Check with your local authorities or service provider. Features using Bluetooth technology, or allowing such features to run in the background while using other features, increase the demand on battery power and reduces the battery life.

This device is compliant with Bluetooth Specification 1.2 supporting the following profiles: Generic Access Profile, Serial Port Profile, Dial-up Networking Profile, Headset Profile, Handsfree Profile, Generic Object Exchange Profile, Object Push Profile, File Transfer Profile, SIM Access Profile, and Basic Imaging Profile. To ensure interoperability between other devices supporting Bluetooth technology, use Nokia approved enhancements for this model. Check with the manufacturers of other devices to determine their compatibility with this device.

Bluetooth technology enables wireless connections between electronic devices within a range of 10 meters (33 feet). A Bluetooth connection can be used to send images, videos, texts, business cards, calendar notes, or to connect wirelessly to devices using Bluetooth technology, such as computers.

Since devices using Bluetooth technology communicate using radio waves, your device and the other devices do not need to be in direct line-of-sight. The two devices only need to be within a maximum of 10 meters of each other, although the connection can be subject to interference from obstructions such as walls or from other electronic devices.

Start using Bluetooth

Select **Menu > Connect > Bluetooth**.

1. When you activate Bluetooth for the first time, you are asked to give a name to your device. Give your device a unique name to make it easy to recognize if there are several Bluetooth devices in the vicinity.
2. Select **Bluetooth > On**.
3. Select **My phone's visibility > Shown to all**.

Your device and the name you entered can now be seen by other users with devices using Bluetooth technology.

Settings

Define the following settings:

- **Bluetooth** — Select **On** to be able to connect to another compatible device using Bluetooth connectivity.
- **My phone's visibility** — Select **Shown to all** to allow other devices using Bluetooth technology to find your device when you have set **Bluetooth > On**. To prevent other devices from finding your device, select **Hidden**. Even if you select **Hidden**, paired devices can still detect your device.
- **My phone's name** — Enter a name for your device. The name is visible to other devices that search for devices using Bluetooth technology. The maximum length of the name is 30 characters.
- **Remote SIM mode** — Select **On** to enable another device, such as a compatible car kit enhancement, to use the SIM card in your device to connect to the network. [See "SIM access profile," p. 46.](#)

If Bluetooth was turned off as a result of entering **Offline** profile, you must re-enable Bluetooth manually.

Security tips

When you are not using Bluetooth connectivity, select **Bluetooth > Off** or **My phone's visibility > Hidden**.

Do not pair with an unknown device.

Send data

Several Bluetooth connections can be active at a time. For example, if you are connected to a headset, you can also transfer files to another compatible device at the same time.

1. Open the application where the item you want to send is stored.
2. Select the item, and select **Options > Send > Via Bluetooth**. The device searches for other devices using Bluetooth technology within range and lists them.



Tip: If you have sent data using Bluetooth before, a list of the previous search results is displayed. To search for more Bluetooth devices, select **More devices**.

Connectivity

3. Select the device with which you want to connect, and press the joystick to set up the connection. If the other device requires pairing before data can be transmitted, you are asked to enter a passcode.
4. When the connection has been established, **Sending data** is shown.

The **Sent** folder in **Message** does not store messages sent using Bluetooth connectivity.

If you have sent items using Bluetooth before, a list of the previous search results is displayed. To search for more Bluetooth devices, select **More devices**.

To use a Bluetooth audio enhancement such as Bluetooth handsfree or headset you need to pair your device with the enhancement. See the enhancement user guide for the passcode and further instructions. To connect to the audio enhancement, press the power key to turn on the enhancement. Some audio enhancements connect automatically to your device. Otherwise open **Paired devices**, scroll to the enhancement, and select **Options > Connect**.

Bluetooth connectivity indicators

 Bluetooth is active.

 When the icon is blinking, your device is trying to connect to the other device. When the icon is shown continuously, the Bluetooth connection is active.

Pair devices

Select **Menu > Connect > Bluetooth**, and scroll right to open the **Paired devices** page.

Before pairing, create your own passcode (1-16 digits), and agree with the user of the other device to use the same code. Devices that do not have a user interface have a fixed passcode. You need the passcode only when you connect the devices for the first time. After pairing, it is possible to authorize the connection. See ["Authorize a device," p. 45](#). Pairing and authorizing the connection makes connecting quicker and easier, as you do not have to accept a connection between paired devices every time you establish the connection.

The passcode for remote SIM access must have 16 digits.

1. Select **Options > New paired device**. The device starts to search for Bluetooth devices within range.



Tip: If you have sent data using Bluetooth before, a list of the previous search results is displayed. To search for more Bluetooth devices, select **More devices**.

2. Select the device with which you want to pair, and enter the passcode. The same passcode must be entered to the other device as well.
3. Select **Yes** to make the connection between your device and the other device automatic or **No** to confirm the connection manually every time a connection attempt is made. After pairing, the device is saved to the paired devices page.

To give a nickname to a paired device that is only displayed in your device, scroll to the device with which you have paired, and select **Options > Assign short name**.

To delete a pairing, select the device whose pairing you want to delete and **Options > Delete**. To delete all pairings, select **Options > Delete all**.



Tip: If you are currently connected to a device and cancel the pairing with that device, pairing is removed immediately, and the connection is switched off.

Authorize a device

If you trust a paired device, you can allow it to connect automatically to your device. You can select from the following options:

- **Set as authorised** — Connections between your device and the other device can be made without your knowledge. No separate acceptance or authorization is needed. Use this status for your own devices, such as your compatible headset or PC, or devices that belong to someone you trust.
- **Set as unauthorised** — Connection requests from the other device must be accepted separately every time.

Receive data

If you want to receive data using Bluetooth, select **Bluetooth > On** and **My phone's visibility > Shown to all**. When you receive data through Bluetooth connectivity, a tone sounds, and you are asked if you want to accept the message. If you accept, the message is placed in the **Inbox** folder in **Message**.



Tip: You can access the files in the device or on the memory card using a compatible accessory that supports the File Transfer Profile Client service (for example, a laptop computer).

End a Bluetooth connection

A Bluetooth connection is disconnected automatically after sending or receiving data. Only Nokia PC Suite and some enhancements such as headsets may maintain a connection even if not actively used.

■ SIM access profile

When the wireless device is in the remote SIM mode, you can only use a compatible connected enhancement, such as a car kit, to make or receive calls. Your wireless device will not make any calls, except to the emergency numbers programmed into your device, while in this mode. To make calls from your device, you must first leave the remote SIM mode. If the device has been locked, enter the code to unlock it first.

With the SIM access profile, you can access the SIM card of your device from a compatible car kit device. This way, you do not need a separate SIM card to access SIM card data and connect to the GSM network.

To use the SIM access profile, you need the following:

- Compatible car kit device that supports Bluetooth wireless technology
- Valid SIM card in your device

For more information about car kit devices and compatibility with your device, see www.nokia.com and your car kit user guide.

Manage the SIM access profile

1. Select **Menu** > **Connect.** > **Bluetooth** to activate Bluetooth connectivity in your device.
2. To enable remote SIM access, scroll to **Remote SIM mode**, and press the joystick.
3. Activate Bluetooth in the car kit device.
4. Use your car kit device to start a search for compatible devices. For instructions, see the user guide of your car kit device.
5. Select your device from the list of compatible devices.
6. To pair the devices, enter the Bluetooth passcode shown on the display of the car kit device to your device.
7. Authorize the car kit device. Select **Menu** > **Connect.** > **Bluetooth**, and scroll to the **Paired devices** page. Scroll to the car kit device, and enter the Bluetooth passcode. When the device asks to make the connection automatic, select **Yes**. Connections between your device and the car kit device can be made without separate acceptance or authorization. If you select **No**, connection requests from this device must be accepted separately every time.



Tip: If you have already accessed the SIM card from the car kit with the active user profile, the car kit searches automatically for a device with the SIM card. If it finds your device, and automatic authorization is activated, the car device automatically connects to the GSM network when you switch on the car ignition.

When you activate the remote SIM access profile, you can use applications on your device that do not need network or SIM services.

To end the remote SIM access connection from your device, select **Menu** > **Connect.** > **Bluetooth** > **Remote SIM mode** > **Off**.

■ Infrared

Do not point the IR (infrared) beam at anyone's eye or allow it to interfere with other IR devices. This device is a Class 1 laser product.

Use infrared to connect two devices and transfer data between them. With infrared, you can transfer data such as business cards, calendar notes, and media files with a compatible device.

Send and receive data

1. Ensure that the infrared ports of the devices face each other. The positioning of the devices is more important than angle or distance.
2. Select **Menu** > **Connect.** > **Infrared**, and press the joystick to turn on infrared on your device. Turn on infrared on the other device.
3. Wait a few seconds until an infrared connection is established.
4. To send, locate the desired file in an application or the file manager, and select **Options** > **Send** > **Via infrared**.

If data transfer is not started within 1 minute after the activation of the infrared port, the connection is cancelled and must be started again.

All items received through infrared are placed in the Inbox folder in **Messag.**

Positioning devices away from each other breaks a connection, but the infrared light beam remains active on your device until it is deactivated.

■ Data connections

Packet data

GPRS (general packet radio service) enables wireless access for mobile phones to data networks (network service). GPRS uses packet data technology where information is sent in short bursts of data over the mobile network. The benefit of sending data

Connectivity

in packets is that the network is occupied only when sending or receiving data. As GPRS uses the network efficiently, it allows for quick data connection set-up and fast data transmission speeds.

You must subscribe to the GPRS service. For availability and subscription to GPRS, contact your network operator or service provider.

Enhanced GPRS (EGPRS) is similar to GPRS, but it enables faster connection. For more information on the availability of EGPRS and data transfer speed, contact your network operator or service provider. Note that when you have selected GPRS as a data bearer, the device uses EGPRS instead of GPRS if this is available in the network.

During a voice call, you cannot establish a GPRS connection, and any existing GPRS connection is put on hold unless the network supports dual transfer mode.

UMTS

UMTS (universal mobile telecommunications system) is 3G mobile communication system. Besides voice and data, UMTS enables audio and video delivery to wireless devices.

Your device can automatically switch between the GSM and UMTS networks.

To select which network to use, select **Menu > Tools > Settings > Network** and the network in **Network mode**. If you want the device to switch between the networks automatically, select **Dual mode**.

The GSM network is indicated with , the UMTS network with **3G**.

When you use your device in GSM and UMTS networks, multiple data connections can be active at the same time, and access points can share a data connection. In the UMTS network, data connections remain active during voice calls. You can, for example, surf the Web faster than previously possible while simultaneously speaking on the phone.

Wireless local area network (WLAN)

Some places, like France, have restrictions on the use of wireless LAN. Check with your local authorities for more information.

Features using wireless LAN, or allowing such features to run in the background while using other features, increase the demand on battery power and reduce the battery life.

This device can detect and connect to a wireless local area network.

If you move the device to another location within the wireless LAN and out of range of a wireless LAN access point, the roaming functionality can automatically connect your device to another access point that belongs to the same network. As long as you remain within range of access points that belong to the same network, your device can stay connected to the network.



Tip: A wireless LAN connection is established when you create a data connection using a wireless LAN Internet access point. The active wireless LAN connection is ended when you end the data connection.

Your device enables different types of communication in a wireless LAN. The two operating modes are infrastructure and ad hoc.

- The infrastructure operating mode allows two kinds of communication: wireless devices communicate with each other through a wireless LAN access point or wireless devices communicate with a wired LAN device through a wireless LAN access point. The advantage of the infrastructure operating mode is that you can have more control over network connections because they pass through an access point. A wireless device can access the services that are available in a regular wired LAN: company database, e-mail, the Internet, and other network resources, for example.
- In the ad hoc operating mode you can send data to and receive it from other devices with compatible wireless LAN support, for example, to be printed. These functions may require an additional third party application to work. No wireless LAN access point is required. Simply make the necessary configurations and start communicating. Ad hoc networking is easy to set up, but communication is limited to devices that are within range and support compatible wireless LAN technology.

If you need to configure the MAC address of your device to a WLAN router, enter ***#62209526#** on the device keypad. The MAC address is shown on the device display.

■ Connection manager

Select **Menu > Connect > Conn. mgr.**

To view the status of data connections or end connections, select **Act. data conn.**

To search for wireless LANs available within range, select **Availab. WLAN**.

View and end active connections



Note: The actual time invoiced for calls by your service provider may vary, depending on network features, rounding off for billing, and so forth.

In the active connections view, you can see the open data connections: data calls, packet data connections, and wireless LAN connections.

Connectivity

To view detailed information about network connections, select the connection from the list and **Options > Details**. The type of information shown depends on the connection type.

To end a network connection, select the connection from the list and **Options > Disconnect**.

To end all active network connections simultaneously, select **Options > Disconnect all**.

To view the details of a network, press the joystick.

Search for wireless LAN

To search for wireless LANs available within range, select **Menu > Connect > Conn. mgr. > Availab. WLAN**. A list of found networks is displayed.

The available wireless LAN view shows a list of wireless LANs within range, their network mode (infrastructure or ad-hoc), signal strength indicator and network encryption indicators, and if your device has an active connection with the network.

To view the details of a network, press the joystick.

To create an Internet access point in a network, select **Options > Define access point**.

■ Modem

Select **Menu > Connect > Modem**.

Together with a compatible computer, you can use your device as a modem to connect to the Web.

Before you can use your device as a modem

- You need the appropriate data communications software on your computer.
- You must subscribe to the appropriate network services from your service provider or Internet service provider.
- You must have the appropriate drivers installed on your computer. You must install drivers for your cable connection, and you may need to install or update Bluetooth or infrared drivers.

To connect the device to a compatible computer using infrared, press the joystick. Make sure the infrared ports of the device and computer are directly facing each other with no obstacles between them.

To connect your device to a computer using Bluetooth wireless technology, initiate the connection from the computer. To activate Bluetooth in your device, select **Menu > Connect > Bluetooth** and select **Bluetooth > On**.

If you use a cable to connect your device to a computer, initiate the connection from the computer.

Note that you may not be able to use some of the other communication features when the device is used as a modem.

■ Mobile VPN

Select **Menu > Tools > Settings > Connection > VPN**.

The Nokia mobile virtual private network (VPN) client creates a secure connection to compatible corporate Intranet and services, such as e-mail. Your device connects from a mobile network, through the Internet, to a corporate VPN gateway that acts as a front door to the compatible corporate network. VPN client uses IP Security (IPSec) technology. IPSec is a framework of open standards for supporting secure exchange of data over IP networks.

VPN policies define the method used by VPN client and a VPN gateway to authenticate each other, and the encryption algorithms that they use to help protect the confidentiality of data. Contact your corporation for a VPN policy.

To use VPN with an application, the application must be associated with a VPN access point. A VPN access point is made up of an Internet access point and a VPN policy.

VPN management

You can manage your VPN policies, policy servers, VPN logs, and key store password in VPN management. VPN policies define how data is encrypted for transfer over unsecured networks. The key store password helps protect private keys.

An access point is where your device connects to the network by way of a data call or packet data connection. To use e-mail and multimedia services or to browse Web pages, you must first define Internet access points for these services. VPN access points pair VPN policies with Internet access points to create encrypted connections.

To manage VPN, select **VPN management > Options > Open** and from the following options:

- **VPN policy** — Install, view, and update VPN policies.
- **VPN policy servers** — Edit the connection settings of VPN policy servers from which you can install and update VPN policies.
- **VPN log** — View the log for your VPN policy installations, updates and synchronizations, and other VPN connections.

Manage VPN policies

To manage VPN policies, select **VPN management > VPN policy > Options** and from the following options:

Connectivity

- **Install policy** — Install a policy. Enter your user name and password for the VPN policy server. Contact your system administrator for your user name and passwords.
- **Define VPN ac. point** — Create a VPN access point that pairs a VPN policy with an Internet access point.
- **Update policy** — Update the selected VPN policy.
- **Delete policy** — Delete the selected VPN policy. If you delete a VPN policy, it is reinstalled when you synchronize your device with the VPN policy server the next time unless it has also been deleted from the server. Similarly, if a VPN policy has been deleted from the server, it is deleted also from your device upon synchronization.

To manage VPN policy servers, select **VPN policy servers > Options > Open** and from the following options:

- **New server** — Add a VPN policy server.
- **Synchronise server** — Install new or update the selected VPN policy.
- **Delete server** — Delete the selected VPN policy server.

To manage VPN policy server settings, select **Options > Open > New server** or **Edit server** and from the following options:

- **Policy server name** — Enter a new name for the server, up to 30 characters.
- **Policy server addr.** — Enter the server address. The policy server address cannot be edited after you connect to the server to install or update VPN policies.
- **Internet access pt.** — Select the Internet access point to connect to the VPN policy server.
- **Key store password** — Change the password of the private key store. The password is created automatically when it is needed for the first time.

View the VPN log

Select **VPN management > VPN log > Open**.

A VPN log records your visits to VPN servers to install, update, and synchronize VPN policies and your VPN connections. Error, warning, and information entries are indicated by an icon on the left-hand side of the entry. To view a log entry in detail, select it. Report the reason codes visible in the detailed view to your system administrators as the codes help to look for causes of possible problems you may have with VPN. When the log size reaches 20 KB, the oldest log entries are deleted to make space for new entries.

Select **Options** and from the following options:

- **Refresh log** — Update the log.
- **Clear log** — Delete the log entries.

■ Email data roaming

Select **Menu > Tools > Settings > Connection > Access point groups**.

Your device allows roaming between wireless access technologies, such as WLAN and GPRS, for e-mail. For example, you can start an e-mail session at home and continue the session on your way to work. While your session continues uninterrupted, your handheld device switches from WLAN to GPRS and back to WLAN when you arrive at your workplace.

Access point groups

1. To create an access point group, select **Access point groups > Options > New group**.
2. In the **Group name** field, enter a name for the group.
3. Define in the **Conn. switching** field whether to show the connection switching process on the display of your device.
4. Choose and edit the access points that belong to this group in the **Access points** section.

To add an access point to the selected access point group, select **Access points > Options > Add access point**, and select the access point to add.

To edit an access point in an access point group, select the access point and **Options > Edit**.

To remove an access point in an access point group, select the access point and **Options > Remove**.

To set the order in which access points are used for email data roaming, select an access point group and **Change**. Scroll to an access point, and select **Options > Raise priority** or **Lower priority**.

To change the STMP settings of an access point, select the desired access point from the access point group list, select **Options**, and select from the following:

- **Override SMTP serv.** — Override the current STMP server settings.
- **SMTP server** — Edit the server name or the server IP address.
- **Secure connection** — Select whether to use secure connection.
- **Use authentication** — Select whether to use authentication.
- **User name** — Edit your user name for the STMP server.
- **Password** — Edit your password for the STMP server.

Connectivity

Configure access point groups for mail and synchronization

To set an access point group for mail, select **Menu > Messaging > Mailbox > E-mail settings > Connection settings > Incoming e-mail > Access point in use > Options > Change**, and select the desired access point group.

To set an access point group for synchronization, select **Menu > Connect. > Sync > Profile > Options > Edit > Connection settings > Access point > Change**, and select the desired access point group.

7. Web

Select **Menu** > **Web** (network service).

Web is one of the two browsers in your device. With **Web**, you can browse regular Web sites. These pages use the extensible hypertext markup language (XHTML) or hypertext markup language (HTML). If you want to browse WAP pages, use **Menu** > **Media** > **Services**. Both of the browsers use the same bookmarks. The links in your received messages open in the **Services** browser.

Check the availability of services, pricing, and fees with your network operator or service provider. Service providers will also give you instructions on how to use their services.

■ Access points

To browse the Web, you need to configure Internet access point settings. If you are using a data call or a GPRS connection, your wireless network must support data calls or GPRS, and the data service must be activated for your SIM card. Your device might have configured the Internet access point settings automatically based on your SIM card. If not, contact your service provider for the correct settings.



Tip: You may receive the Internet access point settings from your service provider as a special text message or from the network operator's or service provider's Web pages.

You can also enter the Internet access point settings manually. See "[Internet access points](#)," p. 41.

■ Browse the Web

Use the joystick for browsing. The joystick is shown as a pointer on a Web page, and you can scroll the pages up, down, left and right with it. When you move the pointer over a link, the pointer changes into a hand. Press the joystick to open the link.

To browse the Web, select a bookmark, and press the joystick. You can also enter the Web address, and press the joystick. Use only services that you trust and that offer adequate security and protection against harmful software.



Tip: When you start to enter the address, addresses of pages you have previously visited that match your input are displayed. To open a page, scroll to the address, and press the joystick.

To open a Web link, scroll to it and press the joystick. On a Web page, new links appear underlined in blue and previously visited links in purple. Images that act as links have a blue border around them.

Addresses of the pages you visit are saved in the **Auto. bookmarks** folder.

Keyboard shortcuts:

- Press **1** to open your **Bookmarks**.
- press **2** to find text.
- Press **3** to return to the previous page.
- Press **5** to switch between your open browser windows.
- Press **8** to open page overview.
- Press **9** to go to a different Web page.

■ Bookmarks

Your device may have some bookmarks loaded for sites not affiliated with Nokia. Nokia does not warrant or endorse these sites. If you choose to access them, you should take the same precautions, for security or content, as you would with any Internet site.

To view a bookmarked Web page, scroll to the bookmark, and press the joystick.

To browse another Web pages, select **Options** > **Navigation options** > **Go to web address**, enter the page address, and select **Go to**.

To delete a bookmark, scroll to it, and press the clear key.

To add a bookmark, select **Menu** > **Web** > **Options** > **Bookmark manager** > **Add bookmark**. Scroll to **Name** to enter a descriptive name for the bookmark, **Address** to enter the Web page address, **Access point** to change the access point to connect to the Web page, and **User name** or **Password** to enter your user name and password, if required by the service provider. To save the bookmark, select **Back**.

■ Download items



Important: Only install and use applications and other software from sources that offer adequate security and protection against harmful software.

Web

You can download different items such as ringing tones, images, operator logos, themes, and video clips. To download an item, scroll to it, and press the joystick. These items can be provided free, or you can purchase them. Downloaded items are handled by the respective applications in your device.

When you start a download, a list of ongoing, paused, and completed downloads from the current browsing session is displayed. To view the list, you can also select **Options > Tools > Downloads**. In the list, scroll to an item, and select **Options** to pause, resume, or cancel ongoing downloads; or open, save, or delete completed downloads.

To purchase items:

1. To download the item, scroll to the link, and press the joystick.
2. Select the appropriate option to purchase the item.
3. Carefully read all the information provided. To continue the download, select **Accept**. To cancel the download, select **Cancel**.

■ End a connection

To end the connection and view the browser page offline, select **Options > Advanced options > Disconnect**; or to end the connection and close the browser, select **Options > Exit**.

Clear the cache

A cache is a memory location that is used to store data temporarily. If you have tried to access or have accessed confidential information requiring passwords, empty the cache after each use. The information or services you have accessed are stored in the cache.

To clear the cache, select **Options > Advanced options > Clear cache**.

■ News feeds and blogs

Select **Menu > Web > Web feeds**.

Feeds usually contain headlines and articles, often about recent news or other topics.



Tip: Blog is a shortening of Weblog, which is a continuously updated Web diary. Often the author's personality is an important factor in the blog.

To download a feed or blog, scroll to it, and press the joystick.

To add a feed or blog, select **Options > Manage feed > New feed**, and enter the information.

To edit a feed or blog, scroll to a feed, select **Options > Manage feed > Edit**, and modify the information.

■ Web settings

Select **Menu > Web > Options > Settings**.

Define the following settings:

- **Access point** — Scroll to the access point to connect to Web pages, and press the joystick.
- **Load imgs. & sounds** — Select **No** to load pages faster when browsing by not loading the images on them.
- **Font size** — Select the font size that you want to use when viewing the Web pages.
- **Default encoding** — Select the correct character encoding for your language.
- **Auto. bookmarks** — Select **On** to save Web page addresses that you visit automatically in the **Auto. bookmarks** folder. To hide the folder, select **Hide folder**.
- **Screen size** — Select **Full screen** to use the whole display area for viewing Web pages. You can press the left selection key to open **Options** and use the available options while browsing in full screen mode.
- **Homepage** — Select the page that you want to appear as your homepage. Select **Default** to use the access point homepage, **User defined** to enter the homepage address, or **Use current page** to use the currently open Web page.
- **Mini map** — Select whether you want to see an overview of the page as a miniature on top of the page you are viewing.
- **History list** — Select whether you want to see miniatures of the pages you have visited when you want to go back in your browsing history.
- **Cookies** — Select to allow or reject the sending and receiving of cookies. Cookies are info the network server collects about your visits to various Web pages. They are necessary if you shop on the Web (for example, to retain the items you buy until you reach the cashier page). However, the information may be misused (for example, you may receive unwanted advertisements in your device).
- **Java/ECMA script** — Some Web pages may include program commands that affect the appearance of the page or interaction between the page and its browsers. To deny the use of such scripts, select **Disabled** (for example, if you have trouble downloading).
- **Security warnings** — Select **Show** or **Hide** to see or hide the security warnings you may receive during browsing.

Web

- **Block pop-ups** — Select whether you want to allow pop-ups. Some pop-ups may be necessary (for example, smaller windows where you write e-mails in Web-based mail systems), but they may also contain unwanted advertising.

■ Services

Select **Menu > Media > Services** (network service).

Services is one of the two browsers in your device. With **Services**, you can browse WAP pages that have been designed specially for mobile devices. For example, operators may have WAP pages for mobile devices. To browse regular Web pages, use the other browser in **Menu > Web**.

Check the availability of services, pricing, and fees with your network operator or service provider. Service providers will also give you instructions on how to use their services.



Tip: To start a connection, press and hold **0** in the standby mode.

8. Media applications

Copyright protections may prevent some images, music (including ringing tones), and other content from being copied, modified, transferred or forwarded.

Select **Menu** > **Media**.

Media contains different media applications that allow you to save and view images, record sounds, and play sound clips.

■ Gallery

Select **Menu** > **Media** > **Gallery**.

Use **Gallery** to access and use different types of media, including images, videos, music, and sounds. All viewed images and videos and all received music and sounds are automatically saved to **Gallery**. You can browse, open, and create folders; and mark, copy, and move items to folders. Sound clips are opened in the Music Player, and video clips and streaming links in the RealPlayer application.

To open a file or a folder, press the joystick. Images are opened in the image viewer.

To create a new folder, select **Options** > **Organise** > **New folder**.

To copy or move files, select a file and **Options** > **Organise** > **Move to folder**, **New folder**, **Move to memory card**, **Copy to memory card**, **Copy to phone mem.**, or **Move to phone mem.**.

To download files into the **Gallery** in one of the main folders using the browser, select **Graphic downl.**, **Video downl.**, **Track downl.**, or **Sound downl.**. The browser opens, and you can choose a bookmark or enter the address for the site to download from.

To search for a file, select **Options** > **Find**. Start to enter a search string (for example, the name or date of the file you are searching for). Files that match the search are shown.

Images

Select **Menu** > **Media** > **Gallery** > **Images**.

Images consists of two views:

- In the image browser view you can send, organize, delete, and rename images stored in your device or memory card. You can set images as wallpaper for your display.
- In the image viewer, which opens when you select an image in the image browser view, you can view, and send individual images.

The following file formats are supported: JPEG, BMP, PNG, and GIF 87a/89a. The device does not necessarily support all variations of the file formats.

To open an image for viewing, select an image in the image browser view, and select **Options** > **Open**. The image opens in the image viewer.

To open the next or previous image for viewing, scroll right or left in the image viewer.

To enlarge the viewed image on the display, select **Options** > **Zoom in**, or press **5** or **7**. To reduce the viewed image on the display, select **Zoom out** or press **0**.

To view the image in full screen size, select **Options** > **Full screen** or press **7** twice. To return to normal view, select **Options** > **Normal screen**.

To rotate an image, select an image, and **Options** > **Rotate**. Select **Right** to rotate the image clockwise by 90 degrees, or select **Left** to rotate the image counterclockwise by 90 degrees.

Manage image files

Copyright protections may prevent some images, ringing tones, and other content from being copied, modified, transferred or forwarded.

To view detailed information about an image, select an image and **Options** > **View details**. Size and format of the file, the time and date the file was last modified and the resolution of the image in pixels are displayed.

To send an image, select the image, **Options** > **Send**, and the method for sending.

To rename an image, select an image and **Options** > **Rename**. Enter a new name, and select **OK**.

To set an image as wallpaper, select the image and **Options** > **Set as wallpaper**.

To add an image to a contact card, select an image and **Options** > **Assign to contact**. The contacts view opens, and you can select the contact for the image.

Organizing images

To create folders to organize your images, select **Options** > **Organise** > **New folder**. Enter a name for the folder, and select **OK**.

To move an image to another folder, select the image and **Options** > **Organise** > **Move to folder**. Scroll to the folder to which you want to move the image, and select **Move**.

RealPlayer

Copyright protections may prevent some images, ringing tones, and other content from being copied, modified, transferred or forwarded.

Select **Menu** > **Media** > **RealPlayer**.

RealPlayer can play video clips and audio files that are stored in the device memory or on a memory card, transferred to your device from e-mail or compatible PC, or streamed to your device over the Web.

Formats supported by **RealPlayer** include MPEG-4, MP4 (not streaming), 3GP, RV, RA, AAC, AMR, and Midi. **RealPlayer** does not necessarily support all variations of a media file format.



Tip: Streaming audio and video files means playing them directly from the Web without downloading them first to your device.

Play video clips and stream links

To select audio and video files to play with **RealPlayer**, select **Options** > **Open**, and scroll to a media clip in your device or on a memory card.

To play streaming media, select a Web link that points to a media clip, and select **Play**; or connect to the Web, browse to a video clip or audio file, and select **Play**. **RealPlayer** recognizes two kinds of links: an `rtsp://` URL and an `http://` URL that points to a RAM file. Before the content begins streaming, your device must connect to a Web site and buffer the content. If a network connection problem causes a playback error, **RealPlayer** attempts automatically to reconnect to the Internet access point.

To play audio and video files stored in your device or on a memory card, select the file and **Play**.

To stop playback or streaming, select **Stop**. Buffering or connecting to a streaming site stops, playback of a clip stops, and the clip rewinds to the beginning.

To view the video clip in full-screen size, select **Options** > **Play in full screen**. The size of the video area changes to normal or full screen. Full screen increases the size of the video to cover the maximum video area possible while the aspect ratio is maintained.

To save a media clip, select **Options** > **Save**, scroll to a folder in device memory or on a memory card, and select **Save**. To save a link to a media file on the Web, select **Save link**.

To fast-forward or rewind the clip during playback, scroll up or down.



Tip: To fast-forward during play, scroll up and hold. To rewind during play, scroll down and hold.

To increase or decrease the volume during playback, press the volume keys.

Send audio files and video clips

You can transfer a media clip to another device or attach a media clip to a multimedia message, document, or slide presentation.

To transfer a media clip through infrared or Bluetooth connection, select a clip and **Options** > **Send**. Select a method to use to send the clip to another device.

To send a media clip inside a message, create a multimedia message, select a clip to attach and **Insert object** > **Video clip** or **Sound clip**.

To remove a media clip you inserted, select **Options** > **Remove** > **Yes**.

Receive videos

Select **Menu** > **Messaging**. Open a message that contains a video clip. Scroll to the clip, and press the joystick.

Select **Pause** or **Stop**, select **Options**, and:

- **Play** — Play the clip from the start.
- **Play in full screen** — Play the clip in full screen mode. Landscape style clips will be rotated by 90 degrees. To switch back to normal view, press any key.
- **Continue** — Resume playing the clip.
- **Continue in full scr.** — Continue playing the clip in full screen mode.
- **Mute** — Mute the sound of the video clip. To turn sound back on, scroll right.
- **Save link** — Save the Web link to a clip.

Media applications

- **Clip details** — View information such as the clip duration and size.
- **Settings** — Change video or connection settings.

The available options may vary.

View information about a media clip

To view the properties of a video clip, audio file, or Web link, select the clip, and select **Options > Clip details**. Information may include the bit rate or the Internet link of a streaming file.

To turn on file protection, select a media clip, and **Options > Clip details > Status > Options > Change**. File protection prevents others from changing a file.

Settings

Select **Menu > Media > RealPlayer > Options > Settings**.

Video settings

Select **Video > Loop > On**, if you want to replay video clips automatically after they finish playing.

Connection settings

Select **Connection**, scroll to the following settings, and press the joystick to edit:

- **Proxy** — Select whether to use a proxy server and to key in the proxy server's IP address and port number.
- **Network** — Change the access point to connect to the Internet and to set the port range used when connecting.

Proxy settings

Proxy servers are intermediate servers between media servers and their users. Some service providers use them for additional security or to speed up access to Web pages that contain media files.

Contact your service provider for the correct settings.

Select **Connection > Proxy**, scroll to the following settings, and press the joystick to edit:

- **Use proxy** — Select **Yes** to use a proxy server.
- **Proxy serv. address** — Enter the IP address of the proxy server. This setting is only available if you select to use a proxy server.
- **Proxy port number** — Enter the port number of the proxy server. This setting is only available if you select to use a proxy server.

Network settings

Contact your service provider for the correct settings.

Select **Connection > Network**, scroll to the following settings, and press the joystick to edit:

- **Default access point** — Scroll to the access point to connect to the Internet, and press the joystick.
- **Online time** — Set the time when **RealPlayer** disconnects from the network when you pause a media clip that plays using a network link. Select **User defined**, and press the joystick. Enter the time, and select **OK**.
- **Lowest UDP port** — Enter the lowest port number of the server port range. The minimum value is 1024.
- **Highest UDP port** — Enter the highest port number of the server port range. The maximum value is 65535.

Advanced network settings

To edit the bandwidth values for different networks, select **Connection > Network > Options > Advanced settings**.

To select the bandwidth for any of the listed networks, scroll to its setting, and press the joystick. Scroll to the desired value, and select **OK**.

To enter the bandwidth yourself, select **User defined**.

Contact your service provider for the correct settings.

To save settings, select **Back**.

■ Music player



Warning: Do not hold the device near your ear when the loudspeaker is in use, because the volume may be extremely loud.

Select **Menu > Media > Music player**.

With the music player, you can play music files, create and listen to track lists, and download music. The music player supports files with extensions such as MP3 and AAC.

Listen to music



Warning: Listen to music at a moderate level. Continuous exposure to high volume may damage your hearing.

Media applications

To select a music track, select **Options** > **Music library**. **All tracks** lists all music on your device. To view sorted songs, select **Albums**, **Artists**, **Genres**, or **Composers**. To play a track, scroll to the track, and select **Options** > **Play**. When a track is playing, to change between play and pause, press **▶** and **⏸**. To stop a track, press **■**.

After you add or remove music files in the device, update your **Music library**. Select **Options** > **Update Music library**. The player searches the device memory for music files and updates them to the **Music library**.

To select the previous or next track, scroll the joystick up or down.

To play the music tracks repeatedly, select **Options** > **Loop**. Select **All** to repeat all the tracks in the current folder, **One** to repeat the selected track, or **Off** to set off the repeating.

To play music in random order, select a folder and **Options** > **Random play**.

To view music track information, scroll to the desired track and select **Options** > **View details**.

Adjust music volume

To control the music volume, press the volume keys. To mute the volume, press the lower volume key until the volume is muted.

Track lists

You can create a new track list and add tracks to it, or select a saved track list.

To create a new track list, select **Options** > **Music library** > **Track lists** > **Options** > **New track list**. Write the name of the new track list, and select **OK**.

To add a track to a track list, open the track list, and select **Options** > **Add tracks**.

Equalizer

Select **Menu** > **Media** > **Music player** > **Options** > **Equaliser**.

You can personalize the sound of your music files with **Equaliser**. You can use preset frequency settings based on styles of music, like classical or rock. You can also create customized settings based on your own listening preferences.

You cannot use other functions of **Music player** while **Equaliser** is open.

With **Equaliser**, you can enhance or diminish frequencies during music playback and modify how your music sounds. There are preset frequency settings in your device, for example **Rock**.

To use a preset frequency setting when playing music, scroll to the frequency setting you want to use, and select **Options** > **Activate**.

Create your own frequency setting

1. To create your own frequency setting, select **Options** > **New preset**.
2. Enter a name for the preset frequency setting, and select **OK**.
3. Scroll up or down to move between the frequency bands and set the frequency on each band. To move between bands, scroll left or right.
4. Select **Back** to save the new frequency setting or select **Options** > **Reset to defaults** to set the bands at a neutral frequency and start over.

To edit a preset frequency setting, select **Options** > **New preset** or **Options** > **Edit**.

To modify the frequency of a preset setting, scroll to the frequency bands, and scroll up or down to increase or decrease their values. You hear your frequency adjustment immediately in the playback.

To reset the frequency bands to their original values, select **Options** > **Reset to defaults**.

To save your new or edited settings, select **Back**.

Recorder

Select **Menu** > **Media** > **Recorder**.

With **Recorder**, you can record up to 60 seconds of a voice memo, save the voice recording as a sound clip, and play the sound clip. **Recorder** supports the AMR format.

Press the voice key to activate **Recorder**. If you have logged in to push to talk, the voice key works as a push to talk key and does not activate **Recorder**.

To record a voice memo, select **Options** > **Record sound clip**. Select **Pause** to pause the recording and **Record** to resume recording. When you finish recording, select **Stop**. The sound clip is automatically saved.

The maximum length of a voice recording is 60 seconds, but it also depends on the storage space available in device memory or on a memory card.

Media applications

Play a voice recording

To listen to a voice recording that you just recorded, select the play icon (▶). Select **Stop** to cancel playback. The progress bar displays the playing time, position, and length of a voice recording.

To pause playback of a voice recording, select **Pause**. Playback resumes when you select **Play**.

Voice recordings that you receive or record are temporary files. You must save the files that you want to keep.

■ Flash player

Select **Menu** > **Media** > **Flash Player**.

With **Flash Player**, you can view, play, and interact with flash files made for mobile devices.

To open a folder or play a flash file, scroll to the folder or file, and press the joystick.

To send a flash file to compatible devices, scroll to it, and press the call key. Copyright protection may prevent the sending of some flash files.

To switch between flash files saved on your device memory or memory card, scroll left or right.

The available options may vary.

9. Office applications

Select **Menu** > **Office**.

Some office applications are not available in all languages.

Opening a large file may not be possible or it may take a while.

■ File manager

With **File mgr.**, you can manage the contents and properties of files and folders. You can open, create, move, copy, rename, and search for files and folders. Copyright protection may prevent sending some files.

Manage files

To manage files, scroll to a folder or file, and select **Options**.

Select the following:

- **Open** — Open a file. Scroll to the desired file, and select **OK**.
- **Send** — Send selected files. Scroll to the desired files, and select **OK**.
- **Delete** — Delete selected files. Scroll to the desired files, and select **Clear**.
- **Move to folder** — To move the folder or file to another folder, scroll to the desired file or folder, and select **OK**. Default folders such as sound clips in gallery cannot be moved or deleted.
- **Copy to folder** — Save a copy of the folder or file in another folder. Scroll to the desired file or folder, and select **OK**.
- **New folder** — Create a folder.
- **Mark/Unmark** — Open a submenu.
- **Rename** — Rename a file or folder. Scroll to the desired file or folder, enter the new name, and select **OK**.
- **Find** — Search for specific folders or files. Select the type of memory to search, and enter the text that you wish to find.
- **Receive via infrared** — Receive a file using an infrared connection.
- **View details** — View information about files.
- **Memory details** — Check the memory consumption in device memory or a memory card.

Search for files

1. To search for files, select **Options** > **Find**.
2. Select the memory you want to search.
3. Enter the search text, and press the joystick. The folders and files whose names contain the search text are displayed.
4. Select **Find** to conduct another search.

■ Documents

You can open, edit, and save documents created with Microsoft Word for Windows versions 97 or later. Note that not all features and formatting of the original files are supported.

Select **Menu** > **Office** > **Docum.**

To open an existing document, browse for the folder and document, and press the joystick. To read the document, select the middle view.



Tip: To open a recently used document, select **Options** > **Most recent files**, select the document, and press the joystick.

To create a new document, select **Options** > **New file**. Select **Blank** to create a new document without using a template or **Use template** to create a document based on an existing template.

To read a document, select the middle view and **Options**. You can browse for different types of objects in the document, zoom in or out, switch between full and normal screen views, or view objects, such as images. You can also search for text and edit application settings such as zooming, scrolling, and handling of invisible characters.



Tip: If you are reading a large document and want to continue to read it later, select **Back** to close the document. Do not change to the editing mode.



Tip: To switch between full and normal screen views in an open document, press *****. To zoom in, press **5**, and to zoom out, press **0**.

View objects in a document

To view all objects, such as tables, comments, workbooks, and video clips in their place in the document, select the middle view and **Options** > **Browse** > **Pages and objects**.

Office applications

To open a table or comment, scroll to the object or its icon, and press the joystick twice.

To open an image or go to a hyperlink or reference, scroll to the object, and press the joystick three times.



Tip: Select **Options > Back to reference** to return to the link of the referenced item.

Format documents

To be able to edit a document, you must activate the edit mode: select the middle view and **Options > Edit document**.

To edit the font, select the text and **Options > Format > Font**. You can change the font type, size, color, and background. Select **Options > Preview** to view the current formatting.

To format the font style, select the text and **Options > Format > Font formatting**. Select the appropriate formatting option. You can add bold, italic, underline, and strikethrough formatting, or position the text in superscript or subscript format.

To format a paragraph, select the paragraph and **Options > Format > Paragraph**. You can modify the text alignment, line spacing, and left and right margins.

To insert bullets, insert the cursor in the text or paragraph, and select **Options > Format > Bullets**. In the bullet page of the formatting settings, you can set the bullets to be visible.

To format the border settings, select **Options > Format > Borders**. The current border is displayed. Select the border you want to modify, and press the joystick. Select the border style and color you want. Select **Back > Options > Apply to**, and the location. For example, if you select **Top**, the border settings are assigned to the top border.

To insert an object into a document, select **Options > Insert object**. Scroll to the type of object you want to insert, and select **Options > Insert new** to open the corresponding editor and create a new file, or **Insert existing** to open a list of existing files.

To format the style settings of a paragraph, select **Options > Format > Style**. Select the style you want to format and **Options > Edit**. Select **New style** to add a new style. In the style editing view, select **Options > Format**, and the style you want. You can modify the font, formatting, paragraph, bullet, and border styles.

To save a document, select **Options > Saving options > Save as**. Specify the file name and location where the file is saved. You can also specify the file type.

View document structure

To view the document outline, select the left view. Select **Options > Expand** or **Collapse** to show only main chapters or all subchapters. If there are objects in the document, select **Options > Display objects** or **Display headings** to switch between object list and chapter heading views.



Tip: To open a selected chapter in the normal view, scroll to the chapter, and press the joystick.

Preview the page layout

To preview the page layout, select the view on the right and **Options**.

Define the following options:

- **Normal view** — Show the current open page in normal view.
- **Pan and zoom** — Zoom the page layout view.
- **View** — Select **Full screen** or **Normal screen** to switch between full screen and normal views.

To zoom the page layout, select the view on the right, scroll to the desired page, and select **Options > Pan and zoom**. A black selection frame appears above the page layout, showing the area to zoom. Select the area and **Options > Zoom**.

Select from the following options:

- **In** or **Out** — Select **In** to zoom in one step in the selected area, or **Out** to zoom out one step in the selected area.
- **Fit to screen** — Adjust the zoom level to fit the page to the screen width.
- **Ratio** — Edit the zoom level, enter the zoom ratio between 10 and 999, and select **OK**.



Tip: While the selection frame is displayed, scroll left, right, up, or down with the joystick to move around the page. Press **5** to reduce and **0** to enlarge the selection frame. Press the joystick to zoom the selected area.

Find text

To find a piece of text from the document, select **Options > Find**, enter the text in the **Find:** field, and press the joystick.

To change search options such as case sensitivity and search direction, select **Options > Search options**.

To find and replace a piece of text in the document, in the editing mode, select **Options > Find and replace**. Enter the text in the **Find:** field, and enter a replacement text in the **Replace with:** field. Select **Options > Replace**. When the text is found, select

Replace to replace the text and move to the next match, or select **Ignore** to skip the current match and **Next** to move to the next match.



Tip: To skip the current match and move to the previous and next ones, scroll up and down with the joystick.

Table editor

You can view tables created in applications, like documents and MS Word.

To view a table in a file, scroll to the file so that a dotted line appears around it, and press the joystick.

To change the selected cell, scroll up, down, left or right. If the selected cell does not fit into visible area, pressing the joystick pans the whole content first before the cell changes.

To edit the text in a cell, select the cell, and press the joystick. To end editing, press the joystick again.

Select **Options** and from the following options:

- **Zoom** — Zoom the table view in, out and to edit a zoom ratio.
- **Format** — Modify the font style and formatting, paragraphs, bullets, and borders.
- **Cell size** — Change the size of the cells, rows and columns.
- **Cells** — Select option to insert, delete, merge or separate cells.
- **Copy table** — Copy the text of the whole table to the clipboard.

■ Sheet

Select **Menu > Office > Sheet**.

You can store data in a file that is called a workbook. Each workbook contains at least one worksheet. A workbook can also contain charts, which are based on data from a worksheet.

To open an existing workbook, browse for the folder where the file is saved, and press the joystick.

To create a new workbook, select **Options > New file**. Select **Blank** to create a new file without using any template or **Use template** to create a file based on an existing template. Select the worksheet in the outline view, and press the joystick to open the file.



Tip: To open a recently used workbook, select **Options > Most recent files**.

Outline view

Outline view enables you to open and navigate worksheets, charts, and named cells.

In outline view, each worksheet has its own main level icon. Under the main level there are sub-items for charts and named cells.

To open the outline view, scroll to the folder and file, and press the joystick. The outline view opens. Recently used worksheet opens the latest view and settings.

To show and hide charts and cells, scroll to the worksheet, press the joystick, and select **Options > Collapse** or **Expand**.

To delete or rename worksheets, charts, or named cells, scroll to the item, and select **Options > Worksheet, Chart, or Named cell**, and the appropriate option.

To create a new worksheet, chart, or named cell, scroll to the position you want to add the new item, and select **Options > Insert > Worksheet, Chart, or Named cell**.

Work with worksheets

To insert data into cells, open the worksheet view. Use the joystick to move to the cell, and select **Options > Show cell field > Edit cell field**. An upper part editing field opens. Enter the data, and select **Done** to finish editing.

To select a range of cells, press and hold the edit key while you scroll right.

To select rows, move the cursor to the first cell on a row, and press and hold the edit key while you scroll left. To select columns, move the cursor to the first cell on a column, and press and hold the edit key while you scroll up.

To select the entire worksheet, move the cursor to cell A1, and press and hold the edit key while you scroll up and left.

To modify the worksheet view, select **Options > View**.

Select from the following options:

- **Pan worksheet** — Define the size of the visible area of the whole worksheet.
- **Full screen** — Switch to the full screen view.
- **Hide headers** — Hide header field and release more space for the worksheet grid.
- **Hide gridlines** — Hide gridlines.



Tip: To switch between the full and normal screen views, press *. To zoom in, press 5; to zoom out, press 0.

To add a comment to the selected cell, select **Options > Advanced options > Insert comment**. Write a comment, and select **OK**. The cell is marked with a small triangle in the upper right corner of the cell.

To keep rows visible when scrolling, select a cell below the area that you want to remain visible and **Options > Advanced options > Freeze panes**. To keep columns visible, select a cell to the right of the area that you want to remain visible and **Options > Advanced options > Freeze panes**.

To change the size of rows and columns, select **Options > Cell size > Row height** or **Column width**.

To sort rows from left to right, select the cells you want to sort and **Options > Advanced options > Sort rows**. You can select the number of the row to use as a primary sorting criteria. You can change the direction of the sorting order and ignore or match the case sensitivity.

To sort columns from top to bottom, select the cells you want to sort and **Options > Advanced options > Sort columns**. You can select the column to use as a primary sorting criteria. You can change the direction of the sorting order and ignore or match the case sensitivity.

To format a font style, select the cells whose font style you want to modify and **Options > Format > Font**. You can change the font type, size, text color, and background color of the cell.

To change a font formatting, select the cells you want to format and **Options > Format > Font formatting**. You can bold, italicize, underline, strikethrough, or position the text in superscript or subscript format within a cell.

To align cell contents, select the cells whose alignment you want to modify and **Options > Format > Alignment**. You can change both the horizontal and vertical alignment and wrap text to adjust the row height of the selected cells to display the entire content of a cell.

To format cell borders, select the cells whose borders you want to modify and **Options > Format > Borders**. You can modify all or only vertical, horizontal, upper, lower, left or right borders. Select **Options > Change** to edit the style and color of the borders.

To change the number format, select the cells whose number format you want to modify and **Options > Format > Numbers**. Select the number format from the list. If the format you select includes decimal values, enter a number from 0 to 12 to indicate the decimal place.



Example: If you want to compare and calculate different loan rates, you can set the number format to **Percentage**.

Work with cells

To edit a cell, select a cell and **Options > Show cell field > Edit cell field**. An upper part editing field opens. Start entering the data, and select **Done** when you finish editing.

To insert cells, select the area where you want to insert new cells and **Options > Cells > Insert**. You can insert cells above (**Shift cells down**) or to the left (**Shift cells right**) of the selected range. If you select only one cell, only one new cell is inserted. If you select a range of cells, a corresponding range of blank cells is inserted. You can also insert a new row or column.

To clear contents or format from cells, select the cells and **Options > Cells > Clear**. If you select **Formats**, the formatting of the selected cells is removed, but the content remains. The default style is used. If you select **Content**, the content of the selected cells is deleted, but the formatting stays the same. You can also remove both formatting and contents of the selected cells.

To delete cells, rows, or columns, select the items you want to delete and **Options > Cells > Delete**. You can delete an entire row or column. If you select **Shift cells left**, the selected cells are deleted, and the cells right of the selected cells are shifted left. If you select **Shift cells up**, the cells below the deleted cells are shifted up.



Tip: When you delete information on which a chart is based, the information is also removed from the chart.

Insert functions

Functions are used for automating calculations.

To insert a function into a cell, select a cell. Select **Options > Insert > Function** and a function from the list. For example, **#MIN** finds the lowest value in the numeric contents of a selected range of cells, **#AVERAGE** calculates the average of the values, and **#SUM** adds the values together. Once you have selected a function, press the joystick. The function is inserted into the selected cell. On the worksheet, enter the cells you want to include in the function inside the brackets, and press the joystick.



Tip: Before inserting a function, verify that **Options > Show cell field > Edit grid** is active and that the selected cell is empty or starts with =.



Example: You want to add up the numbers in cells C2 to C6 and have the results appear in cell C7. Select cell C7 and **Options > Insert > Function**. Select **#SUM**, and press the joystick. Enter **C2:C6** inside the brackets, and press the joystick. The sum appears in cell C7.

To get more information on a function, select a cell and **Options > Insert > Function**. Select a function from the list and **Options > Description**.

Web links

To open a Web link, select the cell with the Web link. Select **Options > Link > Go to**.

To edit a Web link, select the cell with the Web link. Select **Options > Link > Edit**. You can edit the Web address and the name of the link.

Create and modify charts

When you change the information on a worksheet, the chart is updated simultaneously.

To open a chart, open the outline view, select the worksheet and chart, and press the joystick. If charts are not visible, select **Options > Expand**.

To create a new chart, select the worksheet cells that contain the information you want to include in the chart and **Options > Insert > Chart**. To change the general appearance of an existing chart, open a chart view. Select **Options > View > Chart**. You can change the name of the chart and define the cell area. You can change the type of the chart, and make the chart two or three-dimensional or change the color of the background and axis. Scroll right to add a title to the chart and axis.

To format a chart in more detail, open a chart view. Select **Options > View** and the object you want to edit. You can change the series, X-axis, and Y-axis settings (such as the tick marks of either axis).

Find text

To find text, open the worksheet view, and select **Options > Find**. Enter the text in the **Find:** field, and press the joystick. When the cell is found, press the joystick again to find the next match.

To change the search content and direction, select **Options > Search options**.

To find and replace a cell that includes text, open the worksheet view, and select **Options > Find**. Enter the text to be replaced in the **Find:** field, enter the new text in the **Replace with:** field, and press the joystick. When the cell is found, select **Replace** to replace the text and move to the next match. Select **Ignore** to skip the current match and **Next** to move to the next match.



Tip: To skip the current match and to move to the previous and next match, scroll up and down.

■ Presentation

You can open, view, edit, and save presentations created with Microsoft PowerPoint 97 or later. You can also create new presentations. Note that not all features and formatting of the original files are supported.

Select **Menu > Office > Presentat.**

To open an existing presentation, browse for the folder and file, and press the joystick.



Tip: To open a recently viewed presentation, select **Options > Most recent files**.

To create a new presentation, select **Options > New file**. Select **Blank** to create a new presentation without using a template or **Use template** to create a presentation based on an existing template.

To use an existing template, scroll to the template folder and file, and press the joystick. Select **Open template** to modify the template or **Use template** to create a new document based on the current template.

View slide shows

To start a slide show, select **Options > Presentation**.

Select from the following options:

- **Manual** — Move from one slide to another manually.
- **Slide show** — Move from one slide to another manually, or use the automatic slide switching. You must specify the duration for a slide.
- **Manual looped** — The slide show continues from the beginning when the last slide of a presentation has been shown.
- **Looped slide show** — The slide show continues automatically from the beginning when the last slide of a presentation has been shown.

To move between slides in a slide show, scroll up to display a previous slide and down to display the next slide.

To end the slide show, press the right selection key.

Show slide shows with a data projector

You can show slide shows with a compatible data projector, or other compatible projection system.

Office applications

To be able to show slide shows with a compatible data projector, you must install the drivers of the data projector. If the drivers are not installed and the devices are not connected, the menu options are not visible. For more information, check with the data projector manufacturer or its representative.

To show slide shows with a data projector, select the presentation and **Options > View > Data projector**. From the list of devices, select the device you want to use. Select **Options > Enable** to show screen content. To start the slide show, select **Options > Presentation > Slide show**.

To stop showing a slide show with a data projector, select **Options > View > Disable data projector**.

Work with different views

The presentation application consists of different views that help you when reading and creating presentations.

To switch between the different views, scroll right and left with the joystick.

Layout view

To open the layout view, select the view in the middle. To enable or disable the visibility of charts, comments, tables, images, and shapes, select **Options > Settings**, scroll to the settings item, and press the joystick.

To work in the layout view, select **Options**. You can edit and insert new slides, switch between different screen views, delete or hide certain slides, undo or redo latest modifications, and see a slide show. You can also save the presentation, and send it to another device. The available options may vary.

Outline view

The outline view is used to navigate through long presentation documents. The view enables fast vertical scrolling, rearranging of slides, and editing of objects.

To open the outline view, scroll to the view on the left. In the outline view, each slide has its own main level entry. Under the main level there is a sublevel for each text field and object.

To view the slide content, select **Options > Expand**. To hide the content, select **Options > Collapse**. To collapse or expand all entries, select **Options > View > Collapse all** or **Expand all**.

To change the order of slides, scroll to the slide you want to move, and select **Options > Slide > Move**. Scroll up and down to select a new location, and select **OK**.

To insert new slides into a presentation, select **Options > Insert new slide**. Select a template for the new slide. The new slide is inserted after the currently selected slide.

To copy, paste, or remove slides, select a slide and **Options > Slide > Copy, Paste**, or **Delete**.

To show or hide slides in the outline view, select a slide and **Options > Slide > Show** or **Hide**.

Notes view

In the notes view, you can read notes that are attached to slides in the presentation. You can also add your own notes.

To open the notes view, scroll to the view on the right. Each slide has its own main level entry. Under the main level there is a sublevel for notes. If notes are not visible, select **Options > View > Expand all**. To edit a note, scroll to the note, and press the joystick.

To add a note, scroll to a slide without notes, and select **Options > Create note**.

To delete a note, select the note and **Options > Delete note**.

Master slide view

The master slide view lets you view layout details. If you edit the master slide, the changes are updated to all slides in a presentation.

To open the master slide view, open the layout view, and select **Options > View > Master slide**. To edit the master slide, press the joystick.

Edit presentations

To edit a presentation, open the layout view, and select **Options > Edit slide**. Scroll right or down with the joystick to move forward and left or up to move backward. Select **Options**.

Define the following options:

- **Add title, Add subtitle, Add text, Insert table, Insert image** — Add a new text or object inside the selected area.
- **Edit text, Edit table, Edit document, Edit workbook** — Edit the selected object.
- **Edit object** — Select **Move** to move the object, scroll to the item, and press the joystick. Select **Resize** to change the size of the object. Scroll right and left to change the horizontal size of the object and up and down to change the vertical size. To accept

Office applications

the changes, press the joystick. Select **Rotate** to rotate the object. Scroll right to rotate the object clockwise and left to rotate counterclockwise. To accept the changes, press the joystick. Select **Properties** to edit text, line, border, or background properties of the object.

- **Object** — Delete, copy, paste, or add a link to the selected object.
- **Object position** — Change the layered position of the selected object in the presentation: up, down, front, or back.
- **Insert** — Add a new text box, image, shape, table, or comment to the presentation.
- **Undo, Redo** — Withdraw the latest modifications.

To move one or several objects inside a slide, scroll to the objects, and press the joystick in each object you want to edit. Select **Options > Marked objects > Move**. To move the position of the marked objects, scroll right, left, up, and down. To accept the changes, press the joystick. You can also delete or align the marked objects, and create a group of the marked objects. The group forms a new modifiable object. To unmark previously marked objects, select **Options > Unmark all**.

To define font settings, open the layout view, and select **Options > Edit slide**. Scroll to the text field, and select **Options > Edit text > Options > Format > Font**. You can change the font type, size, and color.

To format the font style, open the layout view, and select **Options > Edit slide**. Scroll to the text field, and select **Options > Edit text > Options > Format > Font formatting**. Select the appropriate formatting option. You can add bold, italic, underline, and strikethrough formatting, or position the text in superscript or subscript format.

To format a paragraph, open the layout view, and select **Options > Edit slide**. Scroll to the text field, and select **Options > Edit text > Options > Format > Paragraph**. You can change the text alignment, line spacing, and width of the left margin.

To change the bullet style, open the layout view, and select **Options > Edit slide**. Scroll to the text field, and select **Options > Edit text > Options > Format > Bullets**. You can set the bullets to be visible, change the type of the bullet, and define the size and color.

To edit the text box settings, select the layout view and **Options > Edit slide**. Scroll to the text box, and select **Options > Edit object > Properties**. You can change the position of the text inside the text box, and turn text wrapping on or off.

To modify borders, select the layout view and **Options > Edit slide**. Scroll to the object that has borders, and select **Options > Edit object > Properties**. You can modify all or only vertical, horizontal, upper, lower, left, or right borders.

To format line settings, select the layout view and **Options > Edit slide**. Scroll to the object that has lines, and select **Options > Edit object > Properties**. You can change the line color and style of elements such as dots, dashes, or thick lines.

To format background settings, select the layout view and **Options > Edit slide**. Scroll to an object, and select **Options > Edit object > Properties**. You can change the color of the background, and enable or disable the visibility of a styled background.

Edit tables

To edit a table, select the layout view and **Options > Edit slide**. Scroll to the table, and select **Options > Edit table**. A highlight indicates the active cell. To change the selected cell, scroll up, down, left, and right. Select **Options**.

Select from the following options:

- **Edit text** — Modify the text of the current cell.
- **Insert** — Add rows or columns to the table. A new column is inserted to the left of the selected cell, and a new row is inserted above the selected cell.
- **Delete** — Remove full rows or columns from the table.
- **View** — Zoom in or out in the table, adjust the zoom level to fit the page to the screen width, or change the zoom level.
- **Undo** and **Redo** — Withdraw the latest modifications.

Find text in a presentation

To find a piece of text from in the presentation, select any of the views. Select **Options > Find**, enter the text in the **Find:** field, and press the joystick.

To change the search option for case and whole words, select **Options > Search options**.

To find and replace a piece of text in the presentation, select any of the views. Select **Options > Find**. Enter the text to be replaced in the **Find:** field, enter the new text in the **Replace** field, and press the joystick. When the text is found, select **Replace** to replace the text and move to the next match, or select **Ignore** to skip the current match and **Next** to move to the next match.



Tip: To skip the current match and move to the previous and next ones, scroll up and down.

■ Screen export

You can show the screen of the device to an audience with a compatible data projector, or other compatible projection system. The screen content is transferred to the data projector using, for example, a Bluetooth connection.

Select **Menu > Office > Screen export**.

Office applications

To be able to show screen content with a compatible data projector, you must install the drivers of the data projector. For more information, check with the data projector manufacturer or its representative.

Not all applications support this feature. You can start the external viewer in two ways: from the **Office** folder or inside an application that supports it.

Show screen content

To show screen content with a data projector, open the screen export application, and select **Options > Select device**. In the list of available devices, scroll to the device you want to use, and select **OK**. Select **Options > Enable** to show screen content.

To hide the screen content, select **Options > Hide**. The screen exporter application is moved to the background.

To stop showing screen content, select **Options > Disable**.

■ Print

Print a message or file from the device. Preview a print job, define page layout options, select a printer, or print to a file.

Before you print, make sure that your device is properly connected to the printer.

To print a message or file, open the message or file, and select **Options > Printing options**.

Define the following options:

- **Printer** — Select an available printer from the list.
- **Print** — Select **All pages**, **Even pages**, or **Odd pages** as the print range.
- **Print range** — Select **All pages in range**, **Current page**, or **Defined pages** as the page range.
- **Number of copies** — Select the number of copies to print.
- **Print to file** — Select to print to a file and determine the location for the file.

You may not be able to print all messages, such as multimedia messages or other special message types.

To preview a file or message before you print, select **Options > Printing options > Preview**.

Change the page layout before printing

To change the page layout before printing, select **Options > Printing options > Page setup** and from the following tabs:

- **Paper size** — Change the paper size or orientation and customize the height and width.
- **Margins** — Change the size of the left, right, top, or bottom margins.
- **Header** — The maximum length of the header is 128 characters. You can set the distance from the header to the text and choose to include the header on the first page of the document.
- **Footer** — The maximum length of the footer is 128 characters. You can set the distance from the footer to the text.

To add or delete a printer, select **Menu > Office > Printers > Options > Add or Delete**.

10. Settings

Select **Menu** > **Tools** > **Settings**.

You can define and modify various settings of your device. Modifying these settings affects the operation of your device across several applications.

Some settings may be preset for the device or sent to you in a configuration message by your network operator or service provider. You may not be able to change such settings.

Scroll to the setting that you want to edit, and press the joystick to do the following:

- Switch between two values, such as on or off.
- Select a value from a list.
- Open a text editor to enter a value.
- Open a slider to decrease or increase the value by scrolling left or right.

■ Phone settings

Select **Phone** to change the language settings, standby mode settings, and display settings of your device.

General settings

Select **General** and from the following:

- **Phone language** — Select a language from the list. Changing the device language affects every application in your device. When you change the language, the device restarts.
- **Writing language** — Select a language from the list. Changing the writing language also affects the characters that are available when writing text and the predictive text dictionary that is used.
- **Predictive text** — Select **On** to use predictive text input. The predictive text dictionary is not available for all languages.
- **Welcome note / logo** — Select **Default** to use the default image, **Text** to enter a welcome note of your own, or **Image** to select an image from the Gallery. The welcome note or image is displayed briefly each time you switch on the device.
- **Orig. phone settings** — Restore the original device settings. To do this, you need your device lock code. After resetting, the device may take a longer time to power on. Documents, contact information, calendar entries, and files are unaffected.

Standby mode settings

Select **Standby mode** and from the following:

- **Active standby** — Select **On** to have shortcuts to different applications available in the active standby mode.
- **Left selection key, Right selection key** — Change the shortcuts that open from the left and right selection keys in the standby screen. Press joystick, select a function from the list, and **OK**.
- **Navigation key right, Navigation key left, Navigat. key down, Navigation key up, Selection key** — Change the shortcuts that open when you scroll to different directions. These settings are not available if you select **Active standby** > **On**.
- **Standby apps** — Select the applications that you want to access from the active standby.
- **Active standby mailbox** — Select the inbox or the mailbox that is shown in the active standby.
- **Active standby plug-ins** — Select the plug-ins that are shown in the active standby. You can, for example, see how many voice mails you have. Even if you switch off the active standby notifications for missed calls and messages, the default notification will still show them. The available plug-ins may vary.

Display settings

Select **Display** and from the following:

- **Light sensor** — Adjust the amount of light required to illuminate the device display.
- **Power saver time-out** — Select the amount of time before the screen saver is activated. Activating the screen saver lengthens the device operating time.
- **Light time-out** — Set how quickly after last keypress the display dims.

■ Call settings

Select **Call** and from the following:

- **Send my caller ID** — Select **Yes** to display your phone number to the person you are calling or **Set by network** to let the network to determine whether your caller ID is sent.
- **Send my net call ID** — Set this feature on if you want to display your net caller ID to the person you are calling.
- **Call waiting** — Select **Activate** to be notified of a new incoming call while you have a call in progress or **Check status** to check if the function is active on the network.
- **Internet call waiting** — Activate this feature to be notified of a new incoming call while you have a net call in progress.

Settings

- **Internet call alert** — Set this on if you want the device to respond to the caller that it is busy. If you set this off, the device emits a busy tone to the caller and you receive a notification about the missed call.
- **Default call type** — Select **Cellular** to make normal calls to the phone number or **Internet** to use VoIP to call the number or address.
- **Reject call with SMS** — Select **Yes** to send a text message automatically to the person who is calling you informing why you cannot answer their incoming call.
- **Message text** — Enter the text that is sent when you cannot answer an incoming call and want to automatically send a text message as a reply.
- **Image in video call** — Select **Use selected** to select a still image to be displayed instead of a video during a video call or **None** to not send any image during a video call.
- **Automatic redial** — Select **On** to redial a number if it was busy at the first call attempt. Your device makes a maximum of 10 attempts to connect the call.
- **Summary after call** — Select **On** to briefly display the approximate duration of the last call.
- **Speed dialling** — Select **On** to activate speed dialing on your device. To dial a phone number assigned to the speed dialing keys (2-9), press and hold the key.
[See "Speed dial," p. 19.](#)
- **Anykey answer** — Select **On** to answer an incoming call by briefly pressing any key, except the end key.
- **Line in use** — Select **Line 1** or **Line 2** to change the phone line for outgoing calls and text messages (network service). This setting is displayed only if the SIM card supports the alternate line service and a subscription to two phone lines.
- **Line change** — Select **Disable** to prevent line selection (network service). To change this setting, you need the PIN2 code.
- **Internet call alert** — Select **Off** to notify incoming net calls that your device is busy or **On** to accept incoming net calls.

■ Connection settings

Select **Menu** > **Tools** > **Settings** > **Connection** and from the following:

- **Access points** — Set up new or edit existing access points. Some or all access points may be preset for your device by your service provider, and you may not be able to create, edit, or remove them.
- **Access point groups** — Set up new or edit existing access point groups that are used in automatic connection establishment and e-mail roaming.
- **Packet data** — Determine when packet data connections are used, and enter the access point if you use your device as a modem for a computer.
- **Internet tel. settings** — Define settings for net calls.
- **SIP settings** — View or create session initiation protocol (SIP) profiles.
- **Data call** — Set the time-out period after which data call connections automatically end.
- **VPN** — Install and manage VPN policies, manage VPN policy servers, see the VPN log, and create and manage VPN access points.
- **Wireless LAN** — Determine if the device displays an indicator when a wireless LAN is available, and how often the device searches for networks.
- **Configurations** — View and delete trusted servers from which your device may receive configuration settings.

To obtain information about wireless LAN or subscribing to a packet data service and the appropriate connection and configuration settings, contact your network operator or service provider.

The settings available for editing may vary.

Access points

Select **Menu** > **Tools** > **Settings** > **Connection** > **Access points**.

An access point is where your device connects to the network by way of a data connection. To use e-mail and multimedia services or to browse web pages, you must first define access points for these services.

An access point group is used for grouping and prioritizing access points. An application can use a group as a connection method instead of a single access point. In that case, the best available access point inside a group is used for making the connection, and in case of e-mail, also for roaming.

Some or all access points may be preset for your device by your service provider, and you may not be able to create, edit, or remove them.

[See "Internet access points," p. 41.](#)

Access point groups

Select **Menu** > **Tools** > **Settings** > **Connection** > **Access point groups**.

An access point group is used for grouping and prioritizing access points. An application can use a group as a connection method instead of a single access point. In that case the best available access point inside a group is used for making connection and in case of e-mail, also for roaming. [See "Access point groups," p. 49.](#)

Packet data

Select **Menu** > **Tools** > **Settings** > **Connection** > **Packet data**.

Your device supports packet data connections, such as GPRS in the GSM network. When you are using your device in GSM and UMTS networks, it is possible to have multiple data connections active at the same time; access points can share a data connection, and data connections remain active (for example, during voice calls). See "[Connection manager](#)," p. 47.

Packet data settings

The packet data settings affect all access points using a packet data connection.

Select from the following:

- **Packet data conn.** — Select **When available** to register the device to the packet data network when you switch the device on in a supported network. Select **When needed** to establish a packet data connection only when an application or action requires it.
- **Access point** — Enter the access point name provided by your service provider to use the device as a packet data modem to your computer.

These settings affect all access points for packet data connections.

Net call settings

Select **Menu** > **Tools** > **Settings** > **Connection** > **Internet tel. settings**. Select **Options** > **New profile** or **Options** > **Edit**.

Scroll to **Name**, press the joystick, enter a name for the profile, and select **OK**.

Scroll to **SIP profiles**, press the joystick, select a profile and **OK**. SIP protocols are used for creating, modifying, and terminating communications sessions such as net calls with one or more participants. SIP profiles include settings for these sessions.

To save your settings, press **Back**.

Session initiation protocol (SIP) settings

Select **Menu** > **Tools** > **Settings** > **Connection** > **SIP settings**.

Session initiation protocols (SIP) are used for creating, modifying, and terminating certain types of communication sessions with one or more participants (network service). SIP profiles include settings for these sessions. The SIP profile used by default for a communication session is underlined.

To create a SIP profile, select **Options** > **Add new** > **Use default profile** or **Use an existing profile**.

To edit a SIP profile, scroll to it, and press the joystick.

To select the SIP profile you want to use by default for communication sessions, scroll to the profile, and select **Options** > **Default profile**.

To delete a SIP profile, scroll to it, and press the clear key.

Edit SIP profiles

Select **Menu** > **Tools** > **Settings** > **Connection** > **SIP settings** > **Options** > **Add new** or **Edit**.

Select from the following:

- **Profile name** — Enter a name for the SIP profile.
- **Service profile** — Select **IETF** or **Nokia 3GPP**.
- **Default access point** — Select the access point to use for the Internet connection.
- **Public user name** — Enter your user name received from your service provider.
- **Use compression** — Select if compression is used.
- **Registration** — Select the registration mode.
- **Use security** — Select if security negotiation is used.
- **Proxy server** — Enter the proxy server settings for this SIP profile.
- **Registrar server** — Enter the registration server settings for this SIP profile.

The settings available for editing may vary.

Edit SIP proxy servers

Select **Menu** > **Tools** > **Settings** > **Connection** > **SIP settings** > **Options** > **Add new** or **Edit** > **Proxy server**.

Proxy servers are intermediate servers between a browsing service and its users used by some service providers. These servers may provide additional security and speed up access to the service.

Select from the following:

- **Proxy server address** — Enter the host name or IP address of the proxy server in use.
- **Realm** — Enter the proxy server realm.
- **User name** and **Password** — Enter your user name and password for the proxy server.
- **Allow loose routing** — Select if loose routing is allowed.

Settings

- **Transport type** — Select **UDP** or **TCP**.
- **Port** — Enter the port number of the proxy server.

Edit registration servers

Select **Menu** > **Tools** > **Settings** > **Connection** > **SIP settings** > **Options** > **Add new** or **Edit** > **Registrar server**.

Select from the following:

- **Registrar serv. addr.** — Enter the host name or IP address of the registrar server in use.
- **Realm** — Enter the registrar server realm.
- **User name** and **Password** — Enter your user name and password for the registrar server.
- **Transport type** — Select **UDP** or **TCP**.
- **Port** — Enter the port number of the registrar server.

Data call settings

Select **Menu** > **Tools** > **Settings** > **Connection** > **Data call**.

To set the time-out period after which data calls automatically end if no data has been transferred, select **Online time**, and press the joystick. Select **User defined** to enter the time yourself or **Unlimited** to keep the connection active until you select **Options** > **Disconnect**.

VPN

VPN access points

To manage VPN access points, select **VPN** > **VPN access points** > **Options**, and from the following:

- **Edit** — Edit the selected access point. If the access point is in use or its settings are protected, you cannot edit it.
- **New access point** — Create a new VPN access point.
- **Delete** — Delete the selected access point.

VPN access point settings

Contact your service provider for the correct access point settings.

To edit VPN access point settings, select the access point and **Options**.

Select from the following:

- **Connection name** — Enter a name for the VPN connection. The maximum length of the name is 30 characters.
- **VPN policy** — Select a VPN policy to be used with this access point.
- **Internet access pt.** — Select the Internet access point to be used with this VPN access point.
- **Proxy serv. address** — Enter the proxy server address of this VPN access point.
- **Proxy port number** — Enter the number of the proxy port.

Wireless LAN

Select **Menu** > **Tools** > **Settings** > **Connection** > **Wireless LAN**.

To have an indicator displayed when there is a wireless LAN available in your current location, select **Show availability** > **Yes**.

To select the time interval for your device to scan for available wireless LANs and update the indicator, select **Scan for networks**.

Advanced WLAN settings

Select **Menu** > **Tools** > **Settings** > **Connection** > **Wireless LAN** > **Options** > **Advanced settings**. The wireless LAN advanced settings are normally defined automatically, and changing them is not recommended.

To edit the settings manually, select **Automatic config.** > **Disabled**, and define the following:

- **Long retry limit** — Enter the maximum number of transmission attempts if the device does not receive a receiving acknowledgement signal from the network.
- **Short retry limit** — Enter the maximum number of transmission attempts if the device does not receive a clear-to-send signal from the network.
- **RTS threshold** — Select the data packet size at which the wireless LAN access point device issues a request to send before sending the packet.
- **TX power level** — Select the power level of your device when sending data.
- **Radio measurements** — Enable or disable the radio measurements.
- **Power saving** — Select whether to save the power in the device battery.

To restore all settings to their original values, select **Options** > **Restore defaults**.

Security settings for wireless LAN access points**WEP security settings**

Select **Menu** > **Tools** > **Settings** > **Connection** > **Access points**. Select **Options** > **New access point**, or select an access point and **Options** > **Edit**.

In the access point settings, select **WLAN security mode** > **WEP**.

Wired equivalent privacy (WEP) encryption method encrypts data before it is transmitted. Access to the network is denied to users who do not have the required WEP keys. When WEP security mode is in use, if your device receives a data packet not encrypted with the WEP keys, the data is discarded.

In an **Ad-hoc** network, all devices must use the same WEP key.

Select from the following:

- **WEP key in use** — Select the desired WEP key.
- **Authentication type** — Select **Open** or **Shared**.
- **WEP key settings** — Edit the settings for the WEP key.

WEP key settings

Select **Menu** > **Tools** > **Settings** > **Connection** > **Access points**. Select **Options** > **New access point**, or select an access point and **Options** > **Edit**.

In the access point settings, select **WLAN security mode** > **WEP**.

In an **Ad-hoc** network, all devices must use the same WEP key.

Select **WLAN security sett.** > **WEP key settings** and from the following:

- **WEP encryption** — Select the desired WEP encryption key length.
- **WEP key format** — Select whether you want to enter the WEP key data in **ASCII** or **Hexadecimal** format.
- **WEP key** — Enter the WEP key data.

802.1x security settings

Select **Menu** > **Tools** > **Settings** > **Connection** > **Access points**. Select **Options** > **New access point**, or select an access point and **Options** > **Edit**.

In the access point settings, select **WLAN security mode** > **802.1x**.

802.1x authenticates and authorizes devices to access a wireless network, and prevents access if the authorization process fails.

Select **WLAN security sett.** and from the following:

- **WPA mode** — Select **EAP** (Extensible Authentication Protocol) or **Pre-shared key** (a secret key used for device identification).
- **EAP plug-in settings** — If you selected **WPA mode** > **EAP**, select which EAP plug-ins defined in your device to use with the access point.
- **Pre-shared key** — If you selected **WPA mode** > **Pre-shared key**, enter the shared private key that identifies your device to the wireless LAN to which you connect.

The settings available for editing may vary.

WPA security settings

Select **Menu** > **Tools** > **Settings** > **Connection** > **Access points**. Select **Options** > **New access point**, or select an access point and **Options** > **Edit**.

In the access point settings, select **WLAN security mode** > **WPA/WPA2**.

Select **WLAN security sett.** and from the following:

- **WPA mode** — Select **EAP** (Extensible Authentication Protocol) or **Pre-shared key** (a secret key used for device identification).
- **EAP plug-in settings** — If you select **WPA mode** > **EAP**, select which EAP plug-ins defined in your device to use with the access point.
- **Pre-shared key** — If you select **WPA mode** > **Pre-shared key**, enter the shared private key that identifies your device to the wireless LAN to which you connect.

The settings available for editing may vary.

EAP

To view the EAP (extensible authentication protocol) plug-ins currently installed in your device (network service), select **Menu** > **Tools** > **Settings** > **Connection** > **Access points**. Select **Options** > **New access point** and define an access point that uses wireless LAN as a data bearer and **802.1x** or **WPA/WPA2** as their security mode. Select **WLAN security sett.** > **WPA mode** > **EAP**, scroll to **EAP plug-in settings**, and press the joystick.

EAP settings

Select **Menu** > **Tools** > **Settings** > **Connection** > **Access points**. Select **Options** > **New access point**, or select an access point and **Options** > **Edit**.

Select **WLAN security mode** > **802.1x** or **WPA/WPA2**.

Select **WLAN security sett.** > **WPA mode** > **EAP**, scroll to **EAP plug-in settings**, and press the joystick.

Settings

The extensible authentication protocol (EAP) plug-ins are used in wireless networks to authenticate wireless devices and authentication servers, and the different EAP plug-ins make possible the use of various EAP methods (network service).

To use an EAP plug-in when you connect to a WLAN using the access point, select the desired plug-in and **Options > Enable**. The EAP plug-ins enabled for use with this access point have a check mark next to them. To not use a plug-in, select **Options > Disable**.

To edit the EAP plug-in settings, select **Options > Configure**.

To change the priority of the EAP plug-in settings, select **Options > Raise priority** to attempt to use the plug-in before other plug-ins when connecting to the network with the access point, or **Options > Lower priority** to use this plug-in for network authentication after attempting to use other plug-ins.

The available options may vary.

Configurations

To view and delete configurations for trusted servers, select **Menu > Tools > Settings > Connection > Configurations**.

You can receive messages from your network operator, service provider, or company information management that contain configuration settings for trusted servers. These settings are automatically saved in **Configurations**. You may receive configuration settings for access points, multimedia or e-mail services, and IM or synchronization settings from trusted servers.

To delete configurations for a trusted server, scroll to the server, and press the clear key. The configuration settings for other applications provided by this server are also deleted.

■ Date and time settings

[See "Clock settings," p. 75.](#)

■ Security settings

[See "Define security settings," p. 24.](#)

■ Network settings

Select **Menu > Tools > Settings > Network**.

Define the following:

- **Network mode** (shown only if supported by the network operator) — Select the network type. You can select **GSM** or **UMTS** to use the respective network or **Dual mode** to have your device automatically switch between the two. This setting may be preset for your device and not available for editing. If you set the device to use only the GSM network or only the UMTS network, you will not be able to make any calls, including emergency calls, or use other features requiring a network connection, if the selected network is unavailable.
- **Operator selection** — Select **Manual** to choose from available networks, or **Automatic** to have the device select the network automatically.
- **Cell info display** — Select **On** to set the device to indicate when it is used in Micro Cellular Network (MCN).

■ Enhancement settings

Select **Menu > Tools > Settings > Enhancement**.



Warning: When you use the headset, your ability to hear outside sounds may be affected. Do not use the headset where it can endanger your safety.

With most enhancements, you can select from the following settings:

- **Default profile** — Select the profile that is activated when you attach an enhancement to your device.
- **Automatic answer** — Let the device answer phone calls automatically when an enhancement is attached. Select **On** to have the device answer an incoming call automatically after 5 seconds. If the ringing type is set to **Beep once** or **Silent** in the Profiles menu, automatic answer is disabled.
- **Lights** — Select **On** to illuminate the device while it is attached to an enhancement.

Text phone settings

If you use a text phone (TTY), you must connect it to your device before you can change the settings and use the text phone. Select from the following settings:

- **Default profile** — Select the profile that is activated when you attach a text phone (TTY, teletypewriter) to your device.
- **Use text phone** — Select **Yes** if you want to start using the text phone.

11. Organiser

Select **Menu** > **Organiser**.

Organiser includes tools that help you organize and manage the details of different events in your personal and business life.

■ Calendar

Select **Menu** > **Organiser** > **Calendar**.

In **Calendar**, you can create and view scheduled events and appointments. You can also set alarms for calendar entries.

You can synchronize your calendar data with a compatible computer using Nokia PC Suite. For information on synchronization, see the PC Suite guide.

Create calendar entries

You can create four types of calendar entries:

- **Meeting** entries have a specific date and time.
- **Memo** entries are related to the whole day but not to a specific time of the day. Memo entries do not appear in the weekly time schedule view.
- **Anniversary** entries remind you of birthdays and special dates. They refer to a certain day but not a specific time of the day. Anniversary entries are repeated every year.
- **To-do note** entries remind you of a task that has a due date but not a specific time of the day.

To create a calendar entry, scroll to a date, and select **Options** > **New entry**. Select an entry type. Available settings for meeting, memo, anniversary, and to-do entries vary.

Select from the following:

- **Subject** or **Occasion** — Enter a description for the entry.
- **Location** — Enter any necessary location information.
- **Start time** — Enter the start time.
- **End time** — Enter the end time.
- **Start date** or **Date** — Enter the start date or date the event occurs.
- **End date** — Enter the end date.
- **Alarm** — Set an alarm for meeting and anniversary entries. The alarm is displayed in the **Day view**.
- **Repeat** — Specify whether you want the entry to be repeated and when. Define the repeat type, frequency, and possible ending date.
- **Synchronisation** — If you select **Private**, the calendar entry can be seen only by you and is not shown to others with online access to view the calendar. If you select **Public**, the calendar entry is shown to others who have access to view your calendar online. If you select **None**, the calendar entry is not copied to your PC when you synchronize.



Tip: Make sure you have selected the correct city in the **Clock** application, because scheduled calendar entries may change when the current city is changed and is on another time zone.

To open and edit an existing entry, scroll to the entry, and select **Options** > **Open**. Edit the details in the various fields.



Tip: When you edit or delete a repeated entry, choose how you want the change to take effect. If you select **All calendar entries deleted**, all repeated entries are deleted. If you select **Delete entry**, only the current entry is deleted.

To-do

You can create and maintain a task or list of tasks that must be done by a certain day. Each task can be assigned a due date, and an alarm.

To open the list of to-do notes, select **Options** > **To-do list**.

To add a to-do note, select **Options** > **New entry** > **To-do**. Start to write the task in the **Subject** field. You can set a due date for the task, create an alarm for it, and specify a priority. The priority icons are (!) **High** and (-) **Low**. There is no icon for **Normal**.

To mark a task as completed, scroll to the task in the to-do list, and select **Options** > **Mark as done**.

To restore a task, scroll to it in the todo list, and select **Options** > **Mark as not done**.

Calendar settings

Select **Options** > **Settings** to modify the **Calendar alarm tone**, **Default view**, **Week starts on**, and **Week view title**.

Calendar views

To switch between the different calendar views, select **Options** in any calendar view. Select a type of view from the list.



Tip: When viewing **Calendar** in any view, press * to quickly switch to another view.

To view the current day in the month view, press #.

To set the default calendar view, select **Options** > **Settings** > **Default view** > **Month view**, **Week view**, **Day view**, or **To-do view**.

To view a specific date in the calendar view, select **Options** > **Go to date**. Enter the date, and select **OK**.



Tip: To quickly move to the nearest date with a scheduled event, press #.

In the **Month view**, you can view the entire month at one time. Each row shows one week of dates. The active month is displayed, and the active day is either today or the last day that was viewed. The active day is marked with a colored square. Days that have scheduled events are marked with a small triangle in the bottom right corner. Scroll to switch between the days of the month and day entries.



Tip: When viewing **Calendar** in any view, press * to quickly switch to another view.

The **Week view** shows the events for the selected week in seven day boxes. Today's date is marked with a colored square. Memos and anniversaries are placed before 8:00 a.m.

To change the starting day of the week, select **Options** > **Settings** > **Week starts on**.

The **Day view** shows the events for the selected day. Entries are grouped into time slots according to their starting time. To view the previous or next day, scroll left or right.

The **To-do view** view shows the to-do items for the selected day.

Send calendar entries

To send a calendar entry to a compatible device, scroll the entry, and select **Options** > **Send** > **Via text message**, **Via multimedia**, **Via e-mail**, **Via Bluetooth**, or **Via infrared**.

Add a received calendar entry to your calendar

You can receive a calendar entry as an attachment to a multimedia or e-mail message.

To add a received calendar entry to your calendar, open the calendar entry attachment in the message, and select **Options** > **Save to Calendar**. The entry is added to your default calendar.

■ Notes

Select **Menu** > **Organiser** > **Notes**.

You can create and send notes to other compatible devices, and save plain text files (.txt format) that you receive to **Notes**.

To write a new note, select **Options** > **New note**, write the text and press **Done**.

In the **Notes** main view, the following options are available:

- **Open** — Open the selected note.
- **Send** — To send the selected note, select one of the sending methods.
- **New note** — Create a new note.
- **Delete** — Delete the selected note.
- **Mark/Unmark** — Select a note or multiple notes, and apply the same rule to each.
- **Synchronisation** — Select **Start** to initialize synchronization or **Settings** to define the synchronization settings for the note.

When viewing a note, select **Options** > **Find** to search the note for a phone number, Internet telephone address, e-mail or Web address.

■ Calculator



Note: This calculator has limited accuracy and is designed for simple calculations.

Select **Menu** > **Organiser** > **Calculator**.

To make a calculation, enter the first number of the calculation. Scroll to and select a function such as add or subtract from the function map. Enter the second number of the calculation, and select =. To add a decimal point, press #.

The calculator performs operations in the order they are entered. The result of the calculation remains in the editor field and can be used as the first number of a new calculation.

To save the results of a calculation, select **Options** > **Memory** > **Save**. The saved result replaces the previously stored number in memory.

Organiser

To retrieve the results of a calculation from memory and use them in a calculation, select **Options > Memory > Recall**.

To view the last saved result, select **Options > Last result**.

Exiting the calculator application or turning off the device does not clear the memory. You can recall the last saved result the next time you open the calculator application.

■ Converter

Select **Menu > Organiser > Converter**.

The converter has limited accuracy, and rounding errors may occur.

Convert measurements

1. Scroll to the **Type** field, and select **Options > Conversion type** to open a list of measures. Scroll to the measure you want to use, and select **OK**.
2. Scroll to the first **Unit** field, and select **Options > Select unit**. Select the unit from which you want to convert, and select **OK**. Scroll to the next **Unit** field, and select the unit to which you want to convert.
3. Scroll to the first **Amount** field, and enter the value you want to convert. The other **Amount** field changes automatically to show the converted value.

Press **#** to add a decimal and ***** for + and - (for temperature), and **E** (exponent) symbols.

Set base currency and exchange rate



Note: When you change base currency, you must enter new exchange rates because all previously set exchange rates are cleared.

Before you can make currency conversions, you must choose a base currency and add exchange rates. The rate of the base currency is always 1. The base currency determines the conversion rates of the other currencies.

1. To set the rate of exchange for the unit of currency, scroll to the **Type** field, and select **Options > Currency rates**.
2. A list of currencies opens, and you can see the current base currency at the top. Scroll to the currency type and enter the exchange rate you would like to set per single unit of currency.
3. To change the base currency, scroll to the currency, and select **Options > Set as base curr..**
4. Select **Done > Yes** to save the changes.

After you have inserted all the necessary exchange rates, you can make currency conversions.

■ Voice mailbox

Select **Menu > Organiser > Voice mail**.

When you open the voice mailbox application for the first time, you are asked to enter the number of your voice mailbox. To change the number, select **Options > Change number**. To call the number, select **Options > Call voice mailbox**.



Tip: To call your voice mailbox (network service) in standby mode, press and hold **1**, or press **1** then the call key.

■ Clock

Select **Menu > Clock**.

Clock settings

If the alarm time is reached while the device is switched off, the device switches itself on and starts sounding the alarm tone. If you select **Stop**, the device asks whether you want to activate the device for calls. Select **No** to switch off the device or **Yes** to make and receive calls. Do not select **Yes** when wireless phone use may cause interference or danger.



Tip: To update date and time automatically (network service), select **Tools > Settings > Network operator time > On**.

To change the clock type, select **Options > Settings > Clock type > Analogue** or **Digital**.

To set an alarm, select **Options > Set alarm**. Enter the alarm time, and select **OK**.

To view and change alarms, select **Reset alarm**.

To remove an alarm, select **Remove alarm**.

Date and time settings

To change the date and time, their display formats, alarm tone, and to define whether you want to use automatic time update, select **Options > Settings** and from the following:

- **Time** — Enter the time, and select **OK**.

Organiser

- **Time zone** — Enter the time zone, and select **OK**.
- **Date** — Enter the date, and select **OK**.
- **Date format** — Change how the date is displayed. Scroll to the desired format, and select **OK**.
- **Date separator** — Change the symbol that separates days, months, and years. Scroll to the symbol you want, and select **OK**.
- **Time format** — Select **24-hour** or **12-hour**.
- **Time separator** — Select the symbol that separates hours and minutes.
- **Clock type** — Select **Analogue** or **Digital**.
- **Clock alarm tone** — Select the tone that you want to use for the alarm clock.
- **Network operator time** — Update time, date, and time zone information automatically (network service). Select **Auto-update** to activate. This service may not be available in all networks.

Add and delete cities

To add a city, scroll right, and select **Options > Add city**. Scroll to a city, and select **Options > Select**.



Tip: To search for a city in the **Cities** list, select **Options > Add city > Options > Find**. Enter the city name in the search field.

To delete a city, scroll right, scroll to the city, and select **Options > Remove**.

Changing the home city may change the general system time of your device.

12. Tools

Select **Menu** > **Tools**.

The **Tools** folder contains applications used to configure your device and to configure other applications.

Memory card—See "Memory card," p. 15.

Transfer—See "Transfer content between devices," p. 16.

Profiles—See "Profiles," p. 88.

Settings—See "Settings," p. 67.

■ Positioning

With the positioning service you can receive information from service providers about local issues such as weather or traffic conditions, based on the location of your device (network service).

Select **Menu** > **Tools** > **Positioning**.

To select a positioning method, scroll to the positioning method, and select **Options** > **Enable**. To stop using it, select **Options** > **Disable**. The **Bluetooth** positioning method enables you to use Bluetooth GPS enhancements for positioning. The **Network based** positioning method is provided by your network operator or service provider. Both positioning methods can be used simultaneously.

■ Navigator

This feature is not designed to support positioning requests for related calls. Contact your service provider for more information about how your phone complies with government regulations on location based emergency calling services.

GPS should not be used for precise location measurement, and you should never rely solely on location data from the GPS receiver.

Select **Menu** > **Tools** > **Navigator**.

Navigator is a GPS application that enables you to view your current location, find your way to a desired location, and track distance. The application requires a Bluetooth GPS accessory to operate. You must also have Bluetooth GPS positioning method enabled in **Menu** > **Tools** > **Positioning**.

The application must receive positioning info from at least three satellites to use it as a traveling aid.

The application requires a Bluetooth GPS accessory to operate.

Select from the following: **Navigator** View navigating information to your trip destination. **Position** View positioning information about your current location. **Trip dist.** View your traveling information such as the distance and duration you have traveled and your average and maximum speeds.

Navigation view

The navigation view guides you to your trip destination. The cardinal points are indicated by letters on the circle, and the general direction to your destination by a deeper color.

Select from the following: **Set destination** Select a landmark or location as the destination of your trip, or enter the destination latitude and longitude coordinates. **Stop navigation** Delete the destination set for your trip. **Save position** Save your current position as a location or landmark. **Satellite status** View the signal strength of the satellites that provide the positioning info necessary for navigation. **Saved locations** View the locations you have temporarily saved in your device to help in navigation.

Position view

View positioning info such as the latitude and longitude coordinates and altitude of your current location. You can also see the accuracy of this info.

Select from the following: **Save position** Save your current position as a location or landmark. **Satellite status** View the signal strength of the satellites that provide the positioning info necessary for navigation. **Saved locations** View the locations you have temporarily saved in your device to help in navigation.

Trip distance view

The trip meter calculates the travelled distance and time and your average and maximum traveling speeds.

Select from the following: **Start** Activate the trip meter. **Stop** End using the trip meter. The values calculated by it remain on the display. **Resume** Continue using the trip meter. **Reset** Set the values calculated by the trip meter to zero and start recalculating them from the start. **Clear** Empty the trip meter values after stopping its use. **Save position** Save your current position as a location or landmark. **Satellite status** View the signal strength of the satellites that provide the positioning info necessary for navigation. **Saved locations** View the locations you have temporarily saved in your device to help in navigation.

Tools

Manage locations

Select **Position** > **Options** > **Saved locations**.

You can temporarily save locations in your device to help in navigation.

To save a location in **Navigator**, **Position**, or **Trip dist.** view, select **Options** > **Save position**.

To save a temporary location as a more permanent landmark, select **Options** > **Save as landmark**.

To delete a location, scroll to it, and press **Options** > **Clear**.

Navigator settings

Select **Options** > **Settings**.

To change the measuring system in use, select **Measurement system** > **Metric** or **Imperial**.

To enter the altitude calibration to correct the altitude received from the positioning satellites, select **Altitude calibration**.

■ Landmarks

Select **Menu** > **Tools** > **Landmarks**.

Landmarks are coordinates to geographic locations that you can save to your device for later use in different location-based services. You can create landmarks using a Bluetooth GPS enhancement or network (network service). [See "Navigator," p. 77.](#)

To create a landmark, select **Options** > **New landmark**. Select **Current position** to make a network request for the latitude and longitude coordinates of your current location or **Enter manually** to fill in the necessary location information such as a name, category, address, latitude, longitude and altitude.

To view or edit a landmark, scroll to it, and press the joystick.

To delete a landmark, scroll to it, and press the clear key.

With each landmark, select **Options** and select from the following options:

- **Add to category** — Organize the landmark to a group of similar landmarks. Scroll to the category, and press the joystick. To view your landmark categories, scroll right or left.
- **Send** — Send the landmark to compatible devices.
- **Edit categories** — Add, edit, or delete the your landmark categories.
- **Landmark icon** — Change the icon of the landmark. Scroll to the desired icon, and press the joystick.

Landmark categories

You can view landmark categories in two views: one lists categories that already contain landmarks, and the other lists all categories that your device has.

To view categories that already contain landmarks, select **Menu** > **Tools** > **Landmarks**, and scroll right.

To view the landmarks that a category contains, select the category, and press the joystick.

To move a landmark from one category to another, scroll left. Scroll to a landmark, and press **Options** > **Add to category**. Scroll to the old category, and press the joystick to remove the mark next to it. Scroll to the category or categories to which you want to add the landmark, and press the joystick. Select **Accept**.

With each landmark, select **Options** and select from the following options:

- **Edit** — Modify landmark information such as a name, category, address, latitude, longitude and altitude.
- **New landmark** — Create a landmark directly into the category. Select **Current position** to make a network request for the latitude and longitude coordinates of your current location or **Enter manually** to fill in the necessary location information such as a name, category, address, latitude, longitude and altitude.
- **Add to category** — Organize the landmark to a group of similar landmarks. Scroll to the category, and press the joystick.
- **Send** — Send the landmark to compatible devices.
- **Edit categories** — Add, edit, or delete the your landmark categories.
- **Landmark icon** — Change the icon of the landmark. Scroll to the desired icon, and press the joystick.

The available options may vary.

Edit landmark categories

Select **Options** > **Edit categories**.

Select **Options** and select from the following options:

- **New landmark** — Create a landmark directly into the category. Select **Current position** to make a network request for the latitude and longitude coordinates of your current location or **Enter manually** to fill in the necessary location information such as a name, category, address, latitude, longitude and altitude.
- **Landmark icon** — Change the icon of the landmark. Scroll to the desired icon, and press the joystick.

Tools

To delete a landmark category that you have created, scroll to it and press the clear key. You cannot delete preset categories.

Edit landmarks

Select **Options** > **Edit** or **New landmark** > **Enter manually**. Enter location and other information such as a name, category, address, latitude, longitude and altitude.

With each landmark, select **Options** and select from the following options:

- **Select categories** — Organize the landmark to a group of similar landmarks. Scroll to the category and press the joystick to modify landmark information such as a name, category, address, latitude, longitude and altitude.
- **Current position** — Request and automatically fill in the geographical latitude and longitude coordinates to make a landmark of your current location.
- **Landmark icon** — Change the icon of the landmark. Scroll to the desired icon, and press the joystick.
- **Send** — Send the landmark to compatible devices.

Available options may vary.

Receive landmarks

Select **Menu** > **Message**. Open a message that contains a landmark you have received from another device. Scroll to the landmark, and press the joystick.

To save the landmark in your device, select **Options** > **Save**.

To forward the landmark to compatible devices, select **Options** > **Send**.

■ Voice commands

Select **Menu** > **Tools** > **Voice commands**.

Use voice commands to make phone calls and to launch applications, profiles, or other functions on the device.

The device creates a voice tag for the entries in the contacts list and for the functions designated in the **Voice commands** application. When a voice command is spoken, the device compares the spoken words to the voice tag in the device.

Voice commands are not dependent on a speaker's voice; however, the voice recognition in the device adapts to the main user's voice to better recognize voice commands.

Use a voice command to make a call

The voice tag for a contact is the name or nickname that is saved on the contact card in **Contacts**. To listen to the voice tag, open a contact card, and select **Options** > **Playback**.

1. To make a call using a voice command, press and hold the voice key.
2. When you hear the tone or see the visual display, clearly speak the name saved on the contact card.
3. The device plays a synthesized voice tag for the recognized contact in the selected device language, and displays the name and number. After a timeout of 1.5 seconds, the device dials the number. If the recognized contact was not correct, select **Next** to view a list of other matches or **Quit** to cancel dialing.

If several numbers are saved under the contact, the device selects the default number, if it has been set. Otherwise, the device selects the first available number of the following fields: **Mobile**, **Mobile (home)**, **Mobile (business)**, **Telephone**, **Tel. (home)**, and **Tel. (business)**.

Use a voice command to launch an application

The device creates voice tags for the applications listed in the **Voice commands** application.

To launch an application using a voice command, press and hold the voice key, and clearly speak the voice command. If the recognized application was not correct, select **Next** to view a list of other matches or **Quit** to cancel.

To add more applications to the list, select **Options** > **New application**.

To change the voice command of an application, scroll to the application, and select **Options** > **Change command**. Type the new voice command, and select **OK**.

Use voice commands for profiles

The device creates a voice tag for each profile. To set on a profile using a voice command, press and hold the voice key, and say the name of the profile.

To change the voice command, scroll to the desired profile, and select **Profiles** > **Options** > **Change command**.

Tools

Voice command settings

To switch off the synthesizer that plays recognized voice commands in the selected device language, select **Settings > Synthesiser > Off**.

To reset voice recognition learning when the main user of the device has changed, select **Reset voice adapts.**

■ Voice aid

Select **Menu > Tools > Voice aid**.

The voice aid application reads text on the screen, allowing you to use basic functions of your device without looking at the display.

Select from the following:

- **Contacts** — Hear the entries in your contacts list. Do not use this option if you have more than 500 contacts.
- **Recent calls** — Hear information on your missed and received calls, dialed numbers, and frequent calls.
- **Voice mailbox** — Retrieve and listen to your voice messages.
- **Dialler** — Dial a telephone number.
- **Clock** — Hear the current time and date.

To hear more options, select **Options**.

■ Sett. wizard

Sett. wizard configures your device for operator (MMS, GPRS, and Internet), e-mail, push-to-talk (network service), and video sharing (network service) settings based on your network operator information.

To use these services, you may have to contact your network operator or service provider to activate a data connection or other services.

To edit settings, select **Menu > Tools > Sett. wizard** and the item you want to configure.

E-mail

1. To edit e-mail settings, select **Menu > Tools > Sett. wizard > E-mail**. **Sett. wizard** detects your available network operators. If the device detects more than one network operators, select one and **OK**.

If the network operator is not recognized, you must select **Country/Region** and **Operator**.

2. Select your e-mail service provider from the list.

3. Select the outgoing mail server. Use the default server if you are not sure.

If **Sett. wizard** prompts you to enter the details of your **E-mail address** (including the domain name), **User name**, and **Password**, select each in turn and **Options > Change**. Enter the details, and select **OK**.

1. Select **Options > OK** when you are finished.

2. Select **OK** to confirm that you want to set up the mailbox for the specified operator.

3. Select **OK**.

To send or receive e-mail messages, you must have an active packet data account. Contact your network operator or service provider for details.

Push to talk

Push to talk (PTT) (network service) provides direct voice communication with the push of a key. With push to talk, you can use your device as a walkie-talkie.

1. To edit **Push to talk** (PTT) (network service) settings, select **Menu > Tools > Sett. wizard > Push to talk**. **Sett. wizard** detects your available network operators. If the device detects more than one network operators, select one and **OK**.

If the network operator is not recognized, you must select **Country/Region** and **Operator**.

2. Some operators require a **User name**, **Password**, and **Nickname**. Select each in turn and **Options > Change**. Enter the details, and select **OK**.

3. Select **Options > OK** when you are finished.

4. Select **OK** to confirm that you want to set up PTT for the specified operator.

To use push to talk, you must have an active packet data account. Contact your network operator or service provider for details.

If an access point has not been set up for the selected operator, you are prompted to create a new one.

Video sharing

1. To edit **Video sharing** (network service) settings, select **Menu > Tools > Sett. wizard > Video sharing**. **Sett. wizard** detects your available network operators. If the device detects more than one network operators, select one and **OK**.

Tools

If the network operator is not recognized, you must select **Country/Region** and **Operator**.

2. Some operators require a **Video sharing address**, a user name, and a password. Select each in turn and **Options > Change**. Enter the details, and select **OK**.
 3. Select **Options > OK** when you are finished.
 4. Select **OK** to confirm that you want to set up video sharing for the specified operator.
 5. After creating video sharing settings, **Sett. wizard** asks if you want to create or update your own contact. Select **Yes** or **No**.
- To use video sharing, you must have an active packet data account. Contact your network operator or service provider for details.

Operator

1. To edit operator settings (access points, Web browser, MMS, and streaming), select **Menu > Tools > Sett. wizard > Operator**. **Sett. wizard** detects your available network operators.
2. If the device detects more than one network operators, select one and **OK**.
3. If the network operator is not recognized, you must select **Country/Region** and **Operator**.

If you are not able to use **Sett. wizard**, visit the Nokia phone settings Web site at www.nokia.com.

■ Application manager

Select **Menu > Tools > Application manager**.

When you open the application manager, you see all the software packages that have been installed, with their name, version number, type, and size. You can view the details of installed applications, remove them from your device, and specify installation settings.

Install applications and software



Important: Only install applications from sources that offer adequate protection against harmful software.

You can install two types of applications and software on your device:

- Applications and software specifically intended for your device or compatible with the Symbian operating system. These software installation files have the extension **.sis**.
- J2ME™ applications compatible with the Symbian operating system. The Java application installation file extensions are **.jad** or **.jar**.

Installation files may be transferred to your device from a compatible computer, downloaded during browsing, or sent to you in a multimedia message, as an e-mail attachment, or with Bluetooth. If you use Nokia PC Suite to transfer a file to your device, save the file in the **C:\nokia\installs** folder in your device.

During installation, the device checks the integrity of the package to be installed. The device shows information about the checks being carried out, and you are given options to continue or cancel the installation.

If you install applications that require a network connection, note that the power consumption of your device may increase when you use these applications.

View and remove software

You can view the details of installed applications or remove them from your device.

To view the details of an installed software package, select the application and **Options > View details**.

To remove software, open the application manager main view and select **Options > Remove**.

If you remove software, you can only reinstall it by using the original software package file, or by restoring a full backup that contains the removed software package. If you remove a software package, you may no longer be able to open files created with that software. If another software package depends on the software package that you removed, the other software package may stop working. Refer to the documentation of the installed software package for details.

View the installation log

To view the installation log, select **Options > View log**. A list shows what software has been installed and removed, and the date of installation or removal. If you encounter problems with the device after installing a software package, you can use this list to find out which software package may be the cause of the problem. The information in this list may also help to pinpoint problems that are caused by software packages that are incompatible with each other.

Settings

To modify installation settings, select **Options > Settings** and from the following:

Tools

- **Delete** — The software package installation file is deleted from the device after installation. If you download software packages using the Web browser, this may help to reduce the amount of storage space required. If you want to store the software package file for possible reinstallation, do not select this option, or make sure that you have a copy of the software package file stored on a compatible PC or on a CD-ROM.
- **Select language:** — If the software package contains several language versions of the software, select the language version that you want to install.
- **Type** — Specify what kind of applications you want installed. You may choose to install only applications with validated certificates. This setting applies only to Symbian operating system applications (.sis files).

Specify Java application security settings

To specify security settings for a Java application, select **Options > Suite settings**.

You can define which functions the Java application can access. The value that you can set for each functionality depends on the protection domain of the software package.

- **Network access** — Create a data connection to the network.
- **Messaging** — Send messages.
- **App. auto-start** — Open the application automatically.
- **Connectivity** — Activate a local data connection, such as a Bluetooth connectivity.
- **Multimedia** — Take pictures or record videos or sound.
- **Read user data** — Read your calendar entries, contacts, or any other personal data
- **Edit user data** — Add personal data, such as entries to your address book.

You can define how you will be prompted to confirm Java application access to device functions. Select one of the following values:

- **Ask every time** — Require the Java application to ask for your confirmation each time it uses the functionality.
- **Ask first time** — Require the Java application to ask for initial confirmation to use the functionality.
- **Always allowed** — Allow the Java application to use the functionality without your confirmation.
- **Not allowed** — Prevent the Java application from using the functionality.

The security settings help protect your device against harmful Java applications that may use the functions of your device without your permission. Only select **Always allowed** if you know the supplier and trustworthiness of the application.

Certificate manager



Important: Note that even if the use of certificates makes the risks involved in remote connections and software installation considerably smaller, they must be used correctly in order to benefit from increased security. The existence of a certificate does not offer any protection by itself; the certificate manager must contain correct, authentic, or trusted certificates for increased security to be available. Certificates have a restricted lifetime. If Expired certificate or Certificate not valid yet is shown even if the certificate should be valid, check that the current date and time in your device are correct.

Before changing any certificate settings, you must make sure that you really trust the owner of the certificate and that the certificate really belongs to the listed owner.

Digital certificates are used to verify the origins of software but do not guarantee safety. There are three different types of certificates: authority certificates, personal certificates, and server certificates. During a secure connection, a server may send a server certificate to your device. Upon receipt, it is checked through an authority certificate stored on your device. You receive notification if the identity of the server is not authentic or if you do not have the correct certificate in your device.

Download a certificate from a web site, or receive a certificate as an e-mail attachment, or as a message sent through a Bluetooth or infrared connection. Certificates should be used when you connect to an online bank or a remote server to transfer confidential information. They should also be used if you want to reduce the risk of viruses or other malicious software, and to check the authenticity of software when you download and install software to your device.



Tip: When you add a new certificate, check its authenticity.

Manage personal certificates

Personal certificates are certificates that are issued to you.

To add certificates to your device, select a certificate file and **Save**. To remove a selected certificate, select **Options > Delete**.

To check the authenticity of a certificate, select a certificate and **View details**. Fingerprints uniquely identify a certificate. Contact the help desk or customer service of the owner of the certificate, and ask to compare fingerprints. Six-digit private key store passwords contain the secret keys that come with personal certificates.

Manage authority certificates

Authority certificates are used by some services to check the validity of other certificates.

To add certificates to your device, select a certificate file and **Save**. To remove a selected certificate, select **Options > Delete**.

Tools

To check the authenticity of a certificate, select a certificate and **View details**. Fingerprints uniquely identify a certificate. Contact the help desk or customer service of the owner of the certificate, and ask to compare fingerprints. Six-digit private key store passwords contain the secret keys that come with personal certificates.

Trusting a certificate means that you authorize it to verify web pages, e-mail servers, software packages, and other data. Only trusted certificates can be used to verify services and software.

To change trust settings, select a certificate and **Options > Trust settings**. Select an application field and **Yes** or **No**. You cannot change the trust settings of a personal certificate.

Depending on the certificate, a list of applications is displayed that can use the certificate:

- **Symbian installation** — New Symbian operating system application.
- **Internet** — E-mail and graphics.
- **App. installation** — New Java™ application.
- **Online certif. check** — Online certificate status protocol.

View certificate details

You can only be sure of the correct identity of a server when the signature and the period of validity of a server certificate have been checked.

To view certificate details, select a certificate and **View details**.

One of the following notes may appear:

- **Certificate not trusted** — You have not set any application to use the certificate. You may want to change the trust settings.
- **Expired certificate** — The period of validity has ended for the selected certificate.
- **Certificate not valid yet** — The period of validity has not yet begun for the selected certificate.
- **Certificate corrupted** — The certificate cannot be used. Contact the certificate issuer.

Certificate security settings

Select from the following:

- **Software installation** — Select to install signed applications only or all applications.
- **Online certif. check** — To check the validity of certificates when an application is installed, select **On**.
- **Default web address** — The validity of a certificate is checked from the default address if the certificate does not include its own Web address.

■ Nokia Catalogs

Select **Menu > Catalogs**. Select **OK** if you accept the disclaimer.

Nokia Catalogs (network service) is a mobile content shop available on your device. With Nokia Catalogs you can discover, preview, buy, download, and upgrade content, such as games, ringing tones, wallpapers, services, and applications, for your device. The available content depends on your network operator and service provider.

Nokia Catalogs uses your network services to access the most updated catalog content. For information on additional items available through Nokia Catalogs, contact your network operator or service provider.

Nokia Catalogs receives ongoing updates, bringing you the latest content your network operator or service provider offers for your device. To update the catalogs manually, select **Options > Refresh list**.

Open a catalog

Select **Menu > Catalogs**.

When you scroll to a catalog folder, a description of the contents is shown on the display.

Select **Options** and select from the following:

- **Open** — Open the selected catalog.
- **View details** — View the catalog details.
- **Hide** — Hide the selected catalog from the catalog list.
- **Show all** — Bring the hidden catalogs back to the catalog list.
- **Refresh list** — Download an updated catalog list.
- **Application** — Select **About** to see information about the application or **Disclaimer** to see the catalog provider's disclaimer.
- **Homepage** — Open the Catalogs main view.

Open a folder

Select **Menu > Catalogs**.

A catalog folder may contain several subfolders.

Select **Options** and select from the following:

- **Open** — Open the folder contents if you have purchased and downloaded the selected item.

Tools

- **Open** — Open the selected subfolder.
- **View details** — View the catalog details.
- **Preview** — Show a preview of the selected item.
- **Get** — Download the selected item if you have purchased it, but not yet downloaded it.
- **Buy** — Purchase the selected item.
- **Set as wallpaper** — If the selected item is a wallpaper, select this option to set it as the wallpaper for the device.
- **Set as ringing tone** — If the selected item is a ringing tone, select this option to set it as the ringing tone for the device.
- **Set as theme** — If the selected item is a theme, select this option to set it as the theme for the device.
- **Online information** — Open a Web site with information on the selected item, if available.
- **Purchase details** — Check the details of the purchased item.
- **Refresh list** — Download an updated folder.
- **Application** — Select **About** to see information about the application or **Disclaimer** to see the catalog provider's disclaimer.
- **Homepage** — Open the Catalogs main view.

Catalogs settings

Select **Menu** > **Catalogs**.

From the catalogs main view, select **Options** and select from the following:

- **Access point** — Select a default access point to be used with the catalogs application.
- **Automatic open** — Select whether to open the downloaded application automatically.
- **Preview confirmation** — Select whether to have a confirmation note to pop up before downloading the preview of the item.
- **Buy confirmation** — Select whether to have a confirmation note to pop up before buying the item.

13. Device management

Manage data and software on your device.

■ Server profile settings

Select **Menu** > **Connectivity** > **Dev. mgr.**.

To create a server profile, select **Options** > **New server profile** and select from the following options:

- **Server name** — Enter a name for the configuration server.
- **Server ID** — Enter the unique ID to identify the configuration server. Contact your service provider for correct settings.
- **Server password** — Enter a password that identifies the server to your device when the server starts a configuration session.
- **Session mode** — Select the connection type to use for connecting to the server.
- **Access point** — Select the access point to use for connecting to the server.
- **Host address** — Enter the URL address of the server.
- **Port** — Enter the port number of the server.
- **User name** and **Password** — Enter your user name and password to identify your device to the server when you start a configuration session.
- **Allow configuration** — To be able to receive configuration settings from this server, select **Yes**.
- **Auto-accept all reqs.** — To have your device ask for confirmation before accepting configuration from this server, select **No**.

To edit an existing server profile, select **Options** > **Edit profile**.

■ Remote configuration network service

Select **Menu** > **Connectivity** > **Dev. mgr.**.

You can connect to a server and receive configuration settings for your device. You may receive server profiles and different configuration settings from your network operator, service providers, and company information management department. Configuration settings may include connection and other settings used by different applications in your device. Available options may vary.

The remote configuration connection is usually started by the server when the device settings need to be updated.

Remote configuration settings

In the **Dev. mgr.** main view, select **Options** and select from the following:

- **Start configuration** — Connect to the server and receive configuration settings for your device.
- **New server profile** — Create a new server profile.
- **Edit profile** — Change the profile settings.
- **Delete** — Remove the selected profile.
- **Enable config.** — Select to receive configuration settings from those servers for which you have a server profile and have allowed configuration.
- **Disable config.** — Select to stop receiving configuration settings from all servers for which you have a server profile.
- **View log** — View the configuration log of the selected profile.

Create a configuration profile

To create a new configuration server profile, select **Options** > **New server profile** and select from the following settings. Ask your service provider for the correct values.

- **Server name** — Enter a name for the configuration server.
- **Server ID** — Enter the unique ID to identify the configuration server.
- **Server password** — Enter a password to identify your device to the server.
- **Session mode** — Select the preferred connection type.
- **Access point** — Select the access point to use for the connection, or create a new access point. You can also choose to be asked for the access point every time you start a connection.
- **Host address** — Enter the Web address of the configuration server.
- **Port** — Enter the port number of the server.
- **User name** — Enter your user ID for the configuration server.
- **Password** — Enter your password for the configuration server.
- **Allow configuration** — Select **Yes** to allow the server to initiate a configuration session.
- **Auto-accept all reqs.** — Select **Yes** if you do not want the server to ask for your confirmation when it initiates a configuration session.

■ Data synchronization

Menu > [Connectivity](#) > [Sync](#).

Use [Sync](#) to synchronize your contacts, calendar, or notes with corresponding applications on a compatible computer or remote Internet server. Your synchronization settings are saved in a synchronization profile. The application uses SyncML technology for remote synchronization. For information on SyncML compatibility, contact the supplier of the applications with which you want to synchronize your device.

The available applications you can synchronize may vary. Contact your service provider for more information.



Tip: You may receive the synchronization settings as a message from your service provider.

Create a synchronization profile

To create a profile, select [Options](#) > [New sync profile](#) and select from the following options:

- [Sync profile name](#) — Enter a name for the profile.
- [Applications](#) — Select the applications to synchronize with the profile.
- [Connection settings](#) — Specify the needed connection settings. Contact your service provider for information.

To edit an existing profile, select [Options](#) > [Edit sync profile](#).

Synchronization profiles

In the [Sync](#) main view, select [Options](#) and select from the following options:

- [Synchronise](#) — Synchronize the data included in the selected profile with a remote database.
- [New sync profile](#) — Create a synchronization profile. You may want to create multiple synchronization profiles for an application to vary the data bearer in use or remote database with which you synchronize your device.
- [View log](#) — View the added, updated, and deleted entries in the latest synchronization with the profile.
- [Delete](#) — Remove the selected profile.

Synchronization connection settings

To create the connection settings of a new profile, select [New sync profile](#) > [Connection settings](#) and select from the following options:

- [Server version](#) — Select the SyncML version you can use with your server.
- [Server ID](#) — Enter the server ID of your server. This setting is only available if you select 1.2 as the SyncML version.
- [Data bearer](#) — Select the data bearer to connect to the remote database during synchronization.
- [Access point](#) — Select the access point to use for the synchronization connection, or create a new access point. You can also choose to be asked for the access point every time you start synchronizing.
- [Host address](#) — Enter the Web address of the server that contains the database with which you want to synchronize your device.
- [Port](#) — Enter the port number of the remote database server.
- [User name](#) — Enter your user name to identify your device to the server.
- [Password](#) — Enter your password to identify your device to the server.
- [Allow sync requests](#) — To allow synchronization to start from the remote database server, select [Yes](#).
- [Accept all sync reqs.](#) — To have your device ask for your confirmation before accepting synchronization from the server, select [No](#).
- [Network authentic.](#) — To authenticate your device to the network before synchronization, select [Yes](#). Enter your network user name and network password.

Define synchronization settings for Contacts

To define the synchronization settings for the [Contacts](#) application, scroll to the desired profile, and select [Options](#) > [Edit sync profile](#) > [Applications](#) > [Contacts](#) > [Edit](#) and select from the following options:

- [Include in sync](#) — Select whether to synchronize your contacts directory with this synchronization profile.
- [Remote database](#) — Enter the path to the database with which you synchronize your contacts directory.
- [Local database](#) — If you have more than one contacts directory in your device, select the one you want to synchronize with this synchronization profile.
- [Synchronisation type](#) — Select the direction of synchronization. Scroll to [Normal](#) to synchronize data from the device to remote database and back, [To phone only](#) to synchronize data from the remote database to your device, or [To server only](#) to synchronize data from your device to the remote database.

Define synchronization settings for Calendar

To define the synchronization settings for the **Calendar** application, scroll to the desired profile, and select **Options > Edit sync profile > Applications > Calendar > Edit** and select from the following options:

- **Include in sync** — Select whether to synchronize your calendar with this synchronization profile.
- **Remote database** — Enter the path to the database with which you synchronize your calendar.
- **Local database** — If you have more than one calendar in your device, select the one you want to synchronize with this synchronization profile.
- **Synchronisation type** — Select the direction of synchronization. Scroll to **Normal** to synchronize data from the device to remote database and back, **To phone only** to synchronize data from the remote database to your device, or **To server only** to synchronize data from your device to the remote database.

Define synchronization settings for Notes

To define the synchronization settings for the **Notes** application, scroll to the desired profile, and select **Options > Edit sync profile > Applications > Notes > Edit** and select from the following options:

- **Include in sync** — Select whether to synchronize your notes with this synchronization profile.
- **Remote database** — Enter the path to the database with which you synchronize your notes.
- **Local database** — If you have more than one **Notes** application in your device, select the one you want to synchronize with this synchronization profile.
- **Synchronisation type** — Select the direction of synchronization. Scroll to **Normal** to synchronize data from the device to remote database and back, **To phone only** to synchronize data from the remote database to your device, or **To server only** to synchronize data from your device to the remote database.

14. Personalization

■ Profiles



Warning: In the offline profile you cannot make or receive any calls, or use other features that require network coverage. Calls may still be possible to the official emergency number programmed into your device. To make calls, you must first activate the phone function by changing profiles. If the device has been locked, enter the lock code.

Select **Menu** > **Tools** > **Profiles**.

You can adjust and customize the ringing tones, alert tones, and other device tones for different events, environments, or caller groups.

To customize a profile, scroll to the desired profile in the list, and select **Options** > **Personalise**.

Define the following settings:

- **Ringling tone** — Select a ringing tone from the list, or select **Tone downloads** to open a bookmark folder containing a list of bookmarks for downloading tones using the browser. To listen to the selected tone, select **Play**. If you have two alternate phone lines in use, you can specify a ringing tone for each line.
- **Video call tone** — Select a ringing tone for video calls.
- **Say caller's name** — Activate the text-to-speech ringing tone feature. When someone from your contacts list calls you, the device sounds a ringing tone that is a combination of the spoken name of the contact and the selected ringing tone.
- **Ringling type** — Select how you want the ringing tone to alert.
- **Ringling volume** — Select the volume level of the ringing tone.
- **Message alert tone** — Select a tone for received text messages.
- **E-mail alert tone** — Select a tone for received e-mail messages.
- **IM alert tone** — Select a tone for received instant messages.
- **Vibrating alert** — Select whether you want the device to vibrate when you receive a call.
- **Keypad tones** — Set the volume level of the device keypad tones.
- **Warning tones** — Set the warning tones on or off.
- **Alert for** — You can set the device to ring only upon calls from phone numbers that belong to a selected contact group. Phone calls coming from outside that group have a silent alert.
- **Profile name** — You can give a name to a new profile or rename an existing profile. The **General** and **Offline** profiles cannot be renamed.

The **Offline** profile prevents your device from accidentally switching on or sending or receiving messages; it also closes any Internet connection that may be in operation when the profile is selected. The **Offline** profile does not prevent you from establishing a wireless LAN or Bluetooth connection at a later time, so comply with any applicable safety requirements when establishing and using wireless LAN and Bluetooth connections.

To change a profile, scroll to the desired profile in the list, and select **Options** > **Activate**. If you select the **Offline** profile, you cannot send or receive messages. However, you can establish a WLAN connection to read your e-mails or use Bluetooth at a later time, so comply with any applicable safety requirements when establishing and using wireless LAN and Bluetooth connections.

To create a new profile, select **Options** > **Create new**, and define the settings.

Select ringing tones

To set a ringing tone, scroll to a profile, and select **Options** > **Personalise** > **Ringling tone**. Select a ringing tone from the list or select **Tone downloads** to open a bookmark folder containing a list of bookmarks for downloading tones using the browser. Any downloaded tones are saved to **Gallery**.

To play the ringing tone for a selected contact group only, scroll to a profile, and select **Options** > **Personalise** > **Alert for**, and select the desired group. Phone calls coming from outside that group have a silent alert.

To browse for a message tone, scroll to a profile and select **Options** > **Personalise** > **Message alert tone**.

To listen to the selected tone, select the tone from the list and wait for the tone to play.

Change enhancement settings

Scroll to an enhancement, and select **Options** > **Open**.

Change the default profile for the enhancement.

To change enhancement settings, select an enhancement and **Options** > **Open**.

■ Themes

Select **Menu** > **Tools** > **Themes**.

P e r s o n a l i z a t i o n

You can change the look of the display of your device.

To change the look of the display, highlight the theme you want to use, and select **Options > Apply**.

To edit a theme, highlight the theme you want to edit, and select **Options > Edit**. Select **Wallpaper** to change the background image in the standby modes, or **Power saver** to use a text or the date and time as a power saver that appears on the display when no key presses have been made for a some time.

To download themes, you need to establish a network connection that allows you to download themes from Internet sources that are compatible with your device.

To download a theme, select **Theme downloads**. Enter the link from which you want to download your theme. Once the theme is downloaded you can preview, activate, or edit it.

To preview a theme, highlight the theme you want to preview, and select **Options > Preview**. Select **Apply** to start using the new theme.

Battery information

Your device is powered by a rechargeable battery. The full performance of a new battery is achieved only after two or three complete charge and discharge cycles. The battery can be charged and discharged hundreds of times, but it will eventually wear out. When the talk and standby times are noticeably shorter than normal, buy a new battery. Use only Nokia approved batteries, and recharge your battery only with Nokia approved chargers designated for this device.

Unplug the charger from the electrical plug and the device when not in use. Do not leave fully charged battery connected to a charger, since overcharging may shorten its lifetime. If left unused, a fully charged battery will lose its charge over time.

If the battery is completely discharged, it may take a few minutes before the charging indicator appears on the display or before any calls can be made.

Use the battery only for its intended purpose. Never use any charger or battery that is damaged.

Do not short-circuit the battery. Accidental short-circuiting can occur when a metallic object such as a coin, clip, or pen causes direct connection of the positive (+) and negative (-) terminals of the battery. (These look like metal strips on the battery.) This might happen, for example, when you carry a spare battery in your pocket or purse. Short-circuiting the terminals may damage the battery or the connecting object.

Leaving the battery in hot or cold places, such as in a closed car in summer or winter conditions, will reduce the capacity and lifetime of the battery. Always try to keep the battery between 15°C and 25°C (59°F and 77°F). A device with a hot or cold battery may not work temporarily, even when the battery is fully charged. Battery performance is particularly limited in temperatures well below freezing.

Do not dispose of batteries in a fire as they may explode. Batteries may also explode if damaged. Dispose of batteries according to local regulations. Please recycle when possible. Do not dispose as household waste.

■ Nokia battery authentication guidelines

Always use original Nokia batteries for your safety. To check that you are getting an original Nokia battery, purchase it from an authorized Nokia dealer, look for the Nokia Original Enhancements logo on the packaging, and inspect the hologram label using the following steps:

Successful completion of the four steps is not a total assurance of the authenticity of the battery. If you have any reason to believe that your battery is not an authentic original Nokia battery, you should refrain from using it, and take it to the nearest authorized Nokia service point or dealer for assistance. Your authorized Nokia service point or dealer will inspect the battery for authenticity. If authenticity cannot be verified, return the battery to the place of purchase.

Authenticate hologram

1. When looking at the hologram on the label, you should see the Nokia connecting hands symbol from one angle and the Nokia Original Enhancements logo when looking from another angle.



2. When you angle the hologram left, right, down, and up, you should see 1, 2, 3, and 4 dots on each side respectively.



3. Scratch the side of the label to reveal a 20-digit code, for example, 12345678919876543210. Turn the battery so that the numbers are facing upwards. The 20-digit code reads starting from the number at the top row followed by the bottom row.



4. Confirm that the 20-digit code is valid by following the instructions at www.nokia.com/batterycheck.

To create a text message enter the 20-digit code, for example, 12345678919876543210, and send to +44 7786 200276.

National and international operator charges will apply.

You should receive a message indicating whether the code can be authenticated.



Battery information

What if your battery is not authentic?

If you cannot confirm that your Nokia battery with the hologram on the label is an authentic Nokia battery, please do not use the battery. Take it to the nearest authorized Nokia service point or dealer for assistance. The use of a battery that is not approved by the manufacturer may be dangerous and may result in poor performance and damage to your device and its enhancements. It may also invalidate any approval or warranty applying to the device.

To find out more about original Nokia batteries, visit www.nokia.com/battery.

Care and maintenance

Your device is a product of superior design and craftsmanship and should be treated with care. The suggestions below will help you protect your warranty coverage.

- Keep the device dry. Precipitation, humidity, and all types of liquids or moisture can contain minerals that will corrode electronic circuits. If your device does get wet, remove the battery, and allow the device to dry completely before replacing it.
- Do not use or store the device in dusty, dirty areas. Its moving parts and electronic components can be damaged.
- Do not store the device in hot areas. High temperatures can shorten the life of electronic devices, damage batteries, and warp or melt certain plastics.
- Do not store the device in cold areas. When the device returns to its normal temperature, moisture can form inside the device and damage electronic circuit boards.
- Do not attempt to open the device other than as instructed in this guide.
- Do not drop, knock, or shake the device. Rough handling can break internal circuit boards and fine mechanics.
- Do not use harsh chemicals, cleaning solvents, or strong detergents to clean the device.
- Do not paint the device. Paint can clog the moving parts and prevent proper operation.
- Use a soft, clean, dry cloth to clean any lenses, such as camera, proximity sensor, and light sensor lenses.
- Use only the supplied or an approved replacement antenna. Unauthorized antennas, modifications, or attachments could damage the device and may violate regulations governing radio devices.
- Use chargers indoors.
- Always create a backup of data you want to keep, such as contacts and calendar notes, before sending your device to a service facility.

All of the above suggestions apply equally to your device, battery, charger, or any enhancement. If any device is not working properly, take it to the nearest authorized service facility for service.

Additional safety information

■ Operating environment

Remember to follow any special regulations in force in any area, and always switch off your device when its use is prohibited or when it may cause interference or danger. Use the device only in its normal operating positions. This device meets RF exposure guidelines when used either in the normal use position against the ear or when positioned at least 1.5 centimeters (5/8 inches) away from the body. When a carry case, belt clip or holder is used for body-worn operation, it should not contain metal and should position the device the above-stated distance from your body.

To transmit data files or messages, this device requires a quality connection to the network. In some cases, transmission of data files or messages may be delayed until such a connection is available. Ensure that the above separation distance instructions are followed until the transmission is completed.

Parts of the device are magnetic. Metallic materials may be attracted to the device. Do not place credit cards or other magnetic storage media near the device, because information stored on them may be erased.

■ Medical devices

Operation of any radio transmitting equipment, including wireless phones, may interfere with the functionality of inadequately protected medical devices. Consult a physician or the manufacturer of the medical device to determine if they are adequately shielded from external RF energy or if you have any questions. Switch off your device in health care facilities when any regulations posted in these areas instruct you to do so. Hospitals or health care facilities may be using equipment that could be sensitive to external RF energy.

Pacemakers

Pacemaker manufacturers recommend that a minimum separation of 15.3 centimeters (6 inches) be maintained between a wireless phone and a pacemaker to avoid potential interference with the pacemaker. These recommendations are consistent with the independent research by and recommendations of Wireless Technology Research. Persons with pacemakers should do the following:

- Always keep the device more than 15.3 centimeters (6 inches) from the pacemaker
- Not carry the device in a breast pocket
- Hold the device to the ear opposite the pacemaker to minimize the potential for interference.
- If you suspect interference, switch off your device, and move the device away.

Hearing aids

Some digital wireless devices may interfere with some hearing aids. If interference occurs, consult your service provider.

■ Vehicles

RF signals may affect improperly installed or inadequately shielded electronic systems in motor vehicles such as electronic fuel injection systems, electronic antiskid (antilock) braking systems, electronic speed control systems, and air bag systems. For more information, check with the manufacturer, or its representative, of your vehicle or any equipment that has been added.

Only qualified personnel should service the device, or install the device in a vehicle. Faulty installation or service may be dangerous and may invalidate any warranty that may apply to the device. Check regularly that all wireless device equipment in your vehicle is mounted and operating properly. Do not store or carry flammable liquids, gases, or explosive materials in the same compartment as the device, its parts, or enhancements. For vehicles equipped with an air bag, remember that air bags inflate with great force. Do not place objects, including installed or portable wireless equipment in the area over the air bag or in the air bag deployment area. If in-vehicle wireless equipment is improperly installed, and the air bag inflates, serious injury could result.

Using your device while flying in aircraft is prohibited. Switch off your device before boarding an aircraft. The use of wireless teledevices in an aircraft may be dangerous to the operation of the aircraft, disrupt the wireless telephone network, and may be illegal.

■ Potentially explosive environments

Switch off your device when in any area with a potentially explosive atmosphere, and obey all signs and instructions. Potentially explosive atmospheres include areas where you would normally be advised to turn off your vehicle engine. Sparks in such areas could cause an explosion or fire resulting in bodily injury or even death. Switch off the device at refueling points such as near gas pumps at service stations. Observe restrictions on the use of radio equipment in fuel depots, storage, and distribution areas; chemical plants; or where blasting operations are in progress. Areas with a potentially explosive atmosphere are often, but not always, clearly marked. They include below deck on boats, chemical transfer or storage facilities, vehicles using liquefied

Additional safety information

petroleum gas (such as propane or butane), and areas where the air contains chemicals or particles such as grain, dust, or metal powders.

■ Emergency calls



Important: Wireless phones, including this device, operate using radio signals, wireless networks, landline networks, and user-programmed functions. Because of this, connections in all conditions cannot be guaranteed. You should never rely solely on any wireless device for essential communications like medical emergencies.

To make an emergency call:

1. If the device is not on, switch it on. Check for adequate signal strength.
Some networks may require that a valid SIM card is properly inserted in the device.
2. Press the end key as many times as needed to clear the display and ready the device for calls.
3. Enter the official emergency number for your present location. Emergency numbers vary by location.
4. Press the call key.

If certain features are in use, you may first need to turn those features off before you can make an emergency call. Consult this guide or your service provider for more information.

When making an emergency call, give all the necessary information as accurately as possible. Your wireless device may be the only means of communication at the scene of an accident. Do not end the call until given permission to do so.

■ CERTIFICATION INFORMATION (SAR)

THIS MOBILE DEVICE MEETS GUIDELINES FOR EXPOSURE TO RADIO WAVES.

Your mobile device is a radio transmitter and receiver. It is designed not to exceed the limits for exposure to radio waves recommended by international guidelines. These guidelines were developed by the independent scientific organization ICNIRP and include safety margins designed to assure the protection of all persons, regardless of age and health.

The exposure guidelines for mobile devices employ a unit of measurement known as the Specific Absorption Rate or SAR. The SAR limit stated in the ICNIRP guidelines is 2.0 watts/kilogram (W/kg) averaged over 10 grams of tissue. Tests for SAR are conducted using standard operating positions with the device transmitting at its highest certified power level in all tested frequency bands. The actual SAR level of an operating device can be below the maximum value because the device is designed to use only the power required to reach the network. That amount changes depending on a number of factors such as how close you are to a network base station. The highest SAR value under the ICNIRP guidelines for use of the device at the ear is 0.68 W/kg.

Use of device accessories and enhancements may result in different SAR values. SAR values may vary depending on national reporting and testing requirements and the network band. Additional SAR information may be provided under product information at www.nokia.com.

Index

A

- access points 41, 68
- ad hoc network 47
- answering calls 19
- application manager 81
- applications
 - common actions 18
 - installing 81
 - modifying installations 81
 - removing 81
 - viewing the installation log 81
- attachments 33, 35
- audio files 55
- authority certificates 82
- automatic answer 72

B

- barring calls 20
- barring password 24
- battery
 - charge level 13
 - charging 9
 - installing 8
- blogs 52
- Bluetooth
 - connections 44
 - pairing 45
 - settings 44
- bookmarks 51
- browsing Web pages 51, 53
- business cards 27

C

- cable 43
- calculator 74
- calendar 73
- calling 19
- calls
 - barring 20
 - diverting 20
 - settings 67
- CD-ROM 16
- cells 62
- certificate details 83
- certificates 82
- charging the battery 9
- chart sheets 63
- chat 37
- clock 75
- connecting to the Internet 41
- connection manager 47
- connection methods
 - Bluetooth 44
 - cable 43
 - infrared 46
 - modem 48
 - WLAN 47
- connections
 - data call settings 41
 - GPRS settings 42

- WLAN settings 42, 70
- connectors 10
- contact groups 26
- contact information 26
- contacts
 - adding 26
 - copying information 26
 - default information 26
 - groups 26
 - ringing tones 27
- copying text 14

D

- data
 - connections 46
 - synchronizing 86
- data and software management 85
- day view in calendar 74
- declining calls 19
- device management 85
- display
 - indicators 13
 - rotating 11
 - settings 67
- diverting calls 20
- documents 59
- DTMF tones 20

E

- e-mail
 - accounts 36
 - messages 34
 - replying 35
 - writing 36
- email data roaming 49
- ending network connections 47
- enhancement settings 72
- equalizer 57

F

- feeds 52
- file manager 59
- flash player 58

G

- gallery 54
- general packet radio service
 - See *GPRS*
- GPRS
 - access point settings 42
 - counters 21
 - general 46
 - settings 69

H

- help 17

I

- IM 37
- images
 - add to contacts 54

Index

- set as wallpaper 54
- zooming in or out 54
- inbox** 28
- indicators** 13
- infrared** 46
- installing**
 - applications 81
 - battery 8
 - SIM card 8
- instant messaging** 37
- Internet** 51
 - access points 41
 - net call settings 68
 - settings 41
- IP passthrough** 43
- J**
- Java applications** 81, 82
- joystick** 67
- K**
- keyguard** 10
- keypad lock** 10
- keys** 10
- L**
- landmarks** 78
- language** 67
- listening to music** 56
- locking**
 - device 11
 - keypad 10
- logs** 21, 81
- M**
- mail**
 - See *e-mail*
- media applications** 54
- memory** 14
 - card 14
 - monitoring 15
 - on-device 14
- memory card** 15
- menu** 17
- messages**
 - deleting 35
 - e-mail 34
 - folders 28
 - multimedia messages 31
 - picture messages 31
 - sending 29
 - special messages 40
 - text messages 30
- MMC** 15
- mobile VPN**
 - See *VPN*
- modem** 48
- month view in calendar** 74
- multimedia messages**
 - attachments 33
 - creating 31
 - receiving 32
 - replying to 32
 - sending 31
- settings 33
- music player** 56
- N**
- navigation** 77
- net calls** 23
- network settings** 72
- notes** 74
- O**
- outbox** 29
- outline view** 60, 61
- P**
- packet data**
 - access point settings 42
 - counters 21
 - general 46
 - settings 69
- pairing** 45
- personal certificates** 82
- personalization** 88
- phone**
 - calls 19
 - language 67
 - settings 67
 - video calls 21
- picture messages** 31
- playing**
 - music 56
 - video and audio 55
 - voice recordings 58
- Pop-Port connector** 11
- predictive text input** 14, 67
- presentations** 63
- printing** 66
- profiles** 88
- R**
- RealPlayer**
 - playing media clips 55
 - settings 56
- recording**
 - calls 57
 - voice 57
- reduced-size MMC** 15
- rejecting calls** 19
- remote configuration**
 - creating a profile 85
 - settings 85
- remote synchronization** 86
- ringing tones** 27
- roaming settings** 49
- rotating the display** 11
- S**
- screen export** 65
- security**
 - device 24
 - Java application 82
 - memory card 15
- selecting text and objects** 17
- selection key settings** 67
- service commands** 40

Index

settings

- Bluetooth 44
- calendar 73, 74
- calls 67
- connection 68
- display 67
- email data roaming 49
- general 67
- Internet 41
- IP passthrough 43
- Java application security 82
- message centers 29
- multimedia messages 33
- network 72
- profiles 88
- remote configuration 85
- security 24
- server profile 85
- standby 67
- text messages 31
- text phone 72
- trust 83
- TTY 72
- Web 52
- WLAN 70

SettingWizard 80

shortcuts 12

signal strength 13

SIM access profile 46

SIM card

- installing 8

- text messages 30

slide shows 63

SMS messages 30

SMTP settings 49

software

- installing 81

- removing 81

special messages 40

speed dialing 19

standby

- mode 12

- settings 67

storage 15

switching device on and off 9

Symbian applications 81

synchronizing 86

T

text

- copying 14

- predictive input 14

- selecting 17

- traditional input 13

- writing 13

text messages

- editing message centers 29

- managing messages in the SIM card 30

- replying 30

- sending 30

- writing 30

text phone 72

themes 88

to-do list 73

to-do view in calendar 74

tools folder 77

track lists 57

traditional text input 13

TTY 72

tutorial 17

U

USB data cable 43

V

video calls 21

video clips 55

virtual private network 48

voice commands 79

voice dialing 79

voice mailbox 19

voice memos 57

voice over IP 23

voice recorder 57

volume 13, 57

VPN 48

W

Web 51

week view in calendar 74

welcome note 67

WLAN

- access point settings 42

- advanced access point settings 43

- general 47

- security settings 71

- settings 70

worksheets 61

writing language 67