

# AURORA<sup>®</sup>

VALUE BEYOND ILLUMINATION<sup>™</sup>

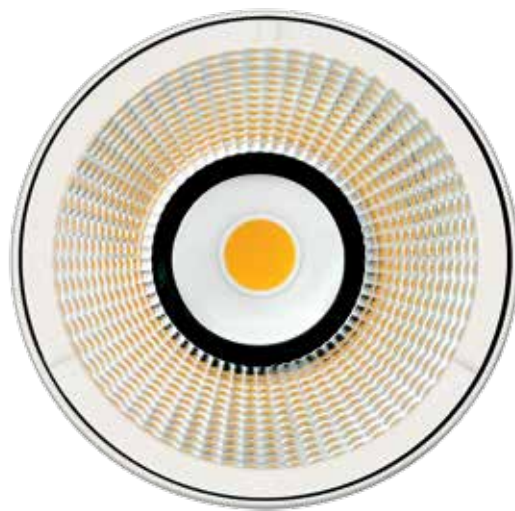

**solis**<sup>™</sup>  
Pure Design

The Aurora Group is a multi award-winning international LED lighting organisation, specialising in the design, manufacture and distribution of innovative, smart, energy saving solutions for projects and trade through our Aurora and Enlite brands via a global network.

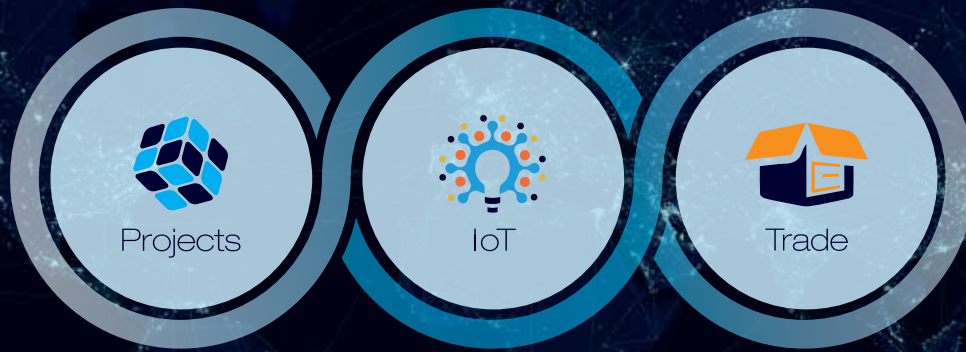

## Delivering Exceptional Customer Value from the Heart of Aurora's Future

Aurora's design and Manufacturing Platform (DMP) incorporates a highly developed IoT technology centre allowing lighting design and technology to merge creating Value Beyond Illumination.

Following client consultations, our designers craft custom lighting schemes addressing special project considerations.

Our products have been specifically developed to allow for personalisation. Powerful design, simulation and rapid 3D prototyping capabilities enable us to

develop a brand new product to meet your requirements. Celebrating over 33 years in UK manufacturing, we continue to heavily invest in new machinery and in-house design and engineering capability. Microlights was founded in 1984 to serve the UK retail lighting market, and became part of the Aurora Group in 2009, fully integrating in 2016.

This allows us to produce products with a build-to-order approach, enabling flexible lead times.

To create the desired, tailored effect, our team carries out product adjustments, installations and focusing, delivering a truly personalised experience.

# 75,000 sq.ft

Research & Development,  
Engineering, Manufacturing,  
Design, Testing & Compliance

# 33 years

of UK Manufacturing



## Aurora Understands Your Needs



### UK Manufacturing

Manufacturing is at the heart of the group's core capabilities. Decades of experience span generations of lighting. Ongoing investment in people, infrastructure and production capabilities keep our product ranges at the forefront of market requirements. A large part of our portfolio is made in the UK whilst leveraging our Asian infrastructure as required.



### Engineering & Design

Over 50 Global R&D, mechanical and electronics engineers work across power, control, lamps and luminaires. Our team manages the ever-changing dynamics of LED technology to maintain compatibility of individual components and deliver world class lighting solutions world wide.



### Testing & Compliance

Ensuring our products meet the highest quality standards requires world class testing capabilities. Our Ji'an megacentre has been officially approved as a NEMKO qualified laboratory operating alongside in-house photometric centres in Asia and the UK.



### IoT Technology Centre

Over £2million of investment establishes Aurora's IoT Centre as our new global technology hub, and focuses solely on the development of connected IoT lighting solutions, tailored to every client's requirements. For each and every product, we offer customer support and aftercare ensuring a dedicated end-to-end project solution.



### Tailored Product Design

From specification to output and energy savings, our products have been developed to allow for a wide range of personalisation. A standard product may not always answer all lighting needs. We are proud to offer bespoke engineering by working closely with our customers to design specialist products. Whether it's a slightly different finish, mounting arrangement, modified output or scale of a component; our build-to-order approach means customers benefit from a personalised solution and the latest technological advancements for market leading performance.



## Services

International infrastructure, innovative product ranges and specialist expertise enable Aurora to successfully deliver premium project solutions that achieve vision and expectations, on time, every time, regardless of scope or scale.

The core of Aurora's project experience is founded on exceptional design consultancy, project and programme management, whilst delivering state-of-the-art products that meet the requirements of each industry. Through a step-by-step process and early identification of customer requirements, Aurora achieves effective and efficient delivery of international roll-out lighting

schemes across five sectors: Residential, Hospitality, Retail, Commercial and Industrial.

Services include interpreting the brief, designing lighting schemes, CAD plans, technical product information, logistics management to deliver on time, and aftersales service.

Providing personalised solutions for any lighting scheme using application-centric products makes Aurora a global partner for any size of project.

### Consultation

Starting with in-depth understanding of client requirements and vision, our turnkey service meets their requirements throughout the entire process.



- Lighting surveys
- Energy audits
- Product trials



### Lighting Design

Utilising the latest software, our experienced team, with a proven track record, successfully designs and produces lighting schemes for a variety of clients.



- Dialux & Relux
- BIM and Revit files
- IES and LDT photometric files



### Project Management

Working with all parties involved in the delivery and installation of lighting, Aurora's project management team ensures that all programs are consistently delivered on time



- On time deliveries
- Logistics and Overseas requirements
- Consistent lighting design for multi-site projects



## Focussing

Multi-functional teams work together to support individual customers on all project requirements to ensure they are met and exceeded, from start to completion. For example in-store retail focusing ensures the scheme delivers on design.



- Light only where you need it
- On site focusing
- Advice and guidance for local personnel



## After Care

Client relationships are at the core of Aurora's philosophy. Following every project, we ensure client satisfaction by providing a thorough after-care service. Expert field based maintenance and support, enabling one stop shop for design and maintenance of lighting schemes.



- In house installation, maintenance and support
- Full technical backup



## Features

### Pure Design

Minimal driver box

### Control the light

1-10V Dimming as standard

### Aesthetic

Unobtrusive design, low impact luminaire

## Specification

Luminous Flux	1000lm, 2000lm, 2700lm
Power Rating (TCW)	10W, 22W, 28W
Colour Temperature (CCT)	2700K, 3000K, 3500K, 4000K
SCDM	3 MacAdam Ellipses
Colour Rendition Index (CRI)	80+, 90 or to specific request
System Efficacy (LL/TCW)	up to 100
Lumen Maintenance	50,000 hours at L80 B10

 **Manufactured in the United Kingdom**

1 Circuit



Pg.7

Surface Mount Plate



Pg. 7

3 Circuit



Pg. 7

Dimmable 3 Circuit



Pg.11

## Design

### PURE VISUAL

- Integrated driver housing  
125 x 55 x 32mm max
- Bespoke optics & luminaire
- Compact head
- Designed to light, engineered for retail



## Refine

### NARROW BEAM

- Hot Spot - up to 22,000 Candela (for narrow beam), 14°
- Tool free, quick-change reflectors
- All reflectors provide a wider 'halo' of light to ensure overall ambient lighting is not affected by swapping beam angles

## Deliver

### PRECISE CONTROL



- Set desirable light levels for morning to evening, summer to winter
- 1-10V Dimmable from 10-100%
- Dimmable track and accessories available

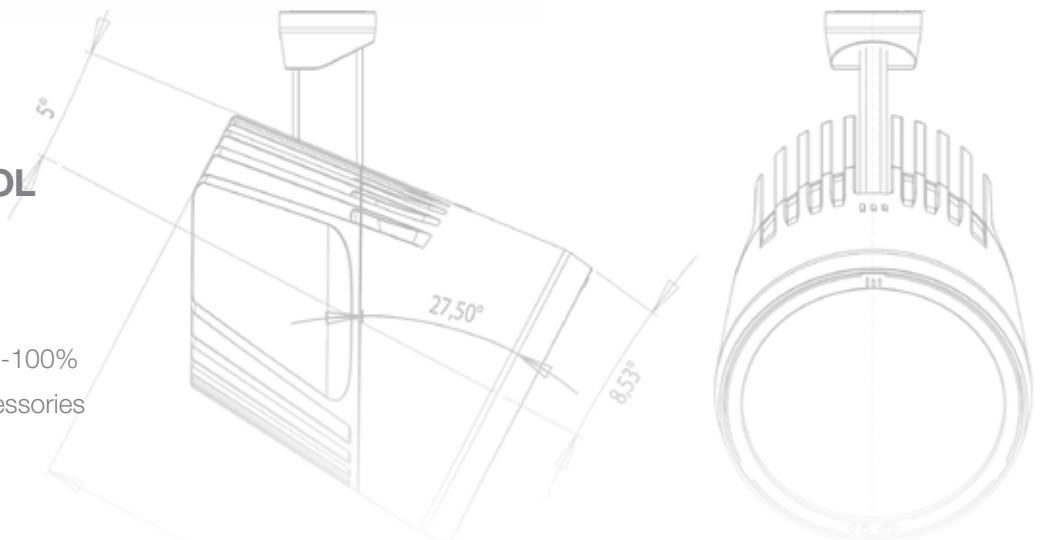

# PURE DESIGN



**solis**<sup>TM</sup>

## ENGINEERED FOR RETAIL

- Integrated driver housing
- Retail reflector with hot spot
- Dimmable 1-10V version as standard



Rotation: 340°  
Head swings: 90°

Pure  
Design



**10W 1000lm 3000K**    **Narrow**    **Medium**    **Wide**    **Extra Wide**

White	112-#504	112-#505	112-#506	112-#507
Silver	112-#552	112-#553	112-#554	112-#555
Black	112-#600	112-#601	112-#602	112-#603

**10W 1000lm 3500K**

White	112-#508	112-#509	112-#510	112-#511
Silver	112-#556	112-#557	112-#558	112-#559
Black	112-#604	112-#605	112-#606	112-#607

**10W 1000lm 4000K**

White	112-#512	112-#513	112-#514	112-#515
Silver	112-#560	112-#561	112-#562	112-#563
Black	112-#608	112-#609	112-#610	112-#611

**22W 2000lm 3000K**

White	112-#520	112-#521	112-#522	112-#523
Silver	112-#568	112-#569	112-#570	112-#571
Black	112-#616	112-#617	112-#618	112-#619

**22W 2000lm 3500K**

White	112-#524	112-#525	112-#526	112-#527
Silver	112-#572	112-#573	112-#574	112-#575
Black	112-#620	112-#621	112-#622	112-#623

**22W 2000lm 4000K**

White	112-#528	112-#529	112-#530	112-#531
Silver	112-#576	112-#577	112-#578	112-#579
Black	112-#624	112-#625	112-#626	112-#627

**28W 2700lm 3000K**

White	112-#536	112-#537	112-#538	112-#539
Silver	112-#584	112-#585	112-#586	112-#587
Black	112-#632	112-#633	112-#634	112-#635

**28W 2700lm 3500K**

White	112-#540	112-#541	112-#542	112-#543
Silver	112-#588	112-#589	112-#590	112-#591
Black	112-#636	112-#637	112-#638	112-#639

**28W 2700lm 4000K**

White	112-#544	112-#545	112-#546	112-#547
Silver	112-#592	112-#593	112-#594	112-#595
Black	112-#640	112-#641	112-#642	112-#643



**Ra >80**  
COLOUR RENDERING

Accessories

Lumen values are nominal for range

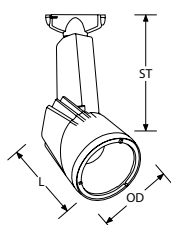

(L) 136mm Length  
(OD) 105mm Overall Ø  
(ST) 170mm Stem Length  
1.04kg Weight

**Ordering Example**

27W 2700lm 3000K	Narrow	Medium	Wide	Ex Wide
White	112-#536	112-#537	112-#538	112-#539



Mount Type
#Insert 1, 2 or 3
1 = Surface Mount Plate
2 = 1 Circuit Track Adaptor
3 = 3 Circuit Track Adaptor

CRI90 options available on request  
2700K luminaires available on request

**Made to Order**

**Track**



Three circuit    Single circuit

- Maximise flexibility within designs
  - Future proof against layout changes
  - Suspend track to avoid costly ceiling installation
  - Specify exact suspension height to control light levels
  - Often more cost effective than recessing into plasterboard
  - Create three separate scene settings by having different luminaires on each circuit (3 circuit only)
  - Solis™ is also available with surface mount
- See pgs. 9-10 for details of complete track collection

**Exploded view of Solis™ Optical System**



see Beam Cone tables on page 14  
dimmable options on page 12

# Non - Dimmable Track

## Track - Single and Three Circuit



Single circuit

Three circuit

When positioning accent lighting, use track to gain flexibility and build in future proofing. Precise focusing can be easily achieved and refurbishment is then not necessary when minor changes are made to the shop layout. Suspended track can allow luminaires to be positioned well below the actual ceiling height without installing an expensive ceiling. It can also be used to visually reduce the appearance of very tall voids.

Aurora three circuit track system features a circuit selector on the track adaptor which allows one of three circuits to be selected. This means that the scheme can have up to three different combinations of lights on at any one time. Ideal for different times of day or year they create different scenes for different activities (main trading or shelf stacking) resulting in energy saving. See page 13 for dimmable track

## Single Circuit Track

Grey White Black



1 Metre, 1 Circuit	#GB2100-1	#GB2100-3	#GB2100-2
2 Metre, 1 Circuit	#GB2200-1	#GB2200-3	#GB2200-2
3 Metre, 1 Circuit	#GB2300-1	#GB2300-3	#GB2300-2

## Three Circuit Track

Grey White Black



1 Metre, 3 Circuit	#XTS410-A	#XTS410-W	#XTS410-N
2 Metre, 3 Circuit	#XTS420-A	#XTS420-W	#XTS420-N
3 Metre, 3 Circuit	#XTS430-A	#XTS430-W	#XTS430-N

## Suspension Kit Single Circuit

Length Aluminium



Single Circuit Track Suspension Clamp			#GBS 33
Adjustable Suspension Wire Kit 2 or 5m	2m		791-0023
	5m		791-0024

## Suspension Kit Three Circuit

Length Aluminium



Three Circuit Track Suspension Clamp			#GBS 33
Adjustable Suspension Wire Kit 2 or 5m	2m		791-0026
	5m		791-0025



Single Circuit  
Track Suspension Kit



Three Circuit  
Track Suspension Kit

Single Circuit Track Accessories		Grey	White	Black	Three Circuit Track Accessories		Grey	White	Black
	Live End	#GB11-1 #GB12-1	#GB11-3 #GB12-3	#GB11-2 #GB12-2		Live End	#XTSA11-A #XTSA12-A	#XTSA11-W #XTSA12-W	#XTSA11-N #XTSA12-N
	Dead End	#GB41-1	#GB41-3	#GB41-2		Dead End	#XTSA41-A	#XTSA41-W	#XTSA41-N
	Straight Connector	#GB21-1	#GB21-3	#GB21-2		Straight Connector	#XTSA21-A	#XTSA21-W	#XTSA21-N
	Adjustable Corner	#GB24-1	#GB24-3	#GB24-2		Flexible Connector	#XTSA23-A	#XTSA23-W	#XTSA23-N
	L Connector Inside Feed	#GB34-1	#GB34-3	#GB34-2		L Connector Inside Feed	#XTSA34-A	#XTSA34-W	#XTSA34-N
	L Connector Outside Feed	#GB35-1	#GB35-3	#GB35-2		L Connector Outside Feed, 3 Circuit	#XTSA35-A	#XTSA35-W	#XTSA35-N
	X Connector	#GB38-1	#GB38-3	#GB38-2		X Connector	#XTSA38-A	#XTSA38-W	#XTSA38-N
	T Connector Outside Right	#GB36-1	#GB36-3	#GB36-2		T Connector Outside Right	#XTSA36-A	#XTSA36-W	#XTSA36-N
	T Connector Inside Left	#GB37-1	#GB37-3	#GB37-2		T Connector Inside Left	#XTSA37-A	#XTSA37-W	#XTSA37-N
	T Connector Outside Left	#GB39-1	#GB39-3	#GB39-2		T Connector Outside Left	#XTSA39-A	#XTSA39-W	#XTSA39-N
	T Connector Inside Right	#GB40-1	#GB40-3	#GB40-2		T Connector Inside Right	#XTSA40-A	#XTSA40-W	#XTSA40-N

Consider polarity for L and T Connectors and the Live Ends. Red line shows polarity

Single Circuit Floor View From Below

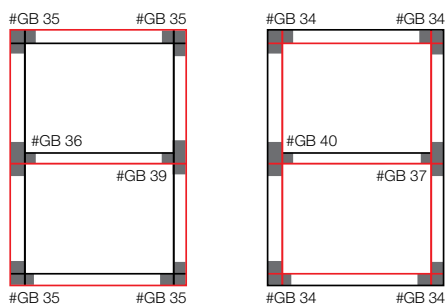

Three Circuit Floor View From Below

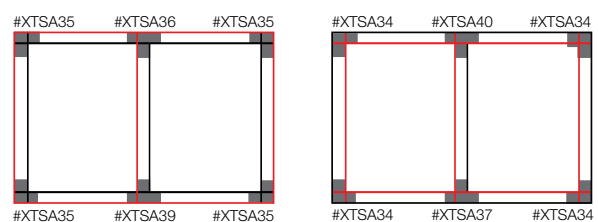

Diagrams show the track layout viewed from below, looking up. The part of the track that takes the fitting faces the viewer. Components must be turned upside down before adding to a floor plan.

Make the most of our experience - call us now for assistance specifying track systems. Contact Aurora direct for details on +44 (0) 1793 467201 or email [projects@auroralighting.com](mailto:projects@auroralighting.com)



Rotation: 340°  
Head swings: 90°

Pure  
Design



	Narrow	Medium	Wide	Extra Wide
<b>28W 2700lm 3000K Dimmable 1-10V</b>				
White	112-3704	112-3705	112-3706	112-3707
Silver	112-3720	112-3721	112-3722	112-3723
Black	112-3736	112-3737	112-3738	112-3739
<b>28W 2700lm 3500K Dimmable 1-10V</b>				
White	112-3708	112-3709	112-3710	112-3711
Silver	112-3724	112-3725	112-3726	112-3727
Black	112-3740	112-3741	112-3742	112-3743
<b>28W 2700lm 4000K Dimmable 1-10V</b>				
White	112-3712	112-3713	112-3714	112-3715
Silver	112-3728	112-3729	112-3730	112-3731
Black	112-3744	112-3745	112-3746	112-3747



CRI90 options available to special order  
2700K luminaires available on request

**Made to Order**

### Dimming Features

- Enhance mood with low level lighting in certain areas
- Create effect with drama varying intensity across the scene using the same luminaires
- Save energy by selecting the minimum light levels necessary, therefore only using minimum energy
- Vary light level throughout the season to compensate for or reflect the external natural light levels
- Tailor light to highlight events in store i.e. promotions or special events

### Technical Specification

- 1-10V Dimming
- Dim 10-100%

### Track



Three circuit dimmable

- Maximise flexibility within designs
- Future proof against layout changes
- Suspend track to avoid costly ceiling installation
- Often more cost effective than recessing into plasterboard
- Create three separate scene settings by having different luminaires on each circuit
- Solis™ is also available with dimmable surface mount

See pg. 13 for details of complete track collection



**Ra >80**  
COLOUR RENDERING

Accessories

Lumen values are nominal for range

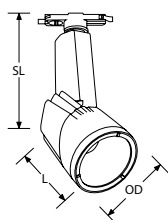

(L) 136mm Length  
(OD) 105mm Overall Ø  
(ST) 170mm Stem Length  
1.04kg Weight

### Exploded view of Solis™ Optical System



see Beam Cone tables on page 14

# Dimmable Track

## Track - Three Circuit Dimmable



Three circuit

When positioning accent lighting, use track to gain flexibility and build in future proofing. Precise focusing can be easily achieved and refurbishment is then not necessary when minor changes are made to the shop layout. Suspended track can allow luminaires to be positioned well below the actual ceiling height without installing an expensive ceiling. It can also be used to visually reduce the appearance of very tall voids.

Aurora three circuit track system features a circuit selector on the track adaptor which allows one of three circuits to be selected, and allows dimming control over the track luminaires. Ideal for different times of day or year are dimming to different scenes for different activities (particularly useful for hospitality, restaurants and reception areas.)

## Three Circuit Dimmable Track

	Grey	White	Black
1 Metre, 3 Circuit	#XTSC6100-1	#XTSC6100-3	#XTSC6100-2
2 Metre, 3 Circuit	#XTSC6200-1	#XTSC6200-3	#XTSC6200-2
3 Metre, 3 Circuit	#XTSC6300-1	#XTSC6300-3	#XTSC6300-2

## Dimmable Track Accessories

Three Circuit Track Accessories	Grey	White	Black
Live End	#XTSC611-1 #XTSC612-1	#XTSC611-3 #XTSC612-3	#XTSC611-2 #XTSC612-2
Dead End	#XTSA41-1	#XTSA41-3	#XTSA41-2
Straight Connector	#XTSC621-1	#XTSC621-3	#XTSC621-2
Flexible Connector	#XTSC623-1	#XTSC623-3	#XTSC623-2
L Connector Inside Feed	#XTSC634-1	#XTSC634-3	#XTSC634-2
L Connector Outside Feed, 3 Circuit	#XTSC635-1	#XTSC635-3	#XTSC635-2
X Connector	#XTSC638-1	#XTSC638-3	#XTSC638-2
T Connector Outside Right	#XTSC636-1	#XTSC636-3	#XTSC636-2
T Connector Inside Left	#XTSC637-1	#XTSC637-3	#XTSC637-2
T Connector Outside Left	#XTSC639-1	#XTSC639-3	#XTSC639-2
T Connector Inside Right	#XTSC640-1	#XTSC640-3	#XTSC640-2

## AU-DSPLED

### 1 Gang 2 Way Rotary Dimmer



## Description

1-10V dimmer suitable for control of dimmable 1-10V dimmable compact fluorescent ballasts or LED drivers (AU-LEDD16CC / AU-LED100CH124 / AU-LEDD9012 / AU-LEDD9024). Integrated over-temperature protection fuse. Module case ultrasonically sealed to reduce dimmer buzzing. Fits a plaster depth (16mm) mounting box. One or two way switching. Complies with the latest Electrical Safety standard for dimmer switches EN 60669-2-1:2000. EMC compliance - EN 55015.

**1 year guarantee.**

Make the most of our experience - call us now for assistance specifying track systems. Contact Aurora direct for details on +44 (0) 1793 467201 or email [projects@auroralighting.com](mailto:projects@auroralighting.com)

## Suspension Kit Three Circuit

	Length	Aluminium
Single Circuit Track Suspension Clamp		#GBS 33
Adjustable Suspension Wire Kit 2 or 5m	2m	791-0026
	5m	791-0025

Solis™ Reflector



Narrow 14°



Medium 20°



Wide 30°



Extra Wide 42°

10W 1000lm 3000K			10W 1000lm 3000K			10W 1000lm 3000K			10W 1000lm 3000K		
8937	0.2	1	4931	0.4	1	2710	0.5	1	1900	0.8	1
2234	0.5	2	1233	0.7	2	678	1.1	2	475	1.7	2
993	0.7	3	548	1.1	3	301	1.6	3	211	2.5	3
22W 2000lm 3000K			22W 2000lm 3000K			22W 2000lm 3000K			22W 2000lm 3000K		
17898	0.2	1	9992	0.4	1	5446	0.5	1	3884	0.8	1
4498	0.5	2	2498	0.7	2	1361	1.1	2	971	1.7	2
1997	0.7	3	1110	1.1	3	605	1.6	3	432	2.5	3
28W 2700lm 3000K			28W 2700lm 3000K			28W 2700lm 3000K			28W 2700lm 3000K		
22144	0.2	1	12282	0.4	1	6730	0.5	1	4786	0.8	1
5536	0.5	2	3070	0.7	2	1682	1.1	2	1196	1.7	2
2460	0.7	3	1365	1.1	3	748	1.6	3	532	2.5	3

Beam angle and diameter shown to half peak value  
 Lumens are nominal for range  
 Engineered for retail : Hotspot and Halo

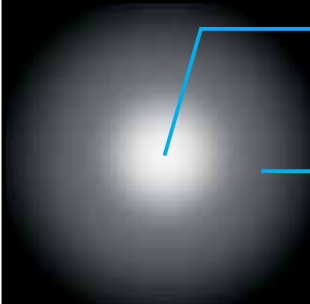

**Hotspot**

- In narrow and medium
- Provides accent highlight

**Halo**

- Adds to overall ambient
- Back lights around highlighted object
- All beams have same diameter halo

Symbols & Keys

Insulation Class

	<b>Class I Luminaire</b>	Luminaires are electrically insulated and earthed. In the event of a basic insulation failure, exposed metal parts that could become live are protected by the earth.
	<b>Class II Luminaire</b>	Live parts are equipped with additional isolation protection such as reinforced or double insulation and do not require an earth.
	<b>Class III Luminaire</b>	Safety extra low voltage (SELV) luminaires that require no additional protection.

Technical

IP20	IP Rating Protected against solid objects up to 12mm (e.g. fingers); no protection from liquids	CE	CE Mark The product complies with all relevant European Directives and standards
ECA	Standards including ECA, SASO and Kucas may apply. Please contact Aurora group for more information		Weight (kg)
	Supplied with industry standard 3 pole connector		Outout Size (mm)
850°	Glow Wire Tested to 850° Standard may apply, please contact Aurora group for more information		Product made to order in Swindon UK

Accessories

	Front Detail - barn doors		Dimmable driver available to special order
	Honeycomb		Squaring lens
	Asymmetric Lens		Coloured glass
	Snoot		Cross Blade Snoot

Warranty - For full warranty information please visit [auroralighting.com/warranty](http://auroralighting.com/warranty)

## DEAN & DELUCA

PURVEYORS OF FINE FOOD, WINE & KITCHENWARE

Dean & Deluca is an international restaurant chain founded in Soho, New York in 1977. The celebration of food is at the heart of this brand.

The proposed lighting solution for Dean & Deluca in Dubai was a complete LED scheme that could be easily controlled.

To create the desired ambience during breakfast, lunch and dinner a dimming control system was installed and commissioned. While breakfast and lunch featured brighter light levels, a romantic ambience with low light levels and a warm colour temperature was created for an evening setting. This combination of product selection, dimming and scene setting provided the client with an enhanced customer dining experience.



Dubai, Emirates, UAE

## Timberland

A long-established resident on London's Regent Street, Timberland selected Aurora to help design a new lighting concept that showcases the brand's retuned identity. The EDDI range was chosen because of its flexibility, versatility and premium performance. Available in track-mounted or recessed versions, the portfolio is highly effective, and once focused in store, delivers an incredible lit appearance. EDDI uses a Philips COB LED chip driven by Philips Xitanium gear and has an incredible 50,000 hours at L80, meaning the store stays brighter for longer.



Regent Street, London, UK

## plusfresc:

de Lleida

Supermarket chain Plusfresc have a long history of working with Aurora. The objectives of the design for the Tarragona store was to highlight its fresh produce, paying particular attention to the fruit and vegetable counters, the fish market, butchers and charcuterie.

For the fruit and vegetable counters, which are always situated at the supermarket entrance, 3000 lumen accent lighting was proposed. LUX levels were excellent (2500-3500 lux), and specification of 80 CRI 3000K resulted in colourful stand-out displays, as required.

Cooler white (5000K) was used for the fish market area to create an enhanced fresh, crisp appearance. Spotlights, with light sources specifically designed for fresh-meat, were used to warm up the areas with red meat, the charcuterie and deli. These emphasised the red colours and created excellent contrast with the cheese zone, which used the standard 3000K 80 CRI luminaire.



Tarragona, Spain



# Aurora Global Clients

With an international framework of offices on every continent, Aurora has acquired a wealth of expertise in servicing retail clients on a global scale over the past 30 years.

Working with several recognised brand names, from multinational retailers to national supermarket chains, Aurora offers a truly personalised and quality lighting solution and service for retail and hospitality clients.

Managing lighting design and production for every retail environment, including in-store, exteriors, restaurants, head offices and warehouses, we provide a one-stop global solution.

Following initial meetings, we work together closely with each client to meet requirements of each brief, focusing on the detail that results in a unique outcome. Our retail applications are designed to bring to life products and services that focus on delivering an experience specific to each brand.

Our extensive product range is tailored to meet regulations and requirements for each market and our international teams provide the service to ensure each installation is fitted in line with the rest of the portfolio.



## GLOBAL DESIGN & MANUFACTURING PLATFORM

Aurora Limited  
Euro Park  
Frankland Road  
Blagrove  
Swindon  
SN5 8YG  
e-mail: [info@auroralighting.com](mailto:info@auroralighting.com)

Tel: +44 (0) 1793 46 72 00  
Fax: +44 (0) 1793 46 72 03

## EUROPEAN

Aurora Lighting Limited  
Aurora Building  
Glasgowstraat 16-20  
3047 AE Rotterdam  
The Netherlands  
e-mail: [europa@auroralighting.com](mailto:europa@auroralighting.com)

Tel: +31 (0) 10 713 1827  
Fax: +31 (0) 10 892 2901

## R.O.I

Tel: +353 (1) 696 8028

## FRANCE

Aurora  
ZAC Entrée Sud de Gonesse  
1 rue Jean Mermoz - Bât. B1  
95500 Gonesse  
France  
e-mail: [france@auroralighting.com](mailto:france@auroralighting.com)

Tel: +33 (0) 1 30 11 11 88  
Fax: +33 (0) 1 39 86 07 28

## GERMANY

Aurora Lighting GmbH  
Am Stock 1  
61118 Bad Vibel  
Germany  
e-mail: [germany@auroralighting.com](mailto:germany@auroralighting.com)

Tel: +49 (0) 68 552 463 398  
Fax: +31 (0) 10 892 2901

## SPAIN & PORTUGAL

C/Alcalde Abril 24, Local 6  
08302 Mataró (Barcelona)  
España  
email: [spain@auroralighting.com](mailto:spain@auroralighting.com)

Tel: +34 93 707 77 70  
Fax: +34 93 757 02 96

## AUSTRALIA

Aurora Lighting Ltd  
4/37 Union Street  
Pymont  
NSW 2009  
Australia  
e-mail: [info.aus@auroralighting.com](mailto:info.aus@auroralighting.com)

Tel: +61 (0) 2 9882 6000  
Fax: +61 (0) 2 9882 6444

## SOUTH AFRICA

Aurora Lighting (Pty) Ltd  
Building 6, Ground Floor  
Pinewood Office Park  
33 Riley Road, Woodmead  
Gauteng  
South Africa  
e-mail: [info.sa@auroralighting.com](mailto:info.sa@auroralighting.com)

Tel: +27 (0) 11 234 4878  
Fax: +27 (0) 11 234 3460

## USA SALES

Aurora Lighting Inc.  
12035 34th Street North  
Suite #2  
St Petersburg, Florida, 33716  
USA  
e-mail: [us@auroralighting.com](mailto:us@auroralighting.com)

Tel: +1 (727) 524 4270  
Fax: +1 (727) 290 3914

## MIDDLE EAST

Al Kuthban Building  
Office 105-107, 1st Floor  
Sheikh Zayed Road  
Dubai, UAE  
e-mail: [uae@auroralighting.com](mailto:uae@auroralighting.com)

Tel: +971 (0) 4 328 5489  
Fax: +971 (0) 4 328 5490

## KINGDOM SAUDI ARABIA

Sanaya Investment Group  
Office 16  
2nd Floor  
Ishara-E-Talatheen (Ameer Sultan)  
Takhassusi Street  
Riyadh, KSA  
e-mail: [ksa@auroralighting.com](mailto:ksa@auroralighting.com)

Tel: +966 11 480 9081  
Tel: +966 11 281 6518

## LEBANON

3rd Floor, Columbia Centre,  
Block B  
Cornish Mazraa  
Beirut, Lebanon  
e-mail: [lebanon@auroralighting.com](mailto:lebanon@auroralighting.com)

Mobile: +961 71 335 659  
Tel/Fax: +961 319 0999

## TAIWAN

Aurora International Lighting Corp. Ltd  
No. 909-1, Sec 2, Liming Road  
Xitun Dist  
Taichung City 407  
Taiwan  
Republic Of China

Tel: +886 (4) 231 051 58  
Fax: +886 (4) 231 052 59

## CHINA

Aurora International Lighting Corp. Ltd  
8 Hehe Road  
Xiangxi Administration Area  
Liaobu Town  
Dongguan City, Guangdong Province  
People's Republic Of China

Tel: +86 (769) 8330 58 28  
Fax: +86 (769) 8330 58 30

## CHINA

Aurora International Lighting Corp.  
Export Processing Zone  
National Jingtangshan Economic  
and Technological Development Zone  
Jian City  
Jiang Xi Province 343100  
People's Republic of China

Tel: +86 (796) 711 3999  
Fax: +86 (796) 711 3998