

Anexo 3. Resultados de la composición florística y formas de vida de cada uno de los 20 sitios estudiados. Los sitios están organizados en base al agrupamiento florístico (Fig. 4.14).

El Arenal

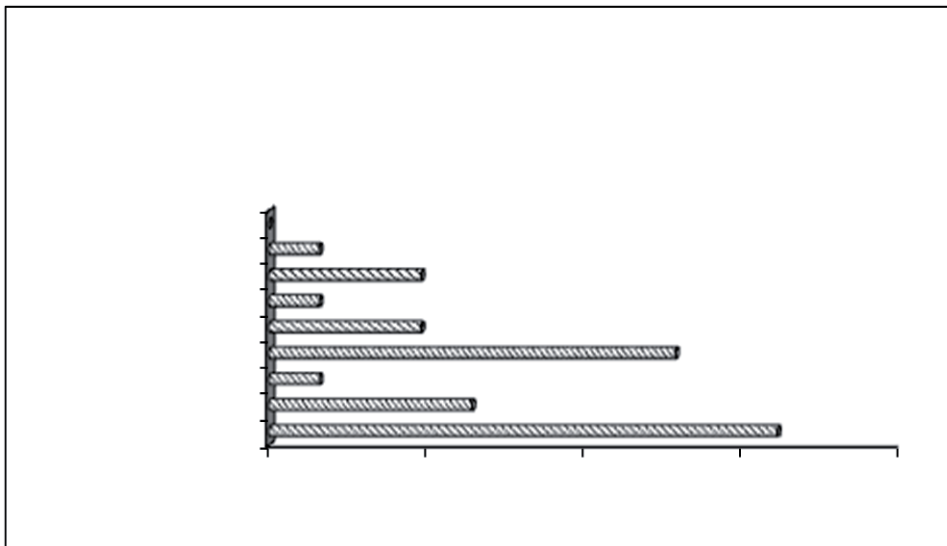
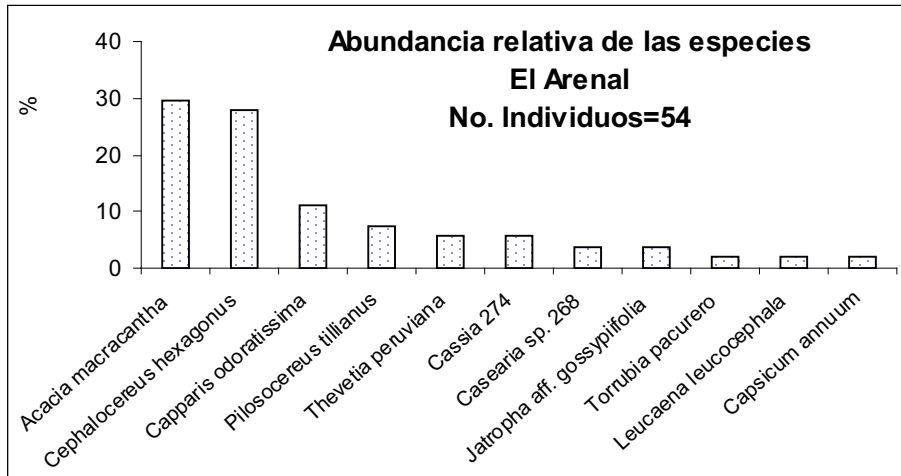

Aranguren, A. 2009. Caracterización de comunidades leñosas estacionalmente secas premontanas y montanas en el estado Mérida. Postgrado en Ecología Tropical. ULA. Mérida

Estanques

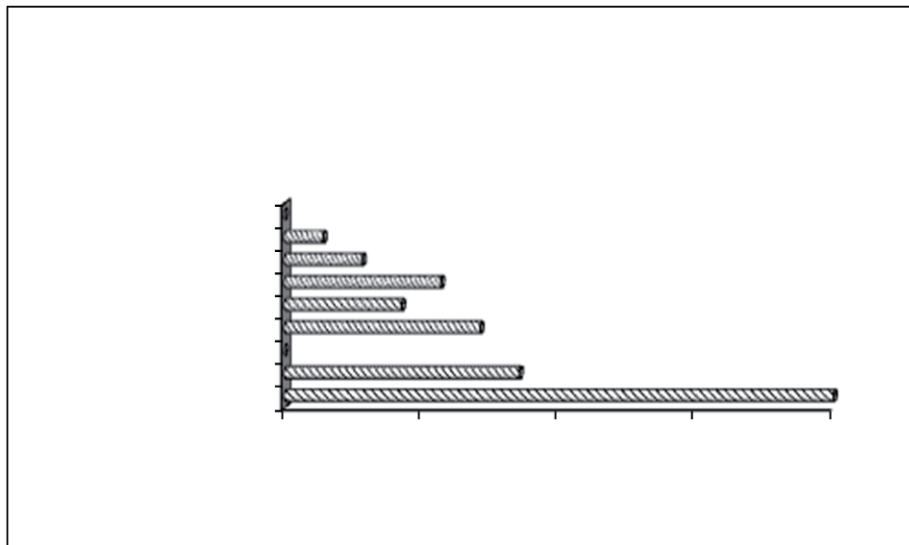
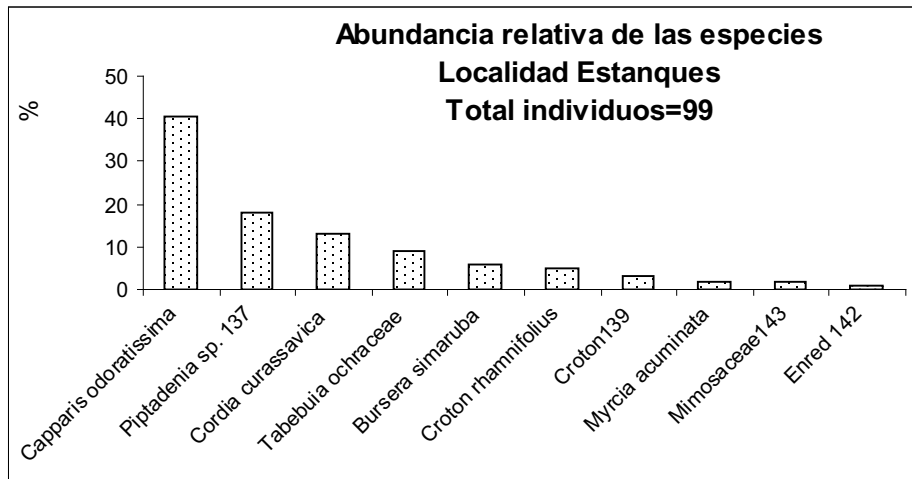

Aranguren, A. 2009. Caracterización de comunidades leñosas estacionalmente secas premontanas y montanas en el estado Mérida. Postgrado en Ecología Tropical. ULA. Mérida

El Corozo

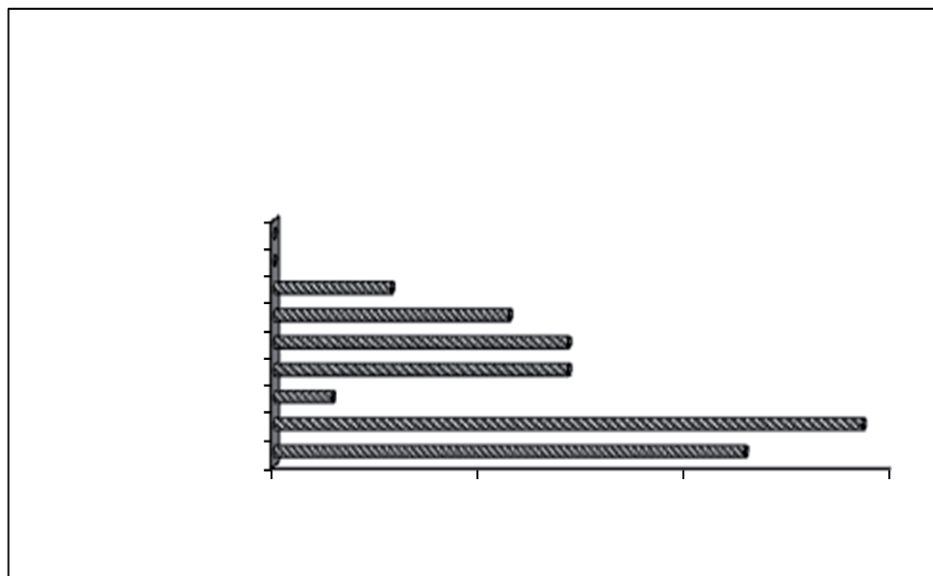
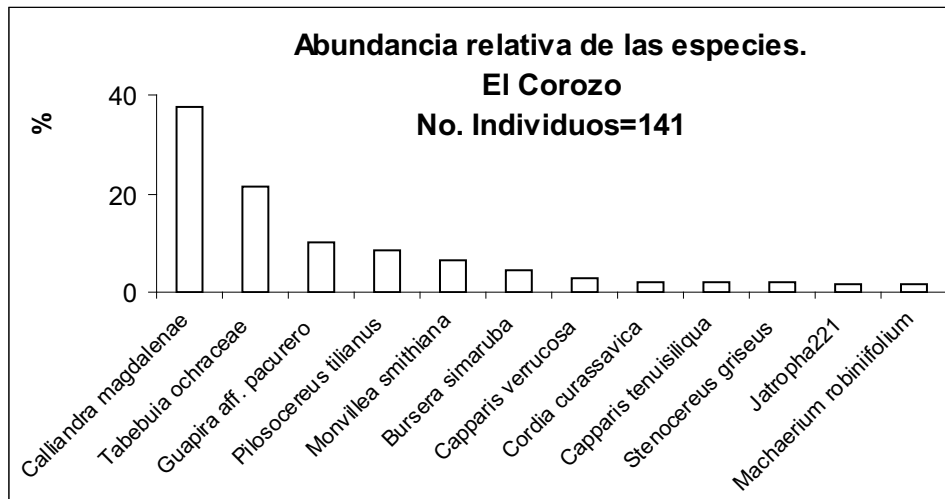

Santo Domingo

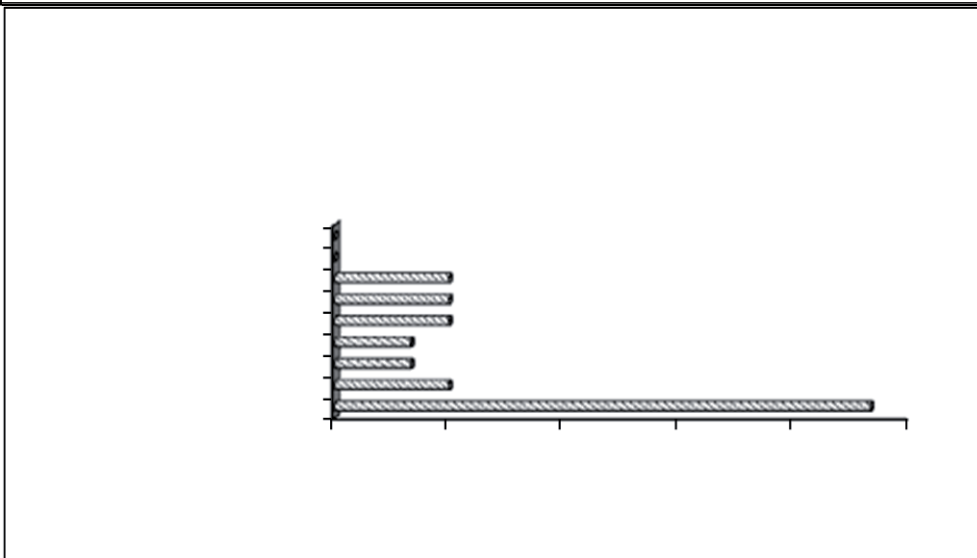
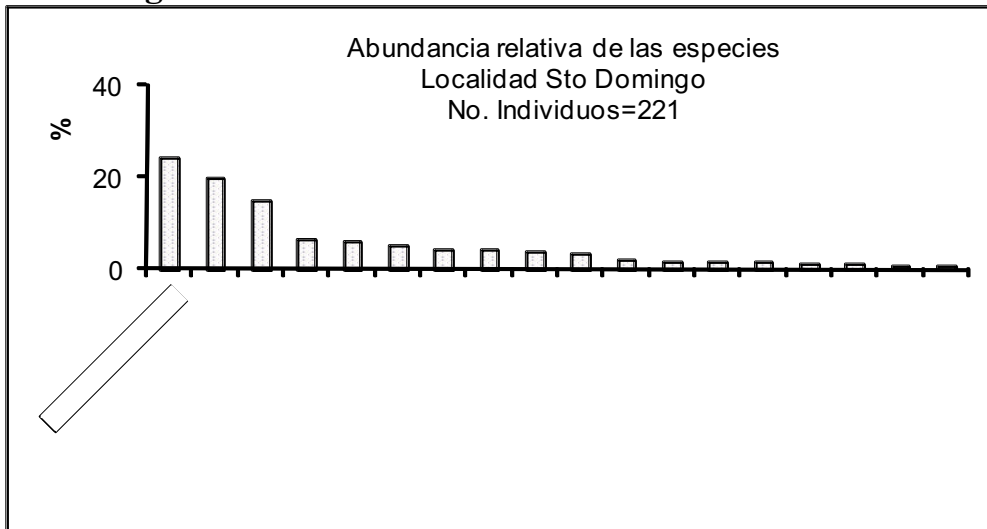

La Pelota

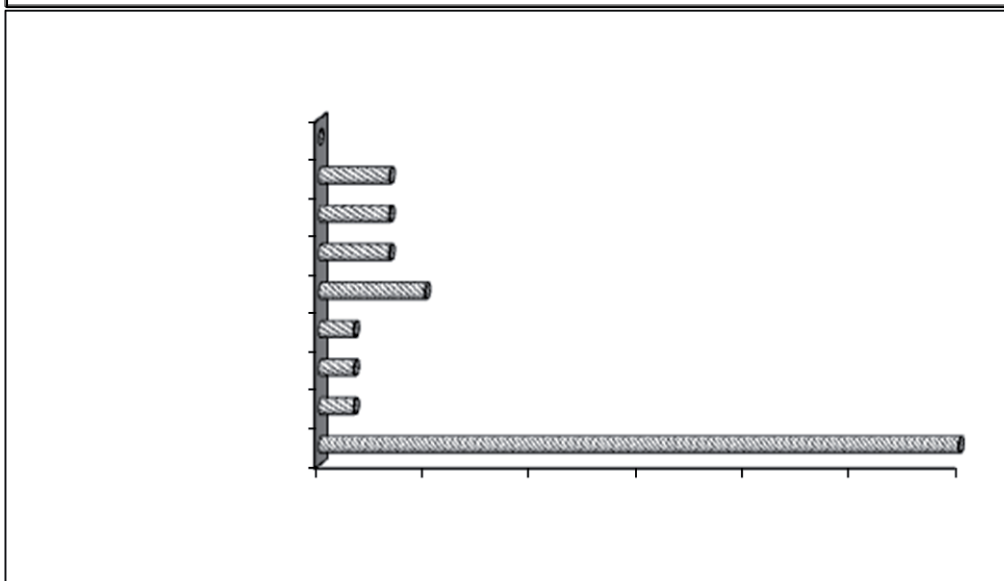
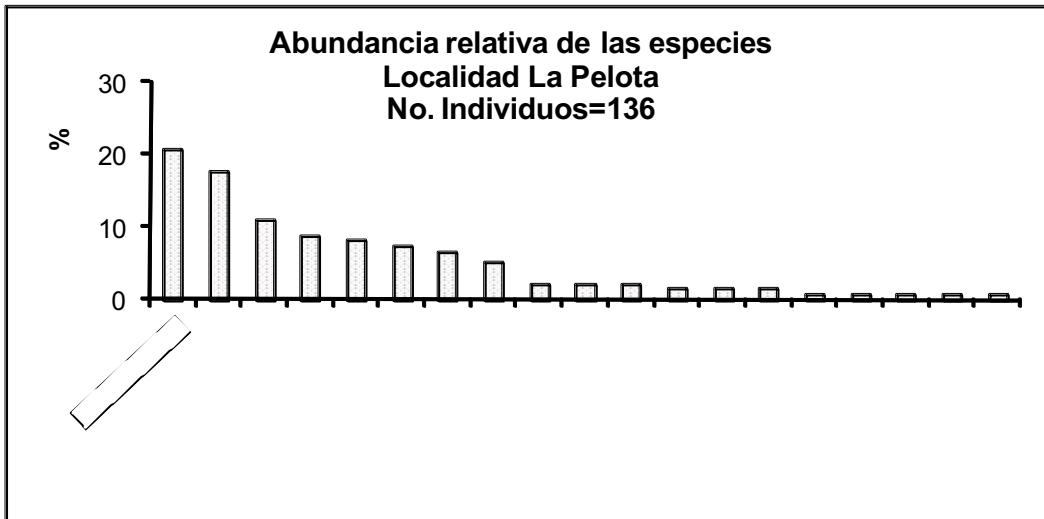

Aranguren, A. 2009. Caracterización de comunidades leñosas estacionalmente secas premontanas y montanas en el estado Mérida. Postgrado en Ecología Tropical. ULA. Mérida

Manzano

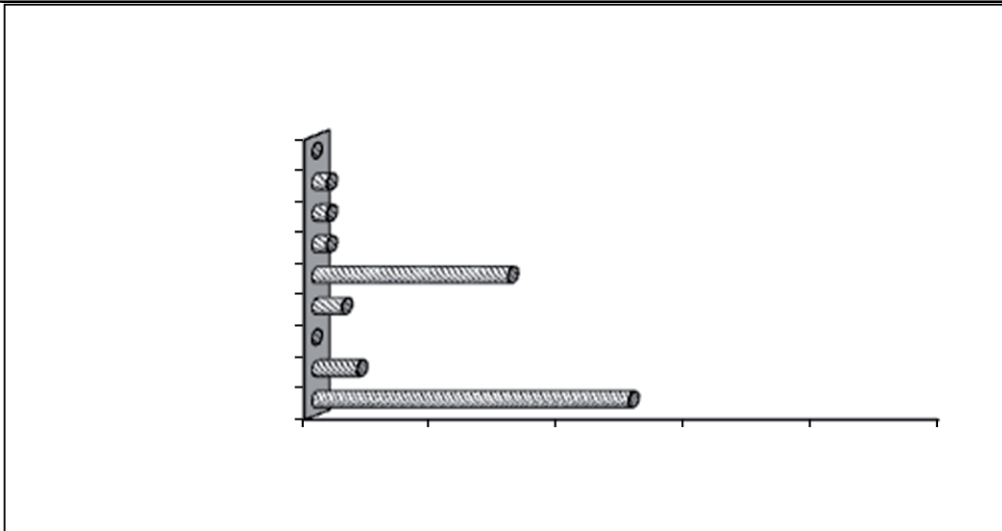
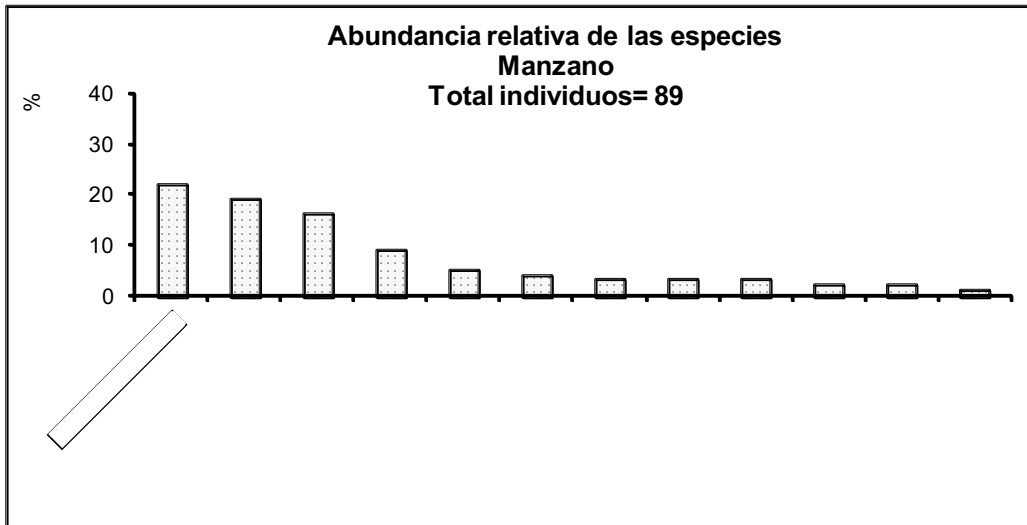

Aranguren, A. 2009. Caracterización de comunidades leñosas estacionalmente secas premontanas y montanas en el estado Mérida. Postgrado en Ecología Tropical. ULA. Mérida

El Escorial

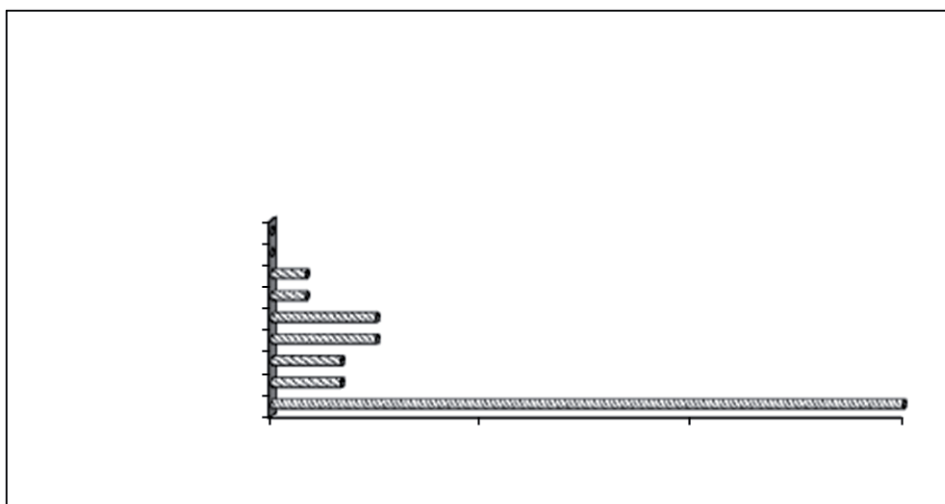
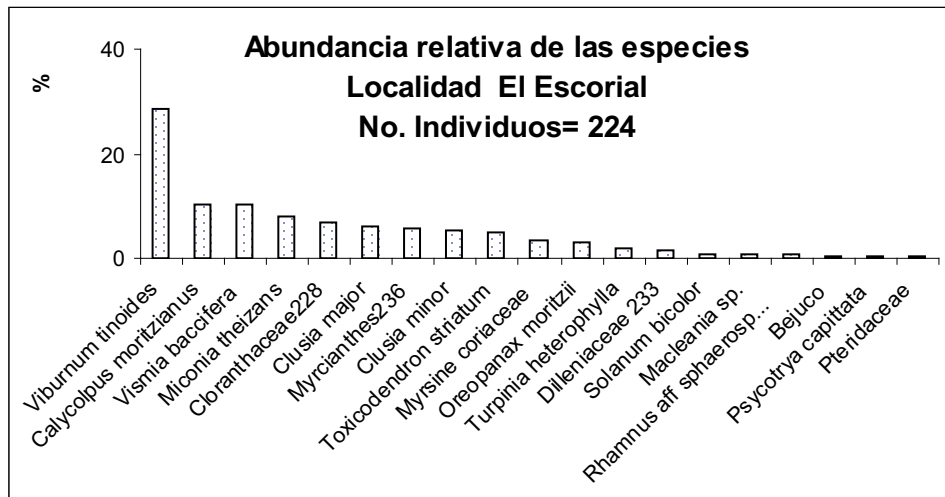

San Juan

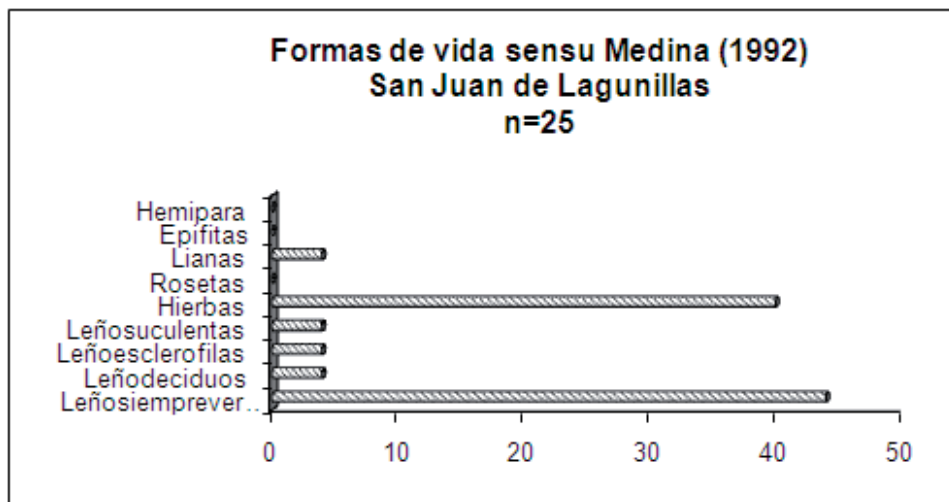
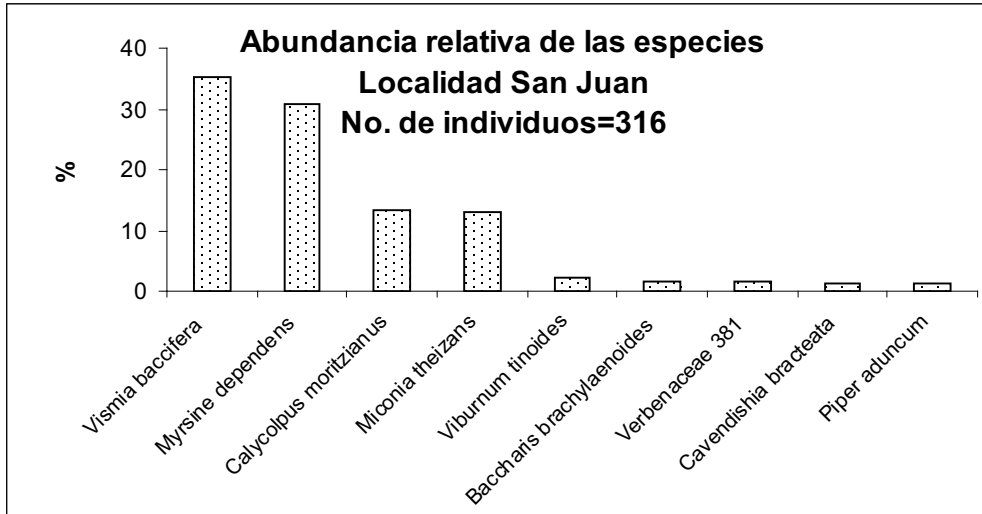

Aranguren, A. 2009. Caracterización de comunidades leñosas estacionalmente secas premontanas y montanas en el estado Mérida. Postgrado en Ecología Tropical. ULA. Mérida

Torondoy

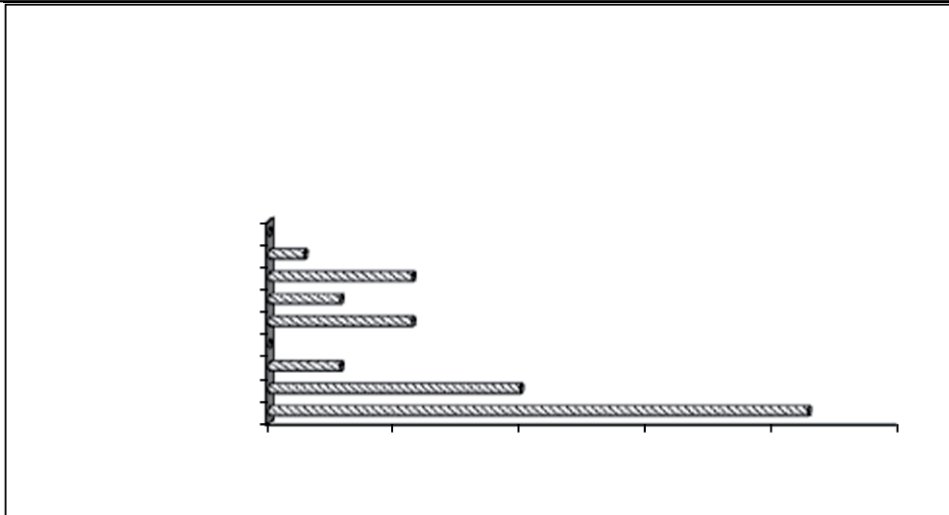
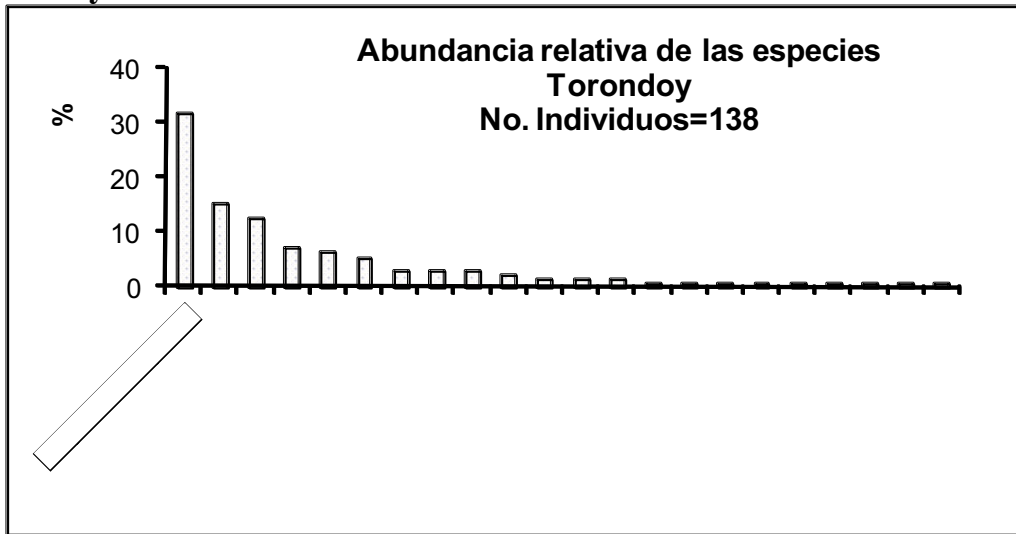

Aranguren, A. 2009. Caracterización de comunidades leñosas estacionalmente secas premontanas y montanas en el estado Mérida. Postgrado en Ecología Tropical. ULA. Mérida

San José

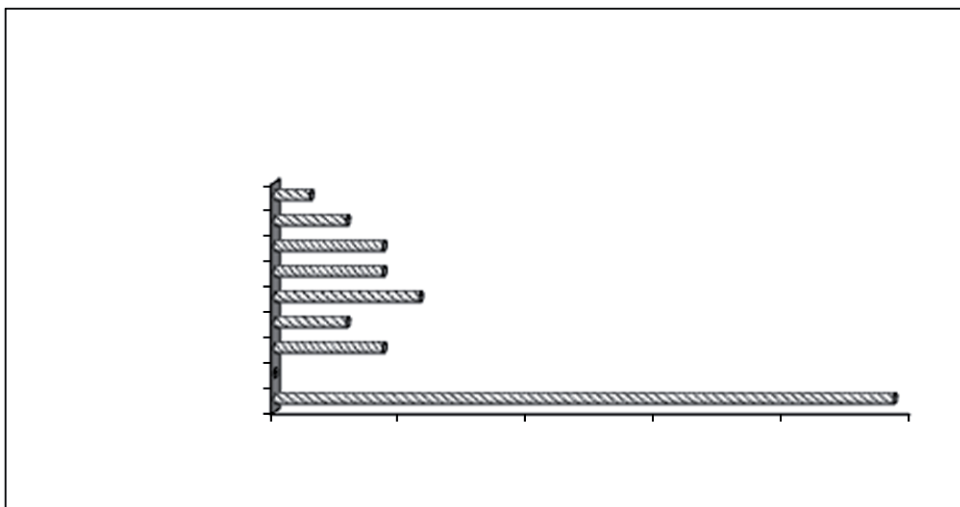
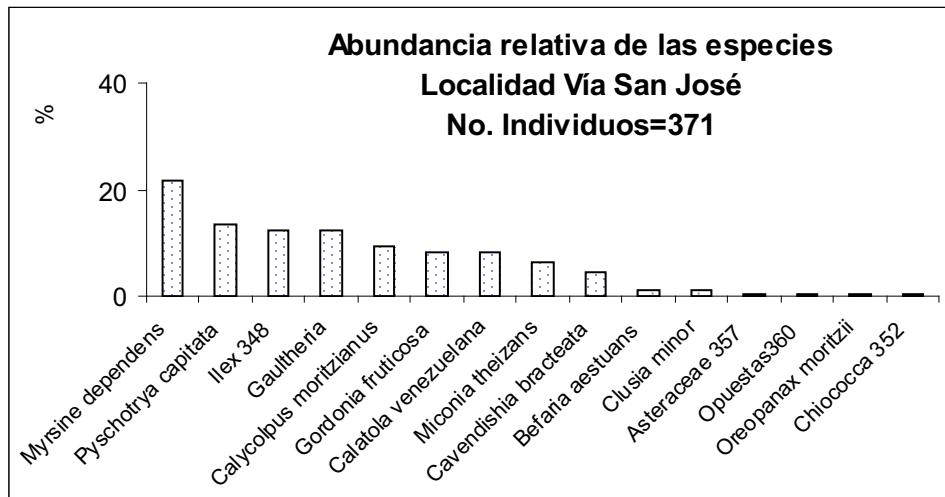

Cucuchica

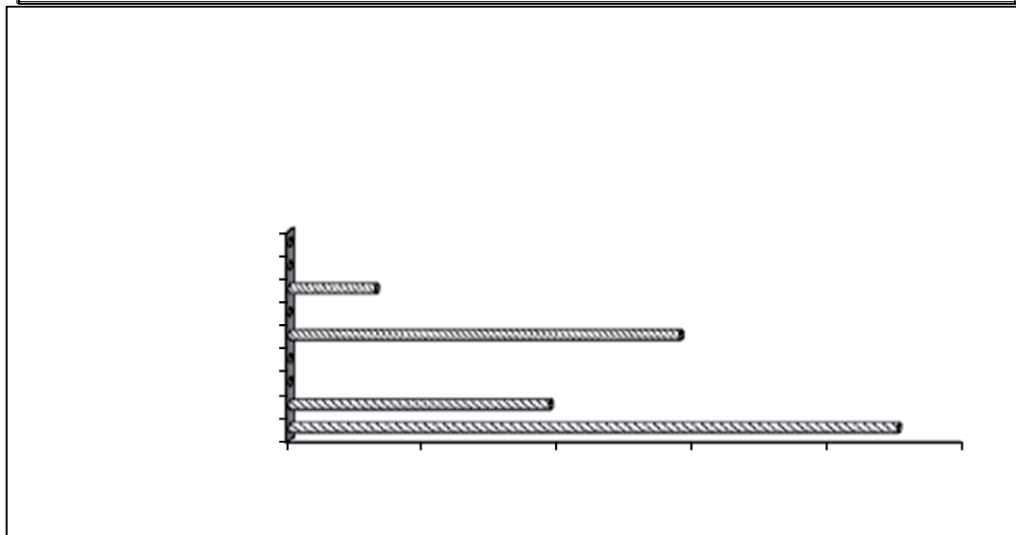
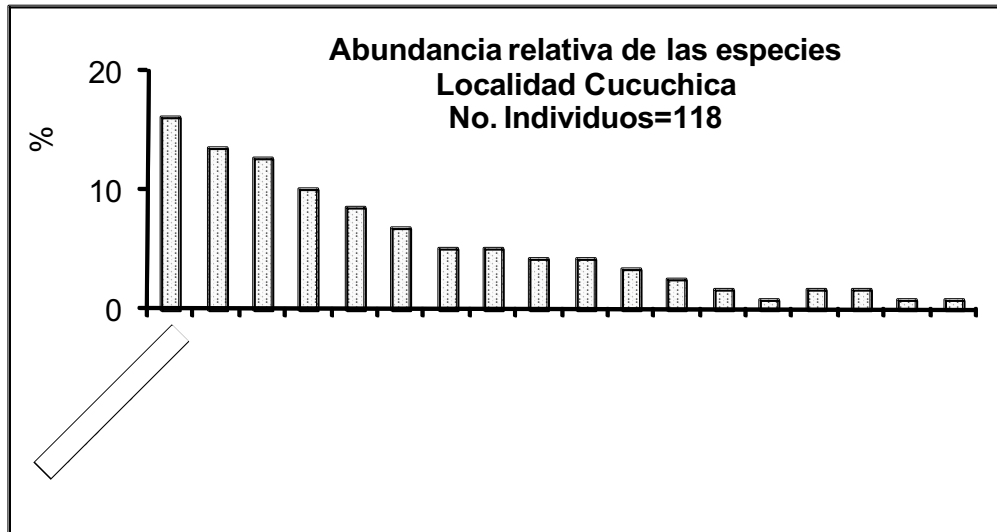

Pedregosa

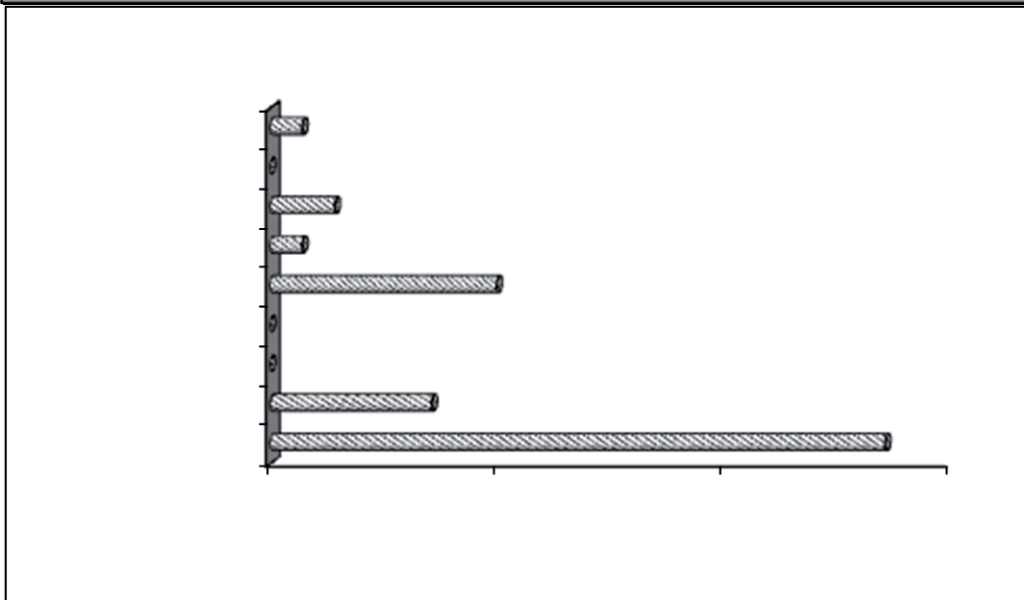
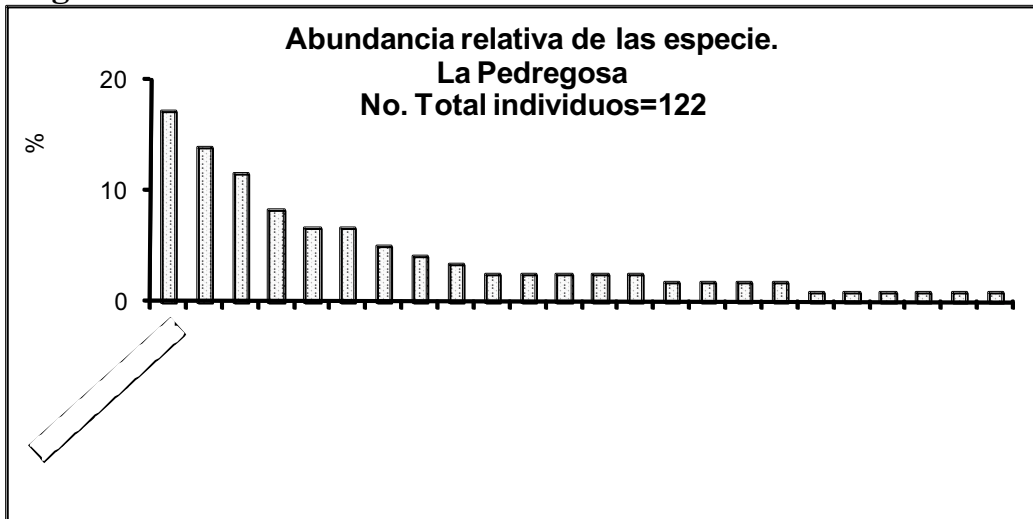

Aranguren, A. 2009. Caracterización de comunidades leñosas estacionalmente secas premontanas y montanas en el estado Mérida. Postgrado en Ecología Tropical. ULA. Mérida

Quebrada Arriba

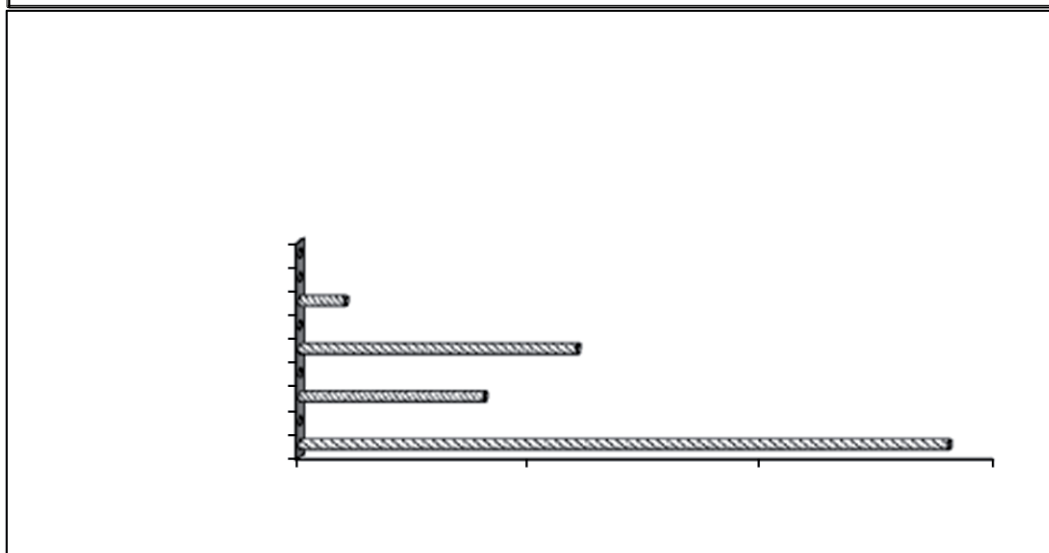
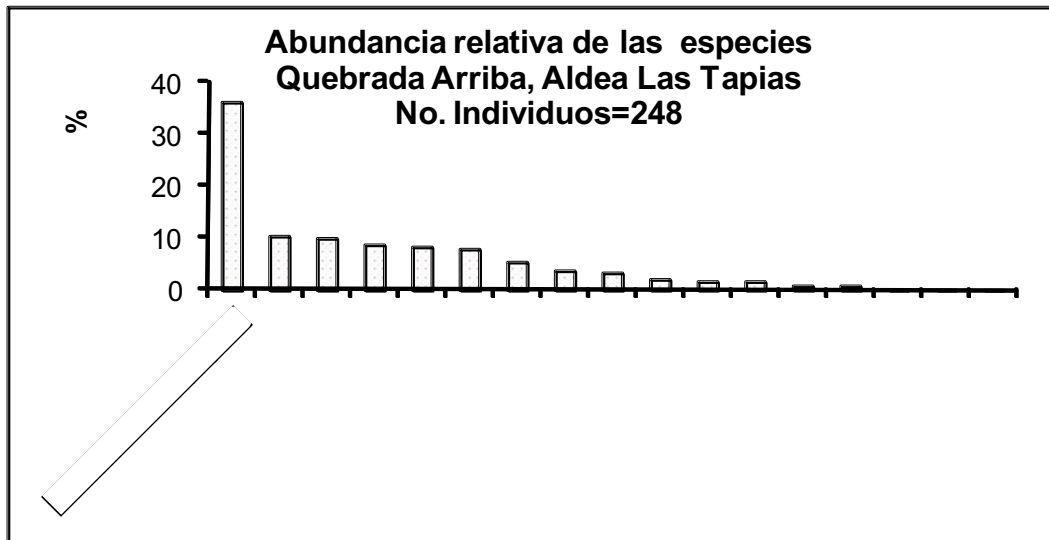

Mucuruba

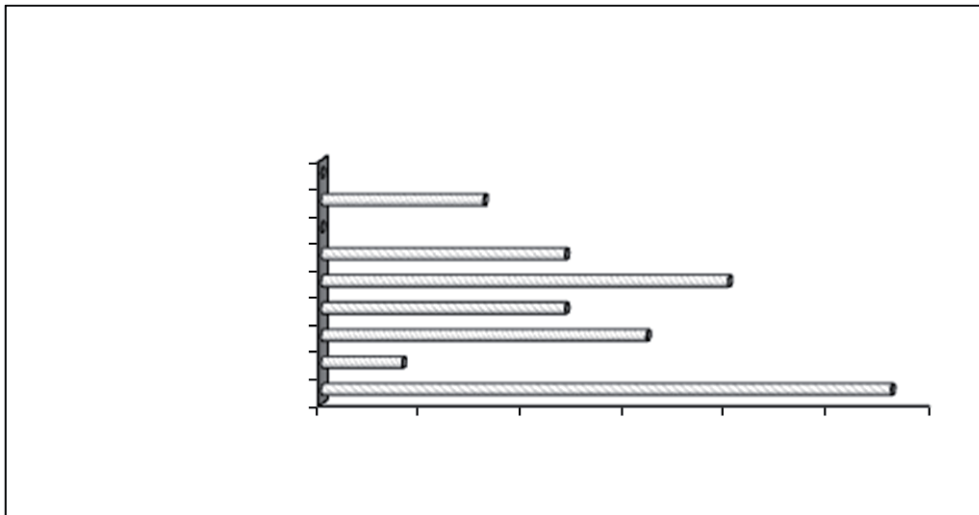
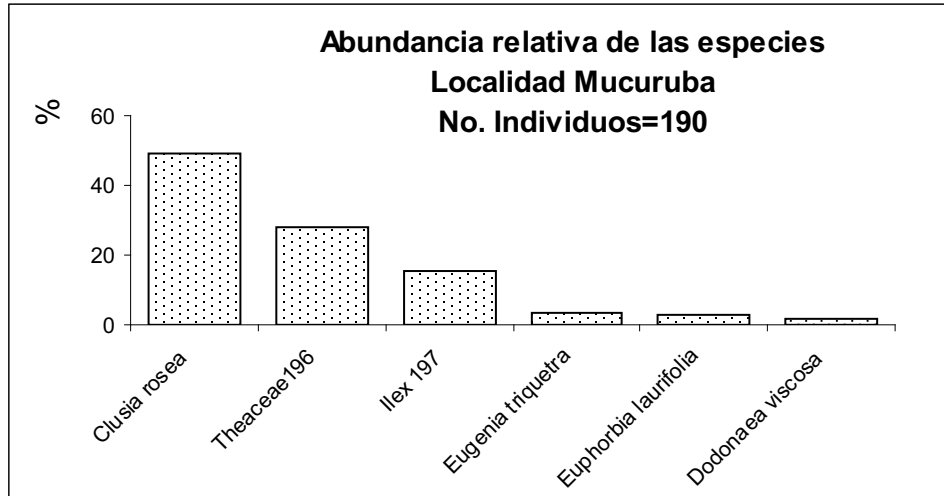

El Salado

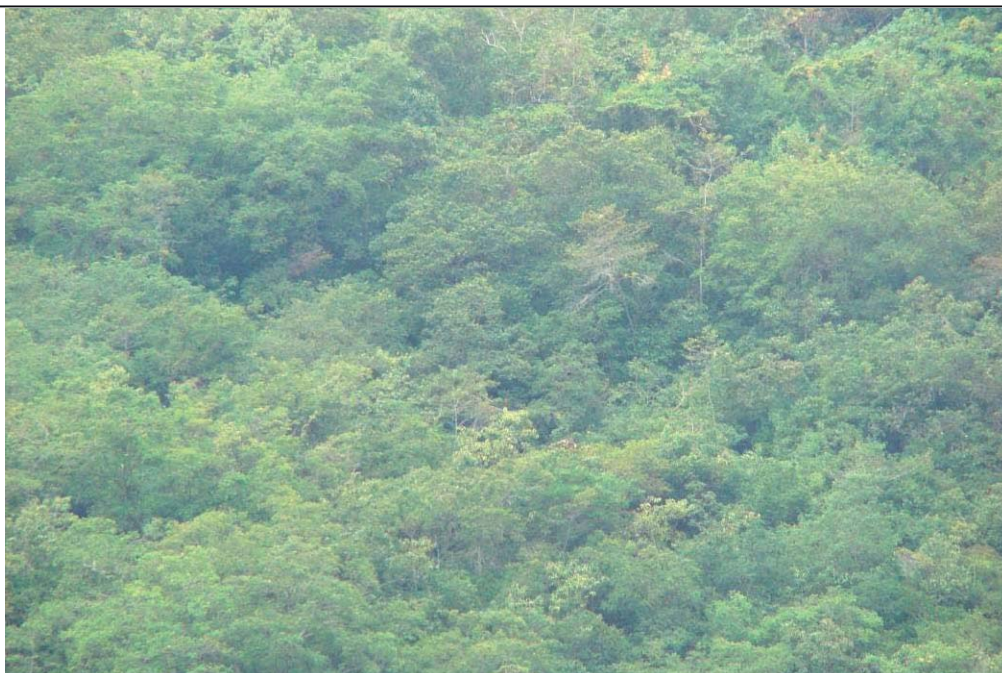
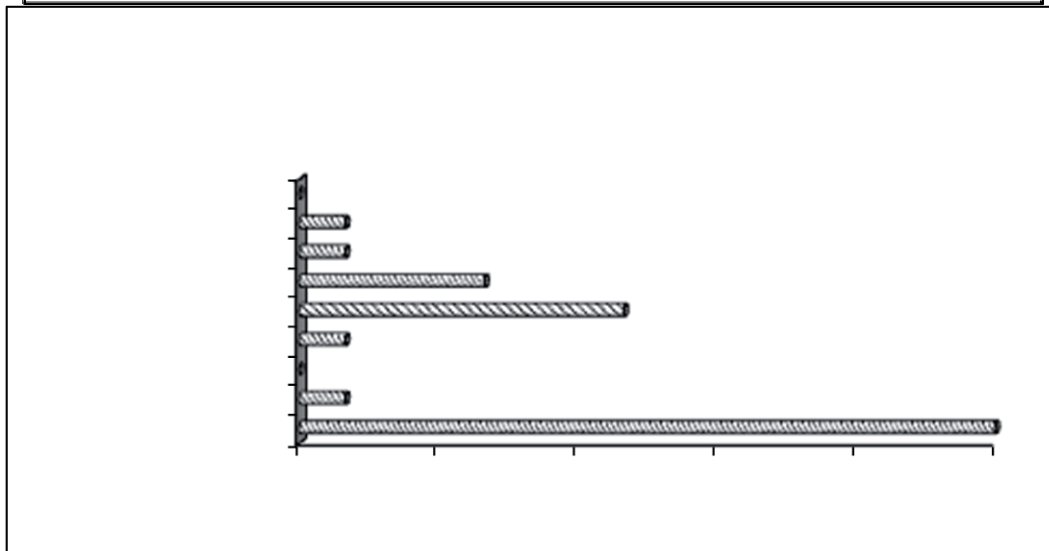
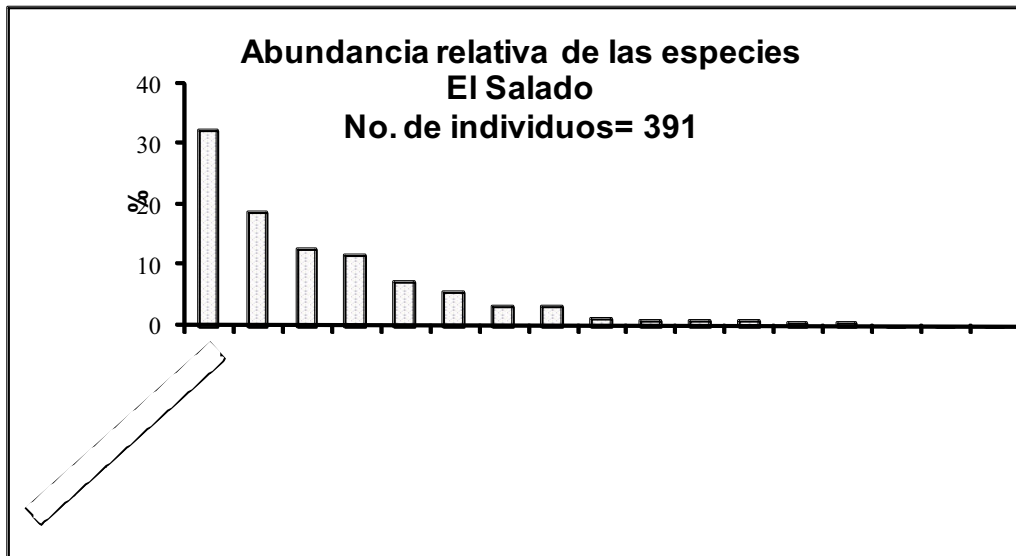

Pedregal

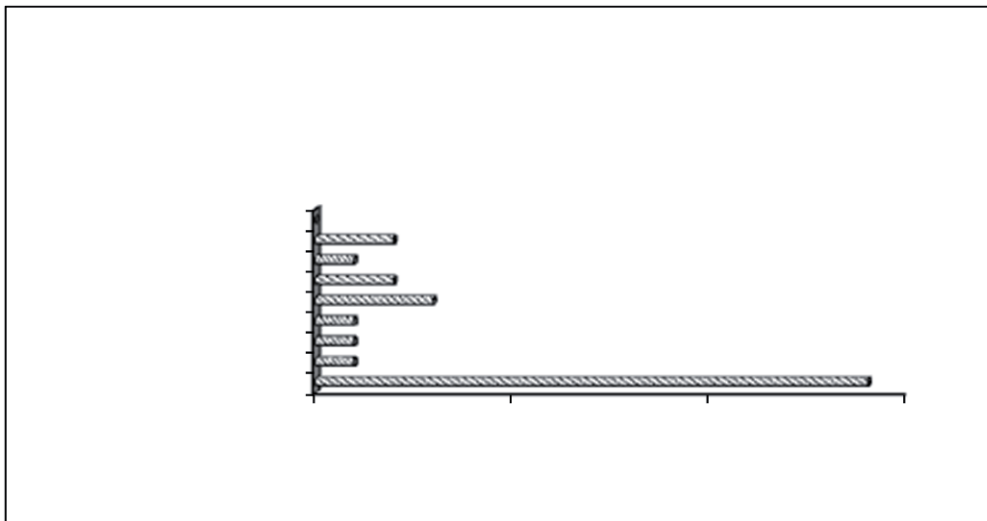
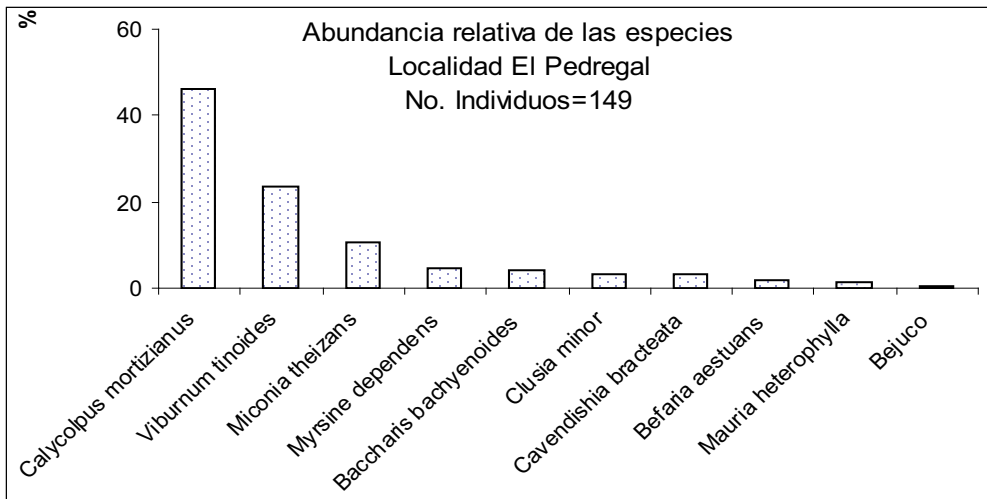

Tabay

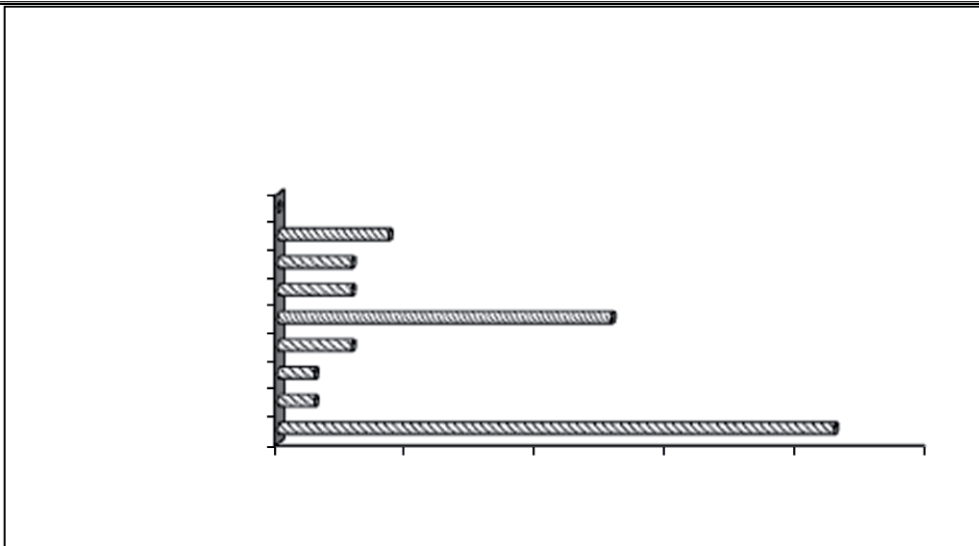
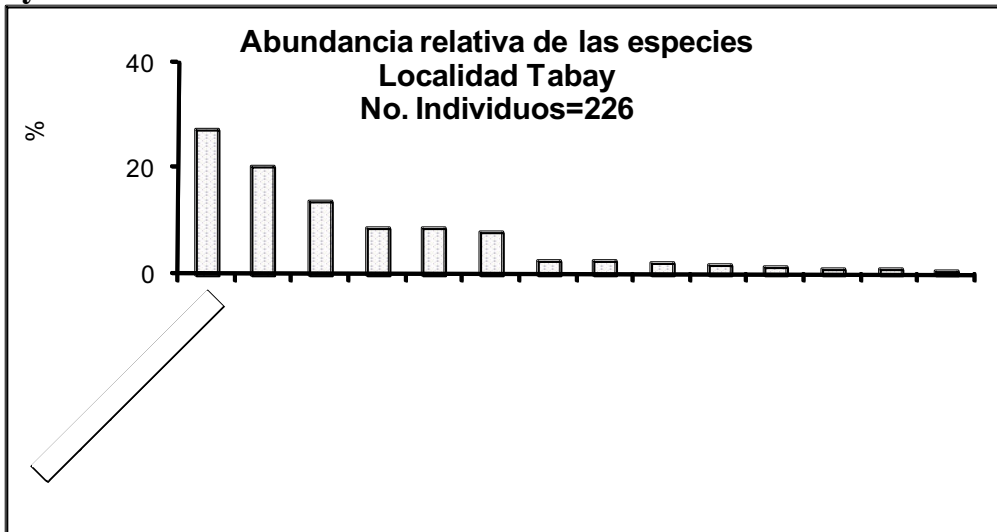

El Banco

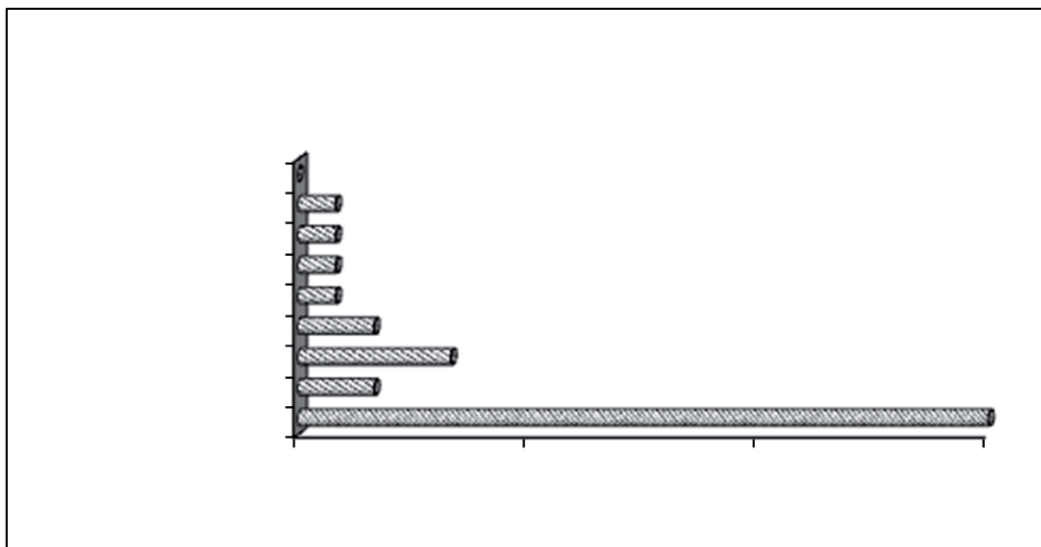
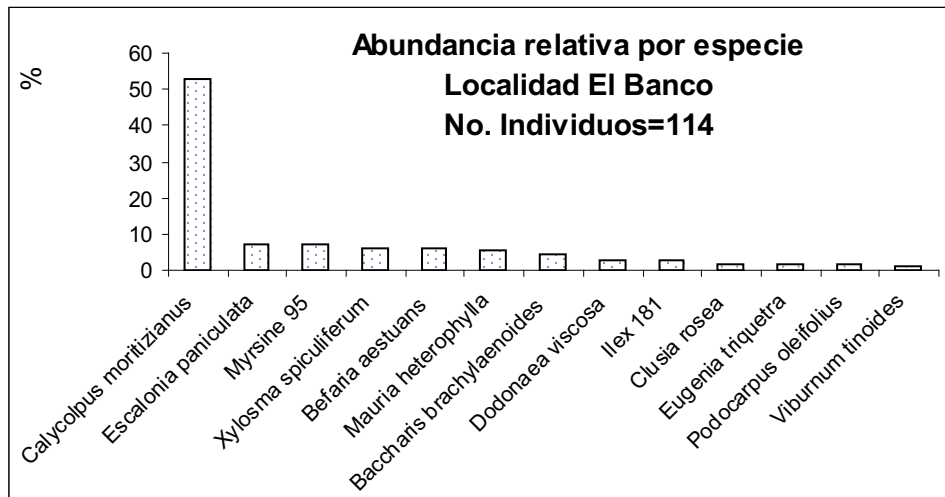

Escagüey

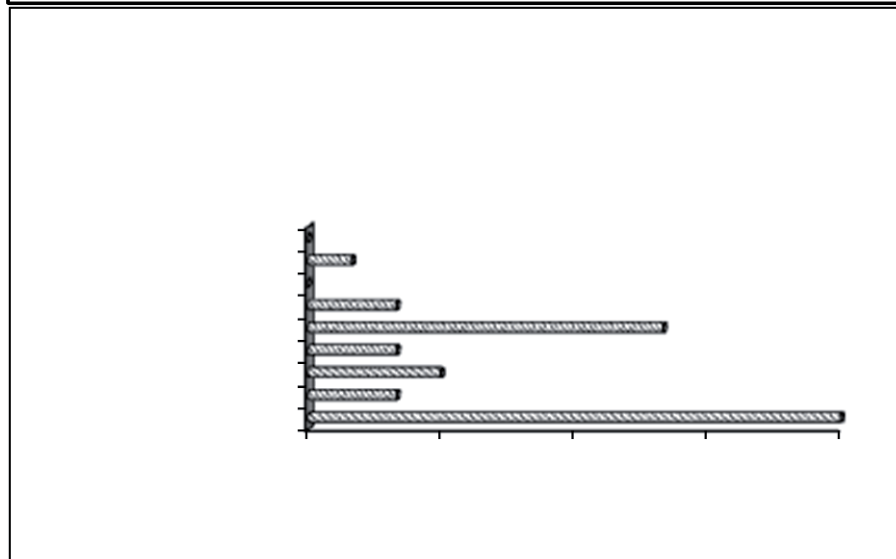
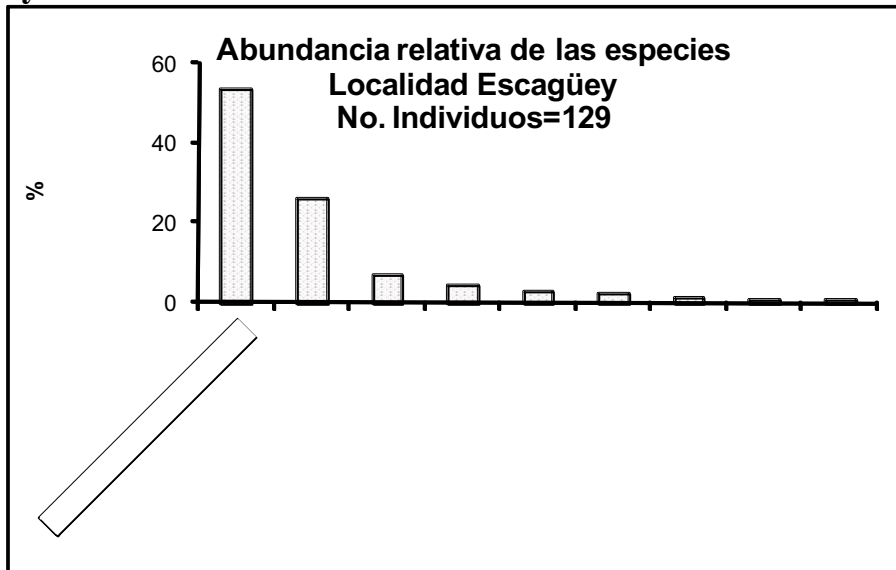

unidades leñosas estacionalmente secas premontanas y
Ecología Tropical. ULA. Mérida

Cacute

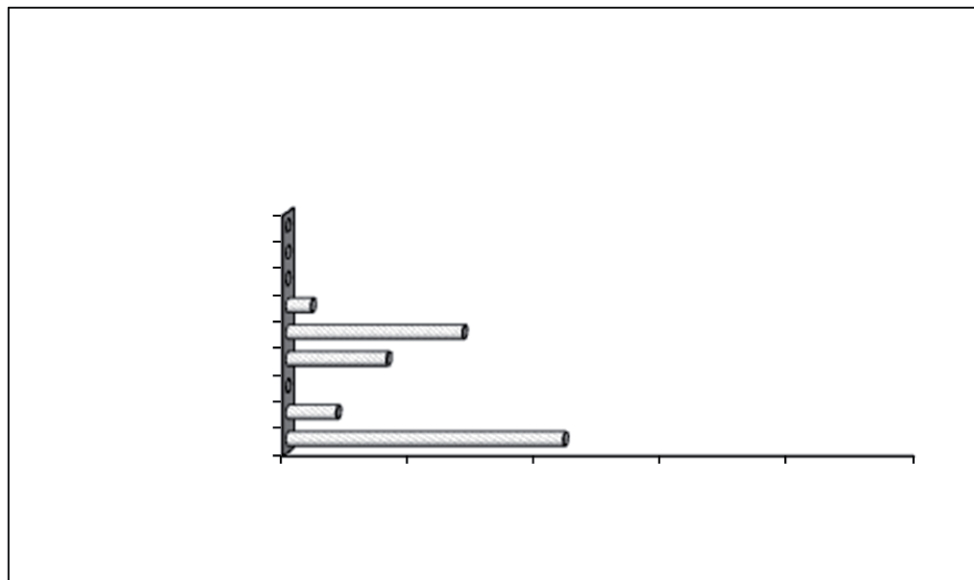
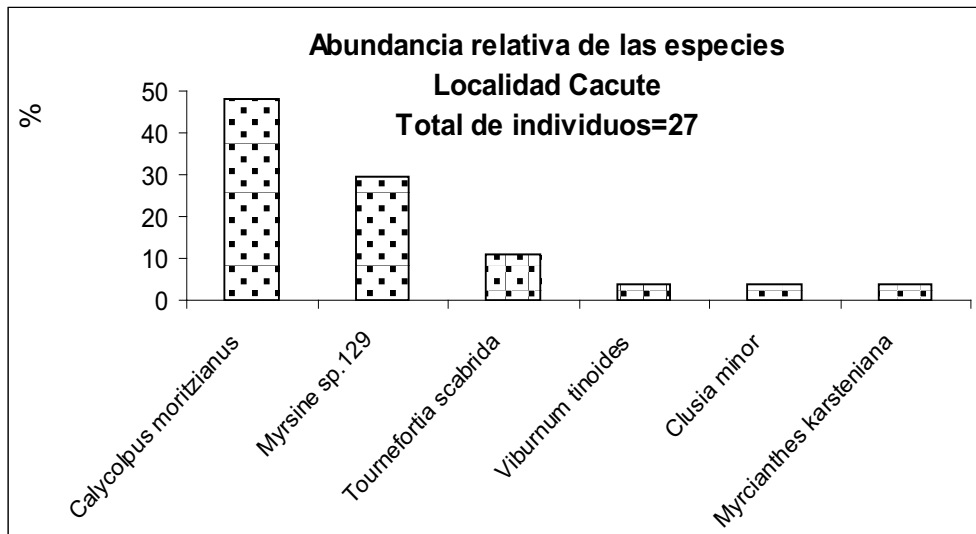

Caracterización del ecosistema estacionalmente seco montano y premontano en el Estado Mérida

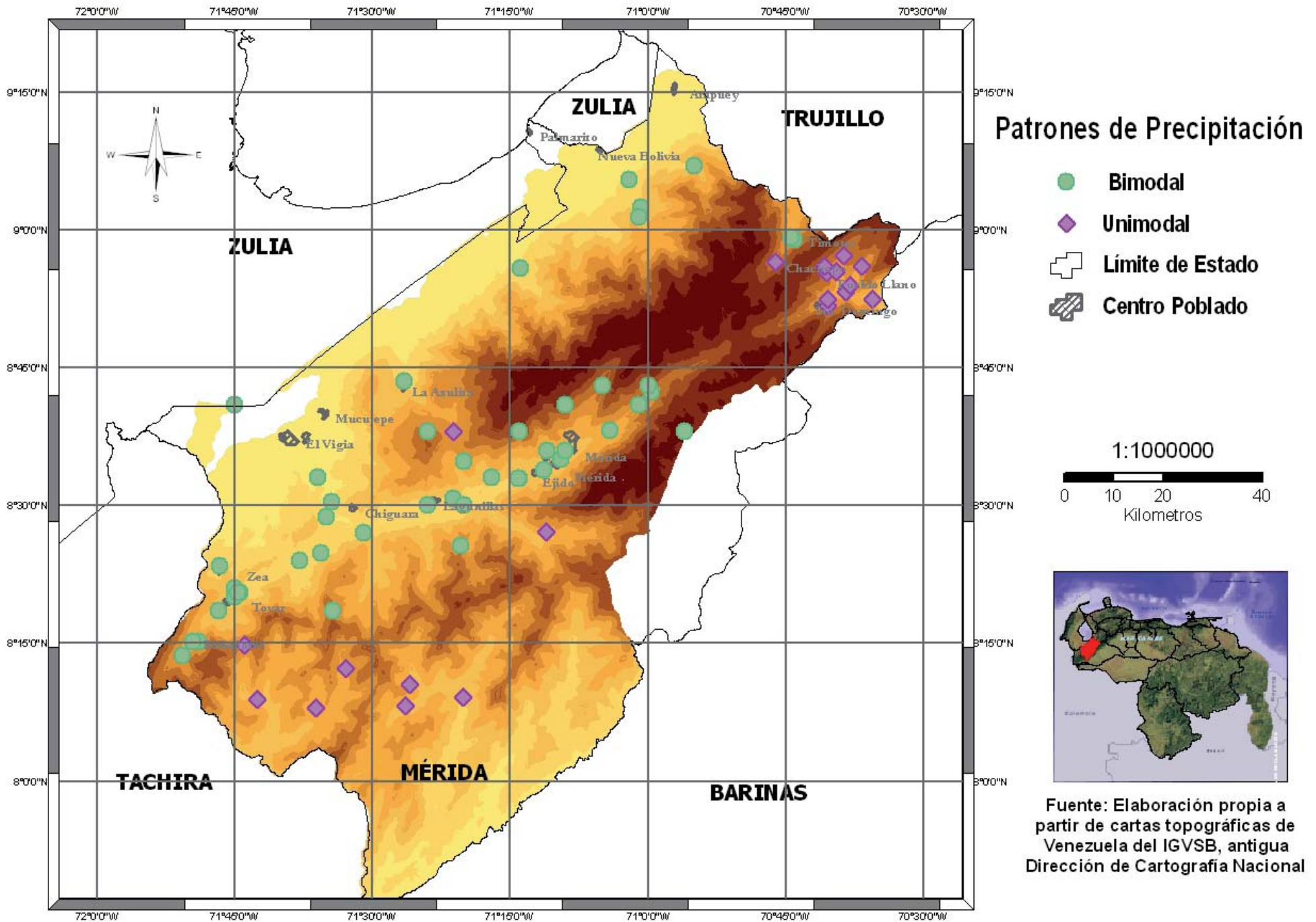

Caracterización del ecosistema estacionalmente seco montano y premontano en el Estado Mérida

