

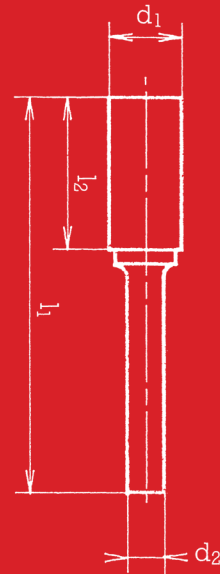

Hartmetallwerkzeuge

# CARBIDE TOOLS

resilient • tough • proven



SWISS MADE



**Schmid & Wezel has stood for the highest degree of precision, quality and cooperative partnership since 1919.**

The company's three divisions include BIAX pneumatic and electric tools, BIAX carbide tools and EFA meat processing machines. These are manufactured in three modern operating facilities in Germany and Switzerland. Schmid & Wezel Maschinenfabrik is a quality leader in the market, not least thanks to the high production depth of up to 90%.

The target is sustained customer satisfaction, which is the most important driving force for constant innovation and quality. The strengths of Schmid & Wezel are demand-oriented solutions in high product quality and individual customer support.

BIAX Neuhausen am Rheinfall ▶



BIAX Maulbronn  
(Group Administration) ▶



BIAX Hilsbach ▶



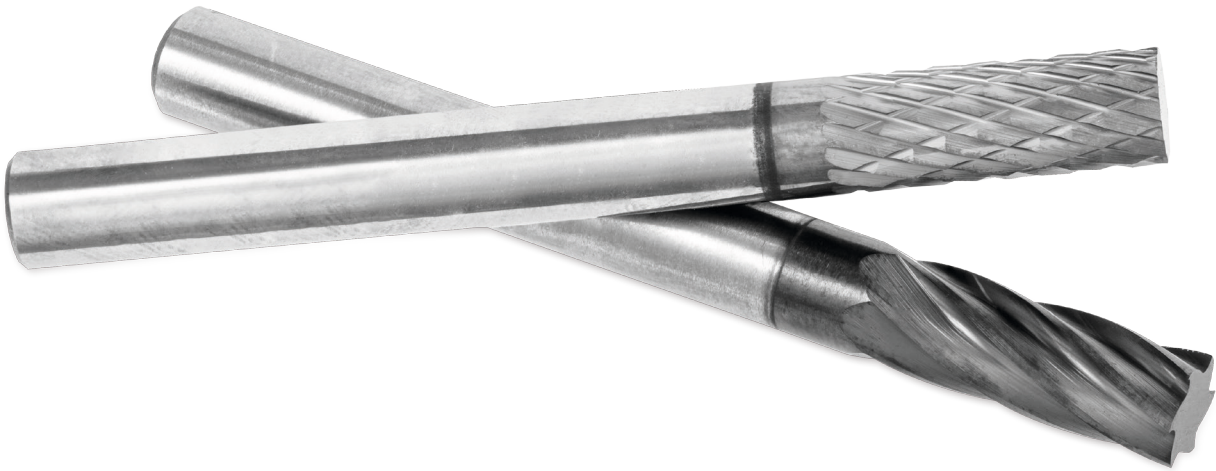

## **PRODUCER OF CARBIDE TOOLS FOR MORE THAN 60 YEARS**

- **Very long service life, thanks to the use of selected carbides**
  - **High cutting capacity**
  - **Very good chip removal**
- **Reduced build-up of chips due to special grinding**
  - **Very soft cut due to optimal cutting geometry**
  - **No carbide corrosion**



SWISS MADE

# List of Contents

## Contents

Page

5	Explanation of the cutting edges
6	Cutting data table
7	Speed diagram
8-15	Universal burrs
15	Special burrs
16-19	Special burrs



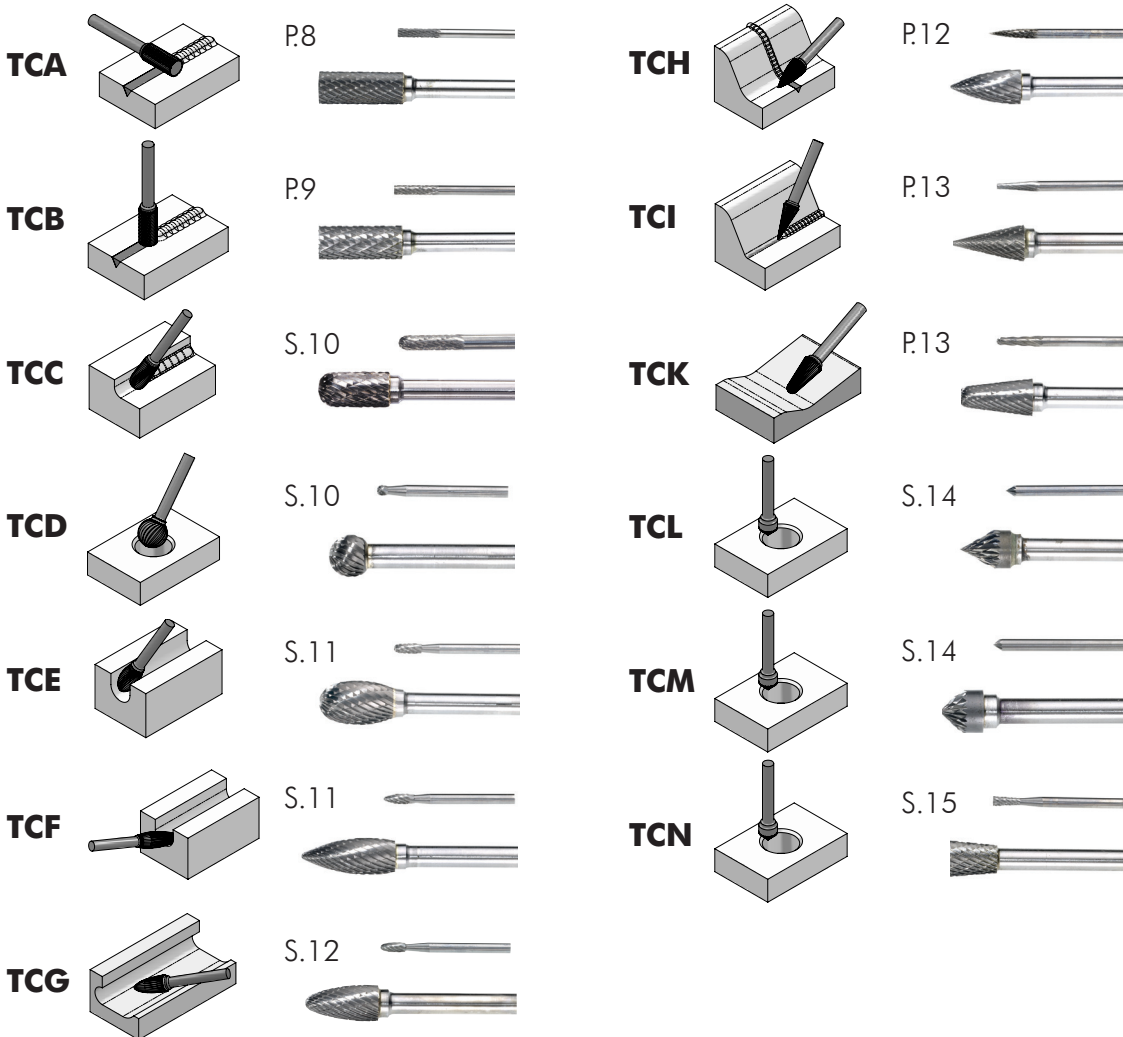





## Types and application

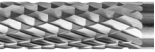

Burrs standardised according to DIN 8033

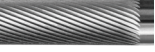

## with precision cutting for high performance

Cutting edges	Description
 <b>2</b> Page 8-15	Tooth geometry 2 is an uncomplicated cutting edge, which enables a <b>high chip removal</b> and yet still achieves a <b>good surface</b> .
 <b>5</b> Page 8-15	As with cutting edge 2, this cutting edge is also uncomplicated. However, due to the <b>increased number of cuts</b> a <b>better surface</b> and <b>lower material removal</b> are achieved.
 <b>63</b> Page 8-17	The highly popular and long-tried cross-cutting edge from BIAx is characterised by <b>high material removal and a smooth guide</b> on the workpieces. This cutting edge can be used for <b>nearly all materials</b> but displays its full capability when machining <b>cast parts</b> .
 <b>63 – Performance</b> Page 17	If difficult-to-machine stainless steels, <b>tempered steels or similar are being handled</b> , it is possible to supply the already strong 63 cutting edge with a special coating. This <b>greatly improves the service life and material removal can be increased even further</b> .
 <b>10 – Superfein</b> Page 17	When you need to work <b>on difficult to access areas</b> or you wish to achieve a <b>perfect surface finish</b> , then we suggest our Superfein cutting edge. This helps to achieve the best possible surfaces and <b>enables a high degree of control</b> .
 <b>13 – Non Ferrous</b> Page 17	Another BIAx speciality is the Non Ferrous cutting edge, which provides a <b>perfect removal of material on brittle, non-ferrous metals and plastics</b> .
 <b>14 – Alu</b> Page 18	The tooth geometry 14 is a specially developed cutting edge to achieve an <b>optimal cutting performance on non-ferrous metals and plastics</b> . Due to the <b>large chip space</b> the milling cutter is always able to "cut freely".
 <b>14 – Alu Performance</b> Page 18	In the case of problematic metals, <b>such as the processing of pure aluminium</b> , to achieve a perfect result we recommend the 14 cutting edge with our specially developed coating.
 <b>16 – Composite</b> Page 19	The 16 cutting edge is new to the BIAx range and is ideally suited to machine <b>fibre composite materials</b> .

Performance means that we produce milling cutters with special coatings, which will impress you directly whilst taking your work to another level.

# Cutting data

Material	Cutting edge	Type of processing	Cutting speed up to
Soft non-ferrous metals and non-ferrous heavy metals (pure aluminium, copper, zinc)	Alu	Roughing	350 m/min
		Finishing	450 m/min
	Alu Performance	Roughing	450 m/min
		Finishing	650 m/min
	Tooth geometry 2	Roughing	400 m/min
		Finishing	500 m/min
Hard non-ferrous metals (aluminium alloys, brass, copper, zinc, bronze, red brass)	Alu	Roughing	400 m/min
		Finishing	500 m/min
	Non Ferrous	Roughing	450 m/min
		Finishing	550 m/min
	Alu Performance	Roughing	600 m/min
		Finishing	750 m/min
	Tooth geometry 2	Roughing	450 m/min
		Finishing	700 m/min
	Tooth geometry 63	Roughing	600 m/min
		Finishing	900 m/min
Plastics	Alu	Roughing	300 m/min
		Finishing	450 m/min
	Non Ferrous	Roughing	300 m/min
		Finishing	450 m/min
	Alu Performance	Roughing	350 m/min
		Finishing	500 m/min
	Tooth geometry 2	Roughing	300 m/min
		Finishing	350 m/min
	Tooth geometry 63	Roughing	300 m/min
		Finishing	450 m/min
Composite materials	Composite	Roughing	450 m/min
		Finishing	800 m/min
Cast iron	Tooth geometry 63	Roughing	600 m/min
		Finishing	900 m/min
	Tooth geometry 2	Roughing	400 m/min
		Finishing	600 m/min
	Tooth geometry 5	Roughing	400 m/min
		Finishing	900 m/min
Steel, cast steel (structural steels, tool steels, reinforcing steels, tempered steels, unalloyed steels, alloyed steels)	Tooth geometry 63	Roughing	450 m/min
		Finishing	600 m/min
	63 Performance	Roughing	600 m/min
		Finishing	900 m/min
	Superfein	Finishing	900 m/min
		Tooth geometry 2	Roughing
	Finishing		600 m/min
	Tooth geometry 5	Roughing	400 m/min
		Finishing	900 m/min
	Stainless steel and titanium	Tooth geometry 63	Roughing
Finishing			600 m/min
63 Performance		Roughing	600 m/min
		Finishing	900 m/min
Superfein		Finishing	900 m/min
		Tooth geometry 2	Roughing
Finishing			600 m/min
Tooth geometry 5		Roughing	400 m/min
		Finishing	900 m/min

# Speed diagram

$v$  = Cutting speed

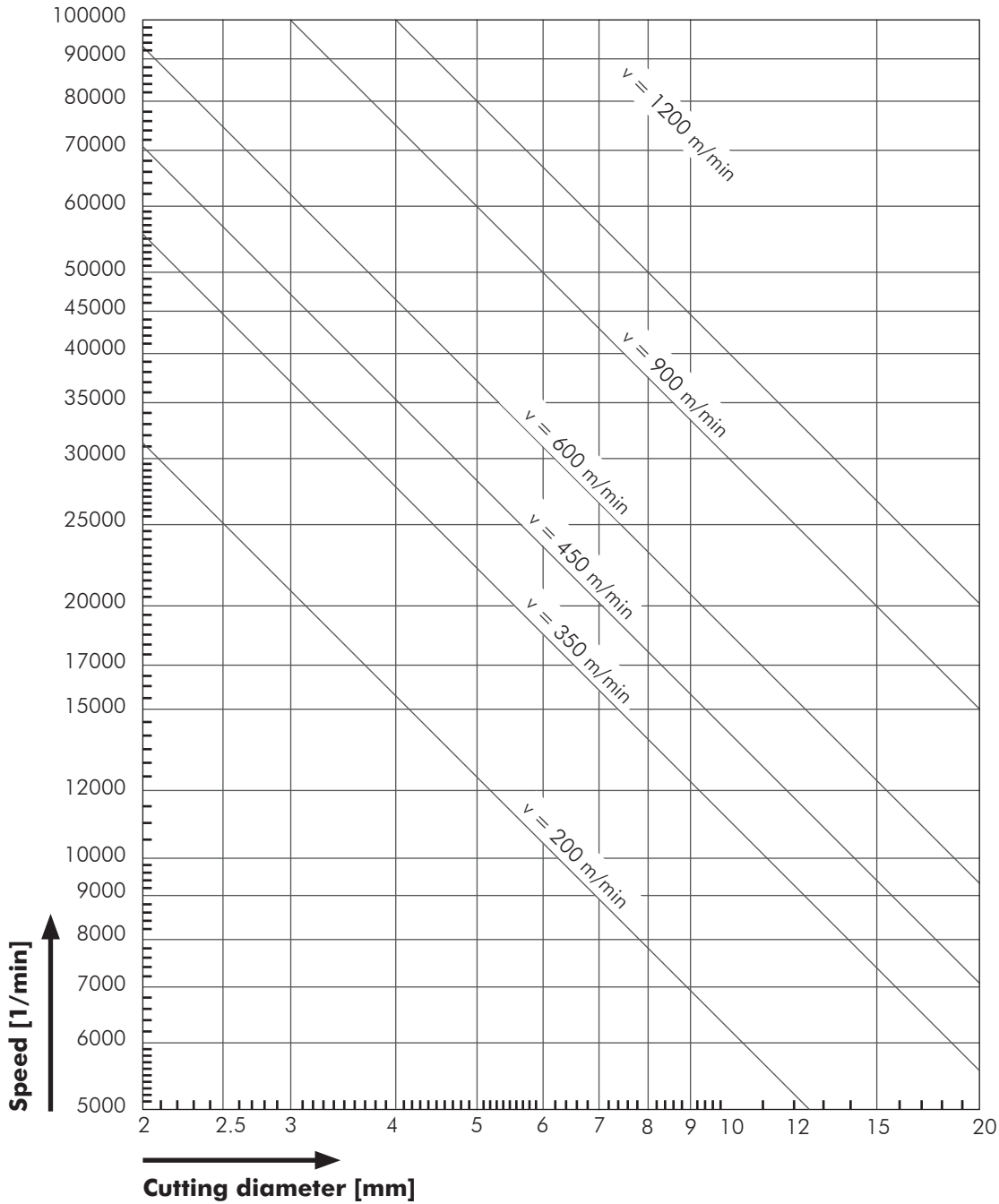

If you have any questions regarding burrs please do not hesitate to contact us or to arrange an appointment with one of our BIAx specialists. You are also very welcome to visit us in our group headquarters in Maulbronn, where we can join together to find the most optimum solution. Alternatively you can also send us a workpiece.

# Universal burrs

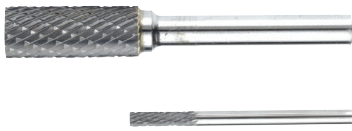

**TCA**

**Cylindrical shape,  
without end cut**

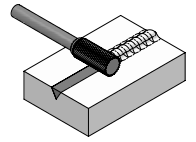
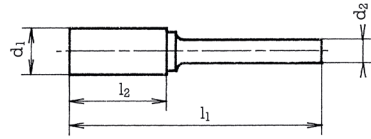

DIN 8033	BIAX	Ø Shaft d2 mm	Ø Head d1 mm	Length head l2 mm	Length total l1 mm	Tooth geometry 2	Tooth geometry 5	Tooth geometry 63
ZYA 0210.03	<b>TCA 0203</b>	<b>3</b>	<b>2</b>	<b>10</b>	<b>40</b>	---	001 952 000	001 952 001
ZYA 0313.03	<b>TCA 0303</b>	<b>3</b>	<b>3</b>	<b>13</b>	<b>43</b>	---	001 952 010	001 952 011
---	<b>TCA 0403</b>	<b>3</b>	<b>4</b>	<b>6</b>	<b>36</b>	---	001 952 056	001 952 057
---	<b>TCA 0503</b>	<b>3</b>	<b>5</b>	<b>5</b>	<b>35</b>	---	001 952 083	001 952 084
ZYA 0607.03	<b>TCA 0603</b>	<b>3</b>	<b>6</b>	<b>7</b>	<b>37</b>	---	001 952 092	001 952 093
ZYA 0613.03	<b>TCA 0613</b>	<b>3</b>	<b>6</b>	<b>13</b>	<b>43</b>	---	001 952 181	001 952 182
ZYA 0413.06	<b>TCA 0406</b>	<b>6</b>	<b>4</b>	<b>13</b>	<b>53</b>	001 952 066	001 952 068	001 952 069
---	<b>TCA 0506</b>	<b>6</b>	<b>5</b>	<b>13</b>	<b>58</b>	001 952 513	001 952 085	001 952 086
ZYA 0616.06	<b>TCA 0606</b>	<b>6</b>	<b>6</b>	<b>16</b>	<b>56</b>	001 952 119	001 952 121	001 952 122
ZYA 0820.06	<b>TCA 0806</b>	<b>6</b>	<b>8</b>	<b>20</b>	<b>60</b>	001 952 514	001 952 195	001 952 196
ZYA 1013.06	<b>TCA 1006</b>	<b>6</b>	<b>10</b>	<b>13</b>	<b>53</b>	001 952 515	001 952 221	001 952 222
ZYA 1020.06	<b>TCA 1016</b>	<b>6</b>	<b>10</b>	<b>20</b>	<b>60</b>	001 952 516	001 952 523	001 952 275
ZYA 1025.06	<b>TCA 1026</b>	<b>6</b>	<b>10</b>	<b>25</b>	<b>65</b>	001 952 517	001 952 524	001 952 285
ZYA 1225.06	<b>TCA 1206</b>	<b>6</b>	<b>12</b>	<b>25</b>	<b>65</b>	001 952 289	001 952 291	001 952 293







### TCB

Cylindrical shape,  
with end cut

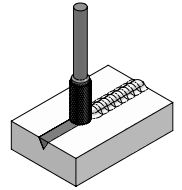
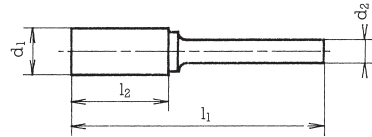

DIN 8033	BIAX	Ø Shaft d2 mm	Ø Head d1 mm	Length head l2 mm	Length total l1 mm	Tooth geometry 2	Tooth geometry 5	Tooth geometry 63
ZYAS 0210.03	<b>TCB 0203</b>	<b>3</b>	<b>2</b>	<b>10</b>	<b>40</b>	---	001 952 002	001 952 003
ZYAS 0313.03	<b>TCB 0303</b>	<b>3</b>	<b>3</b>	<b>13</b>	<b>43</b>	---	001 952 012	001 952 013
---	<b>TCB 0403</b>	<b>3</b>	<b>4</b>	<b>6</b>	<b>36</b>	---	001 952 058	001 952 059
ZYAS 0613.03	<b>TCB 0613</b>	<b>3</b>	<b>6</b>	<b>13</b>	<b>43</b>	---	---	001 952 183
ZYAS 0413.06	<b>TCB 0406</b>	<b>6</b>	<b>4</b>	<b>13</b>	<b>53</b>	001 952 070	001 952 538	001 952 072
ZYAS 0616.06	<b>TCB 0606</b>	<b>6</b>	<b>6</b>	<b>16</b>	<b>56</b>	001 952 123	001 952 126	001 952 127
ZYAS 0820.06	<b>TCB 0806</b>	<b>6</b>	<b>8</b>	<b>20</b>	<b>60</b>	001 952 529	001 952 198	001 952 199
ZYAS 1013.06	<b>TCB 1006</b>	<b>6</b>	<b>10</b>	<b>13</b>	<b>53</b>	001 952 530	001 952 224	001 952 225
ZYAS 1020.06	<b>TCB 1016</b>	<b>6</b>	<b>10</b>	<b>20</b>	<b>60</b>	001 952 531	001 952 539	001 952 277
ZYAS 1025.06	<b>TCB 1026</b>	<b>6</b>	<b>10</b>	<b>25</b>	<b>65</b>	001 952 532	001 952 540	001 952 287
ZYAS 1225.06	<b>TCB 1206</b>	<b>6</b>	<b>12</b>	<b>25</b>	<b>65</b>	001 952 294	001 952 296	001 952 297
ZYAS 1625.06	<b>TCB 1606</b>	<b>6</b>	<b>16</b>	<b>25</b>	<b>65</b>	001 952 534	001 952 542	001 952 410

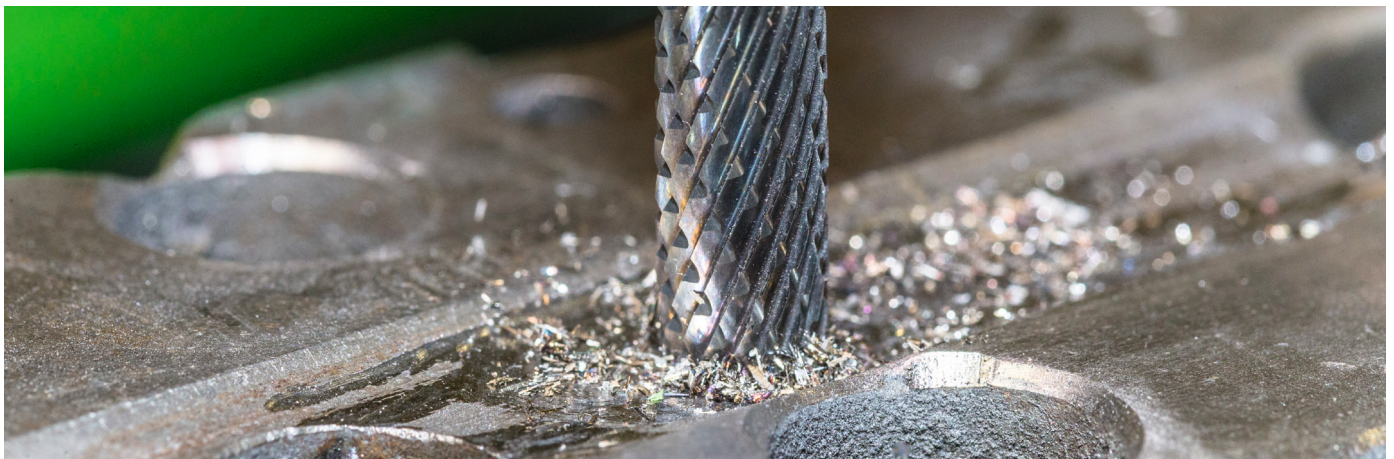

# Universal burrs

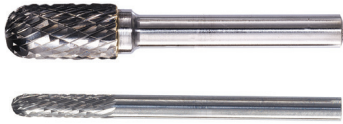

**TCC**

**Cylindrical shape, round nose**

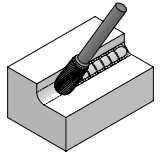
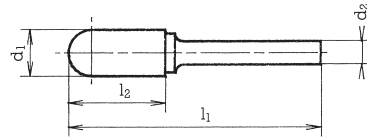

DIN 8033	BIAX	Ø Shaft d2 mm	Ø Head d1 mm	Length head l2 mm	Length total l1 mm	Tooth geometry 2	Tooth geometry 5	Tooth geometry 63
WRC 0210.03	<b>TCC 0203</b>	3	2	10	40	---	001 952 005	001 952 006
WRC 0313.03	<b>TCC 0303</b>	3	3	13	43	---	001 952 017	001 952 018
WRC 0613.03	<b>TCC 0603</b>	3	6	13	43	---	001 952 095	001 952 096
WRC 0413.06	<b>TCC 0406</b>	6	4	13	53	001 952 073	001 952 075	001 952 076
WRC ---	<b>TCC 0506</b>	6	5	13	58	001 952 566	001 952 573	001 952 087
WRC 0616.06	<b>TCC 0606</b>	6	6	16	56	001 952 129	001 952 132	001 952 133
WRC 0820.06	<b>TCC 0806</b>	6	8	20	60	001 952 201	001 952 203	001 952 204
WRC 1020.06	<b>TCC 1006</b>	6	10	20	60	001 952 227	001 952 230	001 952 232
WRC 1025.06	<b>TCC 1016</b>	6	10	25	65	001 952 567	001 952 574	001 952 280
WRC 1225.06	<b>TCC 1206</b>	6	12	25	65	001 952 299	001 952 301	001 952 303



**TCD**

**Spherical shape**

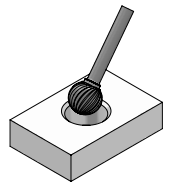
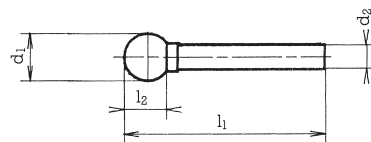

DIN 8033	BIAX	Ø Shaft d2 mm	Ø Head d1 mm	Length head l2 mm	Length total l1 mm	Tooth geometry 2	Tooth geometry 5	Tooth geometry 63
KUD 0201.03	<b>TCD 0203</b>	3	2	1.8	32	---	001 952 007	001 952 008
KUD 0302.03	<b>TCD 0303</b>	3	3	2.7	33	---	001 952 020	001 952 021
KUD 0403.03	<b>TCD 0403</b>	3	4	3.6	34	---	001 952 062	001 952 063
KUD 0605.03	<b>TCD 0603</b>	3	6	5.4	35	---	001 952 098	001 952 099
KUD 0403.06	<b>TCD 0406</b>	6	4	3.6	44	001 952 602	001 952 078	001 952 079
KUD ---	<b>TCD 0506</b>	6	5	4	44	001 952 603	001 952 089	001 952 090
KUD 0605.06	<b>TCD 0606</b>	6	6	5.4	45	001 952 134	001 952 136	001 952 137
KUD 0807.06	<b>TCD 0806</b>	6	8	7.2	47	001 952 206	001 952 208	001 952 209
KUD 1009.06	<b>TCD 1006</b>	6	10	9	49	001 952 234	001 952 237	001 952 238
KUD 1210.06	<b>TCD 1206</b>	6	12	10.8	51	001 952 305	001 950 554	001 952 310



**TCE**

**Oral shape**

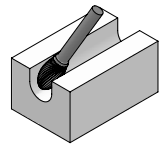
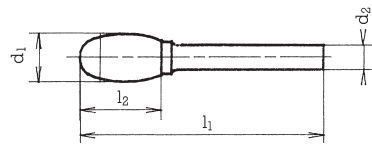

DIN 8033	BIAX	Ø Shaft d2 mm	Ø Head d1 mm	Length head l2 mm	Length total l1 mm	Tooth geometry 5	Tooth geometry 63
TRE 0307.03	<b>TCE 0303</b>	3	3	7	37	001 952 023	001 952 024
TRE ---	<b>TCE 0403</b>	3	4	7.4	38	001 952 064	001 952 065
TRE 0610.03	<b>TCE 0603</b>	3	6	10	40	001 952 101	001 952 102
TRE 0610.06	<b>TCE 0606</b>	6	6	10	50	001 952 139	001 952 140
TRE 0813.06	<b>TCE 0806</b>	6	8	13	53	001 952 212	001 952 213
TRE 1220.06	<b>TCE 1206</b>	6	12	20	60	001 952 313	001 952 315
TRE 1625.06	<b>TCE 1606</b>	6	16	25	65	001 952 628	001 952 417
TRE ---	<b>TCE 1208</b>	8	12	20	60	001 952 627	001 952 364
TRE 1625.08	<b>TCE 1608</b>	8	16	25	65	001 952 629	001 952 449



**TCF**

**Flame shape**

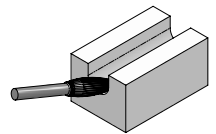
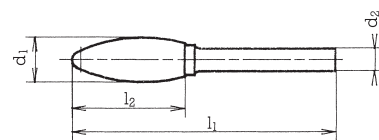

DIN 8033	BIAX	Ø Shaft d2 mm	Ø Head d1 mm	Length head l2 mm	Length total l1 mm	Tooth geometry 2	Tooth geometry 5	Tooth geometry 63
---	<b>TCF 0303</b>	3	3	8	37	---	001 952 026	001 952 027
---	<b>TCF 0603</b>	3	6	13	43	---	001 952 104	001 952 105
---	<b>TCF 0606</b>	6	6	18	58	---	001 952 143	001 952 144
---	<b>TCF 1006</b>	6	10	25	65	001 952 643	001 952 241	001 952 242
---	<b>TCF 1206</b>	6	12	30	70	001 952 317	001 952 319	001 952 321

# Universal burrs

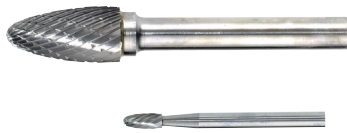

**TCG**

**Arch shape, round nose**

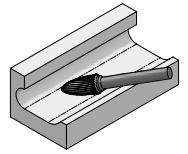
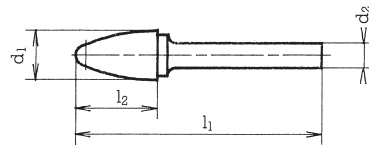

DIN 8033	BIAX	Ø Shaft d2 mm	Ø Head d1 mm	Length head l2 mm	Length total l1 mm	Tooth geometry 2	Tooth geometry 5	Tooth geometry 63
RBF 0307.03	<b>TCG 0303</b>	3	3	7	37	---	001 952 029	001 952 030
RBF 0313.03	<b>TCG 0313</b>	3	3	13	43	---	001 952 048	001 952 049
RBF 0613.03	<b>TCG 0603</b>	3	6	13	43	---	001 952 107	001 952 108
RBF 0618.06	<b>TCG 0606</b>	6	6	18	58	001 952 146	001 952 148	001 952 149
RBF 1020.06	<b>TCG 1006</b>	6	10	20	60	001 952 669	001 952 245	001 952 246
RBF 1225.06	<b>TCG 1216</b>	6	12	25	65	001 952 671	001 952 678	001 952 380



**TCH**

**Arch shape, pointed nose**

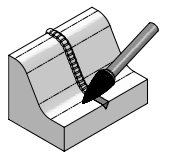
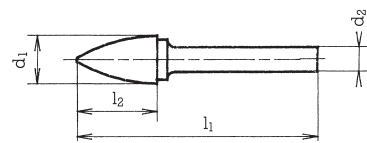

DIN 8033	BIAX	Ø Shaft d2 mm	Ø Head d1 mm	Length head l2 mm	Length total l1 mm	Tooth geometry 2	Tooth geometry 5	Tooth geometry 63
SPG 0307.03	<b>TCH 0303</b>	3	3	7	37	---	001 952 033	001 952 035
SPG 0313.03	<b>TCH 0313</b>	3	3	13	43	---	001 952 051	001 952 052
SPG 0613.03	<b>TCH 0603</b>	3	6	13	43	---	001 952 110	001 952 112
SPG ---	<b>TCH 0406</b>	6	4	14	54	001 952 080	001 952 708	001 952 081
SPG 0618.06	<b>TCH 0606</b>	6	6	18	58	001 952 151	001 952 153	001 952 156
SPG ---	<b>TCH 0806</b>	6	8	18	58	001 952 701	001 952 216	001 952 217
SPG 1020.06	<b>TCH 1006</b>	6	10	20	60	001 952 702	001 952 249	001 952 250
SPG 1220.06	<b>TCH 1206</b>	6	12	20	60	001 952 326	001 952 710	001 952 328
SPG 1225.06	<b>TCH 1216</b>	6	12	25	65	001 952 703	001 952 383	001 952 384
SPG 1230.06	<b>TCH 1226</b>	6	12	30	70	001 952 397	001 952 399	001 952 402



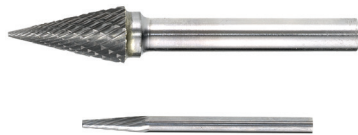

**TCI**

**Conical shape, pointed nose**

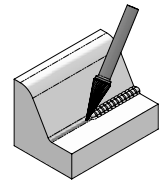
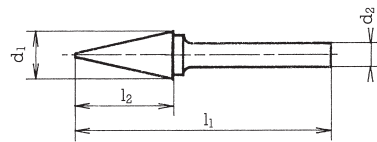

DIN 8033	BIAX	Ø Shaft d2 mm	Ø Head d1 mm	Length head l2 mm	Length total l1 mm	Tooth geometry 2	Tooth geometry 5	Tooth geometry 63
SKM ---	<b>TCI 0212</b>	<b>2.35</b>	<b>1.1</b>		<b>44</b>	---	---	---
SKM 0311.03	<b>TCI 0303</b>	<b>3</b>	<b>3</b>	<b>11</b>	<b>41</b>	---	001 952 037	001 952 038
SKM ---	<b>TCI 0313</b>	<b>3</b>	<b>3</b>	<b>12</b>	<b>41</b>	---	001 952 053	001 952 054
SKM 0613.03	<b>TCI 0603</b>	<b>3</b>	<b>6</b>	<b>13</b>	<b>43</b>	---	001 952 114	001 952 115
SKM ---	<b>TCI 0606</b>	<b>6</b>	<b>6</b>	<b>14</b>	<b>58</b>	001 952 158	001 952 160	001 952 161
SKM 0618.06	<b>TCI 0616</b>	<b>6</b>	<b>6</b>	<b>18</b>	<b>58</b>	001 952 186	001 952 735	001 952 188
SKM ---	<b>TCI 0626</b>	<b>6</b>	<b>6</b>	<b>24</b>	<b>64</b>	001 952 189	001 952 191	001 952 192
SKM 1020.06	<b>TCI 1006</b>	<b>6</b>	<b>10</b>	<b>20</b>	<b>60</b>	001 952 732	001 952 253	001 952 254

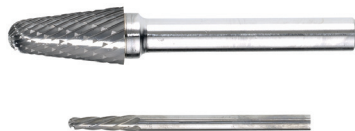

**TCK**

**Conical shape, round nose**

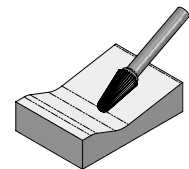
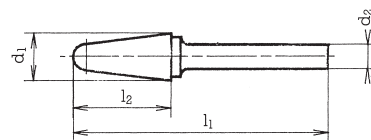

DIN 8033	BIAX	Ø Shaft d2 mm	Ø Head d1 mm	Length head l2 mm	Length total l1 mm	Tooth geometry 2	Tooth geometry 5	Tooth geometry 63
KEL ---	<b>TCK 0303</b>	<b>3</b>	<b>3</b>	<b>12</b>	<b>43</b>	---	---	001 952 834
KEL ---	<b>TCK 0313</b>	<b>3</b>	<b>3</b>	<b>13</b>	<b>43</b>	---	---	001 952 810
KEL ---	<b>TCK 0606</b>	<b>6</b>	<b>6</b>	<b>18</b>	<b>58</b>	001 952 163	001 952 166	001 952 168
KEL 1020.06	<b>TCK 1006</b>	<b>6</b>	<b>10</b>	<b>20</b>	<b>60</b>	001 952 256	001 952 754	001 952 259
KEL 1225.06	<b>TCK 1206</b>	<b>6</b>	<b>12</b>	<b>25</b>	<b>65</b>	001 952 335	001 952 337	001 952 339

# Universal burrs

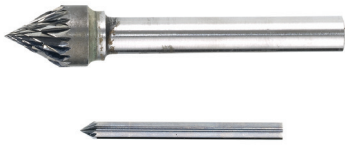

**TCL**

**Conical shape, pointed nose 60°**

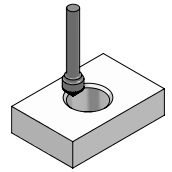
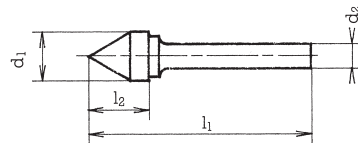

DIN 8033	BIAX	Ø Shaft d2 mm	Ø Head d1 mm	Length head l2 mm	Length total l1 mm	Tooth geometry 5	Tooth geometry 63
KSJ ---	<b>TCL 0303</b>	3	3	2.6	43	001 952 041	---
KSJ 0605.06	<b>TCL 0606</b>	6	6	5	50	001 952 775	001 952 171
KSJ 1008.06	<b>TCL 1006</b>	6	10	8.7	53	001 952 776	---
KSJ ---	<b>TCL 1206</b>	6	12	10.4	55	001 952 777	001 952 342
KSJ 1613.06	<b>TCL 1606</b>	6	16	13.8	56	001 952 778	001 952 429

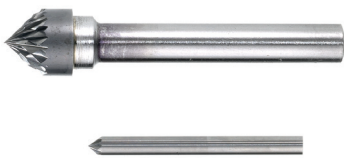

**TCM**

**Conical shape, pointed nose 90°**

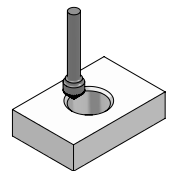
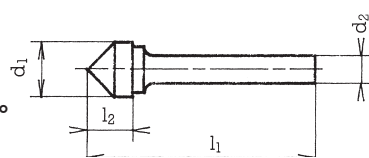

DIN 8033	BIAX	Ø Shaft d2 mm	Ø Head d1 mm	Length head l2 mm	Length total l1 mm	Tooth geometry 2	Tooth geometry 5	Tooth geometry 63
KSK ---	<b>TCM 0303</b>	3	3	1.5	32	---	001 952 043	---
KSK 0603.06	<b>TCM 0606</b>	6	6	3	50	001 952 173	001 952 175	001 952 176
KSK 1005.06	<b>TCM 1006</b>	6	10	5	50	001 952 264	001 952 266	001 952 267
KSK ---	<b>TCM 1206</b>	6	6	12	50	001 952 344	001 952 346	001 952 347
KSK 1608.05	<b>TCM 1606</b>	6	16	8	53	001 952 779	001 952 783	001 952 432





**TCN**

**Conical shape, inverted**

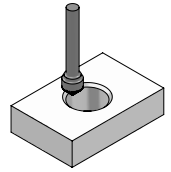
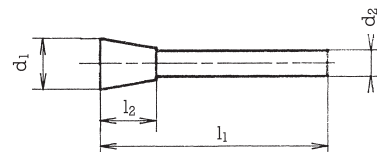

DIN 8033	BIAX	Ø Shaft d2 mm	Ø Head d1 mm	Length head l2 mm	Length total l1 mm	Tooth geometry 5	Tooth geometry 63
WKN 0307.03	<b>TCN 0303</b>	<b>3</b>	<b>3</b>	<b>7</b>	<b>37</b>	001 952 045	001 952 046
WKN 0607.03	<b>TCN 0603</b>	<b>3</b>	<b>6</b>	<b>7</b>	<b>37</b>	001 952 117	001 952 118
WKN 0607.06	<b>TCN 0606</b>	<b>6</b>	<b>6</b>	<b>7</b>	<b>47</b>	---	001 952 178
WKN 1013.06	<b>TCN 1006</b>	<b>6</b>	<b>10</b>	<b>13</b>	<b>53</b>	---	001 952 269
WKN 1213.06	<b>TCN 1206</b>	<b>6</b>	<b>12</b>	<b>13</b>	<b>53</b>	---	001 952 349

## Special burrs

## Long shaft carbide burrs

The following table is a guideline for the maximum length of the long shaft burrs with respect to the head diameter d1.



Ø Shaft mm	Shaft length max. mm	Ø Head mm	Exceptions
3	48	4-6	---
6	180	8-16	x
6	250	8-10	x
8	80	from Ø 12	---
8	100	10-14	---

x = TCD Ø 20mm / TCD Ø 14mm / TCE Ø 12mm / TCF Ø 12mm



To calculate the maximum overall length l1 add the maximum shaft length to the head length l2.

- All special versions are available upon request in accordance with the maximum lengths stated above.
- If the raw material is available in stock, the delivery time is approximately 2–4 weeks.
- Minimum order quantity = 20 pieces.
- For special versions we reserve the right to over deliver and under deliver by 10% (minimum of 1 piece in each case).
- Please note that the concentricity accuracy can not be guaranteed for overlengths.
- We recommend lowering the speed for overlengths.

**Note: Can't find what you are looking for? Give us a call!**

# Special burrs

## Cast – cutting edge 63

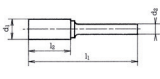
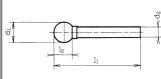
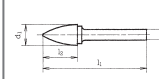
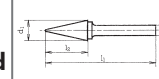
Ø Shaft d2 mm	Ø Head d1 mm								
		Standard	Standard	Standard	Standard				
3	3	001 952 011 l1 = 43mm l2 = 13mm	ZYA 0313.03	001 952 021 l1 = 33mm l2 = 2.70mm	KUD 0302.03	001 952 052 l1 = 43mm l2 = 13mm	SPG 0313.03	001 952 054 l1 = 41mm l2 = 12mm	
	4	001 952 057 l1 = 36mm l2 = 6mm		001 952 063 l1 = 34mm l2 = 3.60mm	KUD 0403.03	---		---	
	6	001 952 093 l1 = 37mm l2 = 7mm	ZYA 0607.03	001 952 099 l1 = 35mm l2 = 5.40mm	KUD 0605.03	001 952 112 l1 = 43mm l2 = 13mm	SPG 0613.03	001 952 115 l1 = 43mm l2 = 13mm	SKM 0613.03
6	4	001 952 069 l1 = 53mm l2 = 13mm	ZYA 0413.06	001 952 079 l1 = 44 l2 = 3.60mm	KUD 0403.06	001 952 081 l1 = 54mm l2 = 14mm		---	
	6	001 952 122 l1 = 56mm l2 = 16mm	ZYA 0616.06	001 952 137 l1 = 45mm l2 = 5.40mm	KUD 0605.06	001 952 156 l1 = 58mm l2 = 18mm	SPG 0618.06	001 952 188 l1 = 58mm l2 = 18mm	SKM 0618.06
	8	001 952 196 l1 = 60mm l2 = 20mm	ZYA 0820.06	001 952 209 l1 = 47mm l2 = 7.20mm	KUD 0807.06	001 952 217 l1 = 58mm l2 = 18mm		---	

## Stainless steel – cutting edge 63 Performance

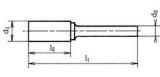
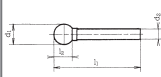
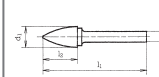
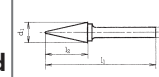
Ø Shaft d2 mm	Ø Head d1 mm								
		Standard	Standard	Standard	Standard				
3	3	001 952 880 l1 = 43mm l2 = 13mm	ZYA 0313.03	001 952 886 l1 = 33mm l2 = 2.70mm	KUD 0302.03	001 952 892 l1 = 43mm l2 = 13mm	SPG 0313.03	001 952 897 l1 = 41mm l2 = 12mm	
	4	001 952 881 l1 = 36mm l2 = 6mm		001 952 887 l1 = 34mm l2 = 3.60mm	KUD 0403.03	---		---	
	6	001 952 882 l1 = 43mm l2 = 13mm	ZYA 0613.03	001 952 888 l1 = 35mm l2 = 5.40mm	KUD 0605.03	001 952 893 l1 = 43mm l2 = 13mm	SPG 0613.03	001 952 898 l1 = 43mm l2 = 13mm	SKM 0613.03
6	4	001 952 883 l1 = 53mm l2 = 13mm	ZYA 0413.06	001 952 889 l1 = 44 l2 = 3.60mm	KUD 0403.06	001 952 894 l1 = 54mm l2 = 14mm		---	
	6	001 952 884 l1 = 56mm l2 = 16mm	ZYA 0616.06	001 952 890 l1 = 45mm l2 = 5.40mm	KUD 0605.06	001 952 895 l1 = 58mm l2 = 18mm	SPG 0618.06	001 952 899 l1 = 58mm l2 = 14mm	
	8	001 952 885 l1 = 60mm l2 = 20mm	ZYA 0820.06	001 952 891 l1 = 47mm l2 = 7.20mm	KUD 0807.06	001 952 896 l1 = 58mm l2 = 18mm		---	

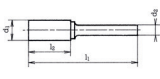
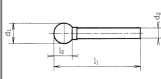
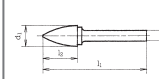
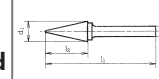

## Superfein – cutting edge 10

Ø Shaft d2 mm	Ø Head d1 mm								
		Standard	Standard	Standard	Standard	Standard	Standard		
3	3	001 952 900 l1 = 43mm l2 = 13mm	ZYA 0313.03	001 952 906 l1 = 33mm l2 = 2.70mm	KUD 0302.03	001 952 912 l1 = 43mm l2 = 13mm	SPG 0313.03	001 952 917 l1 = 41mm l2 = 12mm	
	4	001 952 901 l1 = 36mm l2 = 6mm		001 952 907 l1 = 34mm l2 = 3.60mm	KUD 0403.03	---		---	
	6	001 952 902 l1 = 43mm l2 = 13mm	ZYA 0613.03	001 952 908 l1 = 35mm l2 = 5.40mm	KUD 0605.03	001 952 913 l1 = 43mm l2 = 13mm	SPG 0613.03	001 952 918 l1 = 43mm l2 = 13mm	SKM 0613.03
6	4	001 952 903 l1 = 53mm l2 = 13mm	ZYA 0413.06	001 952 909 l1 = 44 l2 = 3.60mm	KUD 0403.06	001 952 914 l1 = 54mm l2 = 14mm		---	
	6	001 952 904 l1 = 56mm l2 = 16mm	ZYA 0616.06	001 952 910 l1 = 45mm l2 = 5.40mm	KUD 0605.06	001 952 915 l1 = 58mm l2 = 18mm	SPG 0618.06	001 952 919 l1 = 58mm l2 = 14mm	
	8	001 952 905 l1 = 60mm l2 = 20mm	ZYA 0820.06	001 952 911 l1 = 47mm l2 = 7.20mm	KUD 0807.06	001 952 916 l1 = 58mm l2 = 18mm		---	

## Non Ferrous – cutting edge 13

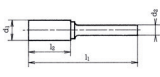
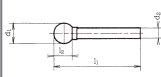
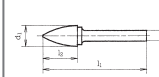
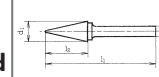
Ø Shaft d2 mm	Ø Head d1 mm								
		Standard	Standard	Standard	Standard	Standard	Standard		
3	3	001 952 484 l1 = 43mm l2 = 13mm	ZYA 0313.03	001 952 579 l1 = 33mm l2 = 2.70mm	KUD 0302.03	001 952 873 l1 = 43mm l2 = 13mm	SPG 0313.03	001 952 715 l1 = 41mm l2 = 12mm	
	4	001 952 485 l1 = 36mm l2 = 6mm		001 952 580 l1 = 34mm l2 = 3.60mm	KUD 0403.03	---		---	
	6	001 952 487 l1 = 37mm l2 = 7mm	ZYA 0607.03	001 952 581 l1 = 35mm l2 = 5.40mm	KUD 0605.03	001 952 111 l1 = 43mm l2 = 13mm	SPG 0613.03	001 952 716 l1 = 43mm l2 = 13mm	SKM 0613.03
6	4	001 952 489 l1 = 53mm l2 = 13mm	ZYA 0413.06	001 952 582 l1 = 44 l2 = 3.60mm	KUD 0403.06	001 952 690 l1 = 54mm l2 = 14mm		---	
	6	001 952 491 l1 = 56mm l2 = 16mm	ZYA 0616.06	001 952 584 l1 = 45mm l2 = 5.40mm	KUD 0605.06	001 952 155 l1 = 58mm l2 = 18mm	SPG 0618.06	001 952 718 l1 = 58mm l2 = 18mm	SKM 0618.06
	8	001 952 492 l1 = 60mm l2 = 20mm	ZYA 0820.06	001 952 585 l1 = 47mm l2 = 7.20mm	KUD 0807.06	001 952 683 l1 = 58mm l2 = 18mm		---	

## Alu – cutting edge 14

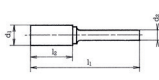
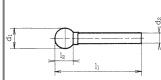
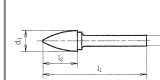
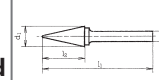
Ø Shaft d2 mm	Ø Head d1 mm								
		Standard	Standard	Standard	Standard	Standard	Standard		
3	3	001 952 497 l1 = 43mm l2 = 13mm	ZYA 0313.03	001 952 590 l1 = 33mm l2 = 2.70mm	KUD 0302.03	001 952 799 l1 = 43mm l2 = 13mm	SPG 0313.03	001 952 724 l1 = 41mm l2 = 12mm	
	4	001 952 498 l1 = 36mm l2 = 6mm		001 952 591 l1 = 34mm l2 = 3.60mm	KUD 0403.03	---		---	
	6	001 952 501 l1 = 43mm l2 = 13mm	ZYA 0613.03	001 952 592 l1 = 35mm l2 = 5.40mm	KUD 0605.03	001 952 689 l1 = 43mm l2 = 13mm	SPG 0613.03	001 952 725 l1 = 43mm l2 = 13mm	SKM 0613.03
6	4	001 952 502 l1 = 53mm l2 = 13mm	ZYA 0413.06	001 952 593 l1 = 44 l2 = 3.60mm	KUD 0403.06	001 952 690 l1 = 54mm l2 = 14mm		---	
	6	001 952 504 l1 = 56mm l2 = 16mm	ZYA 0616.06	001 952 594 l1 = 45mm l2 = 5.40mm	KUD 0605.06	001 952 691 l1 = 58mm l2 = 18mm	SPG 0618.06	001 952 726 l1 = 58mm l2 = 14mm	
	8	001 952 505 l1 = 60mm l2 = 20mm	ZYA 0820.06	001 952 596 l1 = 47mm l2 = 7.20mm	KUD 0807.06	001 952 683 l1 = 58mm l2 = 18mm		---	

## Hard aluminium – cutting edge 14 Performance

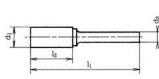
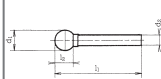
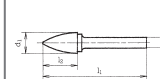
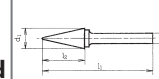
Ø Shaft d2 mm	Ø Head d1 mm								
		Standard	Standard	Standard	Standard	Standard	Standard		
3	3	001 952 853 l1 = 43mm l2 = 13mm	ZYA 0313.03	001 952 859 l1 = 33mm l2 = 2.70mm	KUD 0302.03	001 952 865 l1 = 43mm l2 = 13mm	SPG 0313.03	001 952 870 l1 = 41mm l2 = 12mm	
	4	001 952 854 l1 = 36mm l2 = 6mm		001 952 860 l1 = 34mm l2 = 3.60mm	KUD 0403.03	---		---	
	6	001 952 855 l1 = 43mm l2 = 13mm	ZYA 0613.03	001 952 861 l1 = 35mm l2 = 5.40mm	ZYA 0313.03	001 952 866 l1 = 43mm l2 = 13mm	SPG 0613.03	001 952 871 l1 = 43mm l2 = 13mm	SKM 0613.03
6	4	001 952 856 l1 = 53mm l2 = 13mm	ZYA 0413.06	001 952 862 l1 = 44 l2 = 3.60mm	KUD 0403.06	001 952 867 l1 = 54mm l2 = 14mm		---	
	6	001 952 857 l1 = 56mm l2 = 16mm	ZYA 0616.06	001 952 863 l1 = 45mm l2 = 5.40mm	KUD 0605.06	001 952 868 l1 = 58mm l2 = 18mm	SPG 0618.06	001 952 872 l1 = 58mm l2 = 14mm	
	8	001 952 858 l1 = 60mm l2 = 20mm	ZYA 0820.06	001 952 864 l1 = 47mm l2 = 7.20mm	KUD 0807.06	001 952 869 l1 = 58mm l2 = 18mm		---	

## Composite – cutting edge 16

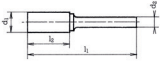
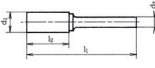
Ø Shaft d2 mm	Ø Head d1 mm		Ø Shaft d2 mm	Ø Head d1 mm	
	3	001 952 874 l1 = 43mm l2 = 13mm		4	001 952 877 l1 = 53mm l2 = 13mm
3	4	001 952 875 l1 = 36mm l2 = 6mm	6	6	001 952 878 l1 = 56mm l2 = 16mm
	6	001 952 876 l1 = 43mm l2 = 13mm		8	001 952 879 l1 = 60mm l2 = 20mm

## Coatings

During coating a fixed layer of shapeless material is applied to the surface of the cutting head. The corresponding production step, as well as the applied layer itself, is also referred to as coating. This procedure offers a variety of possibilities to produce a layer.

In order to achieve optimal results we only work with experts in the field of coating. This enables us to react to individual customer requirements at all times.

### Our specially selected coatings have the following advantages for machining:

- Longer service life
- Better material removal
- Reduced crater wear
- Reduced abrasive wear
- Improved tribology (sliding property)
- Higher heat resistance

**We are also happy to coat any other BIAx milling cutter should you require. Please do not hesitate to contact us. We and our partners would be happy to assist you with any questions concerning coating.**

Minimum order for special coatings 20 pieces.



SWISS MADE



Druckluftwerkzeuge  
Pneumatic Tools  
Outils pneumatiques

### Schmid & Wezel GmbH (Werk Maulbronn)

Maybachstr. 2  
D-75433 Maulbronn  
Tel +49 (0) 70 43 / 102 - 0  
Fax +49 (0) 70 43 / 102 - 78  
biax-verkauf@biax.de  
www.biax.de



Schaber  
Scrapers  
Grattoirs  
Hartmetallwerkzeuge  
Carbide Tools  
Outils en carbure de  
tungstène

### BIAX Maschinen GmbH

Industrieplatz  
CH-8212 Neuhausen/Rheinfall  
Tel +41 (0) 52 / 674 79 79  
Fax +41 (0) 52 / 674 65 64  
info@biax.ch  
www.biax.ch



Biegsame Wellen  
Flexible Shafts  
Machines à arbre flexible

### Schmid & Wezel GmbH (Werk Hilsbach)

Breite Str. 38  
D-74889 Sinsheim-Hilsbach  
Tel +49 (0) 72 60 / 91 33 - 0  
Fax +49 (0) 72 60 / 91 33 - 25  
flexwellen@biax.de  
www.biax-flexwellen.de



Fleischereimaschinen  
Meat Processing Machines  
Machines pour l'industrie  
de la viande

### Schmid & Wezel GmbH (Werk Maulbronn)

Maybachstr. 2  
D-75433 Maulbronn  
Tel +49 (0) 70 43 / 102 - 0  
Fax +49 (0) 70 43 / 102 - 78  
efa-verkauf@efa-germany.de  
www.efa-germany.de



Vertriebsgesellschaft Italien  
Distribution company Italy  
Société de distribution en  
Italie

### BIAX Italia S.r.l.

Zona Industriale  
Via del Garda 46/N  
I-38068 Rovereto (TN)  
Tel +39 (0) 464 / 43 31 24  
Fax +39 (0) 464 / 48 99 52  
biaxitalia@biaxitalia.com  
www.biaxitalia.com