

TASKalfa 6500i/8000i

A3 MONOCHROME MULTIFUNCTIONALS

▶ print ▶ copy ▶ scan ▶ fax

EXTENDING THE SCOPE OF HIGH-VOLUME DEVICES



TASKalfa 

 **KYOCERA**
Document Solutions

REVIVING THE EFFECTIVENESS OF MONOCHROME MULTIFUNCTIONALS

The TASKalfa 6500i and 8000i rewrite the role of high-volume monochrome multifunctionals. Far from being the dull workhorse hidden in the basement, these high-capacity, high-performance devices will form the backbone of your office's document infrastructure.

That they can produce incredible quantities of printed and copied documents is beyond question. The long-life technology for which KYOCERA is famous ensures that the TASKalfa 6500i and 8000i will deliver documents reliably without failure, interruption or intervention.

But these devices are so much more than document factories. They combine quality and finesse with high-volume capabilities. For example, the TASKalfa 6500i and 8000i add booklet-creation and tri-folding of letters to the usual finishing options of stapling and hole-punching*.

* optional

The high-speed, 100ipm colour scanner can process 270-sheet double-sided documents in a single operation. They can be sent to email recipients, server locations and portable USB sticks in a number of common electronic formats – capabilities that are often reserved for more glamorous colour machines.

The flexible solutions platform on which the TASKalfas are built extends their usefulness further. Common applications for document and fleet management, cost-control and security can all be integrated directly into their colour control panels, making them the ultimate combination of simplicity and power.

Combining such stunning facilities into a single device removes the need for your office to maintain separate devices for document input and output. The TASKalfa 6500i and 8000i can handle it all, simplifying the lives of your staff, improving the efficiency of your office and reducing your organisation's costs.

PRODUCT HIGHLIGHTS TO MEET YOUR REQUIREMENTS:

- ▶ Up to 80 A4 pages per minute
- ▶ 2GB RAM & 320GB hard disk memory
- ▶ Network printing (PCL and PostScript-compatible) and colour scanning as standard
- ▶ 4,150-sheet paper capacity as standard, expandable to 7,650 sheets
- ▶ Single-pass double-sided document processor as standard
- ▶ Wide range of media support: 300gsm, over-sized A3 and 1.2m banners
- ▶ Flexible paper handling (up to 8 media sources)
- ▶ Expandable fax functions* – dual-line fax, network fax and Internet fax
- ▶ Productive finishing options including booklet printing and tri-folding
- ▶ Security-ready*: Data Security Kit, Copy Guard Kit and support for ID card authentication
- ▶ Long-life components provide unprecedented efficiency and reliability

*Optional



ACCESSIBILITY FOR ONE AND ALL

To benefit your office, a multifunctional does not just have to deliver features, it has to deliver features your staff can use.

The TASKalfa 6500i and 8000i are equipped with a superb 10.1" colour touch-screen control panel. It incorporates a graphical representation of the device that highlights issues such as toner or paper running out and it uses a simple yet comprehensive menu structure that leads staff through common options and illustrates how they work.

The control panel's display can be customised to suit the way you and your staff work. Buttons can be added to execute complex scanning, formatting and delivery tasks with a single keystroke. If your office depends on common applications such as Equitrac, Safecom or Papercut, they can be controlled from the TASKalfa's control panel without the need for a separate screen.

Its flexibility is not limited to what is shown on-screen; the screen's position is flexible too. Staff with limited mobility will appreciate the adjustable height and tilt that help make the TASKalfas universally accessible.



THE INTELLIGENT DESIGN TO SUIT LARGER TEAMS

To be truly effective in a larger organisation a multifunctional has to be designed to suit the intensity of its working environment.

Larger teams, for example, have a greater need to store standard documents on the multifunctional itself to avoid the network congestion that results from printing them repeatedly. For this reason, the TASKalfa 6500i and 8000i are not just furnished with hard disks, they have massive 320GB hard disks.

Because disruptions to a high-volume multifunctional affect so many staff, the need to keep the device running becomes an imperative. To ensure this, the TASKalfa 6500i and 8000i incorporate intelligent features such as 'job skip': if a job stalls because, for example, there is no A3 paper, other jobs that can print will skip ahead of it in the queue. The device keeps running, backlogs are avoided and your office runs smoothly and efficiently.

The TASKalfas even take steps to eliminate user errors. An incorrectly-rotated scan has to be repeated, doubling the amount of time the job should take and occupying the multifunctional longer than necessary. To avoid this, the TASKalfa 6500i and 8000i have a 'scan preview' function so the user can approve the scan before sending it to its destinations.

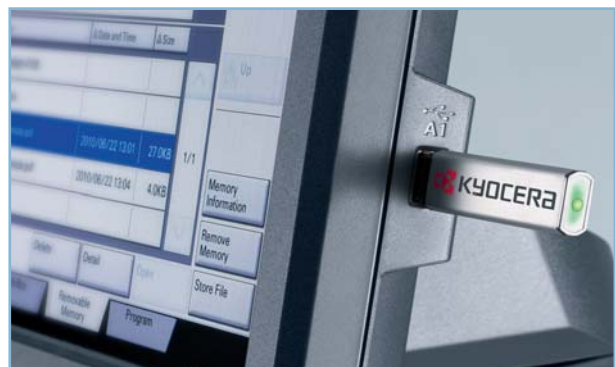

With lesser systems, staff may find themselves using PCs to convert the file format of scanned documents and compress them to an emailable size. Such inefficient and time-consuming processes are avoided with the TASKalfa 6500i and 8000i thanks to their integral support of numerous formats (PDF, JPG, TIF and XPS) and flexible scanning options.

It's about making multifunctionals work for you rather than you working around multifunctionals.



IS YOUR BUSINESS JUST A LITTLE BIT DIFFERENT?

HyPAS™ KYOCERA's open software development platform, allows you to integrate your multifunctionals into your existing business practices in exactly the way you need. Through the combination of Java and Web Services technologies, HyPAS™ is able to communicate with a broad range of line-of-business applications such as DMS or ERP. HyPAS™ places these applications right on the multifunctional's control panel, making them as much a part of its operation as copying and scanning.

DOES YOUR MULTIFUNCTIONAL PROTECT YOUR CONFIDENTIALITY?

It is inevitable that larger organisations face greater security challenges than small ones. Although the ability to share information is powerful and beneficial there are legitimate business reasons for restricting access to sensitive documents.

Keeping track of which staff (and, perhaps, visitors) are allowed to access to your document systems is impossible without automatic assistance – the kind of assistance the TASKalfa 6500i and 8000i provide. They can, for example, be incorporated into your business' existing network authentication process for simple and effective user management.

Furthermore, they support IPsec, IPv6 and PDF encryption as standard to protect data as it travels around your network.

User access to the TASKalfas can be streamlined further using optional Card Authentication systems, bypassing lengthy logon procedures without compromising security. KYOCERA's optional Data Security Kit securely deletes data from the TASKalfa's hard disk. And the optional Document Guard Kit prevents controlled documents being copied without authority.

Used collectively, these features protect sensitive data and documents from unauthorised access.



ENHANCE YOUR COMMERCIAL REPUTATION

THE FLEXIBILITY TO SUIT YOUR CUSTOMERS AND YOUR STAFF

The effectiveness of your documentation depends on your ability to deliver impressive materials in a short space of time. The new TASKalfa multifunctionals have the finishing flexibility to produce documents they way your business

partners prefer them: stapled, hole-punched, stapled booklets or tri-folded letters. They even support over-sized A3 and 1.2m banner printing – the choice is yours.

To boost staff productivity, the TASKalfa 6500i and 8000i also support a 7-bin mailbox sorter to separate one user's output from another plus high-capacity feeders to print up to 7,650 pages without interruption.

Base version

Two 1,500-sheet high capacity paper feeders, two 500-sheet universal feeders plus a 150-sheet multi-purpose tray provide a standard capacity of 4,150 sheets. The 270-sheet double-sided document processor and the 70-sheet job separator are also standard features.

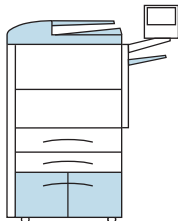

Basic configuration

Extra A4 Capacity

The PF-770 3,000-sheet paper feeder is ideal for large print runs. An optional second tray provides a separate paper output.

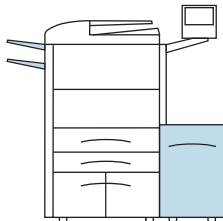

Copy tray (D), PF-770

Basic finishing

For a professional finish to documents you can add a DF-790 4,000-sheet finisher and PH-7C option to staple and punch up to 65 sheets at a time.

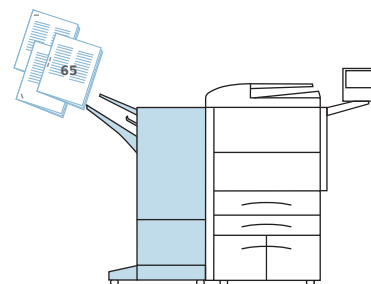

DF-790

Advanced finishing

The DF-790 3,000-sheet finisher* and the BF-730 and PH-7C options add stapling, hole-punching, booklet-creation and tri-folding to the finishing capabilities. The MT-730 7-tray mailbox sorter conveniently separates different users' output.

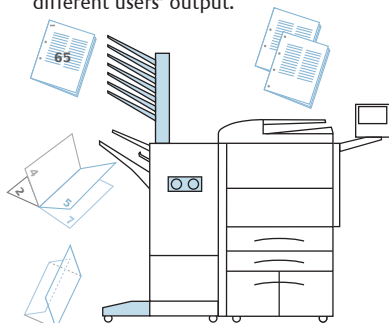

MT-730, DF-790 BF-730, PH-7C

Flexibility for multiple media types

A wide range of media types can be handled and storage capacity is increased to 5,650 sheets when the PF-780 and the PF-730 are combined.

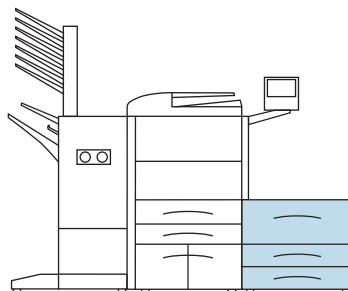

PF-780, PF-730

High-capacity flexibility for multiple media types

Extra media types are supported and paper capacity is increased to 7,650 sheets when the PF-780 and the PF-740 are combined.

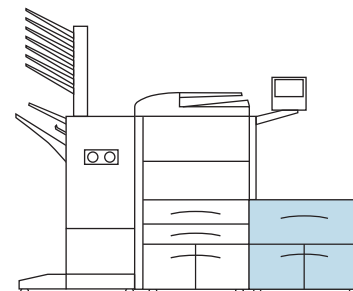

PF-780, PF-740

* 3,000 sheets when BF-730 is attached to DF-790



WANT A SMARTER WAY TO HANDLE LARGE DOCUMENT OUTPUT? COUNT ON US.

As one of the leading manufacturers of office document solutions, KYOCERA is committed to delivering consistently high-quality products and services. We not only provide you with the most reliable hardware and software, but also offer exceptional service, comprehensive consulting and tailor-made financing. Whatever your needs, you can count on us. Want to know more? Simply get in touch with your local KYOCERA Business Partner.

TASKalfa 6500i/8000i

A3 MONOCHROME MULTIFUNCTIONALS



The TASKalfa 6500i and 8000i incorporate extremely durable components that guarantee efficient and reliable operation to meet the demanding requirements of busy office environments. They provide effective productivity and maximum flexibility whilst ensuring minimal impact on the environment.

General

Technology: KYOCERA Laser Monochrome, HyPAS™ solution platform

Engine speed (pages per minute)

TASKalfa 6500i: Up to 65/32 ppm A4/A3
TASKalfa 8000i: Up to 80/40 ppm A4/A3

Resolution

600 x 600 dpi, Multi-bit technology for print quality of 9,600 dpi equivalent x 600 dpi

Warm-up time from power on

Approx. 30 seconds or less

Time to first page

TASKalfa 6500i: Approx. 5.2 seconds or less
TASKalfa 8000i: Approx. 4.7 seconds or less

CPU

IBM PowerPC 750CL/800MHz

Memory

2 GB RAM + 320 GB HDD

Standard interfaces

USB 2.0 (Hi-Speed), USB Host 2.0, Fast Ethernet 10Base-T/100BaseTX/1000BaseT, slot for optional print server, slot for optional CompactFlash® card, slot for optional fax system

Dimensions (W x D x H) – main unit

685 x 723 x 1,053 mm (DP, operation panel not included)
1,039 x 723 x 1,347 mm (DP, operation panel included)

Weight:

Main unit approx. 152 kg

Power source:

AC 220 V ~ 240 V, 50/60 Hz

Power consumption

Printing TASKalfa 6500i: 1,210 W, TASKalfa 8000i: 1,410 W
Ready mode: 300 W
Sleep mode: 20 W

Noise (ISO 7779 / ISO 9296)

Printing: 75 dB(A)
Stand-by (Ready mode): 58 dB(A)

Safety standards:

GS, TÜV, CE
This unit is manufactured according to ISO 9001 quality standard and ISO 14001 environmental standard.
RoHS compatibility

Paper handling

All paper capacities quoted are based on paper thickness of max. 0.11 mm. Please use paper recommended by KYOCERA under normal environmental conditions.

Input capacity

150-sheet multi-purpose tray, 60–300 gsm (banner 136-163 gsm)
A6R–304.8 x 457.2 mm, banner max. 304.8 x 1,219.2 mm;
2 x 1,500-sheet high-capacity paper deck, 60–256 gsm, A4, B5
2 x 500-sheet universal paper cassette, 60–256 gsm, A5R–304.8 x 457.2 mm
Max. input capacity with options: 7,650 sheets A4

Document processor (one-path duplex scanning)

270 sheets; 35–220 gsm (simplex), 50–220 gsm (duplex); A5R–A3

Duplex unit:

Duplex as standard supports A5R-304.8 x 457.2 mm, 60–256 gsm

Output capacity

Max. 420 sheets (standard job separator tray 70 sheets, Copy tray (D) - optional: upper 100 sheets, lower 250 sheets)

Print functions

Controller language: PRESCRIBE IIe

Emulations: PCL6 (PCL5c / PCL-XL), KPDL3 (PostScript 3 compatible), PDF Direct Print, XPS Direct Print

Operating systems: All current Windows operating systems, Mac OS X Version 10.4 or higher, UNIX LINUX, as well as other operating systems on request.

Your KYOCERA Business Partner:

Fonts / barcodes: 93 scalable fonts (PCL/PostScript), 8 fonts (Windows Vista), 1 Bitmap font, 136 PostScript KPDL 3 fonts, 45 types of one-dimensional barcodes plus two-dimensional barcode (PDF-417)
Downloadable fonts: KYOCERA, PCL + TrueType format, Type 1 + 3 format

Print features: Encrypted PDF Direct Print, IPP printing, e-mail printing, WSD print, secure printing via SSL, IPsec, SNMPv3, Quick copy, proof and hold, Private Print, job storage and job management functionality

Copy functions

Max. original size: A3

Continuous copying: 1–9,999

Zoom range: 25–400% in 1% steps

Preset magnification ratios: 5R / 5E

Digital features: Scan-once-copy-many, electronic sort, 2in1 and 4in1 function, image repeat copy, page numbering, cover mode, booklet copy, interrupt copy, form overlay

Exposure mode: Auto, manual: 7 or 13 steps

Image adjustments: Text + photo, text, photo, map

Scan functions

Functionality: Scan-to-email, Scan-to-FTP, Scan-to-SMB, Scan-to-USB Host, Scan-to-box, Network TWAIN, WSD scan

Scan speed (A4, 300dpi, Dual Scan)
monochrome 160 image per minute, colour 100 image per minute

Scan resolution: 600 dpi, 400 dpi, 300 dpi, 200 dpi, 200 x 100 dpi, 200 x 400 dpi, (256 greyscales)

Max. scan size: A3

Original recognition: Text, photo, text + photo, optimised for OCR

Network protocol: TCP/IP

File types: PDF (high compressive, encrypted, PDF/A), JPEG, TIFF, XPS

Fax functions (optional)

Compatibility: ITU-T Super G3

Modem speed: Max. 33.6 kbps

Transmission speed: Max. 3 seconds (JBIG)

Scanning density

Normal: 8 dot/mm x 3.85 line/mm
Fine: 8 dot/mm x 7.7 line/mm
Superfine: 8 dot/mm x 15.4 line/mm
Ultrafine: 16 dot/mm x 15.4 line/mm halftone

Max. original size: A3

Compression method: JBIG, MMR, MR, MH

Memory: Standard 12 MB, max. 120 MB

Features: Opt. Internet-fax, network faxing, rotate transmission, rotate reception, duplex fax reception, memory reception, mailbox, remote diagnostics, dual fax with second fax system

Consumables

TK-6705 Toner-Kit

Average continuous toner yield 70,000 pages in accordance with 6% coverage A4

WT-861 Waste Toner Bottle

500,000 sheets (in accordance with 6% coverage)

Staple cartridge: SH-10 for BF-730, SH-12 for DF-790

Options

Fax System (V)

Internet Fax Kit (A)

Paper handling

PF-730 Paper feeder
2 x 500 sheets, 60–256 gsm, A5R-304.8 x 457.2 mm, folio

PF-740 Paper feeder
3,000 sheets, 60–256 gsm, A4, B5, letter

PF-770 A4 side deck
3,000 sheets, 60–300 gsm, A4, B5

PF-780 Multimedia tray and paper path unit
500 sheets, 60–256 gsm, A5R–304.8 x 457.2 mm

Copy tray (D): Sub upper 100 sheets, lower 250 sheets

DF-790 Document finisher

Main tray: max. 4,000 sheets A4 (3,000 sheets with attachment BF-730); max. 60–300 gsm; max. B5R-304.8 x 457.2 mm

Sub tray: 200 sheets A4; 60–300 gsm; A6R-A3

Sub tray (top): 100 sheets; 60–300 gsm; A6R-A4
Stapling up to 65 sheets A4 or 30 sheets A3 at 3 positions, B5–304.8 x 457.2 mm

PH-7C Punch Unit for DF-790

2-hole/4-hole, 60–300 gsm, A5R–A3

MT-730 Mailbox sorter for DF-790

7 bins x 100 sheets A4, 50 sheets A3/B4, 60–163 gsm

BF-730 Booklet and tri-folding unit for DF-790

Max. 64 pages (16 sheets) booklet folding and stapling 60–256 gsm, A3, B4, A4R, cover sheet 60–220 gsm (simplex), tri-folding: 60–120 gsm, multi tri-folding: 5 sheets (60–90 gsm), 3 sheets (91–120 gsm)

Banner Guide (A)

Banner paper feeding guide, up to 10 sheets

Memory

CompactFlash® card
1 slot (up to 4 GB) for printing forms, fonts, logos, macro storage

Fax memory

MM-16-128: Image memory (120 MB)

Security

Data security kit (E)

ISO 15408 (Common Criteria) with security level EAL3

Printed Document Guard Kit (A)

USB IC Card Reader

UG-33: ThinPrint support

UG-34: Emulation (IBM Proprinter/EPSON LQ-850/Diablo 630)

Optional interface

IB-50: Gigabit-Ethernet board 10BaseT/100BaseTX/1000BaseT



HyPAS™



Product depicted includes optional extras.

KYOCERA Document Solutions (UK) Ltd, 8 Beacontree Plaza, Gillette Way, Reading, RG2 0BS
Tel: 0118 931 1500, Fax: 0118 931 1108
www.kyoceradocumentsolutions.co.uk, info@duk.kyocera.com

*KYOCERA does not warrant that any specification mentioned will be error-free. Specifications are subject to change without notice. Information is correct at time of going to press. All other brand and product names may be registered trademarks and their respective holders are hereby acknowledged.

 **KYOCERA**
Document Solutions