

Archaeological excavation at Hill Farm, Boxted Cross, Boxted, Essex, CO4 5RD

March 2017



by **Laura Pooley**

with contributions by Stephen Benfield and Lisa Gray
figures by Ben Holloway and Emma Holloway

fieldwork by Ben Holloway with Adam Tuffy and Gareth Morgan

**commissioned by Rob Masefield, RPS
on behalf of Joe Jackson, Thomas Bates & Son Ltd**

NGR: TM 0044 3248 (centre)

Planning reference: pre-application

CAT project ref.: 17/03d

CHER ref: ECC3971

Colchester Museum accession code: COLEM 2016.115

OASIS reference: colchest3-279603



Colchester Archaeological Trust

Roman Circus House,
Roman Circus Walk,
Colchester,
Essex, CO2 7GZ

tel.: 01206 501785

email: lp@catuk.org

CAT Report 1085

June 2017

Contents

1	Summary	1
2	Introduction	1
3	Archaeological background	1
4	Results	2
5	Finds	5
6	Environmental report	7
7	Discussion	8
8	Acknowledgements	9
9	References	9
10	Abbreviations and glossary	10
11	Contents of archive	11
12	Archive deposition	11
	Appendix 1 2016 evaluation context list	12
	Appendix 2 2017 excavation context list	13
	Appendix 3 Environmental results	15

Figures after p15

EHER summary sheet

Appendix 4 CAT WSI

Appendix 5 OASIS Summary

List of photographs, tables and figures

Cover: general site shot

Photograph 1	Excavation area 1, looking N	4
Photograph 2	Excavation area 2, looking NW	4
Photograph 3	Fragments of Dressel 20 amphora from ditch F15	6
Photograph 4	Example of a complete Dressel 20 amphora	6
Table 1	Finds by context	5

Fig 1 Site location, shown in relation to 2016 evaluation trenches, proposed development (dashed blue) and cropmarks (purple)

Fig 2 Excavation results shown in relation to the 2016 evaluation trenches and cropmarks (purple)

Fig 3 Excavation area 1 results

Fig 4 Excavation area 2 results

Fig 5 Sections

1 Summary

An archaeological excavation was carried out at Hill Farm, Boxted Cross, Essex prior to the construction of residential dwellings. The development site is located close to a number of prehistoric cropmarks and field systems, including the Boxted 'henge'. Evaluation in 2016 revealed possible prehistoric and Roman field boundary ditches, a possible medieval pit, post-medieval (16th-17th century) ditch and brick foundation, a number of undated ditches, pits and postholes, and several modern features. Excavation revealed fifteen archaeologically significant features consisting of ten ditches, three pits and two small pits/postholes. In addition to this were six tree-throws, two modern pits and a modern service. Although dating evidence was rare across the whole site, most of the poorly dated ditches are likely to be Roman field boundaries forming a complex field system most likely associated with a pastoral economy and stock management. One ditch containing 26 sherds of a Dressel 20 amphora can be more confidently dated to the early Roman period. A single possible medieval ditch was also identified.

2 Introduction (Fig 1)

This report presents the results of an archaeological excavation at Hill Farm, Boxted Cross, Essex which was carried out 22nd-30th March 2017. The work was carried out by the Colchester Archaeological Trust (CAT) on behalf of Joe Jackson of Thomas Bates & Son Ltd, during pre-application work for the construction of residential dwellings. Robert Masefield of RPS provided archaeological consultancy and attended site meetings on behalf of the client.

In response to consultation with Colchester Borough Council Planning Services (CBCPS), Colchester Borough Council Archaeological Advisor Jess Tipper advised that in order to establish the archaeological implications of this application, the applicant should be required to commission a scheme of archaeological investigation in accordance with paragraphs 128, 129 and 132 of the *National Planning Policy Framework* (DCLG 2012).

All archaeological work was carried out in accordance with a *Brief for an Archaeological Excavation*, detailing the required archaeological work, written by Jess Tipper (CBCPS 2017), and a written scheme of investigation (WSI) prepared by CAT in response to the brief and agreed with CBCPS (CAT 2017).

In addition to the brief and WSI, all fieldwork and reporting was undertaken in accordance with English Heritage's *Management of Research Projects in the Historic Environment (MoRPHE)* (English Heritage 2006), and with *Standards for field archaeology in the East of England* (EAA 14 and 24). This report mirrors standards and practices contained in the Institute for Archaeologists' *Standard and guidance for archaeological excavation* (CIfA 2014a) and *Standard and guidance for the collection, documentation, conservation and research of archaeological materials* (CIfA 2014b).

3 Archaeological background

The following archaeological background draws on the major published sources for Colchester archaeology (listed below), the Colchester Historic Environment Record (CHER) and the Essex Historic Environment Record (EHER).

An archaeological desk-based assessment for the development site was carried out in 2014 (CAT Report 796, by Howard Brooks). The following is a summary taken from that report:

There are no archaeological remains or other heritage assets within the Application Site.

However, the modern village of Boxted Cross lies within a prehistoric landscape. The evidence for this consists of archaeological ‘cropmarks’ including a ‘henge’ (ceremonial Neolithic site 400m NE of the Application Site). Other cropmarks include field ditches and droveways. An archaeological evaluation carried out prior to the building of St Peter’s School (immediately east of the Application Site) intercepted two of the cropmarks and showed that they were part of an Iron Age field system dating to approximately 700-200 BC. Prehistoric flints collected during a watching brief on a pipeline west of Carters Hill are further evidence for prehistoric activity in Boxted.

Other nearby heritage assets include a now-demolished WWII spigot mortar, and four groups of listed buildings, the most important of which is the early medieval hall-house Songers on Cage Lane. None of the listed buildings will be affected by this development.

The prehistoric ditches on the St Peter’s School site may continue into the Application Site.

For full details see CAT Report 796, and for details of other archaeological fieldwork carried out in the vicinity see CAT Report 175 and Crossan 1992.

In December 2016 a pre-application archaeological evaluation was carried out on the development site (CAT Report 1049; CHER no. ECC3898). Eighteen trial-trenches revealed a possible prehistoric field boundary running NE/SW across the site, a possible Roman ditch, a possible medieval pit, a post-medieval (16th-17th century) ditch and brick foundation, a number of undated ditches, pits and postholes, and several modern features.

Following the identification of several ditches of archaeological interest Jess Tipper required archaeological mitigation work in the form of archaeological excavation (strip, map and record). Details are given in a Project Brief written by CBCAA (CBC 2017) and full methodology was then provided with the required written scheme of investigation (CAT March 2017) which is provided as Appendix 4.

Two excavation areas were targeted over specific archaeological remains identified during the 2016 evaluation (Fig 2). Area 1 was c.50m long by 12.5m wide and was located over the eastern half of evaluation trench T6, extending towards trenches T3 and T8. The aim of this area was to define the character, significance, context and date of the possible prehistoric ditch (F27) and associated undated features (F24-F26, F28) in T6, and the undated ditch running between T3 (F16) and T8 (F14).

Excavation Area 2 measured 25m long by 7.5m wide was located over evaluation trench T9 to further define the character, significance, context and date of the possible Roman ditch (F15). Both excavation areas were subject to minor modification within the total 800m² excavation allocation based on emerging results from initial stripping.

4 Results (Figs 2-5)

Two excavation areas were laid out over the development site. Both were machine stripped under the supervision of a CAT archaeologist. They were excavated through c 0.1-0.6m of modern tarmac/concrete and crush onto a sandy-silt subsoil (L2, c 0.15-0.61m thick) which sealed natural sands (L3). All of the recorded archaeological features were cut into L3 and sealed by L2.

Note: Context numbers (features (F) and layers (L)) and finds numbers follow on from those used in the 2016 evaluation (see Appendix 1 and CAT Report 1049).

Excavation area 1 (Fig 3)

Excavation area 1 measured 50m long by 12.5m wide. It was located over the eastern half of evaluation trench T6, extending towards trenches T3 and T8, and aimed to define the character, significance, context and date of the possible prehistoric ditch (F27) and associated undated features (F24-F26, F28) in T6, and the undated ditch running between T3 (F16) and T8 (F14).

Three ditches (F24, F27 and F37), separated by short gaps had been laid out in a northeast-southwest slightly curvilinear alignment across the site for an exposed distance of 51m. They were all shallow, U-shaped ditches, measuring 0.41-0.71m wide and 0.22m deep. Between the terminal ends of ditches F24 and F27 and F27 and F37 were gaps/entrances measuring 1.9m wide.

Ditch F37 branches off as ditch F36, aligned approximately north-north-east, and ditch F38, which continues to the east. Ditch F38 is likely to be a part of ditch F14 identified in T8 of the 2016 evaluation, indicating that it most likely turns to a south-easterly direction. The profiles of these two ditches are quite different but this is probably attributable to differences in depths of machining between the evaluation and excavation. Ditches F36 and F38 are both shallow, U-shaped features measuring 0.67m wide by 0.25m deep and 0.64m wide by 0.09m deep respectively.

To the north of ditch F37 is ditch F35. It appears to come from a north-easterly direction and is possibly parallel to ditch F37. However, within the excavation area it turns towards the northwest and is likely to continue as ditch F16 in T3, although again the profiles of the two ditches differ. Ditch F35 measures 0.94m wide by 0.24m deep.

Ditch F44 is aligned northwest-southeast, measures 0.7m wide by 0.25m deep, and appears to form a gap/entrance 1.5m wide with ditch F37. Similarly ditch F48, aligned north-south, measuring 1.07m wide by 0.18m deep, forms a gap/entrance 1.7m wide with ditch F27. The profile of F48 might suggest that it had been recut at some point.

All of the above ditches appear to be contemporary forming agricultural field boundaries with the gaps/entrances between the ditches suggesting a pastoral economy and landscape designed for stock management. One possibility for example is that the arrangement of ditches F35/F16 in relation to F37 was designed to 'funnel' stock moving from an open field area to the west and south-west, north-eastward. Such funnels and associated double ditched droves were common components of pastoral landscapes from the Middle Bronze Age onwards. Unfortunately dating evidence was extremely sparse across the whole site with only one sherd of Roman pottery (possibly 2nd-3rd century) from F35, five fragments of Roman lava quern from F48 and a Roman or later nail from F37. Two undated pits (F25 and F26) were excavated between ditches F24 and F27, and may be contemporary with this activity.

Only one other ditch, F47, was recorded on the site. Aligned northwest-southeast and measuring 1.07m wide by 0.15m deep, it cut ditch F27 and contained a single sherd of medieval (late 12th/13th-14th century) pottery.

Also on the site were two undated small pits/postholes (F40 and F42), an undated pit (F45), two modern pits (F43 and F46) and three three-throws (F39, F41 and F49).

Excavation area 2

Excavation area 2 measured 25m long by 7.5m wide and was located over evaluation trench T9 with an aim to further define the character, significance, context and date of the possible Roman ditch (F15).

Ditch F15 was aligned N-S and was recorded for a distance of 20m. It measured c 1m wide by 0.24-0.42m deep and terminated close to the northern end of the excavation area. A large quantity of amphora and pottery from the ditch confirmed that it was in

fact of a Roman date. It was not seen to continue to the north in either evaluation trench T4 or T1 and may have continued to the W/NW.

Three tree-throws (F32-F34 (F34 not on plan)) were also excavated.



Photograph 1 Excavation area 1, looking N



Photograph 2 Excavation area 2, looking NW

5 Finds

by Stephen Benfield

Only a small quantity of finds were recovered but include the (broken) lower half of a large Roman amphora. All of the finds come from ditch contexts. Most of the closely dated finds are of Roman date with one pottery sherd that is probably medieval. The finds are listed and described by context in Table 1. The Roman pottery fabrics refer to **CAR 10** and the medieval pottery fabric to **CAR 7**.

Ctxt	Ctxt type	Find no	Type/ description	Spot date
F15 (sx2)	Ditch (mid fill)	22	Pottery Roman (46 sherds, 4932 g) Fabric AJ Dressel 20 amphora (M1-2C) buff-brown sandy fabric, light buff surface, medium to large sherds most if not all clearly joining and forming the lower part of the amphora body including the base knob, some deterioration of fabric probably from soil conditions	Roman, M1-2C
F35	Ditch (upper fill)	23	Pottery Roman (1 sherd, 10 g) Fabric GX small rim sherd, everted, slightly flattened, probably from a bowl (prob 2-3C)	Roman, ?2-3C
F37 (sx3)	Ditch (upper fill)	24	Iron object (56 g) probably a corroded nail (length 75 mm) but not certain and not closely dated – probably Roman or later	Probably Roman or later
F47 (sx2)	Ditch (upper fill)	30	Pottery Medieval (1 sherd, 4 g) small, hard, sandy greyware sherd (Fabric 20) with brownish surface	Medieval, L12/13-14C
F48	Ditch (upper fill)	27	Quernstone (Lava) (5 pieces, 62 g) one small piece, recently broken/fractured into 5 joining pieces, imported lava stone (almost without doubt) from the Mayen quarries in the German Rhineland	Roman

Table 1 Finds by context

Finds from an earlier evaluation (CAT Report 1049) included Neolithic (flints), Roman, medieval, post-medieval and modern periods. The few finds here, where closely dated, are Roman (mid 1st-3rd century) and medieval (late 12th/13th-14th century). In the main the few finds recovered, primarily small pottery sherds from the upper fill of ditches, suggest probable agricultural spread away from the centre of occupation. This appears similar to the small quantities of Roman and medieval pottery recovered during the evaluation. However, a significant part of a Spanish imported oil amphora of Roman date (mid 1st-2nd century) stands out. It came from the mid fill of ditch F15 (sx2) (22) and its degree of completeness (broken but consisting of joining sherds) does not fit the pattern of the other finds. These amphorae are not uncommon on rural sites and are known to have been used as secondary containers in various capacities during the Roman period. It appears to have been dumped as a group of sherds into the partly silted ditch and suggests some activity here in the Roman period beyond the incidental discard and spread of material away from the occupation focus. The only other find of note is a small piece of lava quern from F48 (27) which is almost certainly a Roman period import. A small piece of heavily corroded iron from F37 (sx3) (24) appears likely to be a nail and the degree of corrosion suggests it is probably of Roman date, although this is not certain.



Photograph 3 Fragments of Dressel 20 amphora from ditch F15.

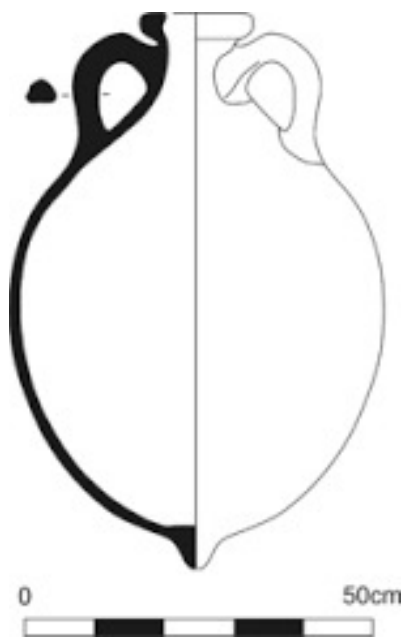

Photograph 4 Example of a complete Dressel 20 amphora

6 Environmental report

by Lisa Gray, MSc MA ACIfA Archaeobotanist

Introduction – aims and objectives

Four samples were presented for assessment. The excavation revealed a small number of Roman ditches forming a field system across the landscape and a single medieval ditch. The aims of this assessment are to determine the significance and potential of the plant macro-remains in the samples, consider their use in providing information about diet, craft, medicine, crop-husbandry, feature function and environment.

Sampling and processing methods

Samples were taken and processed by Colchester Archaeological Trust (see Appendix 3). All samples were processed using a Siraf-type flotation device. Flot was collected in a 300-micron mesh sieve then dried. 80 litres of soil were sampled.

Once with the author the flots were scanned under a low powered stereo-microscope with a magnification range of 10 to 40x. The whole flots were examined. The abundance, diversity and state of preservation of eco- and artefacts in each sample were recorded. A magnet was passed across each flot to record the presence or absence of magnetised material or hammerscale.

Identifications were made using uncharred reference material (author's own and the Northern European Seed Reference Collection at the Institute of Archaeology, University College London) and reference manuals (such as Beijerinck 1947; Cappers *et al.* 2006; Charles 1984; Fuller 2007; Hillman 1976; Jacomet 2006). Nomenclature for plants is taken from Stace (Stace 2010). Latin names are given once and the common names used thereafter.

At this stage, to allow comparison between samples, numbers have also been estimated but where only a very low number of items are present they have been counted. Identifiable charred wood >4mm in diameter has been separate from charred wood flecks. Fragments this size are easier to break to reveal the cross-sections and diagnostic features necessary for identification and are less likely to be blown or unintentionally moved around the site (Asouti 2006, 31; Smart and Hoffman, 1988, 178-179). Charred wood flecks <4mm diameter have been quantified but not recommended for further analysis unless twigs or roundwood fragments larger than 2mmØ were present.

Results (Appendix 3)

The plant remains

Like the evaluation samples (Gray 2017) charcoal flecks too small to identify were present in each sample. Samples 10 (F47, medieval ditch) and 11 (F48, Roman ditch) contained fragments of identifiable size. No other charred plant remains were found in these samples.

Uncharred/dried waterlogged seeds of segetal and ruderal plants were present in low numbers in samples 8 (F27, Roman? ditch), 10 (F47, medieval ditch) and 11 (F48, Roman ditch). These were mostly seeds of the ruderal fat hen (*Chenopodium album*). One fragment of sloe/damson (*Prunus* sp.) endocarp was found in sample 10 (F47, medieval ditch). It is possible that these seeds may be intrusive as uncharred root/rhizome fragments were also frequent in each sample.

Fauna

Low numbers of beetle fragments were found in samples 8, 9 and 10. Terrestrial mollusca were found in low numbers in sample 8.

Inorganic remains

No inorganic remains were found in these samples.

Discussion

Biases in recovery, residuality, contamination

Nothing with regards biases in recovery, residuality or contamination was highlighted for any of these samples. On microscopic examination it was clear that bioturbation was likely due to the presence of root/rhizome fragments and terrestrial mollusca.

Quality and type of preservation

Only charcoal fragments have the likelihood to be of archaeobotanical value in these samples. Charring of plant macrofossils occurs when plant material is heated under ‘... reducing conditions...’ where oxygen is largely excluded (Boardman and Jones 1990, 2) leaving a carbon skeleton resistant to biological and chemical decay (English Heritage 2011,17). These conditions can occur in a charcoal clamp, the centre of a bonfire or pit or in an oven or when a building burns down with the roof excluding the oxygen from the fire (Reynolds, 1979, 57).

Potential of these samples to provide information about food, crop-processing, craft, medicine, trade, feature function and environment

It is likely that given the frequency of uncharred root/rhizome fragments, the uncharred/dried waterlogged plant macro-remains are intrusive.

A recent study of intrusion and residuality in the archaeobotanical record for central and southern England (Pelling *et al.* 2015) has highlighted the problem of assigning charcoal fragments such as these to the dated contexts they were taken from because it is possible that these durable charred plant remains survived being moved between contexts by human action and bioturbation so cannot be properly interpreted unless radiocarbon dates are gained from the plant macro-remains themselves. That is the only way to secure a genuine date for the charred plant macro-remains like these (Pelling *et al.* 2015, 96).

Therefore, it is not recommended that further work is carried out on the plant remains in these samples unless charred wood identification is considered to be necessary.

Significance of the samples and recommendations for further work

No further archaeobotanical work is recommended on these samples.

7 Discussion

Excavation at Hill Farm revealed fifteen archaeologically significant features consisting of ten ditches, three pits and two small pits/postholes. In addition to this were six tree-throws, two modern pits and a modern service.

Roman field systems

Dating evidence from the features excavated at Hill Farm was sparse. However, three of the ditches contained evidence dating to the Roman period, with a fourth ditch containing an iron nail of probable Roman or later date. A further five ditches appear to be contemporary with these dated features, and would therefore also be of probable Roman date. These nine ditches would have formed field boundaries showing that, in the Roman period, the landscape had been divided-up into complex field system. Regular gaps/entrances between these ditches might indicate a pastoral economy with the ditches delineating fields for stock management. This is a significant discovery as no Roman activity had previously been identified in the vicinity of the development site.

Ditches F24, F27 and F37 appear to be on the same NE/SW alignment as a cropmark identified further to the northeast before the school was built (see Fig 2). This cropmark is likely to be undated ditch F10 excavated in a 2002 evaluation on the school site (CAT

Report 175), suggesting that the Roman field system may continue as cropmarks to the NE/E. However, two other features excavated in 2002 (pit F1 and ditch F9) contained pottery of early to mid Iron Age date, perhaps indicating an earlier Iron Age field system to the NE/E of the development site.

Medieval

A single sherd of medieval (late 12th/13th-14th century) pottery was recovered from ditch F47. Little medieval activity has previously been identified in the area of Hill Farm. A single abraded sherd of medieval pottery (13th-14th century) was identified in pit F30 (T3) of the 2016 evaluation (CAT Report 1049). However, it was unclear whether this was a medieval pit or a residual pottery sherd disturbed by modern activity. The only other medieval remains identified nearby were medieval pottery sherds picked up along Carters Hill during the 1992 watching brief to the north of the development site (Crossan 1992) and two residual pottery sherds recorded during the 2016 evaluation.

8 Acknowledgements

CAT thanks Joe Jackson and Thomas Bates & Sons commissioning and funding the work. The project was managed by C Lister and carried out by B Holloway with G Morgan and A Tuffy. Figures were prepared by BH and E Holloway. The project was monitored for the CBCPS by Jess Tipper and by Robert Masefield of RPS for Thomas Bates & Sons.

9 References

Note: all CAT reports, except for DBAs, are available online in PDF format at <http://cat.essex.ac.uk>

- | | | |
|---|-------|---|
| Asouti, E | 2006 | 'Factors affecting the formation of an archaeological wood charcoal assemblage.' Retrieved on 13th February 2015 from World Wide Web: http://pcwww.liv.ac.uk/~easouti/methodology_application.htm |
| Beijerinck, W | 1947 | <i>Zadenatlas der Nederlandsche Flora</i> . Veenman and Zonen, Wageningen |
| Boardman, S, and Jones, G | 1990 | Experiments on the Effect of Charring on Cereal Plant Components. in <i>Journal of Archaeological Science</i> 17 , 1-11. |
| Cappers, R J T, Bekker, R M and Jans, J E A | 2006 | <i>Digital Zadenatlas Van Nederlands - Digital Seeds Atlas of the Netherlands</i> . Groningen Archaeological Studies Volume 4, Barkhius Publishing, Groningen. |
| CAR 7 | 2000 | <i>Colchester Archaeological Report 7: Post-Roman pottery from excavations in Colchester, 1971-85</i> , by J Cotter |
| CAR 10 | 1999 | <i>Colchester Archaeological Report 10: Roman pottery from excavations in Colchester, 1971-86</i> , by R Symonds and S Wade |
| CAT | 2014 | <i>Health & Safety Policy</i> |
| CAT | 2017 | <i>Written Scheme of Investigation (WSI) for an archaeological excavation at Hill Farm, Boxted Cross, Boxted, Essex, CO4 5RD</i> |
| CAT Report 1049 | 2017 | <i>Archaeological evaluation at Hill Farm, Boxted Cross, Boxted, Essex, CO4 5RD: December 2016</i> |
| CBCPS | 2017 | <i>Brief for Archaeological Excavation (strip, map and record) at Land at Hill Farm, Boxted Cross, Boxted, CO4 5RD</i> , by Jess Tipper |
| Charles, M | 1984 | 'Introductory remarks on the cereals.' <i>Bulletin on Sumerian Agriculture</i> 1 , 17-31. |
| CifA | 2014a | <i>Standard and Guidance for an archaeological evaluation</i> |
| CifA | 2014b | <i>Standard and guidance for the creation, compilation, transfer and deposition of archaeological archives</i> |
| CifA | 2014c | <i>Standard and guidance for the collection, documentation, conservation and research of archaeological materials</i> |
| DCLG | 2012 | <i>National Planning Policy Framework</i> |
| English Heritage | 2006 | <i>Management of Research Projects in the Historic Environment (MoRPHE)</i> |
| English Heritage | 2011 | <i>Environmental Archaeology: A Guide to the Theory and Practice of Methods for Sampling and Recovery to Post-Excavation</i> . Swindon: English Heritage Publications. |

Fuller, D	2007	'Cereal Chaff and Wheat Evolution' Retrieved on 12th February 2010 from World Wide Web: http://www.homepages.ucl.ac.uk/~tcrndfu/archaeobotany.htm
Gray, L	2017	'Environmental results' in <i>CAT Report 1049 Archaeological evaluation at Hill Farm, Boxted Cross, Boxted, Essex, CO4 5RD: December 2016</i>
Gurney, D	2003	<i>Standards for field archaeology in the East of England</i> . East Anglian Archaeology Occasional Papers 14 (EAA 14).
Hillman, G C	1976	'Criteria useful in identifying charred Wheat and Rye Grains.' Unpublished versions of notes likely to have entered publication in some form and given to the author by Gordon Hillman during the course of her MSc in 1995-1996.
Jacomet, S	2006	<i>Identification of cereal remains from archaeological sites - second edition</i> . Basel: Basel University Archaeobotany Lab IPAS
Medlycott, M	2011	<i>Research and archaeology revisited: A revised framework for the East of England</i> . East Anglian Archaeology Occasional Papers 24 (EAA 24)
Parks, K	2012	Arable Practice in the Iron Age and Roman East of England. Volume 1. Retrieved from the World Wide Web on 13th January 2017: https://lra.le.ac.uk/bitstream/2381/27951/1/2012parkskphdvol1.pdf
Pelling, R, Campbell, G, Carruthers, W, Hunter, K and Marshall, P Reynolds, P	2015	'Exploring contamination (intrusion and residuality) in the archaeobotanical record: case studies from central and southern England'. In <i>Vegetation History and Archaeobotany</i> (2015) 24: 85-99.
Smart, T and Hoffman, E S	1979	<i>The Iron Age Farm: The Butser Experiment</i> . London: British Museum Press.
	1988	'Environmental Interpretation of Archaeological Charcoal.' In Hastorf C.A. and Popper V.S. <i>Current Palaeobotany</i> . Chicago and London. University of Chicago Press.
Stace, C	2010	<i>New Flora of the British Isles</i> , 3 rd Edition, Cambridge University Press, Cambridge

10 Abbreviations and glossary

CAT	Colchester Archaeological Trust
CBC	Colchester Borough Council
CBCAA	Colchester Borough Council Archaeological Advisor
CBCPS	Colchester Borough Council Planning Services
CHER	Colchester Historic Environment Record (previously UAD, Urban Archaeological Database)
ClfA	Chartered Institute for Archaeologists
context	specific location of finds on an archaeological site
feature (F)	an identifiable thing like a pit, a wall, a drain: can contain 'contexts'
Iron Age	period from 700 BC to Roman invasion of AD 43
layer (L)	distinct or distinguishable deposit of soil
medieval	period from AD 1066 to c 1500
modern	period from c AD 1800 to the present
natural	geological deposit undisturbed by human activity
Neolithic	period from c 4000 – 2500 BC
NGR	National Grid Reference
OASIS	Online Access to the Index of Archaeological InvestigationS, http://oasis.ac.uk/pages/wiki/Main
post-medieval	from c AD 1066 to AD 1800
prehistoric	pre-Roman
residual	something out of its original context, eg a Roman coin in a modern pit
Roman	the period from AD 43 to c AD 410
section	(abbreviation sx or SX) vertical slice through feature/s or layer/s
wsi	written scheme of investigation

11 Contents of archive

Finds: none retained

Paper and digital record

One A4 document wallet containing:

The report (CAT Report 1085)

CBCPS evaluation brief, CAT written scheme of investigation

Original site record (feature and layer sheets, finds record, plans)

Site digital photos and log, architectural plans, attendance register, risk assessment

12 Archive deposition

The paper and digital archive is currently held by the Colchester Archaeological Trust at Roman Circus House, Roman Circus Walk, Colchester, Essex, CO2 7GZ, but will be permanently deposited with Colchester Museum under accession code: COLEM 2016.115.

© Colchester Archaeological Trust 2017

Distribution list

Joe Jackson, Thomas Bates & Son Ltd

Rob Masefield, RPS

Jess Tipper, Colchester Borough Council Planning Services

Essex Historic Environment Record



Colchester Archaeological Trust

Roman Circus House,

Roman Circus Walk,

Colchester,

Essex, CO2 7GZ

tel.: 01206 501785

email: lp@catuk.org

Checked by: Philip Crummy

Date: 6.6.2017

Appendix 1 2016 evaluation context list

Trench	Context No.	Finds No.	Type	Description	Date
T17	F1	1	Ditch	Soft, moist, light grey/brown sandy-silt with 2% stone	16th-mid 17th century
T18	F2		Tree-throw	Firm, dry, medium grey/brown silt with occasional stone	undated
T18	F3		Tree-throw	Firm, dry, medium grey/brown silt with occasional stone	undated
T12	F4	4	Pit	Firm, moist, mottled orange/grey sandy-silt with occasional charcoal, 3% stone and 2% tile/brick; containing modern brick, roofing felt and concrete (not retained)	Modern
T12	F5		Posthole	Firm, dry, light-medium grey/brown silt with <2% stone	Modern
T12	F6	5	Pit	Soft, dry, dark brown silt with <2% stone	Medieval / post-medieval
T10	F7		Tree-throw	Very soft, moist, light grey/brown sandy-silt with 5% stone	undated
T10	F8		Ditch	Soft, moist, medium orange/brown sandy-silt with <1% stone	undated
T4	F9		Ditch	Soft, moist, light grey/brown sandy-silt with 7% stone	undated
T11	F10		Tree-throw	Firm, moist, dark brown silt with charcoal flecks and occasional stone sealing friable, hard, moist, light orange/grey sandy-clay	undated
T10	F11		Posthole?	Firm, light grey/brown silt	undated
T1	F12		Ditch	Firm, moist, light grey/brown sandy-silt	undated
T4	F13	8	Ditch	Soft, moist, light grey/brown sandy-silt with charcoal and brick flecks, 2% stone	Modern
T8	F14		Ditch	Firm, moist, medium grey/brown sandy-silt	undated
T9	F15	10	Ditch	Soft, light, orange/grey/brown sandy-silt with <3% stone	?Roman
T3	F16		Ditch	Soft, moist, light grey/brown sandy-silt with charcoal and daub flecks, 1% stone	undated
T2	F17		Posthole	Soft, moist, medium grey/brown silt with flecks with brick/tile and occasional stone/gravel	Modern
T2	F18	12	Ditch	Soft, moist, dark brown silt with flecks of brick/tile and charcoal, common stones	Modern
T2	F19		Posthole	Soft, moist, dark grey/brown silt with flecks of brick/tile and occasional stone	Modern
T2	F20	13	Posthole	Soft, moist, dark brown/black silt flecks of brick/tile and charcoal, common stone	Modern
T2	F21		Posthole	Soft, moist, light-medium, mottled grey/brown silt with occasional stone	undated
T2	F22		Pit	Soft, friable, dark brown sandy-silt with common stone/gravel	undated
T2	F23		Tree-throw	Loose, soft, moist, light grey/brown sandy-silt with occasional stone	undated

T6	F24		Ditch	Soft, medium grey/brown sandy-silt with <3% stone	undated
T6	F25	14	Pit	Soft, light-medium, mottled orange/grey/brown sandy-silt with rare charcoal flecks and <3% stone	undated
T6	F26		Pit?	Light-medium grey/brown with mottled pale orange sandy-silt, <1% stone	undated
T6	F27	15	Ditch	Soft, grey/brown with mottled orange sandy-silt, <2% stone	?Later prehistoric
T6	F28		Pit or Ditch terminal	Soft, medium-dark grey/brown with lower fill of mottled orange sandy-silt, <2% stone	undated
T3	F29		Ditch	Soft, moist, dark yellow/grey/brown sandy-silt	undated
T3	F30	20	Pit	Soft, moist, medium yellow/grey/brown sandy-silt with 5% stone	?13th-14th century
T3	F31	21	Brick foundation		Post-medieval
	-		Surfaces	Modern tarmac and concrete surfaces/roads sealing modern crush = T1-T11 & T13	Modern
	L1		Topsoil	Loose, dry, medium grey/brown silt with occasional stone = T12 & T14-T18	Modern
	L2	3	Subsoil	Firm, moist, medium orange/brown sandy-silt with charcoal flecks and occasional stone	-
	L3		Natural	Natural sands	-

Appendix 2 2017 excavation context list

Exc area	Context No.	Finds No.	Type	Description	Date
2	F15	22	Ditch	Soft, light, orange/grey/brown sandy-silt with <3% stone	Roman, mid 1st-2nd century
2	F32		Tree-throw	Friable, medium brown silty-clay, 10% stone	-
2	F33		Tree-throw	Medium yellow/brown silty-clay, 5% stone	-
2	F34		Tree-throw	Soft, medium grey/brown sandy-silt, 5% stone	-
1	F35	23	Ditch	Firm, moist, medium grey/brown silt	Roman, ?2nd-3rd century
1	F36		Ditch	Firm, moist, medium grey silt	-
1	F37	24	Ditch	Firm, moist, medium grey silt	Probably Roman or later
1	F38		Ditch	Firm, moist, medium grey silt	-
1	F39		Tree-throw	Firm, moist, medium grey/brown silt	-
1	F40		Small pit/posthole	Firm, moist, medium grey/brown sandy-silt	-
1	F41		Tree-throw	Firm, moist, medium grey/brown silt	-
1	F42		Small pit/	Firm, moist, medium grey/brown sandy-silt	-

			posthole		
1	F43		Pit	Firm, moist, dark grey/brown silt	Modern
1	F44		Ditch	Firm, moist, medium grey/brown silt	-
1	F45		Pit	Firm, moist, medium grey/brown silt	-
1	F46		Pit	Firm, moist, dark grey/brown silt	Modern
1	F47	30	Ditch	Firm, moist, medium grey/brown silt with charcoal flecks	Medieval, late 12th/13th-14th century
1	F48	27	Ditch	Firm, moist, medium grey/brown silt with charcoal flecks	Roman
1	F49		Tree-throw	Firm, moist, medium grey/brown silt	-

Appendix 3 Environmental results

Sample	Finds No.	Sample description	Bulk sample volume (L)	Flot volume (ml)	Charcoal >4mm∅	Charcoal <4mm∅	Dried waterlogged Seeds			Moss (modern)	Modern root/rhizomes	Beetle fragments	Terrestrial mollusca
					a	a	a	d	p	a	a	a	a
8	25	F27 sx2 Roman? ditch	20	2	-	1	1	1	1	1	2	1	1
9	26	F35 sx1 Roman (2nd-3rd century) ditch	20	2	-	1	-	-	-	-	2	1	-
10	28	F47 sx2 Medieval (late 12th-13th/14th century) ditch	20	15	1	2	2	1	3	-	3	1	-
11	29	F48 Roman ditch	20	40	1	2	2	1	3	-	3	-	-

Key: a = abundance [1 = occasional 1-10, 2 = moderate 11-100 and 3 = abundant >100]

d = diversity [1 = low 1-4 taxa types, 2 = moderate 5-10, 3 = high]

p = preservation [1 = poor (family level only), 2 = moderate (genus), 3 = good (species identification possible)]

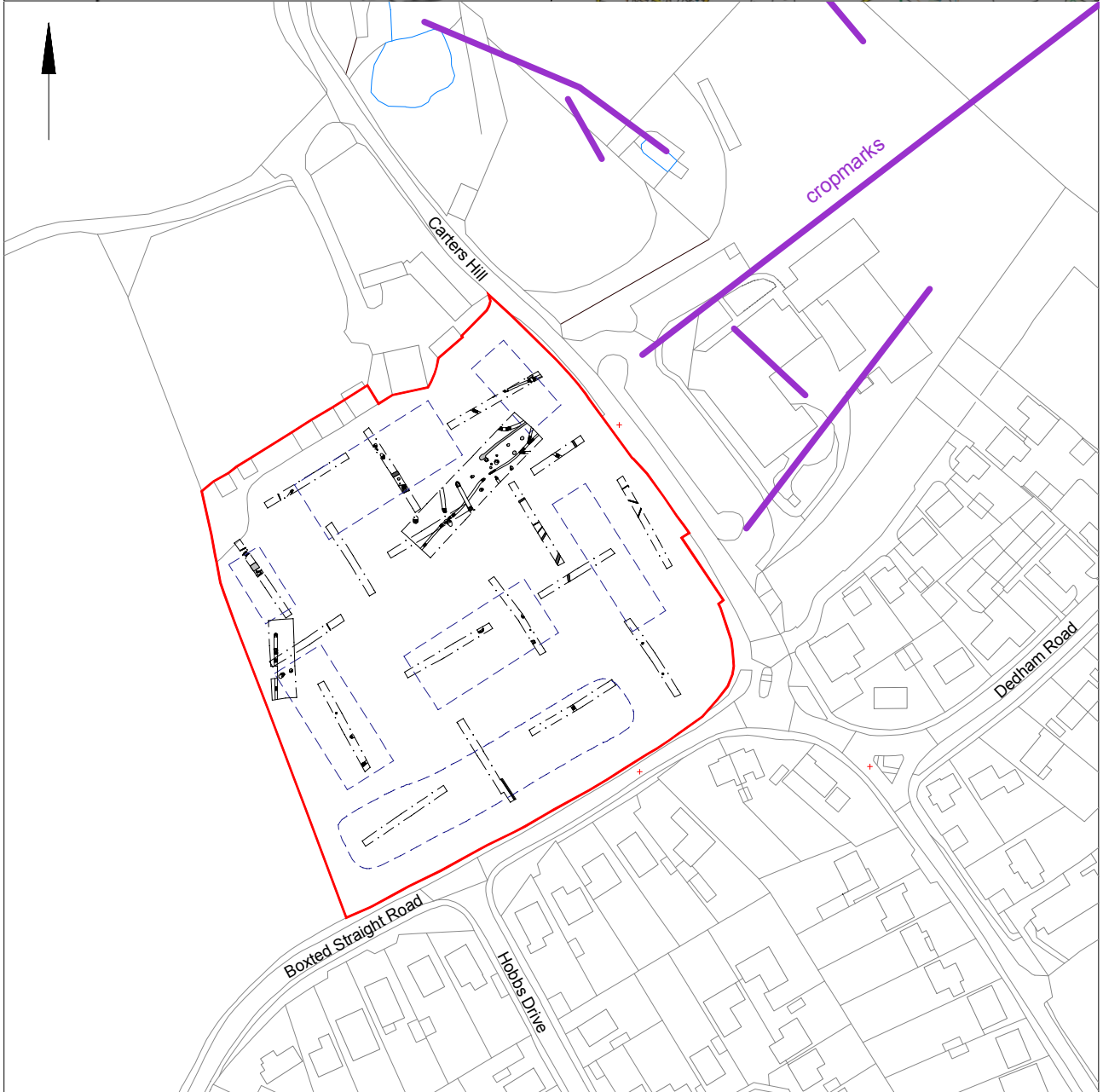
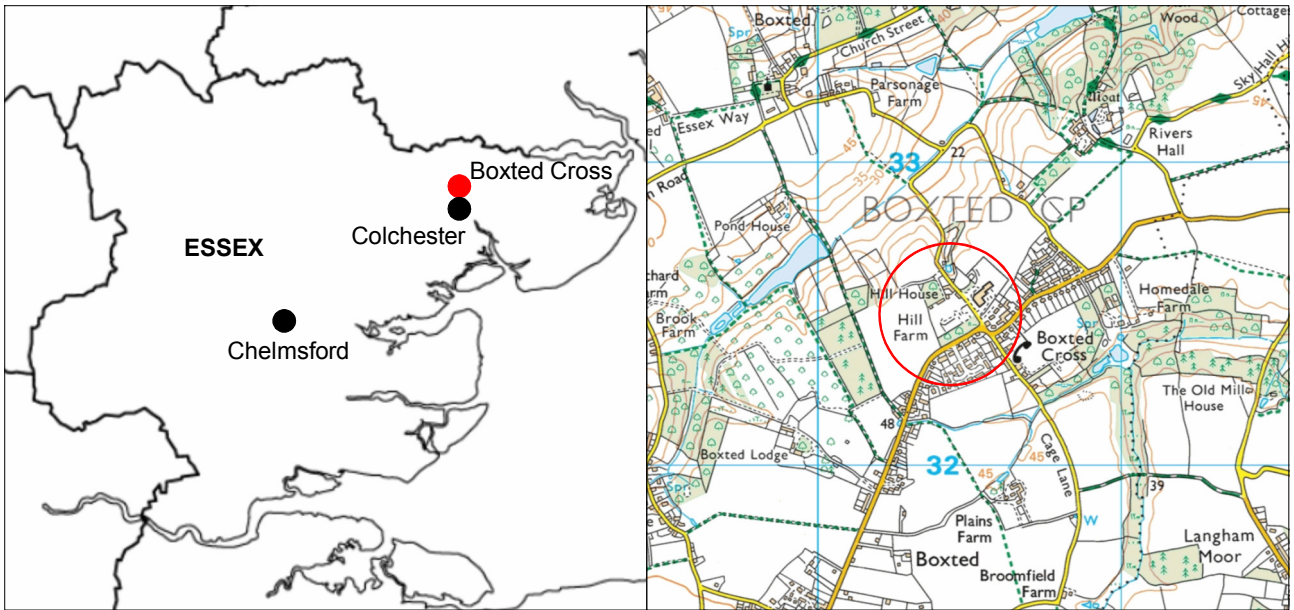

© Crown copyright. All rights reserved. Licence number 100039294.

Fig 1 Site location, shown in relation to 2016 evaluation trenches, proposed development (dashed blue) and cropmarks (purple)



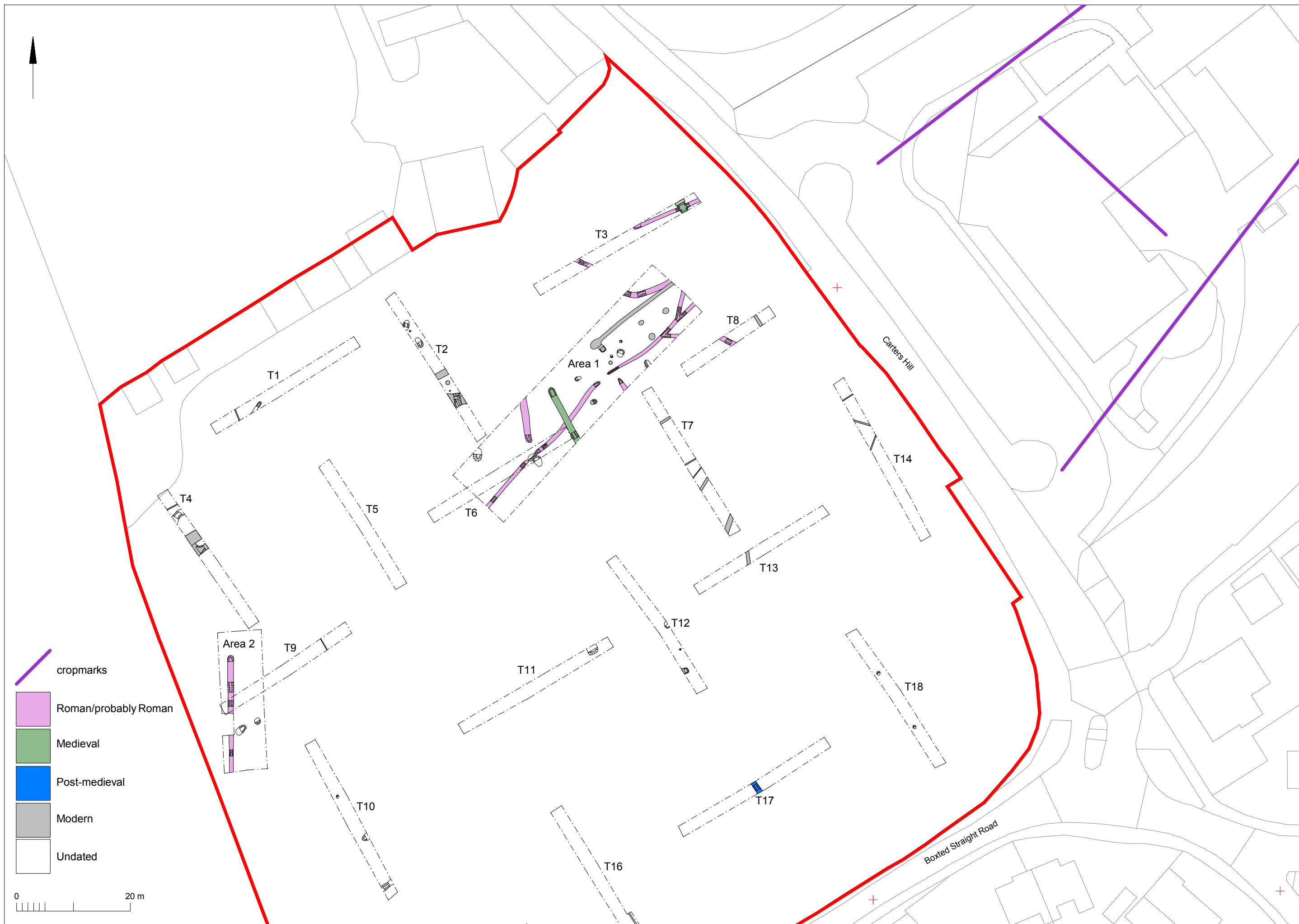

Fig 2 Excavation results shown in relation to the 2016 evaluation trenches and cropmarks (purple)

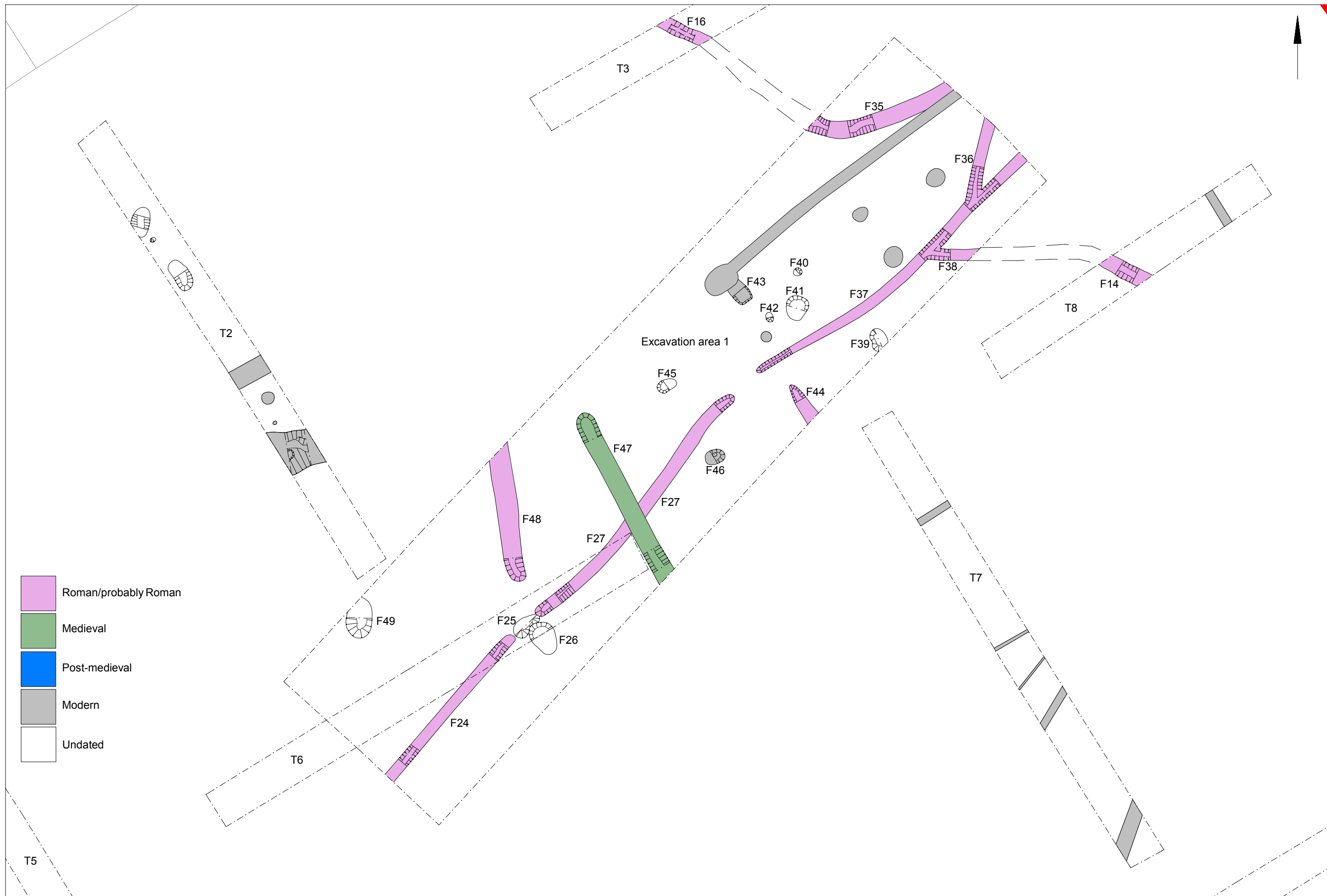

Fig 3 Excavation area 1 results

0 10 m

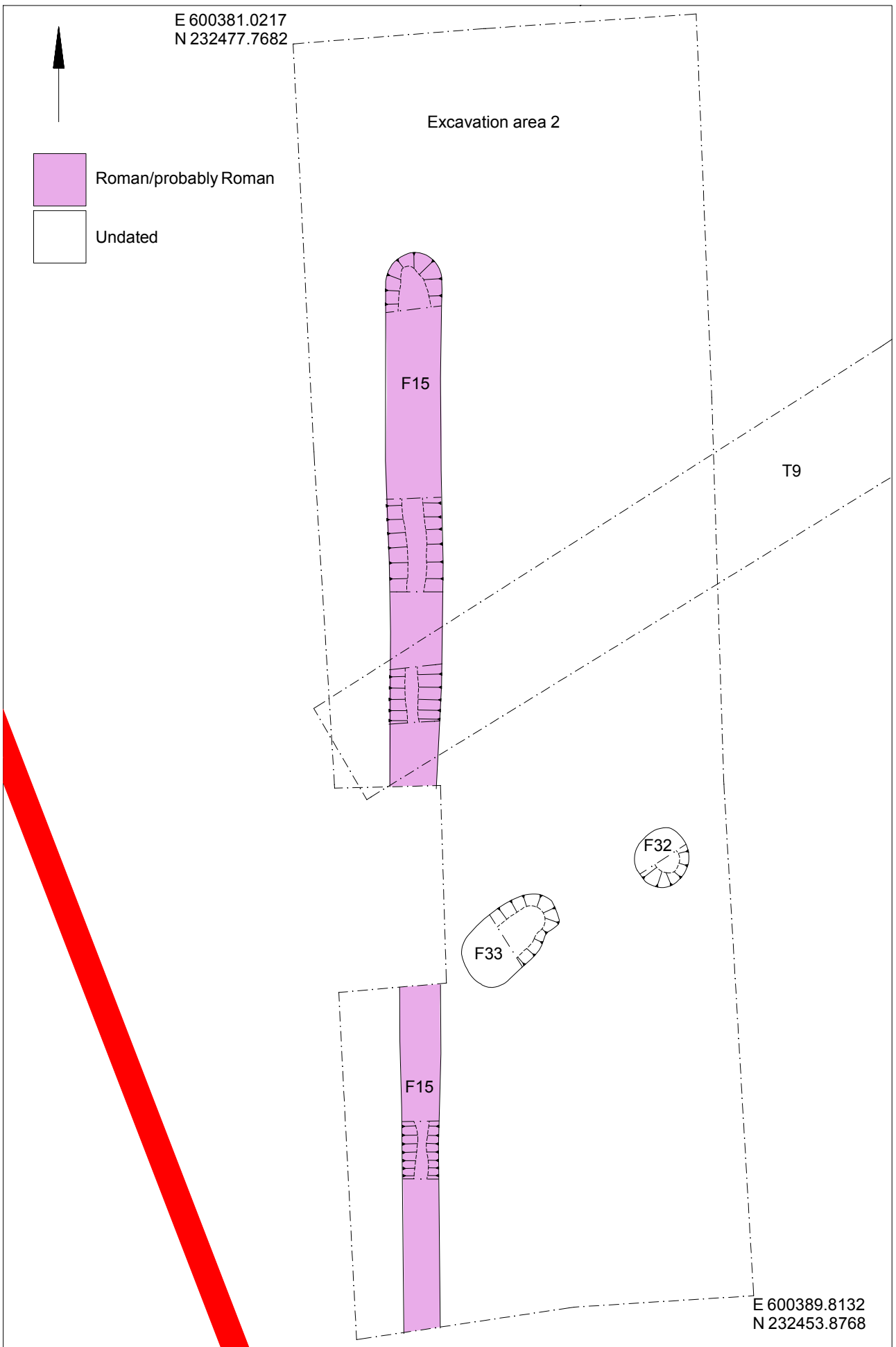

Fig 4 Excavation area 2 results

0 5 m

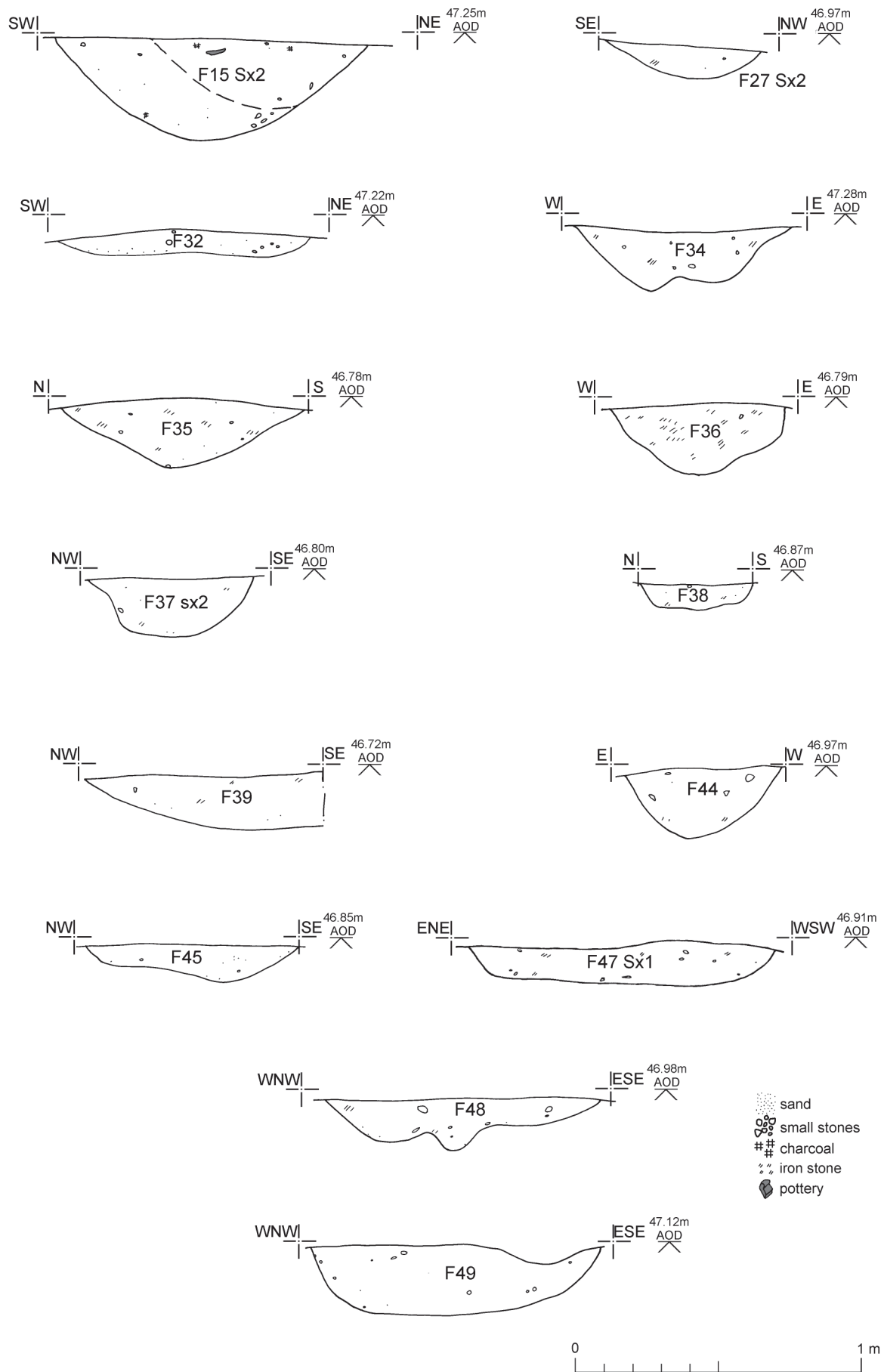

Fig 5 Sections.

Essex Historic Environment Record/ Essex Archaeology and History

Summary sheet

Address: Hill Farm, Boxted Cross, Boxted, Essex, CO4 5RD	
Parish: Boxted	District: Colchester
NGR: TM 0044 3248 (centre)	Site code: CAT project ref.: 17/03d CHER ref: ECC3971 OASIS ref: colchest3-279603
Type of work: Excavation	Site director/group: Colchester Archaeological Trust
Date of work: 22nd-30th March 2017	Size of area investigated: 1.88ha
Location of curating museum: Colchester museum accession code COLEM: 2016.115	Funding source: developer
Further seasons anticipated? Not known	Related EHER/SMR number:
Final report: CAT Report 1085	
Periods represented: Roman, medieval	
<p>Summary of fieldwork results: <i>An archaeological excavation was carried out at Hill Farm, Boxted Cross, Essex prior to the construction of residential dwellings. The development site is located close to a number of prehistoric cropmarks and field systems, including the Boxted 'henge'. Evaluation in 2016 revealed possible prehistoric and Roman field boundary ditches, a possible medieval pit, post-medieval (16th-17th century) ditch and brick foundation, a number of undated ditches, pits and postholes, and several modern features. Excavation revealed fifteen archaeologically significant features consisting of ten ditches, three pits and two small pits/postholes. In addition to this were six tree-throws, two modern pits and a modern service. Although dating evidence was rare across the whole site, most of the poorly dated ditches are likely to be Roman field boundaries forming a complex field system most likely associated with a pastoral economy and stock management. One ditch containing 26 sherds of a Dressel 20 amphora can be more confidently dated to the early Roman period. A single possible medieval ditch was also identified.</i></p>	
Previous summaries/reports: CAT Report 1049	
CBC monitor: Jess Tipper	
Keywords: –	Significance: *
Author of summary: Laura Pooley	Date of summary: June 2017

Written Scheme of Investigation (WSI) for an archaeological excavation (strip, map and record) at Hill Farm, Boxted Cross, Boxted, Essex, CO4 5RD

NGR: TM 0044 3248 (centre)

Planning reference: pre-application

Commissioned by: Rob Masefield, RPS

Client: Joe Jackson, Thomas Bates & Son Ltd

Curating Museum: Colchester

Museum accession code: COLEM: 2016.115

CHER Event number: ECC3971

CAT Project code: 17/03d

OASIS Project id: colchest3-279603

Site Manager: Chris Lister

CBC Monitor: Jess Tipper

This WSI written: 17.03.2017

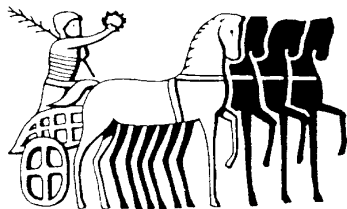

COLCHESTER ARCHAEOLOGICAL TRUST,
Roman Circus House,
Roman Circus Walk,
Colchester,
Essex, CO2 7GZ
tel: 01206 501785
email: lp@catuk.org

Site location and description

The proposed development site (1.9ha) lies approximately 7km north of Colchester on land at Hill Farm, Carters Hill, Boxted Cross, Essex (Fig 1). The site is centred on NGR TM 0044 3248.

Proposed work

A new residential development.

Archaeological background

The following archaeological background draws on the Colchester Archaeological Trust report archive, the Colchester Essex Historic Environment Record (CHER) and the Essex Historic Environment Record accessed via the Heritage Gateway:

An archaeological desk-based assessment for the development site was carried out in 2014 (CAT Report 796, by Howard Brooks). The following is a summary taken from that report:

There are no archaeological remains or other heritage assets within the Application Site.

However, the modern village of Boxted Cross lies within a prehistoric landscape. The evidence for this consists of archaeological 'cropmarks' including a 'henge' (ceremonial Neolithic site 400m NE of the Application Site). Other cropmarks include field ditches and droveways. An archaeological evaluation carried out prior to the building of St Peter's School (immediately east of the Application Site) intercepted two of the cropmarks and showed that they were part of an Iron Age field system dating to approximately 700-200 BC. Prehistoric flints collected during a watching brief on a pipeline west of Carters Hill are further evidence for prehistoric activity in Boxted.

Other nearby heritage assets include a now-demolished WWII spigot mortar, and four groups of listed buildings, the most important of which is the early medieval hall-house Songers on Cage Lane. None of the listed buildings will be affected by this development.

The prehistoric ditches on the St Peter's School site may continue into the Application Site.

For full details see CAT Report 796, and for details of other archaeological fieldwork carried out in the vicinity see CAT Report 175 and Crossan 1992.

In December 2016 an archaeological evaluation was carried out on the development site (CAT Report 1049; CHER no. ECC3898). Eighteen trial-trenches revealed a possible prehistoric field boundary running NE/SW across the site, a possible Roman ditch, a possible medieval pit, a post-medieval (16th-17th century) ditch and brick foundation, a number of undated ditches, pits and postholes, and several modern features.

Planning background

This development is currently in the pre-application stage. The development site was recently identified in Boxted's Neighbourhood Plan as an appropriate location for development and the developer/architect is currently working on a scheme that conforms to the various conditions contained therein.

As the site lies within an area highlighted by the EHER / CHER as having a high potential for archaeological deposits, an archaeological condition was recommended by the Colchester Borough Council Archaeological Advisor (CBCAA). This recommendation was for an archaeological excavation (strip, map and record) and was based on the guidance given in the *National Planning Policy Framework* (DCLG 2012).

Requirement for work

The required archaeological work is for archaeological excavation (strip, map and record). Details are given in a Project Brief written by CBCAA (CBC 2017).

Specifically, two excavation areas will be targeted over specific archaeological remains identified during the 2016 evaluation (Fig 2).

The first excavation area will measure 50m long by 12.5m wide and will be located over the eastern half of evaluation trench T6, extending towards trenches T3 and T8. The aim of this area is to define the character, significance, context and date of the possible prehistoric ditch (F27) and associated undated features (F24-F26, F28) in T6, and the undated ditch running between T3 (F16) and T8 (F14).

The second excavation area, measuring 25m long by 7m wide will be located over evaluation trench T9 to further define the character, significance, context and date of the possible Roman ditch (F15).

Both excavation areas may be subject to modification within the total 800m² excavation allocation, based on emerging results from initial stripping. This iterative process will allow for perpendicular trenches to be extended from the core area to expose particular features, and/or for expansion of a particular edge/s of the excavation (with commensurate reductions of m² elsewhere where potential is deemed lower). An extra 160m² contingency for additional expansion/trial-trenching will also be used if deemed necessary. Any such amendments will be notified to and agreed by the CBCAA.

If unusual, significant or unexpected remains are encountered the CBCAA will be informed immediately and further investigation may be required, which would be the subject of an additional brief and wsi.

General methodology

All work carried out by CAT will be in accordance with:

- Professional standards of the Chartered Institute for Archaeologists, including its *Code of Conduct* (CIfA 2014a-c)
- Standards and Frameworks published by East Anglian Archaeology (Gurney 2003, Medlycott 2011)
- Relevant Health & Safety guidelines and requirements (CAT 2014)
- The Project Brief issued by CBCAA (CBC 2017)

Professional CAT field archaeologists will undertake all specified archaeological work, for which they will be suitably experienced and qualified.

Notification of the supervisor/project manager's name and the start date for the project will be provided to CBCAA one week before start of work.

Unless it is the responsibility of other site contractors, CAT will study mains service locations and avoid damage to these.

A project or site code will be sought from the curating museum, as appropriate to the project. This code will be used to identify the finds bags and boxes, and the project archive when it is deposited at the curating museum.

Staffing

The number of field staff for this project is estimated as follows: one supervisor plus three archaeologists for five days.

In charge of day-to-day site work: Ben Holloway

Excavation methodology

All topsoil removal and ground reduction will be carried out by a machine fitted with a toothless bucket under the supervision of an CAT archaeologist.

If archaeological features or deposits are uncovered, these will be excavated by hand, planned and recorded. This includes a 50% sample of discrete features (pits, etc) and 10% of linear features (ditches, etc) in 1m sections where this is possible.

Fast hand-excavation techniques involving (for instance) picks, forks and mattocks will not be used on complex stratigraphy.

A metal detector will be used to examine the site, spoil heaps, and the finds recovered.

Individual records of excavated contexts, layers, features or deposits will be entered on pro-forma record sheets. Registers will be compiled of finds, small finds and soil samples.

All features and layers or other significant deposits will be planned, and their profiles or sections recorded. The normal scale will be site plans at 1:20 and sections at 1:10, unless circumstances indicate that other scales would be appropriate.

Samples will be taken based on the strategy requested by CBCAA (see 'Environmental Sampling Policy' below)

Site surveying

The evaluation trench and any features will be surveyed by Total Station, unless the particulars of the features indicate that manual planning techniques should be employed. Normal scale for archaeological site plans and sections is 1:20 and 1:10 respectively, unless circumstances indicate that other scales would be more appropriate.

The site grid will be tied into the National Grid. Corners of excavation areas will be located by NGR coordinates.

Environmental sampling policy

The number and range of samples collected will be adequate to determine the potential of the site, with particular focus on palaeoenvironmental remains including both biological remains (e.g. plants, small vertebrates) and small sized artefacts (e.g. smithing debris), and to provide information for sampling strategies on any future excavation. Samples will be collected for potential micromorphological and other pedological sedimentological analysis. Environmental bulk samples will be 40 litres in size (assuming context is large enough)

Sampling strategies will address questions of:

- the range of preservation types (charred, mineral-replaced, waterlogged), and their quality
- concentrations of macro-remains
- and differences in remains from undated and dated features
- variation between different feature types and areas of site

CAT has an arrangement with Val Fryer/Lisa Gray whereby any potentially rich environmental layers or features will be appropriately sampled as a matter of course. CAT staff will process samples (unless of a complex nature) and the flots will be sent to VF/LG for reporting.

Should any complex, or otherwise outstanding deposits be encountered, VF/LG will be asked onto site to advise. Waterlogged 'organic' features will always be sampled. In all cases, the advice of VF and/or the Historic England Regional Advisor in Archaeological Science (East of

England) on sampling strategies for complex or waterlogged deposits will be followed, including the taking of monolith samples.

Human remains

CAT follows the policy of leaving human remains *in situ* unless there is a clear indication that the remains are in danger of being compromised. As the requirement for work is for full excavation any human remains encountered on the site will be subject to the following criteria: if it is clear from their position, context, depth, or other factors that the remains are ancient, then normal procedure is to apply to the Ministry of Justice for a licence to remove them. In that case, conditions laid down by the license will be followed. If it seems that the remains are not ancient, then the coroner, the client, and CBCAA will be informed, and any advice and/or instruction from the coroner will be followed.

Photographic record

Will include both general and feature-specific photographs, the latter with scale and north arrow. A photo register giving context number, details, and direction of shot will be prepared on site, and included in site archive.

Finds

All significant finds will be retained.

All finds, where appropriate, will be washed and marked with site code and context number.

Stephen Benfield (CAT) normally writes our finds reports. Some categories of finds are automatically referred to other CAT specialists:

small finds, metalwork, coins, etc: Pip Parmenter

animal bones (small groups): Pip Parmenter

flints: Adam Wightman

or to outside specialists:

animal bones (large groups) and human remains: Julie Curl (*Sylvanus*)

environmental processing and reporting: Val Fryer / Lisa Gray

conservation of finds: staff at Colchester Museum

Other specialists whose opinion can be sought on large or complex groups include:

Roman brick/tile: Ernest Black

Roman glass: Hilary Cool

Prehistoric pottery: Paul Sealey

Other: Historic England Regional Adviser in Archaeological Science (East of England).

All finds of potential treasure will be removed to a safe place, and the coroner informed immediately, in accordance with the rules of the Treasure Act 1996. The definition of treasure is given in pages 3-5 of the Code of Practice of the above act. This refers primarily to gold or silver objects.

Requirements for conservation and storage of finds will be agreed with the appropriate museum prior to the start of work, and confirmed to CBCAA.

Post-excavation assessment

Once fieldwork has finished the need for a post-excavation assessment will be discussed and agreed with CBCAA.

If a post-excavation assessment is required by CBCAA, it will be normally be submitted within 2 months of the end of fieldwork, or as quickly as is reasonably practicable and at a time agreed with CBCAA. It will be a clear and concise assessment of the archaeological value and significance of the results, and will identify the research potential in the context of the

Regional Research Framework. It will include an Updated Project Design, with a timetable, for analysis, dissemination and archive deposition.

Where archaeological results do not warrant a post-excavation assessment, preparation of the normal site report will begin.

Results

Notification will be given to CBCAA when the fieldwork has been completed.

An appropriate archive will be prepared to minimum acceptable standards outlined in *Management of Research Projects in the Historic Environment* (English Heritage 2006).

The report will be submitted within 6 months of the end of fieldwork, with a copy supplied to CBCAA as a PDF.

The report will contain:

- The aims and methods adopted in the course of the archaeological project.
- Location plan of the excavation areas in relation to the proposed development. At least two corners of the areas will be given 10 figure grid references.
- A section drawing showing depth of deposits from present ground level with Ordnance Datum, vertical and horizontal scale (if this can be safely done)
- Archaeological methodology and detailed results including a suitable conclusion and discussion and results referring to Regional Research Frameworks (Medlycott 2011).
- All specialist reports or assessments
- A concise non-technical summary of the project results.

An EHER summary sheet will also be completed within four weeks and supplied to CBCAA.

Results will be published, to at least a summary level (i.e. round-up in *Essex Archaeology & History*) in the year following the archaeological field work. An allowance will be made in the project costs for the report to be published in an adequately peer reviewed journal or monograph series

Archive deposition

It is a policy of Colchester Borough Council that the integrity of the site archive be maintained (i.e. all finds and records should be properly curated by a single organisation), with the archive available for public consultation. To achieve this desired aim it is assumed that the full archive will be deposited in Colchester Museums *unless otherwise agreed in advance*. (A full copy of the archive shall in any case be deposited).

By accepting this WSI, the client agrees to deposit the archive, including all artefacts, at Colchester & Ipswich Museum.

The requirements for archive storage will be agreed with the curating museum.

If the finds are to remain with the landowner, a full copy of the archive will be housed with the curating museum.

The archive will be deposited with Colchester & Ipswich Museum within 3 months of the completion of the final publication report, with a summary of the contents of the archive supplied to CBCAA.

Monitoring

RPS will be responsible for monitoring the works on behalf of Thomas Bates & Son Ltd.

CBCAA will be responsible for monitoring progress and standards throughout the project, and will be kept regularly informed during fieldwork, post-excavation and publication stages.

Notification of the start of work will be given to CBCAA one week in advance of its commencement.

Any variations in this WSI will be agreed with CBCAA prior to them being carried out.

CBCAA will be notified when the fieldwork is complete.

The involvement of CBCAA shall be acknowledged in any report or publication generated by this project.

References

CAT Report 175	2002	<i>An evaluation at Carter's Hill, Boxted Cross, near Colchester, Essex.</i>
CAT Report 796	2014	<i>A desk-based assessment of the archaeological remains around a site at Boxted Cross, Essex</i>
CAT Report 1049	2017	<i>Archaeological evaluation at Hill Farm, Boxted Cross, Boxted, Essex, CO4 5RD: December 2016</i>
CBCAA	2016	<i>Brief for an Archaeological Excavation (strip, map and record) at Land at Hill Farm, Boxted Cross, Boxted, CO4 5RD</i>
CIfA	2014a	<i>Standard and Guidance for an archaeological excavation</i>
CIfA	2014b	<i>Standard and guidance for the creation, compilation, transfer and deposition of archaeological archives</i>
CIfA	2014c	<i>Standard and guidance for the collection, documentation, conservation and research of archaeological materials</i>
Crossan, C	1992	<i>Watching Brief, water mains renewal at Boxted, Essex. Colchester Archaeological Trust Field Report, 19 November 1992</i>
DCLG	2012	<i>National Planning Policy Framework</i>
English Heritage	2006	<i>Management of Research Projects in the Historic Environment (MoRPHE)</i>
Gurney, D	2003	<i>Standards for field archaeology in the East of England. East Anglian Archaeology Occasional Papers 14 (EAA 14).</i>
Medlycott, M	2011	<i>Research and archaeology revisited: A revised framework for the East of England. East Anglian Archaeology Occasional Papers 24 (EAA 24)</i>

L Pooley



Colchester Archaeological Trust
Roman Circus House
Roman Circus Walk
Colchester
Essex
CO2 2GZ

tel: 01206 501785

email: lp@catuk.org

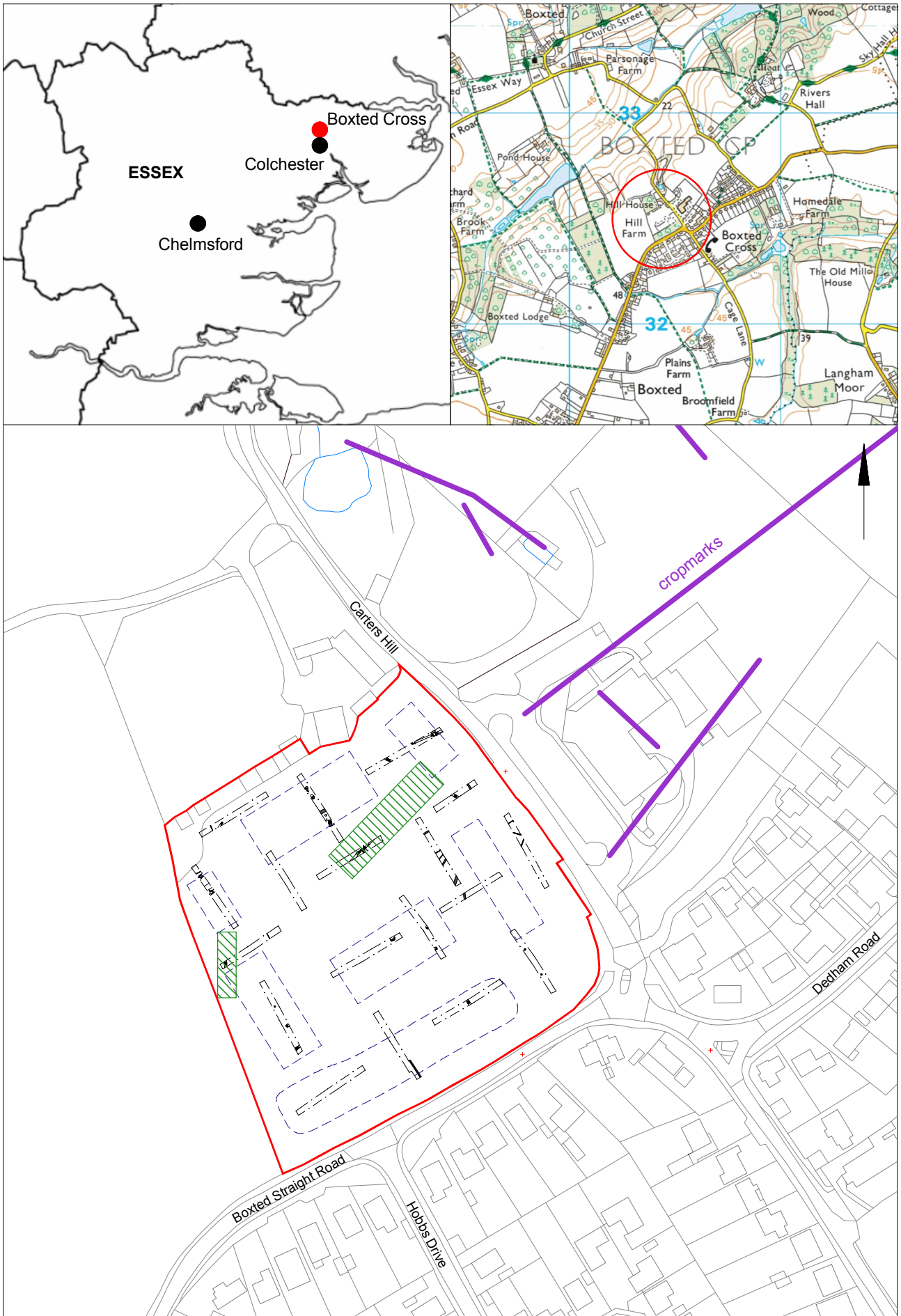

© Crown copyright. All rights reserved. Licence number 100039294.

Fig 1 Site location and proposed excavation areas (green).
Shown in relation to evaluation results, proposed development (dashed blue) and cropmarks (purple)

0 100 m



Fig 2 Proposed excavation areas (green) shown in relation to evaluation results, proposed development (dashed blue) and cropmarks (purple)

OASIS DATA COLLECTION FORM: England

[List of Projects](#) | [Manage Projects](#) | [Search Projects](#) | [New project](#) | [Change your details](#) | [HER coverage](#) | [Change country](#) | [Log out](#)

[Printable version](#)

OASIS ID: colchest3-279603

Project details

Project name	Archaeological excavation at Hill Farm, Boxted Cross, Boxted, Essex, CO4 5RD
Short description of the project	An archaeological excavation was carried out at Hill Farm, Boxted Cross, Essex prior to the construction of residential dwellings. The development site is located close to a number of prehistoric cropmarks and field systems, including the Boxted 'henge'. Evaluation in 2016 revealed possible prehistoric and Roman field boundary ditches, a possible medieval pit, post-medieval (16th-17th century) ditch and brick foundation, a number of undated ditches, pits and postholes, and several modern features. Excavation revealed fifteen archaeologically significant features consisting of ten ditches, three pits and two small pits/postholes. In addition to this were six tree-throws, two modern pits and a modern service. Although dating evidence was rare across the whole site, most of the poorly dated ditches are likely to be Roman field boundaries forming a complex field system most likely associated with a pastoral economy and stock management. One ditch containing 26 sherds of a Dressel 20 amphora can be more confidently dated to the early Roman period. A single possible medieval ditch was also identified.
Project dates	Start: 22-03-2017 End: 30-03-2017
Previous/future work	Yes / Not known
Any associated project reference codes	17/03d - Contracting Unit No.
Any associated project reference codes	ECC3971 - HER event no.
Any associated project reference codes	COLEM: 2016.115 - Museum accession ID
Type of project	Recording project
Site status	None
Current Land use	Vacant Land 1 - Vacant land previously developed
Monument type	DITCH Medieval
Monument type	PITS Uncertain
Monument type	DITCHES Roman
Significant Finds	POTTERY Roman
Significant Finds	POTTERY Medieval
Significant Finds	QUERNSTONE Roman
Investigation type	""Part Excavation""
Prompt	Planning condition

Project location

Country	England
Site location	ESSEX COLCHESTER BOXTED Hill Farm, Boxted Cross
Postcode	CO4 5RD
Study area	1.9 Hectares
Site coordinates	TM 0044 3248 51.954109652837 0.917323312148 51 57 14 N 000 55 02 E Point
Height OD / Depth	Min: 46.69m Max: 47.24m

Project creators

Name of Organisation	Colchester Archaeological Trust
Project brief originator	CBC Archaeological Officer
Project design originator	Laura Pooley
Project director/manager	Chris Lister
Project supervisor	Ben Holloway
Type of sponsor/funding body	Developer

Project archives

Physical Archive Exists?	No
Digital Archive recipient	Colchester Museum
Digital Archive ID	COLEM: 2016.115

Digital Contents "Stratigraphic","Survey"
Digital Media available "Images raster / digital photography","Survey"
Paper Archive recipient Colchester Museum
Paper Archive ID COLEM: 2016.115
Paper Contents "Stratigraphic","Survey"
Paper Media available "Context sheet","Miscellaneous Material","Photograph","Plan","Report","Section"

**Project
bibliography 1**

Publication type Grey literature (unpublished document/manuscript)
Title Archaeological excavation at Hill Farm, Boxted Cross, Boxted, Essex, CO4 5RD: March 2017
Author(s)/Editor(s) Pooley, L.
Other bibliographic details CAT Report 1085
Date 2017
Issuer or publisher Colchester Archaeological Trust
Place of issue or publication Colchester
Description A4 ringbound loose leaf
URL <http://cat.essex.ac.uk/all-reports.html>

Entered by Laura Pooley (lp@catuk.org)
Entered on 8 June 2017

OASIS: Please e-mail [Historic England](#) for OASIS help and advice
© ADS 1996-2012 Created by [Jo Gilham](#) and [Jen Mitcham](#), email Last modified Wednesday 9 May 2012
Cite only: <http://www.oasis.ac.uk/form/print.cfm?id=287044> for this page