

---

# KODAK EASYSHARE Camera / M23



## Extended user guide

[www.kodak.com](http://www.kodak.com)

For help with your camera:

[www.kodak.com/go/m23support](http://www.kodak.com/go/m23support)

---

# Kodak

Eastman Kodak Company  
Rochester, New York 14650

© Eastman Kodak Company, 2011

All screen images are simulated.

Kodak, EasyShare, Perfect Touch, and Pulse are trademarks of Eastman Kodak Company.

4H8707\_en

## Quick start

- ① Load the battery.



- ② Charge until the light stops blinking.

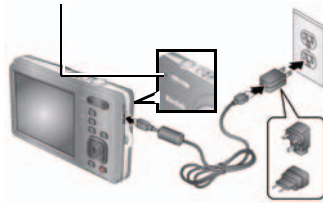

- ③ Set language, dateltime.



- ④ Take pictures, videos.



- ⑤ Install software, then share.



Keep learning!  
Take and share your best  
pictures, videos!



## Front view

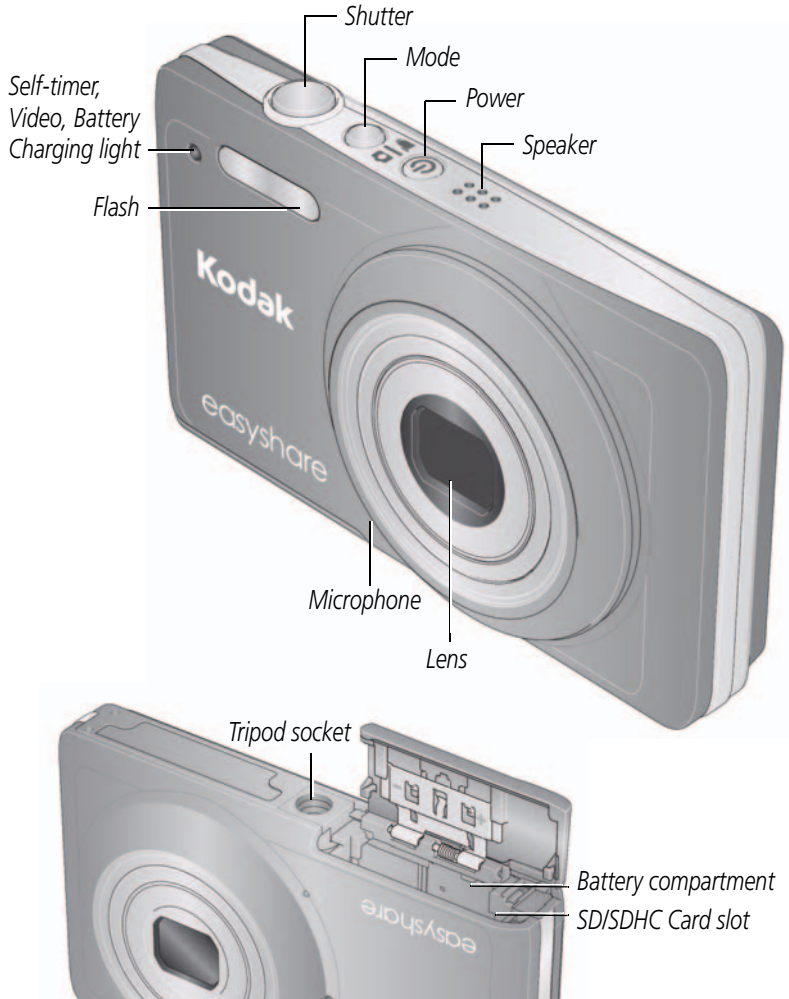

## Back view

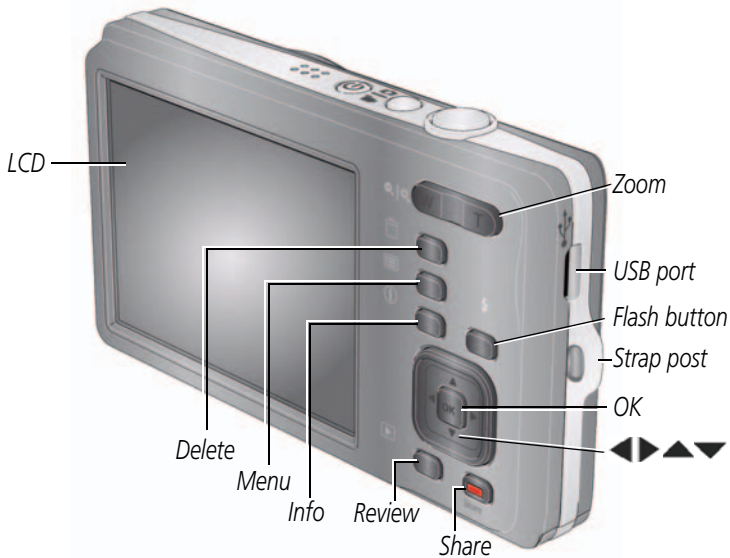

---

# Table of contents

<b>1</b>	<b>Setting up your camera</b>	<b>1</b>
	Attaching the strap	1
	Loading the KLIC-7006 battery	1
	Charging the battery	2
	Turning on the camera	5
	Setting the language and date/time	5
	Storing pictures on an accessory SD or SDHC Card	6
<b>2</b>	<b>Taking pictures/videos</b>	<b>7</b>
	Taking pictures	7
	Taking a video	8
	Understanding the picture-taking icons	9
	Watch the battery level	9
	Using the optical zoom	10
	Adjusting LCD brightness	10
	Using the flash	11
	Using different modes	12
	Using Program mode	14
	Using shortcuts	15
	Using the self-timer	16
	Using burst	16
	Taking panoramic pictures	17
<b>3</b>	<b>Sharing and tagging pictures</b>	<b>18</b>
	Sharing pictures/videos through social networks	18
	Tagging pictures	20
	Marking pictures/videos for emailing	22
<b>4</b>	<b>Reviewing and editing</b>	<b>23</b>
	Reviewing pictures/videos	23
	Deleting pictures/videos	24
	Viewing pictures/videos in different ways	25

---

A smarter way to find and enjoy your pictures.....	26
Understanding the review icons.....	27
Displaying pictures/videos on a television.....	28
Using the menu button in review.....	29
Cropping pictures.....	29
Rotating pictures.....	30
Using KODAK PERFECT TOUCH Technology.....	30
Editing videos.....	31
Selecting multiple pictures/videos.....	32
<b>5 Doing more with your camera.....</b>	<b>33</b>
Using the menu button in picture-taking modes.....	33
Using the Setup menu.....	36
<b>6 Install software, then share.....</b>	<b>39</b>
Install software, transfer pictures.....	39
Printing pictures.....	40
Marking your pictures for print.....	41
<b>7 Troubleshooting.....</b>	<b>42</b>
Getting help on the Web.....	45
<b>8 Appendix.....</b>	<b>46</b>
Specifications.....	46
Care and maintenance.....	48
Upgrading your software and firmware.....	48
Storage capacities.....	49
Important safety instructions.....	49
Battery replacement, battery life.....	50
Limited warranty.....	51
Regulatory compliance.....	52

# 1

## Setting up your camera

### Attaching the strap



### Loading the KLIC-7006 battery

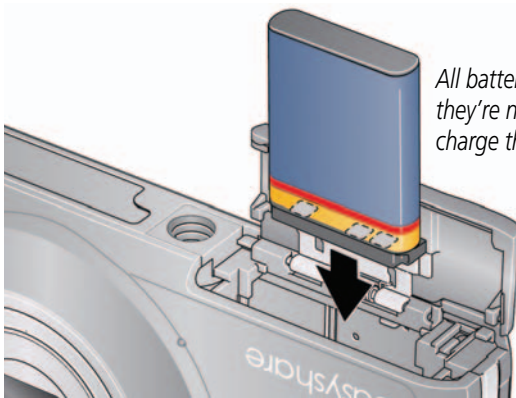

*All batteries lose power over time—even if they're not being used. For longer life, fully charge the battery prior to use.*

---

**Purchase extra batteries** [www.kodak.com/go/accessories](http://www.kodak.com/go/accessories)

---

**Charge the battery** [See page 2](#)

---

**Watch the battery level** [See page 9](#)

---



## Charging the battery

If your package included	Then see
An in-camera battery charger	<a href="#">Using the in-camera battery charger</a>
An external battery charger	<a href="#">Using the external battery charger</a>

### Using the in-camera battery charger

You can charge the Li-Ion battery whenever necessary.

Battery Charging light:

- *Blinking:* charging
- *Steady On:* finished charging

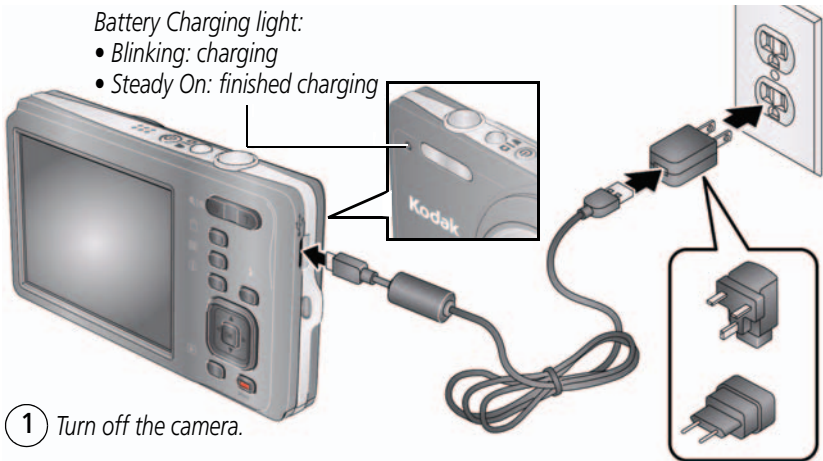

- 1 Turn off the camera.
- 2 Connect the KODAK Camera USB Cable, Micro B / 5-Pin and charger. (Use only the cable included with this camera.)

Your adapter may differ.

*NOTE:* You can use the camera while it's plugged in.

<b>Purchase extra batteries</b>	<a href="http://www.kodak.com/go/accessories">www.kodak.com/go/accessories</a>
<b>Watch the battery level</b>	<a href="#">See page 9</a>

## Using the external battery charger

You can charge the Li-Ion battery whenever necessary.

*If you have this charger...*

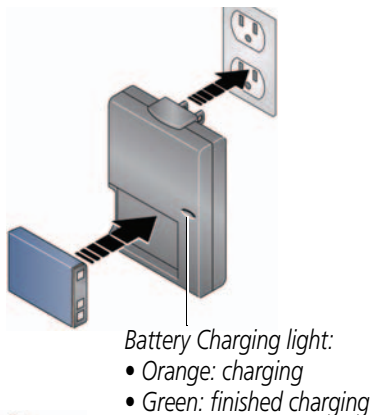
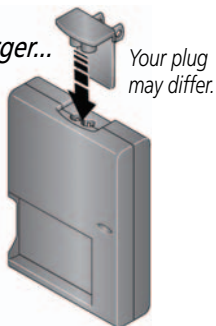

*If you have this charger...*

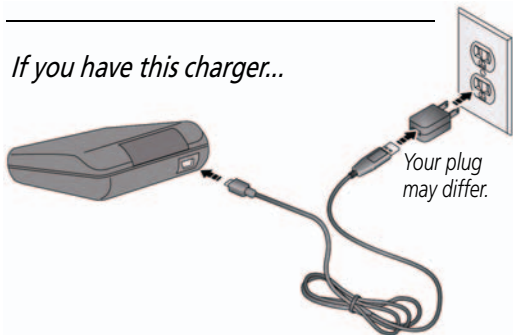

Battery Charging light:  
• Flashing green: charging  
• Steady On green: finished charging



**Purchase extra batteries** [www.kodak.com/go/accessories](http://www.kodak.com/go/accessories)

**Watch the battery level** [See page 9](#)

## Charge via your computer's USB port

You can charge the Li-Ion battery whenever necessary.

**IMPORTANT:** *The camera charges when the computer is on and awake. Turn off the computer's hibernation, sleep, and standby modes.*

- 1 Turn off the camera.
- 2 Connect the KODAK Camera USB Cable, Micro B / 5-Pin and charger. Use only the cable included with this camera.

Battery Charging light:

- *Blinking:* charging
- *Steady:* finished charging

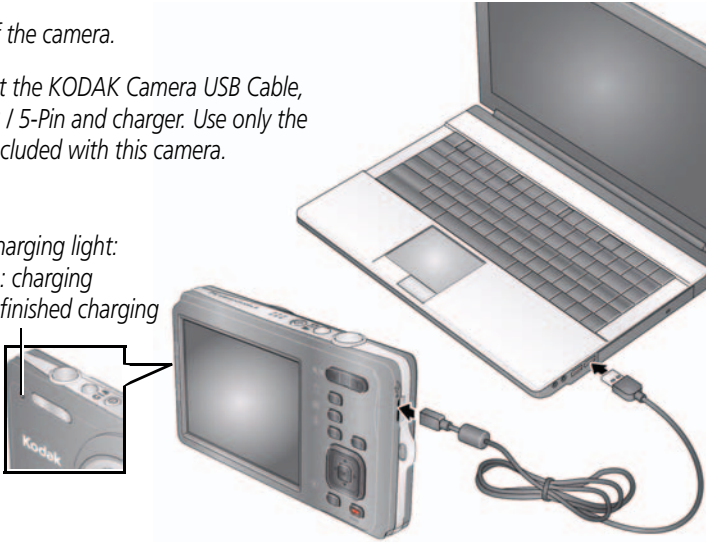

---

**Purchase extra batteries** [www.kodak.com/go/accessories](http://www.kodak.com/go/accessories)

---

**Watch the battery level** [See page 9](#)

---

## Turning on the camera



## Setting the language and date/time



### *Language:*

▲▼ to change.

OK to accept.

### *Date/Time:*

At the prompt, press OK.

▲▼ to change current field.

◀▶ for previous/next field.

OK to accept.

NOTE: To change language in the future, use the Setup Menu (see page 36).

## Storing pictures on an accessory SD or SDHC Card

Your camera has internal memory. **We strongly recommend purchasing an SD or SDHC Card to conveniently store more pictures/videos.**



### CAUTION:

**A card can only be inserted one way; forcing it may cause damage. Inserting or removing a card while the camera is on may damage the pictures, the card, or the camera.**

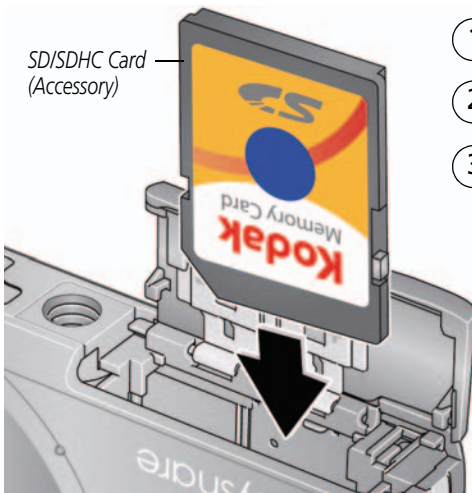

- 1 Turn off the camera.
- 2 Insert the card until it clicks.
- 3 Turn on the camera.

To eject the card, push and release it.

**IMPORTANT:** When you turn on the camera, it checks to see if a card is inserted. If so, new pictures/videos are stored on the card. If no card is inserted, new pictures/videos are stored in the camera's internal memory. If pictures/videos are detected in internal memory and a card is inserted, the camera prompts you to move the pictures to the card (and erase those in internal memory).



**Purchase cards** [www.kodak.com/go/accessories](http://www.kodak.com/go/accessories)

# 2

## Taking pictures/videos

### Taking pictures



1 The camera turns on in Smart Capture mode. (If it's in a different mode, press the Mode button, then  until the LCD displays Smart Capture mode , then press OK.)

2 Compose the picture. Press the Shutter button **halfway** to focus and set exposure.

*If the framing marks are not focused on the desired subject, release the Shutter button and recompose the scene.*

3 Press the Shutter button **completely down**.

Framing marks



## Taking a video



- 1 Press the Mode button.
- 2 Press ▲▼ until the LCD displays Video , then press OK.
- 3 To take a video, press the Shutter button **completely down**, then release it.

*To stop recording, press and release the Shutter button again. To review and work with videos, see [page 23](#).*

## Reviewing the picture/video just taken

After you take a picture/video, the LCD briefly displays a quickview—the picture just taken or the first frame of a video.



*While a picture/video is displayed, you may:*

*Delete the current picture/video*

*OK Play/pause a video*

*▲▼ Adjust the volume*

To dismiss a quickview, press the Shutter button halfway.  
To review pictures/videos anytime, see [page 23](#).

## Understanding the picture-taking icons

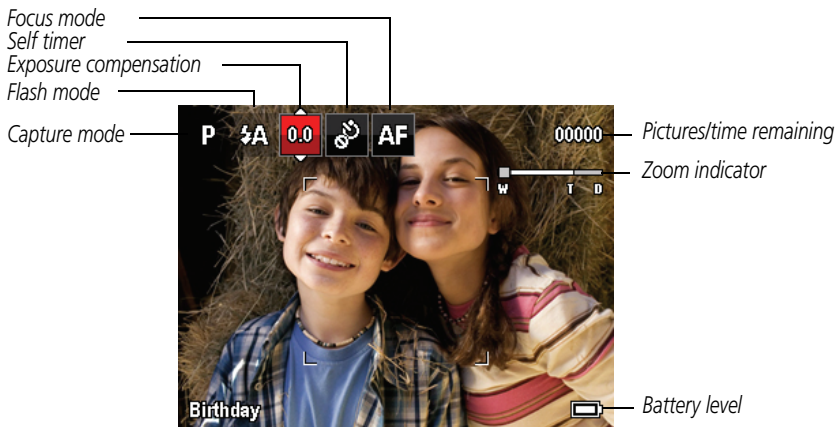

## Watch the battery level

Don't miss out on great pictures and videos—keep your battery fully charged.

Full	
Three quarters	
Half	
Critical	
AC Power	

**Charge the battery** [see page 2](#)

**Purchase extra batteries** [www.kodak.com/go/accessories](http://www.kodak.com/go/accessories)



## Using the optical zoom



- 1 Use the LCD to frame your subject.
- 2 To zoom in, press Telephoto (T).  
To zoom out, press Wide Angle (W).
- 3 Take the picture or video.

NOTE: For focus distances, see Specifications starting on [page 46](#).

## Using digital zoom

Use digital zoom to get up to 5X magnification beyond optical zoom. (Digital zoom is not available in Smart Capture mode.) Press Telephoto (T) until the slider on the LCD is at the end of the optical zoom range. Release Telephoto (T), then press it again.

NOTE: You may notice decreased image quality when using digital zoom.





## Adjusting LCD brightness

You can adjust the LCD brightness for your environment or to conserve battery power, see [page 37](#).

## Using the flash

Press the Flash button repeatedly until the LCD displays the desired flash mode.





Flash modes		Flash fires
Auto		When the lighting conditions require it.
Fill (Flash On)		Every time you take a picture, regardless of the lighting conditions. Use when the subject is in shadow or is "backlit" (when the light is behind the subject).
Off		Never
Red-eye Reduction		A preflash fires, shrinking the eye pupil, before the picture is taken.

## Using different modes

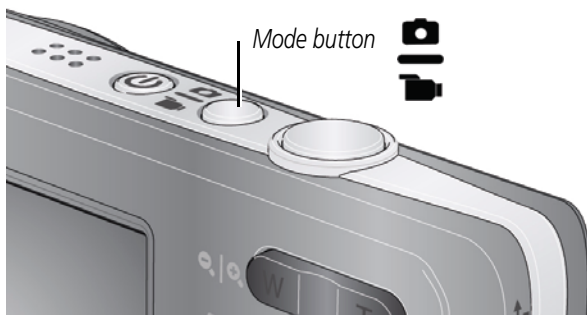
Press the Mode button, then ▲▼ until the LCD displays the mode that best suits your subjects and surroundings, then press OK.



Use this mode	For
 <b>Smart Capture</b>	General picture taking—it offers excellent image quality and ease of use. <ul style="list-style-type: none"> <li>■ Faces get focus and exposure priority.</li> <li>■ The scene is analyzed for other content and for lighting.</li> </ul> You can choose the best picture size and aspect ratio for your needs—just press the Menu  button and choose Picture Size.
<b>SCN</b> Scene	Point-and-shoot simplicity when taking pictures in practically any situation. (See <a href="#">page 13.</a> )
<b>P</b> Program	Advanced picture-taking—gives access to more manual settings than Smart Capture. (See <a href="#">page 14.</a> )
 <b>Video</b>	Capturing video with sound. (See <a href="#">page 8.</a> )

## Using Scene (SCN) modes

Choose a Scene mode—for great pictures in practically any situation.

- 1 Press the Mode button, then ▲▼ until the LCD displays SCN, then press OK.
- 2 Press ◀▶ ▲▼ to choose a mode and read its description.
- 3 Press OK to enter that Scene mode.

*The camera is now in the scene mode that you chose.*

SCN mode	For
<b>Portrait</b>	Full-frame portraits of people.
<b>Sport</b>	Action pictures.
<b>Landscape</b>	Distant scenes.
<b>Close-up</b>	Close range. Use available light instead of flash, if possible.
<b>Sunset</b>	Subjects at dusk or dawn.
<b>Backlight</b>	Subjects that are in shadow or “backlit.”
<b>Candle Light</b>	Subjects illuminated by candle light.
<b>Children</b>	Action pictures of children in bright light.
<b>Bright</b>	Bright scenes.
<b>Fireworks</b>	Fireworks. For best results, place the camera on a steady surface or tripod.
<b>Self Portrait</b>	Close-ups of yourself. Assures proper focus and minimizes red eye.
<b>Night Portrait</b>	Reduces red eye of people in night scenes or low-light conditions.
<b>Night Landscape</b>	Distant scenery at night. Flash does not fire.
<b>High ISO</b>	People indoors, in low-light scenes.
<b>Panorama L-R, R-L</b>	“Stitching” 2 or 3 pictures into 1 panoramic scene. (See <a href="#">page 17.</a> )

---

**SCN mode For**

---

**Blur Reduction** Reducing blur caused by camera shake or subject motion.
 

---

## Using Program mode

Program mode gives access to these settings:

Setting	Description
<b>Exposure Compensation</b>	Adjust the exposure. If a scene is too light, decrease the setting; if it's dark, increase the setting.
<b>Self-timer/Burst</b>	Include yourself in a picture (page 16). Burst takes a series of pictures in rapid succession.
<b>Focus Mode</b>	Choose Auto, Macro (for close-ups), or Infinity.

- 1 Press the Mode button **MODE**.
- 2 Press ▲▼ to choose P (Program) mode, then press OK.
- 3 Press ◀▶ to choose a setting.
- 4 Press ▲▼ to change a setting, then press OK to save it.

*Program mode settings*



## Using shortcuts

Your camera has a clean, uncluttered interface. For quick access to the most popular capture and review functions:

- 1 Press the Info **i** button.







*The shortcuts appear. To hide the shortcuts again, press **i**.*

- 2 Press **◀▶** to access functions like Exposure Compensation, Self-timer, and Auto focus in Capture mode. In Review mode, access People Tags and Keyword Tags. (You'll see different functions in different modes.)
- 3 Press **▲▼** to choose a setting.



## Using the self-timer





Use the self-timer when you want to be included in a picture, or to ensure a steady Shutter button press. For best results, place the camera on a tripod or steady surface. You can turn on the self-timer using a shortcut (see page 15) or these steps:

- 1 Press the Menu  button.
- 2 Press  to choose Self-timer/Burst, then press OK.
- 3 Press  to choose a Self-timer setting:
  - 2 Seconds**—  A picture is taken after a 2-second delay.
  - 10 Seconds**—  A picture is taken after a 10-second delay.
  - 2 Picture Timer**—  The first picture is taken after a 10-second delay. A second picture is taken 8 seconds later.
- 4 Compose the scene. Press the Shutter button **halfway**, then **completely down**.  
*The camera takes the picture/pictures after the delay.*

To take a video after a 2- or 10-second delay, use the same procedure but press the Shutter button **completely down** while in video mode.

## Using burst

Use the burst feature to take up to 3 pictures in rapid succession. You can turn on burst using a shortcut (see page 15) or these steps:

- 1 Press the Menu  button.
- 2 Press  to choose Self-timer/Burst, then press  to choose Burst On.
- 3 Press the Menu  button to exit the menu.
- 4 Compose the scene. Press the Shutter button **halfway**, then **completely down and hold it**.

*The camera stops taking pictures when you release the Shutter button, when pictures are taken, or when there is no more storage space. Burst is unavailable in some modes.*

## Taking panoramic pictures

Use panorama to “stitch” up to 3 pictures into a panoramic scene.

NOTE: Only the panoramic picture is saved; individual pictures are not. (Exposure and white balance are set with the first picture. The flash is set to Off.)

- 1 Press the Mode button, then ▲▼ until the LCD displays SCN, then press OK.
- 2 Press ◀▶▲▼ to choose Panorama Left-Right or Panorama Right-Left (depending on the direction you want to pan), then press OK.
- 3 Take the first picture.

*After a quickview, the LCD displays the liveview and an “overlay” from the first picture. (You can press the Delete button to start over.)*

- 4 Compose the second picture. Make the overlay from the first picture cover the same portion in the new picture.

- 5 If you are taking/stitching only 2 pictures, press OK to stitch them together.

*After you take 3 pictures, the pictures are automatically stitched together.*

*Take  
2 or 3  
pictures.*



*Get 1  
panoramic  
picture.*



NOTE: To use the self-timer 10-second or 2-second setting, see [page 16](#).



# 3

## Sharing and tagging pictures

### Sharing pictures/videos through social networks

It's never been easier to share pictures on your favorite social networking sites.

**IMPORTANT:** *To use the sharing and social networking features, you must install KODAK Software. (See page 39.)*

- 1 Press the Share button, then ◀▶ to find a picture.

*If it's your first time, a Help screen appears.*

- 2 Press ▲▼ to choose a social networking site, then press OK.

*A check mark appears. Repeat this step to choose more sites. (You can press OK again to remove a check mark.)*

- 3 Press ▲▼ to choose Done, then press OK.

*The picture is displayed with the Share icon. When you transfer the picture to your computer, it will be uploaded to the networking site(s) that you chose.*











#### **Tip: Do you send pictures to the same sites each time?**

Find a picture, then press and hold the Share button for about 1 second.

*The camera applies the settings that you used previously and adds the Share icon to the picture.*

## Choose which social networking sites to display on your camera





You can show/hide social networking sites on your camera so that only your favorite sites appear.



- 1 Press the Menu  button.
- 2 Press   to choose the Setup tab, then   to choose Share Button Settings, then press OK.
- 3 Press   to choose a social networking site, then press   to choose Show or Hide. Repeat this step until you have chosen Show/Hide for each social network.
- 4 When finished, press   to choose Done, then press OK.





*To return to picture-taking mode, press the Shutter button halfway down. When you are in Review and press the Share button, only chosen sites are shown.*

## Manage email addresses and KODAK PULSE Digital Frames

You can add, edit, or delete email addresses and KODAK PULSE Digital Frames on your camera.

- 1 Press the Share button. Press   to choose Manage Email Addresses (or Manage Frames), then press OK.
- 2 To add an email address or frame, press   to choose Add Email or Add Frame, then press OK. Use the on-screen keyboard to make the addition. (Example: JohnDoe@domain.com) Add a familiar, unique nickname.

To edit an email address or a KODAK PULSE Digital Frame, press   to choose the address's nickname or the frame, then press OK. Use the on-screen keyboard to make edits.

To delete an email address or frame, choose Delete Email or Delete Frame, then press OK. Press   to choose the address or frames, then press OK so that a check mark appears. Press   to choose Delete, then press OK.

- 3 When finished, press   to choose Done, then press OK.

*To return to picture-taking mode, press the Shutter button halfway down.*











## Tagging pictures



Tag pictures to make them easy to find, later. You can tag pictures in 2 ways:

- **People**, and then find all pictures of “Mary.”
- **Keywords**, and then find all pictures from “Dad’s 60th Birthday.”

## Tagging people



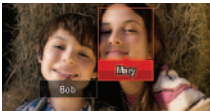

When you tag faces, your camera “learns” to recognize people by name. Then it matches names and faces in pictures you’ve taken *and* those you take in the future.

- 1 Press the Review  button, then   to find a picture that contains faces.
- 2 Press the Menu  button. Press   to choose Tag People, then press OK. You can also access Tag People using a shortcut (see page 15).
- 3 Press   to choose Apply Tags, then press OK.
- 4 Press   to choose an existing name, or New Name to add a new one (see [Using the keyboard, page 21](#)), then press OK.

*If more than one face is detected, a name or question mark is assigned to each detected face. To resolve an incorrect name or a question mark, press   to select a face, then press OK.*



- 5 If prompted to Update People Tags, press   to choose Yes, then press OK.

*Other pictures are scanned and updated with the name(s) you applied here. Press   to add names to other pictures. When finished, press   to choose Done, then press OK. To return to picture-taking mode, press the Shutter button halfway down.*

### Tip: Are faces not always detected?



If a face is turned sideways, is too distant, or if the contrast between face and background is insufficient, then the camera might not detect the face.

## Need to update a name?

If you meet a new friend—James—but you already have pictures tagged with your old friend, James, you can:

- Tag the new James with “James Smith” and/or
- Update the old James to “James Monroe”

Here’s how:

- 1 Press the Review  button.
- 2 Press the Menu  button. Press ▲▼ to choose Tag People, then press OK.
- 3 Press ▲▼ to choose Modify Names List, then press OK.
- 4 Press ▲▼ to choose the name you want to modify, then press OK.
- 5 Edit the name, press ▲▼ to choose OK, then press OK.

*To return to picture-taking mode, press the Shutter button halfway down.*













**Tip:** You can have up to 20 active names.

## Using the keyboard

The keyboard appears when you need to enter text.

- 1 Press ◀▶▲▼ to choose a letter, then press OK.
- 2 When finished, press ▲▼ to choose OK, then press OK.







## Tagging with keywords



- 1 Press the Review  button, then   to find a picture to tag.
- 2 Press the Menu  button. Press   to choose Keyword Tag, then press OK. You can also access Keyword Tag using a shortcut (see [page 15](#)).
- 3 Press   to choose an existing keyword, or New Keyword (see [Using the keyboard, page 21](#)) to add a new one, then press OK.
- 4 Press   to add keywords to other pictures. When finished, press   to choose Done, then press OK.

*To return to picture-taking mode, press the Shutter button halfway down.*

## Marking pictures/videos for emailing

It's simple to mark pictures so that they're ready to email when you transfer them to your computer and use KODAK Software. First, create a new email address. (See [Using the keyboard](#).)

- 1 Press the Share button. Press   to find a picture.
- 2 Press   to choose Email, then press OK.
- 3 Press   to find an email address, then press OK.

To mark other pictures/videos with the same address, press  , then press OK.

To send the pictures/videos to more than one address, repeat step 4.

*To return to picture-taking mode, press the Shutter button halfway down.*

When you transfer the marked pictures/videos to your computer, the software prompts you to send the pictures/videos.

# 4

## Reviewing and editing

### Reviewing pictures/videos







Review

- 1 Press the Review  button.
- 2 Press   for previous/next picture/video.
  - To exit, press the Review button or press the Shutter button halfway down.
  - To view pictures/videos as thumbnails, press the Wide Angle (W) button. (For more information, see [page 25](#).)
  - For tips on finding your pictures/videos, see [page 26](#).

### Playing a video



Press OK to play a video. Press OK to pause/resume. During playback:



- Press   to adjust the volume.
- Press  to play at 2X speed; press again for 4X.
- Press  to reverse at 2X speed; press again for 4X.

*Playback speed*

4X 2X 1X 2X 4X



## Deleting pictures/videos





- 1 Press the Review  button.
- 2 Press  for previous/next picture/video.
- 3 Press the Delete button.
- 4 Follow the screen prompts.



NOTE: To delete protected pictures/videos, remove protection before deleting. (See [Protecting pictures/videos from deletion](#).)

## Using the undo delete picture feature

If you accidentally delete a picture, you may be able to use Undo Delete to retrieve it. This feature is only available immediately after you delete a picture.

## Protecting pictures/videos from deletion

- 1 Press the Review  button.
- 2 Press the Menu  button.
- 3 Press  to choose Protect, then press OK.
- 4 Press  to choose Protect again, then press OK.

*A padlock indicates that the picture/video is protected. Clicking OK again removes the padlock. Press  to protect other pictures/videos, or press  to choose Done, then press OK.*

- Press the Menu  button to exit the menu.



### CAUTION:

**Formatting internal memory or an SD or SDHC Card deletes all (including protected) pictures/videos. (Formatting internal memory also deletes email addresses and keyword tags.)**

## Viewing pictures/videos in different ways

### Magnifying a picture



- 1 Press Telephoto (T) to magnify 2X–8X.
- 2 Press ◀▶ ▲▼ to view other parts of a picture.
  - Press OK to return to 1X.

### Viewing pictures/videos as thumbnails (multi-up)

- 1 Press the Review  button.

*The camera shows the last picture/video that was taken.*

- 2 Press the Wide Angle (W) button to view pictures/videos as thumbnails. (Press it again to see more, smaller thumbnails.)

*To view all pictures/videos, choose the All tab.*

*To sort pictures/videos by date, people, favorites, or keywords, press ◀▶ ▲▼ and choose the appropriate tab.*









- 3 To see a single picture/video, press ◀▶ ▲▼ to choose it. Then press the Telephoto (T) button.
  - To select multiple pictures/videos, see [page 32](#).
  - Press the Review button to exit Review.



## A smarter way to find and enjoy your pictures

Tag pictures—by people or keywords—to make them easy to find, later. For example, the camera can find all pictures that contain “Mary” or “Dad’s 60th Birthday.” (See [Tagging people, page 20](#) or [Tagging with keywords, page 22.](#))

You can also find pictures by date taken or if it’s marked as a favorite.

- 1 Press the Review  button.
- 2 Press the Wide Angle (W) button to view pictures by thumbnail (or choose View Thumbnails shortcut).
- 3 Press     to choose a tab and sort pictures/videos by All, Date, People, Favorite, or Keyword.
- 4 Press     to choose a picture or picture stack.

*Press Telephoto (T) see pictures in a stack or to see an individual picture. Press Wide Angle (W) to see thumbnails or picture stacks.*

To return to picture-taking mode, press the Shutter button halfway down.



**Tip:** For best results, make sure the camera’s date/time is current (see [page 36](#)).

## Understanding the review icons

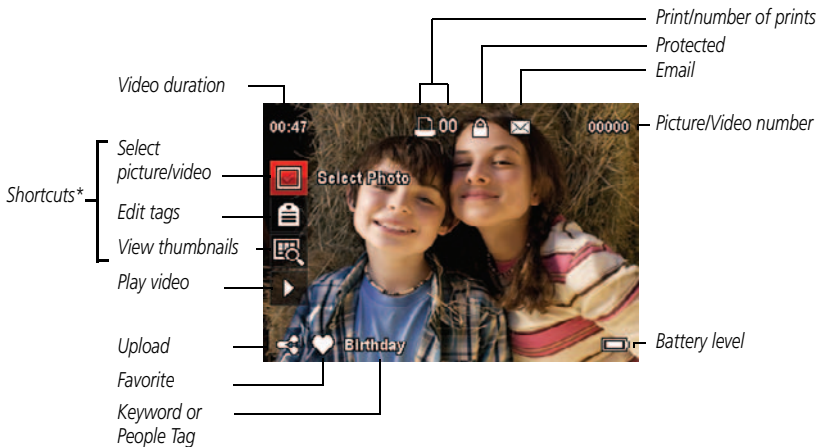

\* For more about shortcuts, see [page 15](#).

## Know when your battery needs charging

The battery level icon appears when the battery requires your attention. Charge the battery whenever necessary.

<b>Purchase extra batteries</b>	<a href="http://www.kodak.com/go/accessories">www.kodak.com/go/accessories</a>
<b>Charge the battery</b>	<a href="#">See page 2</a>
<b>Watch the battery level</b>	<a href="#">See page 9</a>

## Displaying pictures/videos on a television

You can display pictures/videos on a television, computer monitor, or any device equipped with a video input. To connect the camera directly to a television, use an A/V cable (may be sold separately).

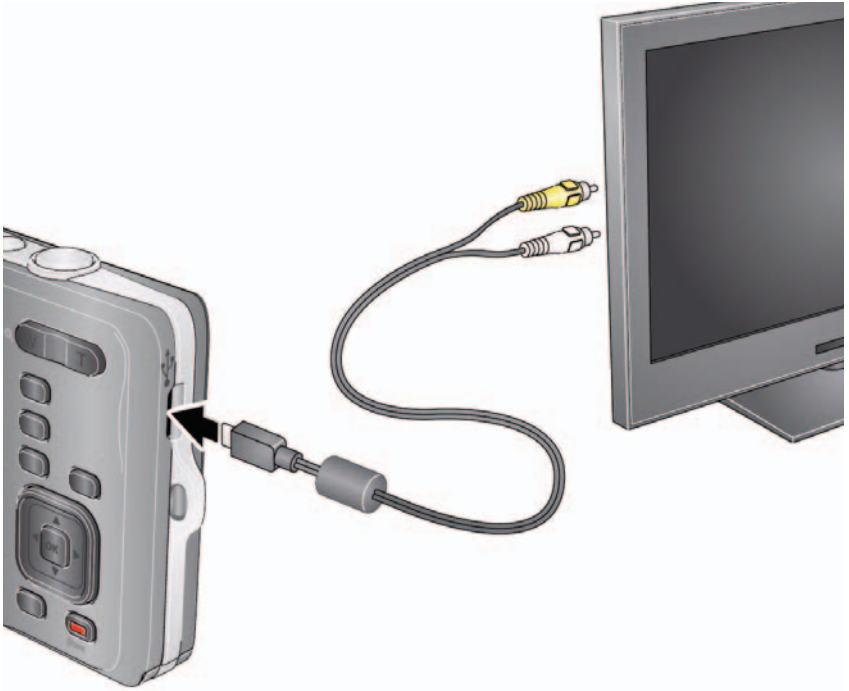







---

**Purchase accessories** [www.kodak.com/go/accessories](http://www.kodak.com/go/accessories)

---

NOTE: Ensure that the camera Video Out setting (NTSC or PAL) is correct (see page 37). Image quality on a television screen may not be as good as on a computer monitor or when printed.









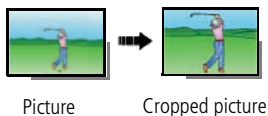

## Using the menu button in review

- 1 Press the Review  button, then the Menu  button.
- 2 Press   to choose a tab:
  - **Review**
  - **Edit**
  - **Setup**
- 3 Press   to choose a setting, then press OK.
- 4 Choose an option, then press OK.

## Cropping pictures

You can crop a picture so that only the desired portion of the picture remains.







- 1 Press the Review  button, then   to find a picture to crop.
  - 2 Press the Menu  button, then   to choose the Edit tab. Choose Crop, then press OK.
  - 3 Press Telephoto (T) to shrink the crop area or Wide (W) to stretch it. Press     to move the crop box. When satisfied with the crop box, press OK.
  - 4 Follow the screen prompts.

*The picture is cropped. (The original is saved.) Cropped pictures cannot be cropped again on the camera.*
- To return to picture-taking mode, press the Shutter button halfway down.





## Rotating pictures

You can rotate a picture to portrait or landscape orientation.

- 1 Press the Review  button, then  to find the previous/next picture.
- 2 Press the Menu  button. Press  to highlight the Edit tab.
- 3 Press  to highlight Rotate Picture, then press OK.
- 4 Press to highlight an option:
  - Rotate Right—rotates the picture 90 degrees clockwise.
  - Rotate Left—rotates the picture 90 degrees counterclockwise.
- 5 Press OK.
  - Press the Shutter button halfway down to return to Capture mode.

## Using KODAK PERFECT TOUCH Technology

KODAK PERFECT TOUCH Technology helps ensure better, brighter pictures.

- 1 Press the Review  button, then  for previous/next picture.
- 2 Press the Menu  button, then  to highlight the Edit tab. Highlight PERFECT TOUCH Tech, then press OK.

*The enhancement is previewed. Press  to view other parts of the picture.*
- 3 Press OK. Follow the screen prompts to replace the original picture or to save the enhanced picture as a new one.
  - Press the Shutter button halfway down to return to Capture mode.







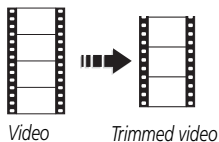

NOTE: You cannot apply PERFECT TOUCH Technology to videos or to pictures to which PERFECT TOUCH Technology is already applied.

## Editing videos

### Trimming a video

You can remove the start or end from a video, saving only the desired portion.



- 1 Press the Review  button, then   to find a video.
- 2 Press the Menu  button, then   to choose the Edit tab. Choose Trim, then press OK.
- 3 Press  to choose the Play icon, then press OK. When the desired first frame is displayed, press OK to pause the video. Press  to choose the Trim icon, then press OK. Repeat this step to choose the last frame.





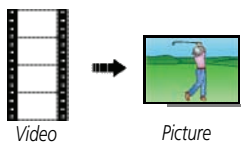

*The video is trimmed. (You can save it as a new video or replace the original.)*

- To return to picture-taking mode, press the Shutter button halfway down.

### Making a picture from a video

You can choose a single frame from a video, then make a picture suitable for a 4 x 6-inch (10 x 15 cm) print.





- 1 Press the Review  button, then   to find a video.
- 2 Press the Menu  button, then   to choose the Edit tab.
- 3 Choose Make Picture, then press OK.
- 4 Follow the screen prompts to choose a video frame and create a picture.

- To return to picture-taking mode, press the Shutter button halfway down.

## Making a video action print

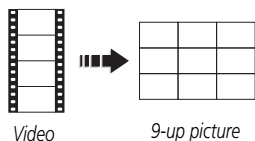
From a video, you can make a 9-up picture, suitable for a 4 x 6-inch (10 x 15 cm) print.





- 1 Press the Review button, then ▲▼◀▶ to find a video.
- 2 Press the Menu  button, then ◀▶ to choose the Edit tab.
- 3 Choose Video Action Print, then press OK.  
*A 9-up picture is created.*

■ To return to picture-taking mode, press the Shutter button halfway down.

## Selecting multiple pictures/videos

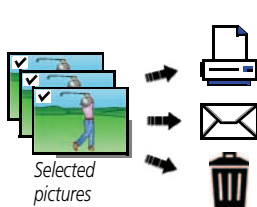
Use the multi-select feature when you have two or more pictures to print, share, delete, protect/unprotect, tag with keyword, etc. Multi-select is used most effectively in Multi-Up mode (see page 25).



- 1 Press the Review  button, then ◀▶ (and ▲▼ if you're in multi-up mode) to find a picture/video.
- 2 Press OK to select pictures/videos.  
*A check mark appears on the picture. (Press OK again to remove a check mark.) You can now print, transfer, delete, etc. the selected pictures.*





# 5

## Doing more with your camera

### Using the menu button in picture-taking modes

You can change settings to get the best results from your camera.

NOTE: Some modes offer limited settings. Some settings remain until you change them; others, until you change modes or turn off the camera. For menu settings in Review, [see page 29](#).

- 1 Press the Menu  button.
- 2 Press   to choose a tab:
  - **Capture/Video** for the most common picture- and video-taking settings
  - **Setup** for other camera settings
- 3 Press   to choose a setting, then press OK.
- 4 Choose an option, then press OK.

**Using the capture tab** (available when the camera is in a capture mode)

 Settings	More information
<b>Picture Size</b> Choose a picture resolution.	See Specifications, starting on <a href="#">page 46</a> .
<b>Self-timer/Burst</b> Choose Self-timer or Burst feature.	<b>Off</b> <b>2 Seconds</b> <b>10 Seconds</b> <b>2 Picture Timer</b> <b>Burst On</b> —Press the Shutter button <b>halfway</b> to focus and set exposure. Press the Shutter button <b>completely down and hold it</b> to take up to 3 pictures.







 <b>Settings</b>	<b>More information</b>
<p><b>Exposure Compensation</b> Make a picture lighter or darker. (Available in Program and Panorama modes.) To access this feature with a shortcut, see <a href="#">page 15</a>.</p>	<p>See Specifications, starting on <a href="#">page 46</a>.</p>
<p><b>ISO Speed</b> Control the sensitivity of the camera to light.</p>	<p>See Specifications, starting on <a href="#">page 46</a>.</p>
<p><b>Long Time Exposure</b> Choose how long the shutter stays open (normally in low-light conditions). For best results, place the camera on a tripod or steady surface.</p>	<p>See Specifications, starting on <a href="#">page 46</a>.</p>
<p><b>Color Mode</b> Choose color tones. Unavailable in Video mode.</p>	<p><b>Vivid Color</b>—For increased saturation and exaggerated color. <b>Full Color</b>—For rich, balanced color. <b>Basic Color</b>—For accurate color. <b>Black &amp; White</b>—For black and white. <b>Sepia</b>—For a reddish-brown, antique look.</p>

 <b>Settings</b>	<b>More information</b>
<p><b>White Balance</b> Choose your lighting condition. (Available only in Program and Panorama modes.)</p>	<p><b>Auto</b>—Automatically corrects white balance. Ideal for general picture taking.</p> <p><b>Daylight</b>—For pictures in natural lighting.</p> <p><b>Tungsten</b>—Corrects the orange cast of incandescent light bulbs. Ideal for indoor pictures under tungsten or halogen lighting without flash.</p> <p><b>Fluorescent</b>—Corrects the green cast of fluorescent lighting. Ideal for indoor pictures under fluorescent lighting without flash.</p> <p><b>Open Shade</b>—For pictures in shade in natural lighting.</p>
<p><b>Focus Mode</b> Choose a focus distance.</p>	<p><b>Auto</b>—For general picture-taking.</p> <p><b>Macro</b>—For sharpness and detail in pictures at close range. Use available light instead of flash, if possible. The camera automatically sets the focus distance depending on the zoom position.</p> <p><b>Infinity</b>—For distant subjects; auto-focus framing marks are unavailable.</p>
<p><b>Focus/Exposure Zone</b> Choose how the camera assesses the scene for exposure and focus.</p>	<p><b>Face Priority</b>—If faces are detected, they receive focus/exposure priority. (If faces are not detected, the camera switches to Multi-Zone.)</p> <p><b>Multi-Zone</b>—Evaluates 5 zones to give an even picture focus. Ideal for general picture taking.</p> <p><b>Center-Zone</b>—Evaluates the small area centered in the lens. Ideal for focusing on a precise area.</p>
<p><b>AF Control (Still)</b> Choose an auto-focus setting.</p>	<p><b>Continuous AF</b>—Because the camera is always focusing during liveview, there is no need to press the Shutter button halfway down to focus.</p> <p><b>Single AF</b>—Focuses when the Shutter button is pressed halfway down. (This setting uses less battery power.)</p>

 Settings	More information
<b>Sharpness</b> Control picture sharpness or softness.	See Specifications, starting on <a href="#">page 46</a> .

## Video settings (available when the camera is in a Video mode)



Press Menu,  ,  ,  ,  , and OK to access settings	More information
<b>AF Control (Video)</b> Choose an auto-focus setting.	<b>Continuous AF</b> —Camera is always focusing during liveview. <b>Single AF</b> —Camera focuses once, when the Shutter button is pressed.
<b>Self-timer</b> Choose a Self-timer feature.	<b>Off</b> <b>10 Seconds</b> <b>2 Seconds</b>

## Using the Setup menu

Use Setup to customize other camera settings.

 Settings	More information
<b>Date &amp; Time</b>	Set date and time.
<b>Share Button Settings</b> Choose what is displayed when the Share button is pressed.	Show or hide: <ul style="list-style-type: none"> <li>■ Individual social networking sites</li> <li>■ E-mail addresses (all or none)</li> <li>■ KODAK PULSE Digital Frames (all or none)</li> </ul>
<b>Language</b>	Choose your language.

 <b>Settings</b>	<b>More information</b>
<b>LCD Brightness</b> Choose LCD brightness during picture/video capture. (During Review, the LCD is set to High Power.)	<b>Auto</b> —LCD brightness is automatically adjusted according to environment. <b>High Power</b> —Brighter LCD; uses more battery power. <b>Power Save</b> —Dimmer LCD; uses less power.
<b>Date Stamp</b> Add a stamp—showing the date/time that a picture was taken—to all future pictures.	<b>On</b> <b>Off</b>
<b>Camera Sounds</b> Choose volume, and sound effects for each function.	<b>Volume</b> <b>Focus Lock</b> <b>Shutter</b> <b>Self-timer</b> <b>Error</b> <b>Power On</b> <b>Exit</b>
<b>Video Out</b> Choose the regional setting that lets you connect the camera to a television or other external device.	<b>NTSC</b> —Used in North America and Japan; most common format. <b>PAL</b> —Used in Europe and China.
<b>Reset Camera</b>	Reset settings to their default.
<b>Computer Connection</b> Choose which application is installed or launched when you connect the camera to the computer. <b>IMPORTANT:</b> <i>To use the sharing and social networking features, you must install KODAK Software (page 39).</i>	<b>KODAK Software</b> <b>Other Application</b> (APPLE IPHOTO, etc.)

 Settings	More information
<b>Format</b>   <b>CAUTION:</b> <b>Formatting deletes all pictures/videos, including those that are protected. Removing a card during formatting may damage the card.</b>	<b>Memory Card</b> —Deletes everything on the card; formats the card. <b>Exit</b> —Exits without making a change. <b>Internal Memory</b> —Deletes everything in internal memory including email addresses and keyword tags; formats the internal memory.
<b>KODAK Camera Software</b>	Download the KODAK Share Button App at <a href="http://www.kodak.com/go/camerasw">www.kodak.com/go/camerasw</a> .
<b>About</b>	View camera information.

For menu settings in Review, [see page 29](#).

# 6

## Install software, then share

### Install software, transfer pictures

Install KODAK Software—so it's easy to transfer and share pictures and videos.

**IMPORTANT:** *To use the sharing and social networking features, you must install the KODAK Share Button App. For help using the software, go to [www.kodak.com/go/support](http://www.kodak.com/go/support).*

Make sure the computer is connected to the Internet. When you connect the camera to the computer, the KODAK Camera Setup App automatically runs. Follow the prompts to install the KODAK Share Button App.



- 1 Turn off the camera.
- 2 Use the KODAK Camera USB Cable, Micro B / 5-Pin to connect the camera to the computer. (Use only the cable included with this camera.)
- 3 Turn on the camera.
- 4 After the software is installed, follow the prompts to transfer pictures and videos to your computer.

**IMPORTANT:** *If the installer does not run, download and install the right version for your computer's operating system: [www.kodak.com/go/camerasw](http://www.kodak.com/go/camerasw)*

NOTE: You can also use a card reader to transfer pictures/videos.

---

**Get Software help**

[www.kodak.com/go/support](http://www.kodak.com/go/support)

---

**Download the Share Button App**

[www.kodak.com/go/camerasw](http://www.kodak.com/go/camerasw)

---

## Printing pictures

### Direct printing with a KODAK All-in-One Printer

**IMPORTANT:** To print using PICTBRIDGE Technology, you must change the Computer Connection setting (in the Setup menu) to Other Application (see page 37).

You need a camera, a PICTBRIDGE enabled Printer, and a USB cable.

#### Connecting the camera to a KODAK All-in-One Printer

- 1 Turn off the camera and printer.
- 2 Connect the appropriate USB cable from the camera to the printer.

#### Printing from a KODAK All-in-One Printer

- 1 Turn on the printer. Turn on the camera.

*The PictBridge logo is displayed, followed by the current picture and menu. (If no pictures are found, a message is displayed.) If the menu turns off, press any button to redisplay it. If the printer sees the camera as a mass storage device, turn the camera off and then back on.*

- 2 Choose a printing option, then press OK.

**Current Picture**—Press ◀▶ to choose a picture.

**Tagged Pictures**—If your printer is capable, print pictures that you marked for printing.

**Index Print**—Print thumbnails of all pictures. (This option requires one or more sheets of paper.)

**All Pictures**—Print all pictures in internal memory or on a card.

**NOTE:** During direct printing, pictures are not permanently transferred or saved to the printer. To transfer pictures to your computer, see page 39.

---

**Purchase cables, accessories** [www.kodak.com/go/accessories](http://www.kodak.com/go/accessories)

---

## Disconnecting the camera from a KODAK All-in-One Printer

- 1 Turn off the camera and printer.
- 2 Disconnect the USB cable from the camera and the printer.

## Ordering prints online

KODAK Gallery ([www.kodakgallery.com](http://www.kodakgallery.com)) makes it easy to:









- Upload your pictures.
- Edit, enhance, and add borders to your pictures.
- Store pictures, and share them with family and friends.
- Have prints, photo greeting cards, frames, and albums delivered to your door.

## Printing from an accessory SD or SDHC Card

- Automatically print tagged pictures when you insert your card into a printer with an SD/SDHC Card slot. See your printer user's guide for details.
- Make prints at an SD/SDHC Card-capable KODAK Picture Kiosk. Go to [www.kodak.com/go/picturemaker](http://www.kodak.com/go/picturemaker).
- Take the card to your local photo retailer for professional printing.

## Marking your pictures for print

You can mark your pictures so they are easy to print:

- 1 Press the Review  button. Press   to find a picture.
- 2 Press the Menu  button.
- 3 Press   to choose Print, then press OK.
- 4 Press   to choose the number of copies.
- 5 Press OK.
  - To return to picture-taking mode, press the Shutter button halfway down.



# 7

## Troubleshooting

### Camera problems

Status	Solution
Camera does not turn on	■ Make sure the battery is installed correctly (see page 1) and charged (see page 2). Charge the Li-Ion battery whenever necessary.
Camera does not turn off	
Camera buttons and controls do not function	
LCD is too dark.	■ Adjust the LCD Brightness setting (see page 37).
Pictures remaining number does not decrease after taking a picture	■ Continue taking pictures. The camera is operating normally. (The camera estimates the number of pictures remaining after each picture is taken, based on picture size and content.)
Flash does not fire	■ Check the flash setting, and change as needed (see page 11). NOTE: The flash does not fire in all modes.
Memory card is almost or entirely full	■ Transfer the pictures to the computer (see page 39). ■ Delete pictures from the card (see page 24) or insert a new card.
Battery life is short	■ Make sure the correct battery type is installed (see page 50). ■ Wipe the battery's contacts with a clean, dry cloth before inserting it in the camera. ■ Insert a new/charged battery (see page 1). Charge the Li-Ion battery whenever necessary. ■ Limit the time you review pictures/videos on the camera LCD. ■ Purchase a spare battery at <a href="http://www.kodak.com/go/accessories">www.kodak.com/go/accessories</a> .

Status	Solution
Memory card not recognized or camera freezes with card	<ul style="list-style-type: none"><li>■ Card may be corrupted. Format the card in the camera (<a href="#">see page 38</a>).</li><li>■ Use another memory card. Only SD or SDHC Cards are supported.</li></ul>
You cannot take a picture	<ul style="list-style-type: none"><li>■ Turn the camera off, then on again.</li><li>■ Depress the Shutter button all the way (<a href="#">see page 7</a>).</li><li>■ Insert a new/charged battery (<a href="#">see page 1</a>). Charge the Li-Ion battery whenever necessary.</li><li>■ Memory is full. Transfer pictures to the computer (<a href="#">see page 39</a>), delete pictures (<a href="#">see page 24</a>), or insert another card.</li></ul>

### Computer/connectivity problems

Status	Solution
Slide Show does not run on an external display device	<ul style="list-style-type: none"><li>■ Adjust the camera Video Out setting to NTSC or PAL (<a href="#">see page 37</a>).</li><li>■ Make sure the external device settings are correct. (See the device's user guide.)</li></ul>
Computer does not communicate with the camera	<ul style="list-style-type: none"><li>■ Turn off the camera, then turn it back on.</li><li>■ Make sure the battery is installed correctly (<a href="#">see page 1</a>) and charged (<a href="#">see page 2</a>).</li><li>■ Make sure the KODAK Camera USB Cable, Micro B / 5-Pin is connected to the camera and the computer (<a href="#">see page 39</a>). Then turn on the camera.</li><li>■ See KODAK Software Help at <a href="http://www.kodak.com/go/camerasw">www.kodak.com/go/camerasw</a>.</li></ul>

### Direct printing (PICTBRIDGE enabled printer) problems

Status	Solution
Cannot print to a PICTBRIDGE Printer	<ul style="list-style-type: none"><li>■ In the Setup menu, change the Computer Connection setting to Other Application (<a href="#">see page 37</a>).</li></ul>

## Picture quality problems

Status	Solution
Picture is not clear	<ul style="list-style-type: none"> <li>■ To automatically set exposure and focus, press the Shutter button <b>halfway</b>. When the framing marks turn green, press the Shutter button <b>completely down</b> to take the picture.</li> <li>■ Clean the lens (see page 48).</li> <li>■ Make sure the camera is in Macro mode only if you are very close to your subject (see page 35).</li> <li>■ Place the camera on a flat, steady surface or use a tripod (especially in high-zoom settings or in low light).</li> <li>■ Use a larger picture size (see page 33).</li> <li>■ If you're manually adjusting the ISO speed, realize that high ISO setting may cause grainy pictures (see page 34).</li> </ul>
Picture is too dark	<ul style="list-style-type: none"> <li>■ Reposition the camera for more available light.</li> <li>■ Use Fill flash (see page 11) in Program mode, Backlight in SCN mode, or change your position so light is not behind the subject.</li> <li>■ Move so that the distance between you and the subject is within the effective flash range. (See Specifications, page 46.)</li> <li>■ To automatically set exposure and focus, press the Shutter button <b>halfway</b>. When the framing marks turn green, press the Shutter button <b>completely down</b> to take the picture.</li> <li>■ In Program mode, increase the Exposure Compensation (see page 34).</li> </ul>
Picture is too light	<ul style="list-style-type: none"> <li>■ Reposition the camera to reduce the amount of available light.</li> <li>■ Turn the flash off (see page 11).</li> <li>■ Move so that the distance between you and the subject is within the effective flash range. (See Specifications, page 46.)</li> <li>■ To automatically set exposure and focus, press the Shutter button <b>halfway</b>. When the framing marks turn green, press the Shutter button <b>completely down</b> to take the picture.</li> <li>■ In Program mode, decrease the Exposure Compensation (see page 34).</li> </ul>

## Getting help on the Web

### Camera

Get support for your product (FAQs, troubleshooting information, arrange for repairs, etc.)	<a href="http://www.kodak.com/go/m23support">www.kodak.com/go/m23support</a>
Purchase camera accessories	<a href="http://www.kodak.com/go/accessories">www.kodak.com/go/accessories</a>
Download the latest camera firmware and software	<a href="http://www.kodak.com/go/m23downloads">www.kodak.com/go/m23downloads</a>
Register your camera	<a href="http://www.kodak.com/go/register">www.kodak.com/go/register</a>
Chat, email, write, or phone Kodak (Chat not available in all languages)	<a href="http://www.kodak.com/go/contact">www.kodak.com/go/contact</a>
Get information on KODAK All-in-One Printers	<a href="http://www.kodak.com/go/inkjet">www.kodak.com/go/inkjet</a>

## Specifications

**CCD**—1/2.3-type

**Effective pixels**—14 MP (4352 x 3264)

**LCD**—2.7 in. (6.9 cm) LCD; 230K pixels; 4:3 aspect ratio

**Image storage**—Accessory SD/SDHC Card  (The SD logo is a trademark of the SD Card Association.) Maximum supported card size: 32 GB

**Internal storage capacity**—32 MB internal memory (18 MB available for image storage. 1 MB equals one million bytes.)

**Taking lens**—5X optical zoom; f/3.5–f/5.0; 35 mm equivalent: 27–108 mm

**Lens protection**—Built-in

**Digital zoom**—5X continuous

**Focus system**—TTL-AF (through-the-lens auto focus); Multi-Zone, Center-Zone, Face Priority. Working range:

0.5 m (1.6 ft)–infinity @ wide, normal

1.0 m (3.3 ft)–infinity @ telephoto, normal

5–80 cm (2–31.5 in.) @ wide, Macro mode

1–1.5 m (3.3–4.9 ft) @ telephoto, Macro mode

**Auto focus control**—Continuous and Single AF

**Face detection**—Yes

**Face recognition**—Yes

**Shutter speed**—1/4–1/1400 seconds

**Long time exposure**—0.5–8 seconds

**ISO speed**—Up to 1000 at full resolution

Program mode: Auto 80–400; manual 80, 100, 200, 400, 800, 1000

**Exposure metering**—TTL-AE; Face Priority, Multi-Zone, Center-Zone

**Exposure compensation**—+/-2.0 EV with 1/3 EV step

**White Balance**—Auto, Daylight, Tungsten, Fluorescent, Open Shade

**Electronic Flash**—Auto flash; Auto, Fill, Red Eye, Off; Guide No. 5.8; working range @ ISO 400 with red-eye reduction off: 0.3–3.0 m (1–9.8 ft) @ wide; 0.5–2.0 m (1.6–6.6 ft) @ telephoto

**Self-timer mode**—2 seconds, 10 seconds, 2 picture timer

**Burst mode**—Maximum 3 pictures @ 1.5 fps

**Capture modes**—Smart Capture, Scene modes (see page 13), Program, Video

**Image file format**—

Still: EXIF 2.21 (JPEG compression); file organization DCF

Video: .AVI (CODEC Motion JPEG; audio:  $\mu$ -Law)

**Picture size**—14 MP (4:3): 4288 x 3216 pixels

12 MP (3:2): 4288 x 2848 pixels

10 MP (16:9): 4288 x 2416 pixels

6 MP (4:3): 2880 x 2160 pixels

3 MP (4:3): 2048 x 1536 pixels

**Color modes**—Vivid Color, Full Color, Basic Color, Black & White, Sepia

**Sharpness modes**—Sharp, Normal, Soft

**Video capture**—2 GB maximum; VGA (640 x 480 @ 25 fps)

**Communication with computer**—USB 2.0 high speed (PIMA 15740 protocol); via KODAK Camera USB Cable, Micro B / 5-Pin

**Video output**—NTSC or PAL

**Microphone**—Yes

**Speaker**—Yes

**PICTBRIDGE support**—Yes

**Power**—KODAK Li-Ion Rechargeable Digital Camera Battery KLIC-7006; 5V AC-to-USB battery charging; USB charging via computer

**Tripod mount**—1/4 inch

**Size**—94.8 x 56.4 x 23.2 mm (3.7 x 2.2 x 0.9 in.) @ power off

**Weight**—160 g (5.6 oz) including card and battery

**Operating temperature**—0–40° C (32–104° F)

## Care and maintenance

- If you suspect water has gotten inside the camera, remove the battery and card. Allow all components to air-dry for at least 24 hours before using the camera.
- Blow gently on the lens or LCD to remove dust and dirt. Wipe gently with a soft, lint-free cloth or an untreated lens-cleaning tissue. Do not use cleaning solutions unless designed specifically for camera lenses. Do not allow chemicals, such as suntan lotion, to contact painted surfaces.
- Service agreements may be available in your country. Contact a dealer of KODAK Products for more information.
- For digital camera disposal or recycling information, contact your local authorities. In the US, go to the Electronics Industry Alliance site at [www.eiae.org](http://www.eiae.org) or Kodak at [www.kodak.com/go/support](http://www.kodak.com/go/support).

## Upgrading your software and firmware

Download the latest versions of KODAK Software and the camera firmware (the software that runs on the camera). Go to [www.kodak.com/go/m23downloads](http://www.kodak.com/go/m23downloads).

## Storage capacities

The LCD displays the approximate number of pictures (or minutes/seconds of video) remaining. For average SD Card capacities, go to [www.kodak.com/go/SDcapacities](http://www.kodak.com/go/SDcapacities). Actual storage capacity varies depending on subject composition, card size, and other factors. You may be able to store more or fewer pictures and videos.

## Important safety instructions



### CAUTION:

**Do not disassemble this product; there are no user-serviceable parts inside. Refer servicing to qualified service personnel. KODAK AC Adapters and Battery Chargers are intended for indoor use only. The use of controls, adjustments, or procedures other than those specified herein may result in exposure to shock and/or electrical or mechanical hazards. If the LCD breaks, do not touch the glass or liquid. Contact Kodak customer support.**

- The use of an accessory that is not recommended by Kodak may cause fire, electric shock, or injury. For approved accessories, go to [www.kodak/go/accessories](http://www.kodak/go/accessories).
- Use only a USB-certified computer equipped with a current-limiting motherboard. Contact your computer manufacturer if you have questions.
- If using this product in an airplane, observe all instructions of the airline.
- When removing the battery, allow it to cool; it may be hot.
- Follow all warnings and instructions supplied by the battery manufacturer.
- Use only batteries approved for this product to avoid risk of explosion.
- Keep batteries out of the reach of children.
- Do not allow batteries to touch metal objects, including coins. Otherwise, a battery may short circuit, discharge energy, become hot, or leak.
- Do not disassemble, install backward, or expose batteries to liquid, moisture, fire, or extreme temperature.



- Remove the battery when the product is stored for an extended period of time. In the unlikely event that battery fluid leaks inside the product, contact Kodak customer support.
- In the unlikely event that battery fluid leaks onto your skin, wash immediately with water and contact your local health provider. For additional health-related information, contact your local Kodak customer support.
- Go to [www.kodak.com/go/reach](http://www.kodak.com/go/reach) for information about the presence of substances included on the candidate list according to article 59(1) of Regulation (EC) No. 1907/2006 (REACH).
- Dispose of batteries according to local and national regulations. Go to [www.kodak.com/go/kes](http://www.kodak.com/go/kes).
- Do not charge non-rechargeable batteries.

## Battery replacement, battery life

KODAK Li-Ion Rechargeable Digital Camera Battery KLIC-7006 (710 mAh): 200 pictures per charge. Battery life per CIPA testing method. (Approx. number of pictures in Smart Capture mode, using an SD Card.) Actual life may vary based on usage.

### Extending battery life

- Use power-saving features, such as LCD Brightness ([see page 37](#)).
- Charge the battery whenever necessary.
- Dirt on the battery contacts can affect battery life. Wipe the contacts with a clean, dry cloth before loading the battery in the camera.
- Battery performance is reduced at temperatures below 41° F (5° C). When using your camera in cold weather, carry spare batteries and keep them warm. Do not discard cold batteries that do not work; when they return to room temperature, they may be usable.

## Limited warranty

Kodak warrants its digital cameras and accessories (excluding batteries) to be free from malfunctions and defects in both materials and workmanship for the warranty period specified on your KODAK Product packaging. Retain the original dated sales receipt. Proof of purchase date is required with any request for warranty repair.

### Limited warranty coverage

Warranty service is only available from within the country where the Products were originally purchased. You may be required to ship Products, at your expense, to the authorized service facility for the country where the Products were purchased. Kodak will repair or replace Products if they fail to function properly during the warranty period, subject to any conditions and/or limitations stated herein. Warranty service will include all labor as well as any necessary adjustments and/or replacement parts. If Kodak is unable to repair or replace a Product, Kodak will, at its option, refund the purchase price paid for the Product provided the Product has been returned to Kodak along with proof of the purchase price paid. Repair, replacement, or refund of the purchase price are the sole remedies under the warranty. If replacement parts are used in making repairs, those parts may be remanufactured, or may contain remanufactured materials. If it is necessary to replace the entire Product, it may be replaced with a remanufactured Product. Remanufactured Products, parts and materials are warranted for the remaining warranty term of the original Product, or 90 days after the date of repair or replacement, whichever is longer.

### Limitations

This warranty does not cover circumstances beyond Kodak's control. This warranty does not apply when failure is due to shipping damage, accident, alteration, modification, unauthorized service, misuse, abuse, use with incompatible accessories or attachments (such as third party ink or ink tanks), failure to follow Kodak's operation, maintenance or repacking instructions, failure to use items supplied by Kodak (such as adapters and cables), or claims made after the duration of this warranty. Kodak makes no other express or implied warranty for this product. In the event that the exclusion of any implied warranty is ineffective under the law, the duration of the implied warranty will be the length of the express warranty period

specified on your Kodak product packaging. The option of repair, replacement, or refund is Kodak's only obligation. Kodak will not be responsible for any special, consequential or incidental damages resulting from the sale, purchase, or use of this product regardless of the cause. Liability for any special, consequential or incidental damages (including but not limited to loss of revenue or profit, downtime costs, loss of the use of the equipment, cost of substitute equipment, facilities or services, or claims of your customers for such damages resulting from the purchase, use, or failure of the Product), regardless of cause or for breach of any written or implied warranty is expressly disclaimed. The limitations and exclusions of liability set forth herein apply to both Kodak and its suppliers.

### **Your rights**

Some states or jurisdictions do not allow exclusion or limitation of incidental or consequential damages, so the above limitation or exclusion may not apply to you. Some states or jurisdictions do not allow limitations on how long an implied warranty lasts, so the above limitation may not apply to you. This warranty gives you specific rights, and you may have other rights which vary from state to state or by jurisdiction.

### **Outside the United States and Canada**

In countries other than the United States and Canada, the terms and conditions of this warranty may be different. Unless a specific Kodak warranty is communicated to the purchaser in writing by a Kodak company, no warranty or liability exists beyond any minimum requirements imposed by law, even though defect, damage, or loss may be by negligence or other act.

## **Regulatory compliance**

### **FCC compliance and advisory**

This equipment has been tested and found to comply with the limits for a Class B digital device, pursuant to Part 15 of the FCC Rules. These limits are designed to provide reasonable protection against harmful interference in a residential installation. This equipment generates, uses, and can radiate radio frequency energy and, if not installed or used in accordance with the instructions, may cause harmful

interference to radio communications. However, there is no guarantee that interference will not occur in a particular installation. If this equipment does cause harmful interference to radio or television reception, which can be determined by turning the equipment off and on, the user is encouraged to try to correct the interference by one or more of the following measures: 1) reorient or relocate the receiving antenna; 2) increase the separation between the equipment and the receiver; 3) connect the equipment to an outlet on a circuit different from that to which the receiver is connected; 4) consult the dealer or an experienced radio/TV technician for additional suggestions. Any changes or modifications not expressly approved by the party responsible for compliance could void the user's authority to operate the equipment. Where shielded interface cables have been provided with the product or specified additional components or accessories elsewhere defined to be used with the installation of the product, they must be used in order to ensure compliance with FCC regulation. The KODAK High Performance USB AC Adapter K20-AM complies with part 15 of the FCC Rules. Operation is subject to the following two conditions: (1) This device may not cause harmful interference, and (2) this device must accept any interference received, including interference that may cause undesired operation.

## Waste Electrical and Electronic Equipment/Battery disposal



In Europe: For human/environmental protection, it is your responsibility to dispose of this equipment and batteries at a collection facility established for this purpose (separate from municipal waste.) For more information, contact your retailer, collection facility, or appropriate local authorities; or go to [www.kodak.com/go/recycle](http://www.kodak.com/go/recycle). Product weight: 160 g (5.6 oz) including card and battery



## Canadian DOC statement

**DOC Class B Compliance**—This Class B digital apparatus complies with Canadian ICES-003.

**Observation des normes-Classe B**—Cet appareil numérique de la classe B est conforme à la norme NMB-003 du Canada.

## CE

Hereby, Eastman Kodak Company declares that this KODAK Product is in compliance with the essential requirements and other relevant provisions of Directive 1999/5/EC.

## Australian C-Tick



## VCCI Class B ITE

この装置は、クラスB情報技術装置です。この装置は、家庭環境で使用することを目的としていますが、この装置がラジオやテレビジョン受信機に近接して使用されると、受信障害を引き起こすことがあります。

取扱説明書に従って正しい取り扱いをして下さい。

VCCI-B

## China RoHS

## 环保使用期限 (EPUP)

在中国大陆，该值表示产品中存在的任何危险物质不得释放，以免危及人身健康、财产或环境的时间期限（以年计）。该值根据操作说明中所规定的产品正常使用而定。

有毒有害物质或元素名称及含量标识表

部件名称	有毒有害物质或元素					
	铅	汞	镉	六价铬	多溴联苯	多溴二苯醚
数码相机电路板元件	X	○	○	○	○	○
锂电池	X	○	○	○	○	○
交流变压器	X	○	○	○	○	○
电池充电器	X	○	○	○	○	○

○：表示该有毒有害物质在该部件所有均质材料中的含量均在SJ/T 11363-2006规定的限量要求以下。  
 X：表示该有毒有害物质至少在该部件的某一均质材料中的含量超出SJ/T 11363-2006规定的限量要求。



USB 数据线

## Russian GOST-R



Eastman Kodak Company  
Rochester, NY 14650

Фотокамера изготовлена в Китае, остальные элементы -  
в соответствии с маркировкой.

## Korean Li-Ion Regulatory

## 취급상의 주의사항

- < 경고 > 발열, 화재, 폭발 등의 위험을 수반할 수 있으니 다음 사항을
- 육안으로 식별이 가능할 정도의 부풀음이 발생된 전지는 위험할 수 있으므로 제조자 또는 판매자로 즉시 문의할 것
  - 지정된 정품 충전기만을 사용할 것
  - 화기에 가까이 하지 말 것 (전자레인지에 넣지 말 것)
  - 여름철 자동차 내부에 방치하지 말 것
  - 필절방 등 고온다습한 곳에서 보관, 사용하지 말 것
  - 이불, 전기장판, 카펫 위에 올려 놓고 장시간 사용하지 말 것
  - 전원을 켜 상태로 밀폐된 공간에 장시간 보관하지 말 것
  - 전지 단자에 목걸이, 동전, 열쇠, 시계 등 금속 제품이 닿지 않도록 주의할 것
  - 휴대 기기, 제조 업체가 보증한 리튬2차전지 사용할 것
  - 분해, 압착, 관통 등의 행위를 하지 말 것
  - 높은 곳에서 떨어뜨리는 등 비정상적 충격을 주지 말 것.
  - 60°C 이상의 고온에 노출하지 말 것
  - 습기에 접촉되지 않도록 할 것

## 기타정보

- 폐기지침 : 각 지방자치단체의 법규에 의거하여 폐기할 것
- 충전방법에 대한 권고지침

- 1 본 충전지와 함께 사용할 디지털카메라 사용자 설명서의 충전설명 참조하세요.
- 2 코닥 정품 충전기 및 카메라에서만 충전하세요. (타사 충전셋 사용 금지)

제조년월 : Y = Year(제조년도의 마지막 숫자), WW = Week(제조년도의 주)

제조년월 표시 예 : 901 = 9 (2009년), 01 (첫째주)

## Korean Class B ITE

B급 기기 (가정용 방송통신기기)	이 기기는 가정용(B급)으로 전자파적합등록을 한 기기로서 주로 가정에서 사용하는 것을 목적 으로 하며, 모든 지역에서 사용할 수 있습니다.
-----------------------	---

---

# Index

## A

- A/V out, 28
- about this camera, 38
- accessories
  - battery, 50
  - buying, 45
  - SD/SDHC Card, 6
- add keywords, names, 21
- AF control (Still), 35
- AF control (video), 36
- AF zone, 35
- auto
  - enhancement, 30
  - focus control, 35, 36
- auto focus (AF)
  - zone, 35

## B

- backlight, 13
- battery
  - charging, 2
  - expected life, 50
  - icons, 9
  - loading, 1
  - purchase, 27
  - status, 27
  - types, 50
- bright, 13
- brightness, LCD, 10
- burst, 16
- button
  - delete, 8

telephoto/zoom, 10

## C

- cable
  - audio/video, 28
- camera sounds, 37
- Canadian compliance, 53
- care and maintenance, 48
- charging
  - battery icon, 9
  - USB, 4
- charging the battery, 2
- children, 13
- clock, setting, 5
- color mode, 34
- computer
  - connect camera, 39
  - transfer to, 39
- connector, USB / A/V, 28
- copy pictures
  - to computer, 39
- cropping pictures, 29
- customize camera, 36

## D

- date setting, 5
- deleting
  - during quickview, 8
  - from internal memory, 24
  - from SD/SDHC Card, 24
  - protecting pictures, videos, 24
- digital zoom, 10



display, brightness, 10  
disposal, recycling, 48  
download  
    KODAK Software, 39  
download pictures, 39

## E

edit videos, 31  
emailing pictures, videos, 22  
expected battery life, 50  
exposure  
    long time, 34, 36  
exposure compensation, 34  
external video device  
    viewing pictures, videos, 28

## F

faces, tagging, recognition, 20  
FCC compliance, 52  
find pictures, 26  
fireworks, 13  
firmware, upgrading, 48  
flash, using, 11  
flower, 13  
focus mode, 35  
format, 38  
framing marks, 7

## G

guidelines, battery, 50

## H

help  
    Web links, 42  
high ISO, 13

## I

icons  
    battery, 9  
icons, modes, 12  
installing  
    battery, 1  
    SD/SDHC Card, 6  
ISO speed, 34

## K

keyboard, 21  
keywords, 22  
KODAK EASYSHARE Software  
    upgrading, 48  
KODAK PERFECT TOUCH  
    Technology, 30  
KODAK Share Button App, 39  
KODAK Software, download, 39  
Kodak Web sites, 42

## L

language, 36, 37  
LCD  
    brightness, 37  
    reviewing pictures, 23  
    reviewing videos, 23  
LCD brightness, 10, 37  
lens, i  
    cleaning lens, 48  
loading  
    battery, 1  
    SD/SDHC Card, 6  
locate pictures, 26  
long time exposure, 34, 36

## M

- magnify a picture, 25
- maintenance, camera, 48
- make picture from video, 31
- making a video action print, action print, video action print, 32
- marking
  - for email, 22
- memory
  - inserting card, 6
- menu settings, 33
- microphone, i
- modes, 12
  - backlight, 13
  - bright, 13
  - children, 13
  - fireworks, 13
  - flower, 13
  - high ISO, 13
  - night landscape, 13
  - night portrait, 13
  - scene (SCN), 13
  - self portrait, 13
- modes, capture
  - smart capture, 12
- multiple selections, 32
- multi-up, 25

## N

- names, tagging, 20
- night landscape, 13
- night portrait, 13

## O

- online prints, ordering, 41
- optical zoom, 10

## P

- panoramic pictures, 17
- people, tagging, 20
- PERFECT TOUCH Technology, 30
- PICTBRIDGE enabled printer, 40
- picture size, 33, 34
- pictures
  - cropping, 29
  - emailing marked, 22
  - KODAK PERFECT TOUCH, 30
  - marking, 41
  - protecting, 24
  - review icons, 27
  - reviewing, 23
  - taking, modes, 12
  - transfer to computer, 39
- pictures/video
  - deleting, 24
- playing a video, 23
- power
  - camera, 5
- power icon, 9
- printing
  - from a card, 41
  - optimizing printer, 42
  - order online, 41
  - PICTBRIDGE, 40
  - tagged pictures, 41
  - protecting pictures, videos, 24

**Q**

quickview, using, 8

**R**

recognizing faces, 20  
recording light, i  
recycling, disposal, 48  
regulatory information, 52  
repair, 45  
reset camera, 37  
reviewing pictures/video  
    as you take them, 8  
    deleting, 24  
    LCD, 23  
    protecting, 24

**S**

safety, 49  
scene modes (SCN), 13  
SD/SDHC Card  
    inserting, 6  
    printing from, 41  
search pictures, 26  
select multiple pictures/videos, 32  
self portrait, 13  
self-timer, 16  
setting  
    AF zone, 35  
    auto-focus, 35, 36  
    camera sounds, 37  
    color mode, 34  
    date and time, 5  
    ISO, 34  
    language, 36, 37

LCD brightness, 37  
long time exposure, 34, 36  
picture size, 33, 34  
picture-taking mode, 12  
self-timer, 16  
sharpness, 36  
video out, 37  
white balance, 35  
setting up the camera, 1  
setup menu, 36  
Share button, 36  
Share Button App, 39  
sharpness, 36  
shutter  
    problems, 43  
    self-timer delay, 16  
smart capture, 12  
smart display, 37  
smart find, 26  
software  
    upgrading, 48  
software downloader, 39  
sounds, 37  
specifications, camera, 46  
strap, 1

**T**

tagging  
    keywords, 22  
    people, faces, 20  
taking pictures, videos, 7  
television, slide show, 28  
time, setting, 5  
timer, shutter delay, 16

tips

- battery guidelines, 50
- care & maintenance, 48

transfer pictures, 39

trash can, deleting, 8

trimming a video, 31

troubleshooting, 42

turning camera on and off, 5

typing, 21

**U**

undelete, undo, 24

upgrading software, firmware, 48

URLs, Kodak Web sites, 42

USB

- transfer pictures, 39

USB charging, 4

**V**

VCCI compliance, 54

video

- edit, 31

- emailing marked, 22

- out, 37

- playback, 23

- protecting, 24

- review icons, 27

- transfer to computer, 39

- viewing, 23

video out, 37

viewing

- by multi-up, 25

- picture, after taking, 8, 23

**W**

warranty, 51

white balance, 35

**Z**

zoom

- digital, 10

- optical, 10