

# Morphology and ecology of a new centric diatom belonging to the *Cyclotella comta* (Ehrenberg) Kützing complex: *Lindavia khinganensis* sp. nov. from the Greater Khingan Range, Northeastern China

Patrick RIOUAL<sup>a\*</sup>, David JEWSON<sup>b</sup>, Qiang LIU<sup>a</sup>,  
Guoqiang CHU<sup>a</sup>, Jingtai HAN<sup>a</sup> & Jiaqi LIU<sup>a</sup>

<sup>a</sup>Key Laboratory of Cenozoic Geology and Environment,  
Institute of Geology and Geophysics, Chinese Academy of Sciences,  
19 Beitucheng xilu, Beijing 100 029, China

<sup>b</sup>Freshwater Laboratory, University of Ulster, Cromore Road, Coleraine,  
Co. Derry, BT52 ISA, Northern Ireland, UK

**Abstract** – During an investigation on the diatom communities of volcanic lakes of Northeastern China a new species belonging to the “*Cyclotella comta* species complex” was observed. This taxon forms relatively large populations in the phytoplankton of Lake Tuofengling Tianchi, a 33m-deep, oligotrophic, crater lake located in Inner Mongolia. In this paper, the valve morphology and ultrastructure of this taxon is described using light and scanning electron microscopy and a new name, *Lindavia khinganensis* sp. nov., is proposed. A discriminant analysis based on morphological LM and SEM data confirmed that *L. khinganensis* is distinct from other *Lindavia* species with a similar morphology such as *L. comta* (Ehrenberg) Nakov *et al.*, *L. radiosa* (Grunow) De Toni & Forti, *L. balatonis* (Pantocsek) Nakov *et al.*, *L. praetermissa* (Lund) Nakov *et al.* and *L. tenuistriata* (Hustedt) Nakov *et al.* In addition, the seasonal and interannual distribution of *L. khinganensis* was investigated using sediment trap samples collected over a two-year period. Limnological data from Lake Tuofengling, including water chemistry and temperature recording from a thermistor chain provided complementary information about the ecology of this new species. This species was not found in any other lakes from Northeastern China that we investigated.

**Bacillariophyceae / *Cyclotella* / Discriminant Analysis / *Handmannia* / life-cycle / *Lindavia annulata* (Kociolek) Rioual comb. nov. / *Puncticulata* / sediment trap / taxonomy / thermal stratification / *Theriotia***

**Résumé** – Au cours d’une étude sur les communautés de diatomées des lacs volcaniques du nord-est de la Chine, une nouvelle espèce appartenant au complexe *Cyclotella comta* a été observée. Ce taxon forme des populations relativement importantes dans le phytoplancton du lac Tuofengling Tianchi, un lac de cratère oligotrophique de 33 mètres de profondeur situé en Mongolie intérieure. Dans cet article, la morphologie valvaire et l’ultrastructure de ce taxon sont décrites à l’aide de la microscopie optique (MO) et électronique à balayage (MEB) et un nouveau nom, *Lindavia khinganensis* sp. nov., est proposé. Une analyse discriminante basée sur les données morphologiques de MO et de MEB a confirmé que *L. khinganensis* est distinct d’autres espèces de *Lindavia* avec une morphologie similaire telle que *L. comta*

\* Corresponding author: prioual@mail.iggcas.ac.cn

(Ehrenberg) Nakov *et al.*, *L. radiosa* (Grunow) De Toni & Forti, *L. balatonis* (Pantocsek) Nakov *et al.*, *L. praetermissa* (Lund) Nakov *et al.* et *L. tenuistriata* (Hustedt) Nakov *et al.* De plus, la distribution saisonnière et interannuelle de *L. khinganensis* a été étudiée à l'aide d'échantillons prélevés avec une trappe à sédiment sur une période de deux ans. Les données limnologiques du lac Tuofengling, y compris la chimie de l'eau et l'enregistrement de la température à partir d'une chaîne d'enregistreurs, ont fourni des informations complémentaires sur l'écologie de cette nouvelle espèce. Cette espèce n'a pas été trouvée dans d'autres lacs du nord-est de la Chine que nous avons étudiés.

**Bacillariophyceae / *Cyclotella* / Analyse discriminante / *Handmannia* / cycle de vie / *Lindavia annulata* (Kociolek) Rioual comb. nov. / *Puncticulata* / trappe à sédiment / taxonomie / stratification thermique / *Theriotia***

## INTRODUCTION

Climate change and the pollution caused by anthropogenic activities, such as nitrogen deposition, are affecting lake ecosystems even in the most remote parts of the world (Battarbee *et al.*, 2012; Saros *et al.* 2012; Spaulding *et al.*, 2015). In China, these disturbances are even more severe due to the rapid economic development that took place in recent years (Liu *et al.*, 2013; Jia *et al.*, 2014). In that context of rapid changes, the study of the lakes located in the relatively pristine regions of China is a matter of urgency as they may quickly and irreversibly change in the near future.

Diatoms (= Bacillariophyceae) are very abundant microalgae that are quasi ubiquitous in aquatic ecosystems. They are also particularly useful bio-indicators for the monitoring of water quality (e.g. Pignata *et al.*, 2013; Tan *et al.*, 2013) and in palaeolimnological studies (e.g. Battarbee *et al.*, 2014; Gao *et al.*, 2016). However, the taxonomy of the diatoms is currently in a state of flux as researchers constantly discover species new to science, re-analyze the morphology of type specimens (Mann & Vanormelingen, 2013) and make use of molecular methods (e.g. Acs *et al.*, 2016). The aim of this taxonomic work on diatoms is to investigate their diversity and to achieve a phylogenetic classification of this group of microalgae (Williams & Kociolek, 2007) while providing more accurate identifications for the application of diatom analysis in ecology and/or palaeoecology.

Among the centric diatoms, the “*Cyclotella compta* species complex” includes numerous fossil species as well as several extant representatives that are found in the phytoplankton of lakes globally. These species are notoriously difficult to differentiate taxonomically (Wolfe & Siver, 2009). To add to the confusion, there is no agreement on the definition of even the most common species of this group as some authors use a narrow species concept (Houk *et al.*, 2010), while others have adopted a much broader concept (Genkal *et al.*, 2013; Genkal, 2013). Yet, this group of centric diatoms is important not just for taxonomists but also for ecologists and palaeolimnologists as they serve as indicators of environmental change. In particular, several recently published studies have focused on how planktonic “*Cyclotella*” are responding to climate warming (Malik & Saros, 2016; Rühland *et al.*, 2015; Saros & Anderson, 2015).

In a recent phylogenetic study, Nakov *et al.* (2015) resurrected the genus *Lindavia* (Schütt) De Toni & Forti to include centric diatom species within the order Thalassiosirales that have both the internal and external openings of the rimoportula

(labiate processes) located on the valve face. This genus includes all the species of the “*Cyclotella comta* complex” that were regrouped in the now redundant genera *Puncticulata* Håkansson and *Handmannia* Peragallo in Handmann. In addition to the position of the rimoportula, *Lindavia* is also distinguished from other genera of the Thalassiosirales by having circumferential costae inside the alveoli and their exclusively freshwater habitat. In total 89 species of *Lindavia* were listed by Nakov *et al.* (2015) as these authors also included species such as *Cyclotella comensis* Grunow in Van Heurck and *Cyclotella ocellata* Pantocsek and their allies as well as the species of the genus *Pliocaenicus* Round & Håkansson. Since then, Ács *et al.* (2016) proposed that the *Cyclotella/Lindavia ocellata* group should be transferred to a new genus, *Pantocsekiella* Kiss & Ács, based on morphological and gene sequence data while Kociolek *et al.* (2016) established the new genus *Theriotia* Kociolek *et al.* to accommodate the species formerly known as *Cyclotella shanxiensis* Xie & Qi as well as another similar species from south-central China.

During our investigation of the diatom communities from volcanic lakes of Northeastern China a new species of *Lindavia* was observed. This taxon forms relatively large populations in the phytoplankton of Lake Tuofengling Tianchi, a deep, oligotrophic crater lake. In this paper, the valve morphology and ultrastructure of this taxon is described using light and scanning electron microscopy and a new name, *Lindavia khinganensis* sp. nov., is proposed. Its morphology is compared with that of other similar species of the genus *Lindavia* such as *L. comta* (Ehrenberg) Nakov *et al.*, *L. radiosa* (Grunow) De Toni & Forti, *L. balatonis* (Pantocsek) Nakov *et al.*, *L. praetermissa* (Lund) Nakov *et al.* and *L. tenuistriata* (Hustedt) Nakov *et al.* The ecology of this new species is also discussed, especially its seasonal distribution that was investigated using sediment trap samples.

## STUDY AREA

Lake Tuofengling (47°27'N, 120°39'E) is a crater lake located in the southeastern part of the Greater Khingan Mountain range (= Da Xing'anling, in Chinese) at an elevation of 1280 m above sea level (Fig. 1). The terrane of this region is mainly composed of Jurassic volcanic series and Cenozoic strata. Lake Tuofengling is one of the numerous volcanic landforms that occur in the area. The eruption of these volcanoes started in the late Jurassic and reached its peak during the Pleistocene and the Holocene (Wang *et al.*, 2014). This area of China encompasses the southernmost distribution of continuous permafrost that extends from the Arctic region of Eurasia. The region has a cold temperate continental climate with an annual average temperature of 3.1°C and an annual average precipitation of 460 mm (Wang *et al.*, 2014). The vegetation around the lake is mainly composed by a deciduous conifer forest dominated by Larch, *Larix gmelinii* (Rupr.) Rupr. (Shi *et al.*, 2010). The lake has an area of ~8 ha and a maximum water depth of 33 m. It has no surface inflow or outflow and as most crater lakes, has a small catchment area delimited by the rim of the crater that forms the basin (Figs 2, 3). An overview of the main limnological parameters is given in Table 1. The lake is located within a protected area, the Aershan National Forest Park, and has remained relatively well preserved from the local impact of anthropogenic activities, despite the numbers of tourists visiting the park increasing steadily in recent years (Wang *et al.*, 2014).

In recent years, the diatom flora of the region around Lake Tuofengling has been investigated especially species of the genera *Cymbella* (Liu *et al.*, 2007),

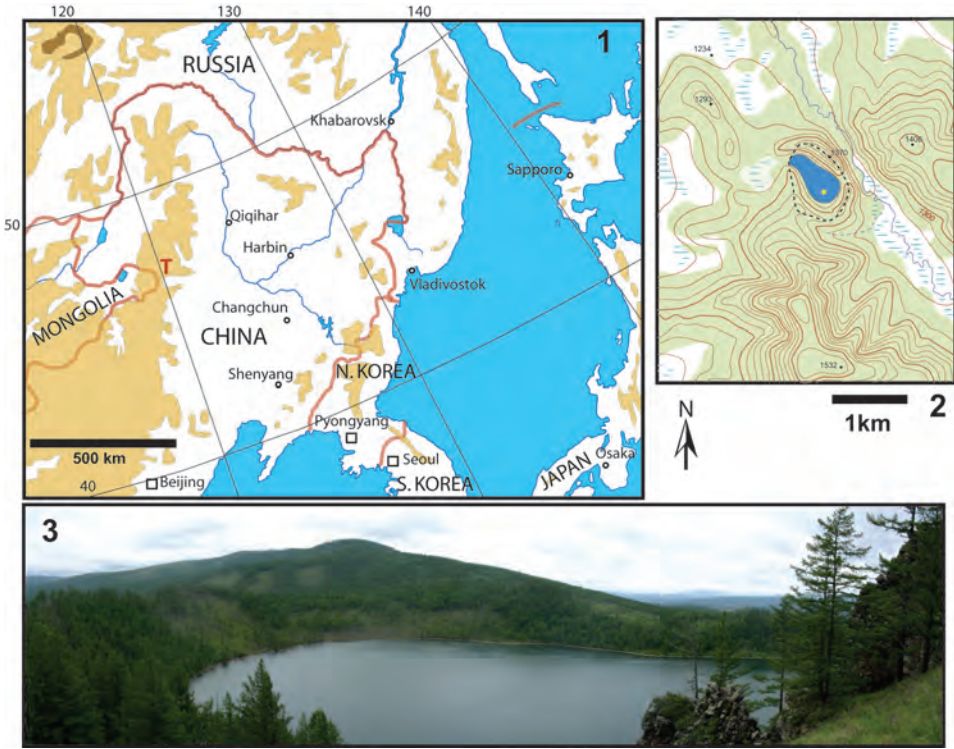

Figs 1-3. Location of the study site. **1.** Map of northeastern China (the study site is marked with a T). **2.** Topographic map of the Lake Tuofengling and its catchment. **3.** Lake Tuofengling (photo. P. Rioual).

*Diatoma* (Liu *et al.*, 2010), *Eunotia* (Liu *et al.*, 2011), *Gomphonema* (Liu *et al.*, 2013), *Hantzschia* (You *et al.*, 2011), *Nitzschia* (Liu *et al.*, 2009), *Pinnularia* (Liu *et al.*, 2010) and *Stauroneis* (Rioual *et al.*, 2013a) with several species described as new to science or reported for the first time in China (Liu *et al.*, 2015; Wu *et al.*, 2015). In addition to diatoms, chrysophycean stomatocysts from lakes and peat bogs of this region have also been investigated (Pang & Wang, 2014). There is however no report on algae from Lake Tuofengling itself.

## MATERIAL AND METHODS

### Diatom samples collection, preparation and analysis

In November 2005, a sample of the surface-sediment was retrieved from the deepest point of Lake Tuofengling using a gravity corer. In the spring of the following year, a cylindrical sediment-trap was deployed in the lake. The sediment trap is similar to the one used by Chu *et al.* (2008) in another volcanic lake of NE China. It consisted of a non-transparent, polyethylene tube (15 cm in diameter and

Table 1. Limnological characteristics for Lake Tuofengling. Sampling period from 3-Nov-2005 to 17-Oct-2007. The samples analyzed correspond to surface water unless specified otherwise

	units	3-Nov-05	4-Jul-06	24-Aug-06	26-Sep-06	2-Nov-06	2-Jun-07	30-Jun-07	1-Aug-07	12-Sep-07	17-Oct-07	Mean
Secchi depth	m	2.7	5.5	5.3	n/a	2.3	2.6	5.0	5.3	6.6	3.6	4.3
Water temperature (surface)*	° Celsius	5.0	20.5	19.8	13.5	4.9	15.0	22.0	21.4	16.2	7.7	14.6
pH**	n/a	6.8	6.7	7.1	7.5	6.5	6.7	6.9	6.8	6.7	6.6	6.8
Electrical Conductivity***	µS/cm	51	38	41	40	46	44	44	47	46	46	44
Alkalinity	µeq/L	382	371	372	365	348	352	403	389	381	380	374
Total phosphorus (TP) surface	µg/L	13.1	1.8	2.8	5.0	15.2	18.8	11.1	6.9	8.6	12.6	10
TP – 5 m	µg/L	n/a	n/a	6.6	8.3	n/a	n/a	11.1	14.5	11.5	12.7	11
TP – 10 m	µg/L	n/a	n/a	13.5	n/a	n/a	n/a	13.4	36.4	20.4	13.3	19
Total nitrogen (TN) surface	µg/L	402	212	325	245	466	428	368	301	429	368	354
TN – 5 m	µg/L	n/a	n/a	338	367	n/a	n/a	348	422	417	379	379
TN – 10 m	µg/L	n/a	n/a	429	n/a	n/a	n/a	377	484	670	615	515
Dissolved organic carbon	mg/L	2.9	5.2	4.4	3.8	3.9	3.1	2.8	3.4	3.5	3.2	3.6
Chloride (Cl)	mg/L	2.0	0.9	0.7	0.6	0.7	0.7	0.8	1.8	1.5	0.9	1.1
Nitrate (NO <sub>3</sub> )	mg/L	1.8	0.0	0.0	0.0	0.0	0.0	0.0	0.0	0.0	0.0	0.2
Sulphate (SO <sub>4</sub> )	mg/L	0.0	1.4	1.8	1.7	1.8	1.4	1.5	1.5	1.4	1.8	1.4
Calcium (Ca)	mg/L	3.8	4.3	4.4	4.3	4.6	4.5	4.8	4.8	4.7	3.7	4.4
Potassium (K)	mg/L	1.6	1.8	1.8	1.7	1.8	2.0	2.2	3.3	3.2	1.0	2.0
Magnesium (Mg)	mg/L	2.2	2.1	2.1	2.1	2.2	2.1	2.2	2.2	2.2	1.9	2.1
Sodium (Na)	mg/L	1.9	2.1	2.3	2.2	2.3	2.3	3.9	3.1	2.5	1.7	2.4
Dissolved silica (Si)	mg/L	0.35	0.10	0.25	0.14	0.27	0.20	0.16	0.13	0.07	0.00	0.2

\* Directly recorded in the lake with a hand thermometer, not with the data loggers

\*\* The mean for pH was obtained after calculating the concentrations of hydrogen ion [H<sup>+</sup>]

\*\*\* Measured in the laboratory and standardized to a temperature of 25°C

78 cm in height), that was fixed on ropes held by a float and anchored at the lake bottom. The trap was deployed one meter above the sediment surface in the centre of the lake in such way that it collects most of the material that deposits through the water column while avoiding taking in sediment re-suspended from the lake bottom (for example, when deploying the trap). Sediment trap samples were retrieved on 8 occasions between June 2006 and October 2007.

The sediment samples were prepared using the water-bath method (Renberg, 1990). Sub-samples of the cleaned, homogenized suspension were diluted with distilled water and left to settle onto glass coverslips and dry overnight in ambient conditions. For LM analysis, 18-mm round glass coverslips were mounted on glass slides with Naphrax® (a commonly used mountant with a refraction index of 1.73).

To establish abundance values expressed as relative percentages at least 500 diatom valves were enumerated in the surface-sediment sample and at least 300 valves in the sediment trap samples. Counting was performed with a Leica DM LB2 light microscope using bright-field and phase contrast oil immersion optics at 1000× magnification. Diatom identification and taxonomy were mainly based on Hofmann *et al.* (2011) but many other publications were also used, especially for planktonic species.

Diatom valve concentration was calculated using the method of Battarbee & Kneen (1982) that consists by adding a known quantity of divinyl-benzene microspheres to the cleaned diatom suspension. Diatom concentration values were then used to derive for each trap period the diatom fluxes, expressed in number of valves per cm<sup>2</sup> per year.

For SEM analyses, aliquots of cleaned samples were air-dried onto glass coverslips of 12-mm diameter. These were mounted onto aluminum stubs using Ted Pella® double-coated carbon conductive adhesive tape and coated with gold using a Polaron SC7640 sputter coater for viewing on a LEO 1530 VP at the State Key Laboratory of Paleobiology and Stratigraphy (Chinese Academy of Sciences, Nanjing). Additional SEM photographs were taken on a Phantom ProX at the Institute of Earth Environment (Chinese Academy of Sciences, Xi'an).

In the description of the new taxon the herbarium acronyms follow Index Herbariorum (<http://sciweb.nybg.org/science2/IndexHerbariorum.asp>) with IGGDC = Herbarium of Bacillariophyceae, Institute of Geology and Geophysics, Chinese Academy of Sciences, Beijing, People's Republic of China.

### **Morphometric analysis and comparison with other *Lindavia* species**

In order to compare the specimens of the *Lindavia* population from Lake Tuofengling with specimens from the “*Cyclotella comta* species complex” we used published LM and SEM illustrations of the taxa listed in Table 2. These images include a wide range of material, including type material, from Europe, Asia and North America.

The LM dataset consisted of 186 images, including 50 from Lake Tuofengling (surface sediment collected in November 2005). The SEM dataset consisted of 88 images, including 46 from surface sediment and sediment trap samples collected between November 2005 and October 2007 in Lake Tuofengling.

The datasets were investigated using conventional morphometric analysis using the public domain software ImageJ (<http://imagej.nih.gov/ij/>). For the LM dataset the following five morphological characters were analysed and measured: valve diameter (d), central area diameter (dCA), the number of punctae (punctae) in the central area, the number of striae on the edge of the valve face (striae) and the

Table 2. List of images (LM and SEM) used in statistical analyses

Taxon (as used in references)	Reference	Site	Remark	LM	SEM	CVA group
<i>Lindavia khinganensis</i>	this study	Lake Tuofengling (China)		50	46	<i>khinganensis</i>
<i>Cyclotella balatonis</i>	Houk <i>et al.</i> (2010)	Lake Balaton (Hungary)	type material	5	3	<i>balatonis</i>
<i>Cyclotella balatonis</i>	Houk <i>et al.</i> (2010)	Tachinifer See (Germany)		1		<i>balatonis</i>
<i>Cyclotella balatonis</i>	Houk <i>et al.</i> (2010)	Reservoir Želivka (Czech Rep.)		2		<i>balatonis</i>
<i>Cyclotella balatonis</i>	Houk <i>et al.</i> (2010)	Ukleisse (Germany)		1		<i>balatonis</i>
<i>Cyclotella balatonis</i>	Krammer & Lange-Bertalot (1991)	Lake Balaton (Hungary)	type material	2	3	<i>balatonis</i>
<i>Cyclotella comita</i>	Houk <i>et al.</i> (2010)	Diatomite from Hochsimmmer (Germany)	type material	23		<i>comita</i>
<i>Cyclotella comita</i>	Håkansson (1988)	Diatomite from Hochsimmmer (Germany)	type material	3		<i>comita</i>
<i>Cyclotella kuetzingiana</i> var. <i>radiosa</i>	Huang <i>et al.</i> (1998)	Xuwen county, Guandong (China)		2	1	<i>kuetzingiana</i>
<i>Cyclotella praetermissa</i>	Houk <i>et al.</i> (2010)	Mondsee (Austria)		2		<i>praetermissa</i>
<i>Cyclotella praetermissa</i>	Houk <i>et al.</i> (2010)	Blausee (Switzerland)		2		<i>praetermissa</i>
<i>Cyclotella praetermissa</i>	Houk <i>et al.</i> (2010)	Karer See (Italy)		2		<i>praetermissa</i>
<i>Cyclotella praetermissa</i>	Houk <i>et al.</i> (2010)	Obersee (Germany)		2	3	<i>praetermissa</i>
<i>Cyclotella praetermissa</i>	Krammer & Lange-Bertalot (1991)	Unspecified lake in England		1		<i>praetermissa</i>
<i>Cyclotella praetermissa</i>	Lange-Bertalot & Metzeltin (1996)	Mittersee (Austria)		2		<i>praetermissa</i>
<i>Cyclotella praetermissa</i>	Wunsam <i>et al.</i> (1995)	lakes in Alpine region		2	1	<i>praetermissa</i>
<i>Cyclotella radiosa</i>	Håkansson (1988)	Mondsee (Austria)	type material	2		<i>radiosa</i>
<i>Cyclotella radiosa</i>	Houk <i>et al.</i> (2010)	Mondsee (Austria)	type material	2	7	<i>radiosa</i>
<i>Cyclotella radiosa</i>	Houk <i>et al.</i> (2010)	Grunow slide 2146, Larå (Sweden?)		5		<i>spp.</i>
<i>Cyclotella radiosa</i>	Wunsam <i>et al.</i> (1995)	Several lakes in Alpine region		1	2	<i>radiosa</i>
<i>Cyclotella tenuistriata</i>	Houk <i>et al.</i> (2010)	Lunzersee (Austria)	type material	6	4	<i>tenuistriata</i>
<i>Handmannia balatonis</i>	Solak & Kulikovskiy (2013)	Springs in Turkmen Mountain (Turkey)		12		<i>balatonis</i>
<i>Handmannia comita</i>	Genkal (2013)	Lake Siilkatnoye (Russia)		2	2	<i>spp.</i>
<i>Handmannia comita</i>	Genkal (2013)	Lake Mal' Yal'chik (Russia)		2	2	<i>spp.</i>
<i>Handmannia comita</i>	Genkal (2013)	Lake Tashtu, Altai (Russia)		2	2	<i>spp.</i>
<i>Handmannia comita</i>	Genkal (2013)	Muminabads Reservoir (Tajikistan)		2	2	<i>spp.</i>
<i>Handmannia comita</i>	Genkal (2013)	Lake Son-Kul' (Kyrgyzstan)		2	2	<i>spp.</i>
<i>Handmannia radiosa</i>	Chudayev & Gololobova (2016)	Lake Glubokoe (Russia)		8	2	<i>spp.</i>
<i>Lindavia praetermissa</i>	Bahls (2013a)	Bowman Lake, Montana (USA)		8		<i>praetermissa</i>
<i>Lindavia radiosa</i>	Bahls (2013b)	Beaver Woman Lake, Montana (USA)		8		<i>radiosa</i>
<i>Puncticulata balatonis</i>	Budżyńska & Wojtal (2011)	Rusalka Lake (Poland)		9	1	<i>balatonis</i>
<i>Puncticulata praetermissa</i>	Håkansson (2002)	Blelham Tarn (UK)	type material	2		<i>praetermissa</i>
<i>Puncticulata praetermissa</i>	Tanaka (2007)	Lakes in Japan		7	2	<i>Japanese praetermissa</i>
<i>Puncticulata radiosa</i>	Tanaka (2007)	Onogami formation (Japan)		6	1	<i>radiosa</i>
<i>Puncticulata radiosa</i>	Håkansson (2002)	Mondsee (Austria)	type material	2	1	<i>radiosa</i>
<i>Puncticulata radiosa</i>	Wojtal & Kwadrans (2006)	Springs in Wyzyna Krakowsko-Częstochowska Upland (Poland)		2	1	<i>spp.</i>
<i>Puncticulata radiosa</i>	Żelazna-Wieczorek (2011)	Springs of Łódź Hills (Poland)		3		<i>radiosa</i>
			Sum images:	186	88	

number of marginal fuloportulae (mfp). For the SEM dataset, seven morphological characters were measured. Compared with the characters measured on LM images, the number of punctae was replaced by the numbers of areolae (areolae) and central fuloportulae (cfp) in the central area, and the number of rimoportulae (rp) was added. Densities of central areolae and cfp (as reported in Table 4) were obtained by referring the number of areolae and cfp to  $10 \mu\text{m}^2$  of valve central area (Duleba *et al.*, 2015).

To check if the different taxa could be separated based on the combination of variables (e.g. Beszteri *et al.*, 2005, Duleba *et al.*, 2015), Canonical Variate Analyses (CVA) of these morphological data (with five and seven characters for the LM and SEM datasets, respectively) was then performed in Canoco 5 (ter Braak & Šmilauer, 2012). CVA, also called linear discriminant analysis, is a technique that maximizes the separation of predefined groups in multivariate space with respect to their within-group variance (Beszteri *et al.*, 2005). As recommended by Theriot (1988) we did not use ratios or density data (e.g. striae density) in the statistical analysis as these are often curvilinearly related to diameter, whereas total numbers are linearly related or unrelated to diameter. For the CVA, we used the procedure described by Šmilauer & Lepš (2014) that includes the  $\log(x + 1)$  transformation of the data, and consists in the forward selection of the morphological characters so that only the characters effective for predicting to which taxon a specimen belongs are retained in the analysis. Unrestricted permutation tests ( $n = 999$ ) and Bonferroni correction were used to choose the characters during the forward selection. Characters were not considered significant if their P-value (Bonferroni adjusted) was  $> 0.05$ .

In addition to the morphometric characters listed above, internal valve views were used to measure the orientation of the rimoportula labium (as in Beszteri *et al.*, 2005 and Duleba *et al.*, 2015), the thickness of the costae (as in Genkal, 2013) and external valve views to check for the presence/absence of papillae.

### **Inter-annual and seasonal variations in valve morphology of *Lindavia***

In addition to the morphometric analyses, LM images taken from the surface sediment sample and trap samples were also analyzed to assess how the cell-size and morphology of *Lindavia* varied during the period investigated (from November 2005 to October 2007). From digitized LM images calibrated against a slide micrometer and using ImageJ the following morphological features were analyzed and measured: valve diameter, central area diameter, the number of striae on the edge of the valve face and the number of marginal fuloportulae. Following Duleba *et al.* (2015), the number of striae were referred to  $10 \mu\text{m}$  valve perimeter. One hundred valves were measured along a transect through the coverslip for each of the 8 trap samples collected and from the surface sediment sample. That slide was also scanned to look for very large and very small *Lindavia* valves to estimate the full size range (as reported below, in the formal description of the taxon) and for the presence of auxospores.

As shown by Jewson (1992a), the distribution of the valves diameter in each sample can be plotted to investigate the dynamics and life cycle of a centric diatom. In addition, notched boxplots were used to identify outliers and to check if there was statistically significant dissimilarity in morphological characters between the populations investigated. Non-overlapping notches on boxplots were used to infer statistically significant dissimilarity at the 95% confidence interval (Rioual *et al.*, 2013a). The boxplots were drawn using R (R Development Core Team 2013).



### Limnological analyses: water chemistry and water temperature recording

In parallel with the collection of sediment trap samples, surface water samples (~ 0.3 m depth) were taken and analyzed for a wide range of chemical and physical variables including pH, conductivity, alkalinity and the concentrations in total phosphorus (TP), total nitrogen (TN), dissolved silica, and in the major ions. The methods used to measure these various environmental variables are given in Rioual *et al.* (2013a). Measurements of the Secchi depth and surface water temperature were also taken when collecting these water samples. Water samples retrieved from deeper water depth using a through-flow sampling bottle were also analyzed, but less frequently.

For the monitoring of water temperature within the water column, a second mooring located nearby the sediment trap was fitted with several temperature data loggers (Minilog, Vemco Ltd, Canada). Temperature readings were recorded every 2 hours. Recording started on the 4<sup>th</sup> of July 2006 and was stopped on the 29<sup>th</sup> of June 2007 when the mooring was lost. Isobathytherms were plotted using the program Surfer 12.0. The approximate boundaries of the metalimnion were determined according to the method described in Wetzel (2001).

## RESULTS

### Results of the CVA on *Lindavia* morphological data

Results of the CVA on the LM and SEM datasets are shown in Figs 4 and 5, respectively.

In Fig. 4, for the LM dataset, the number of punctae in the central area contributes most on the CVA-axis 1, while the number of marginal fultoportulae (mfp) contributes most to the separation of the taxa on the CVA axis-2 (Fig. 4). We identified several clusters that mostly match with the original identifications proposed in the references we used.

– A “*comta* cluster” located in the upper right quadrant of the CVA diagram, that includes images of the type material of *Cyclotella comta* given in Houk *et al.* (2010) and Håkansson (1988).

– A “*radiosa* cluster”, situated just below the *L. comta* cluster, that includes images of the type material of *Cyclotella radiosa* given in Houk *et al.* (2010) and Håkansson (1988, 2002) as well as images of *C. radiosa* from lakes in the Alps as illustrated by Wunsam *et al.* (1995), of *Puncticulata radiosa* from Japan (Tanaka 2007) and Poland (Żelazna-Wieczorek, 2011) and of *Lindavia radiosa* from a lake in Montana (USA) as illustrated by Bahls (2013b).

– A “*kuetzingiana* var. *radiosa* cluster”, characterized by high scores on CVA axis-2 (high number of mfp) that includes two specimens from Chinese fossil material illustrated by Huang *et al.* (1998).

– A “*balatonis* cluster”, located in the lower right quadrant, that includes the type material of *Cyclotella balatonis* from Lake Balaton (Hungary) as illustrated by Houk *et al.* (2010) and Krammer & Lange-Bertalot (1991) as well as various European populations identified as *Cyclotella balatonis* (Houk *et al.*, 2010) or *Puncticulata balatonis* (Wojtal & Kwadrans, 2006; Budzyńska & Wojtal, 2011) and *Handmannia balatonis* from Turkey (Solak & Kulikovskiy, 2013).

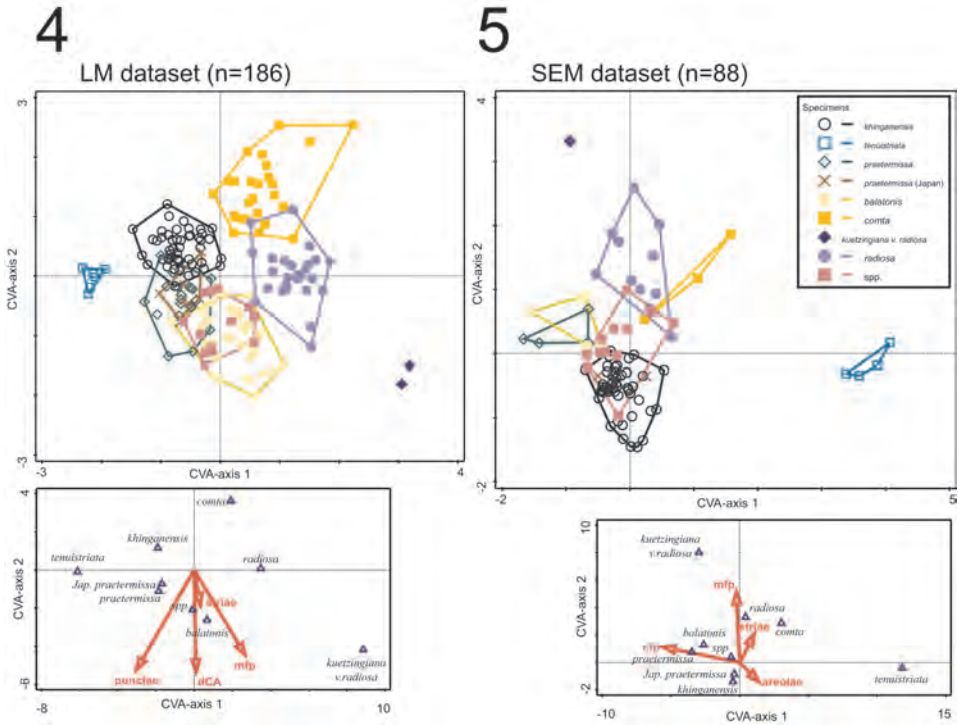

Figs 4-5. Ordination plot representing the first two axes of the Canonical Variates Analyses (CVA) performed on morphological variables measured on digitized LM and SEM images of *Lindavia khangensis* and other species of *Lindavia*. **4.** CVA on LM images. **5.** CVA on SEM images.

- A “spp. cluster”, that completely overlaps with the “*balatonis* cluster” and includes specimens from Russia identified as *Handmannia radiosa* by Chudaev & Golobova (2016) and specimens from the slide 2146 of the Grunow’s collection, reported as *Cyclotella radiosa* by Houk *et al.* (2010).

- A “*tenuistriata* cluster”, located in the bottom left quadrant of the CVA that includes type material of *Cyclotella tenuistriata* as shown by Houk *et al.* (2010).

- A “*praetermissa* cluster”, also located in the bottom left quadrant, that includes type material of *Cyclotella praetermissa* from the United Kingdom as illustrated by Håkansson (2002) plus various European populations of *C. praetermissa* (Krammer & Lange-Bertalot, 1991; Wunsam *et al.*, 1995; Lange-Bertalot & Metzeltin, 1996; Houk *et al.*, 2010) and a population from a lake in Montana (USA) identified as *Lindavia praetermissa* by Bahls (2013a).

- A “Japanese *praetermissa* cluster”, including specimens illustrated in Tanaka (2007), that largely overlaps with the “*praetermissa* complex” but that we kept distinct because details of the ultrastructure only visible under the SEM (see below) suggest that it does not belong to *Lindavia praetermissa sensu stricto*.

- And finally, a cluster regrouping the valves from Lake Tuofengling, positioned in the upper left quadrant and characterized by low numbers of marginal fulcportulae, low number of punctae in the cenral area and small diameter of the central area. This cluster partly overlaps with the “*praetermissa*” and “Japanese *praetermissa*” clusters.

For the SEM dataset, Fig. 5 shows that the number of central fuloportulae (cfp) contributed most on the CVA axis-1 (clearly separating the “*tenuistriata* cluster” in which cfp are absent from all the other species with cfp present) while the number of marginal fuloportulae (mfp), and to a lesser extent, the number of striae contributed to the separation of the taxa on the CVA axis-2. In particular, the taxon from Lake Tuofengling is characterized by lowest values for mfp. The valve diameter, the diameter of the central area and the number of rimoportulae were found to be not significant during the forward selection procedure. We used the same “clusters” compared with the CVA based on LM images except that the “spp. cluster” now includes SEM and TEM images of various Russian populations identified by Genkal (2013) as *Handmannia comta*. As in the LM-based CVA, the “*comta*”, “*radiosa*”, “*balatonis*” and “*tenuistriata*” clusters are clearly separated from the Tuofengling population. In addition, the “*praetermissa*” complex is also separated from the Tuofengling population by having a higher number of cfp (and a lower number of areolae). By contrast, the two SEM images of the “Japanese *praetermissa*” as well as some of the valves identified by Genkal (2003) in his broad concept of *Handmannia comta* plotted within the Tuofengling cluster.

The two CVA show that the Lake Tuofengling *Lindavia* population is morphologically distinct from the type material of *L. comta*, *L. radiosa*, *L. balatonis*, *L. tenuistriata* and *L. praetermissa*. We therefore formally describe (below) this taxon as a new species called *Lindavia khinganensis* nov. sp.

### Description of *Lindavia khinganensis* Rioual sp. nov.

Figs 6-37

*Type locality* – All the type material was sampled from Lake Tuofengling, 1280 m.a.s.l., 47°27'N, 120°39'E (China, Inner Mongolia, Greater Khingan Mountain range) by Dr Patrick Rioual, IGG-CAS, Beijing.

*Material examined* – The holotype slide (IGGDC-DB-TUOF-0511) is deposited at the Herbarium of Bacillariophyceae, Institute of Geology and Geophysics, Chinese Academy of Sciences, Beijing, People’s Republic of China (herbarium acronym following: <http://sciweb.nybg.org/science2/IndexHerbariorum.asp>). The holotype specimen is illustrated in Fig. 9, located using England finder F35/3 or at coordinates 14.7 S and 19.4 E following the method described by Sterrenburg *et al.* (2012). An isotype slide, BM 101 672, is deposited in the collection of Natural History Museum, London, United Kingdom.

*Diagnostic description* – Valves circular, 6-25 µm in diameter, solitary. Striae of nearly equal length taking 40-70% of the valve diameter. Circumferential stria density 14-23 in 10 µm. Each stria is composed of two rows of coarse pori marking out the boundary of the internal alveoli, with small pori scattered between them (Figs 23-26). The interstriae are extremely narrow. A few of the interstriae can be bifurcated on the mantle. Small granulae can be present at the junction between the valve face and the mantle and on the mantle (Figs 27, 28). The alveoli are internally occluded with a marginal and central lamina. Internal alveolar openings between costae are elongated (Figs 29, 35, 36). Internally there are (2) 4-6 (12) thin costae between 2 thickened costae. Every thickened costa bears one marginal fuloportula near the valve margin, with a short tube surrounded by two satellite pori positioned laterally (Figs 29, 35). Circumferential density of marginal fuloportulae 1.7-3.9 in 10 µm. 1-2 rimoportulae are situated in the marginal area close to the limit with the central area at the end of shortened costa. Internally, with a sessile labium with an oblique to radial orientation (angle range: 35-90°, average ~ 70°, standard

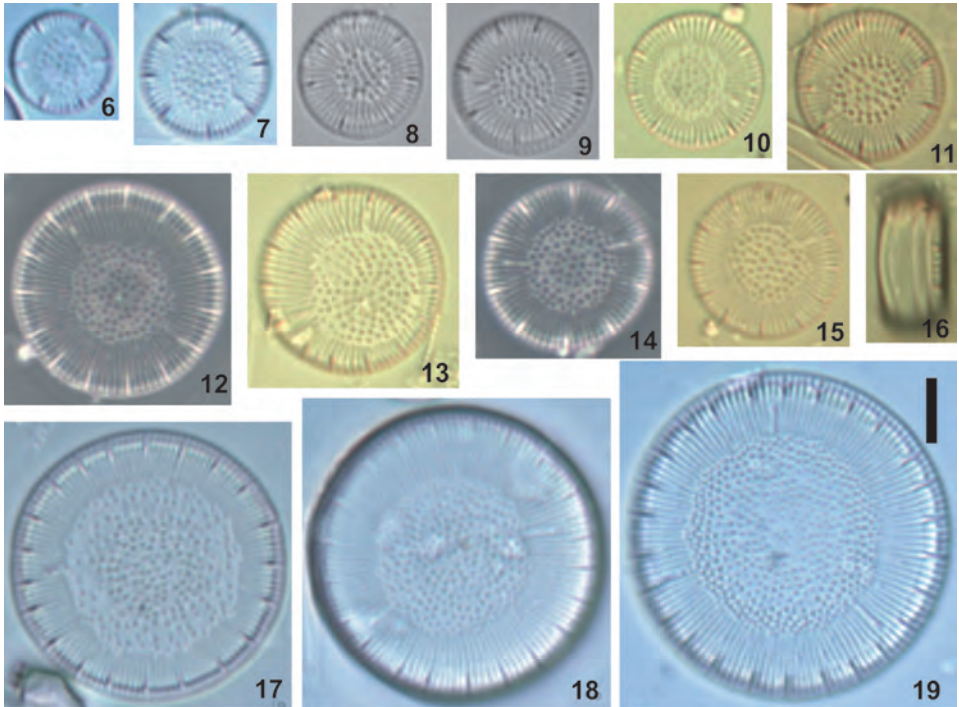

Figs 6-19. LM images of *Lindavia khinganensis*. Fig. 9 is the type specimen. Scale bar = 5  $\mu$ m.

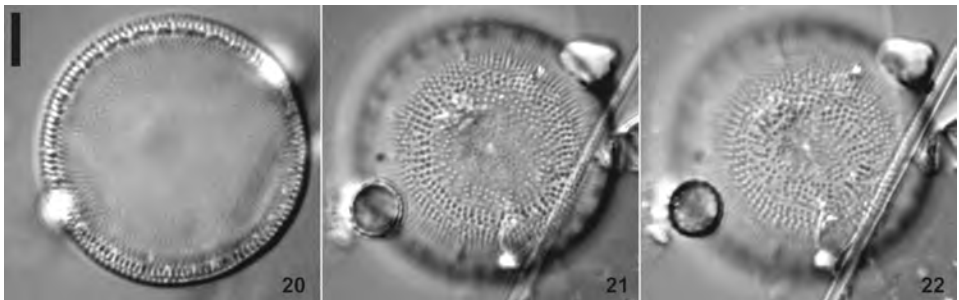

Figs 20-22. LM images of *Lindavia khinganensis* showing an auxospore under three different levels of focus. Scale bar = 5  $\mu$ m.

Figs 23-30. SEM images of *Lindavia khinganensis*. external view. **23-28, 30.** External views showing structure of marginal striae with two rows of coarse pori bracketing scattered small pori and very narrow interstriae, central areolae of various size and shape, external opening of rimoportula (white arrows), external opening of central fuloportulae (black arrows). **28, 30.** Granulae can be present on the margin of the valve face. **29.** Oblique view showing the mantle, external opening of marginal fuloportula (black arrows). Scale bars (23, 25, 27, 29, 30) 2  $\mu$ m; (24, 26, 28) 1  $\mu$ m.

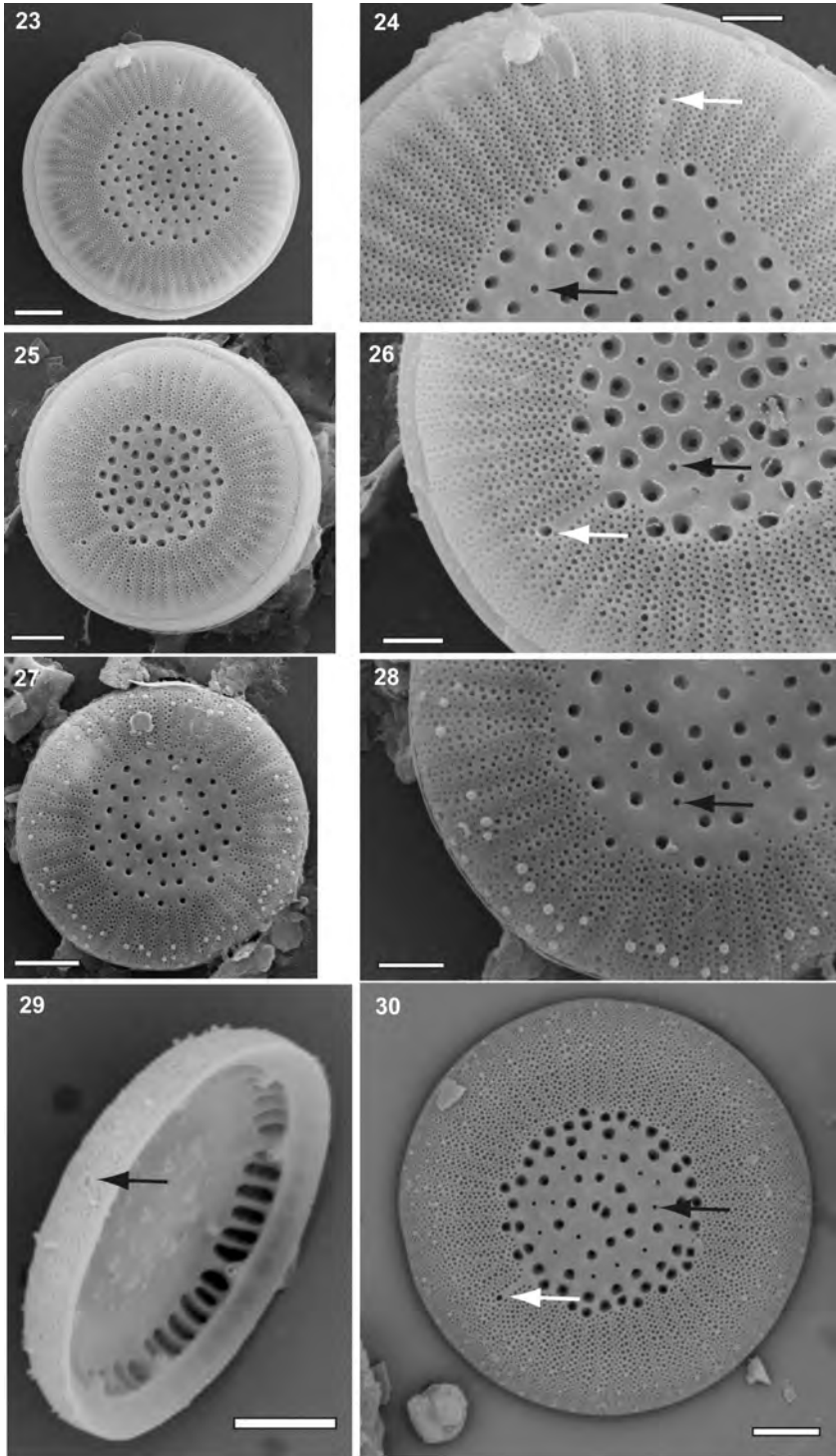

deviation =  $14^\circ$ ,  $n = 43$ ) (Figs 32, 34, 37). Valve face flat or slightly concave/convex (Figs 25, 30, 33) with numerous central fuloportulae (externally visible as minor puncta) and areolae (externally visible as bigger puncta) that are scattered or arranged in radial rows. Areolae greatly variable in shape and size. The areolae are internally

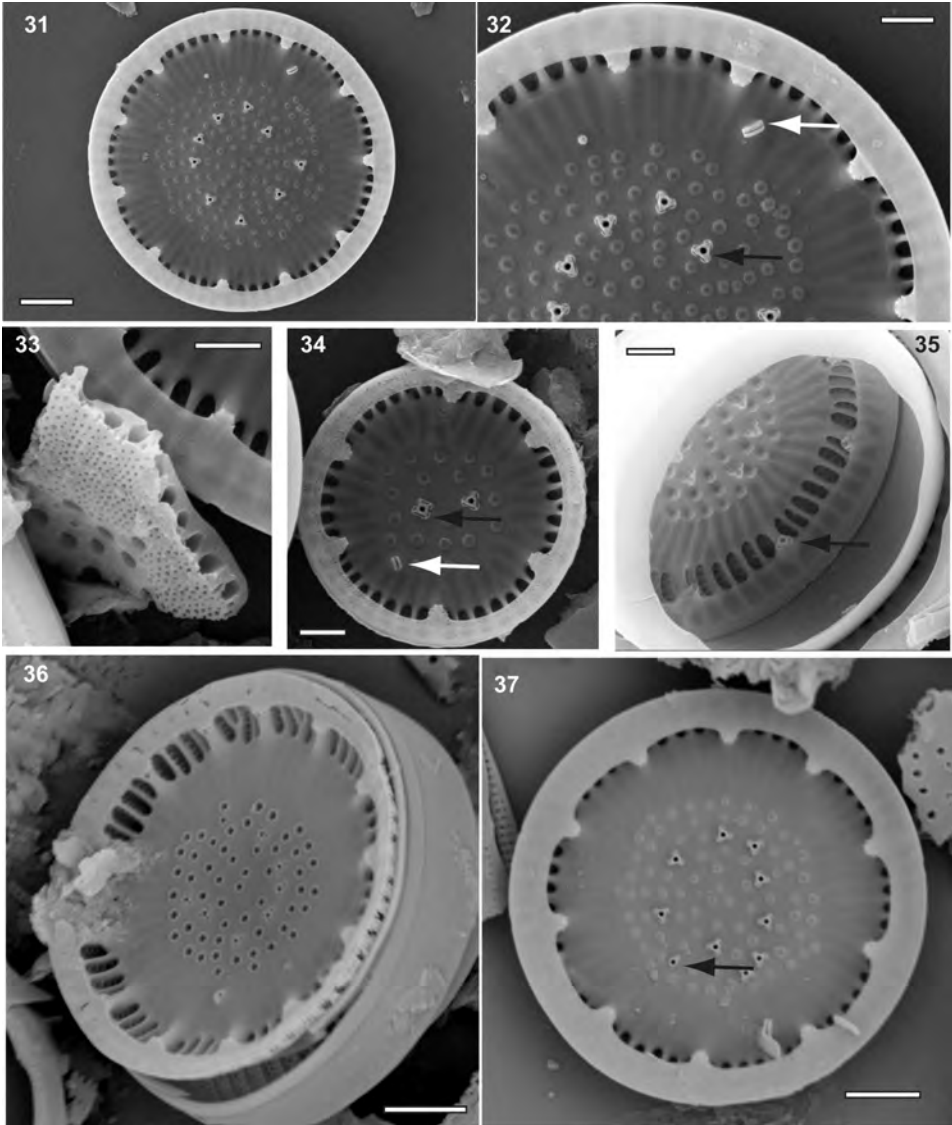

Figs 31-37. SEM images of *Lindavia khinganensis*, inside view. **31, 32.** Ring of central fuloportulae with 3 satellite pores (black arrows), internal opening of rimoportula (white arrows). **33.** Oblique view of a broken valve showing internal structure of alveolae. **34.** A central fuloportula with 4 satellite pores (black arrow). **35-36.** Oblique view showing elongated alveolae, marginal fuloportulae with 2 satellite pores (black arrow) and smooth girdle composed of several copulae. **37.** A central fuloportula with 1 satellite pore (black arrow). Scale bars (31, 36, 37) 2  $\mu\text{m}$ ; (32, 33, 34, 35) 1  $\mu\text{m}$ .

covered with domed cribra (Fig. 32). The central fultoportulae internally with three satellite pori (very seldom 1, 2 or 4 satellite pori) are either scattered among the areolae or arranged in a ring (Figs 31, 37). The girdle is smooth, composed of several copulae (Fig. 36).

*Etymology* – the species name refers to the Greater Khingan Mountain range.

### Limnology of Lake Tuofengling

*Temperature recording* (Fig. 39) – At the start of our period of recording, in early July 2006, thermal stratification was already established and the depth boundaries of the metalimnion were between 2 and 6.5 m. Then, the metalimnion deepened and in early September, its boundaries were between 7 and 10.5 m. By the end of October, the water column was fully mixed. That year, ice formed at the surface of the lake in early November and the lake was ice-covered until mid-April 2007. In spring, the lake remained isothermal until the end of May after which thermal stratification developed rapidly. On the last day of recording, at the end of June 2007, the metalimnion was between 5 and 11.5 m. From this data we can infer that Lake Tuofengling is dimictic.

*Water chemistry* – Lake Tuofengling has weakly alkaline, circumneutral water. Its TP and TN values indicate that while oligotrophic conditions generally prevail in the epilimnion, the metalimnion is mesotrophic. Relatively low Secchi depth values may be caused by relatively high DOC values (Table 1).

### Inter-annual and seasonal variations in diatom assemblages and fluxes

The major difference in assemblage composition between the surface sediment sample collected in November 2005 and the trap samples collected in 2006 and 2007 is the much reduced relative abundance of *Aulacoseira subarctica* in the trap samples by comparison with the surface sediment. Inversely, *Fragilaria gracilis* (for 2006), *Discostella stelligeroides*, *L. khinganensis* and *Stephanodiscus binatus* (for 2007) are more abundant in trap samples than in the surface sediment. The other planktonic diatoms, *Asterionella formosa* and *Tabellaria flocculosa* strain III, have low abundances in all samples. High percentages of benthic diatoms are associated with the periods of mixing, in spring and in autumn (Table 3, Fig. 41).

The highest diatom flux was recorded in June 2007 ( $\sim 1.9 \times 10^9$  valves.  $\text{m}^{-2} \cdot \text{d}^{-1}$ ) but for *L. khinganensis*, the highest flux occurred in autumn in both years with  $\sim 0.2 \times 10^9$  valves.  $\text{m}^{-2} \cdot \text{d}^{-1}$  in September 2006 and  $\sim 0.35 \times 10^9$  valves.  $\text{m}^{-2} \cdot \text{d}^{-1}$  in October 2007 (Table 3, Fig. 40).

### Variation in cell-size and morphology of *Lindavia khinganensis*

Only two auxospores were found despite scanning the whole slides. These two specimens were found in the surface sediment sample and both had a diameter of 25  $\mu\text{m}$ .

When considering all the valves measured under the LM ( $n = 900$ ), the valve diameter was negatively correlated to the circumferential stria density ( $r = -0.23$ ,  $p = 0.001$ ) and positively correlated with the density of marginal fultoportulae ( $r = 0.11$ ,  $p = 0.01$ ). There is no significant correlation with the central area/valve diameter ratio.

Table 3. Results on the analyses of the surface sediment (Nov-05) and sediment traps samples (all others), including fluxes and the percentages of the main diatom species

	units	3-Nov-05	24-Aug-06	26-Sep-06	2-Nov-06	2-Jun-07	30-Jun-07	1-Aug-07	12-Sep-07	17-Oct-07
Nb of days		n/a	51	33	37	212	28	32	42	35
Sediment flux	g/m <sup>2</sup> /day	n/a	0.358	0.444	0.952	1.519	1.060	0.811	0.496	1.044
Diatom flux (in billions)	valves/ m <sup>2</sup> /d	n/a	0.35	0.93	0.69	0.46	1.92	0.75	0.54	1.33
<i>Lindavia khinganensis</i>	%	13.1	17.7	21.7	17.6	7.9	3.4	11.2	43.3	26.4
<i>Asterionella formosa</i>	%	3.2	2.3	1.6	3.1	1.2	0.9	0.3	0.3	1.1
<i>Aulacoseira subarctica</i>	%	33.9	0.5	1.6	0.8	1.2	1.1	1.2	0.6	2.4
<i>Discostella stelligeroides</i>	%	11.2	6.4	12.3	27.9	30.9	63.2	50.5	21.8	24.3
<i>Fragilaria gracilis</i>	%	5.5	69.1	52.1	18.7	11.1	8.0	11.8	5.5	5.8
<i>Stephanodiscus binatus</i>	%	1.7	0.0	1.0	2.0	4.1	12.6	5.9	2.2	1.3
<i>Tabellaria flocculosa</i>	%	1.5	0.5	0.6	1.7	1.5	0.3	0.3	1.4	2.1
Benthic diatoms	%	26.9	2.7	7.1	25.1	37.9	9.2	17.4	23.4	35.1

Changes in valve morphology during the course of the trap experiment can be assessed using notched boxplots. There was no significant change in valve diameter in the four samples retrieved between the 24<sup>th</sup> August 2006 and the 2<sup>nd</sup> June 2007, as shown by the overlaps of the notched boxplots (Fig. 42). In the samples collected on the 30<sup>th</sup> of June and 1<sup>st</sup> of August 2007, however, the median valve diameter of *Lindavia* was significantly larger. Valve diameter declined in the last two trap samples collected on the 12<sup>th</sup> of September and 17<sup>th</sup> of October 2007. A similar trend was observed in the central area / valve diameter ratio (Fig. 43). The median stria density was comprised between 18 and 20 striae per 10 mm in all samples except for the one collected on the 26<sup>th</sup> of September 2006, which had significantly higher stria density (Fig. 44). This sample was also characterized by the smallest median valve diameter, which confirms the negative correlation between these two variables as observed earlier. There was no significant change in the density of marginal fultoportulae (Fig. 45).

Figs 38-41. **38.** Meteorological data (monthly averages) from Aershan City weather station. **39.** Isobathytherm diagram for the period between the 4<sup>th</sup> July 2006 and 30<sup>th</sup> June 2007. **40.** Total diatom and *Lindavia* fluxes measured from sediment trap samples. **41.** Relative abundance of the main planktonic species observed in Lake Tuofengling trap sample (the bar widths match with the duration of the trap exposure).



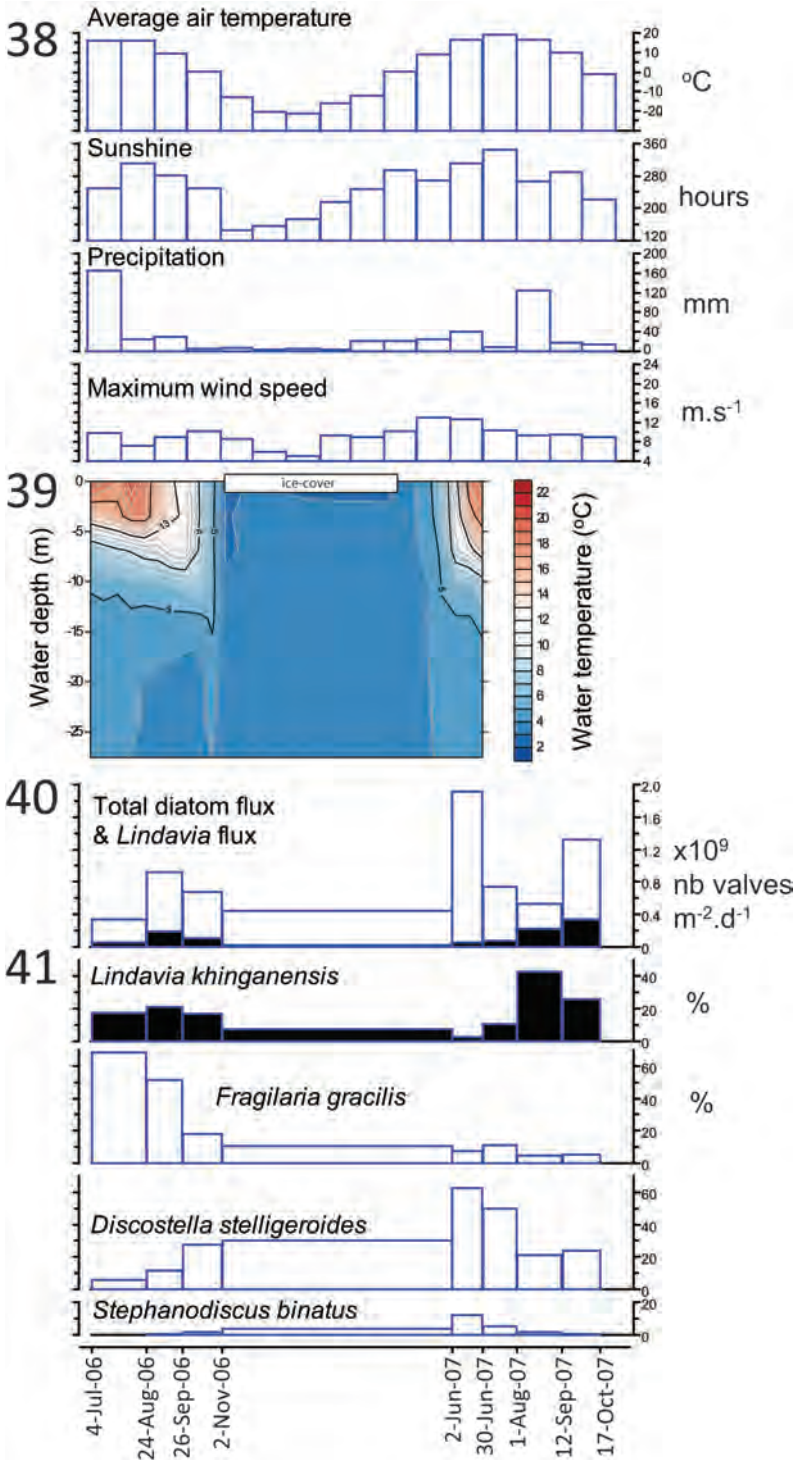

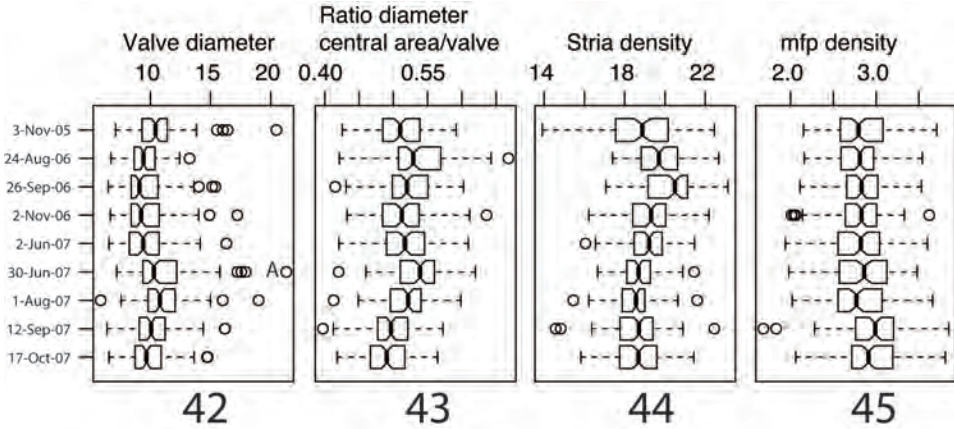

Figs 42-45. Box plots showing quantile distribution of valve characters for populations of *Lindavia khangensis* observed in a surface sediment sample (3<sup>rd</sup> Nov. 2005) and in trap samples (all others). For all samples  $n = 100$ . The 25-75 percent quartiles (excluding outliers) are drawn using a box. The median is shown with a horizontal line inside the box. The whiskers represent the upper and lower “inner fence”, *i.e.* are drawn from the edge of the box up to the largest/lowest data point less than 1.5 times the box height. Outliers, *i.e.* values outside the inner fences, are shown as circles if they lie further from the edge of the box than 3 times the box height. **42.** Valve diameter (in  $\mu\text{m}$ ). **43.** Ratio diameter central area/valve. **44.** Stria density (number in 10  $\mu\text{m}$ ). **45.** Marginal fuloportula density (number in 10  $\mu\text{m}$ ).

Relative size distributions of valve diameter of *L. khangensis* are shown in Fig. 46. The upper curve shows a surface sediment sample collected on the 3<sup>rd</sup> November 2005. The other size distributions are part of a sequence collected from sediment traps on dates between 24<sup>th</sup> August 2006 and 17<sup>th</sup> October 2007. The highest cell frequency in all samples was at 8 to 9  $\mu\text{m}$  diameter. This constancy and the skewed nature of the curves is typical for many centric diatom populations where there is a low but frequent rate of size restoration, as cells lost are replaced by the decline of larger diameter cells (Jewson, 1992a, b). However, in Lake Tuofengling there is also one example of a higher proportion of cells being involved between 2<sup>nd</sup> and 30<sup>th</sup> June 2007. This can be seen in the change in shape of the curve below 9  $\mu\text{m}$ , which changes from convex to concave, because there was a decrease of 56% of the cells at and below 8  $\mu\text{m}$ , which was equivalent to 23% of the total cells. It is likely that the diameter size range for inducing size restoration is between 6 to 9  $\mu\text{m}$ , and results in auxospores of 25  $\mu\text{m}$  diameter. This would mean an increase in size of approximately three to four times and a size threshold for inducing size restoration that is 36 % of the maximum diameter. An anomaly at this time was that there was an apparent rise in the population diameter (Fig. 42), but this was solely due to the loss of the smaller cells, with the size distributions of cells above the threshold of 8-9  $\mu\text{m}$  showing little or no change (Fig. 46). By the 1<sup>st</sup> August, the curve below 9  $\mu\text{m}$  was again becoming convex, as size decline of larger diameter cells began to replace those cells lost in size restoration. Although the discarded valves during size restoration disappeared from the water column, the evidence from the size distributions of the sediment (Fig. 46) suggests that most sank to the bottom. This is supported by the high proportion of cells at and below 8  $\mu\text{m}$  found in the surface sediment sample.

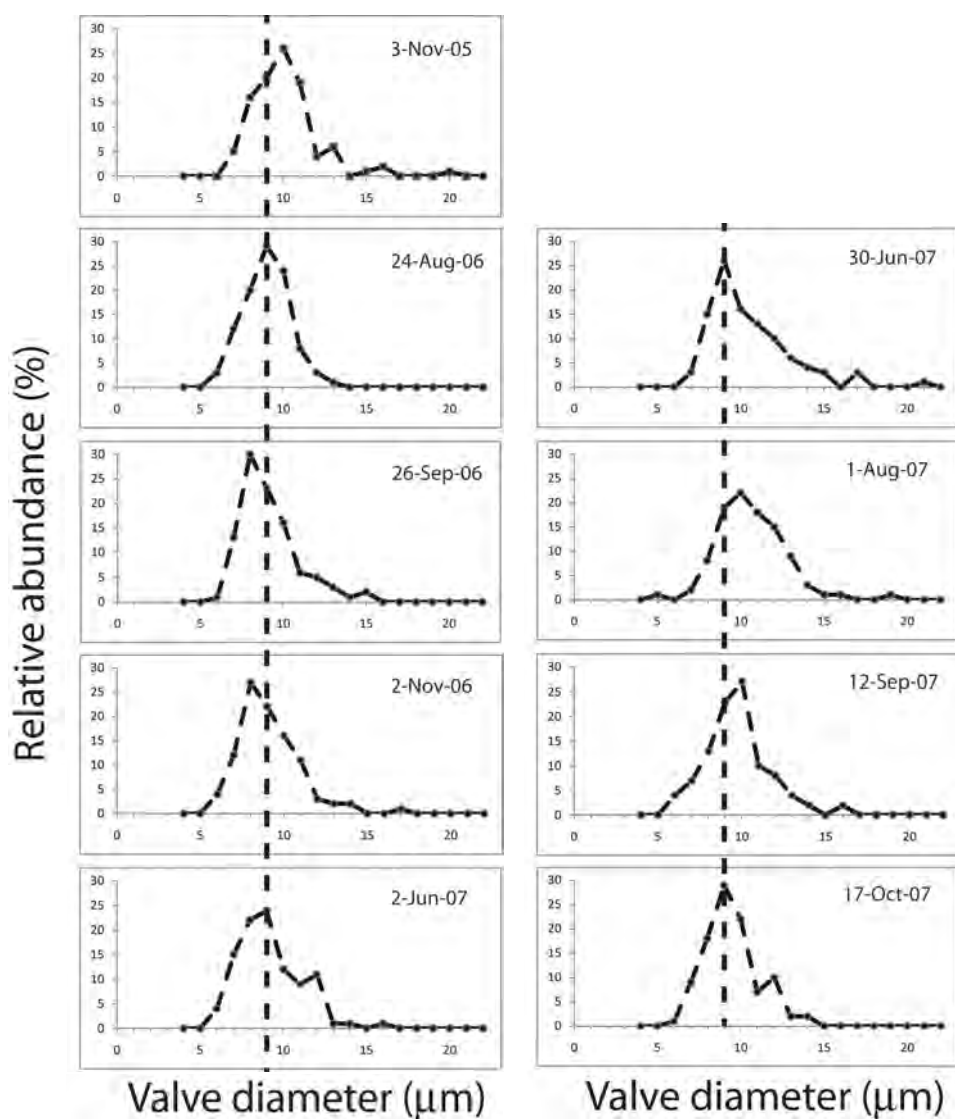

Fig. 46. Size variation in *Lindavia khinganensis* expressed by the relative size distributions ( $n = 100$ ) of valve diameters in the surface sediment (first sample, November 2005) and sediment trap samples collected from Lake Tuofengling. The dashed line indicates the size threshold of sexually inducible cells.

## DISCUSSION

### Species concept in “*Cyclotella*” *sensu lato*

There are two conflicting concepts regarding the taxonomy of the “*Cyclotella comta* complex”. Until the late 1990s the prevailing concept was a broad one in which *L. comta*, *L. radiosa* and *L. balatonis* were considered synonyms (Krammer & Lange-Bertalot, 1991). This is still the concept adopted by Genkal (2013) who considers these taxa as one species with very variable valve morphology. The conclusions of Genkal (2013) however, were based on a qualitative study of plankton samples collected from 23 lakes and reservoirs across Eurasia. No quantitative morphometric analysis of the data was proposed and the possibility that the material collected contained more than one species was not evaluated.

In recent years, most authors have adopted a narrower concept in which the three above taxa represent distinct species (e.g. Houk *et al.*, 2010; Budzyńska & Wojtal, 2011; Bahls, 2013b; Solak & Kulikovskiy, 2013; Nakov *et al.*, 2015).

It is interesting to compare our results with that of a recent study by Duleba *et al.* (2015) on the “*Cyclotella ocellata*” and “*Cyclotella comensis*” complexes, in which both morphological and genetic evidence were used. The morphological variability observed in the “*Cyclotella comensis* complex” and used to distinguish species such as *Cyclotella comensis* Grunow, *C. costei* Druart & F. Straub and *C. pseudocomensis* Scheffler (e.g. Houk *et al.*, 2010) is only related to the valve face with characters such as the number of radially symmetric valve sectors and the number of punctae. Duleba *et al.* (2015) showed that *C. costei* and *C. pseudocomensis* are conspecific with *C. comensis*. These morphological differences were sufficient however to separate *C. comensis* from *C. ocellata* Pantocsek in their CVA. These morphometric results were supported by molecular phylogeny.

As discussed by Theriot & Jones (2009), diatom taxonomists “...should not reason about the stability or utility of a character from one set of observations to another”. This means that what is valid for the “*C. comensis* complex” should not automatically be extended to other species complexes. For the “*C. comta* complex”, our morphometric analyses show that not only the number of punctae on the valve face but also the number of marginal fultoportulae contributed to the separation of *L. khinganensis* from the type material of the other taxa in the complex. The difference between taxa within the *C. comta* complex is even more obvious when considering the number of central fultoportulae and areolae (instead of just the number of punctae). In addition, ultrastructural details such as the thickness of the costae (see below for details) are also useful to separate the various taxa in this complex. By contrast, the internal views of all the “morphs” examined by Duleba *et al.* (2015) in the “*C. comensis* complex” were indistinguishable from one another.

The numbers of images analyzed from type material in our study are small but they still encompass the range of cell size for each of taxon investigated. So the morphological difference found between the *L. khinganensis* and the other taxa cannot be explained by size differences because their distinctness was found despite overlapping size ranges (Beszteri *et al.*, 2005).

### Comparison with other *Lindavia* species

The new species described here is comparable to several other species of *Lindavia*. The most similar under LM is *Lindavia tenuistriata* (Hustedt) Nakov *et al.*

(syn: *Cyclotella tenuistriata* Hustedt; *Cyclotella glabriuscula* (Grunow) Håkansson; *Handmannia glabriuscula* (Grunow) Kociolek & Khursevich) as both taxa have overlapping size range (Table 4), a fine striation pattern and low density of thick ribs (4-8 thin costae between 2 thicken ribs for *L. tenuistriata* according to Houk *et al.*, 2010). However, the complete absence of central fuloportulae in *L. tenuistriata* is a very obvious difference (as highlighted by the SEM-based CVA, Fig. 5). *L. tenuistriata* also differs from *Lindavia khinganensis* by, externally the presence on the valve face of radial rows of small granulae in the central area (Houk *et al.* 2010, fig. 2 p. 423) and internally, by the prominent internal projections of the marginal fuloportulae (Houk *et al.*, 2010, figs 4-6 p. 423). In fact, considering the absence of central fuloportulae, the radial rows of granulae and the position of its rimoportulae, it is possible that *L. tenuistriata* might be better placed within the newly erected genus *Theriotia* Kociolek *et al.* (2016) than within *Lindavia*.

Another species that appears similar to *L. khinganensis* is *Lindavia praetermissa* (Lund) Nakov *et al.* (syn: *Cyclotella praetermissa* Lund; *Handmannia praetermissa* (Lund) Kulikovskiy & Solak). In our SEM-based CVA (Fig. 5), *L. praetermissa* is distinguished from *L. khinganensis* by having a higher number of cfp. *L. praetermissa* also differs from *L. khinganensis* by the arrangement of the central fuloportulae, scattered among the areolae instead of arranged in a central ring and by the structure of the striae, that are composed of several rows of fine pori. More importantly, perhaps, the costae bearing the marginal fuloportulae in *L. praetermissa* are almost as thin as the costae non bearing fuloportulae (Houk *et al.* 2010) by contrast with *L. khinganensis* and other similar species of *Lindavia*. Genkal (2013) measured this character and found ranges of 0.24-0.28  $\mu\text{m}$  and 0.18-0.20  $\mu\text{m}$  for the thick and thin costae of *L. praetermissa*, respectively. For *L. khinganensis* the thickness of costae are in the ranges of 0.24-0.43  $\mu\text{m}$  (mean = 0.33, n = 25) and 0.11-0.24  $\mu\text{m}$  (mean = 0.17, n = 96) for the thick and thin costae, respectively. Therefore, the thickened costae are about twice as thick as the thin costae in *L. khinganensis*. A similar ratio is observed in *L. radiosa*, *L. comta* and *L. balatonis* (Genkal 2013) and in the Japanese taxon reported as *Puncticulata praetermissa* by Tanaka (2007). This ultrastructural feature and the results of our SEM-based CVA suggest that the Japanese taxon does not belong to *L. praetermissa*. This point had already been made by Genkal (2013) as he included this taxon in his broad concept of *Handmannia comta* while keeping *L. praetermissa* as a separate taxon. Yet, despite not being separated by quantitative LM and SEM data on the CVA diagrams, this Japanese taxon is probably not conspecific with *L. khinganensis* as SEM images published by Tanaka (2007) show a reticulate-verrucose central area externally (Pl. 57: figs 1-3) and well-defined interstriae on the valve margin (Pl. 57: figs 3-4) that were not observed in *L. khinganensis*.

*Lindavia khinganensis* could also be confused with *Lindavia balatonis* (syn: *Cyclotella balatonis* Pantocsek; *Puncticulata balatonis* (Pantocsek) Wojtal & Budzyńska; *Handmannia balatonis* (Pantocsek) Kulikovskiy & Solak). *L. balatonis* differs from *L. khinganensis* by having a more concave/convex valve face, a higher density of marginal fuloportulae (as seen in the CVA, Figs 4, 5), a higher number of rimoportulae and well-defined interstriae. In *L. khinganensis* the external openings of the rimoportula are situated at the end of a more or less shortened stria (Figs 24, 26, 28, 30). By contrast in *L. balatonis*, these striae are markedly shortened and the differences are more clearly visible from the internal valve views in which the rimoportula openings can be seen to be located very close to the internal alveolar openings (compare our Figs 32, 34, 37 with Figs 20 and 22 in Budzyńska & Wojtal, 2011 and Figs 1-6, Plate 271 in Houk *et al.*, 2010).

Table 4. Comparison of morphological characters for selected species of *Lindavia* as described in Houk *et al.* (2010) except when specified otherwise.

Taxon	<i>Lindavia khinganensis</i>	<i>Lindavia balatonis</i>	<i>Lindavia comita</i>	<i>Lindavia praetermissa</i>	<i>Lindavia radiosa</i>	<i>Lindavia tenuistriata</i>
Valve diameter (µm)	6.3-24.1	16-22; 8.7-21 <sup>1</sup>	5-32	8-30; 10.8-15.7 <sup>3</sup>	7-25; 10.9-23.8 <sup>3</sup>	5-30
Valve face	Flat or slightly concave/convex	slightly concave/convex	Flat to slightly concave/convex	flat	distinctly concentrically undulate/concave/convex	Concentrically undulate, convex/concave
Size of the central area (ratio Dc/D)	0.4-0.7	0.3-0.5	0.25-0.5	0.25-0.5	0.5	0.25-0.5
Circumferential stria density (nb/10 µm)	14-21 (median = 18)	16-22; 15-18.5 <sup>1</sup>	14-18	15-18	15-18	20-25
Circumferential density of marginal fulportulae (nb/10 µm)	1.7-3.9	3.5-4.7 <sup>1</sup>	2.9-5.2 <sup>4</sup>	2.8-6.6 <sup>4</sup>	3.0-5.9 <sup>4</sup>	3.1-3.6 <sup>4</sup>
Alternating pattern of thick/thin costae	(2) 4-6 (12)	2-4; 3 - 5 <sup>1</sup>	(2) 3-5	(2) 3-5 (7)	(2) 3-4	4-8
Satellite pores on mfp	2	2	2	2	2	2
Alveoli	radially elongated	relatively small	relatively small	radially elongated	relatively small	radially elongated
Thick costae thickness (µm)	0.24-0.42	0.45-0.57 <sup>2</sup>	0.65-0.71 <sup>2</sup>	0.24-0.28 <sup>2</sup>	0.47-0.59 <sup>2</sup>	n/a
Thin costae thickness (µm)	0.11-0.24, seldom forked	0.22-0.28 <sup>2</sup>	0.18-0.27 <sup>2</sup> , often forked	0.18-0.20 <sup>2</sup>	0.28-0.34, often forked	n/a
Valve face	smooth	smooth to colliculate	smooth	smooth	radially wrinkled	smooth
Arrangement of areolae in central area	scattered or ± radial rows	± radial rows	scattered or ± radial rows	scattered or radial rows	depressed radial rows	in radial rows

Density of areolae in central area (nb/10 $\mu\text{m}^2$ )	17-39	6-17 <sup>4</sup>	12-17 <sup>4</sup>	13-31 <sup>4</sup>	5-26 <sup>4</sup>	37-41 <sup>4</sup>
Arrangement of central fuloportulae	often arranged in a central ring	often arranged in a central ring	often arranged in a central ring	scattered among the areolae	inserted in radial rows	none
Density of central fuloportulae (nb/10 $\mu\text{m}^2$ )	1.9-6.5	1.9-5.2 <sup>4</sup>	1.6-3.0 <sup>4</sup>	4.0-12.7 <sup>4</sup>	1.4-5.9 <sup>4</sup>	0
Nb satellite pores on cfp	3, seldom 1, 2 or 4	3	3	3	(2) 3	n/a
Nb or rimoportulae	1-2	(1) 2-5	at least 1	1-5	at least 1	1-2
Orientation of rimoportulae (angle with tangential line)	oblique to radial, 35-90°	oblique to radial	oblique to circumferential	oblique to circumferential	oblique to circumferential	oblique to almost radial
Pattern of pori in marginal striae	2 rows of coarse pori with numerous finer pori scattered in between	2 rows of pori with numerous finer pori scattered between	2 to 4 rows of pori of pori	several rows of fine pori	2 to 4 rows of pori	one increasing to two rows of pori
Interstriae (in external view)	barely defined	well defined, raised	barely defined	barely defined	well defined, raised	well defined
Granulae	present in ~40% of valves	can be present	none	can be present	can be present	tows of granulae between rows of areolae in central area. Small granulae scattered on mantle
Spines	none	not reported	none	not reported	none	can be present on valve face/mantle junction

**References:** <sup>1</sup>Budzynska & Wojtal (2011); <sup>2</sup>Genkal (2013); <sup>3</sup>Bahls (2013); <sup>4</sup>this study, measured from images available in the literature (see Table 2)

One of the most distinguishing characters of the new species is the extremely narrow interstriae. This character can also be found in *Lindavia comta* (Kützing) Nakov *et al.* (Håkansson, 2002; Houk *et al.*, 2010). In *L. comta* however, the presence of pori on the costae is not a constant character, and a majority of valve have well-defined interstriae as illustrated in Houk *et al.* (2010; Tab. 259, page 355, contrast valves on figs 3, 6, 7 without well-defined interstriae with the other valves with clear interstriae). Besides, *L. comta* differs from *L. khinganensis* by having much lower density of areolae and cfp in its central area as shown in the CVA.

The CVA results clearly indicate that *Lindavia radiosa* and the fossil taxon identified by Huang *et al.* (1998) as *C. kuetzingiana* var. *radiosa* are distinct from *L. khinganensis*. Note that the identification proposed by Huang *et al.* (1998) is incorrect as Houk *et al.* (2010) showed that *Cyclotella kuetzingiana* var. *radiosa* taxon has no areolae with domed cribra in its central area and therefore does not belong to the “*Cyclotella comta* complex”. The LM and SEM images given by Huang *et al.* (1998) most likely belong to *Lindavia affinis* (Grunow) Nakov *et al.* as they match with the descriptions given by Houk *et al.* (2010) and Tanaka (2007).

*Lindavia lacunarum* (Hustedt) Nakov *et al.* is also broadly similar to *L. khinganensis*. We could not include this taxon in the CVA due to the paucity and/or poor quality of the LM and SEM images available in the literature (Houk *et al.*, 2010; Krammer & Lange-Bertalot, 1991). The external appearance of the striae in *L. lacunarum* is extremely similar to that of *L. khinganensis*, with two rows of coarse pori marking out the boundary of the internal alveoli, small pori scattered between them and extremely narrow interstriae (Houk *et al.*, 2010; Tab. 268 5 page 373). *L. lacunarum* however, clearly differs from *L. khinganensis* by having a strongly convex and colliculate central area.

Like in the other species of *Lindavia*, most central fultoportulae in *L. khinganensis* are surrounded by 3 satellite pores (98.2%, n = 436) but we found cases with 1 (0.2%), 2 (1.4%) and 4 satellite pores (0.2%). Central fultoportulae with 2 satellite pores can be found in several species of *Lindavia* as illustrated by Houk *et al.* (2010) for *Lindavia bodanica* (Euleinstein ex Grunow) Nakov *et al.*, *Lindavia intermedia* (Grunow) Nakov *et al.*, *L. praetermissa*, *Lindavia socialis* (Schütt) De Toni & Forti and *Lindavia styriaca* (Hustedt) Nakov *et al.*, and by Kociolek *et al.* (2014) for *Handmannia annulata* Kociolek (see below for the formal transfer of this taxon to the genus *Lindavia*). Genkal (2013) also reported finding central fultoportulae with 2-4 satellite pores in Russian populations of his *Handmannia comta/radiosa* complex. However, we have not found reports in the literature of cfp with 1 satellite pore like with found in *L. khinganensis* (Fig. 37).

### Seasonality, life-cycle and distribution

Regarding its seasonal distribution, *L. khinganensis* would appear to be most abundant in autumn when summer thermal stratification breaks down in Lake Tuofengling. Peak abundance in late summer and/or autumn has been reported previously for various species of *Lindavia* (e.g. Stoermer & Ladewski, 1976; Battarbee, 1981; Inokuchi & Maruyama, 1990; Morabito *et al.*, 2002; Baier *et al.*, 2004; Kienel *et al.*, 2005). *Lindavia* species have also been found associated with the circulation period in spring (Lund, 1951; Inokuchi & Maruyama, 1990; Padišák *et al.*, 2003, 2009; Simona, 2003; Rimet *et al.*, 2009; Budzyńska & Wojtal, 2011). In fact, from the literature it seems that *Lindavia* populations do not peak during thermal stratification in summer, and bloom during turnover events (e.g. Rioual



*et al.*, 2009; Saros *et al.*, 2012). A mid-summer peak in a Japanese lake reported by Inokuchi & Maruyama (1990) appears as an exception. In their review on lake diatom responses to warming Rühland *et al.* (2015) also considered *Lindavia* among the large, heavily silicified species with low surface area to volume ratios that require turbulence to remain in suspension in the water column. Beside turbulence, light conditions were also found to be important in explaining the distribution of *Lindavia* spp. (Interlandi *et al.*, 1999; Malik & Saros, 2016).

The cycle of size decline and size restoration is a mechanism used by most centric diatoms to time the length of their life cycle (Lewis 1984, Jewson 1992a, b Jewson *et al.* 2015). In the case of *Lindavia khinganensis*, it is probable that some size restoration went on at low frequencies, but with additional periods when more cells became involved, as in June 2007 described above. This is similar to the situation reported for *Aulacoseira subarctica* by Jewson (1992b), which resulted in life cycles of 3 to 5 years. In the case of *A. subarctica*, light conditions were the cue for switching to size restoration, but we do not yet know the nature of the cue for *L. khinganensis*. In summary, we can identify a growth period of asexual division between June and October, when the mixing depth increased before freezing of the lake in November. It is at the initial phase of this growth period that there was an increase in the proportion of cells involved in size regeneration. Size distributions are characteristic for a species, because of their link to the timing of the life cycle. Therefore, it is important to include such data where possible.

So far, *Lindavia khinganensis* has not been found in other lakes from NE China or anywhere else. It is however premature to consider this species as endemic of the Greater Khingan Range as it very likely that it was identified under a different name (e.g. “*Cyclotella comta*”) in previous taxonomic investigations.

Finally, preliminary results from the diatom analysis of a short sediment core revealed that *Lindavia khinganensis* has been a major component, both in terms of relative abundance and biovolume, of the diatom plankton flora of Lake Tuofengling for at least the past 600 years.

### **New combination arising from this study**

While studying the literature for this research we realized that the taxon *Handmannia annulata* Kociolek described by Kociolek *et al.* (2014) from lake sediments samples of the western U.S.A. was overlooked by Nakov *et al.* (2015) when they proposed the transfer of the species of *Handmannia* to the genus *Lindavia*. We make the formal transfer here.

### ***Lindavia annulata* (Kociolek) Rioual, **comb. nov.****

Basionym: *Handmannia annulata* Kociolek in Kociolek *et al.* (2014), Diatoms of the United States 1, *Bibliotheca Diatomologica* vol. 61, J. Cramer, pl. 15: figs 1-5, pl. 16: figs 1-5.

**Acknowledgements.** Dr Yan Fang (State Key Laboratory of Paleobiology and Stratigraphy, Nanjing) is thanked for assistance with the SEM. Several master students at IGG-CAS helped with fieldwork and the collection of trap samples and with water chemistry analyses. Dr Patrick Rioual acknowledges financial support from the National Science Foundation of China (grants # 41320104006 and 40502018). This research was also supported by the “Strategic Priority Research Program” of the Chinese Academy of Sciences, Climate Change: Carbon Budget and Relevant Issues (grant # XDA05120201-2).

## REFERENCES

- ÁCS É., ARI E., DULEBA M., DRESSLER M., GENKAL S.I., JAKÓ É., RIMET F., ECTOR L. & KISS K.T., 2016 — *Pantocsekiella*, a new centric diatom genus based on morphological and genetic studies. *Fottea, Olomouc* 16: 56-78.
- BAHLS L., 2013a — *Lindavia praetermissa*. In Diatoms of the United States. [http://westerndiatoms.colorado.edu/taxa/species/lindavia\\_praetermissa](http://westerndiatoms.colorado.edu/taxa/species/lindavia_praetermissa). Searched in 2017.
- BAHLS L., 2013b — *Lindavia radiosa*. In Diatoms of the United States. [http://westerndiatoms.colorado.edu/taxa/species/lindavia\\_radiosa](http://westerndiatoms.colorado.edu/taxa/species/lindavia_radiosa). Searched in 2017.
- BAIER J., LÜCKE A., NEGENDANK J.F.W., SCHLESER G.H. & ZOLITSCHKA B., 2004 — Diatom and geochemical evidence of mid- to late Holocene climatic changes at Lake Holzmaar, West-Eifel (Germany). *Quaternary international* 113: 81-96.
- BATTARBEE R.W., 1981 — Diatom and chrysophyceae microstratigraphy of the annually laminated sediments of a small meromictic lake. *Striae* 14: 105-109.
- BATTARBEE R.W. & KNEEN M.J., 1982 — The use of electronically counted microspheres in absolute diatom analysis. *Limnology and oceanography* 27: 184-188.
- BATTARBEE R.W., ANDERSON N.J., BENNION H. & SIMPSON G.L. 2012 — Combining limnological and palaeolimnological data to disentangle the effects of nutrient pollution and climate change on lake ecosystems: problems and potential. *Freshwater biology* 57: 2091-2106.
- BATTARBEE R.W., SIMPSON G.L., SHILLAND E., FLOWER R.J., KREISER A.M., YANG H. & CLARKE G., 2014 — Recovery of UK lakes from acidification: an assessment using combined palaeoecological and contemporary diatom assemblage data. *Ecological indicators* 37: 365-380.
- BESZTERI B., ÁCS E. & MEDLIN L.K., 2005 — Conventional and geometric morphometric studies of valve ultrastructural variation in two closely related *Cyclotella* species (Bacillariophyta). *European journal of phycology* 40: 89-103.
- BUDZYŃSKA A. & WOJTAL A.Z., 2011 — The centric diatom *Puncticulata balatonis* (Pantocsek) Wojtal et Budzyńska, comb. nov., in the plankton of eutrophic-hypertrophic Rusalka Lake (Western Poland). *Nova Hedwigia* 93: 509-524.
- CHU G., SUN Q., RIOUAL P., BOLTOVSKOY A., LIU Q., SUN P., HAN J. & LIU J., 2008 — Dinocyst microlaminations and freshwater “red tides” recorded in Lake Xiaolongwan, northeastern China. *Journal of paleolimnology* 39: 319-333.
- CHUDAEV D.A. & GOLOBOVA M.A., 2016 — *Diatom algae in deep lakes (Moscow Region)*. Moscow, Tovarischestvo nauchnykh izdaniy KMK, Moscow, 447 p. [in Russian].
- DULEBA M., KISS K.T., FÖLDI A., KOVÁCS J., KRALJ BOROJEVIĆ K., MOLNÁR L.F., PLENKOVIĆ-MORAJ A., POHNER Z., SOLAK C.N., TÓTH B. & ÁCS É., 2015 — Morphological and genetic variability of assemblages of *Cyclotella ocellata* Pantocsek/C. *comensis* Grunow complex (Bacillariophyta, Thalassiosirales). *Diatom research* 30: 283-306.
- GAO Q., RIOUAL P. & CHU G., 2016 — Lateglacial and early Holocene climatic fluctuations recorded in the diatom flora of Xiaolongwan maar lake, NE China. *Boreas* 45: 61-75.
- GENKAL S.I., MITROFANOVA E.Y. & KULIKOVSKIY M.S., 2013 — Morphological variability, taxonomy, and distribution of *Cyclotella bodanica* Eulenstein (Bacillariophyta) in Russia. *Inland water biology* 6: 85-97.
- GENKAL S.I., 2013 — Morphological variability, taxonomy, and ecology of species of the complex *Handmannia comita* / *H. radiosa* (Bacillariophyta). *International journal on algae* 15: 333-356.
- HÅKANSSON H., 1988 — A study of species belonging to the *Cyclotella bodanica/comita* complex (Bacillariophyceae). In: Round F.E. (ed.), *Proceedings of the 9th Diatom-Symposium – Bristol 1986*. Bristol, Biopress Limited, pp. 329-354.
- HÅKANSSON H., 2002 — A compilation and evaluation of species in the genera *Stephanodiscus*, *Cyclostephanos* and *Cyclotella* with a new genus in the family stephanodiscaceae. *Diatom research* 17(1): 1-139.
- HOFMANN G., WERUM M. & LANGE-BERTALOT H., 2011 — *Diatomeen im Süßwasser-Benthos von Mitteleuropa*. Ruggell/Liechtenstein, A.R.G. Gantner Verlag K.G., 908 p.
- HOUK V., KLEE R. & TANAKA H., 2010 — Atlas of freshwater centric diatoms with a brief key and descriptions Part III. Stephanodiscaceae A. *Cyclotella*, *Tertiarius*, *Discostella*. *Fottea* 10 (Supplement) : 1-498.
- HUANG C., MAO Y., LIU S. & CHENG Z., 1998 — *Atlas of limnetic fossil diatoms of China*. Beijing, China Ocean Press, 164 p.

- INOKUCHI M. & MARUYAMA K., 1990 — Intraspecific differences in *Cyclotella comta* populations in the Fuji Five lakes and Lake Ashino-ko in Japan. *Japanese journal of phycology (Sōrui)* 38: 105-117.
- INTERLANDI S.J., KILHAM S.S. & THERIOT E.C., 1999 — Responses of phytoplankton to varied resource availability in large lakes of the Greater Yellowstone ecosystem. *Limnology and oceanography* 44: 668-682.
- JIA Y., YU G., HE N., ZHAN X., FANG H., SHENG W., ZUO Y., ZHANG D. & WANG Q., 2014 — Spatial and decadal variations in inorganic nitrogen wet deposition in China induced by human activity. *Scientific reports* 4: 3763. DOI:10.1038/srep03763
- JEWSON D.H., 1992a — Life cycle of a *Stephanodiscus* sp. (Bacillariophyta). *Journal of phycology* 28: 856-866.
- JEWSON D.H., 1992b — Size reduction, reproductive strategy and the life cycle of a centric diatom. *Philosophical transaction of the Royal society London B* 336: 191-213.
- JEWSON D.H. & GRANIN N.G., 2015 — Cyclical size change and population dynamics of a planktonic diatom, *Aulacoseira baicalensis*, in Lake Baikal. *European journal of phycology* 50: 1-19.
- KIENEL U., SCHWAB M.J. & SCHETTLER G., 2005 — Distinguishing climatic from direct anthropogenic influences during the past 400 years in varved sediments from Lake Holzmaar (Eifel, Germany). *Journal of paleolimnology* 33: 327-347.
- KOCIOLEK J.P., LASLANDES B., BENETT D., THOMAS E., BRADY M. & GRAEFF C., 2014 — Diatoms of the United States 1. Taxonomy, ultrastructure and descriptions of new species and other rarely reported taxa from lake sediments in the Western U.S.A. In: Lange-Bertalot H. & Kociolek J.P. (eds). *Bibliotheca diatomologica vol. 61*, Stuttgart, J. Cramer, Gebr. Borntraeger Verlagsbuchhandlung, 188 p.
- KOCIOLEK J.P., YOU Q., STEPANEK J.G., LOWE R.L. & WANG Q., 2016 — New freshwater diatom genus, *Theriotia* gen. nov. of the Stephanodiscaceae (Bacillariophyta) from south-central China. *Phycological research* 64: 274-280.
- KRAMMER K. & LANGE-BERTALOT H., 1991 — Bacillariophyceae, 3. Teil: Centrales, Fragilariaceae, Eunotiaceae. In: Ettl H., Gerloff J., Heynig H. & Mollenhauer D. (eds). *Süßwasserflora von Mitteleuropa*. Bd. 2. Stuttgart and Jena, G. Fischer, 576 p.
- LANGE-BERTALOT H. & METZELTIN D., 1996 — Indicators of oligotrophy. 800 taxa representative of three ecologically distinct lake types. Carbonate buffered – oligodystrophic – weakly buffered soft water. In: Lange-Bertalot H. (ed.). *Iconographia Diatomologica, Band 2*, Königstein, Germany, Koeltz Scientific Books, 390 p.
- LEWIS W.M., 1984 — The diatom sex clock and its evolutionary significance. *American naturalist* 123:73-80.
- LIU X., ZHANG Y., HAN W., TANG A., SHEN J., CUI Z., VITOUSEK P.M., ERISMAN J.W., GOULDING K.W.T., CHRISTIE P., FANGMEIR A. & ZHANG F., 2013 — Enhanced nitrogen deposition over China. *Nature* 494: 459-462.
- LIU Y., WANG Q. & SHI Z., 2007 — Newly recorded species of Cymbellaceae (Bacillariophyta) from Da'erbin Lake Daxing'anling Mountains, China. *Journal of Wuhan botanical research* 25: 565-571. [in Chinese with English abstract].
- LIU Y., YOU Q. & WANG Q., 2009 — Newly recorded species of Nitzschiaceae (Bacillariophyta) from Da'erbin Lake in Great Xing'an Mountains, China. — *Journal of Wuhan botanical research* 27: 274-276. [in Chinese with English abstract].
- LIU Y., FU C., WANG Q. & STOERMER E.F., 2010 — A new species, *Diatoma rupestris*, from the Great Xing'an Mountains, China. *Diatom research* 25: 337-347.
- LIU Y., FU C., WANG Q. & STOERMER E.F., 2010 — Two new species of *Pinnularia* from Great Xing'an Mountains, China. *Diatom research* 25: 99-109.
- LIU Y., WANG Q. & FU C., 2011 — Taxonomy and distribution of diatoms in the genus *Eunotia* from the Da'erbin Lake and surrounding bogs in the Great Xing'an Mountains, China. *Nova Hedwigia* 92: 205-232.
- LIU Y., KOCIOLEK J.P. & WANG Q., 2013 — Six new species of *Gomphonema* Ehrenberg (Bacillariophyceae) species from the Great Xing'an Mountains, Northeastern China. *Cryptogamie, Algologie* 34: 301-324.
- LIU Y., FAN Y. & WANG Q.X., 2015 — Newly recorded genera and species of diatom from Great Xing'an mountains, China. *Acta hydrobiologica Sinica* 39: 382-393. [in Chinese with English abstract].
- LUND J.W.G., 1951 — Contributions to our knowledge of British algae. XII. A new planktonic *Cyclotella* (*C. praetermissa* n. sp.); notes on *C. glomerata* Bachmann and *C. catenata* Brun and the occurrence of setae in the genus. *Hydrobiologia* 3: 93-100.

- MALIK H.I. & SAROS J.E., 2016 — Effects of temperature, light and nutrients on five *Cyclotella sensu lato* taxa assessed with *in situ* experiments in arctic lakes. *Journal of plankton research* 38: 431-442.
- MANN D.G. & VANORMELINGEN P., 2013 — An inordinate fondness? The number, distributions, and origins of diatom species. *Journal of eukaryotic microbiology* 60: 414-420.
- MORABITO G., RUGGIU D. & PANZANI P., 2002 — Recent dynamics (1995-1999) of the phytoplankton assemblages in Lago Maggiore as a basic tool for defining association patterns in the Italian deep lakes. *Journal of limnology* 61: 129-145.
- NAKOV T., GUILLORY W.X., JULIUS M.L., THERIOT E.C. & ALVERSON A.J., 2015 — Towards a phylogenetic classification of species belonging to the diatom genus *Cyclotella* (Bacillariophyceae): transfer of species formerly placed in *Puncticulata*, *Handmannia*, *Pliocaenicus* and *Cyclotella* to the genus *Lindavia*. *Phytotaxa* 217: 249-264.
- PADISÁK J., SCHEFFLER W., SÍPOS C., KASPRZAK P., KOSCHEL R. & KRIENITZ L., 2003 — Spatial and temporal pattern of development and decline of the spring diatom populations in Lake Stechlin in 1999. *Archiv für hydrobiologie* 58: 135-155.
- PADISÁK J., CROSSETTI L.O., & NASELLI-FLORES L., 2014 — Use and misuse in the application of the phytoplankton functional classification: a critical review with updates. *Hydrobiologia* 621: 1-19.
- PANG W. & WANG Q., 2014 — Chrysophycean stomatocysts from the Aershan geological park (Inner Mongolia), China. *Phytotaxa* 187: 1-92.
- PIGNATA C., MORIN S., SCHARL A., TRAVERSI D., SCHILIRÒ T., DEGAN R., BARTLEY P., TU M., LIU H., PERES F., COSTE M., LIU W. & GILLI G., 2013 — Application of European biomonitoring techniques in China: are they a useful tool? *Ecological indicators* 29: 489-500.
- R DEVELOPMENT CORE TEAM 2013 — R a language and environment for statistical computing, R foundation for statistical computing. Available from: <http://www.R-project.org>
- RENBERG I., 1990 — A procedure for preparing large sets of diatom slides from sediment cores. *Journal of paleolimnology* 4: 87-90.
- RIMET F., DRUART J.-C. & ANNEVILLE O., 2009 — Exploring the dynamics of plankton diatom communities in Lake Geneva using emergent self-organizing maps (1974-2007). *Ecological informatics* 4: 99-110.
- RIOUAL P., CHU G.Q., LI D., MINGRAM J., HAN J. & LIU J., 2009 — Climate-induced shifts in planktonic diatoms in Lake Sihailongwan (North-East China): a study of the sediment traps and palaeolimnological records. *Proceedings of the 11th International Paleolimnology Symposium*, Guadalajara, Mexico, p. 120.
- RIOUAL P., GAO Q., PENG Y. & CHU G., 2013a — *Stauroneis lacusvulcani* sp. nov. (Bacillariophyceae), a new diatom from volcanic lakes in northeastern China. *Phytotaxa* 148: 47-56.
- RIOUAL P., LU Y., YANG H., SCUDERI L.A., CHU G., HOLMES J.A., ZHU B. & YANG X., 2013b — Diatom-environment relationships and a transfer function for conductivity in lakes of the Badain Jaran Desert, Inner Mongolia, China. *Journal of paleolimnology* 50: 207-229.
- RÜHLAND K.M., PATERSON A.M. & SMOL J.P., 2015 — Lake diatom responses to warming: reviewing the evidence. *Journal of paleolimnology* 54: 1-35.
- SAROS J.E., STONE J.R., PEDERSON G.T., SLEMMONS K.E.H., SPANBAUER T., SCHLIEP A., CAHL D., WILLIAMSON C.E. & ENGSTROM D.R., 2012 — Climate-induced changes in lake ecosystem structure inferred from coupled neo- and paleoecological approaches. *Ecology* 93: 2155-2164.
- SAROS J.E. & ANDERSON N.J., 2015 — The ecology of the planktonic diatom *Cyclotella* and its implications for global environmental change studies. *Biological reviews* 90: 522-541.
- SHI F., SASA K. & KOIKE T., 2010 — Characteristics of larch forests in Daxingan Mountains, Northeast China. In: Osawa A. *et al.* (eds.): *Permafrost Ecosystems: Siberian Larch Forests, Ecological studies*, Vol. 209, Springer Science+Business Media B.V., pp. 367-383.
- SIMONA M., 2003 — Winter and spring mixing depths affect the trophic status and composition of phytoplankton in the northern basin of Lake Lugano. *Journal of limnology* 62: 190-206.
- SOLAK C.N. & KULIKOVSKIY M., 2013 — Species composition and distribution of centric diatoms from Türkmen Mountain (Sakarya River Basin/Turkey). *Turkish journal of botany* 37: 589-596.
- SPAULDING S.A., OTU M.K., WOLFE A.P. & BARON J.S., 2015 — Paleolimnological records of nitrogen deposition in shallow, high-elevation lakes of Grand Teton National Park, Wyoming, U.S.A. *Arctic, Antarctic, and Alpine research* 47: 703-717.

- STOERMER E.F. & LADEWSKI T.B., 1976 — *Apparent optimal temperatures for the occurrence of some common phytoplankton species in southern Lake Michigan*. Great Lakes Research Division, Publication 18, Ann Arbor, The University of Michigan, 49 p.
- STERRENBURG F.A.S., HAMILTON P. & WILLIAMS D., 2012 — Universal coordinate method for locating light-microscope specimens. *Diatom research* 27: 91-94.
- ŠMILAUER P. & LEPSŠ J., 2014 — *Multivariate analysis of ecological data using Canoco 5, second edition*. Cambridge, UK, Cambridge University Press, 362 p.
- TAN X., SHELDON F., BUNN S.E. & ZHANG Q., 2013 — Using diatom indices for water quality assessment in a subtropical river, China. *Environmental science and pollution research* 20: 4164-4175.
- TANAKA H., 2007 — Taxonomic studies of the Genera *Cyclotella* (Kützing) Brébisson, *Discostella* Houk et Klee and *Puncticulata* Håkansson in the family Stephanodiscaceae Glezer et Makarova (Bacillariophyta) Japan. In: Lange-Bertalot H. & Kociolek J.P. (eds), *Bibliotheca diatomologica, Band 53*, Berlin, J. Cramer, 205 p.
- TER BRAAK C.J.F. & ŠMILAUER P., 2012 — *Canoco reference manual and user's guide. Software for ordination (version 5.0)*. Ithaca, NY, USA, Microcomputer Power, 496 p.
- THERIOT E., 1988 — An empirically based model of variation in rotational elements in centric diatoms with comments on ratios in phyecology. *Journal of phycology* 24: 400-407.
- THERIOT E.C. & JONES B., 2009 — The morphology, physiology and taxonomy of two small *Stephanodiscus* species in Yellowstone Lake and Jackson Lake, Wyoming, USA. *Nova Hedwigia, Beiheft* 135: 275-293.
- WANG L., TIAN M., WEN X., ZHAO L., SONG J., SUN M., WANG H., LAN Y. & SUN M., 2014 — Geoconservation and geotourism in Arxan-Chaihe volcano area, Inner Mongolia, China. *Quaternary international* 349: 384-391.
- WETZEL R.G., 2001 — *Limnology: Lake and river ecosystems. Third edition*. San Diego, Academic Press, 1006 p.
- WILLIAMS D.M. & KOCIOLEK J.P., 2007 — Pursuit of a natural classification of diatoms: history, monophyly and the rejection of paraphyletic taxa. *European journal of phycology* 42: 313-319.
- WOJTAL A.J. & KWANDRANS J., 2006 — Diatoms of the Wyzyna Krakowsko-Czestochowska upland (S Poland) – Coscinodiscophyceae (Thalassiosirophycidae). *Polish botanical journal* 51(2): 177-207.
- WOLFE A.P. & SIVER P.A., 2009 — Three extant genera of freshwater Thalassiosiroid diatoms from middle Eocene sediments in northern Canada. *American journal of botany* 96: 487-497.
- WU B., LIU Y. & WANG Q.X., 2015 — Newly recorded species in Bacillariophyta from the Great Xing'an Mountains in China. *Plant science journal* 33: 144-150. [in Chinese with English abstract].
- WUNSAM S., SCHMIDT R. & KLEE R., 1995 — *Cyclotella*-taxa (Bacillariophyceae) in lakes of the alpine region and their relationship to environmental variables. *Aquatic sciences* 57(4): 360-386.
- YOU Q., LIU Y. & WANG Q., 2011 — Newly recorded species of *Hantzschia* (Bacillariophyta) in China. *Bulletin of botanical research* 31: 129-133 [in Chinese with English abstract].
- ŻELAZNA-WIECZOREK J., 2011 — Diatom flora in springs of Łódź Hills (central Poland). Biodiversity, taxonomy, and temporal changes of epipsammic diatom assemblages in springs affected by human impact. In: Witkowski A. (ed.), *Diatom Monographs vol. 13*, Ruggell, A.R.G. Gantner Verlag K.G., 419 p.

