

SHARP

MX-M850

Black & White Production Machine



SETTING NEW STANDARDS
IN DOCUMENT PRODUCTION

BLACK & WHITE PRODUCTION MACHINE

MX-M850

Black & White Production Machine

A BREAKTHROUGH IN DOCUMENT PRODUCTION

First-class reliability, productivity,
operability, finishing options,
expandability, security
and serviceability

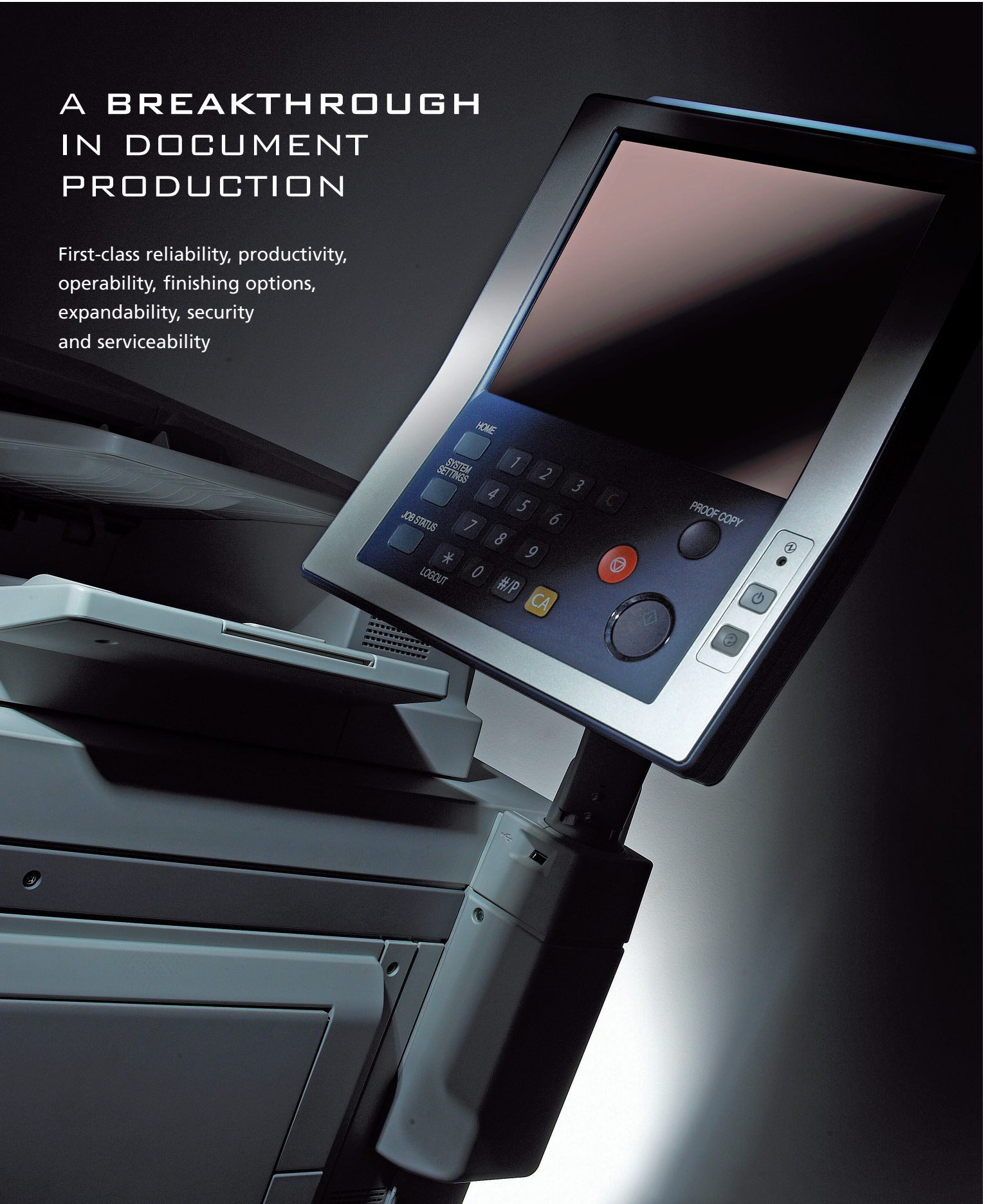

A WHOLE NEW PERFORMANCE BENCHMARK

Sharp's MX-M850 sets a new performance benchmark for high-speed black and white products; delivering the versatility, performance and dependable reliability that you need to support everyone's document production needs. Its innovative design and true walk-up simplicity lets everyone benefit from the MX-M850 straight away, and its highly customisable software architecture and flexible options let you customise it to meet your exact requirements.

A GREAT ALL-ROUNDER

The MX-M850 is perfect for any large office or busy workgroup that needs to produce high volume and/or advanced office documents at high speeds. And, unlike other highly specified machines, it really is easy enough for everyone to get to grips with. An extra large LCD screen and user-friendly graphical interface make complex jobs simple, while low running costs, easy maintenance and a wide range of finishing options make it ideal for everyday use.



BLI Pick of the Year 2007 -
Outstanding Segment 5 Monochrome MFP



MX-M850

Black & White Production Machine

ENGINEERED TO THE HIGHEST STANDARDS

The rugged design of the MX-M850 production machine mean built-in reliability and minimum downtime. The purpose-built, highly rigid framework was specifically designed to protect critical components and to withstand the stress of any demanding office or production environment. And that's just one of the reliability features. Others include:

MULTIPLE INDEPENDENT MOTOR UNITS

for key components such as the paper transfer developer units; increasing reliability and ensuring trouble-free paper transportation.

DEVELOPER COOLING SYSTEM

to prevent excessive heat build-up during heavy use, ensuring predictable, consistent image quality from the first page through to the very last.

FULL FRONT ACCESS FOR EASY SERVICING

Everything about the new MX-M850 is designed for maximum productivity. The full front access means that units simply slide out for immediate adjustment or replacement; the toner can be replenished without interrupting the print run, and also the firmware is upgradeable over the network or a USB port. The result is fewer and shorter interruptions and the highest possible return on your investment.

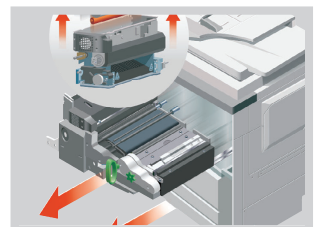
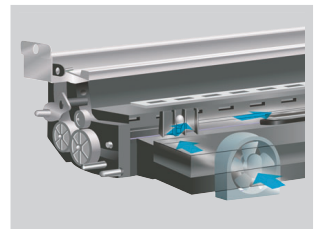
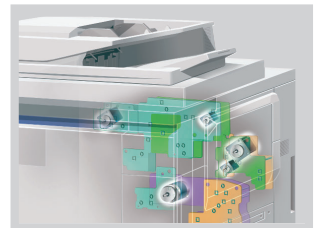

INCREASED DURABILITY
AND RELIABILITY

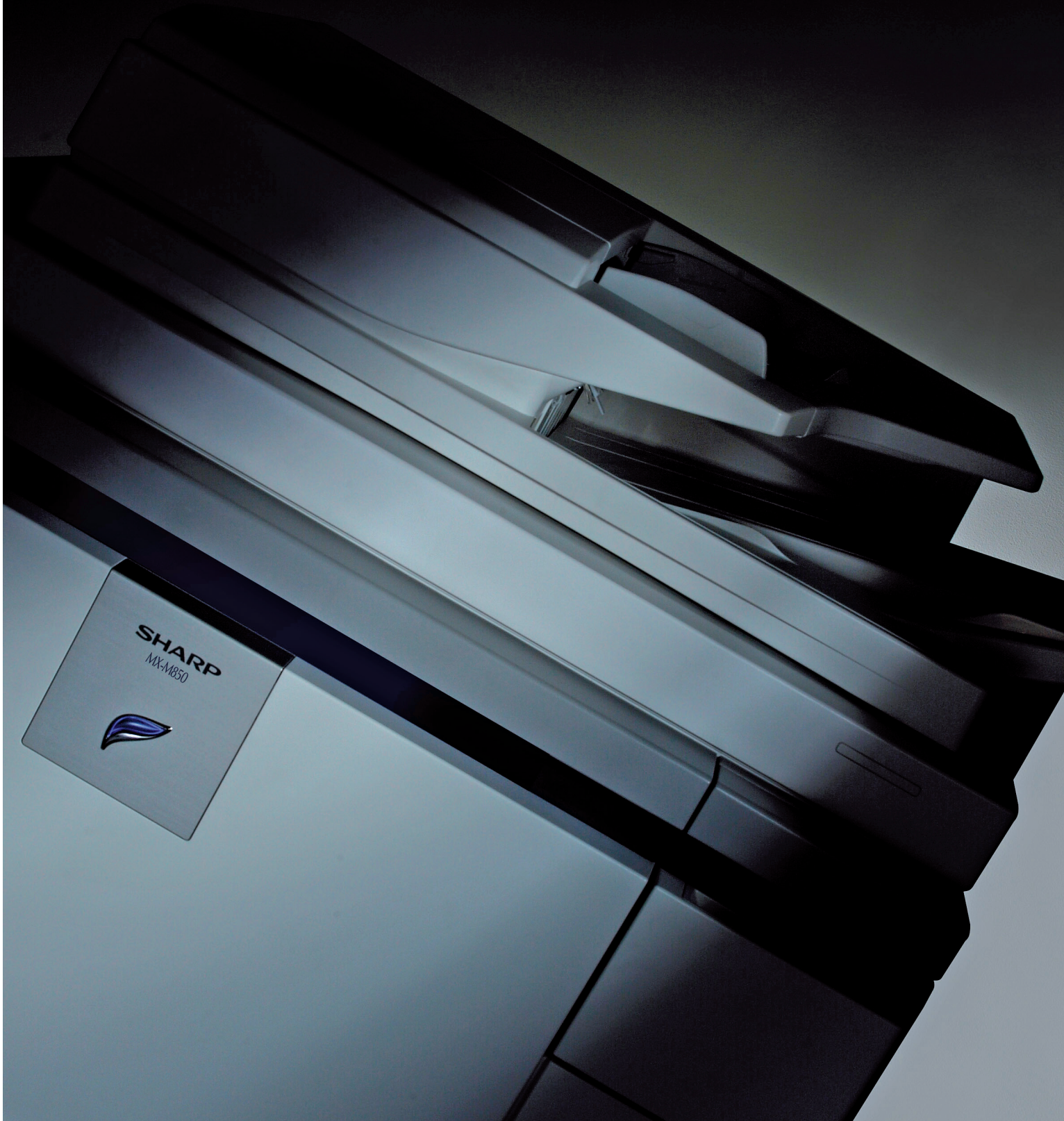

MX-M850

Black & White Production Machine

WIDE CHOICE OF
FINISHING OPTIONS

A detailed, low-angle, close-up photograph of the MX-M850 Black & White Production Machine's finishing mechanism. The image shows the intricate internal components, including rollers, gears, and paper paths, all rendered in a dark, industrial aesthetic. The lighting is dramatic, highlighting the metallic and plastic surfaces against a deep black background. The text 'WIDE CHOICE OF FINISHING OPTIONS' is overlaid in white, sans-serif capital letters on the left side of the image.

PROFESSIONAL LOOKING OUTPUT



As you would expect from Sharp, the speed and quality of the MX-M850 is enhanced by a wide range of professional finishing options. Whatever your challenge - sorting, stacking, stapling, punching, folding - this versatile machine can take care of it.

Stapled or hole punched office documents and saddle stitched or perfect bound booklets: now any number of complex jobs can be handled in their entirety with just a few keystrokes. Add to this an up to 8-way paper supply*¹ and the ability to handle stock up to 300gsm*², and it's easy to see why the MX-M850 is setting new standards in document production.

OPTIONS AT A GLANCE

- **Versatile stapling capabilities** - with a finisher that provides a choice of 4 staple positions and up to 100-sheet stapling capacity.
- **Booklet-making saddle unit** - for a wide range of everyday finishing capabilities with 15-sheet saddle stitch.
- **Various hole punch** - for professional looking office documents.
- **GBC® SmartPunch™** - supports commonly used binding styles.
- **Sophisticated Z-folding unit** - which automatically folds A3 into A4, or A4 into A5, allowing effortless inclusion of larger sheets in smaller sized document sets.
- **Cover Inserter** - for automatically inserting pre-printed covers and card dividers in their correct positions in multi-page documents.
- **Professional Booklet Maker** - for producing professional quality, perfect bound booklets of up to 120 pages. Various options include the Square Folder for producing squared printable spines; the Trimmer for trimming off the shingle on thicker booklets, and a Cover Feeder for adding alternative covers to the booklet.



Top Stapling



Top Slant Stapling



Bottom Stapling



2 Stapling



Booklet Stapling



4-Hole Punch



2-Hole Punch



4-Hole Wide Punch



GBC Punch



Z-Fold



Offset Finishing



Professional Booklet Maker



GBC Punch

*1 Requires maximum number of paper trays

*2 Via MX-LCX5 paper trays or MX-MFX1 bypass tray

MX-M850

Black & White Production Machine

THE KEY FEATURES

Take one look at the specifications of the MX-M850 and you'll see that it's ideal for use in busy and demanding walk-up environments. Its impressive output speed of 85 pages per minute and ability to handle stock of up to 300 gsm are complemented by a generous, up to 8-way 8050-sheet paper supply; a fast scanning speed of 85 images per minute (with optional network and colour scanning) and a huge choice of finishing options. Precision engineering for proven durability and surprisingly quiet operation make it easy to own and work with, too.



PRODUCTIVITY

- High-speed output of 85ppm
- First copy out time in 4 seconds
- Warm up time: 240 sec.
- Large paper capacity of max. 8050 sheets
- Std 250-sheet DSPF, optional colour scanning, up to 85 opm
- Network tandem function that links two machines in the same network doubles the output speed up to 170 ppm and increases the paper capacity up to 16100 sheets
- 'Load while run' easy toner changing

RELIABILITY

- Average copy/print volume of up to 200K (Max. 500k)
- Highly rigid Main Frame for high durability
- Developer Cooling System for consistent image quality
- Multiple Independently Driven Units for more reliable machine operation

EXPANDABILITY

- Optional A3 & A4 large capacity trays for maximum paper capacity
- Fully customisable third-party applications via Sharp OSA® (Open Systems Architecture)
- Optional Fiery print controller for increased print performance and job management
- Sophisticated finishing options for all your day-to-day document finishing needs
- Super G3 fax option for faster faxing capability

SECURITY

- Optional Data Security Kit encrypts and overwrites confidential data
- Secure embedded network interface with IP/MAC address filtering
- Secure Sockets Layer (SSL)/IPSEC prevent unauthorised interception across the network
- Secure data storage for filing confidential documents

OPERABILITY

- 10.4" colour touch TFT LCD control panel with user friendly graphic interface
- Job Status Lamp for visible machine diagnosis
- Extremely quiet in operation
- Std network card allows for remote administration

SERVICEABILITY

- Full front access to all the machine key components ensure easy servicing and thus maximum uptime
- 1,000k long life drum
- 500k PM Cycle



MX-M850

Black & White Production Machine

A STEP UP IN WALK-UP
PERFORMANCE





Paper capacity up to 8050 sheets

HIGH PRODUCTIVITY AND EASE OF USE

Capable of printing* up to 8050 pages at a speed of 85 ppm with a superb array of performance-boosting features, the MX-M850 will raise productivity and efficiency right across any large office or busy workgroup.

A generous 2560Mb memory makes light work of large and graphic-intensive jobs; up to 59,000 pages can be stored for instant retrieval, thanks to the 80GB internal hard disk, and a 250-sheet A3 Duplex Single Pass Feeder with optional colour capability makes it easy to scan and copy large volumes of two-sided documents. You can even use two machines in tandem, for a combined output speed of 170 pages per minute and a capacity of 16,100 sheets.

VERSATILE PRINTING FUNCTIONS

- Direct printing of TIFF, JPEG and PDF files without special applications.
- FTP Server Printing - select and print files on FTP server from LCD control panel.
- Web Submit Print - set and print files from the network using the built-in web page.
- Prints directly from - and scans directly to - any standard plug-in USB storage device.
- Prints directly from email

MAXIMUM CONVENIENCE

Controlling jobs on the MX-M850 is easy either remotely, via an embedded web page that's accessible over the network or directly, thanks to a 10.4 inch colour LCD screen. This large control panel is equipped with highly visible red/green job status lights that can be seen from right across the room.

FIERY PRINT CONTROLLER

The optional Fiery Print Controller makes it easy to manage large or complex jobs. It comes with a number of powerful productivity tools for better process management, faster print processing, reduced manual intervention and superior workflow.

*Requires optional MX-PBX2



Colour LCD touch panel with highly visible Job Status Lamp

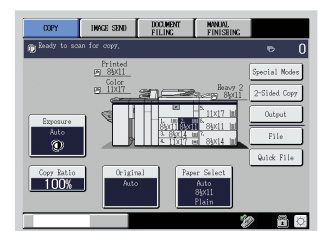

Intuitive Operator Interface - easy-to-use and easy-to-understand



MX-M850

Black & White Production Machine

POWERFUL SECURITY AND BUSINESS SOLUTIONS

Sharp has a selection of powerful solutions that both safeguard and advance your business. The MX-M850 has several proven security features and options to protect your data from any known data threat or unauthorised access. Sharp Open Systems Architecture (OSA®) on the other hand offers a platform to get more out of your business and production applications.

TOUGH MULTI-LEVEL DATA SECURITY

- **Data Security Kit** - encrypts and then overwrites residual data.
- **Secure network interface card** - provides a firewall that prevents access by unauthorised third parties.
- **Secure Sockets Layer (SSL)/IPSEC** - encrypts network communications to prevent unauthorised interception across the network.
- **IPv6** - next generation Internet protocol to ensure an even higher level of network security.
- **User authentication** - requires a password for machine access.
- **Confidential data storage and printing** - protects sensitive information by requiring the user to enter a PIN code at the machine before the documents are produced.
- **Encrypted PDF** with password protection prevents unauthorised viewing of confidential image data.

BRING YOUR PRODUCTION MACHINE TO A NEW LEVEL

A Sharp innovation, Sharp OSA® (Open Systems Architecture) development platform, allows users to control the power of their back-end systems right from the control panel. It's really a new way of thinking with "power at the panel" for automation of various everyday jobs. It can truly save time and increase the efficiency, because it can be virtually seamless to the user. Any MX-M850 anywhere in the organisation can display choices that were once only available on a desktop PC, and with one-touch access to business applications via Sharp OSA integration, you can start and finish a document distribution task without a worry.

MAIN BENEFITS AT A GLANCE

- Automate tasks and save time with seamless integration between the MX-M850 and network applications
- Centralised applications minimise set-up and installation of multiple Sharp products
- Virtually eliminates repetitive tasks and streamlines workflow, increasing efficiency
- Maximise your return on investment with tighter integration among IT assets
- Industry standard programming leads to faster deployment of new solutions



**BEST-IN-CLASS DATA
PROTECTION AND
CUSTOMISED APPLICATIONS**

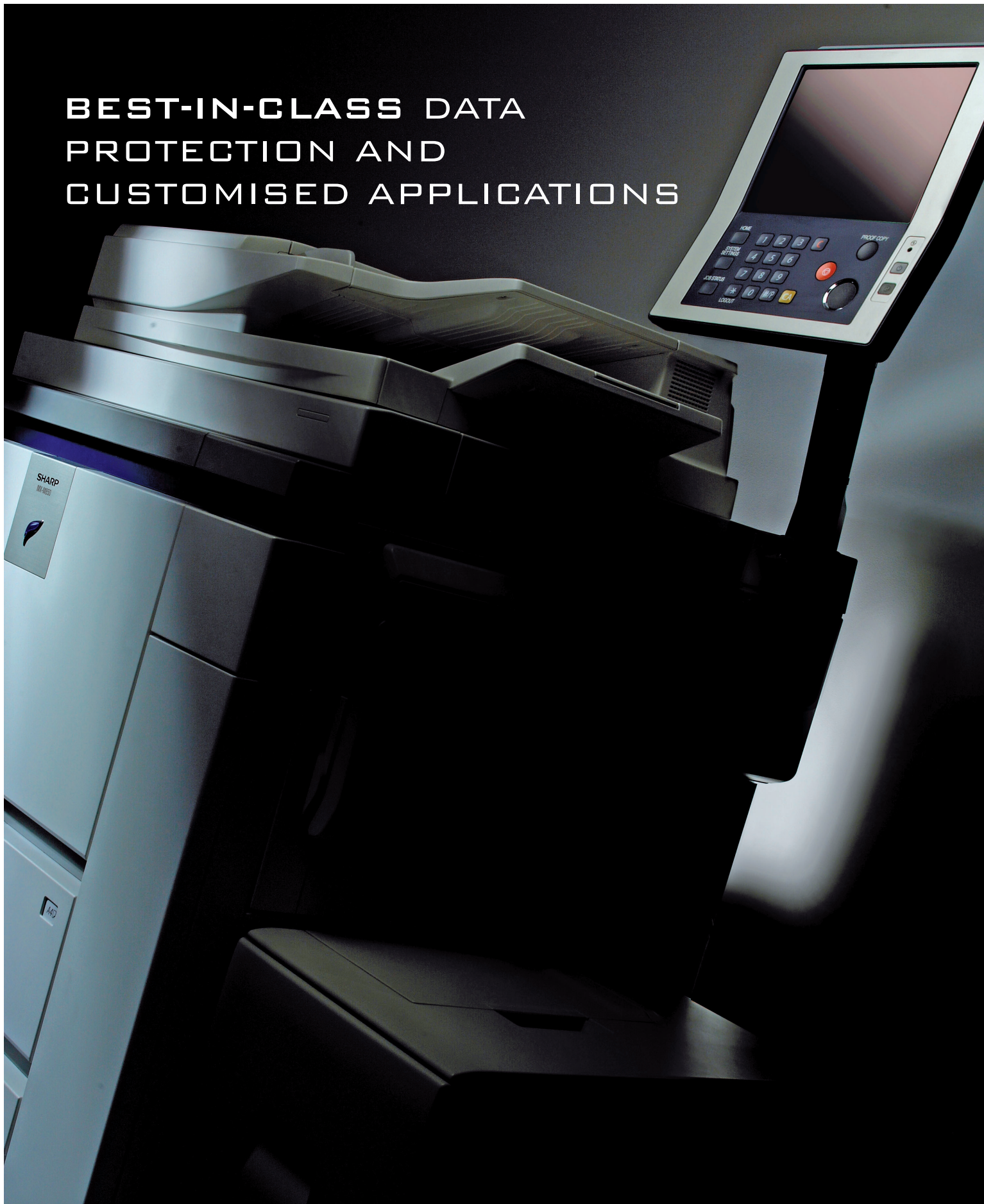

MX-M850

Black & White Production Machine

OPTIONS

The MX-M850's speed and ease of use are complemented by a full range of paper capacity, finishing and connectivity options, to make them ideal for handling any office production job from the simplest to the most complex.

Finishing

- 1. MX-FNX7 Saddle Stitch Finisher**
Paper size: A3W - A5R
Upper tray: 250 sheets
Middle tray: 2000 sheets
Saddle stitch tray (lower) 30 sets (2 to 5 sheets), 15 sets (6 to 10 sheets), 10 sets (11 to 15 sheets)
Stapling position: 4 locations (top, top slant, bottom, 2 staples) and saddle stitch, Stapling capacity: 50 sheets, 15 sheets for saddle stitch only (no hole punch)
- 2. MX-FNX6 Finisher**
Paper size: A3W to A5R
Upper tray: 250 sheets
Lower tray: 3000 sheets
Stapling position: 4 locations (top, top slant, bottom, 2 staples),
Stapling capacity: 50 sheets
- 3. Punch Unit for MX-FNX6 and MX-FNX7 Finisher**
MX-PNX4A - 2 holes
MX-PNX4C - 2 or 4 holes
MX-PNX4D - 4 hole wide
- 4. MX-FNX5 Finisher**
Paper size: A3W to A5R,
Upper tray: 500 sheets
Lower tray: 3000 sheets
Stapling position: 4 locations (top, top slant, bottom, 2 staples)
Stapling capacity: 100-sheets
- 5. Punch Unit for MX-FNX5 Finisher**
MX-PNX3A - 2 or 3 holes
MX-PNX3C - 2 or 4 holes
MX-PNX3D - 4 hole wide
- 6. MX-GBX1 GBC SmartPunch™**
Dimensions (W x H x D): 305 x 978 x 723 mm
Paper size: A4
Paper weight for Punching: 75 - 216 gsm except for ProClick which is 160 gsm

MX-GBX20	20 Hole Plastic Comb
MX-GBX21	21 Hole Plastic Comb
MX-GBX23	23 Round Hole Wire
MX-GBX34	34 Round Hole Wire
MX-GBX2H65	2 Hole 6.5mm Round
MX-GBX4H65	4 Hole 6.5mm Round
MX-GBX2H80	2 Hole 8mm Round
MX-GBX4H80	4 Hole 8mm Round
MX-GBX12	12 Hole VeloBind
MX-GBX47	47 Hole Colour Coil
MX-GBX34PR	34 Square Hole ProClick

MX-GBXCVR **Cover Kit (required for use with MX-FNX8)--**

Finishing

- 7. MX-FNX8 Saddle unit**
Paper size: A3W - B5R
Saddle stitch tray: 30 sets (2 to 5 sheets), 15 sets (6 to 10 sheets), 10 sets (11 to 15 sheets)
Stapling position: saddle stitch only
Saddle stitch capacity: up to 15 sheets (no hole punch)
- 8. MX-FDX1 Advanced Z-folding unit**
- 9. MX-CFX2 Inserter**
Upper tray: 200 sheets
Lower tray: 200 sheets
- 10. MX-BMX1 Professional Booklet Maker**
Min paper size: 206 x 275 mm
Max paper size: 320 x 457.2 mm
Paper weight: 64g - 300 gsm
Dimensions (W x H x D): 1420 x 970 x 700 mm (incl. Stacker)
Weight: 130 kg

Options

- 11. MX-CFX3 Cover Feeder**
Min Paper Size: 206 x 275 mm
Max Paper Size: 320 x 457.2 mm
Paper weight: 70 - 300 gsm
Dimensions (W x H x D): Incl. with booklet maker
Weight: 7 kg
- 12. MX-FDX2 Square Folder**
Min Paper Size: 206 x 275 mm
Max Paper Size: 320 x 457.2 mm
Paper weight: 64 - 300 gsm
Dimensions (W x H x D): 360 x 900 x 620 mm
Weight: 52 kg
- 13. MX-TMX1 Trimmer**
Min Paper Size: 206 x 275 mm
Max Paper Size: 320 x 457.2 mm
Paper weight: 64 - 300 gsm
Dimensions (W x H x D): 360 x 900 x 620 mm
Weight: 65 kg

MX-XBX1 Rail Unit
For easy docking/undocking from MFP
MX-SCX4 Staple Cartridge
5000 staples per cartridge

Expandability

- 14. MX-LCX3N A3 Large Capacity Tray**
3000 sheets
Max. paper weight 205 gsm
- 15. MX-LCX6 A4 Large Capacity Tray**
3500 sheets
Max. paper weight 205 gsm
- 16. MX-LCX4 A4 Large Capacity Trays (3 trays)**
4550 sheets
Max. paper weight 205 gsm
- 17. MX-LCX5 A3 Large Capacity Trays (3 trays)**
4000 sheets
Max. paper weight 300 gsm
- 18. MX-MFX1 Multi bypass Tray**
100 sheets (required with MX-LCX3N/LCX6)
Max. paper weight 300 gsm
- 19. MX-MFX2 Multi bypass tray**
500 sheets
Max. paper weight 205 gsm (optional with MX-LCX4/LCX5)

Connectivity

- | | |
|-----------------------------|--|
| Printing | |
| MX-PBX2 | Printer expansion kit |
| 20. MX-PEX3 | Fiery Print Controller |
| MX-PXX3 | Fiery print controller interface connection kit |
| MX-PKX4 | PostScript expansion kit |
| AR-PF1 | Barcode font kit |
| Scanning | |
| MX-NSX1 | Network scanner expansion kit |
| MX-EBX1 | Colour expansion kit |
| AR-SU1 | Stamp Unit |
| Faxing | |
| MX-FWX1 | Internet-FAX expansion kit |
| MX-FXX1 | Super G3 fax kit |
| Sharpdesk™ licenses: | |
| MX-USX1 | Sharpdesk 1-License Kit |
| MX-USX5 | Sharpdesk 5-License Kit |
| MX-US10 | Sharpdesk 10-License Kit |
| MX-US50 | Sharpdesk 50-License Kit |
| MX-USA0 | Sharpdesk 100-License Kit |
| Security | |
| MX-FRX8U | Data Security Kit (Commercial version or MX-FRX8 Data Security Kit*) |
| Sharp OSA® | |
| MX-AMX1 | Application Integration Module |
| MX-AMX2 | Application Communication Module [†] |
| MX-AMX3 | External Account Module [‡] |

[†] Available at a later date

[‡] Cannot be installed with MX-FRX8

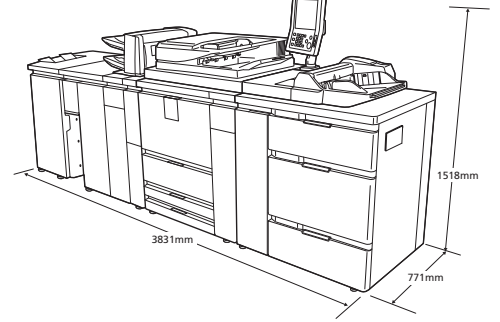
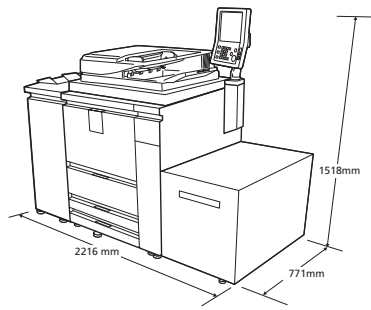

Office Configuration

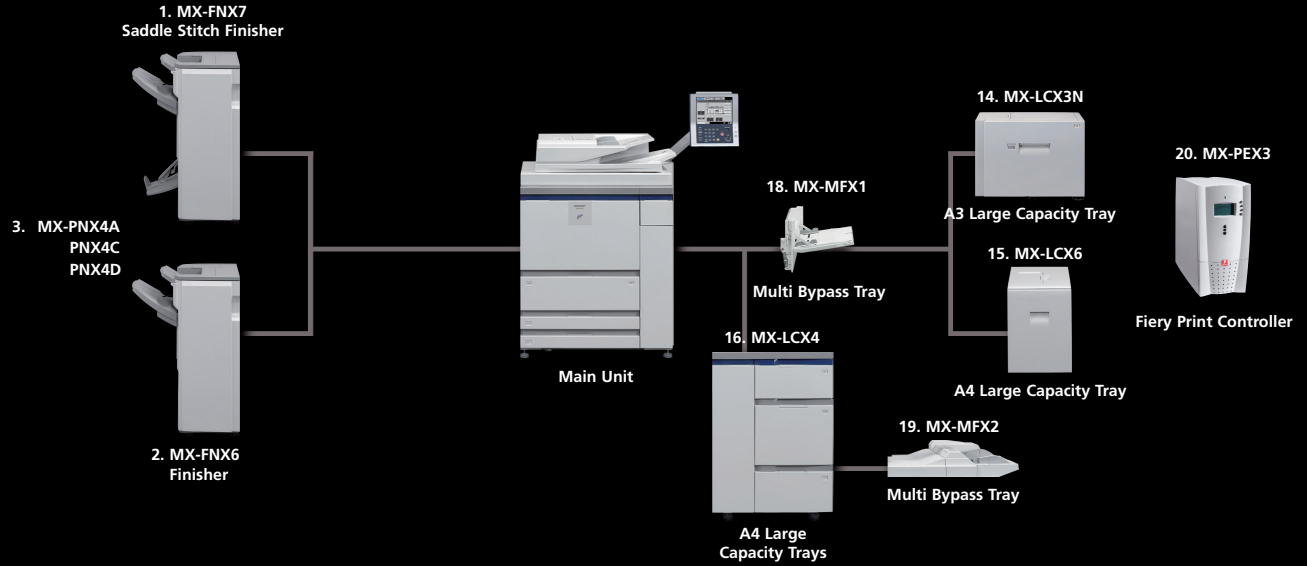

Production Configuration

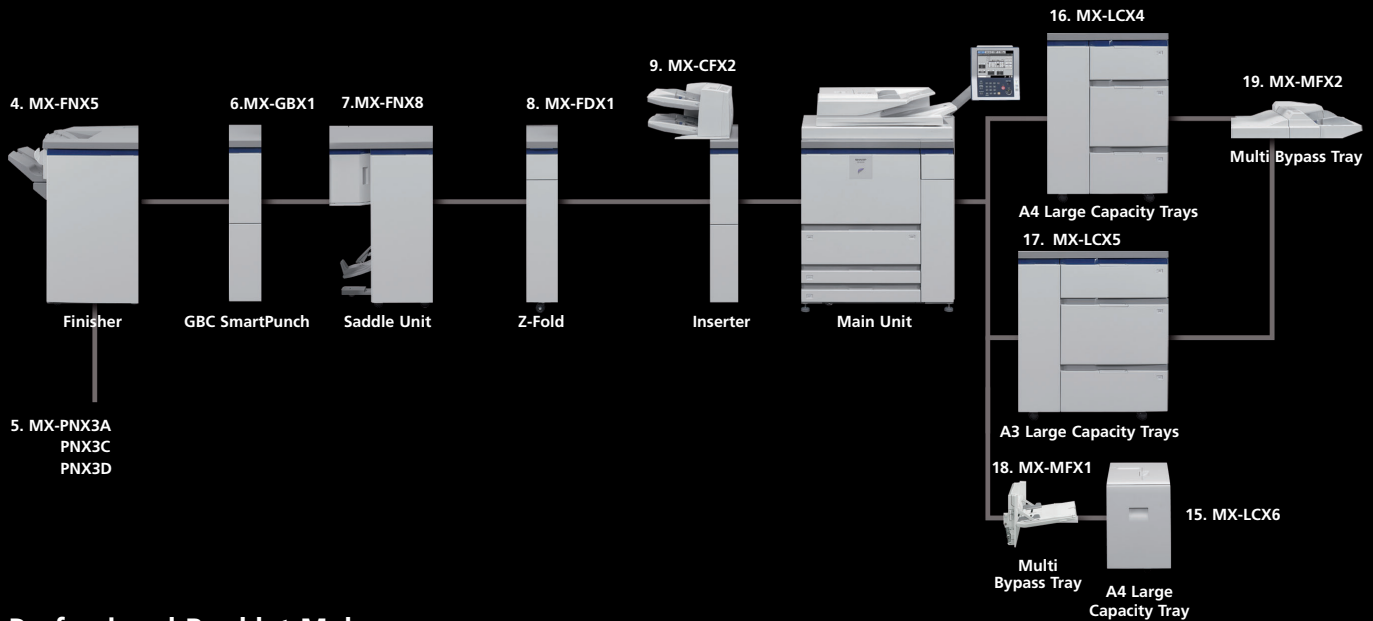

Professional Booklet Maker

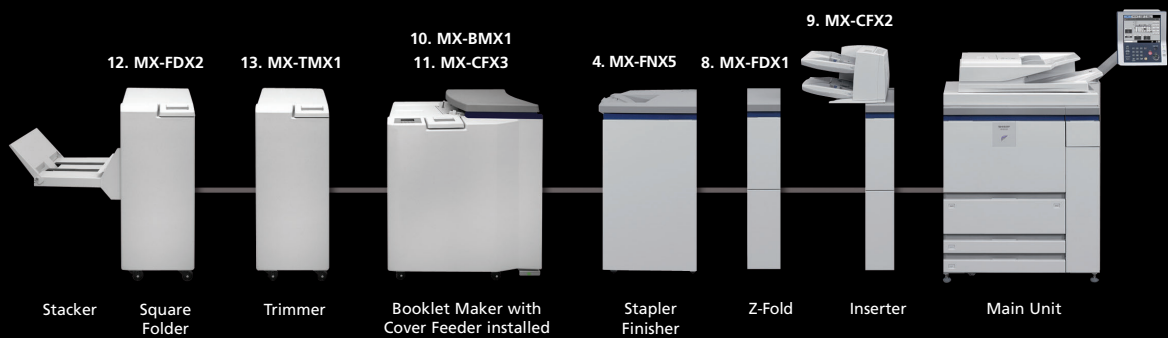

SPECIFICATIONS

MX-M850

Black & White Production Machine



General	
Type	Console
Resolution	Copy 600 x 600 dpi, Print 1200 x 1200, 600 x 600 dpi
Engine speed ¹	A4 A3 85 cpm/ppm 36 cpm/ppm
Paper size	Tray 1 & 2: A4 Tray 3 & 4: up to A3W (305 x 457mm) Max. paper size: 320 x 470mm (requires an option)
Paper weight	Tray 1 & 2: 60-105 gsm Tray 3 & 4: 60-205 gsm Max. paper weight up to 300 gsm (requires an option)
Paper capacity	Std. 3000 sheets: 1200 sheets 800 sheets 2 x 500 sheets Max. 8050 sheets (1200 sheets, 800 sheets, 500 x 2 sheets, 4550 sheet LCC, 500 sheets via bypass)
Warm-up time	240 seconds or less ²
Memory	Max. Local memory 1024MB + System memory 1024 MB + 80GB HDD ³
Power requirements	220-240V 8A (main) 220-240 2.5A (options)
Power consumption	Max. 2.44 kW
Dimensions (W x D x H)	Basic: 1301 x 771 x 1518 mm (inc. touch panel) Full production configuration: 3831 x 771 x 1518 mm Full office configuration: 2216 x 771 x 1518 mm
Weight (approx.)	300 kg

Copier	
Original paper size	Max. A3
First copy out time ⁴	4.0 sec
Continuous copy	Max. 9999 copies
Resolution	600 x 600 dpi
Gradation	Equivalent to 256 levels
Zoom range	Platen : 25 - 400 %, DF : 25 - 200 %
Preset copy ratios	10 ratios (5R/5E)

Network Scanner ⁶ (optional MX-NSX1 required)	
Scan method	Push Scan (via control panel),
Resolution	100 dpi, 200 dpi, 300 dpi, 400 dpi, 600 dpi
Colour scanning	Optional MX-EBX1 required
Scanning speed	Max. 85 opm
File formats	TIFF, PDF, JPG, encrypted PDF
Scanner utilities	Sharpdesk™
Scan destinations	Scan to email, desktop, FTP, USB memory, i-fax (optional), Network folder (SMB)

Document Filing (Std. B/W, Opt. Colour MX-EBX1)	
Document filing capacity	Main and custom folder 45,000 pages, Quick folder 14,000 pages ⁸
Stored jobs	Copy, print, scan, fax transmission ⁹

Network Printer (optional MX-PBX2 required)	
Resolution	1200 x 1200 dpi, 600 x 600 dpi
Interface	USB 2.0 high speed, 10Base-T/100Base-TX
Supported OS ¹⁰	Win / 98 / Me / NT4.0 SP5 or later / 2000 / XP x64 / server 2003 x64, Vista, Vista x64, Mac OS 9.0-9.2.2, 10.1.5, 10.2.8, 10.3.3-10.3.9, 10.4, 10.4.4, 10.4.8
Network protocols ¹⁰	IPX/SPX, TCP/IP, NetBEUI, EtherTalk, IPv6
Printing protocols	LPR, Raw TCP (port 9100), POP3 (e-mail printing), HTTP, Novell Printserver application with NDS and Bindery, FTP for downloading print files, EtherTalk printing, IPP
PDL emulation	PCL5e, PCL6 / Post Script3 (requires MX-PKX4)
Available fonts	80 fonts for PCL, 136 fonts for PS3 emulation ¹¹

Facsimile (optional MX-FXX1 required)	
Compression method	MH/MR/MMR/JBIG
Communication protocol	Super G3
Transmission time	Less than 3 sec. ¹³
Modem speed	33,600 bps
Transmission resolution	Std 203.2 x 97.8 dpi, extra fine: 406.4 x 391 dpi
Recording width	A3 - A5R
Memory	Std 8MB
Grey scale levels	Equivalent to 256 levels
Inbound routing	Yes
PC-Fax	Available

Options
Please refer to the Options section on the previous page



SAP® Printer Vendor Solution



*1: Copy mode: When copying same document continuously on portrait A4 plain paper in non-offset mode. Print mode: When printing same document continuously on portrait A4 plain paper in non-offset mode, excluding processing time. *2: At rated voltage, 25°C, 65% RH. *3: HDD capacity depends on procurement and sourcing status. *4: Portrait feeding of A4 sheets from main unit's 1st paper tray, using document glass in Auto Exposure mode with polygon motor running. *5: Optional MX-FWX1 required for Internet fax and PC fax. Max resolution 400 dpi. *6 Optional MX-EBX1 required.*7 Measured using Sharp's standard chart (A4 with 6% coverage). The Quick File Folder shares the HDD with the Job Build function. *8: Optional MX-FXX1 required. *9: Optional MX-PKX4 required for Mac OS and EtherTalk. IPsec available at a later date. *10: Optional MX-PKX4 required. *11: Based on Sharp's standard chart with approx. 700 characters (A4 portrait) at standard resolution in Super G3 mode, 33,600 bps, JBIG compression.

SHARP

Design and specifications are subject to change without prior notice. All information was correct at time of print. The ENERGY STAR logo is a certification mark and may only be used to certify specific products that have been determined to meet the ENERGY STAR programme requirements. ENERGY STAR is a US registered mark. Windows, Windows Server, and Windows Vista are registered trademarks of Microsoft Corporation. SAP is the registered trademark of SAP AG in Germany and in several other countries. mCitrix is a trademark of Citrix Systems, Inc. and/or one or more of its subsidiaries, and may be registered in the United States Patent and Trademark Office and in other countries. Sharp, Sharp OSA and all related trademarks are trademarks or registered trademarks of Sharp Corporation and/or its affiliated companies. All other company names, product names, and logotypes are trademarks or registered trademarks of their respective owners. ©Sharp Corporation 2008
Ref: ESBC-MX-M850_Jul_08. All trademarks acknowledged. E&OE.