

# **DYMO<sup>®</sup>**

## **MobileLabeler**

### User Guide

## Copyright

© 2019 Newell Rubbermaid Europe LLC. All rights reserved. Revised 7/30/19

No part of this document or the software may be reproduced or transmitted in any form or by any means or translated into another language without the prior written consent of Newell Rubbermaid Europe LLC.

## Trademarks

DYMO is a registered mark in the U.S. and other countries.

Apple and the Apple logo are trademarks of Apple Inc., registered in the U.S. and other countries. App Store is a service mark of Apple Inc.

IOS is a trademark or registered trademark of Cisco in the U.S. and other countries.

The Bluetooth® word mark and logos are registered trademarks owned by the Bluetooth SIG, Inc. and used under license.

Android, Google Play and the Google Play logo are trademarks of Google Inc.

All other trademarks are the property of their respective holders.

“Made for iPhone” and “Made for iPad” mean that an electronic accessory has been designed to connect specifically to iPhone or iPad, respectively, and has been certified by the developer to meet Apple performance standards. Apple is not responsible for the operation of this device or its compliance with safety and regulatory standards. Please note that the use of this accessory with iPhone or iPad may affect wireless performance.

## FCC Statement

**Caution:** The user is cautioned that changes or modifications not expressly approved by the party responsible for compliance could void the user's authority to operate the equipment.

**Note:** This equipment has been tested and found to comply with the limits for a Class B digital device, pursuant to part 15 of the FCC Rules. These limits are designed to provide reasonable protection against harmful interference in a residential installation. This equipment generates, uses and can radiate radio frequency energy and, if not installed and used in accordance with the instructions, may cause harmful interference to radio communications. However, there is no guarantee that interference will not occur in a particular installation. If this equipment does cause harmful interference to radio or television reception, which can be determined by turning the equipment off and on, the user is encouraged to try to correct the interference by one or more of the following measures:

- Reorient or relocate the receiving antenna.
- Increase the separation between the equipment and receiver.
- Connect the equipment into an outlet on a circuit different from that to which the receiver is connected.
- Consult the dealer or an experienced radio/TV technician for help.

# Contents

---

<b>1</b>	<b>About Your New Label Maker</b>
1	Registering Your Label Maker
1	Wireless Safety Warnings
2	Safety Precautions for Lithium-Polymer Rechargeable Battery
2	General Safety Precautions
<b>4</b>	<b>Getting to Know the Label Maker</b>
5	Power
5	Power Status Light
5	Battery Status Light
5	Bluetooth Connection
6	Bluetooth Status Light
6	RESET
<b>7</b>	<b>Getting Started</b>
7	Connecting the Power
7	Inserting the Battery
7	Removing the Battery
8	Charging the Battery
9	Inserting the Label Cassette
9	Cutting the Labels
<b>10</b>	<b>Printing Labels from a Mobile Device</b>
10	Pairing the Label Maker to your Mobile Device
10	Downloading the DYMO Connect App
11	About the DYMO Connect Mobile App
11	Home Screen
11	Design Screen
<b>12</b>	<b>Printing Labels from your Computer</b>
12	Downloading and Installing DYMO Desktop Software
12	Connecting your Label Maker to your Computer
<b>13</b>	<b>Caring for the Label Maker</b>
13	Cleaning the Cutter Blade
14	Cleaning the Print Head
<b>15</b>	<b>Troubleshooting</b>
15	General
17	Bluetooth Connection
<b>18</b>	<b>Technical Specifications</b>
<b>19</b>	<b>Documentation Feedback</b>
<b>19</b>	<b>Environmental Information</b>

## About Your New Label Maker

---

With the DYMO® MobileLabeler electronic label maker, you can create a wide variety of high-quality, self-adhesive labels and print using **Bluetooth®** wireless technology from your Apple® or Android™ mobile device. You can also print from your Windows® or Mac computer using Bluetooth wireless technology or the included USB cable.

You can choose to print your labels in many different fonts, font sizes, and styles. The label maker uses DYMO D1 label cassettes in widths of 6 mm (1/4"), 9 mm (3/8"), 12 mm (1/2"), 19 mm (3/4"), or 24 mm (1"). Labels are available in a wide range of colors.

Visit [www.dymo.com](http://www.dymo.com) for information on obtaining labels and accessories for your label maker.

## Registering Your Label Maker

---

Visit [www.dymo.com/register](http://www.dymo.com/register) to register your label maker online. During the registration process, you will need the serial number, which is located on the bottom of the label maker. See Figure 1 on page 4.

Register your label maker to receive these benefits:

- An additional one year of warranty
- Email notification of free software upgrades
- Special offers and new product announcements

## Wireless Safety Warnings

---

Nearly every electronic device is susceptible to electromagnetic interference (EMI) if inadequately shielded, designed, or otherwise configured for electromagnetic compatibility.

Similar to a mobile phone, your DYMO device is a low power transmitter/receiver and is covered by regulations pertaining to such devices.

- Turn off your DYMO device in any facility where posted notices instruct you to do so. These facilities may include hospitals or health care facilities that may be using equipment that is sensitive to external RF energy.
- Observe all signs and instructions that require an electrical device or RF radio product to be switched off in designated areas, such as gas/refueling stations, hospitals, blasting areas, potentially explosive atmospheres, or aircraft.
- Some Bluetooth devices may interfere with some hearing aids. In the event of such interference, you may want to consult your hearing aid manufacturer or physician to discuss alternatives.
- If you use any other personal medical device, consult the manufacturer of your device to determine if it is adequately shielded from RF energy. Your doctor or physician may be able to assist you in obtaining this information.
- If you are in doubt about whether your device can be safely turned on or used, please consult an authorized person in the location you want to use your device. If no authorized person is available or you remain uncertain, DYMO recommends that you turn off your Bluetooth device.

## Safety Precautions for Lithium-Polymer Rechargeable Battery

---

### Battery Type: LiPolymer 7.4V 1500mAh 11.1Wh

Improper handling of a lithium-polymer rechargeable battery may cause leakage, heat, smoke, an explosion, or fire. This could cause deterioration of performance or failure. This may also damage the protection device installed in the battery. This could damage equipment or injure users. Thoroughly follow the instructions below.

#### **⚠ Danger**

- Use the battery only in the MobileLabeler label maker.
- Battery can only be charged while inserted in the label maker using the charging adapter provided (9VDC/4A).
- Do not connect directly to an electric outlet or cigarette lighter charger.
- Do not store battery close to fire or inside the car where temperature may be over 140°F (60°C).

#### **⚠ Warning**

- Stop charging the battery if charging is not completed within three hours.

#### **⚠ Caution**

- Do not use the label maker or battery in a place that generates static electricity.
- Use the label maker only at room temperature.
- Battery can only be charged within +50°F to 95°F (+10°C to 35°C) temperature range.

## General Safety Precautions

---

Follow the guidelines in this section to use this product safely. In addition, make sure to read the **Safety Precautions for Lithium-Polymer Rechargeable Battery** on page 2.

### Charging Adapter and Power Cord

- Only use the charging adapter and power cord that came with the label maker.
- Do not handle charging adapter or power cord if your hands are wet.
- Do not cut, damage, alter, or place heavy objects on the charging adapter or power cord.
- Do not use the charging adapter or power cord if either are damaged.

### Label Maker

- Only use the USB cable that came with the label maker.
- Do not insert objects into or block the label exit slot.
- Do not touch the cutter blade. Personal injury could result.
- Do not allow any liquids to come into contact with the label maker.
- Do not disassemble the label maker. For inspection, adjustment, or repair, contact DYMO Customer Support (<http://support.dymo.com>).

- Unplug the power cord immediately if you notice any abnormal odor, heat, smoke, discoloration, deformation, or anything unusual while the label maker is in use.

#### **DYMO D1 Label Cassettes**

- Use only DYMO-branded D1 label cassettes in this label maker.
- Do not use any unauthorized accessories or supplies.
- Clean the surface before applying the adhesive label or the label may not adhere correctly and could peel off easily.
- Do not expose the labels to extreme heat or sunlight.

## Getting to Know the Label Maker

Become familiar with the features shown in the following figure.

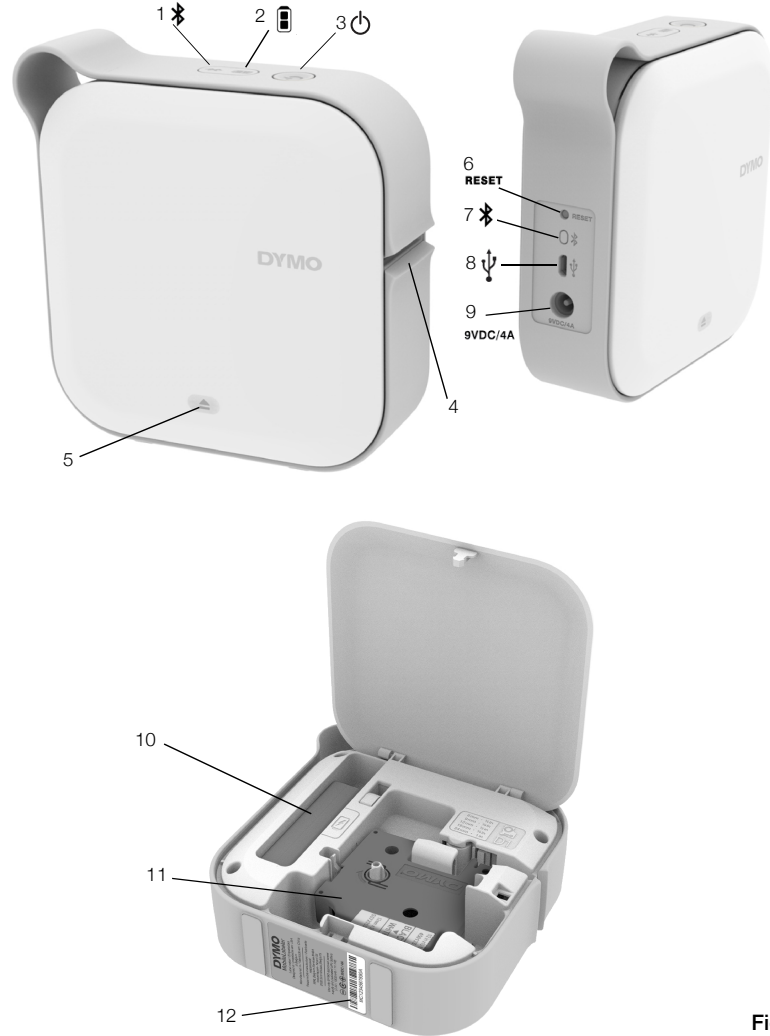





Figure 1

- |                           |                           |  |
|---------------------------|---------------------------|--|
| <b>1</b> Bluetooth status | <b>5</b> Press to open    | <b>9</b> Power connector                     |
| <b>2</b> Battery status   | <b>6</b> RESET button     | <b>10</b> Battery                            |
| <b>3</b> Power button     | <b>7</b> Bluetooth button | <b>11</b> Label cassette                     |
| <b>4</b> Label exit slot  | <b>8</b> USB port         | <b>12</b> Serial number/<br>Regulatory label |

## Power

---

The  button turns the label maker power on and off. A short press of the  button turns the power on. A long press turns the power off.

A short press of the  button will also cancel any ongoing print job.

After a period of inactivity, the printer will enter a power-saving standby mode. The period of time before entering standby mode will vary based on your mobile device.

## Power Status Light

---

 The power status light visually shows the power status of the label maker.



Status Light	Power Status
Off	The power is turned off; the battery may still be charging if plugged into a wall outlet.
Glowing	The label maker is in standby mode.
Fast Blinking	The label maker is on and there is an error.
Solid	The power is turned on.

When the label maker is turned on but not connected to a power source, the power status light remains on but is dimmed.

## Battery Status Light

---

 The battery status light visually shows the charge status of the battery.

Status Light	Label Maker Status
Off	The battery is empty.
Moving	The battery is charging.
Solid	 The battery is fully charged.  The battery is partially charged.

## Bluetooth Connection

---

The label maker can connect to a maximum of two devices using Bluetooth wireless technology. For example, two phones, a phone and a tablet, or a laptop and a phone.

By default, the label maker is always discoverable when the power is turned on. You can change the label maker's discoverability in the desktop software.

- **General** - Always discoverable.
- **Limited** - Discoverable for two minutes.
- **Off** - Never discoverable.

When set to limited discoverability, the two minute discoverable time period can be started by pressing the Bluetooth  button on the back of the label maker.



### To change the discovery mode

- 1 Connect the MobileLabeler label maker to the computer where you have DYMO Label software installed.
- 2 From DYMO Label software, select the MobileLabeler label maker as the current printer.
- 3 Click  to open MobileLabeler Options.
- 4 Select the desired discovery option.



### Bluetooth Status Light

---

✦ The Bluetooth status light visually shows the connection status of the label maker.

Status Light	Label Maker Status
Off	The label maker is not discoverable.
Blinking	The label maker is discoverable.
Solid	The label maker is connected.

### RESET

---

The RESET button resets the label maker to the factory default settings. Resetting the label maker results in the loss of all current settings, including all Bluetooth settings. Press this button only if you want to erase all current information on the label maker.

To press the RESET button, use a narrow pointed object such as the tip of a pen or pencil.

## Getting Started

---

Follow the instructions in this section to set up your label maker.

### Connecting the Power

---

The label maker is powered by a rechargeable, lithium-polymer (LiPo) battery . The battery included with your label maker comes partially charged.

 For best performance, fully charge the battery before using your label maker.

### Inserting the Battery

---

 Make sure all cables are disconnected before inserting the LiPo battery.

#### To insert the battery

- 1 Press  and then lift to open the side cover of the label maker.
- 2 Insert the battery into the battery compartment as shown in Figure 2.
- 3 Close the side cover of the label maker.

 Make sure to read the LiPo Safety Precautions found on page 2.



Figure 2

### Removing the Battery

---

Remove the battery when the label maker will not be used for more than seven days.

 Make sure all cables are disconnected before removing the LiPo battery.

#### To remove the battery

- 1 Press  and then lift to open the side cover of the label maker.
- 2 Remove the battery from the battery compartment as shown in Figure 3.

 Make sure to read the LiPo Safety Precautions found on page 2.



Figure 3

## Charging the Battery

---

The battery can only be charged using the DYMO charging power adapter included with the label maker. Fully charging the battery will take approximately 2.5 to 3 hours.

For best performance, fully charge the battery before using your label maker.

 Make sure to read the LiPo Safety Precautions found on page 2.

### To charge the battery

- 1 Make sure the battery is inserted in the label maker.
- 2 Plug the power cord into the power adapter as shown in Figure 4.
- 3 Plug the power adapter into the power connector on the back of the label maker and plug the power cord into a power outlet. See Figure 5.

Movement of the battery status lights indicate that the battery is charging. The battery continues to charge even if you turn the label maker off.

The battery status lights stop moving and are both on when the battery is fully charged.



Figure 4



Figure 5

## Inserting the Label Cassette

---

Your label maker uses DYMO D1 label cassettes. Visit [www.dymo.com](http://www.dymo.com) for information about purchasing additional label cassettes.



Cutter blade is extremely sharp. While replacing the label cassette, keep fingers and other body parts away from cutter blade and do not press the cutter button.

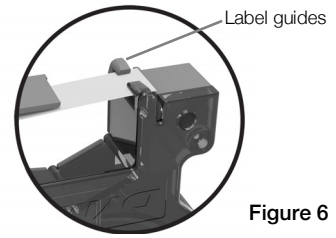



Figure 6

### To insert the label cassette

- 1 Press  and then pull outward to open the side cover of the label maker.
- 2 Make sure the tape and ribbon are taut across the mouth of the cassette and that **the tape passes under the label guides**. See Figure 6.  
If necessary, turn the ribbon rewind spool clockwise to tighten the ribbon. See Figure 7.
- 3 Insert the cassette and press firmly until the cassette clicks into place.
- 4 Close the side cover of the label maker.

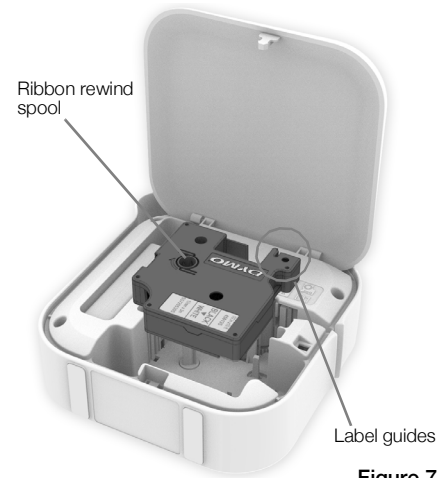

Figure 7

## Cutting the Labels

---

The label maker has an automatic cutter which will cut the label after each label is printed. Clear the label exit slot of labels after every 10 labels to prevent a label jam.

## Printing Labels from a Mobile Device

You can design and print labels from the MobileLabeler label maker using the DYMO Connect mobile app.

 DYMO Connect is recommended for use with recently released versions of Android and iOS mobile devices.

## Pairing the Label Maker to your Mobile Device

Pair the label maker to your mobile device using Bluetooth settings on your device. The label maker displays in your list of Bluetooth devices with the name **DYMO ML xxxx** where xxxx is unique for every label maker.

 If you are asked for a pairing code, use 0000.

### Pairing with an iOS device

- 1 In Settings, turn on the Bluetooth setting.
- 2 Tap **DYMO ML xxxx** under **MY DEVICES** to connect the label maker.  
After a few seconds, **Connected** is displayed when pairing is complete.

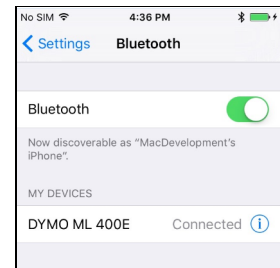

### Pairing with an Android device

- 1 In Settings, turn on the Bluetooth setting.
- 2 Tap **DYMO ML xxxx** under **Available devices** to pair the label maker.  
After a few seconds, it is listed under **Paired devices** when pairing is complete.

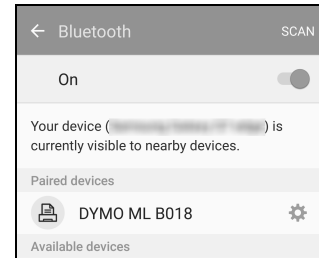

## Downloading the DYMO Connect App

The DYMO MobileLabeler label maker works wirelessly with the DYMO Connect mobile app available on the Apple® App store or the Google Play™ store.



## About the DYMO Connect Mobile App

---

Learn about the features available in the DYMO Connect mobile app.

### Home Screen

---

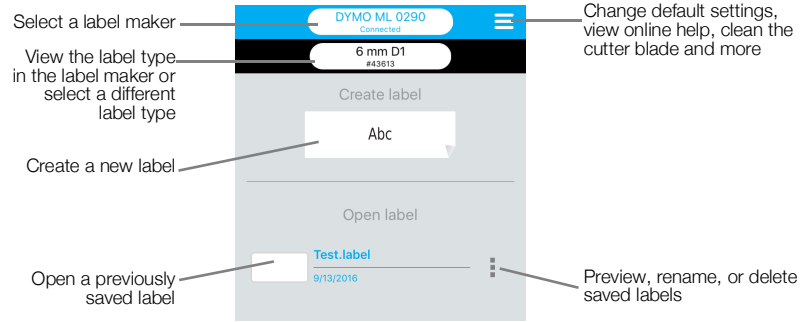

### Design Screen

---

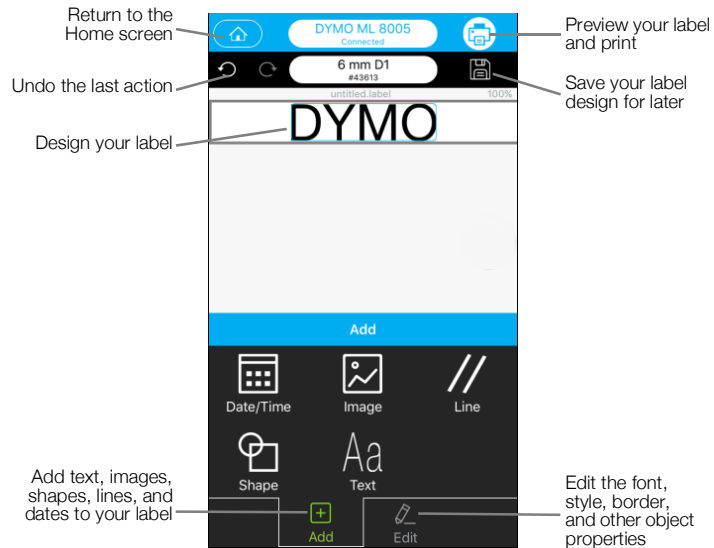

From the DYMO Connect menu , you can view the DYMO Connect Help for more information.

## Printing Labels from your Computer

---

The label maker can connect to your computer using Bluetooth wireless technology or the USB cable supplied with the label maker.

### Downloading and Installing DYMO Desktop Software

---

You can print to the label maker from our DYMO Desktop software.

#### To install the software on a Windows® system

- 1 Download the latest version of our desktop software from the Support section of the DYMO Web site at [support.dymo.com](http://support.dymo.com).
- 2 Close all open Microsoft Office applications.
- 3 Double-click the installer icon.  
After a few seconds, the installation screen appears.
- 4 Click **Install** and follow the instructions in the installer.

#### To install the software on a Mac

- 1 Download the latest version of our desktop software from the Support section of the DYMO Web site at [support.dymo.com](http://support.dymo.com).
- 2 Double-click the installer icon and follow the on-screen instructions.

### Connecting your Label Maker to your Computer

---

The label maker connects to your computer using the USB connection located on the back of the label maker.

Use only the USB cable included with your label maker.

#### To connect the label maker to your computer

- 1 Plug the USB cable into the USB port on the back of the label maker.
- 2 Plug the other end of the USB cable into a USB port on your computer.



Figure 8

## Caring for the Label Maker

---

Your label maker is designed to give you long and trouble-free service, while requiring very little maintenance. Clean your label maker regularly to keep it working properly.



### Cleaning the Cutter Blade

---

Clean the cutter blade each time you replace the label cassette.

 The cutter blade is extremely sharp. Avoid direct contact with the cutter blade while cleaning the blade.

#### To clean the cutter blade

- 1 Press  and then lift to open the side cover of the label maker.
- 2 Remove the label cassette.
- 3 Make sure the label maker is turned on and paired to the mobile device running DYMO Connect.
- 4 Open DYMO Connect and tap .
- 5 Tap **Cutter cleaning** and then **Expose cutter blade**.  
The cutter blade will advance into a position where you can clean both sides.
- 6 Use a cotton ball and alcohol to clean both sides of the blade.
- 7 After cleaning the blade, tap **Hide cutter blade** in DYMO Connect.

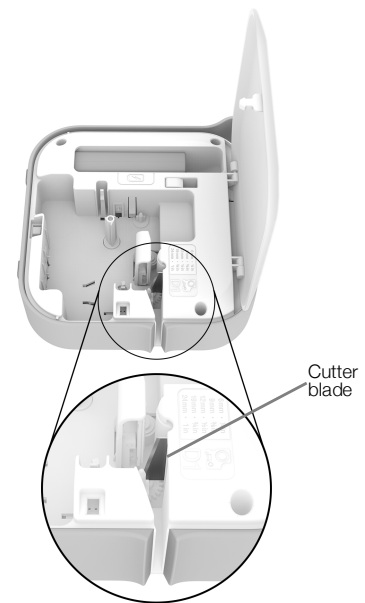

Figure 9



## Cleaning the Print Head

---

The print head is very delicate, so use care when cleaning.

### To clean the print head

- 1 Disconnect the power adapter, if connected.
- 2 Press  and then lift to open the side cover of the label maker.
- 3 Remove the label cassette and battery.
- 4 Use a small, soft brush or cotton swab to wipe away dust and other stray particles from the inside of the label compartment.
- 5 Wipe the print head with a cotton swab and a small amount of alcohol.
- 6 Insert the label cassette and close the cover.

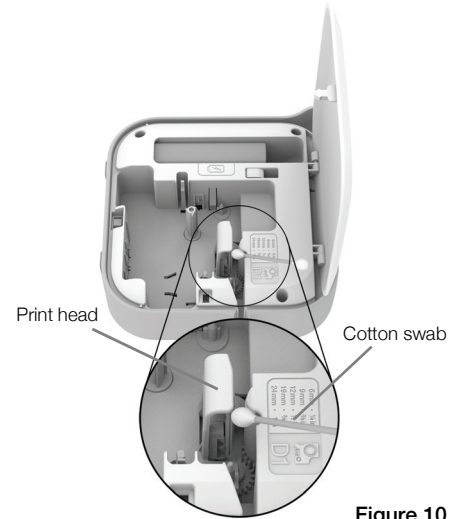

Figure 10

## Troubleshooting

---

Review the following sections if you encounter a problem with your label maker.

 When the printer is showing an error, turn the power off and on to clear the error.

### General

---

Problem/Error Message	Solution
-----------------------	----------

Label did not print correctly	<ul style="list-style-type: none"><li>Make sure the label maker is within range of your mobile device and that there are no obstructions between the two devices.</li><li>Make sure the label maker is away from other wireless devices (including but not limited to microwave ovens, cordless phones, fluorescent lights, wireless video cameras, outdoor microwave links, wireless game controllers, and Zigbee devices) which may cause interference during printing.</li><li>Make sure no other Bluetooth connections are active that could cause interference while printing to the label maker, such as streaming audio to Bluetooth speakers, voice call on a Bluetooth headset, and so on.</li></ul>
-------------------------------	---



Label jam	<ol style="list-style-type: none"><li>Remove the cassette from the label maker.</li><li>Make sure the tape and ribbon are taut across the top of the cassette and that <b>the tape passes under the label guides</b>. If necessary, turn the ribbon rewind spool clockwise to tighten the ribbon.</li></ol> <div data-bbox="849 1155 1385 1680"><p>Correct                      Incorrect</p><p>Label guides</p><p>Cutter slot</p><p>Ribbon rewind</p></div> <ol style="list-style-type: none"><li>Make sure the tape extends at least 1/8" past the label guides and is not caught under the guides.</li><li>Insert the cassette into the label maker.</li></ol>
-----------	---

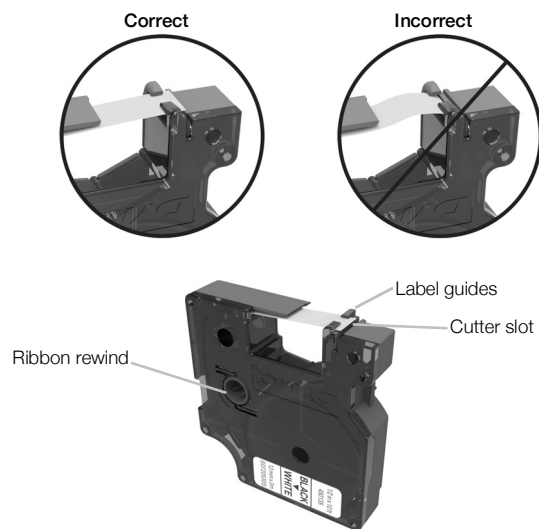

<b>Problem/Error Message</b>	<b>Solution</b>
Poor print quality	<ul style="list-style-type: none"> <li>■ Use only DYMO-branded D1 label cassettes.</li> <li>■ Attach the charging adapter to the label maker to recharge the battery. See <b>Charging the Battery</b>.</li> <li>■ Clean the print head. See <b>Cleaning the Print Head</b>.</li> <li>■ Ensure the label cassette is inserted properly.</li> <li>■ Replace the label cassette.</li> </ul>
Poor cutter performance	<ul style="list-style-type: none"> <li>■ Use only DYMO-branded D1 label cassettes.</li> <li>■ Clean the cutter blade. See <b>Cleaning the Cutter Blade</b>.</li> </ul>
Label maker error; power LED is blinking quickly	<ul style="list-style-type: none"> <li>■ Ensure the label cassette is inserted properly and not jammed or empty.</li> <li>■ Ensure the battery is inserted properly.</li> <li>■ Ensure the cover is closed.</li> <li>■ Recharge the battery. See <b>Charging the Battery</b>.</li> </ul>
Label maker does not turn on	<ul style="list-style-type: none"> <li>■ Ensure the battery is inserted properly.</li> <li>■ Ensure the label maker is connected to a working wall outlet.</li> <li>■ Recharge the battery. See <b>Charging the Battery</b>.</li> </ul>
Label maker does not print	<ul style="list-style-type: none"> <li>■ Ensure the label cassette is inserted properly.</li> <li>■ Battery charge level may be too low to print. <ul style="list-style-type: none"> <li>• Recharge the battery and reprint the label. See <b>Charging the Battery</b>.</li> </ul> </li> </ul>
Battery is not charging	<ul style="list-style-type: none"> <li>■ Ensure the battery is inserted.</li> <li>■ Ensure the label maker is connected to a working wall outlet. See <b>Charging the Battery</b>.</li> </ul>
Battery level is low	<ul style="list-style-type: none"> <li>■ Recharge the battery. See <b>Charging the Battery</b>.</li> </ul>

## Bluetooth Connection

---

Many connection issues can be resolved quickly by disconnecting the power adapter, and removing and reinserting the battery.



For safety, all cables must be disconnected when handling the LiPO battery.

<b>Problem</b>	<b>Solution</b>
Label maker status is <b>Not connected</b> or does not appear in the printer list in the DYMO Connect mobile app	<ul style="list-style-type: none"><li>■ Make sure the label maker power is turned on.</li><li>■ Make sure the label maker is paired in your device's settings.</li><li>■ Quit DYMO Connect and restart the app.</li></ul>
Paired label maker will not connect in my device's Bluetooth settings	<ul style="list-style-type: none"><li>■ Make sure the label maker power is turned on.</li><li>■ Unpair the label maker from your mobile device and then pair again: <b>iOS</b><ul style="list-style-type: none"><li>• Tap <b>DYMO ML xxxx</b> and tap <b>Forget this device</b>.</li></ul><b>Android</b><ul style="list-style-type: none"><li>• Tap <b>DYMO ML xxxx</b> and tap <b>Unpair</b>.</li></ul></li></ul>
Authentication error	<p>Perform a hard restart of the label maker.</p> <ol style="list-style-type: none"><li>1 Turn off the label maker.</li><li>2 Disconnect the power adapter and remove the battery.</li><li>3 Reinsert the battery and reconnect the power adapter.</li><li>4 Turn the label maker on.</li></ol>

If you need further assistance, visit the Support section of the DYMO Web site at <http://support.dymo.com>.

## Technical Specifications

---

DYMO MobileLabeler label maker

<b>Dimensions (WHD)</b>	2.18" x 5.8" x 5.75" (55.4 mm x 147.2 mm x 146 mm)
<b>Weight (without battery)</b>	17.4 ounces (494 grams)
<b>Maximum print width</b>	3/4" (19 mm)
<b>Maximum label width</b>	1" (24 mm)
<b>Label type</b>	DYMO D1 label cassettes
<b>Battery</b>	LiPolymer 7.4V 1500mAh 11.1Wh
<b>Power adapter</b>	9 VDC, 4 Amp
<b>Print method</b>	Thermal transfer
<b>Print resolution</b>	300 dpi
<b>USB</b>	USB 2.0 Full speed
<b>Bluetooth® version</b>	BR/EDR V2.1 or newer
<b>Bluetooth® range</b>	≤ 32 feet (10 meters)
<b>Regulatory approvals</b>	FCC, IC, TUV CB, RCM, R-NZ, RoHS, REACH
<b>Warranty</b>	2 year limited (refer to Quick Start Guide for full warranty statement)

## Documentation Feedback

---

We are constantly working to produce the highest quality documentation for our products. We welcome your feedback.

Send us your comments or suggestions about our user guides. Include the following information with your feedback:

- Product name, model, and User Guide page number
- Brief description of instructions that are inaccurate or unclear, areas where more detail is needed, and so on

We also welcome your suggestions about additional topics you would like to see covered in the documentation.

Send email messages to: [dymo.docfeedback@newellco.com](mailto:dymo.docfeedback@newellco.com)

Keep in mind that this email address is only for documentation feedback. If you have a technical question, contact DYMO Customer Care (<http://support.dymo.com>).

## Environmental Information

---

The equipment that you have bought requires the extraction and use of natural resources for its production. It may contain substances that are hazardous to health and the environment.

In order to avoid the dissemination of those substances in our environment, and to diminish the pressure on natural resources, we encourage you to use the appropriate take-back systems. These systems will reuse or recycle most of the materials of your end-of-life equipment in an environmentally sound way.

The crossed-bin symbol marked on your device indicates you should use these systems.



If you need more information on the collection, reuse, and recycling of this product, please contact your local or regional waste administration.

You can also contact DYMO for more information on the environmental performance of our products.