

Xerox ColorQube
9301 / 9302 / 9303
Multifunction Printer
Imprimante multifonction

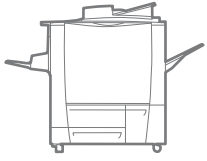

Xerox® ColorQube® 9301 / 9302 / 9303 Xerox ConnectKey Controller User Guide Guide d'utilisation

Italiano Guida per l'utente
Deutsch Benutzerhandbuch
Español Guía del usuario
Português Guia do usuário
Nederlands Gebruikershandleiding
Svenska Användarhandbok

Dansk Betjeningsvejledning
Suomi Käyttöopas
Norsk Brukerhåndbok
Русский Руководство пользователя
Čeština Uživatelská příručka

Polski Przewodnik użytkownika
Magyar Felhasználói útmutató
Türkçe Kullanıcı Kılavuzu
Ελληνικά Εγχειρίδιο χρήστη
Română Ghid de Utilizare



© 2013 Xerox Corporation. All rights reserved. Unpublished rights reserved under the copyright laws of the United States. Contents of this publication may not be reproduced in any form without permission of Xerox Corporation.

Copyright protection claimed includes all forms of matters of copyrightable materials and information now allowed by statutory or judicial law or hereinafter granted, including without limitation, material generated from the software programs are displayed on the screen such as styles, templates, icons, screen displays, looks, and so on.

XEROX[®] and XEROX and Design[®], Phaser[®], PhaserSMART[®], PhaserMatch[®], PhaserCal[®], PhaserMeter™, CentreWare[®], PagePack[®], eClick[®], PrintingScout[®], Walk-Up[®], WorkCentre[®], FreeFlow[®], SMARTsend[®], Scan to PC Desktop[®], MeterAssistant[®], SuppliesAssistant[®], Xerox Secure Access Unified ID System[®], Xerox Extensible Interface Platform[®], ColorQube[®], Global Print Driver[®], and Mobile Express Driver[®] are trademarks of Xerox Corporation in the United States and/or other countries.

Adobe[®]Reader[®], Adobe[®]Type Manager[®], ATM™, Flash[®], Macromedia[®], Photoshop[®], and PostScript[®] are trademarks of Adobe Systems Incorporated in the United States and/or other countries.

Apple[®], AppleTalk[®], Bonjour[®], EtherTalk[®], Macintosh[®], Mac OS[®], and TrueType[®] are trademarks of Apple Inc., registered in the U.S. and other countries.

HP-GL[®], HP-UX[®], and PCL[®] are trademarks of Hewlett-Packard Corporation in the United States and/or other countries.

IBM[®] and AIX[®] are trademarks of International Business Machines Corporation in the United States and/or other countries.

Microsoft[®], Windows Vista[®], Windows[®], and Windows Server[®] are trademarks of Microsoft Corporation in the United States and other countries.

Novell[®], NetWare[®], NDPS[®], NDS[®], IPX™, and Novell Distributed Print Services[®] are trademarks of Novell, Inc. in the United States and other countries.

SGI[®] and IRIX[®] are trademarks of Silicon Graphics International Corp. or its subsidiaries in the United States and/or other countries.

Sun, Sun Microsystems, and Solaris are trademarks or registered trademarks of Oracle and/or its affiliates in the United States and other countries.

UNIX[®] is a trademark in the United States and other countries, licensed exclusively through X/ Open Company Limited.

Document Version 1.0: February 2013

Contents

1	Copy	
	Introduction	8
	Copy Options	9
	Image Quality	15
	Layout Adjustment	17
	Output Format	20
	Job Assembly	28
	Log In/Out	31
2	ID Card Copy	
	Introduction	34
	ID Card Copy Options	35
	Image Quality	37
3	Print From	
	Introduction	40
	Using Print From	41
	Saving Jobs for use with Print From	43
	Log In/Out	46
4	Scan To	
	Introduction	48
	Scan To Using the Printer Address Book	49
	Scan To Using Favorites	50
5	Fax	
	Introduction	52
	Dialing Options	53
	Fax	56
	Image Quality	58
	Layout Adjustment	59
	Fax Options	61
	Job Assembly	67
	Log In/Out	68

6	Fax from PC	
	Introduction	70
	Faxing from a PC.....	71
	Fax from PC Options.....	72
7	Email	
	Introduction	76
	Email.....	77
	Advanced Settings	81
	Layout Adjustment.....	84
	Email Options.....	86
	Job Assembly	88
	Log In/Out.....	89
8	Server Fax	
	Introduction	92
	Dialing Options	93
	Server Fax Options	95
	Image Quality	96
	Layout Adjustment.....	97
	Fax Options.....	98
	Job Assembly	99
	Log In/Out.....	100
9	Workflow Scanning	
	Introduction	102
	Workflow Scanning Options.....	104
	Advanced Settings	106
	Layout Adjustment.....	109
	Filing Options	111
	Job Assembly	113
	Log In/Out.....	122
10	USB Port	
	Introduction	124
	Scan to USB	125
	Print from USB.....	126
	Log In/Out.....	127

11	Internet Fax	
	Introduction	130
	Internet Fax	131
	Advanced Settings	134
	Layout Adjustment	136
	Internet Fax Options	137
	Job Assembly	139
	Log In/Out	140
12	Print	
	Introduction	142
	Wireless Configuration	144
	Printing Options	145
	Image Options	150
	Document Options	151
	Advanced	155
13	CentreWare Internet Services	
	Introduction	158
	Accessing CentreWare Internet Services	159
	Status	160
	Jobs	163
	Print	164
	Scan	165
	Address Book	166
	Properties	167
	Support	168
	Help	169
14	Paper and Media	
	Introduction	172
	Trays 1 and 2	173
	Tray 3	175
	Tray 4	176
	Tray 5	178
	Tray 6	179
	Media Types	181
	Storage and Handling	185

15	Machine and Job Status	
	Introduction	188
	Job Status	189
	Machine Status	193
16	Administration and Accounting	
	Tools	198
	Device Settings.....	199
	Service Settings	209
	Network Settings.....	217
	Accounting Settings	218
	Security Settings	220
	Troubleshooting.....	222
17	Safety and Regulation	
	Notices and Safety	226
	Safety Labels and Symbols.....	227
	Operational Safety Information.....	228
	Basic Regulations	232
	Copy Regulations	234
	Fax Regulations.....	237
	Material Safety Data	240
	Product Recycling and Disposal	241
	Energy Program Compliance	243
	Environmental Health and Safety Contact Information.....	244
18	General Care and Troubleshooting	
	Power Options	246
	General Care.....	248
	Troubleshooting.....	253
	Further Assistance.....	261

Copy

1

This chapter includes:

- [Introduction](#) on page 8
- [Copy Options](#) on page 9
- [Image Quality](#) on page 15
- [Layout Adjustment](#) on page 17
- [Output Format](#) on page 20
- [Job Assembly](#) on page 28
- [Log In/Out](#) on page 31

Introduction

This guide describes the copying features of the printer, including options for Output Color, Reduce/Enlarge, 2-Sided Copying, Layout Adjustment, Image Quality, Output Format, Job Assembly, and other copy functions.

Copy is a standard feature and is selected by pressing the **Services Home** button and touching **Copy**.

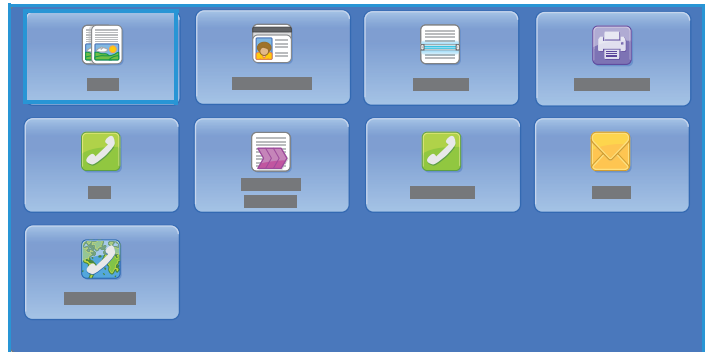

When **Copy** is selected, the printer scans the originals and stores the images. It then prints the images, based on the selections made.

Most feature screens include these buttons to confirm or cancel the choices.

- **Cancel** resets the screen and returns to the previous screen.
- **OK** saves the selections made and returns to the previous screen.
- **Close** closes the screen and returns to the previous screen.

Instructions for making a copy and using the basic features are provided in ColorQube 9301/9302/9303 Multifunction Printer How To Sheets. If Authentication or Accounting is enabled on the printer, you may have to type login details to access the features. Refer to [Log In/Out](#) on page 31.

Copy Options

The **Copy** tab includes basic copying selections such as Output Color, Reduce / Enlarge, Paper Supply, 2-Sided Copying, and Copy Output.

Output Color

The Output Color options include selections to automatically detect and match the color of your original or produce monotone, full color, or a single color output from your original automatically. Touch **More** to access the following options:



- **Auto Detect** selects output that matches your original.
- **Black & White** selects monotone output regardless of the color of your original.
- **Color** selects color output from your original.
- **Single Color** selects a single color output regardless of the color of your original.



Reduce / Enlarge

A variety of options are available on your printer to enable you to reduce or enlarge the output from your original. These options include selecting a specific ratio, either proportionately or independently, and choosing from a selection of predefined preset buttons. For convenience, easy access to ratio selection can be found on the Copy tab in the Reduce / Enlarge area. Use **More** to access all the options.

You can enlarge or reduce images placed on the document glass by any ratio 25 %–400 % . Images from originals fed through the automatic document feeder enlarge or reduce by any ratio 25 %–200 % .

- Use the - / + buttons  on the Copy screen to select the required reduction or enlargement percentage.
- Alternatively, select the **ratio** button  and use the numeric keypad to type the ratio required.
- To have your output image be the same size as your original, set the ratio window to 100 % .

Proportional %

Selections made on this screen reduce or enlarge the image by the same ratio in both directions so that the image resizes, but the proportions remain the same.

- Select  and use the numeric keypad or the arrow buttons to enter the ratio required.
- Use the **Presets (X-Y%)** buttons to select **100%**, **Auto %**, or commonly used ratios defined by your administrator. The selected proportional ratios in percentages appear next to the button, together with an example application.

When **Auto %** is selected, the printer chooses the best ratio to reduce or enlarge the original onto the selected paper size. Specify a paper tray before using this option.

Independent %

This selection enables you to set different reduction or enlargement ratios for the **X** (width) and the **Y** (height) of the image. This produces a distorted copy of the original.

- Select the resize button  and use the numeric keypad or the arrow buttons to enter the **Width - X%** and **Length - Y%** ratios required.
- Use the **Presets (X-Y%)** buttons to select **100%/100%**, **Auto Independent X-Y%** or commonly used ratios set up by your administrator. The selected X and Y ratios in percentages are shown next to the button, together with an example application.

Use **100%/100%** to produce an image the same size as your original.

Auto Independent X-Y% automatically fits the image of your original onto the paper you select. The reduction or enlargement is not proportional, and the printer distorts the image to fit onto the paper. Specify a paper tray before you use this option.

Auto Center

This option can be selected with either the Proportional or Independent options to position the image in the center of the paper selected.

Paper Supply

On the Paper Supply section of the **Copy** tab, you can select a paper tray, the paper size required, or **Automatically Select**. Use **More** to access all the options.

- **Automatically Select** automatically selects the appropriate paper size for each original, based on the size of the original and any directly selected magnification ratios.
- Alternatively, you can select a paper tray that contains the size and type of paper you require. The size and type of media loaded in each tray is displayed.

When **More** is selected, the Paper Supply screen is displayed showing all the trays and the confirmed size and type of media loaded in each tray.

- A user can select a tray to use from this list. The chosen tray is highlighted in blue.
- If the Auto Tray Switching feature is enabled and the same size and type of media is loaded in more than one tray, the printer automatically switches from one tray to another when media in the active tray runs out.

2-Sided Copying

The printer provides options to make 1-sided or 2-sided copies from 1-sided or 2-sided originals, using either the automatic document feeder or the document glass. The options are:

- **1>1-Sided** Use this option if the originals are printed on one side and you want 1-sided copies.
- **1>2-Sided:** Use this option if the originals are printed on one side and you want 2-sided copies. You can also press the **Rotate Side 2** button to have the second page rotated 180°.
- **2>2-Sided:** Use this option if you want to make 2-sided copies from 2-sided originals. You can also press the **Rotate Side 2** button to have the second page rotated 180°.
- **2>1-Sided:** Use this option to make 1-sided copies from 2-sided originals.

Note: If using the document glass to scan originals, the printer displays a message when ready to scan side 2.

Copy Output







The most commonly used Copy Output options are selected directly from the **Copy** tab. The options available are dependent on the finishing device and kits installed. Refer to [Finishing Devices](#) on page 13.

- **Collated** sorts the copies into sets 1,2,3 1,2,3 1,2,3.
- **1 Staple (Portrait)** staples in one of the short edge corners, depending on how the originals are loaded.
- **1 Staple (Landscape)** staples in one of the long edge corners, depending on how the originals are loaded.
- **Folding** a new window opens providing access to the folding options. Refer to [Folding](#) on page 12.
- Use **More** to access the following additional output options:
 - **Uncollated** sorts the copies into stacks 1,1,1 2,2,2 3,3,3.
 - **Staple:** The stapling options available are dependent on the finishing device available and the configuration setup. For information about the available finishing devices, refer to [Finishing Devices](#) on page 13.
 - **Off:** When staples are not needed, use this option.
 - **1 Staple:** When this option is selected, a single staple is positioned in the top left corner of the output.
 - **2 Staples:** When this option is selected, two staples are positioned parallel to the left or top edge of the copies.
 - **Multi-Staple:** When this option is selected, depending on the size of the copy paper, three or four staples will be positioned parallel to the left edge of the copies. For example:
 - 4 Staples = A4 LEF, A3, 8.5 x 11 in. LEF, 11 x 17 in., 8 x 10 in. LEF.
 - 3 Staples = 8 x 10 in. SEF, 8.5 x 11 in. SEF, 8.5 x 5.5 in. LEF, A4 SEF, A5 LEF, 8.5 x 14 in. SEF, B5 SEF.

Note: SEF is Short Edge Feed, and LEF is Long Edge Feed.

- Use the Original Orientation option to select the orientation of the originals being scanned. Select **Portrait Originals** or **Landscape Originals** or **Upright Images** or **Sideways Images**.
- **Hole Punching:** If the printer is equipped with one of the optional Hole Punch kits, 2 Hole, 3 Hole, 4 Hole, Swedish 4 Hole, or 2 Hole Legal Punch is available.
 - Hole punching can be selected only for A4 LEF, Legal SEF, and A3 (8.5 x 11 in. LEF, Legal SEF, and 11 x 17 in. SEF) paper; and it can be combined with a stapling option, if required.
 - Each sheet is hole punched individually so there is no limit to the number of pages in the set.
- Use the Paper Supply option to select the output media required.

To achieve some of the staple options, load the copy paper as shown:

Paper Size and Orientation	Output Required	Original Orientation	Output Tray Orientation
A4, 8.5 x 11 in. LEF	LEF A4, 8.5 x 11 in. Single Staple Top Left		
A4, 8.5 x 11 in. SEF	SEF A4, 8.5 x 11 in. Single Staple Top Left		
A4, 8.5 x 11 in. SEF	SEF A4, 8.5 x 11 in. Single Staple Bottom Left		

Note: For some selections, the printer rotates the image. If you are unable to staple, ensure that Image Rotation is **On** in **Tools**. Refer to [Administration and Accounting](#) on page 195 for more information.

Folding

If the optional Tri-fold Module is installed on the printer, A4 or 8.5 x 11 in. media in a weight range of 60 to 105 g/m² (16 lb to 28 lb) can be folded in a Single Fold, C-Fold, or Z-fold. Load originals SEF, and select the orientation of the originals.

- **Off:** Use this option when no folding is required.
- **Single Fold**  folds the page in half. Select an option:
 - **Individually** is used to fold each page individually.
 - **Together as a Set** is used to fold all the pages together to create a single booklet.
 - **Booklet Staple** is selected to fold and staple the output. This option is only available with the **Together as a Set** option.
 - **Advanced Settings** are used to select additional layout options:
 - **Originals** options allow you to select if the originals are standard or already formatted as a booklet.
 - **Side 1 Image** options are used to select if the image on the first side is printed inside or outside the fold.
 - **Collation** is used to select collated or uncollated output.
- Use the Original Orientation option to select the orientation of the originals being scanned. Select **Upright Images** or **Sideways Images**. The images are rotated, as required.

Finishing Devices

Your printer is equipped with one of the following finishing devices:



- 1 **High Volume Finisher:** The High Volume Finisher has a comprehensive range of finishing options. It collates, offsets, stacks, and staples your output. The top tray can receive up to 250 sheets of paper and the stacker tray up to 3000 sheets of paper. This finisher can be fitted with the optional 2, 3 or 4 Hole-Punch kit and the Tray 6 (Post Process Inserter) kit.
- 2 **Booklet Maker:** The High Volume Finisher is also available with a Booklet Maker that enables booklets to be folded and stapled. Folded sheets and booklets are delivered to the booklet tray that can hold 10–30 booklets, depending upon the number of pages. If the flap on the right of the tray is folded down, an unlimited number of booklets can be collected in a suitable container.
- 3 **Tri-fold Module:** If you have a High Volume Finisher with Booklet Maker, a Tri-fold module can also be fitted. This enables your printer to tri-fold booklets. With the Tri-fold module fitted, the capacity of the finisher stacker tray is reduced to 2000 sheets. Refer to [Folding](#) on page 12 for information about the folding options.
- 4 **Tray 6 (Post Process Inserter):** This optional accessory is a feeder that sits on top of the finisher unit. It enables pre-printed sheets created by the printer to be inserted into sets. The inserted sheets do not go through the copy or print process in the printer. For more information about using Tray 6 (Inserter), see [Tray 6](#) on page 177.
- 5 **Office Finisher:** This finisher can receive up to 250 sheets of paper in the top tray and up to 2000 sheets of paper in the stacker tray. The Office Finisher can be fitted with the optional 2, 3 or 4 Hole-Punch Kit.
- 6 **Offsetting Catch Tray (OCT):** The offset catch tray holds up to 500 sheets of 80 g/m² (20 lb) paper and is on the right-hand side of the printer.

Note: Thick stacks of paper can be removed from your finisher more easily by using the pause function. Press the button as shown to lower the stacker tray to a more convenient height. Then press the button again to return the stacker tray to normal height. Alternatively, it automatically resets after 30 seconds.

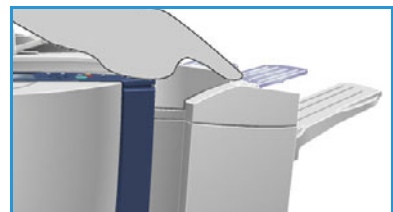

Convenience Stapler

This optional device is used to manually staple documents. Documents can be stapled straight or at an angle. The Convenience Stapler can staple 2 sheets of 64 g/m² (18 lb) through 50 sheets of 80 g/m² (20 lb). The Staple Cartridge holds 5000 staples.

- To use the Convenience Stapler, hold your documents face up and slide the corner to staple into the stapler. During stapling, the indicator light on the top of the stapler is lit.
- The stapler automatically staples the documents.



Image Quality

This section describes how to enhance the quality of the output and available options. Options enable you to set the type of original; adjust the lightness, darkness, contrast, and sharpness of the image; and customize the settings for color output.

Original Type

Use this option to define the type of the original being copied. Making the correct selection enhances the quality of the output. The options are:

Content Type

- **Photo and Text** is recommended for originals containing high-quality photographs and halftones. Using this setting, the output will contain medium quality pictures though the sharpness of text and line art is slightly reduced.
- **Text** produces sharper edges and is recommended for text and line art.
- **Photo** is used specifically for originals containing photos, magazine pictures, or continuous tones, without any text or line art. Produces the best quality for photos but reduced quality text and line art.
- **Map** is used if the original is a map or contains intricate line art and text.
- **Newspaper / Magazine** is used if the original is So a magazine or newspaper that contains photographs or text.

How the Original was Produced

- **Printed** is for originals that have come from a magazine, book, or newspaper, or that have been printed on a large printing device.
- **Photocopied** is for originals that are photocopies.
- **Photograph** is for high-quality photo originals.
- **Inkjet** is for originals that have been produced using an inkjet printer.
- **Solid Ink** is for originals produced by a solid ink printing process, such as the output from this printer.

Image Options

Use Image Options to change the appearance of the copy output. The options are:

- **Lighten / Darken** provides manual control to adjust the lightness or darkness of the scanned images. Move the indicator down to darken the image or up to lighten the image.
- **Sharpness** provides manual control to adjust the sharpness of the scanned images. Move the indicator up to sharpen the image. Move the indicator down to soften the scanned image.
- **Saturation** controls the balance between vivid and pastel shades of the image. Move the indicator toward Vivid for more saturated colors. Move the indicator toward Pastel for less saturated colors.

Image Enhancement

Image Enhancement provides options for improving the quality of the output by reducing the background or adjusting the contrast. The options are:

- **Background Suppression** enhances originals that have colored backgrounds by reducing or eliminating the background on the output copy. This option is useful when the original is on colored paper.
 - Select **Auto Suppression** to suppress the unwanted background automatically.
 - Select **Off** to turn off the Background Suppression feature, particularly when:
 - The **Darken** adjustment does not produce a satisfactory output from light originals.
 - The original has a gray or colored border, such as a certificate.
 - You want to bring out the fine detail that was lost due to a dark edge when using bound originals.
- **Contrast** controls the image density on the output and compensates for an original that has too much or too little contrast on the image.
 - Select **Manual Contrast** to set the level of contrast yourself. Move the indicator toward the More setting to reproduce more vivid blacks and whites for sharper text and lines but less detail in pictures. Move the indicator toward the Less setting to reproduce more detail in the light and dark areas of the original.
 - Select **Auto Contrast** to set the contrast level automatically, depending on the original being scanned.

Color Presets

Color Presets provide options for enhancing the quality of the color copies. Selecting a color preset option optimizes all the image quality features. The options are:

- **Off** removes any color presets.
- **Lively** increases the depth of color of the copies.
- **Bright** increases the lightness of the copies.
- **Warm** brings out the red tones in the output.
- **Cool** brings out the blue tones in the output.

Color Balance

Color Balance enables you to adjust the balance between individual colors and the overall amount of color on the copies. The options are:

- **Normal** leaves the color the same as the original.
- **Basic Color** adjusts the individual density levels for each of the four process colors, yellow, magenta, cyan, and black. Move the indicator up the scale for increased density and down the scale for less density for each color.
- **Advanced Color** adjusts the highlight, mid-tone, and shadow density levels in each of the four process colors. Select a process color and move the indicator up the scale for increased density and down the scale for less density for each of the three options.

Layout Adjustment

Using the Layout Adjustment features, you can change the appearance of the output image. This includes shifting the image, producing a mirror image, deleting an area from any or all of the edges of the original, and copying from book originals.

Original Orientation

Use to specify the orientation of the originals being scanned. The options are:

- **Portrait Originals** refer to the image orientation on the original documents. Use this option to select a Portrait image orientation. Originals can be fed in any direction.
- **Landscape Originals** refers to the image orientation on the original documents. Use this option to select a Landscape image orientation. Originals can be fed in any direction.
- **Upright Images** refers to the direction the images are loaded in the automatic document feeder. Use this option if the images are in the orientation, matching the image shown when loaded in the automatic document feeder.
- **Sideways Images** refers to the direction the images are loaded in the automatic document feeder. Use this option if the images are in the orientation, matching the image shown when loaded in the automatic document feeder.

Select **OK** to save the selections and exit.

Original Size

Original Size allows you to specify automatic size detection of the originals, mixed size originals, or the specific size of the image scanned. The options are:

- **Auto Detect** is the default setting and enables automatic size sensing. The size detected is matched to standard-size paper.
- **Preset Scan Areas** allows you to define the size of the original from a list of pre-set, standard original sizes. You can view the list by using the scroll bar.
- **Custom Scan Area** is used to mark a specific area for scanning. Measure the desired scan area on the original and type the X- and Y-axis measurements in the fields provided. Only the area specified is scanned.
- **Mixed Size Originals** allows you to scan documents containing different size pages. The pages must be the same width, like A4 LEF and A3 SEF (8.5 x 11 in. LEF and 11 x 17 in. SEF). Other combinations are shown on the screen. The printer detects the size of the documents and can produce the following output:
 - If **Auto Reduce/Enlarge** and a specific **Paper Supply** is selected, all the images are reduced or enlarged and copied onto the same size paper.
 - If **Auto Paper Supply** is selected, the images are copied size for size, and a mix of paper sizes is the output.

Book Copying

CAUTION: Do not close the automatic document feeder when scanning bound originals.

This feature enables you to specify page or pages of a book are scanned. The book original is placed face down on the document glass with the spine of the book lined up with the marker on the rear edge of the glass. Align the top of the bound original against the rear edge of the document glass.



The printer identifies the size of the original during scanning. If the pages have a black- or dark-colored border, the printer assumes that the pages are smaller than they really are. To overcome this, use the **Custom Scan Area** feature in **Original Size** to type the exact size of the page. Refer to [Original Size](#) on page 17.

- **Off** is used to clear any scan settings.
- **Both Pages** is used to scan both pages; the left page of the book scans first. Use the arrow buttons to specify a value, 0–50 mm (0–2 in.), to be deleted from the center of the book in order to delete the unwanted marks reproduced from the gutter of the book.
- **Left Page Only** is used to scan the left page only. Use the arrow buttons to specify a value, 0–25 mm (0–1 in.), to be deleted from the right side of the page in order to delete the unwanted marks reproduced from the gutter of the book.
- **Right Page Only** is used to scan the right page only. Use the arrow buttons to specify a value, 0–25 mm (0–1 in.), to be deleted from the left side of the page in order to delete the unwanted marks reproduced from the gutter of the book.

Select **OK** to save the selections and exit.

Image Shift

Image Shift allows you to move the position of the image on the output page. The options are:

- **Auto Center** automatically centers the scanned image on the output paper. To work effectively, the original should be smaller than the selected output media, or alternatively, the image should be reduced.
- **Margin Shift** moves the image up / down or left / right on the page to give a bigger or smaller top and left margin. Enter the shift required by selecting a field or use the arrow buttons.

This shift is entered in 1-mm (0.1 in.) increments up to 50 mm (2.0 in.).

When copying 2-sided, there are two options:

- Adjust the margin of side two, independently of side one.
- Create a mirror image of side one to provide a binding margin.
- **Presets** provide access to commonly used shift settings and are customized by the system administrator by using **Tools**.

Edge Erase

Edge Erase enables you to specify how much of the image to erase around the edges of the document. For example, you can remove the marks caused by punched holes or staples in the original.

Note: The printer applies an automatic edge deletion to all the printed output.

The options are:

- **All Edges** is used to erase an equal amount from all the edges. Use the arrow buttons to adjust the amount to be erased, 0–50 mm (0–2 in.). All marks or defects within the measurement set are deleted.
- **Individual Edges** enables an individual value to be erased from each of the edges, on both the first and second sides.
Use the arrow buttons to adjust the values for each edge, 0–50 mm (0–2 in.).
- **Mirror Side 1** can be selected to erase exactly the same amount on the Side 2 image, as selected for Side 1.
- **Presets** provide access to commonly used erase settings and are customized by the system administrator by using **Tools**.

Invert Image

Invert Image allows you to reverse the image or create a negative. This feature is useful for originals that have a substantial amount of dark background or light text and images, saving on ink usage.

The options are:

- **Mirror Image** reverses the original image, creating a mirror of the original.

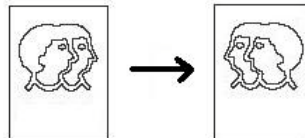

- **Negative Image** converts the dark image areas to light and the light image areas to dark.



Output Format

The Output options allow you to manipulate the copied images and enhance the appearance and style of the copy jobs. For example, you can add covers or annotations, create booklets, combine several images onto one page, and interleave transparencies.

Booklet Creation

Booklet Creation enables the production of booklets from 1-sided or 2-sided originals. The printer scans the originals and automatically reduces and arranges the images in the correct sequence on the selected copy paper so that a booklet is created when the copy set is folded in half.

A cover can be inserted onto the booklet automatically by selecting the **Special Pages** option through the **Output Format** tab.

If the printer is fitted with a High Volume Finisher with Booklet Maker, you can use the Booklet Creation feature to automatically produce folded and stapled booklets. The following Booklet Maker specifications apply:

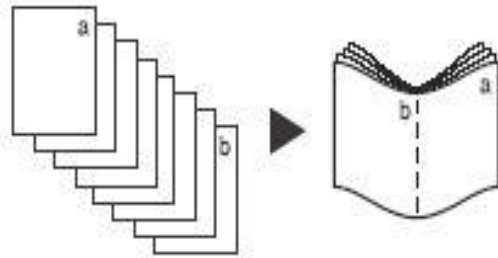

- Paper Sizes A3, 11 x 17 in., A4, 8.5 x 11 in., 8.5 x 13 in. and 8.5 x 14 in.
- All media must be SEF.
- Booklet thickness:
 - For Folded and Stapled booklets, a maximum of 15 sheets of 80 g/m² (20 lb) or equivalent thickness. For example, you can have 13 sheets of 80 g/m² (20 lb) and a cover sheet of 160 g/m² (43 lb).
 - For Folded Only booklets, a maximum of 5 sheets of 80 g/m² (20 lb) or equivalent thickness. For example, you can have 3 sheets of 80 g/m² (20 lb) and a cover sheet of 200 g/m² (53 lb).

To create a booklet:

1. Select **Booklet Creation** and **On**.

Note: Booklet Creation is not available if **Auto Paper** is selected. Select an alternative **Paper Supply** option.

2. Select the **Paper Supply** button and select the tray that contains the paper you want to use. If using High Volume Finisher with Booklet Maker to fold and staple the output, SEF Paper Supply must be selected.
3. From the Original Input drop-down menu, select either **1-Sided Originals** or **2-Sided Originals**, according to the originals you are using.
4. If available, select either **Fold Only** or **Fold and Staple**, as required, and select **OK** to confirm the selections.
5. Load the originals into the automatic document feeder.
6. Use the **Original Orientation** option on the **Layout Adjustment** tab to select the correct feed and image orientation for the originals. Refer to [Original Orientation](#) on page 17.

7. Select **OK** to confirm the selections and run the job.

Note: The default reading order of the booklet is from the left page to the right page. If a different reading order is required, the system administrator can use **Tools** to display a reading order option. Refer to [Administration and Accounting](#) on page 195 for more information.

Special Pages

The Special Pages feature controls how you add special pages such as covers and inserts to the copy job. If you have High Volume Finisher and the optional Tray 6 (Inserter) installed, you can feed the Covers or Inserts from this tray. Media loaded into Tray 6 (Inserter) is not part of the printing process. If you require printed Covers, you must use pre-printed media or use another tray. Refer to [Paper and Media](#) on page 169 for more information.

Note: Special Pages cannot be used with **Auto Paper Supply**; a paper supply must be specified.

The **Special Pages** options are:

- **Covers** enables blank or printed pages to be added to the front, back, or both sides of the set. The covers can be a different media to the rest of the job. Refer to [Covers](#) on page 21.
- **Chapter Starts** ensures each chapter starts on a right or left page, as required blank pages are inserted automatically, if needed. Refer to [Chapter Starts](#) on page 22.
- **Inserts** enables blank pages to be inserted at designated places within the copy sets. Single or multiple pages can be inserted. This option is also used to insert Pre-Cut tabs into the document. Refer to [Inserts](#) on page 22.
- **Exceptions** is used to program pages that require printing on a different media to the rest of the job. Refer to [Exceptions](#) on page 23.

Note: When scanning a 2-sided document and identifying the page number to be entered for Chapter Starts, Inserts, and Exceptions, count each side as a separate page.

Covers

Use the following instructions to program **Covers**:

1. On the **Copy** tab, select the paper you want to use for the main body of the copies.

Note: **Special Pages** is not available if **Auto Paper** is selected.

2. If required, load special paper into another paper tray, ensuring that it is in the same orientation as the paper you are using for the body of the copies.

Update the Paper Settings screen and **Confirm** the selections.

3. Select the **Output Format** tab, the **Special Pages** button, and then **Covers**.

4. Select **Covers Option** required:

- **Off** clears all options selected for covers.
- **Front & Back Same** is used if the same media and printing options are required for both covers.
- **Front & Back Different** is used for front and back covers with different programming requirements.
- **Front Only** is used if only a front cover is required.
- **Back Only** is used if only a back cover is required.

5. Select **Printing Option** from the drop-down menu for each of the covers required:
 - **Blank Cover** is used if no printing is required.
 - **Print on Side 1** is used to print the first or last page of the document onto side 1 of the front or back cover sheet.
 - **Print on Side 2** is used to print the first or last page of the document onto side 2 of the front or back cover sheet.
 - **Print on Both Sides** is used to print the first or last two pages of the document onto side 1 and side 2 of the front or back cover sheet.

Note: If **Front & Back Same** is selected, the same programming options are applied to the Front and Back covers.

6. Select the paper tray that contains the cover media.
7. Select **Close** to return to the Special Pages screen.

A list of the selected Special Pages is displayed on the screen. To make changes, select the item in the list you wish to change and use **Edit**. Use **Delete** or **Delete All** to delete unwanted entries. Select **Close Menu** to exit the drop-down menu.
8. Select **OK** to confirm the selections and run the job.

Chapter Starts

Use the following instructions to program **Chapter Starts**:

1. On the **Copy** tab, select the paper you want to use the job.

Note: **Special Pages** is not available if **Auto Paper** is selected.
2. Select the **Output Format** tab, the **Special Pages** button, and then **Chapter Starts**.
3. Select the **Chapter Starts** button.
4. Select the **Page Number** box and use the numeric keypad to type a page number for the chapter start.
5. Select either **On Right Page** to print on Side 1, or **On Left Page** to print on Side 2.
6. Select the **Add** button to confirm the selections and add the programmed Chapter Start to the list on the right.

Add further Chapter Starts, as required.
7. Select **Close** to return to the Special Pages screen.

A list of the selected Special Pages is displayed on the screen. To make changes, select the item in the list you wish to change and use **Edit**. Use **Delete** or **Delete All** to delete unwanted entries. Select **Close Menu** to exit the drop-down menu.
8. Select **OK** to confirm the selections and run the job.

Inserts

Use the following instructions to program **Inserts**:

1. On the **Copy** tab, select the paper you want to use for the main body of the copies.

Note: **Special Pages** is not available if **Auto Paper** is selected.

2. If required, load special paper into another paper tray ensuring that it is in the same orientation as the paper you are using for the body of the copies.

If using Tab Stock for the inserts, refer to [Paper and Media](#) on page 169 for information about loading tabs.

Update the Paper Settings screen and **Confirm** the selections.

3. Select the **Output Format** tab, the **Special Pages** button, and then **Inserts**.
4. Select the **After Page Number** box and use the numeric keypad to type the page number you want the insert to follow.

Note: To add an insert before page 1 of the document, use the Covers option. Refer to Covers.

5. Use the arrow buttons to type how many inserts should be added.
6. Select the **Paper Supply** button and select the tray that contains the Inserts media. Select **OK** to save the selection.
7. Select the **Add** button to confirm the selections and add the programmed Insert to the list on the right. Add further Inserts, as required.
8. Select **Close** to return to the Special Pages screen.
A list of the selected Special Pages is displayed on the screen. To make changes, select the item in the list you wish to change and use **Edit**. Use **Delete** or **Delete All** to delete unwanted entries. Select **Close Menu** to exit the drop-down menu.
9. Select **OK** to confirm the selections and run the job.

Exceptions

Use the following instructions to program **Exceptions**:

1. On the **Copy** tab, select the paper you want to use for the main body of the copies.
Note: **Special Pages** is not available if **Auto Paper** is selected.
2. If required, load special paper into another paper tray, ensuring that it is in the same orientation as the paper you are using for the body of the copies.
Update the Paper Settings screen and **Confirm** the selections.
3. Select the **Output Format** tab, the **Special Pages** button, and then **Exceptions**.
4. Select the **Page Number** boxes and use the numeric keypad to type the page number or sequence of pages you want printed on different media.
5. Select the **Paper Supply** button and select the tray that contains the Exceptions media. Select **OK** to save the selection.
6. Select the **Add** button to confirm the selections and add the programmed Exceptions to the list on the right. Add further Exceptions, as required.
7. Select **Close** to return to the Special Pages screen.
A list of the selected Special Pages is displayed on the screen. To make changes, select the item in the list you wish to change and use **Edit**. Use **Delete** or **Delete All** to delete unwanted entries. Select **Close Menu** to exit the drop-down menu.
8. Select **OK** to confirm the selections and run the job.

Annotations

The **Annotations** feature enables you to automatically add a comment, page number, date, or Bates Stamp to the copy output. You can select any or all of these annotation options and specify where these should appear on the copy output. You can also select the appearance of the annotations, such as the font size and font color. The options are:

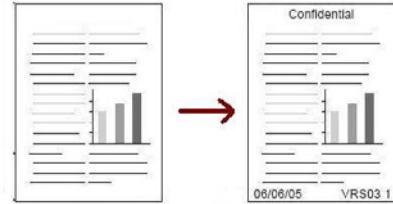

- **Page Numbers** to automatically print the page number at a specified position on the page. Page numbers are automatically increased by one. For 2-sided copy output, the page number is printed on both sides and counts as two pages.
- **Comment** to add up to 50 alpha-numeric characters at a specified position on the page. An existing comment can be added, or a new comment can be created or edited.
- **Date** to add today's date in a specified format and position on the page. The date printed is the date set on the printer.
- **Bates Stamp** to add a selected Bates Stamp at a specified position on the page. Bates Stamping is used primarily in the legal and business fields and consists of a set prefix (such as a case number or client reference) together with a page number applied to a document as it is being processed. The prefix can contain up to eight alpha-numeric characters. You can add a new prefix or choose an existing one from the list provided.

Page Numbers

Use the following instructions to program Page Numbers:

1. Select the **Output Format** tab, the **Annotations** button, and then **Page Numbers**.
2. Select the **On** button.
3. Specify the position of the page number by selecting one of the arrow buttons on the right.
4. Select the **Page Number** input box, and use the numeric keypad to type the starting page number you want printed on the copy output.
5. From the drop-down menu on the left, select either **All Pages** or **All Pages Except First** to determine pages the page number will apply to.
6. Select **OK** to store the selections and return to the Annotations screen. Program additional annotations, as required.
7. Program the **Format & Style** options required for Annotations. Refer to [Format and Style](#) on page 26 for instructions.
8. Select **OK** to confirm the selections and run the job.

Comment

Use the following instructions to add a Comment:

1. Select the **Output Format** tab, the **Annotations** button, and then **Comment**.
2. Select the **On** button.
3. Select one of the arrow buttons to determine the position of the comment on the page.

4. Specify if you want the comment to appear on **All Pages**, **All Pages Except First**, or **First Page Only**.
5. Use the scroll bar to browse the list of available comments, and select the comment you require.
6. To add a new comment to the list, highlight an empty entry and use the keyboard to type up to 50 alpha-numeric characters. To edit an existing comment, highlight the comment in the list and select the **Edit** button. Use the keyboard to edit the entry and select **OK** to close the keyboard.
7. Select **OK** to store the selections and return to the Annotations screen. Program additional Annotations, as required.
8. Program the **Format & Style** options required for Annotations. Refer to [Format and Style](#) on page 26 for instructions.
9. Select **OK** to confirm the selections and run the job.

Date

Use the following instructions to add the Date:

1. Select the **Output Format** tab, the **Annotations** button, and then **Date**.
2. Select the **On** button.
3. Select one of the arrow buttons to determine the position of the date on the page.
4. Specify the date format by selecting **DD/MM/YYYY**, **MM/DD/YYYY**, or **YYYY/MM/DD**.
5. Specify if you want the date to appear on **All Pages**, **All Pages Except First**, or **First Page Only**.
6. Select **OK** to store the selections and return to the Annotations screen. Program additional Annotations, as required.
7. Program the **Format & Style** options required for Annotations. Refer to [Format and Style](#) on page 26 for instructions.
8. Select **OK** to confirm the selections and run the job.

Bates Stamp

Use the following instructions to program a Bates Stamp:

1. Select the **Output Format** tab, the **Annotations** button, and then **Bates Stamp**.
2. Select the **On** button.
3. Select one of the arrow buttons to determine the position of Bates Stamp on the page.
4. Select the **Starting Page Number** box and use the numeric keypad to type a starting page number. Leading zeros may be typed to set the starting page number length, such as 000000001.
5. Specify if you want Bates Stamp to appear on **All Pages** or **All Pages Except First**.
6. Use the scroll bar to browse the list of available prefixes and select the one you require. To add a new prefix to the list, highlight an empty entry and use the keyboard to type up to eight alpha-numeric characters. Alternatively, to edit an existing prefix, highlight the prefix in the list and select the **Edit** button. Use the keyboard to edit the entry and select **OK** to close the keyboard.
7. Select **OK** to store the selections and return to the Annotations screen. Program additional Annotations, as required.
8. Program the **Format & Style** options required for Annotations. Refer to [Format and Style](#) on page 26 for instructions.
9. Select **OK** to confirm the selections and run the job.

Format and Style

Once you have programmed the required Annotations, use the following instructions to select the required format and style:

1. Select the **Output Format** tab, the **Annotations** button, and then **Format & Style**.
2. Specify the appearance of annotated text:
 - **Opaque:** The annotated text is placed on the copy output with a white border. No copy text is visible under the annotated text.
 - **Transparent:** The annotated text is placed on the copy output so that the copy text is visible under the annotated text.
3. Use the arrow buttons to enter the **Font Point Size** that determines the size of all the annotation options used on the copy output.
4. Use the scroll bar to browse the list of font colors and select the one you require.
5. Select **Side 2 Options** from the following selections:
 - **Same as Side 1** settings will apply to both Side 1 and Side 2 of the output.
 - The **Mirror Side 1 Flip on Horizontal** output will open from right to left like a book, with the binding edge on the left. The position of the annotation on Side 2 will mirror Side 1. For example, if a page number is positioned in the bottom left corner of Side 1, it will appear in the bottom right corner of Side 2.
 - The **Mirror Side 1 Flip on Vertical** output will open from bottom to top like a calendar, with the binding edge at the top. The position of the annotation on Side 2 will mirror Side 1. For example, if a page number is positioned in the bottom left corner of Side 1, it will appear in the bottom right corner of Side 2.
6. Select **OK** to save the annotation Format & Style options.
7. Select **OK** to confirm the selections and run the job.

Transparency Separators

Use Transparency Separators to interleave each printed transparency with a blank sheet of paper from a specified paper tray.

1. Load the transparencies into Tray 4 (Bypass), update the Paper Settings screen, and **Confirm** the selections. Refer to [Paper and Media](#) on page 169 for loading instructions.

Note: **Transparency Separators** is not available if **Auto Paper** is selected.

2. Select the **Output Format** tab, next **Transparency Separators**, and then **On**.
3. Select the paper tray containing paper for the separators.
4. Select the tray that contains the transparencies.
5. Select **OK** to confirm the selections and run the job.

Page Layout

The Page Layout feature is ideal for handouts, storyboards, or archival purposes. It allows up to 36 images to fit onto one sheet of paper. The printer will reduce or enlarge the images, as needed, to display them either in landscape or portrait orientation on one page, based on the paper supply selected. The options are:

- **Pages per Slide:** Individual images reduced to fit onto one sheet of paper.

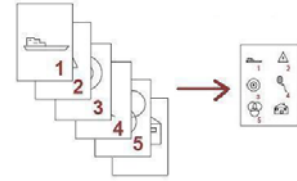

- **Repeat Image:** Multiple copies of the same image reduced to fit onto one sheet of paper. The actual number of rows and columns available is limited by the minimum reduction value (25 %) and the selected paper output.



Note: Some features cannot be used with the Page Layout feature and will be grayed out on the touch screen.

The examples shown here are typical outputs that can be produced when using the Page Layout feature.

Note: The practical limit is for 16 images on A4 (8.5 x 11 in.) paper.



4 Originals using 2 rows and 2 columns

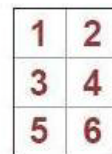

6 Originals using 3 rows and 2 columns



2 Originals using 2 rows and 1 column

1. On the **Copy** tab, select the paper you want to use for the copies.
2. Select the **Output Format** tab and then select **Page Layout**.
3. Select the required Page Layout option:

Pages per Slide

- Select the button that represents the required number of images per page.
- Alternatively, select the **Specify Rows and Columns** button and use the arrow buttons to select 1–15 rows and columns.
- Select **Portrait Originals** or **Landscape Originals** from the drop-down menu on the right.

Repeat Image

- Select the button that represents the required number of images per page.
 - Alternatively, select the **Specify Rows and Columns** button and use the arrow buttons to select 1–15 rows and columns.
 - Select **Portrait Originals** or **Landscape Originals** from the drop-down menu on the right.
 - If **Auto Repeat** is selected, the size of the original is used to automatically calculate the maximum number of rows and columns that can be accommodated on the currently selected paper size.
 - To determine how the images are printed, select either **Upright Images** or **Sideways images** from the drop-down menu on the right.
4. Select **OK** to save the selections and run the job.

Job Assembly

Use the Job Assembly options to program a job that requires individual selections for specific pages or sections, produce Sample Set before printing the whole job or for storing and retrieving frequently run programs.

Build Job

Use this feature to build a job that requires different settings for each page, or a segment of pages.

You can select the appropriate settings to be applied to individual pages or segments of a completed job. First, split the originals into sections for individual programming.



Some pages with text and some with photos



Some pages 2-sided and some 1-sided



Various sized originals



More than 100 pages

1. Select **Build Job** on the **Job Assembly** tab and then select the **On** button.
2. Select **Options**, select **Display this window between segments** to view the Build Job screen during scanning, and then select **OK**.
3. Select the options required for the first segment of the job.
4. Load the first segment originals and press **Start**.
5. Remove the first segment originals. The Build Job screen displays the first segment in the list. The following options can be applied to any segment:
 - **Sample Last Segment** produces a proof print of the last segment scanned. The proof is delivered to the output module. If you are satisfied with the proof, you can continue programming Build Job.
 - **Delete Last Segment** deletes the last segment scanned. You can continue programming Build Job.
 - **Delete All Segments** deletes current Build Job and returns you to the main Build Job screen.
6. Using **Program Next Segment**, select the options required for the second segment.
7. Load the second segment originals and press **Start**.
8. Repeat these steps until all segments of the job have been programmed and scanned.
9. After the last segment has been scanned, select **Print the Job** to indicate that you have finished scanning and the job can be processed and completed.

Sample Job

When copying many sets, use the Sample Set feature to review a proof copy to ensure that all the print settings are correct, before printing the remaining sets.

1. Select the **Sample Job** button on the **Job Assembly** tab.
2. Select the **On** button and then select **OK**.
3. Load the originals in the automatic document feeder and program the job requirements.

4. Type the total quantity required and press the **Start** button.
One copy set of the job, the Sample Set, is printed.
The Job Progress screen is displayed, and the job is held in Job List.
5. If the Sample Set is acceptable, select **Release**. The programed number of sets will be produced.
If the Sample Set is unacceptable, select **Delete** and **Delete Job** to confirm. The job will be deleted from the list.

Note: If the Job Progress screen is not displayed, access the job by selecting the **Job Status** button. Select the job in the list and select **Release** or **Delete**.

Print Multiple Copies

To produce multiple copies:

1. Press the **Services Home** button and then touch **Copy**.
2. Program and scan the first segment:
 - a. Load the originals for the first segment.
 - b. Select the required settings, such as layout adjustments, image quality, Build Job, and so on.
3. Use the alphanumeric keypad to type the number of copies and press **Start** in the control panel.

Save Current Settings

Up to 10 combinations of commonly used feature selections can be retained in the printer memory as Saved Settings. The printer stores only the programming of the job and NOT the image. Each time Saved Settings are retrieved and used, the image must be scanned.

To Save

1. Program the required job features.
2. Press the **Save Current Settings** button on the **Job Assembly** tab.
3. Select the **Setting** drop-down menu and use the scroll bar to select the **<Available>** setting.
4. Use the keyboard to type a name for the saved settings.
5. Select **OK**.

The settings are stored and can be accessed using the Retrieve Saved Settings feature.

Retrieve Saved Settings

This feature enables you to use Retrieve Saved Settings from the printer memory and apply them to the current job. Changes can be made to the retrieved settings, but these changes are not stored with the saved settings.

1. Press the **Retrieve Saved Settings** button on the **Job Assembly** tab.
2. Select the required job settings from the list. If needed, use the scroll bar to access all the settings.
3. Select the **Load Settings** button to retrieve the programming information.

The recalled programming features become active.

To delete a Settings entry, select the **Delete Settings** option and select **Delete** to confirm.

Job Assembly

4. Modify the selections, as required for this job.
These additional modifications are not saved with the saved settings.
5. Load the originals and press the **Start** button.

Log In/Out

If Authentication or Accounting has been enabled on the printer, you may need to log in before using some or all of the services. A picture of a lock on a button indicates that you must log in to use that service.

1. To log in, press the **Log In/Out** button on the control panel. Pressing a locked service prompts you to type your user name and password.
2. Use the keyboard to type your user name and then touch **Next**.
3. Use the keyboard to type your password and then touch **Done**.
4. If an accounting system is used on the printer, you may also need to enter additional information.
 - If Xerox Standard Accounting is enabled, log in using your Xerox Standard Accounting details.
 - If Network Accounting is enabled, type your User ID and Account ID.
 - If a Foreign Device Interface (FDI) is installed, you are prompted to access the printer using the device, such as a card reader or coin slot.

Your user details appear in the User Details area on the right side of the displayed message.
5. To log out, press the **Log In/Out** button again, or touch the User Details area and touch **Log Out** from the drop-down menu.
6. A confirmation screen is displayed; touch **Log Out** or **Cancel**.

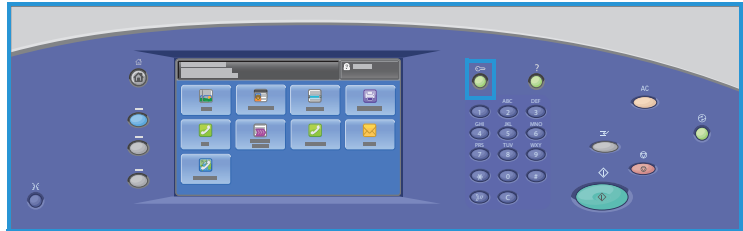

Log In/Out

ID Card Copy

2

This chapter includes:

- [Introduction](#) on page 34
- [ID Card Copy Options](#) on page 35
- [Image Quality](#) on page 37

Introduction

ID Card Copy enables you to scan each side of an ID card onto one side of a single sheet of paper. The ID card is placed on the document glass, and the first side is scanned. When prompted, the card is turned over and the other side is scanned. You can also set different image quality settings for side 1 and side 2.

This chapter describes the ID card copying features of the printer, including options for Image Quality, Output Color, Reduce/Enlarge, Paper Supply, Output Format, Background Suppression, and other functions.

ID Card Copy is a standard feature and is selected by pressing the **Services Home** button and touching **ID Card Copy**.

When **ID Card Copy** is selected, the printer scans the originals and stores the images. It then prints the images, based on the selections made.

Most feature screens include these buttons to confirm or cancel the choices.

- **Cancel** resets the screen and returns to the previous screen.
- **OK** saves the selections made and returns to the previous screen.
- **Close** closes the screen and returns to the previous screen.

Instructions for making an ID Card copy and using the basic features are provided in ColorQube 9301/9302/9303 Multifunction Printer How To Sheets. If Authentication or Accounting is enabled on the printer, you may have to type login details to access the features. For details, see [Log In/Out](#) on page 46.

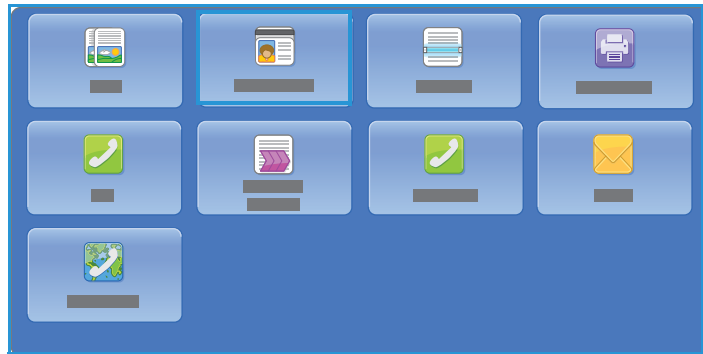

ID Card Copy Options

The ID Card Copy tab includes basic options such as Output Color, Reduce/Enlarge, Paper Supply, and Copy Output.

You can copy both sides of an ID card or small document onto one side of paper. Each side is copied using the same location on the document glass. The printer stores both sides and prints them side by side on paper.

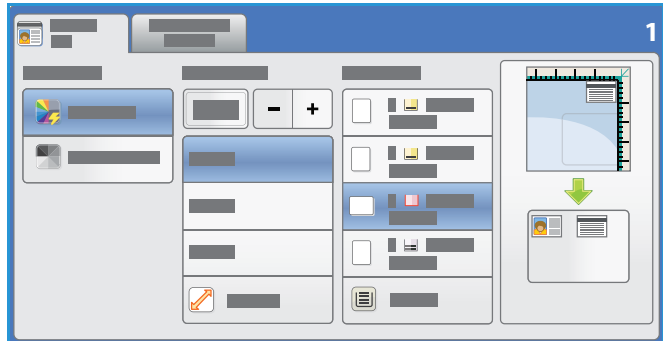

To copy an ID Card:

1. Lift the automatic document feeder. Place the ID card face down onto the document glass and align it to the arrow at the top right rear corner. Close the automatic document feeder.
2. Press the **Clear All (AC)** button once to cancel any previous screen programming selections.
3. Press the **Services Home** button and touch **ID Card Copy**.
The ID Card Copy features are displayed.
4. Select the required enlargement or reduction.
5. Select the paper tray required for the job. The graphic on the screen changes to reflect the orientation of the output paper.
6. Touch **Image Quality Side 1** and program the features required for side 1.
7. Type the copy quantity by using the numeric keypad and press **Start** on the Control Panel to scan side 1 of the ID card.
8. Lift the automatic document feeder and turn over the ID card to enable side 2 to be scanned. Close the automatic document feeder.
9. Touch **Image Quality Side 2** and program the features required for side 2.
10. Press **Start** to scan side 2 of the ID card.
The job is processed and printed. Retrieve your copies from the output tray.

If your job is held in the list, it requires additional resources to print. To identify the resources required, press the **Job Status** button. Touch your job in the list and touch **Job Details**. Once the resources are available, the job prints.

Output Color

The Output Color options include selections to detect and match the color of the original or produce monotone, full color, or a single color output from the original automatically. Use **More** to access all the options. The options are:

- **Auto Detect** to select output that matches the original.
- **Black and White** to select monotone output regardless of the color of the original.

Reduce/Enlarge

A variety of options are available on the printer to enable you to reduce or enlarge the output from the original. This includes selecting a specific ratio, either proportionately or independently, and choosing from a selection of pre-defined, preset buttons. For convenience, easy access to ratio selection can be found on the **ID Card Copy** tab in the Reduce / Enlarge area.

Images from originals placed on the document glass can be enlarged or reduced in any proportion, 25 %–400 %.

To reduce or enlarge the image:

1. Press the **Services Home** button and touch **ID Card Copy**.
2. Touch the **ID Card Copy** tab.
3. Under Reduce / Enlarge:
 - Touch - / + buttons to select the required reduction or enlargement percentage.
 - Alternatively, touch **ratio** and use the numeric keypad to type the ratio required.
 - To set the output image to be the same size as the original, set the ratio window to 100 %.
4. Touch **More** for additional options.
 - a. To reduce or enlarge, touch an option:
 - **Proportional %** reduces or enlarges the image proportionally, 25 %–400 %.
 - **Independent %** allows you to reduce or enlarge the width and length of the image by different percentages in the range of 25 %–400 %.
 - b. To select custom or preset values, touch an option:
 - **Proportional %** or **Independent %** allows you to specify exact values. Touch the arrows or touch the % field and then use the alphanumeric keypad to enter the value.
 - **Presets (X-Y%)** or **Presets (Y/X)** allows you to select from a list of preset values.
 - c. Touch **OK** to Save.

Paper Supply

Select a paper tray loaded with the desired paper to make copies on letterhead, colored paper, transparencies, or different paper sizes.

To select the tray to use for ID card copies:

1. Press the **Services Home** button and then touch **ID Card Copy**.
2. Touch the **ID Card Copy** tab.
3. Under Paper Supply, touch the desired tray.
4. If the desired tray is not listed, touch another tray:
 - Touch **More** for additional options.
 - Touch the desired tray. The selected tray is highlighted in blue.
 - Touch **OK** to Save.

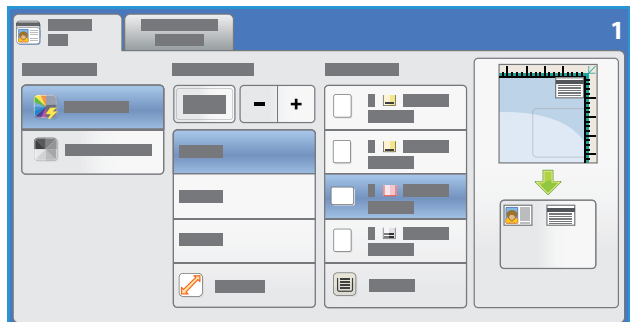

Image Quality

The Image Quality tab includes Image Quality options for Side 1 and Side 2. Each option is described in detail.

Image Quality Side 1 and Side 2

This section describes how to enhance the quality of the output and the options available. These options enable you to set the type of the original; adjust the lightness, darkness, contrast, and sharpness of the image; and also to customize the settings for color output.

Original Type

The printer optimizes the image quality of the copies based on the type of images in the original document and how the original was created.

To specify the original type:

1. Press the **Services Home** button and then touch **ID Card Copy**.
2. Touch the **Image Quality** tab.
3. Under **Original Type**, select the appropriate settings:
 - **Photo and Text** is recommended for originals containing high-quality photographs and halftones. This setting produces medium quality pictures with slightly reduced sharpness of text and line art.
 - **Text** produces sharper edges and is recommended for text and line art.
 - **Photo** is used specifically for originals containing photos, magazine pictures, or continuous tones, without any text or line art. Produces the best quality for photos but reduced quality text and line art.
 - **Newspaper / Magazine** is used if the original is from a magazine or newspaper that contains photographs or text.

Lighten/Darken

Lighten / Darken provides manual control to adjust the lightness or darkness of the scanned images. Move the indicator down to darken the image or up to lighten the image.

To adjust the image:

1. Press the **Services Home** button and then touch **ID Card Copy**.
2. Touch the **Image Quality** tab.
3. To lighten or darken the image for side 1, under Lighten/Darken, adjust the slider up or down.
4. Lift the document cover.
5. Place the ID card, or a document smaller than half the selected paper supply size, in the upper left corner of the document glass.
6. Press the **Start** button.
7. Lift the document cover.

Image Quality

8. Turn over the document and position it in the upper left corner of the document glass.
9. To lighten or darken the image for side 2, adjust the slider up or down.
10. Press the **Start** button.
11. Lift the document cover and remove the ID card or document.

Background Suppression

Background Suppression enhances originals that have colored backgrounds, by reducing or eliminating the background on the output copy. This option is useful when the original is on colored paper.

To change this setting:

1. Press the **Services Home** button and then touch **ID Card Copy**.
2. Touch the **Image Quality** tab.
3. Under Background Suppression, touch **Auto Suppression**.
4. Touch **Off** to turn off the Background Suppression feature, particularly when:
 - The **Darken** adjustment does not produce a satisfactory output from light originals.
 - The original has a gray or colored border, such as a certificate.
 - You want to bring out the fine detail that was lost due to a dark edge when using bound originals.
5. Touch **OK** to save your selections and exit.

Print From

3

This chapter includes:

- [Introduction](#) on page 40
- [Using Print From](#) on page 41
- [Saving Jobs for use with Print From](#) on page 43
- [Log In/Out](#) on page 46

Introduction

Print From is a standard feature that can be enabled. If enabled, it is selected by pressing the **Services Home** button, then touching the **Print From** option.

Print From enables you to print jobs, have been stored on the printer or on a USB Flash Drive.

Jobs can be stored on the printer by using the Print Driver or CentreWare Internet Services Print Submission. Stored jobs are placed in a folder on the printer. Stored jobs can be recalled and printed multiple times, as required.

To print directly from a USB memory printer, insert the USB Flash Drive and touch **Print from USB** from the drop-down menu on the screen. The **Print From** options are displayed. Touch the print-ready file for printing, the required options, and then print the job.

If Authentication or Accounting has been enabled on your printer, you may have to type login details to access the features; refer to [Log In/Out](#) on page 46.

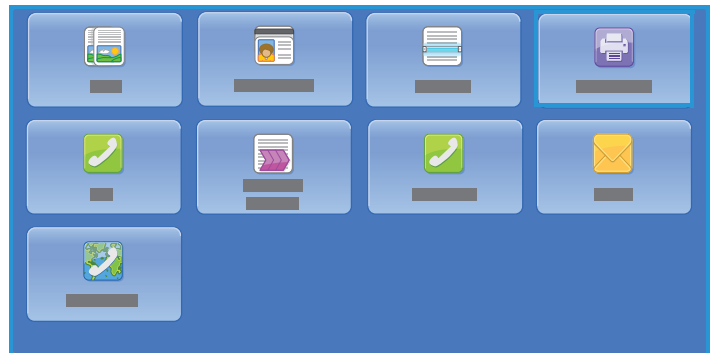

Using Print From

The Print From service can be used to print saved jobs have been stored on the printer, or PDF, TIFF, JPEG, XPS and other print ready files have been stored on a USB Flash drive. Jobs stored on the printer can also be printed using CentreWare Internet Services.



Using the Printer

1. Press the **Clear All** (AC) button twice and then **Confirm** to cancel any previous screen programming selections.
2. Press the **Services Home** button and touch **Print From**
3. Jobs can be printed from the printer or from the USB Flash Drive:
 - **Saved Jobs:** To print a job stored on the printer, touch **Saved Jobs**.
 - **USB Drive:** To print jobs from a USB Flash Drive, insert a USB Flash Drive into the USB Port on the left side of the printer. The USB Drive Detected screen appears. Touch **Print from USB**.

The system administrator must set up this feature before you can use it. For details, see the *System Administrator Guide* for your printer model.

The list of folders and jobs is displayed.

4. Touch the folder required and the print ready job required. If necessary, use the **Up** and **Down** buttons to scroll the list until the folder or job is displayed.
5. Touch the features required for your job:
 - **Paper Supply** is used to select the paper size, type and color, or touch **Auto** for the printer to choose a suitable paper supply.
 - **2-Sided Printing** is used to select 1- or 2-sided output, or touch **Auto** for the printer to choose an appropriate option.
 - **Finishing** is used to select a specific finishing option for the output, or touch **Auto** for the printer to choose an appropriate option.
6. Touch the Quantity box and type the number of copies required by using the numeric keypad.
7. Press **Start** to print the job. If the job is a secure job, type the passcode required and touch **Print Job**.
8. The Job Progress screen is displayed. Touch **Job Status** to view status information or use **Program Next Job** to run a different job.

If using a USB Flash Drive, remove it from the USB Port when you have finished printing.

Using CentreWare Internet Services

You can reprint your saved jobs using CentreWare Internet Services:

1. Open the Web browser from your Workstation.

2. In the URL field, type `http://` followed by the IP Address of the printer. For example: If the IP Address is 192.168.100.100, type the following into the URL field: `http://192.168.100.100`.
3. Press **Enter** to view the Home page.

The CentreWare Internet Services options for your printer are displayed.

Note: To find out the IP address of your printer, print a Configuration Report. Refer to [Machine and Job Status](#) on page 185.

4. Touch **Jobs**.
This screen shows the jobs currently in the printer list.
5. To access the list of Saved Jobs, touch the **Saved Jobs** tab.
6. Touch the folder that contains the job you want to print.
7. Touch the check box next to the job you want to print.
You may choose several jobs and specify how many copies you would like.
8. Touch **Print Job** from the drop-down menu and then touch **Go**.
9. Your selected job or jobs are printed at the printer using the saved print setting for each job.

Saving Jobs for use with Print From

Saved jobs stored on the printer can be accessed and printed using the Print From service. Saved Jobs are created using the Print Driver or CentreWare Internet Services. Job folders can be set up by the system administrator by using CentreWare Internet Services and can be managed by the users. Refer to [Managing Saved Jobs](#) on page 44.

Submitted print jobs can only be saved to Default Public Folder. Once jobs are on the printer, authorized users may copy or move them to either the Private folder or the Read Only folder.

Using the Print Driver

Touch or create a document on your computer.

1. Touch **Print** from the application File menu. The application Print window is displayed.
2. Touch the ColorQube 9301/9302/9303 Multifunction Printer from the Printer Name drop-down menu.
3. Touch **Properties** to access print settings for the job.
4. Touch the Job Type drop-down menu and touch **Saved Job**.
The Saved Job options are displayed.
5. Program the Saved Job options as required:
 - Touch **Save** to store the job only or **Save and Print** to store and print the job.
 - **Job Name** is used to type a name for the job or touch Use Document Name to use the filename of the document being submitted.
 - **Save in Folder** is used to select a location to store the job. The Default Public Folder is available to all users; other folders may have restricted access.
 - **Secure Saved Job** is used to add a passcode to the job. The job can only be accessed and printed by typing the passcode here.
6. Touch **OK** to save the settings and exit the Saved Job options.
Program the print features required for the saved job.
7. The **Help** option provides an explanation of all the options.
8. Touch **OK** to save the print settings.
9. Touch **OK** on the Print dialogue window to send the job.
The job is processed and sent to the printer for saving or saving and printing, depending on the selection.

Using CentreWare Internet Services

The Print option within CentreWare Internet Services can also be used to create a Saved Job. The job file submitted must be a print ready file, such as a PDF or PostScript file. To access CentreWare Internet Services:

1. Open the Web browser from your Workstation.
2. In the URL field, type http:// followed by the IP Address of the printer. For example: If the IP Address is 192.168.100.100, type the following into the URL field: http://192.168.100.100.

3. Press **Enter** to view the Home page.

The CentreWare Internet Services options for your printer are displayed.

Note: To find out the IP address of your printer, print a Configuration Report. Refer to [Machine and Job Status](#) on page 185.

4. Touch **Print** to access the Job Submission options.
5. Enter the file name of the job requiring saving, or use the **Browse** option to locate the file.
6. Touch the **Job Type** drop-down menu and touch **Save Job for Reprint**.
The **Saved Job** options are displayed.
 - Touch **Save** to store the job only or **Save and Print** to store and print the job.
 - **Job Name** is used to type a name for the job.
 - **Save in Folder** is used to select a location to store the job. The Default Public Folder is available to all users, other folders may have restricted access.
 - **Secure Saved Job** is used to add a passcode to the job. The job can only be accessed and printed by typing the passcode here.
 - Program the **Paper, Paper Selection, 2-Sided Printing, Output Color, Collate, Orientation, Staple, Hole Punch, and Output Destination** as required.
7. Touch **Submit Job** at the top of the page to send the job to the printer over the Internet.
The job is processed and sent to the printer for saving or saving and printing, depending on the selection.

Managing Saved Jobs

Create New Folder

Folders and the files saved within them can be managed using CentreWare Internet Services.

1. Open the Web browser from your Workstation.
2. In the URL field, type http:// followed by the IP Address of the printer. For example: If the IP Address is 192.168.100.100, type the following into the URL field: http://192.168.100.100.
3. Press **Enter** to view the Home page.
The CentreWare Internet Services options for your printer are displayed.
Note: To find out the IP address of your printer, print a Configuration Report. Refer to [Machine and Job Status](#) on page 185.
4. Touch **Jobs**.
5. Touch the **Saved Jobs** tab to access the folder options.
6. Touch **Create New Folder**.
7. Input the name for the folder in the **Name** field.
As a normal user you are only able to create Public folders. These are the other kind of folders you may see.
 - The **Public** folder has been created by a user. It can be used by any user and has no access authority limitations. Any user can access and modify the documents in this folder.

- The **Read Only** folder is created by the system administrator or a user as a Read Only Public folder. Any user can print from the folder but documents cannot be deleted or modified.
 - The **Private** folder is created by a user only when the printer is in Authentication mode. The User marks the folder as Private and the folder is only visible to the Owner and the system administrator.
8. When you have selected the appropriate Permissions, touch **Apply**.
The Folder is displayed in the Folders List.

Modify or Delete Folder

You can modify or delete existing folders that contain Saved Jobs using CentreWare Internet Services.

1. Open the Web browser from your Workstation.
2. In the URL field, type `http://` followed by the IP Address of the printer. For example: If the IP Address is 192.168.100.100, type the following into the URL field: `http://192.168.100.100`.
3. Press **Enter** to view the Home page.
The CentreWare Internet Services options for your printer are displayed.

Note: To find out the IP address of your printer, print a Configuration Report. Refer to [Machine and Job Status](#) on page 185.

4. Touch **Jobs**.
5. Touch **Saved Jobs** tab to access the folder options.
6. Touch **Manage Folders**.
The window displays all the Public folders and any Private folders belonging to you.
Check the box next to the folder you want to modify.
7. Touch options required for the folder.
The folder can be deleted by touching the **Delete Folders** button.
The folder and the contents of the folder are deleted from the list on this screen and the list of available folders at the printer.

Log In/Out

If Authentication or Accounting has been enabled on the printer, you may need to log in before using some or all of the services. A picture of a lock on a button indicates that you must log in to use that service.

1. To log in, press the **Log In/Out** button on the control panel. Pressing a locked service will also prompt you to type your user name and password.
2. Use the keyboard to type your user name, and then touch **Next**.
3. Use the keyboard to type your password, and then touch **Done**.
4. If an accounting system is in use on the printer, you may also need to type additional information.
 - If Xerox Standard Accounting is enabled, you need to log in by using your Xerox Standard Accounting details.
 - If Network Accounting is enabled, you must type your User ID and Account ID.
 - If a Foreign Device Interface (FDI) is installed, you are prompted to access by using the device installed, for example, a card reader or coin slot.

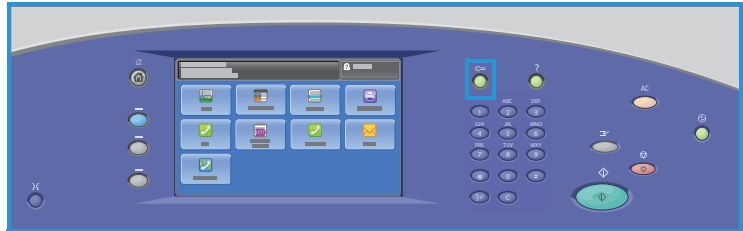

Your user details appear in the User Details area on the right side of the displayed message.

5. To log out, press the **Log In/Out** button again, or touch the User Details area and touch **Log Out** from the drop-down menu.
6. A confirmation screen is displayed; touch **Log Out** or **Cancel**.

Scan To

4

This chapter includes:

- [Introduction](#) on page 48
- [Scan To Using the Printer Address Book](#) on page 49
- [Scan To Using Favorites](#) on page 50

Introduction

The Scanning feature provides several methods for scanning and storing an original document. The scanning procedure using your printer differs from that of desktop scanners. The printer is connected typically to a network then to a single computer, so you select a destination for the scanned image at the printer.

Workflow Scanning enables the creation of an electronic image file by scanning an original hard copy document. For more information, refer to [Workflow Scanning](#) on page 99.

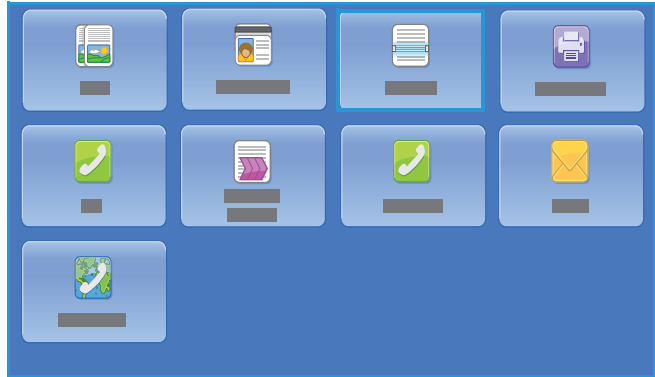

Scan To is a standard feature that can be enabled. If enabled, it is selected by pressing the **Services Home** button and then touching **Scan To**, which enables the electronic images to be scanned to the selected recipient on the printer address book or Favorites.

The **Address Book** is used to store individual numbers, names, email addresses, Internet Fax address, Fax number, and Scan To destination.

Favorites is a way of distinguishing a contact and/or contact information in such a way that it can be displayed separately from the Address Book listing, which allows speed dial by name.

Scan To Using the Printer Address Book

If individual names and other details have been saved in the Address Book, they can be accessed using the **Address Book** button.

1. Touch the **Address Book** button. A list of often used individuals, which are called Favorites in the Address Book, is displayed.

You can add, delete, or edit fields in the Address Book if the system administrator allows users to edit it. For details, see the *System Administrator Guide* for your printer model.

2. Touch the required recipient and select **Add to Recipients** from the drop-down menu. The contact is added to the Recipients list.

Continue adding recipients, as required.

Use the Search option to search for a specific entry. Touch **Search**, type the required name by using the touch screen keyboard, and touch **Search**.

The matching entries are displayed. Select the required name from the drop-down list and add the recipient to the recipient list.

3. To view the details of an existing entry, touch the entry in the list and touch the **Details** button. Edit the entry, as required, and touch **OK**.

4. Touch **Close** to return to the Address Book screen.

The scanned image is sent to all the contacts in the Recipients list.

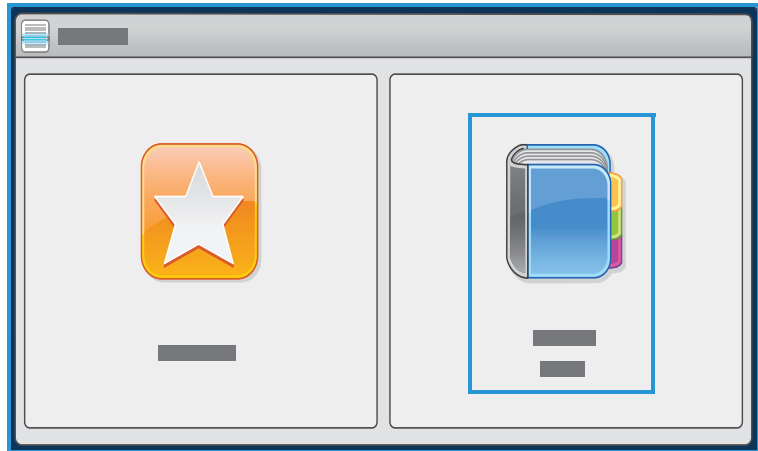

Scan To Using Favorites

1. The Scan To Favorites option must be enabled and set up by the system administrator. If frequently used individual names and other details have been grouped as Favorites within the address book, they can be accessed using the Favorites button. Touch the **Favorites** button.

A list of individual names used often from the Address Book, which are called Favorites, is displayed.

2. Touch the required recipient in Favorites. Select recipients, then press **Start** to submit the job. Optionally, you can add a contact to the Recipients list by touching **OK**.

Continue adding recipients, as required.

Use the **Search** option to search for a specific entry. Touch

Search, type the required name by using the touch screen keyboard, and touch **Search**.

The matching entries are displayed. Touch the required name from the drop-down list and add the recipient to the recipient list.

3. To view the details of an existing entry, touch the entry from the list and touch the **Details** button. Edit the entry, as required, and touch **OK**.
4. Touch **Close** to return to the Favorites screen.

The scanned image is sent to all the favorite contacts in the Recipients list.

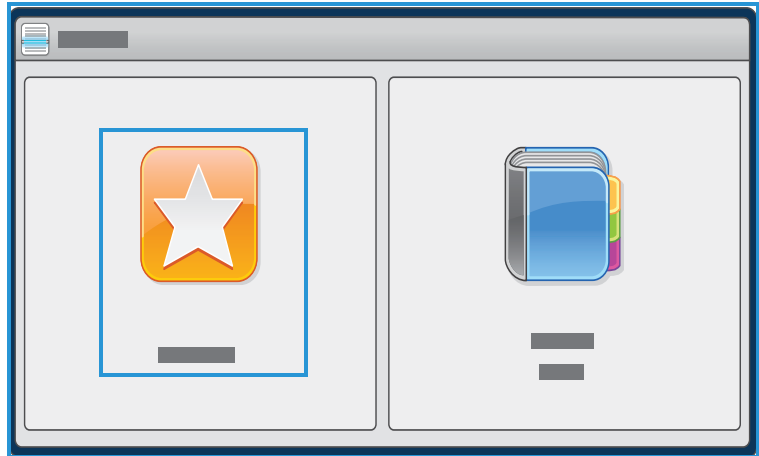

Fax

5

This chapter includes:

- [Introduction](#) on page 52
- [Dialing Options](#) on page 53
- [Fax](#) on page 56
- [Image Quality](#) on page 58
- [Layout Adjustment](#) on page 59
- [Fax Options](#) on page 61
- [Job Assembly](#) on page 67
- [Log In/Out](#) on page 68

Introduction

Fax is an optional feature that can be installed on your printer. If installed, it can be accessed by pressing the **Services Home** button, then touching **Fax**. Using Fax enables you to scan the documents and send them to most types of fax machines that are connected to the telephone network.

The printer is connected directly to a telephone line and, therefore, gives you direct control over the fax transmissions.

This type of fax travels over normal telephone lines and will, therefore, be charged at telephone rates.

The standard Fax option has the ability to connect to one telephone. An Extended Fax option is also available, utilizes two telephone lines. Using two telephone lines provides the capability to simultaneously send and receive.

Note: This printer faxes only in black and white.

Most feature screens include these buttons to confirm or cancel the choices.

- **Cancel** resets the screen and returns to the previous screen.
- **Save** saves the selections made and returns to the previous screen.
- **Close** closes the screen and returns to the previous screen.

Instructions for sending a fax and using the basic features are provided in ColorQube 9301/9302/9303 Multifunction Printer How To Sheets. If Authentication or Accounting has been enabled on the printer, you can type login details to access the features. Refer to [Log In/Out](#) on page 68.

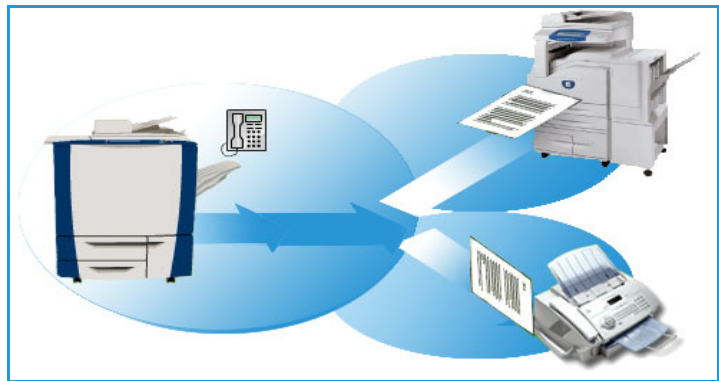
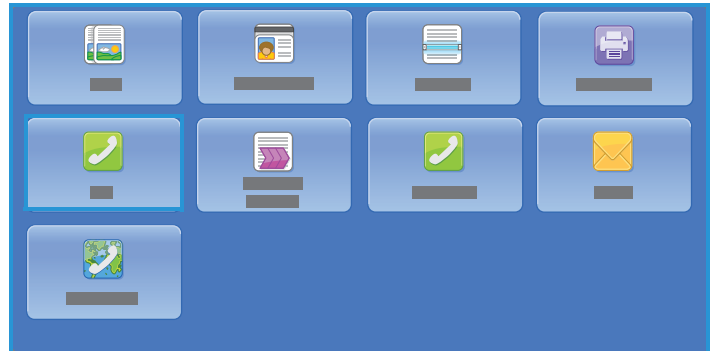

Dialing Options

The dialing options enable you to type the destination fax number or numbers. Touch the appropriate dialing option for the fax job.

To access Dialing Options, Press the **Services Home** button, and then touch **Fax**.

Manual Dialing

1. Touch the fax number field and type the fax number required by using the numeric keypad.
2. If special characters are required, use the **Dialing Characters** option to type the number plus additional dialing characters. Refer to [Dialing Characters](#) on page 53.
3. Touch **Add** to add the number to the recipient list. Type additional numbers, as required.

The fax is sent to all the numbers in the recipient list.

Dialing Characters

Additional dialing characters can be accessed by pressing the **Dialing Characters** button. Use this option to type the fax number if special characters are required. To type a fax number by using the dialing characters:

1. Touch **Dialing Characters**.
2. Use the numeric keypad to type the number plus additional dialing characters.

The following characters are available:

- **Dial Pause [,]** is used to pause between numbers. For additional pause time, add multiple pauses. If you are using charge code numbers, type a pause after the fax number but before the charge code number.
- **Pulse to Tone [:]** is used to switch between pulse and tone dialing.
- **Mask Data [/]** is used to protect confidential information. For example, if a special charge code or credit card number is required for a call, use the Mask Data character. Touch the / character before typing confidential numbers. After the last confidential numbers, touch / again to turn off the mask data. Characters between the / symbols appears as *.
- **Wait for Dial Tone [=]** suspends dialing until an expected network tone is detected. It can also be used to detect a specific tone when accessing an outside line or other service.
- **Readability Characters [Space () -]** are used for readability purposes but do not affect the number typed. For example, if you wish to identify the area code of a fax number, use the Readability Characters (1234) 567890.

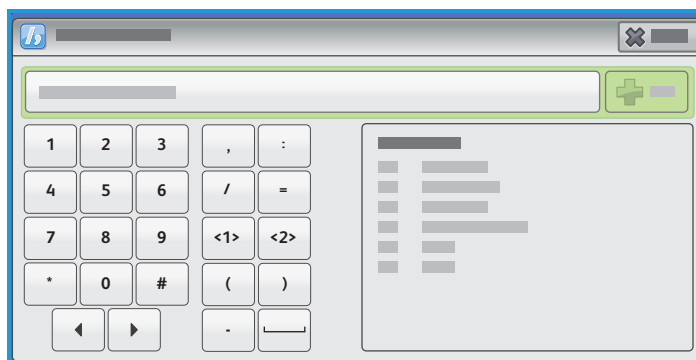

If more than one fax line is available, the following characters are also available:

- **Line 1** [**<1>**] selects line 1 to dial the number. Using the line selection identifier temporarily overwrites the fax settings and is for the current job only.
- **Line 2** [**<2>**] selects line 2 to dial the number. Using the line selection identifier temporarily overwrites the fax settings and is for the current job only.

If an incorrect entry is made, use the left/right arrows to navigate through the number and use  or backspace in the keyboard to delete an incorrect entry, or to delete the entire entry.

3. When you have typed the fax number and dialing characters required, touch **Add** to the number to the recipient list.
Up to 5000 fax destinations can be added. These fax destinations can be individual fax numbers or fax group designations.
4. Touch **Close** to return to the fax options.

Address Book

The Address Book is used to store contacts, can be individuals or groups. Therefore, a contact can contain an individual fax number or multiple fax numbers in the case of groups. To add, edit, or remove Individual or Group entries, refer to *System Administrator Guide*.

If numbers have been designated as an Address Book, they can be accessed using the **Address Book** option.

1. Touch **Address Book**.
A list of individuals added in the Address Book is displayed.
2. Touch the required recipient and touch **Add to Recipients** from the drop-down menu. The number is added to the Recipients list.
Continue adding recipients as required.
3. To add a Group entry to the list, touch **Fax Group** from the Fax Contacts drop-down menu. The available Groups are displayed. Touch the Group required and touch **Add to Recipients** from the drop-down menu.
The Group is added to the Recipients list.
Continue adding Individual or Group entries as required.
4. To view the details of an existing entry, touch the entry from the list and touch **Details**, and touch **Close** to return to the printer address book screen.
5. Touch **Close** to return to the fax options screen.

The fax is sent to all the numbers in the Recipients list.

Favorites

The Favorites is used to store contacts can be individuals or groups used frequently. Therefore a contact can contain an individual fax number or multiple fax numbers in the case of groups. To add, edit, or remove Individual or Group entries refer to *System Administrator Guide*.

If numbers have been designated as Favorites, they can be accessed using the **Favorites** option.

1. Touch **Favorites**.

A list of individuals and group added in the Favorites is displayed.

2. Touch the required recipient, and touch **OK**. The number is added to the recipients list and return to the fax options screen.

Continue adding recipients as required.

The fax is sent to all the numbers in the Recipients list.

Fax

These Fax options provide access to fax features, are required for programming basic fax jobs. To access the Fax options, press the **Services Home** button and then touch **Fax**. The **Fax** tab is displayed.

2-Sided Scanning

The 2-sided Scanning option allows you to set if one or two sides of the original document are scanned. The options are:

- **1-Sided** is used if the original documents are 1-sided.
- **2-Sided** is used if the original documents are 2-sided. Use the automatic document feeder to scan the originals with this option.
- **2-Sided, Rotate Side 2** touch if the original opens up like a calendar. Use the automatic document feeder to scan the originals with this option.

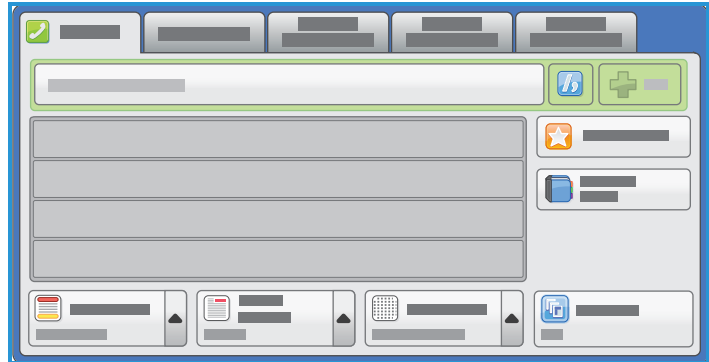

Original Type

Use this option to define the type of original being used for scanning. Making the correct selection enhances the quality of the output image. The options are:

- **Photo and Text** is recommended for originals containing high-quality photographs and halftones. Using this setting, the scanned image will contain medium quality pictures though the sharpness of text and line art is slightly reduced.
- **Photo** is used specifically for originals containing photos, magazine pictures, or continuous tones without any text or line art. Produces the best quality for photos but reduced quality text and line art.
- **Text** produces sharper edges and is recommended for text and line art.

Resolution

The Resolution affects the appearance of the fax at the receiving fax terminal. A higher resolution produces a better quality image. A lower resolution reduces the communication time. The options are:

- **Standard (200x100 dpi)** is recommended for text originals. It requires less communication time but does not produce the best image quality for graphics and photos.
- **Fine (200 dpi)** is recommended for line art and photos. This is the default resolution and the best choice in most cases.
- **Super Fine (600 dpi)** is recommended for photos and halftones or for images that have gray tones. It requires more communication time but produces the best image quality.



Cover Sheet

The Cover Sheet feature attaches a cover sheet to the document being transmitted. This feature replaces the routine of manually sending a cover sheet each time you send a document.

The Cover Sheet includes the following information:

- **To:** The recipient's name, as can be typed at the printer.
- **From:** The sender's name, as typed at the printer.
- **Comment:** The comment, as specified, from the comment list.
- **Start Time:** The date and time of the fax transmission. Depending on the setup, the time is displayed as a 12- or 24-hour clock. This information is added automatically to the cover sheet.
- **Pages:** The page count, excluding the cover page. This information is added automatically to the cover sheet.
- **Fax number:** The number of the sending fax printer. This information is added automatically to the cover sheet.

To select a Cover Sheet:

1. Touch the **Cover Sheet** button and touch **On**.
2. Touch the **To** field and type the name of the recipient by using the touch screen keyboard.
 - Up to 30 alphanumeric characters can be typed.
 - To delete a character, touch  or use the back arrow key.
 - To change the current touch screen language keyboard, touch  to access additional language keyboards, select the language, and touch **OK** to save and return to the previous screen.
 - Touch **OK**.
3. Touch the **From** field, type the name of the sender by using the touch screen keyboard, and touch **OK**.
4. Touch the comment required from the list.

If a customized comment is required, touch an **<Available>** comment and use  to type the text required, then touch **OK**.

5. To delete a comment from the list, touch the comment and touch .

A confirmation screen is displayed; touch **Delete**.

The cleared comment becomes **<Available>**.
6. Touch **OK** to save the selections and exit.

Image Quality

The Image Quality options provide access to the features, enhance the image quality or output quality. To access the Image Quality options, press the **Services Home** button, touch **Fax**, and touch the **Image Quality** tab.

Image Options

Use Image Options to change the appearance of the output image. The options are:

- **Lighten / Darken** provides manual control to adjust the lightness or darkness of the scanned images. Move the indicator down to darken the image or up to lighten the image.
- **Sharpness** provides manual control to adjust the sharpness of the scanned images. Move the indicator up to sharpen the image. Move the indicator down to soften the scanned image.

Image Enhancement

Image Enhancement provides options for improving the quality of the output by reducing the background or adjusting the contrast. The options are:

- **Background Suppression** enhances originals that have colored backgrounds by reducing or eliminating the background on the output. This option is useful when the original is on colored paper.
 - Touch **Auto Suppression** to automatically suppress unwanted background.
 - Touch **Off** to turn the Background Suppression feature off, particularly when:
 - The **Darken** adjustment does not produce a satisfactory output from light originals.
 - The original has a gray or colored border, such as a certificate.
 - You want to bring out the fine detail that was lost due to a dark edge when using bound originals.
- **Contrast** controls the image density on the output and compensates for an original that has too much or too little contrast on the image.
 - Touch **Manual Contrast** to set the level of contrast. Move the indicator towards the More setting to reproduce more vivid blacks and whites for sharper text and lines but less detail in pictures. Move the indicator towards the Less setting to reproduce more detail in light and dark areas of the original.
 - Touch **Auto Contrast** to automatically set the contrast level, depending on the original being scanned.

Layout Adjustment

The Layout Adjustment options allow you to manipulate the scanned image and enhance the appearance and style of the faxed document. To access the Layout Adjustment options, press the **Services Home** button, touch **Fax**, and touch the **Layout Adjustment** tab.

Original Size

Touch **Original Size** to type the size of the document when scanning from the document glass or the document feeder. The printer uses this information to calculate the size of the original and the scanned image. You can also touch **Auto Detect** for automatic size detection, or **Mixed Size Originals**, if scanning a mix of sizes. The options are:

- **Auto Detect** is the default setting and enables automatic size sensing. The size detected is matched with the standard-size paper.
- **Preset Scan Areas** allows you to define the size of the original from a list of pre-set, standard document sizes. You can view the list by using the scroll bar.
- **Custom Scan Area** is used to type a specific area for scanning. Measure the area to be scanned on the original and type the X- and Y-axis measurements in the fields provided. Only the area specified is scanned.
- **Mixed Size Originals** allows you to scan documents containing different size pages. The pages must be the same width, like A4 LEF and A3 SEF (8.5 x 11 in. LEF and 11 x 17 in. SEF). Other combinations are shown on the screen.

The printer will detect the size of the documents and determine if the receiving fax machine can support the various paper sizes. If the receiving fax cannot support the page sizes, the image is reduced or enlarged to fit.

Touch **OK** to save the selections and exit.

Reduce/Split

Touch **Reduce/Split** to specify how the faxed document is printed if the document paper size is larger than the receiving fax machine capabilities. The options are:

- **Reduce to Fit** reduces the image to fit the paper size of the receiving fax machine.
- **Split Across Pages** splits the document into two equal parts, or the majority of the image is put on to one page and the remainder on the next page.

Touch **OK** to save the selections and exit.

Book Faxing

CAUTION: Do not close the automatic document feeder when scanning bound originals.

Touch **Book Faxing** to specify page or pages of a book are to be scanned. The book original is placed face down on the document glass with the spine of the book lined up with the marker on the rear edge of the glass. Align the top of the bound original against the rear edge of the document glass.

The printer will identify the size of the original during scanning. If the pages have a black- or dark-colored border, the printer considers that the pages are smaller than they really are. To overcome this, use the **Custom Scan Area** feature in **Original Size** to type the exact size of the page. Refer to [Original Size](#) on page 59.

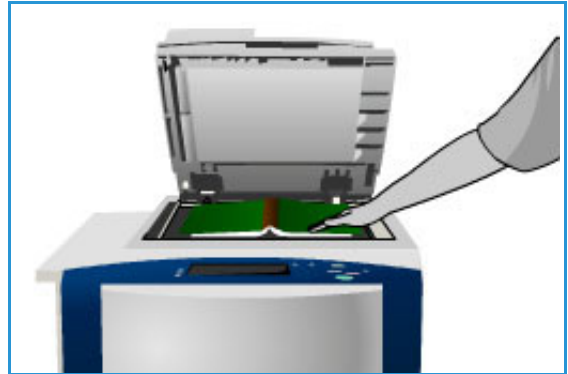

The options are:

- **Both Pages** is used to scan both pages; the left page of the book will be scanned first. Use the arrow buttons to specify 0–50 mm (0–2 in.) to be deleted from the center of the book in order to delete unwanted marks reproduced from the gutter of the book.
- **Left Page Only** is used to scan the left page only. Use the arrow buttons to specify 0–25 mm (0 in. to 1 in.) to be deleted from the right side of the page, in order to delete unwanted marks reproduced from the gutter of the book.
- **Right Page Only** is used to scan the right page only. Use the arrow buttons to specify 0–25 mm (0 in. to 1 in.) to be deleted from the left side of the page, in order to delete unwanted marks reproduced from the gutter of the book.

Touch **OK** to save the selections and exit.

Several pages of a bound document can be faxed by using the Build Job feature. Refer to [Build Job](#) on page 67 for more information.

Fax Options

The Fax Options allow you to specify how the fax document is transmitted, how it is printed at the receiving fax machine, and how to print confirmation report after performing these tasks. To access the Fax Options, press the **Services Home** button, touch **Fax**, and touch the **Fax Options** tab.

Confirmation Report

Touch **Confirmation Report** to print a broadcast report to identify the success or failure of a fax job. The options displayed depend on the settings enabled in **Tools**. Refer to [Administration and Accounting](#) on page 195 for more information.

The options are:

Print Confirmation

- Use to print a transmission report containing details about the fax, together with a reduced copy of the first faxed page.
- The Confirmation report is printed after every transmission.
- When sending a fax to multiple recipients, one report is printed listing all the recipients.

Print On Error Only

- Touch this option to print the Confirmation report only if an error occurs with the transmission.
- Touch **OK** to save the selections and exit.

Starting Rate

Use **Starting Rate** to select the speed at the printer starts transmitting the fax job. A high starting rate should be used in good transmission areas, and a low rate should be used in poor quality areas. The options are:

Super G3 (33.6 Kbps)

- Determines the transmission rate to be used, based on the maximum capabilities of the receiving fax machine.
- This rate minimizes transmission errors by using Error Correction Mode (ECM). The initial transmission speed is 33,600 Bits Per Second (bps).

G3 (14.4 Kbps)

- Selects the transmission rate, based on the maximum capabilities of the receiving fax machine.
- Initial transmission speed is 14,400 BPS. This rate minimizes transmission errors by using ECM.

Forced (4800 bps)

- Used in areas of low quality communication, when experiencing telephone noise or when fax connections are susceptible to errors.
- Forced 4,800 bps is a slower transmission rate but is less susceptible to errors. In some regional areas, the use of Forced 4,800 bps is restricted.

Touch **OK** to save the selections and exit.

Delay Send

Touch **Delay Send** to specify the time within the next 24 hours that you want the fax to be transmitted. Use this feature to transmit faxes during off-peak hours or when sending to another country or time zone. **Delay Send** can also be used with Mailbox and Polling options.

The option is:

Delay Send

- Touch **Delay Send** and touch either the **Hour** or **Minute** field to type a time to send the fax.
- Use the arrow buttons or numeric keypad to type the hours and minutes.
- If the printer is set up to display the time by using a 12-hour clock, you must also touch either the **AM** or the **PM** button.
- Touch **OK** to save the selections and exit.

The fax will be stored in memory and sent at the specified time.

Send Header Text

This feature allows you to include header text information when sending the fax. The information is printed in the header at the top of each page of the fax transmission. The information included is displayed on the screen and can be customized using **Tools**. Refer to [Administration and Accounting](#) on page 195.

- Touch **On** to enable the Send Header Text to print on the fax output.
- Touch **OK** to save the selections and exit.

Mailboxes

Mailboxes are areas of the printer memory where incoming faxes are stored and where outgoing faxes can be polled. Mailboxes enable you to store all received fax documents until it is convenient to retrieve them. Conversely, storing fax documents in a mailbox for Polling allows a remote user or users to retrieve the fax on demand.

Mailboxes must be set up by the system administrator before fax documents can be stored in them. The printer can contain up to 200 electronic mailboxes within its memory. To allow remote user to send fax message to your mailbox, they must know your mailbox number. To retrieve a document from your mailbox, the remote user must know your mailbox number and, if appropriate, your passcode.

The mailbox passcode ensures that the fax documents held in the mailbox are secure and can only be accessed by an authorized user. The passcode is a 4-digit number. If the mailbox has been set up with a passcode of 0000, then any combination of numbers, including no numbers, can be typed as the passcode to gain access to the mailbox.

Touch **Mailboxes**. The options are:

Send to Remote Mailbox

This feature enables you to send a fax directly to an private mailbox on a remote machine. The remote machine must have mailbox capabilities.

1. Touch **Send to Remote Mailbox**.
2. Type fax number of the recipient using the control panel, or touch **Dialing Characters** to type the number plus additional dialing characters. Refer to [Dialing Characters](#) on page 53.
3. To send to a remote mailbox, you need the mailbox number of the recipient. Type the **Mailbox Number**, in the range 001–200.
4. Type the 4-digit **Mailbox Passcode**.
5. Touch **OK** to save the selections and exit.
6. Use **Delay Send** to program a delay time to send the fax. Refer to [Delay Send](#) on page 62.
7. Load the originals and touch **Start** on the Control Panel to send the fax to the private mailbox. A Store to Remote Mailbox message is displayed showing information.
If enabled by the system administrator, a report is printed once the documents are sent to the remote mailbox.

Store to Local Mailbox

This feature allows you to store documents to be polled. The document is stored in your mailbox on the printer and automatically sent to a remote fax machine when requested.

1. Touch **Store to Mailbox**.
2. Type the **Mailbox Number**, in the range 001–200.
3. Type the **Mailbox Passcode**.
4. Touch **OK** to save the selections and exit.
5. Load the originals and touch **Start**.
Your fax job is scanned and stored in the mailbox, and the Mailboxes screen returns.

Print Local Mailbox Documents

Faxes stored in your mailbox can be printed.

1. Touch **Print Local Mailbox Documents**.
2. Type the **Mailbox Number**, in the range 001–200.
3. Type the **Mailbox Passcode**.
4. Touch **Print All Documents** to print the contents of the mailbox.

The documents can be deleted after printing, depending on the Mailbox & Polling Policies set.

Delete Local Mailbox Documents

All the faxes stored in your mailbox can be deleted. Local Mailbox Documents are faxes you have stored ready for Polling and faxes that you have received in your mailbox.

1. Touch **Delete Local Mailbox Documents**.
2. Type the **Mailbox Number**, in the range 001–200.
3. Type the **Mailbox Passcode**.
4. Touch **Delete All Documents** to delete the contents of the mailbox.
A confirmation screen is displayed, touch **Delete All** or **Cancel**.

Note: The storage time for faxes is set up by the system administrator.

5. A confirmation screen is displayed before deleting the faxes stored in the selected mailbox.

Local Polling

The Local Polling feature allows a fax document to be left in the memory of your printer and retrieved by another fax machine. If the fax document is in memory, it can be polled once and deleted, or polled several times, depending on the Mailbox & Polling Policies set.

Touch **Local Polling**. The options are:

Non-Secure Polling

This feature allows you to scan documents and store them in the memory of your printer. When a remote fax machine polls your printer, it is able to retrieve the scanned fax document or documents. No passcode is required for Non-Secure Polling.

1. Touch **Non-Secure Polling**.
2. Touch **Save** to save the selections and exit.
3. Load the originals to store for polling and press **Start**.

The originals are scanned and stored in memory ready to be polled.

Secure Polling

This feature allows you to scan documents and store them in the memory of your printer ready for polling. Secure Polling is used for sensitive documents, access is granted if the fax numbers of the retrieving devices have been entered, or if the Allow access to all option is selected.

1. Touch **Secure Polling**.
2. Type the fax numbers of the devices retrieving the document or touch **Allow access to all**.
3. Use **Add** to add more than one number to the list.
4. Touch **OK** to save your selections and exit.
5. Load the originals to store for polling and press **Start**.

The originals are scanned and stored in memory ready to be polled.

Print All Stored Documents

Documents stored in the memory for local polling can be printed. Touch **Print All Stored Documents** to print all the documents stored in the memory.

Touch **OK** to save the selections and exit.

Delete All Stored Documents

Documents stored in the memory for local polling can be deleted. Touch **Delete All Stored Documents** to delete all the documents stored in the memory. A confirmation screen is displayed; touch **Delete All** or **Cancel**.

Touch **OK** to save the selections and exit.

Remote Polling

The **Remote Polling** feature allows you to retrieve a stored document from a remote machine, where you call or Poll that machine. The printer offers several ways of Polling another fax machine:

- **Poll a Remote Fax** retrieves a fax from a remote fax machine or machines, immediately or at a specified time by using Delay Send.
- **Poll a Remote Mailbox** retrieves a fax document from the mailbox of a remote fax machine. The mailbox number and, if applicable, the passcode must be known.

Note: If your printer does not connect with the remote machine when Polling, it redials the number. If it connects and then the transmission fails, it does not redial the number and you have to start the Polling activity again. Polling a remote machine is not available if the fax line is set to **Send Only** or **Receive Only**.

Touch **Remote Polling**. The options are:

Poll a Remote Fax

The **Poll a Remote Fax** feature allows you to call a remote fax machine. The call locates and retrieves faxes stored at the remote machine. Remote Polling allows you to poll a remote machine immediately or at a specified time. More than one remote machine can be polled at a time.

1. Touch **Remote Fax**.
2. Type the fax numbers of the devices that are being polled. Use **Add** to add more than one number to the list.
Use the **Dialing Characters** option to type the number if special characters are required. Refer to [Dialing Characters](#) on page 53.
3. Use **Delay Send** to program a specific time to poll the remote machine. Refer to [Delay Send](#) on page 62.
4. Touch **Poll Now** to commence polling.

The remote printer is polled, and the retrieved document is printed. Touch **Close** to exit.

Poll a Remote Mailbox

The Poll Remote Mailbox feature allows you to call a mailbox that is set up on a remote fax machine. The call locates and retrieves faxes stored within the Polled mailbox.

1. Touch **Remote Mailbox**.
2. Type the fax number of the printer being polled.
Use the **Dialing Characters** option to type the number if special characters are required. Refer to [Dialing Characters](#) on page 53.
3. Type Mailbox Number, in the range 001–200.
4. Type 4-digit Mailbox Passcode.
5. Touch **Poll Now** to commence polling the mailbox.

The remote printer is polled, and the retrieved document is printed. Touch **Close** to exit.

Job Assembly

This tab provides access to the Build Job feature for compiling jobs that have different originals or programming requirements within a job. To access Job Assembly options, press the **Services Home** button, touch **Fax**, and touch the **Job Assembly** tab.

Build Job

Use this feature to build a job that requires different settings for each page, or a segment of pages.

You can touch the appropriate settings to apply to individual pages or segments of a completed job. First, split the originals into sections for individual programming.

1. Touch **Build Job** on the **Job Assembly** tab and touch the **On** button.
2. Touch **Options** and **Display this window between segments** to view the Build Job screen during scanning, then touch **OK**.
3. Select **Options** and **Turn Build Job Off after Job is submitted** to turn off the Build Job after job submitted.
4. Touch the options required for the first segment of the job.
Note: Type fax destination details before scanning.
5. Load the segment originals and press **Start**.
6. Remove the first segment originals. The Build Job screen displays the first segment in the list. The following options can be applied to any segment:
 - **Delete Last Segment** deletes the last segment scanned. You can continue programming the Build Job.
 - **Delete All Segments** deletes the current Build Job and returns you to the main Build Job screen.
7. Using **Program Next Segment**, touch the options required for the second segment.
8. Load the second segment originals and press **Start**.
9. Repeat these steps until all segments of the job have been programmed and scanned.
10. After the last segment has been scanned, touch **Submit the Job** to process and complete the job.

Secure Faxes

All incoming faxes are submitted to the Incomplete Jobs list as fax jobs and printed immediately.

If the administrator has switched on the **Secure Receive** feature, all incoming faxes require a passcode to release them for printing.

1. To release Secure Fax for printing, press the **Job Status** button and touch the held fax in the list.
2. To release a fax for printing, touch **Release** from the drop-down menu.
3. Use the numeric keypad to type the passcode and touch **Release Job**.
 The secure fax job is released for printing.

Log In/Out

If Authentication or Accounting has been enabled on the printer, you may need to log in before using some or all of the services. A picture of a lock on a button indicates that you must log in to use that service.

1. To log in, press the **Log In/Out** button on the control panel. Pressing a locked service prompts you to type your user name and password.
2. Use the keyboard to type your user name, and then touch **Next**.
3. Use the keyboard to type your password, and then touch **Done**.
4. If an accounting system is in use on the printer, you can also need to type additional information.
 - If Xerox Standard Accounting is enabled, log in by using your Xerox Standard Accounting details.
 - If Network Accounting is enabled, type your User ID and Account ID.
 - If a Foreign Device Interface (FDI) is installed, you are prompted to access by using the device installed, for example, a card reader or coin slot.

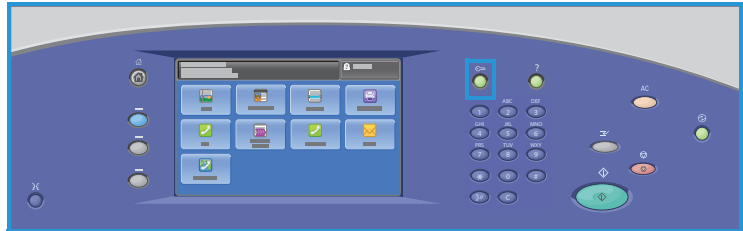

Your user details appear in the User Details area on the right side of the displayed message.

5. To log out, press the **Log In/Out** button again, or touch the User Details area and touch **Log Out** from the drop-down menu.
6. A confirmation screen is displayed; touch **Log Out** or **Cancel**.

Fax from PC

6

This chapter includes:

- [Introduction](#) on page 70
- [Faxing from a PC](#) on page 71
- [Fax from PC Options](#) on page 72

Faxing from a PC

To fax your job, the fax option must be installed on your printer and fax must be enabled on the Installable Options screen.

1. Select or create a document on your computer.
2. With the document open in your application, select **Print** from the Quick Access menu to display the Print options.
3. Select the correct print driver from the drop-down list corresponding to Name and then click **Properties**.
4. Select **Fax** as the **Job Type** on the Properties screen of the print driver.
The Fax screen is displayed. The Recipients tab is selected by default.
5. To add names, you can now click the **Add Recipient** icon or the **Add From Phonebook** icon in the Recipients tab.
6. To add a new recipient, press the **Add Recipient** button. Type the name and fax number of the recipient. Complete the additional information and select **OK**.
7. If you require a Cover Sheet to be sent with your fax document, select **Print a Cover Sheet** in the Cover Sheet tab.
The Cover Sheet window appears, allowing you to customize the page according to your requirements.
8. When you have selected all the required options, select **OK**.
9. Select the **Options** tab to choose:
 - The Confirmation Sheet: **Print a Confirmation Sheet** or **Do Not Print a Confirmation Sheet**.
 - The Send Speed: **G3 (Automatic)**, **G3 (14.4 Kbps)**, or **Forced (4800 bps)**.
 - The Fax Resolution: **Standard**, **Fine**, or **Superfine**.
 - The Send Time: **Send Now** or **Send At** (specify the time).
 - **Dialing prefix**.
 - **Credit card** details.
 When you have selected all the required options, select **OK**.
10. Select **OK** on the Properties screen and then select **OK** on the Print screen.
The Fax Confirmation screen displays the list of recipients you have chosen.
11. If you wish to make any changes, edit the details by selecting the button with a pencil icon. If the details are correct, select **OK**.
Your fax will be submitted to the printer job list ready to be transmitted.
12. Press the **Job Status** button on the control panel to display the job list.
Your job is displayed in the list. If there are no other jobs in the list, your job may have been processed. Refer to [Machine and Job Status](#) on page 185.

Fax from PC Options

Recipients

Use the **Recipients** option to type a recipient or group of recipients for your fax.

1. Select **Fax** as the Job Type on the Properties screen of the print driver.
The Fax screen will open. The Recipients tab is the default tab.
2. To add a recipient, click the **Add Recipient** button.
3. Type the following information for the recipient:
 - Name
 - Fax Number
 - Organization
 - Telephone Number
 - Email Address
 - Mailbox
4. Select **OK**.
Your entry is added to the recipient list.
5. Select the **Save** icon on the Recipients screen if you want to add the recipient to your Personal Phonebook.
6. To enter a recipient from a phonebook, click the **Add From Phonebook** button.
You can choose from three Phonebooks—Personal, Shared, and Shared LDAP. The Personal and Shared phonebook information is stored in data files. The file for your Personal Phonebook is on your computer or personal file space. The file for the Shared Phonebook, if you have one, is on a server and can be shared with other people. The Shared LDAP option will be linked to your company phonebook, if you have one.
Select the required phonebook. The system retrieves the phonebook information and displays the entries.
 - Type a name, or select the required name from the list.
 - Use the arrow pointing to the recipient list to add a recipient from the phonebook to the list.
 - To delete an entry from the recipient list, select it, use the **Delete** button, and select **Yes** in the **Remove Recipient** window to delete it.
 - To edit an entry from the recipient list, select it, use the **Edit** button to make the changes, and click **OK**.
7. When you have selected all the required options, select **OK** to continue making other selections for the job.

Cover Sheet

The Cover Sheet option enables you to add a cover sheet to your fax.

Select **Print a Cover Sheet** to send a cover sheet with your job. The cover sheet options are displayed.

Information

The Information tab is selected by default:

- Type the details of the sender to be included on the cover sheet:
 - Sender Name
 - Sender Organization
 - Sender Email Address
 - Sender Telephone Number
 - Sender Fax Number
- From the Recipients drop-down list:
 - Select **Show Recipient** to print the names of the recipients on the cover sheet.
 - Select **Hide Recipients** if you do not want the recipient names to be printed on the cover sheet.
 - Select **Show Custom Text** to customize the cover sheet with your information.

Image

Select the **Image** tab to select an image or text to be included on the cover sheet:

- If you want to include a watermark:
 1. Select **Custom** from the Watermark drop-down list.
 2. From the next drop-down list, choose **Text** or **Picture**.
 3. Select the desired angle and alignment respectively by using the rotate and position options for the image or text.
 4. From the Layering drop-down list, select **Print in Background**, **Blend**, or **Print in Foreground**.
 5. From the drop-down list below the Preview on the right side of the screen, you can select the cover sheet paper size, **Letter (8.5 x 11")** or **A4**.
 6. If you want to save your customized watermark, select **Save As** from the Watermark drop-down list.
- If you do not want to include a watermark, select **None** from the Watermark drop-down list.

Select **OK** to apply all your selection and close the Cover Sheet screen.

Options

On this screen, there are six fax transmission options that you may use to customize fax transmission.

Confirmation Sheet

You can choose to print a confirmation sheet that will confirm success or failure of the transmission.

Select **Print a Confirmation Sheet** from the drop-down menu.

Send Speed

You can choose one of the three transmission speeds. The options in the Send Speed drop-down list are:

- **G3 (Automatic):** This is the fastest transmission rate and is the default setting. This rate minimizes transmission errors by using Error Correction Mode (ECM). The initial transmission speed is 33,600 bits per second (bps).
- **G3 (14.4Kbps):** This speed option selects the transmission rate, based on the maximum capabilities of the receiving fax machine. The initial transmission speed is 14,400 bps. This rate minimizes transmission errors by using ECM.
- **Forced 4800 bps:** This speed is used in areas of low quality communication when experiencing telephone noise or when fax connections are susceptible to errors. The speed of 4800 bps is slow but less susceptible to errors. In some regions, use of 4800 bps is restricted.

Fax Resolution

You can choose one of the three image resolutions, depending on the type of documents being sent. The higher the resolution, the better the received image will be, but a high-resolution image will take longer to be transmitted. The options are:

- **Standard** is recommended for text originals. It requires less communication time but does not produce the best image quality for graphics and photos.
- **Fine** is recommended for line art and photos. This is the default resolution and the best choice in most cases.
- **Superfine** is recommended for photos and halftones, or images that have gray tones. It requires more communication time but produces the best image quality.

Send Time

It is sometimes called Delayed Send. Use this feature to transmit fax messages during off-peak hours or when sending to another country or time zone. The default setting called Send Now sends the fax immediately.

To send the fax at a specific time in the next 24 hours, select **Send At** and either type or use the arrow buttons to choose the local time you want the fax to be sent.

Dialing Prefix

Use the **Dialing Prefix** option if you need to add information such as an external access number, a country code, or an area code, to the recipient number you have selected on the Recipients screen.

Credit Card

Use the **Credit Card** option if you want to bill the call to a credit card.

Email

7

This chapter includes:

- [Introduction](#) on page 76
- [Email](#) on page 77
- [Advanced Settings](#) on page 81
- [Layout Adjustment](#) on page 83
- [Email Options](#) on page 85
- [Job Assembly](#) on page 87
- [Log In/Out](#) on page 88

Introduction

Email is a standard feature that can be enabled. If enabled, it is selected by pressing the **Services Home** button and touching **Email**.

Email first enables the creation of an electronic image file by scanning a hard copy document. The scanned image is then mailed to the specified email recipient or recipients over the Internet or intranet.

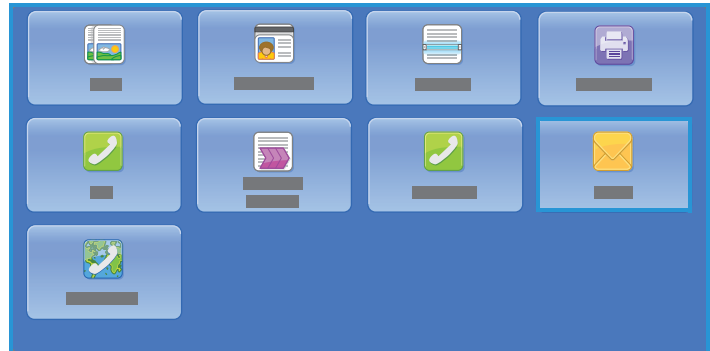

Using the Email feature allows you to add and remove recipients and edit the subject line of the email message.

Most feature screens include these buttons to confirm or cancel your choices.

- **Cancel** resets the screen and returns to the previous screen.
- **OK** saves the selections made and returns to the previous screen.
- **Close** closes the screen and returns to the previous screen.



Instructions for sending an email and using the basic features are provided in ColorQube 9301/9302/9303 Multifunction Printer How To Sheets. If Authentication or Accounting has been enabled on your printer, you can have to type login details to access the features; refer to [Log In/Out](#) on page 88.

Email

These Email options provide access to features that are required for programming basic email jobs. Details such as To (the recipient), Cc (copy to), and Subject are specified here.

New Recipient

Use this option to type details of all the recipients of the email message. To type the recipient details:

1. Touch **New Recipient**.
2. Touch **To:**, **Cc:**, or **Bcc:** to type the recipient name by using the drop-down menu on the left of the email address box.
3. Using the touch screen keyboard, type the email address.
 - Up to 40 alphanumeric characters can be typed.
 - To delete a character, touch  or use the back arrow key.
 - To change the current touch screen language keyboard, touch  to access additional language keyboards, select the language, and touch **OK** to save and return to the previous screen.
4. Touch **Add** to add the email address to the recipient list.
5. Continue adding email addresses until all the recipients have been added to the list.
6. Touch **Close**.
All the recipients are displayed in the recipient list.

Favorites

Use this option to choose recipients' names that you have saved earlier in this list on the printer Address Book.

Address Book

If the printer has been set up to access the Network and Public Address Books, you can use them to select recipients. For information about setting up address books, refer to the *System Administrator Guide*.

1. Touch the **Address Book** field.
A list of email addresses is displayed.
2. From the Email Contacts drop-down menu, you can touch **Email Contacts**, **Email Favorites**, or **All Contacts**.
3. Touch the required email address in the Names list and touch **To**, **Cc**, **Bcc**, or **Details** from the drop-down menu that appears.
The email address is added to the recipient list.
4. Continue adding email addresses, as required.
5. Use the **Search** option to search for a specific entry. Touch **Search** and type the required name by using the touch screen keyboard. Touch **Search** to start the search.
The matching entries are displayed.



6. Touch the required name; and by using the drop-down menu, add the recipient to the list.
7. After selecting all the recipients, touch **Close** to exit the Address Book window.
8. To find out more information about an address in the Address Book, touch the address and then touch **Details**.
Full details of the email address owner are displayed.
9. Touch **Close** to exit the Details window.

From

To type or edit the sender's name:



1. Touch **From**.

Note: This option may not be available.

2. If the default name is displayed, use  or backspace in the keyboard to delete it.
3. Using the touch screen keyboard, type the email address of the sender.
 - Up to 40 alphanumeric characters can be typed.
 - To delete a character, touch  or use the back arrow key.
 - To change the current touch screen language keyboard, touch  to access additional language keyboards, select the language, and touch **OK** to save and return to the previous screen.
4. Touch **OK** to save and return to the previous screen or touch **Cancel** to exit.
The specified email address is displayed in the **From** field.

Subject

To type a subject for the email:

1. Touch **Subject**.
2. Using the touch screen keyboard, type the subject of the email.
 - Up to 40 alphanumeric characters can be typed.
 - To delete a character, touch  or use the back arrow key.
 - To change the current touch screen language keyboard, touch  to access additional language keyboards, select the language, and touch **OK** to save and return to the previous screen.
3. Touch **OK** to save and return to the previous screen or touch **Cancel** to exit.
The specified subject is displayed in the **Subject** field.

Output Color

Touch **Output Color** to automatically detect and match the color of your original or produce monotone, full color, or a single color output from your original. The options are:

- **Auto Detect** to select the output that matches your original.
- **Black and White** to select the monotone output regardless of the color of your original.

- **Grayscale** to use gray scales instead of color.
- **Color** to select the color output from your original.

2-Sided Scanning

The 2-Sided Scanning option allows you to set if one or two sides of your original document are scanned. The options are:

- **1-Sided** is used if original documents are 1-sided.
- **2-Sided** is used if original documents are 2-sided. Use the automatic document feeder to scan the originals with this option.
- **2-Sided, Rotate Side 2** is used if the original opens up like a calendar. Use the automatic document feeder to scan the originals with this option.

Original Type

Use this option to define the type of original being used for scanning. Touching the correct option from the list of Content Type and How Original was Produced enhances the quality of your image.

Content Type



- **Photo and Text** is recommended for originals containing high-quality photographs and halftones. Using this setting, the scanned image will contain medium quality pictures, although the sharpness of text and line art will be slightly reduced.
- **Photo** is used specifically for originals containing photos, magazine pictures, or continuous tones without any text or line art. Produces the best quality for photos but reduced quality for text and line art.
- **Text** produces sharper edges and is recommended for text and line art.
- **Map** is used if the original is a map or contains intricate line art and text.
- **Newspaper / Magazine** is used if the original is from a magazine or newspaper that contains photographs or text.

How Original was Produced

- **Printed** is for originals that have come from a magazine, book, or newspaper, or printed on a large printing device.
- **Photocopied** is for originals that are photocopies.
- **Photograph** is for high-quality photo originals.
- **Inkjet** is for originals that have been produced using an inkjet printer.
- **Solid Ink** is for originals produced by a solid ink printing process, such as an output from this printer.

File Name

This feature enables you to name the file that is sent by Email.

- Using the touch screen keyboard, type the file name.
 - Up to 40 alphanumeric characters can be typed.
 - To delete a character, use  or backspace in the keyboard to delete it, or to delete the entire entry.
 - Touch  to access additional language keyboards.

Touch **OK** to save your selection and exit.

Advanced Settings

The Advanced Settings provide access to the features that enhance the image quality or output quality. To access Advanced Settings, press **Services Home**, touch the **Email** tab, and then touch the **Advanced Settings** tab.

Image Options

Image Options is used to change the appearance of the output image. The options are:

- **Lighten / Darken** provides manual control to adjust the lightness or darkness of the scanned images. Move the indicator down to darken the image or up to lighten the image.
- **Sharpness** provides manual control to adjust the sharpness of the scanned images. Move the indicator up to sharpen the image. Move the indicator down to soften the scanned image.
- **Saturation** controls the balance between vivid and pastel shades of the image. Move the indicator toward Vivid for more saturated colors. Move the indicator toward Pastel for less saturated colors.

Image Enhancement

Image Enhancement provides options for improving the quality of the output by reducing the background or adjusting the contrast. The options are:

- **Background Suppression** enhances originals that have colored backgrounds, by reducing or eliminating the background on the output. This option is useful when your original is on colored paper.
 - Touch **Off** to turn the Background Suppression feature off, particularly when:
 - The **Darken** adjustment does not produce a satisfactory output from light originals.
 - The original has a gray or colored border, such as a certificate.
 - You want to bring out the fine detail that was lost due to a dark edge when using bound originals.
 - Touch **Auto Suppression** to automatically suppress unwanted background.
- **Contrast** controls the image density on the output and compensates for an original that has too much or too little contrast on the image.
 - Touch **Manual Contrast** to set the level of contrast yourself. Move the indicator toward the More setting to reproduce more vivid blacks and whites for sharper text and lines but less detail in pictures. Move the indicator toward the Less setting to reproduce more detail in light and dark areas of the original.
 - Touch **Auto Contrast** to automatically adjust the contrast settings.

Scan Presets

Use **Scan Presets** to optimize scan settings to match the intended purpose of the scanned documents. The options are:

- **Sharing and Printing** is used for sharing files that are going to be viewed onscreen and for printing most standard business documents. This setting results in a small file size and normal image quality.

- **Archival - Small File Size** is the best for standard business documents that are stored electronically for record-keeping purposes. This setting results in the smallest file sizes and normal image quality.
- **OCR** is best for documents that need to be processed by Optical Character Recognition (OCR) software. This setting results in large file sizes and the best image quality.
- **High Quality Printing** is best for business documents containing detailed graphics and photos. This setting results in large file sizes and the highest image quality.
- **Simple Scan** is used for faster processing but can result in excessively large file sizes. Using this setting requires only minimal image processing and compression.

Touch **OK** to save your selection and exit.

Resolution

The **Resolution** affects the appearance of the scanned image. A higher resolution produces a better quality image. A lower resolution reduces communication time. The options are:

- **72 dpi**: Recommended for output displayed on a computer. It produces the smallest file size.
- **100 dpi**: Recommended for output that delivers low quality text documents.
- **150 dpi**: Recommended for average quality text documents and line art. Does not produce the best image quality for photos and graphics.
- **200 dpi**: Recommended for average quality text documents and line art. Does not produce the best image quality for photos and graphics.
- **300 dpi**: Recommended for high-quality text documents that are to pass through OCR applications. Also recommended for high-quality line art or medium quality photos and graphics. This is the default resolution and the best choice in most cases.
- **400 dpi**: Recommended for photos and graphics. It produces average image quality for photos and graphics.
- **600 dpi**: Recommended for high-quality photos and graphics. It produces the largest image file size, but delivers the best image quality.

Touch **OK** to save your selection and exit.

Quality/File Size

The **Quality/File Size** settings allow you to choose between scan image quality and file size. These settings allow you to deliver the best quality or make smaller files. A small file size delivers slightly reduced image quality but is better when sharing the file over a network. A large file size delivers improved image quality but requires more time when transmitting over the network. The options are:

- **Normal Quality** produces small files by using advanced compression techniques. Image quality is acceptable, but quality degradation and character substitution errors can occur with some originals.
- **Higher Quality** produces larger files with better image quality.
- **Highest Quality** produces the largest files with the maximum image quality. Large files are not ideal for sharing and transmitting over the network.

Touch **OK** to save your selection and exit.

Layout Adjustment

The Layout Adjustment options allow you to manipulate the scanned image and enhance the appearance and style of your output. To access the Layout Adjustment options, press **Services Home**, touch the **Email** tab, and then touch the **Layout Adjustment** tab.

Original Orientation

Allows you to specify the orientation of the originals being scanned. The options are:

- **Portrait Originals** refers to the image orientation on the original documents. Use this option to select a portrait image orientation. Originals can be fed in any direction.
- **Landscape Originals** refers to the image orientation on the original documents. Use this option to select a landscape image orientation. Originals can be fed in any direction.
- **Upright Images** refers to the direction the images are loaded in the automatic document feeder. Use this option if your images are in the orientation, matching the image shown when loaded in the automatic document feeder.
- **Sideways Images** refers to the direction the images are loaded in the automatic document feeder. Use this option if your images are in the orientation, matching the image shown when loaded in the automatic document feeder.

Touch **OK** to save your selection and exit.

Original Size

Original Size allows you to specify automatic size detection of the originals, mixed size originals, or the specific size of the image to be scanned. The options are:

- **Auto Detect** is the default setting and enables automatic size sensing. The size detected is matched to standard-size paper.
- **Preset Scan Area** allows you to define the size of your original from the Presets list of standard original sizes. You can view the list by using the scroll bar.
- **Custom Scan Area** is used to enter the dimensions of a specific area for scanning. Measure the area to be scanned on the original, and type the X- and Y-axes measurements in the fields provided. Only the area specified is scanned.
- **Mixed Size Originals** allows you to scan documents containing different size pages. The pages must be the same width, such as A4 LEF and A3 SEF (8.5 x 11" LEF and 11 x 17" SEF). Other combinations are shown on the screen.

Touch **OK** to save your selection and exit.

Edge Erase

Edge Erase enables you to specify how much of the image to erase around the edges of your document. For example, you can remove the marks caused by punched holes or staples in your original. The options are:

Layout Adjustment

- **All Edges** is used to erase an equal amount from all the edges. Use the arrow buttons to adjust the amount to be erased, 0–50 mm (0–2 in.). All marks or defects within the measurement set are deleted.
- **Individual Edges** enables an individual amount to be erased from each of the edges. Use the arrow buttons to adjust the amount for each edge, 0–50 mm (0–2 in.).

Touch **OK** to save your selection and exit.

Blank Page Management

Blank Page Management allows you to include or exclude blank pages in your originals when scanning. The options are:

- **Include Blank Pages** is used to include blank pages.
- **Remove Blank Pages** is used to ignore non-imaged pages in your originals. This setting is useful when scanning 2-sided originals with no image on side 2.

Touch **OK** to save your selection and exit.

Email Options

Email Options allows you to temporarily change the format of the email image file, set a Reply To address, and add a brief message. To access Email Options, press **Services Home**, touch the **Email** tab, and then the **Email Options** tab.

File Format

File Format determines the type of file created. You can select the file format you wish to use for your scanned image. The options are:

- **Portable Document Format (PDF)** allows recipients with the right software to view, print, or edit email files, no matter what their computer platform is.
 - **Image Only** optimizes the file for viewing and printing and cannot be modified.
 - **Searchable** runs the file through an Optical Character Recognition (OCR) process. This can take a few minutes but allows the text in the file to be searchable and editable. If **Searchable** is selected, the drop-down language menu becomes available. Touch the appropriate language in the menu.



Depending on the receiving printer, the **PDF** selection may not be compatible when the resolution is set to **200 dpi**.

- **PDF/A** is an industry standard format for long-term document preservation, based on the PDF format. The **Advanced Settings** may need checking to ensure they are appropriate for extended use.
 - **Image Only** optimizes the file for viewing and printing and cannot be modified.
 - **Searchable** runs the file through an OCR process. This can take a few minutes but allows the text in the file to be searchable and editable. If **Searchable** is touched, the drop-down language menu becomes available. Touch the appropriate language in the menu.
- **XML Paper Specification (XPS)** is a new format supported by Windows Vista.
 - **Image Only** optimizes the file for viewing and printing and cannot be modified.
 - **Searchable** runs the file through an OCR process. This can take a few minutes but allows the text in the file to be searchable and editable. If **Searchable** is touched, the drop-down language menu becomes available. Touch the appropriate language in the menu.
- **Tagged Image File Format (TIFF) Multi-Page** produces a single TIFF file containing several pages of scanned images. Specialized software is required to open this type of file format.
- **TIFF 1 File per Page** produces a graphic file that can be opened by a variety of graphic software packages across a variety of computer platforms. A separate file is produced for each image scanned.
- **Joint Photographic Experts Group (JPEG), 1 File Per Page** produces a compressed graphic file that can be opened by a variety of graphic software packages across multiple computer platforms. A separate file is produced for each image scanned.

Touch **OK** to save your selection and exit.



Message

This option is used to type a message for the email. The message is the text contained within the email message and not the subject line.

- Using the touch screen keyboard, type the required message.
 - Up to 50 alphanumeric characters can be typed.
 - To delete a character, use  or backspace in the keyboard to delete it, or to delete the entire entry.
 - Touch  to access additional language keyboards.
- Touch **OK** to save your selection and exit.

Reply To

The **Reply To** feature enables you to include the email address you want the recipient to reply to. For example, you can type your personal email address. If you logged in through authentication and your details are available in the Address Book, your email address is displayed.

- Using the touch screen keyboard, type the required email address.
 - Up to 50 alphanumeric characters can be typed.
 - To delete a character, use  or backspace in the keyboard to delete it, or to delete the entire entry.
 - Touch  to access additional language keyboards.
- Touch **OK** to save your selection and exit.

Job Assembly

This tab provides access to the Build Job feature for compiling jobs that have different originals or programming requirements within a job. To access the Job Assembly options, press the **Services Home** button, touch the **Email** tab, and then touch the **Job Assembly** tab.

Build Job

Use this feature to build a job that requires different settings for each page or a segment of pages.

You can select the appropriate settings to be applied to individual pages or segments of a completed job. First, split the originals into sections for individual programming.

1. Touch **Build Job** on the Job Assembly tab and touch **On**.

Note: The recipient details must be entered prior to scanning.

2. Touch **Options** and **Display summary window between segments** to view the Build Job screen during scanning.
3. Touch the options required for the first segment of the job.
4. Load the first segment originals and touch **Start**.
5. Remove the first segment originals. The Build Job screen displays the first segment in the list. **Delete All Segments** deletes the current Build Job and returns you to the main Build Job screen.
6. Using **Program Next Segment**, touch the options required for the second segment.
7. Load the second segment originals and touch **Start**.
8. Repeat these steps until all the segments of your job have been programmed and scanned.
9. After the last segment has been scanned, touch **Submit the Job** to indicate that you have finished scanning and the job can be processed and completed.

Log In/Out

If Authentication or Accounting has been enabled on the printer, you may need to log in before using some or all of the services. A picture of a lock on a button indicates that you must log in to use that service.

1. To log in, press the **Log In/Out** button on the control panel. Pressing a locked service will also prompt you to type your user name and password.
2. Use the keyboard to type your user name and then touch **Next**.
3. Use the keyboard to type your password and then touch **Done**.
4. If an accounting system is in use on the printer, you may also need to enter additional information.

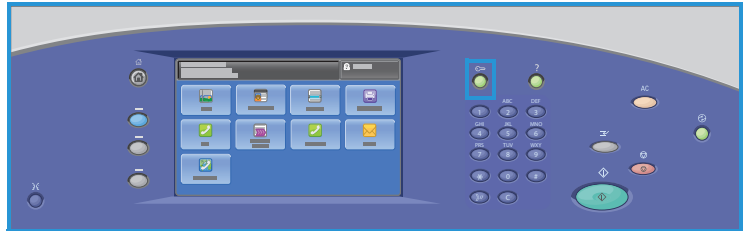

- If Xerox Standard Accounting is enabled, you need to log in by using your Xerox Standard Accounting details.
- If Network Accounting is enabled, you must type your User ID and Account ID.
- If Foreign Device Interface (FDI) is installed, you are prompted to access by using the device installed, for example, a card reader or coin slot.

Your user details appear in the User Details area on the right side of the displayed message.

5. To log out, press the **Log In/Out** button again, or touch the **User Details** area and touch **Log Out** from the drop-down menu.
6. A confirmation screen is displayed; touch **Log Out** or **Cancel**.

Server Fax

8

This chapter includes:

- [Introduction](#) on page 90
- [Dialing Options](#) on page 91
- [Server Fax Options](#) on page 93
- [Image Quality](#) on page 94
- [Layout Adjustment](#) on page 95
- [Fax Options](#) on page 96
- [Job Assembly](#) on page 97
- [Log In/Out](#) on page 98

Introduction

Server Fax is a standard feature that can be enabled. If enabled, it is selected by pressing the **Services Home** button, then touching **Server Fax**.

Server Fax scans the documents and sends them to any type of fax machine that is connected to a telephone network. Your images are sent from the printer to a Third-Party fax server that relays them over the telephone network to the fax number of choice.

This means that the fax transmissions are controlled by the server that may limit the faxing options. For example, the server may be set up to collect and send all faxes at off-peak times.

Most feature screens include these buttons to confirm or cancel the choices.

- **Cancel** resets the screen and returns to the previous screen.
- **OK** saves the selections made and returns to the previous screen.
- **Close** closes the screen and returns to the previous screen.

Instructions for sending a server fax and using the basic features are provided in ColorQube 9301/9302/9303 Multifunction Printer How To Sheets. If Authentication or Accounting has been enabled on the printer, you may have to enter login details to access the features; refer to [Log In/Out](#) on page 98.

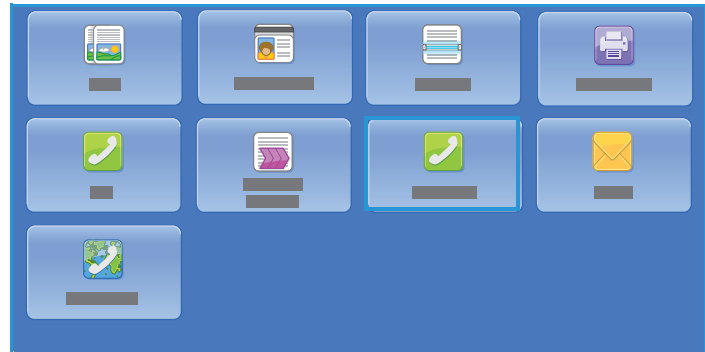

Dialing Options

The Dialing Options enable you to enter the destination fax number or numbers. Select the appropriate dialing option for the fax job.

To access Dialing Options, press the **Services Home** button and then touch **Server Fax**.

Manual Dialing

1. Using the numeric keypad, select the fax number field and enter the fax number required.
2. If special characters are required, use **Dialing Characters** to enter the number plus additional dialing characters. Refer to [Dialing Characters](#) on page 91.
3. Touch **Add** to add the number to the recipient list. Enter additional numbers, as required.

The fax will be sent to all the numbers in the recipient list.

Dialing Characters

Additional dialing characters can be accessed by touching **Dialing Characters**. Use this option to enter the fax number if special characters are required. To enter a fax number using the dialing characters:

1. Touch **Dialing Characters**.
2. Use the numeric keypad to enter the number plus additional dialing characters.

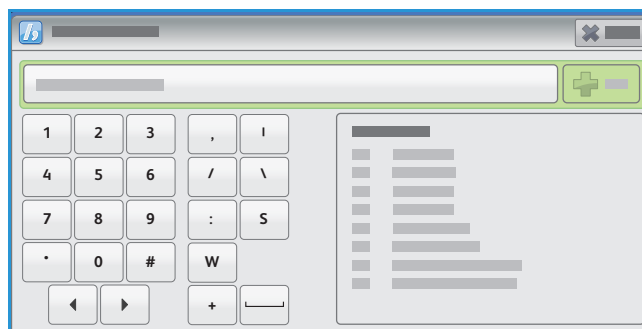

The following characters are available:

- **Dial Pause [,]** is used to pause between numbers. The pause allows time to switch from an inside to an outside line during automatic dialing. For additional pause time, add multiple pauses. If you are using charge code numbers, enter a pause after the fax number but before the charge code number.
- **Long Pause [I]** is used to enter a long pause between numbers.
- **Mask Data [/]** is used to protect confidential information. For example, if a special charge code or credit card number is required for a call, simply use the Mask Data character. touch the / character before entering confidential numbers. After the last confidential number, select / again to turn the mask data off. Characters between the / symbols will appear as *.
- **Group Dial [\]** is used to add another fax number to the entry if the fax is being sent to multiple recipients.
- **Pulse to Tone [:]** is used to switch between pulse and tone dialing.
- **Password Check [S]** is used for remote terminal identification. This character verifies that the correct number has been dialed.
- **Wait for Network Tone [W]** suspends dialing until an expected network tone is detected. This character can also be used to detect a specific tone when accessing an external line or other service.

- **Optional Readability Character [+]** is used for readability purposes and does not affect the number entered. For example, if you wish to identify the area code of a fax number, use the Readability Character 01234+567890.

If an incorrect entry is made, use the left/right arrows to navigate through the number and use  or backspace in the keyboard to delete an incorrect entry, or to delete the entire entry.

3. When you have entered the fax number and required dialing characters, touch **Add** to add the number to the recipient list.
4. Touch **Close** to return to the fax options.

Fax Directory

Fax Directory is used to store individual fax numbers that are used frequently. Fax Directory can be accessed from all screens where a fax number requires entering. Up to 29 entries can be added.

Using Fax Directory

If numbers have been entered into the Fax Directory they can be accessed using **Fax Directory**.

1. Touch **Fax Directory**.
A list of fax numbers entered in Fax Directory is displayed.
2. Select the required number and touch **Add to Recipients** from the drop-down menu. The number is added to Recipients list.
Continue adding recipients, as required.
3. To edit an entry, select it in the list and touch **Edit**.
Edit the entry, as required, and touch **OK**.
4. To clear an entry from the list, select the entry requiring deletion and touch **Remove** from the drop-down menu. A confirmation screen is displayed; touch **Remove** or **Cancel**.
5. Touch **Close** to return to the fax options.

The fax will be sent to all the numbers in the recipient list.

Setting up the Fax Directory

1. Touch the **Server Fax** tab, then the **Fax Directory**.
2. Select an empty slot from the list of entries. If necessary, use the scroll bar.
3. Enter the fax number in the **Enter Fax Number** field.
Use  or backspace in the keyboard to delete an incorrect entry, or to delete the entire entry.
Touch **OK**.
The new entry is displayed in the list.
4. To use the entry for the current job, select the entry in the list and touch **Add To Recipients**.
The number is added to the Recipients list.
5. To edit an entry, select it in the list and touch **Edit**.
Edit the entry, as required, and touch **OK**.
6. To exit the Fax Directory, touch **Close**.

Server Fax Options

The Server Fax options provide access to fax features that are required for programming basic server fax jobs. To access Server Fax Options, press **Services Home** button and **Server Fax**. **Server Fax** tab is displayed.

2-Sided Scanning

The 2-Sided Scanning option allows you to set if 1 or 2 sides of the original document are scanned. The options are:

- **1-Sided** is used if the original documents are 1-sided.
- **2-Sided** is used if the original documents are 2-sided. Use the automatic document feeder to scan the originals with this option.
- **2-Sided, Rotate Side 2** select if the original opens up like a calendar. Use the automatic document feeder to scan the originals with this option.

Original Type

Use this option to define the type of original being used for scanning. Making the correct selection enhances the quality of the output image. The options are:

- **Photo and Text** is recommended for originals containing high-quality photographs and halftones. Using this setting, the scanned image will contain medium quality pictures, although the sharpness of text and line art is slightly reduced.
- **Photo** is used specifically for originals containing photos, magazine pictures, or continuous tones, without any text or line art. Produces the best quality for photos but reduced quality text and line art.
- **Text** produces sharper edges and is recommended for text and line art.

Resolution

The Resolution affects the appearance of the fax at the receiving fax terminal. A higher resolution produces a better quality image. A lower resolution reduces the communication time. The options are:

- **Standard (200x100 dpi)** is recommended for text documents. It requires less communication time but does not produce the best image quality for graphics and photos.
- **Fine (200 dpi)** is recommended for line art and photos. This is the default resolution and the best choice in most cases.

Image Quality

Image Quality options provide access to the features that enhance the image quality or output. To access the Image Quality options, press the **Services Home** button and **Server Fax**, then touch the **Image Quality** tab.

Image Options

Image Options is used to change the appearance of the output image. The option **Lighten / Darken** provides manual control to adjust the lightness or darkness of the scanned images. Move the indicator down to darken the image or up to lighten the image.

Image Enhancement

Image Enhancement provides options for improving the quality of the output, by reducing the background or adjusting the contrast. The options are:

- **Background Suppression** enhances originals that have colored backgrounds, by reducing or eliminating the background in the output. This option is useful when the original is on colored paper.
 - Touch **Auto Suppression** to automatically suppress the unwanted background.
 - Touch **Off** to turn the Background Suppression feature off, particularly when:
 - The Darken adjustment does not produce a satisfactory output from light originals.
 - The original has a gray or colored border, such as a certificate.
 - You want to bring out fine detail that was lost due to a dark edge when using bound originals.
- **Contrast** controls the image density on the output and compensates for an original that has too much or too little contrast on the image.
 - Touch **Manual Contrast** to set the level of contrast yourself. Move the indicator towards the More setting to reproduce more vivid blacks and whites for sharper text and lines but less detail in pictures. Move the indicator towards the Less setting to reproduce more detail in the light and dark areas of the original.
 - Touch **Auto Contrast** to automatically set the contrast level, depending on the original being scanned.
 - Touch **OK** to save the selections and exit.

Layout Adjustment

The Layout Adjustment options allow you to manipulate the scanned image and enhance the appearance and style of the faxed document. To access Layout Adjustment options, press the **Services Home** button and **Server Fax**, then touch the **Layout Adjustment** tab.

Original Orientation

Used to specify the orientation of the originals being scanned. The options are:

- **Portrait Originals** refers to the image orientation on the original documents. Use this option to select the Portrait image orientation. Originals can be fed in any direction.
- **Landscape Originals** refers to the image orientation on the original documents. Use this option to select the Landscape image orientation. Originals can be fed in any direction.
- **Upright Images** refers to the direction the images are loaded in the automatic document feeder. Use this option if the images are in the orientation, matching the image shown when loaded in the automatic document feeder.
- **Sideways Images** refers to the direction the images are loaded in the automatic document feeder. Use this option if the images are in the orientation, matching the image shown when loaded in the automatic document feeder.

Touch **OK** to save the selections and exit.

Original Size

Touch **Original Size** to enter the size of the document when scanning from the document glass or the automatic document feeder. Your printer uses this information to calculate the size of the original and scanned images. You can also touch **Auto Detect** for automatic size detection, or **Mixed Size Originals**, if scanning a mix of sizes. The options are:

- **Auto Detect** is the default setting and enables automatic size sensing. The size detected is matched to standard size paper.
- **Preset Scan Areas** allows you to define the size of the original from a list of pre-set, standard document sizes. You can view the list by using the scroll bar.
- **Custom Scan Area** is used to enter a specific area for scanning. Measure the area to be scanned on the original and enter the X- and Y-axis measurements into the fields provided. Only the area specified is scanned.
- **Mixed Size Originals** allows you to scan documents containing different size pages. The pages must be the same width, such as A4 LEF and A3 SEF (8.5 x 11 in. LEF and 11 x 17 in. SEF). Other combinations are shown on the screen.

The printer will detect the size of the documents and determine if the receiving fax machine can support various paper sizes. If the receiving fax cannot support the page sizes, the image is reduced, or enlarged to fit.

Touch **OK** to save the selections and exit.

Fax Options

Fax Options allow you to specify when the fax document is transmitted. To access Fax Options, press the **Services Home** button and **Server Fax**, then touch the **Fax Options** tab.

Delay Send

Touch **Delay Send** to specify the time within the next 24 hours that you want the fax to be transmitted. Use this feature to transmit faxes during off-peak hours or when sending to another country or time zone. **Delay Send** can also be used with the Mailbox and Polling options.

- Touch **Off** to send the fax within 24 hours from the current time.
- Touch **Delay Send** to transmit faxes during off-peak hours or when sending to another country or time zone.
 - Touch either the **Hour** or **Minute** field to enter a time to send the fax.
 - Use the arrow buttons or numeric keypad to enter hours and minutes.
 - If the printer is set up to display the time using a 12-hour clock, you must also touch either the **AM** or **PM**.
- Touch **OK** to save and program and scan the fax job.

The fax will be stored in memory and sent at the specified time.

Job Assembly

This tab provides access to the Build Job feature for compiling jobs that have different originals or programming requirements within a job. To access Job Assembly options, press the **Services Home** button and **Server Fax**, then touch the **Job Assembly** tab.

Build Job

Use this feature to build a job that requires different settings for each page, or a segment of pages.

You can select the appropriate settings to be applied to individual pages or segments of a completed job. First, split the originals into sections for individual programming.

1. Touch **Build Job** on the Job Assembly tab and touch **On**.

Note: The fax destination details must be entered prior to scanning.

2. Touch **Display summary window between segments** to view the Build Job screen during scanning, then touch **OK**.
3. Select the options required for the first segment of the job.
4. Load the first segment originals and press **Start**.
5. Remove the first segment originals. The Build Job screen displays the first segment in the list. **Delete All Segments** deletes the current Build Job and returns you to the main Build Job screen.
6. Using **Program Next Segment**, select the options required for the second segment.
7. Load the second segment originals and press **Start**.
8. Repeat these steps until all segments of the job have been programmed and scanned.
9. After the last segment has been scanned, touch **Submit the Job** to indicate that you have finished scanning and the job can be processed and completed.

Log In/Out

If Authentication or Accounting has been enabled on the printer, you may need to log in before using some or all of the services. A picture of a lock on a button indicates that you must log in to use that service.

1. To log in, press the **Log In/Out** button on the control panel. Pressing a locked service will also prompt you to type your user name and password.
2. Use the keyboard to type your user name and then touch **Next**.
3. Use the keyboard to type your password and then touch **Done**.
4. If an accounting system is in use on the printer, you may also need to enter additional information.

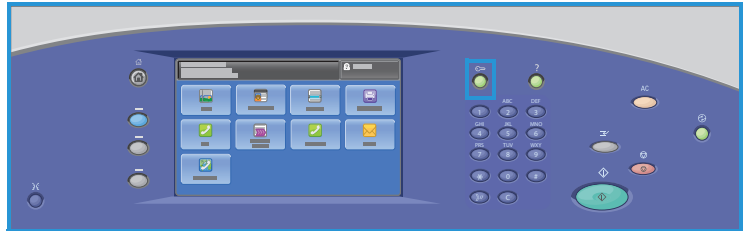

- If Xerox Standard Accounting is enabled, you need to log in by using your Xerox Standard Accounting details.
- If Network Accounting is enabled, you must type your User ID and Account ID.
- If a Foreign Device Interface (FDI) is installed, you are prompted to access by using the device installed, for example, a card reader or coin slot.

Your user details appear in the User Details area on the right side of the displayed message.

5. To log out, press the **Log In/Out** button again, or touch the User Details area and touch **Log Out** from the drop-down menu.
6. A confirmation screen is displayed; touch **Log Out** or **Cancel**.

Workflow Scanning

9

This chapter includes:

- [Introduction](#) on page 100
- [Workflow Scanning Options](#) on page 102
- [Advanced Settings](#) on page 104
- [Layout Adjustment](#) on page 107
- [Filing Options](#) on page 109
- [Job Assembly](#) on page 111
- [Log In/Out](#) on page 120

Introduction

Workflow Scanning is a standard feature that can be enabled. If enabled, it is selected by pressing the **Services Home** button and touching **Workflow Scanning** option.

Workflow Scanning enables the creation of an electronic image file by scanning a hard copy document. Use Workflow Scanning when both the printer and the computer have access to the same specified filing location. The scanned file is placed in

location specified by the template selected on the printer, for example, a repository set up on a network server, a PC drive or a USB Flash Drive.

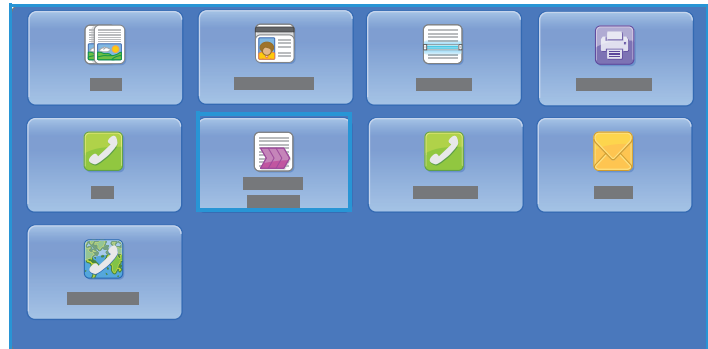

The standard Workflow Scanning option enables the electronic images to be stored and retrieved from a server or workstation on the network. Further options are available:

- **Scan to Mailbox** will store the image in the printer memory and a user can retrieve the files by using CentreWare Internet Services. For further information, refer to [Scan to Mailbox](#) on page 115.
- **Scan to Home** allows a user to send the files to a location on the network specified as the Home destination. For further information, refer to [Scan to Home](#) on page 118.
- **Scan to USB Flash Drive** allows a user to store the images on a USB Flash drive inserted into the printer USB Port, refer to [USB Port](#) on page 121.

Workflow Scanning is set up by a system administrator using CentreWare Internet Services. Users can use CentreWare Internet Services to create templates and folders once the relevant scanning function has been set up and enabled.

Instructions for using the basic Workflow Scanning features are provided in the ColorQube 9301/9302/9303 Multifunction Printer How To Sheets. If Authentication or Accounting has been enabled on the printer, you may have to enter login details to access the features, refer to [Log In/Out](#) on page 120.

Repositories

Repositories are directories or filing locations set up on a server, where the scanned files are saved to and held. The Repositories are set up using CentreWare Internet Services. Before you can use Workflow Scanning, the system administrator must set up the repositories available to the printer. Selecting a template identifies the repository / location the scanned job is filed to. Repositories are validated by CentreWare Internet Services when defined by the system administrator as a scanning destination. Up to five Repositories (one default and four additional) can be defined. After the Repositories are set up, they are available to you as choices when modifying templates.

Templates

Templates are used for scanning and faxing jobs at the printer using the Workflow Scanning service. They define the parameters of the scan or fax job. Information such as the final destination of the job (the file location) and the image quality settings are defined within the template, along with the template name. The template name is displayed within the template list, accessed on the printer touch screen.

You can select an existing template 'as is' or use CentreWare Internet Services to create a brand new one or modify an existing one. To successfully complete a Workflow Scanning job, you must select a template from the printer touch screen.

Template operations can either be performed using CentreWare Internet Services, or FreeFlow™ SMARTsend™. For information about FreeFlow™ SMARTsend™ templates, refer to the FreeFlow™ SMARTsend™ User Guide. This guide is included with the FreeFlow™ software documentation that accompanies the printer.

Always present on the printer, at the top of the list, is the Default template. The Default template is supplied with the printer software. Once the system administrator has set up the file repository, they define the parameters of the Default template.

As a user, you can create a new template, delete an existing template or copy, and then modify an existing template. These template operations are performed using CentreWare Internet Services. More information on these operations is given later in this guide.

Workflow Scanning Options

Selecting a Template

To use a template, select the template required from the template list. To access additional templates, use the drop-down menu above the list. To ensure that the latest templates are available, touch **Update Templates** from the **Advanced Settings** tab.

- **All Templates** allows you to identify and select all the scanning templates or workflows that are available on the printer. Use the scroll options to browse the list and select a scanning template for use.
- **DEFAULT** displays the basic scanning templates that have been created using the options provided by the printer.
- **USB** is used to store the scanned images on a USB Flash Drive. The USB Flash Drive is specified as the filing location on this template. If this template is selected and a USB Flash Drive has not been inserted, a message is displayed.

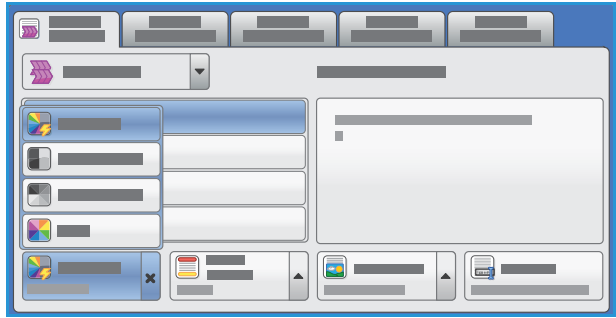

Output Color

Touch **Output Color** to automatically detect and match the color of the original or produce monotone, full color, or a single color output from the original. The options are:

- **Auto Detect** to select the output that matches the original.
- **Black and White** to select the monotone output regardless of the color of the original.
- **Grayscale** to use gray scales instead of color.
- **Color** to select the color output from the original.

2-Sided Scanning

The 2-Sided Scanning option allows you to set if 1 or 2 sides of the original document are scanned. The options are:

- **1-Sided** is used if the original documents are 1-sided.
- **2-Sided** is used if the original documents are 2-sided. Use the automatic document feeder to scan the originals with this option.
- **2-Sided, Rotate Side 2** select if the original opens up like a calendar. Use the automatic document feeder to scan the originals with this option.

Original Type

Use this option to define the type of original being used for scanning. Making the correct selection enhances the quality of the output image. The options are:



- **Photo and Text** is recommended for originals containing high-quality photographs and halftones. Using this setting, the scanned image will contain medium quality pictures though the sharpness of text and line art is slightly reduced.
- **Text** produces sharper edges and is recommended for text and line art.
- **Photo** is used specifically for originals containing photos, magazine pictures, or continuous tones, without any text or line art. Produces the best quality for photos but reduced quality text and line art.
- **Map** is used if the original is a map or contains intricate line art and text.
- **Newspaper / Magazine** is used if the original is from a magazine or newspaper that contains photographs or text.

How the Original was Produced

- **Printed** is for originals that have come from a magazine, book, or newspaper, or that have been printed on a large printing device.
- **Photocopied** is for originals that are photocopies.
- **Photograph** is for high quality photographic originals.
- **Inkjet** is for originals that have been produced using an inkjet printer.
- **Solid Ink** is for originals produced by a solid ink printing process, such as output from this printer.

File Name

This feature enables you to name the file that is stored.

- Using the touch screen keyboard, enter the name of the file.
 - Up to 40 alphanumeric characters can be entered.
 - Use  or backspace in the keyboard to delete an incorrect entry, or to delete the entire entry.
 - Touch  to access additional language keyboards.

Touch **OK** to save the selections and exit.

Advanced Settings

The Advanced Settings provide access to the features that enhance the image quality or output quality. To access the Advanced Settings, press the **Services Home** button and touch **Workflow Scanning**, then touch **Advanced Settings** tab.

Image Options

Image Options is used to change the appearance of the output image. The options are:

- **Lighten / Darken** provides manual control to adjust the lightness or darkness of the scanned images. Move the indicator down to darken the image or move up to lighten the image.
- **Sharpness** provides manual control to adjust the sharpness of the scanned images. Move the indicator up to sharpen the image. Move the indicator down to soften the scanned image.
- **Saturation** controls the balance between vivid and pastel shades of the image. Move the indicator towards Vivid for more saturated colors. Move the indicator towards Pastel for less saturated colors.
- Touch **OK** to save the selections and exit.

Image Enhancement

Image Enhancement provides options for improving the quality of the output by reducing the background or adjusting the contrast. The options are:

- **Background Suppression** enhances originals that have colored backgrounds, by reducing or eliminating the background on the output. This option is useful when the original is on colored paper.
 - Touch **Auto Suppression** to automatically suppress unwanted background.
 - Touch **Off** to turn the Background Suppression feature off, particularly when:
 - The **Darken** adjustment does not produce a satisfactory output from light originals.
 - The original has a gray or colored border, such as a certificate.
 - You want to bring out the fine detail that was lost due to a dark edge when using bound originals.
- **Contrast** controls the image density on the output and compensates for an original that has too much or too little contrast on the image.
 - Touch **Manual Contrast** to set the level of contrast yourself. Move the indicator towards the More setting to reproduce more vivid blacks and whites for sharper text and lines but less detail in pictures. Move the indicator towards the Less setting to reproduce more detail in light and dark areas of the original.
 - Touch **Auto Contrast** to automatically set the contrast level depending on the original being scanned.
 - Touch **OK** to save the selections and exit.

Scan Presets

Use **Scan Presets** to optimize scan settings to match the intended purpose of the scanned documents. The options are:

- **Sharing and Printing** is used for sharing files that are going to be viewed onscreen and for printing most standard business documents. This setting results in a small file size and normal image quality.
- **Archival - Small File Size** is best for standard business documents that are stored electronically for record-keeping purposes. This setting results in the smallest file sizes and normal image quality.
- **OCR** is best for documents that are going to be processed by Optical Character Recognition (OCR) software. This setting results in large file sizes and the highest possible image quality.
- **High Quality Printing** is best for business documents containing detailed graphics and photos. This setting results in large file sizes and the highest possible image quality.
- **Simple Scan** is used for faster processing but may result in excessively large file sizes. Using this setting requires only minimal image processing and compression.
- Touch **OK** to save the selections and exit.

Resolution

The **Resolution** affects the appearance of the scanned image. A higher resolution produces a better quality image. A lower resolution reduces [the] communication time. The options are:

- **72 dpi**: Recommended for output displayed on a computer. It produces the smallest file size.
- **100 dpi**: Recommended for output that delivers low quality text documents.
- **150 dpi**: Recommended for average quality text documents and line art. Does not produce the best image quality for photos and graphics.
- **200 dpi**: Recommended for average quality text documents and line art. Does not produce the best image quality for photos and graphics.
- **300 dpi**: Recommended for high-quality text documents that are to pass through OCR applications. Also recommended for high-quality line art or medium quality photos and graphics. This is the default resolution and the best choice in most cases.
- **400 dpi**: Recommended for photos and graphics. It produces average image quality for photos and graphics.
- **600 dpi**: Recommended for high-quality photos and graphics. It produces the largest possible image file size, but delivers the best image quality.
- Touch **OK** to save the selections and exit.

Quality/File Size

The **Quality/File Size** settings allow you to choose between scan image quality and file size. These settings allow you to deliver the highest quality or make smaller files. A small file size delivers slightly reduced image quality but is better when sharing the file over a network. A larger file size ensures improved image quality but requires more time when transmitting over the network. The options are:

- **Normal Quality** creates small files by using advanced compression techniques. Image quality is acceptable but some quality degradation and character substitution errors may occur with some originals.

- **Higher Quality** creates larger files with better image quality.
- **Highest Quality** creates the largest files with the maximum image quality. Large files are not ideal for sharing and transmitting over the network.

Touch **OK** to save the selections and exit.

Note: If you change the **Quality / File Size**, you may affect the settings in **Scan Presets** on the Workflow Scanning tab.

Update Templates

The **Update Templates** feature retrieves new or updated templates or workflow and removes outdated items from the list.

- **Update Now** retrieves updated template information immediately.
- Touch **Update Now** to confirm that an update is required.
- Touch **Close**.

Note: Selecting this option may cause a delay, and the Workflow Scanning service to be unavailable for several minutes. The delay does not affect other services available on the printer.

Layout Adjustment

The Layout Adjustment options allow you to manipulate the scanned image and enhance the appearance and style of the output. To access the Layout Adjustment options, press the **Services Home** button and touch **Workflow Scanning**, then touch **Layout Adjustment** tab.

Original Orientation

Used to specify the orientation of the originals being scanned. The options are:

- **Portrait Originals** refers to the image orientation on the original documents. Use this option to select the Portrait image orientation. Originals can be fed in any orientation.
- **Landscape Originals** refers to the image orientation on the original documents. Use this option to select the Landscape image orientation. Originals can be fed in any orientation.
- **Upright Images** refers to the direction that the images are loaded in the automatic document feeder. Use this option if the images are in the orientation matching the image shown when loaded in the automatic document feeder.
- **Sideways Images** refers to the direction that the images are loaded in the automatic document feeder. Use this option if the images are in the orientation matching the image shown when loaded in the automatic document feeder.

Touch **OK** to save the selections and exit.

Original Size

Original Size allows you to specify automatic size detection of the originals, mixed size originals, or the specific size of the image to be scanned. The options are:

- **Auto Detect** is the default setting and enables automatic size sensing. The size detected is matched with standard-size paper.
- **Preset Scan Areas** allows you to define the size of the original from a list of pre-set, standard original sizes. You can view the list by using the scroll bar.
- **Custom Scan Area** is used to enter a specific area for scanning. Measure the area to be scanned on the original, and enter the X- and Y-axis measurements in the provided fields. Only the specified area is scanned.
- **Mixed Size Originals** allows you to scan documents containing different size pages. The pages must be the same width, like A4 LEF and A3 SEF (8.5 x 11 in. LEF and 11 x 17 in. SEF). Other combinations are shown on the screen.

Touch **OK** to save the selections and exit.

Edge Erase

Edge Erase enables you to specify how much of the image is to be erased around the edges of the document. For example, you can remove the marks caused by punched holes or staples in the original. The options are:

- **All Edges** is used to erase an equal amount from all the edges. Use the arrow buttons to adjust the amount to be erased, 0–50 mm (0–2 in.). All marks or defects within the measurement set are deleted.
- **Individual Edges** enables an individual amount to be erased from each of the edges. Use the arrow buttons to adjust the amount for each edge, 0–50 mm (0–2 in.).

Touch **OK** to save the selections and exit.

Blank Page Management

Blank Page Management allows you to include or exclude blank pages in your originals when scanning. The options are:

- **Include Blank Pages** is used to include blank pages.
- **Remove Blank Pages** is used to ignore non-imaged pages in your originals. This setting is useful when scanning 2-sided originals with no image on side 2.

Select **OK** to save your selection and exit.

Filing Options

Use the filing options to specify details about the scanned images to be stored, for example, the file name, the file format, and the overwrite conditions. To access the Filing Options, press the **Services Home** button and touch **Workflow Scanning**, then touch **Filing Options** tab.

File Format

File Format determines the type of file created. You can select the file format you wish to use for the scanned image. The options are:

- **Portable Document Format (PDF)** allows recipients with the right software to view, print or edit the file, no matter what their computer platform.
 - **Image Only** optimizes the file for viewing and printing and cannot be modified.
 - **Searchable** runs the file through an OCR process. This can take a few minutes but allows the text in the file to be searchable and editable. If **Searchable** is selected, the **Language** menu becomes available. Select the appropriate language from the menu.

Depending on the receiving printer, the **PDF** selection may not be compatible when the resolution is set to **200 dpi**.

- **PDF/A** is an industry standard format for long-term document preservation based on the PDF format. The **Advanced Settings** may need checking to ensure they are appropriate for extended use.
 - **Image Only** optimizes the file for viewing and printing and cannot be modified.
 - **Searchable** runs the file through an OCR process. This can take a few minutes but allows the text in the file to be searchable and editable. If **Searchable** is selected, the **Language** menu becomes available. Select the appropriate language from the menu.
- **XML Paper Specification (XPS)** is a new format supported by Windows Vista.
 - **Image Only** optimizes the file for viewing and printing and cannot be modified.
 - **Searchable** runs the file through an OCR process. This can take a few minutes but allows the text in the file to be searchable and editable. If **Searchable** is selected, the **Language** menu becomes available. Select the appropriate language from the menu.
- **TIFF** produces a graphic file that can be opened by various graphic software packages across various computer platforms. Specialized software is required to open this type of file format.
- **JPEG (1 File per Page) (Joint Photographic Experts Group)** produces a compressed graphic file that can be opened by various graphic software packages across various computer platforms. A separate file is produced for each scanned image.

Note: **Multi-Page** produces a single file containing several pages of scanned images. **1 File per Page** produces a separate file for each scanned image.

Touch **OK** to save the selections and exit.

If File Already Exists

This option is used to determine how the printer handles duplicate filenames.

- **Add Number to Name** adds a unique number to the current filename.
- **Add Date and Time To Name** appends a date and timestamp and a printer identifier to the filename.
- **Add to PDF** adds the scanned images as PDF.
- **Overwrite Existing File** overwrites the existing file with the new file.
- **Do Not Save** does not save the scanned image if a file with the same name exists.

Document Management

The Document Management feature enables users to assign descriptive data to a scanned job. The descriptive data can be accessed by other software applications to assist in searching, indexing, and automated processing of scanned documents.

The Document Management data requirements are individually defined and programmed within the workflow scanning template.

The Document Management data fields can be either mandatory or optional. If the data is mandatory, the user is prompted to enter the data before scanning is allowed. Once the required data is entered, the user can commence scanning the job. If the data is optional, the user is prompted to enter the data but can complete the job without the data, if required.

Add File Destination

This option allows you to select additional network locations as filing destinations for the scanned documents. These additional filing destinations must be set up by the system administrator by using CentreWare Internet Services.

- Select the destination required from the list.
- To view information about the destination, touch **View Details**.

The destination filing path and information are displayed.

Job Assembly

This tab provides access to the Build Job feature for compiling jobs that have different originals or programming requirements within a job. To access the Job Assembly options, press the **Services Home** button and touch **Workflow Scanning**, then touch **Job Assembly** tab.

Build Job

Use this feature to build a job that requires different settings for each page, or a segment of pages.

You can select the appropriate settings to be applied to individual pages or segments of a completed job. First split the originals into sections for individual programming.

1. Touch **Build Job** on the Job Assembly tab and touch **On**.

Note: The destination details must be entered prior to scanning.

2. Touch **Display summary window between segments** to view the Build Job screen during scanning, then touch **OK**.
3. Select the options required for the first segment of the job.
4. Load the first segment originals and press **Start**.
5. Remove the first segment originals. The Build Job screen displays the first segment in the list. **Delete All Segments** deletes the current Build Job and returns you to the main Build Job screen.
6. Using **Program Next Segment**, select the options required for the second segment.
7. Load the second segment originals and press **Start**.
8. Repeat these steps until all segments of the job have been programmed and scanned.
9. After the last segment has been scanned, touch **Submit the Job** to indicate that you have finished scanning and the job can be processed and completed.

Creating Templates

Templates can be created, modified, and deleted using the CentreWare Internet Services option on the printer. Template operations can only be performed once the system administrator has defined the repositories and the default template. This operation is performed within CentreWare Internet Services. To access CentreWare Internet Services:

1. Open the Web browser from the Workstation.
2. In the URL field, enter http:// followed by the IP Address of the printer. Example: If the IP address is 192.168.100.100, enter the following in the URL field: http://192.168.100.100.
3. Press **Enter** to view the Home page.

The CentreWare Internet Services options for the printer are displayed.

Note: To find out the IP address of the printer, print a Configuration Report. Refer to [Machine and Job Status](#) on page 185 for instructions.

New Templates

1. To create a template, touch **Scan** and touch **Create New Template**.

Note: A New Distribution Template General Information window is displayed.

2. Enter the name that you want to appear as the template name on the printer.
3. Complete the Description and Owner fields, if required.
4. Touch **Add** to create the template.

The new template name is added to the list on the left of the screen. The new template is populated with the same settings as the Default template.

You can now modify the settings, as required.

Modifying a Template

Existing templates can be modified by using CentreWare Internet Services.

1. To modify a template, touch **CentreWare Internet Services Scan**.
2. Select the required template from the list on the left of the screen.
The template settings are displayed. Refer to [Template Options](#) on page 113 for information about the available settings.
3. Touch **Edit** to change the options required.
4. Touch **Apply** to save the selections and exit.

Copying a Template

A template can be copied and used as a base for a new template by using CentreWare Internet Services.

1. To copy a template, touch **CentreWare Internet Services Scan**.
2. Select the required template from the list on the left of the screen.
3. Touch **Copy**.
4. Enter the new template name and the template description and owner, if required.
If the name is not changed, "Copy" is appended to the template name.
5. Touch **Add**.
An exact copy of the original template is displayed with the new name.
6. Select the copied template and make any required changes.

Deleting a Template

Templates can be deleted by using CentreWare Internet Services.

1. To delete a template, touch **CentreWare Internet Services Scan**.
2. Select the required template from the list on the left of the screen.
3. Touch **Delete**.

The template is deleted from the list on the left of the screen.

Note: The Default template cannot be deleted.

Template Options

Destination Services

This option is used to select if the template is for filing and/or faxing.

- **File** is selected if you only require the originals to be scanned and stored in the designated filing location.
- **Fax** is selected if you also require the scanned images to be faxed to a remote fax destination. If this is selected, the fax destination must also be entered.

File

This option is used to select the filing location required for scanned images.

A default filing destination is always available. If additional locations have been defined by the system administrator, these can also be added to the template.

1. To add a new destination, touch **Add**. The **Filing Destination** options are displayed.
2. Touch **Filing Policy** required for the destination if a file exists with the same name:
 - Add Number to Name
 - Add Date and Time to Name
 - Overwrite Existing File
 - Do Not Save
3. Touch **File Destination** required using the drop-down menu.
4. If required, enter a file path for storing the scanned images.
5. Touch **Apply** to add the new destination and exit the screen. The destination is listed.

Document Management Fields

This option enables users to assign descriptive data to a scanned job. The descriptive data can be accessed by other software applications to assist in searching, indexing, and the automated processing of scanned documents.

1. To add a field, touch **Add** and enter the required data.
2. Touch **Editable** if the user is required to enter data at the time of scanning. Touch **Not Editable** to include fixed data.
3. Enter a field label and a default value, if required. If user input is required, Touch **User Input Required**. Touch **Mask User Input** if the data entered is confidential, such as a passcode. If details of the entry must be added to the log, touch **Record User Input to Job Log**.
4. Touch **Apply** to save the field entry.

Workflow Scanning

These options are used to set the basic options for a job. The options are:

- **Output Color** provides selections to automatically detect and match the color of the original or produce monotone, full color, or a single color output from the original.

- **2-Sided Scanning** allows you to set if 1 or 2 sides of the original document will be scanned and then filed.
- **Content Type** is used to define the type of original being used for scanning.
- **How Original was Produced** is used to select the production method of the original.
- **Scan Presets** are used to optimize scan settings to match the intended purpose of the scanned documents.

Advanced Settings

These settings provide advanced scanning options used to adjust image quality, select the file size and enhance the image.

The following options are available:

- **Image Options** are used to adjust the image quality applied to the scanned document.
- **Image Enhancement** is used to select an image quality setting appropriate for the originals.
- **Resolution** is used to define the resolution to use for scanning the original. The higher the scanning resolution, the better the image quality, although a larger image file is created.
- **Build Job** allows you to build a job that requires different settings for each page, or a segment of pages, or has more originals that can be scanned in the automatic document feeder at one time.
- **Quality / File Size** allows you to choose between scan image quality and file size. These settings allow you to deliver the highest quality or make smaller files. A small file size delivers slightly reduced image quality but is better when sharing the file over a network. A larger file size delivers improved image quality but requires more time when transmitting over the network.

Touch **Edit** to change the options. Touch **Apply** to save the selections and exit.

Layout Adjustment

These options allow you to manipulate the scanned image and enhance the appearance and style of the filed image.

The following options are available:

- **Original Orientation** is used to specify the orientation of the originals being scanned.
- **Original Size** is used to enter the size of the document when scanning from the document glass or the automatic document feeder. Your printer uses this information to calculate the size of the original and the scanned image.
- **Edge Erase** is used to erase spots, unwanted lines, marks, and punched holes that appear on the original but are not required on the scanned image.

Filing Options

These options are used to specify the document name and file format used to store the scanned images. The following options are available:

- **Document Name** enables you to name the file that will be stored.
- **File Format** determines the type of file created and can be temporarily changed for the current job.

File Name Extension

This option is used to specify if the file name extension uses lowercase or uppercase characters, for example, .pdf or .PDF.

Report Options

These options are used to enable the confirmation sheet and job log.

- **Confirmation Sheet** provides information about the success of the scanning job and prints at the printer when the job is complete.
- **Job Log** allows you to print a list of the last jobs that the system has completed processing.

Workflow Scanning Image Settings

These settings are used to set the image optimization, the searchable options, and the compression settings. The following options are available:

- **Optimized for Fast Web Viewing:** Used to set the printer to optimize the image file for viewing on a website.
- **Searchable Options:** Used to select if the file content is searchable and the language options.
- **Text Compression:** Allows you to enable the text to be compressed if the file format output is PDF or PDF/A.

Scan to Mailbox

Scan to Mailbox allows you to scan hard copy originals and store them on the printer for later retrieval. To use Scan to Mailbox, you must first create a private folder using CentreWare Internet Services. You must give the folder a name and a secure password.

Once set up, the private folder is displayed on the printer under the templates list. To store images in the private folder, select the folder in the list of templates, enter the passcode and scan the images.



The scanned images can then be retrieved at the PC by accessing CentreWare Internet Services, selecting the folder, and entering the passcode. You can then print the scanned documents or download them on the PC.

The Workflow Scanning option needs to be installed before this feature can be used, but it is NOT necessary for the Workflow Scanning repositories and templates to be configured.

Creating a Private Folder

The system administrator enables the Scan to Mailbox feature by using CentreWare Internet Services. To use Scan to Mailbox, you must set up a personal folder using CentreWare Internet Services. To access CentreWare Internet Services:

1. Open the Web browser from the Workstation.
2. In the URL field, enter `http://` followed by the IP Address of the printer. Example: If the IP Address is 192.168.100.100, enter the following into the URL field: `http://192.168.100.100`.
3. Press **Enter** to view the Home page.
The CentreWare Internet Services options for the printer are displayed.
Note: To find out the IP address of the printer, print a Configuration Report. Refer to [Machine and Job Status](#) on page 185 for instructions.
4. Touch **Scan** and then touch **Mailboxes**.
The Scan to Mailbox options are displayed.
5. Touch **Create Folder**, enter the folder name and password, and then confirm the password.
6. Touch **Apply**.
The new folder is created and displayed in the folder list.
7. To access the private folder and customize the options, enter the folder password.
Touch **Personalize Settings** to customize the scanning selections by using the **Edit**. Touch **Apply** after customizing each option.
When you have finished customizing the scanning options, touch **Back** to return to the Folder Contents screen.
8. To change the folder password or delete the folder, use the **Modify Folder**.

The private folder is now set up and will display in the templates list when Workflow Scanning is selected on the printer.

Using Scan to Mailbox

1. Load the original documents in the automatic document feeder or on the document glass.

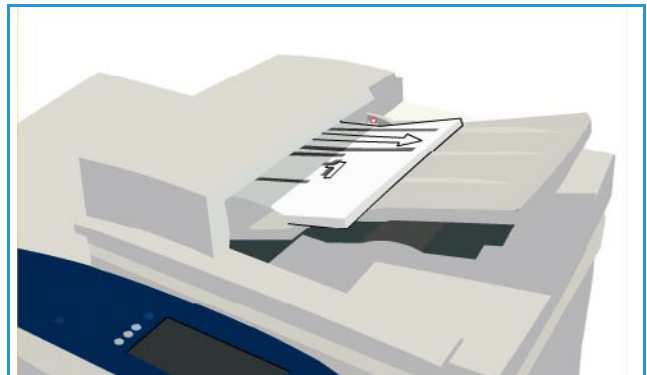

2. Press the **Clear All (AC)** button twice and then **Confirm** to cancel any previous screen programming selections.



3. Press the **Services Home** button and touch **Workflow Scanning**.

The Workflow Scanning features are displayed.

4. Select the private folder template from the templates list.
5. Enter the folder password by using the touch screen keyboard. The template settings are updated to the customized settings defined when the folder is created.
6. Make programming changes to **Output Color**, **2-Sided Scanning**, **Original Type**, and **Scan Presets**, as required.

Refer to [Workflow Scanning Options](#) on page 102 for more information.

7. Additional Workflow Scanning options are provided on each of the tabs. Refer to the following sections for further information:

- [Advanced Settings](#) on page 104
- [Layout Adjustment](#) on page 107
- [Filing Options](#) on page 109
- [Job Assembly](#) on page 111

8. Press **Start** to scan the originals and process the Workflow Scanning job.

Remove the originals from the automatic document feeder or glass when scanning is complete. The Workflow Scanning job enters the job list ready for filing.

9. Press the **Job Status** button to view all the job lists and check the status of the job. Refer to the [Machine and Job Status](#) on page 185 for more information.

The scanned images are filed in the private folder and are accessed using CentreWare Internet Services.

10. To access CentreWare Internet Services, open the Web browser from the Workstation.

In the URL field, enter http:// followed by the IP Address of the printer. Example: If the IP Address is 192.168.100.100, enter the following into the URL field: http://192.168.100.100.

Press **Enter** to view the Home page.

The CentreWare Internet Services options for the printer are displayed.

Note: To find out the IP address of the printer, print a Configuration Report. Refer to the [Machine and Job Status](#) on page 185 for instructions.

11. Touch **Scan** and touch **Mailboxes**. Select the private folder, enter the folder password, and touch **OK**.

A list of the folder contents is displayed. If necessary, use **Update View** to update the list of contents.

12. Select the file required. The following options are available:

- **Download** is used to save a copy of the file to a specified location. If Download is selected, you need to touch **Save** and specify the file location.
- **Reprint** can be used to print the file on the printer. The job is sent to the printer immediately and printed.

- **Delete** is used to permanently remove the file from the private folder and from the printer.
- **Job Log** is used to view the job log information for the selected job.

13. Select the action required from the drop-down menu and touch **Go**.

Scan to Home

Scan to Home allows you to scan hard copy documents at the ColorQube 9301/9302/9303 Multifunction Printer and send them to a destination on the network that is specified as the Home destination.

Enter the Network Authentication login at the printer. The printer displays a Scan to Home template. When you scan a document, the authentication server provides the information as to who is logged in at the printer.

The Workflow Scanning option needs to be installed before this feature can be used, but it is NOT necessary for the Workflow Scanning repositories and templates to be configured.



The system administrator enables the Scan to Home option in CentreWare Internet Services. The system administrator also needs to enable Network Authentication for this feature to be available. Lightweight Directory Application Protocol (LDAP) connectivity can also be used.

Using Scan to Home

The Scan to Home option must be enabled and set up by the system administrator in order for the Scan to Home template to be available on the printer. You must also be logged in to the printer by using Network Authentication to use this option.

1. Load the original documents in the automatic document feeder or on the document glass.
2. Press the **Clear All (AC)** button twice and then **Confirm** to cancel any previous screen programming selections.

3. To login, press the **Log In/Out** button on the control panel.
4. Use the keyboard to enter the **User Name**, then touch **Next**.

Use the keyboard to enter the **Password**, then touch **Enter**.

5. Press the **Services Home** button and touch **Workflow Scanning**.

The Workflow Scanning features are displayed.

6. Touch **Scan To Home Templates** from the drop-down menu.

The Default Template is displayed, and the current settings are changed to the settings in the Scan to Home template.

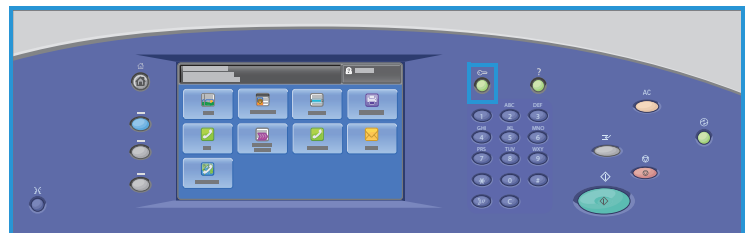

7. Make programming changes to **Output Color, 2-Sided Scanning, Original Type** and **Scan Presets**, as required.

Additional Workflow Scanning options are provided on each of the tabs. Refer to the following sections for further information:

- [Advanced Settings](#) on page 104
- [Layout Adjustment](#) on page 107
- [Filing Options](#) on page 109
- [Job Assembly](#) on page 111

8. Press **Start** to scan the originals and process the Scan to Home job.

Remove the originals from the automatic document feeder or glass when scanning has completed.

The job enters the job list ready for filing to the specified home location.

9. Press the **Job Status** button to view all the job lists and check the status of the job. Refer to the [Machine and Job Status](#) on page 185 for more information.

The scanned images are filed to the location specified on the template and ready for retrieval by the user.

Log In/Out

If Authentication or Accounting has been enabled on the printer, you may need to log in before using some or all of the services. A picture of a lock on a button indicates that you must log in to use that service.

1. To log in, press the **Log In/Out** button on the control panel. Pressing a locked service will also prompt you to type your user name and password.
2. Use the keyboard to type your user name and then touch **Next**.
3. Use the keyboard to type your password and then touch **Done**.
4. If an accounting system is in use on the printer, you may also need to enter additional information.

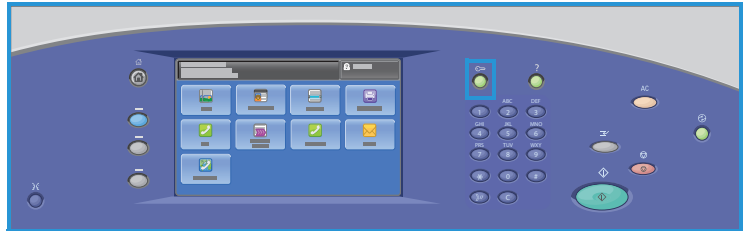

- If Xerox Standard Accounting is enabled, you need to log in by using your Xerox Standard Accounting details.
- If Network Accounting is enabled, you must type your User ID and Account ID.
- If a Foreign Device Interface (FDI) is installed, you are prompted to access by using the device installed, for example, a card reader or coin slot.

Your user details appear in the User Details area on the right side of the displayed message.

5. To log out, press the **Log In/Out** button again, or touch the User Details area and touch **Log Out** from the drop-down menu.
6. A confirmation screen is displayed; touch **Log Out** or **Cancel**.

USB Port

10

This chapter includes:

- [Introduction](#) on page 122
- [Scan to USB](#) on page 123
- [Print from USB](#) on page 124
- [Log In/Out](#) on page 125

Introduction

ColorQube 9301/9302/9303 Multifunction Printer has a USB Port, which enables users to insert a USB Flash Drive and access jobs for printing or storing scanned jobs.

When a USB Flash Drive is inserted into the USB Port on the left side of the printer, the USB Drive Detected screen appears.

To scan and store files on a USB Flash Drive, touch **Scan to USB** from the drop-down menu. The **Workflow Scanning** options are displayed. Touch the options required for scanning and scan the job. The scanned job is stored in the USB Flash Drive root directory.

To print directly from a USB Memory printer, insert the USB Flash Drive and touch **Print from USB** from the drop-down menu on the screen. The **Print From** options are displayed. Touch the print-ready file and the required options, and then print the job.

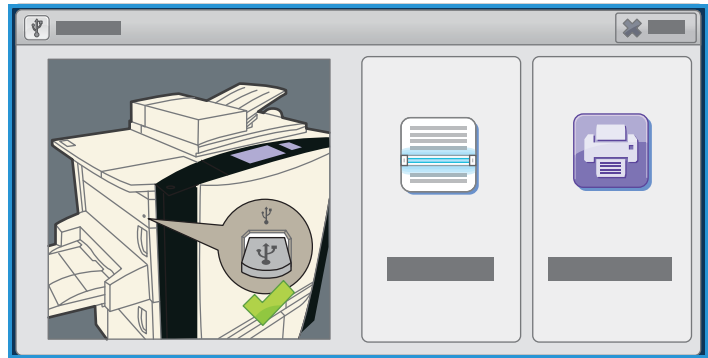

Instructions for using the basic features are provided in ColorQube 9301/9302/9303 Multifunction Printer How To Sheets.

Scan to USB

You can insert a USB Flash Drive into the printer, scan a document, and save the scanned file on the USB Flash Drive.

Note: The system administrator must set up this feature before you can use it. Refer to the *System Administrator Guide* for instructions.

To scan to a USB Flash Drive:

1. Load the original documents in the automatic document feeder or on the document glass.
2. Insert the USB Flash Drive into the USB Port on the left side of the printer.
The USB Drive Detected screen appears.
3. Touch **Scan to USB**.
The **Workflow Scanning** options are displayed and touch the Scan to USB template.
4. If required, modify the template settings by using the options on the Workflow Scanning, Advanced Settings, Layout Adjustment, and Filing Options tabs.
For information about all the **Workflow Scanning** options, refer to [Workflow Scanning Options](#) on page 102.
5. Press **Start** to scan the originals.
Remove the originals from the automatic document feeder or document glass when the scanning is complete.
The file is saved on the USB Flash Drive in the root directory.
6. Remove the USB Flash Drive from the USB Port.

Print from USB

You can print PDF, TIFF, JPEG, XPS, and other print-ready files directly from a USB Flash Drive.

Note: The system administrator must set up this feature before you can use it. Refer to the *System Administrator Guide* for instructions.

To print from a USB Flash Drive:

1. Insert the USB Flash Drive into the USB Port on the left side of the printer. The USB Drive Detected screen appears.
2. Touch **Print from USB**.
The **Print From** options are displayed.
3. Touch the required folder and print-ready job.
If necessary, use the **Up** and **Down** buttons to scroll the list until the folder or job is displayed.
4. Select the features required for the job:
 - **Paper Supply** is used to select the paper source, or select **Auto** for the printer to choose suitable paper supply.
 - **2-Sided Printing** is used to select 1- or 2-sided output, or select **Auto** for the printer to choose an appropriate option.
 - **Finishing** is used to select a specific finishing option for the output, or select **Auto** for the printer to choose an appropriate option.
5. Touch **Quantity** box and type the number of copies required using the numeric keypad.
6. Press **Start** to print the job.
7. The Job Progress screen is displayed. Press the **Job Status** button to view status information or use **Program Next Job** to run a different job.

When you have completed printing, remove the USB Flash Drive from the USB Port.

Log In/Out

If Authentication or Accounting has been enabled on the printer, you may need to log in before using some or all of the services. A picture of a lock on a button indicates that you must log in to use that service.

1. To log in, press the **Log In/Out** button on the control panel. Pressing a locked service will also prompt you to type your user name and password.
2. Use the keyboard to type your user name, and then touch **Next**.
3. Use the keyboard to type your password, and then touch **Done**.
4. If an accounting system is in use on the printer, you may also need to enter additional information.

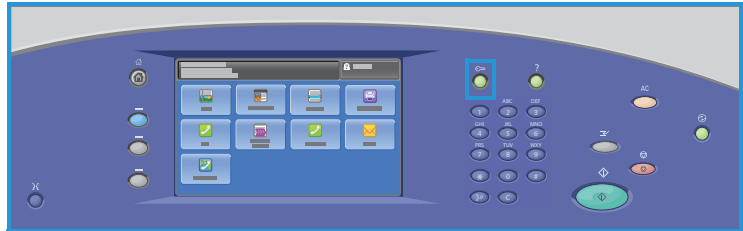

- If Xerox Standard Accounting is enabled, you need to log in by using your Xerox Standard Accounting details.
- If Network Accounting is enabled, you must type your User ID and Account ID.
- If a Foreign Device Interface (FDI) is installed, you are prompted to access by using the device installed, for example, a card reader or coin slot.

Your user details appear in the User Details area on the right side of the displayed message.

5. To log out, press the **Log In / Out** button again, or touch the User Details area and touch **Log Out** from the drop-down menu.
6. A confirmation screen is displayed; touch **Log Out** or **Cancel**.

Log In/Out

Internet Fax

11

This chapter includes:

- [Introduction](#) on page 128
- [Internet Fax](#) on page 129
- [Advanced Settings](#) on page 132
- [Layout Adjustment](#) on page 134
- [Internet Fax Options](#) on page 135
- [Job Assembly](#) on page 137
- [Log In/Out](#) on page 138

Introduction

Internet Fax is a standard feature that can be enabled. If enabled, it is selected by pressing the **Services Home** button, then touch **Internet Fax**.

Internet Fax enables the creation of an electronic image file by scanning a hard copy document. The scanned image is converted into the email format to transmit over the Internet or intranet.

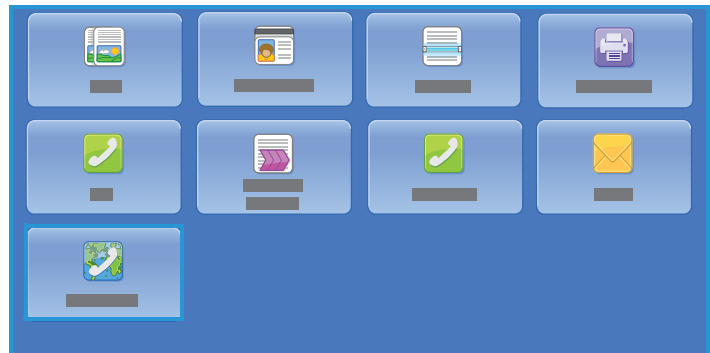

Recipients are selected from an address book or entered manually by using the touch screen keyboard. Received Internet Faxes are automatically sent from the server to the printer as print jobs.

Most feature screens include these buttons to confirm or cancel your choices.

- **Cancel** resets the screen and returns to the previous screen.
- **OK** saves the selections and returns to the previous screen.
- **Close** closes the screen and returns to the previous screen.



Instructions for sending an Internet fax and using the basic features are provided in *ColorQube 9301/9302/9303 Multifunction Printer How to Sheets*. If Authentication or Accounting has been enabled on your printer you may have to enter log in details to access the features, refer to [Log In/Out](#) on page 138.



Internet Fax

These Internet Fax options provide access to features that are required for programming basic Internet fax jobs. To access Internet Fax options, press the **Services Home** button and then touch **Internet Fax**. The **Internet Fax** tab is displayed.



New Recipient

Use this option to enter details of all the recipients of the Internet Fax. To enter the recipient details:



1. Touch **New Recipient**.
2. Touch **To** or **Cc** for the recipient by using the drop-down menu to the left of the entry box.
3. Using the touch screen keyboard, type the email address.
 - Up to 40 alphanumeric characters can be typed.
 - To delete a character, touch  or use the back arrow key.
 - To change the current touch screen language keyboard, touch  to access additional language keyboards, select the language, and touch **OK** to save and return to the previous screen.
4. Touch **Add** to add the email address to the recipient list.
5. Continue adding email addresses until all the recipient's have been added to the list.
6. Touch **Close**.

All the recipients are displayed in the recipient list.

From

To enter or edit the sender's name:



1. Touch **From**.

Note: This option may not be available.
2. If a default name is displayed, touch  to delete the entry.
3. Using the touch screen keyboard, type the email address of the sender.
 - Up to 40 alphanumeric characters can be entered.
 - To delete a character, touch  or use the back arrow key.
 - To change the current touch screen language keyboard, touch  to access additional language keyboards, select the language, and touch **OK** to save and return to the previous screen.
4. Touch **OK** to save and return to the previous screen, or touch **Cancel** to exit.

The email address entered is displayed in the **From** field.

Subject

To enter a subject for the Internet fax:

1. Touch **Subject**.
2. Using the touch screen keyboard, enter the subject of Internet Fax.
 - Up to 40 alphanumeric characters can be entered.
 - To delete a character, touch  or use the back arrow key.
 - To change the current touch screen language keyboard, touch  to access additional language keyboards, select the language, and touch **OK** to save and return to the previous screen.
3. Touch **OK** to save and return to the previous screen, or touch **Cancel** to exit.

The subject entered is displayed in the **Subject** field.

Address Book

If the printer has been set up to access Network and Public Address Books, you can use them to select recipients. For information about setting up address books, refer to the *System Administrator Guide*.

1. Touch **Address Book**.
A list of email addresses is displayed.
2. Touch the email address required and touch **To** or **Cc** from the drop-down menu.
The email address is added to the recipient list.
3. Continue adding email addresses as required.
4. Use the **Search** option to search for a specific entry. Touch **Search** and type the required name by using the touch screen keyboard and touch **Search**.
The matching entries are displayed. Touch the required name from the drop-down list and add the recipient to the recipient list.
5. To find out more information about an address in Address Book, touch **Details**. Full details of the email address owner are displayed. Touch **Close** to exit the Details window.

Output Color

Output Color options include selections to automatically detect and match the color of the original or to produce monotone, full color or grayscale output from the original. The options are:

- **Auto Detect** to select output that matches the original.
- **Black & White** to select monotone output regardless of the color of the original.
- **Grayscale** to use gray scales instead of color.
- **Color** to select the color output from the original.

2-Sided Scanning

The 2-Sided Scanning option allows you to set if one or two sides of the original documents are scanned. The options are:

- **1-Sided** is used if the original documents are 1-sided.
- **2-Sided** is used if the original documents are 2-sided. Use the automatic document feeder to scan the originals with this option.
- **2-Sided, Rotate Side 2** select if the original opens up like a calendar. Use the automatic document feeder to scan the originals with this option.

Original Type

Use this option to define the type of original being used for scanning. Making the correct selection enhances the quality of the output image. The options are:

- **Photo and Text** is recommended for originals containing high-quality photographs and halftones. By using this setting the scanned image will contain medium quality pictures although the sharpness of text and line art is slightly reduced.
- **Photo** is used specifically for originals containing photos, magazine pictures or continuous tones without any text or line art. Produces the best quality for photos but with reduced quality text and line art.
- **Text** produces sharper edges and is recommended for text and line art.
- **Map** is used if the original is a map or contains intricate line art and text.
- **Newspaper / Magazine** is used if the original is from a magazine or newspaper that contains photographs or text.

File Format

File Format determines the type of file created. You can touch the file format you wish to use for the scanned image. The options are:

- **Multi-Page Tagged Image File Format (TIFF)** produces a single TIFF file containing several pages of scanned images. Specialized software is required to open this type of file format.
- **Portable Document Format (PDF)** allows recipients with the appropriate software to view, print, or edit the Internet Fax file, no matter what their computer platform is. Depending on the receiving printer, the **PDF** selection may not be compatible when the resolution is set to **200 dpi**. This file format is optimized for viewing and sharing.
- **PDF/A** is an industry standard format for long-term document preservation based on the PDF format. The **Advanced Settings** may need checking to ensure they are appropriate for extended use.

How the Original was Produced

- **Printed Original** is for originals from a magazine, book, or newspaper or that have been printed on a large printing device.
- **Photocopied Original** is for originals that are photocopies.
- **Photograph** is for high-quality photographic originals.
- **Inkjet Original** is for originals produced by using an inkjet printer.
- **Solid Ink Original** is for originals produced by a solid ink printing process, such as output from this printer.

Advanced Settings

The Advanced Settings provide access to the features that enhance the image quality or output quality. To access Advanced Settings, press the **Services Home** button, and touch **Internet Fax**, then touch the **Advanced Settings** tab.

Image Options

Image Options is used to change the appearance of the output image. The options are:

- **Lighten / Darken** provides manual control to adjust the lightness or darkness of the scanned images. Move down the indicator to darken the image or move it up to lighten the image.
- **Sharpness** provides manual control to adjust the sharpness of the scanned images. Move up the indicator to sharpen the image. Move down the indicator to soften the scanned image.
- **Saturation** controls the balance between the vivid and pastel shades of the image. Move the indicator towards Vivid for high saturated colors. Move the indicator towards Pastel for reduced saturated colors.

Image Enhancement

Image Enhancement provides options for improving the quality of the output, by reducing the background or adjusting the contrast. The options are:

- **Background Suppression** enhances originals that have colored backgrounds, by reducing or eliminating the background on the output. This option is useful when the original is on colored paper.
 - Touch **Auto Suppression** to automatically suppress the unwanted background.
 - Touch **Off** to turn the Background Suppression feature off, particularly when:
 - The **Darken** adjustment does not produce a satisfactory output from light originals.
 - The original has a gray or colored border, such as a certificate.
 - You want to bring out the fine detail that was lost due to a dark edge when using bound originals.
- **Contrast** controls the image density on the output and compensates for an original that has too much or too little contrast on the image.
 - Touch **Manual Contrast** to set the level of contrast. Move the indicator towards the More setting to reproduce more vivid blacks and whites for sharper text and lines but less detail in pictures. Move the indicator towards the Less setting to reproduce more detail in light and dark areas of the original.

Resolution

The Resolution affects the appearance of the scanned image. A high resolution produces a better quality image. A low resolution reduces the communication time. The options are:

- **72 dpi** is recommended for output displayed on a computer. It produces the smallest file size.
- **100 dpi** is recommended for output that delivers low-quality text documents.

- **150 dpi** is recommended for average quality text documents and line art. Does not produce the best image quality for photos and graphics.
- **200x100 dpi** is recommended for good quality text documents and line art.
- **200 dpi** is recommended for good quality text documents and line art. Suitable for office documents and photographs.
- **300 dpi** is recommended for high-quality text documents that are to pass through OCR applications. Also recommended for high-quality line art or medium quality photos and graphics. This is the default resolution and the best choice in most cases.
- **400 dpi** is recommended for photos and graphics. It produces average image quality for photos and graphics.
- **600 dpi** is recommended for high-quality photos and graphics. It produces the largest image file size, but delivers the best image quality.

Touch **OK** to save the selections and exit.

Quality/File Size

Quality/File Size settings allow you to choose between scan image quality and file size. These settings allow you to deliver the highest quality or create small files. A small file size delivers slightly reduced image quality but is better when sharing the file over a network. A larger file size delivers improved image quality but requires more time when transmitting over the network. The options are:

- **Normal Quality** produces small files by using advanced compression techniques. Image quality is acceptable but some quality degradation and character substitution errors may occur with some originals.
- **Higher Quality** produces larger files with better image quality.
- **Highest Quality** produces the largest files with the maximum image quality. Large files are not ideal for sharing and transmitting over the network.

Touch **OK** to save the selections and exit.

Layout Adjustment

The Layout Adjustment options allow you to manipulate the scanned image and enhance the appearance and style of the faxed document. To access Layout Adjustment options, press the **Services Home** button, and touch **Internet Fax**, then touch the **Layout Adjustment** tab.

Original Orientation

Use to specify the orientation of the originals being scanned. The options are:

- **Portrait Originals** refers to the image orientation on the original documents. Use this option to select the Portrait image orientation. Originals can be fed in any direction.
- **Landscape Originals** refers to the image orientation on the original documents. Use this option to select the Landscape image orientation. Originals can be fed in any direction.
- **Upright Images** refers to the direction the images are loaded in the automatic document feeder. Use this option if the images are in the orientation matching the image shown when loaded in the automatic document feeder.
- **Sideways Images** refers to the direction the images are loaded in the automatic document feeder. Use this option if the images are in the orientation matching the image shown when loaded in the automatic document feeder.

Touch **OK** to save the selections and exit.

Original Size

Touch **Original Size** to enter the size of the document when scanning from the document glass or the automatic document feeder. The printer uses this information to calculate the size of the original and the scanned image. You can also touch **Auto Detect** for automatic size detection, or touch **Mixed Size Originals** if scanning a mix of sizes. The options are:

- **Auto Detect** is the default setting and enables automatic size sensing. The size detected is matched with standard-size paper.
- **Preset Scan Areas** allows you to define the size of the original from a list of pre-set, standard document sizes. You can view the list by using the scroll bar.
- **Custom Scan Area** is used to enter a specific area for scanning. Measure the area to be scanned on the original and enter the X and Y-axis measurements into the fields provided. Only the area specified is scanned.
- **Mixed Size Originals** allows you to scan documents containing different size pages. The pages must be the same width, such-as A4 LEF and A3 SEF (8.5 x 11" LEF and 11 x 17" SEF). Other combinations are shown on the screen.



Touch **OK** to save the selections and exit.

Internet Fax Options

The Internet Fax Options allow you to temporarily change the format of the image file, set a Reply To address, and add a brief message. The Acknowledgement Report can also be enabled. To access Internet Fax Options, press the **Services Home** button, and touch **Internet Fax**, then touch the **Internet Fax Options** tab.



Message

This option is used to enter a message for the Internet fax. The message is the text contained within the fax and not the subject line.

1. Using the touch screen keyboard, type the required message.
 - Up to 50 alphanumeric characters can be entered.
 - To delete a character, touch  or use the back arrow key.
 - To change the current touch screen language keyboard, touch  to access additional language keyboards, select the language, and touch **OK** to save and return to the previous screen.
2. Touch **OK** to save the selections and exit.

Reply To

The **Reply To** feature enables you to include an email address that the recipient can use to reply. For example, you can type your personal email address. If you logged in through authentication and your details are available in the Address Book, your email address is displayed.

1. Using the touch screen keyboard, type the required email address.
 - Up to 50 alphanumeric characters can be entered.
 - To delete a character, touch  or use the back arrow key.
 - To change the current touch screen language keyboard, touch  to access additional language keyboards, select the language, and touch **OK** to save and return to the previous screen.
2. Touch **OK** to save the selections and exit.

Acknowledgement Report

Using this feature a confirmation report is printed indicating the delivery status of the Internet fax job. Each Internet fax recipient provides a delivery receipt when the job is received. Once the receipt is received by the printer, the report is compiled and printed.

Note: The report may be delayed depending on how quickly the recipient's respond.

Print Report

- The printer requests a receipt from each of the recipients when the Internet fax is sent.
- Once the recipient's acknowledge the receipt, the report is compiled and printed automatically.

Touch **OK** to save the selections and exit.

Job Assembly

This tab provides access to the Build Job feature for compiling jobs that have different originals or programming requirements within a job. To access Job Assembly options, press the **Services Home** button, and touch **Internet Fax**, then touch the **Job Assembly** tab.

Build Job

Use this feature to build a job that requires different settings for each page, or a segment of pages.

You can select the appropriate settings to be applied to individual pages or segments of a completed job. First split the originals into sections for individual programming.

1. Touch **Build Job** on the Job Assembly tab and touch **On**.

Note: The recipient details must be entered prior to scanning.

2. Touch **Options** and **Display summary window between segments** to view the Build Job screen during scanning.
3. Touch **Options** and **Turn Build Job Off after Job is submitted** to turn off the Build Job after job submitted, then touch **OK**.
4. Touch the options required for the first segment of the job.
5. Load the first segment originals and press **Start**.
6. Remove the first segment originals. The Build Job screen displays the first segment in the list. **Delete All Segments** deletes the current Build Job and returns you to the main Build Job screen.
7. Using **Program Next Segment**, touch the options required for the second segment.
8. Load the second segment originals and press **Start**.
9. Repeat these steps until all segments of the job have been programmed and scanned.
10. After the last segment has been scanned, touch **Submit the Job** to indicate you have finished scanning and the job can be processed and completed.

Log In/Out

If Authentication or Accounting has been enabled on the printer, you may need to log in before using some or all of the services. A picture of a lock on a button indicates that you must log in to use that service.

1. To log in, press the **Log In/Out** button on the control panel. Pressing a locked service will also prompt you to type your user name and password.
2. Use the keyboard to type your user name, and then touch **Next**.
3. Use the keyboard to type your password, and then touch **Done**.
4. If an accounting system is in use on the printer, you may also need to enter additional information.

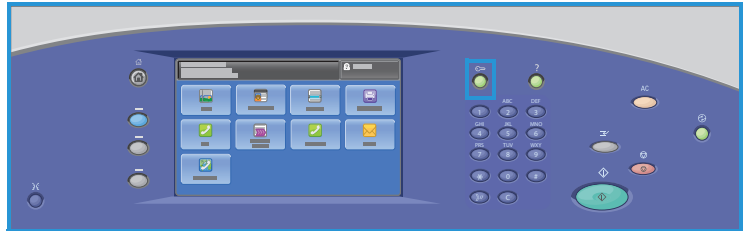

- If Xerox Standard Accounting is enabled, you need to log in by using your Xerox Standard Accounting details.
- If Network Accounting is enabled, you must type your User ID and Account ID.
- If a Foreign DeviceInterface (FDI) is installed, you are prompted to access by using the device installed, for example, a card reader or coin slot.

Your user details appear in the User Details area on the right side of the displayed message.

5. To log out, press the **Log In / Out** button again, or touch the User Details area and touch **Log Out** from the drop-down menu.
6. A confirmation screen is displayed; touch **Log Out** or **Cancel**.

Print

12

This chapter includes:

- [Introduction](#) on page 140
- [Wireless Configuration](#) on page 142
- [Printing Options](#) on page 143
- [Image Options](#) on page 148
- [Document Options](#) on page 149
- [Advanced](#) on page 153

Introduction

ColorQube 9301/9302/9303 Multifunction Printer will produce high-quality prints from your electronic documents. However, the advanced print features of this machine will enable you to create professionally finished documents at the click of a button.

For example, you can:

- Publish your prints as booklets
- Put covers onto your prints
- Automatically staple or hole punch
- Produce sets of transparencies with dividers ready for a presentation, and many more features that will take the strain out of printing.

You access the printer from your computer application using a print driver. A print driver converts the code in an electronic document into a language that the printer can understand. You can use generic print drivers on this printer, but these will not enable all features. Therefore, it is best to use the print drivers that accompany this printer.



There are a number of print drivers available for this printer to enable use on most computer operating systems. These drivers are provided on a disc with your printer, or you can download the latest versions from the Xerox website, www.xerox.com/office/CQ930Xdrivers.

Instructions for installing the ColorQube 9301/9302/9303 Multifunction Printer and print drivers are provided in the *System Administrator Guide*.

Print Drivers

For Windows users, there are several drivers. The system administrator may have loaded specific drivers on your computer. However, if the choice of driver is yours, the following information will help you decide driver is most suited to your workstation.

The print drivers are available in PostScript, PCL 5, PCL 6, and XPS printing formats:

- **PostScript** gives you greater ability to scale and manipulate images and offers more precision with high-end graphics. PostScript also provides you with different types of error-handling and font substitution options.
- **Printer Command Language (PCL)** generally has fewer advanced features than PostScript. However, by using PCL, you can process most jobs faster.
- **XML Paper Specification (XPS)** is an open specification for a page description language and a fixed-document format, originally developed by Microsoft.

Once you have decided on the most appropriate print driver, install it on your workstation. If you do not know how to install drivers, refer to the *System Administrator Guide* or consult your system administrator.

Note: You can load more than one print driver for the printer on your workstation. When you send a job for print, you can choose the most appropriate print driver for the job.

Xerox System PPD Files

A PostScript Printer Description (PPD) file is a readable text file that provides a uniform approach to specifying special features for print drivers that interpret PostScript. Xerox provides PostScript PPDs for use with generic Windows XP/Server 2003/Vista PostScript print drivers. These PPD files are available on the disc provided with your printer or from the Xerox website.

Control Options

There are a number of options that appear on all of the print driver screens:

- **OK:** Saves all the new settings and closes the driver or the dialog box. These new settings remain in effect until changed or until the software application is closed and the print driver options revert to the default settings.
- **Cancel:** Closes the dialog box and returns all settings in the tabs to the values that were in place before the dialog box was opened. Any changes made are lost.
- **Help:** The print driver help system is the primary source of information about using print drivers. You can access the Help system through the Help buttons in the driver. The Help system includes feature descriptions, step-by-step procedures, Xerox system information, problem-solving information, and support information.
- **Reset:** Resets the current tab and all its settings to the system default values. The action of this button applies only to the current tab. All other tabs remain unchanged.
- **Earth Smart Settings:** Displays the Earth Smart Settings window that lists Earth Smart Features:
 - **Set 2-Sided Print:** Prints 2-sided to save paper.
 - **Turn off Banner Pages:** Turns off banner pages to reduce the amount of paper and ink used.
 - **Set 2-Up as my Layout:** Prints two pages of content on each sheet to reduce the amount of paper and ink used. You can print ID in Margins only on the first page or on all the pages.
 - **Set Sample Set as my Job Type:** Use this option to print one copy of each job to check, before printing all the required sets.

Wireless Configuration

If your IT infrastructure includes wireless connectivity, you can connect the printer to the network with an optional wireless USB interface. The printer can be configured for an active wired or wireless interface, but not for both interfaces active simultaneously. All printer services available over the wired interface will also be available through the wireless interface. Detailed wireless configuration must be completed through a connection to CentreWare Internet Services.

A wireless network connection provides the same access and services as a wired connection. A wireless network connection is faster than USB and allows direct access to setting of the printer by using CentreWare Internet Services.

For more information on wireless settings and configuration, refer to the *System Administrator Guide*.

Printing Options

Use the Printing Options tab to select the basic printing requirements for your job. Identify the type of job being submitted, the paper, sides printed, finishing, and quality requirements.

Note: Some features are only supported by specific printer configurations, operating systems, or driver types. You may see more features or options listed than your specific printer supports.

Job Type

Use this option to select the type of job being submitted to the printer.

- **Normal Print** prints the job immediately without requiring a passcode.
- **Secure Print** is used for confidential or sensitive jobs. The job is held at the printer until a passcode is typed to release the job for printing.

When you select this job type, the Secure Print screen appears. You need to type a unique passcode.

When the job arrives at the printer, it is held in the job list until you release the job by using the same passcode.

Note: If multiple secure jobs are held in the list and require the same secure code, they will all be released for printing.

- **Sample Set:** Use this option to print one copy of the job as a sample and hold the remaining copies in the job list at the printer.
- **Delay Print:** Use this option to type a specific time to print the job. This option is useful for large jobs or if you want all your jobs to be printed at the same time. When you select this job type, the Delay Print screen is displayed.

Once you have checked the sample set, you can release the remaining sets for printing, or delete the job, if no longer required.

Type the time, then click **OK**. The job remains in the job list until the specified time for printing.

- **Saved Job:** Use this option to store the job on the printer hard drive so that it can then be printed on demand when required or printed from CentreWare Internet Services.

Type a name for the job or select **Use Document Name** to provide the file name.

Select **Print and Save** to print a copy of the job at the printer.

Select **Public** or **Private** to specify the folder to be used for the saved job and to determine if the job is available to other users or not. If you have selected **Private**, type the passcode required to print the job.

Note: To save jobs on the printer, Job Storage must be enabled on the Installable Options screen.

- **Fax:** Use this option to send the current job as a Fax from PC job. The job is sent from the computer to the printer over the network and then faxed over a telephone line to the specified fax destination.

When you select this job type, the Fax screen is displayed so that you can specify the fax recipients and other fax settings.

Refer to [Fax from PC](#) on page 69 for more information.

Note: To fax your job, the fax option must be installed on your printer and fax must be enabled on the Installable Options screen.

Paper

This option displays information about the paper to be used for the print job, such as the size and type.

To change the paper to be used for printing, select the **Paper** drop-down menu.

Other Size

Select this option to display the Paper Size screen. On this screen, select **Output Paper Size**, **Scaling Options**, **Alignment**, and **Orientation** to select the options in each list. Original Document Size appears, as specified by the application.

Output Paper Size

Select this drop-down list to specify the size of the paper. The default selection is Letter (8.5 x 11"). To specify a size that is not available in the list, select **New**.

Scaling Options

You can reduce the image to 25 % of its original size or enlarge it to 400 % of its original size. The default setting is 100 %.

In Windows, **Scaling Options** can be accessed by clicking the arrow at the right side of the Paper field and selecting **Other Size**:

- **Automatic Scale** changes the print from one standard paper size to another standard paper size.
- **No Scaling** does not increase or decrease the size of the image from the original.
- **Manually Scale** changes the output print size by the percentage typed in the field below the graphic, to the right of Scaling Options.

Alignment

The alignment styles are available soon after Scaling Options. You can choose an alignment style from the different styles available in the drop-down list.

Original Document Size

Original Document Size is scaled to fit on the selected output paper size shown in the Output Paper Size field. Any changes made to it will not appear in the printed document.

Orientation

Depending on your requirement, you can choose a suitable orientation, Portrait, or **Landscape**.

Select **OK** to apply your selections and exit.

Other Color

Use this option to select a paper color for the print job. Select a color from the drop-down menu.

Other Type

Use this option to select a type of paper or media to be used for the print job. The default selection is Printer Default Type. You can select **Automatically Select** to enable the printer to select the paper type.

Select by Tray

Use this option to select a specific tray for printing the job. The printer uses only the paper in the selected tray, even when more than one tray contains the same paper size and type. You can select **Automatically Select** to enable the printer to select a tray loaded with the required size and type of paper.

Transparency Separators

Select this option to display the Transparency Separators screen. If the **Blank Separators** or **Printed Separators** option is selected, a blank or printed sheet is respectively placed after each transparency. From the Separator Color drop-down list, you can select the separator color.

2-Sided Printing

You can have your job automatically printed on both sides of a sheet of paper.

- **1-Sided Print** prints on one side of paper or transparency. Use this option when printing on transparencies, envelopes, or labels.
- **2-Sided Print** prints on both sides of a sheet of paper. The images are printed so that the job can be bound on the long edge of the sheet.
- **2-Sided Print, Flip on Short Edge** prints on both sides of a sheet of paper. The images are printed so that the job can be bound on the short edge of the sheet.

Note: Some media types, sizes, and weights cannot be automatically printed on both sides. Refer to www.xerox.com/paper for specifications information.

Finishing

Use this drop-down list to select the finishing options for the print job, such as stapling or hole punching. To change the finishing options, select the button to the right of the summary to display the finishing selection drop-down menu.

Staple

- Select **1 Staple**, **2 Staples**, or **Multiple Staples**, per your requirement.
- Select **No Stapling** to switch off stapling.



Note: The stapling options vary depending on the type of the finisher.

Hole Punch

Select **Hole Punch** to punch the paper.

Note: The number of holes punched and their locations depend on the hole punch unit in the finisher.

Folding

- **Bi-Fold Multiple Sheets**  : The page will be folded once to create two leaves.
- **C Tri-Fold**  : Folds the output twice to create three leaves, with the outer flap folded over the inner flap.
- **Z Tri-Fold**  : Folds the output twice to create three leaves in a Z effect.
- **No Folding** Switches off folding.

Booklet Creation

Select this menu item to display the Booklet Creation screen to select a booklet layout and booklet finishing options.

Booklet Layout

- Using this option, the document pages are rearranged in the correct sequence to create the booklet.

Booklet Fold

- Select **Booklet Fold** to fold the booklet.

Booklet Fold and Staple

- Select **Booklet Fold and Staple** to staple the booklet in the center and then fold.

Page Border

- In addition to the above options, you can select **Print Page Borders** if you want to place a border around the images or text on each page.

Booklet Paper Size

- Use **Automatically Select** to enable the printer to select the paper size for the job.
- To select a paper size for the job, clear the checkbox and use the drop-down menu.

Booklet Adjustments

1. Select **Booklet Adjustments**.
The Booklet Adjustment screen appears.
2. You can select the **Imposition Source** type and the **Booklet Paper Size** option.
3. Select **OK** to save your selection and exit.

Note: Some media types, sizes, and weights cannot be stapled, punched, or folded. Refer to www.xerox.com/paper for specifications information.

Print Quality

The Print Quality affects the appearance of printed output and the time the job takes to print.

High Resolution

Use this option for printing high-quality output or photos.

Enhanced

- This is the default option when color printing is selected.
- It is a high-quality printing mode for fine lines and detail.
- Recommended for vibrant, saturated, color prints.

Note: The print job may take longer to process when printed in the Enhanced print-quality mode.

High Speed

- This option is a high-speed printing mode, available for black and white printing only.
- It is the default setting for black and white printing and is recommended for most office uses and quick prints.

Output Destination

- Use this option to select the destination for your output from the tray choices in the drop-down menu.
- Use **Automatically Select** to send the printed output to a destination, based on the paper size.

Note: If a destination appears in gray text, it may not be available due to other settings that you have selected.

- Select **Top Tray** to send the printed output to Top Tray.
- Select **Stacker Tray** to send the print output to Stacker Tray.

Image Options

The Image Options tab enables you to see the preview of your printout. Select **Preview** and then click the arrow below the preview area to see various image previews. To see the preview in the black and white mode, select **Xerox Black and White Conversion**.

Document Options

The Document Pages tab allows you to choose layouts, provide different types of special pages, and provide watermarks, depending on the type of document.

Page Layout

Use this tab to specify the page per sheet settings and the booklet layout.

Pages Per Sheet (Normal)

Select this option to print 1, 2, 4, 6, 9, or 16 pages on each side of a sheet of paper. Selecting multiple pages per sheet saves paper and is useful when you want to review the layout of the document.

Booklet Creation

Select **Booklet Creation**. The Booklet Creation screen appears from where you can access the options to create layouts, fold the book, and complete the folding and stapling steps.

- Select **Booklet Layout** to specify the layout.
- Select **Booklet Fold** to fold the booklet.
- Select **Booklet Fold and Staple** to staple the booklet at the center and then fold it.
- Select **Page Borders** if you want to create borders on the pages of the book. Clear the **Page Borders** check box if you do not require borders.
- Select **Booklet Adjustments** to specify Imposition Source, Booklet Paper Size, and Booklet Margins.







Note: Some media types, sizes, and weights cannot be stapled, punched, or folded. Refer to www.xerox.com/paper for specifications information. If your document is already formatted as a booklet, do not select **Booklet Layout**.

Special Pages

The Special Pages tab enables you to add, modify, or delete cover pages, inserts, or exception pages.

The table provides a summary of the special pages for your print job. Up to 250 inserts and exception pages can be included in the table. You can change the width of the columns in the table.

To edit, delete, or move an entry in the table, use the following buttons:

-  **Edit** is used to change the properties of the entries after selecting them.
-  **Delete** is used to delete an individual entry or a selection of entries.
-  **Delete All** is used to delete all the entries in the table.
-  **Undo** is used to undo the last actions if you make an error.
-  **Up** and  **Down** are used to move the entries up or down in the table.

Some features are only supported by specific printer configurations, operating systems, or driver types. You may see more features or options listed than your specific printer supports.

Add Covers

Use this option to add blank or printed covers to your printed document.

1. To add a cover, select the **Add Covers** button above the table.
2. Select the required **Cover Options**:
 - **Front Only** provides a front cover.
 - **Back Only** provides a back cover.
 - **Front and Back: Same** provides the front and back covers with the same settings, on the same media.
 - **Front and Back: Different** provides the front and back covers with individual programming requirements and on different media, if required.
3. Select Paper Settings for the selected cover options.
4. Select the printing options:
 - **Blank or Preprinted** inserts a blank or pre-printed sheet and does not print an image.
 - **Print on Side 1** prints on side 1 of the cover.
 - **Print on Side 2** prints on side 2 of the cover only.
 - **Print on Both Sides** prints on both sides of the cover.
5. Select **OK** to save your selections and exit.
The cover details appear in the table.

Add Inserts

Use this option to add blank or pre-printed inserts to your printed document. To program the inserts, type the page number of the page before the insert. If an insert is required as your first page, **Before Page 1** can be specified. It is recommended that you work through your document and identify the page numbers where inserts are required before programming.

This option is also used if tabs are required in the job. Refer to [Paper and Media](#) on page 169 for further information about tabs.

1. To add an insert, click the **Add Inserts** button above the table.
2. Using the Inserts Options drop-down menu, select if the insert is to be placed **Before Page 1** or select **After Page(s)** to place inserts after the specified page numbers.
Note: To add an insert to the front of your document, use the **Before Page 1** option.
3. Select the number of insert sheets required.
4. Specify the page number before each insert. If multiple inserts are required, you should type all the page numbers separated by a comma or type a page range separated by a dash.
5. Select the Paper requirements for the inserts and select **OK**. If **Pre-Cut Tab** is selected as the paper type, type the number of tabs in the sequence in the displayed Pre-Cut Tab window.
Note: If you are using the Tab Stock for your blank or pre-printed inserts, refer to [Paper and Media](#) on page 169 for information about loading tabs.
All the programmed inserts appear in the table.
6. If any inserts have different programming, such as a different paper color or a different number of inserts, select the required entry and use the **Edit** button to change the programming.

Add Exceptions

Use this option to specify the characteristics of any pages in the print job that differ from the settings used for the majority of the job. For example, your print job may contain 30 pages that print on standard-size paper and two pages that print on a different size of paper. Use this option to indicate these two exception pages and select the alternate paper size to be used.

1. To add Exceptions, select the **Add Exceptions** button above the table.
2. Type the page number that the exception programming applies. If multiple exceptions are required, type all the page numbers separated by a comma or type a page range separated by a dash.
If different programming is required for some of the exceptions, those entries can be edited from the table.
3. Select the Paper requirements for the exceptions.
If **Use Job Setting** is displayed, the same paper as the main job is used.
4. Select 2-Sided Printing requirements for the exceptions:
 - **Use Job Setting** uses the same programming as applied to the main job.
 - **1-Sided Print** prints the exception pages on one side only.
 - **2-Sided Print** prints the exception pages on both sides of the sheet of paper with the images printed so that the job can be bound along the long edge of the sheet.
 - **2-Sided Print, Flip on Short Edge** prints the exception pages on both sides of the sheet of paper with the images printed so that the job can be bound along the short edge of the sheet.

Job Settings displays the paper requirements specified for the main job.
5. Select **OK** to save your selections and exit.
All the exceptions programmed appear in the table.
6. If any exceptions pages require different programming such as a different paper color or a different number of inserts, select the entry and use the **Edit** button to change the programming.

Watermark

A watermark is a picture or text, independent of that provided by the application, printed on every page or the first page of the job.

The watermark options are provided in the drop-down menu. There are preset watermarks listed and available—None, Custom, Draft, Confidential, and Copy.

Once a watermark is selected, provide the text to be used in the watermark. Use the Layering menu to select to print the watermark in the background, in the foreground, or to blend it with the job. Also select to print the watermark on Page 1 only or on all pages.

Additional watermarks can be created using **New**. The Watermark Editor screen is displayed with options for creating a new watermark.

- **Name** is used to type a name for the watermark. The name appears in the watermark selection menu under the Watermark tab. When creating a new watermark, type a name that is not more than 255 characters.
- The next drop-down menu allows you to choose the type of watermark to create. Select one of the following options:

- **Text** uses the characters that you type in the Text field. This text is displayed in the document as a watermark.
- **Time Stamp** uses a time stamp as the watermark. Select to include the weekday, date, time, and/or time zone in the **Time Stamp Format** drop-down list.
- **Picture** uses a picture as the watermark. The picture can be in the Bitmap, GIF, or JPG format. Specify the file name in the File Name field or select the **Choose File** button to browse the picture that you want to use.
- **Font:** If you selected **Text** or **Time Stamp**, select this option to access the Font screen to change the font family, style, size, and script to be used for the text.
- **Font Color:** If you selected **Text** or **Time Stamp**, select this option to access the Color screen, to change the color to be used for the text.
- If you selected **Text** or **Time Stamp**, use the rotation arrows to get the required angle of the text on the page. The default angle is 45 degrees.
- Use the position boxes to shift the watermark from the center of the page or select the **Center** option to center align the watermark.
- Use the arrow below the Preview area to select the paper size, scale, density, and orientation to be used for the preview image of the watermark. Select **Color** or **Black and White** to display the watermark in the selected font color or gray, respectively.

Note: All applications do not support watermark printing.

Advanced

The Advanced tab enables you to select advanced printing options that are rarely changed.

Note: Some features are only supported by specific printer configurations, operating systems, or driver types. You may see more features or options listed than supported by specific printer.

CentreWare Internet Services

13

This chapter includes:

- [Introduction](#) on page 156
- [Accessing CentreWare Internet Services](#) on page 157
- [Status](#) on page 158
- [Jobs](#) on page 161
- [Print](#) on page 162
- [Scan](#) on page 163
- [Address Book](#) on page 164
- [Properties](#) on page 165
- [Support](#) on page 166
- [Help](#) on page 167

Introduction

CentreWare Internet Services uses the embedded HTTP Server on the printer. This server allows you to communicate with ColorQube 9301/9302/9303 Multifunction Printer through a Web browser and gives you access to the Internet or intranet.

Typing the IP address of the printer as the Universal Resource Locator (URL) in the browser provides direct access to the printer.

CentreWare Internet Services enables users to perform many functions, including:

- Checking machine status, billing information, and consumable status.
- Submitting print jobs over the Internet or intranet.
- Setting up the Public Address Book by importing an existing address book or by adding entries individually.
- Creating, modifying, and deleting Workflow Scanning templates.
- Customizing printer settings, such as Energy Saver, Paper Trays, and Timeout Settings.

The CentreWare Internet Services Help function describes all the available features and functions.

Accessing CentreWare Internet Services

Before connecting to CentreWare Internet Services, the printer must be physically connected to the network with TCP/IP and HTTP enabled. An operational workstation with TCP/IP Internet or Intranet accessibility is also required. To access CentreWare Internet Services:

1. Open the Web browser from your workstation.
2. In the URL field, type `http://` followed by the IP Address of the printer. For example, if the IP address is 192.168.100.100, type the following into the URL field: `http://192.168.100.100`.
3. Press **Enter** to view the Home page.

The CentreWare Internet Services options for your printer are displayed.

Note: To find out the IP address of your printer, print a Configuration Report. Refer to [Machine and Job Status](#) on page 185 for instructions.

Status

The Status option provides information about the printer.

Welcome

The **Welcome** page provides information about setting up and installing your printer.

Once you have reviewed this page, it can be switched off using **Don't Show Welcome Page again**.

Description and Alerts

A description of any problems or Alerts on the printer.

Billing Information

Provides the machine serial number, the number of Black Impressions, Color Impressions, and Total Impressions.

Usage Counters

Provides more detailed information on printer usage, such as total impressions, number of copied sheets, number of printed sheets, number of faxes, and number of large sheets.

Configuration Report

This section displays the links to configuration information about the printer and the option to print the complete Configuration Report.

Supplies

This option provides information about the status and life of printer consumables that includes solid ink, Cleaning Unit, and Automatic Document Feed Roller.

Trays

This area displays status information about all the paper trays. It also provides information about the tray media and settings.

Information Pages

You can use this option to print individual guides that provide information about ColorQube 9301/9302/9303 Multifunction Printer services and features.

It also provides sampler pages that are used for checking quality and color settings.

Select the required guide or sampler page and select **Print**.

Smart eSolutions

Smart eSolutions provides the ability to automatically send data to Xerox to be used for billing, supplies tracking and replenishment and for troubleshooting problems.

Smart eSolutions provides the following features:

- **MeterAssistant:** Automatically submits billing meter readings to Xerox from the networked devices; therefore, there is no need to collect and report billing meter read information manually.
- **SuppliesAssistant:** Manages ink and component supplies for the printer and monitors the actual usage. This feature also lists % Life Remaining for components, such as Cleaning Unit.
- **Maintenance Assistant:** Monitors the printer and reports diagnostic information to Xerox through the network. You can also use Maintenance Assistant to conduct an online troubleshooting session with Xerox and to download information about printer performance.

MeterAssistant

MeterAssistant provides detailed information, including dates, times, and counts of impressions, sent in the last billing meter transmission. The billing meter data is recorded in the Xerox service management system. It is used for invoicing of metered service agreements and also for evaluating consumable usage against printer performance.

Email notifications can be set up to alert you of the following changes:

- **Billing meter reads reported:** An alert is generated when billing of billing meter readings has taken place. You can set up your printer so that it will automatically offer billing meter readings when requested by the Xerox Communication Server.
- **Smart eSolutions enrollment is canceled:** An alert is generated when the state is changed from "Enrolled" to "Not Enrolled."
- **Smart eSolutions communication error has occurred:** An alert is generated when there is a communication error.

For information about configuring MeterAssistant settings, refer to the *System Administrator Guide*.

SuppliesAssistant

SuppliesAssistant enables you to manage ink and component supplies for the printer, ensuring that you never run out of these. This feature monitors supplies usage and automatically orders supplies, based on the actual usage.

The most recent supplies usage information sent to Xerox can also be viewed. Use the **Refresh** button to ensure that the latest information is displayed.

For information about configuring SuppliesAssistant settings, refer to the *System Administrator Guide*.

Maintenance Assistant

Maintenance Assistant monitors your printer and notifies Xerox support services of potential issues. This feature automates the notification, troubleshooting, and repair process, minimizing printer downtime.

- If a problem occurs, you can use the **Send Diagnostics Information to Xerox** option to immediately send information to Xerox that will assist with troubleshooting activities.
- Use the **Start an Online Troubleshooting session** at www.xerox.com/CQ930XSupport button to access the Xerox website for immediate advice on resolving printer problems.
- Use the **Download File to Your Computer** button to save or view a Comma-Separated Values (CSV) file containing detailed information about printer usage and any problems that have occurred on your printer.
- Use the **Refresh** button to view the latest status information.

For information about configuring the Maintenance Assistant settings, refer to the *System Administrator Guide*.

Jobs

The Jobs option provides information about all the incomplete jobs in the Job List on the printer and the Saved Jobs.

Active Jobs

Use this option to check the status of your job. The Incomplete Jobs list displays a list of the current jobs and the status of each job.

Saved Jobs

Jobs that which have been saved to the printer memory, can be accessed using the Saved Jobs option. A Saved Job can be selected and printed, deleted, copied, or moved.

For information about creating and managing Saved Jobs, see [Saving Jobs for use with Print From](#) on page 43.

Print

The Print option enables you to send a print-ready job, such as a PDF or PostScript file, to the printer over the Internet. You can send the job from your desktop or from a remote location.

To use the Job Submission option:

- Type the file name of the job that requires printing or use the **Browse** option to locate the file.
- Program the required printing options.
- Select **Submit Job** to send the job to the printer over the Internet.

Scan

The Scan option displays a list of all the Workflow Scanning templates that were created using CentreWare Internet Services.

Use Scan options to create, modify, copy, or delete Workflow Scanning templates.

Refer to [Workflow Scanning](#) on page 99 for more information about the Scan options.

Address Book

The printer supports two types of address books:

- Internal: A global address book provided by Lightweight Directory Access Protocol (LDAP) services.
- Public: An address book created from a list of names and addresses saved in a CSV file format.

The Address Book tab is used to set up and manage a Public Address Book. The file must be in a CSV format for the printer to be able to read the file contents. The printer can have access to both an LDAP server and a Public Address Book. If the system administrator configures these address books to provide access to users, you can use either address book to select email recipients.

Refer to the *System Administrator Guide* for further information about Address Books.

Properties

The Properties option contains all the settings, setups, and default values for installing and setting up the printer. These values are protected by a user name and a password and should only be changed by the system administrator.

Refer to the *System Administrator Guide* for information about configuring the printer.

Support

The Support option contains the General, Troubleshooting, Billing Impression Mode, and Remote Control Panel tabs.

The **General** tab displays Assistance Links, the name and telephone number of the system administrator, and the telephone numbers you should use for Customer Support, Service, and Supplies.

Use the **Troubleshooting** tab to access reports and information to help identify and resolve printer printing problems.

The **Billing Impression Mode** tab displays the Impression Mode and provides information on how to receive a PIN and change the current Billing Impression Mode.

The **Remote Control Panel** tab allows the system administrator to remotely interact with the printer Control Panel. The administrator has the option to block the local control panel access so that the users can only observe the actions performed.

Help

Select the **Help** button to display the Help screen.

The structure of the Help screens corresponds to the structure of the CentreWare Internet Services options.

Use the menu on the left of the Help page to access descriptions and instructions about all the features and functions of CentreWare Internet Services.

Paper and Media

14

This chapter includes:

- [Introduction](#) on page 170
- [Trays 1 and 2](#) on page 171
- [Tray 3](#) on page 173
- [Tray 4](#) on page 174
- [Tray 5](#) on page 176
- [Tray 6](#) on page 177
- [Media Types](#) on page 179
- [Storage and Handling](#) on page 183

Introduction

This chapter describes the different types of media that can be used on the printer, the paper trays available, and the types and sizes of media that can be loaded and fed from each tray.

The chapter also identifies the orientation that the media can be loaded, long-edge feed (LEF) or short-edge feed (SEF).



- 1 Paper Tray 1:** This tray is the standard tray on the printer. It is a fully adjustable tray and is used for media sizes 5.5 x 8.5 in. to 11 x 17 in. / A5 to A3. The capacity of this tray is 550 sheets of 75 g/m² or 20 lb paper.
- 2 Paper Tray 2:** This tray is standard on the printer. It is a fully adjustable tray and is used for media sizes 5.5 x 8.5 in. to 11 x 17 in. / A5 to A3. The capacity of this tray is 550 sheets of 75 g/m² or 20 lb paper.
- 3 Paper Tray 3:** This tray is the standard tray on the printer. It is a dedicated tray and is set to a fixed size, either A4 or 8.5 x 11 in. The capacity of this tray is 2,100 sheets of 75 g/m² or 20 lb paper.
- 4 Tray 4 (Bypass):** This tray is also standard on the printer and is used for non-standard printing media. It can be used for media sizes in the range A5 SEF to SRA3 SEF (5.5 x 8.5 in. SEF to 12x18 in. SEF). The capacity of this tray is 100 sheets of 75 g/m² or 20 lb paper.
- 5 Tray 5:** An optional high-capacity paper source that feeds A4 or 8.5 x 11 in. LEF media as the standard. Additional kits can be purchased to enable different paper sizes to be fed. The capacity of this tray is 4000 sheets of 75 g/m² or 20 lb paper (A4 or 8.5 x 11 in. LEF); or 2000 sheets of 75 g/m² or 20 lb paper (A3 or 11 x 17 in.).
- 6 Tray 6 (Post Process Inserter):** An optional paper tray for use with the High Volume Finisher. It is used to insert pre-printed sheets into copy sets. The printer cannot print on sheets fed from this tray. The capacity of this tray is 250 sheets of 75 g/m² or 20 lb paper.

The trays automatically detect low media and out of media conditions. A warning message is displayed on the screen when a tray requires loading.

Always use the labels in each of the trays for guidance on loading orientations and maximum fill information.

Trays 1 and 2

Trays 1 and 2 are located on the front of the printer and feed the majority of media sizes. Media can be loaded in the LEF or SEF orientation. The printer uses a system of programmable settings to manage the trays and media. These settings are established by The system administrator who can set Trays 1 and 2 to **Fully Adjustable** or **Dedicated**.

- **Fully Adjustable:** If this option is set, the paper settings screen is displayed each time the tray is opened and closed. The drop-down menus are used to change the size, type, and color of the loaded media. The guides automatically detect the size of media loaded, and the printer gives a warning if the guides are not set correctly or a non-standard paper size is used.
- **Dedicated:** When a tray is opened, a screen is displayed identifying the media that should be loaded in the tray. If the media of incorrect size is loaded or the tray guides are set incorrectly, the printer gives a warning to adjust the guides.

Note: Only the system administrator can change the media attributes for a dedicated tray.

If a non-standard size media is loaded or the tray guides are set incorrectly, the printer displays a screen showing Unknown size and asking you to confirm or change the settings.

If set to Adjustable, the following media can be loaded in Trays 1 and 2:

- Up to 550 sheets of 75 g/m² or 20 lb paper.
- Weights from 60 g/m² to 216 g/m² (16 lb to 56 lb).
- Media sizes ranging from A5 SEF to A3 SEF (5.5 x 8.5 in. SEF to 11 x 17 in. SEF).
- Media types:
 - Bond, standard, or recycled paper
 - Card
 - Pre-printed media
 - Labels
 - Hole-punched paper
 - Carbonless paper

Trays 1 and 2 must not be used to feed transparencies, envelopes, or tabs. Tray 4 (Bypass Tray) can be used for these media types.

Note: For 80 g/m² paper, capacities are slightly lower than specified.

Loading Trays 1 and 2

If Tray 1 or Tray 2 is set as a Dedicated tray, the media requested must be loaded in the tray and the settings cannot be adjusted.

 **CAUTION:** A problem occurs if a tray is opened while it is being used to feed media. Do not open Tray 1 if Tray 2 is open.

1. Open the tray.

Trays 1 and 2

2. Place the media in the tray. Media must be positioned against the left side of the tray.

- Load pre-printed paper and labels face up and with the top toward the front of the printer.
- Load hole-punched paper with the holes on the right edge.

Paper must not be loaded above the maximum fill line.

3. Make sure that the paper guides just touch the paper.

- To position the right side guide, squeeze the clamp mechanism and slide the guide to touch the right edge of the media.
- To position the rear guide, squeeze the clamp mechanism and slide the guide to touch the rear edge of the media.

4. Close the paper tray.

The paper settings for the tray are displayed on the touch screen.

5. Touch **Confirm** or change the settings, as required.

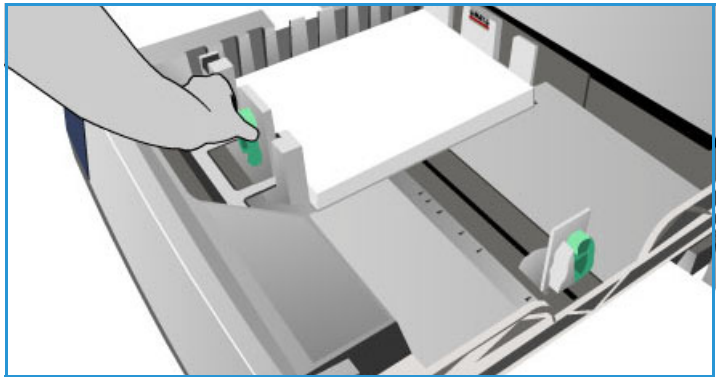
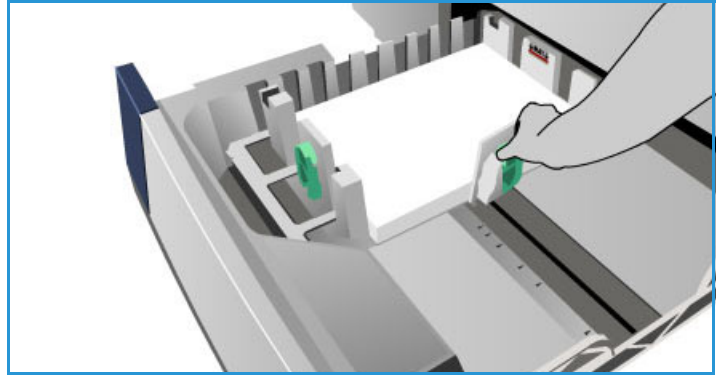

Tray 3

Tray 3 is a high-capacity tray. It is intended to be the primary feeder for the most commonly used media. This tray is permanently set as a dedicated tray and feeds only A4 or 8.5 x 11 in. LEF-sized media. The following media can be loaded in Tray 3:

- Up to 2,100 sheets of 75 g/m² or 20 lb paper.
- Weights from 60 g/m² to 216 g/m² (16 lb to 56 lb).
- Media types:
 - Bond, standard, or recycled paper
 - Card
 - Pre-printed media
 - Hole-punched paper
 - Carbonless paper

Tray 3 must not be used to feed labels, transparencies, envelopes, or tabs. Tray 4 (Bypass Tray) can be used for these media types.

Note: For 80 g/m², paper capacities are slightly lower than specified.

Loading Tray 3

Only A4 or 8.5 x 11 in. LEF-sized media can be loaded. The requested paper size and type must be loaded in the tray, and the settings cannot be adjusted by the user.

Note: The printer does not warn you if the media of incorrect size is loaded.

! CAUTION: A problem may occur if a tray is opened while it is being used to feed media.

1. Opening the tray automatically lowers an elevator in the base of the tray.
2. The required media is displayed on the screen. Ensure the correct media is loaded.
3. Place the media in the tray. The media must be positioned against the left side of the tray.

- Load pre-printed paper and labels face up and with the top toward the front of the printer.
- Load hole-punched paper with the holes on the right edge.

Paper must not be loaded above the maximum fill line.

4. Close the paper tray.

When the tray is closed, the elevator rises to feed the media.

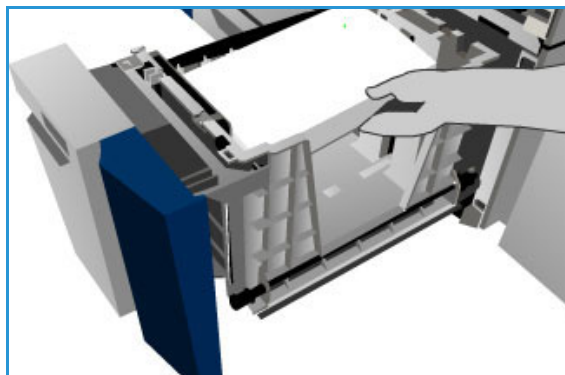

Tray 4

Tray 4, or Bypass, is a paper tray on the left-hand side of the printer and can be folded away when not in use. It is primarily intended for use as a small quantity, special materials feeder and accommodates media of all types, including transparencies, envelopes, and tabs.

When media is detected in Tray 4, a paper settings screen is displayed. The drop-down menus are used to change the size, type, and color of the loaded media. The guides automatically detect the size of the media loaded, and the printer gives a warning if the guides are not set correctly or a non-standard paper size is used. The following media can be loaded in Tray 4 (Bypass):

- Up to 100 sheets of 75 g/m², or 20 lb paper.
- Weights ranging from 60 g/m² to 216 g/m² (16–56 lb).
- Media sizes ranging from A5 SEF to SRA3 SEF (5.5 x 8.5 in. SEF to 12x18 in. SEF). Envelope sizes ranging from DL to C4 (#10 to 9 x 12 in.) must be fed in the SEF orientation.
- Media types:
 - Bond, standard, or recycled paper
 - Card
 - Pre-printed media
 - Labels
 - Transparencies
 - Hole-punched paper
 - Carbonless paper
 - Tabs
 - Envelopes

Note: For 80 g/m², paper capacities are slightly lower than specified.

Loading Tray 4

The printer alerts you if Tray 4 is selected for a job and the media requested does not match the media currently loaded. The printer also warns you if the tray runs out of paper during a job.

1. Make sure the tray is in the down position. For larger media, use the tray extension.
2. Place the media on the tray. Locate the media to the right edge.
 - Load pre-printed paper and labels face down and with their top toward the front of the printer.
 - Load hole-punched paper with the holes on the left.
 - Load transparencies face down with the white strip on the left.



For information about loading tabs, refer to [Pre-Cut Tabs](#) on page 181.

Paper must not be loaded above the maximum fill line.

3. Make sure that the guides just touch the paper.
The paper settings for the tray are displayed on the touch screen.
The tray detects the position of the side guide to determine the size of the media.
4. Touch **Confirm** or change the settings, as required.

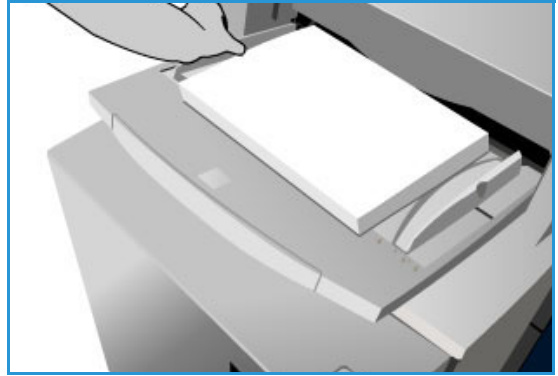

Tray 5

Tray 5 is an optional high-capacity paper source. When installed, Tray 5 takes priority as the primary paper feeder. This tray is a dedicated tray and as standard feeds A4 or 8.5 x 11 in. LEF media. Additional kits can be purchased and enable the tray to take either A4, 8.5 x 11 in. or 8.5 x 14 in. SEF, or A3 or 11 x 17 in. SEF. The following media can be loaded in Tray 5:

- Up to 4000 sheets of 75 g/m² or 20 lb paper (A4 or 8.5 x 11 in. LEF), up to 2000 sheets of 75 g/m² or 20 lb, paper (additional kits).
- Weights ranging from 60 g/m² to 216 g/m² (16–56 lb).
- Media types:
 - Bond, standard, or recycled paper
 - Card
 - Pre-printed media
 - Hole-punched paper

Tray 5 must not be used to feed labels, transparencies, envelopes, tabs, or carbonless paper. Tray 4 (Bypass) can be used for these media types.

Loading Tray 5

The requested paper size and type must be loaded in the tray, and the settings cannot be adjusted by the user.

Note: The printer does not warn you if media of incorrect size is loaded.

⚠ CAUTION: A problem may occur if a tray is opened while it is being used to feed media.

1. Press the button to open the door.

Opening the tray automatically lowers an elevator in the base of the tray. Wait for the paper tray to lower.

2. The required media is displayed on the screen. Ensure that the correct media is loaded.

3. Place the media in the tray. The media must be positioned against the right side of the tray.

- Load pre-printed paper face down and with the top toward the front of the printer.
- Load hole-punched paper with the holes on the left edge.



Paper must not be loaded above the maximum fill line.

4. Close the door.

When the door is closed, the elevator rises to feed the media.

Tray 6

Tray 6, or Inserter, is an optional paper tray for use with the HVF and is used for inserting post-process sheets in the set. This tray provides a convenient and efficient way of adding pre-printed covers or inserts to a job. The following media can be loaded in Tray 6:

- Up to 250 sheets of 75 g/m² or 20 lb paper
- Weights from 60 g/m² to 216 g/m² (16–56 lb)
- Media sizes:
 - A4 or 8.5 x 11 in. SEF or LEF
 - 8.5 x 13 in. SEF
 - 8.5 x 14 in. SEF
 - A3 or 11 x 17 in. SEF
- Media types:
 - Bond, standard, or recycled paper
 - Card
 - Pre-printed media
 - Hole-punched paper
 - Clear transparencies

Tray 6 must not be used to feed labels, envelopes, tabs, or carbonless paper. Tray 4 can be used for these media types.

Loading Tray 6

A4 or 8.5 x 11 in. media may be loaded either in the LEF or SEF orientation. Media sizes larger than A4 or 8.5 x 11 in. must be loaded in the SEF orientation.

1. Place the media in the correct orientation for the job.

The labels on the top of Tray 6 provide instructions for the input and output orientations. Refer to [Orientation of Pre-printed Media](#) on page 178.

2. The paper is registered centrally, to the left edge of the tray.



















Paper must not be loaded above the maximum fill line.

3. Make sure that the guides just touch the paper.



Orientation of Pre-printed Media

It is important to load the media in the correct orientation so that it matches the output. The table below compares various original orientations and how the pre-printed media should be loaded in each case.

Paper Size and Orientation	Output Required	Original Orientation	Output Tray Orientation	Inserter Orientation (to match output)
A4, 8.5 x 11 in. LEF	Long Edge Feed Stapled Top Left or non-stapled			
A4, 8.5 x 11 in. SEF	Short Edge Feed Stapled Top Left or non-stapled			
A4, 8.5 x 11 in. SEF	Short Edge Feed Staple Bottom Left or non-stapled			
A4, 8.5 x 11 in. SEF	Short Edge Feed Stapled Top Left or non-stapled			
A4, 8.5 x 11 in. LEF	Booklets From A4/8.5 x 11 in. Long Edge Feed Originals			
A3/A4 11 x 17 in./8.5 x 11 in. SEF	Booklets from A4/A3 or 11 x 17 in./8.5 x 11 in . SEF originals in a booklet format			

Media Types

This section describes the different types of media that can be loaded in the printer. For further information about media types and specifications, refer to www.xerox.com/paper.

The Type can be selected from a drop-down menu for the adjustable trays. It is important to select the correct Type setting for the media loaded in each tray. The printer can detect different types of media as it travels through the paper path, and the printer halts a job if a mismatch occurs.

The following media types are supported:

- Plain
- Pre-punched
- Transparency
- Pre-printed
- Recycled Paper
- Labels
- Heavyweight
- Extra Heavyweight
- Pre-Cut Tabs
- Envelopes

Plain

This media type is used for plain and colored paper, as well as a lightweight card. It is also the type used when loading carbonless paper.

The following paper types are not recommended:

- Coated paper
- Conductive paper
- Paper containing talc
- Highly glossy paper
- Paper containing wax, stearate, or plasticizer

Pre-Punched

This media type is used for hole-punched media that has two or more holes along one edge for use in ring binders and notebooks. To ensure ink is not placed where the holes occur, a small deletion is applied to the binding edge of the image.

Media Types

- Load pre-punched paper with the holes on the right edge in Trays 1, 2, 3, and 6.
- Load pre-punched paper with holes on the left edge in Tray 4 and Tray 5.

Note: If the deletion affects the output image, refer to [Copy](#) on page 7 for instructions on using **Image Shift**.

! CAUTION: Before loading the media, make sure that any plugs (the round pieces cut out of the paper to create the holes) do not remain in the stack. If they get into the system they can cause jams and can also damage the internal components of the printer. Fan the media to help separate the individual sheets.

Transparencies

Transparencies are used to create images that can be projected on a screen for presentations, or as covers. Transparencies are made of polyester film coated with a chemical substance. Clear transparencies allow maximum presentation space.

Note: Only Tray 4 can be used to feed transparencies.

- Load transparencies that have a white strip along one edge with a strip to the left and on the underside of the transparencies.
- Fan transparencies to stop them sticking together.
- Load transparencies on top of a small stack of same-size paper.

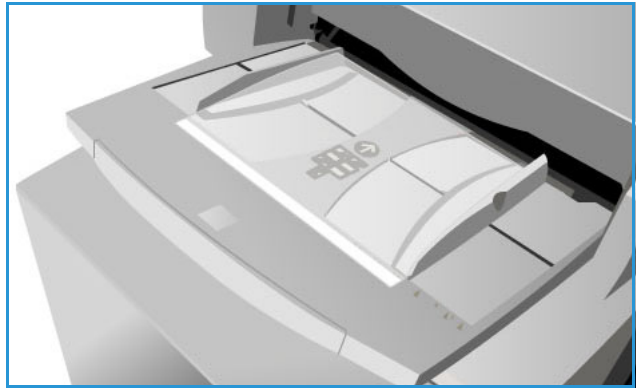

If a coating of oil remains on the transparency after printing, remove it with a lint-free cloth.

Pre-Printed

Use this option for pre-printed paper such as letterheads and forms.

- Load pre-printed paper face up and with the top toward the front of the printer in Trays 1, 2, 3, and 6.
- Load pre-printed paper face down and with the top toward the front of the printer in Tray 4 and Tray 5.

Recycled Paper

Use this option for any recycled paper being loaded in the trays.

The printer supports recycled media that has been designed for laser and solid ink devices, such as Xerox Recycled paper.

Labels

Labels consist of three layers, the face sheet, pressure sensitive adhesive, and the backing or release sheet. The printer supports labels that have been designed for laser and solid ink devices, such as Xerox Labels. The adhesives are designed to withstand the high temperatures of these devices without bleeding and causing spotting or damage to the internal components.

Note: Dry gum labels—those that require moistening before being applied—can cause dry particles of glue to detach from the backing and should not be used.

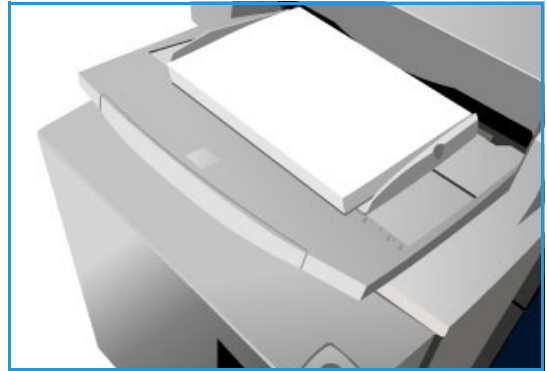

The labels should be left in the printing environment overnight before using it in the printer to allow it to adjust to the ambient temperature.

- Load labels face up and with the top toward the front of the printer in Trays 1 and 2.
- Load labels face down and with the top toward the front of the printer in Tray 4.

Note: Do not fan the label sheets before use unless the package instructs you to do so. If jamming or multi-sheet feeding occurs, shuffle the labels before loading.

Heavyweight and Extra Heavyweight

Use this paper type for feeding heavyweight and card. The maximum weight that can be fed is 216 g/m² (56 lb).

Pre-Cut Tabs

Tabs are used as dividers in documents. The printer can accommodate tabs with 1–10 tabs and weights of up to 200 g/m² (53 lb).

- Do not use tabs with bent corners. They can cause feeding-related problems. If a tab is bent, remove it from the set and replace it with an undamaged tab in the same position.
- Tabs can only be loaded into Tray 4.
- The tabs must be loaded with tab 1 on the top, with the tab to the left.
- Select the **Special Pages > Inserts** option in Copy or the Print Driver to program inserts where the tabs are required. Refer to the [Copy](#) on page 7 or [Print](#) on page 139 for information.



Envelopes

Printing on envelopes is available using Tray 4 only. Envelopes should not be used in Trays 1, 2, 3, 5, or 6.

- Place the envelopes face down in Tray 4.
- Envelopes must always be fed SEF.
- The flaps should always be closed. Flap edge should be to the left or toward the front.

The printer can feed the following types of envelopes:

Acceptable Types

- Diamond/Banker
- Wallet
- Business envelopes with diagonal seams
- Baronial
- Booklet

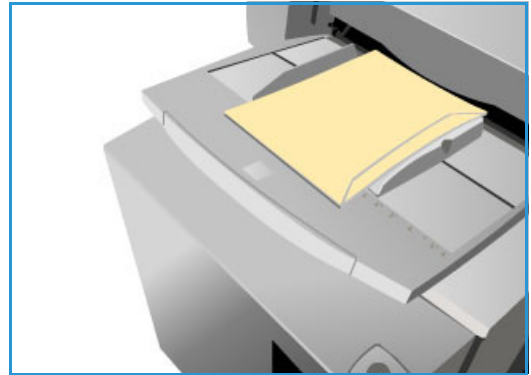

Weight

Lightweight and medium weight

Sizes

- DL, C5, and C4
- Commercial #10, 6x9 in., 9 x 12 in.

Acceptable Sealing

- Gummed
- Press and Seal

Unacceptable Types

The following envelope characteristics are not acceptable:

- Side seamed construction
- Announcement or catalog envelopes
- Windows
- Board backed
- Padded
- Self-adhesive with release strips
- Clasps of any kind

Storage and Handling

It is important for optimum printing that paper is stored correctly. Make a note of the following when storing media:

- Store at ambient temperature. Damp paper may cause problems or poor image quality.
- Do not open reams of paper until they are required for use. The ream wrapper contains an inner lining that protects the paper from moisture.
- Store on a flat surface to prevent paper from folding or curling.
- Stack reams of paper carefully on top of one another to avoid crushing the edges. Do not stack more than five reams on top of each other.

For problem-free printing and copying, observe the following when loading paper into the paper trays:

- Do not use folded or wrinkled paper.
- Do not load paper of varied sizes into a tray.
- If feed problems occur, fan the media or shuffle labels before loading.

Machine and Job Status 15

This chapter includes:

- [Introduction](#) on page 186
- [Job Status](#) on page 187
- [Machine Status](#) on page 191

Introduction

This guide explains how to use the Machine Status and Job Status functions. These are both accessed by buttons on the control panel.

Job Status displays all the jobs in the job list that are waiting to be processed, secure print jobs, and completed jobs. Each list can be viewed by touching the relevant tab.

Machine Status provides information about the installed options on the printer, the status of the paper trays and consumables, and fault information. The serial number and printer details are also provided, along with usage information, such as the number of impressions.



Job Status

The job lists can be accessed by pressing the **Job Status** button. The information about current jobs, secure print jobs, and completed jobs is displayed.

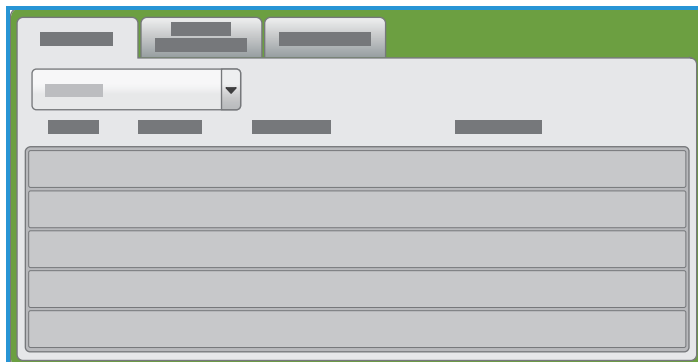

Active Jobs

This screen displays all the jobs currently in the list that are waiting to be processed. Each job is identified with the following information Owner, Name, and Status. The Active Jobs list displays up to 150 jobs.

- Pressing the **Job Status** button on the control panel.
The Active Jobs list is displayed.
Use the **Up** and **Down** buttons to scroll the jobs.
The most recently submitted job is displayed at the bottom of the list.
- The sequence of jobs can be altered by promoting or deleting jobs in the list.
- The Status is updated as the jobs are processed and printed. The following status information can be shown:
 - **Printing:** The printer is currently printing the job.
 - **Scheduling:** The job has been converted into the appropriate format and is being scheduled to print.
 - **Pending:** The job has been scanned, but is awaiting the resources to be formatted.
 - **Paused:** The active job was paused. The pause can be initiated using the Stop button on the control panel, by pressing Pause from the print queue screen on the computer or due to a system fault during the running of the job. The job is not deleted from the list and can be resumed.
 - **Interrupted:** The job was interrupted because a task at the printer is being carried out. Once the task is completed, the interrupted job automatically continues.
 - **Sending:** The printer is sending the job through network transmission.
 - **Completed:** The job was successfully completed without errors.
 - **Waiting for Printer:** The job is ready to print and is waiting for the current job to finish printing and the required resources to become available.
 - **Formatting:** The job is being converted into the appropriate format. For print tasks the job is decompressed, for fax, Internet fax, scan and email tasks the job is compressed.
 - **Scanning:** The printer is currently scanning the image for this job, ready for formatting.

- **Held:** The job has been temporarily stopped from printing. The job remains in the job list and continues to proceed up the list as prior jobs are printed. If a held job is at the top of the list all subsequent jobs continue to be processed and printed. A held job does not hold up other jobs in the list. There are various reasons why a job might be held, for example the job is a secure print or fax job, or the required resources are not available. The reason for the held status identified by touching **Job Details** and **Required Resources**.
- **Receiving:** The printer is receiving the job through a network transmission.
- **Deleted:** The job is deleted from the job list.
- **Completed with Errors:** The job was completed with errors.
- Touch **All Jobs** and use the drop-down list to filter the jobs and display only **Copy, Print and Fax Received Jobs** or **Scan Jobs and Fax Sent Jobs**, are active on the printer.

Secure Print Jobs

Secure print allows you to associate a 4–10 digit passcode with a print job when sending it to the printer. The job is held at the printer until you enter the passcode at the control panel. When printing a series of secure print jobs, you can assign a default passcode in Printing Preferences of the print driver. You can then use the default passcode for all print jobs sent from that computer. If you must use a different passcode, you can override it in the application print driver.

Note: Only the user that sent the job or the system administrator can delete a secure print job.

Sending a Secure Print Job

1. On the **Print** tab, from the Job Type list, touch **Secure Print**.
2. In the **Secure Print** window, type the passcode in the Passcode field. You are required to type this passcode when you print the job from the control panel.
3. In the Confirm Passcode field, type the passcode again.

Notes:

- If you do not supply a passcode, the printer assigns a passcode and displays it in the **Passcode Required** window. Use this passcode to print the document at the printer, or touch **Cancel** and type your passcode to use in the Secure Print window.
 - The passcode is associated with your user name. After you set a passcode, it becomes the default passcode for any print job that requires a passcode on all Xerox® printers. You can reset the passcode at any time from any window that contains the passcode.
4. Touch **OK**.
 5. Verify that the paper is the correct size, type, and weight. If not, change the paper settings.
Note: You can select the paper for the print job by using Select By Tray.
 6. Touch an option for 2-sided printing.
 7. If the printer has a finisher installed, touch a stapling option. The image next to Stapling displays the staple position.
 8. Touch the print-quality mode.
 9. Touch the output destination.
 10. Touch **Apply** and touch another tab or touch **OK**.

Releasing a Secure Print

1. At the control panel, press the **Job Status** button.
2. Touch the **Secure Print** tab.
3. Touch the folder that holds the print job.
4. Enter the passcode number that you assigned to the print job by using the keypad and touch **OK**.
5. Touch the corresponding print job in the list, then touch **Release**.

Deleting a Secure Print

1. At the control panel, press the **Job Status** button.
2. Touch the **Secure Print** tab.
3. Touch the folder that holds the print job.
4. Enter the passcode number that you assigned to the print job by using the keypad and touch **OK**.
5. Touch the corresponding print job in the list, then touch **Delete**.

Completed Jobs

This option displays the jobs, have been completed on the printer. Up to 150 jobs can be displayed. The Owner, Name, and Status of each job are shown.

1. Press the **Job Status** button on the control panel.
2. The Active Jobs list is displayed.
3. Touch **Completed Jobs**.
4. The list of completed jobs is displayed.
5. Use the **Up** and **Down** buttons to scroll the jobs in the list.
6. To view the details of a completed job, touch the job.
7. The job details are displayed.
8. Touch **Close** to exit the Job Details screen.

Touch **All Jobs** to filter the jobs and display only **Copy, Print and Fax Received Jobs** or **Scan Jobs and Fax Sent Jobs** that have been completed.

Managing Jobs

Manage the Active Jobs by using **Job Commands**.

- Press the **Job Status** button on the control panel.
The Active Jobs list is displayed.
- To access **Job Commands**, highlight the required job in the list.
The job command buttons are available depending on the selected job.
- The following options are available:

- **Delete** removes the selected job from the list. Any job can be deleted using the feature, regardless of the job originator.

Notes:

- The system administrator can restrict users from deleting jobs. If a system administrator has restricted job deletion, you can view the jobs, but not delete them.
- Only the user that sent the job or the system administrator can delete as secure print job.
- **Job Progress** displays status information about an individual job.
- **Details** can be accessed for incomplete and completed jobs. Depending on the type of a selected job, such as copy or print, the details show the submission time, image quality settings, the owner, finishing options, or sender's email address.

Held Jobs

If a job is Held in the list, it requires additional resources or a passcode to print.

1. Touch the job in the list and touch **Job Details > Required Resources**.
The resources required for the job are displayed.
2. Ensure the job resources to print the job are available.
3. Touch **Close** to exit the Job Details screen.
4. If the job is a Secure Print or Fax job, a passcode is required to release the job for printing.
5. Touch the job in the list and touch **Release**.
6. Type the passcode. For Secure Print jobs, it must match the passcode entered when the job was submitted using the print driver. For Secure Fax jobs, it must match the passcode entered when **Secure Receive** was enabled in **Tools**.

If the passcode is valid, the job is released for printing.

Notes:

- If multiple secure jobs are held in the list and require the same secure code, they will all be released for printing.
- Only the user that sent the job or the system administrator can delete as secure print job.

Machine Status

Machine Status provides information about the printer, the status of paper trays, consumables, and any current faults. Usage counters are also available.



Machine Information

Machine Information provides general information about the printer, such as the printer model, serial number, and software version.

This documentation supports ColorQube 9301\9302\9303 with software version 071.180.002.03100.

To find the software version number in the control panel:

1. Press the **Machine Status** button.
2. Touch the **Machine Information** tab and note the software version number listed.

Machine Information also provides options for access status information about the paper trays and consumables.

Further information can be printed about printer options, and a list of the installed services and solutions is available.

Paper Tray Status

Information about each of the trays, including Tray 4, or Bypass, is displayed. The paper Size, Type, and Color are the attributes set when loading the trays.

Information Pages

Using this option, a Configuration Report, billing summary, and quick user guide can be printed, providing information about the setup, functions, and features of ColorQube 9301/9302/9303 Multifunction Printer.

It also provides sampler and example pages, are used for checking quality and color settings.

Touch the report, guide, demo, or sampler page required and touch **Print**.

Note: Access to the Information Pages may be restricted. Contact the system administrator, or refer to the [Administration and Accounting](#) on page 195 for further information.

Installed Options

This option displays a list of Services, or additional solutions, that have been installed on the printer.

Maintenance Assistant

Use this option to send diagnostic information about the printer to Xerox over the network connection.

Active Messages

The Active Messages tab displays alerts on faults and lists printer error logs.

The messages are separated into Current Faults, Current Alerts, and Fault History.

- **Faults & Alerts** displays both list of current faults on the printer and all current fault messages.
- **Faults** displays a list of current faults on the printer. Each fault can be touched for further information.
- **Alerts** displays a list of all the current fault messages.
- **Fault History** provides a log of all the printer errors along with fault codes.

Supplies

The **Supplies** tab provides information on consumables, such as Solid Ink and SMart Kits.

ColorQube Ink

This option displays the status of each of the Solid Ink Sticks. The percentage used, the estimated number of days remaining, and the estimated number of pages remaining is shown.

Other Supplies

This option displays the percentage used and the pages remaining for each of the consumables, such as Cleaning Unit and Document Feeder Feed Roller.

Billing Information

This tab provides printer utilization and performance statistics. This information is typically used by Xerox or third-party organizations to calculate billings pertaining to leasing or other warranty and maintenance agreements.

Usage Counters

The Usage Counters track all input/output functions, scanning functions, and performance data.

- **Impression Counters** displays the total number of impressions the printer has made, along with various levels of color impressions.
- **Sheet Counters** displays the number of sheets that have passed through the printer in each of the job categories.
- **Images Sent Counters** displays the number of Fax, Server Fax, Internet Fax, Email, and Workflow Scanning images that have been sent from the printer.
- **Fax Impressions Counters** displays the number of prints generated from Fax, Server Fax, and Internet Fax jobs received.
- **All Usage Counters** displays the total impressions the printer has made.

Tools

Tools provides access to the administrative and maintenance tools for the printer. The following options can be set:

- Device Settings
- Service Settings
- Network Settings
- Accounting Settings
- Security Settings
- Troubleshooting

General users are not permitted to view or alter some options.

Note: Information about the **Tools** option is provided in [Administration and Accounting](#) on page 195 and the *System Administrator Guide*. Contact the system administrator for more details.

Administration and Accounting

This chapter includes:

- [Tools](#) on page 196
- [Device Settings](#) on page 197
- [Service Settings](#) on page 207
- [Network Settings](#) on page 215
- [Accounting Settings](#) on page 216
- [Security Settings](#) on page 218
- [Troubleshooting](#) on page 220

Tools

The settings on the printer can be set up using two options, CentreWare Internet Services or **Tools**. This guide explains the options available in **Tools**. For information about the settings available in CentreWare Internet Services, refer to [Accessing CentreWare Internet Services](#) on page 157.

These options should be set up and customized by the system administrator. Therefore, access to **Tools** options is passcode-protected. Entry to **Tools** pathway is by using the **Machine Status** button on the control panel.

Accessing Tools

1. Press the **Machine Status** button.
2. Select the **Tools** tab.
To have access to all **Tools** options, you must be logged in as the Administrator.
3. Press the **Log In/Out** button and type your User Name and Password, as directed.

For further information, refer to the *System Administrator Guide*.

The **Tools** options are displayed.

Most **Tools** screens include the following buttons to confirm or cancel your choices:

- **Cancel** resets the screen and returns to the previous screen.
- **OK** saves the selections made and returns to the previous screen.
- **Close** closes the screen and returns to the previous screen.

Device Settings

The Device Settings are used to customize options that are specific to the printer, such as Energy Saver and Paper Tray settings.

General

Select **General** to access the following settings:

- [Energy Saver](#) on page 197
- [Date and Time](#) on page 197
- [Language/Keyboard Selection](#) on page 198
- [Custom Keyboard Button](#) on page 198
- [Xerox Customer Support](#) on page 198
- [Entry Screen Defaults](#) on page 198
- [Measurements](#) on page 198
- [Paper Size Preference](#) on page 199
- [Audio Tones](#) on page 199
- [Billing Impression Mode](#) on page 199
- [Feature Installation](#) on page 199

Energy Saver

The printer is designed to be energy efficient and automatically reduces its power consumption after periods of inactivity. This utility enables the administrator to modify the time the printer spends between standby, low power, and sleep modes.

- **Intelligent Ready** wakes up and sleeps automatically, based on previous usage.
- **Job Activated** wakes up when an activity is detected.
- **Scheduled** wakes up and sleeps at set times on a daily basis. Select **Scheduled Settings** to program the setting for each day.
 - **Activity** is selected if the printer is required to wake up when an activity is detected.
 - **Time** is selected if specific **Warm up Time** and **Energy Saver Time** are required. Select the time required for each option by using the scroll bar.
- **Fast Resume** reduces the time taken to wake up. This changes the default sleep/low power timeouts and increases energy usage.

Date and Time

Some features and functions on the printer require the local date and time, such as Delayed Send or the Configuration sheet. This utility enables you to set and change the local date and time on the printer.

- **GMT Offset (Time Zone)**: Use this option to set the difference between your local time and Greenwich Mean Time. Enter the GMT Offset time from -12.0 to +14.0 hours, using the arrow buttons.

- **Date:** Select the Format required and enter the Month, Day, and Year.
- **Time:** Enter the correct Hour and Minute and select **PM** or **AM**. If a 24-hour clock is required, select the **Display 24 hour clock** option and enter the Hour and Minute by using the 24-hour clock format.
- Select **Reboot** to save and reboot the printer, or **Cancel** to exit without saving.

Language/Keyboard Selection

You can choose the default language used on the printer touch screen, that is, the language that displays when the printer is switched on. You can also select the keyboard to display when a text entry is required.

- **Languages** is used to select the required language by using the scroll bar.
- **Keyboard** is used to select the appropriate keyboard layout for the selected language.

Custom Keyboard Button

Use this option to enter frequently used text that you would like to appear in the keyboard.

Enter the required text by using the touch screen keyboard. Use  or backspace in the keyboard to delete an incorrect entry, or to delete the entire entry.

Xerox Customer Support

Use to enter the Xerox Customer Support telephone number. This number is displayed on the touch screen and is accessed using the **Machine Status** button.

Enter the appropriate telephone number by using the keyboard. Use  or backspace in the keyboard to delete an incorrect entry, or to delete the entire entry.

Entry Screen Defaults

This feature can only be set using CentreWare Internet Services. It enables the system administrator to set the screen the user sees first on the printer. Instructions for accessing the feature are displayed on the screen when the option is selected. For further information, refer to the *System Administrator Guide*.

Measurements

This utility enables you to set the printer to display measurements, either in millimeters or inches, and the numeric separator, as a period (full stop) or a comma.

- **Units** is used to select **Inches or mm** (millimeters) as the unit of measure.
- **Numeric Separator** is used to define which character is used to separate numbers; select **Comma** or **Period**.

Paper Size Preference

This option is used to select the most frequently used paper size formats.

- **Inches** for formats such as 8.5 x 11 in. or 11 x 17 in.
- **Metric** for formats such as A4 or A3.

Audio Tones

The printer generates three types of audio tones to notify the user of an event that has occurred at the printer. Use this feature to switch off or adjust the volume of each of the tones.

- **Fault Tone** sounds when there is a fault on the printer. Select **High, Medium, Low, or Off**. Use **Test** to hear the tone selected.
- **Conflict Tone** sounds when an incorrect touch screen selection is made. Select **High, Medium, Low, or Off**. Use the **Test** option to hear the selected tone.
- **Selection Tone** sounds when the printer accepts your selection. Select **High, Medium, Low, or Off**. Use **Test** to hear the selected tone.

Billing Impression Mode

This feature enables you to change the Billing Impression Mode on your preference. To change the Billing Impression mode, contact Xerox Customer Support with provided sequence PIN number and serial PIN number. For further information, refer to the *System Administrator Guide*.

Feature Installation

This feature enables you to do feature installations. For further information, refer to the *System Administrator Guide*.

Paper Management

Select **Paper Management** to access the following settings:

- [Paper Type and Color](#) on page 199
- [Paper Substitution](#) on page 200
- [Paper Size Preference](#) on page 200
- [Tray Settings](#) on page 200
- [Tray Contents](#) on page 200

Paper Type and Color

Allows the programming of the default paper type and color. This is usually the most common media that is used in the printer and is the media that the printer feeds if a specific paper type is not selected.

- Select **Plain** or **Recycled** for the paper type, using the scroll bar.
- Select a paper color from the list shown, using the scroll bar. If the required color is not shown, use the **Other** option.

Paper Substitution

Enables the printer to automatically substitute the common US and metric paper sizes when printing.

- **Nearest Match** is used to automatically substitute the paper sizes shown on the screen if they are not available. For example, if an A4 document is received for printing and only 8.5 x 11 in. paper is available, the printer substitutes 8.5 x 11 in. for A4. If **Disable** is selected, the printer does not substitute the sizes shown. In this instance, a job would be held in the job list until the correct paper size is loaded.
- **Replace 8.5 x 14 in.** is used to automatically substitute 8.5 x 14 in. paper with A3 or 11 x 17 in. if 8.5 x 14 in. paper is requested but is not available. If **Disable** is selected, the printer does not substitute the paper.

Paper Size Preference

This option is used to select the most frequently used paper size formats.

- **Inches** for formats such as 8.5 x 11 in. or 11 x 17 in.
- **Metric** for formats such as A4 or A3.

Tray Settings

Use these to apply attributes to each paper tray so that they operate productively in your working environment. You can assign trays as dedicated to a specific paper size and type, and set up Auto Selection and the selection Priority of each tray.

- Select the required tray and select **Change Settings**.
- Select the **Tray Type** required:
 - **Dedicated** is set to contain one size and type of media only and cannot be adjusted by the user.
 - **Adjustable** is selected if the tray can be adjusted by the user to contain any media within specification. This option may not be available for all trays.
 - Select the required setting and select **Save**.
- **Priority** is used to indicate what tray is selected if trays contain the same media. This setting also determines the order that the trays are displayed on the **Copy** tab. Set the **Tray Priority** 1–99; 1 is the highest priority and 99 is the lowest. Select **Save**.
- **Auto Selection** enables the printer to choose the best media for the job. This setting also enables the printer to automatically switch from one tray to another when a tray runs out of paper and another tray is available with the same media loaded. Select **Enable** or **Disable** and select **Save**.
- Repeat the process for each tray, as required.

Tray Contents

Use these to specify the size, type, and color of the media in a tray that has been designated as a dedicated tray.

- Select a tray designated as the dedicated tray.
- **Change Size** is used to select the size required for the tray. Select the size of the media loaded in the tray and select **Save**.

- **Change Description** is used to specify the paper type and color. It is important that this setting matches the paper type and color loaded in the printer. Select the appropriate Paper Type and Color setting and select **Save**.
- Repeat the process for each of the trays, as required.

Timers

Select the **Timers** option to access the following settings:

- [Auto Resume Timer](#) on page 201
- [Held Job Timeout](#) on page 201
- [System Timeout](#) on page 201

Auto Resume Timer

If the printer is stopped during a job execution, this feature determines if the printer automatically resumes the job after a set period of time or if it waits for user intervention to resume the job. This can prevent a user leaving the printer in a stopped or paused state.

- **Auto Resume** is selected to automatically resume stopped operations at the designated time. Select the period of time the printer waits for before resuming, 15 –120 seconds, using the arrow buttons.
- **Wait for User** instructs the system to remain stopped until a user selects **Resume** or **Cancel**.

Held Job Timeout

Use this option to enable the printer to delete jobs that have been held in the job list for a specified period of time and have been abandoned by a user. email, network scanning, incoming server fax, embedded fax, and Internet fax jobs are not affected by this setting.

- **Enable** allows the printer to automatically delete held jobs after a specified period, set the period of time, 0–120 hours and 0–59 minutes, using the arrow buttons.
- **Disable** instructs the printer not to delete held jobs from the job list. The held jobs are deleted only if the printer is switched off.

System Timeout

Use this option to set the printer to return to the default screen and feature settings after a specified period of time. This option enables the system administrator to define the timeout period by using CentreWare Internet Services or the UI. After the timeout on the UI, the screen appears the same as it does after pressing **Clear All**, log out, or remove a partial job.

- Select **Enable** to instruct the printer to time out after a specified period. Select the time period, 0–60 minutes, using the slide bar.
 - The time range should be 0–45 seconds in 15-second increments.
 - There is always some timeout for security reasons.
- When the timeout reaches the specified limit, a system timeout screen will appear, letting the user know that the session will time out in 5 seconds and asking if the user would like to continue. For further information, refer to the *System Administrator Guide*.
- Select **Disable** if you do not want the printer to automatically return to the default settings after the specified period of time.

Input

Select the **Input** option to access the following settings:

- [Auto Color Detection](#) on page 202
- [Photo/Text Settings](#) on page 202

Auto Color Detection

When the **Auto Detect** option is used, the printer can focus on black and white or colors during scanning. This option allows you to customize the bias based on the type of originals scanned and the output required.

- Select the bias toward color or monochrome for scanning, using the document glass.
- Select the bias toward color or monochrome for the automatic document feeder.

Photo/Text Settings

When the **Photo/Text Setting** option is used, the printer can be customized to enhance the photo or the text, depending on requirements.

- Select **Bias Photo** if the photo quality is more important.
- Select **Bias Text** to enhance the text quality.

Output

Select the **Output** option to access the following settings:

- [Contention Management](#) on page 202
- [Out of Staples Options](#) on page 202
- [Output Location](#) on page 203
- [Within Job Offsetting](#) on page 203
- [Staple Productivity Mode](#) on page 203

Contention Management

The printer is capable of processing several jobs at the same time, such as scanning, sending a fax, and printing a job. At times, two jobs may require the same resource and the contention management system decides which job has priority. This printer enables you to change the priority of print and copy jobs.

- **Priority** enables you to choose which jobs have priority, Copy or Print jobs. Use the arrow buttons to set the priority for Copy Jobs and Print Jobs. Number 1 has the highest priority.
- **First In, First Out** instructs the printer to process jobs based on when they are received. The jobs are processed in the order they enter the job list.

Out of Staples Options

If the printer has a finisher, you can set how the printer handles a stapling job when the stapler runs out of staples.

- **Complete Job Without Stapling** instructs the printer to continue the job without stapling.
- **Fault/Hold Job** instructs the printer to hold the job in the job list for the user. If a job has already started and the stapler runs out of staples, a fault is declared.

Output Location

This option determines the output location for unfinished jobs. The output location for finished jobs is determined by the system.

System generated reports are sent to the Top Tray automatically.

The following options are available for Copy, Print, and Fax jobs:

- **Top Tray** delivers the output to the Top tray.
- **Stacker Tray** delivers the specified job output to the Stacker Tray.

Within Job Offsetting

The printer offsets every set from the previous set, making it easier to separate the sets. There may be occasions when you require the job to stack without offsetting. Use this feature to enable or disable the offsetting.

- **Enable** instructs the printer to offset each printed set.
- **Disable** instructs the printer to stack the sets without offsetting.

Staple Productivity Mode

Productivity can be improved by stapling LEF documents in the top right corner.

- **Enable** instructs the printer to staple LEF documents in the top right corner.
- **Disable** instructs the printer to staple LEF documents in the top left corner.

Supplies

Select the **Supplies** option to access the following settings:

- [Enter Supplies Plan Activation Code](#) on page 203
- [Low Supply Warning](#) on page 204
- [Supply Counter Reset](#) on page 204
- [Printer Software Upgrade](#) on page 204

Enter Supplies Plan Activation Code

This option is used to set up the optional services available on the printer. To enable a service, enter the Authorization Code provided with the option and select **Enter**.

Once a service is enabled, it may require configuring using CentreWare Internet Services. For further instructions, refer to the *System Administration Guide*.

Note: Some services will require a Reboot to activate them on the printer.

Low Supply Warning

This option is used to set up the warning period given for each of the printer consumables. The printer will display a message showing the specified number of days before the consumable reaches the end of its life. Set the notification period for the following consumables:

- **ColorQube Ink Sticks**
- **Cleaning Unit**
- **Automatic Document Feeder Feed Roller**

If 0 is set, no warning is provided.

Supply Counter Reset

This option is used to reset the counter when a listed supply is replaced.

- Select the supply and then select **Reset Counter**.
- Select **Reset** to confirm.

Printer Software Upgrade

This option is used to upgrade the software in the printer. For further instructions, refer to the *System Administration Guide*.

Quick Setup Home

This option is used to quickly set up the printer with the key information required to start using the features and functions.

Select the **Quick Setup Home** option to access the following settings:

- [IP Address Settings](#) on page 204
- [Contact Numbers](#) on page 205

IP Address Settings



Use to enter the IP Address Settings for the system. There are several screens for entering the IP Address information; select the **Next** option to view further screens.

- **IPv4** is used to select IPv4 protocol. Select **Enabled** to activate this setting.
- **IPv6** is the new standard protocol for the Internet. If you are unsure which IP setting to use, select **Enabled** for both IPv4 and IPv6.
- Select **Next** to continue to the next screen.
- **Get IP Address from a DHCP Server** is used if you want to have an IP address automatically assigned to this printer.
- **Use a Static IP Address** is used if you know the IP address you want to assign to the printer.
- Select the required option and then select **Next** to continue to the next screen.

- Enter the **IPv4 Address**, **Subnet Mask**, **Host Name**, and **Gateway** information by selecting each of the fields in turn. A numeric keypad is displayed for numeric entries, or a keyboard is displayed for text entries.
- Select **Next** to continue to the next screen. A completion screen is displayed with instructions for printing a Configuration Report, if required. Select **Done** to exit.
- Select another option to program, or select **Close** to return to the previous screen.

Contact Numbers

Use to enter the Customer Support and Supplies Telephone numbers that are displayed on the printer.

- **Customer Support Number** is selected to type the Xerox Support number supplied with the printer. Enter the number by using the keyboard and select **Save**. Use  option or backspace on the keyboard to delete an incorrect entry, or to delete the entire entry.
- **Supplies Number** is selected to type the telephone number that you call to obtain supplies for the printer. Enter the number by using the keyboard and select **Save**. Use  option or backspace on the keyboard to delete an incorrect entry, or to delete the entire entry.

Select **Next** to continue to the next screen. A completion screen is displayed with instructions for printing a Configuration Report, if required. Select **Done** to exit. Select another option to program or select **Close** to return to the previous screen.

Display Brightness

Enables you to adjust the brightness of the touch screen to suit ambient light levels.

Adjust the brightness, as required, using the indicator.

Configuration/Information Pages

Provides various options for printing the Configuration Report and information pages.

- **Administrator only:** Ensures that the Configuration Report and information pages can be printed only by authenticated system administrators.
- **Open to all users** Provides all users with access to print the Configuration Report and information pages.
- **Print Configuration at Power On:** Is set to **Yes** to print a configuration when the printer is powered on, or **No** to disable the option.
- **Print Now** prints the Configuration Report immediately.

Reset UI to Factory Settings

This option resets all the control panel and touch screen settings to their original state when the printer was set up at the factory.

A confirmation screen is displayed. Select **Reboot** to continue with the reset and to reboot the printer. Select **Cancel** to exit without resetting the settings.

Interrupt Printing Enablement

If this option is enabled, jobs printing can be held in the job list for more urgent jobs to print.

- **Enable** instructs the printer to allow jobs to be interrupted.
- **Disable** instructs the printer not to allow jobs to be interrupted and held for more urgent jobs.

Service Settings

The Service Settings are used to customize options that are specific to individual services, such as Copy, Fax, or Print.

Copy Service Settings

Select the **Copy Service Settings** option to access the following settings:

- [Feature Defaults](#) on page 207
- [Edge Erase Presets](#) on page 207
- [Image Shift Presets](#) on page 207
- [Reduce/Enlarge Presets](#) on page 208
- [Reading Order Options](#) on page 208
- [Auto Image Rotation](#) on page 208

Feature Defaults

Is used to select the default settings for each programming feature within the Copy service, such as paper supply, output, and 2-sided.

- Select the default required for each feature in each of the programming tabs.
- Select **Save Defaults**. The selected settings become the default settings for each copy job. A confirmation screen is displayed.
- Select **Done** to return to the previous screen.

Edge Erase Presets

Enables you to set up the Edge Erase pre-set entries. There are 2 pre-named, pre-set options and an Available setting. All of the presets can be customized with names and settings to meet your needs.

Note: The printer applies an automatic edge deletion to all the printed output.



- Select the preset option required from the **Presets** menu.
- Select the side options, as required, **Side 1**, **Side 2**, and **Mirror Side 1**.
- Select **Name** to customize the name of the preset option. Use **Clear Text** to clear the existing name and type a new name by using the touch screen keyboard. Use the  option or backspace in the keyboard to delete an incorrect entry, or to delete the entire entry. Select **Save**.
- Enter the deletion amounts for the **Top**, **Bottom**, **Left**, and **Right** margins. The parameters entered are the defaults shown when the preset is selected.

Image Shift Presets

Enables you to set up the Image Shift pre-set entries. There are two pre-named, pre-set options and an Available setting. All of the presets can be customized with names and settings to meet your needs.

- Select the preset option required from the **Presets** menu.

- Select **Name** to customize the name of the preset option. Use **Clear Text** to clear the existing name and type a new name by using the touch screen keyboard. Use the  option or backspace on the keyboard to delete an incorrect entry, or to delete the entire entry. Select **Save**.
- Enter the amounts for shifting Up/Down and Left/Right for Side 1.
- Enter the amounts for shifting Up/Down and Left/Right for Side 2. Select **Mirror Side 2** if the shift for the second side should be the same as for the first side.

The parameters entered are the defaults shown when the preset is selected.

Reduce/Enlarge Presets

This feature enables you to set 10 proportional reduce/enlarge pre-set ratios and 4 pre-set independent reduce/enlarge ratios.

- Select **Proportional** and then enter the preset ratios required for each preset option. You can choose 25 %–400 %.
- If you wish to reset all the proportional preset values back to the default settings, select **Reset All to Default**.
- Use the **Common Values** option to view the ratios for common reduce/enlarge activities.
- Select **Independent** and enter the preset ratios required for each preset option. A separate ratio is required for the X and Y options. You can choose 25 %–400 %.

Reading Order Options

This option allows you to show or hide the Reading Order option. The Book Copying and Booklet Creation options assume that the bound originals and booklets have a reading order of left to right and are scanned or printed in this order by default. If there is a requirement to select a different scanning or printing order, this feature provides users with the option of changing the scan or print order.

- **Scan Order** impacts the Book Copying and Book Faxing features. Select **Hide Reading Order** if you do not want the user to view the option to change the reading order. To display the feature, select **Show Reading Order**.
- **Print Order** impacts the Page Layout and Booklet Creation features. Select **Hide Reading Order** if you do not want the user to be able to view the option to change the reading order. To display the reading order feature, select **Show Reading Order**.

Auto Image Rotation

The Auto Image Rotation feature optimizes the image output based on the selected job settings. Disabling Auto Rotation may result in image loss.

- Use **When Auto R/E Selected** options to instruct the system how to proceed if the Auto Reduce/Enlarge feature is selected. Select **Auto Rotate as needed** to allow automatic rotation or **Disable Rotation** to restrict the printer from rotating the image.
- Use **When Auto Paper Selected** options to instruct the system how to proceed if Auto Paper is selected. Select **Auto Rotate as needed** to allow automatic rotation or **Disable Rotation** to restrict the printer from rotating the image.

Embedded Fax Settings

Select the **Embedded Fax Settings** option to access the following settings:

- [Fax Setup](#) on page 209
- [Feature Defaults](#) on page 207
- [Fax Country Setting](#) on page 209
- [Line 1 Setup](#) on page 209
- [Line 2 Setup](#) on page 210
- [Incoming Fax Defaults](#) on page 210
- [Transmission Defaults](#) on page 211
- [Mailbox and Polling Policies](#) on page 212
- [Mailbox Setup](#) on page 212
- [Setup Fax Reports](#) on page 213
- [Print Fax Reports](#) on page 213

Fax Setup

Use this setting to **Enable** or **Disable** Embedded Fax.

- **Enable** activates the Embedded Fax service and is selectable from the Services Home screen.
- **Disable** switches off the service, and it is not available for selection.

Feature Defaults

Use this setting to select the default settings for each programming feature within the Embedded Fax service.

1. Select the default required for each feature in each of the programming tabs.
2. Select **Save Defaults**. The settings selected become the default settings for each fax job.
3. A confirmation screen is displayed.

Select **Done** to return to the previous screen.

Fax Country Setting

Use this option to select the country the printer is located in. Select the Country required from the options shown.

Line 1 Setup

The standard fax option supports one analog telephone line. If the Extended Fax option is installed, the printer can support two analog telephone lines. This option enables you to set up Line 1.

- **Fax Number** is the number of phone lines the system is attached to. Type the number for Line 1, using the numeric keypad.

- **Line Name** is a friendly name to logically identify the system. Type the name, using the touch screen keyboard provided. Use the backspace key to delete an incorrect character, or use **Delete Text** to delete the entire entry. Select **Save**.
- **Options** determine if the line is able to **Send and Receive**, **Send Only**, or **Receive Only**. Select the required option for the fax line.

Line 2 Setup

If the Extended Fax option is installed, the printer can support two analog fax lines. This option enables you to set up Line 2.

- **Fax Number** is the number of the phone line that the system is using. Type the number for Line 2, using the numeric keypad.
- **Line Name** is a friendly name to logically identify the system. Type the name using the touch screen keyboard provided. Use the backspace key to delete an incorrect character, or use **Delete Text** to delete the entire entry. Select **Save**.
- **Options** determine if the line is able to **Send and Receive**, **Send Only**, or **Receive Only**. Select the required option for the fax line.

Incoming Fax Defaults

This setting allows you to select the default options for incoming faxes.

Auto Answer Delay

This setting allows you to set a time delay before the printer responds to a call. This is particularly useful if the printer is attached to a shared telephone line.

Type the time delay required, 0–15 seconds.

Paper Settings

This setting determines if an incoming fax is printed onto media that is selected automatically by the printer according to the parameters of the fax, or specified manually within this feature.

- **Automatic** allows the printer to automatically select a paper size for incoming faxes. If an exact match is not available, the incoming fax is printed on the next best match available and may be reduced to fit.
- **Manual** enables you to select the required paper selection options.
 - **Paper Size** is used to select Normal paper size for all incoming faxes.
 - **Paper Type and Color** is used to program the type and color of media required for incoming faxes.
 - **Fit to Paper** allows you to select **Reduce to Fit** if all faxes require reducing or enlarging to fit the selected paper.

Ring Volume

This setting enables the user to hear a ringing tone from the printer when an incoming fax is received.

- **Enabled** instructs the printer to sound the tone when a fax is received. Select **High**, **Medium**, or **Low**.
- **Disabled** deactivates the tone.

Secure Receive

If this option is enabled, a four-digit passcode is requested. The passcode is required in order to print any incoming fax.

- **Enable** activates Secure Receive. type a four-digit passcode to be used to release incoming fax jobs for printing.
- **Disable** enables all incoming faxes to print without the passcode.

Default Output Options

If the printer is fitted with a finisher, you are able to staple, two-hole punch, or double-side your incoming faxes. This utility is used to specify the output options you require for all the incoming faxes.

- **Staple** staples all incoming fax output, if enabled.
- **Hole Punch** prints all incoming faxes on two-hole punched media, if enabled.
- **2-Sided** prints all incoming faxes 2-sided, if enabled.

Transmission Defaults

Use these options to set the fax sending defaults.

Automatic Redial Setup

If the printer cannot make contact with the destination fax machine, it automatically waits and redials later. Use this setting to specify the interval between unsuccessful attempts and the number of times the printer redials.

- **Redial Time Interval** is used to specify the time interval between redials for a failed transmission. Type a value, 1–25 minutes.
- **Automatic Redial Attempts** instructs the printer how many times to redial the remote fax machine, before rejecting the job. Type a value, 0–14.

Automatic Resend

If the printer connects to the receiving fax machine, but the fax transmission is unsuccessful, the printer automatically attempts to resend the fax. Use this setting to specify how many attempts should be made to resend the fax and which pages should be resent.

- **Set number of resends** is used to specify how many times the fax is resent. Select a number, 0–5.
- **Failed page(s) without a cover page** is selected to resend the failed pages but not the cover page again.
- **Whole Job without a cover page** is selected if the entire job except the cover page should be resent.
- **Failed page(s) with a cover page** is selected if only the failed pages should be resent with the cover page.
- **Whole job with cover page** is selected if the whole job including the cover page should be resent.

Audio Line Monitor

When the printer is transmitting a fax, the dialing, handshake, and digital data creates audible beeps and buzzing sounds. The audio line monitor allows a user to listen to the call progress and hear the number dialed and the beginning of the handshake.

- **Enable** allows the transmission tones to be heard. Select **High**, **Medium**, or **Low**.
- **Disable** deactivates the sounds.

Send Header Text

When a fax is sent it, includes the telephone number, name, date, time, and page number at the top of each page of the fax. You can add a personalized sentence to the header of all the fax pages using this option. Enter the text required on the Header. Up to 30 characters can be typed. Use the backspace key to delete an incorrect character entry, or use **Clear Text** to delete the entire entry.

Batch Send

Use this feature to enable a user to send several fax jobs to the same destination in one transmission.

- **Disabled** switches off the function.
- **Enabled** activates the Batch Send option.

Mailbox and Polling Policies

Use this option to specify how long the system keeps documents received or stored in mailboxes before deleting them.

- **Received Documents** is used to specify the policy for documents received from remote machines.
 - **Delete On Print** deletes the document after printing.
 - **Keep 1–72 Hours** allows you to specify a value, 1–72, and keep the document for those hours before deleting the document.
 - **Keep Forever** keeps the document until manually deleted. A confirmation screen is displayed because this can cause the memory to become full quickly.
- **Stored Documents** is used to specify the policy for documents stored in the printer for polling.
 - **Delete On Poll** deletes the document after it has been polled.
 - **Keep 1–72 Hours** allows you to specify a value, 1–72, and keep the document for those hours before deleting the document.
 - **Keep Forever** keeps the document until manually deleted. A confirmation screen is displayed because this can cause the memory to become full quickly.

Mailbox Setup

Incoming Faxes can be stored in mailboxes prior to printing for convenience or added security. Users can print the faxes in their mailboxes at anytime. This option enables you to create, edit, and delete mailboxes. There is also a facility to print a list of all 200 mailboxes.

The Mailbox List displays the list of mailboxes available on the system. If a mailbox has already been set up and assigned the user name, the name is displayed next to the mailbox number.

- **Edit** is used to set up or amend an individual mailbox. Select the mailbox required from the Mailbox List and select **Edit**.
 - **Mailbox Passcode** is used to enter a four-digit passcode required to access the mailbox.
 - **Mailbox Name** is used to enter a name for the mailbox, such as the owner, department, or group. Use the backspace key to delete an incorrect character entry or **Delete Text** to delete the entire entry.
 - **Mailbox Notification** is enabled to provide notification of faxes received into the mailbox. If disabled, no notification is provided.
- **Delete Mailbox** is used to delete a mailbox that has already been set up. A confirmation screen displays a warning that the mailbox and its contents will be deleted if **Confirm** is selected.
- **Print Mailbox List** is used to print a list of all the mailboxes available on the system.

Setup Fax Reports

There are three fax reports available: Activity Report, Confirmation Report, and Broadcast and MultiPoll Report. This option enables you to specify the appearance and printing behavior of these reports.

- **Activity Report** provides information on the fax activities that have occurred on the printer:
 - **Auto Print** is used to print an Activity Report automatically.
 - **Off** is selected if the Activity Report is not required.
- **Confirmation Report** provides information on an individual transmission.
 - **Report Options** is used to determine when the report prints. Select **Always Print** to print after each transmission, **Off** if a report is not required, or **Print On Error** if the report is required only when an error occurs.
 - **Print Options** is used to specify if a **Reduced Image** of the first page or **No Image** is required on Confirmation Report.
- **Broadcast and Multipoll Report** provides a report when there is broadcast or multi-poll fax activity.
 - **Always Print** prints a report after each broadcast or multipoll fax transmission.
 - **Off** switches off the report.
 - **Print On Error** is selected if the report is required only when an error occurs.
- Select **Close** to return to the previous screen.

Print Fax Reports

Use this option to print fax reports. The reports available are Activity Report, Protocol Report, Dial Directory Report, Group Directory Report, Options Report, and Pending Jobs Report.

- Select the report required and then **Print Now**.
The report is sent to the job list and printed.
- Select **Close** to return to the previous screen.

Job Sheets

Select the **Job Sheets** option to access the following settings:

- [Banner Sheets](#) on page 214
- [Output Error Sheets](#) on page 214
- [Paper Type and Color](#) on page 199

Banner Sheets

With this option, the printer can print a banner page with every print job. If enabled, you can still choose not to print the banner page from the print driver for specific jobs.

- **Enable** is selected to print a banner page.
- **Disable** switches off the banner page option.

Output Error Sheets

Enables the printer to print an error report, if an error occurs during a print job.

- **Enable** is selected to print an Output Error Sheet.
- **Disable** switches off the Output Error Sheet option.

Paper Type and Color

Allows you to select the type and color of media used to print the Banner, Error, Scan Status, and Fax Status sheets. Select the required Paper Type and Paper Color.

Service Plan

This option is used to change your Xerox Service Plan. To change the plan, contact the Xerox Support Center with your machine serial number. Xerox will provide you with a Service Plan Authorization Number. Type the number and select the **Change Service Plan** button.

Network Settings

These settings are used to enter the network parameters for the system. This section provides an overview of the options available.

Detailed instructions for network installation are provided in the *System Administrator Guide*.

Online/Offline

Use this option to disconnect the printer temporarily from the network. Selecting **Offline** disconnects the printer from all networks. Any job entering the system is held. Any current outgoing jobs are not completed while the system is offline.

Select **Online** to reconnect the printer to the network.

TCP/IP Settings

This option enables the system administrator to enter the TCP/IP settings for the printer.

Advanced Settings

This option enables the system administrator to set up Network Settings. A warning screen is displayed. Prior to accessing these settings as a Network Controller, reset is required after the settings are changed. These settings must only be accessed and entered or changed by the system administrator.

Network Logs

Use this option only if instructed to do so by the Xerox Support Center. This option is used to download log information that can help to troubleshoot network-related problems.

USB Settings

This option is used to set up the USB Port at the rear of the printer. This port is used for software tools and for direct printing through a print driver. This option cannot be used for direct printing through a USB Flash Drive. The USB Port on the left side of the printer supports this function.

Accounting Settings

Accounting settings are used to configure the accounting options. Accounting options are used to record printer usage by different groups or departments and can also be used to restrict access to different services.

Detailed instructions for Accounting Setups are provided in the *System Administrator Guide*.

Accounting Mode

Use this option to select the required Accounting Mode:

- **None** is used if no accounting mode is required.
- **Auxiliary Access** is used if a third party auxiliary printer is installed on the printer for accounting purposes. For example, card activated or coin activated devices can be installed.
- **Xerox Standard Accounting** is an accounting system setup using the CentreWare Internet Services user interface. Once enabled, the IP address of the printer is typed and Xerox Standard Accounting can be set up.
- **Network Accounting** is a feature of the printer that automatically tracks print, scan, server fax, and copy usage for each user. Network Accounting is run over a network, and the accounting functions are performed remotely using third-party software.

Auxiliary Access

These options are used to set up and configure a third party device installed on the printer for accounting purposes or to restrict use.

- **Auxiliary Device Type** is used to select the auxiliary device being used on the printer.
- **Service Access and Accounting** is used to select the services that require restricting and usage tracking.
- **Job Timeout** sets the duration of time allowed before the system deletes the current job because of required additional payment or a network printing job being held in the job list.
- **Double Count Large Impressions** is used to specify how the system counts the impressions for sheets larger than 380 mm (15 in.), such as A3 or 11 x 17 in.

Xerox Standard Accounting

Xerox Standard Accounting provides the ability to track usage of print, copy, scan, and fax job services. It is provided as standard and is set up using CentreWare Internet Services. Select **Save** to enable Xerox Standard Accounting. Usage limits can be applied to users to restrict their usage. XSA is configured using CentreWare Internet Services or UI and requires no additional software.

For further information, refer to the *System Administrator Guide*.

Network Accounting

Network Accounting provides the ability to track usage of print, copy, scan, and fax job services over the network. It works with third-party devices that are compatible with the Network Accounting function.

- **Customize Prompts** allows you to customize the prompts that are provided to the users.
- **Code Entry Validation** is used to check user accounting credentials prior to providing access to the accounting database.

Copy Activity Report

Use this option to print a report after each copy session. The report details the type of job and the number of copies made during the session. This feature is intended for devices that are accessed by the general public and enables the user to be charged for the copies.

- Select **Copy Activity Report**.
- Select **Enable** to have the printer print a report at the end of each copy session.
- Alternatively, select **Disable** to turn this feature off.

Security Settings

The Security Settings are used to manage the security features of the printer. Job Deletion rights and Image Overwrite Settings can be configured.

Detailed instructions for Security Settings are provided in the *System Administrator Guide*.

Authorization

Use this option to set up the deletion rights for authenticated users.

Job Deletion

Use this option to set up users that are authorized to delete jobs from the printer. The options available are **All Users** or **System Administrator Only**.

Image Overwrite Security

Image Overwrite

If you have sent confidential or sensitive print jobs to the printer, you can set up the printer to automatically remove any data stored on the hard drive after the job has been printed. Select **Enable** to enable the Image Overwrite activity after each job.

On Demand Overwrite

If you have sent confidential or sensitive print jobs to the printer, you can delete any data that is stored on the hard drive after the job has been printed. This task is done using the On Demand Overwrite option.

There are two types of Overwrite options available: **Standard** or **Full**. Standard Overwrite takes approximately 20 minutes and excludes:

- Print file directories
- Scan to mailbox jobs
- Fax dial directories
- Mailbox contents

A Full Overwrite takes approximately 60 minutes and includes all data. Select the required Overwrite option and select **Overwrite Now** to run the overwrite process.

IPsec

IPsec is a security protocol enabled using CentreWare Internet Services. To disable IPsec on the printer, select the **Disable IPsec** option.

Valid Recipients

This feature sets the parameters for allowed recipients in the email and Internet Fax Services.

- **Allow any valid E-mail Address** enables jobs to be sent to any recipient.
- **Limit to Address Book entries only** allows you to send to addresses that have been typed in the Address Book. The New Recipient and Reply To features are disabled.

Troubleshooting

These settings are used to troubleshoot any problems that may occur on the printer. They provide various tests to check the functionality of the system and identify performance levels.

Support Pages

A list of reports and support pages for identifying image quality problems are displayed. Use the **Print** option to print the list.

Fix Image Quality

Use this option to Print Test Pages to help you diagnose print issues. Analyze the output and choose one of the options to fix image quality problems:

- **Light Line** fixes unexpected continuous lines of lighter colors or empty stripes visible on the printed output.
- **Smears** fixes streaks, smudges, and inks pots of the same or different colors scattered over the printed output.
- **Advanced** provides a list of expert routines. Customer Support may direct you to select this option. Refer to [Fix Image Quality](#) on page 220.

Automatic Light Lines Fix

Use this option to fix any Banding problems.

- Quick Banding Fix corrects banding temporarily and may slow print speeds until Full Banding Fix is completed.
 - **On** is used to correct banding when it is detected.
 - **Off** is selected if no action is required.
- Full Fix takes approximately eight minutes to complete.
 - **Eco Fix** is selected to correct banding when the printer is not in use.
 - **Always Fix** is selected to correct banding when it is detected.
 - **Off** is selected if no action is required.

Resets

Use this option to reset the system software.

- [Software Reset](#) on page 221
- [Supply Counter Reset](#) on page 221

Software Reset

Software Reset is faster and wastes fewer consumables than switching the printer off and then on.

When instructed by the printer to perform a restart, choose a software option and then select the **Reset** button.

- **All Software** resets the whole system software.
- **Network Software** resets the network controller software.
- **Copy Software** resets the copier software.

Supply Counter Reset

This option is used to reset the counter when a listed supply is replaced.

- Select the supply and then select **Reset Counter**.
- Select **Reset** to confirm.

Network

Network options are used to troubleshoot problems related to the network connection.

Echo Test

Echo Test allows you to test the network connectivity. Select the appropriate protocol and select the **Start Test** button to run the echo test.

- **TCP/IP**
- **AppleTalk**
- **Novell or IPX**

Fax

The Fax options are used to test the Fax functionality on the printer.

Fax Protocol Report

Fax Protocol Report provides information about the Fax function on the printer. Select **Protocol Report** and then select the **Print Now** button to print the report.

Safety and Regulation

17

This chapter includes:

- [Notices and Safety](#) on page 224
- [Safety Labels and Symbols](#) on page 225
- [Operational Safety Information](#) on page 226
- [Basic Regulations](#) on page 230
- [Copy Regulations](#) on page 232
- [Fax Regulations](#) on page 235
- [Material Safety Data](#) on page 238
- [Product Recycling and Disposal](#) on page 239
- [Energy Program Compliance](#) on page 241
- [Environmental Health and Safety Contact Information](#) on page 242

Notices and Safety

Read the following instructions carefully before operating the equipment. Refer to them as required to ensure the continued safe operation of the equipment.

The Xerox product and supplies have been designed and tested to meet strict safety requirements. These include safety agency evaluation and certification, and compliance with electromagnetic regulations and established environmental standards.

The safety and environment testing and performance of this product have been verified using Xerox materials only.



WARNING: Unauthorized alterations that can include the addition of new functions or connection of external devices, can affect product certification. Contact the Xerox representative for more information.

Safety Labels and Symbols

All warnings and instructions marked on or supplied with the product should be followed.

! WARNING: This label alerts the users about an area of the equipment, that is, a sharp edge. This edge could cause lacerations if extreme force is used on the guard that prevents contact in normal use. The edge is colored yellow to indicate the area to be avoided.

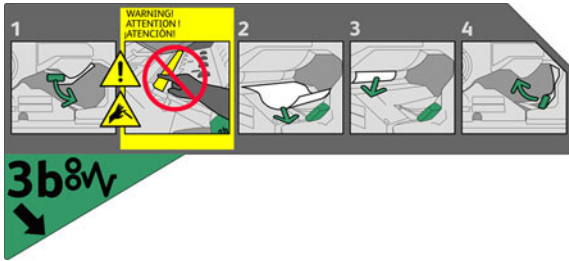

! WARNING: These labels alert users to areas of the equipment that are heated. The surfaces are safe to touch, but long-term contact may result in discomfort.



Operational Safety Information

Your Xerox equipment and supplies have been designed and tested to meet strict safety requirements. These include safety agency examination, approval, and compliance with established environmental standards.

To ensure continued safe operation of the Xerox equipment, follow these safety guidelines at all times:

Electrical Supply

This section provides important electrical supply safety information to read before installing or using the printer.

Read the information in the following sections:

- [Power Outlet Electrical Safety](#) on page 226
- [Power Cord Electrical Safety](#) on page 226
- [Equipment Safety](#) on page 227
- [Emergency Power Off](#) on page 228
- [Disconnect Device](#) on page 228

Power Outlet Electrical Safety

This equipment must be operated from the type of electrical supply indicated on the data plate label on the rear cover of the equipment. If you are not sure that the electrical supply meets the requirements, consult the local power company or a licensed electrician for advice.

Ensure the electrical supply outlet is near the equipment and easily accessible.



! WARNING: This equipment must be connected to a ground fault interrupter. This equipment is supplied with a plug that has a protective earth pin. Only this plug fits into an earthed electrical outlet. This is a safety feature. If you are unable to insert the plug into the outlet, contact a licensed electrician to replace the outlet. Always connect the equipment to a correctly grounded power outlet. If in doubt, have the outlet checked by a qualified electrician.

Improper connection of the equipment-grounding conductor can result in electrical shock.

Power Cord Electrical Safety

- Use only the power cord supplied with this equipment.
- Plug the power cord directly into a grounded electrical outlet. Do not use an extension cord. If you do not know if an outlet is grounded, consult a qualified electrician.
- Do not place this equipment where people can step on or trip on the power cord.
- Do not place objects on the power cord.

Equipment Safety

This equipment has been designed to provide operator access to safe areas only.

Operator access to hazardous areas is restricted using covers or guards that require a tool to enable removal.

Never remove the covers or guards that protect hazardous areas.

Do These:

 **WARNING:** Do not use aerosol cleaners. Aerosol cleaners can be explosive or flammable when used on electromechanical equipment.

- Always follow all warnings and instructions that are marked on or supplied with the equipment.
- Before cleaning this product, unplug the product from the electrical outlet. Always use materials specifically designated for this product. The use of other materials can result in poor performance and create a hazardous situation.
- Always exercise care when moving or relocating equipment. Contact the local Xerox dealer to arrange relocation of the equipment to a location outside of the building.
- Always locate the equipment on a solid support surface that has adequate strength to support the weight of the printer.
- Always locate the equipment in an area that has adequate ventilation and room for servicing.
- Always unplug this equipment from the electrical outlet before cleaning.

Note: The Xerox equipment has an energy-saving function to conserve power when the equipment is not in use. The equipment can be left on continuously.

Do Not Do These:

 **WARNING:** Do not use aerosol cleaners. Aerosol cleaners can be explosive or flammable when used on electromechanical equipment.

- Never use a ground adapter plug to connect the equipment to a power outlet that lacks a ground connection terminal.
- Never attempt any maintenance function that is not specifically described in this documentation.
- Never obstruct ventilation openings. They are provided to prevent overheating.
- Never remove covers or guards that are fastened with screws. There are no operator serviceable areas within these covers.
- Never place the machine near a radiator or any other heat source.
- Never push objects of any kind into ventilation openings.
- Never override or “cheat” any of the electrical or mechanical interlock devices.
- Never place this equipment where people might step on or trip on the power cord.
- Ensure this equipment is placed in a room with proper ventilation. Contact the local authorized dealer for further information.

Emergency Power Off

If any of the following conditions occur, turn off the equipment immediately and disconnect the power cables from the electrical outlets. Contact an authorized Xerox Service Representative to correct the problem:

- The equipment emits unusual odors or makes unusual noise.
- The power cable is damaged or frayed.
- A wall panel circuit breaker, fuse, or other safety device has been tripped.
- Liquid is spilled into the equipment.
- The equipment is exposed to water.
- Any part of the equipment is damaged.

Disconnect Device

The power cable is the disconnect device for this equipment. It is attached to the back of the printer as a plug-in device. To remove all electrical power from the equipment, disconnect the power cable from the electrical outlet.

Maintenance Information

 **WARNING:** Do not use aerosol cleaners. Aerosol cleaners can be explosive or flammable when used on electromechanical equipment.

- Any operator product maintenance procedures are described in the user documentation supplied with the product.
- Do not carry out any maintenance on this product that is not described in the customer documentation.
- Use supplies and cleaning materials only as directed in the user documentation.
- Do not remove covers or guards fastened with screws. There are no parts behind these covers that you can consider for maintenance or service.

Consumables Information

- Store all consumables in accordance with the instructions provided on the package or container.
- Keep all consumables away from the reach of children.
- Cartridges: When handling cartridges, avoid skin or eye contact that can cause irritation and inflammation. Do not attempt to disassemble the cartridge. This can increase the risk of skin or eye contact.

Product Safety Certification

This product is certified by the following agency, using the safety standards listed:

Agency	Standard
Canadian Standards Association	UL60950/CSA 22.2 No 60950
Canadian Standards Association	IEC60950/EN60950

This product has been manufactured under a registered ISO9001 quality system.

Basic Regulations

Xerox has tested this product for electromagnetic emission and immunity standards. These standards are designed to mitigate any interference caused or received by this product in a typical office environment.

Regulatory Information for the 2.4-GHz Wireless LAN Module

This product contains a 2.4-GHz wireless LAN radio transmitter module, which complies with the requirements specified in FCC Part 15, Industry Canada RSS-210 and European Council Directive 99/5/EC.

Operation of this device is subject to the following two conditions:

1. This device may not cause harmful interference.
2. This device must accept any interference received, including interference that may cause undesired operation.

Changes or modifications to this device, not specifically approved by the Xerox Corporation, may void the user's authority to operate this equipment.

United States (FCC Regulations)

This equipment has been tested and found to comply with the limits for a Class A digital printer, pursuant to Part 15 of the FCC Rules. These limits are designed to provide reasonable protection against harmful interference in a commercial environment. This equipment generates, uses, and can radiate radio frequency energy. If it is not installed and used in accordance with these instructions, it may cause harmful interference in radio communications. Operation of this equipment in a residential area can cause harmful interference that the user will be required to correct at his/her own expense.

If this equipment does cause harmful interference to radio or television reception that can be determined by turning the equipment off and on, the user is encouraged to try to correct the interference by one or more of the following measures:

- Reorient or relocate the receiver.
- Increase the separation between the equipment and the receiver.
- Connect the equipment to an outlet on a circuit different from that used by the receiver.
- Consult the dealer or an experienced radio/television technician for help.

Any changes or modifications not expressly approved by Xerox could void the user's authority to operate the equipment. To ensure compliance with Part 15 of the FCC rules, use shielded interface cables.

Canada (Regulations)

This Class A digital apparatus complies with Canadian ICES-003.

Cet appareil numérique de la classe A est conforme à la norme NMB-003 du Canada.

European Union

 **WARNING:** This is a Class A product. In a domestic environment this product may cause radio interference that may require the user to take adequate measures.

 The CE mark applied to this product symbolizes Xerox's declaration of conformity with the following applicable Directives of the European Union as of the dates indicated:

- December 12, 2006: Low Voltage Directive 2006/95/EC. Approximation of the laws of the member states related to low voltage equipment.
- December 15, 2004: Electromagnetic Compatibility Directive 2004/108/EC. Approximation of the laws of the member states related to electromagnetic compatibility.
- March 9, 1999: Radio & Telecommunications Terminal Equipment Directive 1999/5/EC.

This product, if used in accordance with the user's instructions, is neither dangerous for the consumer nor for the environment.

To ensure compliance with European Union regulations, use shielded interface cables.

A signed copy of the Declaration of Conformity for this product can be obtained from Xerox.

Turkey RoHS Regulation

In compliance with Article 7 (d)

We hereby certify

"It is compliant with the EEE Regulation"

""EEE yönetmeliğine uygundur"

Copy Regulations

United States

Congress, by statute, has forbidden the reproduction of the following subjects under certain circumstances. Penalties of fine or imprisonment may be imposed on those guilty of making such reproductions.

1. Obligations or Securities of the United States Government, such as:
 - Certificates of Indebtedness
 - National Bank Currency
 - Coupons from Bonds
 - Federal Reserve Bank Notes
 - Silver Certificates
 - Gold Certificates
 - United States Bonds
 - Treasury Notes
 - Federal Reserve Notes
 - Fractional Notes
 - Certificates of Deposit
 - Paper Money
 - Bonds and Obligations of certain agencies of the government, such as FHA, and so on.
 - Bonds (U.S. Savings Bonds may be photographed only for publicity purposes in connection with the campaign for the sale of such bonds.)
 - Internal Revenue Stamps. If it is necessary to reproduce a legal document that has a canceled revenue stamp, this may be done provided the reproduction of the document is performed for lawful purposes.
 - Postage Stamps, canceled or uncanceled. For philatelic purposes, Postage Stamps may be photographed, provided the reproduction is in black and white and is less than 75 % or more than 150 % of the linear dimensions of the original.
 - Postal Money Orders.
 - Bills, Checks, or Draft of money drawn by or upon authorized officers of the United States.
 - Stamps and other representatives of value, of whatever denomination that have been or may be issued under any Act of Congress.
2. Adjusted Compensation Certificates for Veterans of the World Wars.
3. Obligations or Securities of any Foreign Government, Bank, or Corporation.
4. Copyrighted materials, unless permission of the copyright owner has been obtained or the reproduction falls within the “fair use” or library reproduction rights provisions of the copyright law.

Further information of these provisions may be obtained from the Copyright Office, Library of Congress, Washington, D.C. 20559. Ask for Circular R21.5.
5. Certificate of Citizenship or Naturalization.

Foreign Naturalization Certificates may be photographed.

6. Passports. Foreign Passports may be photographed.
7. Immigration papers.
8. Draft Registration Cards.
9. Selective Service Induction papers that bear any of the following Registrant's information:
 - Earnings or Income
 - Court Record
 - Physical or mental condition
 - Dependency Status
 - Previous military service

Exception: United States military discharge certificates may be photographed.

10. Badges, Identification Cards, Passes, or Insignia carried by military personnel, or by members of the various Federal Departments, such as FBI, Treasure, and so on. (Unless photograph is ordered by the head of such department or bureau.)

Reproducing the following is also prohibited in certain states:

- Automobile Licenses
- Drivers' Licenses
- Automobile Certificates of Title

The above list is not all inclusive, and no liability is assumed for its completeness or accuracy. In case of doubt, consult your attorney.

Canada

Parliament, by stature, has forbidden the reproduction of the following subjects under certain circumstances. Penalties of fine or imprisonment may be imposed on those guilty of making such reproductions.

1. Current bank notes or current paper money.
2. Obligations or securities of a government or bank.
3. Exchequer bill paper or revenue paper.
4. The public seal of Canada or of a province, or the seal of a public body or authority in Canada, or of a court of law.
5. Proclamations, orders, regulations or appointments, or notices thereof (with intent to falsely cause same to purport to have been printed by the Queens Printer for Canada, or the equivalent printer for a province).
6. Marks, brands, seals, wrappers or designs used by or on behalf of the Government of Canada or of a province, the government of a state other than Canada or a department, board, Commission or agency established by the Government of Canada or of a province or of a government of a state other than Canada.
7. Impressed or adhesive stamps used for the purpose of revenue by the Government of Canada or of a province or by the government of a state other than Canada.

Copy Regulations

8. Documents, registers or records kept by public officials charged with the duty of making or issuing certified copies thereof, where the copy falsely purports to be a certified copy thereof.
9. Copyrighted material or trademarks of any manner or kind without the consent of the copyright or trademark owner.

The above list is provided for the convenience and assistance, but it is not all-inclusive, and no liability is assumed for its completeness or accuracy. In case of doubt, consult your solicitor.

Other Countries

Copying certain documents may be illegal in your country. Penalties of fine or imprisonment may be imposed on those found guilty of making such reproductions:

- Currency notes
- Bank notes and checks
- Bank and government bonds and securities
- Passports and identification cards
- Copyright material or trademarks without the consent of the owner
- Postage stamps and other negotiable instruments

This list is not inclusive and no liability is assumed for either its completeness or accuracy. In case of doubt, contact your legal counsel.

Fax Regulations

United States

Fax Send Header Requirements

The Telephone Consumer Protection Act of 1991 makes it unlawful for any person to use a computer or other electronic device, including a fax machine, to send any message unless such message clearly contains in a margin at the top or bottom of each transmitted page or on the first page of the transmission, the date and time it is sent and an identification of the business or other entity, or other individual sending the message and the telephone number of the sending machine or such business, other entity or individual. The telephone number provided may not be a 900 number or any other number for charges that exceed local or long-distance transmission charges. In order to program this information into the machine, refer to customer documentation and follow the steps provided.

Data Coupler Information

This equipment complies with Part 68 of the FCC rules and the requirements adopted by the Administrative Council for Terminal Attachments (ACTA). On the cover of this equipment is a label that contains, among other information, a product identifier in the format US:AAAEQ##TXXXX. If requested, this number must be provided to the Telephone Company. A plug and jack used to connect this equipment to the premises wiring and telephone network must comply with the applicable FCC Part 68 rules and requirements adopted by the ACTA. A compliant telephone cord and modular plug is provided with this product. It is designed to be connected to a compatible modular jack that is also compliant. See installation instructions for details.

You may safely connect the machine to the following standard modular jack: USOC RJ-11C using the compliant telephone line cord (with modular plugs) provided with the installation kit. See installation instructions for details.

The Ringer Equivalence Number (REN) is used to determine the number of devices that may be connected to a telephone line. Excessive RENs on a telephone line may result in the devices not ringing in response to an incoming call. In most but not all areas, the sum of RENs should not exceed five (5.0). To be certain of the number of devices that may be connected to a line, as determined by the total RENs, contact the local Telephone Company. For products approved after July 23, 2001, the REN for this product is part of the product identifier that has the format US:AAAEQ##TXXXX. The digits represented by ## are the REN without a decimal point (for example, 03 is a REN of 0.3). For earlier products, the REN is separately shown on the label.

To order the correct service from the local telephone company, you may also have to quote the codes listed below:

- Facility Interface Code (FIC) = 02LS2
- Service Order Code (SOC) = 9.0Y



WARNING: Ask the local telephone company for the modular jack type installed on the line. Connecting this machine to an unauthorized jack can damage telephone company equipment. You, not Xerox, assume all responsibility and/or liability for any damage caused by the connection of this machine to an unauthorized jack.

If this Xerox equipment causes harm to the telephone network, the Telephone Company will notify you in advance that temporary discontinuance of service may be required. But if advance notice is not practical, the Telephone Company will notify the customer as soon as possible. Also, you will be advised of your right to file a complaint with the FCC if you believe it is necessary.

The Telephone Company may make changes in its facilities, equipment, operations or procedures that could affect the operation of the equipment. If this happens, the Telephone Company will provide advance notice in order for you to make necessary modifications to maintain uninterrupted service.

If trouble is experienced with this Xerox equipment, for repair or warranty information, please contact the appropriate service center; details appear either on the machine or contained within the User Guide. If the equipment is causing harm to the telephone network, the Telephone Company may request that you disconnect the equipment until the problem is resolved.

Repairs to the machine should be made only by a Xerox Service Representative or an authorized Xerox Service provider. This applies at any time during or after the service warranty period. If unauthorized repair is performed, the remainder of the warranty period is null and void.

This equipment must not be used on party lines. Connection to party line service is subject to state tariffs. Contact the state public utility commission, public service commission or corporation commission for information.

If your office has specially wired alarm equipment connected to the telephone line, make sure that the installation of this Xerox equipment does not disable the alarm equipment.

If you have questions about what will disable alarm equipment, consult the Telephone Company or a qualified installer.

Canada

Note: The Industry Canada label identifies certified equipment. This certification means that the equipment meets certain telecommunications network protective, operational and safety requirements as prescribed in the appropriate Terminal Equipment Technical Requirements document(s). The Department does not guarantee the equipment will operate to the user's satisfaction.

Before installing this equipment, users must make sure that it is permissible to be connected to the facilities of the local telecommunications company. The equipment must also be installed using an acceptable method of connection. The customer should be aware that compliance with the above conditions may not prevent degradation of service in some situations.

Repairs to certified equipment should be coordinated by a representative designated by the supplier. Any repairs or alterations made by the user to this equipment, or equipment malfunctions, may give the telecommunications company cause to request the user to disconnect the equipment.

Users should make sure for their own protection that the electrical ground connections of the power utility, telephone lines and internal metallic water pipe systems, if present, are connected together. This precaution may be particularly important in rural areas.

 **CAUTION:** Users should not attempt to make such connections themselves, but should contact the appropriate electric inspection authority, or electrician, as appropriate.

The Ringer Equivalence Number (REN) assigned to each terminal device provides an indication of the maximum number of terminals allowed to be connected to a telephone interface. The termination on an interface may consist of any combination of devices subject only to the requirement that the sum of the Ringer Equivalent Numbers of all of the devices does not exceed 5. For the Canadian REN value, please see the label on the equipment.

Europe

Radio Equipment & Telecommunications Terminal Equipment Directive

The Facsimile has been approved in accordance with the Council Decision 1999/5/EC for pan-European single terminal connection to the public switched telephone network (PSTN). However, due to differences between the individual PSTNs provided in different countries, the approval does not, of itself, give an unconditional assurance of successful operation on every PSTN network terminal point.

In the event of a problem you should contact the authorized local dealer in the first instance.

This product has been tested to and is compliant with ES 203 021-1, -2, -3, a specification for terminal equipment for use on analog-switched telephone networks in the European Economic Area. This product provides a user-adjustable setting of the country code. Refer to the customer documentation for this procedure. Country codes should be set prior to connecting this product to the network.

Note: Although this product can use either loop disconnect (pulse) or DTMF (tone) signaling, it is recommended that it is set to use DTMF signaling. DTMF signaling provides reliable and faster call setup. Modification of this product, connection to external control software or to external control apparatus not authorized by Xerox, will invalidate its certification.

South Africa

This modem must be used in conjunction with an approved surge protection device.

Material Safety Data

For Material Safety Data information regarding the printer, go to:

North America: www.xerox.com/msds

European Union: www.xerox.com/environment_europe

For the Customer Support Center phone numbers, go to www.xerox.com/office/worldcontacts.

Product Recycling and Disposal

USA & Canada

Xerox operates a worldwide equipment take back and reuse/recycle program. Contact the Xerox sales representative (1-800-ASK-XEROX) to determine if this Xerox product is part of the program. For more information about Xerox environmental programs, visit www.xerox.com/environment.

If you are managing the disposal of your Xerox product, please note that the product may contain lead, mercury, Perchlorate, and other materials whose disposal may be regulated due to environmental considerations. The presence of these materials is fully consistent with global regulations applicable at the time that the product was placed on the market. For recycling and disposal information, contact the local authorities. Perchlorate Material: This product may contain one or more Perchlorate-containing devices, such as batteries. Special handling may apply, please see www.dtsc.ca.gov/hazardouswaste/perchlorate.

European Union

WEEE Directive 2002/96/EC

Some equipment may be used in both a domestic/household and a professional/business application.



Professional/Business Environment

Application of this symbol on the equipment is confirmation that you must dispose of this equipment in compliance with agreed national procedures. In accordance with European legislation, end of life electrical and electronic equipment subject to disposal must be managed within agreed procedures.



Domestic/Household Environment

Application of this symbol on the equipment is confirmation that you should not dispose of the equipment in the normal household waste stream. In accordance with European legislation, end of life electrical and electronic equipment subject to disposal must be segregated from household waste. Private households within EU member states may return used electrical and electronic equipment to designated collection facilities free of charge. Please contact the local disposal authority for information. In some member states, when you purchase new equipment, the local retailer may be required to take back the old equipment free of charge. Please ask your retailer for information. Prior to disposal, please contact the local dealer or Xerox representative for end of life takeback information.

Information for Users on Collection and Disposal of Old Equipment and Used Batteries



These symbols on the products, and/or accompanying documents, mean that used electrical and electronic products and batteries should not be mixed with general household waste.

For proper treatment, recovery and recycling of old products and used batteries, please take them to applicable collection points, in accordance with the national legislation and the Directive 2002/96/EC and 2006/66/EC.

By disposing of these products and batteries correctly, you will help to save valuable resources and prevent any potential negative effects on human health and the environment that could otherwise arise from inappropriate waste handling.

For more information about collection and recycling of old products and batteries, please contact the local municipality, the waste disposal service or the point of sale where you purchased the items.

Penalties may be applicable for incorrect disposal of this waste, in accordance with national legislation.

For Business Users in the European Union

If you wish to discard electrical and electronic equipment, please contact the dealer or supplier for further information.

Information on Disposal in Other Countries Outside the European Union

These symbols are only valid in the European Union. If you wish to discard these items, please contact the local authorities or dealer and ask for the correct method of disposal.



Note for the Battery Symbol

This wheeled bin symbol may be used in combination with a chemical symbol. This establishes compliance with the requirements set out by the Directive.

Removal

Batteries should only be replaced by a MANUFACTURER approved service facility.

Energy Program Compliance

All Markets

ENERGY STAR

The Xerox® ColorQube 9301/9302/9303 Multifunction Printer is ENERGY STAR® qualified under the ENERGY STAR Program Requirements for Imaging Equipment.



The ENERGY STAR and ENERGY STAR MARK are registered United States trademarks.

The ENERGY STAR Imaging Equipment Program is a team effort between U.S., European Union and Japanese governments and the office equipment industry to promote energy-efficient copiers, printers, fax, multifunction machine, personal computers, and monitors. Reducing product energy consumption helps combat smog, acid rain and long-term changes to the climate by decreasing the emissions that result from generating electricity. The default time settings for the ColorQube 9301/9302/9303 Multifunction Printer are 5 minutes and 60 minutes.

Environmental Health and Safety Contact Information

For more information on Environment, Health, and Safety in relation to this Xerox product and supplies, please contact the following customer help line numbers:

USA: 1-800 828-6571

Canada: 1-800 828-6571

Europe: +44 1707 353 434

Product safety information is also available on the Xerox website. See www.xerox.com/environment.

General Care and Troubleshooting

This chapter includes:

- [Power Options](#) on page 244
- [General Care](#) on page 246
- [Troubleshooting](#) on page 251
- [Further Assistance](#) on page 259

Power Options

Power On

Press the **Power On/Off** button. The printer begins the power-on procedure.

Power Off

- Press the **Power On/Off** button. A confirmation screen appears.
- Select **Power Off** to commence the power off cycle.

If **Power Off** is selected, the printer remains on for approximately

60 seconds before the power is terminated. Any jobs in the job list will be deleted. Ensure that you wait at least 60 seconds before turning on power again.

Note: It is recommended to power off the printer only if a problem occurs or if it is being moved. Use the power save function to conserve energy during periods of inactivity. If the printer is being moved, allow the printer to cool down for 30 minutes before moving it.

WARNING: Use only the power switch to reboot the printer. The printer can get damaged if power is removed by other means.

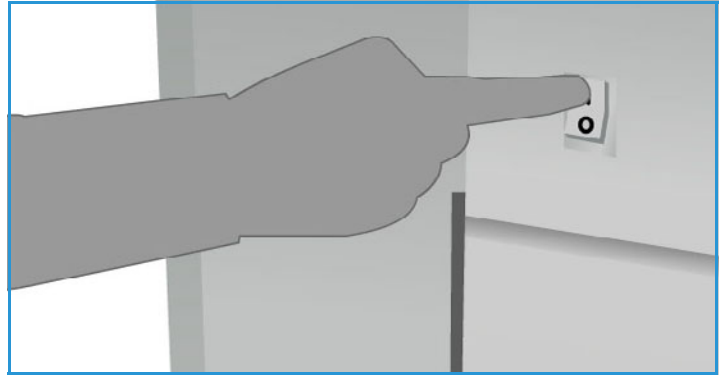

Energy Saver and Quick Restart

The **Power Saver** button on the control panel can be used for additional power functions.

- Press the **Power Saver** button.
The **Power** window appears, showing the options Energy Saver and Quick Restart.
- If **Energy Saver** is selected, the current session ends and keeps the printer running on low power. When in Energy Saver mode, press any key or touch the screen to wake up the printer.
- If **Quick Restart** is selected, the current session ends, the printer restarts, and any jobs in progress are lost. Use this option if you are experiencing any problems with the printer.
- If **Cancel** is selected, the power saver option is canceled and the printer is available for use.
- Select **Close** to exit.

Energy Saver Options

The printer is designed to be energy efficient and automatically reduces its power consumption after periods of inactivity. The system administrator can set up the following **Energy Saver** options.

- **Intelligent Ready:** This option wakes up and sleeps automatically, based on the previous usage. It uses algorithms and data gathered on the usage profile to anticipate periods when the printer is likely to be busy. Using this information, it automatically wakes up the printer.
- **Job Activated:** The printer wakes up when activity is detected.

- **Scheduled:** The printer wakes up and sleeps at set times on a daily basis. It can be set to wake up when activity is detected, or a specific time can be entered.
- **Fast Resume:** The time taken to wake up is reduced. This changes the default sleep/low power timeouts and increases energy usage.

For information about setting up **Energy Saver** options, refer to the *System Administrator Guide*.

General Care

There are a number of maintenance tasks that need to be performed to ensure that the printer performs at optimum levels:

- Replenish solid ink.
- Replace Cleaning Unit.
- Replace Staple Cartridges (Office Finisher/High Volume Finisher only).
- Empty Waste Ink Tray.
- Empty Hole Punch Waste Container (Office Finisher/High Volume Finisher only).
- Print Quality Maintenance.
- Cleaning Tasks.

⚠ CAUTION: When replacing units, DO NOT remove the covers or guards that are fastened with screws. You cannot maintain or service any of the parts that are behind these covers and guards. Do NOT attempt any maintenance procedure that is NOT specifically described in the documentation supplied with your printer.

To place an order for consumables or replacement units, please contact a Xerox representative, providing your company name, product number, and the printer serial number. An option is available within CentreWare Internet Services that allows the printer to contact Xerox automatically to order units when required. Refer to the *System Administrator Guide* for more information.

Note: For information about locating the serial number, please refer to [Further Assistance](#) on page 259.

The printer displays a message on the touch screen when consumables or units require replacing or emptying. For units nearing the end of life, an initial message is displayed to warn you that the unit will shortly require a replacement. An additional message is displayed when a unit requires replacing. Replace the unit when a message instructs you to do so.

Solid ink

Solid ink is added to four receptacles in the ink loader through an access door at the top of the printer. The shape of each ink stick is unique for each color, to prevent inks sticks being loaded into incorrect receptacles. Ink can be added to the ink loader at any time if there is enough room to accommodate the new stick.

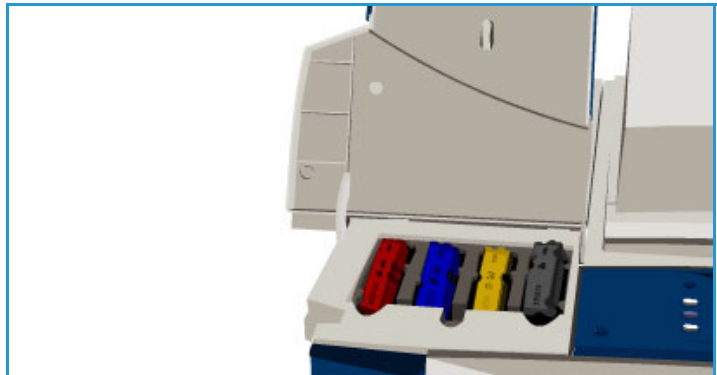

Each ink loader has a low ink sensor that is activated when approximately two usable solid inks are left. The printer stops printing when the ink loader has about one-third of an ink stick remaining of any color. A message notifies you when it is time to order ink, when the ink is low or has run out.

An ink loader cover sensor detects when the ink cover is opened, the touch screen displays the status of the solid inks.

Cleaning Unit

The Cleaning Unit applies a silicone oil release agent to the imaging unit.

⚠ WARNING: SILICON FLUIDS ARE AN EXTREME SLIP HAZARD. In the event of accidental spillage onto floors covered with any surface including carpeting, immediately provide a slip hazard warning and cordon off the area. Do not walk in the contaminated area and avoid any risk of coating the surface of footwear. Do not attempt to mop up the spill with conventional mops and water. This will spread the contamination and may extend the slip hazard outside the immediate contaminated area. Large spills on non-absorbent surfaces should be contained using suitable absorbent material. Following contamination, suitable absorbing material (diatomaceous earth or other silica-based liquid absorbent) should be used to soak the spillage. Clean any residual slippery coating by using a strong detergent/soap solution and apply sand or other inert granular material to improve traction. Dispose of all waste material in accordance with national, local, state or federal regulations that are applicable.

When the Cleaning Unit is nearing end of life, a warning message is displayed informing you to reorder a new unit but not to replace at that time. The warning appears when approximately 13 days' usage is left.

When the Cleaning Unit reaches end of life and must be replaced, another message is displayed. The unit must be changed for the printer to operate.

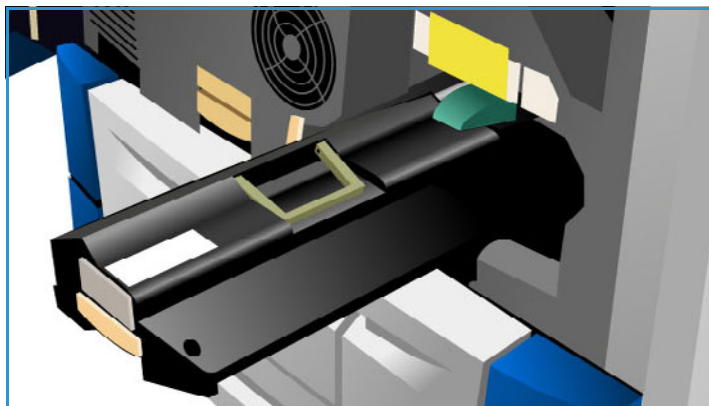

Replace the unit by using the instructions provided on the touch screen and within the packaging of the new unit. Recycle the old unit, as directed on the packaging or per your local Xerox representative.

Note: The warning period can be customized by the system administrator by using **Tools** or CentreWare Internet Services. Refer to [Administration and Accounting](#) on page 195 for more information.

Staple Cartridges

If your printer is equipped with Office Finisher or High Volume Finisher, you will be required to replace the staple cartridge or cartridges when the printer displays a message instructing you to do so.

The staple cartridges for the Office Finisher and the High Volume Finisher contain 5000 staples. The High Volume Finisher with Booklet Maker has two additional staple cartridges located within the Booklet Maker module. Each of these cartridges holds 2000 staples.

Detailed instructions are provided on the touch screen. Follow the instructions and labels provided when replacing the staple cartridge.

Office and High Volume Finisher Staple Cartridge:

1. Open the finisher door.
2. If using the Office Finisher, rotate the staple access handle (a green cog) clockwise until the staple unit is accessible.
3. Unlatch the staple cartridge by using the light-colored catch and remove the used staple cartridge.
4. Dispose of the staple cartridge according to the instructions contained in the new staple cartridge box.

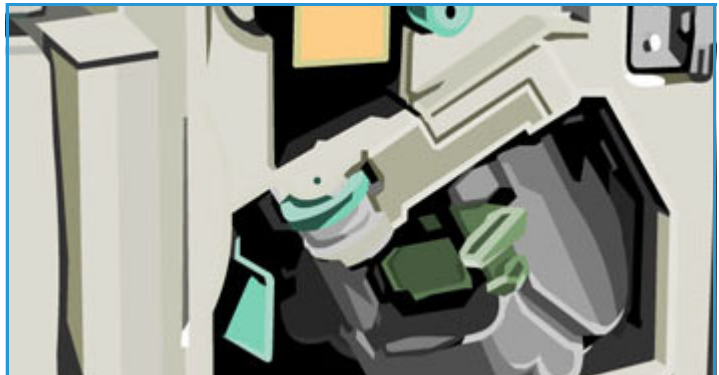

5. Unpack the new staple cartridge and install it into the finisher. The staple cartridge clicks into place.
6. If using the Office Finisher, rotate the staple access handle (the green cog) counterclockwise until it is back in position.
7. Close the finisher door.

High Volume Finisher Booklet Maker Staple Cartridges:

1. Open the finisher door. Pull out the booklet maker module.
2. Lower the lever to gain access to a staple cartridge. Grip the staple cartridge and pull it out of the staple head.
3. Dispose of the staple cartridge according to the instructions contained in the new staple cartridge box.
4. Unpack and install the staple cartridge in the finisher. The staple cartridge clicks into place. Repeat the procedure for the other booklet maker staple cartridge.
5. Push in the booklet maker module and close the finisher door.

Emptying the Waste Ink Tray

The Waste Ink Tray accumulates ink debris resulting from printhead maintenance. You must occasionally empty the Waste Ink Tray. The printer will not work if the waste ink tray is full. The waste ink is non-toxic and can be disposed of through your normal refuse collection.

The printer displays a message when the tray is approximately 80 % full and does not permit the printhead maintenance sequence to begin when the tray is full. The waste tray needs to be emptied approximately four times per year or more, depending on the usage.

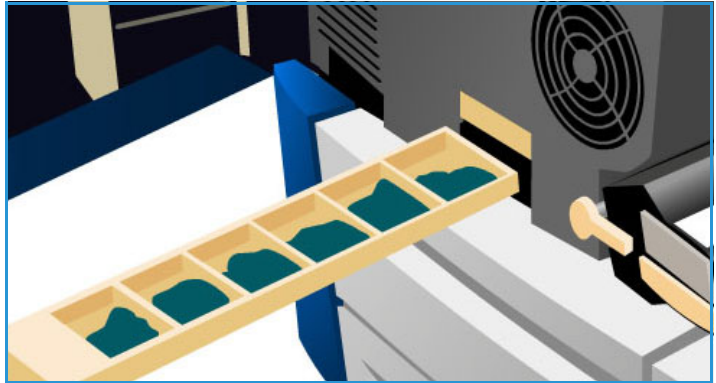

⚠ CAUTION: If you remove the waste ink tray, always empty it before replacing it.

Emptying the Hole Punch Waste Container

The hole punch waste container is a catch tray that collects the waste punched paper. Your printer will prompt you when the hole punch waste container needs emptying.

Detail instructions are provided on the touch screen. Follow the instructions and labels provided when emptying the container.

- Slide the hole punch waste container out of the finisher. Dispose of the waste punched paper in the waste bin.
- Install the emptied hole punch waste container, ensuring that the container is inserted correctly.



Print Quality Maintenance

There are a number of tasks your printer performs automatically to ensure it is running at optimum print quality:

Automatic Print Quality Maintenance

Your printer contains a sub-system that periodically monitors the quality of the image being put on the drum. This system is known as the Ink On Drum (IOD) system. This system will automatically detect and correct a number of parameters in order to maintain optimum print quality.

This maintenance routine is automatic and lasts for approximately 60 seconds. The printer schedules this maintenance during non-use time, that is determined by the Intelligent Ready feature.

Cleaning Pages

If a problem occurs and ink residue remains in the system, the printer will run blank sheets through the paper path to clean the system. This procedure does not require any user intervention, but may take a few minutes to complete. The cleaning pages are directed to the top tray and should be discarded.

There are additional troubleshooting tasks that can be performed to fix image quality problems. Refer to [Image Quality Problems](#) on page 255.

Cleaning Tasks

! WARNING: When cleaning the printer, do NOT use organic or strong chemical solvents or aerosol cleaners. Do NOT pour fluids directly onto any area. Use supplies and cleaning materials only as directed in this documentation. Keep all cleaning materials out of the reach of children.

! WARNING: Do not use pressurized air-spray cleaning aids on or in this equipment. Some pressurized air-spray containers contain explosive mixtures and are not suitable for use in electrical applications. Use of such cleaners can result in a risk of explosion and fire.

Document Glass and Constant Velocity Transport Glass

- Apply Xerox Cleaning Fluid or Xerox Anti-Static Cleaner to a lint-free cloth. Liquid should never be poured directly onto glass.
- Clean the entire glass area.
- Wipe away any residue with a clean cloth or paper towel.

Note: Spots or marks on the glass are reproduced on the prints when copying from the document glass.

Spots on the CVT glass—the strip of glass on the left—show up as streaks on the prints when copying from the document handler.

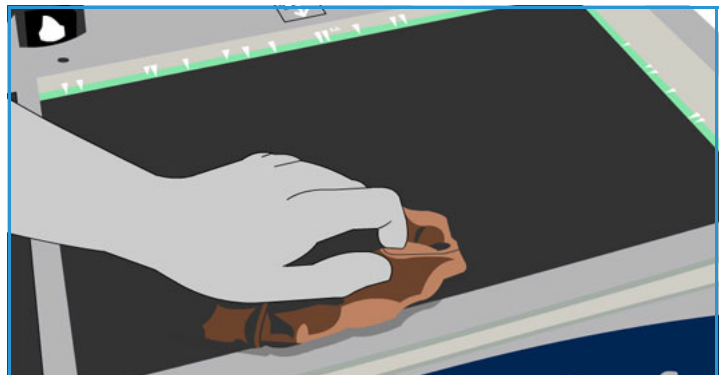

Touch Screen

- Use a soft, lint-free cloth, lightly dampened with water.
- Clean the entire area, including the Touch Screen.
- Remove any residue with a clean cloth or paper towel.

Troubleshooting

Defining the Problem

This section contains problem-solving procedures to help you locate and resolve a problem.

Some problems can be resolved by rebooting your printer. Refer to [Power Options](#) on page 244 for instructions about power procedures.

If rebooting the printer does not resolve the problem, use the instructions contained in this guide to identify and solve the problem. If you still cannot fix the problem, contact the Xerox Support Center for advice.

Faults

There are different categories of faults that can occur on your printer and different ways in that they are identified, depending on the type of fault. This section provides an overview of the different types of faults and the way these faults are displayed and recorded.

Your printer has three fault types, Hard Down faults, Custom Clearable faults, and Status Messages. Within each fault type, there are subgroups of fault categories relating to the effect the fault has on the printer operation. The fault display generated for each fault depends on the category of that fault.

Hard Down Faults

Hard Down faults prevent a subsystem, module, or component from functioning properly. There are three categories of Hard Down faults:

- **Low Level Fault:** This fault occurs when a subsystem or module is unable to function correctly. For example, if during a stapler job, a fault is detected, other features are still functional, but the stapler is unavailable.
- **Failure Fault:** This fault is declared when a low-level fault causes a major subsystem to function incorrectly. For example, a fault occurs with the cleaning unit causing the print and copy features to become non-functional.
- **Fatal Fault:** This fault occurs when an existing system-wide failure is unrecoverable. For example, a power fault occurs causing the printer to be inoperable.

Customer Clearable Faults

A Customer Clearable fault is a fault that can be cleared by the user. There are three categories of Customer Clearable faults:

- **Low-Level Fault:** This occurs when a subsystem detects a customer clearable fault. For example, when a stapler runs out of staples, the print and copy features are still operable, but the stapler function is not.
- **Failure Fault:** This is declared when a Low-Level Fault causes a major subsystem to become unavailable. For example, when a paper misfeed is detected, the print and copy functions are made inoperable until the paper is cleared by the user.
- **Reset Fault:** This can be cleared by powering the printer off and then on.

Status Messages

Status Messages are informal messages that do not impact the printer from functioning properly. There are two categories of Status Messages:

- **Warning Messages** are informational and usually have to do with replacing consumables. The messages warn the local user of impending problems, or actions, that need to be taken to avoid a fault occurrence. For example, if the Cleaning Unit is close to the end of its life, the printer displays a warning message that the unit needs to be replaced soon. At this time, the system sets a predefined limit until a Customer Clearable fault is declared to change the Cleaning Unit.
- **Job Fault Messages** indicate a fault with the job, for example, the required paper is unavailable. If a job is paused because of a fault, the user is required to take action to correct the condition, or to delete the job.

Fault Displays

All faults that affect the users of the printer are presented to the user by one of these two methods:

Interrupting Fault

Interrupting faults are presented if the associated fault affects the entire printer, where the printer is not capable of accepting input or output. They are also presented if the associated fault affects the currently selected document service but does not affect another service that can still be used.

The type of fault screen presented depends on the type of fault occurrence.

Some fault displays present the user with fault recovery options. A series of button selections allows you to choose a fault recovery option.

When an interrupting fault window is displayed, any status messages associated with the displayed fault are presented in the Status Message area.

Non-Interrupting Fault

Non-Interrupting fault displays consist of messages displayed in the Status Message area. They do not affect the successful completion of a job from the current pathway.

For example, if the user is running a Copy job and a fault occurs with fax, then a non-interrupting fault display is presented.

Both Interrupting and Non-Interrupting fault displays are generated automatically by the printer and are displayed in the fault logs. Once the conditions that resulted in the fault display are resolved, the display is removed.

Fault Logs

Fault information can be accessed using the **Machine Status** button.

Machine Status provides information about the printer, the status of the paper trays, consumables, and any current faults. Usage counters are also available.

For information on alerts and faults, select the **Active Messages** tab and select Faults or Alerts from the Faults & Alerts drop-down list on the left side. Each fault can be selected for further information and instructions.

For fault history, select the **Fault History** option on the right side.

Fault History

The Fault History is a log of the last 20 faults occurring on the printer. The fault code associated with each fault and the date and time that the fault occurred are displayed. The Fault History also displays the printer image count at the time each fault occurred and any relevant paper or document size information.

Paper Problems

The printer has designated misfeed clearance areas. If a misfeed occurs, a message and clearance instructions are displayed on the touch screen. There are also labels showing how to clear each area.

When clearing the paper path, ensure all the areas stated are checked and cleared. Before closing the front door, ensure that all handles and levers are returned to their correct position.

If misfeeds persist, or occur intermittently, check the following points:

Handling of Media

For optimum printing results, observe the following when loading paper into the trays:

- Do not use folded or wrinkled paper.
- Do not load paper of varied sizes into the tray.
- Always fan transparencies and shuffle labels before loading. Labels and transparencies can only be loaded into Tray 4 (Bypass).
- Before loading paper into the trays, fan the edges. This procedure separates any sheets of paper that are stuck together and reduces the possibility of misfeeds.

Storing of Media

It is important for optimum printing that paper is stored correctly. Make a note of the following when storing paper:

- Store in ambient room temperature. Damp paper may cause feed problems or poor image quality.
- Do not open paper packages until they are required for use. The wrapper contains an inner lining that protects the paper from moisture.
- Store on a flat surface to avoid folding or curling of paper.
- Stack reams of paper carefully on top of one another to avoid crushing the edges. Do not stack more than five reams on top of each other.

Finishing Problems

The finishing devices can occasionally experience misfeed, stapler, hole punch, or stacking problems. If a problem occurs, message and clearance instructions are displayed on the touch screen. If problems persist or occur intermittently, check the following points:

- Unload the finisher tray frequently.
- Do not remove stapled sets while the finisher is compiling.
- Check that the paper tray guides are locked into position against the paper.
- When using large paper, remove any output contained in the Stacker Tray.
- If the paper curls excessively, flip the paper over in the applicable paper tray.
- Check that the correct paper size has been selected for the paper loaded in the tray.
- To correct stapling problems, use less than 50 sheets of paper if the paper is heavier than 80 g/m² or 20 lb.
- Check that Hole Punch Waste Container is not full. The container collects waste from the hole punch. Refer to [Emptying the Hole Punch Waste Container](#) on page 249 for instructions.

If a stapler problem occurs, use the instructions below to clear the problem:

Office Finisher

- If a problem occurs in the Office Finisher Stapler, remove the staple cartridge and release any misfed staples. Refer to [Staple Cartridges](#) on page 247 for instructions on removing the staple cartridge.
- Remove any partially used staple strips and any staple strips that are not flat.
- Reinstall staple cartridge.

High Volume Finisher

- If a problem occurs in the Finisher Stapler, remove the Staple Cartridge and release any misfed staples. Refer to [Staple Cartridges](#) on page 247 for instructions on removing the staple cartridge.
- If the Staple Cartridge is not at the front of the printer, power the printer **Off** and **On** by using the **On/Off** switch on the side of your printer.
- Remove any partially used staple strips and any staple strips that are not flat.
- Reinstall the Staple Cartridge.

High Volume Finisher Booklet Maker Stapler

- If a problem occurs in the Booklet Maker Staplers, remove both Stapler Cartridges and release any misfed staples. Refer to [Staple Cartridges](#) on page 247 for instructions on removing the staple cartridge.
- Remove any partially used staples from the Stapler Cartridges and Stapler Heads.
- Reinstall Stapler Cartridges.

Automatic Document Feeder Problems

Automatic document feeder misfeeds can occur in the automatic document feeder. The printer has designated automatic document feeder clearance areas. If a misfeed occurs, a message and clearance instructions are displayed on the touch screen. There are also labels showing how to clear each area.

If misfeeds persist or occur intermittently, check the following points:

- Check that the top cover of the automatic document feeder is firmly closed.
- Check your originals. Ensure that your originals are of good quality.
Note: If you have poor quality originals, use the document glass to copy a new set.
- Ensure that the automatic document feeder guides are against the edges of the loaded originals.
- Check that your originals are within specification and that the loaded originals do not cover the maximum fill line on the automatic document feeder guides. Refer to www.xerox.com/paper for specification information.

Image Quality Problems

Additional options for correcting image quality problems are available in **Tools**. They provide various tests to check the functionality of the system and identify performance levels.

- Press the **Machine Status** button.
- Select the **Tools** tab.
- Select **Troubleshooting**. The following troubleshooting options are displayed.

Support Pages

Use this option to print the Troubleshooting Print Quality Page and the Jet Test Pages. The Troubleshooting Print Quality Page provides information about problem solving and the options that can be used to resolve issues. The Jet Test Pages highlight any image quality issues on your printer.

Use the **Print** option to print the pages.

Fix Image Quality

Use this option to fix the image quality problems on your printer. Print a test page and then analyze the output and choose one of the options to fix the problem:

- **Light Lines** fixes unexpected continuous lines of lighter colors or empty stripes visible on the printed output.
- **Smears** fixes streaks, smudges, and ink spots of same or different colors scattered over the printed output.
- **Advanced** provides a list of expert routines. Customer Support may direct you to select this option.

Advanced

Use this option to select a quick or full fix for the light line problems, or fix the problem of ink smears. Select the option required and then select **Fix** when the confirmation screen is displayed.

- **Light Lines (Quick)** corrects Light Lines when detected, until a Full Fix is completed.

- **Light Lines (Full)** performs a maintenance routine when the machine is idle, to fix the light line problem.
- **Ink Smears** is selected to correct any ink smear quality issues.

Problem Statements

If you are experiencing difficulties using your printer, check the suggestions below for problem-solving advice.

Problem	Potential Solution
Dark or colored lines and streaks appear on the output when copying or scanning from the document glass.	<ul style="list-style-type: none"> • Reprint the job. • Make sure the defect is not on the original. • Clean the document glass and the Constant Velocity Transport (CVT) glass. • Fix the image quality problems. Refer to Image Quality Problems on page 255 for instructions.
Dark or colored lines and streaks appear on the output when copying or scanning from the automatic document feeder.	<ul style="list-style-type: none"> • Reprint the job. • Make sure the defect is not on the original. • Clean the document glass and the Constant Velocity Transport (CVT) glass. • Fix the image quality problems. Refer to Image Quality Problems on page 255 for instructions.
Blurry prints are being produced.	<ul style="list-style-type: none"> • Reprint the job. • Fix the image quality problems. Refer to Image Quality Problems on page 255 for instructions.
Printer makes a tearing or ripping noise as paper exits and part of the image may be missing from the page.	<ul style="list-style-type: none"> • Reprint the job. • Fix the image quality problems. Refer to Image Quality Problems on page 255 for instructions.
A skewed or crooked image is produced when copying or scanning from the document glass.	<ul style="list-style-type: none"> • Reprint the job. • Make sure the defect is not on the original.
A skewed or crooked image is produced when copying or scanning from the automatic document feeder and document glass.	<ul style="list-style-type: none"> • Reprint the job. • Make sure the defect is not on the original. • Use originals within specification. Refer to www.xerox.com/paper for specifications information. • Make sure originals are correctly loaded in the automatic document feeder.
Smears and smudges appear on the output when copying or scanning from the document glass or automatic document feeder.	<ul style="list-style-type: none"> • Reprint the job. • Make sure the defect is not on the original. • Clean the document glass and the Constant Velocity Transport (CVT) glass. • Fix the image quality problems. Refer to Image Quality Problems on page 255 for instructions.

Problem	Potential Solution
Smears and smudges appear on the output when printing or copying.	<ul style="list-style-type: none"> • Reprint the job. • Make sure paper is the correct type and size and is properly loaded in the tray. • Make sure you select the 2nd side option in the options if printing Side 2 on pre-printed paper. • Fix the image quality problems. Refer to Image Quality Problems on page 255 for instructions.
Light lines and streaks appear on prints or copies.	<ul style="list-style-type: none"> • Reprint the job. • Fix the image quality problems. Refer to Image Quality Problems on page 255 for instructions.
Background appears on copies.	<ul style="list-style-type: none"> • Reprint the job. • Make sure the automatic document feeder is fully closed when using the document glass. • Enable Auto Suppression for the Background Suppression feature in the Image Quality options.
The image has shifted, or is split, incomplete or scrambled.	<ul style="list-style-type: none"> • Reprint the job.
Steps in horizontal or vertical lines.	<ul style="list-style-type: none"> • Reprint the job. • Fix the image quality problems using the Light Lines (Quick) option. Refer to Image Quality Problems on page 255 for instructions.
Print color is not what was expected.	<ul style="list-style-type: none"> • Reprint the job. • Use a higher-quality print mode. • Select a different color correction from the print driver. • Fix the image quality problems. Refer to Image Quality Problems on page 255 for instructions. • Try using different colors in the document.
Copy color is not what was expected.	<ul style="list-style-type: none"> • Reprint the job. • Use a higher-quality print mode. • Select a different Original Type. • Fix the image quality problems. Refer to Image Quality Problems on page 255 for instructions.
Small white specks or graininess appears on the output.	<ul style="list-style-type: none"> • Reprint the job. • Use a higher-quality print mode. • Print 1-sided rather than 2-sided. • Use a smoother paper.
Missing or weak image on output.	<ul style="list-style-type: none"> • Reprint the job. • Make sure paper is the correct type and size and is properly loaded in the tray.

Problem	Potential Solution
Dots on copies.	<ul style="list-style-type: none"> • Reprint the job. • Make sure the defect is not on the original. • Clean the document glass and the Constant Velocity Transport (CVT) glass.
Marks on the leading edge of paper stack that are in line with the image.	<ul style="list-style-type: none"> • Reprint the job. • Fix the image quality problems. Refer to Image Quality Problems on page 255 for instructions. • Run 20 blank sheets through the printer.
Oil in long-edge feed (LEF) paper edges (at top and bottom) after running long jobs of short-edge feed (SEF).	<ul style="list-style-type: none"> • Reprint the job.
Tray 1 and 2 (or 3) raise failure.	<ul style="list-style-type: none"> • Reprint the job. • Open and close the tray.
Tray 1 and 2 misfeed.	<ul style="list-style-type: none"> • Reprint the job. • Check the tray side guides are tight against the stack of paper. Turn or rotate the stack over if possible (unless using media with a defined paper print side).

Further Assistance

For any additional help, visit our customer website at www.xerox.com/worldcontacts or contact the Xerox Welcome and Technical Customer Support, quoting the printer serial number.

- Press the **Machine Status** button on the control panel.
The **Machine Information** tab is displayed.
- The Technical Customer Support information and the Machine Serial Number are displayed on this screen.

Maintenance Assistant

If a problem occurs requiring further investigation from Xerox, diagnostic information can be sent directly to Xerox by using the Maintenance Assistant option.

- Access the Maintenance Assistant option by selecting the **Machine Status** button.
The Maintenance Assistant button is on the Machine Information tab.
- Select the **Maintenance Assistant** button.
The option to send diagnostic information to Xerox is provided.
- Select the option and follow the screen messages to send the information to Xerox.
This information will assist Xerox in identifying the problem.

Further Assistance