

 esa

bulletin

number 103 - august 2000

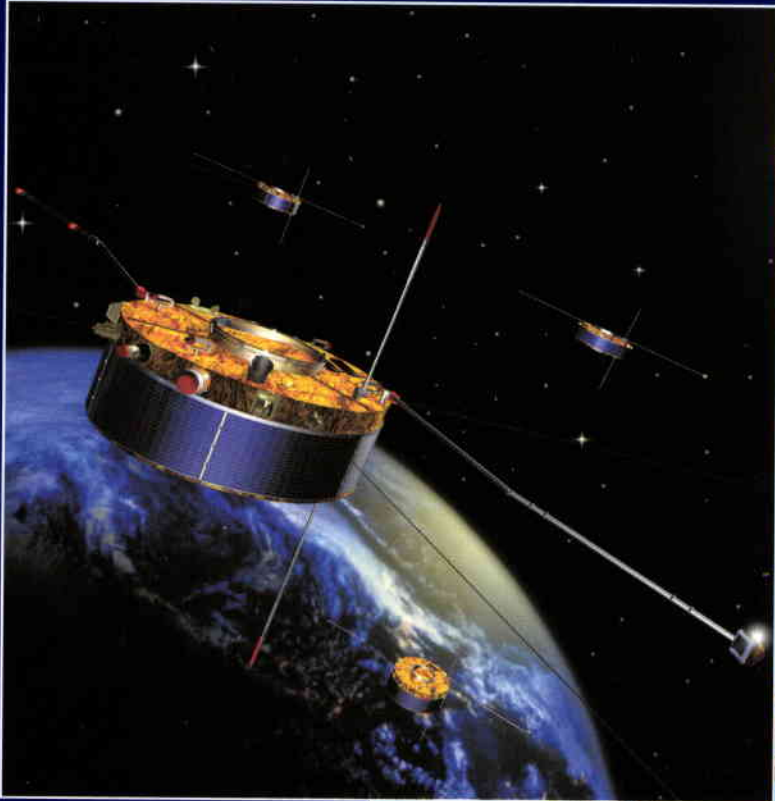

European Space Agency
Agence spatiale européenne



european space agency

The European Space Agency was formed out of, and took over the rights and obligations of, the two earlier European Space Organisations: the European Space Research Organisation (ESRO) and the European Organisation for the Development and Construction of Space Vehicle Launchers (ELDO). The Member States are Austria, Belgium, Denmark, Finland, France, Germany, Ireland, Italy, Netherlands, Norway, Spain, Sweden, Switzerland and the United Kingdom. Canada is a Cooperating State.

In the words of the Convention: The purpose of the Agency shall be to provide for and to promote, for exclusively peaceful purposes, co-operation among European States in space research and technology and their space applications, with a view to their being used for scientific purposes and for operational space applications systems.

- (a) by elaborating and implementing a long-term European space policy, by recommending space objectives to the Member States, and by concerting the policies of the Member States with respect to other national and international organisations and institutions;
- (b) by elaborating and implementing activities and programmes in the space field;
- (c) by co-ordinating the European space programme and national programmes, and by integrating the latter progressively and as completely as possible into the European space programme, in particular as regards the development of applications satellites;
- (d) by elaborating and implementing the industrial policy appropriate to its programme and by recommending a coherent industrial policy to the Member States.

The Agency is directed by a Council composed of representatives of Member States. The Director General is the chief executive of the Agency and its legal representative.

The ESA HEADQUARTERS are in Paris.

The major establishments of ESA are:

THE EUROPEAN SPACE RESEARCH AND TECHNOLOGY CENTRE (ESTEC), Noordwijk, Netherlands.

THE EUROPEAN SPACE OPERATIONS CENTRE (ESOC), Darmstadt, Germany

ESRIN, Frascati, Italy

Chairman of the Council: A. Bensoussan

Director General: A. Rodotà.

agence spatiale européenne

L'Agence Spatiale Européenne est issue des deux Organisations spatiales européennes qui l'ont précédée — l'Organisation européenne de recherches spatiales (CERS) et l'Organisation européenne pour la mise au point et la construction de lanceurs d'engins spatiaux (CECLES) — dont elle a repris les droits et obligations. Les Etats membres en sont: l'Allemagne, l'Autriche, la Belgique, le Danemark, l'Espagne, la Finlande, la France, l'Irlande, l'Italie, la Norvège, les Pays-Bas, le Royaume-Uni, la Suède et la Suisse. Le Canada bénéficie d'un statut d'Etat coopérant.

Selon les termes de la Convention: l'Agence a pour mission d'assurer et de développer, à des fins exclusivement pacifiques, la coopération entre Etats européens dans les domaines de la recherche et de la technologie spatiales et de leurs applications spatiales, en vue de leur utilisation à des fins scientifiques et pour des systèmes spatiaux opérationnels d'applications:

- (a) *en élaborant et en mettant en oeuvre une politique spatiale européenne à long terme, en recommandant aux Etats membres des objectifs en matière spatiale et en concertant les politiques des Etats membres à l'égard d'autres organisations et institutions nationales et internationales;*
- (b) *en élaborant et en mettant en oeuvre des activités et des programmes dans le domaine spatial;*
- (c) *en coordonnant le programme spatial européen et les programmes nationaux, et en intégrant ces derniers progressivement et aussi complètement que possible dans le programme spatial européen, notamment en ce qui concerne le développement de satellites d'applications;*
- (d) *en élaborant et en mettant en oeuvre la politique industrielle appropriée à son programme et en recommandant aux Etats membres une politique industrielle cohérente.*

L'Agence est dirigée par un Conseil, composé de représentants des Etats membres. Le Directeur général est le fonctionnaire exécutif supérieur de l'Agence et la représente dans tous ses actes.

Le SIEGE de l'Agence est à Paris.

Les principaux Etablissements de l'Agence sont:

LE CENTRE EUROPEEN DE RECHERCHE ET DE TECHNOLOGIE SPATIALES (ESTEC), Noordwijk, Pays-Bas.

LE CENTRE EUROPEEN D'OPERATIONS SPATIALES (ESOC), Darmstadt, Allemagne.

ESRIN, Frascati, Italie

Président du Conseil: A. Bensoussan

Directeur général: A. Rodotà.

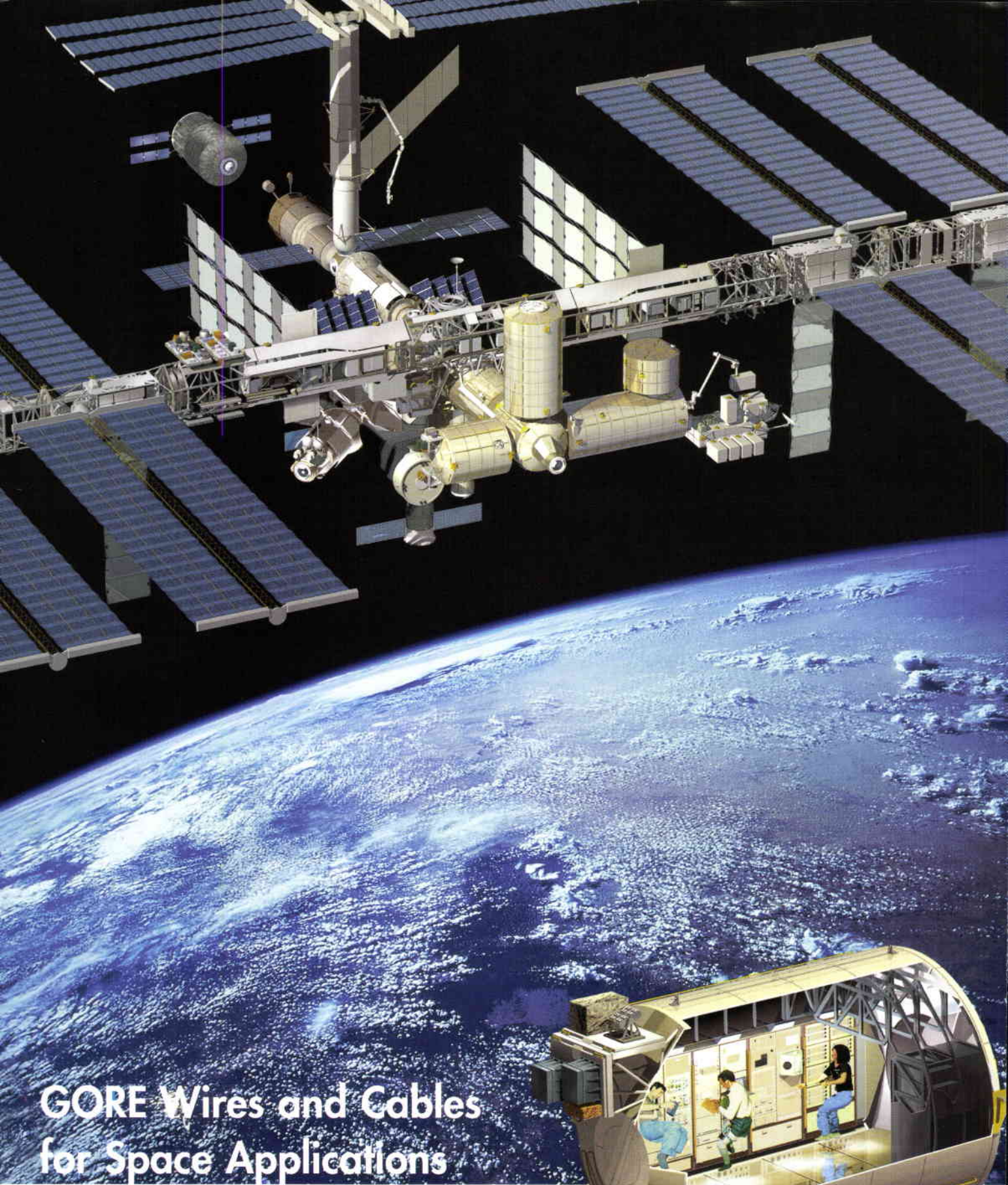

GORE Wires and Cables for Space Applications

Over twenty years of technological experience, Gore has proved competence in space applications for many milestones of space missions, such as Moon Landing, Spacelab, EURECA, ERS1 + 2, Italsat, SAX, SPOT, ISO, Envisat, XMM, Metop, Integral, scientific research in space, Columbus.

As a special cable supplier we support you in planning the next step into space. Call us now.

TEL.:+ 49/91 44/6 01-0 • FAX:+ 49/91 44/60 14 53
W. L. GORE & ASSOCIATES GMBH • NORDRING 1 • D-91785 PLEINFELD / GERMANY



©1999 W. L. GORE & Associates GmbH. Illustrations: David Ducros.

bulletin

contents/sommaire

number 103 - august 2000



Cover: Cluster-II quartet launched; see page 130 of this issue

Editorial/Circulation Office

ESA Publications Division
ESTEC, PO Box 299, Noordwijk
2200 AG The Netherlands
Tel.: (31) 71.5653400

Editor

Bruce Battrick

Layout

Carel Haakman

Graphics

Willem Versteeg

Montage

Paul Berkhout
Isabel Kenny

Advertising

Brigitte Kaldeich

The ESA Bulletin is published by the European Space Agency. Individual articles may be reprinted provided the credit line reads 'Reprinted from ESA Bulletin', plus date of issue. Signed articles reprinted must bear the author's name. Advertisements are accepted in good faith; the Agency accepts no responsibility for their content or claims.

Copyright © 2000 European Space Agency
Printed in the Netherlands ISSN 0376-4265

European Space Agency
Agence spatiale européenne

The Candidate Cornerstone Science Missions:	9
BepiColombo – A Multidisciplinary Mission to a Hot Planet <i>R. Grard, M. Novara & G. Scoon</i>	10
Darwin – The Infrared Space Interferometry Mission <i>C.V.M. Fridlund</i>	20
GAIA – Unravelling the Origin and Evolution of our Galaxy <i>M.A.C. Perryman & O. Pace</i>	26
LISA – Detecting and Observing Gravitational Waves <i>R. Reinhard</i>	36
Ulysses at Solar Maximum and Beyond <i>R.G. Marsden</i>	41
MERIS – A New Generation of Ocean-Colour Sensor onboard Envisat <i>J.-L. Bézy, S. Delwart & M. Rast</i>	48
Hydrological Services: The Need to Integrate Space-Based Information <i>J. Dreher et al.</i>	57
Using Open-Source Software and Low-Cost Computers for Earth-Observation Data Processing <i>M. Önnestam, W. Balzer & M. Curtis</i>	64
IT-Based Quality Management of Earth-Observation Operations at ESRIN <i>W. Lengert, U. Gebelein & G. Lavaux</i>	71
Inflatable Re-Entry Technologies: Flight Demonstration and Future Prospects <i>L. Marraffa et al.</i>	78
Programmatic Risk Management in Space Projects <i>M. Belingheri, D. von Eckardstein & R. Tosellini</i>	86
Ways to the Moon <i>R. Biesbroek & G. Janin</i>	92
Database Administration for Spacecraft Operations – The Integral Experience <i>J. Houser & M. Pecchioli</i>	100
SMP: A Step Towards Model Reuse in Simulation <i>L. Argüello et al.</i>	108
Programmes under Development and Operations	113
Focus Earth: Portugal <i>J. Robalo & J. Lichtenegger</i>	122
In Brief	126
Publications	140

Alcatel Espacio

Your Best Spanish Space Supplier

Main Products

▼ Digital Electronic Equipment

- On-Board Data Handling
- Digital Payload Engineering
- Antenna Pointing Systems



▼ Radiofrequency Equipment

- S-Band TTC Digital Transponders and Transceivers
- S-Band TTC Spread Spectrum Transponders
- S-Band TTC High Power Amplifiers
- L-Band Transmitters
- BPSK/QPSK Modulators
- Filters, Diplexers, Multiplexers, etc.

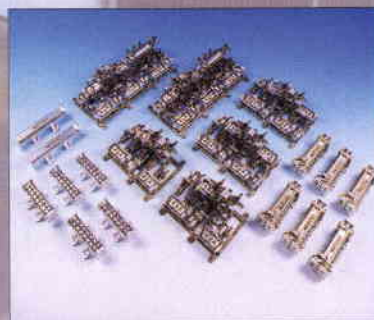

▼ Systems Engineering

- On-Board Processing (OBP)/Multimedia
- Satellites Telecommunication Systems Studies
- Specific Checkout Equipment (SCOE)
- Power Benches



RF Active and Passive, On-Board Data Handling Equipment and Subsystems is our main line of business. We are specialised in the development and manufacture of a few equipment, through partnership with the main space prime contractors.

Our track record includes participation in more than 45 programs satellites.

Alcatel Espacio is a Spanish subsidiary company of Alcatel Space Industries



ARCHITECTS OF AN INTERNET WORLD

Alcatel Espacio, S.A. C/ Einstein, 7. 28760 Tres Cantos (PTM) • Madrid - Spain. Tel. 34 91 807 79 00 - Fax 34 91 807 79 99

www.alcatel.es/espacio/index_i.htm

**Advanced System Engineering & Proven Solutions
for Spacecraft AIT & Ground Infrastructure**

A prime Dutch Aerospace System Engineering, Telecommunication, Simulation, Data Processing & EGSE Solution Provider

**Satellite
SERVICES BV**

Scheepmakerstraat 40
2222 AC Katwijk aan Zee
The Netherlands
Tel: +31-(0)71-402-8120
Fax: +31-(0)71-402-7934

www.satserv.nl
info@satserv.nl

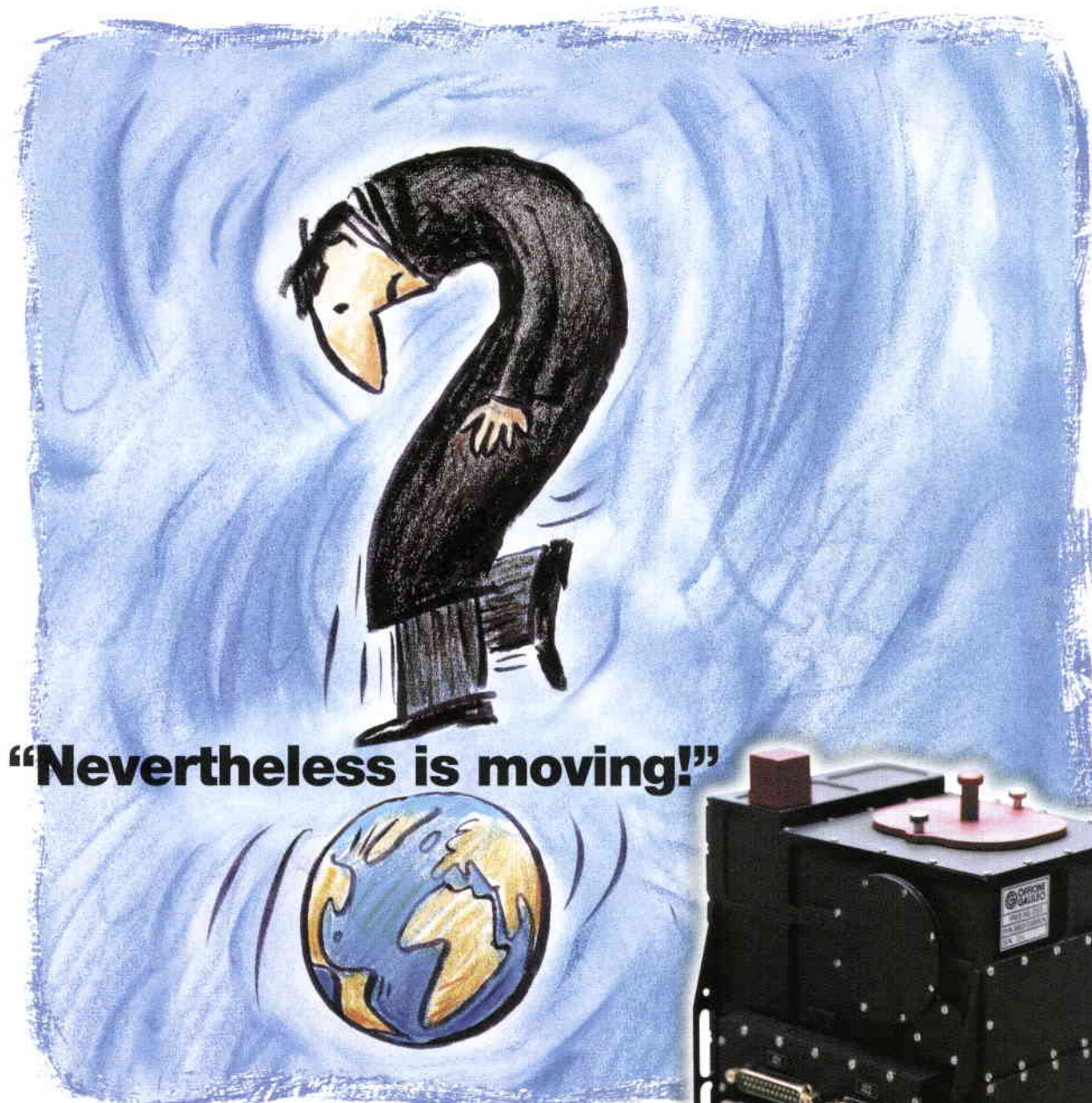

“Nevertheless is moving!”



 **Officine Galileo**
B.U. Spazio

Marketing Communications:
Via Montefeltro, 8
20156 MILANO, Italy
Phone: ++39.0230242.362
Fax: ++39.0230242.052
e-mail: mkt.space@officine-galileo.finmeccanica.it

 **Alenia**

DIFESA
A FINMECCANICA COMPANY

IRES-NE allows geostationary spacecrafts to remain pointed towards Earth, while rotating at 36,000 km altitude.

But Officine Galileo BU Spazio, a world leader in pointing and navigation, can provide you more: a full range of electro-optical attitude sensors is available for communications, remote sensing and scientific applications.

Earth sensors, Sun sensors, Star trackers, autonomous Star trackers, cameras for navigation and robotics.



Charting the way forward with the
**International
Space University**

11-month Master of Space Studies

In Strasbourg, France, with a 3-month professional placement in industry, a government facility or an academic institution in another country.

2-month Summer Sessions

Held in an institution in a different country around the world each year.

2001: 14 July – 15 September at the University of Bremen, Zentrum für angewandte Raumfahrttechnologie und Mikrogravität, Bremen, Germany.

The international, interdisciplinary boost to your career!

Funding available for participants from ESA Member States and Canada!

Apply before: 28 February 2001 (MSS), 31 December 2000 (SSP)

E-mail: admissions@isu.isunet.edu

Annual International Symposium

A different kind of Symposium: space technology in its economic and social context.

2001: Small satellites: bigger business?

21-23 May 2001, Strasbourg, France

E-mail: symposium@isu.isunet.edu

**ISU, Parc d'Innovation, Bd G. d'Andernach, 67400 Illkirch, France
Tel. +33 (0)3 88 65 54 30, Fax. +33 (0)3 88 65 54 47**

Visit the ISU Internet site at: <http://www.isunet.edu/>

Satellite Tool Kit

Better. Faster. Cheaper.

Interplanetary mission design
High-fidelity orbit propagation
3D visualization
Communication link analysis
Navigation and coverage analysis
Orbit determination
Orbit maneuvering
User-definable central bodies
Real-time telemetry interface
Deep space maneuver planning
Collision analysis
Attitude modeling
Planetary ephemerides
Constellation analysis
Formation flying
Integrated land, sea, air & space
Customizable reporting & graphing

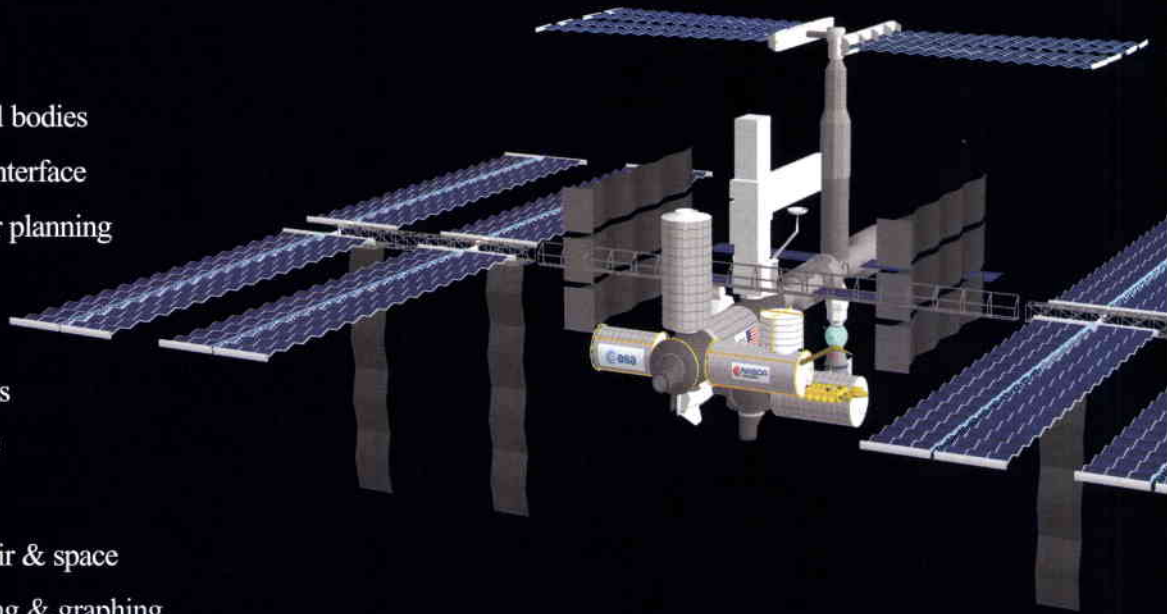

Contact +44 1908 551105 or visit www.stk.com for your free copy of STK®.

ANALYTICAL GRAPHICS, INC.
325 Technology Drive • Malvern, PA 19355
info@stk.com • www.stk.com



Software Solutions for the Aerospace Industry



INTAERO

International STK Resellers
Stoke Goldington, Bucks MK 16 8NY, UK
Tel: +44 1908 551105
Email: info@intaero.com

To power

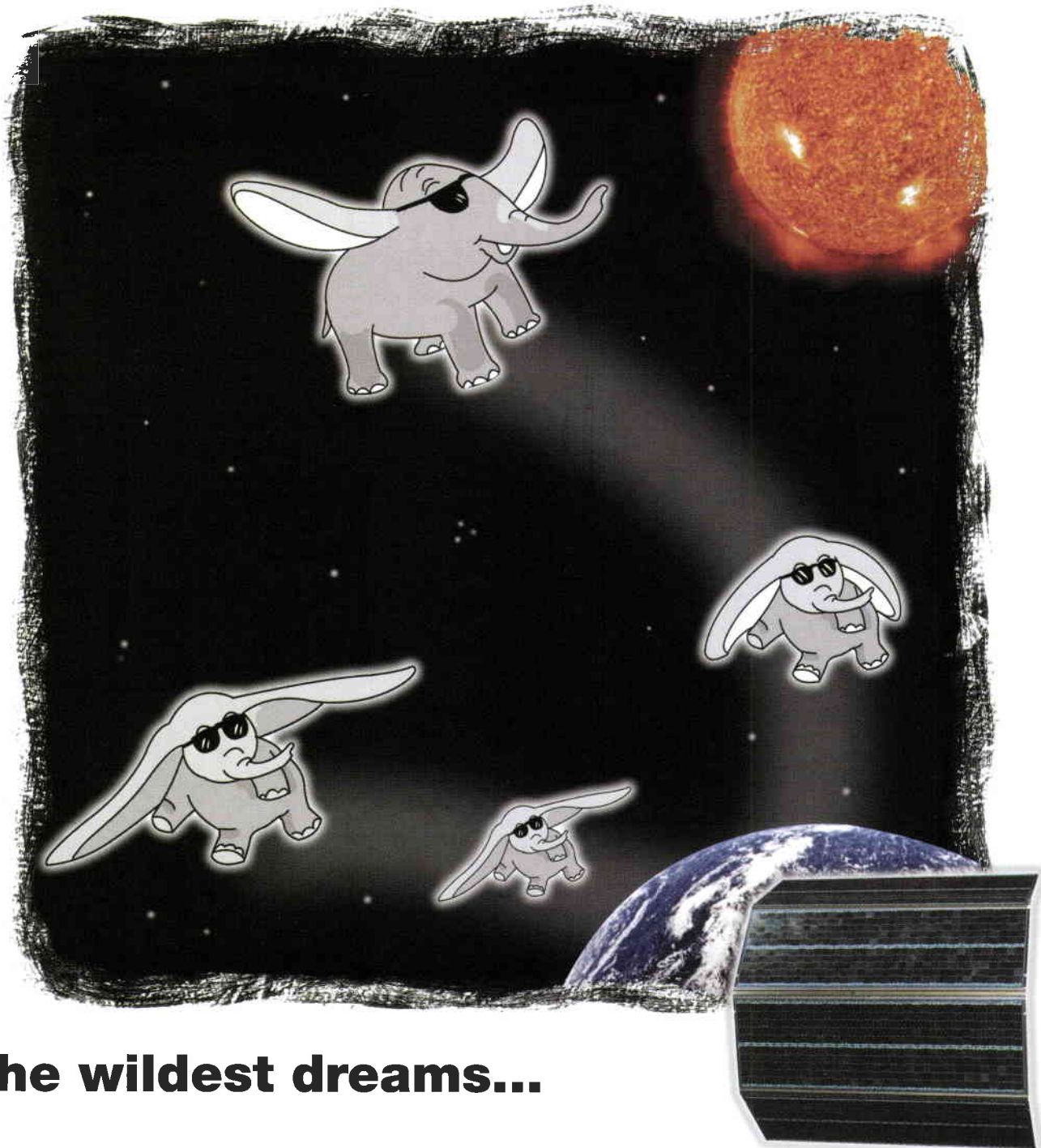

the wildest dreams...



Officine Galileo
B.U. Spazio

Marketing Communications:
Via Montefeltro, 8
20156 MILANO, Italy
Phone: ++39.0230242.362
Fax: ++39.0230242.052
e-mail: mkt.space@officine-galileo.finmeccanica.it



Alenia

DIFESA

A FINMECCANICA COMPANY

... or your most demanding mission, as the Rosetta space probe and RoLand lander on Comet Wirtanen.

From low budget missions to ambitious scientific missions, to power demanding telecommunication spacecraft:

- Photovoltaic Networks
- Solar Panels
- Solar Arrays

SOLUTIONS FOR YOUR DREAMS

The Candidate Cornerstone Science Missions

The first four articles in this issue of the Bulletin describe the 'Cornerstone' missions that are under study in the ESA Science Programme. 'Cornerstones' are defined as being missions that are world-class, scientifically excellent, and require significant new technology development prior to implementation. The four missions presented here



have been under study for some three years to define the mission concepts and technology needs. Two, namely BepiColombo and GAIA, have reached a sufficient point of definition to consider them as candidates for selection as the next Cornerstone mission to be launched in 2009. The other two, Darwin and LISA, still have some way to go in terms of key technology developments before either can be implemented as a full mission. Both, however, are being studied actively and have associated technology-development programmes to prepare for eventual flight projects. Part of this programme includes some pre-cursor flight testing of key



technology items. These will be tested on a dedicated flight in 2006.

The concept of Cornerstones began in 1984 with the inception of the strategic plan for Space Science known as Horizon 2000. In that document, four Cornerstones were identified, namely: the Solar Terrestrial Physics Programme (STP), which included the SOHO and Cluster missions; the XMM X-ray observatory; the Rosetta cometary mission; and the Far-Infrared Space Telescope, FIRST. All of these

missions are either already flying, or will be flown by

2007. Beyond 2007, the next funding opportunity is for a launch in 2009. It is expected that either BepiColombo or GAIA will be selected in October 2000 for this launch date. Further launch opportunities will occur at three- to four-year intervals.

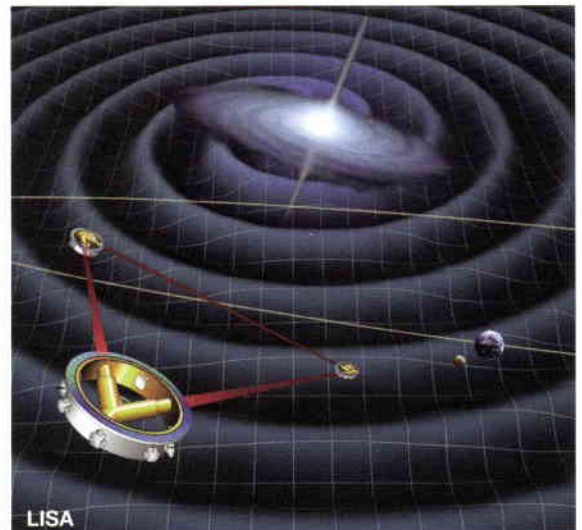

G. Whitcomb
 Head of Science Future Projects and Technology
 ESA Directorate of Scientific Programmes

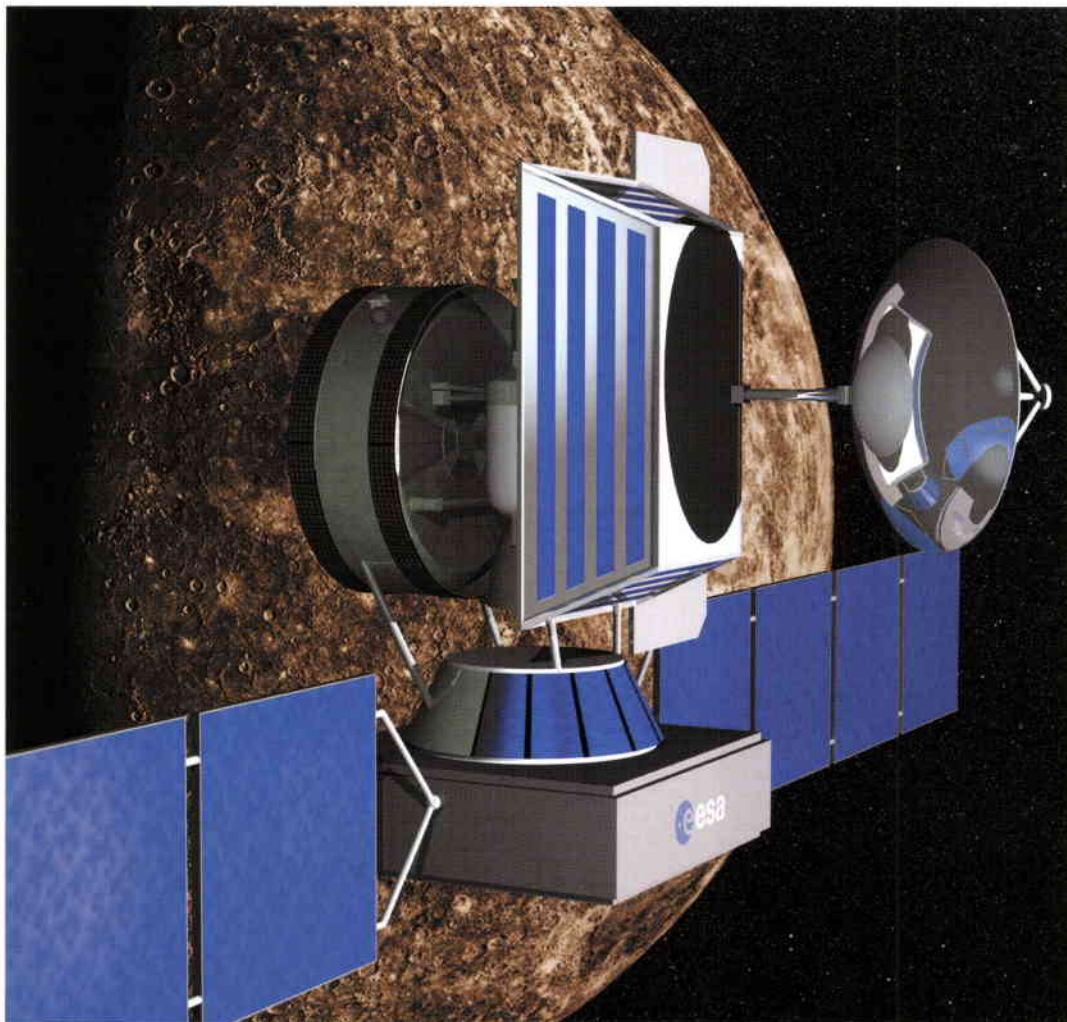

The BepiColombo spacecraft (cruise configuration in the single-launch scenario) superimposed on an image of the planet Mercury collected during the Mariner-10 flyby mission (courtesy of NASA)

Giuseppe Colombo (1920-1984). The ESA Science Programme Committee (SPC) recognised the achievements of the late Giuseppe (Bepi) Colombo of the University of Padua by adopting his name for the Mercury Cornerstone mission. The Italian scientist was a mathematician and engineer of astonishing imagination who

explained Mercury's peculiar habit of rotating three times around itself in every two revolutions around the Sun. He also advised NASA how to place Mariner-10 into an orbit that would enable it to perform three flybys of the planet Mercury in 1974-1975

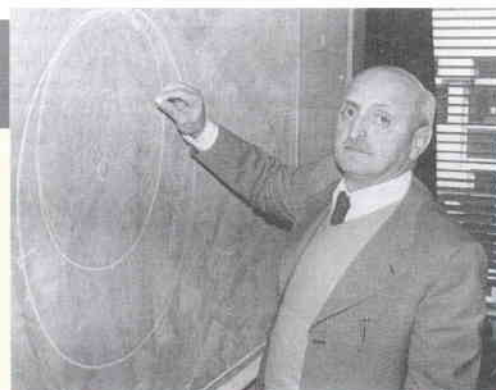

BepiColombo – A Multidisciplinary Mission to a Hot Planet

R. Grard

Space Science Department, ESA Directorate of Scientific Programmes, ESTEC, Noordwijk, The Netherlands

M. Novara and G. Scoon

Science Future Projects and Technology Office, ESA Directorate of Scientific Programmes, ESTEC, Noordwijk, The Netherlands

Introduction

The planet Mercury has a radius of 2440 km and is slightly larger than our Moon. It revolves around the Sun in approximately 88 days and rotates around itself in two-thirds of that time, i.e. 58.6 days. Quite surprisingly, this resonance

means that the same side of the planet faces the Sun every two hermean years. Its orbit is very eccentric and its distance to the Sun varies between 0.308 and 0.466 AU*.

As the inner end-member of the planetary system, Mercury plays an important role in constraining and testing dynamical and compositional theories of planetary formation. With its companions Venus, Earth and Mars, it forms the family of terrestrial planets, a category of celestial object where each member holds information essential for retracing the history of the whole group. For example, knowledge about the origin and evolution of these planets is one of the keys to understanding how conditions to support life have been met in the Solar System and, possibly, elsewhere. This quest is all the more important as terrestrial-like objects orbiting other stars are not accessible; our own environment remains the only laboratory where we can test models that are also applicable to other planetary systems. The exploration of Mercury is therefore of fundamental importance for answering questions of astrophysical and philosophical significance, such as: ‘Are terrestrial bodies a common feature of most planetary systems in the Galaxy?’.

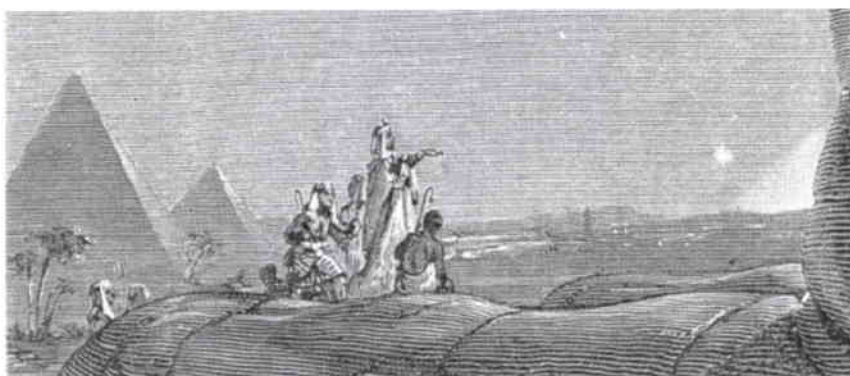

Figure 1. Mercury was already known in ancient Egypt (after an engraving of Régnier Barbant in G. Flammarion, *Astronomie Populaire*, 1881)

Mercury was already known to the ancient Egyptians (Fig. 1), but is still largely unexplored. Its proximity to the Sun makes it a difficult target for ground-based observations and space missions (Fig. 2). Seen from Earth, Mercury's maximum elongation from the Sun is 28°. It is visible for just two hours before sunrise or after sunset, so that Earth-based observations have normally to be performed in front of a strong sky background. Earth-orbiting optical telescopes, such as the Hubble Space Telescope, usually cannot target Mercury either, because of the high potential risk to instruments when pointed so close to the Sun. On the other hand, putting a spacecraft into orbit around Mercury is not a trivial task, because of the

* 1 Astronomical Unit is the average distance from the Earth to the Sun, which is about 150 million km.

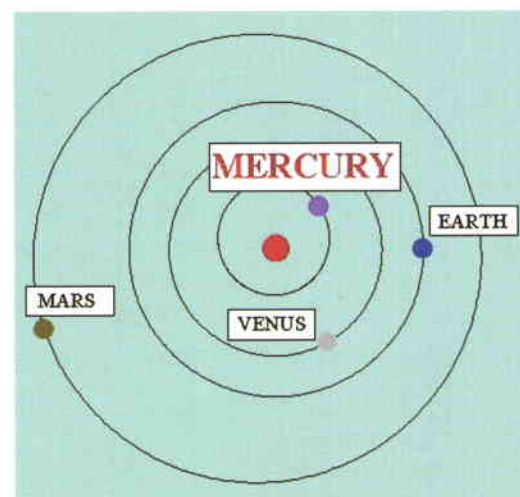

Figure 2. The terrestrial planets: the cradle of life

large difference in the gravitational potentials of the Sun at the orbits of Earth and Mercury. The solar irradiation is about 10 times larger at Mercury and the heat flux is further increased above the dayside because of reflected sunlight and infrared emission, which puts enormous thermal constraints on any orbiter.

Missions to the giant planets and to the small undifferentiated bodies, such as comets and asteroids, provide information on the cold regions of the Solar System. With the Rosetta mission to comet P/Wirtanen, to be launched in 2003 as Cornerstone-3, ESA is conducting a programme that will investigate some of the pristine material found in the outer regions of the heliosphere. Mercury represents the other challenge, since this small and important body will yield complementary data about planetary formation in the hottest part of the proto-solar nebula. Consequently, the Cornerstone mission to Mercury, BepiColombo, appears the logical next step for the Agency's planetary exploration programme.

Einstein explained the advance of Mercury's perihelion (43 arcsec per century) in terms of space-time curvature (Fig. 3). Owing to the proximity of the Sun, a mission to Mercury offers, in addition, unique possibilities for testing general relativity and exploring the limits of other metric theories of gravitation with unprecedented accuracy. The discovery of any violation of general relativity would have profound consequences in theoretical physics and cosmology.

Mercury is also an unrivalled vantage point from which to observe minor bodies with semi-major axes of less than 1 AU, the so-called Atens and Inner-Earth Objects which might possibly impact our planet.

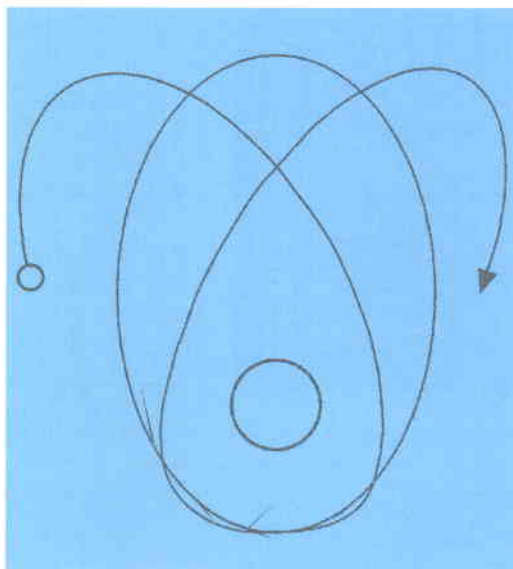

Figure 3. Advance of Mercury's perihelion (schematic only)

In summary, BepiColombo not only covers objectives related to the exploration of the planet and its environment, but also addresses fundamental science and minor-body issues. Some of the questions that form the rationale behind this mission are:

- What is on the unimaged hemisphere of Mercury?
- How did the planet evolve geologically?
- What is the chemical composition of the surface?
- Why is Mercury's density so high?
- What is Mercury's internal structure and is there a liquid outer core?
- What is the origin of the magnetic field?
- How does the planetary magnetic field interact with the solar wind in the absence of any ionosphere?
- Is there any water ice in the polar regions?
- Which volatiles compose the exosphere?
- What new constraints can we set on general relativity and gravitational theories?
- Is the Earth threatened by cosmic impactors?

The space segment of the BepiColombo mission consists of two orbiters and one lander, to fulfil the scientific goals in an optimum way:

- The Mercury Planetary Orbiter (MPO), a three-axis-stabilised and nadir-pointing module, revolves around the planet at a relatively low altitude and is dedicated to planet-wide remote sensing and radio science.
- The Mercury Magnetospheric Orbiter (MMO), a spinner in a relatively eccentric orbit, accommodates mostly the field, wave and particle instruments.
- The Mercury Surface Element (MSE), a lander module, performs in-situ ground-truth physical, optical, chemical and mineralogical observations, which serve as references for the remote-sensing measurements.

The method selected for transporting the spacecraft elements to their destinations is the result of a trade-off between mission cost and launch flexibility. It combines electrical propulsion, chemical propulsion and gravity assists. The interplanetary transfer is performed by a Solar Electric Propulsion Module (SEPM), which is jettisoned upon arrival. The orbit injection manoeuvres are then realised with a Chemical Propulsion Module (CPM), which is also jettisoned once deployment of the spacecraft elements is completed. The spacecraft concept is modular and lends itself to a large variety of schemes. Two specific scenarios have been studied:

- a single-launch scenario, in which the three spacecraft elements and the two propulsion modules are injected together into an interplanetary orbit with a large rocket, such as an Ariane-5

- a dual-launch scenario, in which the spacecraft is divided into two composites with nearly identical propulsion elements, which are launched separately with smaller rockets, such as a Soyuz-Fregat.

The two approaches have been shown to be feasible and compatible with the given mission objectives and scientific instrumentation. They also provide flexibility and offer alternative routes with different schedules and funding scenarios.

Rationale

What is on the unimaged hemisphere of Mercury?

Mariner-10 returned images of less than half of the planet (Fig. 4). This first question is therefore pragmatic and reflects the curiosity of both the layman and the scientist. Our knowledge of the topography of Mercury, in terms of global coverage and spatial resolution, reminds us of that of the Moon in the Sixties, which was derived from Earth-based telescopic observations. The images of Mariner-10 show a cratered and lunar-like landscape, but with many different characteristics, indicating the different evolutions of the two bodies. As for the Moon, the unknown hemisphere might prove quite different from the known side; for example, ground-based radar observations suggest the presence of a gigantic dome on the unseen hemisphere.

How did the planet evolve geologically?

The surface of Mercury has been shaped by various exogenic (bombardment) and endogenic (volcanic) processes. The major impacts occurred before the end of the accretionary period and the age of the surface generally exceeds 3.5 Ga*. The collisional

* One giga-annum (Ga) is equivalent to one thousand million years

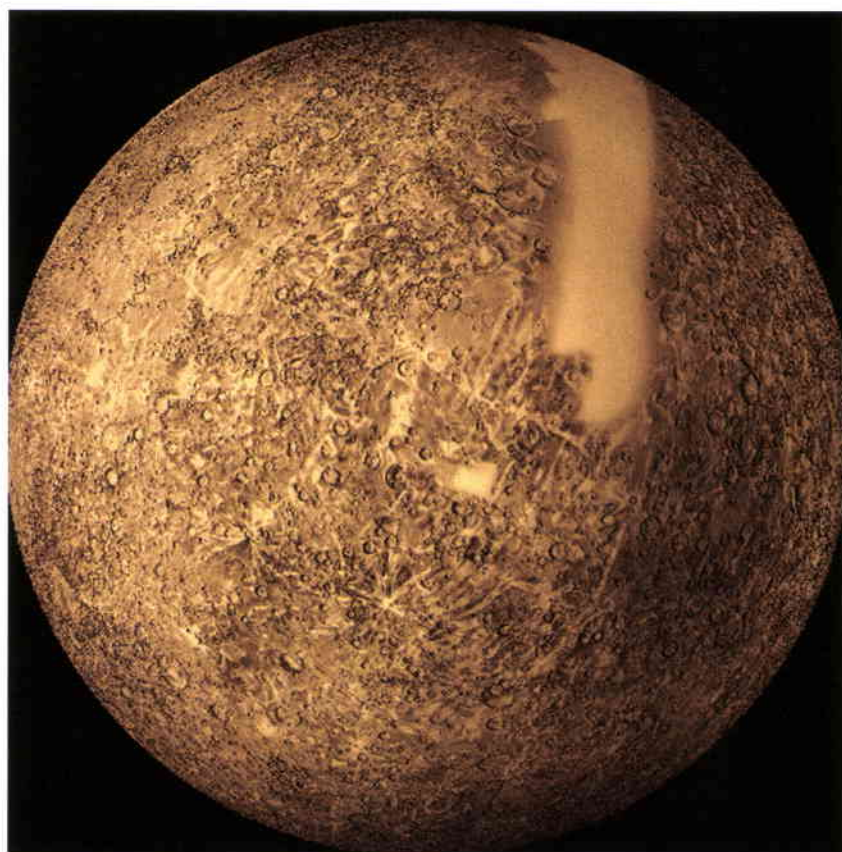

Figure 4. Hemisphere of Mercury imaged by Mariner-10 (courtesy of NASA: no data available in blank areas)

energies were relatively more important on Mercury than on any other terrestrial planet, because of the lack of an atmosphere and the larger relative velocities between impactor and target (Fig. 5). Inter-crater plains have been formed before the end of the heavy bombardment, 4 Ga ago, but it is not known whether these features are associated with volcanic activity or widespread basin ejecta. Mercury may still be tectonically active now; the relaxation of the equatorial bulge, the contraction due to the cooling of the mantle and the tidal stresses caused by a highly eccentric orbit, have induced scarps, faults and lineaments, which bear evidence of these processes. A systematic investigation of the



Figure 5. Caloris basin (1300 km in diameter), the curved features of which were formed when a giant projectile hit Mercury 3.9 Ga ago. Many small craters are superimposed on the sunlit part; the rest of the basin is in shadow. Strange lineaments extending outwards can be traced to the opposite side of the planet (courtesy of NASA)

geologic evolution of Mercury will require the global imaging of the surface, as well as data on topography, core and crust densities, mascons and gravity anomalies.

What is the chemical composition of the surface?

The mineralogical and elemental composition mapping of the surface provides the means of distinguishing between various models of the origin and evolution of the planet. The iron-oxide content of silicates, for example, is one indicator of the condensation temperature of the solar nebula during the accretion of the planet. The concentration ratio of key elements such as potassium, uranium and thorium also reflects the temperature of the feeding zone where the body was accreted.

Why is Mercury's density so high?

The density of Mercury does not line up with those of the other terrestrial planets, including the Moon (Fig. 6); when corrected for compression due to size, it is the largest of all. Several scenarios have been proposed to explain this anomaly:

- (a) The iron concentration was larger in the feeding zone where the planet accreted.
- (b) Oxides were reduced to metallic form due to the proximity of the Sun.
- (c) The temperature of the young Sun was sufficient to sublimate and blow off silicates, thereby leaving only materials with higher condensation temperatures.
- (d) The initial composition of the planet has been significantly altered by gigantic impacts, which may have removed a substantial part of the mantle.

What is Mercury's internal structure and is there a liquid outer core?

The high density also suggests a relatively large iron core in which 70 to 80% of the planetary mass is concentrated, and implies a low

moment of inertia factor. The very existence of a molten outer core is a challenge because such a small planet should have frozen out early in its history. A small concentration of sulphur (1 to 5%) could, however, account for the molten shell, because this element would depress the freezing point of the core alloy.

Knowledge of global shape, gravity field and rotational state are required to estimate the radius and the mass of the core. For example, the amplitude of the 88-day libration in longitude, which is influenced by the orbit eccentricity, is small for a rigid body and increases significantly when the surface layer (crust and mantle) is decoupled from the solid inner core by a molten shell.

What is the origin of the magnetic field?

The previous issue is all the more important as it is directly related to the existence of the magnetic field, one of the most remarkable discoveries of Mariner-10 (Fig. 7). The field is weak, a few 100 nT at the equator equivalent to about one hundredth of that of the Earth, and could be generated by an internal hydromagnetic dynamo driven by a liquid shell, perhaps 500 km thick, in the outer core. While it is possible to produce thermal and compositional models compatible with a planetary dynamo, we must also account for the absence of substantial magnetic fields at Venus and Mars.

A detailed mapping of the magnetic field will provide the necessary constraints on the structure and mechanism of the internal dynamo.

How does the planetary magnetic field interact with the solar wind in the absence of any ionosphere?

Much can be learned from a comparative study of the magnetospheres of Earth and Mercury, due to their vastly different volumes and boundary conditions. The size of the hermean magnetosphere is only 5% of that of the Earth, although the planetary radii differ by less than a factor of 3 (Fig. 8). The magnetosphere of Mercury is exposed to a solar-wind density and an interplanetary magnetic field (IMF) which are 4 to 9 times larger than at 1 AU. The absence of an ionosphere and the massive emission of photoelectrons on the dayside poses interesting problems regarding the closure of the magnetospheric currents, the topology of which might differ significantly from that observed at the Earth.

If magnetospheric substorms occur, are they triggered by IMF reversals or internal instabilities? Are they waves at the electron gyro frequency similar to the auroral kilometric radiation emitted from the Earth? Is the

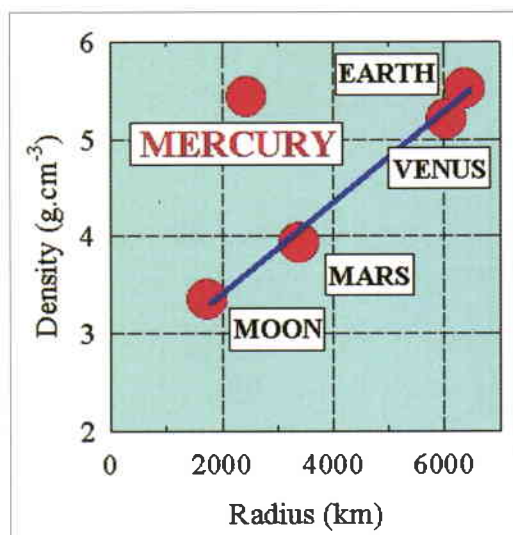

Figure 6. Absolute densities of the terrestrial planets and the Moon

planetary magnetic field perturbed by a ring current associated with possible radiation belts? How are field-line resonances, if they occur, affected by the reflection properties of the surface? Magnetic-field, wave and particle observations will tell us whether phenomena reminiscent of the Earth's environment also take place in the magnetosphere of Mercury.

Is there any water ice in the polar regions?

Mercury is a world of extremes. The surface temperature at the sub-solar point reaches 700 K (427°C), 100°C above the melting point of lead, but it can be as low as 100 K (-173°C) in shadowed areas. New observations from the ground have added new questions to the long list left open by Mariner-10. A major discovery was made by radar observations in 1992. The possibility that water ice or, more prosaically, sulphur may be present in permanently shadowed craters near the poles, deposited there by meteorites or diffused and trapped from the planet's crust, is potentially important for the study of surface processes.

Which volatiles compose the exosphere of Mercury?

Mercury has no stable atmosphere; the gaseous environment of the planet is best described as an exosphere, i.e. a medium so rarefied that its neutral constituents never collide. The existence of five elements – O, H, Ne, Na and K – has been established by Mariner-10 and by ground-based observations. Other elements, contributed by the regolith, and possible ices near the poles may be detected using UV spectroscopic observations of the limb. Production mechanisms include solar photo-

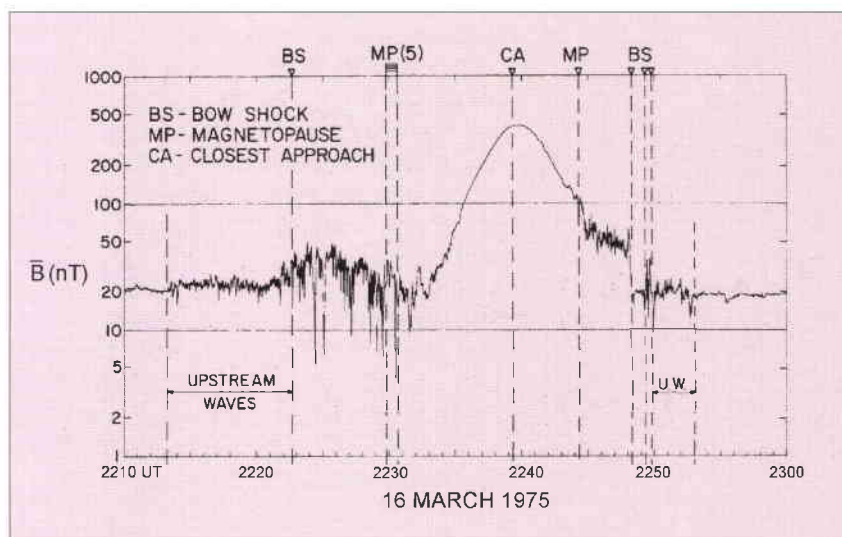

Figure 7. Modulus of Mercury's magnetic field (in nanotesla) measured during the third flyby of Mariner-10 (after Ness et al., *J. Geophys. Res.* 80: 2708, 1975)

and ion sputtering, and impact vaporisation by in-falling micrometeorites. Study of the exosphere will therefore provide another clue as to the chemical composition of the surface.

Can we take advantage of the proximity of the Sun to test general relativity with improved accuracy?

A Mercury orbiter offers a unique opportunity to test general relativity and alternative theories of gravity. Classical tests can be repeated with improved accuracy and new experiments based upon different observable quantities can be performed due to the proximity of the Sun, the high eccentricity of Mercury's orbit and frequent solar occultations. The classical tests rely upon the precession of the perihelion of Mercury, the deflection of radio waves by the Sun, and the time delay of radio signals. The accurate orbital determination required by

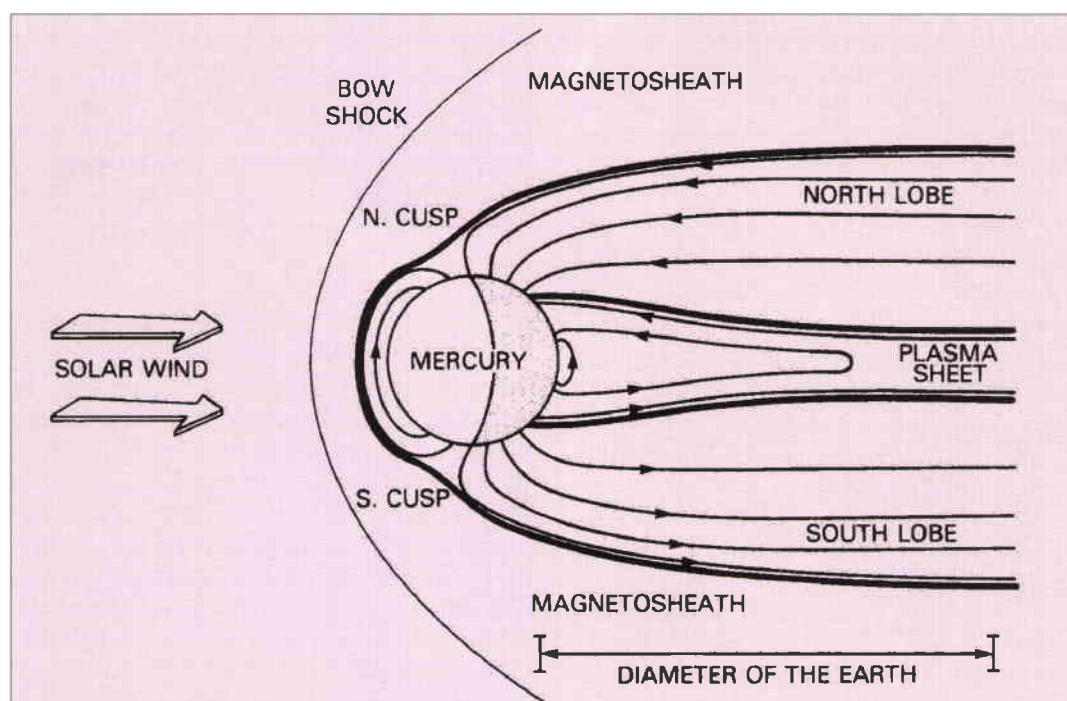

Figure 8. The magnetosphere of Mercury (from Slavin et al., *Planet. Space Sci.* 45: 133, 1997)

these measurements also yields the quadrupole moment of the Sun and the time derivative of the gravitational 'constant'. All of these experiments require precision spacecraft tracking, a good solution for the gravity field of Mercury, and accurate measurement of non-gravitational accelerations, in particular the radiation pressure.

The importance of the tests of general relativity could indeed justify a fully dedicated Mercury orbiter, but BepiColombo combines these objectives with others pertinent to planetary and magnetospheric physics in a truly multi-disciplinary mission.

Is the Earth threatened by cosmic impactors?

A mere 65 million years ago, an impact created the Chicxulub crater in Mexico and wiped out 70% of the Earth's living species, including the dinosaurs. It is believed that there are many Near-Earth Objects (NEOs) with small aphelia, or whose orbits lie entirely within that of the Earth (IEOs), which have never been detected. BepiColombo has the potential to observe such objects at distances from the Sun as small as 0.4 AU.

Launch configuration and mission design

The scientific payload is a combination of high-priority instruments and forms a representative model that addresses the scientific objectives of BepiColombo. These instruments do not necessarily constitute the final payload, but they provide a set of realistic requirements for the system design, mission analysis, data links and flight operations.

The planetary and magnetospheric instruments have very specific requirements in terms of orbit, attitude and electromagnetic cleanliness. They are therefore carried by two different spacecraft elements: MPO (Mercury Planetary Orbiter) and MMO (Mercury Magnetospheric Orbiter).

The main requirements of the orbiters and those of MSE (Mercury Surface Element) are compared in Table 1. The orbits are polar in order to ensure global coverage of the planet. The data volume of MPO is about 10 times that

of MMO because Ka-band rather than X-band telemetry is required to fulfil the imaging requirements. The MSE data are relayed by one of the two orbiters; the largest data volume is achieved with MPO, which has an orbital period four times smaller than that of MMO and therefore offers more opportunities for telemetry links with MSE.

A mass of 1000-1200 kg must be placed in orbit around Mercury to fulfil the mission objectives. The elements of the spacecraft composite can either be launched together on one large rocket (Ariane-5) from Kourou, or separately on several smaller rockets (Soyuz-Starsem) from Baikonur.

In the single-launch approach, the spacecraft composite consists of MPO, MMO and MSE; the wet mass of the total system (SEPM and CPM included) is 2500-2800 kg at launch. In the dual-mission scenario, MPO and the MMO-MSE composite are launched separately with their own electric and chemical propulsion modules, the overall system masses at launch both being close to 1500 kg.

An artist's impression of the single-launch cruise configuration (height 5.1 m; wing span up to 32.8 m) is shown in the frontispiece. The split configurations are illustrated in Figures 9a,b, which show MMO on top of MSE and MPO, respectively. The split-spacecraft elements are designed for a dual launch on a Starsem-Soyuz, but are also compatible with a single Ariane-5 launch, using the Speltra adapter.

Combining electrical propulsion with Venus, Mercury and even Moon gravity assists provides mission flexibility and short cruise times of 2.6 to 3.6 years, against 6 years or more for entirely ballistic flights, which constitute back-up options. Electrical propulsion is therefore considered as a baseline (Table 2); launch windows at intervals of 1.6 years, the synodic period of Venus, offer optimal conditions for the first gravity assist from this planet.

Depending upon the size of the spacecraft composite, SEPM is equipped with a solar array delivering 6 to 10 kW of power at 1 AU and 3 or 5 engines having individual nominal thrusts of 0.2 N, which provides for recovery strategies in the event of single, or even double, thruster failures. NASA has successfully tested electrical propulsion with the DS1 mission and ESA will launch SMART-1 in late 2002 to validate all aspects of a mission associating this technique with gravity assists.

The Mercury capture manoeuvres are executed

Table 1. Requirements summary

Spacecraft Element	MPO	MMO	MSE
Stabilisation	3-axis	Spin	NA
Altitude/latitude	400 km x 1500 km	400 km x 12000 km	± 85 °
Payload mass	> 50 kg	> 25 kg	~ 6 kg
Data volume	1550 Gb/yr	160 Gb/yr	75-138 Mb/week
Equivalent bit rate	50 kb/s	5 kb/s	128-228 b/s
Nominal lifetime	> 1 yr	> 1 yr	> 1 week

with CPM, which can also be used earlier during the transit for a partial recovery of the mission in the event of total SEPM failure. The chemical module is a bi-propellant system with a 400 N main engine and eight 20 N thrusters for attitude control during the cruise.

Figure 10 shows one of many possible interplanetary trajectories. In the single-launch scenario, MMO is first placed in its Mercury orbit with CPM; a second burn lowers the apoapsis to an altitude of 1500 km as required for MPO. In the split-launch scenario, a similar approach is used to insert MMO and MPO independently into their nominal orbits (Fig. 11). The pericentre of the two orbits is in the antisolar direction when Mercury is at perihelion to minimise thermal constraints; the ratio of the orbital periods is an integer (4:1), so that a back-up telemetry relay configuration can be implemented around periapsis if the two spacecraft are operated simultaneously. MSE is delivered from the MPO or MMO orbit to its destination on the surface of the planet, at a latitude of $\pm 85^\circ$ near the terminator, where the environmental conditions are less severe.

Spacecraft composite

Planetary Orbiter

The Planetary Orbiter configuration is driven by scientific requirements as well as thermal constraints (Fig. 12). It has the shape of a truncated pyramid; the apertures of the remote-sensing instruments are located on the base and point constantly along the nadir direction; the antenna is mounted on an articulated arm attached to the opposite side and has a diameter of 1.5 m. The radiator is never illuminated by the Sun and is protected from the planet IR flux by a shield; the three other sides are covered with solar cells, which deliver 420 W. The mass of MPO is 360 kg.

An imager system performs a global mapping of the surface at better than 200 m resolution and explores selected areas (up to 5% of the total surface) at better than 20 m resolution; the orbital period of 2.3 h provides for a suitable shift in ground track between successive orbits. An IR spectrometer has a range that covers the absorption bands of most minerals, and its spatial resolution varies from 150 m to 1.25 km. A UV spectrometer observes the limb airglow by means of an articulated mirror and identifies the constituents of the exosphere through their emission lines. A geochemistry package yields the surface concentrations of various elements and searches for polar water deposits.

A radio-science experiment (RAD) investigates the rotation state (libration), global gravity field and gravity anomalies (mascons) of the planet

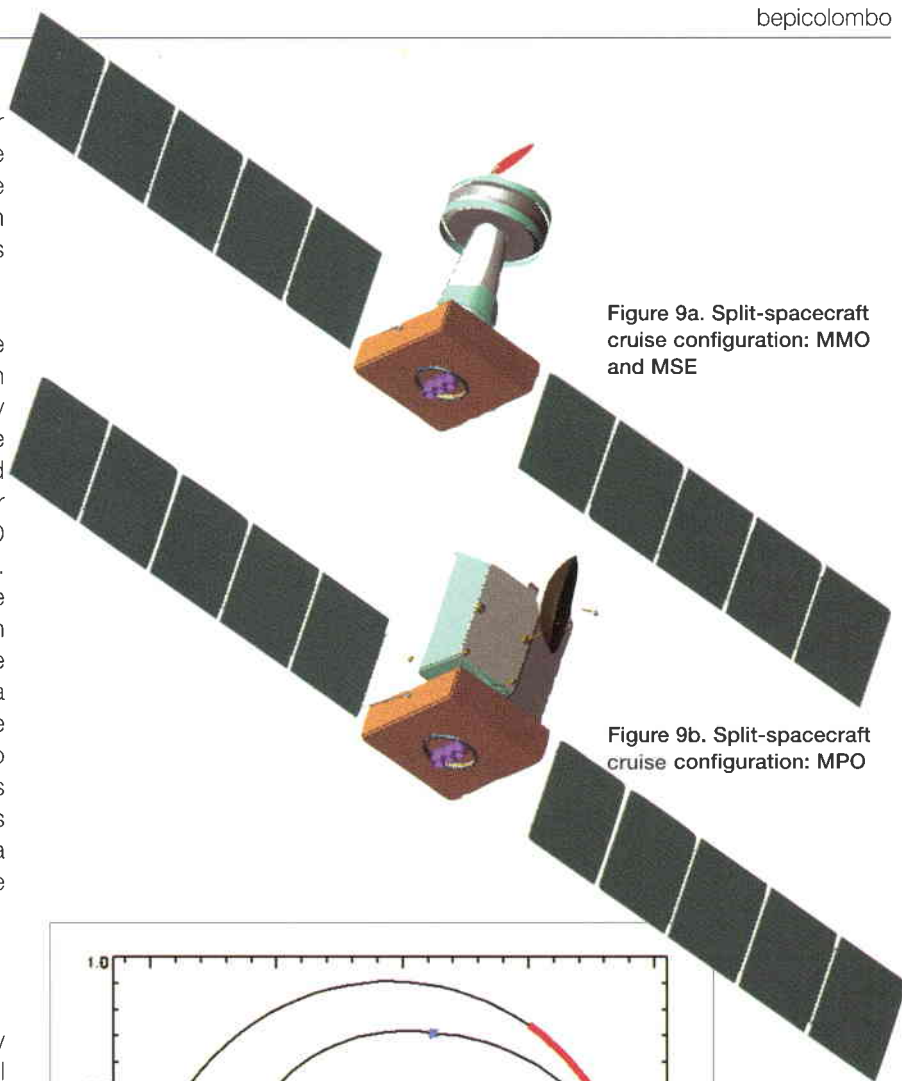

Figure 9a. Split-spacecraft cruise configuration: MMO and MSE

Figure 9b. Split-spacecraft cruise configuration: MPO

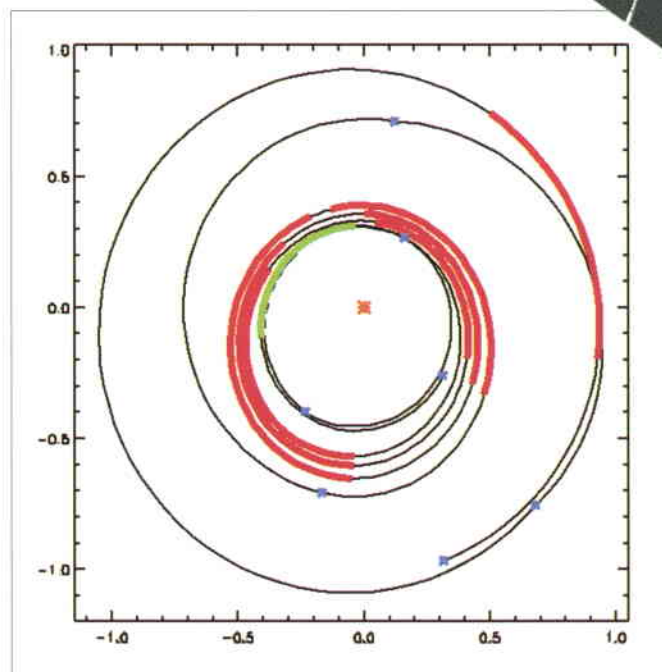

Figure 10. Ecliptic projection of the trajectory from Earth to Mercury for a launch in 2009 (the SEPM thrust is parallel or antiparallel to the direction of motion along the green and red arcs, respectively; planetary flybys are indicated by stars)

Table 2. Mission opportunities with Ariane-5 and Starsem-Soyuz

Date	Launcher	Mass margin*	Cruise time (yr)
2009/01	Ariane-5	41 %	2.6
2008/01	Starsem-Soyuz**	24 %	3.6
2009/07	Starsem-Soyuz**	22 %	3.3

* with ion thrusters

** with lunar flyby

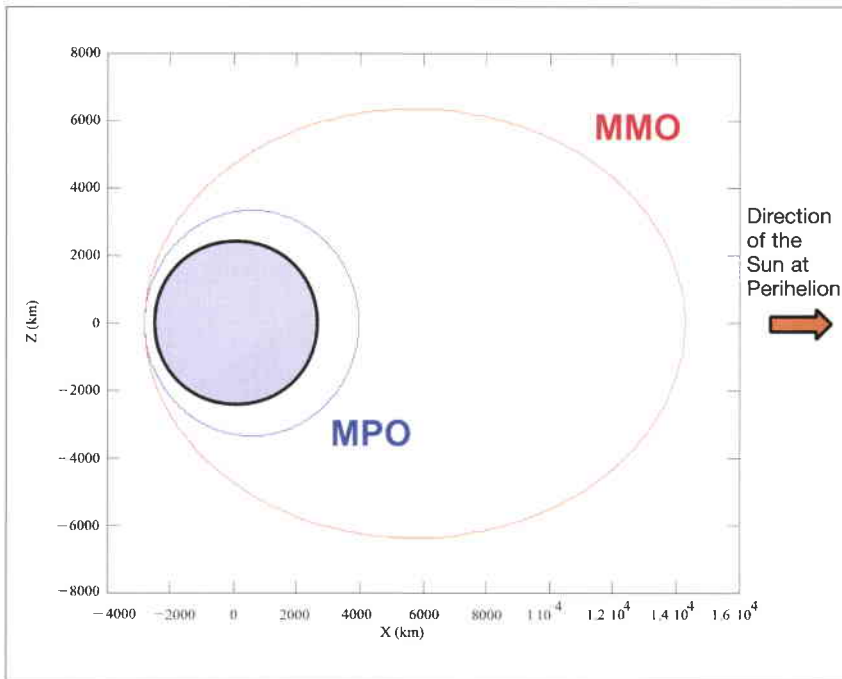

Figure 11. The nominal orbits of MMO and MPO around Mercury

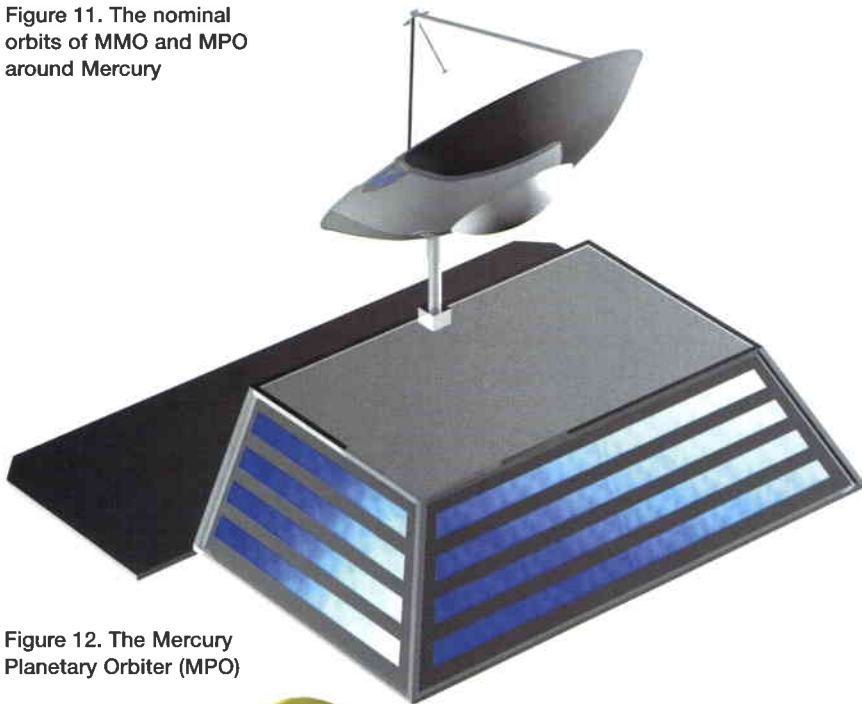

Figure 12. The Mercury Planetary Orbiter (MPO)

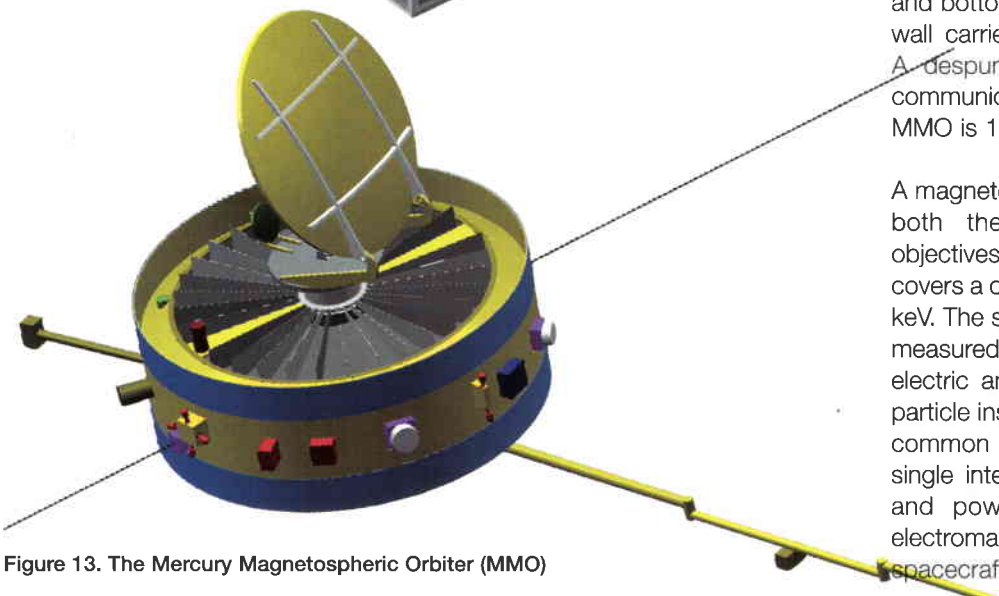

Figure 13. The Mercury Magnetospheric Orbiter (MMO)

to constrain its internal structure and the physical state of its core; RAD observes the motion of Mercury around the Sun and studies the propagation of electromagnetic waves between Mercury and the Earth to solve for fundamental quantities such as the oblateness of the Sun, J_2 , the general relativity parameters, β , γ and η , and the time derivative of the gravitational 'constant' G , with unprecedented accuracy. RAD is a complex experiment which combines the measurements performed with a dedicated radio transponder, an accelerometer, a high-resolution imager and a star tracker.

A laser altimeter is also considered as a desirable addition to the payload, because topographic measurements with a resolution of a few 10 m are required for the evaluation of the gravimetry data.

A small telescope with an aperture of 20 cm can be dedicated to the observation of NEOs with few additional constraints on spacecraft resources and operation. Owing to the unique location of Mercury, it is believed that, in order to fulfil similar objectives from an Earth orbit, one would require an instrument with the capability of detecting objects with magnitudes of the order of 20-21 and pointing at angles of less than 20 deg from the Sun.

Magnetospheric Orbiter

The Magnetospheric Orbiter is spin-stabilised at 15 rpm about an axis perpendicular to Mercury's equator, which facilitates the deployment of a wire antenna and the azimuthal scan of the particle detector fields of views. The line of apsides of the orbit lies in the equatorial plane, which makes it possible to explore the magnetotail up to planetocentric distances of almost 6 Mercury radii.

MMO is cylindrical in shape (Fig. 13); the top and bottom are used as radiators and the side wall carries solar cells, which deliver 185 W. A despun 1m-diameter antenna is used to communicate with Earth. The overall mass of MMO is 160 kg.

A magnetometer is essential since it addresses both the planetary and magnetospheric objectives. A set of charged-particle detectors covers a combined energy range of several 100 keV. The spectrum of electromagnetic waves is measured with a search coil and a 70m-long electric antenna. The mass of the wave and particle instruments is minimised by including a common central processor, which ensures single interfaces for telecommands, telemetry and power. MMO is electrostatically and electromagnetically clean. The surface of the spacecraft is conductive and an ion emitter is

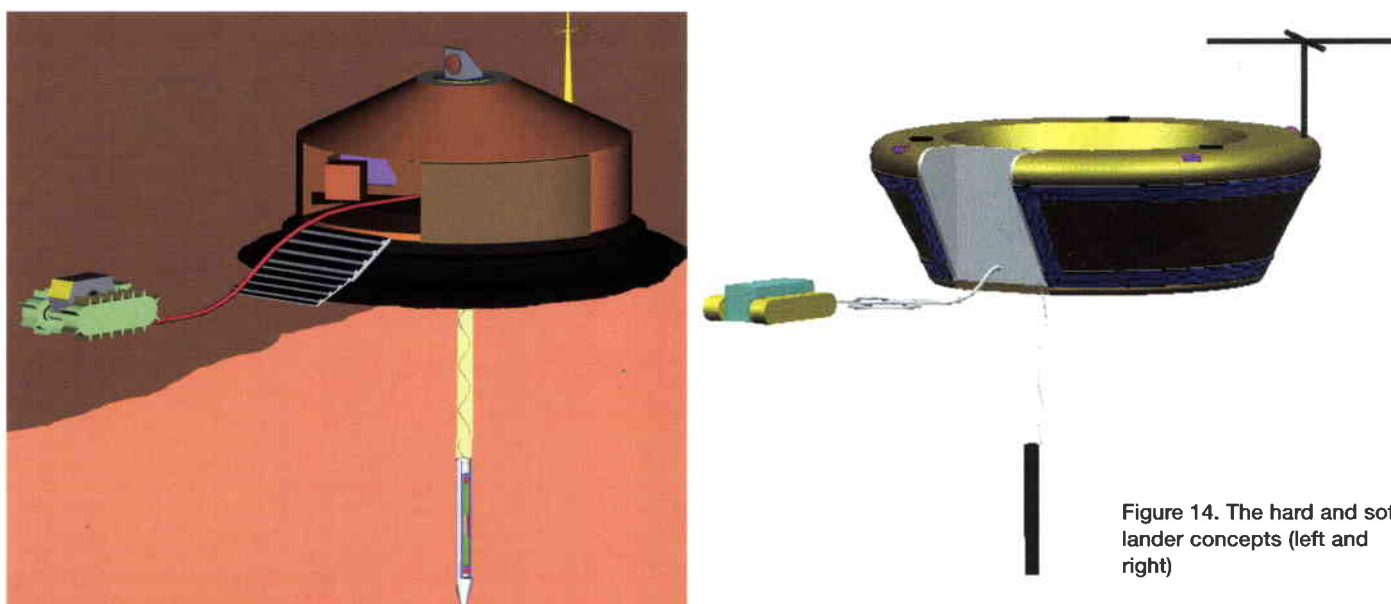

Figure 14. The hard and soft lander concepts (left and right)

included to prevent its potential from reaching several 10 V and invalidating the low-energy particle measurements.

A multicolour camera is considered as a backup for the imagers carried by MPO; its resolution varies from a few 10 m to a few 100 m from periapsis to apoapsis. This payload complement is certainly not exhaustive and additional, or alternative, instruments such as an energetic neutral imager are also desirable.

Surface Element

Two versions of the Surface Element have been studied: a hard-lander consisting of a penetrator linked to a surface station by means of an umbilical, and a soft-lander equipped with a self-penetrating device (Fig. 14). The hard-lander relies on a solid-propellant descent motor and crushable material to limit the impact deceleration. The soft-lander makes use of a liquid propellant motor and airbags to further constrain the impact shock below 250 g ($1 \text{ g} = 9.81 \text{ ms}^{-2}$). The dry mass of MSE is of the order of 50-70 kg. The hard-lander version is assumed in the cruise configurations illustrated in the frontispiece and in Figure 9a.

A heat flow and physical properties instrument performs measurements which can only be achieved in-situ; it can be integrated in the fore-body, or penetrator, of a hard lander or in a self-penetrating device, or mole, in the case of a soft-lander. An alpha X-ray spectrometer is transported to selected surface areas by a micro-rover and provides measurements that serve as ground-truth for the MPO observations.

Two cameras record images before and after landing. A magnetometer characterises the magnetic properties of the surface and yields the electrical conductivity of the ground by

recording simultaneously, both on MMO and MSE, the magnetic-field fluctuations induced by the solar wind. A seismometer enhances the scientific return provided that MSE's lifetime is significantly longer than one week.

Conclusion

The potential scientific return from the BepiColombo mission is both significant and novel; it addresses the planet's internal structure and magnetic field, the surface features and composition, the planetary environment, as well as important fundamental science issues and Near-Earth Object (NEO) observations.

The study has demonstrated that an attractive strategy exists for interplanetary transfer to Mercury, combining gravity assists and electric propulsion. The requirements of the electric-propulsion elements (thrusters, solar array) are compatible with current technologies. The proposed concept is modular, and lends itself to reconfiguration depending on the future evolution in terms of mission goals, funding scenarios and international cooperation.

Acknowledgements

This article is based on contributions provided by the members of, and consultants to the BepiColombo Scientific Advisory Group – A. Balogh, A. Boattini, L. Blomberg, J. Brückner, A. Carusi, L. Iess, Y. Langevin, A. Milani, S. Mottola, T. Spohn, N. Thomas and P. Wurz – and by the industrial manager of the System and Technology Study, A. Anselmi. Thanks are also due to M. Coradini from the ESA Science Mission Coordination Office.



Darwin – The Infrared Space Interferometry Mission

C.V.M. Fridlund

Space Science Department, ESA Directorate of Scientific Programmes, ESTEC, Noordwijk, The Netherlands

Introduction

ESA already identified interferometry in space as an important topic in its original Horizon 2000 plan. Consequently, a number of conferences/workshops were held during the 1980s in order to define the scientific case, and even then the search for terrestrial exoplanets figured prominently. When an external survey committee made its recommendations for the extension of the Horizon 2000 Programme (Horizon 2000+), in response to technology developments worldwide, they identified interferometry from space as a potential Cornerstone candidate for the new programme.

Darwin is a suggested ESA Cornerstone mission, with the express purpose of achieving unprecedented spatial resolution in the infrared wavelength region, leading to new astrophysics discoveries and the carrying out of the first direct search for terrestrial exoplanets. The detection and study of the latter promises to usher in a new era in science and will have an impact on a broad spectrum of science and technology.

Within the interferometric context, three topics were identified for further study:

- Astrometry.
- The search for terrestrial exoplanets, including characterisation of their properties and atmospheres and the possible detection of biospheres through remote sensing.
- Astrophysical imaging at a spatial resolution 2 – 3 orders of magnitude higher than that foreseen with the Next Generation Space Telescope (NGST).

Of these, the first was considered to be (relatively) 'simpler' to implement and subsequently resulted in the GAIA mission proposal and study. The Darwin study concerns itself with the two latter concepts, and during the mission definition phase the possibility of addressing both topics – exoplanets and imaging – with a single mission was given great weight.

To address fully the recommendations of the Horizon 2000+ Survey Committee for Darwin, it is necessary to:

- directly detect exoplanets
- define and observe the fundamental requirements for life as we know it
- define and observe signposts for the existence of life as we know it.

Below we describe the 'model mission', resulting from the system-level scientific and industrial study, that can fulfil these requirements. The version of Darwin that finally flies may depart significantly from this model mission, in the light of possible collaborations (see below). We also outline the intended technology-development schedule, the necessary pre-cursor programmes, and a possible framework for collaboration with other space agencies.

Ground-based observations of exoplanets

The last five years have seen the detection of many planets beyond our Solar System. Since the first detection of a planet around 51 Peg, reported by Queloz and Mayor in 1995, several groups have added about 30 planets to the map in our immediate neighbourhood in the Galaxy. The so-called 'indirect' technique used provides very little information about the planet itself (essentially its minimum mass, because the planetary orbit's inclination to our line of sight is unknown). The reflex motion in the parent star with respect to the common centre of mass of the star-planet system caused by the planet's gravity is observed as a periodic Doppler shift in the stellar spectrum over a relatively long period of time. The ground-based method's precision therefore depends on the accuracy with which we can measure the star's spectrum and is currently limited to a of a few ms^{-1} , allowing the detection of planets like Jupiter (12 ms^{-1}) or Saturn (3 ms^{-1}). It therefore appears unlikely that this method could be used to infer the presence of Earth-

type planets. The lower limit eventually expected to be attainable is more plausibly a planet about the size of Uranus, but at significantly smaller distances.

Nevertheless, important results have been and are being achieved with this method, including the detection of the first planetary system *upsilon Andromedae*, which contains three planets with minimum masses of $0.77 M_{\text{Jupiter}}$, $2.11 M_{\text{Jupiter}}$ and $4.61 M_{\text{Jupiter}}$. The planets so far discovered are also found mainly to have short orbital periods – something that has been clearly demonstrated to be a selection effect caused by the period of time during which observations have been carried out being relatively short. Consequently, as time passes, longer and longer periods are picked up, and there are now a number of confirmed planets in orbits with periods of a few years. Theorists, however, have problems explaining the formation of the ‘hot Jupiters’ – the massive planets orbiting very near their parent stars – as well as the high eccentricities possessed by the majority of the confirmed planets.

Another ‘indirect’ ground-based method is to obtain astrometric data and thus track a star’s path across the sky, measuring the wobble introduced by the rotation around the common centre of mass of the star-planet system. Reports of the detection of planetary companions to some nearby stars have been legion during the last century. Both Barnard’s star and 61 Cyg have several times become the central objects of planetary systems, but none of these observations have ever been confirmed. In contrast, Hipparcos data have recently provided upper masses for a number of planets, including 51 Peg. ESA’s GAIA mission promises statistical surveys of massive planets over large distances. The micro-arcsecond wobbles introduced in the solar proper motion across the sky, as viewed over distances of order 10 pc are, however, too small to be detected by this mission. Moreover, if a system involves more than one planet, there is a difficulty in characterising the planets (orbital period, mass) uniquely and unambiguously.

The scientific case for studying terrestrial exoplanets

The scientific case for Darwin is easy to state, but complex to describe. The phrase *to detect and study Earth-type planets and characterise them as possible abodes of life*, summarises the case nicely, but nevertheless does not project the complete picture. The simple fact is that Darwin is not only an astronomy mission, but also contains elements from geophysics (including atmospheric physics), biophysics, organic chemistry and philosophy and the

humanities. Being so cross-disciplinary, therefore, the mission can also address the question:

“Are we alone in the Universe?”

which is one of mankind’s longest standing quests. Although this question has been the topic of vigorous philosophical and religious debate for centuries, we have finally arrived at a point where technology has advanced sufficiently to allow it to be properly addressed.

In order to answer questions like:

- How unique is the Earth as a planet?
- How unique is life in the Universe?

we need to observe other stars and directly determine the existence and characteristics of any accompanying bodies. This has hitherto been impossible because of the influence of the star on the attempts to observe any planet circling it.

Definition of an unambiguous signpost for life is another matter completely. First we need to define what is life, and then to determine how that life affects its environment. Finally, we need to define observables that can be obtained with the level of technology foreseen for the mission. In the context of Darwin, we have so far avoided the first of these questions by instead specifying the mission requirements based on life as we have observed it on Earth. We thus disregard speculation about life forms based on a chemistry different from that found on our own planet. We then try to imagine the differences that would occur if life were nonexistent on Earth, and to use information on how life disturbs the equilibrium in the Earth’s atmosphere as our criterion.

To fully answer the questions raised above, we need to:

- Detect planets within the ‘life zone’ (term coined by Frank Drake), i.e. the orbital radii where water is found in a liquid state surrounding other stars. In the Darwin study, the life zone is defined in terms of a black-body temperature and a range, and does not a priori take into account atmospheric pressure, etc. This assumes, of course, that life is based on the existence of liquid water.
- Determine the planets’ orbital characteristics, which means that we need to repeat the observations several times.
- Observe the spectrum of the planet (Does it have an atmosphere?) and determine its effective temperature, total flux and diameter (emitting area \times albedo).
- Determine the composition of the atmosphere viz. the presence of water and ozone/oxygen for an Earth-type planet, mainly inert gases

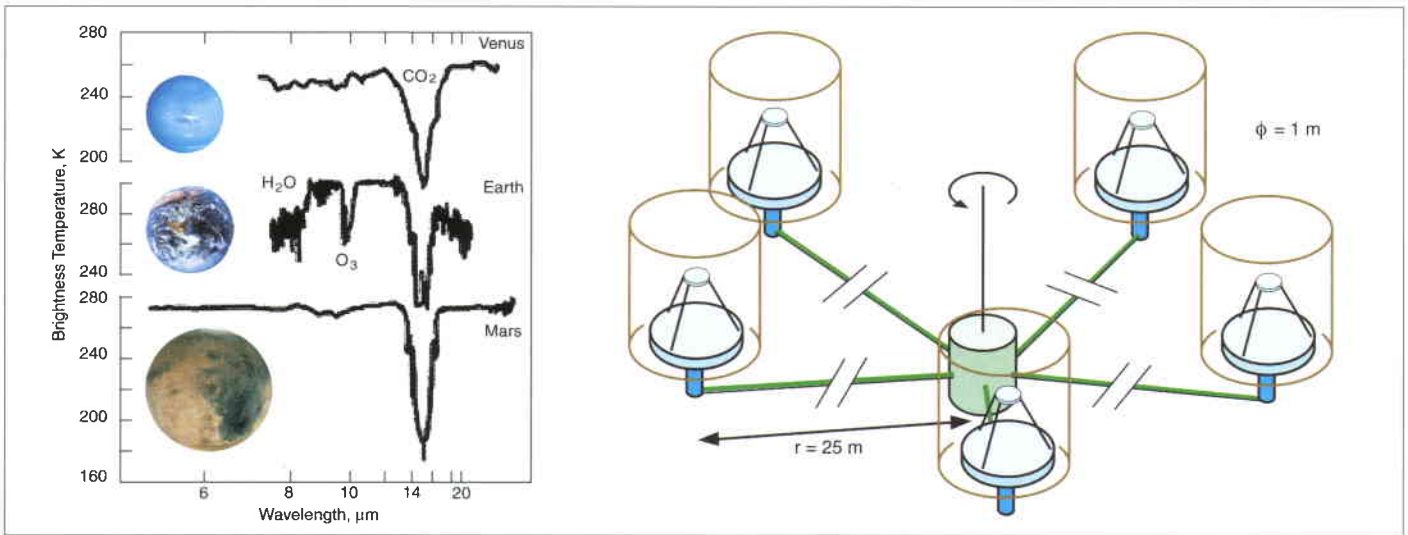

Figure 1. Left: Representative spectra (left) of the planets Venus, Earth and Mars at the relevant wavelengths. Right: schematic of the

for a Mars/Venus-type planet and hydrogen/methane atmospheres for Jupiter-type planets (Fig. 1a)

The Darwin Science Advisory Group and the industrial study

ESA received the Darwin proposal in response to a Call for Ideas in 1993, and it was among the mission concepts selected for a system-level industrial study. It can be briefly described as a nulling interferometer comprising five 1 m-class telescopes, flying at a distance of about 5 AU from the Sun (to reduce the background radiation from the zodiacal dust). It was specifically designed for the detection and study of terrestrial exoplanets (Fig. 1b). A subsequent reevaluation of the dust emission in the inner Solar System led to the currently favoured orbit at about 1 AU.

The Darwin community prepared for the coming study activity by holding its first (European) workshop in Toledo, Spain, in March 1996. To advise ESA on Darwin-related matters, a temporary external advisory body – the Darwin Science Advisory Group (SAG) – was formed in early 1997. This group was first tasked with aiding in the preparation of the

scientific specification for an Invitation to Tender (ITT) for industry, and arrived at the end of 1997 at the following specification:

- Major Goal I: to detect Earth-like planets orbiting nearby stars and to set constraints on the possibility of the existence of ‘life as we know it’ on these planets.
- Major Goal II: to provide imaging in the 5 to 28 micron band, with spatial resolution an order of magnitude better than that expected of the Next Generation Space Telescope (NGST).

More specifically, these targets were quantified as:

- Directly detecting an Earth-like planet at a black-body temperature close to 300 K, circling a G0V star at a distance of at least 10 pc (preferably 20 pc) with a signal/noise ratio of 5-10 in a reasonable integration time (less than 30 h)
- Characterising the detected planet physically through determination of its orbital elements, requiring observations at several epochs.
- Obtaining the planet’s thermal spectrum with a spectral resolution large enough (more than 20) to determine its atmospheric composition (Fig. 2).

Figure 2. The Earth’s spectrum as it would appear observed with Darwin from a distance of 10 pc. The spectral range has been specified here as 7 to 17 microns. Ideally, one would like to observe a larger part of the spectrum in order to detect the thermal continuum on both sides of the H₂O and CO₂ lines.

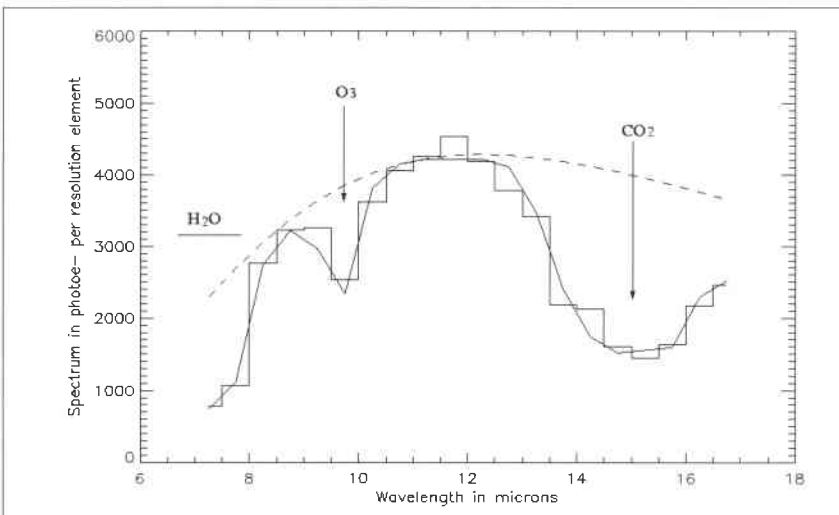

One item here requires further comment, namely the selection of the thermal spectrum. In principle, one could also use the reflected spectrum of the planet and detect signatures of life within the visual or ultraviolet spectral bands. As explained below, however, observations in these wavelength bands would severely constrain the mission in a number of ways.

This specification was provided in the ITT offered to European industry in September 1997. After a tender evaluation of industrial proposals to ESA, Alcatel Space Division (at the time Aerospatiale Space Division) was selected, thus concluding the evaluation phase. Their study ended in mid-April 2000.

The specific goals of the feasibility study were to:

- define a model mission that would be able to achieve the scientific goals
- identify a technology development programme
- identify the necessary pre-cursor missions (ground- and space-based).

The current mission-model baseline consists of six free-flying 1.5 m telescopes, arranged in a hexagonal configuration, with in the centre of the array a beam-combining satellite equipped with optical benches for both the ‘nulling’ and the ‘imaging’ parts of the mission axis – the so-called ‘Robin Laurance configuration’, in honour of the first Darwin Study Manager who tragically passed away in 1999, developed by A. Karlsson at ESTEC (Figs. 3 a,b). All components in the optical path, from the main mirrors to the output of the beam-combination unit, need to be passively cooled to less than 40 K, something that Alcatel’s thermal modelling indicates is possible if the mission is flown in an orbit far from heat sources such as the Earth (Fig. 2). To minimise the influence of the zodiacal dust emission at 10 micron, the observing zone is a 40 deg cone around the anti-Sun axis. This planar configuration (good thermal environment) combines transfer optics of manageable size with a good rejection ratio of the central null, and can use both internal modulation and simple translational movement for discriminating, for example, exo-zodiacal light from the signature of an Earth-type planet. It also allows, in principle, for both an imaging and a nulling mission to be flown on the same spacecraft.

The six telescopes, the hub beam-combiner satellite and a separate power and communications spacecraft are all foreseen to be

launched by a single Ariane-5 vehicle into a direct transfer orbit to the L2 Lagrangian point in the Sun-Earth system.

The nulling-interferometry technique

As mentioned above, directly detecting exoplanets is essentially a matter of contrast and dynamic range. The star around which the planet revolves is going to be more than 10^9 times brighter than the planet, if we chose to observe in visual light. The planet is also going to be very close – an Earth-type planet in an orbit in the ‘life-zone’, i.e. 1 AU from its sun, is going to be 1 arcsec away at a distance of 1 parsec. Unfortunately, the closest potential target we have is α Centauri at 1.1 parsec. To get a suitable number of targets, we have to reach out to at least 10 parsec, and preferably 25 parsec, thus making the life zone viewable at 0.1 and 0.04 arcsec, respectively. This is for solar-type targets; for K- and M-type stars, which will dominate our sample, the separation will be much smaller, because of observing planets within the zone where we expect water to be liquid. It is clear that, using conventional telescopes, our detectors would have to handle an impossible dynamic range in order to separate out the planetary light.

The problem is alleviated by going to the infrared, where the relative contrast between primary and planet drops several orders of magnitude (Fig. 4). This was first pointed out by Bracewell (in 1978) and Angel et al. (in 1986), who also pointed out the advantage of using lines of the H_2O , O_3 and CO_2 molecules as tracers of life as we know it. Kasting et al. (in 1985) and Leg er et al. (in 1993) have demonstrated that O_3 is a very nice tracer for O_2 , since the former has a logarithmic dependence on the concentration of the latter.

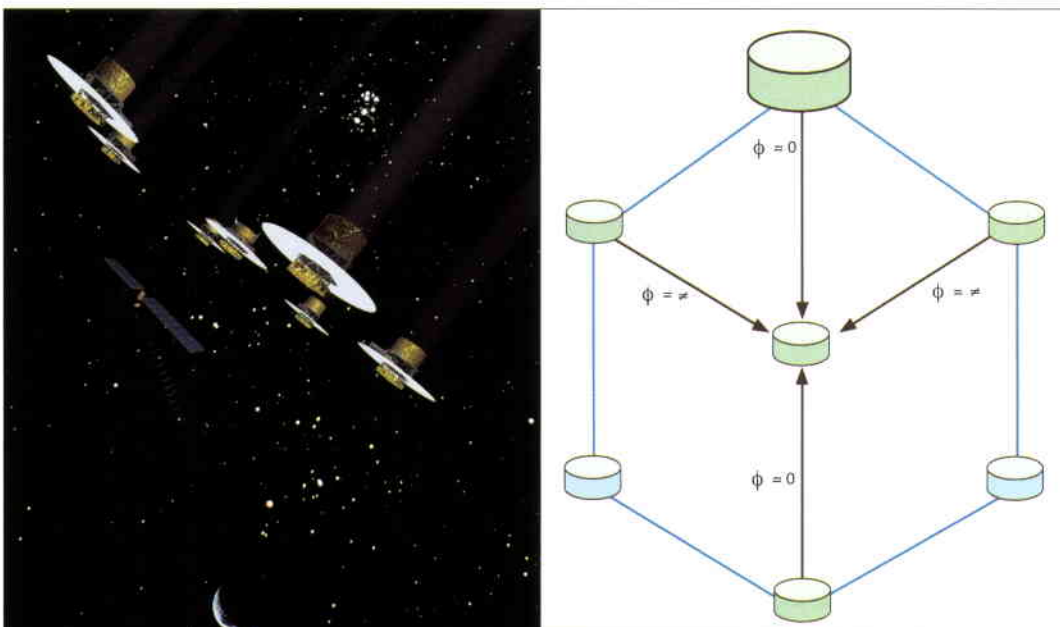

Figure 3. Left: Artist’s impression of the current Darwin configuration, seen orbiting at the Sun-Earth L2 point (courtesy of Alcatel). Right: the planar Robin Laurance configuration, which is the current Darwin baseline

We then have suitable tracers for Earth-type atmospheres in a wavelength band between about 6 and 20 microns. We can still only allow 10^{-6} of the stellar light to remain in the input feed to our spectrograph if we are to have any hope of detecting the planetary light and registering its spectrum in a reasonable time.

It can be shown that coronagraphic methods on monolithic telescopes do not suffice to accomplish such an extinguishing of light at the relevant spatial scales. To overcome this hurdle, the 'nulling interferometry' technique is baselined for Darwin. A nulling interferometer (also known as a Bracewell interferometer) can best be described by considering two telescopes. By restricting the beams coming from each of the telescopes to the diameter of the point spread function, and after making the light beams parallel, we can introduce a phase shift of $\phi = \pi$ into one of the ray paths, which will achieve destructive interference on the optical axis of the system (in the combined beam). At the same time, we will have constructive interference a small angle θ away. This angle θ depends on the distance between the two input telescopes (Fig. 3b). The output of this system is a set of interference fringes or 'map', with a sharp 'null' in its centre. By placing the central star under this null, and the zone where for example H_2O will be liquid under a bright fringe, one can in principle search for planets in the 'life zone'. Now, by using more telescopes, we can achieve a symmetric pattern around the star, with a deep central null on top of the star. The actual shape and transmission properties of the pattern around the central 'null' depends on the configuration of, and the distance between the telescopes.

Essentially, if we had an ideal case with a star and a single planet and no disturbing sources, such as exosolar zodiacal dust, i.e. dust left over from collisions between asteroids, comets

and suchlike in the target system, the detection of a positive flux would imply that a planet is present, if the star is well and truly 'nulled out'. This means that the detector could consist of a single element. We wish, however, to also carry out spectroscopy with as high a resolution as possible, and a linear array is thus indicated. In the real world, there is of course a significant amount of background radiation coming from dust. The zodiacal dust in our own Solar System is strong enough to be seen as a bright band (in visible light) from dark locations on the ground. At a wavelength of 10 microns, this radiation is dominant (the zodiacal dust temperature within the 'life zone' will also be close to 300 K, and thus the peak of the emission is radiated around 10 microns) and thus a significant background signal is present in the inner Solar System.

When observing the Solar System at interstellar distances, the zodiacal dust is actually about 400 times brighter than the Earth at these wavelengths. To separate out the planet's signal from this background, one needs to modulate the signal from the planet and from the zodiacal dust at different frequencies. This is done either by switching between different combination schemes (certain geometrical arrangements of the telescope array), or by moving the individual telescopes around, or both.

Technology development and precursor missions

One prominent goal in the Alcatel study was to identify a technology-development programme leading to a Darwin mission as soon as possible. Consequently, an ambitious technology-development plan has been initiated, including space qualification and verification, in the context of ESA's SMART programme. Activities planned for the next three years include development and construction of:

- high-stability optical benches
- active optics control

Figure 3. Left: contrast between the solar flux and the Earth as a function of wavelength in microns, with the Darwin spectral band indicated (adapted from Angel, Cheng & Woolf, 1986). Right: a two-telescope nulling interferometer, where the angle theta depends on the distance D (drawing courtesy of IAS, Orsay, France)

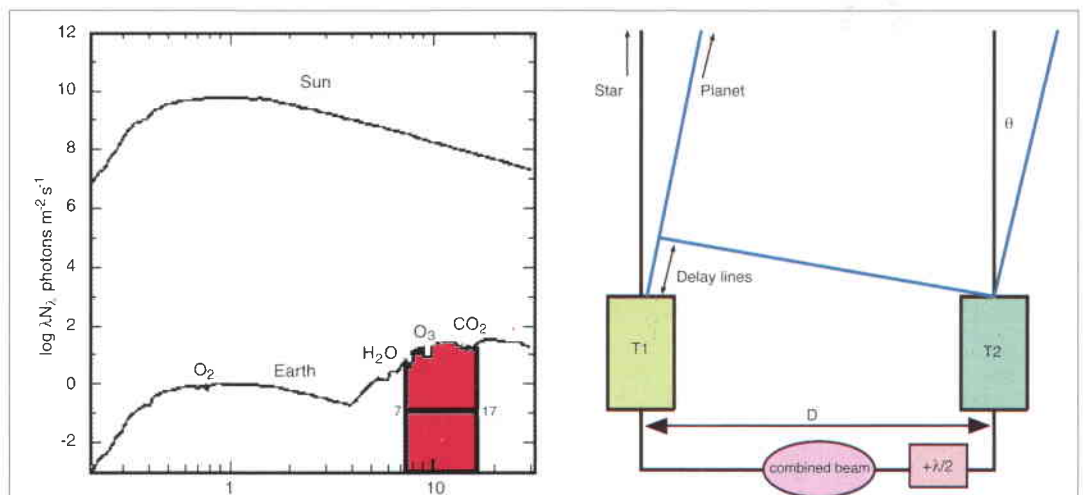

- fibre-optic wavefront filtering, with single-mode fibres operating in the 10 micron region, and an investigation into the phasing capabilities of fibres
- integrated optics, optical components for nulling and imaging interferometry
- achromatic phase shifters for nulling interferometry
- detectors and cooling systems
- satellite formation flying, deployment and control, with a local GPS system for 1 cm positional accuracy
- ultra-high-precision (laser) metrology
- Field Electric Emission Propulsion (FEEP) technology.

One of the key issues is to develop and verify 'nulling' interferometry. It is currently not deemed necessary to demonstrate this in space, but a representative breadboard with an associated simulator providing the necessary input signals has to be designed and built within the next few years. An associated precursor activity is observation of the exozodiacal light from target systems. This can be carried out from the ground, using the breadboard in conjunction with a large enough interferometer, e.g. using the Very Large Telescope Interferometer (VLTI) of the European Southern Observatory (ESO). By using the breadboard together with the VLTI, its qualification would also provide much-needed scientific information. Plans for such a collaboration between ESA and ESO are well advanced and a joint ESA/ESO science group has been formed.

One of the most challenging technological aspects of the Darwin mission is that it requires several spacecraft to be flown in close proximity with centimetre precision. This control is foreseen to be provided – during an observation – with micro-Newton FEEP thrusters (the greatest disturbing force in an L2 orbit is the differential solar photon pressure on the individual spacecraft). Spacecraft deployment and source acquisition will be effected using milli-Newton FEEP thrusters. A local GPS system keeps the spacecraft within one centimetre of their intended positions, while a laser metrology system measures their actual positions to within 5 nm. A separate channel in the interferometric system will observe the fringes from the central star in the target system – which is nulled out in the 'science channel' – and since the observed systems are all relatively nearby, there is no lack of photons for tracking the fringes. This information is fed into the control loop of the interferometer's two 'nulling' and imaging circuits, as well as into the attitude and control systems of the individual spacecraft. This technology requires a

precursor mission to actually test:

- the deployment, acquisition of observing positions, and control of a spacecraft flotilla
- the metrology components – fringe tracker, laser system
- the software/hardware of the control system
- milli- and micro-Newton thrusters.

Consequently, this technology is also being introduced into the SMART precursor mission programme. It should be noted in this context, that most of the new technologies required for Darwin will also have other valuable applications, the flotilla flying (for communication satellite purposes), interferometry (Earth observation of many kinds) and the ultra-high-precision laser metrology being good examples. This provides an additional source of support for Darwin, since many of the technology-development items can be partially or totally funded from outside the Science Programme. This is also an added factor in ensuring that such developments can be carried out relatively quickly.

International collaboration

Space interferometry is also being pursued elsewhere outside Europe, the two most obvious examples with the capability to search for exoplanets being SIM (Space Interferometry Mission) and TPF (NASA's Terrestrial Planet Finder). SIM is an optical interferometer which will use relative astrometry to attempt to detect 'super-Earths', i.e. planets of 5 to 10 Earth masses, through an indirect method. Another of its goals is to carry out 'nulling interferometry' to one part in ten thousand at visual wavelengths. Because of these targets, SIM can be considered a pre-cursor mission to Darwin and TPF.

TPF has the same objectives and uses the same technology as foreseen for Darwin. Given that both projects are extremely complex, require very ambitious technology-development programmes, and are likely to be very expensive, it would make sense for NASA and ESA to cooperate. Discussions have in fact begun regarding a possible joint mission, to be launched sometime around 2012.

Acknowledgments

This article reflects several years of work by the Darwin Science Advisory Group (SAG), including that of a number of experts who participated in the concept's development. We all pay tribute to our colleagues Jean Marie Mariotti and Robin Laurance, who passed away during the study but who will be with us in spirit to the completion of the task before us.



GAIA – Unravelling the Origin and Evolution of Our Galaxy

M.A.C. Perryman

Space Science Department, ESA Directorate of Scientific Programmes, ESTEC, Noordwijk, The Netherlands

O. Pace

Science Future Projects and Technology Office, ESA Directorate of Scientific Programmes, ESTEC, Noordwijk, The Netherlands

The GAIA Science Advisory Group

Introduction

GAIA builds upon the observational techniques pioneered and proven by ESA's Hipparcos mission to solve one of the most difficult yet deeply fundamental challenges in modern astronomy – to create an extraordinarily precise three-dimensional map of our Galaxy and beyond. In the process, by combining positional data with radial velocities, GAIA will map the stellar motions, which encode the origin and subsequent evolution of the Galaxy. Through comprehensive photometric

classification, GAIA will provide the detailed physical properties of each star observed, characterising their luminosity, temperature, gravity and elemental composition. This massive multi-parameter stellar census will provide the basic observational data required to quantify the origin, structure and evolutionary history of our Galaxy.

GAIA will achieve this by repeatedly measuring the positions and multi-colour brightnesses of all objects down to $V = 20$ th magnitude (400 000 times fainter than the human eye can see). On-board object detection will ensure that variable stars, supernovae, transient sources, micro-lensed events and minor planets (including those that cross the orbit of the Earth) will all be detected and catalogued to this faint limit. Final accuracies of 10 microarcsec at 15 mag, comparable to the diameter of a human hair at a distance of 1000 km, will provide distances accurate to 10 percent as far as the Galactic Centre, 30 000 light-years away. Stellar motions will be measured even in the Andromeda galaxy more than 2.5 million light-years away, and tens of thousands of extra-solar planets will be discovered.

GAIA was the Greek goddess of Earth worshipped as the universal mother who had created the Universe. More recently her name was taken by James Lovelock for his theory on the interdependency of the Earth's atmosphere and biological organisms. Now it is the name given to an ambitious project to unravel the structure, origin and evolution of our Galaxy. GAIA is a Cornerstone candidate in ESA's Scientific Programme, proposed to carry out a stereoscopic survey of more than a billion stars – a detailed census of around 1 percent of the stellar content of our Galaxy. It will also detect upwards of 20 000 extra-solar planets, provide a comprehensive Solar System census of asteroids, and undertake tests of General Relativity with unprecedented accuracy. The extensive harvest from this revolutionary undertaking is expected to have enormous scientific implications.

A Scientific Harvest of Enormous Extent and Implication

GAIA will pinpoint exotic objects in colossal numbers: many thousands of extra-solar planets will be discovered (see 'Extra-Solar Planets'), and their detailed orbits and masses determined; brown dwarfs and white dwarfs will be identified in their tens of thousands; some 100 000 extragalactic supernovae will be discovered, alerting ground-based observers to follow-up observations; Solar System studies will receive a massive impetus through the detection of many tens of thousands of new minor planets (see 'Asteroids and Near Earth Objects'); inner Trojans and even new trans-Neptunian objects, including Plutinos, will be discovered. In addition to astrophysical and Solar System studies, GAIA will contribute some surprising results to fundamental physics (see 'General Relativity').

Science with GAIA

The primary science goal of the GAIA mission is to clarify the origin and history of our Galaxy, quantifying tests of galaxy formation theories, and also dramatically advancing our knowledge of star formation and evolution. This is possible since low-mass stars live for much longer than the present age of the Universe, and retain in their atmospheres a fossil record of the chemical elements in the interstellar medium at the time of their formation. The orbits of these stars similarly encode their dynamical histories, so that the GAIA results will precisely identify relics of tidally-disrupted accretion debris, and probe the distribution of dark matter. The GAIA survey will establish the luminosity function for pre-Main Sequence stars, detect and categorise rapid evolutionary stellar phases, place unprecedented constraints on the age, internal structure and evolution of all stellar types, establish a rigorous distance-scale framework throughout the Galaxy and beyond, and classify the star formation, kinematical and dynamical behaviour across the Local Group of galaxies.

Our Galaxy – the Milky Way

GAIA will determine the physical characteristics, kinematics and distribution of stars over a significant fraction of the Galaxy, with the goal of achieving a full understanding of the Galaxy's dynamics and structure and consequently its formation and history (Fig. 1).

Extra-Solar Planets

In the past five years, a huge programme of high-precision ground-based radial velocity (Doppler) measurements has led to the detection of about 40 extra-solar planets surrounding stars other than our Sun. These are all within a distance of about 100 light-years. The planets detectable by this method are rather massive, comparable to Jupiter (which has about 300 times the mass of Earth). The systems have some surprising properties: two thirds of these giant planets are orbiting their host stars much closer than Mercury orbits the Sun (0.39 astronomical units), some having periods as short as 3 days. More than one third have significantly elliptical orbits, with $e > 0.3$, compared with the largest eccentricities in our Solar System of about 0.2 for Mercury and Pluto, and 0.05 for Jupiter. The puzzle is how they can have formed or been displaced to such unexpected orbits. Theories of planetary formation developed to explain the formation of our own Solar System predicted that they would not form so close to the central star, where temperatures are high, and where the amount of protoplanetary disc matter was believed to be small. A transit across the face of the parent star has been observed for one system, and this leads to estimates of the radius, mass and density of the planet. One system is multiple, consisting of three massive planets, and theorists are involved in modelling its stability, and how it too might have formed. Over the next 5 years, a total of about 100 extra-solar planets may be known.

GAIA will completely revolutionise the field of extra-solar planetary physics. It is estimated that the remarkable precision of GAIA's positional measurements will lead to the detection and measurement of between 20 000 and 30 000 extra-solar giant planets out to distances of 300-500 light-years, corresponding to some 20 new planets per day, for each day of the 5-year mission. Masses and orbits will be determined for each, leading to a comprehensive inventory of planets near to our Sun. Theorists are currently estimating temperatures, radii, chemical compositions and other properties of extra-solar planets, aiming to predict which combination of physical parameters will lead to planets on which life may have developed: for example, as a function of stellar type and age, distance from the central star such that water will be in liquid form, mass and radius of the planet, etc. GAIA's survey will underpin future ambitious missions related to extra-solar planets, such as Darwin and Eddington.

Stellar Astrophysics

GAIA will provide distances of astonishing accuracy and in remarkable numbers for all types of stars of all stellar populations, even the brightest, or those in the most rapid evolutionary phases, which are very sparsely represented in the solar neighbourhood. About 20 million stars will be measured with a distance precision of 1% (compared to a few hundred now), and about 200 million will be measured to better than 10% (compared to about 20 000 now). Some 10 million resolved binary systems will be detected within 250 pc. With the parallel determination of extinction/reddening and metallicities by the use of multi-band photometry and spectroscopy, this huge amount of basic data will provide an extended basis for reading in-situ stellar and galactic evolution. All parts of the Hertzsprung-Russell diagram will be comprehensively calibrated, including all phases of stellar evolution, from pre-Main Sequence stars to white dwarfs and all existing transient phases; all possible masses, from brown dwarfs to the most massive O stars; all types of variable stars; all possible types of binary systems down to brown dwarf and planetary systems; all standard distance indicators (pulsating stars, cluster sequences, supergiants, central stars of planetary nebulae, etc.). This extensive amount of data of extreme accuracy will stimulate a revolution in the exploration of stellar and galactic formation and evolution, and the determination of the cosmic distance scale.

The most conspicuous component of our Galaxy, or Milky Way, is its flat disc which contains nearly 10^{11} stars of all types and ages orbiting the Galactic Centre. The Sun is located at 27 000 light-years from the Galactic Centre. The disc displays a spiral structure and contains interstellar material, predominantly atomic and molecular hydrogen, and a significant amount of dust. The inner part of the disc also contains the bulge, which is less

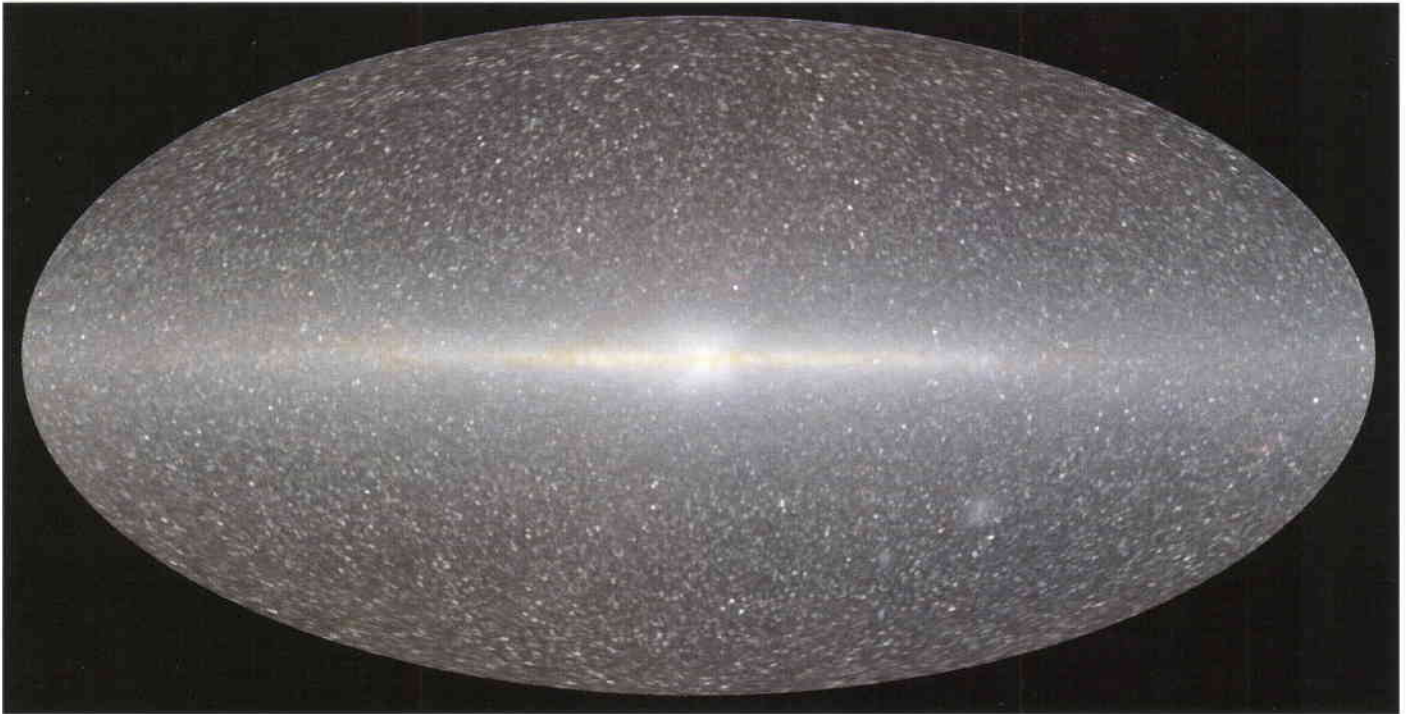

Figure 1. This composite near infrared (COBE) image of the Milky Way shows our Galaxy as it might be seen by an external observer. It shows red stars and dust in our Galaxy superposed against the faint glow of many dim stars in distant galaxies. Faintly visible as an S-shaped sash running through the image centre is zodiacal light – dust in our own Solar System. The thin disc of our Galaxy is clearly visible
(Courtesy of Edward L. Wright (UCLA), COBE, DIRBE, NASA, used with permission)

flattened and consists mostly of fairly old stars. At the centre lies a massive black hole of about 2.9×10^6 solar masses. The disc and the bulge are surrounded by a halo of about 10^9 old and metal-poor stars, as well as some 140 globular clusters and a small number of satellite dwarf galaxies. The entire system is embedded in a massive halo of dark material of unknown composition and poorly known spatial distribution. The various components of the Milky Way (stars, planets, interstellar gas and dust, radiation and dark matter) are distributed in age (reflecting their birth rate), in space (reflecting their birth place and subsequent motion), on orbits (determined by the gravitational force generated by their own mass) and with different chemical abundances (determined by the past history of star formation and gas accretion.) The history of the formation and subsequent evolution of our Galaxy is thus preserved in these complex

distributions. Unravelling these complex patterns to trace the development of our Galaxy since its creation is the primary aim of the GAIA mission.

The Galactic Disc

Star formation has been reasonably continuous in the disc of the Galaxy over the past 12 billion years and, as a result, the disc contains stars with a range of chemical compositions, ages and kinematics. In the past decades, radio and millimetre observations, combined with kinematic models, have revealed the distribution and kinematics of the interstellar gas for nearly the entire Galaxy. They have delineated the spiral structure, and mapped a warping of the galactic disc outside the solar orbit. However, very little is known about the stellar disc beyond about 1000 light-years from the Sun. This is due to significant interstellar extinction towards the central regions of the Galaxy at optical wavelengths, and our inability to determine accurate distances and space motions. The GAIA parallaxes, proper motions, radial velocities and photometry will allow derivation of the structure and kinematics throughout the stellar disc for a large fraction of the Milky Way (Fig. 2).

Figure 2. The disc of the Milky Way based on HI observations. The vertical axis is exaggerated by a factor of 10. The arrows show the motion of the Sun and an outlying star on their orbits in the Galaxy. The outlying star has an upward motion as seen from the Sun. Directions in the sky as seen from Earth, are indicated by their constellation names. GAIA observations will provide an enormous advance in understanding the structure of our galactic disc
(Courtesy of R.L. Smart et al.)

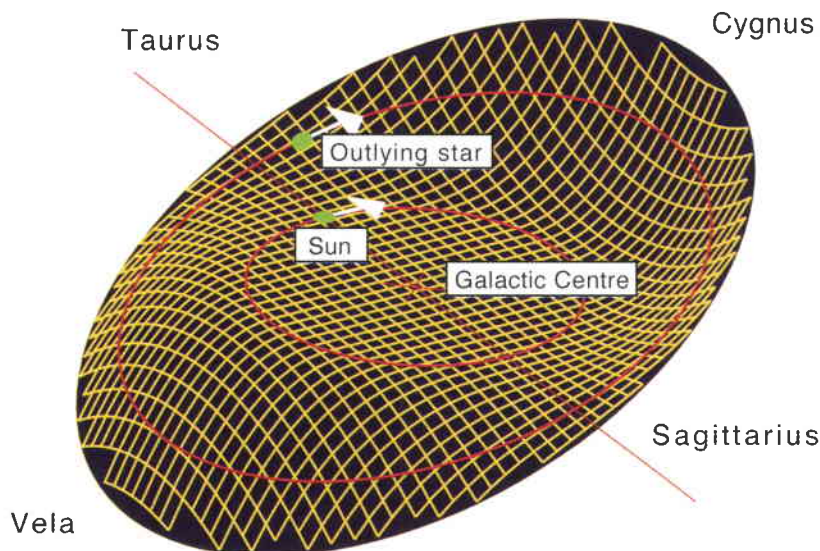

Spiral arms

Spiral arms are a distinguishing feature of disc galaxies with an appreciable gaseous component, and are clearly evident in the radio and far-infrared emission of our Galaxy. They are an important component, as they have associated streaming motions, redistribute angular momentum and are the primary locations of star formation, funnelling mass from one component (the gas) to another (the stars). Currently, our understanding of the large-scale dynamics and structure of the galactic disc derives mainly from 21-cm observations of HI, but these observations only provide the density as a function of radial velocity in any given direction, i.e. a single velocity component. To infer the actual distribution of the gas, and its kinematics, we rely upon the assumption of circular rotation. Even with this assumption, distances within the solar circle are ambiguous. GAIA will overcome these problems by providing a direct map of all of the major arms on our side of the Galaxy, using the location of young tracer populations. It will identify what constitutes an arm, its kinematic signature, and its stellar population mix.

Galactic disc warps

Galactic discs are thin, but they are not flat. Approximately one-half of all spiral galaxies have discs that warp significantly out of the plane defined by the inner galaxy. Remarkably, there is no realistic explanation of this common phenomenon, though the large-scale structure of the dark matter, and tidal interactions, must be important, as the local potential at the warp must be implicated. Neither the origin nor the persistence of galaxy warps is understood, and insufficient information exists to define empirically the relative spatial and kinematic distributions of the young (OB) stars, which should trace the gas distribution, and the older (gKM) stars, which define a more time-averaged gravitational field. At a distance of 50 000 light-years from the Galactic Centre, for a flat rotation curve, the systematic disc rotation corresponds to 6 milliarcsec per year. The kinematic signature from a 3000 light-year-high warp corresponds to a systematic effect of about 90 microarcsec per year in latitude and about 600 microarcsec per year in longitude. The study of the galactic warp will be well within the limits of GAIA's performance.

Galactic interstellar matter

The combination of GAIA parallaxes with GAIA photometry over a large part of the visual spectrum will provide a database of unprecedented size and accuracy with which to investigate the distribution of interstellar matter. The dust embedded in the gas causes extinction of starlight, both in terms of dimming,

and as a colour change. These can then be used, through the known correlation of extinction and column density of neutral gas, to estimate the amount of gas along the path length to the star. The power of this method was demonstrated by the Hipparcos data. Important topics in this area that can be addressed with GAIA data are the optical thickness of the Milky Way disc, and the scale length of the dust distribution.

Dark matter in the disc

The distribution of mass in the galactic disc is characterised by two numbers, its local volume density and its total surface density. They are fundamental parameters for many aspects of galactic structure, such as chemical evolution (Is there a significant population of white dwarf remnants from early episodes of massive star formation?), the physics of star formation (How many brown dwarfs are there?), disc galaxy stability (How important dynamically is the self-gravity of the disc?), the properties of dark matter (Does the Galaxy contain dissipational dark matter, which may be fundamentally different in nature from the dark matter assumed to provide flat rotation curves, and what is the local dark matter density and velocity distribution expected in astro-particle physics experiments?), and non-Newtonian gravity theories (Where does a description of galaxies with non-Newtonian gravity and no

General Relativity

In 1919, Einstein's General Theory of Relativity was put to its first observational test – at the time of a total solar eclipse, the displacement of stellar images close to the Solar limb was measured, and demonstrated to be consistent with the deflection of 1.7 arcsec predicted by General Relativity. This was the first of many experimental tests that General Relativity has been subjected to, and all have been passed with flying colours. ESA's Hipparcos satellite measured light deflection from space – even 90 deg away from the Sun, starlight is still bent by 0.004 arcsec due to the Sun's gravitational field. Hipparcos was able to place one of the best constraints on light bending, demonstrating the accuracy of General Relativity to 1 part in 10³.

GAIA achieves such extraordinary measurement accuracies that a number of other key fundamental physical constants will be measured with unprecedented precision. The light-bending term, γ , will be measured with an accuracy of 5 parts in 10⁷. Another important number in 'Parameterised Post-Newtonian' formalism of gravity is a quantity referred to as β , which GAIA will measure with a precision of about 1 part in 10⁴. These numbers are important since deviations from General Relativity are predicted in scalar-tensor theories of gravity, which are being considered in view of recent developments in cosmology (inflation) and elementary particle physics (string theory and Kaluza-Klein theories). GAIA will accurately measure the solar quadrupole moment from the perihelion precession of minor planets. It will be able to place the best constraints on any change in the value of the constant of gravitation, G , over cosmological time scales, based on models of the cooling times of white dwarfs. Even gravity wave detection is in principle possible, although unlikely. All of these remarkable measurements are consequences of the exquisite measurement capabilities of GAIA. Not only one billion stars in our Galaxy, but even space itself, will be seen to move.

Asteroids and Near-Earth Objects

As it sweeps the sky, GAIA will observe everything that crosses its sensitive fields of view. Supernovae will be seen in huge numbers, gravitational micro-lensed events will be detected, and variable stars of all descriptions will be detected as they oscillate in brightness throughout the mission lifetime. Also within our Solar System, GAIA will provide a whole range of spectacular results. Because of its accurate positional measurements, anything that moves will be noted immediately. Simulations show that GAIA might detect up to a million minor planets, or asteroids (about 60 000 are known at the present time). The Edgeworth-Kuiper Belt objects, now known to move around the Sun beyond the orbit of Neptune, will also be detectable. GAIA could even discover objects like Pluto if they exist and if they are moving on orbits inclined to the ecliptic plane where they will not have been detected up to now. Detection and classification of these objects is of tremendous interest for studies of the formation and evolution of our Solar System: they are relics of this formation process, and their physical properties as a function of distance from the Sun will reveal important clues about the Solar System's origin.

A particular class of objects which will also not escape the satellite's sensitive vision are the Near-Earth Objects, of significant interest due to the fact that they may impact the Earth in the future, with potentially catastrophic results, albeit with a very low probability. The Barringer Meteor Crater in New Mexico probably resulted from the impact of a 40 m diameter object. The object that is believed to have ended the Cretaceous period probably had a diameter of about 10 km. By April 2000, the Minor Planet Centre had recorded 75 Aten-class objects, 455 Apollos, and 442 Amors (these classes reflecting their orbital characteristics). Many objects so far undetected with sizes from tens of metres up to 1 km will be detected and measured by GAIA.

In a related field, GAIA will measure the trajectories of stars that have passed close to the Sun in the (geologically) recent past, and will identify those that will come close to the Sun in the future. These close stellar passages are believed to be responsible for disruptions of the Oort Comet Cloud, which may lead to the diverting of swarms of objects into Earth-impacting orbits. The Hipparcos results have already shown that the star called Gliese 710 is approaching our Solar System at about 14 km/s, and will pass through the Oort Cloud in about 1 Myr. But the trajectories of many other, fainter stars, will be probed by GAIA.

dark matter fail?). The most widely referenced and commonly determined measure of the distribution of mass in the galactic disc near the Sun is the local volume mass density, i.e. the amount of mass per unit volume near the Sun, which for practical purposes is the same as the volume mass density at the Galactic Plane. Its local value is often called the 'Oort limit'. The contribution of identified material to the Oort limit may be determined by summing all local observed matter – an observationally difficult task. The uncertainties arise in part due to difficulties in detecting very low luminosity stars, even very near the Sun, in part from uncertainties in the binary fraction among low-mass stars, and in part from uncertainties in the stellar mass/luminosity relation. All of these quantities will be determined directly and with extremely high precision by GAIA.

The second measure of the distribution of mass in the solar vicinity is the integral surface mass density, the total amount of disc mass in a column perpendicular to the Galactic Plane. It is this quantity which is required for the deconvolution of rotation curves into 'disc' and 'halo' contributions to the large-scale distribution of mass in galaxies. If one knew both of these quantities, one could immediately constrain the scale height of any contribution to the local volume mass density that was not identified. In other words, one could measure directly the velocity dispersion, i.e. the temperature, of the 'cold' dark matter.

The Bulge

At the centre of our Galaxy is a more extended,

roughly spherical agglomeration of stars, the bulge. The distance to the bulge is so immense that studies of its composition, dynamics and age are very difficult. Bulge stars are predominantly moderately old, unlike the present-day disc they encompass a wide abundance range, peaking near the Solar value, as does the disc and they have very low specific angular momentum, similar to stars in the halo. Thus the bulge is, in some fundamental parameters, unlike both disc and halo. There are many open questions about the origin of the bulge: What is its history? Is it a remnant of a disc instability? Is it a successor or a precursor to the stellar halo? Is it a merger remnant? It is not clear whether the formation of the bulge preceded that of the disc, as predicted by 'inside-out' models of galaxy formation; or whether it happened simultaneously with the formation of the disc, by accretion of dwarf galaxies; or whether it followed the formation of the disc, as a result of the dynamical evolution of a bar. Large-scale surveys of proper motions and photometric data inside the bulge can cast light on the orbital distribution function. Knowing the distance, the true space velocities and orbits can be derived, thus providing constraints on current dynamical theories of formation. GAIA data for bulge stars, providing intrinsic luminosities, metallicity and numbers, can be inverted to deduce star-formation histories.

There is substantial evidence that the bulge has a triaxial shape seen nearly end-on. Indications for this come from the asymmetric near-infrared light distribution, star counts, the atomic and

molecular gas morphology and kinematics, and the large optical depth to micro-lensing. The actual shape, orientation, and scale-length of the bulge, and the possible presence of an additional bar-like structure in the disc plane, however, remain a matter of debate. The reason why it is so difficult to derive the shape of the galactic bar is that three-dimensional distributions cannot be uniquely recovered from projected surface brightness distributions such as the COBE/DIRBE maps. GAIA proper motions to faint magnitudes, in particular in a number of low-extinction windows, will allow unambiguous determination of the shape, orientation, tumbling rate mass profile and star-formation history of the bulge.

The Halo

The stellar halo of the Galaxy contains only a small fraction of its total luminous mass, but the kinematics and abundances of halo stars, globular clusters, and the dwarf satellites contain imprints of the formation of the entire Milky Way. In fact the halo is likely to be the most important component that may be used to distinguish among competing scenarios for the formation of our Galaxy. The classical picture of inner monolithic collapse plus later accretion in the outer Galaxy predicts a smooth distribution both in configuration and velocity space for our solar neighbourhood, which is consistent with the available observational data. Currently popular hierarchical cosmologies propose that big galaxies are formed by merging and accretion of smaller building blocks, and many of its predictions seem to be confirmed in high-redshift studies. These merging and accretion events leave signatures in the space and velocity distribution of the stars that once formed those systems. Recent work has considered the present-day signature that could be observed arising from the debris of a precursor which was disrupted during or soon after the formation of the Milky Way. These studies show that while there are no strong correlations after 10 billion years of evolution in the spatial distribution of a satellite's stars, there are strong correlations in velocity space. These correlations manifest themselves as a very large number of moving groups each having a small velocity dispersion and containing several hundred stars. To detect individual streams would require accuracies of less than a few kilometres per second, requiring measurement precisions of microarcseconds. GAIA will be able to achieve this (Fig. 3).

The Outer Halo

GAIA will find several million individual stars in the outer halo, at distances of more than about 50 000 light-years from the Galactic Centre. These will mostly be G and K giants and red

and blue horizontal branch stars. G and K giants are intrinsically bright, they form in all known old stellar population types, they have easily measurable radial velocities, and they are historically well studied because they are the most easily accessible stars in the globular clusters. Horizontal branch stars have been the preferred tracer stellar type for the outer halo to date, because they can be much more easily identified amongst field stars than G and K giants. In particular, blue horizontal branch stars have been very easy to locate. However they are a biased tracer of the halo population in the sense that they do not always form in old metal weak populations. Redder horizontal branch stars and G and K halo giants are drowned out by the huge numbers of foreground turnoff and dwarf stars in the galactic disc.

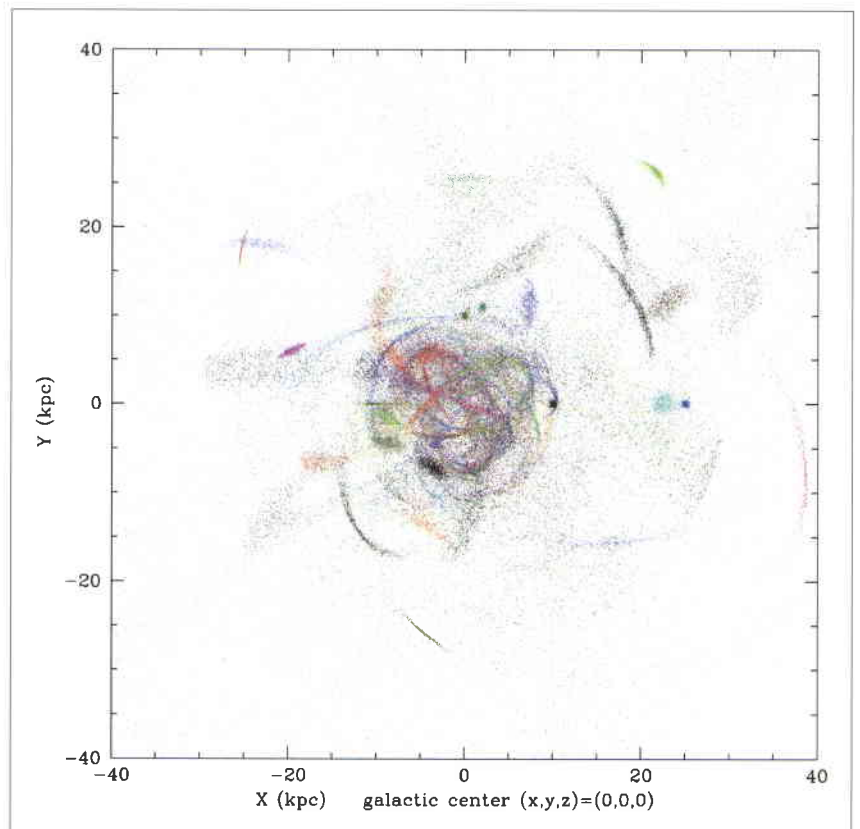

GAIA will circumvent all these difficulties. The late-type foreground dwarfs are much closer than the background late-type giants, so that even at the faintest magnitudes the dwarfs have a measurable parallax while the background giants do not. It will be possible to lift the veil of foreground stars and reveal millions of background halo stars, on the giant branch, and the red and blue horizontal branch.

The GAIA observatory

GAIA will do more than just record huge volumes of positional data on a vast number of astrophysical targets. GAIA will also provide a complementary range of data, with a diversity

Figure 3. This simulation shows how a galaxy halo, like our own, may have been built up by the accretion of 50 dwarf galaxies colliding with the galaxy at various times during the last 10 billion years. The unit of distance is the kpc, or kiloparsec, where 1 kpc is a little more than 3000 light-years. GAIA would be able to detect the fossil streams of these ancient merging events (Courtesy of Paul Harding)

of applications. Every one of the 10^9 GAIA targets will be observed typically 100 times, each time with a complementary set of photometric filters, and a large fraction also with a radial velocity spectrograph. The available angular resolution exceeds that available in ground-based surveys. Source detection happens on-board at each focal-plane transit, so that variable and transient sources are detected. All these complementary data sets, in addition to the superb positional and kinematic accuracy derivable from their sum, make GAIA a powerful and revolutionary observatory mission: every observable object will be scrutinised every time it crosses the focal plane.

These data allow studies from asteroids to distant supernovae, from planets to galaxies, and naturally interest almost the entire astronomical community. Because of this enormous interest, GAIA will be an open observatory mission, directly making available its rich scientific resource to the sponsoring communities. The scale of the GAIA data is such that some analyses can be undertaken during operations, while others must await final data reduction. The GAIA observatory will provide exciting scientific data to a very wide community, beginning with the first photometric observations, and rapidly increasing until the fully reduced GAIA data become available. The resulting analyses will provide a vast scientific legacy, providing a wealth of quantitative data on which all of astrophysics will build.

The payload

To access a very significant fraction of the Galaxy requires accuracies of 10 micro-arcseconds at 15th magnitude (this was also a

requirement specified by the Horizon 2000+ Survey Committee in 1994). The limiting magnitude and the number of objects that can be observed with GAIA follow from this accuracy requirement. The current technical design allows meaningful observations to 20th magnitude; this implies that important galactic tracers that only become accessible at 17-18th magnitude will be observed in significant numbers. A global sky-surveying mission such as GAIA must also be complete to well specified limits: this can be achieved by the on-board detection of all objects crossing the field-of-view.

There are three motivations for considering the parallel acquisition of radial velocities with GAIA: (i) the astrometric measurements supply only two components of the space motion of the target stars. The third component, the radial velocity, is required for proper kinematic or dynamical studies; (ii) radial velocity measurements are a powerful astrophysical diagnostic tool; (iii) at GAIA accuracies, perspective acceleration must be accounted for.

GAIA photometric measurements will provide essential diagnostic data, allowing the classification of all objects observed on the basis of luminosity, effective temperature, mass, age and composition. A wide separation of two individual viewing directions is a fundamental pre-requisite for the payload, since this leads to the determination of absolute trigonometric parallaxes, and thereby circumvents the problem that has plagued ground-based parallax determinations, namely the transformation of relative parallaxes to absolute distances.

Figure 4. Characteristics of the observing strategy. The satellite rotates slowly about its spin axis, which itself precesses at a fixed angle of 55 deg to the Sun. LOS 1 and LOS 2 indicate the lines of sight for the two viewing angles which scan the same great circle on the sky

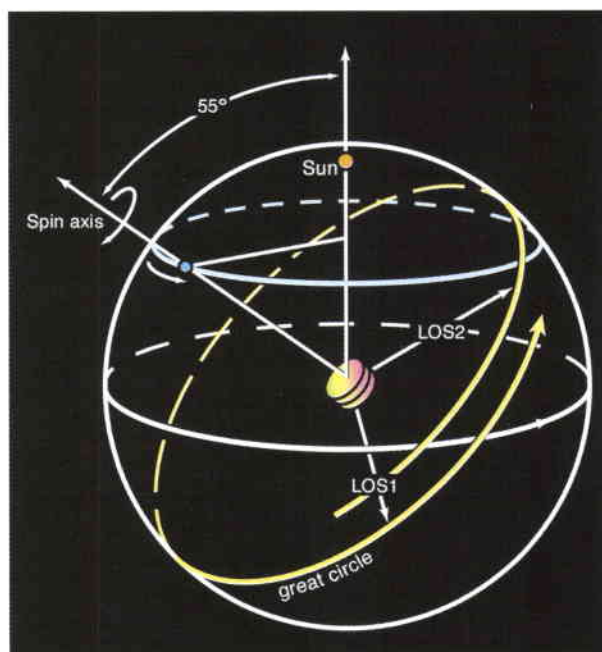

The measurements conducted by a continuously scanning satellite can be shown to be almost optimally efficient, with each photon acquired during a scan contributing to the precision of the resulting astrometric parameters (Fig. 4). Pointed observations cannot provide the overriding benefit of global astrometry using a scanning satellite, which is that a global instrument calibration can be performed in parallel, and the interconnection of observations over the celestial sphere provides the rigidity and reference system, immediately connected to an extragalactic reference system.

Quantifying and generalising from these basic design considerations, the general principles of the proposed mission can be summarised as follows:

(i) it is a continuously scanning instrument, capable of measuring simultaneously the angular separations of thousands of star images as they pass across a field of view of about 1 deg diameter. Simultaneous multi-colour photometry of all astrometric targets is a necessary and integral part of the concept; (ii) high angular resolution in the scanning direction is provided by a monolithic mirror of dimension ~ 1.7 m; (iii) the wide-angle measuring capability is provided by two viewing directions at large angles to each other and scanning the same great circle on the sky; (iv) the whole sky is systematically scanned in such a way that observations extending over several years permit a complete separation of the astrometric parameters describing the motions and distances of the stars.

The resulting payload design consists of:
 (a) Two astrometric viewing directions. Each of these 'Astro' instruments comprises an all-reflective three-mirror telescope with an aperture of 1.7×0.7 m², the two fields separated by a basic angle of 106 deg (Fig. 5). Each astrometric field comprises an astrometric sky mapper (providing an on-board capability for star detection and selection, and for the star position and satellite scan-speed measurement), and the astrometric field proper, employing CCD technology, with about 250 CCDs and

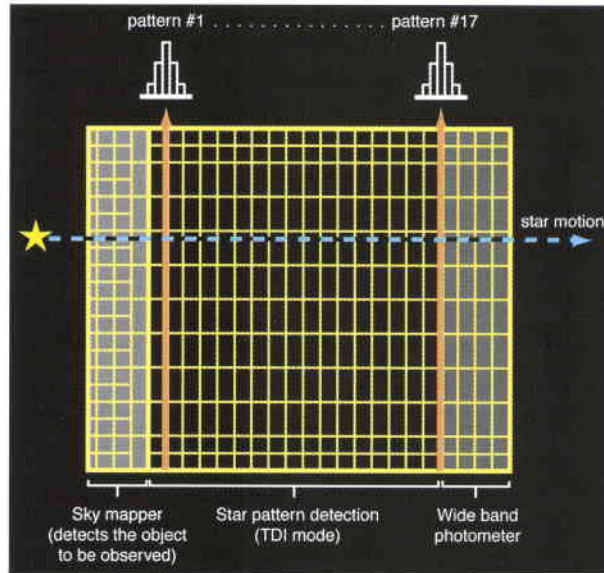

Figure 5. Overview of the astrometric focal plane (identical for Astro-1 and Astro-2). Star images cross the field, are detected by the astrometric sky mapper (left), observed in windowing mode across the main CCD arrays, and finally across the broad-band photometric field

accompanying video chains per focal plane, a pixel size of $9 \mu\text{m}$ along scan, TDI operation, and an integration time of ~ 0.9 s per CCD. There is also a broad-band photometer, providing multi-colour, multi-epoch photometric measurements for each object observed in the astrometric field.

(b) An integrated radial velocity spectrometer and photometric instrument, comprising an all-reflective three-mirror telescope of aperture 0.75×0.70 m² (Fig. 6). The field of view is separated into a dedicated sky mapper, the

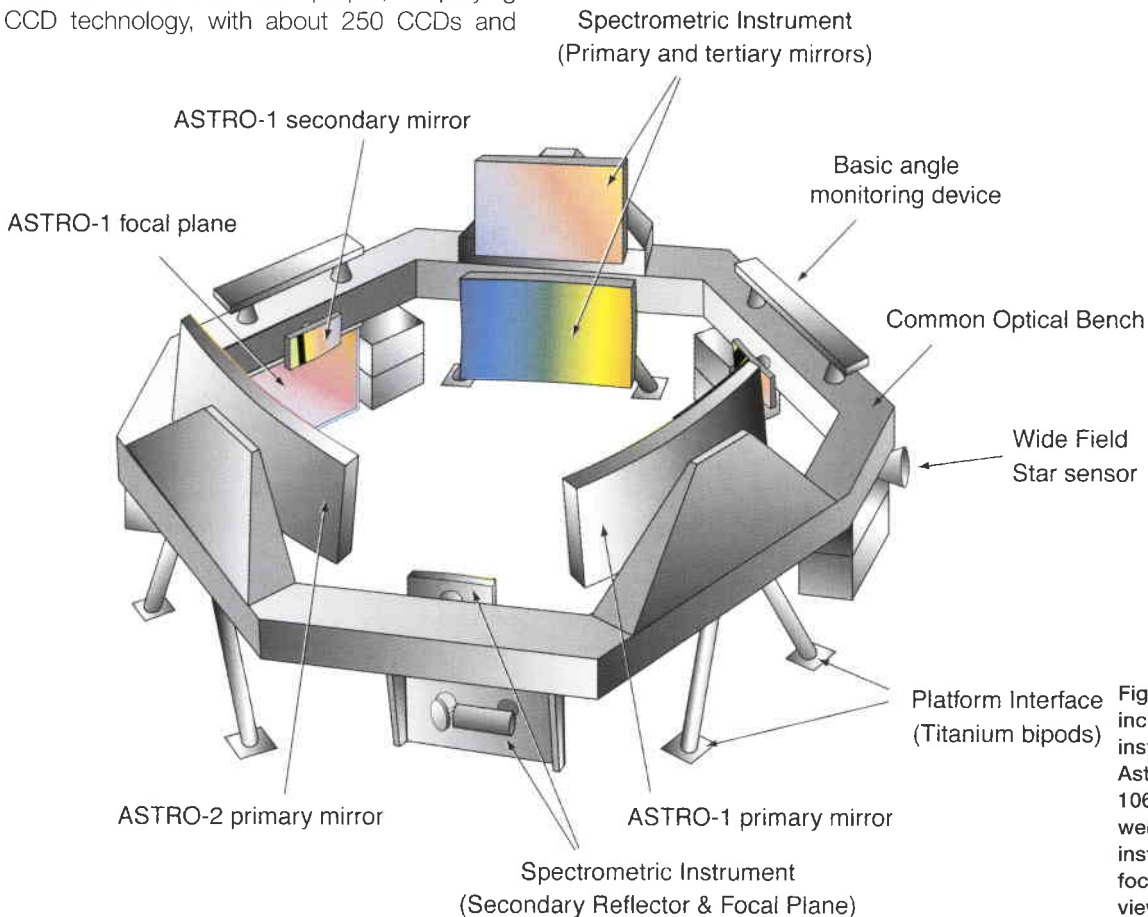

Figure 6. The GAIA payload includes two identical instruments (Astro-1 and Astro-2) separated by the 106 deg basic angle, as well as a spectrometric instrument which shares the focal plane of a third viewing direction

radial-velocity spectrometer, and a medium-band photometer with 11 filters. Both instrument focal planes are also based on CCD technology operating in TDI mode. The 11 medium spectral bands have been provisionally selected to optimise the scientific content of these photometric measurements.

(c) The opto-mechanical-thermal assembly comprising: (i) a single structural torus supporting all mirrors and focal planes, employing SiC for both mirrors and structure; (ii) a deployable sunshield to avoid direct Sun illumination and rotating shadows on the payload module, combined with the solar-array assembly; (iii) control of the heat injection from the service module into the payload module, and control of the focal-plane assembly power dissipation in order to provide an ultra-stable internal thermal environment; (iv) an alignment mechanism on the secondary mirror for each astrometric instrument, with micron-level

positional accuracy and 200 μm range, to correct for telescope aberration and mirror misalignment at the beginning of life; (v) a permanent monitoring of the basic angle, but without active control on board.

Spacecraft design, launch and orbit

The GAIA spacecraft has been designed to take advantage of a dual/multiple launch with the Ariane-5 launcher (Fig. 7). The satellite consists of a payload module and a service module, which are mechanically and thermally decoupled. The solar array/sunshield assembly has a span of 9.50 m when deployed. The optical covers are removed from the instrument entrance apertures in orbit.

The service module has a conical shape to avoid any turning shadows falling onto the solar array/sunshield assembly. It interfaces on one side with the standard 1666 mm adapter of the Ariane-5 launcher, and on the other with the payload module. The service module structure is made of aluminium, with CFRP shear walls. All units accommodated in the module are thermally coupled to the lateral panels of the module, which are used as radiators and covered with optical solar reflectors. The temperature of the service module in orbit is around 20°C, and the payload module temperature about 200 K, with a temperature stability of the order of tens of μK . The system therefore provides a very quiet and stable thermal environment for the payload optical bench.

The solar array/sunshield assembly includes six solar-array wings, which are stowed during launch against the six lateral panels of the service module. Each wing is made of two solar panels based on Ga-As cells on CFRP structure. Hinges, based on a shape-memory-alloy construction, are foreseen between the panels, as well as between the wings and the service module core structure. The solar panels are insulated from the payload module with multi-layer insulation (MLI) on their rear face. Additional MLI sheets, reinforced with kevlar cables, are spread between the solar-array wings to complete the sunshield function. They are deployed together with the solar panels. The communications to ground are provided by an X-band link, with 3 Mbps science data rate, RF on-board power of 17 W, and a high-gain, electronically-steered phased-array antenna. The Perth 32 m diameter ground station is foreseen to be used for GAIA, with around 8 hours of visibility per day. The satellite telecommand (2 kbps) and housekeeping telemetry (2 kbps) is provided by a low-gain antenna system with omni-directional coverage. The present design concept includes an

Figure 7. The GAIA satellite in orbit, with solar panels and sunshield deployed, viewed from above (top) and below (bottom)

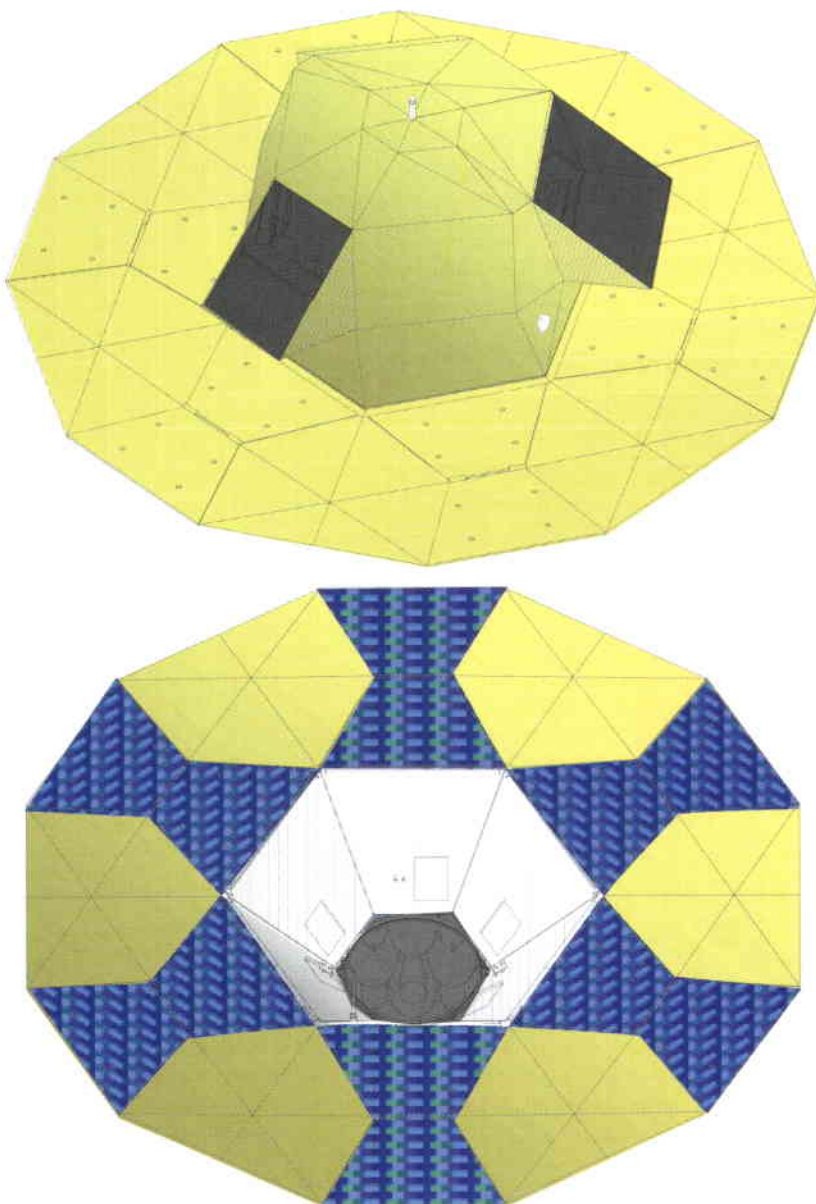

autonomous propulsion system with a 400 N motor, to take the satellite from geostationary transfer orbit to its final orbit around L2. This propulsion system could be deleted, thereby simplifying the satellite's design, if availability of the planned re-startable Ariane-5 launcher stage is confirmed before GAIA project activities start.

If selected as the next ESA Cornerstone mission, GAIA would be launched from the European spaceport at Kourou in 2009. The operational orbit selected for GAIA is a Lissajous-type, eclipse free orbit around the L2 Lagrangian point of the Sun-Earth system (at 1.5 million kilometres from the Earth). This particular orbit offers many advantages, including a very stable thermal environment, a very high observing efficiency (Sun, Earth and Moon are always outside the instrument field of view), and a low-radiation environment. An operational lifetime of five years is foreseen.

Conclusion

GAIA addresses science of enormous general appeal, and will deliver huge scientific impacts across the whole of astrophysics from studies of the Solar System, and other planetary systems, through stellar astrophysics, to its primary goal, the origin and evolution of galaxies, out to the large-scale structure of the Universe, and fundamental physics. In this article we have presented just some of the scientific questions that will be addressed by GAIA. A more detailed discussion of the scientific case, including results from specific GAIA simulations, can be found on the GAIA web site at <http://astro.estec.esa.nl/GAIA/>.

GAIA is timely as it builds on recent intellectual and technological breakthroughs. Current understanding and exploration of the early Universe, through microwave background studies (e.g. Planck) and direct observations of high-redshift galaxies (HST, NGST, VLT) have been complemented by theoretical advances in understanding the growth of structure from the early Universe up to galaxy formation. Serious further advances require a detailed understanding of a 'typical' galaxy, to test the physics and assumptions in the models. The Milky Way and the nearest Local Group galaxies uniquely provide such a template.

While challenging, the entire GAIA design is within the projected state-of-the-art, and the satellite can be developed in time for launch in 2009. With such a schedule, a detailed stereoscopic map of our Galaxy will be available within 15 years. By providing a quantitative census of the Milky Way, GAIA will provide a huge advance in unlocking its origins.

Acknowledgements

This summary of the GAIA mission is based on the GAIA Study Report, which is the result of a large collaboration between ESA, the European scientific community, and European industry. The study has been supervised by the Science Advisory Group Members, chaired by M. Perryman (ESA), comprising: K.S. de Boer (Sternwarte Universität Bonn), G. Gilmore (University of Cambridge), E. Høg (Copenhagen University Observatory), M.G. Lattanzi (Osservatorio Astronomico di Torino), L. Lindegren (Lund Observatory), X. Luri (Universitat de Barcelona), F. Mignard (Observatoire de la Côte d'Azur) and P.T. de Zeeuw (Sterrewacht Leiden).

The work of the Science Advisory Group has been supported by a Science Working Group, chaired by P.T. de Zeeuw and G. Gilmore (18 members) and responsible for quantifying the scientific case; a Photometry Working Group, chaired by F. Favata (18 members); an Instrument Working Group, chaired by L. Lindegren (16 members); and 52 other European scientists directly supporting the GAIA study.

ESA scientific involvement includes contributions from S. Volonté (ESA Paris), and from scientists within the Astrophysics Division (F. Favata, K.S. O'Flaherty, W. O'Mullane, M. Vannier and A. Colorado-McEvoy).

Technological activities have been led by the Study Manager, O. Pace (SCI-PF), and supported by M. Hechler (ESOC Study Manager), and a number of D-TOS engineers: J. Doutréau (data processing), H. Evans (radiation), C. Gomez (thermal control), J. Gavira (structure), A. Martin Polegre (antenna), A. Mohammadzadeh (CCD CTE), R. Morgan-Owens (communications), P. Nieminen (radiation), C. Philippe (attitude and orbit control system), A. Popescu (basic angle monitoring), and I. Zayer (CCD operations). The satellite design was contracted to Matra Marconi Space (F), under Study Manager P. Mérat, and involving EEV Ltd (UK), and Alcatel Space (F). An Alenia Study Team, under Study Manager S. Cesare, evaluated the performance of an interferometric design, with the involvement of the Istituto di Metrologia 'G. Colonnetti', EICAS Automazione, the Osservatorio Astronomico di Torino, Matra Marconi Space (F), and Alcatel Space. Other industrial studies have been carried out by SIRA UK (CCD CTE), and TNO-TPD Delft (basic angle monitoring).



LISA – Detecting and Observing Gravitational Waves

R. Reinhard

Space Science Department, ESA Directorate of Scientific Programmes, ESTEC, Noordwijk, The Netherlands

In Newton's theory of gravity, the gravitational interaction between two bodies is instantaneous, but according to Einstein's theory of gravity this should be impossible because the speed of light represents the limiting speed for all interactions. If a body changes its shape, the resulting change in the force field will make its way outward at the speed of light. In Einstein's theory of gravity, massive bodies produce 'indentations' in the 'fabric' of spacetime and other bodies move in this curved spacetime taking the shortest path. If a mass distribution moves in a spherically asymmetric way, then the spacetime indentations travel outwards as ripples in spacetime called 'gravitational waves'.

Gravitational waves are fundamentally different from the familiar electromagnetic waves. While

electromagnetic waves, created by the acceleration of electric charges, propagate in the framework of space and time, gravitational waves, created by the acceleration of masses, are waves of the spacetime fabric itself. Unlike charge, which exists in two polarities, mass always comes with the same sign. This is why the lowest order asymmetry producing electromagnetic radiation is the dipole moment of the charge distribution, whereas for gravitational waves it is a change in the quadrupole moment of the mass distribution. Hence those gravitational effects that are spherically symmetric will not give rise to gravitational radiation. A perfectly symmetric collapse of a supernova will produce no waves, while a non-spherical one will emit gravitational radiation. A binary system will always radiate.

The primary objective of the LISA (Laser Interferometer Space Antenna) mission is the detection and observation of gravitational waves from massive black holes and galactic binaries down to a gravitational wave strain sensitivity of 10^{-23} in the frequency range $10^{-4} - 10^{-1}$ Hz (Fig. 1). This low-frequency range is inaccessible to ground-based interferometers because of the unshieldable background of local gravitational noise.

Gravitational waves are a direct consequence of Einstein's theory of General Relativity (GR). If Einstein's theory is correct, gravitational waves must exist, but up to now they have not been detected. However, there is strong indirect evidence for the existence of gravitational waves: the binary pulsar PSR 1913 +16 loses energy exactly at the rate predicted by GR by emitting gravitational radiation.

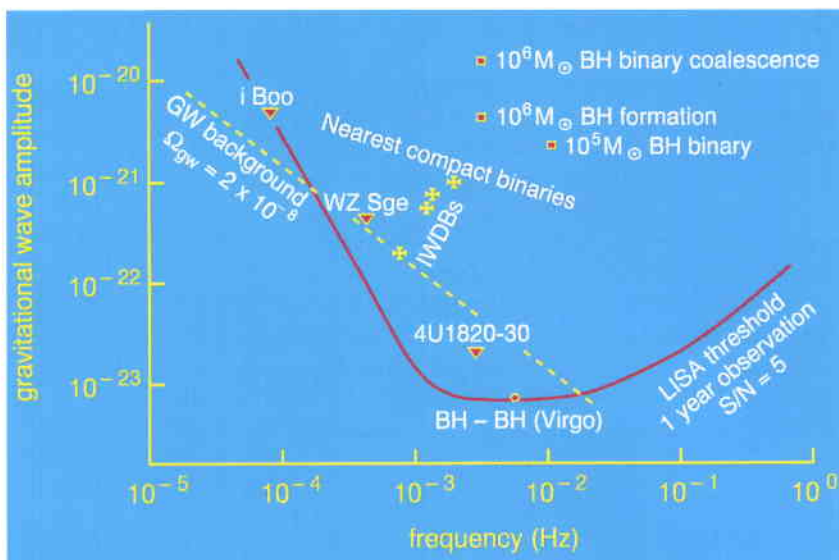

Gravitational waves distort spacetime; in other words they change the distances between free macroscopic bodies. A gravitational wave passing through the Solar System creates a time-varying strain in space that periodically changes the distances between all bodies in the Solar System in a direction that is perpendicular to the direction of wave propagation. These could be the distances between spacecraft and the Earth, as in the case of Ulysses or Cassini (attempts were and will be made to measure these distance fluctuations) or the distances between shielded proof masses inside spacecraft that are

Figure 1. The target sensitivity curve of LISA and the strengths of expected gravitational wave sources

separated by a large distance, as in the case of LISA.

The main problem is that the relative length change due to the passage of a gravitational wave is exceedingly small. For example, the periodic change in distance between two proof masses, separated by a sufficiently large distance, due to a typical white dwarf binary at a distance of 50 pc, is only 10^{-10} m. This is not to say that gravitational waves are weak in the sense that they carry little energy. On the contrary, a supernova in a not too distant galaxy will drench every square metre here on Earth with kilowatts of gravitational radiation. The resulting length changes, though, are very small because spacetime is an extremely stiff elastic medium, so that it takes extremely large energies to produce even minute distortions.

It is because of the extremely small distance changes that gravitational waves have not yet been detected. However, with the LISA space interferometer, orbiting the Sun at 1 AU, millions of sources will be detected in one year of observation with a signal-to-noise ratio of 5 or better.

The LISA mission consists of three identical spacecraft located 5×10^6 km apart, forming an equilateral triangle (Fig. 2). The distance

between the spacecraft – the interferometer arm length – determines the frequency range in which LISA can make observations; it has been carefully chosen to allow for the observation of most of the interesting sources of gravitational radiation. The centre of the triangular formation is in the ecliptic plane, 1 AU from the Sun and 20° behind the Earth. The plane of the triangle is inclined at 60° with respect to the ecliptic. These particular heliocentric orbits for the three spacecraft have been chosen such that the triangular formation is maintained throughout the year, with the triangle appearing to rotate about the centre of the formation once per year.

While LISA is basically a giant Michelson interferometer in space, the actual implementation in space is very different from a laser interferometer on the ground and is much more reminiscent of the technique called spacecraft tracking, but here realised with infrared laser light instead of radio waves. The laser light going out from the centre spacecraft to the other corners is not directly reflected back because very little light intensity would be left over in that way. Instead, in complete analogy with a radio-frequency transponder scheme, the laser on the distant spacecraft is phase-locked to the incoming light, providing a return beam with full intensity again. After being transponded back from the far spacecraft to

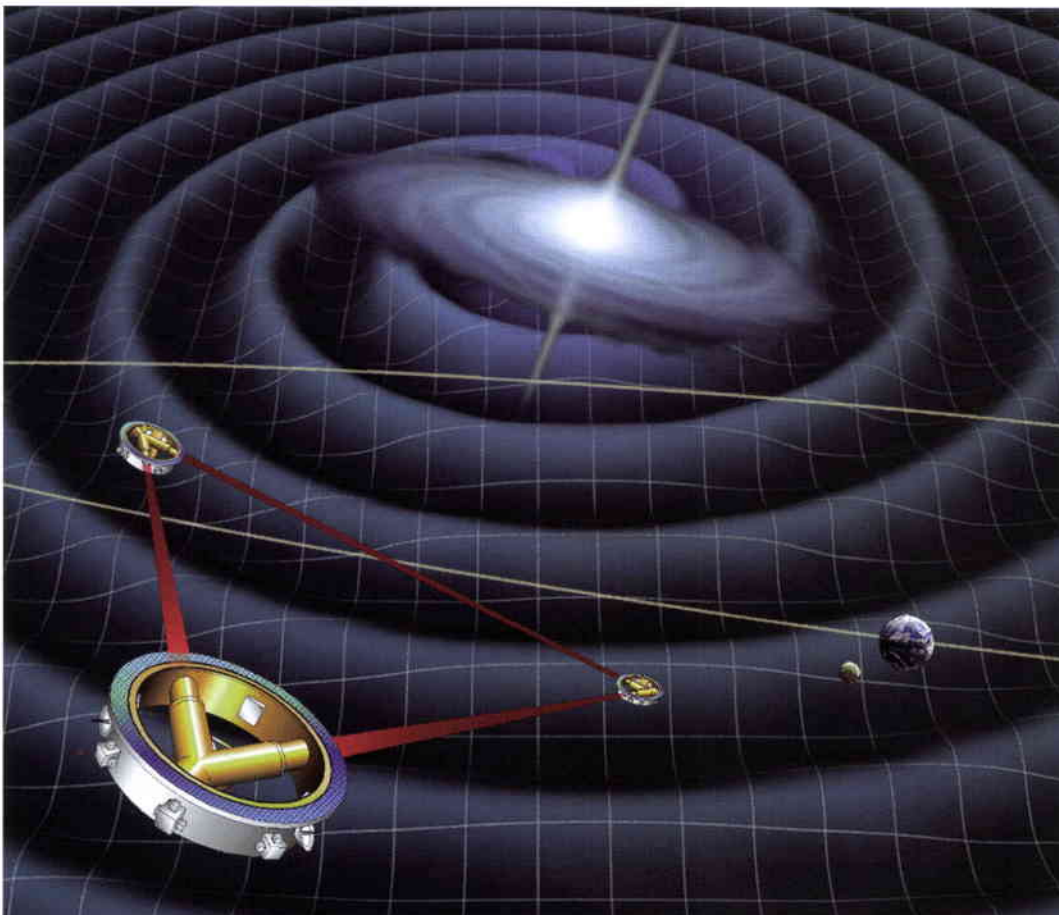

Figure 2. Artist's concept of gravitational waves emitted by a binary system, with the three-spacecraft LISA configuration and the Earth-Moon system

the centre spacecraft, the light is superposed with the on-board laser light serving as a local oscillator in a heterodyne detection.

Each spacecraft contains two optical assemblies (Fig. 3). The two assemblies on one spacecraft each point towards an identical assembly on each of the other two spacecraft. A 1 W infrared laser beam is transmitted to the corresponding remote spacecraft via a 30-cm aperture f/1 Cassegrain telescope. The same telescope is used to focus the very weak beam (a few pW) coming from the distant spacecraft and to direct the light to a sensitive photo-detector, where it is superimposed with a fraction of the original local light. At the heart of each assembly is a vacuum enclosure containing a free-flying polished platinum-gold cube, 4 cm in size, referred to as the 'proof mass', which serves as an optical reference ('mirror') for the light beams. A passing gravitational wave will change the length of the optical path between the proof masses of one arm of the interferometer relative to the other arm. These distance fluctuations are measured to sub-Ångstrom precision which, when combined with the large separation between the spacecraft, allows LISA to detect gravitational-wave strains down to a level of order $\Delta l/l = 10^{-23}$ in one year of observation (l is the baseline length of 5×10^6 km).

The spacecraft mainly serve to shield the proof masses from the adverse effects of the solar radiation pressure, and the spacecraft's position does not directly enter into the measurement. It is nevertheless necessary to keep all spacecraft moderately accurately (10^{-8} m Hz^{-1/2} in the measurement band) centred on their respective proof masses to reduce spurious local noise forces. This is achieved by a 'drag-free' control system, consisting of an accelerometer (or inertial

sensor) and a system of electrical thrusters. Capacitive sensing is used to monitor the relative motion between each spacecraft and its test masses. These position signals are used in a feedback loop to command micro-Newton ion-emitting proportional thrusters to enable the spacecraft to follow its test masses precisely and without introducing disturbances in the bandwidth of interest. The same thrusters are used for precision attitude control relative to the incoming optical wave fronts.

Each of the three LISA spacecraft has a launch mass of about 460 kg (incl. margin). Ion drives are used for the transfer from the Earth orbit to the final position in interplanetary orbit. All three spacecraft can be launched by a single Delta-II 7925H vehicle.

Several large interferometers for the detection of gravitational waves are currently under construction on the ground: two LIGO interferometers in the USA (each 4 km), the French-Italian collaborative VIRGO in Europe (3 km), GEO 600 in Germany (0.6 km), AIGO 500 in Australia (0.5 km) and TAMA 300 in Japan (0.3 km) (interferometer baseline lengths in parentheses). The ground-based interferometers and the LISA interferometer in space complement each other in an essential way. Just as it is important to complement the optical and radio observations from the ground with observations from space at submillimetre, infrared, ultraviolet, X-ray and gamma-ray wavelengths, so too is it important to complement the gravitational-wave observations made by the ground-based interferometers in the high-frequency regime (10 to 10³ Hz) with observations in space in the low-frequency regime (10⁻⁴ to 10⁻¹ Hz).

Ground-based interferometers can observe the bursts of gravitational radiation emitted by

Figure 3. Left: Cut-away view of one of the three identical LISA spacecraft. The main structure is a ring with a diameter of 1.8 m and a height of 0.48 m, made from graphite-epoxy for low thermal expansion. A lid on top of the spacecraft is removed to provide a view of the Y-shaped payload. Right: Detail of the payload on each Y-shaped LISA spacecraft, consisting of two identical telescopes and two optical benches each housing a drag-free test mass (the yellow cubes in the centres)

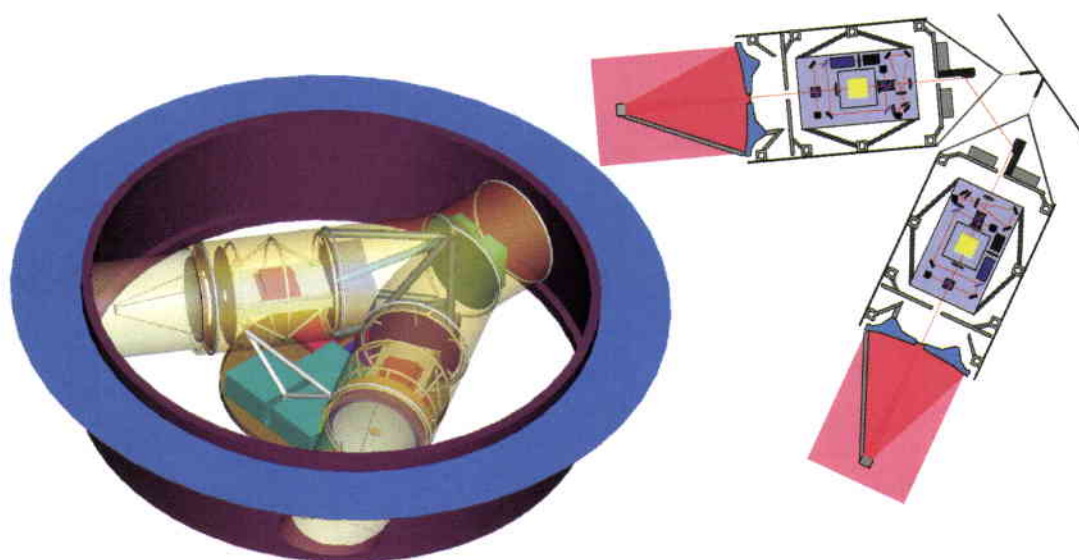

galactic binaries during the final stages (minutes and seconds) of coalescence, when the frequencies are high and both the amplitudes and frequencies increase quickly with time. At low frequencies, which are only observable in space, the orbital radii of the binary systems are larger and the frequencies are stable over millions of years. Coalescences of massive black holes are only observable from space. Both ground- and space-based detectors will also search for a cosmological background of gravitational waves. Since both kinds of detectors have similar energy sensitivities, their different observing frequencies are ideally complementary: observations can provide crucial spectral information.

LISA was proposed to ESA in May 1993 in response to the Agency's Call for Mission Proposals for the third Medium-Size Project (M3). The proposal was submitted by a team of American and European scientists who envisaged LISA as an ESA/NASA collaborative project. The mission was conceived as comprising four spacecraft in a heliocentric orbit forming an interferometer with a baseline of 5×10^6 km.

LISA was selected for study as an ESA-only project, but it became clear quite early in the Assessment Phase that it was not likely to be a successful candidate for M3 because the cost for an ESA-only LISA considerably exceeded the M3 limit of 350 MEuro. In December 1993, LISA was therefore re-proposed to ESA, this time as a Cornerstone mission for 'Horizon 2000 Plus', involving six spacecraft in a heliocentric orbit with a pair of spacecraft at each vertex of an equilateral triangle.

Initially, ESA scenarios for the launch of future Cornerstones included an ESA-only LISA launch in 2017 or even later, but then it became clear that by that time the LISA Cornerstone would in all likelihood be pre-empted by an earlier NASA mission. Bearing in mind that it had consistently been the wish of the international LISA Team to see LISA carried out as an ESA/NASA collaborative mission, it was agreed in the summer of 1998 that this would be the new baseline. A launch around 2010 of the ESA/NASA collaborative LISA mission is now widely being considered as extremely desirable. Recently, ESA's Fundamental Physics Advisory Group (FPAG) recommended capping the ESA involvement in this joint endeavour at 150 MEuro. In 1996 and 1997, the LISA team suggested a series of cost-saving measures which should bring the total project cost to about 300 MEuro (excl. the payload), i.e. ESA's contribution of 150 MEuro should allow a 50/50 partnering arrangement.

In this arrangement it is assumed that ESA would provide the three spacecraft, while NASA would provide the launch vehicle and the mission operations; the payload would be shared 50/50. The most drastic cost-saving measure was a reduction of the number of spacecraft from six to three; this was achieved by replacing a pair of spacecraft at the vertices of a triangular configuration by a single spacecraft, with essentially two identical instruments on each spacecraft. This and other measures taken together allowed the launch mass to be reduced from 6.8 t to 1.4 t.

An ESA system-level industrial study (June 1999 – February 2000) fully confirmed the feasibility of the three-spacecraft configuration. Nevertheless, LISA is not a candidate for selection as Cornerstone 5 in the September/October 2000 time frame because:

- Unlike BepiColombo and GAIA, the two candidates for CS5, LISA is a collaboration with NASA and a commitment by NASA cannot be expected by September.
- Unlike BepiColombo and GAIA, LISA has no clearly identified technology demonstration mission (BepiColombo has SMART-1 with a launch in 2002, while GAIA does not need a technology demonstration mission).

LISA requires several new technologies, which should be tested in space for extended time periods under zero-gravity conditions. These are:

- the inertial sensor performance to within an order of magnitude of the LISA requirements
- the low-frequency laser interferometry between two proof masses
- drag-free satellite operations with two inertial sensors using field-emission ion thrusters.

Ideally, such a technology demonstration mission should be launched about five years before LISA. A launch much earlier would not allow full utilisation of the latest technologies to be tested, while one much later would not allow full advantage to be taken of the know-how obtained during the technology demonstrator flight in the design phase of the LISA mission. To preserve the possibility of launching the NASA/ESA collaborative LISA mission in 2010, the technology demonstration mission should therefore be flown in 2005.

A LISA technology demonstrator is a strong candidate for ESA's SMART-2 (Small Mission for Advanced Research in Technology) mission foreseen for launch in 2005. The selection process for SMART-2 will take place in October 2000.



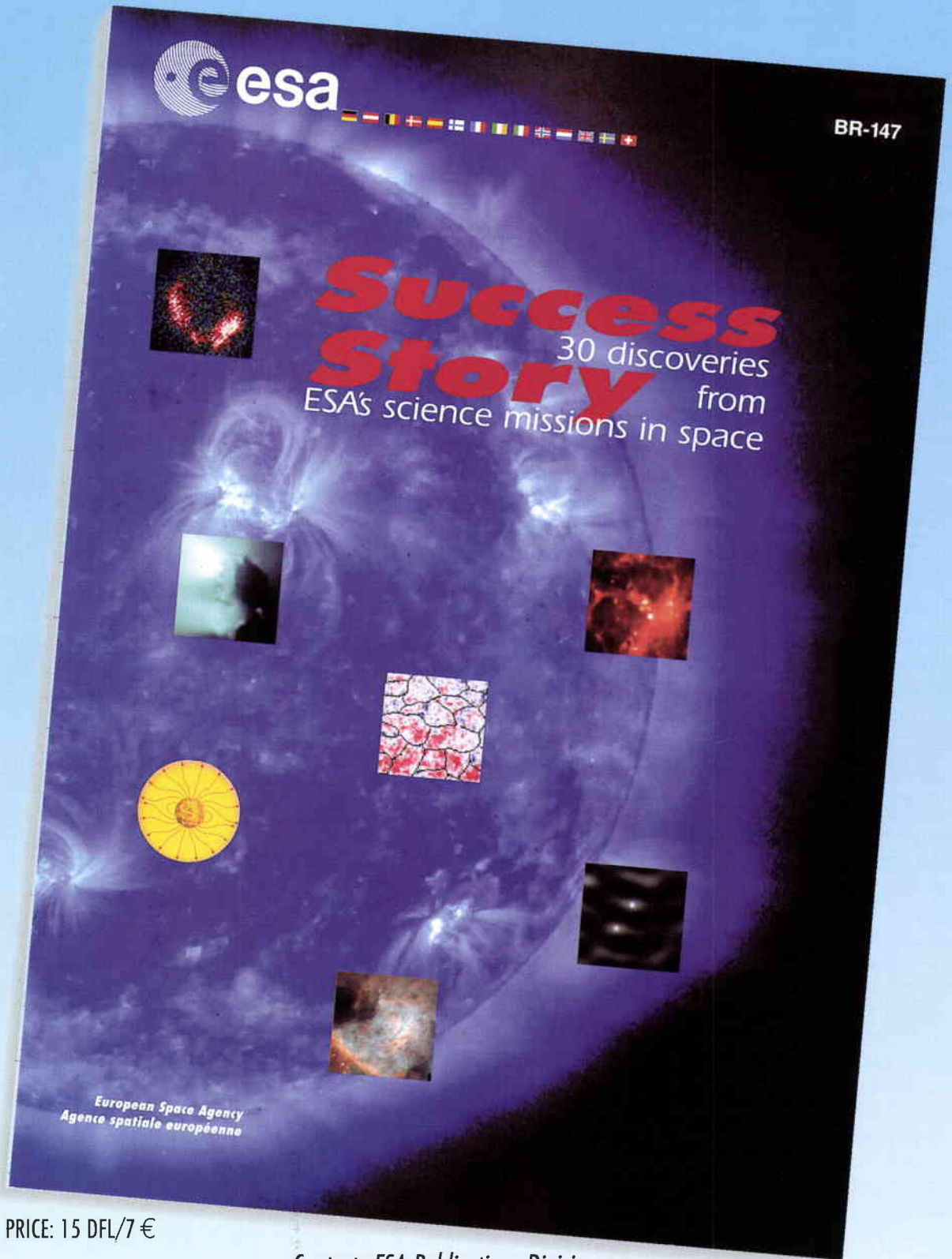

esa

BR-147

Success Story
30 discoveries
from
ESA's science missions in space

European Space Agency
Agence spatiale européenne

PRICE: 15 DFL/7 €

Contact: *ESA Publications Division*
c/o ESTEC, PO Box 299, 2200 AG Noordwijk, The Netherlands
Tel. (31) 71 565 3405 - Fax (31) 71 565 5433

ORDER FORM INSIDE BACK COVER

Ulysses at Solar Maximum and Beyond

R.G. Marsden

Solar System Division, Space Science Department, ESA Directorate of Scientific Programmes, ESTEC, Noordwijk, The Netherlands

Introduction

After a brief review of the mission and its achievements, this article presents some recent highlights. These include the discovery, not recognised at the time, that in 1996, Ulysses set the record for finding the longest comet tail ever. This record is not the only one held by ESA's intrepid heliospheric explorer. Ulysses attained a speed of 15.4 km/s just after burn-out of the upper-stage motors, making it the fastest man-made object to have left the Earth's gravitational pull. It has also reached by far the highest solar latitude of any spacecraft,

and travelled further from the Sun than any other ESA-built space probe. Following a look at some of the operational challenges ahead, the remainder of the article is devoted to the future, which for Ulysses continues to look bright. The spacecraft and its payload are in excellent condition, and there are plans to extend orbital operations until September 2004. By that time Ulysses will have completed its second out-of-ecliptic orbit of the Sun. ESA's Science Programme Committee (SPC), at its meeting on 6 June, unanimously approved the proposed extension, and there is good hope that NASA will do likewise when the mission comes up for review next year.

The year 2000 promises to be highly eventful for the joint ESA-NASA Ulysses mission. Not only does it mark an important anniversary – on 6 October, Ulysses will have been in orbit for 10 years – it also sees the return of Ulysses to the poles of the Sun. Given the spectacular success of the spacecraft's first visit to these previously unexplored regions in 1994/95, there is every reason to expect a rich scientific harvest once again. Bound inexorably by the laws of celestial mechanics, Ulysses has followed an almost identical path on its climb to high latitudes to that travelled six years earlier. The conditions it has encountered this time have, however, been markedly different. The first polar passes in 1994 and 1995 took place at a time of low solar activity, whereas now the sunspot cycle is very close to its peak. This has had a clear effect on many of the phenomena recorded by the scientific instruments on board the spacecraft.

The mission to date

Ulysses was launched by the Space Shuttle 'Discovery' in October 1990. Following a gravity-assist manoeuvre at Jupiter in February 1992, the space probe and its suite of scientific instruments have been pursuing goals related to the Sun, its heliosphere, and the region of interstellar space surrounding the heliosphere, all from the unique perspective of a solar polar orbit (Fig. 1). The portions of the orbit when Ulysses is above 70° solar latitude have been designated 'polar passes', and the first such polar passes occurred in 1994 (south) and

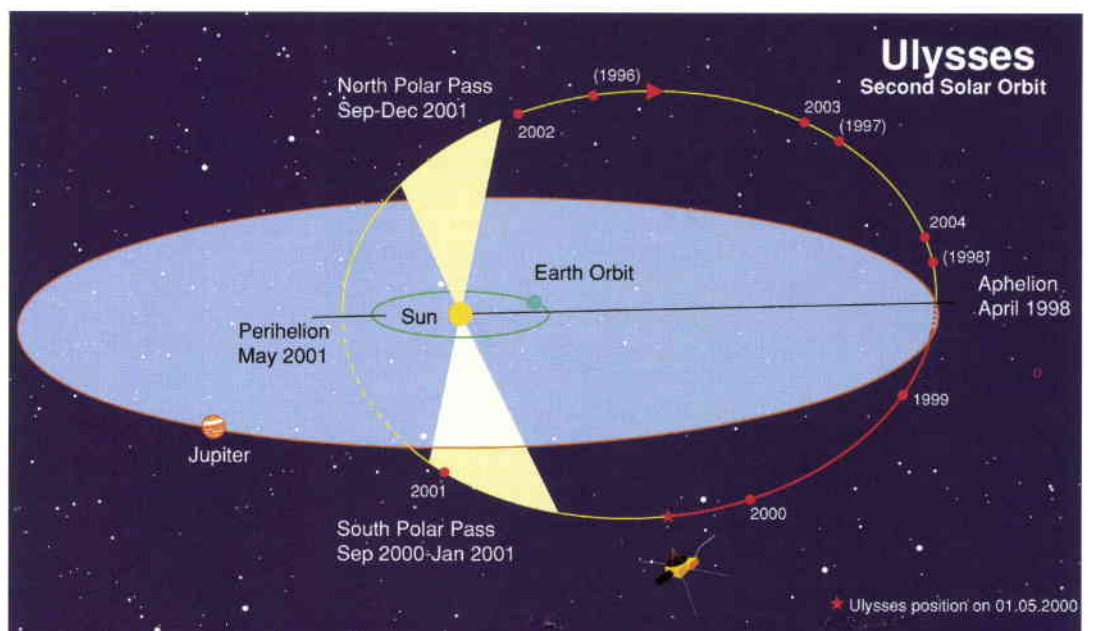

Figure 1. The Ulysses orbit viewed from 15 deg above the ecliptic plane. Dots mark the start of each year

1995 (north). The spacecraft takes 6.2 years to make a complete orbit of the Sun, and so the second set of polar passes will take place from September 2000 to January 2001 (south), and September to December 2001 (north).

Specific topics of interest to the scientists working with data from Ulysses include the solar wind and its magnetic field, energetic particles and cosmic rays, interstellar dust and gas, cosmic gamma-ray bursts, and natural radio emission from the Sun, the planets, and the interplanetary medium. It is a tribute to the skill of the engineers and scientists involved in the mission that such scientific diversity could be achieved by nine experiments weighing only 55 kg in total. A small ESA-led team stationed at the Jet Propulsion Laboratory in Pasadena, California, conducts the mission operations.

As reported in the many articles summarising the successes of the mission to date (e.g. ESA Bulletin 92, pp. 75-81), Ulysses has literally added a third dimension to our knowledge of the heliosphere and the space that surrounds it. While far from exhaustive, the following list highlights some of key findings from the 'solar minimum' phase of the mission.

- The existence of two distinct solar-wind states, a fast high-latitude wind that only occasionally extends down to low latitudes, and a slow low-latitude wind centred about the heliospheric current sheet, is confirmed. These two types of solar wind are separated by a sharp boundary extending from the Sun's corona down to the chromosphere.
- The magnitude of the radial component of the heliospheric magnetic field does not increase towards the poles. The constancy of the radial field implies that the dipole-like configuration of the Sun's surface field is not maintained, and that as a result the polar solar wind undergoes significant non-radial expansion.
- Co-rotating solar-wind stream structures with forward and reverse shock waves, well-studied at low latitudes and expected to be confined to those regions, produce effects extending to the highest latitudes explored by Ulysses. These effects include the recurrent modulation of galactic cosmic rays and injection of accelerated lower-energy particles into the polar regions, suggesting a revised global structure for the heliospheric magnetic field.
- The influx of cosmic rays at high latitudes is smaller than predicted for the minimum phase of the solar activity cycle, most likely as a result of large-amplitude waves found by Ulysses to be present in the polar magnetic fields.

- The density of interstellar atomic hydrogen and helium has been derived from Ulysses data, leading to improved knowledge of the interaction of the local interstellar cloud with the heliosphere.
- The ratio of interstellar ^3He to ^4He has been measured for the first time. The value suggests that the amount of dark matter produced in the Big Bang was greater than previously thought.
- The local population of interstellar dust particles, measured for the first time by Ulysses, contains a larger number of heavy grains than predicted by observations of starlight. Ulysses also discovered dust streams coming from the vicinity of Jupiter.

In global terms, Ulysses has taught us that, at solar minimum, the high- and low-latitude regions of the heliosphere are much more intimately linked than was expected. It has also revealed that interstellar gas plays a surprisingly important role in the dynamics of the heliosphere. Last but not least, Ulysses continues to be one of the cornerstones of the interplanetary network of spacecraft recording cosmic gamma-ray bursts. Because of its unique orbit, Ulysses can provide significant constraints on the location of such bursts on the sky.

Ulysses at solar maximum

The Ulysses mission has already clearly succeeded in extending our two-dimensional, ecliptic view of the heliosphere into a global, three-dimensional one. There is, however, a fourth dimension to be considered: time. The Sun, like most other stars, undergoes significant temporal changes in its activity. These variations in turn affect the heliosphere, the bubble in space blown out by the solar wind, in a way that is literally far-reaching. Ulysses is ideally placed to study the effects of changing solar activity on the large-scale structure of the heliosphere, so this has been one of the major goals in recent months. Before turning to the latest results, however, a brief review of the solar activity cycle is given.

The solar activity cycle

Even a modest telescope (with a suitable filter in place for visual observations!) will reveal that the Sun is not simply a featureless ball of gas. 'Blemishes' that were already noted many centuries ago in China, and which were first studied in detail by Galileo at the beginning of the seventeenth century, mark its surface. These dark areas are what scientists now call 'sunspots', and they are an indication of one of the Sun's fundamental properties – its magnetic activity. Daily observations of the number of sunspots on the disk provide a reasonably

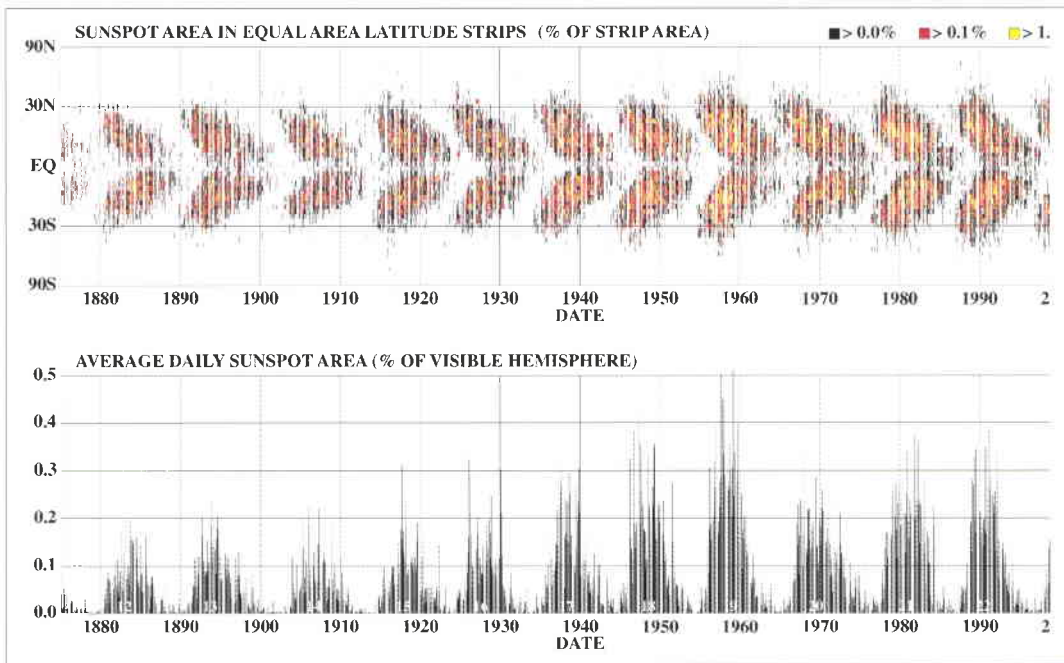

Figure 2. An historical overview of the solar cycle, plotted in the form of a so-called 'butterfly diagram' (upper panel), and in a more conventional representation (lower panel)

reliable record of this activity going back hundreds of years. From this record, a very clear periodicity emerges in which the number of sunspots, and hence the magnetic activity, varies on average with an 11-year cycle. Within this overall pattern, however, there are significant variations in both the size of individual peaks, and the time between consecutive maxima. Nevertheless, at least during the last 150 years for which the most reliable observations are available, the general pattern seems to hold. Figure 2 shows an historical overview of the sunspot cycle in two different representations.

Sunspots typically form in pairs, and the regular 11-year variation of sunspot numbers is accompanied by similar oscillations in the magnetic polarity of these pairs. The polarity of the so-called 'bipolar spot groups' in a given hemisphere switches from one sunspot cycle to the next, leading to a 22-year magnetic cycle. A characteristic feature of the magnetic cycle is the reversal of the Sun's polar fields every 11 years on average. During the most recently completed cycle (number 22), which peaked in 1989, the polar fields in the northern and southern hemisphere were predominantly of positive and negative magnetic polarity, respectively. With the activity of the current cycle (23) rapidly nearing its peak, the polar fields are once again reversing, this time becoming negative in the north and positive in the south. The change in polarity, which usually occurs over a period of a year or more with one hemisphere following the other, has lagged the sunspot maximum by 1-2 years in recent cycles. Cycle 23, however, appears to be unusual in that the polarity reversal is already underway.

Recent results

As noted above, when comparing the current interplanetary conditions with those encountered by Ulysses at the same location more than six years ago, the effects of increased solar activity are quite evident. The stable solar-wind structures that swept over the spacecraft once per solar rotation in 1993 as solar activity declined have given way to a much more complex and less repetitive configuration. This is seen clearly in the plot of the solar-wind speed recorded by Ulysses during its two traversals from the equator to the south pole (Fig. 3). The regular appearance of fast (~750 km/s) solar wind flowing from the southern polar coronal hole that characterised the earlier period has not been repeated in the recent data. Given the rapid increase in sunspot number at the present time, and the corresponding evolution of the magnetic field at the surface of the Sun, it is unlikely that this will

Figure 3. The solar-wind speed measured at Ulysses plotted as a function of solar latitude for the current descent to the south pole (upper panel), and during the previous descent in 1992-94 (lower panel) (Courtesy D.J. McComas)

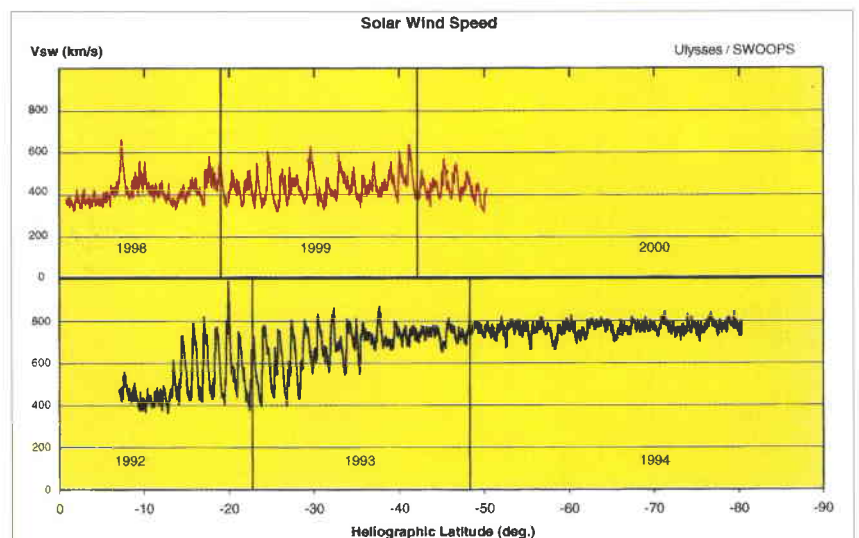

occur at all during Ulysses' return to the polar regions this year and next. Even though 'pure' fast wind from the polar coronal holes may not be present, fast wind streams are clearly still present at the highest latitudes encountered so far. These streams are thought to originate in the isolated, lower-latitude coronal holes that develop near solar maximum. One of the intriguing questions to be answered is how different are these fast streams from the fast wind from the poles?

The approach of solar maximum is also apparent in the behaviour of the energetic particles detected by Ulysses during its climb to high latitudes. Here again, a comparison with the earlier results reveals that the regular increases in particle intensity once per solar rotation – a consequence of stable, long-lasting solar-wind structures found near solar minimum – no longer exist. Instead, a more haphazard picture is seen, due in large part to the increase in transient events at the Sun, and the rapidly changing pattern of solar-wind streams characteristic of solar maximum. The development of these and other trends will be watched with great interest as Ulysses passes over the Sun's poles for the second time.

Ulysses data are being used to infer not only the local conditions in the solar wind, but also the global structure of the heliosphere. Charge exchange with solar-wind protons is the primary ionization process for interstellar

Figure 4. Meridional cut through the heliosphere showing the surface (blue curve), calculated from Ulysses solar-wind observations, where the neutral hydrogen density should drop to 1/e of its interstellar value. The solar images (not to scale) are taken from the EIT and LASCO C2/C3 instruments on SOHO (Courtesy D.J. McComas)

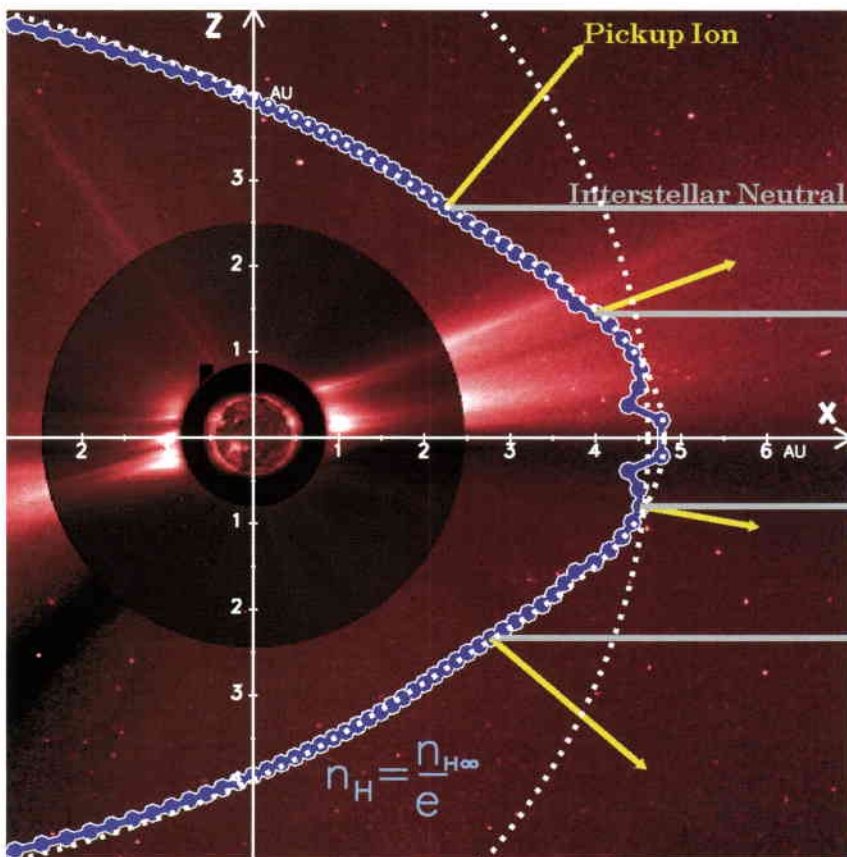

hydrogen atoms travelling through the heliosphere. Ulysses solar-wind data have been used to examine and quantify variations in charge exchange, which has implications for, for example, the interpretation of observations of scattered Lyman-alpha radiation. The Ulysses observations have revealed that the charge exchange rate is higher at low than at high latitudes, and that this rate drops off more slowly than the inverse square of heliocentric distance. This result is depicted in Figure 4.

Although the scientific focus of Ulysses remains the heliosphere, the diversity of scientific topics addressed by the mission has continued to be impressive. Among the fascinating results to be reported recently was the identification of the passage of Ulysses through the distant (3.8 AU)

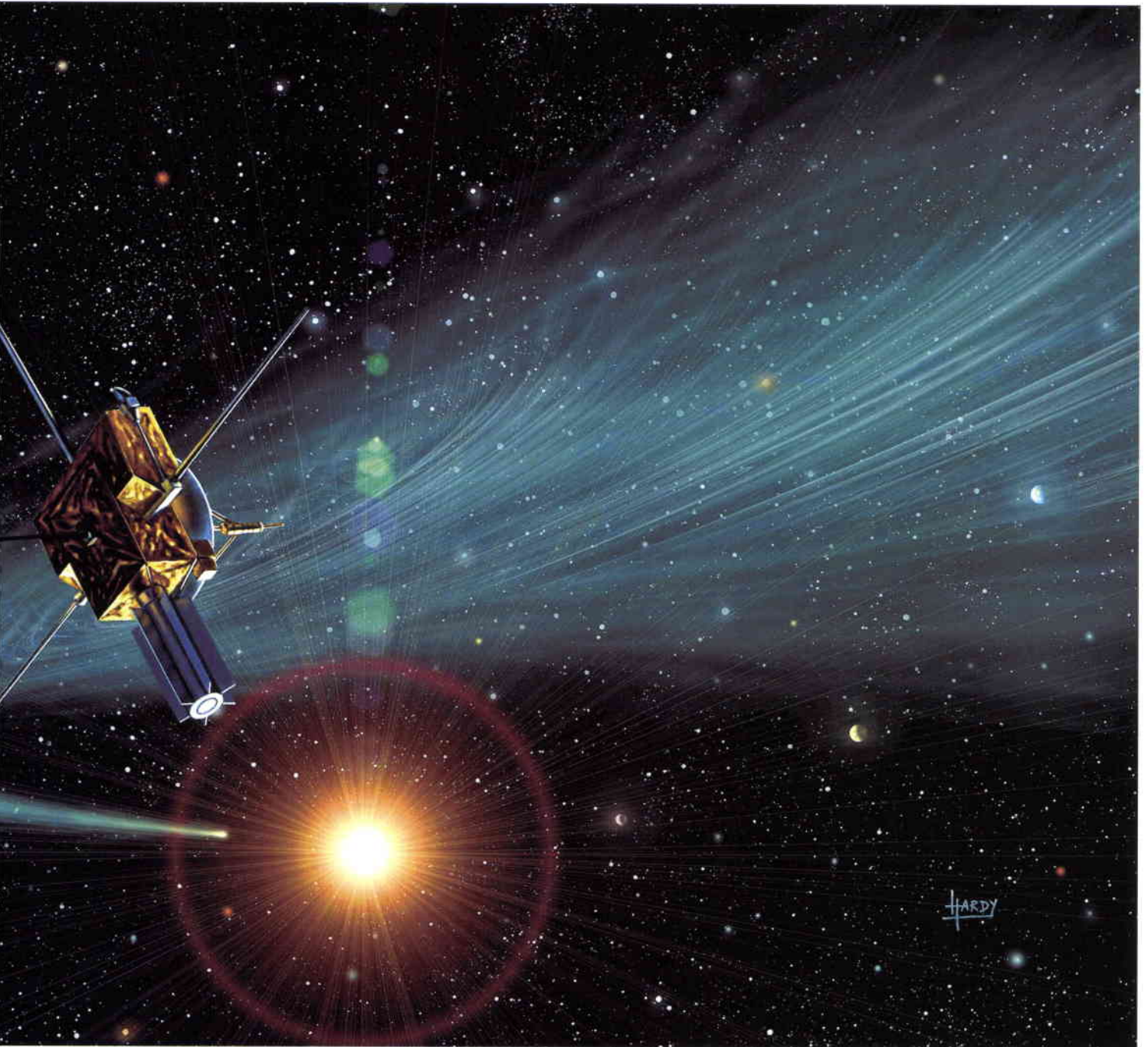

tail of comet C/1996 B2 (Hyakutake) on 1 May 1996. First reported in 1998 as a 'density hole' in the Ulysses solar-wind observations, the event was subsequently 'rediscovered' independently in the magnetic-field data and the ion-composition measurements. The magnetic field pattern at the time of the density drop-out was highly reminiscent of that expected within a comet tail, and the unusual heavy ions present in the solar-wind data added weight to the hypothesis. A member of the Imperial College magnetometer team made the specific association with comet Hyakutake. This discovery was due in large part to Ulysses' unique, high-latitude position in the heliosphere, and the fact that both Ulysses and the comet were immersed in the high-speed solar wind. By being in 'the right place at the

right time', Ulysses now holds the record for finding the longest comet tail ever. An artist's impression of this serendipitous event is shown in Figure 5.

The ten years of continuous Sun-related observations acquired by Ulysses are in themselves an impressive data set. That these measurements can form the basis for studies over a much longer time-scale is equally gratifying. Ulysses magnetic-field data have been used to infer global properties of the Sun's coronal magnetic field extending back in time to the mid-19th century. A critical part of the calculation relies on the Ulysses finding that the radial component of the heliospheric field is independent of solar latitude. A particularly striking result is the fact that the inferred

Figure 5. Artist's impression of Ulysses crossing the distant tail of comet Hyakutake (David A. Hardy)

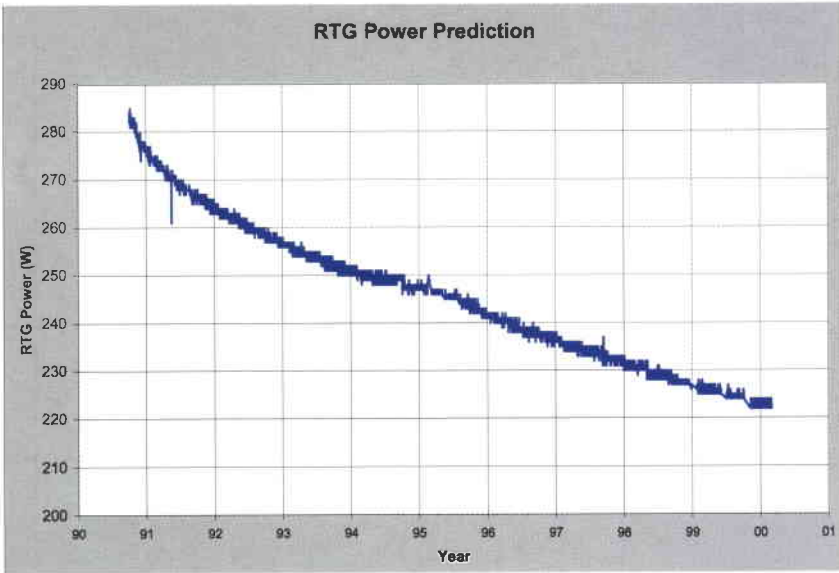

Figure 6. The power output of the Radioisotope Thermoelectric Generator (RTG) on board Ulysses

coronal field has approximately doubled in the past 100 years, perhaps as a result of chaotic changes in the solar dynamo. Although not well understood, a connection is believed to exist between the Sun's magnetic field and its luminosity, indicating possible implications for the global climate of the Earth.

Operational challenges in 2000/2001

The Ulysses spacecraft has proven to be highly reliable, and the members of the Spacecraft Operations Team have had to cope with remarkably few in-orbit anomalies during the past 10 years. Nevertheless, there are operational challenges to be faced during the upcoming phase of the mission. The thermal effect of the Sun on Ulysses varies dramatically over the spacecraft's orbit due to the large changes in solar distance (1.34 – 5.41 AU). Thermal control is therefore an important

operational task. It is performed by dumping power either into various heaters inside the spacecraft body or to external radiators. The sole power source is a Radioisotope Thermoelectric Generator (RTG) and its output decays exponentially with time (Fig. 6). Delivering 285 W at launch, the RTG now provides only 223 W, so maintaining an acceptable thermal balance while ensuring a good science data return from all of the experiments has become more of a challenge. A number of redundant components have been switched off over the past few years and simultaneous use of several power-hungry operating modes has been avoided. If, as is hoped, the mission continues past 2001, some time-sharing of payload elements will be inevitable. Even so, it will be possible to power a group of 'core-science' instruments, together with a selection of 'discretionary' experiments, at least until the autumn of 2004.

In addition to the continuous decline in available power, another major operational challenge over the next eighteen months will be the return of spacecraft nutation in December 2000. The nutation anomaly was first discovered when the axial boom was deployed shortly after launch, and appeared again in 1994/95. Under certain conditions of illumination by the Sun, the boom goes in and out of shadow as the spacecraft spins. The resulting thermal stresses cause the boom to flex, and the body of the spacecraft then begins to wobble or nutate. This spacecraft motion must be kept as small as possible for the following reasons:

- Damage or loss of spacecraft may occur if it is left uncontrolled.

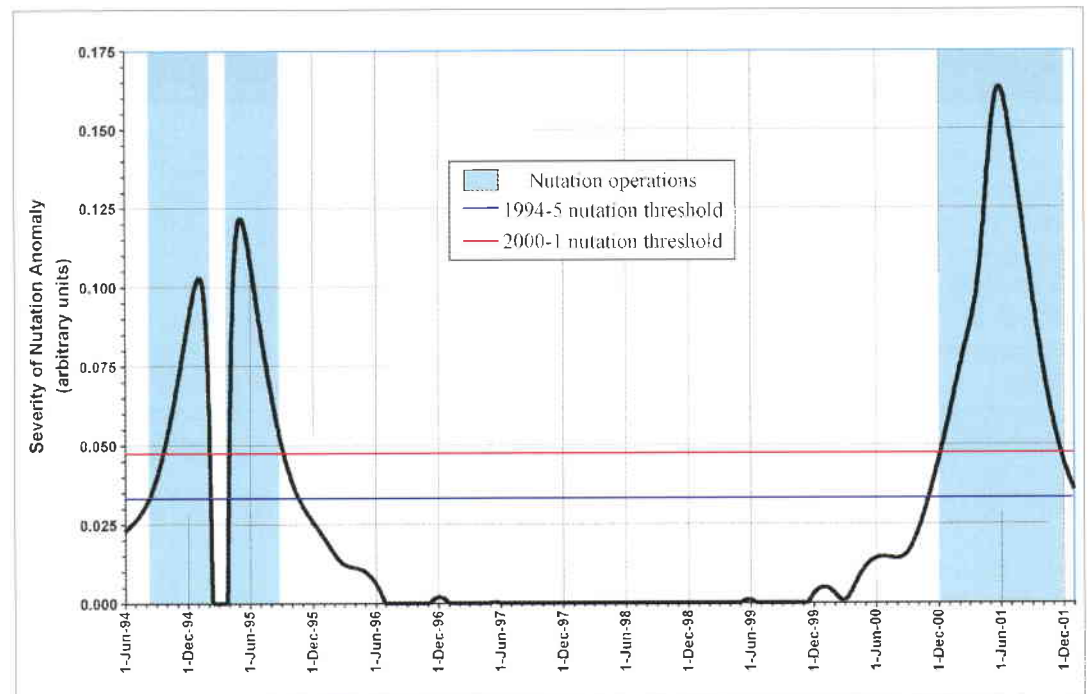

Figure 7. The strength of the solar-induced forcing responsible for the Ulysses nutation anomaly plotted in arbitrary units versus time

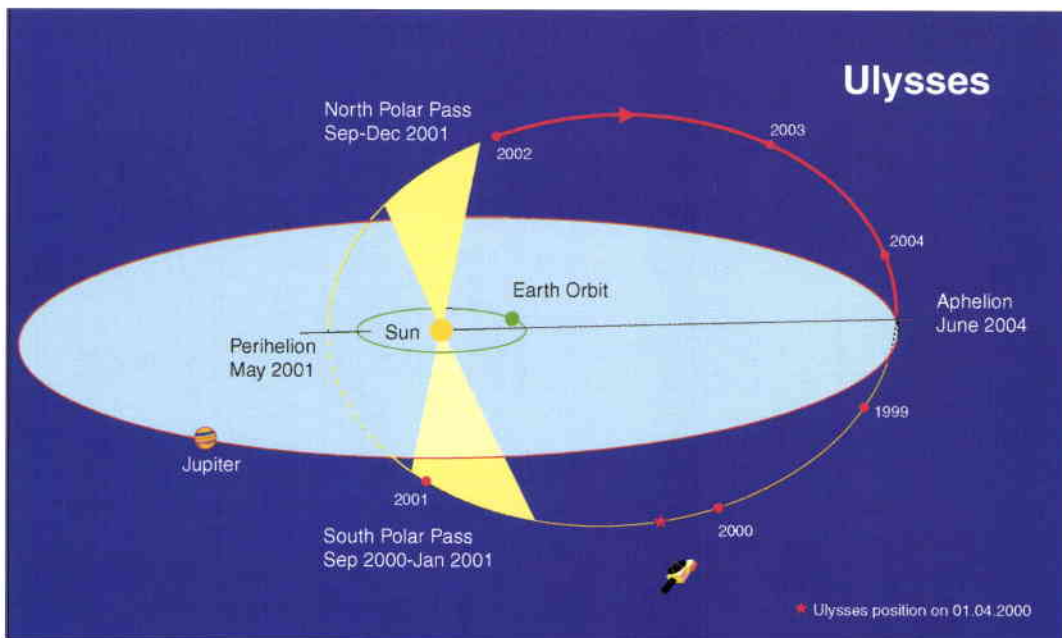

Figure 8. The orbit of Ulysses, showing the planned extension of orbital operations (heavy red line)

- Flexing of the axial and wire booms may induce metal fatigue.
- Booms may wrap around the spacecraft, dislodge thermal blankets or even detach.
- The uncertainty of the spacecraft attitude at any given time will make data reduction more difficult.
- Large off-pointing of the high-gain antenna will result in loss of data.

From the graph in Figure 7, we can see that the severity of the anomaly in 2000/01 will be greater than in 1994/95. The tools and techniques developed in 1994/95 to control the levels of nutation are being refined, however, and will be employed again to minimise the threat to spacecraft health. A critical element in this regard is the presence of a continuous uplink beacon for the onboard Conscan system, and detailed scheduling of the required ground-station coverage is already well underway.

The future

As we have seen, the heliosphere is a dynamic environment that undergoes large variations in both large and small-scale structure over the period of an 11-year solar cycle. It is certain that new insights will be gained as we continue to observe the effects of increasing solar activity, changing coronal structure, and the reversal of the solar magnetic polarity from Ulysses' high-latitude vantage point. Based on the success of the 'prime mission' (launch to September 1995), ESA and NASA agreed to continue Ulysses operations until December 2001, the end of the second north polar pass. The recent ESA SPC decision opens the way for a further 2.75 years of orbital operations. The spacecraft will then have reached aphelion again, thereby completing a second out-of-

ecliptic orbit of the Sun (Fig. 8). The proposed extension would enable the effects of the magnetic polarity reversal on, for example, the cosmic-ray intensity gradients, to be studied in detail. At the same time, the additional observation time will be highly beneficial to the measurement of rare pick-up ion species and cosmic-ray isotopes.

One of the 'frequently asked questions' concerning Ulysses is: 'Will there ever be another Jupiter encounter?' Although not as intimately as in 1992, the spacecraft will approach Jupiter again in February 2004. Compared with the first fly-by, which at 6.3 Jupiter radii from the planet's centre dramatically modified the Ulysses flight-path, the second 'encounter' has a closest approach distance of 1682 Jupiter radii and will not change the orbit significantly. Nevertheless, it should provide a unique opportunity to observe Jovian radio emissions from the planet's polar regions.

Another important argument in favour of extending the mission is the opportunity afforded for joint observations by members of the 'Solar Armada' that includes Ulysses, SOHO, TRACE, Yohkoh, and ACE. This formidable fleet is soon to be joined by the four Cluster-II spacecraft. Collaborations with other space missions and ground-based projects already characterise a significant part of the scientific work carried out using Ulysses data. In all such studies, the unique high-latitude perspective of Ulysses and its integrated instrument payload are, and will hopefully continue to be, invaluable assets.



MERIS – A New Generation of Ocean-Colour Sensor onboard Envisat

J.-L. Bézy, S. Delwart & M. Rast

ESA Directorate of Applications Programmes, ESTEC, Noordwijk, The Netherlands

Introduction

In mid-2001, ESA will launch the Medium Resolution Imaging Spectrometer (MERIS) onboard its polar-orbiting Envisat Earth-observation satellite. MERIS, initially primarily dedicated to ocean-colour observations, has had the scope of its objectives broadened during development to include atmospheric and land-surface related studies. This has been possible due to the great flexibility that sensor and ground segment provide.

ESA has developed a multidisciplinary Earth-observation instrument that focuses on biological ocean observations. This Medium Resolution Imaging Spectrometer (MERIS) will provide a remote-sensing capability for observing, inter alia, oceanic biology and marine water quality through observations of water colour. MERIS, which will be the first spaceborne wide-field imaging spectrometer, is a nadir-looking sensor operated in a push-broom mode. The instrument measures the solar reflected radiation in fifteen spectral bands in the visible and near-infrared parts of the spectrum. Of particular interest is the ability to programme the position and width of the spectral bands in flight. This allows a large set of applications, making the instrument concept also attractive for future Earth Watch missions. ESA will produce a set of validated data products, such as chlorophyll concentration, water vapour and global vegetation index, which will be available at two spatial resolutions (300 m and 1200 m).

MERIS will have a high spectral and radiometric resolution and dual spatial resolution, within a global mission covering open ocean and coastal-zone waters and a regional mission covering land surfaces. One of the instrument's most outstanding features is the programmability of its spectral bands in terms of width and position.

MERIS's global mission will make a major contribution to scientific projects that seek to understand the role of the oceans and ocean productivity in the climate system, through its observations of water colour, and will further increase our ability to forecast change through modelling. Secondary objectives of the mission will be directed to the understanding of atmospheric parameters associated with clouds, water vapour and aerosols, in addition

to land-surface parameters, in particular vegetation processes.

With all of the above-mentioned features, MERIS is considered to be a remote-sensing tool with great potential to contribute to climate studies and global-change observations by addressing environmental features in a multidisciplinary way. This article introduces the MERIS end-to-end mission concept (Fig. 1), based upon the scientific requirements and mission objectives.

In advance of launch, the ground segment is being designed and algorithms are being developed for the interpretation of MERIS's observations, and dedicated studies are establishing the means for validating its data products. This effort is being undertaken in close co-operation with the European Expert Support Laboratories, whose scientists are the main providers of the retrieval algorithms. Wherever possible, the underlying physical models are being validated based on experience acquired before Envisat's launch, using data provided by airborne or shipborne campaigns and in-situ measurements at specially equipped campaign sites.

Scientific rationale

With the advent of large-scale optical imaging spaceborne sensors in the seventies, a tool was found that enabled the observation and monitoring of the Earth's surface in a qualitative, but synoptic fashion. The biggest asset of these sensors, of which the Advanced Very High Resolution Radiometer (AVHRR) is the most prominent example, was their large coverage swath and high repeat rate, enabling the timely observation of changing large-scale phenomena. With the end-of-life of the US Coastal-Zone Color Scanner mission (CZCS) in 1986, the scientific oceanographic community demanded a new spaceborne ocean-colour observing system that would allow more accurate determination of oceanic constituents, such as chlorophyll, suspended matter and decayed organic material, thereby providing

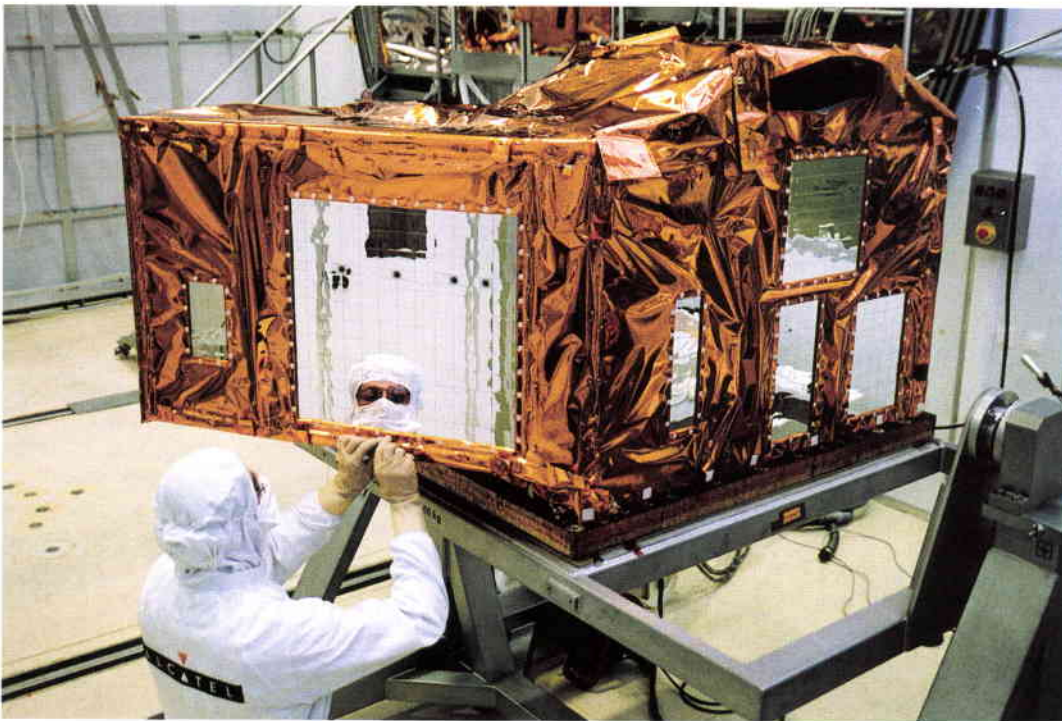

Figure 1. The MERIS flight model during integration at Alcatel Space Industries in Cannes (F)

vital information about the water's quality and its productivity.

Driven by the concerns about our environment and the pressing need for a new ocean-colour observing system, ESA, supported by its international scientific advisors, began the development of a spaceborne large-scale optical system with the primary objective of providing quantitative ocean-colour measurements, but having enough flexibility to also serve applications in atmospheric and land-surface science.

Mission objectives

Based on the above rationale, mission objectives were derived driving the development of the MERIS instrument and its mission.

Ocean mission

The principal contributions of MERIS data to the study of the upper layers of the ocean will be:

- the measurement of photosynthetic potential by detection of phytoplankton (algae)
- the detection of yellow matter (dissolved organic material)
- the detection of suspended matter (re-suspended or river-borne sediments).

Apart from the above three major observable features, it should also be possible to detect special plankton blooms, for example red tides through their absorption feature near 520 nm. In addition, investigations of water quality, the monitoring of extended pollution areas and topographic observations (such as coastal erosion) should also be possible.

Atmospheric mission

The radiation balance of the Earth/atmosphere system is dominated by water vapour, carbon dioxide and clouds, as well as being very dependent on the presence of aerosols. However, the global monitoring of cloud properties and their processes is not yet sufficiently accurate. MERIS is intended to help redress this balance by providing data on cloud-top height and optical thickness, water-vapour column content, as well as aerosol properties.

Land mission

Questions related to global change include the role of terrestrial surfaces in climate dynamics and bio-geochemical cycles. Spatial and temporal models of the biosphere are currently being developed to study the mechanics of such complex systems in order to predict their behaviour under changing environmental conditions. These models are based on physical and biophysical relationships, which need to be validated on a regular basis using data from spaceborne sensors. Repetitive, accurate physical measurements are necessary to quantify surface processes and to improve the understanding of vegetation seasonal dynamics and responses to environmental stress.

Scientific requirements

In order to achieve these mission goals, the different radiometric and geometric requirements imposed by the various objectives have to be satisfied. With the help of the ESA Science Advisory Group for MERIS, these requirements have been refined, taking into account the constraints imposed by a

polar-orbiting platform and the technical capabilities of an imaging spectrometer.

Geometric requirements

The MERIS data are of interest both for global observations and for detailed examinations for regional applications, and operation at two spatial resolutions has therefore been selected. Full-resolution (FR) data with 300 m on-ground resolution at the sub-satellite point will be mainly required in coastal zones and over land. Reduced-resolution (RR) data with 1200 m on-ground resolution at the sub-satellite point are intended for large-scale studies. Oceanographic and atmospheric investigations require global Earth coverage within three days.

Spectral requirements

MERIS is designed to acquire 15 spectral bands in the 390 - 1040 nm region of the electromagnetic spectrum. The band position, bandwidth and gain are in-flight programmable. The spectral bandwidth can be varied between 1.25 and 30 nm, depending on the width of a spectral feature to be observed and the amount of energy needed within a given band to perform an adequate observation. Over open ocean, an average bandwidth of 10 nm is required for bands located in the visible part of the spectrum. Driven by the need to resolve other spectral features such as the oxygen absorption band occurring at 760 nm, a spectral bandwidth lower than 10 nm is required. In accordance with the mission goals and priorities for this instrument, a set of 15 spectral bands has been derived for oceanographic and interdisciplinary applications (Table 1). These spectral bands are used as the reference set for prototyping the ground-segment algorithms. Preliminary results seem to advocate a fine tuning of some of the bands to optimise product quality. If confirmed, this fine-tuning can be performed using the instrument's programmability.

Table 1. The 15 spectral bands of MERIS

The spatial, spectral and radiometric

Band Nr.	Band Center (nm)	Bandwidth (nm)	Potential Applications
1	412.5	10	Yellow substance, turbidity
2	442.5	10	Chlorophyll absorption maximum
3	490	10	Chlorophyll, other pigments
4	510	10	Turbidity, suspended sediment, red tides
5	560	10	Chlorophyll reference, suspended sediment
6	620	10	Suspended sediment
7	665	10	Chlorophyll absorption
8	681.25	7.5	Chlorophyll fluorescence
9	705	10	Atmospheric correction, red edge
10	753.75	7.5	Oxygen absorption reference
11	760	2.5	Oxygen absorption R-branch
12	775	15	Aerosols, vegetation
13	865	20	Aerosols correction over ocean
14	890	10	Water vapour absorption reference
15	900	10	Water vapour absorption, vegetation

programmability of MERIS is justified by the different scales of the various targets to be observed and the diversity of their spectral and radiometric properties. The advantage of the programmability lies not only in being able to select the width and position of a particular spectral band, but also in being able to tune the dynamic range and adapt it to different target observations, which may become of higher priority during the lifetime of the MERIS mission.

Radiometric requirements

The radiometric performance is one of the most crucial requirement for MERIS because the signals coming from the ocean are weak and thus most difficult to detect and quantify. Even though the radiometrically most challenging target to be observed is the open ocean, MERIS also has to have a large dynamic range to cover these low-level signals as well as signals emanating from bright targets such as clouds and land surfaces, throughout its spectral range. This imposes demanding radiometric performance requirements.

- Open ocean

In the upper layer of the open ocean, the chlorophyll concentration varies from less than 0.03 mg.m⁻³ in oligotrophic waters, up to about 30 mg.m⁻³ in eutrophic situations. Ocean colour responds to this variation, which spans over three orders of magnitude, in a non-linear manner. The goal with MERIS is to discriminate 30 classes of pigment concentrations within the three orders of magnitude. These classes should be of equal logarithmic width. This requirement translates into a radiometric sensitivity of 2 x 10⁻⁴ for NEΔR (noise equivalent spectral reflectance at sea level) being set for MERIS.

- Coastal waters

For the detection of several water substances, commonly used techniques like simple colour ratios which are applied successfully for open oceans, are not sufficient. The similarity of the spectral scattering and absorption coefficients for all optically active water substances poses problems in finding an adequate procedure for their detection. Here the Sun-stimulated chlorophyll fluorescence at a wavelength of 681.25 nm can improve the detection of pigment concentration. The fluorescence signal is small, but is detectable from space. The spectral resolution should ideally be better than 10 nm and the radiometric resolution better than 0.03 W (m⁻² sr⁻¹ nm⁻¹) for the discrimination of a 1 mg.m⁻³ pigment concentration.

Outstanding radiometric accuracy is imperative for the atmospheric correction, which is of critical importance since, over ocean, typically

90% of the signal reaching the sensor originates from the atmosphere. MERIS is designed to achieve this by having spectral bands positioned such that quantification of the atmosphere's influence is possible. Moreover, MERIS is required to have a sensitivity to the polarisation of the incoming light scattered from the atmosphere lower than 1%.

Instrument operation

Measurement principle

MERIS is an imaging spectrometer that measures reflected solar radiation in the visible and near-infrared parts of the spectrum. It is a nadir-looking sensor operated in a pushbroom mode. Image acquisition is performed with a line of detectors scanning the two-dimensional scene. The motion of the satellite provides the along-track dimension. This imaging mode permits a much longer dwell time compared to classical scanners. The spectrum of every single ground pixel is recorded thanks to the use of a two-dimensional detector. The swath width is imaged over the detector line, the spectrum over the detector column. The instrument has the ability to transmit 15 spectral bands. As a unique feature, the spectral bands can be changed in width and position by ground command. The global Earth coverage within three days required by oceanographic and atmospheric investigations is ensured thanks to the large instrument swath of 1150 km.

Operating concept

MERIS is designed to acquire data whenever illumination conditions are suitable. Instrument operation is restricted to the day zone of the orbit where the Sun's incidence angle is less than 80° at the subsatellite point (Fig. 2). Calibration will be carried out, on average, once every two weeks, when the spacecraft flies over the south orbital pole and the Sun illuminates the instrument's onboard calibration device. For the rest of the orbit, MERIS will be in non-observation mode.

The MERIS instrument is designed to serve both global and regional applications. It will acquire reduced-resolution (RR – 1200 m) data continuously over the Sun-illuminated part of the orbit, with data recorded on-board and dumped once per orbit (every 100 min) via X- or Ka-band links to high-latitude ground stations. This data will be processed systematically for all orbits.

In addition to the RR data, MERIS will deliver full-resolution (FR – 300 m) data in the same 15 spectral bands. This FR data will be transmitted via a Data Relay Satellite (DRS) or an X-band ground receiving station when in view of the

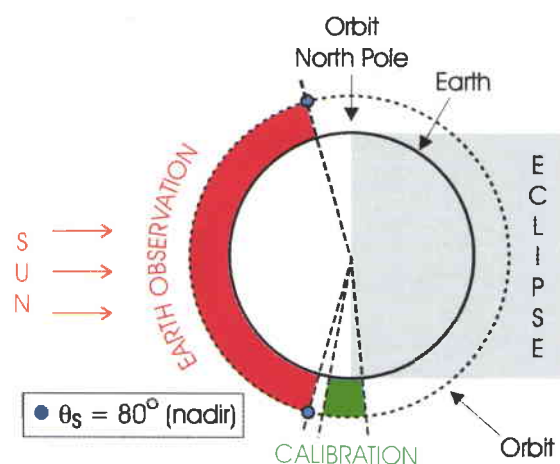

Figure 2. MERIS operation profile

satellite. Envisat also has a Solid-State Recorder (SSR) which can be used to record FR data when outside DRS coverage or ground-station visibility. The combined usage of DRS, ground station and SSR will ensure that every part of the globe can be accessed with FR data.

Instrument design and performance

Figure 3 shows the mechanical layout of MERIS. The instrument consists of five identical cameras sharing the large field of view of 68.5° . These cameras are arranged in a fan-shaped configuration in which their fields of view overlap slightly. The modular design ensures high optical image quality over the large field of view. The output of each camera is processed separately in an analogue and digital processing unit (Fig. 4).

Optical sub-assembly

The optics of each camera has an external window, a folding mirror, an off-axis catadioptric ground imager and a spectrometer. The window scrambles the incident light coming from the Earth, making the instrument less sensitive to changes in polarisation. The dispersive element of the spectrometer is a low-groove-density holographic grating. The aperture stop is located on the grating. The entrance pupil is located in front of the camera optics, making it a suitable position for the scrambling window.

Focal-plane sub-assembly

The camera's detectors are CCD arrays specifically developed for MERIS (Fig. 5). Thinned back-side-illuminated CCDs have been selected, which offer the required high responsivity in the blue part of the spectral range. The CCDs are operated in frame transfer mode. At the end of a fixed period (integration time), the charges are rapidly transferred to the store region allowing the acquisition of the next frame to start. Charges in the store region are subsequently transferred to the shift register.

Figure 3. The MERIS mechanical layout, showing the locations of the various subsystems

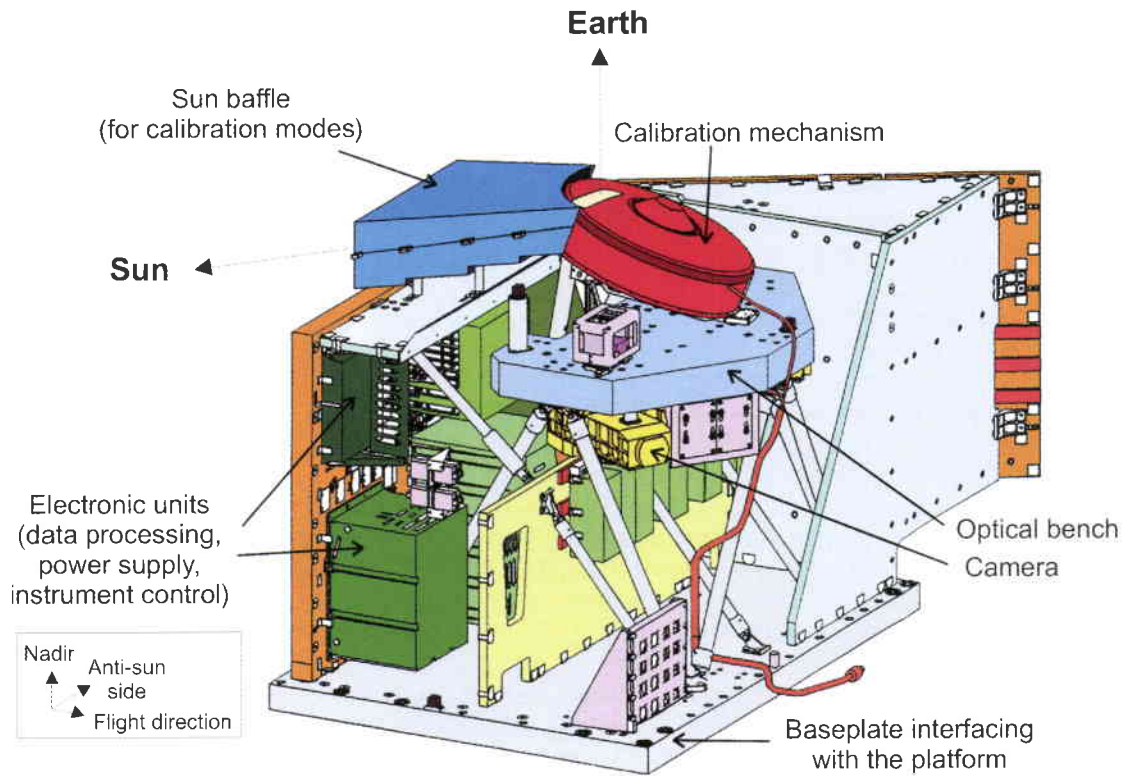

Figure 4. MERIS functional block diagram

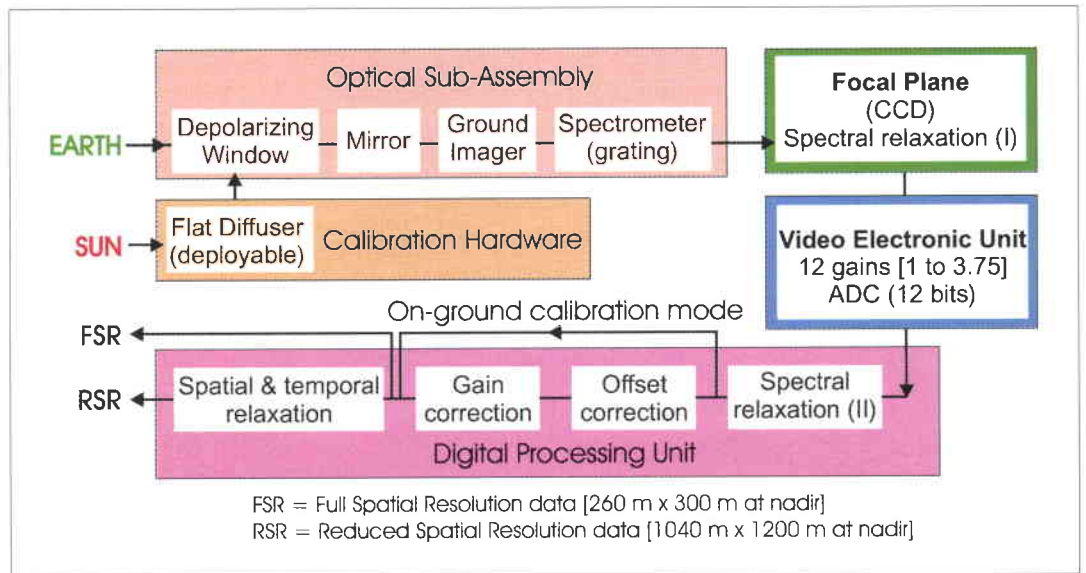

Figure 5. The MERIS CCD



The spectral range of MERIS is 390 to 1040 nm, with a spectral sampling interval of 1.25 nm. 530 rows are required to cover this range, including a margin of 10 rows for spectral alignment. The camera swath is imaged over 740 pixels along the CCD line. Included on either side of the line are dark reference pixels, which are covered by the aluminium shield. These pixels are used for offset compensation to ensure the stringent signal stability required along the orbit and between calibrations. The CCDs are operated at -22.5°C to reduce the dark current.

A special coating has been developed for the CCD surface. This coating features a wedge along the CCD column to reduce internal stray light to an acceptable level.

The CCDs play an important role in the programming of the spectral bands. Thanks to its large storage capacity, several lines can be accumulated in the shift register before clocking out the pixels. The selected bandwidth is obtained by summing the correct number of lines. The CCD lines that fall outside the 15 spectral bands are dumped at shift-register level.

Processing chain

Signals read out from the CCD pass through several processing steps in order to achieve the required image quality. Analogue electronics perform pre-amplification of the signal, correlated double sampling and gain adjustment before digitisation of the video signal on 12 bits. The signal amplification is done by selecting one of the 12 fixed gains defined in the range 1 to 3.75. The amplification gain is selected separately for each spectral band to minimise the noise contribution of the processing chain. Thus, the saturation level of any band can be optimised for the purposes of that band. For instance, a spectral band used only for ocean applications can saturate over clouds, leaving the full 12-bit digitisation for the useful dynamic range of the oceanic signal.

The digital output of the Video Electronic Unit is subsequently processed by the Digital Processing Unit in three major steps:

- completion of spectral relaxation up to the required bandwidth
- subtraction of the offset and correction for gain non-uniformity
- reduction of the spatial resolution of the data to 1200 m for the global mission summation of four adjacent pixels across-track over four consecutive frames.

The offset and gain corrections are based on coefficients computed during the calibration sequences. These coefficients are stored onboard as well as being sent to the ground. The instrument design offers the flexibility to have these corrections applied either onboard or on the ground. In the latter case, offset and gain correction are bypassed in the onboard processing flow and performed on the ground.

Performances

Verification of the instrument's performance is based on an extensive testing programme at camera and instrument level (Table 2). Of particular importance is the large signal-to-noise ratio in the blue part of the spectrum, which permits the required Noise Equivalent Difference in Reflectance at sea level to be met.

Instrument calibration

To meet the stringent accuracy requirements,

the data need to be corrected for any non-uniformities and distortions introduced in the overall measurement system, as well as being converted into radiance values. Four in-flight calibration sequences are defined:

- dark calibration
- radiometric gain calibration
- diffuser ageing characterisation
- wavelength referencing.

During the dark calibration, the signal is recorded with the Earth and Sun aperture closed. In the gain calibration mode, a white diffuser plate, Sun-illuminated, is inserted at the cross-over point of the fields of view of the five cameras. The diffuser provides a reflectance standard across the entire spectral range and field of view.

Geometric Image Quality	
Field of View	68.5° centred about nadir
Swath width	1150 km
Localisation accuracy	< 2 km (without the use of landmarks)
Spatial resolution	RR: 1040 m x 1200 m (nadir) FR: 260 m x 300 m (nadir)
Band to band registration	< 0.1 FR pixel
Spectrometric Image Quality	
Spectral range	390 nm – 1040 nm
Spectral sampling interval	1.25 nm
Spectral resolution	1.8 nm
Band transmission capability	15 bands programmable in position and width
Band width	Programmable from 1.25 nm up to 30 nm
Band center knowledge	< 0.6 nm
Radiometric Image Quality	
Radiometric accuracy	< 2% in reflectance (i.e. relative to the sun irradiance)
Dynamic range	Up to bright clouds (100 % reflectance)
Signal to noise ratio	1650 (@ 412.5 nm) for typical ocean signal
Polarisation sensitivity	< 0.3% over the full spectral range
Orbital signal stability	< 0.05%
Interface Budgets	
Mass	200 kg
Power	175 W
Data rate	RR: 1.60 Mbit/s FR: 24.0 Mbit/s

The calibration diffuser will be exposed to the Sun for a total cumulative period of about 1 h during MERIS's lifetime. Some limited degradation due to UV/VUV radiation and particle exposure may be expected even though ground testing has demonstrated remarkable diffuser stability over the instrument's spectral range. A second white diffuser is therefore implemented to evaluate changes in BRDF of the gain calibration diffuser. This diffuser will be used infrequently and will thus not degrade at the same rate as the first diffuser. Diffuser ageing will be monitored by comparing the data acquired with both diffusers.

Wavelength calibration will be achieved by using another diffuser featuring well-known absorption peaks. MERIS spectral bands will be reprogrammed to sample the absorption features adequately. From this calibration, the spectral position of any spectral band can be

Table 2. MERIS performance summary

derived. Use of the solar Fraunhofer absorption lines as an alternative when observing the Sun-illuminated white diffuser is also envisaged.

Following extensive environmental tests, Spectralon™ has been selected for the diffuser plates. Diffusers manufactured with this material offer both the requisite uniformity over the field of view and remarkable stability. A diffuser plate doped with a rare Earth oxide is used for the wavelength calibration.

The calibration hardware is implemented on a selection disc (Fig. 6). A stepper motor allows the selection of five disc positions, as the instrument mission requirements dictate. The calibration mechanism also supports the diaphragm introduced into the field of view to minimise stray light when observing the Earth.

Data processing

The MERIS products will be available with different time scales – with both near-real-time and consolidated processing – and with different spatial scales depending on the geographical location – global (1200 m) and regional (300 m) products – and with different levels of processing (1b & 2).

Near-real-time and consolidated processing

The Near Real Time (NRT) services will provide data 3 h after acquisition. Consolidation is a gradual process by which more accurate external (auxiliary) data become available over time. The consolidated data products will therefore typically be available within about three weeks. The formats of the NRT and consolidated data products are the same, but the quality of the auxiliary data used in the processing of the consolidated product is improved.

Global and regional products

MERIS products will be available in FR and RR resolution. The RR data will be acquired globally for the entire daytime orbit and processed systematically for all orbits. The FR data will be available mainly over land and coastal zones, representing the regional mission for which data will be processed only on user request.

Data product levels

ESA has defined the following data product levels for MERIS (Table 3):

- *Level-0 Product:* This raw format data will not generally be made available to the users.
- *Level-1b Products:* These consist of calibrated top-of-atmosphere radiances in 15 VIS/NIR spectral bands, geolocated and resampled on a regular grid. Annotations will include surface identification (land, sea and clouds), localisation (latitude, longitude, altitude, or bathymetry), viewing and solar geometries, as well as meteorological data (ECMWF).
- *Level-2 Products:* These are called ‘distributed’ products because the geophysical quantities found in the data sets vary depending on the surface being measured. They will contain both geophysical parameters and surface radiances/reflectances, depending on the surface products group – ocean colour products, land products and cloud products.
- *Browse Product:* This will be processed systematically to a 4.8 km resolution for the entire daytime orbital segment. It will consist of an RGB colour product, where the three MERIS bands have been chosen for the best visualisation of the land, sea, ice and cloud features. The browse will enable the user to choose the position of a scene of interest. User tools will be provided to allow the selection and ordering of scenes of 1150 km x 1150 km for RR products, and of 575 km x 575 km or 296 km x 296 km for FR products located anywhere along- and across-track in the acquired data sets. Users will be able to order multiple scenes to acquire a complete (daytime) orbit.

Figure 6. The MERIS calibration mechanism supporting three diffusers - for gain calibration (1), for diffuser ageing monitoring (2) and wavelength calibration (3) - the Earth shutter (4) and the Earth diaphragm (5)

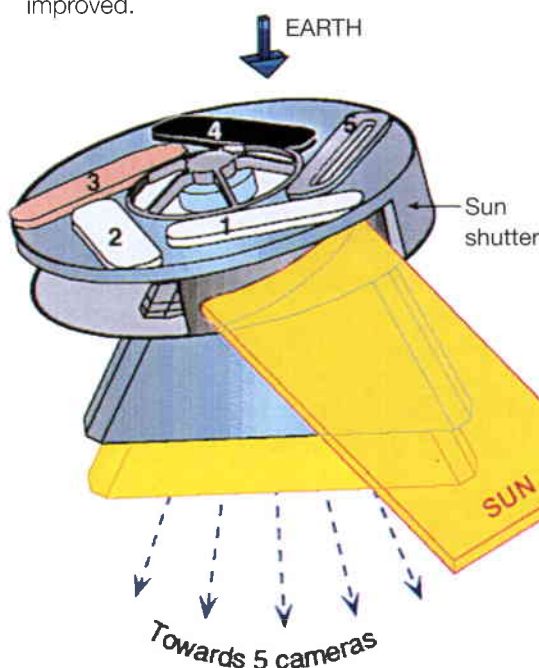

Processing architecture

The architecture of the MERIS Level-2 processing is shown schematically in Figure 7. Pixel identification is the process by which the underlying surface type (cloud, land and ocean) is determined. This is achieved using radiometry to separate bright targets (cloud, snow and ice) from land or ocean. The darker targets (land and ocean) are further classified according to their typical spectra and, finally, clouds are distinguished from the other bright targets using pressure (altitude) information retrieved

Processing level		Reduced Resolution Mode Scene Size [Mb] Coverage	Full Resolution Mode Scene Size [Mb] Coverage
Level 0	Annotated source packets	• 522 Mb per Orbit	3600 Mb for 20° per Orbit
Browse	RedGreenBlue	• 3.2 Mb per Orbit	N/A
Level 1b	Geolocated and calibrated TOA radiance + auxiliary data (meteo, geometry, altitude, bathymetry)	• 39 Mb per scene (1150kmx1150km) • 532 Mb per Orbit	157 Mb for 575kmx575km
Level 2	Geolocated oceanic, cloud, land and water vapour geophysical parameters + surface leaving reflectances+ auxiliary data	• 48.5 Mb per scene (1150kmx1150km) • 620 Mb per Orbit	187 Mb for 575kmx575km

Table 3. MERIS products

from the bands situated in the spectral absorption features of oxygen (760 nm).

Once the surface type has been identified, surface-specific computing can start. Over water, computation starts with the identification of those areas affected by Sun glint (direct reflection of Sun on the water surface) and its partial correction in order to increase the coverage area of the ocean-colour products. This is followed by the identification of whitecaps and high inland lakes where the atmospheric correction quality will be reduced. Turbid waters are then screened and a special 'bright water' correction is applied to remove the marine signal contribution in the near-infrared (NIR) prior to entering the atmospheric correction, which is based on the assumption that the marine signal in the NIR is nil. The atmospheric-correction computations return water-leaving reflectances which are used for the estimation of the ocean-colour products (see below) and the aerosol optical thickness and type, which are then used in the computation of water-vapour content over oceans. Ocean-colour products are then computed using band ratios over the open ocean, while for the more complex coastal-water products all visible bands are used as inputs to a neural network.

Over clouds, the cloud optical thickness and albedo are derived directly using top-of-atmosphere radiances and the results of the cloud-top pressure computed earlier; a simple cloud type is computed based on cloud characteristics established by the International Satellite Cloud Climatology Project (ISCCP).

Over land, the MERIS Global Vegetation Index (MGVI) is computed using top-of-atmosphere reflectances. Atmospheric correction here consists only of removing molecular scattering and absorption, while the aerosol optical thickness and type are computed only above those targets identified as Dense Dark Vegetation (DDV), where it is assumed that the target has a well-determined reflectance.

Water vapour is computed over all surface types. The same algorithm is used over bright targets – land and Sun glint. Over the ocean, the aerosol contribution to the signal is corrected for.

Finally, all intermediate results are formatted according to the Envisat product specifications and the product confidence information computed using all of the results of the internal tests performed during the computation.

The data products

The variety of geophysical parameters that are to be measured by MERIS will support a host of applications in marine biology, land and atmospheric sciences, as outlined below.

Ocean products

Ocean colour is the key objective of the MERIS mission and therefore the ocean is the surface for which the largest number of products will be generated. In the open ocean (97% of the World's oceans), the concentration of phytoplankton (algae) is a key parameter for understanding the processes involved in the carbon cycle. In coastal areas, phytoplankton cohabit with suspended particulate and dissolved detritus matter (yellow substance) which will be derived by inverting a model of the optical properties of these complex water

Figure 7. Level-2 product processing steps

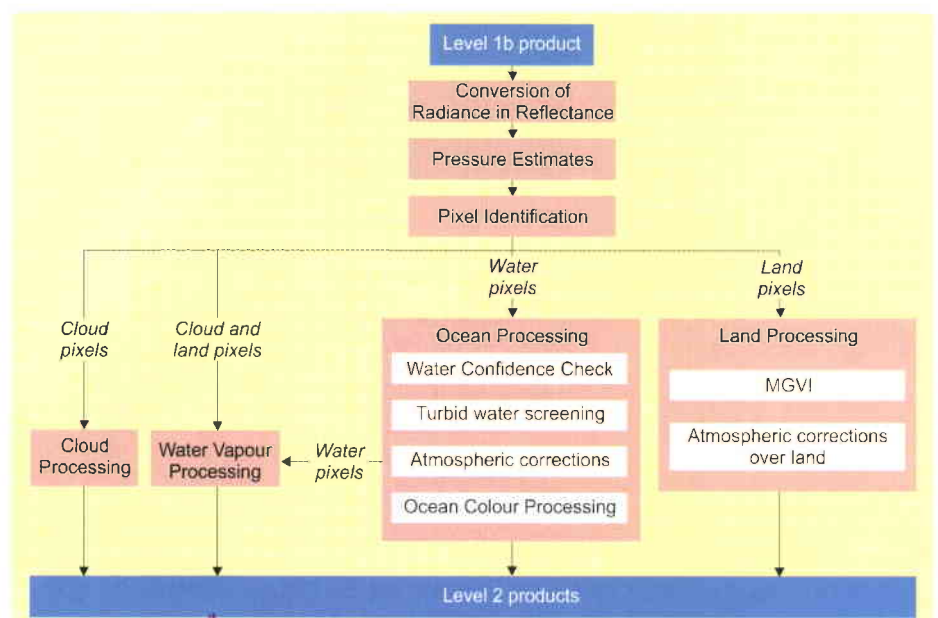

bodies using a neural network. The Photosynthetically Active Radiation (PAR) – the amount of radiation available to the oceanic flora – will be provided to support studies of chlorophyll fluorescence. Desert dust, continental and maritime aerosol types and their optical thicknesses will be generated as a byproduct of the atmospheric correction.

Cloud products

Cloud-top pressure, optical thickness, albedo and type will be provided for climatological studies of the Earth's radiation budget.

Land products

The MERIS Global Vegetation Index (MGVI) is a measure of the presence of healthy live green vegetation, estimated from the fraction of absorbed photosynthetically active radiation. Surface pressure will be provided as an experimental product. Aerosol optical thickness and type will be provided for users to improve the atmospheric correction over land.

Water-vapour products

The concentration of water vapour found in the total atmospheric column will be computed over all surfaces. It is of particular interest over land where the traditional measurement means are limited and where MERIS can provide products with a resolution of up to 300 m.

Breadboarding for modelled test-cases has enabled the accuracy of the products expected from MERIS to be estimated (Table 4). Typical images of the sort that will be acquired by MERIS are illustrated in Figure 8. They have been generated by the MERIS processor using reformatted MOS data.

Product validation

ESA has the responsibility to guarantee the quality of its data products. Consequently, a calibration/validation plan is being defined that includes in-flight calibration and campaigns in support of vicarious calibration and product validation. The plan forms the basis for developing scientific exploitation and application pilot projects related to MERIS, as already selected through the first Announcement of Opportunity for the exploitation of Envisat data.

Conclusions

The Medium Resolution Imaging Spectrometer (MERIS) belongs to a new generation of ocean-colour sensors that will provide a major improvement in our knowledge of such crucial processes as the contribution that the oceans make to the carbon cycle. The instrument has the unique capability of in-flight programmability of the position and width of the 15 spectral bands acquired in the visible and near-infrared parts of the spectrum. Data will be acquired with two spatial resolutions, 300 m and 1200 m, over a swath of 1150 km.

ESA will produce a set of validated data products from MERIS that will be available at various spatial resolutions, processing levels and within different time frames. These products and geophysical parameters have been identified as the most important, globally attainable parameters to be derived from MERIS. In addition to the Level-2 data, ESA will also provide the user with sufficient information to process the data to higher levels. The inherent flexibility of the MERIS instrument and the phased implementation plan will result in the development of a ground segment providing the most up-to-date products possible.

Acknowledgements

The MERIS instrument has been developed by an international team led by Alcatel Space Industries (F) under the Envisat prime contractorship of Dornier (D). The data-product algorithms have been developed under the leadership of ACRI (F).



Figure 8. Images generated by the MERIS processor using reformatted data from the Modular Optoelectronic Scanner (MOS) on India's IRS-P3 satellite:
 - TOA Radiance is a Level -1b product in band 2 acquired over the Adriatic Sea, central Italy and the Tyrean Sea
 - Chlorophyll concentration and MGVI illustrate the Level-2 distributed product concept over the same area as TOA Radiance
 - Cloud optical thickness and water vapour computed using an image acquired over Germany

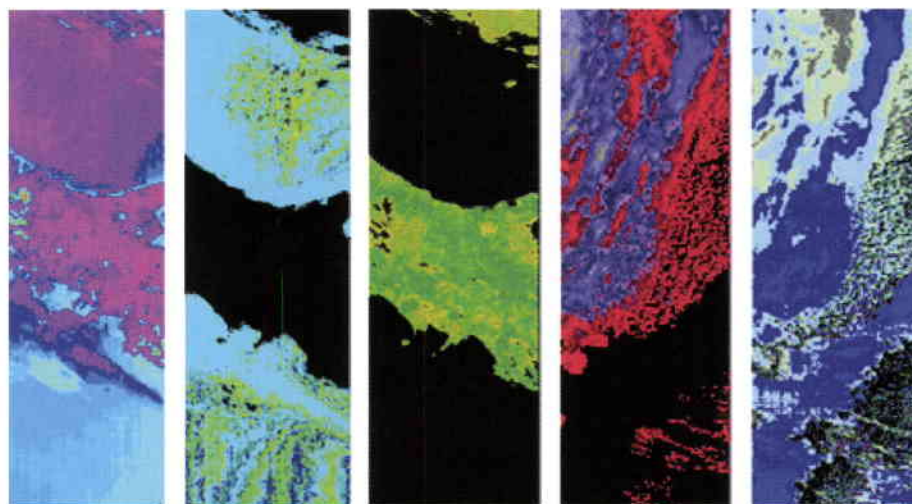

TOA radiance @ 442.5 nm Chlorophyll concentration MERIS Global Vegetation Index Cloud optical thickness Water vapour

Products	Accuracy
Chlorophyll retrieval	30%
Sediment	30%
Yellow Substance	50%
Water Vapour	10% (over land)
Cloud Top Pressure	10%
Cloud Albedo	10%
Cloud Optical Thickness	30%
Aerosols Optical Thickness	20% (over ocean) 50% (over land)
Surface Pressure	5% (over land)
Surface Reflectance	10%

Table 4. Estimated product accuracies

Hydrological Services: The Need to Integrate Space-Based Information

J. Dreher, G. Kubu

Verbundplan, Vienna, Austria

T. Nagler, H. Rott

Institut für Meteorologie und Geophysik, Leopold Franzens Universität Innsbruck, Austria

M. Schönerklee, G. Triebnig

Austrian Research Center, Seibersdorf, Austria

F. Gampe

Technology Transfer Programme, ESA Directorate of Industrial Matters and Technology Programmes, ESTEC, Noordwijk, The Netherlands

Introduction

Two different hydrological business cases have been investigated in the framework of an ESA study. 'Service Case 1' addressed run-off forecasting for the hydro power generation chain on the Austrian Danube. 'Service Case 2' looked at a trans-boundary river-basin management system embracing agriculture, forestry, environment, flood and risk management within a shared watercourse, for the Limpopo River in Mozambique.

altitude of 157 m together with the substantial flow rate (1980 m³/s average discharge at the Slovakian border) provides important potential for energy production.

There are in fact ten major power stations on the Austrian stretch of the river, all of which are multi-purpose schemes, including power generation, flood protection, navigation, and environmental protection issues.

The main interest of the inhabitants of the river-bank zones is early warning of flooding and the reduction of damage to property and infrastructure. Knowledge of the potential impact of flood events is a prerequisite for the planning and installation of appropriate protection measures.

The main interest for river navigation is to ensure regular shipping conditions. Timely notification of shipping companies of expected changes in water level and flow forecasting – both of low water and of potential flooding – is essential for secure navigation and economically efficient river-based operations.

The main interest for energy-production forecasting is to optimise the operation of the hydro and thermal power plants. This can be ensured by gathering real-time data and making short-term forecasts, ranging from a few hours to one day ahead.

Mid-term forecasts (over a few days) are essential for the economic optimisation of

Enormous socio-economic and environmental pressures in both developed and developing countries are making proper integrated management and efficient exploitation of water resources, often in a trans-boundary approach, an absolute necessity. This requires better information and management systems. Space-based systems that integrate weather, remote-sensing and communication satellites could provide a major contribution. A recent ESA-sponsored study has shown that the use of satellite remote sensing leads to an economically attractive solution compared with conventional monitoring and ground-based survey methods.

Case 1: Operational run-off forecasting for the Danube River Basin

Along its 2857 km length, the Danube drains water from much of central Europe, with the total catchment area amounting to 817 000 km². In Austria itself, an area of 80 700 km² (97% of the country) drains into the Danube, which is about 10% of the river's total catchment area. The topography is broadly divided into the alpine area in the west, and the pre-alpine region in the east. The Austrian part of the Danube is 350 km long, and the fall in

electricity generation and supply from the service-provider's point of view. So far, these forecasts have been based on ground-based hydrological, and even more importantly ground-based meteorological parameters. Longer term forecasts (one week or more) would be essential to optimise decision making in the de-regulated European electricity marketing sector. The meteorological parameters, particularly precipitation and snowmelt, are therefore of critical importance.

Forecasting on a regional scale (about 100 000 km²) calls for the modelling of run-off and flood routing, based on:

- rainfall forecasts
- soil-moisture models
- snow-melt models.

The efficiency of the proposed combined control of the hydropower plants along the Austrian Danube based on existing numerical approaches has been questioned because of the restrictions imposed by the weir operation rules (which are specific for each power plant and establish the background for a fine-tuned system for coordinated discharge control) and limited application possibilities (once or twice per year). The economic advantages achievable by the optimised operation of the hydropower chain with better run-off forecasting are therefore restricted. However, improved flood forecasting based on the integration of satellite-gathered data would still be highly advantageous for the timely implementation of flood-protection measures along the Austrian stretch of the Danube.

Integrated river-basin management for the Limpopo

The Limpopo is the second largest river in

Mozambique, stretching for more than 1450 km and draining an area of approximately 412 000 km². Its catchment area extends over four southern African countries (Fig. 1): South Africa, Botswana, Zimbabwe and Mozambique. The river actually rises South Africa, near Pretoria, at an altitude of 1500 m, and eventually drains into the Indian Ocean at Xai-Xai.

The basin has an annual mean rainfall of 560 mm, varying from 400 to 1500 mm year on year. The mountains situated between the Limpopo and Elefantas rivers receive between 800 and 1500 mm of annual rainfall. The annual precipitation in the remaining catchment area varies from 400 to 800 mm.

Agriculture can be considered the main economic activity of the Limpopo catchment area, in Gaza Province, with a cultivated area of 345 000 ha, corresponding to 4.6% of the total area of 7.5 million ha. The main crops are:

Maize	59%
Rice	8.2%
Peanuts	4.3%
Manioc	12.3%
Beans	9.0%
Sweet potatoes	2.7%

Compared to the water-supply needs for irrigation, those for the urban population can be neglected today, the two main urban centres being Xai-Xai and Chokwe.

The most serious problems in the Limpopo River Basin, which are typical also for similar river basins in both Africa and Asia, can be summarised as:

- irregular seasonal variations in water supply over the year



Figure 1. The Limpopo River Basin in Southern Africa

- disastrous droughts and floods
- increasing demands on water for irrigation purposes
- growing importance of crop yield
- progressive erosion caused by floods, deforestation and inappropriate agricultural practices
- uncontrollable inflow from upstream basins
- periodic floods causing public calamities
- insufficient waste water treatment
- threats to groundwater quality by pollution and salt intrusion.

Comprehensive analysis of the above problems in integrated water-resource management terms requires a very extensive set of capabilities. Many different hydrological and ecological models are needed to describe the water-quantity and water-quality processes (Fig. 2). The integration of the most appropriate sources of available information, using the latest Geographical Information Systems (GIS) and other special environmental and hydrological models, is critical to achieving a successful strategy .

To assist the Limpopo River Basin Management Unit (UGBL) with an improved information system to support its decision making, the following processes have to be addressed:

(i) *Planning processes*

- Flood protection/flood-plain management
- Watershed run-off forecasting
- Water distribution and reservoir management
- Land-use and forestry management
- Detection of erosion-prone areas
- Estimation of agricultural water demand and crop yield.

(ii) *Operational processes*

- Precipitation forecasting
- Flood forecasting and warning
- Detection of flood-prone areas
- Determination of soil moisture
- Determination of evapo-transpiration
- Monitoring of water quality and quantity
- Irrigation management and water accounting
- Data communication (telematics).

Most of the population of Gaza province lives close to the river banks, in cities like Massingir, Pafuri, Chókwé, Guij , Chibuto and Xai-Xai. They are therefore very vulnerable to flooding of the Limpopo. An adequate observation network and a comprehensive hydrological information system are therefore fundamental requirements for human safety and prosperity. The construction of such a system would allow:

- optimal operation and management of the hydro-meteorological network

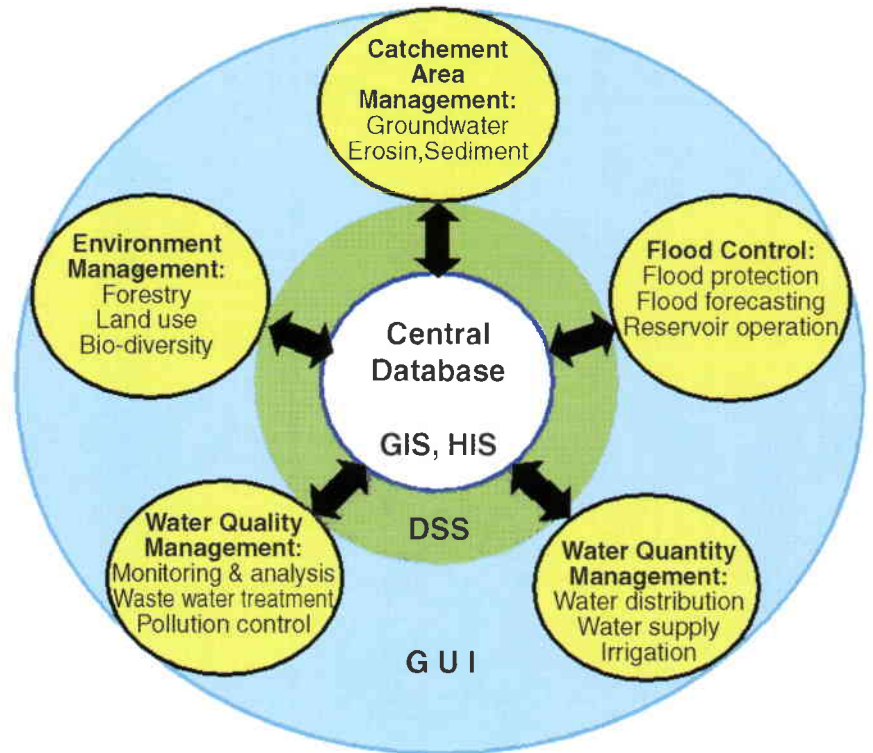

- optimal operation and management of the water resources
- access to the different types of information needed for decision-making in flood situations and dry periods
- optimisation of the water-distribution procedures
- event-dependent, continuous communication system
- better management and evaluation of the flow received from neighbouring basins and improved flood alarms
- implementation of an appropriate 'Decision Support System'.

Figure 2. Schematic of the proposed data integration approach for the Limpopo River Basin, with a central database and user-friendly Graphical User interface (GUI). The Decision Support System (DSS) represents the backbone of the system for the various applications

The role of satellite-based technologies

Remote-sensing technologies

Space-based Earth-observation techniques can be applied to:

- optimise the management of the water resources through utilisation of combined rainfall run-off routing and reservoir operation models based on monitoring data and meteorological satellite images
- improve the information system, allowing immediate decision-making before flood situations occur and in case of drought through additional global meteorological information
- improve and optimise the assessment of flow transfer and flood warning from neighbouring countries through additional 'trans-boundary' meteorological information
- improve flood-risk assessment and delineation of flood hazard areas using satellite imagery
- improve agricultural development by the optimisation of land irrigation through registration of cultivated areas and observation of the changes in the vegetation cover

Figure 3. A satellite-based telemetry and data-transmission network for the Limpopo River Basin

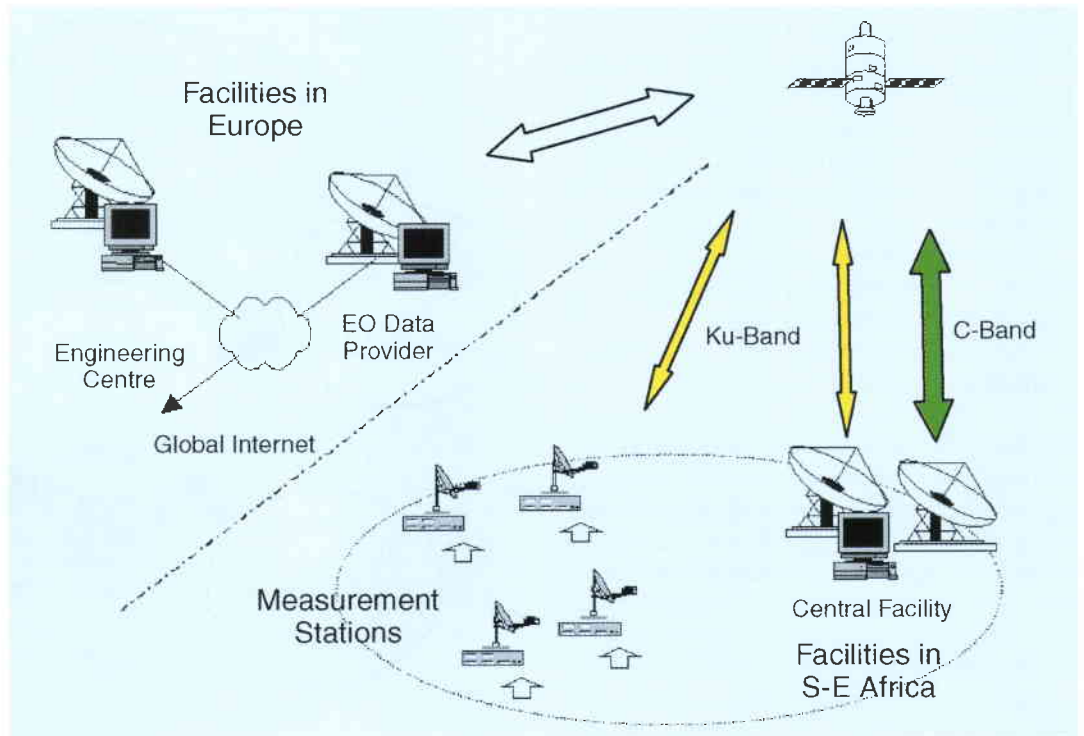

- detect changes in the water bodies, e.g. chlorophyll and turbidity
- facilitate forestry management and erosion control using satellite imagery.

Satellite remote-sensing and ground-truth data have to be: (i) acquired, (ii) made available, i.e. transferred to the point of data utilisation, and (iii) merged and converted into information through ingestion into a state-of-the-art information system (Fig. 3) equipped with an appropriate graphical user interface (GUI). The 'Hydrological Information System' (HIS) must therefore be capable of receiving and processing data from several different sources in order to produce the desired output. The reception path could be via land lines, but satellite links might be the more convenient or the only solution in this region.

Space-based data transmission and computer-network connectivity

A satellite-based data and computer communication system for the Limpopo River Basin management system would include:

- two-way low-bit-rate data transmission between ground measurement devices
- high-bit-rate Earth-observation data transmission
- transcontinental computer-network connectivity.

The ground measurement stations should be equipped with satellite terminals which can communicate (in Ku-band) via a geostationary satellite with a hub at the central facility in Xai-Xai. For the reception of Earth-observation data, a satellite link is foreseen from Xai-Xai to the provider location in Europe or Africa. The

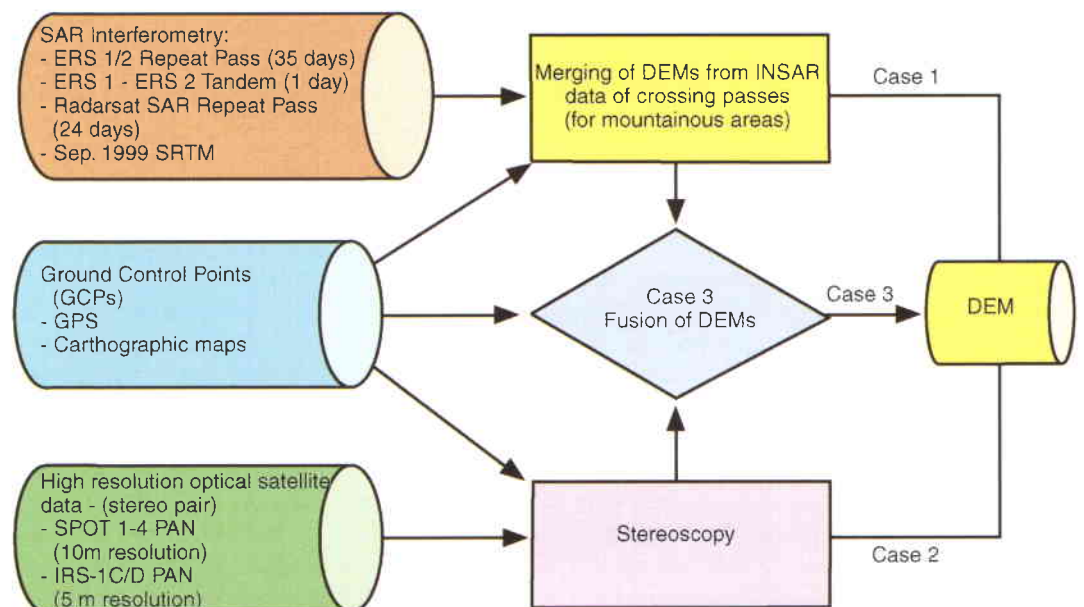

Figure 4. Flow chart for data integration and DEM generation

system implementation, maintenance and network management can be supported by an 'engineering and training centre', located in Europe, until full hand-over of system operations to the central facility in Xai-Xai has taken place. Global Internet access can also be established via the same lines.

The Integration of Earth-observation information

Our studies have identified six key targets for monitoring and measurement via satellite:

- precipitation run-off
- detection of flooded areas and flood plains
- agricultural water management
- surface-water quality
- erosion
- forest monitoring.

To achieve this, the following source elements need to be integrated:

Digital Elevation Model (DEM)

The mathematical-hydrological descriptions of the interrelations leading from precipitation to run-off within river basins, or selected river sub-basins, form the basis for river run-off prognosis, the operation of flood warning systems, flood-control planning and the operation of reservoirs for drinking water, hydropower generation and irrigation and drainage. The DEM raster size and accuracy needed for water-management activities in the Limpopo Basin still have to be specified exactly, but will be more in the metre rather than in the 10 m domain. For distributed run-off modelling and forecasting, a coarser resolution would probably be sufficient. For deriving physiographical information and for terrain-corrected geo-coding, it can be assumed that a 50 m spacing would be sufficient, but lower resolutions might be used for sites for which special activities (e.g. flood protection and other construction work) are planned. Figure 4 shows an example of a data-integration approach for DEM from different optional data sources.

Precipitation intensity and distribution

Knowledge of the spatial and temporal variability of rainfall is of primary importance for water management and run-off forecasting. Conventional rain gauges only provide point measurements. The combination of ground-based measurements and complementary Earth-observation data will significantly improve the input for run-off calculations, especially for convective events in small sub-basins. For the Limpopo River Basin, a combined system with geostationary satellite (Meteosat) data is proposed, as these data are already available operationally.

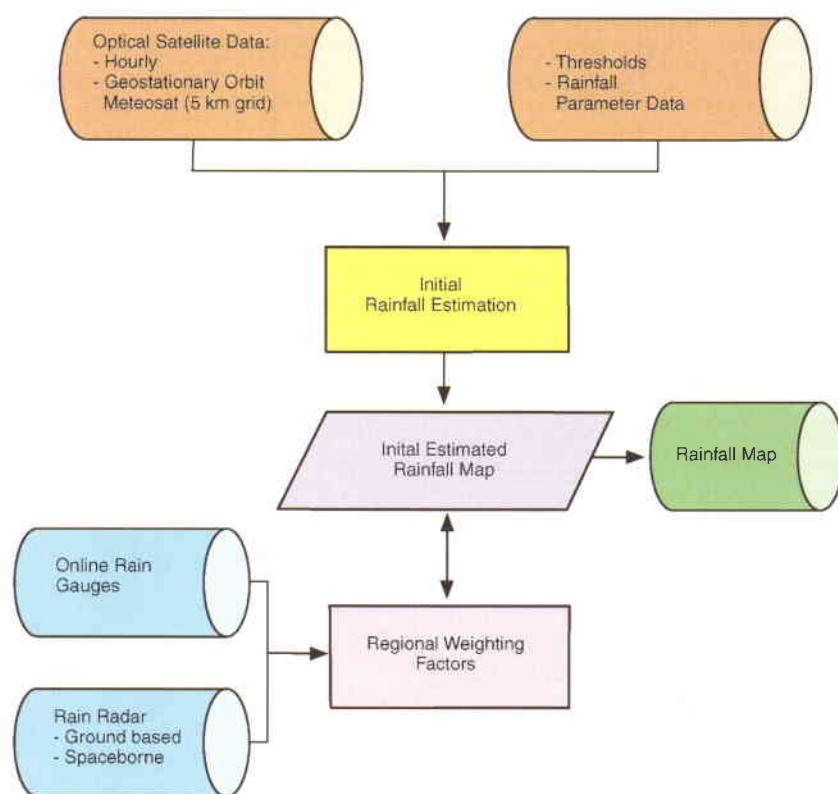

Figure 5. Data integration concept for rainfall monitoring in the Limpopo Basin (rain radar optional)

The data-integration concept is shown in Figure 5. Future extension of the system to include ground-based or satellite radar data is optional. The initial data source would be Meteosat, with its 30 min imaging sequence, and its visible (VIS: 2.5 km resolution at nadir), infrared (IR) and water-vapour (WV) absorption band (5 km resolution at nadir) channels. The Meteosat Second Generation (MSG), with a 15 min imaging sequence, will eventually provide improved resolution and additional spectral bands.

Land-use classification

Using hierarchical and statistical classification schemes, combining GIS and satellite data, will provide the best results. With NOAA-AVHRR input, the classification can be based on the Normalised Difference Vegetation Index (NDVI), augmented if necessary by thermal-infrared data. This already enables the separation of several classes of vegetation, but future satellite sensors, such as those of the MERIS instrument on Envisat, will have better spectral capabilities and will provide more sophisticated products on a pre-operational basis.

Evapotranspiration

Evapotranspiration (EVPT) is by far the dominant loss factor as far as the water balance in the Limpopo Basin is concerned. In addition, EVPT data are required for irrigation planning and estimation of reservoir losses. In conventional run-off models, EVPT is estimated from meteorological measurements, which is insufficient particularly for semi-arid regions.

River Basin Management	Satellite Applications and Methods	Status	Improvements
1. Planning:			
Flood Protection (high-precision Digital Elevation Model: DEM)	High-resolution optical satellite data Stereoscopy	Poor vertical accuracy	Laser altimeter; very high resolution panchromatic stereo data
Flood Plain Management (flood monitoring)	Optical images (VIS channels) Active MW (change detection)	Disturbances by clouds Active MW: poor time resolution	Wide-swath SAR with higher repeat cycle and beam-steering capabilities
Watershed Definition for Run-off Forecasting (DEM)	Stereo imagery matching with high-resolution optical data (VIS, NIR) SAR interferometry (ERS, SRTM)	Operational	SRTM data (depending on data delivery policy)
Irrigation and Drainage (registration; land-use classification)	Multispectral data (VIS,NIR,SWIR) Active MW (SAR)	Operational	High spatial and spectral resolution
2. Main Services:			
Precipitation Forecasting (indirect determination) (direct observation)	Cloud indexing (VIS, IR) Thresholding (VIS, TIR) Cloud life history (VIS, TIR) Passive MW (18-85 GHz) Rain radar: active MW (13 – 25 GHz)	Partly operational Link to operational run-off models still missing	Satellite rain radar with increased swath width used in synergy with other sensors due to restricted repeat cycle of radar
Snow Cover Snow Water Equivalent	VIS,NIR,SWIR; Active MW Passive MW for dry-snow mapping Active MW for wet-snow mapping	Operational for optical sensors and for SAR wet-snow mapping	Multichannel imaging MW Radiometer with improved spatial resolution
Determination of Soil Moisture (soil moisture content in the top layer)	Active and passive MW Wind scatterometer for very large scales	Experimental	Dual L- / X- band SAR and 3 to 5 day coverage.
Estimation of Evapotranspiration	Temperature maps (meteorological satellites) (indirect method, statistical approach)	Poor spatial and spectral resolution	SVAT-models and high-resolution VIS/IR sensors
Quality of Surface Water (empirical and analytical methods)	High spectral resolution (VIS,NIR) Thermal maps (TIR) Active MW (oil slicks)	Poor spectral resolution and need for thermal IR	Several narrow spectral bands (MERIS standard bands VIS)
3. Communication:			
Data Transfer from On-site Monitoring Stations	C-, Ku- or L-band on-demand access mode (64 kbit/s)	Operational	Operational costs have to be reduced

Table 1. Satellite applications within River Basin Management, and the proposed technical solutions for improvements

Satellite Earth-observation data enable spatially distributed estimation of EVPT.

Successful operational applications of satellite EVPT monitoring have been reported not only for semi-arid areas, but also for the mid-latitudes. In both cases the hourly VIS- and IR-Meteosat data are being used in synergy with ground-based measurements.

Flood-plain maps

Maps of flooded areas are required in near-real-time for the taking of emergency measures and for the short-term prediction of changes in

the flood level and of flood propagation. Satellite-based Synthetic-Aperture Radar (SAR) is then the best source of data due to its cloud penetration and hence all-weather operation, with geodetic, and if possible accurate digital-elevation data as complementary information:

- SAR data sources: ERS SAR precision-image (PRI) and Radarsat SAR SGF data, with day and night acquisition independent of cloud cover. A change-detection method can then be applied (e.g. ratioing) using data for times with and without flooding.

- *Optical images:* e.g. SPOT HRV, Landsat TM/ETM+; the flooded parts cannot be mapped for cloud-covered areas. A method for the classification of open-water areas can be applied. This data is, however, only of secondary interest because of the weather dependence.

Agricultural water management

Registration and development of agricultural regions requires detailed geographical information on land use, cropping and irrigation infrastructure. With multi-spectral high-resolution sensors and with a two-step strategy for surface type-classification, high-resolution land-cover maps can be derived for agricultural areas for irrigation and crop-yield surveying. SPOT HRV, Landsat-5 TM and Landsat-7 ETM+ can be exploited.

Water quality

Detection of water parameters can be carried out on a weekly basis with imaging spectrometers for the reservoirs of Massingir, Macarretane and other natural lakes close to Chókwe, which are large surface-water bodies. Data sources can include the MODIS instrument on NASA's Terra platform and the MERIS instrument on ESA's Envisat (due to be launched in 2001).

Forest monitoring

Forested areas have positive effects in terms of floods and erosion, and therefore need to be treated differently from other surface types in distributed hydrological models. The two parameters of most relevance for hydrology are the forest area and its temporal changes, and the forest type. Both require high-resolution data, but due to the reduced need for repeat surveys, aerial photographs may be suitable for surveying small areas. For large drainage basins, however, satellite imagery is the only economic source of data.

A business plan

Establishing a realistic business plan involves investigation of the relevant market and potential clients, as well as the development of a market strategy and financial planning. For the Limpopo Water Service case, we have to distinguish between national water sector planning, which falls to the national government and/or its autonomous corporations, and the policies of the international financing institutes. The main objectives are to provide capacity building to the water sector and to promote regional co-operation by translating global water concerns into regional initiatives. The financing for a trans-boundary water resource project of this nature, in a developing country, can be sought from such international

financing institutes as the European Union and the World Bank. River-basin management has on the one hand the nature of a public good, which can be used by anybody regardless of financial means, and on the other that of a technical-assistance project where the objective of the investment is primarily to create conditions for sector reform rather than to generate a high return on investment.

Careful analysis of the needs in this particular case have shown that the estimated costs of completing the project (initial investment, operations and maintenance) using conventional means are approximately 18% higher than when using satellite-based data, based on the defined investment, operation and maintenance cost conditions.

Conclusion

The capacity to monitor the global state of hydrological elements faces several technical, economic and institutional limitations, which have tended to result in restrictive data policies worldwide as well as severe delays in data availability to research institutions. Remote areas also suffer from a scarcity of hydrological observations and great difficulties in acquiring data in near-real-time, especially in the developing countries.

Remote-sensing techniques, particularly from space, have the potential to provide permanent surveillance of hydrological parameters on both a continental and a global scale. Satellite-based sensors can therefore be expected to play a major and growing role in hydrology and water-resource management in the coming years.

For the Limpopo River Basin Management System, our studies have shown the clear advantages of space-based Earth-observation technology for hydrological services in terms of:

- improved product quality by integrating spatially distributed information from satellite in place of ground-based point measurements
- less dependence on trans-border hydrological information systems, and
- better access to remote regions.

The Least Cost Analysis (LCA) method has also conclusively demonstrated the greater cost-effectiveness of using satellite-based technology, which can also open up new market possibilities for the region, with the prospect of additional commercial benefits.



Using Open-Source Software and Low-Cost Computers for Earth-Observation Data Processing

M. Önnestam

ESA Directorate of Applications Programmes, ESRI, Frascati, Italy

W. Balzer

Deutsches Zentrum für Luft- und Raumfahrt (DLR), Oberpfaffenhofen, Germany

M. Curtis

National Remote Sensing Centre Ltd. (NRSC), Farnborough, United Kingdom

Processing Earth-observation data

The Agency's Earth-observation projects involve space missions in which instruments carried by polar-orbiting satellites provide data to numerous users all over the World. This data arrives in a raw format requiring processing on the ground to convert it to data products that can be understood and exploited by users. This processing has until recently required very specific hardware and software, implying expensive electronic and computer equipment. The evolution of technology over the last few years, however, has now made it possible to use standard, high-performance computers even for these demanding tasks.

System re-hosting

The current evolution of technology in general and computers and electronics in particular, means that systems that were fully state of the art in their design when built rapidly become obsolete as more modern solutions become available. This creates problems in maintaining equipment, as spare parts for and knowledge of the systems become scarcer after a number of years. It also becomes increasingly difficult to add or change functions of the original systems, as their performance is limited and difficult to increase. It can also be difficult to find new peripheral equipment compatible with the older technology.

The introduction of open-source software compliant with industry standards has allowed the use of low-cost standard computers for a new set of Earth-observation applications. The Linux operating system is an example of this kind, which makes it possible to use ordinary PCs for demanding data-processing needs. ESA has benefited from this opportunity by replacing old and difficult to maintain systems with new ones providing both a significant increase in performance and a reduction in investment as well as maintenance costs.

The basic algorithms used for data processing meanwhile often need to be maintained in the same state throughout the lifetime of an Earth-observation mission, which can last for many years. The in-orbit instrumentation always remains the same, although it may degrade slightly. This means that the original software and algorithms need to be kept for several years, whilst the computer hardware needs regular replacement.

The Agency utilises a number of facilities in Europe for its Earth-observation data-processing tasks, where equipment, systems and resources have been assembled to form entities that provide the required services. The ERS mission is such an example, supported by so-called 'Processing and Archiving Facilities' (PAFs) where the data are archived and made available for processing. The PAFs have data-processing systems that read data from the archives and produce data products for the users.

The process of changing the computer equipment while maintaining the software and algorithms is called 're-hosting'. It means that hardware is replaced by new equipment while the software remains, wherever possible, identical. The main problem in this process is that new hardware often requires a new intermediate layer, the Operating System, where basic input and output and most importantly mathematical functions are implemented in different ways. This leads to situations where the original software needs to

be updated although the intention is to keep it unchanged. It also means that thorough validation and testing is required to prove that the re-host generates output indistinguishable from that of the original system.

Open-source software

The recent evolution in networking using the Internet has enabled software developers around the World to co-operate in the so-called 'open-source' movement. This has been based on the GNU General Public license for software whereby anyone has the right to modify the code and re-distribute it as they see fit. The Linux operating system is one example of this international co-operation. It is technically a Unix kernel managing the computer hardware and networks that was first developed for the PC architecture. It is now also available for many other platforms.

It is possible for anyone, through the licence, to acquire the source code of Linux by downloading it from an Internet server. In practice, however, is it more convenient to buy a CD-ROM on which the source code is distributed together with support programs and applications.

The fact that the source code is open and freely available makes modification and tailoring for a specific application possible. The code can be changed and re-built for the specific environment by the teams building the application. This means also that the application when ready is more amenable to future re-hosting, if required.

The GOME Data Processor re-hosting

The GOME Data Processor (GDP) at the German Processing and Archiving Facility (D-PAF) in Oberpfaffenhofen generates data products for the monitoring of the Earth's atmosphere. This processor has been in operational use since the launch of ESA's ERS-2 Earth-observation mission in 1995. The output products derived from the Global Ozone Monitoring Experiment (GOME) instrument provide global information about the atmosphere's content of trace gases like ozone.

The GOME algorithms and processing software used by the GDP have evolved over the years since the start of operations, due both to increased knowledge of the instrument's capabilities and to innovations in processing techniques. This led to data acquired at different points in time being processed with different versions of the data processor, leading in turn to small but significant differences in the product output. However, the scientific users of

the products looking for global trends and changes ideally require a coherent data set processed with the same software version covering the full mission. The requirement for re-processing capabilities was therefore acknowledged by the Agency during 1998.

The GDP at that time was coping successfully with the processing of new data, but could not simultaneously support extensive re-processing. ESA therefore asked the institution hosting the processing facility, namely the Deutsches Zentrum für Luft- und Raumfahrt (DLR), to examine the possibility of upgrading the processing capacity. It was soon apparent that there were two possibilities, to extend the system with the same brand of hardware or to replace the system with low-cost PCs running Linux. The second possibility offered a price/performance ratio an order of magnitude better than the more traditional first alternative.

The fact that the original processing system used hardware running a Unix operating system helped at this stage when the effort to re-host was analysed. Linux, being a flavour of Unix aiming for standard compliance, supported the application well without requiring major coding changes. The Agency therefore finally selected the PC-based solution whereby twenty identical units would be assembled into a 'PC-farm' to execute the most demanding parts of the data processing (Fig. 1).

The original software already supported an architecture in which the processing could be spread over a network of computers. The main advantage of this was that one unit could fail without disturbing the others and that the overall performance would only be slightly degraded.

The scope of the project at this stage was:

- Re-hosting of the most demanding part of the application, the data-processing engine, starting from calibrated instrument data and ending with user products containing geo-physical information.
- Maintenance of all existing external interfaces by keeping the system front-end as it was without changing the hardware.
- Implementation of memory handling to handle the differences in processor architecture correctly.

The GDP re-hosting project now consisted of two major activities related to the application software: the original software had to be re-built for the new Linux environment, and the differences in processor architecture had to be handled correctly. The software re-build demonstrated the fact that Linux and software



Figure 1. The Linux farm for GOME data processing at the German Processing and Archiving Facility (D-PAF)

designed for Linux follows accepted standards more strictly than other commercially available products, where machine-specific extensions are often introduced. The tool translating the code to machine instructions, the compiler, in this case showed this behaviour. The original code used many of these specific extensions, which the Linux compiler did not support. A complete inspection of the code was therefore needed to remove all such extensions. This also had the beneficial effect that several previously undetected errors were spotted and also corrected.

The second major task was the implementation of the memory handling, the so-called 'byte swapping'. The new PC architecture differed in its memory organisation from the existing hardware. The project therefore implemented a byte-swap routine at an early stage that corrected for this.

After these two activities had been completed, the project proceeded smoothly and the application software could be compiled and executed on the new PC hardware just 60 days after the kick-off. Comparisons between outputs from the new and the existing chains

showed very small relative differences, all within the level of mathematical precision, but very few cases where the relative difference was high but the absolute difference was low, because the computed values were close to zero.

The D-PAF now uses the re-hosted GDP for its GOME data processing. The first re-processing campaign took place during autumn 1999. The processor generated user products for all ERS-2 GOME data over a number of months, achieving a speed whereby one year of data got processed in one month, despite several hardware problems. This can be compared with the previous performance of processing two months of data in one month with no operational failures.

The UK-PAF re-hosting

The United Kingdom Processing and Archiving Facility (UK-PAF) has provided data-processing and product-generation services for the user community since the first ESA Earth-observation mission, ERS-1, was launched in 1991. The products have been derived from the source data of the main ERS instruments, i.e. the Radar Altimeter (ALT), the Synthetic Aperture Radar (SAR) and the Along-Track Scanning Radiometer (ATSR). The architecture known as the Earth Observation Data Centre was first assembled to support the ERS-1 mission. It was subsequently extended during 1994 and 1995 to support ERS-2.

One of the main UK-PAF data products is the Radar Altimeter Waveform Product (ALT.WAP), which contains the processed RA telemetry as well as important annotations such as correction factors for atmospheric conditions. This is a global data product offering a unique data set covering oceans, ice- and land-masses, which no other Radar Altimeter data set is capable of delivering. The ALT.WAP processing chain is located only at the UK-PAF and its hardware has not been updated since the ERS-2 launch.

In 1998, the Agency began replacing obsolete hardware in its Earth-observation data-processing facilities, while also ensuring year-2000 system compliance. The UK-PAF host, the National Remote Sensing Centre Ltd. (NRSC), carried out a study of the implications for their facility. It was found that the architecture from 1995 utilised computer hardware that was obsolete such that it made maintenance very expensive and the replacement of peripheral equipment like magnetic tape devices almost impossible. Moreover, the operating system was not year-2000 compliant. It was also recognised that

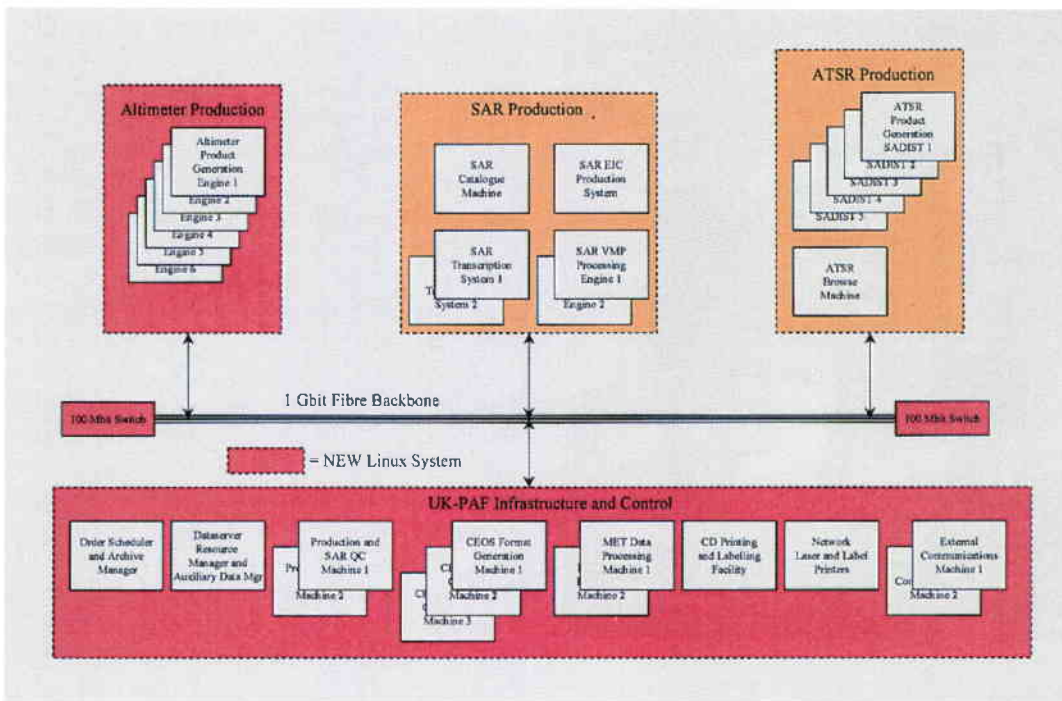

Figure 2. The system architecture of the UK Processing and Archiving Facility (UK-PAF)

critical subsystems did not have any redundancy, which would cause long periods of unavailability in case of failures.

All of these facts led to an NRSC study whereby the possibility of an upgrade was considered. The alternatives were soon recognised, as in the case of the D-PAF, as either replacing the hardware with a modern version from the same manufacturer, but still using the same basic software, or replacing the hardware with PCs running Linux, which would also imply system re-hosting. The fact that the operating system in use at the UK-PAF was an older version complicated the alternative of a simple hardware replacement, as the existing operating system would not execute on any new platform available. This meant that both alternatives would effectively lead to a re-hosting, and the study showed that the effort required would be of the same magnitude in both cases.

The success of the D-PAF re-hosting, together with the significantly better price/performance ratio of the PC-based solution combined with much lower maintenance costs, led to the selection of this alternative and the re-hosting project was started in late spring 1999. It included all external interfaces, the control of the SAR and ATSR processing chains, and the full ALT.WAP processing. The SAR and ATSR processing chains were not included as they are delivered by other entities for the UK-PAF's use.

The project elected to maintain the existing architecture, whereby discrete functions are statically distributed over a network of

computers (Fig. 2). The lower hardware cost allowed generous redundancy and each function could thus reside on at least two computer hosts. This, combined with the use of RAID (Rapid Array of Independent Discs) technology allowing secure data storage and redundant local-area networks, removed all possibility of outages due to a single failure (Fig. 3).

The re-hosting project not only aimed at replacing obsolete hardware, but also had the goal of securing UK-PAF operations in the year 2000. This meant that the schedule had to be very ambitious, to allow startup before the end of 1999. The project was therefore divided into three phases, with the most critical functions to be addressed first, thus securing at least limited use. The first of the phases secured the

Figure 3. The scheduler subsystem of the UK-PAF. The black unit on the left is the RAID unit, providing full data redundancy



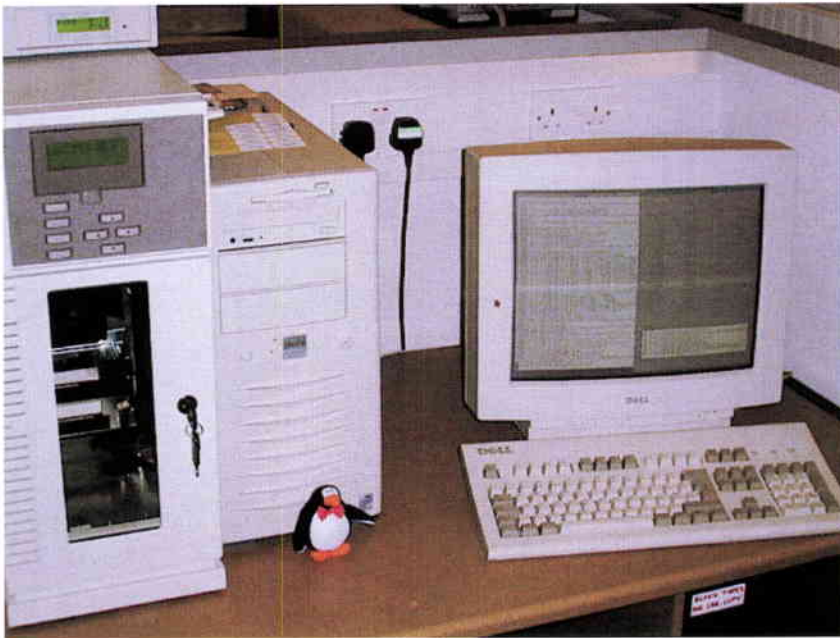

Figure 4. One of the UK-PAF data-processing sub-systems. The unit on the left is a robotic cassette-handling facility enabling continuous data processing

external interfaces of the UK-PAF to enable at least manually controlled data processing. The second integrated the functions of controlling the SAR and ATSR processing chains, thus allowing automated processing for these sensors. The last provided the fully automated ALT.WAP product processing.

The project experienced some initial delay due to problems with one of the Custom Off-the-Shelf Software (COTS) products being used. This item provided the management of the UK-PAF databases and had just been released as a native version for Linux. The project initially successfully used a preview version that was not officially supported, but encountered problems when trying to use a later supported version. These problems proved so serious that the preview version was actually recovered and used in the final operational system.

The first two phases, allowing SAR and ATSR product generation and supporting all external interfaces, were finished just in time for Christmas 1999 and the UK-PAF successfully completed the year 2000 roll-over. The final phase did, however, encounter problems that delayed the re-starting of ALT.WAP product generation.

The ALT.WAP re-hosting differed from the rest of the project in that it touched upon the data processing itself, and not just the processing control. This meant that the issues of memory organisation and mathematical precision also encountered in the D-PAF case became valid. The first of these caused some problems and delay, but were resolved quickly in a similar way to the D-PAF when a general byte-swapping strategy was implemented. The latter, on the other hand, created problems that were more

difficult to understand. The values in the output products differed from those of the original chain in a way that could not be justified. Finally, a single instruction, namely a numerical division, appeared to be critical where the rounding systematically differed compared to the original system. This error was then propagated throughout the chain to the output results. The difference could thus be explained and accepted and the processor became ready to use.

The UK-PAF is now fully operational for all production chains ten months after project kick-off. The new systems perform according to expectations and well above the previous system levels (Fig. 4).

Re-hosting achievements and benefits

The two Linux re-hosting projects described in this article have both shown the excellent performance of this low-cost alternative. It is evident in particular that the possibilities of multiplying the hardware in a way that traditional alternatives do not permit raises the performance significantly. This means in the end that much higher throughputs can be achieved for a similar or even a lower cost.

The re-hosting to Linux on PCs requires specific attention to two issues: the differences in memory organisation between different hardware types, and the differences in mathematical precision. Re-hosting projects should therefore identify and establish strategies to handle these issues in the early stages, in order to avoid surprises when the new outputs are compared with those of the existing systems.

The two implementations have also demonstrated the reliability of the Linux operating system. There have been very few reported outages and all have been related to hardware or other components outside the control of the operating system. Projects implementing this technology should therefore select hardware with a good reputation for reliability in order to benefit fully from the good performance of the Linux operating system itself.

All things considered, Linux is proving a very good candidate for use as the operating system of choice in Earth-observation data-processing facilities.

Space Radiation Alarm

"CEASE"

COMPACT ENVIRONMENTAL ANOMALY SENSOR

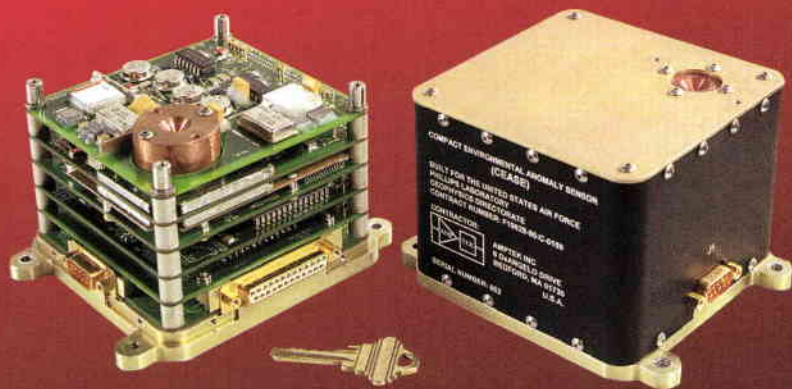

FEATURES:

- Compact: 10 x 10 x 8.1 cm³, 1 kg
- Low Power: 1.5 W
- Flexible I/O: Supports 1553B and RS422
- Full GSE and operational software
- On-board determination of hazardous conditions

CEASE is a compact, radiation hard, low power, space "weather" hazard sensor developed to monitor the local radiation environment and to provide autonomous real-time warnings of:

- Total Radiation Dose
- Radiation Dose Rate
- Surface Charging
- Deep Dielectric Charging
- Single Event Effects
- Solar Cell Damage.

CEASE detailed radiation data is used to pinpoint causes of spacecraft anomalies, and to forecast hazardous conditions before they affect the mission. The spacecraft, in turn, can re-prioritize its operations, inhibit any anomaly sensitive tasks such as attitude control adjustments, or initiate other prudent actions as indicated by the **CEASE** warning flags. Device degradation mechanisms and radiation tolerance of components can also be monitored. The US Department of Defense has selected **CEASE** for several missions, including:

- **TSX-5**
- **STRV-1C**
- **SBIRS LADS**

and the **DSP** operational spacecraft.

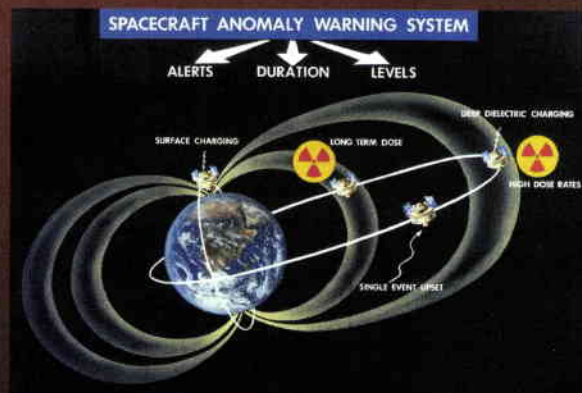

Amptek has a long and distinguished track record in the manufacture of space instrumentation. Mission examples include: DMSP, TIROS, CRRES, NEAR and APEX.

Current off-the-shelf Amptek sensors measure spacecraft charging, thermal and suprathreshold, and high energy particles. In addition, Amptek provided the X-ray Detector on the Mars PATHFINDER Mission.



High reliability components from Amptek have been the number one choice of many missions, including: GALILEO, CASSINI, GIOTTO, AXAF, SUISEI, CLUSTER, SOLAR, GEOTAIL, SOHO, INTEGRAL, WIND and AMPTE.

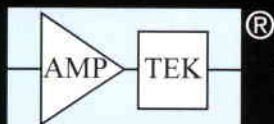

AMPTEK INC.

6 DE ANGELO DRIVE, BEDFORD, MA 01730-2204 U.S.A.

Tel: +1 (781) 275-2242 Fax: +1 (781) 275-3470 email: sales@amptek.com <http://www.amptek.com>

JOB OPPORTUNITIES IN SPACE

Serco is the largest technical services contractor to ESA. We have been supporting the Agency's programmes for over 25 years and regularly have job opportunities based at ESTEC (Netherlands), ESRIN (Italy), ESOC (Germany), ESA/HQ (France) and Kourou Spaceport (French Guiana).

Typical activities within the space field encompass:

- AIV Engineering
- Component Testing and Failure Analysis
- Antenna Engineering
- Earth Observation
- Ground Segment Engineering
- PC Support
- Unix System Administration
- Software Development
- Database Development and Management
- IBM MVS System Ops and Programming
- Web Development
- Project Management
- Product/Quality Assurance
- Technical Authoring

If you would like to be considered for future job opportunities with Serco please send your full curriculum vitae to:

Jane Marcham, Serco Europe Ltd.
5th Floor, Kempton Point
68 Staines Road West, Sunbury-on-Thames
Middlesex TW16 7AX, U.K.
Tel.: +44 1932 733 000

SERCO

Serco is an Equal Opportunities Employer

SPACE IS OUR CORE BUSINESS!

WHAT'S YOURS?

KEC has contributed to various international, governmental and commercial space programmes. Whether you are looking for new opportunities or have already established a steady space business, KEC can offer you attractive services in the field of:



Management: Interim Management, Project Management, PA&S Management, Industrial Organisation, Trouble Shooting, Consultancy

Systems Engineering: Methodology, AOCS, OBDH, Data Storage, Electrical Power Systems, Mechatronics, Mechanical Engineering, Using COTS in harsh environments, Consultancy

Business Development: Strategic Alliances, Opportunities, Market Development, Business Plans, Technology Transfer, Investments, Feasibility Studies, Consultancy

KEC
Van Kempen Engineering & Consultancy

P.O. Box 2226, 5001 CE Tilburg, The Netherlands, Tel.: (+31) 13 4 55 00 44 - Fax: (+31) 13 4 55 04 50
E-mail: kec@planet.nl - Internet: <http://www.kec-home.nl>

KEC
Van Kempen Engineering & Consultancy

IT-Based Quality Management of Earth-Observation Operations at ESRIN

W. Lengert

Earth Observation Applications Department, ESA Directorate of Application Programmes, ESRIN, Frascati, Italy

U. Gebelein & G. Lavaux

Serco SpA, Frascati, Italy

Introduction

The ESRIN Earth Observation (EO) operational environment consists of a network of remote facilities (acquisition stations and processing and archiving facilities) scattered throughout Europe and Canada, supporting the payload data-handling operations for the Earth-observation satellites operated by ESA. The network is managed by ESRIN in Frascati, Italy, where a centralised facility supports the operational activities.

The facility was created within the Earthnet Programme in the late 1970s to ensure the minimum capability needed for solving problems encountered at the remote sites and

for supporting the remote operations. Since then, the ESRIN facility has been growing steadily in terms of the number of missions handled and adapting to the changes in technology and the constantly increasing user requirements. With the Agency's ERS missions, the ESRIN facility became the 'Central Processing Reference Facility' (CPRF), including the functions of ERS operational mission planning, ERS sensor monitoring and control, and product generation and distribution, mainly related to data received from remote international ground stations.

The rapid growth in the functionality and the services required resulted in an increasing number of on-site contractors from several different companies, quickly transforming the Centre into a complex operational environment. This in turn has called for constant organisational adjustments and has demanded a very rational approach to the management of the access to and control of the computing infrastructure and the related human resources.

This complex task of rationalisation has been completed by applying an Information

The functions and services provided within the Earth-observation operational environment at ESRIN have grown rapidly in recent years. This has resulted in the need for a rationalised approach providing transparency, optimum use of human and facility resources, and structured reporting as a basis for sound decision making, planning and resource allocation. Methodologies have been developed to improve both the quality and efficiency of the Earth-observation operations, with an intranet-based framework to support quality management.



Figure 1a. The main computer room in 1980's



Figure 1b. The main computer room at present

Technology (IT) based framework, into which identified key functions have been integrated and are monitored to provide reliable quality management. This solution allows the standardisation of procedures for handling service requests, service provision, conflicts of requirements monitoring, resource allocation and control, and generally improves visibility for the user and the management. This article describes the methodology adopted, the off-the-shelf tools used, and the many benefits that have been obtained on a comparatively short time scale.

The complexity of the environment

The operational computing environment consists of a non-homogeneous mix of computer equipment in the computer room and various offices running operational and scientific applications, including applications under operational qualification on both old and new technology equipment. The infrastructure is based on about 100 platforms from the most popular vendors, and several hundred peripherals of various types (magnetic/optical), plus quite a number of very specific pieces of equipment and laboratory-type units. Most hardware items are running very specialised applications, which requires specific configurations.

Operations also require an adequate logistics set up including hot spare parts, shipment of products, consumables procurement and storage, tracing of hardware and software configuration changes, tracking of data and hardware (down to board level) in transit to and from the remote facilities (stations, Processing and Archiving Facilities) and hardware undergoing repair or on loan.

Figure 2. Kiviat graph of identified QM functional

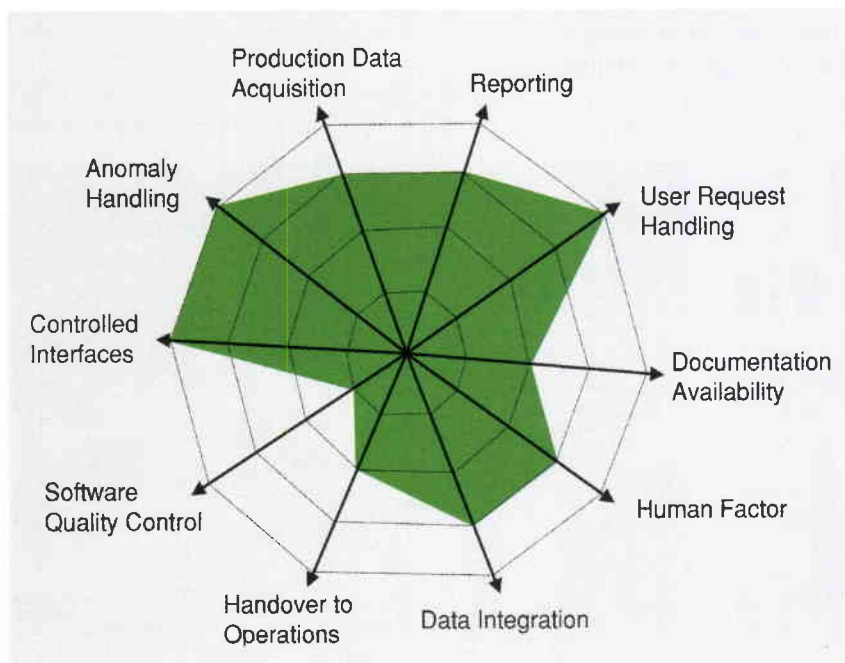

The EO operations consist of some predictable routine work, activities initiated by random user requests and special tasks, requiring continuous adaptation of the infrastructure as well as ad-hoc solutions:

- day-to-day operations
- data-transfer monitoring
- product generation and distribution
- reference system operations
- acceptance of new operational chains
- installation of EO applications and system integration
- application/system troubleshooting
- product and system operational qualification
- product and software quality control.

The major tasks can be grouped into seven broadly defined 'key classes':

- Computer Operations (including support to specialised services)
- System Administration
- Historical Data Archiving
- System/Application Library
- Logistics
- Shipment
- Hardware/Software Inventory.

Quality-management objectives in operations

Commitments to be fulfilled at all times as part of the routine service to external users by the operational facility can be summarised as:

- Guaranteed availability and reliability of the resources.
- Satisfaction of customer/user needs.
- Defined and committed product quality.

The problem was how to fulfil such commitments despite the complexity of the service requirements highlighted above, and the constant evolution in the environment being managed. The solution was to adopt a proper integrated management system allowing those responsible to work in a fully synchronised fashion, with everyone aware, at any given time, of the system requirements, the expected workload, the availability of resources, and the expected output. Full system visibility has thereby been extended to all people involved in the operational process, including the service requesters.

The main objectives set for quality management were:

- ensuring transparency in the EO operations-provided services towards ESA management and within the industrial contract providing the operational services to ESA
- ensuring continuous control over best usage of the human and facility resources, for increased system efficiency and monitoring

Services	Computer Operations	System Administration	Historical Data Archive	System/Application Library	Logistics	Hardware/Software Inventory	Shipment
Controlled Interfaces	M	M	M	M	M	M	M
User Request Handling	M	M	R	M	N	N	M
Anomaly Handling	M	R	O	O	O	O	O
Reporting	M	M	M	M	M	M	M
Handover to Operations	R	R	O	O	N	O	O
Production Data Acquisition	R	R	M	O	O	O	O
Documentation Availability	R	R	O	M	O	O	O
Software Quality Control	R	O	N	N	N	N	N
Human Factor	M	M	M	M	M	M	M
Data Integration	R	R	O	O	O	M	O

Legend

- M (Mandatory) absolutely necessary
- R (Recommended) helps in the day-to-day work, but depends on the service requestor
- O (Optional) value-added service, case-dependent
- N (Not Applicable) functional activity not part of service

- providing for structured reporting and decision mechanisms for the timely identification of any necessary corrective actions to the core services
- allowing proper planning for resource allocation, taking technological evolution and evolving user requirements into account.

The QM methodology adopted

An analysis of the work processes and flow identified ten major functional activities as being of highest priority and therefore candidates for constant monitoring and improvement to ensure the continued availability of high-level EO services and products.

The methodology adopted was based as a first step on an evaluation of the relationship between the functional activities and the services to be provided. The accompanying matrix (above) serves as an example of the identified links and assigned weights, depending of the value of the operational process. The idea was to build up an adaptive system to allow flexibility and incremental implementation.

The Kiviat graph in Figure 2 depicts each function along an axis and shows a qualitative measure of its importance for improving the performance of EO operations.

To implement the chosen methodology, an Intranet-based framework called the Common Support System, or CSS, was built up. Reflecting the structure of the rationalised organisation, it links the chosen support tools to an integrated information system and is thus a logical model of the operational support structure. The entry page is shown in Figure 3.

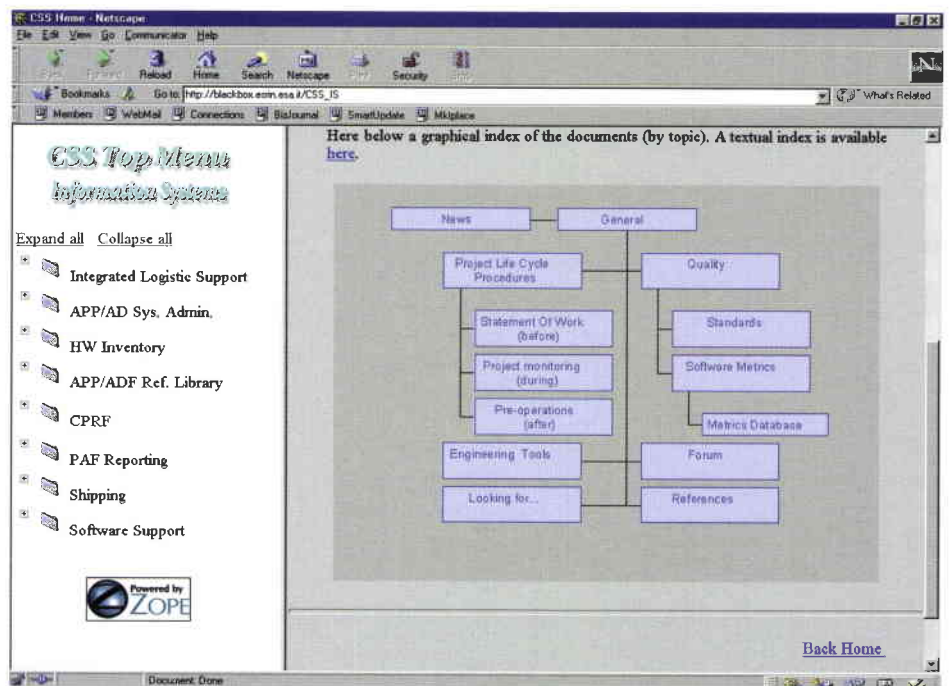

Controlled Interfaces

The complexity of the system to be managed demanded that careful attention be paid to interface identification and control. The methods employed had to be flexible and adaptable to the different levels of communication required. The information necessary to support operation and monitoring must be systematically organised and kept in such a way that it can be easily retrieved and analysed.

Formalisation of the interactions between service units was therefore considered a key issue in improving quality management. Means had to be found to:

- collect data and maintain the historical data records

Figure 3. Top level of the CSS framework

- structure and attribute the data
- foster the adherence to predefined sequences
- allow monitoring of interactions and control of deadlines
- allow basic reporting with the provision of more flexible reporting
- become an integral part of the work processes without disturbing them
- make previously 'personalised' information easily available to staff and management.

Within the CSS framework, such interactions were therefore modelled and formalised via Web data-entry pages. Work-flow management was implemented where task execution needed to be synchronised.

User Request Handling

Adequate methods needed to be identified and implemented to:

- register user requests
- log the current status of activities
- keep track of activities performed
- control deadlines
- keep any information related to requested tasks
- allocate resources and assign priorities.

Within the CSS, requests can be structured hierarchically both in terms of time scale (subdivided into reporting periods) and request type. Additional information can be attached to all hierarchical levels.

Reporting

Proper structured reporting is required for monitoring purposes, but also to measure the performance of the service and thereby

support decision-making. The presentation of the information needs to be standardised, with a distinction between two types of report: those to management presenting trends, systematic problems, and the scope of the work performed, and detailed reports allowing the technical officer to closely follow the services being provided.

Operational production data are, by their nature, inconsistent, incomplete and, in isolation from their context, not very meaningful. Processing anomalies have to be handled properly by data collection tools, which ensure data consistency and integrity.

Reporting is updated on a weekly basis mainly with data extracted from application log files (processing, distribution). The reports themselves are kept in a database that can be queried to answer operational questions concerning performances, bottlenecks and critical dependencies. Figure 4 is an example of a typical report used today within the CSS framework. The work packages are linked to applications, to staff and to the computer systems utilised. The throughput of critical systems for each work step is displayed and is checked for consistency with the overall system performances, thereby ensuring the reliability of the information in the report.

Anomaly Handling

Existing knowhow was used to control anomaly handling, leading to the implementation of a distributed Change Request Management System (CRMS). This COTs package was considered not only easy to use, but also the

leading defect tracking system, linkable to a configuration-control tool, and therefore best suited to manage information throughout the software life cycle. The CRMS is fully configurable, and change requests can be easily submitted and queried via a Web interface.

Production Data Acquisition

EO applications generally produce extensive logs, which are checked both manually and automatically. They are collected and displayed on the Information System Intranet page.

The integrated system makes best use of available production data by providing two levels of product-generation status visibility:

- Monitoring: for example, the state of currently ongoing productions is visualised and critical production status is flagged

Figure 4. Structured reporting

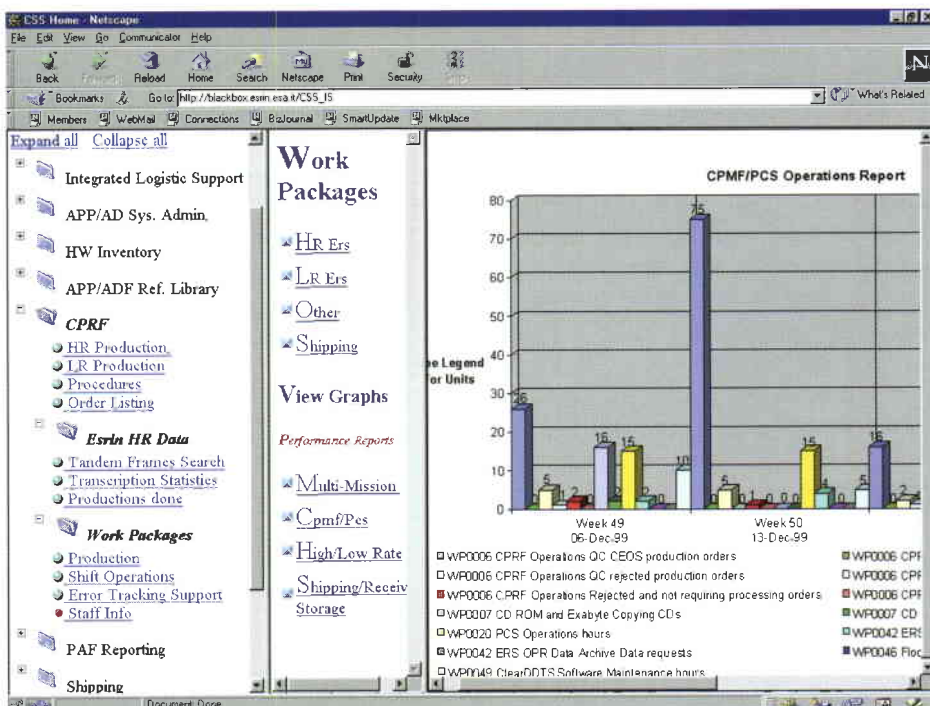

- Reporting: production data is systematically collected and stored in a database, allowing flexible retrieval and easy evaluation of both the data and performance parameters.

Software Quality Control

Software quality is essential for ensuring smooth and continuous operation. However, noisy telemetry or corrupted or wrongly treated media must also be handled in operations, including data outside specifications. In order to ensure reparability, adaptability, expandability and robustness of the operational systems, it was agreed to ensure stricter application of recognised software-engineering standards and guidelines. Software metrics have been applied following the idea of Tom De Marco that "you cannot control what you cannot measure".

A suite of appropriate engineering tools was established and made available to foster standardised working practices during the several project/life cycle phases (anomaly handling, configuration control, test execution, source code analysis, quality guidelines) and thus create comparable historical records (Fig. 3).

Handover to Operations

To satisfy the objectives listed above, the system handed over to operations first needs to be qualified. This requires knowledge of the application, the system configuration, special requirements for integration in the operational environment, project history, test configurations, etc.

Since qualification is not always applicable, the Hand-Over-to-Operation for Quality Management is classified in the following two categories:

- With operational qualification; the operation team operates the system and takes commitments for associated products and services;
- Without operational qualification; the operation team operates the system on a best-effort basis for associated products and services.

In Figure 5, it can be seen that the handover process involved up to 7 service/user groups, and hence a considerable co-ordination effort. The methodology implemented assists the planning and co-ordination activities and allows monitoring and deadline control for the ongoing activities. Threshold exceeds are automatically communicated by the reporting system via e-mail and must then be justified. To help decide on the best corrective action, the test information, acceptance test documentation, configuration items, hardware/software inventory, reference data, etc. needs to be readily accessible. An additional approach

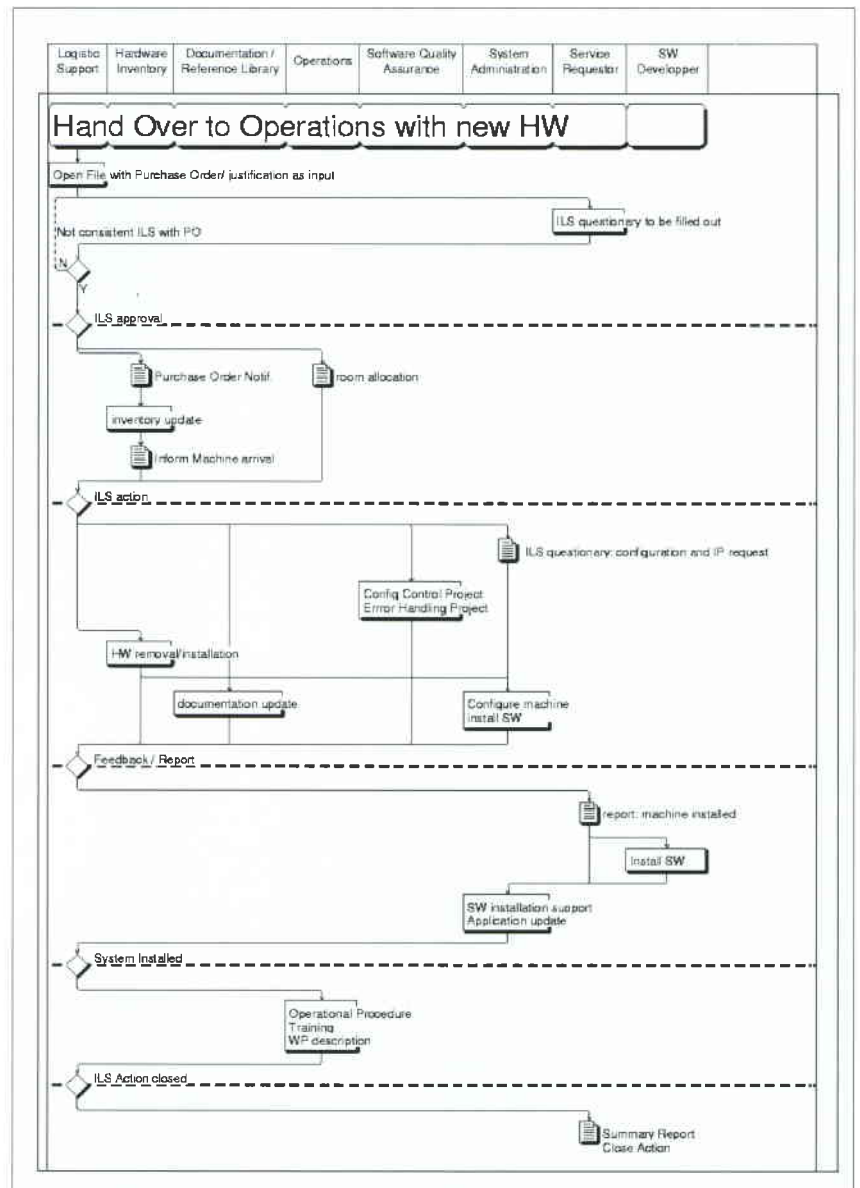

channelling the information to the operations team was used, compacting these data by Intranet questionnaires. Accessing these data is easy because it is the retrieval of structured information, while searching for specific information of systems/application in documents might be tedious and sometimes unsuccessful.

Figure 5. Example Handover workflow

Data Integration

The utilisation of data as 'information' must be approached very carefully, since operational data can be:

- incomplete, due to operational disturbances or certain data not being identified when requirements were defined
- inconsistent, due to changes in application programs, formats or work processes, and therefore no longer comparable
- incorrect, due to operational disturbances or being an uncontrolled copy of duplicated data
- inaccessible, by being difficult to access or retrieve from where it is stored, or the system does not efficiently support crucial queries.

Figure 6. Integration of inventories and service activities

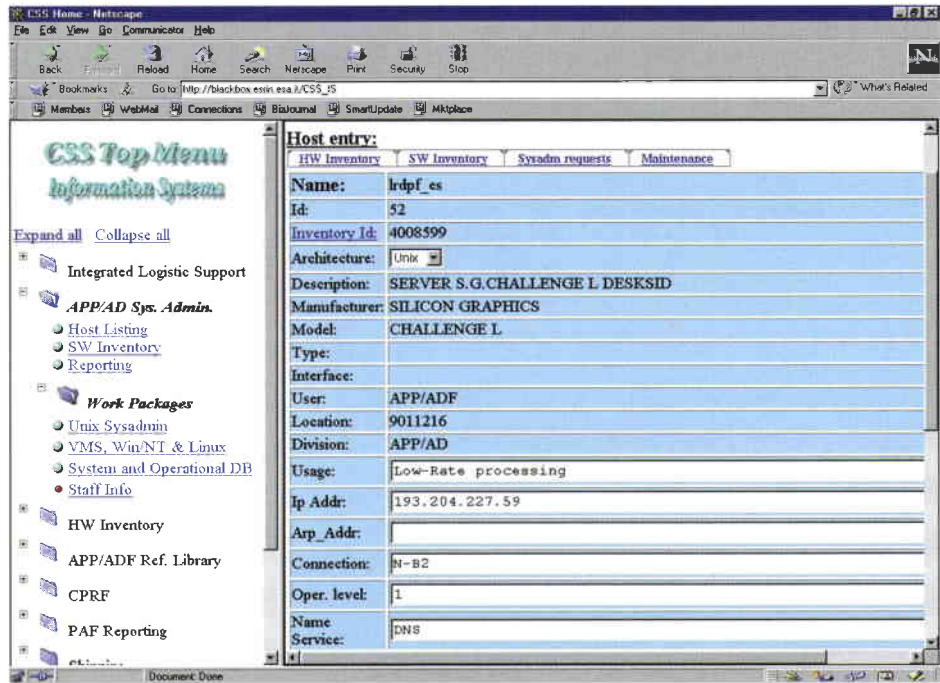

To measure performance, it is essential to thoroughly structure and model and to obtain clean and consistent data, with provision for performing effective plausibility checks. Cross-checks between data derived from different systems must be applied wherever possible. The database management system itself therefore provides valuable means for guaranteeing data integrity. Data need to be transformed and be prepared for use. Data can be collected automatically to avoid the effects of human error, with the collection of historical records being an integral part of the process. Data must be readily available and easily accessible to avoid that individual services create their own local and uncontrolled collection of information files. The use of private mailboxes for operational use must be discouraged and public means used instead. Comfortable user interfaces and query tools allow the best usage of data.

Within the CSS, data integration is facilitated by

- Enabling access to relevant information of the inventories (hardware and maintenance contracts) handled by the finance department, and linking them to the anomaly-handling system to ensure consistency,
- Cross-linking hardware and software inventory with the system administration activities and the maintenance contracts to identify systematic problems,
- Keeping the data model of the handover separate from the other inventories, resulting in two data worlds – a planned/requested and a nominal/actual world – to provide traceability of actual computer configurations back to their origins.

The CSS Web-page tree displays different information levels with the same look-and-feel:

- The request view tree only supplies Web pages that are of relevance to the inexperienced user who needs to make a request.
- The information system view tree contains Web pages for searching in production data and fetching reports (see Fig. 4)
- The internal view comprises pages with restricted access, for service-unit staff only.

Documentation Availability

A System Documentation Library was set up to maintain a master list of applicable documents for the operations environment, including reference systems, EO off-the-shelf software, prototypes and test documents. Documents can be requested directly via the Web within a search. For the reference systems, a compatibility check needs to be performed after hardware/software maintenance or anomaly de-bugging. The documented nominal system configuration items and the project history are therefore strictly linked to the system itself.

In order to have the correct level of information available for each system, the Handover-to-Operations procedure discussed above gathers information through the use of focussed questionnaires.

Human Factors

As already noted, well-motivated and well-trained staff are key to making quality management in an operational environment a reality. Roles and responsibilities need to be clearly defined and documented. The

qualifications and training and assignment histories of the staff are also available on-line. Performance has to be maintained by continuously improving the working environment, implementing best working practices, communication and training. The CSS provides human-resource information transparency (work packages, assignments, responsibilities, reporting) to the staff and thereby helps to encourage a constructive working culture.

Use of IT Tools

The Linux operating system is both fast and reliable and the Alpha machines were chosen for their outstanding price/performance ratio. To ensure high system availability at reasonable cost, the fault-tolerant Linux cluster solution was adopted.

POSTGRESQL (also a freeware tool) was chosen as a low-cost solution for the Database Management System (DBMS), providing the performance, flexibility, scalability, distributed access, safety and physical independence required, and last but not least the powerful SQL (Structured Query Language) capability. POSTGRESQL can be easily accessed from PC office packages without disturbing day-to-day operations on the production database. PC query tools can be employed to elaborate, analyse and display the production data for reporting purposes.

A Web-based strategy was followed to guarantee a high level of information transparency. The chosen public-domain Web publishing system Zope has plug-in interfaces for the most common databases, and commercial adapters are also available. Most of the pages of the Web site tree are dynamically created and stored within Zope using its object-oriented functionality and thus guaranteeing consistency of links. Zope is linked to a Apache Web server, which hosts the static Web pages of guidelines, procedures, work instructions and other documentation. A synchronisation mechanism avoids concurrent production data extraction and database ingestion being performed on the operational machine whilst maintaining data integrity and consistency.

The benefits

After some months of operations using the new tools adopted and the application of the procedures imposed by the Information Management System, the benefits are very clear. The effort needed to manage the entire operational setup has been reduced and user satisfaction has increased, due to the overall improvement in efficiency. The staff directly

involved in the operational process now feel part of an integrated system, with greater personal visibility in the operational process.

The Central Facility is certainly now more prepared to absorb the expected increasing workload, stemming mainly from the imminent start of Envisat mission operations, and to integrate the new services required by the growing market activity associated with Earth Observation payload data exploitation.

Conclusion

As highlighted above, operations should not be seen as just a repetitive sequence of routine work. In our environment, a predominant component is certainly represented by adaptation of the operational setup to the changing requirements and the evolution of the controlled infrastructure due to technology trends. That also means adjusting and controlling its dynamic reference in relation to the external and internal interfaces. This objective can only be achieved through the application of systematic quality-management methodologies.

Quality management implies fact-based reasoning to provide a solid basis for decision-making at all times. An integrated communication infrastructure is therefore essential and can only be provided by a centralised Information Technology system, based on common databases as core elements, thereby ensuring the meeting of the key objectives of:

- potential growth of the overall system within a controlled environment
- adaptability by controlled incremental adjustments
- rationalisation of human resources
- transparency of the decision process to service users
- increased overall system efficiency.

However, information technology and systematic methodologies alone do not necessarily ensure successful quality management. Optimised processes, good working practices and motivation cannot just be expected. The working culture and the behaviour of the staff involved must also evolve accordingly, and this evolution must be carefully planned and actively guided.



Inflatable Re-Entry Technologies: Flight Demonstration and Future Prospects

L. Marraffa, D. Kassing, P. Baglioni
ESTEC, Noordwijk, The Netherlands

D. Wilde, S. Walther
Astrium-I, Bremen, Germany

K. Pitchkhadze & V. Finchenko
NPO Lavochkin, Khimki, Russia

An innovative concept

The first qualification flight of the Soyuz Fregat launcher took place from Baikonur in Kazakhstan at 4.20 AM on 9 February. On board was a small capsule, the IRDT (Inflatable Re-entry and Descent Technology) demonstrator, destined to enter the Earth's atmosphere and land without recourse to a parachute or a conventional heat shield. In place of these heavy and cumbersome items, the IRDT deployed an inflatable envelope able to withstand the extreme hypersonic flight environment before re-entry (Fig. 1). The newly developed Fregat upper stage was also to be returned to Earth using the same re-entry technology.

In cooperation with Astrium-I (formerly DASA), NPO Lavochkin and the European Commission, ESA has developed and launched a capsule that re-entered the Earth's atmosphere protected by an inflatable heat shield. During the same mission, the newly developed Russian Fregat upper stage was also returned to Earth using the same technology. The last phase of the descent in both cases was performed with no parachute, allowing substantial savings in launch volume and mass. Obvious future applications for this new re-entry technology include International Space Station sample return, the delivery of networks of small stations to the Martian surface, and the return to Earth of launcher upper stages.

Such a flexible inflatable shield had been developed earlier by Lavochkin in the framework of the MARS-96 project for the entry and descent of a penetrator into Mars' atmosphere. However, this mission was lost due to a launcher failure, and the inflatable technology had therefore never been tested previously.

The inflatable technology offers great advantages due to its low volume and mass and is therefore of interest to many potential users, ranging from the Space Station to

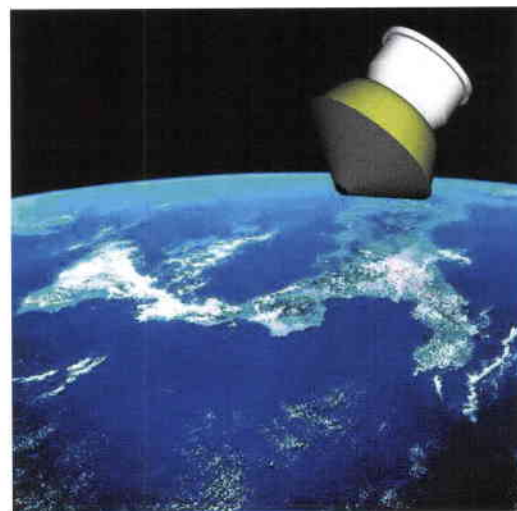

planetary science, and even possibly launcher or technology developers. ESA therefore decided to investigate the potential of this advanced concept further.

A new programmatic approach

There are at least three aspects of the IRDT project that made it unique. Firstly, the programme was conducted, from initial assessment study to flight, for less than 2 MEuro, including the experimental payload. This low cost was achieved thanks to the maturity of the concept (due to Lavochkin's earlier work), to the simplification of the design and manufacturing, and of course to the availability of the comparatively inexpensive Soyuz Fregat qualification flight.

Secondly, the capsule's development and launch was completed in less than a year, the programme even being shortened by three months along the way in order to benefit from an earlier launch opportunity. Even so, some new experiments could still be incorporated at the last moment. A preliminary concept

feasibility assessment was performed between December 1998 and March 1999, and the programme was officially kicked-off on 1 May 1999. A Critical Design Review was performed in July 1999, and integration and testing took place from August to November 1999. The launch took place on 9 February 2000, and the capsule was recovered on 14 February, five days after its landing. The final presentation of the results took place at ESTEC on 6 April.

Thirdly, there was real co-operation between ESA, NASA, Lavochkin and the European Commission, both in terms of funding and at the working level. The total cost of the project was 1.95 M\$. Under a contract with the International Science and Technology Centre (ISTC), ESA contributed US\$ 650 000, the European Commission provided US\$ 600 000,

(Fig. 2), and a flexible envelope inflated in two stages. First the flexible entry shield is deployed, increasing the capsule diameter from 80 cm to 2.3 m. This flexible shield consists of an internal network of rubber hoses pressurised with nitrogen, covered by an insulating layer (Multi-Layer Insulation)

Table 1. IRDT initial mass budget

Rigid nose	17.0 kg
Instrument container	8.5 kg
Filling system	21.0 kg
Inflatable shell	40.0 kg
Search system	2.5 kg
Sensor package	13.0 kg
Miscellaneous (damping, harness, etc.)	10.0 kg
Total mass	112.0 kg

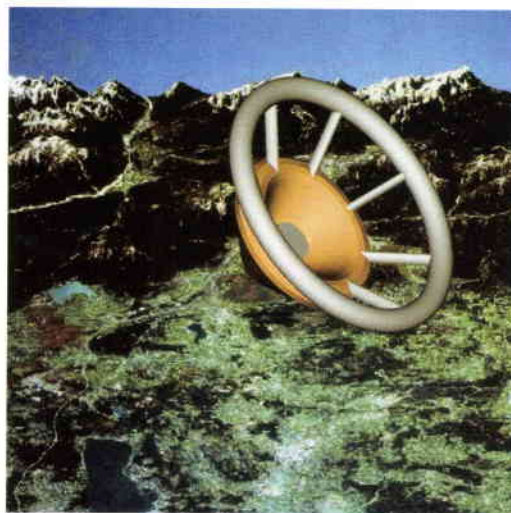

Figure 1. Artist's impressions of the various IRDT in-flight configurations

Figure 2. The IRDT in stowed configuration

DASA provided US\$ 500 000, and Lavochkin US\$ 200 000. In addition to funding and evaluating the project, ESA, Lavochkin and NASA actively participated together in its technical definition and assembled the payload.

A flexible, re-configurable heat shield

During its entry into the Earth's atmosphere, a capsule relies on the surrounding air for braking. The gas molecules impinging on its surfaces convert kinetic energy into heat, most of which is carried away by the air flow. However, a huge amount of heat still enters the capsule itself. To moderate the resulting temperature increase inside the capsule, heavy thermal protection systems are traditionally used, with a fixed size and shape. In addition, a dedicated system (parachute, parafoil or retro-rockets) is necessary to provide proper landing conditions and stability, and sometimes a floatation capability.

The demonstrator deceleration system consists instead of a small ablative nose

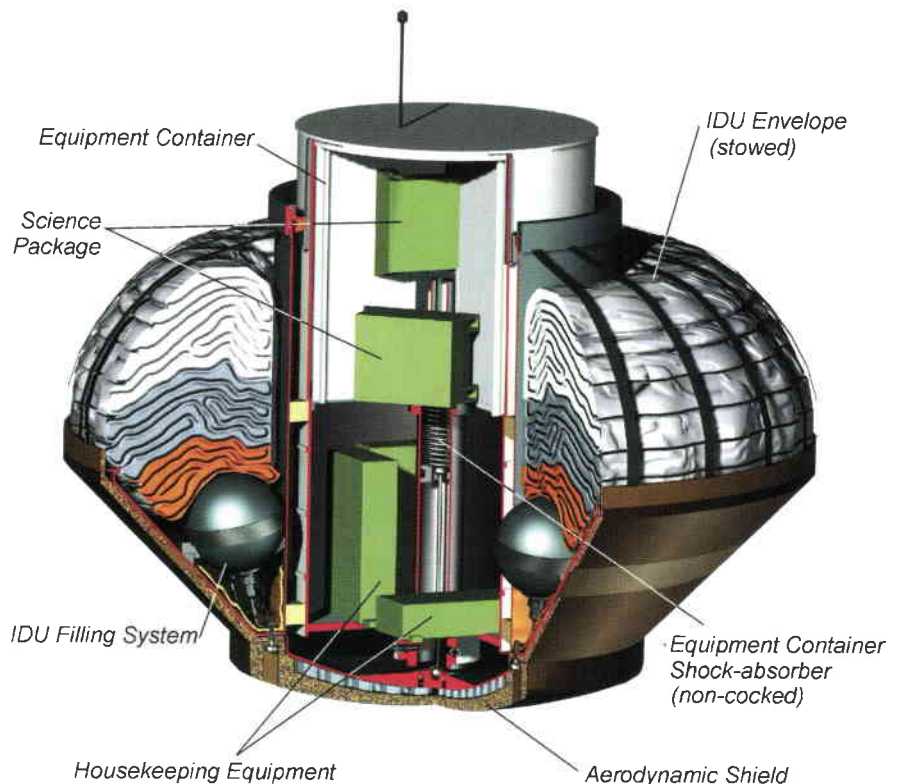

protected by a silica-based fabric impregnated with an ablative material. As its temperature increases, this ablative material decomposes, absorbing heat and thereby limiting the heat input to the capsule's interior. The thickness of the material, i.e. number of layers, is designed to cope with the expected atmospheric-entry heat loadings with some margin. Then, in place of a parachute system, a second cascade is opened, further increasing the capsule's diameter to 3.8 m (Fig. 3) and slowing the demonstrator down to achieve a nominal landing velocity in the order of 13 -15 m/s.

Figure 3. The IRDT fully deployed

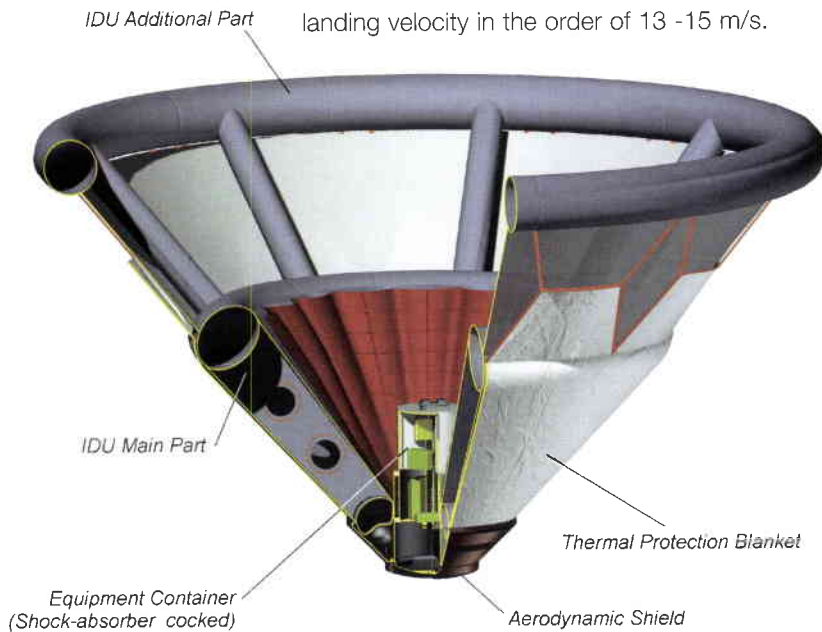
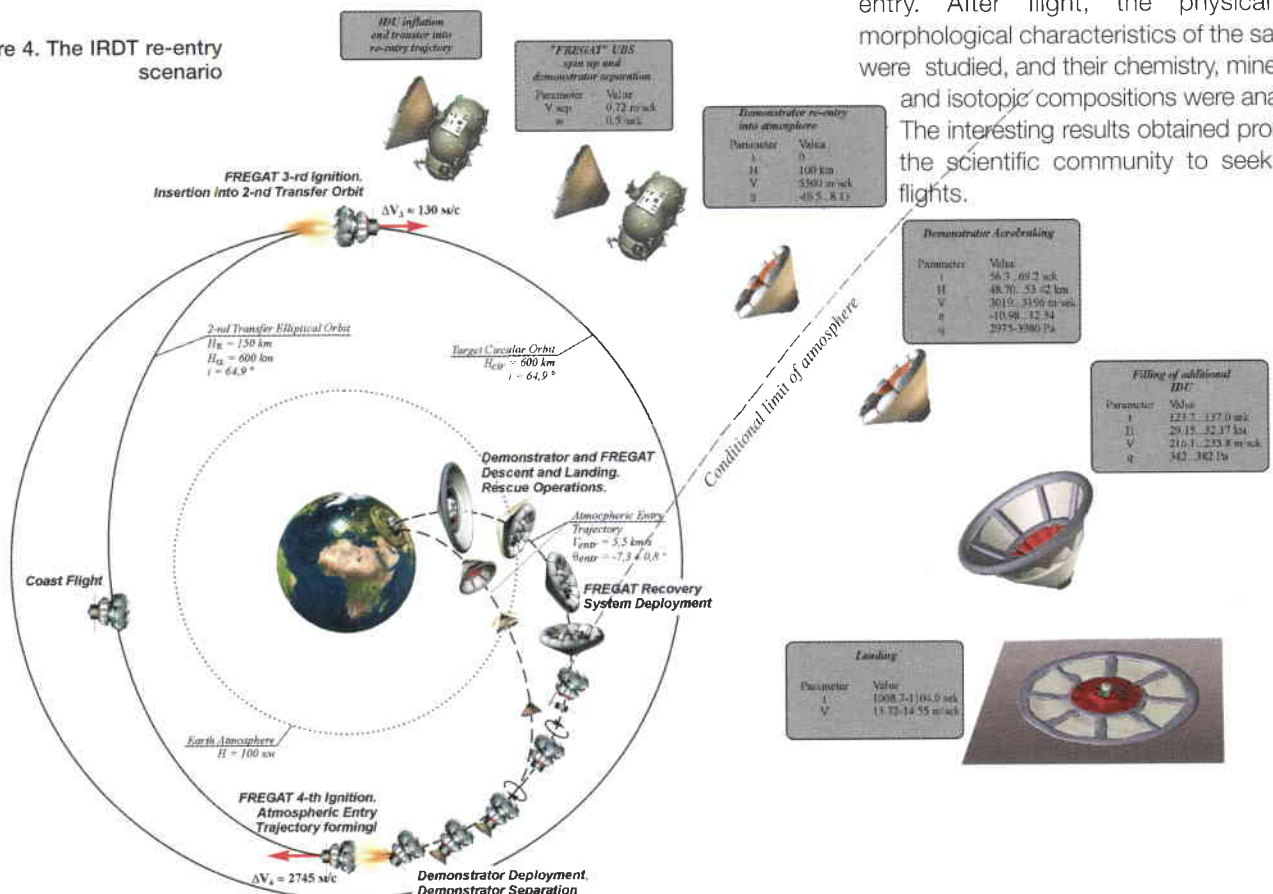

Figure 4. The IRDT re-entry scenario



The inflation process is triggered by the sequential firing of a series of pyro-valves, which progressively empties of a set of 13 nitrogen bottles into the envelopes, at different stages of the mission. To ensure adequate stability during all phases of re-entry and provide proper deceleration, a sphere-cone shape, with a nose radius of 0.61 m and a cone half angle of 45° has been selected.

An advanced payload

The payload consisted of two scientific experiments:

- **The FIPEX sensor:** Developed by IRS Stuttgart for measuring atomic oxygen in the upper layers of the atmosphere, this instrument also provided pressure measurements allowing the altitude history of the demonstrator in the stable phases of its flight to be derived.
- **The STONE experiment:** STONE, an artificial meteorite experiment proposed by Prof. A. Brack (CNRS, Orleans), was intended to study the physical and chemical modifications affecting sedimentary rocks falling through the Earth's atmosphere. The first experiment of this kind had been conducted on Foton-12, flown in September 1999 (see ESA Bulletin No. 101 and 'On Station', Issue 1, December 1999). Three pieces of terrestrial rock were embedded in the Foton capsule's ablative heat shield and exposed to the rigours of atmospheric re-entry. After flight, the physical and morphological characteristics of the samples were studied, and their chemistry, mineralogy and isotopic compositions were analysed. The interesting results obtained prompted the scientific community to seek more flights.

ESA supported the installation of three more rock samples (designated 'STONE 2') on the nose of the IRDT demonstrator, to endure the hottest re-entry conditions. The samples were glued onto the ablative heat shield, whilst on Foton they had been attached to the capsule's outer surface by special holders. The new fixing method was verified by analysis and validated with both thermal and vibration/shock tests in Lavochkin's laboratories.

To facilitate post-landing recovery, a beacon similar that on the Soyuz capsule was installed. In addition, a dedicated sensor package developed by Astrium-I monitored and recorded the flight parameters:

- a three-axis accelerometer (Triade B-290) and three gyroscopes developed by LITEF
- a three-axis accelerometer from NPO Lavochkin, for system operations (house-keeping equipment)
- 15 temperature sensors (thermocouples) placed at various points on the internal structure, and 8 in the payload container.

- 81 CIMTs (Crystal Indicators of Maximum Temperature), within the ablative front shield at depths of 3, 6 and 9 mm. These silicon-carbon (SiC) or diamond (C) crystals contain defects artificially created in their crystalline network by a neutron beam. The exponential decay of the defects can be related to the maximum temperature encountered by the crystal, as well as its duration of application. X-ray measurements performed later on the ground, combined with adequate heat-transfer analysis methods, allow the maximum temperature experienced to be derived. Such crystals can measure temperatures up to 2000°C.

The mission

The launch took place from Baikonur Launch Site Number 6 at 4.20 AM (to provide optimum visibility during IRDT search operations after landing) on the first of the two Soyuz-Fregat qualification flights for ESA's Cluster project. The capsule performed five orbits attached to the Fregat upper stage, at 600 km altitude. After two upper-stage burns and separation of the Fregat dummy payload representing the two Cluster satellites, the third burn lowered its trajectory perigee to 150 km. A large fourth burn then injected Fregat and the IRDT into a Earth return trajectory (Fig. 4).

Then, the probe inflated the first cascade of its deceleration device acting as a heat shield. It separated from Fregat without spinning, and began re-entry at the conventional altitude of 100 km at an absolute velocity of 5.52 km/s, at an entry angle of -7.69° above the Earth's sphere, at an azimuth of 134.4°N. The longitude was 49.67°E, the latitude 53.7°N. The second cascade, replacing the parachute, opened

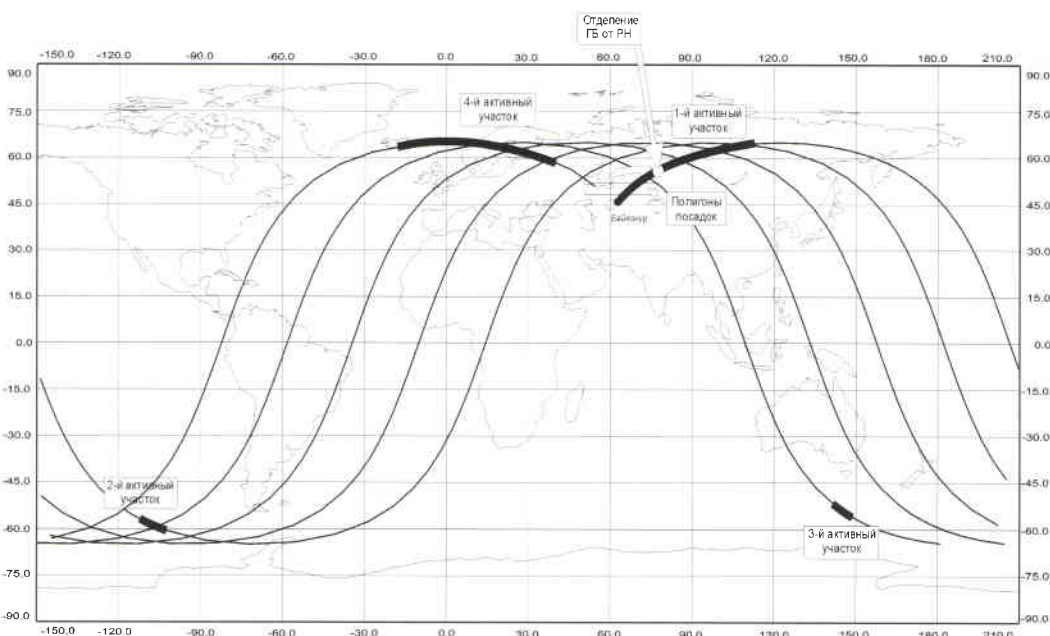
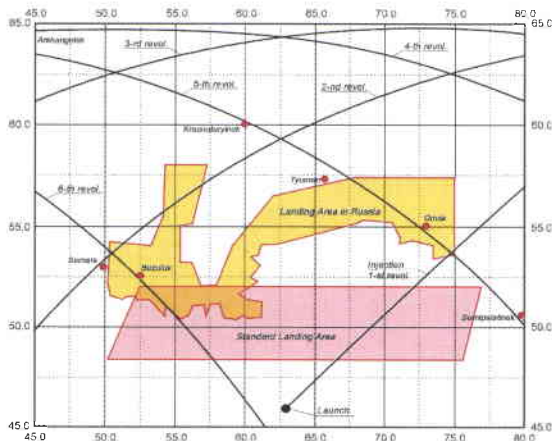

Figure 5. Ground track of fire orbits of the IRDT-Fregat upper stage, with the four burns highlighted. Above, a map of the launch and landing region

around Mach 0.77, at an altitude of approximately 32 km. The command was correctly issued, but the opening was not provoked by the pyrotechnic firing, probably due to a malfunction related to non-nominal events during re-entry.

Lavochkin was responsible for operations at the landing site, with the support of the local military authorities and their radars. Two days before the landing, ESA and DASA representatives joined the Lavochkin engineers and specialists in Orenburg, a city close to the Kazakhstan border some 1500 km southeast of Moscow. The recovery operations were directed from the Russian military airfield of Chebinky, some 50 km northeast of Orenburg, where a squadron of Mil-Mi 8 and Mil-Mi 6 helicopters is based (the same squadron usually involved in the recovery of manned capsules returning from the Mir space station; it had also participated in the recovery of the Foton-12 descent capsule two months earlier).

The separation of the two payloads occurred as planned, and the radar stations detected two objects falling with different trajectories within the nominal zone. The Demonstrator landed at 12.40 local time, 4 min 51 sec after re-entry, at 50° 56 min North, 53° 43 min East, just inside the Kazakhstan border (Fig. 5). This was about 50 km behind nominal point, but within the dispersion ellipse. The velocity at touchdown was estimated at 60 m/s, which

resulted in some damage to the lower part of the IRDT demonstrator containing the housekeeping equipment, the radio transmitter and the locator beacon.

Bad weather (snow and fog) and poor visibility hampered the recovery operations, which had to be carried out with a single low-altitude helicopter flight each day. It was not until 14 February, five days after the landing, that one of the helicopters finally picked up the IRDT demonstrator (Fig. 6).

Unfortunately, the high heat load experienced by the Demonstrator shield during its high-speed descent had almost completely ablated the protective layer (9 mm against the 2 mm foreseen), and the STONE samples were not recovered. The Demonstrator hardware was returned to Moscow for post-flight evaluation, including detailed inspection and data retrieval. This inspection confirmed the mechanical damage due to too heavy a ground impact, but no thermal burning effects were visible. Flight data from the Demonstrator and sensor package on-board computers could be retrieved perfectly. The nose of the heat shield showed greater ablation than expected, and the three STONE samples were missing (Fig. 7). The inflatable heat shield was damaged, but was 80% intact.

Figure 6. The Demonstrator at the recovery site



Flight evaluation

After the capsule's recovery, all sensor data were retrieved, downloaded and made available to the various teams involved for detailed evaluation and discussion. A formal flight-evaluation review then took place at ESTEC in Noordwijk (NL) on 4 and 5 April 2000.

The accelerometers and gyroscopes indicate a sharp increase in IRDT acceleration and rotational rates 37.4 s after its separation from Fregat (Figs. 8a,b). The Demonstrator's tumbling motion is attributed to a collision between the IRDT and its Fregat interface adapter jettisoned shortly after the Demonstrator's separation.

Figure 7. The nose shield before and after re-entry. Note the locations of the three STONE samples

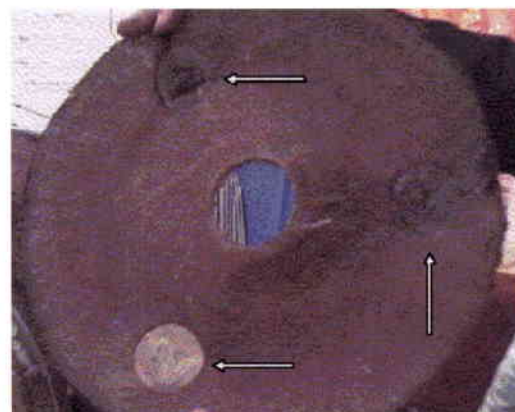

The accelerometer and thermocouple data show that the Demonstrator's stability was restored during the beginning of the re-entry and that the inflatable structure survived the peak heat-flux (350 kW/m²) and g-load (15 g) conditions intact, but partially collapsed later. This resulted in unstable flight conditions, as indicated by the accelerometer and gyroscope measurements, and in a local increase in temperature. This failure could be related to the earlier impact with the adapter having locally weakened the thermal protection, to defective pressure regulation, or to insufficient thickness of the thermal protection. A significantly larger mechanical load and ablated thickness on the rigid nose element was observed afterwards, and this provoked the loss of the STONE experiment and of all but six of the CIMTs.

The temperature inside the Demonstrator increased locally by 200°C, but the internal temperature of the payload container was almost unchanged (Figs. 9a-c).

The second cascade opened nominally (at close to Mach 0.8), but did not inflate. The final descent was therefore faster than nominal, leading to a touch-down velocity of around 60 m/s (corresponding to the free fall of the rigid core body), instead of the 13 m/s design value. Consequently, the total descent time was shorter than nominal.

The beacon system was damaged during touch-down, and its antenna was covered precluding signals from being acquired during the recovery operations.

Potential future applications

ISS payload download system

The first practical application envisaged for the IRDT is as a payload downloading system for the International Space Station (ISS), with an ATV or a Progress spacecraft as the carrier

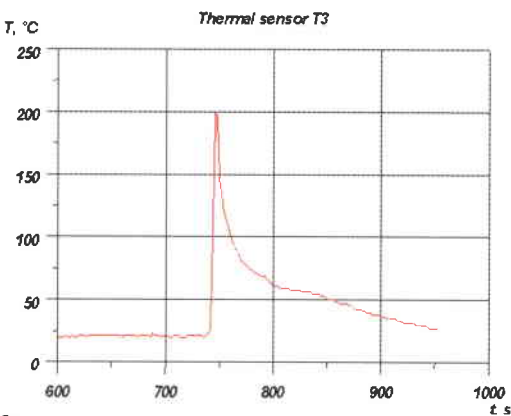

9a

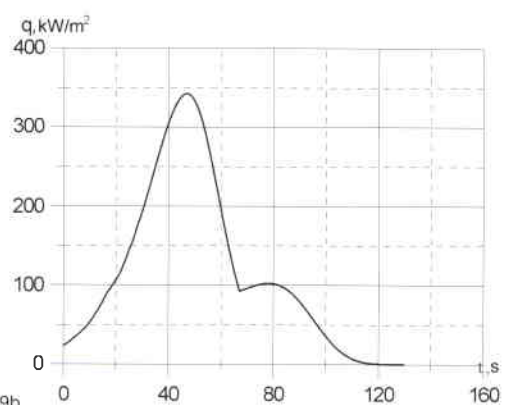

9b

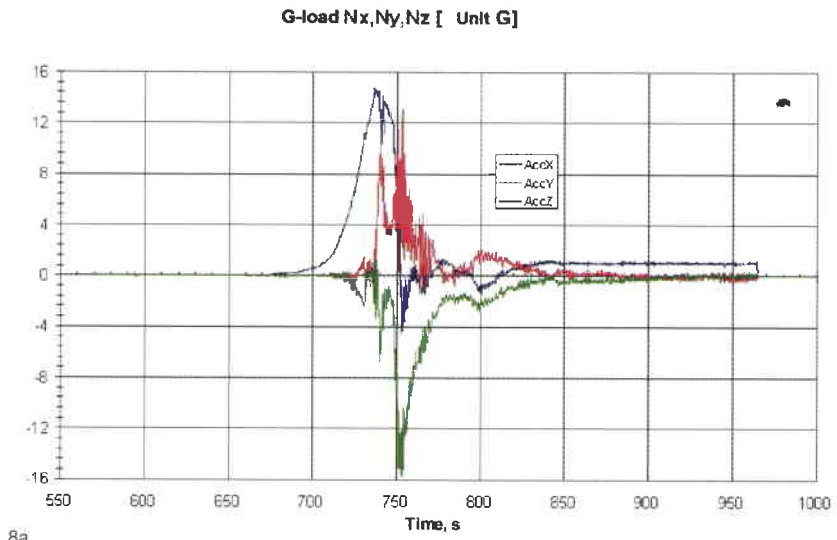

8a

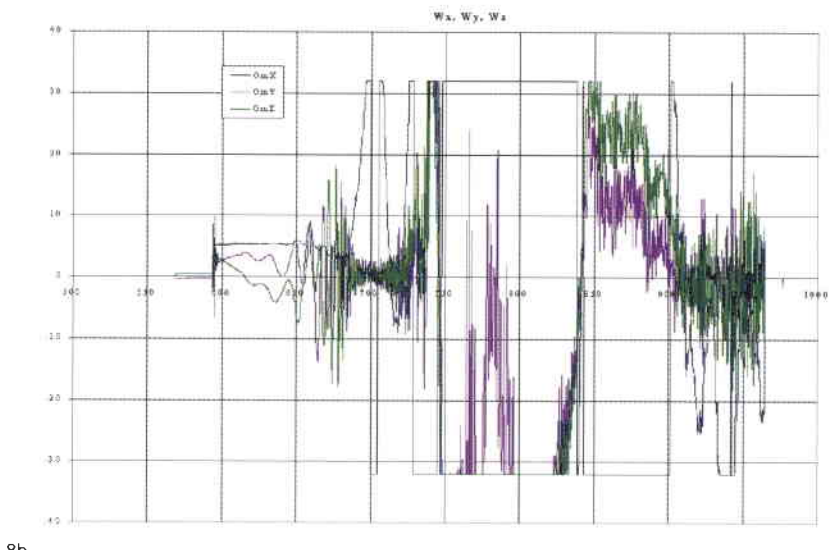

8b

Figure 8a,b. Acceleration and angular-velocity components during re-entry

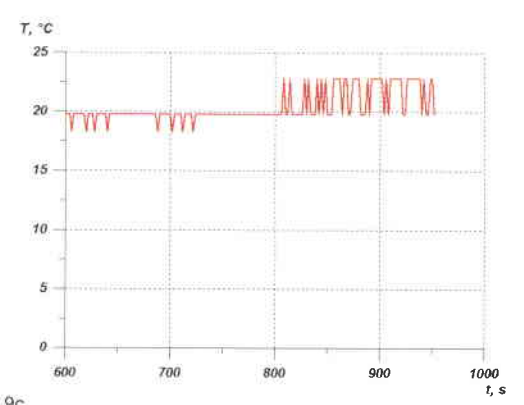

9c

Figure 9a-c. Shield temperature, nose heat flux (flight rebuilding) and payload-container temperature logged during re-entry

Figure 10. ISS download scenario with the ATV

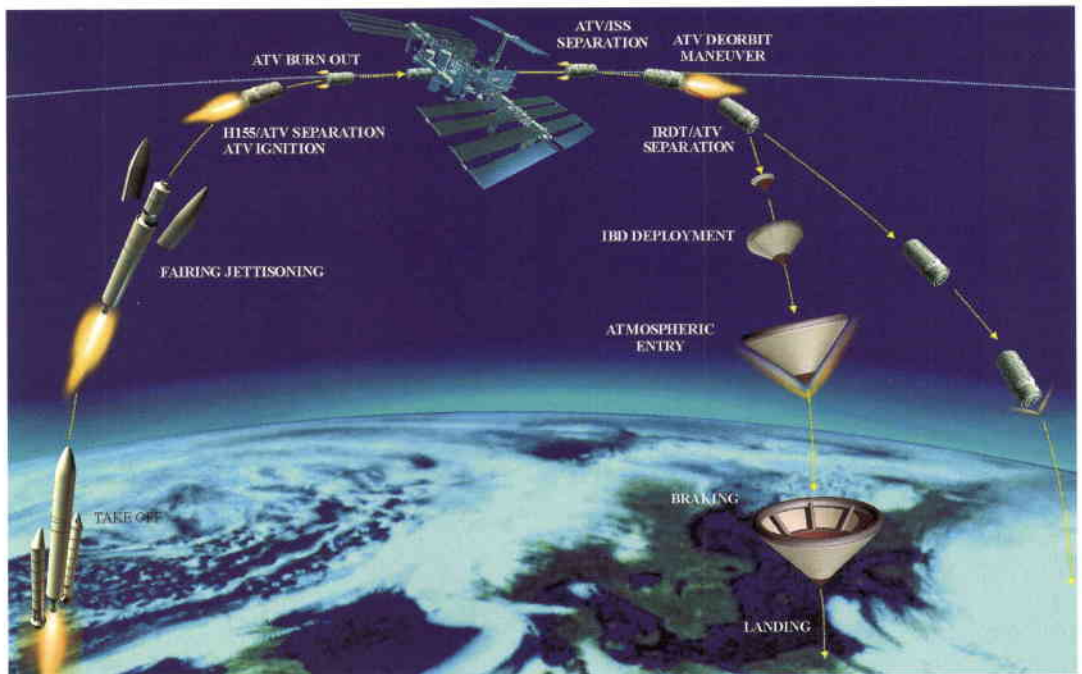

Figure 11. The Netlander scenario

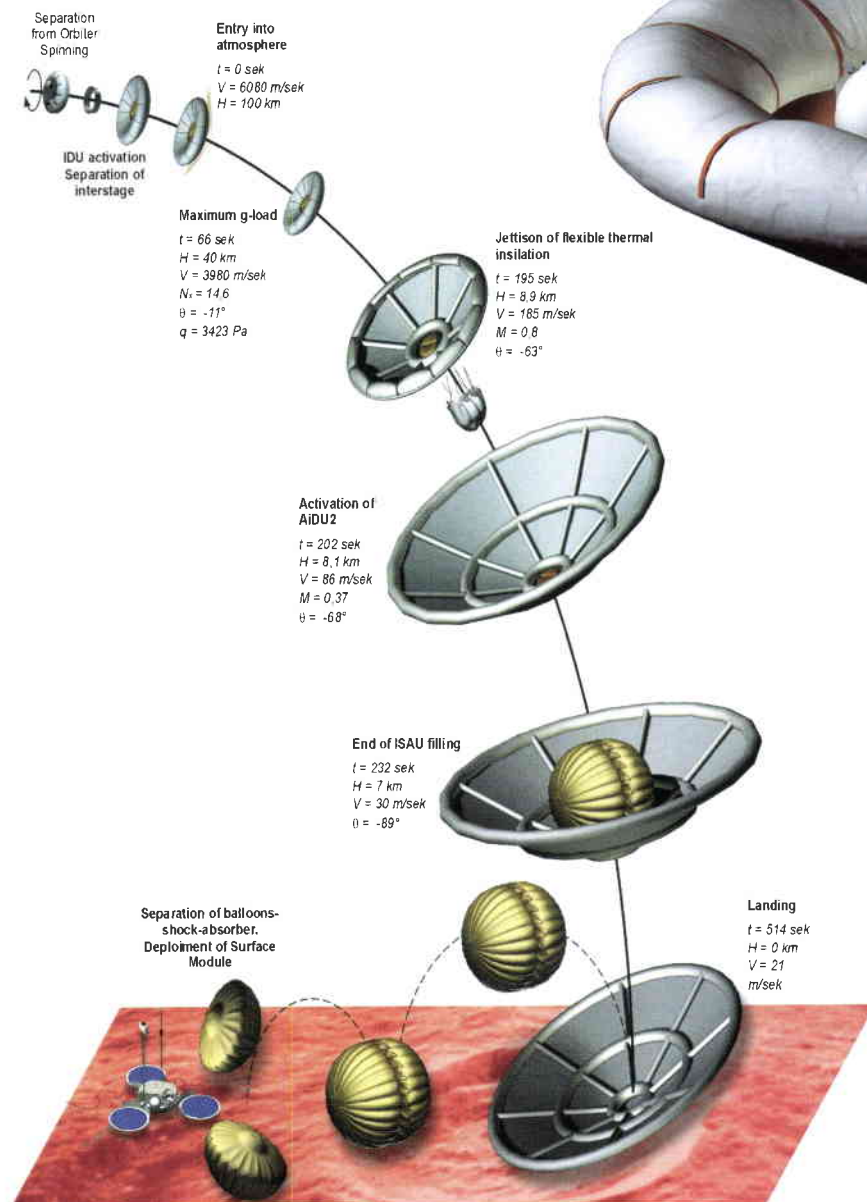

Figure 12. Fregat upper stage entry configuration with IRDT first cascade deployed

(Fig 10). ESA's own download needs are estimated at 600 kg per year. As for the Russian Raduga system, a small capsule would be installed inside the carrier whilst docked with the ISS, and would then be jettisoned after the de-orbit burn of the spacecraft. Each flight of such a vehicle could return 200 – 250 kg of payload to Earth. A first analysis indicates that the costs would be competitive with today's options for providing such a service, for example using the Space Shuttle.

Marsnet landers

A second possible application of the IRDT could be for Mars landers. Its potential high payload/mass ratio and small size is an advantage for accommodating several probes on a spacecraft to Mars. Lavochkin has already studied its potential for a CNES/NASA co-operation on the Mars Sample Return mission, with the aim of delivering four Netlander descent vehicles and surface stations to the planet's surface (Fig. 11). The system consists of a descent module and a surface module with a total mass of 60 kg, of which 20 kg is available for the surface module payload.

Recovery of launcher upper stages

The Fregat upper stage was also returned by an IRDT system as part of the first flight demonstration, using 8 and 14 m diameter inflations of the two cascades (Fig. 12). This demonstration served as a good example of IRDT applications in the areas of reusable and expendable launch-vehicle stage return, their safe disposal, and aerobraking.

Conclusion

For the first time, an inflatable heat shield has been deployed in space and has successfully performed a flight experiencing maximum thermal and mechanical entry loads. Despite some non-nominal conditions and partial damage to the envelope, the flight hardware and data were successfully recovered. The sensor payload worked perfectly and provided a rich mission database. The FIPEX instrument was space-qualified.

This new concept allows both mass and volume savings compared to conventional technology, and is easily reconfigured. Improvements and adaptations are now being prepared to suit the requirements of future space missions. In particular, its application to the return of samples from the International Space Station (ISS) requires extension and demonstration of the IRDT's capabilities for orbital re-entry conditions. A second verification flight with more extensive instrumentation is felt necessary, to incorporate the lessons learned

from the first flight and the new requirements emanating from the ISS downloading system. The pressure regulation system and the launcher interface will be improved, and the heat shield will be strengthened. Telemetry and navigation systems allowing better descent monitoring and more efficient recovery operations will also be introduced, and a camera will provide images of the various stages of deployment.

Among several longer-term improvements to the capsule, it is foreseen to increase the payload/mass ratio and offer soft-landing capabilities. In addition to the ISS sample-return project, a number of other applications have already been identified, and will be more thoroughly investigated.

Acknowledgement

This project was possible only because of a unique programme arrangement involving four sponsors, ISTC/EU, ESA/ESTEC, Lavochkin-Babakin and Astrium-I, and a highly motivated project team. The authors would like to thank E. Deksnis and D. Gambier of the European Commission, and D. Nietzold from the ISTC in Moscow, for their special efforts in setting up this project. The support of the MSM-GM Division and the ESA Office in Moscow was also an important element, which was much appreciated.



ERS – ENVISAT SYMPOSIUM

'Looking Down to Earth in the New Millennium'

Organised by: ESA and the Chalmers University of Technology

16-20 October 2000 – Gothenburg, Sweden

<http://www.esa.int/sympo2000>

Contacts:

- for Website aspects, registration, information:

Barbara Scarda, ESRIN

tel. +39-06-94180941

fax +39-06-94180942

E-mail: bscarda@esrin.esa.it

- for Symposium contents:

Gianna Calabresi, ESRIN

tel. +39-06-94180625

fax +39-06-94180552

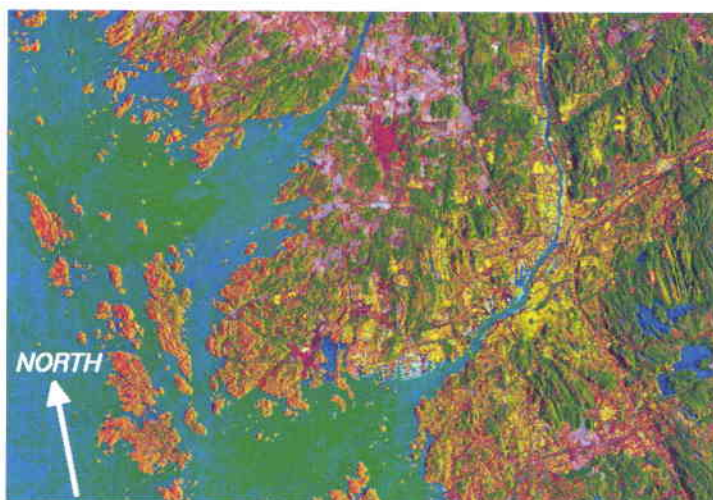

- for Local Support:

Britt-Marie Boisen

Chalmers University of Technology,

Gothenburg, Sweden

tel. +46-31-7721840

fax +46-31-164513

E-mail: boisen@rss.chalmers.se

Programmatic Risk Management in Space Projects

M. Belingheri, D. von Eckardstein & R. Tosellini

ESA Directorate of Manned Space and Microgravity,
ESTEC, Noordwijk, The Netherlands

Introduction

ESA's core business is the conception and the implementation of space programmes. A major element of this responsibility is the definition of requirements for and the development of space vehicles and instruments that support space research and applications. ESA performs this task in cooperation with its European industrial partners with whom the Agency agrees contracts on the basis of commercial proposals defining the technical tasks to be undertaken, the duration within which the tasks are to be completed, and the financial arrangements by which the Agency compensates its industrial partners for their efforts. Any programme undertaken by the Agency is limited in funding to the allocations provided by Member States and typically 80 to 85% of the allocated funds are passed to the participating companies.

The focus of this article is the non-insurable programmatic risk at programme/project level. To stimulate risk awareness and to assist in risk mitigation and control, the Directorate of Manned Spaceflight and Microgravity has devised a process and established an implementation plan that is being applied to its major programmes.

ESA's space programmes vary significantly in size, duration, and complexity. They can range from some tens of millions of Euros to several thousand million Euros, and may be completed in just a few years or may last ten years or more. As far as complexity is concerned, a space programme may be conceived against a single objective with a well-defined end product, or with a multitude of objectives and a variety of products and services to be supplied.

All programmes embarked upon involve risks, risks that:

- the technology needed cannot be provided
- technical specifications are not met
- interfaces do not match
- required performance is not achieved
- products are not available in time
- costs are higher than estimated.

These and other risks need to be accounted for. ECSS-M-00-03A is an available standard (from ESA Publications Division) which may be consulted for establishing a suitable risk-management process.

At the outset, when a programme is initiated, risks may be covered through the allocation of a funding reserve as part of the financial envelope provided. However, in today's economic climate, the trend is to reduce such reserves to the absolute minimum at which a programme is still considered feasible. This leads to the question of how existing risks can be 'measured' and the results translated into a required allocation of a minimum funding reserve to cover them.

It is standard ESA practice for its space-vehicle development contracts with industry to include provisions for as many of the foreseeable risks as possible. These are generally in the technical domain. As this practice is constrained by how much risk the industrial partners are willing to bear for the funds offered, a considerable part of the total risk cannot be covered by this method. This share of the risk catalogue needs to be controlled by the Agency by the application of mitigation measures and through the retention of a funding reserve suitably sized to cover the remaining risk items.

Risk control requires awareness of the risk domains summarised in Figure 1.

The programmatic risk-management cycle
Programmatic risk management in ESA Programmes is an iterative process throughout the project life cycle, with iterations being determined by the progress through different project phases and by changes to a given baseline influencing resource allocations. Since the greatest uncertainty is in the earliest stages of a project, when decisions with major impacts are also made, risk analysis should be initiated as early as possible.

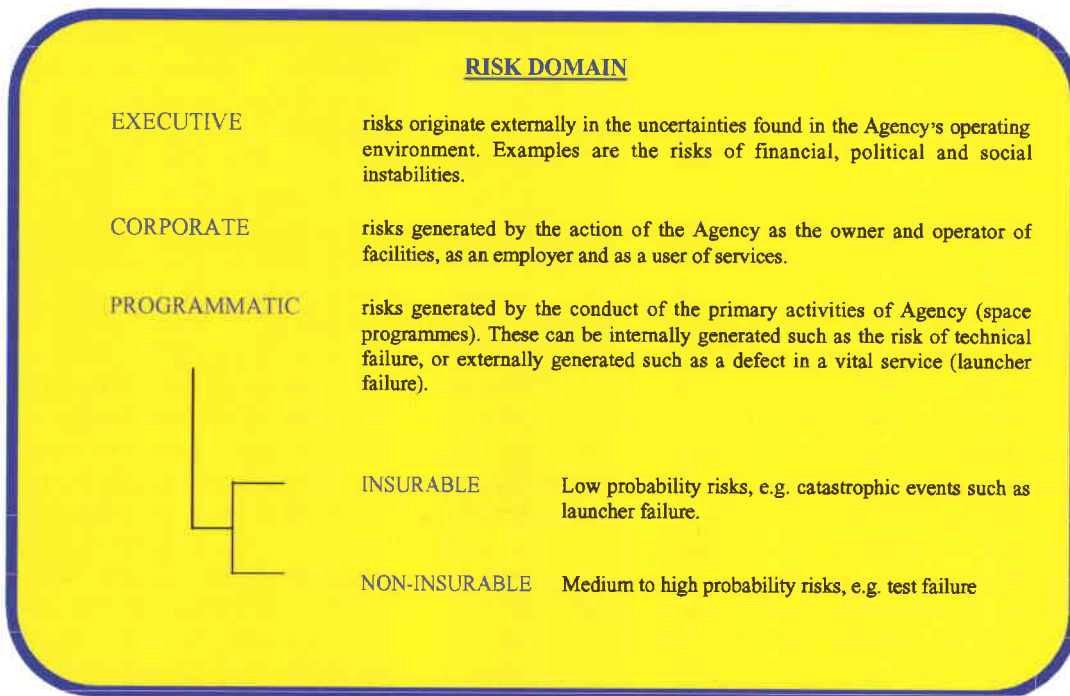

Figure 1. The risk domain

The process as applied in Manned Space and Microgravity is illustrated in Figure 2. The first step, the risk assessment, based on expert judgement, identifies and estimates the magnitude of the risk scenarios in terms of cost/schedule impact on the project baseline. In this phase, a risk-scenario prioritisation, based on a defined risk policy, is also carried out with the aim of sorting the risk scenarios in terms of their relative criticality. The second step addresses the contingency analysis and defines which risks may be accepted, and for which risk scenarios avoidance/mitigation plans must be prepared. The third step consists of the management and decision making by which avoidance/mitigation plans are implemented and the eventual acceptance of residual risk is approved. The fourth step, monitoring and reporting, foresees the

systematic control and tracking of the implementation of the plans selected in the previous step. A report is produced to show the overall risk status of the project and to track the risk trend during its life cycle.

The frequency of application of the risk-management cycle depends on the needs and complexity of the programme/project. Occasional updates are required when major changes to the schedule, technologies, techniques, performance, etc. of the project baseline occur.

The identification of risk

Managing risk first of all requires that the risks be known. The risk analysis starts by gathering the project team and explaining the objectives of risk management. Under the supervision of

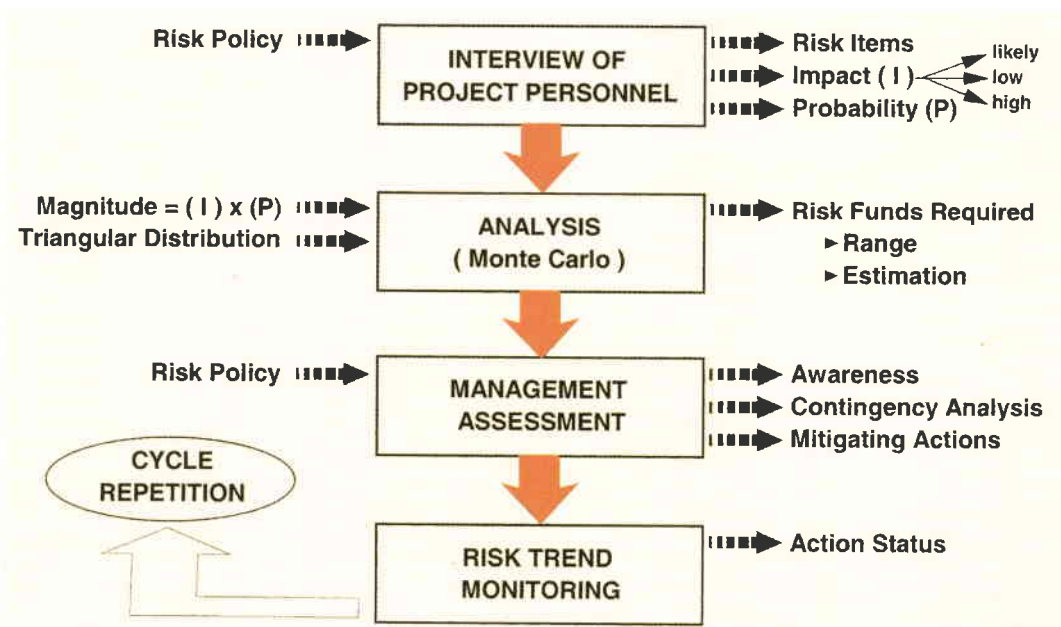

Figure 2. Process adopted in ESA's Manned Spaceflight and Microgravity Directorate

and identifying possible magnitudes. From the data collected in the Programmatic Risk Assessment Register, the risk magnitude can be expressed in terms of the equation in Figure 5.

$$R(n) = P(n) * I(n)$$

Where $P(n)$ = probability of occurrence of scenario n
 $I(n)$ = likely cost/schedule impact of scenario n

Figure 5. The risk equation

The various risk scenarios are then cumulated to assess the total programme/project risk magnitude. The risk owner is the entity totally/partially responsible for bearing the risk consequences (e.g. ESA, Prime Contractor or both). Plotting the risk scenarios on a Probability-Impact Grid (Fig. 6) provides an immediate and intuitive means of representing the criticality of each risk scenario. It also facilitates risk prioritisation by indicating those areas on which attention should be concentrated.

Such prioritisation alone, however, is not sufficient and needs to be complemented by a judgement based on a wider set of constraints, since risks of small magnitude may also be unacceptable under certain conditions. This set of constraints is referred to as the Risk Policy. Screening of the risk scenarios against the Risk Policy leads to the final prioritisation.

The graphic of the risk scenarios helps to identify three main areas (Fig. 7):

- *Avoidance Area*: the risk is not acceptable; it has to be eliminated or mitigated.
- *Mitigation Area*: the risk is within the risk policy, but still represents a threat; avoidance/mitigation actions should be considered.
- *Acceptance Area*: the risk does not violate the risk policy and is negligible, and can therefore be accepted.

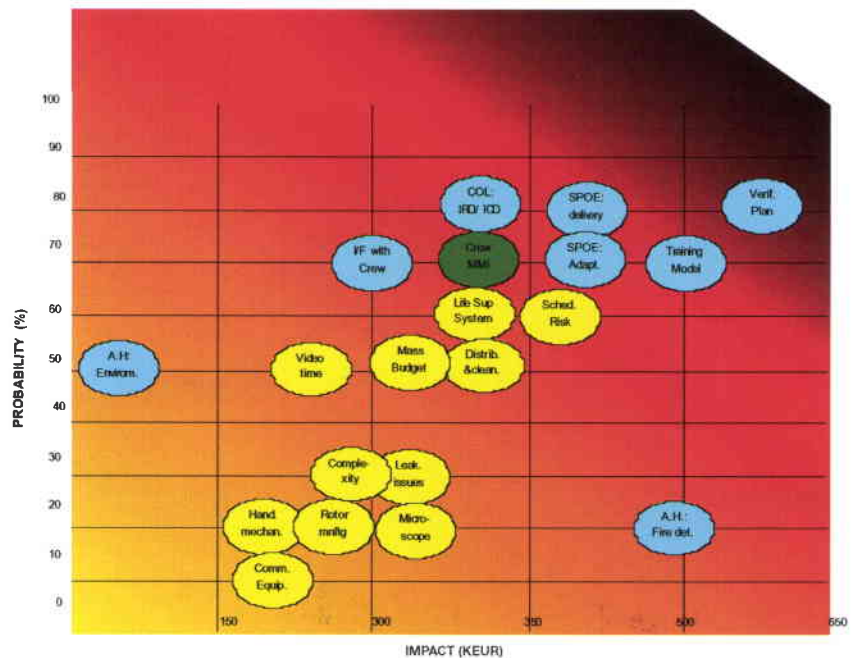

Figure 6. The Probability – Impact Grid

Another dimension of risk relates to time distribution (Fig. 8) and the period in which the risks are expected to occur and, therefore, the time left to act against them. Experience shows that the curve of risk distribution over time tends to be front-loaded due to the better perception of short-term risks by the staff interviewed.

Risk Policy definition

The Risk Policy is the main tool for prioritising risk scenarios. It identifies the principles, boundaries and constraints that drive the assessment and acceptance of risks. Generally, the policy is established at Programme level and it is part of the process for establishing programmatic baselines. The definition of a Risk Management Policy Baseline includes the establishment of criteria for:

- What are the goals?
- When is a risk acceptable?
- How to manage risk?
- How to control risk?



Figure 7. The risk decision areas

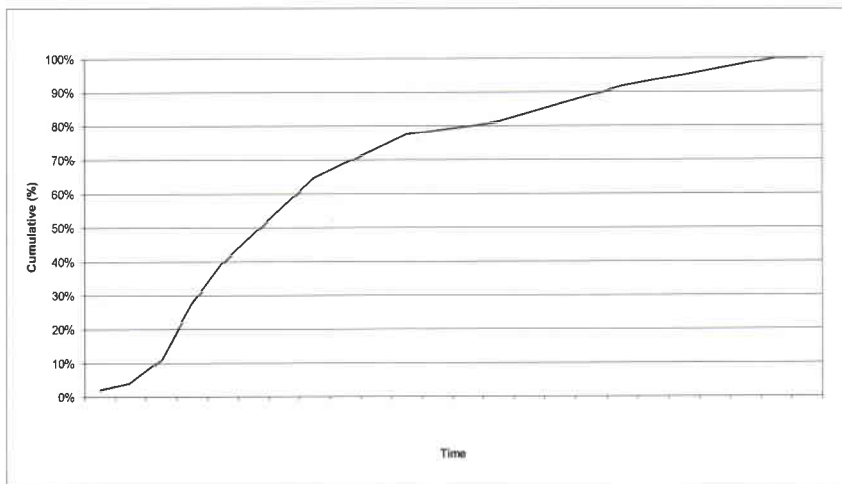

Figure 8. Typical risk impact time-distribution

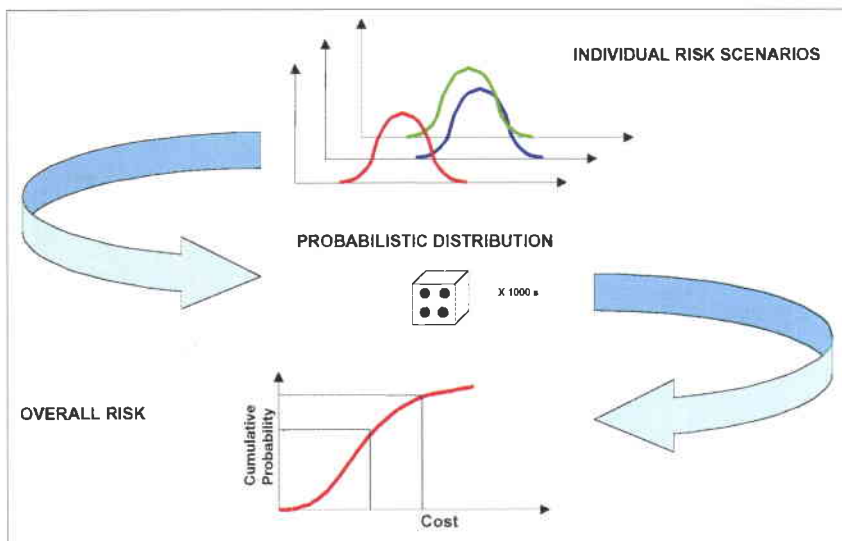

Figure 9. The Monte-Carlo computation

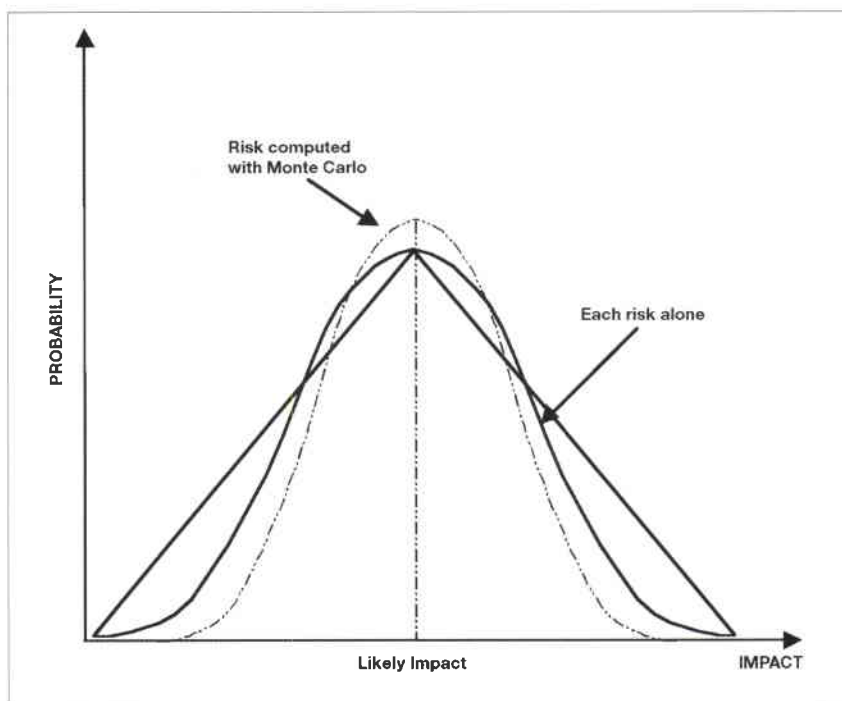

Figure 10. The probabilistic distribution of risk

This provides the opportunity to:

- establish goals with related levels of confidence for achievement
- develop concepts, strategies and tactics consistent with the levels of confidence
- develop agreements and contracts that are equitable in their apportionment of risk and opportunity
- avoid built-in budget and schedule overruns and shortfalls
- trade-off risks against opportunities
- replace reactive management by proactive management.

Contingency analysis

The purpose of the Contingency Analysis is to estimate the financial resources needed to cover all identified project/programme risks in an optimum manner. The Monte-Carlo simulation that is applied calculates the probabilistic distribution of the overall risk impact, starting from the single risk scenario. Each single scenario has its own distribution based on Likely Impact, Lowest Impact, Highest Impact, and a probability function. The most significant advantage of this method is that many independent items are treated as one set, and therefore the overall probabilistic distribution of risk is narrowed. The benefit of applying this method grows with the number of risk scenarios and/or projects/programmes involved in the aggregated analysis.

The total project/programme risk impact is the sum of the estimated scenarios obtained by generating a random probability and impact for each scenario and then adding them (Fig. 9). The profile of the distribution curve is narrower than that obtained simply by summing the distribution of each risk alone, due to the interdependency between the risks. Indeed, the probability that all risks would materialise at the Highest or Lowest Impact is very low (Fig. 10).

The cumulative probabilistic curve obtained by applying the Monte-Carlo simulation helps to select a confidence level related to a certain risk impact. The confidence level is a measure of the probability that the project/programme may actually incur an impact. If incurred, the impact is projected as the Programme/Project Risk Magnitude identified during the analysis. As shown in Figure 11, a line drawn from a selected probability factor (confidence level) on the vertical axis, across to the curve and then down to the cost axis, shows the cost estimated to be incurred at the selected confidence level. For example, a contingency selected at a confidence level of 75% means that the risk impact has a probability of 75% of remaining within the amount 'X'. A confidence level has to be chosen to determine a suitable

amount of funding reserve to cover the identified risks. The choice depends mainly on:

- risk policy
- available resources
- risk typology
- project/programme specificity.

The selection of a suitable confidence level is one of the major management decisions required to identify the contingency needed at programme or project level.

Risk management

All risk scenarios falling inside the 'Avoidance' and 'Mitigation' areas of the Probability-Impact Grid are, in principle, candidates for the risk avoidance/reduction process. The purpose of this step is to control the risk by implementing avoidance/mitigation plans leading to deletion of the risk or lowering of its magnitude. A risk can be reduced by implementing preventive and mitigation measures aimed at:

- eliminating the cause of a problem
- interrupting the propagation of a problem to an actual impact.

Typically, the Project Manager prepares the avoidance/mitigation plans, which may need to be submitted to a higher management level, depending on the degree of authority assigned to the Project Manager and the complexity of the issue. The avoidance/mitigation plans are assessed from a cost/benefit point of view to ensure that:

- the cost of implementation does not exceed the likely benefits
- there is a reasonable probability of success
- resources assigned to avoidance and mitigation actions are chosen such that they offer the greatest chance of success.

This step will result in one of the following:

- *Risk Resolved*
- *Risk Partially Resolved*, i.e. risks that still constitute a potential danger, but for which the impact is estimated to be reduced to acceptable levels
- *Risk Unresolved*, i.e. no mitigation plans can be devised, or the resources required exceed the anticipated benefits.

The result of this exercise is compiled in a report that includes:

- Programme/Project policy baselines
- Programmatic Risk Assessment Register, including 'potential risks'
- Probability-Impact Grid and trends
- Risk analysis
- Prioritisation list
- Contingency analysis
- Avoidance/Mitigation Plan implementation status
- Recommendations.

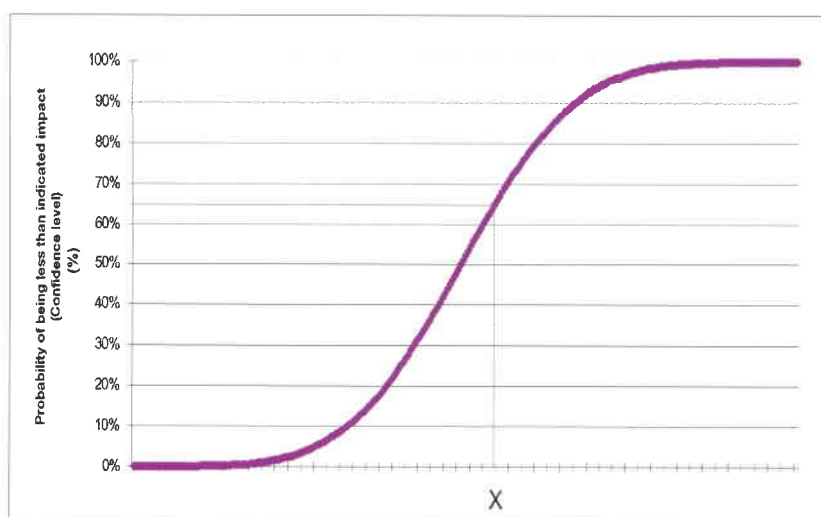

Figure 11. Contingency analysis

Last but not least, a database is created and maintained to ensure full visibility of the evolution of the Risk Management effort.

Conclusions

The Agency anticipates substantial benefits from implementing the above process in its major space programmes, in terms of:

- *risk awareness*: the most important aspect of the approach, supporting risk perception and control, and a common vision for the entire organisation
- *risk policy*: making project-management boundaries and constraints more explicit
- *risk estimation*: allowing more consistent and traceable estimation based on a systematic method of identifying risks and the repetition of the analysis cycle
- *risk control*: striving towards risk avoidance/mitigation actions, and a confidence-level approach to contingency allocation.

The details of this process are documented in the Programmatic Risk Management Plan released for use in the Directorate of Manned Spaceflight and Microgravity. A simple software application to support data analysis is in preparation, and it will shortly be available via the ESA Web Site.

Acknowledgements

The authors wish to acknowledge the contributions provided by: Booz-Allen and DASA in the definition of the check-list for interviews; and AGF and Marsh in sharing their experience in applying the Monte-Carlo technique in the insurance industry.



Ways to the Moon?

R. Biesbroek

JAQAR Space Engineering, Den Haag, The Netherlands

G. Janin

Mission Analysis Section, ESA Directorate of Technical and Operational Support, ESOC, Darmstadt, Germany

Previous lunar missions

Lunar exploration began on 1 February 1959 when the Soviet satellite Luna-1 flew past the Moon. The 360-kg spacecraft was originally designed to impact on the Moon, but missed and escaped from the Earth-Moon system. That same year Luna-2 did hit the Moon and became the first spacecraft to impact another world (Fig. 1), Luna-3 was the last of the first generation of Luna spacecraft (launched by Vostok) and became the first spacecraft to view the far side of the Moon. The second generation

(Lunas-4 to 14) were landers and orbiters, launched by Molniya rockets due to the larger spacecraft masses involved (1500 - 1600 kg). Many of these attempts resulted in failure, but Luna-9 was the first spacecraft to land softly on the Moon, and Luna-10 was the first to orbit another world, in 1966. The third generation were 5700 kg spacecraft (Lunas-15 to 24) launched by Proton rockets. They were sample-return, rover and orbiter missions, with Luna-16 being the first robotic mission to return a lunar sample, and Luna-17 the first mission to put a rover (Lunokhod) on another world. Several Zond missions were launched by the Soviets in the 1960s, mainly as test missions for future manned Moon missions. Zond-5 was the first mission to return to the Earth from lunar orbit.

ESA has conducted several studies on missions to the Moon in recent years. The lunar trajectories for most of these missions differ substantially from those of the lunar missions flown in the 1960s and 70s. In particular, the use of shared Ariane-5 launches to reduce cost puts the spacecraft into a transfer orbit from which novel transfers and trajectories are needed to minimise the propellant required to reach lunar orbit. This has led to intensive studies of Weak Stability Boundary (WSB) transfers, which exploit the presence of low-gravity fields in which small manoeuvres can have large effects on the spacecraft's motion. The long travel times incurred with this approach are compensated by the large reduction in propellant mass.

The USA's lunar programme included several unmanned missions. The 330 kg Rangers (1962-65) were the first objects sent to the Moon by the United States and were meant to deliver television images before impact. Ranger-4 crashed on the lunar far side, and is

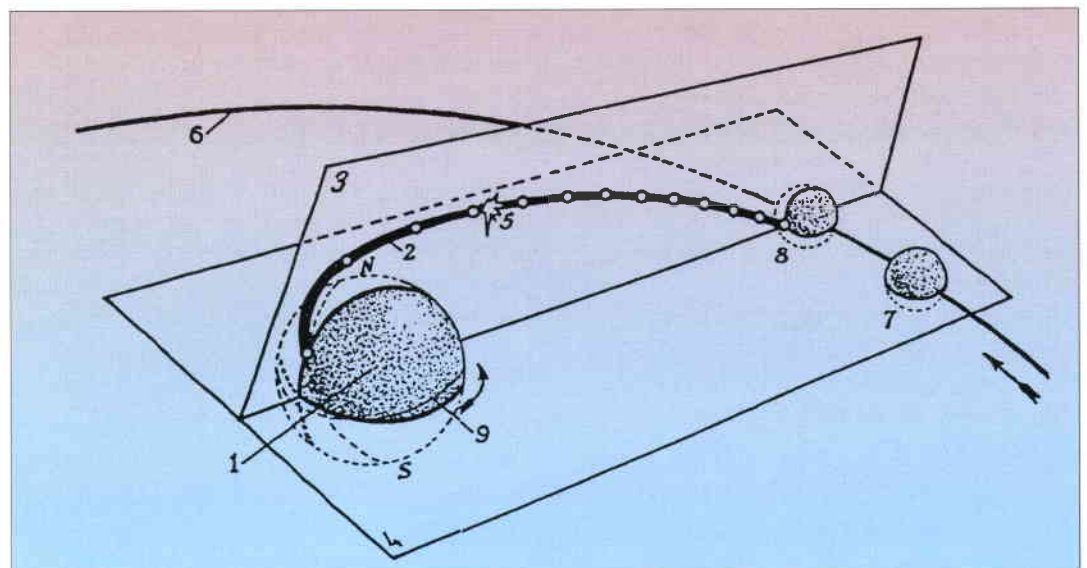

Figure 1. The Luna-2 mission profile

therefore the only known human object on that side. Between 1966 and 1968, five 1000 kg Surveyors landed in the near-side equatorial region. During that same period, five Lunar Orbiters (mass 390 kg) successfully mapped the equatorial region of the Moon for Apollo landing-site selection. The famous Apollo Programme followed. In 1968, Apollo-8 became the first manned mission to orbit another world. On 20 July 1969, Apollo-11 became the first manned landing on another world, and in 1971 Apollo-15 put the first manned rover on the Moon.

Figure 2 shows the Apollo mission profile. The first three stages of the Saturn-V rocket put the spacecraft into a 160 km Low Earth Orbit (LEO). After about 2.5 hours, the S-IVB upper stage performed the Translunar Injection. The Moon was reached after about 70 hours. The first Lunar Orbit Insertion manoeuvre was performed by the Service Module (SM) motor when Apollo was on the far side of the Moon, putting the spacecraft into an elliptic 270 km x 100 km orbit. The second insertion manoeuvre circularised the orbit to 100 km height. The Lunar Module (LM) was de-coupled and a Descent Orbit Insertion changed its orbit to 15 km x 100 km. Finally, a Powered Descent Initiation took the LM to the lunar surface. Apollos-8, 10, 11, 12 and 13 used 'free-return trajectories', i.e. the orbital energy of the Translunar Trajectory was chosen such that the spacecraft could not escape from the Earth-Moon system if the SM motor failed to operate, and could return safely to Earth within a few days. All these missions used a 'direct' transfer to the Moon, which meant that the transfer time was at most four days, but the Δv requirement

(velocity increase to be given to the spacecraft) was high. A high Δv means a high propulsion-mass/total-mass ratio, thereby reducing the mass available for payload.

The 1990s brought a 'return to the Moon', when four more spacecraft passed close to or orbited the Moon. These unmanned craft were more interesting from a mission-analysis point of view, because alternative trajectories were used to lower the Δv requirement. For example, the Japanese Hiten mission used both a lunar swing-by and a Weak Stability Boundary (WSB) trajectory to reach the Moon with favourable conditions for capture into a highly elliptic lunar orbit. The transfer time was 6 months and the launch mass was only 196 kg. The US Clementine mission, launched in 1994, used a direct transfer with intermediate orbits and went into a lunar polar orbit. The launch mass was 1690 kg and the transfer time about three weeks. The Hughes Global Services-1/Asiasat-3 satellite became the first commercial satellite to reach the Moon's sphere of gravitational influence, after its launcher failed to put it into the correct orbit. There was not enough propellant on the spacecraft for it to directly reach Geostationary Orbit (GEO), but there was sufficient to place it into a Translunar Orbit to swing by the Moon twice and return to GEO. This showed the power of using the Moon's gravity field to increase orbital energy. Lunar Prospector was launched in 1998, by an Athena-II launcher, directly into Translunar Orbit, which meant that the on-board propellant mass was limited. The lunar insertion was performed in three stages to place the 300 kg spacecraft into a 100 km circular polar orbit.

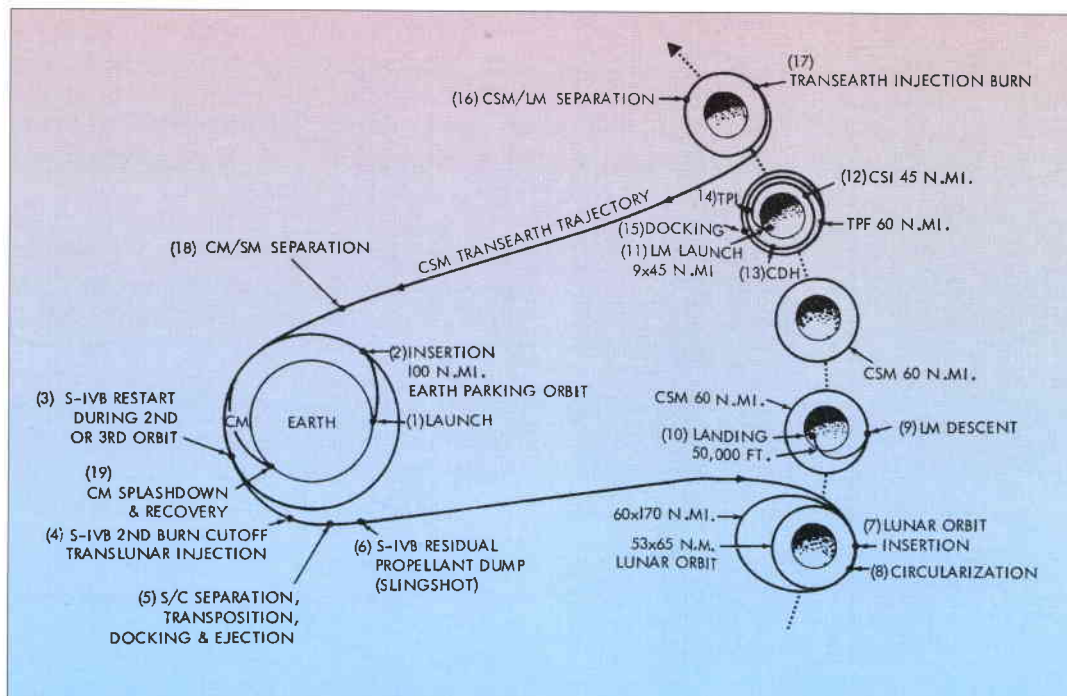

Figure 2. The Apollo mission profile

ESA studies of lunar missions

Studies on missions to the Moon within ESA began in 1980 when scenarios for a Polar Orbiting Lunar Observatory (POLO) were studied. The POLO mission involved two spacecraft: an orbiter and a relay satellite. The baseline for the POLO (total mass 1050 kg) launch was either a deployment from the Space Shuttle into a circular 300 km orbit using a PAM-A solid-rocket stage for Translunar Orbit Injection, or a dedicated Ariane launch. A direct transfer to the Moon was selected, but the mission was never flown.

Ten years later, MORO (Moon Orbiting Observatory) was an unsuccessful candidate for an ESA M3 medium-size scientific mission. MORO highlighted the use of a shared Ariane-5 launch into Geostationary Transfer Orbit (GTO). A direct Translunar Orbit would have been used to reach the Moon, where the spacecraft would have been inserted into a 100 to 200 km circular polar orbit. The Translunar Orbit Injection consists of three manoeuvres (Fig. 3) of 240 m/s to increase the apogee (largest distance to the Earth, within the orbit) from the GTO apogee to the Earth-Moon

distance. This was done to minimise gravity losses (which occur because the thruster burns are not impulsive shots, but take a finite time during which the spacecraft has changed its position) during the burns at perigee (shortest distance from Earth). The transfer time would have been 8 days, and the total Δv , including mid-course correction and Lunar Orbit Injection, was 1580 m/s, resulting in a launch mass of 1207 kg.

In 1994/5, an assessment study of LEDA (Lunar European Demonstration Approach) was performed to define an exploration mission that would land on the lunar surface after having been put into GTO by Ariane-5. This again highlighted the problems of starting from a GTO orbit when going to the Moon, due to the different planes of the GTO and the Moon's orbit. This resulted in a high Δv for the transfer to the Moon (1730 m/s) and long transfer times of up to 2 months. The spacecraft mass was 3347 kg due to this high Δv and the fact that a large amount of propellant had to be included for the landing.

EuroMoon 2000 was an ESA initiative for a lunar South Pole expedition at the start of the new millennium. The prime objective of the mission was to perform a soft landing on the lunar South Pole Peak of Eternal Light. This place, constantly illuminated by the Sun, is unique in the Solar System and is ideally suited for future lunar bases. The baseline for the 1300 kg EuroMoon spacecraft was a direct launch into Translunar Orbit using a Soyuz-Molniya launcher. In order to reduce gravity losses during the insertion into lunar orbit, it was divided into three phases: (i) a capture manoeuvre to a 150 km x 5000 km elliptic orbit, (ii) a manoeuvre to reach a 100 km x 5000 km orbit, and finally (iii) circularisation of the orbit at 100 km altitude. After an initial orbital phase, the lander would descend toward the South Pole. Following an ESA Council decision, the project was abandoned in March 1998.

LunarSat (Lunar Academic and Research Satellite) is a 100 kg satellite designed by students, scientists and young engineers that functions as the focus for a variety of educational activities. The project's Phase-A and B were sponsored by ESA's Office for Educational Project Outreach Activities. The mission study demonstrated lunar access via the Ariane-5 auxiliary payload capability. However, as with LEDA, the spacecraft would have to reach the Moon starting from GTO. Since only 40% of the spacecraft mass could be allocated to propellant, this led to a Δv budget of only 1450 m/s (compared to LEDA's 1730 m/s), and so a different approach was

Figure 3. The MORO mission profile

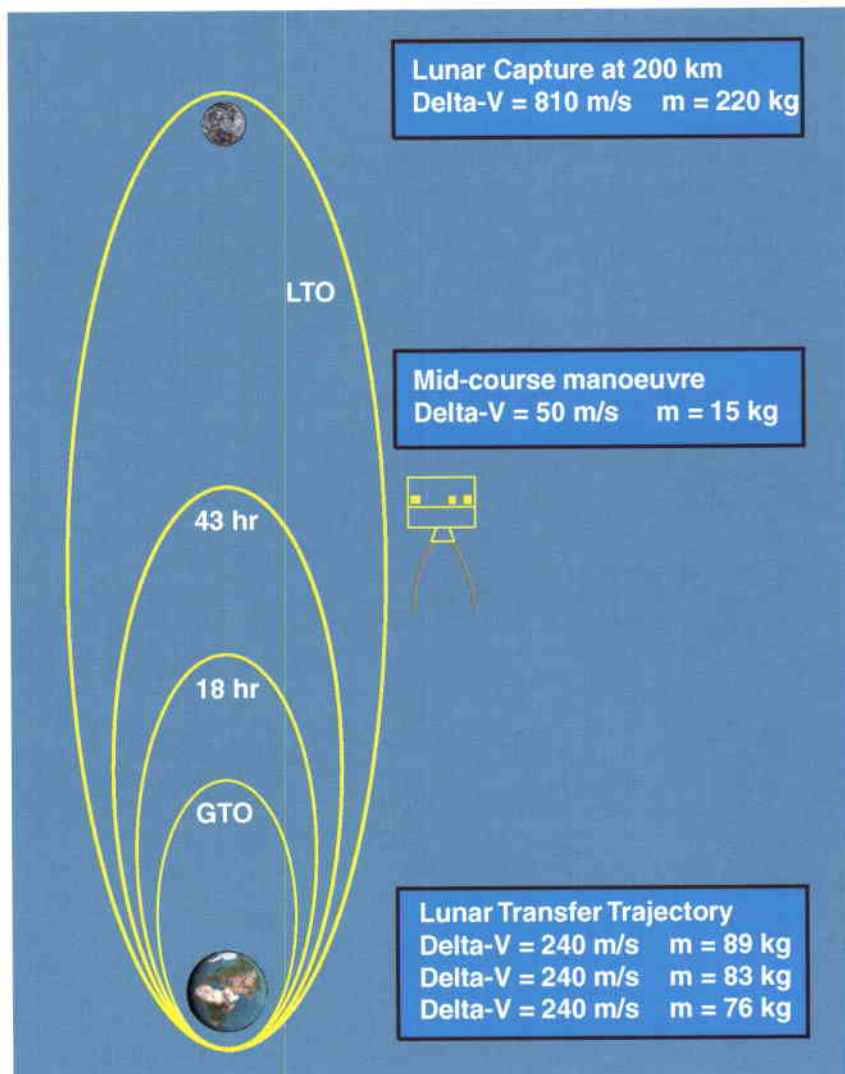

necessary. This resulted in a study on using Weak Stability Boundary transfers, performed at the end of 1998.

SMART-1 (described in detail in ESA Bulletin No. 95) is an approved ESA project intended, inter alia, to demonstrate Solar Electric Propulsion as a primary drive mechanism. 250 days will be needed to get from GTO to a 1000 km x 10000 km lunar polar orbit.

Going to the Moon now

The Moon is the Earth's only known natural satellite. According to the most popular theory, it exists as a result of a violent encounter between a heavy celestial body and the Earth about 4 billion years ago, which caused the ejection of Earth matter. It is gravitationally bound to the Earth and part of its direct environment. Going to the Moon is therefore a natural continuation of the exploration of planet Earth. This was well understood at the First International Lunar Workshop in Beatenberg, Switzerland, in 1994, where ESA proposed a four-phase lunar programme:

Phase-1: Lunar robotic explorer

Phase-2: Permanent robotic presence

Phase-3: First use of lunar resources

Phase-4: Lunar human outpost.

It is the pursuit of Phase-1 of this programme that has led to the investigation of more novel, and less expensive, ways of reaching the Moon. These are discussed below, after first recalling the classical direct route.

The direct way: fast but expensive

The 'classical' lunar mission begins from a so-called 'parking orbit' around the Earth. The orbit's apogee (farthest point from the Earth) is then raised to the Moon's distance or higher by a Translunar Injection, using either the spacecraft's own main engine or the launcher's upper stage. When starting, for example, from a circular orbit at 300 km altitude, the orbital velocity is 7.7 km/s. A Translunar Orbit with perigee at 300 km and apogee at 384 400 km has a perigee velocity of 10.8 km/s. The Δv for Translunar Orbit Injection is therefore $10.8 - 7.7 = 3.1$ km/s (Fig. 4). This single 'perigee burn' can also be divided into several smaller burns.

Since the orbital angular momentum is constant, the spacecraft's velocity decreases as it gets further away from the Earth. On reaching the Moon, its velocity has fallen to only 0.2 km/s and since the Moon travels with a velocity of 1 km/s, the spacecraft will be in an orbit relative to the Moon with a velocity of about 0.8 km/s. Therefore, another Δv has to be applied to the spacecraft to match the

Moon's velocity, to be captured by the Moon, and then orbit around it. This is usually done when passing the periselenium (closest point of the orbit with respect to the Moon). This burn can also be divided into several smaller burns to minimise gravitational losses. The location of the periselenium cannot be chosen arbitrarily, but depends on the arrival geometry.

The lowest Δv is needed when using a Hohmann transfer, when the apogee of the Translunar Orbit is equal to the Earth-Moon distance. To reduce the transfer time, the apogee of the Translunar Orbit could be chosen higher, at the expense of a slightly greater Δv . A direct transfer typically takes 2–5 days. The spacecraft should be launched when the declination of the Moon is smaller than the inclination of the parking orbit (usually equal to the latitude of the launch site). Since the maximum declination of the Moon at the Earth's equator is 29 deg, launches from higher latitudes (such as Cape Canaveral and Baikonur) are preferable, where there are two launch opportunities per day.

This 'classical' direct transfer was used for all lunar missions from the 1960s to the 1980s, including the Luna and Apollo missions.

Indirect ways: slow but cost-effective

The launch is a major part of the total cost of any space mission; the smaller the launcher, the less costly will be the mission. The choice of launcher depends on its performance and the mass of the spacecraft to be launched. To reduce cost, the spacecraft's mass has to be reduced. A large part of that mass is dedicated to the propellant needed for the various injection and insertion Δv 's. Reducing Δv

Figure 4. Direct transfer to the Moon

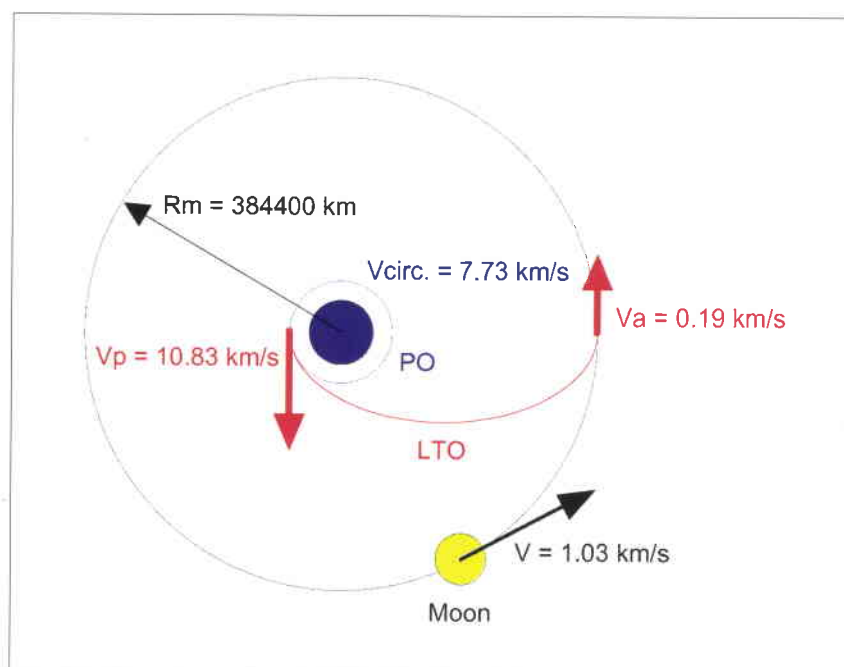

requirements will therefore reduce mission cost, and there are two options available:

- piggy-back with a 'rich' passenger, or
- 'steal' energy from other celestial bodies,

Piggy-back launches

The Ariane launcher offers a dual-launch capability, which can be used to reduce the cost of injecting satellites into orbit. Ariane-5 offers a specially designed structure, the Ariane Structure for Auxiliary Payloads (ASAP), for the piggy-back launching of micro- and mini-satellites.

However, companion satellites are usually only sought for Geostationary Transfer Orbit (GTO) launches, making GTO the most likely parking orbit for a dual launch. This is nevertheless quite interesting for our purposes because the energy of a GTO is considerably higher than that of a low Earth parking orbit, allowing savings on the Translunar Orbit injection. Unfortunately, GTO and Translunar Orbit missions are normally not compatible, because

the GTO apsidal line (line through perigee and apogee) lies in the equatorial plane, whereas the Moon's orbit is in a plane inclined between 18 and 29 deg.

Short transfers from GTO

The Moon can only be reached by direct Translunar Orbit from GTO without a plane change when it is at its nodes (where the Moon's orbital plane crosses the Earth's equatorial plane). The GTO apsidal line depends on the direction of the Sun; it is almost tangential to the projection of the Earth-Sun line on the equatorial plane. Therefore, a direct-transfer Translunar Orbit can reach the Moon only when the Sun is along the line of nodes of the Moon's orbit, which occurs just twice per year. Otherwise, a plane-change manoeuvre is needed. If the GTO node is close to the Moon orbit node, the plane change manoeuvre needed is small and can be accomplished as a mid-course correction on the way to the Moon. This is illustrated in Figure 5, where the node difference is 18 deg. The waiting time for the Moon to arrive at its node is up to one lunar month.

Long transfers from GTO

If the GTO node is distant from the Moon's orbital node, a different strategy has to be used because a large plane change is required. The manoeuvres for plane changes can be very costly, but the cost can be reduced if the velocity of the spacecraft is low. This is the case at apogee, and higher apogees lead to lower velocities at apogee. Therefore, the following strategy is therefore proposed:

- Raise the apogee to about 1 million km, so that the apogee velocity is very small. This adds only about 72 m/s to the Δv compared with an apogee raise to the Moon's distance.
- Perform a plane change at apogee ($\Delta v = 300$ m/s approximately), so that the orbit's return leg meets the Moon's orbit.

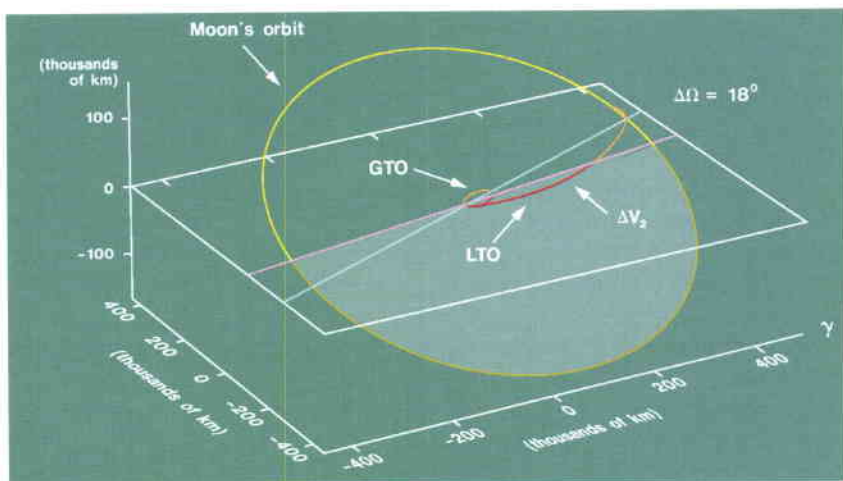

Figure 5. Direct transfer from GTO. The GTO and the Moon's orbit nodal line are close together (here within 18 deg). A mid-course plane-change manoeuvre (Δv_2) is performed before apogee

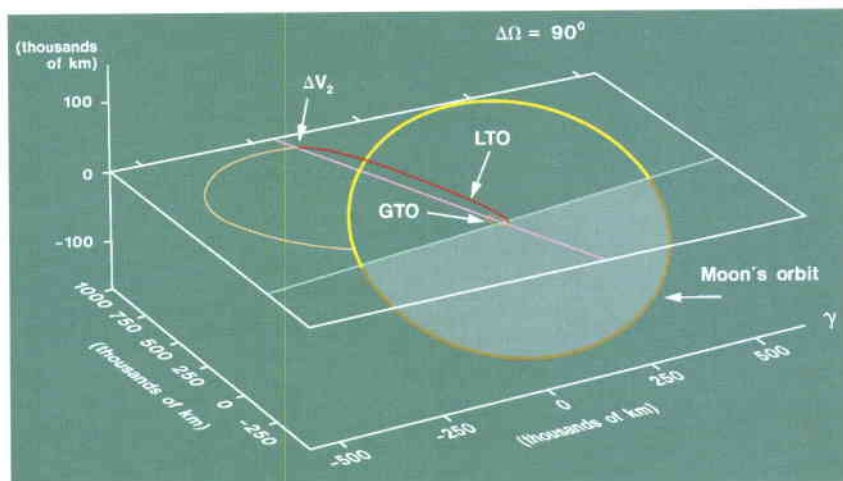

Figure 6. Bi-elliptic transfer from GTO. The GTO and Moon's orbit nodal line are far apart (in this drawing 90 deg). A mid-course plane-change manoeuvre (Δv_2) is performed at the LTO's apogee, about 1 million km from Earth

The long transfer (also called a 'bi-elliptic transfer') reduces the cost of the plane change considerably. However, the transfer duration extends to 50 days and up to one lunar month is required to wait for the Moon to be present at spacecraft's arrival. Figure 6 is an example of a bi-elliptic transfer when the node difference is 90 deg.

It can be shown, however, that when starting from a circular orbit with radius R_1 and going to a higher circular orbit with radius R_2 , a bi-elliptic transfer is more efficient than a direct transfer, if $R_2/R_1 \geq 12$. This is the case, for example, when starting from a 300 km circular Earth parking orbit and arriving at the Moon's orbit at 384 400 km radius.

Arrival conditions at the Moon are comparable to those of a direct transfer, but the spacecraft now arrives around the perigee of the Translunar Orbit. Since its velocity is now higher, the relative velocity with respect to the Moon is lower and therefore the Δv needed for Lunar Orbit Insertion is also lower. The location of the periselenium cannot be chosen, but depends on the arrival geometry. Additional burns are needed to position the periselenium, for example, above the lunar South Pole.

Long transfers from GTO, though more complex, make Moon missions less dependant on appropriate launch windows.

Weak Stability Boundary transfers

How can the Δv requirements be further reduced? Lowering the Translunar Injection Δv would mean that we could not reach the Moon, and therefore this is not an option. The only other option is to try to reduce the requirements on the Lunar Orbit Injection. This could be achieved by arriving in the vicinity of the Moon with a low relative velocity, which implies increasing the Translunar Orbit energy level up to the Moon's orbit energy level.

How can the orbital energy be increased without paying for it? A practical way is to 'steal' orbital energy from other celestial bodies, such as the Sun and the Moon. A bi-elliptic orbit already provides enhanced arrival conditions, and gives a Δv saving compared with the direct transfer if the GTO node is distant from the Moon's orbital node. The total Δv requirement could be further reduced if the apogee manoeuvre were not provided by a main-engine burn, but by a perturbation from the Sun's gravity, for example.

This implies taking the spacecraft to a Weak Stability Boundary (WSB) region, where the Sun's or the Moon's gravity is of the same order as that of the Earth. A small manoeuvre within such a WSB region can lead to a drastic change in lunar arrival conditions. These WSB regions are located around the Lagrangian points (see Fig.12).

The concept is not new; in Jules Verne's book 'Journey to the Moon' (1872), the spacecraft 'Columbiad' is shown orbiting the Moon with an aposelenium close to the L1 point. A small Δv given close to the L1 point, achieved using fireworks, was just enough to send the Columbiad back to Earth! More than a century later, the Japanese Hiten spacecraft was the first non-fictional mission to exploit the power of the 'Jules Verne procedure'. After the failure of the Muses-B

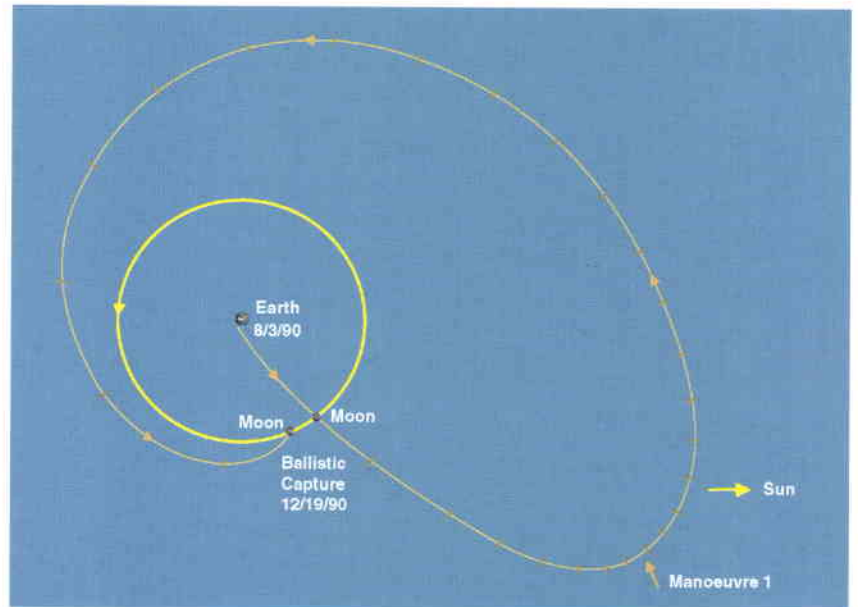

spacecraft to nominally reach the Moon, an attempt was made to send its companion spacecraft Muses-A, renamed Hiten, towards the Moon. There was insufficient propellant available for a classical transfer, and so a WSB transfer was performed to salvage the mission (Fig. 7).

Figure 7. Hiten mission profile (the Sun's direction is shown at Earth departure) Tick marks are at 5 day intervals

A WSB transfer as used by the Hiten spacecraft involves crossing the Sun-Earth WSB at a distance of about 1.4 million km from Earth, where the solar perturbation can substantially increase the Translunar Orbit energy, i.e. increase the perigee to close to the Earth-Moon distance. Figure 8 shows the field-line directions of the Sun's gravity gradient in a rotating co-ordinate system (x-axis always points towards the Sun) with the Earth at the origin. The gradient gets stronger as one moves further away from the Earth, and the greatest effect is therefore at apogee. Figure 8 also shows two highly elliptical orbits with the spacecraft moving in an anti-clockwise direction. It can be seen that the gravity

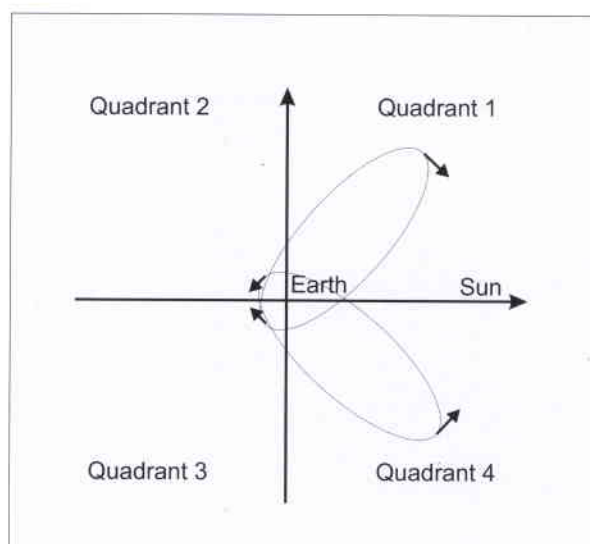

Figure 8. Field-line directions of the Sun's gravity gradient. Two orbits are shown where the Sun's gravity would decrease (quadrant 1) or increase (quadrant 4) the orbital energy

gradient is directed alongside the velocity vector at apogee in the second and fourth quadrants of the co-ordinate system. In the first and third quadrants, it is directed in the opposite direction to the velocity vector at apogee. Therefore, if the apogee is located within the second or fourth quadrant, the Sun increases the orbital energy which, integrated

over the long period that the spacecraft spends in the apogee region, raises the perigee towards the Moon's distance.

Upon arrival at the Moon, the Earth-Moon WSB can be used to further reduce the Δv requirement. If the Translunar Orbit energy is close to the Moon's orbital energy, the spacecraft can be captured by the Moon. When reaching the Moon, Earth's gravity can be used to lower the orbital energy relative to the Moon so that the spacecraft can no longer escape from it. A ballistic capture occurs because the Earth has provided the spacecraft with just the right amount of energy to be captured by the Moon.

For such a ballistic capture, the resulting orbit around the Moon has an aposelenium close to the Lagrangian-point distance. A small Δv is then required to lower the aposelenium, since further Earth perturbations could again send the spacecraft into a higher energy escape orbit.

Application to LunarSat

LunarSat is a 100 kg spacecraft, 40 kg of which is propellant and 6 kg is payload. An Ariane-5 could put the spacecraft into GTO within the 2000-2001 time frame. The Δv budget amounts to 1450 m/s. Studies have shown that a direct transfer would require 1270 to 1770 m/s, depending on the GTO and Moon's orbit node difference (i.e. launch date). A bi-elliptic transfer would call for 1380 to 1490 m/s, also depending on the launch date. As an auxiliary passenger, LunarSat has to be compatible with the standard Ariane-5 dual-launch window for any launch date.

A study was performed at ESTEC to see if a WSB transfer would be compatible at all times with the constraint on the Δv . WSB transfers were calculated for a six-month period from December 2000 to May 2001, using genetic algorithms to optimise towards low Δv 's. Figure 9 shows a WSB transfer for a launch on 1 December 2000. The solar perturbation raises the perigee to the Moon's distance, and raises the inclination of the Translunar Orbit (7 deg at GTO) towards the inclination of the Moon's orbit (22 deg at end-2000). The transfer takes 93 days, and the apogee is at 1.4 million km. The apogee manoeuvre was optimised to 0 m/s.

Some creative solutions were found by the genetic algorithm using lunar swing-bys and resonance orbits like the example (launch on 31 December 2000) shown in Figure 10. The trajectory resembles the one described previously, but upon reaching the Moon, a swing-by occurs that puts the spacecraft into a

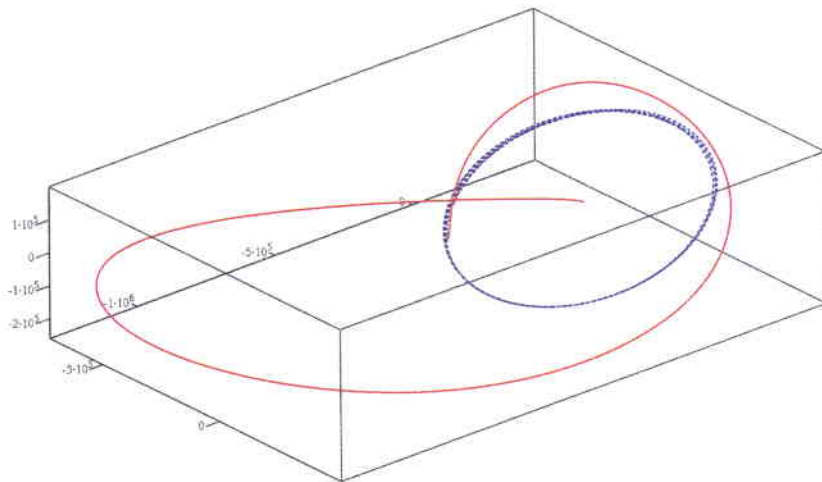

Figure 9. A WSB transfer for a 1 December 2000 launch. The red line shows the spacecraft's orbit, the blue line the Moon's orbit. The Earth is located at the origin of the plot

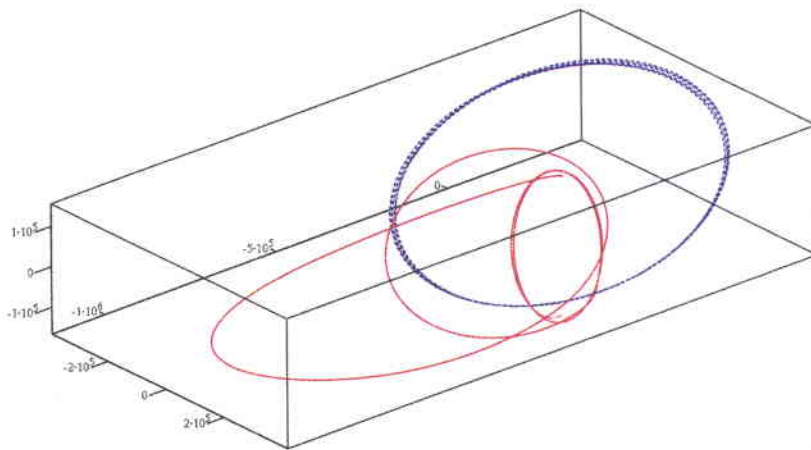

Figure 10. A creative WSB transfer with multiple gravity assists and resonance orbits, for a launch on 31 December 2000

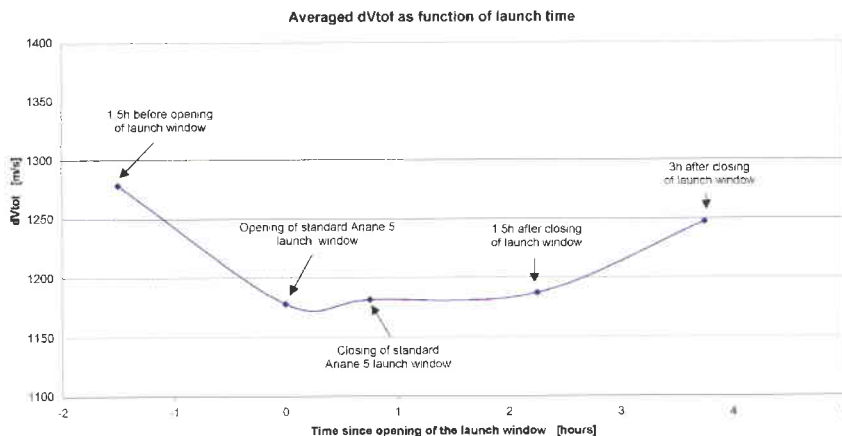

Figure 11. Influence of the time of launch on the total Δv

The Lagrangian Points

When considering one celestial body in circular rotation around another one, such as the Moon around the Earth or the Earth around the Sun, there are particular points in space fixed relative to the celestial bodies where the force acting on a spacecraft vanishes. This was discovered by the French mathematician Comte Louis de Lagrange (1736-1813) and these points are therefore called the Lagrangian or libration points. There are five of them: three (L1, L2 and L3) are along the axis going through the two celestial bodies and two others (L4 and L5) are located at the extremity of an equilateral triangle with the two bodies. It is even possible to define orbits around these points. They are unstable, but the corrective manoeuvres needed for keeping a spacecraft in such an orbit are relatively modest. ESA's solar observatory SOHO is in such a Halo orbit around point L1 of the Earth-Sun system, located 1.5 million km from Earth towards the Sun.

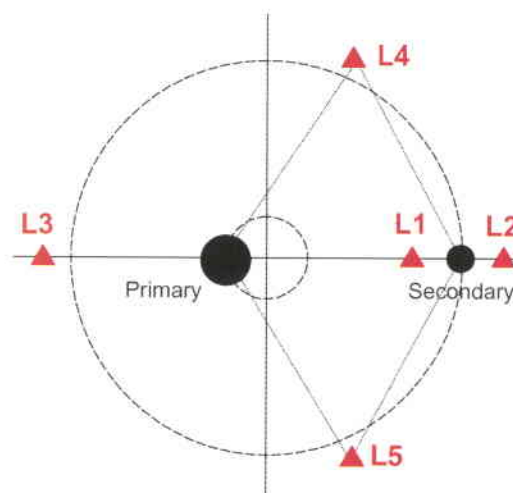

Figure 12. The five Lagrangian points, with the primary and secondary celestial bodies rotating about their common centre of mass

resonance orbit with the Moon, enabling another lunar encounter after 28 days. Another swing-by at this encounter puts the satellite into a new resonance orbit (1:2) such that, after another 28 days, Lunar Orbit Insertion occurs. The total transfer time is 105 days.

The results of the study showed that the Δv ranged from 1130 to 1340 m/s, well below the budget. Another positive finding scientifically speaking was that LunarSat's periselenium was located above the lunar South Pole. The study showed that the spacecraft could arrive in any lunar orbit, in contrast to direct and bi-elliptic transfers, which need extra manoeuvres to adjust the lunar orbit.

For LunarSat, then, WSB transfers reduce the Δv required by approximately 200 m/s compared with direct or bi-elliptic transfers, allowing the overall Δv budget to be reduced from 1450 to 1350 m/s. This implies a reduction in propellant mass of more than 2 kg, which in turn means an increase in payload from 6 to 8 kg, or a 33% increase!

These results were confirmed by a later study conducted by Grupo de Mecánica del Vuelo (GMV, Madrid), in which a parametric analysis for LunarSat was performed for the entire year 2002. The Δv requirement showed a periodic behaviour, with maxima occurring around January-February and July-August, depending on whether the perigee is located in either the 'correct' or the 'incorrect' quadrant. The longest waiting time in GTO is 16 days, with a monthly repetition pattern due to the Moon's rotation period. The transfer duration ranges between 80 and 120 days. Shorter transfer times can be achieved at the expense of a slightly higher Δv .

The GMV study therefore showed that several solutions for a WSB transfer are possible, whatever the launch date and time within the standard Ariane-5 dual-launch window (Fig. 11). It also confirmed the feasibility of WSB transfers from a navigational point of view, in that no exceedingly large correction manoeuvres are needed to reach the target. In addition, the combination of WSB transfers with multiple swing-bys to escape the Earth and reach other planets which was investigated showed substantial savings in terms of Δv .

Conclusions

A variety of scenarios for missions to the Moon have been studied in Europe. Recent studies have focussed on the Geostationary Transfer Orbit as a starting point due to the possibility of reducing launch costs by sharing an Ariane-5 launcher making a commercial flight to GEO. One of the most promising options from such a parking orbit is the use of a Weak Stability Boundary transfer to reach the Moon. The longer transfer times involved are compensated by large savings in Δv , and the possibility of having all types of lunar arrival orbits, which are not possible with the classical approaches.

Acknowledgements

The support received from Dr W. Ockels in the preparation of this article is gratefully acknowledged.



Database Administration for Spacecraft Operations – The Integral Experience

J. Houser & M Pecchioli

Mission Operations Department, ESA Directorate of Technical and Operational Support, ESOC, Darmstadt, Germany

Introduction

Long before the integration of a spacecraft begins, the structure of the spacecraft database is defined and documented. Because of the large amount of data involved, a proper and clear definition of the database structure is crucial to minimise the effort subsequently required to populate and maintain it.

ESA's flight control teams have always used databases for spacecraft monitoring and control. The mission control systems rely on a database to interface with the spacecraft, in order to know how to encode the telecommands sent and interpret the telemetry received. This approach allows the control system software and the data describing the controlled domain to be decoupled. Given the number of changes typically implemented in a database prior to and even after launch, no other approach would be feasible.

The population, validation and configuration control of the spacecraft database therefore play an important role in mission pre-launch activities. Experience shows that a reliable database is possibly the most fundamental prerequisite for the successful execution of spacecraft operations.

The typical spacecraft database consists of several dozen tables, each containing a portion of the data. The tables are interrelated in that one table record can refer to items further described in other tables. Unfortunately, the database structure is influenced not only by the characteristics of the controlled domain (i.e. the spacecraft), but also by the design features of the control system itself. Given that different control systems are typically used by the satellite manufacturer's Assembly, Integration and Test (AIT) team and the flight control team at ESOC, several different database structures are normally defined. To support the exchange of data across the different formats, interfaces are formally agreed and data-conversion applications (import/export) developed.

The database is initially populated, used and validated by the teams responsible for the design and integration of the different satellite subsystems. The flight control team at ESOC would normally see it for the first time two to three years before the launch. At this stage, the database is typically in an incomplete and unstable state, and progressively matures throughout the integration and test phase. During the same period, the flight control team at ESOC will need to augment and sometimes modify it. These parallel activities introduce the need to ensure coherence between these different versions of the database and to coordinate their maintenance.

The size and complexity of spacecraft databases differs significantly depending upon the particular mission, and has been significantly affected by the evolution in spacecraft design over the years. For example, the adoption of modern telemetry/telecommand standards (e.g. the Packet Utilisation Standard) allows great data-handling flexibility on board and therefore implies the need to introduce more sophisticated techniques on the ground to describe variable packets, for example. The amount of data required to describe a spacecraft has also increased dramatically in recent years. For the early spacecraft, only about 500 telemetry parameters had to be defined in the database, whereas those for today's scientific satellites typically contain more than 15 000 parameters. This growth has imposed severe requirements on the functional and performance capabilities of database editors and mission-control systems.

The database maintained by the satellite manufacturer and delivered to ESOC is normally referred to as the 'Satellite Database, or SDB'. The database maintained at ESOC by the flight control team is normally referred to as

the off-line 'Operational Database, or ODB'. For performance reasons, the ODB is converted into an internal format when it is imported into the Mission Control System (MCS), which is normally referred to as the 'Run-Time Database'.

History

The 80-column card era

In the late 1970s and early 1980s spacecraft databases were defined and managed on 80-column punched cards. These cards were a matrix of holes, 80 columns wide by 12 columns deep. Each column was used to record one character of information as a series of holes. The first two rows were used for the header information, and the remaining 10 to represent the characters.

There were many punched-card machines in ESOC during this period. They were as loud and as large as today's photocopying machines. The problem with punched cards was flexibility – there just wasn't any! With punched cards it was almost impossible for the operations personnel to have an overview of the data contained within them.

As computer technology progressed, punched cards were replaced by electronic storage media, but the organisation of the data itself was not modified. The data were accessed using remote terminals connected to a central mainframe computer and edited using very basic text editors. Inputs about the database content were still received from the satellite manufacturer in paper form.

The 80-column card era has been the driving factor in the design of the database structure for many control systems. The database structure of the SCOS-1 control system, still in use today, can be mapped to 80 columns of information per record.

Relational databases

Relational databases (e.g. ORACLE) were introduced in the late 1980s with the development of the SCOS-1 infrastructure and are still being widely used in ESA. The use of relational database technology has opened the door to a progressive increase of the automation in the creation and maintenance of the spacecraft databases. ORACLE, in particular, supports a powerful query language (SQL), which allows interrogation of the database and the manipulation of all data meeting specified criteria (bulk data editing). It also supports a development environment, which has been used extensively to produce the editor forms. The visibility of the database content as well as the sophistication of the

syntactical and on-line consistency checks could be progressively improved. Most of the off-line databases that are managed currently at ESOC are still in ORACLE format.

Object-oriented databases

Object-oriented databases have only recently been introduced at ESOC both for the off-line and for the run-time database. The Rosetta off-line database system and the run-time database of SCOS-2000 (latest ESOC infrastructure for spacecraft control systems) are both based on object-oriented technology.

Database content

The content of the satellite database can normally be split into three main areas: telemetry, telecommand and flight dynamics. This last area is not addressed in this article, which focusses on the telemetry and telecommand databases of the Integral Mission Control System.

Telemetry

All of us are involved in one way or another in monitoring data in our daily lives, for example the water temperature indicators in our cars. What about attaching your thermometer to the inside housing of a spacecraft's service module and launching it into space? As opposed to seeing the data directly, as you can in your car, you encode the temperature value in the form of binary bits and place them in a data unit (e.g. a 'packet'), which is eventually down-linked from the spacecraft. In order to present you with an engineering view of the on-board status, your control system first needs to identify which data unit is being received and then to know how to extract and decode the telemetry data delivered by it. In most cases, the location of telemetry data in the transmission data units is fixed. This is the simplest and traditionally most commonly used approach, but not necessarily the most efficient one. To optimise the usage of the down-link bandwidth, it maybe required to transmit different data depending on some conditions related to the on-board status. The Packet Telemetry Standard allows this flexibility in that different packets can be generated depending on the actual data to be down-linked. A further level of sophistication may be required under some circumstances, whereby the content of some asynchronously generated packets depends on the prevailing on-board states.

Once the bits corresponding to a telemetry parameter sample have been extracted, the control system needs to know how to decode them (depending on the parameter type, e.g. integer, real, string, time) and how to calibrate them to derive a proper engineering view. One

aspect that is of fundamental importance in the monitoring of spacecraft telemetry data is an assessment of the validity of the data received. Is the temperature shown in your car a valid indication if the car is switched off? Validity conditions have to be specified in order to ensure that the data being used are reliable. This may sound trivial, but in fact it is not as the validity conditions are normally based on other telemetry parameters that also require validation. A chain of conditions is established, which is typically organised in a hierarchical manner. Once the validity of the received data is established, the system is supposed to notify the operator if the on-board status is not nominal. This is achieved by applying to each received parameter a set of checks ensuring that its value is within the allowed ranges (limit checks) and also that no unexpected change in on-board status has taken place (status consistency checks). A different set of checks has to be applied, for example, during different mission phases. This implies that applicability conditions have to be specified for each check, each condition also being dependent on telemetry data.

In many cases, the telemetry data received also have to be consolidated to ease the visibility of the on-board status. This is achieved by associating with a 'pseudo' telemetry parameter (derived parameter) a routine that is evaluated based on some trigger criterion, for example the reception of a contributing telemetry packet.

The telemetry databases contain all of the data required to identify, extract, decode, calibrate, validate, check, derive and display the telemetry data.

Telecommands

Telecommands are encoded messages transmitted to the spacecraft to trigger one or more actions on-board. They can perform many different functions, the most obvious one being to switch a unit on or off, as you would with your normal television remote-control unit. Of course, commanding a modern spacecraft implies a much higher level of complexity and also imposes severe safety requirements.

A telecommand is typically composed of several elements, which may be given a fixed value, or a default value which can be changed at each instantiation level (parameters). Mirroring the processing of telemetry parameters, a value for a command parameter can be specified/viewed in engineering form and thus has to be properly (de-)calibrated and eventually encoded in a format that depends on the parameter type. Parameter values can also be subject to

syntactical as well as range checks. Unlike previous standards, the Packet Telecommand Standard, and the Packet Utilisation Standard in particular, allow great flexibility in the encoding of a command packet, including a variable number of parameters, or parameters that may be given values with variable length.

The execution of spacecraft operations typically requires the transmission of many telecommands to achieve a specified goal. To ease this process, telecommands are normally collected in named lists (command sequences), which can also be associated with parameters (mapped to the parameters of the constituting elements). Command sequences are also allowed to contain other sequences (nested sequences), thereby enabling the hierarchical definition of the commanding activities.

The telecommand databases contain all of the data required to (de-)calibrate and check command parameter values, to encode, validate and verify commands and to store the definitions of command sequences.

The Integral experience

The Integral Mission Control System has been developed based on the SCOS-2000 infrastructure. As noted above, SCOS-2000 allows full freedom in the design of the off-line database system for a client mission. In the case of Integral, however, the structure of the off-line database was directly derived from the organisation of data expected by the SCOS-2000 database importer. This approach offered the advantage of minimising the conversions taking place when importing the database into the run-time system, and thus afforded the users access to all of the flexibility offered by SCOS-2000. Also, the organisation of the SCOS import data is fully 'normalised', in that many-to-many relationships between data are avoided by means of mapping tables. The adoption of a normalised database structure simplifies significantly the relationships between data items and thus the development of the database editors and consistency checker.

The size of the Integral database is significant in that it currently contains about 150 000 records, occupying more than 12 Mbyte of memory. As for many other missions currently managed at ESOC, this has imposed the need to electronically import as many data as possible from the database delivered by the manufacturer, thereby avoiding the risk – and effort – implied by manually inputting all data.

The data flow involved in the process of creating and maintaining the Integral off-line database is shown in Figure 1. This process is not a one-off

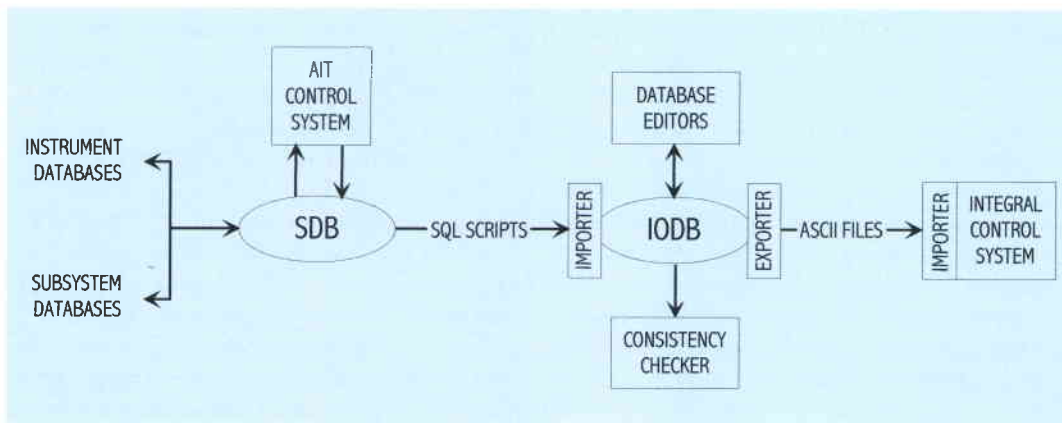

Figure 1. Data flow within the Integral database maintenance process

exercise, because in the years prior to launch population of the database basically takes place in parallel on the manufacturer's side and at ESOC. This is explained and described further in the following sections.

The Satellite Database (SDB)

The SDB is populated and maintained by the spacecraft manufacturer based on inputs from those responsible for each subsystem. It contains all of the basic telemetry/telecommand data required to interface with the spacecraft, as well as some basic Boolean expressions, which are used as telemetry validity criteria, check applicability criteria, and command pre-transmission validation checks. Each SDB version is delivered to ESOC in the form of SQL scripts, from which a Microsoft Access database with the same structure is created at ESOC. This database is not manipulated further at ESOC. It is only used as a reference and for importing data into the Operational Database (ODB, see below). A browser developed in MS-Access is available to all users to visualise the SDB content.

In order to ensure its integrity and consistency prior to importation into the ODB, the SDB is interrogated by the database administrator at ESOC. Any problems with that particular version of the SDB are thereby isolated and addressed during the importation process.

The Operational Database (ODB) editors

As noted above, the telemetry/telecommand data contained in the SDB are automatically imported into the ODB by means of a set of MS-Access queries (basically SQL queries), which convert the SDB data and import them into the appropriate fields of the ODB. Additional information not delivered by the spacecraft manufacturer as part of the SDB is required in the ODB. On the manufacturer's side, only those items essential to safely interface with the spacecraft are introduced into the database. The flight control teams at ESOC also have to take into account how the data are entered (commanding side) and how

they are presented to the end operators (monitoring side). This is crucial both during the execution of critical mission phases (when operations have to be executed under time pressure), as well as during the routine operations phase (when only a single spacecraft operator is responsible for the execution of all operations without any on-line engineering support).

Typical examples of data stored in the ODB but not imported from the SDB are the definitions of monitoring displays and command sequences, which the flight control team directly defines to be fully in line with the Flight Operations Plan. Another area where the ODB requires significant extension after SDB importation is the definition of derived parameters. Typically, hundreds of additional derived parameters are defined by the flight control team to refine the validity, monitoring check applicability and PTV* criteria, and also to present the on-board status to the spacecraft operators in the most convenient manner. Finally, other extensions of the ODB are required to introduce the data relating to all of the functions of the Integral Mission Control System that are not supported by the control system used by the AIT** team (e.g. status consistency checks, load/dump comparison verification checks, report based verification, variable packets definition).

Thus, although a large portion of the ODB data is directly imported from the SDB, database editors are nonetheless required to support the flight control team at ESOC in the definition of the additional data. Severe requirements apply in that the Man/Machine Interface has to be unambiguous, efficient, user-friendly and protective against the introduction of invalid data.

The Integral ODB (IODB) editors have been developed based on Microsoft Access, allowing easy integration of the several elements involved in a database editor, such as the Man/Machine Interface forms and the code written in Visual Basic. It also supports easy

*PTV= Pre-Transmission Validation

**AIT= Assembly, Integration and Test

access to an intuitive query definition environment (based on SQL), which significantly eases the data manipulation and visualisation. The IO DB editors were designed with the continuous involvement of the end users, to ensure that the product would meet the actual user needs, including those sometimes not easily specified in the form of requirements. One of the main achievements lies in fact that the editor forms provide a very good overview of the data being edited as well as of any referenced data, as shown in Figures 2 and 3.

The IO DB editors are designed for multiple users accessing a centralised set of tables from their own PC in their office environment. The database tables are based on a structure that

mirrors the data organisation and the relationships between data items as expected by the MCS database importer. This allows simplification of the database export function, which is a pure conversion into ASCII format.

Figure 4 provides an overview of the different elements related to the IO DB editors and associated tools (importer and consistency checker). The IO DB editors support a dedicated on-line function, which enables the user to understand exactly how a data field is going to be used in the Mission Control System and all of the constraints applying to it.

Last but not least, the content of a database needs to be documented. Reports are produced in order to support reviews and also

Figure 2. The calibration curve editor

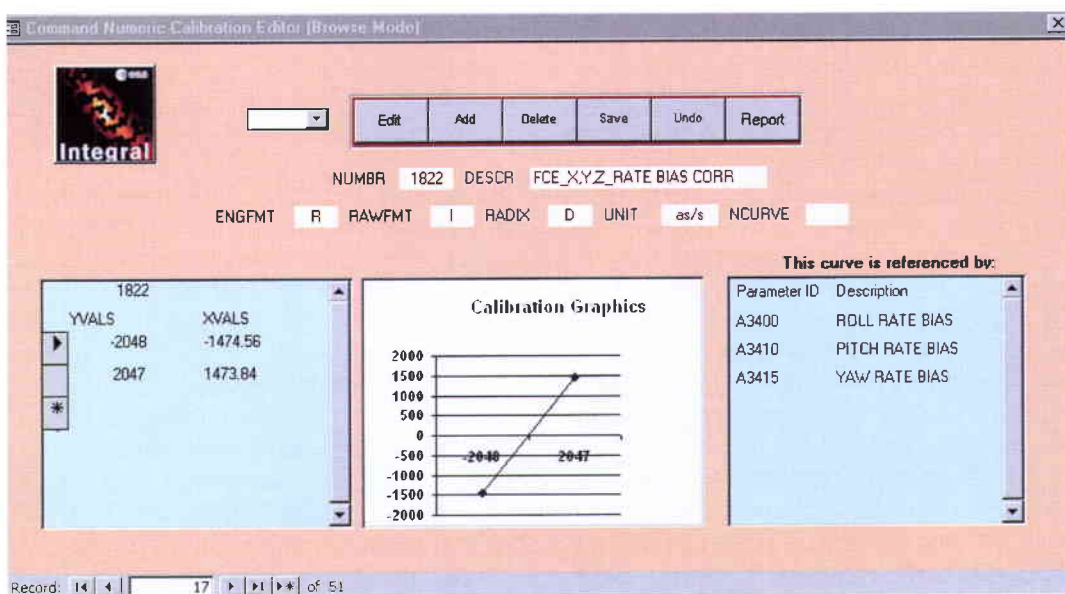
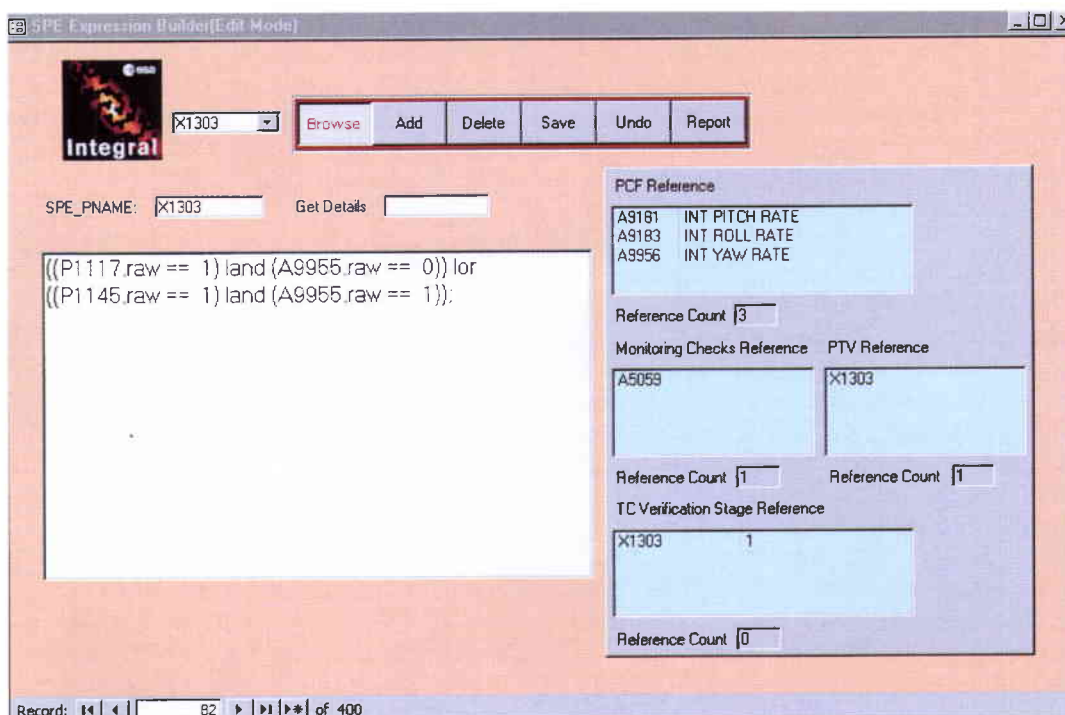

Figure 3. The derived parameters editor



to be used as a reference in the control rooms. The IODB editors support the generation of reports containing not only the attributes of each data item, but also cross-reference lists (i.e. which item is referenced by which other item).

The database consistency checker

The IODB editors are designed so as to avoid as much as possible the inputting of incorrect data. This is achieved, for example, by means of drop-down selection lists for all multiple-choice fields. Relational integrity is also automatically preserved using the relationships between tables by means of cascade delete and cascade update mechanisms. However, the execution of on-line checks is not adequate to ensure in all cases that no database inconsistencies are introduced. The database table organisation is complex, with many interactions between data. Executing all applicable checks following any user input would introduce unnecessary complexity and possibly in some cases even lead to a chicken and egg loop. Furthermore, a large portion of the data is imported from external sources, thereby imposing the need to check the overall consistency of the data after each data import operation.

For Integral, developing an off-line consistency checker tool has solved these problems. This application accesses the same database tables that are manipulated via the editors. It runs a predefined set of sophisticated queries about the current database content and returns a report that can be filtered based on tables, fields and type of checks. This approach has proved to be very powerful in providing users with a 'snapshot' of the current database status in terms of data consistency.

Database validation and configuration control

By the time a spacecraft is launched, its Operational Database must be completely error free and fully tested. There is no system in the world that can ensure this, and only an intensive test campaign can provide the required confidence. Several methods are used at ESOC to accomplish this task.

Spacecraft telemetry playback

The first satellite data typically made available to ESOC for testing are in the form of recorded telemetry data units. These data are useful not only to start testing the telemetry processing in the control system, but also to start exercising the telemetry database.

Simulations

Prior to launch, intensive testing activities using a spacecraft simulator take place. These are

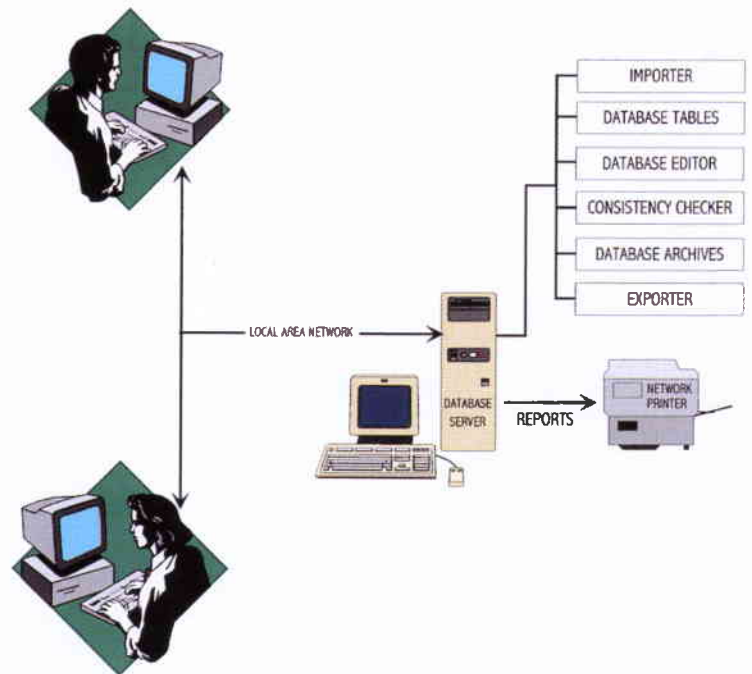

Figure 4. Organisation of the IODB applications

geared to the validation of the Mission Control System, the Flight Operations Plan as well as the Operational Database. The advantage of using the simulator for the validation of the database is that the various test scenarios (including failure scenarios) can be relatively easily recreated. However, the validation achieved using the simulator cannot be considered conclusive. In fact, the simulator's behaviour is also driven in many cases by configuration tables that are populated using the same input as for the Operational Database.

System Validation Tests

The System Validation Tests (SVTs) are conducted by interfacing with the real spacecraft whilst it is still on the ground. The actual ground-segment equipment is used and realistic operational scenarios are exercised. One of the SVT objectives is to confirm the correctness of the telemetry and telecommand database. In fact, SVTs ensure an end-to-end validation of all items in the Operational Database, which are actually used during the tests.

Historical data reprocessing

The execution of the above tests will lead to the identification of any problems with the Operational Database and their subsequent correction, but final confirmation of the database's correctness is still required. On the telemetry side, this can be achieved by simply reprocessing the data that have caused the problem. In SCOS-2000 this is in many cases simply achieved by opening the monitoring displays in retrieval mode, which implies

Table 1

Need/Problem	Solution for Integral
Manage large amount of data	Automatically import TM/TC spacecraft characteristics from the manufacturer's Satellite Database (SDB). Allow the users to access the powerful and intuitive query language supported by MS-Access
Maximise the work efficiency in the definition of the Operational Database (ODB) specific data	Support high-level 'replicate' functions at the level of data items (e.g. commands). Minimise the set of checks performed on-line during editing activities
The first version of the SDB is imported when it is not yet in a final state	Support a 'delta' SDB import option preserving all data added or modified at ODB level
Ensure overall consistency of the imported and edited data request	Support an off-line consistency checker performing all required checks upon user. Establish relationships across database tables with cascade delete and update mechanisms
Allow parallel maintenance of the Operational Database from the users' office environment	Support the remote access of a centralised set of tables directly from the users' PCs
Provide the users with adequate visibility of the database content	Design editor forms in collaboration with the users. Implement navigation techniques across related data items
Keep change and version control of the operational database	Automatically log all user edit actions. Automatically archive all exported databases

complete reprocessing of the raw telemetry packets based on the currently active database.

Database configuration control

After the execution of SVTs, it is crucial to ensure that new errors are not introduced into previously validated data. A rigid database change- and version-control procedure is typically adopted, whereby each change has to be traceable and, even more importantly, it must always be possible to roll back to an older database version if new problems are indeed identified. For this purpose, the Integral ODB editors support the automatic logging of all user edit operations, and all database versions exported to the Mission Control System are automatically archived under a dedicated directory.

Conclusions

This article has described the main problems encountered in administering the Operational Database for spacecraft operations and the solutions adopted for the Integral mission. The problems and the solutions adopted in each case for Integral are summarised in the accompanying table (Table 1).



SMP: A Step Towards Model Reuse in Simulation

L. Argüello, J. Miró

Electrical Engineering Department, ESA Directorate of Technical and Operational Support, ESTEC, Noordwijk, The Netherlands

J.J. Gujer & K. Nergaard

Ground Systems Engineering Department, ESA Directorate of Technical and Operational Support, ESOC, Darmstadt, Germany

Rationale

Within ESA's broad range of space programmes, simulators are continually being developed for many different purposes – typically engineering, verification, operations preparation and training – in a more or less independent manner. Up to now, it has not been easy to take advantage of the obvious commonality between these simulators within one project because they were developed following different design guidelines. There was basically a lack of standards that could be applied to support the reuse of simulation products.

A standard specification for the interface between simulator models and simulator infrastructures – the 'Simulation Model Portability (SMP) Standard' – has been established and validated in the framework of an ESA initiative, with the participation of the main companies involved in spacecraft simulation. This will facilitate the implementation of a 'plug-and-play' approach for simulators and will allow for rationalisation of simulation developments by reusing existing models independently of the tool for which they have originally been developed. In particular this will allow the exchange of models between flight-segment simulators and the simulators used to support operations and training.

The rationalisation of simulation developments is now being actively pursued within ESA and a clear objective is the exploitation of commonality between simulators, first within the same project and then across projects. This implies 'portability' of spacecraft models from one platform to another, since different platforms are used at different companies and ESA sites. Achieving that portability requires the following steps:

- The architecture of the simulator must implement a clear separation between: the simulation models representing the spacecraft and its environment, i.e. the project-specific parts of the simulator; the general-purpose

part of the simulator, namely the simulation framework (also called simulation infrastructure or simulation tool). This separation is already enforced on most simulator developments by the use of off-the-shelf simulation tools.

- A standard interface specification between models and simulator frameworks needs to be defined, in order to apply the 'plug-and-play' approach already well-established in other software areas. This has recently been done by ESA and is the main focus of this article. Compliance with such a standard interface will ensure portability for both simulation models and simulation tools.
- In addition to being compliant with the standard interface specification, models must be properly documented, validated and easily accessible, if reuse is to be successfully applied. We also identify here how these aspects are supported in the present concept and what developments are required in the future to support simulation rationalisation.

Objectives of the SMP standard

The main purpose of the SMP standard is to promote the re-use of simulation models by ensuring their portability from one simulation platform, or infrastructure, to another. The SMP standard has been developed to fulfil the following objectives:

- Minimise model interactions with their simulation environment.
- Standardise interfaces between models and the simulation infrastructure.
- Make models understandable for other developers.

To achieve these goals, the SMP standard defines a set of specifications for coding and documenting models, with particular emphasis on their interfaces, i.e. their visible part to the rest of the simulation:

– *Simulation Model Interface (SMI) specification*

The SMI specification defines a set of services to be provided both by the models to the simulation infrastructure and by the simulation infrastructure to the models.

– *Portability guidelines*

The portability guidelines provide a list of recommendations for developing a model that is as portable (i.e. re-usable) as possible.

– *Document template*

Appropriate standardised model documentation is a key factor in facilitating software re-use. The standard defines a model document template which, if completed, should ensure that all of the important aspects of the model are accurately described.

– *Compliance test*

As well as defining compliance tests for each of the guidelines, the SMP standard defines a system that should be used to test the model's compliance.

A concerted ESA-Industry effort

The SMP standard is the result of a concerted effort involving both ESA and Industry. Two sections of ESA's Technical and Operational Support Directorate (to which the authors of this article belong), representing the mission-operations simulation requirements at ESOC and the spacecraft-development requirements at ESTEC, jointly undertook the establishment of a technical specification to ensure portability of simulation models between the two domains. This was based on preliminary user requirements put together under ESA co-ordination by a working group with the participation of the main European companies involved in simulation tool development. Industry was also invited to support the development of the standard specification, to

ensure that the outcome would fulfil the industrial requirements as well as the requirements laid down by ESA, and also that the standard would be easy to adopt.

Available SMP products

The main SMP product is the model interface specification. In order to validate it, a software implementation was developed and integrated with existing simulation infrastructures. The complete documentation is contained in the SMP Handbook, consisting of three volumes:

- Volume 1: SMP User Manual General Concepts.
- Volume 2: SMP Software User Manual, which describes the installation, building and execution procedures for the software associated with the SMP.
- Volume 3: SMP Interface Specification, which is the Simulator Model Interface (SMI) Specification Reference, describing the SMI software types and services available, classified by category.

The SMP software consists of:

- The generic software, independent of the simulation infrastructure used.
- The specific software (plug-ins) required to implement the SMP standard in a particular simulation infrastructure. Two such plug-ins are currently available:
 - SIMSAT SMP Plug-in
 - EUROSIM SMP Plug-In
- SLIMSAT: a freeware SMP-compliant simulation environment available on-line for learning, model-development and testing purposes.

Users of the SMP standards

There are three categories of SMP user:

- Model developers, who need to know the simulator model interface specification as contained in Volume 3 of the SMP Handbook.
- Simulation Infrastructure vendors, who need to adapt their simulation infrastructure to be SMP-compliant and therefore need to know the simulator model interface specification as contained in Volume 3 of the SMP Handbook. They also need the generic, or simulation-infrastructure-independent software implementing the standard and the corresponding User Manual (Volume 2 of the SMP Handbook). They then have to develop the infrastructure-dependent software interface for their particular simulation infrastructure.
- Simulator developers, or model integrators, who have to build a simulator, and who need to know the interface specification (Volume 3 of the SMP Handbook) and the SMP Software User Manual (Volume 2 of the SMP Handbook).

Figure 1. Architecture of an SMP-compliant simulator

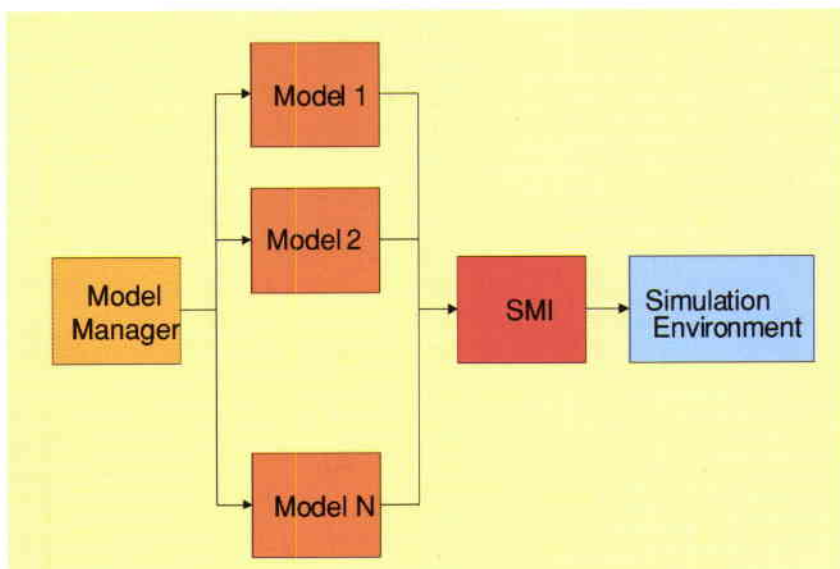

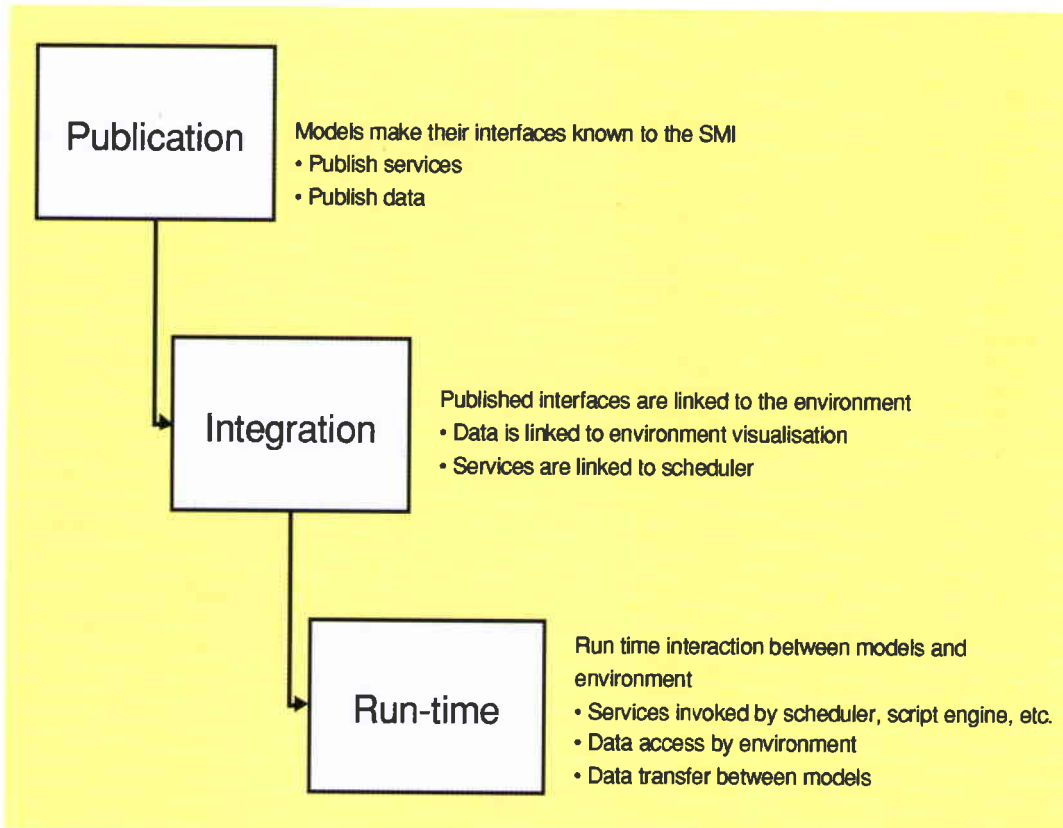

Figure 2. Application of the SMP standard to the different simulation phases

All of these categories of SMP user need to be familiar with the general concepts (Volume 1 of the SMP Handbook).

Technical details

An SMP-based simulation system

A typical SMP-based simulator will consist of four components, as illustrated in Figure 1 (the 'simulation environment' is equivalent to the simulation 'infrastructure' or 'tool').

1. Models

The models are the functional representation of the various physical elements being simulated, e.g. satellite dynamic model, spacecraft subsystem model, position and environment model, thermal model, ground equipment model, etc.

2. Model Manager

The Model Manager is implemented by the simulator developer. It links together all of the individual model components. The Model Manager's task is to manage the initialisation of the models, to establish the connections between the models and the environment, and to control the interactions between models. The general purpose of the Model Manager is generic, and it is therefore identified here as a component of the overall SMP system.

3. SMI Software

The SMI software component acts as the interface between the models and the simulation environment. It provides a set of

standardised services that the models use to interact with the simulation environment. These standard interfaces are referred to as the Simulation Model Interface, or SMI.

4. Simulation Environment.

The Simulation environment provides the typical simulation support functions that apply to any spacecraft simulator, including:

- time-keeping (event handling, scheduling, etc.)
- public-data handling
- public-data visualisation (alphanumeric displays, graphs, etc.)
- simulator commanding

Figure 3. Interaction between simulation models and simulation infrastructure through the Simulation Model Interface (SMI)

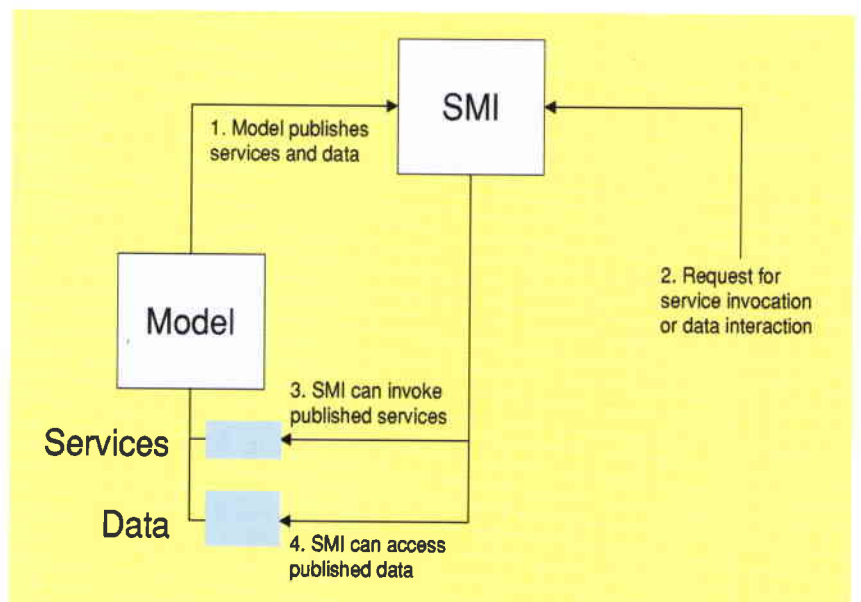
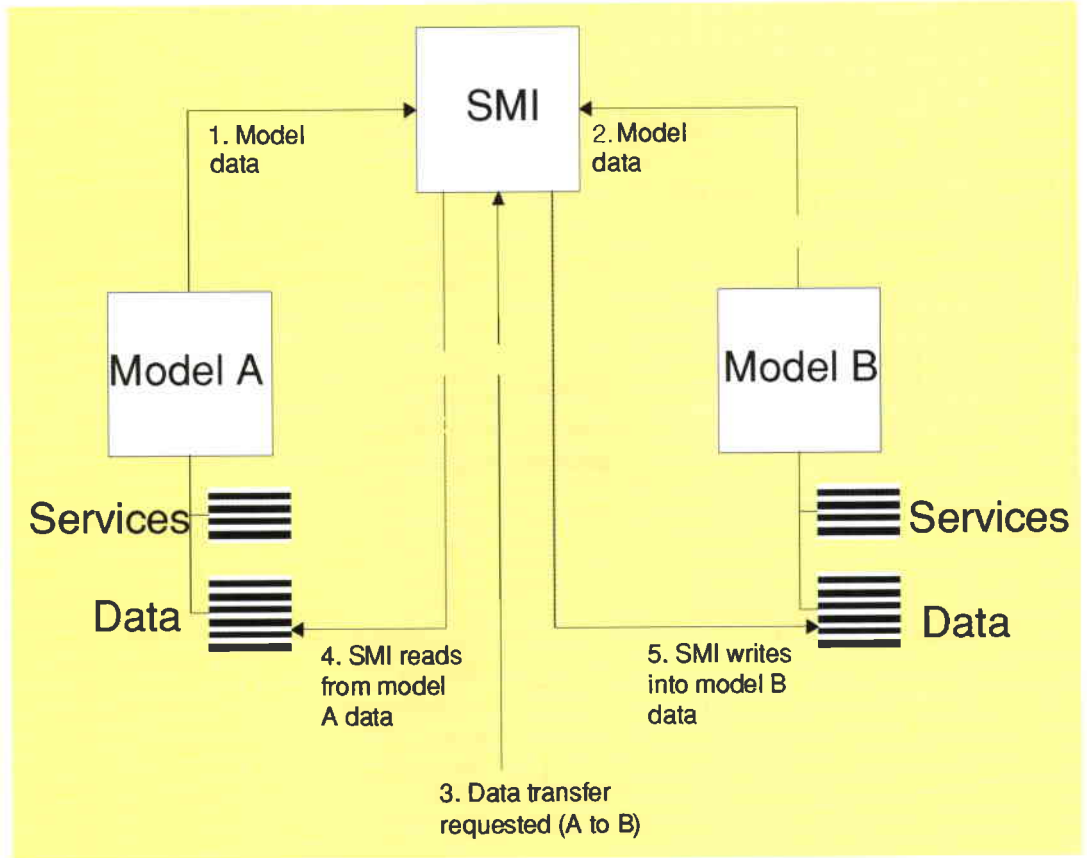

Figure 4. Data transfer from one model to another via the Simulation Model Interface (SMI)



- saving/restoring of break points or simulator states.

Simulation operational phases

The three operational phases for a typical SMP-compliant simulation system are shown in Figure 2:

- **Publication phase:** making the SMP system component interfaces known using the publishing services of the SMI. The Model Manager 'publishes' the individual models that are in the simulation system, and then 'calls' each of the published models so that it can publish its own internal services and data (Fig. 3).
- **Integration phase:** integrating all of the services and data that have been published into the environment. The Model Manager uses the SMI environment services to add published services to the environment schedule, so that they are invoked in the run-time phase.
- **Run-time phase:** executing the models in a simulation. In this phase, models can use the SMI services to write log messages and get simulation time. The Model Manager can also use SMI data-transfer services to move data from one model to another (Fig. 4).

Current and future work

The SMP standard specification has achieved a stable status and has been frozen. A Configuration Control Board (SMP CCB) has

been established, under ESA co-ordination and involving industrial simulation infrastructure vendors, to decide upon future upgrades to the specification. Any company is invited to join either as a full member, if committed to compliance with the standards, or as an observer. The implementation of upgrades to the specification and to the associated software, including corrective maintenance of that software, is managed by ESA.

In parallel with the development of the specification, a validation exercise involving the simulation infrastructures SIMSAT and EUROSIM has been carried out. SIMSAT is ESA's simulation infrastructure for the development of simulators to support operations preparation. EUROSIM is a commercial-off-the-shelf real-time simulation infrastructure used in a number of ESA projects. The resulting demonstration systems are available as examples.

Other companies involved in simulation infrastructures, either vendors or satellite prime contractors who have participated in the settingup of the SMP requirements, are planning to make their infrastructures compliant with the SMP standard specification.

Support to industry willing to adopt this standard is provided, inter alia, by means of a Web site (<http://www.estec.esa.nl/smp/>) from which it is possible to download the SMP

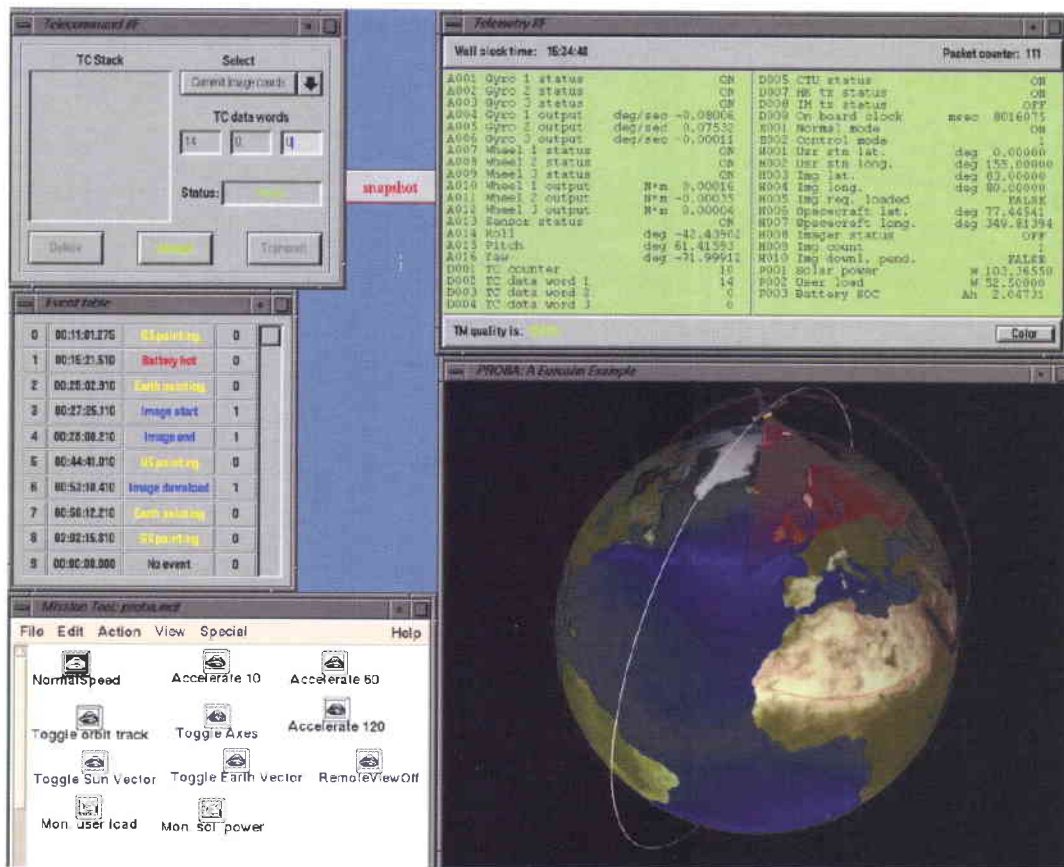

Figure 5. A screen from the Project Test Bed simulator for the PROBA satellite, showing the telemetry and telecommand windows, the onboard event table, a three-dimensional view of the satellite orbiting the Earth, and the mission-tool panel

Handbook, the generic SMP software, as well as the associated examples and test suites. From this Web site, the user can subscribe to a list server and become part of the discussion forum. The Agendas and Minutes of the Configuration Control Board meetings will also be accessible from this Web site, as well as any related papers and publications.

The SMP standard is already being applied:

- at the European Space Operations Centre (ESOC), where new simulators are based on SIMSAT-NT, the new version of SIMSAT, compliant with the SMP standard. The first satellite simulators to follow these standards will be those for ESA's Rosetta and Mars Express missions
- in the Galileo Programme (devoted to the development of the European satellite navigation infrastructure), which has chosen to apply the SMP standard in the development of the GalileoSat System Simulation Facility (GSSF)
- in the Project Test Bed, a satellite simulation test-bed available at ESTEC to support early project phases. Based on EUROSIM, it has been upgraded to the SMP standard (Fig. 5).

It is envisaged to formalise the SMP standard specification by submitting it to the European Co-operation for Space Standardization (ECSS) organisation for formal review and, hopefully, adoption as an ECSS standard.

To further promote the reuse of simulation models, it is foreseen to establish a model repository for verified models that conform to the SMP standard, thereby facilitating their integration into any SMP-compliant simulation platform. The SMP model document template will define a standard format that will provide the minimum necessary information to the users of the repository regarding the adequacy of the model for the intended purpose.

Conclusions

The SMP standard specification is increasingly being made applicable to ESA projects. The main real-time simulation tools used in these projects are becoming compliant with the SMP standard specification, which should soon be raised to a formal ECSS standard.

ESA is supplying a software implementation of the SMP standard specification to facilitate its adoption by simulation-tool vendors as well as model developers. A Web site set up for this purpose allows the necessary documentation and software to be easily downloaded from <http://www.estec.esa.nl/smp/>.

Further work is required to promote the reuse of models. A prototype of the model repository needed to facilitate access to well-documented and validated models is foreseen within the framework of the ESA R&D programme.

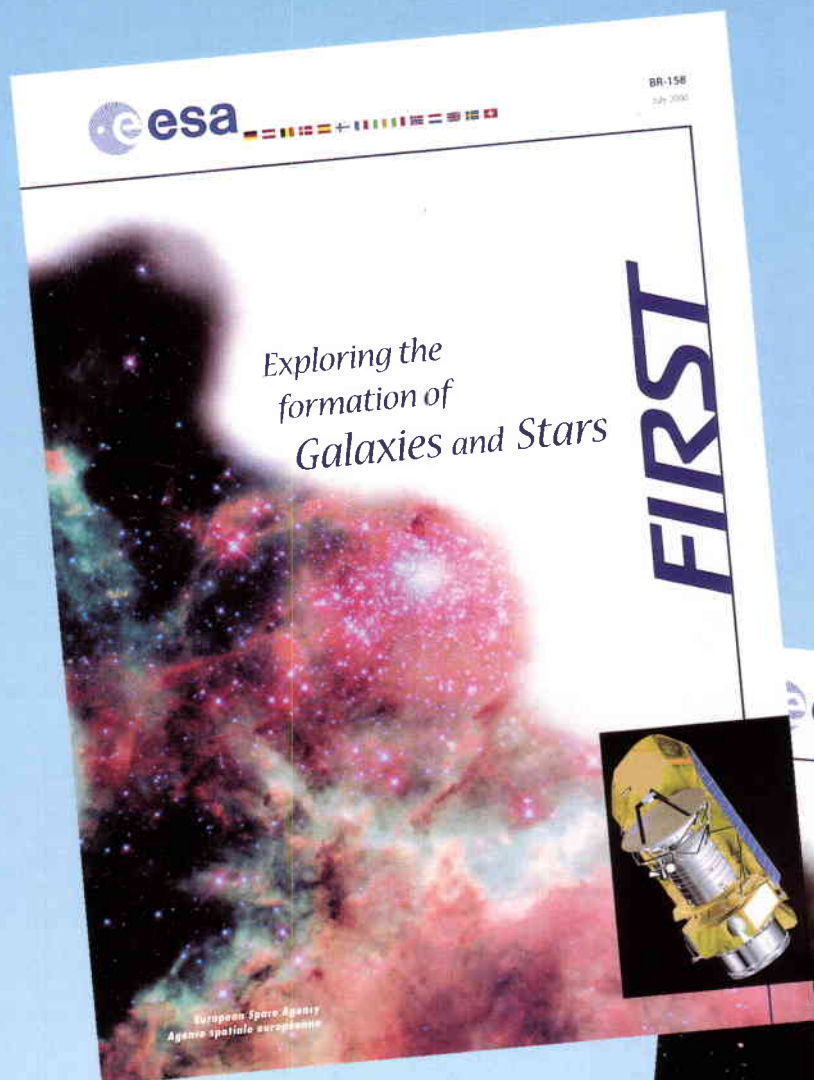

Price: 15 Dfl/7 Euros

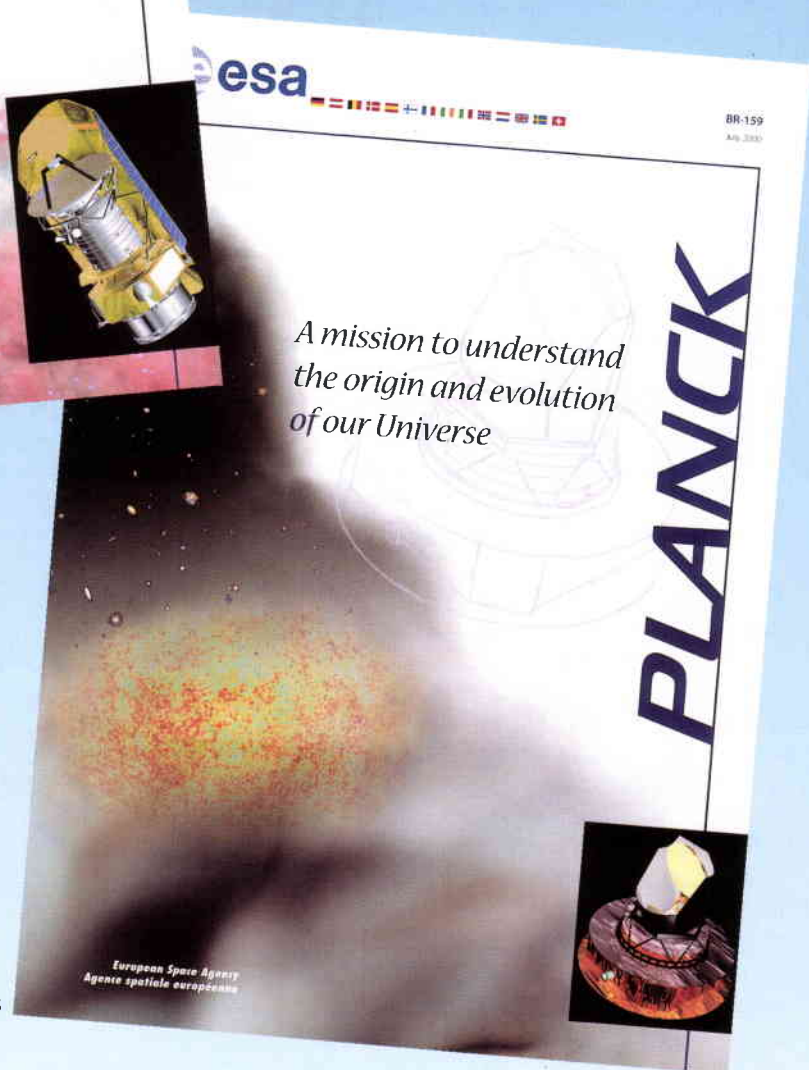

Price: 15 Dfl/7 Euros

Contact: *ESA Publications Division*
c/o ESTEC, PO Box 299, 2200 AG Noordwijk, The Netherlands
Tel. (31) 71 565 3405 - Fax (31) 71 565 5433

ORDER FORM INSIDE BACK COVER

Programmes under Development and Operations

Programmes en cours de réalisation et d'exploitation

(status end-June 2000)

In Orbit / En orbite

PROJECT		1998	1999	2000	2001	2002	2003	2004	COMMENTS	
		JFMAMJJASON	DJFMAMJJASON	DJFMAMJJASON	DJFMAMJJASON	DJFMAMJJASON	DJFMAMJJASON	DJFMAMJJASON		
SCIENCE PROGRAMME	SPACE TELESCOPE	[Green bar from Jan 1998 to Dec 1999]								LAUNCHED APRIL 1990
	ULYSSES	[Green bar from Jan 1998 to Dec 1999]								LAUNCHED OCTOBER 1990
	SOHO	[Green bar from Jan 1998 to Dec 1999]								LAUNCHED DECEMBER 1995
	HUYGENS	[Green bar from Jan 1998 to Dec 1999]								LAUNCHED OCTOBER 1997
	XMM-NEWTON	[Green bar from Jan 1998 to Dec 1999]								LAUNCHED DECEMBER 1999
APPLICATIONS PROGRAMME	MARECS-B2	[Green bar from Jan 1998 to Dec 1999]								POSSIBLE NEW LEASE
	METEOSAT-5 (MOP-2)	[Green bar from Jan 1998 to Dec 1999]								OPERATED BY EUMETSAT
	METEOSAT-6 (MOP-3)	[Green bar from Jan 1998 to Dec 1999]								OPERATED BY EUMETSAT
	METEOSAT-7 (MTP)	[Green bar from Jan 1998 to Dec 1999]								OPERATED BY EUMETSAT
	ERS - 1	[Green bar from Jan 1998 to Dec 1999]								MISSION ENDED MARCH 2000
	ERS - 2	[Green bar from Jan 1998 to Dec 1999]								LAUNCHED APRIL 1995
	ECS - 4	[Green bar from Jan 1998 to Dec 1999]								OPERATED FOR EUTELSAT
	ECS - 5	[Green bar from Jan 1998 to Dec 1999]								MISSION ENDED MAY 2000

Under Development / En cours de réalisation

PROJECT		1998	1999	2000	2001	2002	2003	2004	COMMENTS	
		JFMAMJJASON	DJFMAMJJASON	DJFMAMJJASON	DJFMAMJJASON	DJFMAMJJASON	DJFMAMJJASON	DJFMAMJJASON		
SCIENTIFIC PROGRAMME	CLUSTER-II	[Green bar from Jan 1998 to Dec 1999]								RE-LAUNCHED MID 2000
	INTEGRAL	[Green bar from Jan 1998 to Dec 1999]								LAUNCH APRIL 2002
	ROSETTA	[Green bar from Jan 1998 to Dec 1999]								LAUNCH JANUARY 2003
	MARS EXPRESS	[Green bar from Jan 1998 to Dec 1999]								LAUNCH JUNE 2003
	SMART-1	[Green bar from Jan 1998 to Dec 1999]								LAUNCH LATE 2002
COMMS / NAV. PROG.	FIRST/PLANCK	[Green bar from Jan 1998 to Dec 1999]								LAUNCH FEBRUARY 2007
	ARTEMIS	[Green bar from Jan 1998 to Dec 1999]								LAUNCH DATE TBC
	GNSS-1/EGNOS	[Green bar from Jan 1998 to Dec 1999]								INITIAL OPS. END 2003
EARTH OBSERV. PROGRAMME	GALILEOSAT	[Green bar from Jan 1998 to Dec 1999]								FIRST LAUNCH 2003
	EOPP	[Green bar from Jan 1998 to Dec 1999]								
	EOEP	[Green bar from Jan 1998 to Dec 1999]								INCL. CRYOSAT, SMOS, GOCE
	ENVISAT 1/ POLAR PLATFORM	[Green bar from Jan 1998 to Dec 1999]								LAUNCH JUNE 2001
	METOP-1	[Green bar from Jan 1998 to Dec 1999]								LAUNCH MID-2003
MANNED SPACE & MICROGRAVITY PROGRAMME	MSG-1	[Green bar from Jan 1998 to Dec 1999]								LAUNCH JANUARY 2002
	COLUMBUS	[Green bar from Jan 1998 to Dec 1999]								LAUNCH OCTOBER 2004
	ATV	[Green bar from Jan 1998 to Dec 1999]								LAUNCH JUNE 2004
	X-38	[Green bar from Jan 1998 to Dec 1999]								V201 TEST FLIGHT MARCH 2002
	CRV	[Green bar from Jan 1998 to Dec 1999]								OPERATIONAL 2005
	NODE-2 & -3	[Green bar from Jan 1998 to Dec 1999]								LAUNCHES FEBRUARY 2003 & SEPTEMBER 2004
	CUPOLA	[Green bar from Jan 1998 to Dec 1999]								LAUNCH MAY 2004
	ERA	[Green bar from Jan 1998 to Dec 1999]								LAUNCH JUNE 2002
	DMS (R)	[Green bar from Jan 1998 to Dec 1999]								LAUNCHED 12 JULY 2000
	FREEZER	[Green bar from Jan 1998 to Dec 1999]								LAUNCH AUGUST 2001
LAUNCHER PROGRAMME	GLOVEBOX	[Green bar from Jan 1998 to Dec 1999]								LAUNCH AUGUST 2001
	HEXAPOD	[Green bar from Jan 1998 to Dec 1999]								LAUNCH OCTOBER 2003
	EMIR	[Green bar from Jan 1998 to Dec 1999]								
	MFC	[Green bar from Jan 1998 to Dec 1999]								BIO, FSL, EPM in COLUMBUS
	ARIANE-5 DEVELOP.	[Green bar from Jan 1998 to Dec 1999]								V504 LAUNCHED DECEMBER 1999
	ARIANE-5 PLUS	[Green bar from Jan 1998 to Dec 1999]								FIRST LAUNCH APRIL 2002
	FESTIP	[Green bar from Jan 1998 to Dec 1999]								REUSABLE LAUNCHER DEFIN.
FTLP	[Green bar from Jan 1998 to Dec 1999]								TECHNOLOGY DEVELOPMENT	

■ DEFINITION PHASE
 ■ MAIN DEVELOPMENT PHASE
 ▲ LAUNCH/READY FOR LAUNCH
■ OPERATIONS
 ■ ADDITIONAL LIFE POSSIBLE
 ▼ RETRIEVAL
 ■ STORAGE

Hubble Space Telescope (HST)

On 24 April, Hubble celebrated its 10th Anniversary in orbit. An ESA Press Conference was organised at the Space Telescope European Co-ordinating Facility (ST-ECF) in Garching (D) on 27 April to mark this milestone. The speakers included C. Nicollier and J.-F. Clervoy, the two ESA astronauts who participated in the last Hubble maintenance mission (SM3-A) in December 1999.

Since that maintenance mission, Hubble has continued to operate nominally. The latest Call for Proposals (Cycle 10) was issued in June and offered as observing instruments the Fine Guidance Sensors (FGS), the ST Imaging Spectrograph (STIS), the Wide Field and Planetary Camera 2 (WFPC2), the Advanced Camera for Surveys (ACS) and the Near-Infrared Camera and the Multi-Object Spectrograph (NICMOS) refurbished with a cryo-cooler. The last two Instruments were announced in anticipation of their installation and refurbishment during the next servicing mission (SM3-B) scheduled for mid-2001.

The ST-ECF is actively participating with the Space Telescope Science Institute (STScI) in the design and implementation of the calibration software and procedures for the 'grism' observing mode of the Advanced Camera for Surveys (ACS).

This activity includes participation in the ground testing and in the data evaluation during the scientific verification of the new instrument.

The improved calibration for the Faint Object Spectrograph (a 'post-operation' HST instrument), which has been developed by the ST-ECF, has been tested and implemented in the HST Archive. ASTROVIRTEL, a project aimed at supporting European Archive research and funded by the European Commission (DGXII), has been initiated and the deadline for the First Call for Proposals was 15 June.

Ulysses

At the beginning of June, Ulysses was at a latitude of 57.5 deg south, 3.4 astronomical units (507 million km) from the Sun. The spacecraft remains in excellent condition as it approaches the start of the next polar pass. Data acquisition has been at a consistently high level, regularly exceeding 98% coverage. The second visit to the Sun's southern polar regions officially commences on 8 September when Ulysses reaches 70° latitude, and will last until 16 January 2001. The most southerly latitude of 80.2° will be attained on 27 November.

Although the nutation-like disturbance that affects the spacecraft as the axial boom

receives progressively more illumination is not expected to appear before early December, preparations for dealing with this operational complication are already underway. These include readying the Kourou ground station that will be required to provide support in February/March 2001. A Mission Implementation Plan addressing these specific ESOC activities has been prepared. Given the useful body of experience gained during the 1994/95 nutation episode, the expectation is that no major problems resulting from nutation will occur, even though the solar forcing will be about 1.5 times stronger than on the last occasion.

Given the outstanding success of the Ulysses mission to date, and the excellent prospects for new and exciting science in the future, it was recently proposed to extend orbital operations for a period of 2.75 years beyond the already approved end-of-mission date of 31 December 2001. This further extension was approved by the ESA Science Programme Committee (SPC) at its meeting on 6 June.

Huygens

The Cassini/Huygens spacecraft entered the asteroid belt in mid-November last year. Distant observations of asteroid 2685 Masursky were carried out by the Orbiter cameras on 23 January. The spacecraft then exited the asteroid belt in mid-April and it is now well on its way towards a

distant encounter with Jupiter in late December 2000. Planning for the six-month long Jupiter observations is well advanced and continuous observation of Jupiter will start in early October.

The fifth Huygens Probe checkout was successfully carried out on 2 February, and all Probe instruments performed as expected. On 3 and 4 February, an in-flight, end-to-end test of the Probe-to-Orbiter radio link was carried out. While the Probe itself remained turned off, a NASA Deep Space

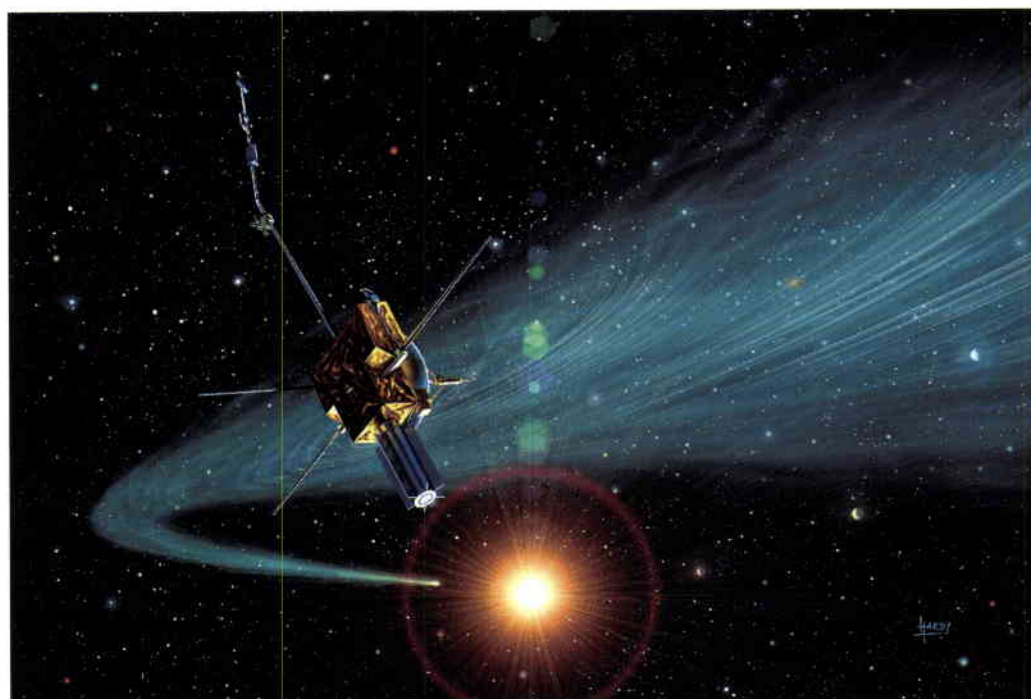

Artist's impression of Ulysses crossing the distant tail of Comet Hyakutake

Network (DSN) station in Goldstone was used to transmit a simulated Probe radio signal to the Huygens Probe Support Equipment on board Cassini via Cassini's High-gain Antenna (HGA). The objectives of the test were to: (i) carry out an in-flight characterisation of Huygens' receiver performance in mission configuration, and (ii) perform a calibration of the Automatic Gain Control (AGC) signal strength, to validate the mission link budget that had been established before launch.

Integral

The spacecraft, launcher and ground-segment activities have continued according to the master schedule agreed at the payload review in April. Launch is planned to take place in April 2002.

The spacecraft Service Module (SVM) flight-model integration is nearing completion. A revised detailed flight-model Assembly, Integration and Testing (AIT) schedule is being finalised to take into account the late payload deliveries.

A Proton launcher Mission Preliminary Design Review (MPDR) was completed in early July.

The second part of System Validation Test (SVT-B) has been successfully completed. The test demonstrated that the satellite Service plus Payload Module configuration functions as planned. SVT-B included the execution of operational scenarios to validate relevant flight procedures. At a later stage, when the payload has been integrated, similar tests will be conducted to ensure that the Mission Operations Centre (MOC) will also be able to control the scientific instruments on board Integral.

The development of the four scientific instruments making up the Integral payload is progressing according to the agreed completion schedule.

Rosetta

The spacecraft engineering (EM) model is currently being integrated at Alenia in Turin (I). The EM structure, which is the structural thermal model (STM) refurbished after its environmental testing, is being



Participants in the Integral Proton launcher Mission Preliminary Design Review

equipped with the various spacecraft subsystems, including power, data handling and attitude control. Five of the ten EM experiments have already been delivered and their integration will begin in late July, by which time the rest of the units will have arrived at Alenia.

All of the actions arising from the spacecraft Hardware Design Review (HDR) in November 1999 have now been closed and the Review has been formally finalised.

Payload development is also proceeding according to plan. After the delivery of the EM units, the experimenter groups have started to work on the flight units. In November 1999, a Review of the Lander identified critical items that were endangering the planned deliveries. A Task Force was set up, which included an augmented group from the Lander management team at DLR (Cologne) and ESA team members. This Task Force has now addressed all of the open areas and at a management meeting at the beginning of July all parties agreed that, although the Lander's development was still a major challenge, the programme was now compatible with the Rosetta system schedule.

Development of the ground segment is still proceeding according to plan.

unveil a face of the Universe that has so far remained hidden, studying how the first galaxies and stars formed and evolved. Other targets will be the clouds of gas and dust where new stars are being born, discs out of which planets may form, and cometary atmospheres packed with complex organic molecules.

FIRST/Planck

ESA's Far-Infrared and Submillimetre Telescope (FIRST) will be the first space observatory to cover the full far-infrared and submillimetre waveband. FIRST will

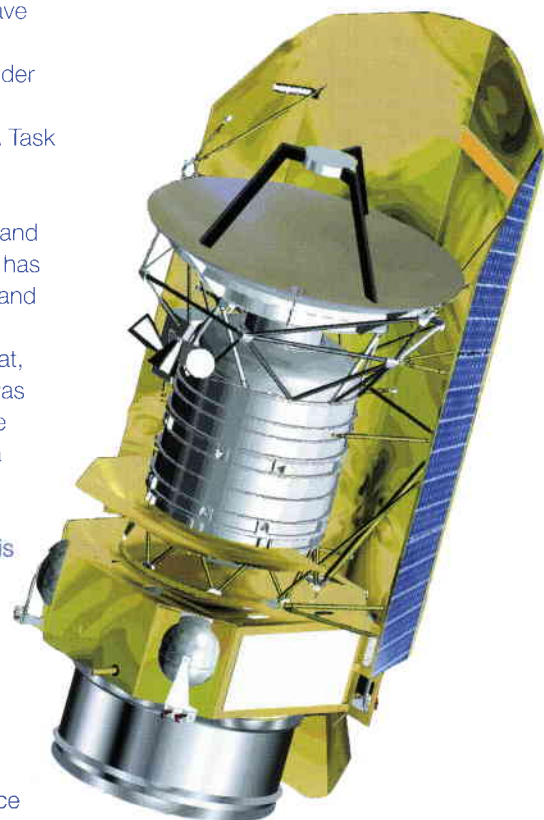

Artist's impression of the FIRST spacecraft

Three instruments will make up FIRST's payload: HIFI (Heterodyne Instrument for FIRST), a high-resolution spectrograph; PACS (Photoconductor Array Camera and Spectrometer); and SPIRE (Spectral and Photometric Imaging Receiver). These instruments, which cover the 60 – 670 micron waveband, will be cooled to temperatures very close to absolute zero. Approximately 9 m high, 4.5 m wide and weighing some 3 tonnes, FIRST will be launched in 2007, together with the Planck spacecraft (see below). The two satellites will separate shortly after launch and will be operated independently thereafter. They will orbit a virtual point in space known as the second Lagrangian point (L2), between the Earth and the Sun, about 1.5 million km from Earth

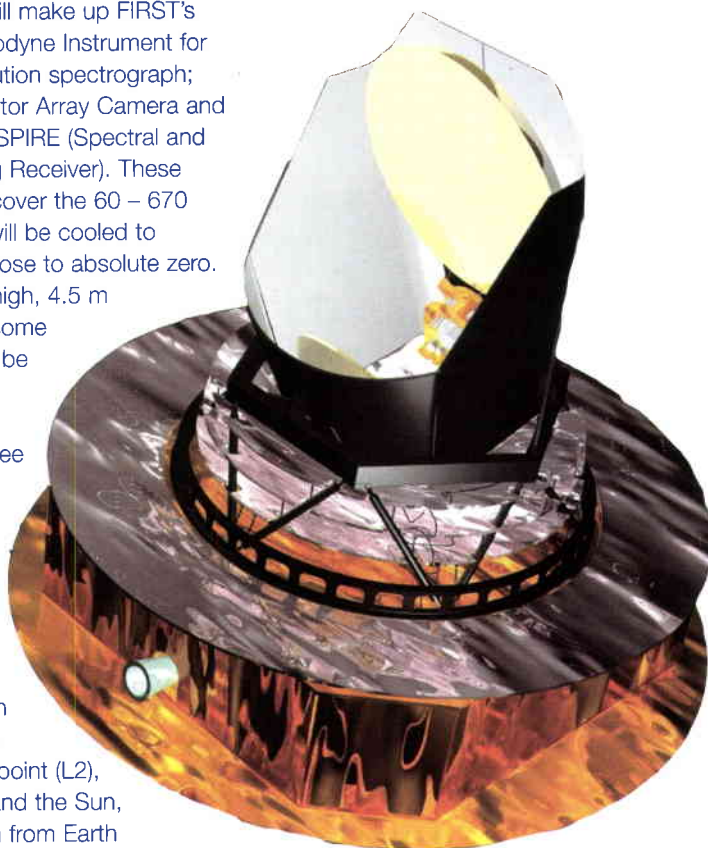

Artist's impression of the Planck spacecraft

The Planck satellite has also been designed to help answer key questions about the Universe for humankind. It will analyse with the highest accuracy ever achieved the first light that filled the Universe after the Big Bang, the so-called 'Cosmic Microwave Background (CMB) radiation'.

Planck's payload will include a 1.5 m telescope that will focus radiation from the sky onto two arrays of highly sensitive radio detectors, the so-called Low-Frequency and High-Frequency Instruments. Together they will measure the temperature of the CMB over the sky, searching for regions that are very slightly warmer or colder than average. More than 40 European and some US scientific institutes will participate in the design and construction of these instruments, which will cover the wavelength range from 1 cm to one-third of a millimetre, i.e. from the microwave to the far-infrared.

The 1.5 tonne, 4 m high and 4.5 m wide spacecraft will rotate slowly in orbit to sweep a large swath of the sky each minute. It will cover the complete sky twice in about 15 months. Operating fully automatically for an expected 15 months of routine operations, it will dump the data that it acquires once per day over a 3 h period.

The industrial Invitation to Tender (ITT) for the FIRST/Planck mission will be issued by the Agency in September 2000. The main development phase (Phase-B) is planned to start in June 2001, with launch of the two spacecraft currently foreseen for February 2007.

EOEP

This is the second quarterly report on the Earth Observation Envelope Programme (EOEP). By the end of the period, the industrial Phase-A studies for the Cryostat mission had been completed and were under review, the industrial offers for the GOCE mission were in evaluation, Phase-A studies for the SMOS were in negotiation, and the Aeolus-ADM instrument pre-development design studies had been initiated. The Call for Ideas for market development had attracted more than eighty proposals, which have been evaluated and a selection made for initiation of this new activity.

EOPP

The Call for Ideas for the next cycle of Earth Explorer Core Missions assessment and study was released to the Earth Observation scientific communities of Europe and Canada at the end of June.

Meanwhile, work has continued on the potential candidate missions remaining from a last cycle. The previous Earth Radiation Mission (ERM) is the subject of joint actions between ESA and NASDA and has been renamed Earth CARE (Clouds, Aerosol and Radiation Experiment).

During the last quarter, considerable effort has also been devoted to Earth Watch activities, following the ERSIS study. A number of preliminary technical actions have been identified.

Meteosat Second Generation

The MSG-1 flight model spacecraft is presently undergoing optical vacuum testing to verify the performances of the cold channels of the SEVIRI instrument. End-to-end spin tests will then follow. The final test programme is presently under review pending the preparation of the MSG-1 flight model for storage, since the October 2000 launch date has been shifted by Eumetsat to January 2002 due to non-availability of its ground segment and the Ariane-4 launcher.

The Flight Acceptance Review (FAR) is maintained for August 2000 as planned, but certain elements of it may be postponed until the spacecraft comes out of storage to avoid the unnecessary repetition of activities.

Analysis of flight data from the Ariane-505 launch in March confirmed predicted shock loads, resulting in the selection of an Ariane-4 launcher for MSG-1. For MSG-2 and MSG-3, a new batch of Ariane-5 launchers with improved shock performance will be available. Due to the non-availability of Ariane-4 at the time of their launch dates, a special qualification programme for these two spacecraft is being planned in order to make them compatible with future Ariane-5 shock loads.

The Eumetsat Council, at its June 2000 meeting, approved the procurement plan for a fourth flight model, MSG-4, and the procurement of the necessary obsolete parts for this model, and two potential further models, MSG-5 and MSG-6.

Metop

Integration of the engineering model of the Payload Module is now in full swing, with the avionics already fully integrated and the first instruments being assembled and tested. Notably, the Data Collection System and the Search and Rescue panels have completed their panel-level integration at Alenia Aerospazio in Rome (I), and will be the next items for integration at Astrium in Friedrichshafen (D).

A solution to the HIRS synchronisation problem has been found, requiring only a minor modification to the instrument, which - once verified by the instrument supplier - will allow resolution of this issue.

A significant change to the Metop baseline is being prepared following the Eumetsat Council's approval of the start of the procurement of Soyuz-ST launch vehicles from Starsem, in place of the currently baselined Ariane-5. Work now has to start in Industry to provide a detailed confirmation of the initial assessment regarding the compatibility of this launch vehicle, and to prepare all necessary changes to the programme.

Work continues with Industry to reassess and optimise the development programme and logic, especially for the first flight model, in view of the actually anticipated customer furnished instrument delivery dates.

Envisat

System

The system activities have been focussing on:

- supporting the satellite system tests
- performing the Ground Segment Overall Verification (GSOV) tests to verify interface compatibility between the satellite and the ground segment (PDS and FOS)
- progressing the in-orbit commissioning preparations with the payload calibration and validation teams.

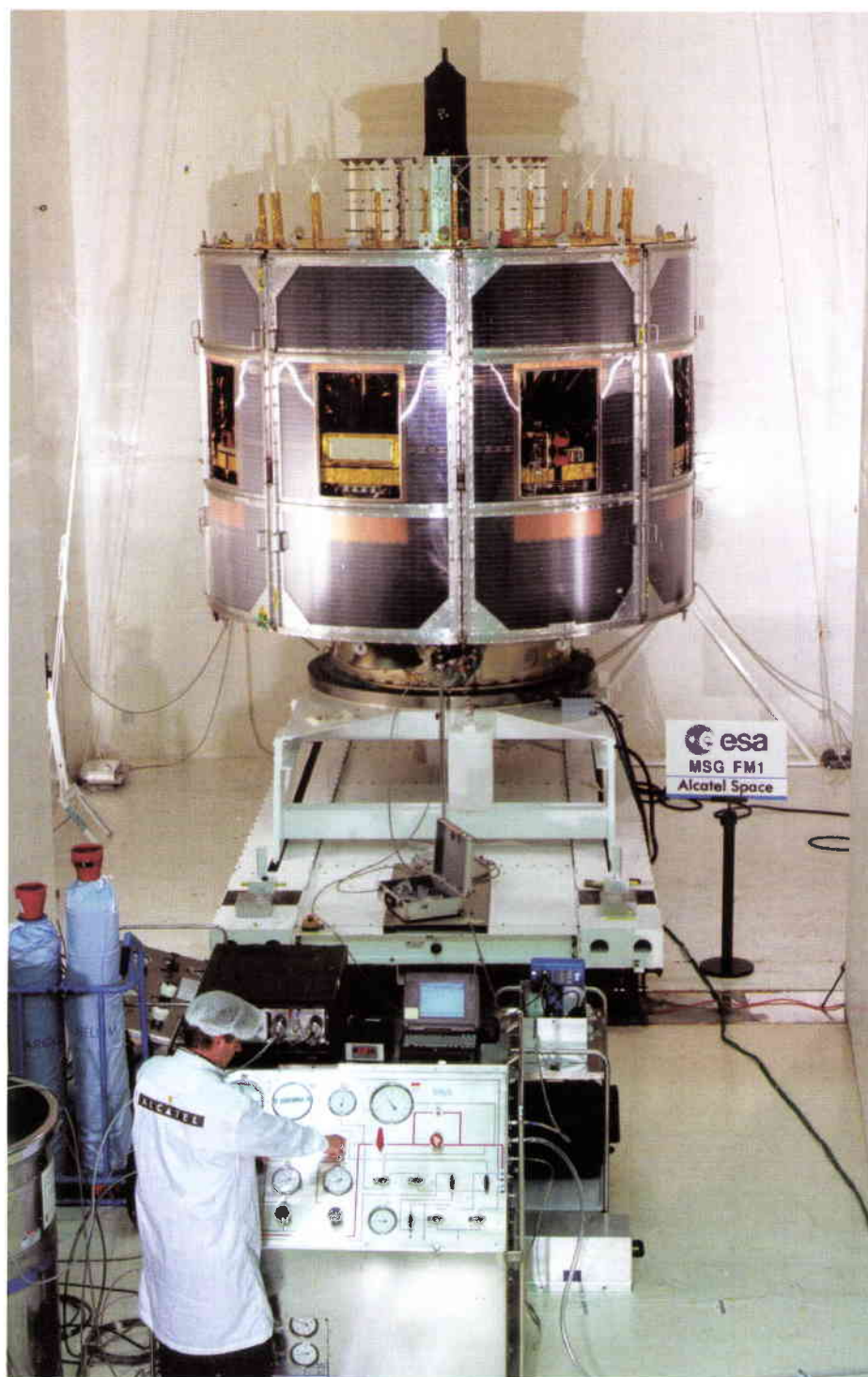

Satellite and payload

Two thirds of the satellite system tests have been performed during the second quarter of 2000. The remaining tests, requiring an updated version of the Payload Module Computer (PMC) software, will be performed during the fourth quarter of the year.

The solar array is currently being installed on the satellite to make it complete and ready for the acoustic and mechanical tests planned to be performed in the LEAF and on the HYDRA facilities, respectively, at ESTEC during the third quarter of 2000.

The MSG flight model under test at Alcatel Space (F)

The Radio Frequency Compatibility (RFC) test, planned for this autumn, will be the last opportunity for deploying the ASAR antenna and completing its radiating panel (14 of the 20 tiles are currently installed). The EMC and RFC tests will be performed within a special large RFC enclosure to be assembled in the HYDRA test hall during the summer.

The satellite Assembly, Integration and Test (AIT) schedule is being regularly scrutinised and the necessary work-around solutions introduced to ensure its continued compatibility with the target launch date of end-June 2001.

Ground segment

The Flight Operations Segment (FOS) has successfully driven phase-1 of the Satellite Verification Tests (SVT-2), executed as part of the satellite system tests. SVT-2 is a key test for demonstrating compatibility between the satellite and the Flight Operations Control System implemented at ESOC in Darmstadt (D). Phase-2 of this test will be executed with the updated PMC software version available in the fourth quarter of this year.

The Payload Data Segment (PDS) Version 2, accepted during the first quarter, has been used to start training operators. The PDS version V3 is currently being implemented and an integration/validation logic has been defined to ensure timely availability of this PDS upgrade.

The Processing and Archiving Centre (PAC) implementation activities are in progress. Discussions have been held and agreement reached with the PAC providers to ensure that they will benefit from the PDS V3 improvements when procuring the PDS generic elements.

Following evaluation of the offers received in response to the Invitation to Tender (ITT), two commercial distributors which are already charged with distributing ERS products have been selected.

International Space Station

European participation in the ISS Exploitation Programme

The Executive's procurement proposal for the Exploitation Phase Operations Contract was unanimously approved at the June meeting of ESA's Industrial Policy Committee (IPC). A Preliminary Authorisation to Proceed (PATP) has been prepared and released to Industry. This PATP constitutes the framework within which the Preparatory Phase Activities will be conducted. A Statement of Work for the Operations Preparation Detailed Definition Phase has been prepared and will shortly be released to Industry.

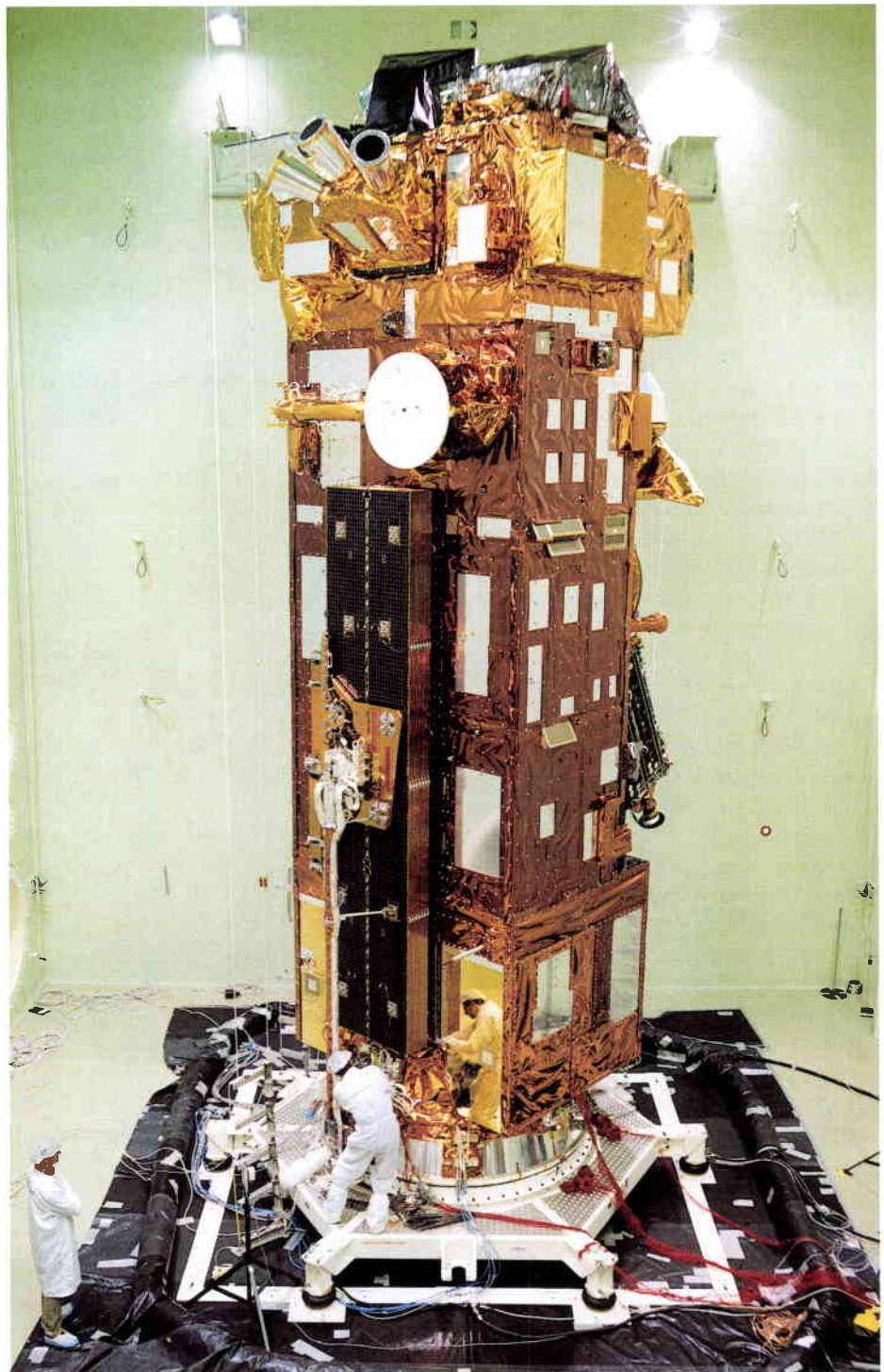

Envisat under test in the LEAF facility at ESTEC (NL)

The Executive has launched Calls for Interest to companies and other entities interested in participating in an organisation to develop commercial utilisation of the ISS. Two separate Calls for Interest have been released, one for Research and Technology Development and the other for Innovative Markets. In connection with the release of the Calls for Interest, an ISS Information Day was held at ESTEC (NL) for potential business developers on 16 June.

A Pathfinder project on global branding/sponsoring has been started.

Further Pathfinder projects are being prepared

ISS Overall Assembly Sequence

A first draft of the ISS Assembly Sequence (Revision-F) was issued by NASA in May for review and comment by the International Partners. This first draft, which retained the Columbus launch date in October 2004, was generally

satisfactory to ESA. However, a second draft was released in late June, in which the total number of Shuttle flights per year was reduced from 8-9 to 7-8, as a consequence of which the proposed launch date for Columbus was shifted to May 2005. ESA rejected this further slippage in launch date and is currently working with NASA to restore the October 2004 date, for which a number of options have been identified. NASA currently proposes to baseline Revision-F at the next Space Station Control Board meeting on 26 July.

A General Designers' Review was held in Moscow on 26 June, during which the readiness of the Service Module, Mission Control, and the launch site to enter final launch preparation was reviewed in detail. No problems were identified, and the Service Module was cleared to enter the final phase of launch preparation, with a target launch window of 12/14 July, subject to the successful launch of the second Phase-2 modified Proton on 5 July.

Columbus laboratory

Significant potential delays in the flight-unit integration schedule are arising from quality problems associated with fibre-optic cables (this is an ISS-wide problem, not Columbus unique). Otherwise, on the flight unit, the acceptance pressure testing (proof tests and leakage tests) of the primary structure is complete, and integration is underway to complete the modal-survey configuration. The results of

the neutral-buoyancy tests at NASA are being incorporated. Testing on the electrical test model is proceeding, with the manually commanded data-management, electrical-power-distribution and video functions all having been completed. The Data Management Subsystem Critical Design Review (CDR) has been successfully conducted, and the PICA CDR closeout review is underway. Preparations are well ahead for the Columbus System CDR later this year.

Columbus Launch Barter Nodes-2 and -3

Negotiations with NASA have been completed to incorporate the effects of the many NASA-driven design changes into a revision of the Columbus Launch Barter. The corresponding effects on the industrial return are also being evaluated. The schedule for the Node-2 delivery meets the revised Assembly Sequence need dates, but NASA now plans to have Node-2 spend 20 months at Kennedy Space Center for various tests prior to launch, making it schedule-critical for all subsequent launches (which include Columbus and the JEM). Node-3 is not at all critical.

Cryogenic Freezer Racks

The negotiation of NASA requirements was successfully completed at an ESA/NASA meeting in June. The Invitation to Tender (ITT) for Phase-B/C/D was also sent out in June. The deadline for proposal submission by Industry is September 2000.

Cupola

The dome and ring forging are now in final machining and will be delivered to the Prime Contractor this summer. Following the Design Consolidation Review in the spring, the two major areas of concern have been addressed. That relating to thermal robustness during launch-to-activation and during Cupola in-orbit transfer from one location to another has been satisfactorily resolved. The change from one-crew to two-crew member EVAs is, however, still being resolved to determine solutions with the least impact. The internal layout/secondary structure design concept has now been established and detailed design has begun.

Automated Transfer Vehicle (ATV)

The ATV Preliminary Design Review (PDR) took place as planned in Les Mureaux (F), from 15 to 26 May 2000. The PDR Pre-Board met on 29/30 May and concluded that a number of key issues need further consolidation prior to the PDR Board meeting, which has now been rescheduled for end-October. As a consequence of this delay, launch of the first ATV is now expected to take place in mid-2004.

Clarification has been obtained regarding the complementary development tasks to be performed in support of ATV as part of the Ariane-5 Plus programme.

A contract with Arianespace for nine launches was signed on 7 June in Berlin. This is the largest contract ever signed by Arianespace at one time with a single customer.

X-38/CRV and Applied Re-entry Technology (ART)

X-38 deliveries and activities continue, although some delays have occurred. Programmatic adjustments have been made to keep the project within its allocated budget. The next series of drop tests, this time of the updated aerodynamic shape corresponding to that of the operational Crew Return Vehicle (CRV), are in preparation. NASA has delivered the V131R test vehicle to Dryden Air Force Base.



Participants in the ISS Information Day at ESTEC (NL) on 16 June

Following the evaluation of industrial cost estimates for the ESA CRV items, a re-evaluation of the project's scope and contributions has been conducted. Further negotiations with NASA have taken place re the potential barter for CRV and good progress has been made. The NASA Phase-1 start up has been delayed until the end of the year, and the corresponding ESA Request for Quotation (RFQ) is also on hold pending confirmation of the new subscription levels. Selected early ESA CRV activity tasks have nevertheless been initiated, principally in the areas of aero/thermodynamics, avionic analyses and man/machine interface display requirements and developments.

Ground-segment development and operations preparation

The kick-off meeting for the Columbus Control Centre Phase-B2 Extension was held on 28 June. The ATV Control Centre activities have been expanded to address specifically the task sharing between the Control Centre and the flight vehicle, as recommended in the ATV Preliminary Design Review. Competitive Phase-B studies have been kicked-off for the ATV Crew Trainer. In addition, initial discussions with Russia have taken place to determine their ATV training obligations stipulated by the ATV Integration Contract. Development of the ATV cargo-integration software tools has been initiated.

Utilisation

Promotion

The European Utilisation Board (EUB) meeting in May was primarily devoted to presentations by EUB members on national and ESA user programmes for ISS utilisation preparation. The 50th meeting of the Space Station User Panel (SSUP) was held in June with the current members. The next SSUP meeting will have a new Chairman and several new members. The Panel's terms of reference are still being reworked to reflect more applications and commercialisation aspects.

At its June meeting, the ESA Industrial Policy Committee (IPC) endorsed a second group of Microgravity Application Projects (MAPs). A MAP-related project submitted to the European Commission for funding has been approved. By the end of June, there were seven MAP projects for which contracts had been signed, another seven projects that were near kick-off, and nine projects for which

contract preparation was in progress. As of end-June, the total MAP funding amounted to 44 MEuro.

Preparation for commercial utilisation

A Call for Interest to identify companies and entities to set up the commercial business development for ISS was issued in mid-June and replies are due by end-July. These replies will be carefully evaluated and those companies retained will be invited for more detailed discussions with a view of establishing high-level commitments.

Accommodation hardware development

The submission of new conversion proposals from industry covering the main development Phase (Phase-C/D) for the European Drawer Rack (EDR) and the European Stowage Rack (ESR) at reduced cost is expected by end-July. Some interface-related issues still need to be resolved.

Development of the scientific instruments for the SOLAR and EXPORT Coarse Pointing Devices (CPDs) is in progress. Delivery of the flight models is expected by March 2003.

Astronaut activities

The newly established European Astronaut Centre (EAC) Team started its activities on 1 April by integrating the available DLR expertise and training infrastructure. On 21 June, an ESA/CNES Arrangement defining CNES's participation in the EAC Team was signed in Paris. Negotiations concerning the integration of available ASI experts are underway.

On its post-flight tour to Europe, the STS-99/Shuttle Radar Topography Mission crew, which included the European astronaut Gerhard Thiele, met German Chancellor Gerhard Schröder in Berlin and visited EAC in Cologne.

On 17 May, EAC celebrated its 10th Anniversary with an event attended by some 250 guests and international media representatives, as well as all 16 European astronauts. A full article on the event will appear in ESA Bulletin No. 104.

Early deliveries

Data Management System for the Russian Service Module (DMS-R)

Following successful completion of all Service Module integrated system testing at Baikonur, the DMS-R Certificate of

Qualification (COQ) was signed off by RSC-Energia, clearing the DMS-R for launch.

The ESA DMS-R Support Plan for the Service Module launch campaign was also agreed with RSC-Energia in May. Under this Plan, ESA and its Contractor personnel will be located at Baikonur, Mission Control (TsUP), and RSC-Energia throughout the Service Module launch and early in-orbit operations, including ISS docking approximately two weeks after launch.

European Robotic Arm (ERA)

The ERA flight model is now reaching its final stages of assembly prior to commencing its test campaign. The first major tests planned are vibration and EMC testing, both of which are to be carried out at ESTEC (NL). Problems with some parts of the flight model have delayed completion of the integration, however, with the consequence that the previously planned early functional testing has been delayed until after the ESTEC tests. This will delay flight-model delivery until June 2001.

Delivery of the Mission Preparation and Training Equipment (MPTE) is still awaited and is now scheduled for August.

A meeting has been held with NASA on ERA safety issues, with no major problems being identified.

Laboratory Support Equipment (LSE)

In June, the MELFI (Minus Eighty-Degree Laboratory Freezer) Training Unit was delivered to NASA and accepted by ESA and NASA. Qualification testing of all major MELFI subsystems is in progress. Qualification of the electrical subsystem has been completed. System-level testing is now planned to start by end-July.

Manufacture of critical flight-unit parts for the Microgravity Science Glovebox (MSG) and integration of the engineering unit are ongoing. The interface to the International Sub-Rack has been agreed with NASA. The software-interface discussions with NASA (resulting from NASA's request to use the Express Rack protocol) are continuing, but it is still planned to finalise the Software Interface Control Document (ICD) by mid-July.

The data package for the Critical Design Review (CDR) for the Hexapod pointing

system will be completed by end-July. The ISS technical requirements for External Payloads remain unstable and some recently received requirement changes, especially for thermal and contingency power, remain critical. Once the CDR data package has been reviewed, ESA and NASA will recheck the technical requirements for stability.

Microgravity

EMIR programmes

After its installation in Spacehab in mid-November 1999, the MOMO (Morphological Transitions in a Model Substance) facility had to wait for its flight on the STS-101/Spacehab logistics mission to the Zarya/Unity configuration of the ISS until 19 May this year. From the data retrieved from the Digital Tape Recorder (DTR) following the return of MOMO to ESTEC, it became evident that not all data were properly recorded. The available data, including the MOMO housekeeping data, are currently under evaluation.

Without significant improvements, such as replacement of the ageing DTR by a data downlink or a more advanced onboard data-storage device, and the implementation of a telescience capability allowing MOMO to be controlled from the ground, a re-flight is neither recommended nor foreseen.

The 28th ESA parabolic-flight campaign – the fifth with the Airbus A-300 – was conducted successfully from 22 to 26 May, performing a total of 11 experiments. A summary of the campaign activities can be found in the 'In Brief' news section of this Bulletin.

Development activities in preparation for the STS-107 Spacehab flight in 2001 have continued. The ESA facilities scheduled to fly on this mission are Biopack, Biobox, the Facility for Absorption and Surface Tension (FAST) and the Advanced Respiratory Monitoring System (ARMS).

In June, the Microgravity Programme Board approved a complement of experiments for flight with Fluidpac on a Foton mission in 2002 and on the Maxus-5 sounding rocket in 2002. Maxus-4 and Maser-9 are being prepared for flights in 2001.

The Preliminary Design Reviews (PDRs) for EXPOSE and PCDF (Protein Crystallisation Diagnostics Facility) were completed. The development activities for the life-sciences facilities for the International Space Station (MARES, EMCS, Matroshka) are in progress. The Matroshka development contract, with DLR as prime contractor, was kicked-off in May and signed in June.

Microgravity Facilities for Columbus (MFC)

The engineering-model subsystems of Biolab, the Fluid Science Laboratory (FSL) and the Materials Science Laboratory (MSL) in the US Lab have been manufactured and their Critical Design Reviews (CDRs) are nearing completion. Engineering-model integration has been completed for Biolab. A Crew Evaluation Review has also been completed successfully.

The PDRs of the subsystems for the European Physiology Modules (EPMs) have been successfully completed, including the results of breadboarding.

The Agency's Microgravity Programme Board (PB-MG) and Industrial Policy Committee (IPC) have approved the study and design phase (Phase-A/B) for MSL, which is to be performed in co-operation with DLR and Astrium. The Request for Quotation (RFQ) will be sent to industry by the end of September.



Focus Earth

Shallow-Water Hydrography in Portugal Using ERS-SAR Data

J. Robalo

Instituto Hidrográfico, Lisbon, Portugal

J. Lichtenegger

Earth Observation Applications Department, ESA Directorate of Application Programmes, ESRIN, Frascati, Italy

Introduction

The aim of hydrography is basically to chart the underwater topography. A precise knowledge of the sea-bottom features has great relevance mainly in shallow waters, where navigational safety must be assured at any cost. Ideally, one should have available a complete series of maps of the sea-bottom topography.

The capacity of Synthetic Aperture Radar (SAR) to image the sea-bottom topography in shallow waters is now well-known. Nevertheless, the difficulties associated with its quantification in terms of depth determination have in some way prevented the effective use of SAR imagery for bathymetry mapping. This article describes an approach for combining ERS-SAR and limited bathymetric survey data with the use of the Bathymetry Assessment System (BAS), developed by ARGOSS, for sea-bottom mapping in shallow-water areas. It focusses on the extraction of bathymetric information in the Tejo Estuary, in Portugal.

The surveillance of coastal and estuarine waters is an ambitious task. Large river estuaries, such as the Tejo Estuary, cannot be covered with a single hydrographic survey. In addition, some particularly critical areas need more frequent coverage, given that river estuaries are zones where changes are likely to occur frequently due to sediment transportation.

Remote sensing, mainly from space, can play an important role in the characterisation and monitoring of sea-bottom topography in shallow waters. It is now well known that Synthetic Aperture Radar (SAR) systems can, under favourable hydrodynamic and meteorological conditions, reveal patterns associated with bottom features. ESA's ERS remote-sensing satellites have provided SAR data in frames covering an area of

approximately 100 km x 100 km. Although the basic information provided by ERS-SAR is only qualitative, in terms of bright and dark departures from the surrounding mean radar intensity, numerical models have been developed to quantify a SAR image in terms of depths. These models have been incorporated into the Bathymetry Assessment System (BAS), developed in the Netherlands by ARGOSS. BAS calculates the seabed topography based on ERS-SAR images and on a limited set of soundings (Fig. 1).

In the framework of an agreement between ESA and Portugal, a research project has been carried out using ERS-SAR data and the BAS tool to study bathymetric features visible in satellite images of the Tejo Estuary.

Background

In Portugal, the Instituto Hidrográfico (IHPT) is responsible for the production of the Official Nautical Charts (ONC). These charts are used for navigation purposes and cover the entire coast of Portugal on different scales. Harbour areas are shown on the largest scale. Lisbon harbour is covered by four charts on a scale of 1:15 000. This harbour is heavily used due to the highly favourable natural conditions offered by the Tejo Estuary, which covers an area of approximately 210 km². As in most major estuaries, the bottom morphology is subject to continual change. One of the most sensitive areas is the harbour entrance, where a dredged channel must be regularly maintained to ensure safe navigation.

The depth measurements used to produce the ONCs come from different sources, but always relate to the most recent survey performed in

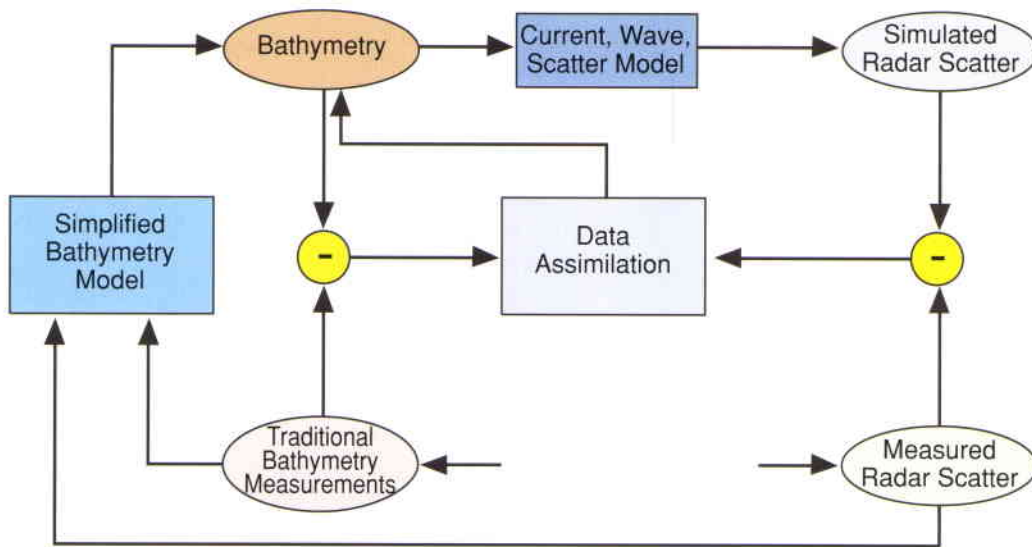

Figure 1. The Bathymetry Assessment System (BAS) is an intelligent interpolator that computes water depths between transects of echo soundings (survey lines) based on the grey-tone variations in Synthetic Aperture Radar (SAR) images. These variations are modelled taking water currents and winds into account also

the respective area. Each ONC has its own compilation history, which influences the level confidence in the information in the chart.

Access to up-to-date bathymetric information would represent a unique opportunity for the verification of existing maps, and would also help in establishing adequate planning of hydrographic surveys.

The opportunity to investigate these issues arose during a one-year traineeship granted by the Portuguese Government and ESA to one of the authors, J. Robalo. As a result, a research project was set up with the aim of demonstrating the potential of ERS-SAR in imaging sea-bottom topography in shallow-water areas. As a case study, the Tejo Estuary area was selected for a preliminary assessment of the feasibility of applying ERS-SAR images and the BAS in order to extract bathymetric information.

Project area and mapping methodology

The project area corresponds to the section of the Tejo Estuary represented in the Portuguese ONC 26306. Using the BAS for bathymetry modelling requires further input. Data have to be collected from different sources and include: ERS-SAR images, soundings, and tidal and meteorological data. Moreover, all data have to be geo-referenced into a unique grid system.

Data

The ERS-SAR Precision Images (PRI) were supplied by ESA. Several were analysed from a set available at ESRIN. It was not possible to make a selection based on the most favourable hydro-meteorological conditions because relevant information in the form of image quick-looks was not available. The two ERS-2 images eventually selected were acquired on 14 June and 23 August 1998 (Figs. 3 and 4).

The location accuracy of the ERS-SAR PRI product is assumed to be 100 m in the range direction and 200 m in azimuth, which was not good enough for the purposes of this project. More precise geo-referencing of the two SAR images was achieved using a set of ground control points (lighthouses, towers, etc.), obtained from IHPT.

The soundings used in the project were digitised from the bathymetric contour lines represented in ONC 26306. Tidal predictions were obtained from IHPT and the Instituto de Meteorologia provided wind information, recorded at Lisbon Airport, close to the Tejo Estuary.

SAR image interpretation

The principles of seabed and current interaction and its manifestation as surface roughness are explained in Figure 2. In the data of 14 June (Fig. 3), the hydrodynamic and meteorological conditions at the time of recording seemed to be more favourable for the imaging of seabed topography. Compared to the acquisition of 23 August (Fig. 4), low-wind (dark) areas are less evident and tidal

Figure 2. The principles of seabed and current interaction and its manifestation as surface roughness. In a SAR image, any changes in this surface roughness are visible as variations in backscatter values and hence as different grey tones

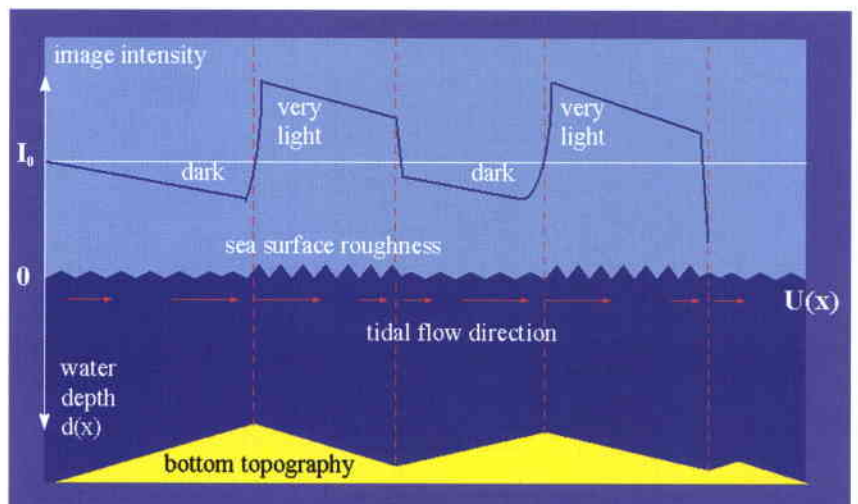

Figure 3. ERS-SAR PRI image of the project area acquired on 14 June 1998, including the mouth of the Tejo Estuary. Sea-bottom-related features can be seen in terms of bright and dark departures from the surrounding mean radar intensity. It is not possible to quantify these patterns directly in terms of depths.

To extract bathymetry information, the Bathymetry Assessment System (BAS) must be used



current seems to be swifter. This is confirmed by a white area near the Vasco da Gama bridge, inside the Estuary. It is the result of a strong interaction between the tidal current (ebb flow) and the bridge pillars, rendering the water surface rougher than elsewhere. On the image of 23 August, this effect is not visible, indicating that the tidal current (flood flow) was weaker.

Bathymetric maps

Two bathymetric maps with a grid resolution of

50 m were generated by the BAS, using a different radar image for each map. These bathymetric maps, based on the ERS-SAR images of 14 June and 23 August, are shown in Figures 5 and 6, respectively. The bathymetry contour lines corresponding to 0, 2, 5, 10, 15 and 20 m as generated by BAS are shown in black. For a visual verification, the digitised contour lines from the ONC are shown in red.

There is a strong similarity between the two maps generated by the BAS. The bathymetry

Figure 4. ERS-SAR PRI image of the project area acquired on 23 August 1998. Sea-bottom-related features can be observed with the same generic pattern as those in Figure 3. Dark patches are related to low-wind areas, but they could also represent tidal flats



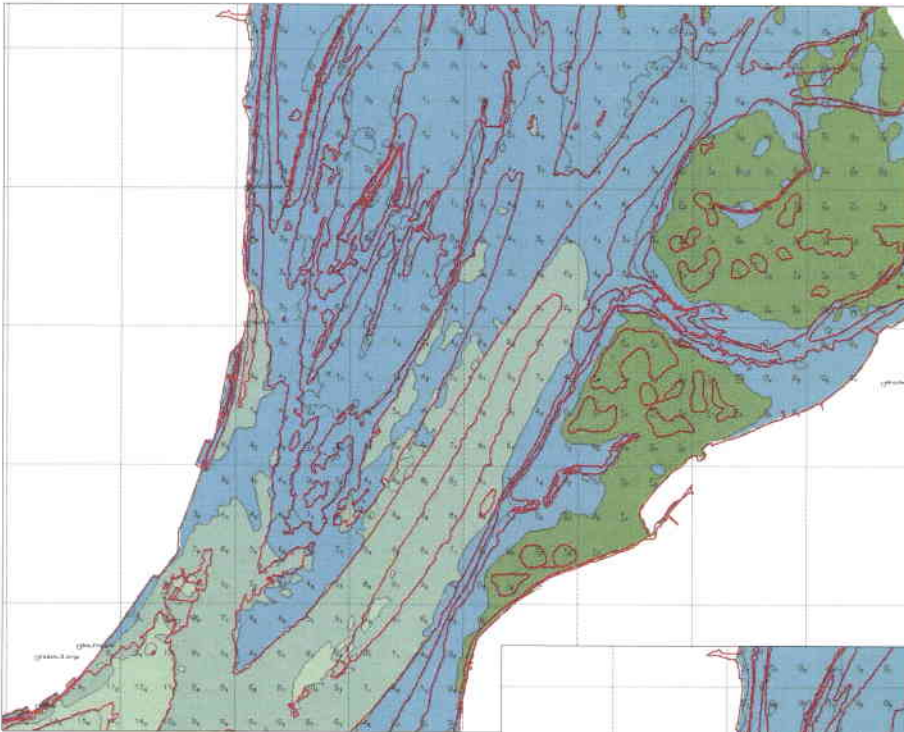

Figure 5. A bathymetric map generated by the BAS, based on the ERS-SAR image of 14 June 1998. Grid resolution is 50 m, and the red lines are contours digitised from the Nautical Chart

contour lines show a similar general pattern in corresponding locations, although many more details are visible in the map based on the 14 June SAR image.

Comparison of BAS map and nautical chart

A visual inspection shows that there is a fair resemblance between the BAS maps and ONC 26306 (black and red contour lines). A statistical analysis indicates that for the 'best' map (based on 14 June image), the difference is less than 85 cm, when applying a confidence level of 95%.

Conclusions

Hydrography can benefit greatly from the use of remote-sensing-based methods. The combined use of ERS-SAR and limited survey data, introduced into the Bathymetry Assessment System, may be very helpful for shallow-water hydrography. Bathymetric maps with a reasonable level of accuracy can be produced, which provide an instantaneous overview of a vast area. The method presented here can be used very successfully for:

- an overall verification of existing nautical charts
- the detection of problem areas with fast-changing bottom morphology, where hydrographic surveys should be carried out more frequently
- improving bathymetry maps of areas where only coarse surveys are performed.

The quality of the information content of the SAR images used is an important factor in determining the accuracy of the depth maps generated by the BAS. Favourable hydro-

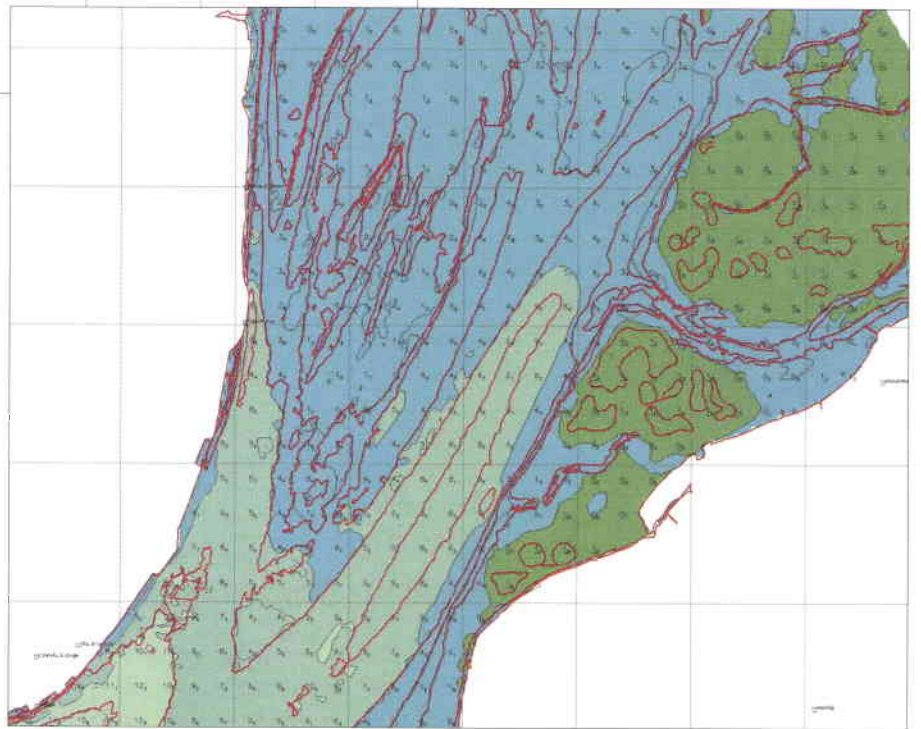

Figure 6. The BAS-generated bathymetric map, based on the ERS-SAR image of 23 August 1998. The calculated bathymetry contour lines agree with those depicted in Figure 5, but much more detail is visible in that map due to the better quality of the feature representation in the SAR image used

meteorological conditions are crucial for sea-bottom imaging by SAR. A wide choice of images acquired under different conditions is therefore required, and the availability of quick-look images is essential for cost-effective selection and would certainly stimulate this type of data application considerably.

Acknowledgment

J. Robalo wishes to thank ESA, and its ESRIN establishment in particular, for providing the facilities and data for his one-year traineeship, granted by the Portuguese Government. He also gratefully acknowledges the technical assistance received at ARGOSS in The Netherlands, during an additional two-week training period there.

In Brief

ESA and the EC Open Joint Galileo Programme Office

On 4 May ESA's Director General Antonio Rodotà and European Commission Vice-President Loyola de Palacio opened the Galileo Programme Office at 24-26 Rue De Mot, in Brussels, Belgium. The new office will coordinate studies already under way and make preparations for decisions by the Board directing the programme, provide technical support to the Board and the industrial and scientific teams working on Galileo, and prepare the way for decisions on the transition to the implementation phase.

At the opening, Antonio Rodotà noted that *"this marks a step forward in one of Europe's most promising new space programmes"*, and Mrs de Palacio added *"the office is the first permanent physical link between the two main European institutions, which are pressing ahead with work on our new satellite-based navigation, positioning and precision timing system, Galileo."*

Less than a year ago, the EU and ESA decided to enter the race to develop the next-generation satellite-based navigation and precision timing system with a European-developed, state-of-the-art design that would set the industry standard for the 21st Century. Galileo's

new technology will revolutionise our transport systems, increasing safety and improving efficiency. This will make for a better quality of life and less pollution in our cities. Galileo will also bring benefits to other aspects of everyday life, with precision farming raising yields, improved information for emergency services speeding up response times, and more reliable and accurate time signals underpinning our most vital computer and communications networks. It could also contribute greatly to the improvement of maritime safety issues.

The definition phase of the Galileo programme is being run by the Commission's Directorate-General for Energy and Transport, with ESA as an equal partner in the joint management Board and playing a full role in technical development. Industry has been pushing ahead with the various studies required for this phase, and user groups have been defining their potential needs, which will eventually determine the system performance requirements. The Galileo Programme Office will now serve as the central source of expertise and permanent point of contact for coordination between the various players and parts of the programme. Inauguration of the Galileo Programme Office is also the first step towards an ESA/EC institutional framework for Galileo.



New Star in Orbit

Assembly of the International Space Station can now continue apace following the successful docking of the Zvezda ('star') Service Module on 26 July. Zvezda is the first fully Russian Station element and is the cornerstone for the early permanent occupation of the complex. As

a result of the new module's arrival, the first long-stay crew is expected aboard by early November. Zvezda's 'brain' is ESA's Data Management System (DMS-R) which, ultimately, will perform overall control of all Russian station elements, and guidance and navigation for the whole Station. Zvezda is also carrying hardware for the first European experiment aboard the Station: the Global Time System will broadcast accurate time and data signals to users on Earth.

Zvezda was launched on 12 July at 04:56 UT from the Baikonur Cosmodrome, Kazakhstan aboard a Proton-K rocket. It was released 580 s later by Proton's third stage into an initial 185x356 km orbit inclined at 51.6° to the equator. For the next 6 min, Zvezda automatically deployed the Kurs rendezvous/docking system and Lira communications system antennas, released the solar wings (which

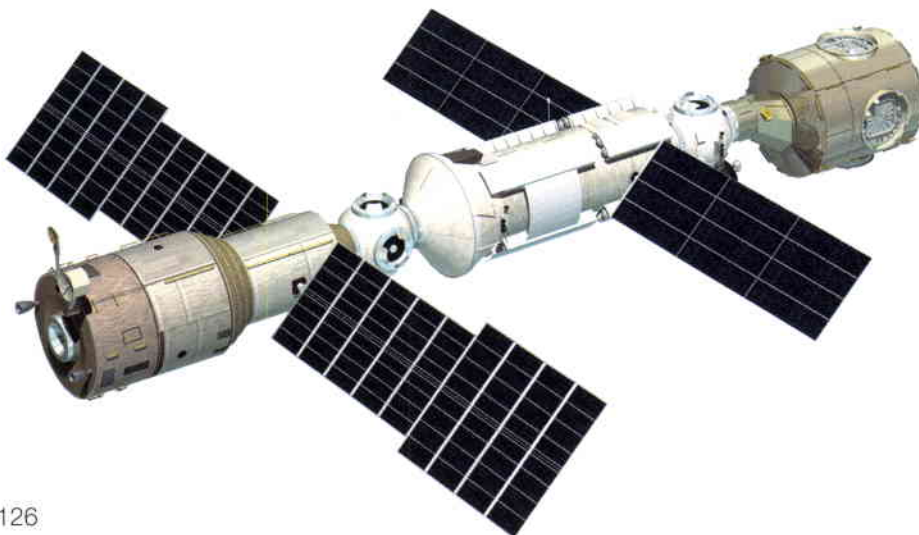

immediately began tracking the Sun) and activated the power, thermal, command & data handling, communications and life support systems.

During Zvezda's first four passes over the Russian ground stations, controllers in the TsUP Mission Control Centre in Korolyov, near Moscow, first verified that all systems were working properly and then oriented the module to minimise propellant usage while allowing the solar arrays to gather sunlight. They reconfigured Zvezda's attitude sensors and activated its star trackers.

Two test-firings of the manoeuvring engines during 13 July showed that Zvezda was ready to begin the long journey to the waiting Zarya/Unity complex in its 376 km orbit. The first two major rendezvous burns using the two 3070 N main engines were made on 14 July. Beginning at 05:09 UT, the orbit was raised to 183x358 km and then, starting at 05:44 UT, to 269x361 km. The firings were so accurate that a correction burn scheduled for 15 July was not required. Attitude control continued to be provided by 16 of the small, 130 N thrusters.

On 17 July, final tests verified the full operation of the software that manages Zvezda's guidance system. Routine cycling of the five batteries began; the final three will be delivered by September's Space Shuttle mission. Zarya on 18 July practised the final two orbits leading up to docking using its Kurs automatic control system. For this final approach, Zarya was the active partner.

Zvezda made its first correction burn on 20 July, firing the two main engines for 15 s to change its orbit to 290x361 km. A day before docking, it manoeuvred to the docking orientation and the solar arrays rotated into their docking attitude. The Kurs rendezvous system was activated on 25 July and, with Zarya in control, the Station caught up with Zvezda. Docking came at about 00:46 UT 26 July. It then took about 25 minutes for the hooks and latches on the two modules to close fully for the hard mating.

Over the next 16-24 hours, mission controllers planned to monitor the air pressure between the modules to ensure an airtight seal, and then began the work to transfer control of most Station functions from Zarya to Zvezda. In



particular, Zvezda assumed responsibility for attitude control and reboost. Soyuz, Progress and ESA's Automated Transfer Vehicle will dock with its aft port. Many of the systems aboard Zarya are deactivated and this first module now provides primarily propellant storage and equipment stowage.

What happens next? Zvezda's success means there will be a rapid sequence of missions in the near future. The first supply ferry, Progress-M1-3, was launched on 6 August from Baikonur, docking with Zvezda 2 days later. Shuttle mission STS-106/2A.2b will dock with Unity in September to continue preparations for the first permanent crew. They will also unload the Progress. STS-92/3A in October will deliver the first Truss section (Z1), four Control Moment Gyros and a second conical docking adapter. The first dedicated Station crew of William Shepherd (Expedition Commander), Yuri Gidzenko (Soyuz Commander) and Sergei Krikalev (Flight Engineer) will appear aboard the Station's first Soyuz in early November. This

'Expedition-1' crew will stay aboard for about 4 months, activating Station systems and the first experiments, and making the first spacewalks from Zvezda's forward airlock. STS-97/4A in November will add the first pair of giant solar arrays, paving the way for STS-98/5A in January 2001 to attach the first science module: Destiny. STS-102/5A.1 in February 2001 will carry Europe's Multi Purpose Logistics Module with supplies and experiment racks for Destiny. The Expedition-1 crew will return to Earth aboard that Shuttle, swapping with the Expedition-2 crew of Yuri Usachev, Susan Helms and Jim Voss. The Soyuz craft will remain attached to the Station as a lifeboat.



Zvezda launch: TV coverage from the Erasmus User Centre at ESTEC (NL)

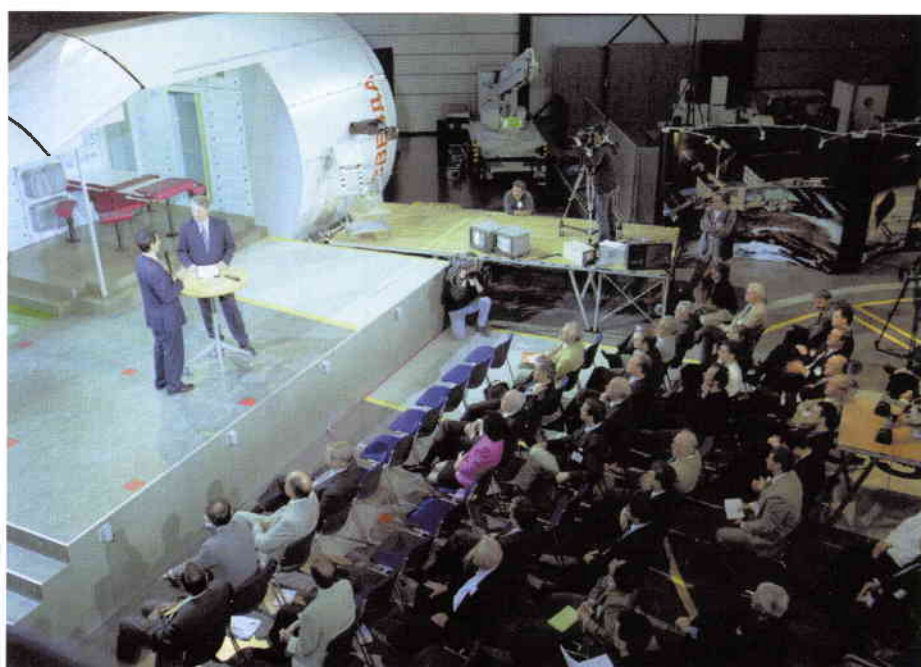

ECS-5 Decommissioned after 12 years of Service

After almost 12 years of successful ECS-5 operations, Eutelsat, the satellite's operator, has decided to retire it. ESA, which was responsible for the satellite's procurement and subsequent in-orbit control therefore initiated end-of-life testing, decommissioning and re-orbiting activities to put ECS-5 into a 'graveyard orbit' at least 150 km above geostationary altitude, thus removing any risk of contributing to debris in this valuable orbit.

The ECS series of spacecraft was the operational successor to ESA's very successful Orbital Test Satellite (OTS) programme of the 1970s. Designed to promote pan-European telecommunications traffic, the four ECS spacecraft (a fifth one was lost because of a launcher failure) have provided services in digital telephony, international television distribution, cable television, trunk telephony, Eurovision transmissions and mobile services. Some of these services have even extended beyond Europe. All four spacecraft have far exceeded their design requirements, in particular their 7-year design lifetime, together accumulating almost 3 million channel-hours of payload operation.

ECS-1 and ECS-2 had already been decommissioned following more than 13 and 9 years of successful operation, respectively. The remaining spacecraft, ECS-4, continues in operation after 12.5 years in orbit and is expected to remain in use for some time to come.

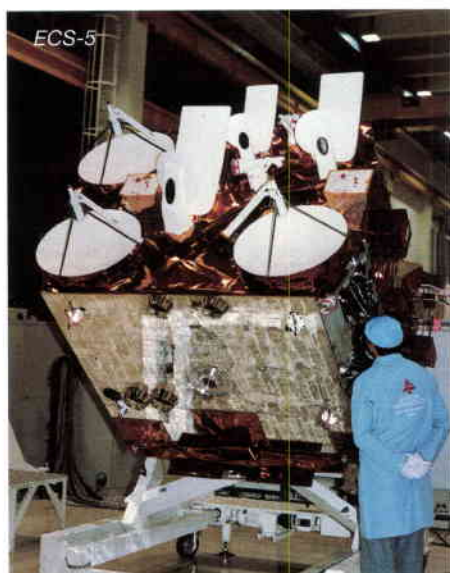

Envisat at ILA 2000

ESA at ILA 2000 in Berlin

The International Aerospace Exhibition ILA 2000 took place at Schönefeld airport in Berlin from 6 to 12 June. As in recent years, ESA, the German space agency DLR, and German aerospace industry shared a pavilion under the motto 'The Space Experience'.

Visitors were attracted to the pavilion with a full-size model of ESA's future Envisat Earth-observation satellite, scheduled for launch next year on an Ariane-5 launcher. Inside the 'Space Experience', the flight unit of ESA's Atmospheric Re-entry Demonstrator was on show. This was the actual capsule carried aloft in 1998 on the second Ariane-5 launch and retrieved after a perfect flight and splash-down. Also on show was a model of the X-38 rescue vehicle, which will be the 'lifeboat' for astronauts living and working on the International Space Station (ISS), and a 1:20 model of the Space Station itself. The exhibition also included models of Cluster-II; the X-ray telescope XMM-Newton, which was launched last December; the Huygens spacecraft, currently on its journey to Saturn's moon Titan; and ERS-2, ESA's radar 'eye in the sky' that is monitoring our planet's environment. A special display was devoted to the results of last February's Shuttle Radar Topography Mission, in which DLR and ESA's astronaut Gerhard Thiele were heavily involved.

Experts from ESA, DLR and German industry were joined by ESA astronauts for media interviews on the various programmes being showcased.



ESA's Council Extends Directors' Contracts

In restricted session on 20 June 2000, the ESA Council extended the mandates of the Director General and two of his Directors:

The term of office of the Director General, Antonio Rodotà, has been extended for a period of two years from 1 July 2001.



A. Rodotà

Those of Hans Kappler, Director of Industrial Matters and Technology, and Daniel Sacotte, Director of Administration,



H. Kappler

have been renewed for a period of four years from 1 June 2001.



D. Sacotte

ESA and Canada Extend Cooperation

Canada's Prime Minister, the Hon. Jean Chrétien, attended a special ceremony at ESA Headquarters in Paris on 21 June to celebrate the continuing partnership between Europe and Canada in space applications and technology. The Prime Minister met the Director General, Antonio Rodotà, and the Heads of Delegation representing ESA's 14 Member States. The Prime Minister's visit culminated in the renewal of Canada's association with ESA through the signing of a new 10-year Cooperation Agreement by Antonio Rodotà and William (Mac) Evans, President of the Canadian Space Agency.

The new Agreement acknowledges the long history of cooperation between Europe and Canada and the socio-economic benefits that come from joint promotion of the peaceful development of space activities and technology. The latest Agreement is the fourth since 1 January 1979 between ESA and Canada. As a Cooperating State, Canada participates in ESA deliberative bodies and decision-making and takes part in ESA's programmes and activities. Canadian firms bid for and receive contracts to work on programmes of interest to them. The Agreement contains a specific provision ensuring a fair industrial return to Canada. In addition to Canada's participation in ESA's programmes, the new Agreement makes provision for ESA to take part in Canadian programmes for the first time.

"With this new Agreement, we are building on a proud tradition of partnership in space-based research and development", said Prime Minister Chrétien, "It is a model of international cooperation, one that will continue to drive innovation, the sharing of knowledge and expertise, and the creation of partnerships between countries, agencies and space-based industries to meet the needs of future generations all over the World".

"Cooperation with Canada", said Mr Rodotà, "is serving as a bridge across the Atlantic, allowing us to draw on our

collective strengths, knowledge and expertise to pilot leading-edge research, technology and space-based initiatives that make a positive impact on the lives of all of our citizens".

Established in 1989, with its headquarters in Saint Hubert, Quebec, the Canadian Space Agency supports and promotes a highly competitive national space industry as one of its many roles. Canadian companies are expanding their links with European firms in Earth observation and satellite navigation and in building the next generation of satellites offering access to faster and cheaper high-speed communications, multimedia and Internet services. Over the past 20 years, under the successive Cooperation Agreements, ESA has awarded contracts worth in excess of 200 million Euros to space companies throughout Canada. This has spurred the creation of jobs, the acquisition of knowledge and expertise and has led to the development of industrial alliances with European contractors.



The signature of the Cooperation Agreement. Left to right: Front row: Marco Ferrazzani (ESA), William (Mac) Evans, Antonio Rodotà and André Farand (ESA). Back row (standing): Jean Chrétien, Alain Bensoussan, Chairman of the ESA Council, and Brian Walker (ESA) (behind André Farand).



Three 'Wise Men' to Advise ESA

Thanks to ESA's successes over the last thirty years, Europe's space systems are providing increasingly competitive solutions for implementing environmental, transport and communications policies. The European Union too is evolving rapidly, extending its competence to the defence sector, regulating a Europe-wide knowledge-based economy, enlarging its membership and reforming its operating procedures. In the light of these converging developments, a first step was taken towards a closer relationship between ESA and the EU when the Councils of both organisations asked for a European space strategy to be prepared jointly by the end of 2000.

ESA is an 'open' organisation that has grown and will keep on growing: with Portugal now joining, the original membership of 11 States in 1975 has already expanded to 15, Canada is a Cooperating State, and cooperation agreements have already been signed with Greece, Hungary, Poland, Romania and the Czech Republic. This is therefore considered an appropriate moment for ESA to reflect on the links between its potential enlargement and the directions in which it needs to evolve to meet Europe's future expectations.

To help with these reflections and to provide independent advice, ESA's Director General, Antonio Rodotà, has set up a Committee of three 'Wise Men', comprised of Carl Bildt (Chairman), former Swedish Prime Minister and United Nations Envoy to the Balkans, Jean Peyrelevade, President of Crédit Lyonnais, and Lothar Späth, CEO of Jenoptik. This Committee, which represents a formidable combination of high-level political, economic and industrial expertise, has already held its first meeting, at ESA Headquarters in Paris, on 27 June.

The Wise Men are expected to make their recommendations to the Director General by October this year, in line with the calendar for the European space strategy being prepared jointly by ESA and the European Union.



All Four Cluster-II Spacecraft Safely in Orbit

The ESA Cluster-II mission to explore the Earth's magnetosphere in three dimensions successfully got underway on 16 July. At 14.39 CEST, a Soyuz-Fregat launch vehicle provided by the French-Russian Starsem Consortium lifted off from the Baikonur Cosmodrome in Kazakhstan carrying the first pair of Cluster-II satellites, 'Salsa' and 'Samba' (see accompanying panel). Approximately 90 minutes into the mission, the rocket's Fregat fourth stage fired for a second time to insert the spacecraft into a 240 km x 18 000 km parking orbit. A few minutes later, the ground station in Kiruna, Sweden, acquired the two spacecraft and started to receive telemetry, confirming that the satellites had successfully separated from the Fregat and were flying independently.

Over the next week, the two spacecraft used their own onboard propulsion systems to reach 19 000 km x 119 000 km orbits above the Earth, taking them almost one third of the way to the Moon at their furthest point (apogee) from the Earth. Five engine firings were required to enlarge the initial orbits and change their inclination so that the spacecraft would pass over the Earth's polar regions.

Less than a month later, at 13.13 CET on 9 August, the second pair of Cluster-II spacecraft were safely lifted into orbit from Baikonur aboard a similar Soyuz-Fregat vehicle. Approximately 75 minutes into this mission, the Fregat transfer module was



fired again to insert the spacecraft into a 250 km x 18 000 km separation orbit. About 20 minutes later, the ground station in Kiruna confirmed that this pair of satellites had also successfully separated from the Fregat and were in good health.

After five major orbital manoeuvres per spacecraft executed in just five days, this second pair, 'Rumba' and 'Tango', had been successfully inserted into their operational polar orbits, completing the rendezvous with the first pair, Salsa and Samba, launched on 16 July. Before the four Cluster spacecraft could come together, four apogee-raising manoeuvres had to be carried out. These raised the high points of the orbits to approximately 120 000 km above the Earth.

'Name the Cluster Quartet' Competition Winner Announced

The winner of ESA's 'Name the Cluster Quartet' competition was announced on the day of the first Cluster-II launch (16 July), during a special launch event for the media at the European Space Operations Centre (ESOC) in Darmstadt, Germany.

After an exhaustive examination of more than 5000 entries from all 15 ESA Member States, Prof. Roger Bonnet, Director of the ESA Science Programme, selected the winning entry from a short list of 15 national prize winners recommended by the international jury. The lucky winner was Raymond Cotton of Bristol (UK), who had suggested the names of four dances - Rumba, Salsa, Samba and Tango - for the individual satellites of the Cluster quartet.

"We thought of these names because my wife and I both like ballroom dancing, and they seemed to fit with the movement of the satellites through space," Mr Cotton said, "The names are also international and will be recognised in any country." Prof. Bonnet explained that: "It was an extremely hard decision. There were some excellent suggestions, but I considered the short-listed entry from the UK to be the best because it is catchy, easy to remember, and reflects the way the four satellites will dance in formation around the heavens during their mission."



The spacecraft are now in their final elliptical orbits, with perigees around 17 200 km and apogees of about 120 600 km. The distances between the individual spacecraft vary between 125 km and 2000 km. The Cluster armada completes one orbit of the Earth every 57 hours. A series of trim manoeuvres will take place in the second half of August to place the quartet into its operational tetrahedral (three-sided pyramid) flying formation. Three months of instrument calibration and checkouts will follow in preparation for beginning Cluster's two-year scientific programme of investigating the interaction between the Sun and our planet in three dimensions and in unprecedented detail.

"This second perfect launch within less than four weeks means that Cluster is on track for a highly successful mission," said Prof. Bonnet, Director of ESA's Science Programme. *"We are now looking forward to receiving the unique three-dimensional data that will give new understanding of the interaction between the Sun and Earth."*

The four Cluster-II spacecraft have been built for ESA by European industry under the prime contractorship of Astrium (formerly Dornier Satellitensysteme GmbH, Germany). Detailed descriptions of the four spacecraft, their scientific payloads and their operations were published in the May issue of ESA Bulletin (No. 102) and are also available at: sci.esa.int/cluster 



The Soyuz-Fregat launcher carrying 'Rumba' and 'Tango' on the pad shortly before launch on 9 August



Clamp release, and lift-off of the Soyuz-Fregat



ISS Commercialisation

ESA took a major step on 16 June towards commercialisation of the International Space Station (ISS) when it released two Calls for Interest aimed at creating an organisation to market Europe's commercial allocation and to share in the generated income. The Calls are targeted at distinct market segments. The *Commercial Research and Technology Development* element is aimed primarily at space and research companies operating in the space and microgravity fields. The *Innovative Markets* element emphasises sponsorship, advertising, entertainment and education. The goal here is to attract communications, sponsorship and multimedia companies in developing the unique opportunities offered by the ISS in terms of image, brand visibility and public interest.

An ISS Information Day at ESTEC's Erasmus User Centre (EUC), also on 16 June, supported the release of the Calls for Interest, and was attended by companies from both market segments. ESA astronaut Pedro Duque helped to describe the Space Station, its facilities and the EUC, adding his own experiences in space and a virtual reality tour of the Station.

This event marks the first time that ESA has publicly declared its intention to create strategic partnerships for commercial exploitation of the Station. Business proposals were due in by the end of July, to be followed at the end of the year with high-level commitments from invited organisations, and kick-off the ISS Commercialisation Programme in 2001. The Information Day also saw the creation of a forum among participating companies, promoting interactions that should generate detailed proposals covering a wider range of commercial activities.

The ISS Commercial Development Organisation could be a single entity or a more complex structure such as a Consortium, a Joint Venture with other industrial or semi-industrial entities, or a Public-Private Partnership. As the R&D and innovative sectors likely require different knowledge and expertise, more than one Business Developer may be appointed. If so, ESA may appoint a Business Development Coordinator to act as the Agency's sole interface.



ESA astronaut Pedro Duque (right) describes what the Space Station offers potential commercial developers.

The companies that have already expressed interest include Alenia Aerospazio, Astrium GmbH, BEOS AG & Co.oHG Space Operators, Bikker, Carlo Gavazzi Space, CMP Scientifica s.l., D3 Group GmbH, ESYS, Intospace GmbH, Kesberg, Bütfering & Partner, National Aerospace Laboratory (NL), OHB System

GmbH, Publicis Consultants, Space Channel and Verhaert.

The Calls for Interest and company contact details are available at: www.estec.esa.int/spaceflight/isscommercialisation



ATV Launch Contract

ESA and Arianespace signed a contract in June worth more than 1 billion Euros to launch nine Automated Transfer Vehicles (ATVs) to the International Space Station over a period of 10 years. Following the maiden flight in late 2003, ATVs will be launched every 15 months to resupply the Station, boost its orbit and remove waste.

Currently under development by a consortium led by Aerospatiale Matra Lanceurs of Les Mureaux (F), the ATV will be Europe's payment 'in kind' rather than in cash for its 8.3% share of the common ISS operating costs. The nine ATVs will be produced and operated by European industry under a single ESA contract to be awarded in 2001. This contract will later include the launch services contract.

The 20.75 t ATV will be launched by the Ariane-5 Plus version of the heavy-lift launcher, equipped with the reignitable

EPS upper stage, directly into a 300 km circular orbit inclined at 51.6°. From there, ATV will use its own propulsion system to reach the 400 km orbit of the ISS and dock with the Russian Zvezda Service Module. The cargo can include up to 5.5 t of dry cargo in the pressurised carrier, 840 kg water, 100 kg air, oxygen or nitrogen, 860 kg propellants for Station refuelling, and 4 t of propellants for its own engines to provide Station reboost and attitude control during the 6-month attachment. At the end of its mission, ATV can remove 5.5 t of waste for disposal during the destructive reentry.



(Right) The launch contract for nine ATV missions was signed on 7 June at the ILA 2000 air show in Berlin. Centre is ESA Director General Antonio Rodotà, left is Director of ESA Manned Spaceflight & Microgravity Jörg Feustel-Büechl, right is Arianespace Chairman/CEO Jean-Marie Luton.



The assembled astronauts

Astronauts Past and Present Celebrate Tenth Anniversary of the European Astronaut Centre

On 17 May, more than 20 astronauts from eight European countries gathered at ESA's European Astronaut Centre (EAC) in Cologne, Germany, to celebrate the Centre's 10th Anniversary.

On the threshold of the new era for space exploration being ushered in with the International Space Station (ISS), pioneers

from the early days of Europe's involvement in manned spaceflight and today's 16-strong European Astronaut Corps came together for the first time to discuss Europe's preparations for the years ahead.

These astronauts represent more than two decades of Europe's endeavours in space flight and research. To date 27 Europeans have taken part in 31 space flights. From the days of the Soviet Salyut stations to Russia's Mir, from the first Space Shuttle flights to the International Space Station now under construction, they have had a hand in writing the history of man's presence in space. As the European



Dr. Ernst Messerschmid, Head of EAC, opening the Celebration

astronauts' home base, EAC provides training and medical support to ESA's astronauts, both on the ground and during missions.

The International Space Station crews will spend time at EAC to be trained in the operation of the ESA contributions to ISS, namely the Columbus Laboratory, the Automated Transfer Vehicle (ATV) and numerous payload facilities for scientific experiments. The first ISS crews are expected to begin training at EAC in about two years' time.

A full article on EAC's role and the Anniversary celebrations will appear in the November issue of the ESA Bulletin (No. 104).



New ESA Antenna in Spain Inaugurated

On 18 May, the newly refurbished antenna to be used to support ESA's latest scientific mission Cluster-II, consisting of four satellites, was inaugurated in Spain. The antenna (VIL-1), located at the Agency's Villafranca del Castillo Satellite Tracking Station (VILSPA) near Madrid, will provide the prime communications link with the four spacecraft and will therefore play a vital role in their monitoring and control, as well as receiving the vast amounts of scientific data that will be returned to Earth during the planned two years of Cluster operations.

The upgrading of VIL-1 has included the replacement of the 60 dish panels, the subreflector, the antenna equipment room and other parts of the main structure. One of the most significant modifications has been the replacement of the servo and tracking systems in order to follow the four Cluster-II satellites, which will move in

highly elliptical orbits (perigee 19 000 km, apogee 119 000 km) and therefore require high-speed tracking.

The four satellites will be visible for an average of about 10 hours per day from VILSPA, but only one satellite can be in communication with the ground at any given time, which reduces the available time per satellite each day to around two and a half hours. Further challenges arise from the need to send new instructions to the 11 scientific instruments on each spacecraft, and from the vast amount of data to be returned each day from the 44 experiments. Over two years of operations, this adds up to 580 Gigabytes (580 000 000 000 bytes!) of data, equivalent to 290 million pages of printed text.

Built in 1975, VILSPA is major part of the European Space Operations Centre (ESOC) Tracking Station Network (ESTRACK). In the last 25 years, it has supported many ESA and international

satellite programmes, including the International Ultraviolet Explorer (IUE), Exosat and the Infrared Space Observatory (ISO). In addition to supporting the Cluster-II mission, it has been designated as the Science Operations Centre for ESA's XMM-Newton mission, launched in December 1999, and for the Far-Infrared Space Telescope (FIRST), due for launch in 2007.

Various European companies participated in the relocation and upgrading of the VIL-1 antenna hardware. MAN (D) was responsible for dismantling the antenna at its original site in the Odenwald, in Germany, and for the installation of the dish at VILSPA, while Vitrociset (I) handled the transfer of the antenna back-end equipment, which included the satellite telemetry and telecommunication signal computers. These companies were supported by Spanish contractors and local industry.



Twelve Physics and Biology Experiments Flown on 28th ESA Parabolic Flight Campaign

On 23 May, a specially adapted Airbus A-300 took off from Bordeaux-Mérignac airport in France to begin a four-day long campaign of parabolic flights designed to carry out experiments in weightlessness and test instruments and equipment before they are operated in space, either on sounding rockets or on the International Space Station (ISS). This 28th parabolic flight campaign organised by ESA focussed on the physical sciences and biology, with twelve experiments provided by international teams of investigators (see accompanying table).

Parabolic flights are practically the only means of reproducing on Earth the weightlessness experienced in space. The 'Zero-g Airbus' pilot - flying at an altitude of approximately 6000 metres, usually in a specially reserved air-corridor above the Gulf of Gascogne - first performs a nose-up manoeuvre to put the aircraft into a steep climb (7600 m). This generates an acceleration of 1.8 g (1.8 times the acceleration of gravity on the ground) for

about 20 seconds. Then the pilot reduces engine thrust to almost zero, injecting the aircraft into a parabola. The plane continues to climb until it reaches the apex of the parabola (8500 m), before it starts descending. This condition lasts for about 20 seconds, during which the passengers in the cabin float in the weightlessness resulting from the free fall of the aircraft. When the angle below the horizontal reaches 45°, the pilot accelerates again and pulls up the aircraft to return to steady horizontal flight. These manoeuvres are repeated 30 times per flight.

The 27 previous campaigns that ESA has conducted since 1984 have provided a total of more than 2650 parabolas and almost 15 hours of weightlessness, the equivalent of flying around the Earth (in low Earth orbit) nearly 10 times. A total of 360 experiments have been carried out so far. With Europe and its international partners now building the International Space Station, onboard which research will be carried out for the next 15 years, parabolic flights are crucial to the preparation of experiments, equipment and astronauts, and allow scientists to have their experiments tested before they

are actually flown on a space mission.

Over the next four years, ESA will be running two parabolic campaigns a year, for which the scientific community will be regularly invited to submit experiment proposals for peer review and selection for flight. The next ESA parabolic-flight campaign (the 29th) is scheduled for November 2000 and will feature a mix of experiments in the life and physical sciences, focusing mainly on physiological and medical topics.

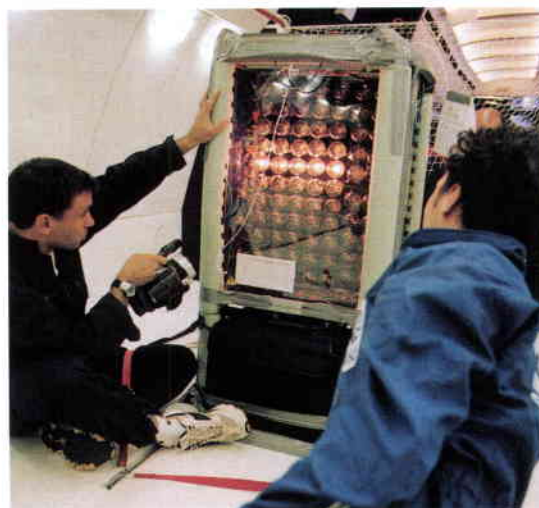

Experiments Flown on the 28th ESA Parabolic-Flight Campaign

“Hydrodynamics of Wet Foams”, from Dr B. Kronberg (*Inst. for Surface Chemistry, Stockholm, S*) and Dr M. Adler (*Univ. of Marne la Vallée, Paris, F*)
Studied different types of foams and tested a new method of forming foams by injecting CO₂ into different liquids. The foam-generation technique cannot be tested on the ground as foams are transient and collapse rapidly in 1-g conditions.

“Interfacial Turbulence in Evaporating Liquids”, from Prof. J.C. Legros and Dr P. Colinet (*Univ. of Brussels, B*)
Studied the three-dimensional temperature field in an evaporating liquid (ethanol) caused by turbulent motions at the liquid/gas interface, known as Marangoni convection.

“Vibrational Phenomena in Inhomogeneous Media”, from Dr P. Evesque (*CNRS, Ecole Centrale, Paris, F*), Dr D. Beysens (*CEA, Grenoble, F*) and Dr Y. Garrabos (*CNRS, Pessac, F*)
Investigated the effect of vibrations in weightlessness on inhomogeneities in two-phase fluids and granular matter. This is one of the experiments recommended to fly in the Fluid Science Laboratory currently being developed for ESA's Columbus Laboratory.

“Liquid Diffusion Model Experiments with the Shear Cell Technique”, from Prof. G. Froberg, Dr A. Griesche (*Berlin Technical Univ., D*) and Dr G. Matthiak (*DLR, Cologne, D*)
Continued a previous experiment flown on the Russian satellite Foton-12. Diffusion is the main process in metallurgy and crystal growth, but the diffusion coefficient of liquids is difficult to measure on the ground due to other mass transport phenomena resulting from gravity-induced natural convection.

“Study of Synthesis of Carbon Species in Microgravity”, from Prof. J.P. Issi, Dr J.C. Charlier and Dr J.M. Beuken (*Univ. of Louvain, B*)
Investigated the synthesis of new forms of carbon, such as fullerenes, nanotubes and diamonds, by applying a strong electrical discharge between two graphite electrodes. Similar experiments conducted during previous parabolic flights showed that the process of obtaining these different carbon forms could be improved to some extent.

“Recrystallisation of Tungsten Filament”, from Dr R. Van Wijk and P. Dona (*Philips, NL*)
Studied aspects of processing tungsten filaments to improve the performance of new lamps. This is one of the first experiments conducted directly by an industrial company in weightlessness, and shows the potential of applied research and development in microgravity.

“Laminar Diffusion Flames Representative of Fires in Microgravity Environments”, from Prof. P. Joulain (*CNRS, F*) and Dr J.L. Torero (*Univ. of Maryland, USA*)
Continued a series of combustion experiments conducted during previous parabolic-flight campaigns, sounding-rocket flights and drop-tower tests. The final experiment goal is to provide the scientific background necessary to evaluate material flammability in microgravity, enabling the risk of fire on board manned space vehicles to be reduced.

“Real-time Physiological and Molecular Biological Measurements of Osteoblast-like Cells under Microgravity using Fluorescence Techniques”, from Prof. D. Jones (*Univ. of Marburg, D*) and Prof. Vander Sloten (*Univ. of Leuven, B*)
Investigated bone cells stimulated mechanically in microgravity. Osteoblasts are responsible for the regeneration of bone tissue, while osteoclasts are responsible for resorption of used bone tissue. The results will help to shed light on the mechanisms of bone resorption and regeneration, which are not yet fully understood.

“Effects of Gravity at the Biomolecular Level”, from Prof. P. Vanni (*Univ. of Florence, I*)
Investigated whether microgravity can affect enzyme reactions, complementing a previous experiment on a sounding rocket in 1996.

“Lipoxygenase Activity in Microgravity”, from Dr M. Maccarone and Prof. A. Finazzi-Agro (*Univ. of Rome, I*) with the support of Profs. G.A. Veldink and J.F.G. Vliegenhart (*Univ. of Utrecht, NL*)
Investigated the role of microgravity in enzyme catalysis reactions, as enzymes play important regulatory roles in all living cells, in both plants and animals.

“Postural Control in Flat Fish”, from Prof. A. Berthoz (*CNRS, F*)
Studied the behaviour of flat fish swimming in a large pressurised aquarium. This experiment is related to the study of the inner-ear vestibular system and complements previous investigations to bring more information on the central mechanisms of imbalance compensation, postural balance and asymmetries in the gravistatic system, thought to be the cause of space sickness.

“Testing of the Mirsupio Crew Support Pouch”, from the European Astronaut Centre (*ESA/EAC*)
Mirsupio is an improved multi-functional, wearable equipment pouch worn around the waist to support the astronaut in his daily life in orbit. An early version of this pouch was flown on Mir during the Perseus mission with ESA astronaut J.P. Haigneré.



ESTEC 'Capital of the Moon' for a Week

From 10 to 15 July, ESA's European Space Research and Technology Centre (ESTEC) in Noordwijk (NL) became the 'Capital of the Moon' when it hosted the Fourth International Conference on Exploration and Utilisation of the Moon (ICEUM4). Organised by the International Lunar Exploration Working Group (ILEWG), the ICEUM4 Conference brought together lunar explorers (young and old), scientists, engineers, industrial firms and other organisations to review recent activities and to prepare for the next steps on the Moon.

At the Young Lunar Explorers Session, on 10 July, young professionals from all over the World – many specially invited by ESA and the ILEWG – presented their ideas, dreams and work concerning lunar and Solar System exploration. During the Lunar Science and Technology Sessions, on 11 and 12 July, the most recent

scientific discoveries on the Moon – notably the possible presence of water – were discussed and the participants reviewed the key questions regarding the origin and evolution of the Earth-Moon system that still remain unanswered.

On 13 July, several ILEWG Splinter Groups held dedicated sessions on all aspects of lunar exploration, including: Science of, from and on the Moon, Living on the Moon, Key Technologies, Utilisation of Lunar Resources, Infrastructures for Lunar Bases, Lunar Role in Human Expansion in the Solar System, and Social, Cultural, Artistic and Economic Aspects. On 14 July, these Groups reported their findings and recommendations to the ICEUM4 participants and the Press.

At the close of the Conference, the participants formulated the 'ILEWG 2000 Lunar Declaration', which proposes a specific action plan for international lunar explorers and space agencies in the years to come.

What do Students see as the Next Projects in Space Astronomy?

56 students from ESA Member States attended the annual Alpbach Summer School, from 18 to 27 July in the mountain village of Alpbach in the Austrian Tyrol, sponsored by the Austrian Federal Ministry for Transport, Innovation and Technology, the Austrian Space Agency and ESA and its Member States.

The participants at this year's Summer School, with the theme 'Extragalactic Astronomy and Cosmology from Space', were set the task of defining future X-ray and gamma-ray as well as infrared missions. As part of the curriculum, 25 European experts provided them with an overview of the evolution of the Universe, including many aspects of black holes, supernovae and the cosmic microwave background. The eminent cosmologist Sir Martin Rees, Astronomer Royal and



The complete Proceedings of the ICEUM4 Conference will be available from ESA Publications Division in September as ESA Special Publication SP-462. 

The ICEUM4 participants, gathered at ESTEC (NL)



Professor at the University of Cambridge, presented this year's keynote lecture, on 'Cosmology and Dark Matter'. The students also learned about the scientific instruments that are used in space astronomy as well as some of the engineering and operations tools with which space missions are designed. The scientific aims and technological challenges of several current ESA science missions, including the recently launched XMM-Newton (giant X-ray telescope), Integral (the International Gamma-Ray Laboratory, to be launched in 2002), and some later missions looking at the cold Universe (FIRST and Planck), were also presented.

Throughout the two weeks, the students participated in a series of workshops, teaching them the basic skills necessary to become Europe's future space-mission designers. The students had to come up with their own ideas for scientific space missions, culminating in the design of two infrared and two X-ray astrophysics space missions:

SNOOPY (Submm N Observation Of Polarimetry): This is an all-sky-survey infrared astrophysics mission, designed to fit within the framework of an ESA flexi-mission. The mission demonstrates how to achieve an optimal scientific return for minimum cost using space technology already developed for

existing space missions. SNOOPY's key objective is to understand the Inter-Stellar Matter (ISM) structure and to detect galactic magnetic field lines by measuring polarisation effects in the infrared region of the spectrum.

Mi-3 (Mission Interferometer with 3 baselines): This is an ambitious L2 Lagrangian point orbiting, infrared interferometry mission consisting of a total of four spacecraft, carrying three telescopes and the beam-combiner optics. The mission provides high angular resolution and high-resolution spectroscopy for imaging active and merging galaxies, as well as galactic and extragalactic star-formation processes, to improve our understanding of the physics of accreting systems throughout the history of the Universe.

In.XS: This is an all-sky-survey space mission in the X-ray band (2 - 80 keV) to detect obscured Active Galactic Nuclei (AGNs) and to measure the X-ray background radiation. It uses innovative X-ray multi-layer optics currently under development at ESA.

ASTeRIX (Alpbach Summer-school Telescope Realising Interferometry X-rays): This X-ray interferometry mission uses a revolutionary X-ray optics concept developed at the Summer School, which can provide milliarcsecond resolution

capabilities. In combination with a second spacecraft, microarcsecond resolution can be achieved. The mission would be launched to the L2 Lagrangian point by an Ariane-5 vehicle.

These four missions were presented on the last day of the Summer School to a distinguished Review Panel – including Dr. Roger Bonnet, Director of ESA's Scientific Programme, and Dr. Bo Andersen, Chairman of the ESA Science Programme Committee (SPC) – which congratulated the students on their remarkable achievements during their ten days of work in Alpbach.

A more detailed article will appear in a forthcoming issue of the ESA Bulletin. Meanwhile, further information can be obtained from:

Ms Michaela Gitsch
Austrian Space Agency
Garnisongasse
A-1090 Wien

Tel. (43)1.403 81 77/12
Fax. (43)1.405 82 28
E-mail: mgitsch@asaspace.at

or by visiting: www.asaspace.at.



The Ethics of Outer Space

In 1998, the World Commission on the Ethics of Scientific Knowledge and Technology (COMEST) – the UNESCO body charged with studying the social and ethical implications of the applications of science and technology, chaired by Mrs Vigdis Finnbogadóttir, former President of Iceland (1980-1996) – decided to examine ethical issues related to the exploration of extra-atmospheric space. This Commission had previously studied the topics of energy and water. In the same spirit, in December of that year ESA's Director General, Antonio Rodotà (who inspired the initiative), and Federico Mayor, Director General of UNESCO, created a working group on the ethics of extra-atmospheric space. This multi-disciplinary group was tasked with preparing a report on the ethical implications of space

activities. Its work was coordinated by Prof. Alain Pompidou, former Member of the European Parliament and a member of the French 'Conseil Economique et Social'.

ESA and UNESCO have recently published this report, which draws on the experience and knowledge of international experts worldwide, including representatives of the United Nations, national space agencies and industry. On Monday 10 July, the report was presented to the media by Prof. Pompidou and Antonio Rodotà during a Press Conference at ESA Headquarters in Paris.

The report examines the ethical problems posed by the utilisation of outer space and addresses such topics as life in space (manned space flight, the search for extraterrestrial life and the return of samples from other celestial bodies),

space debris, Earth monitoring, environment and security, and the public image of space exploration.

In Mr Rodotà's words:

"Ethics is a fundamental aspect of human society. For those who are involved in space activities, ignoring this debate is not an option..... We at ESA are committed to ensuring that the ethics of space science and technology are considered in our decisions and in our programmes".

Further information can be obtained from:

Géraldine Naja
ESA Strategy and Business Development

Tel: +33(0)1.53.69.7532
Fax: +33(0)1.53.69.7690



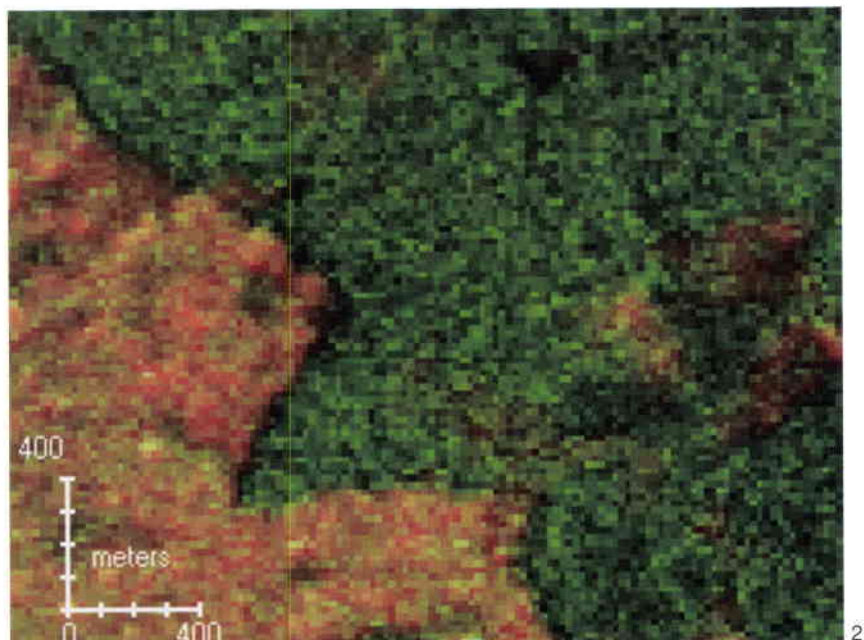

2



1

Forest Damage Mapping in North Eastern France

The devastating storms that struck France in December 1999 destroyed vast areas of forest and woodland (Fig. 1). Mapping of the damage was an immediate high priority, both for short-term clear-up actions as well as for long-term reforestation planning.

Coherence products derived from space-based Synthetic Aperture Radar (SAR) imagery can discriminate forested and non-forested areas accurately, and by applying a multitemporal approach various levels of damage can be identified. This approach, based on the exploitation of the coherence product developed by Spot Image with the support of ESA, was applied over the forest of Haguenau, 30 km north of Strasbourg, France's second largest forest. The results obtained from the processing of two coherence products derived from two ERS-1/ERS-2 tandem image pairs acquired before the storm, on 31 October and 1 November 1999, and after the storm, on 9 and 10 January 2000, allowed damage maps to be produced at 1:25 000 scale. The results were validated by regional forestry services.

Coherence can be related to vegetation density in SAR imagery: wooded areas generally show a low coherence, appearing green in a standard coherence product, while bare soils and cultivated areas are usually associated with high coherence, appearing orange-red (Fig. 2). The coherence product from archive data therefore allows one to separate forest/non-forest areas, to be compared with the topographic map, the land-use map and Spot XS imagery (Figs. 3-5). The

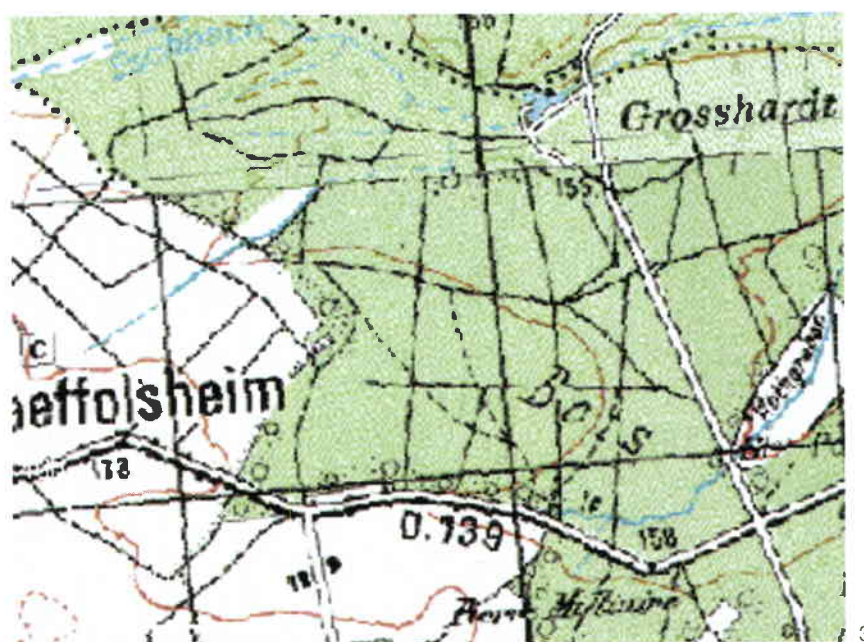

3

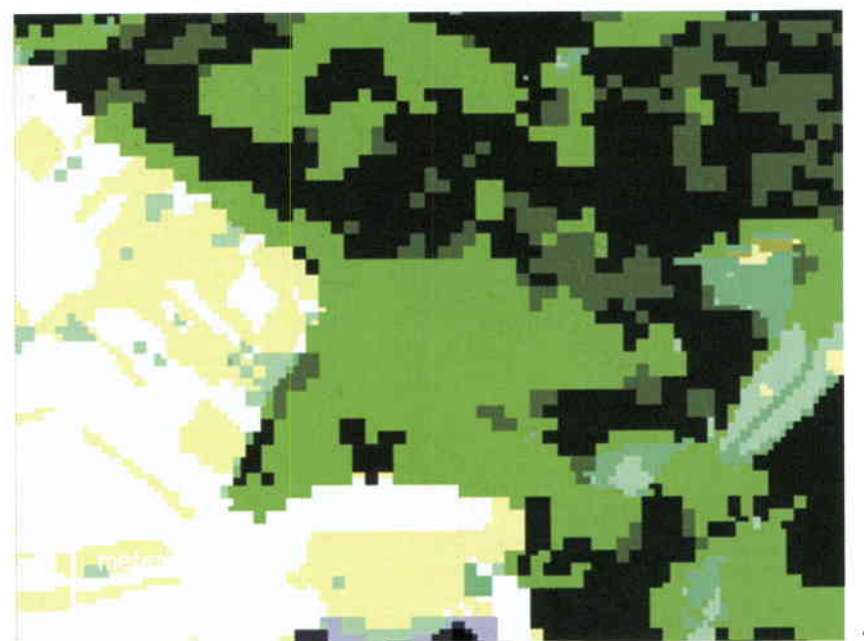

4



post-storm coherence product shows a strong increase in the coherence level within forested areas (Fig. 6). A 'damage image' was produced based on the ratioing of the two coherences, and the averaged SAR intensity (Fig. 7). In this image, pink tones provide an immediate estimate of the degree of damage. In this case a damage level of 50% had been reported by the forestry service, which corresponds well statistically with the observed increase in coherence over the area.

Acknowledgement

This work was carried out by A. Herrmann, K. Fellah, P. de Fraipont and H. Yésou of the Service Régional de Traitement d'Image et de Télédétection (SERTIT), and J. Bequignon of ESA/ESRIN, Frascati, with both Spot Image and ESA support. ESA organised the special tandem satellite ERS acquisition campaign and provided the ERS data, while Spot Image provided the coherence products. The help of the French forestry service during the product validation phase is gratefully acknowledged by the authors.

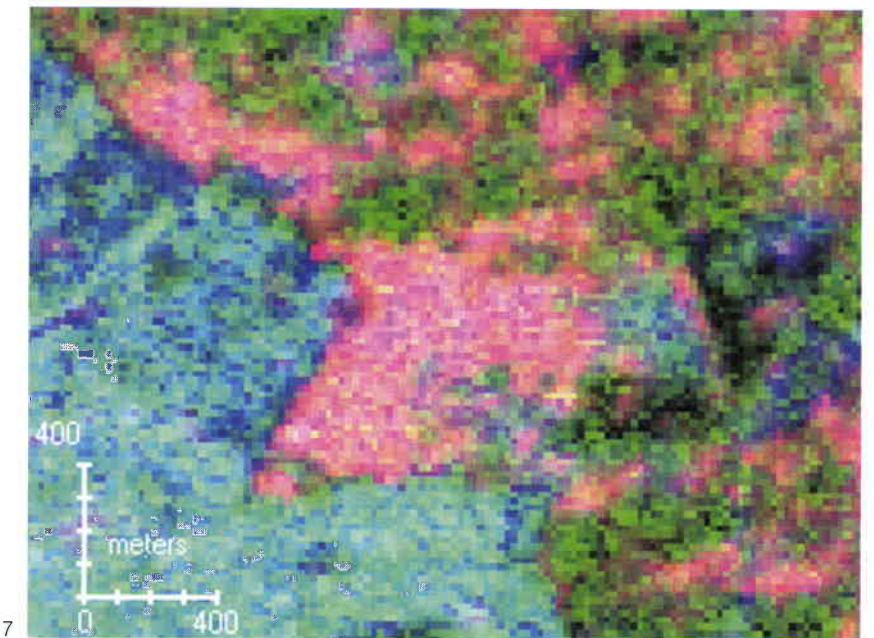
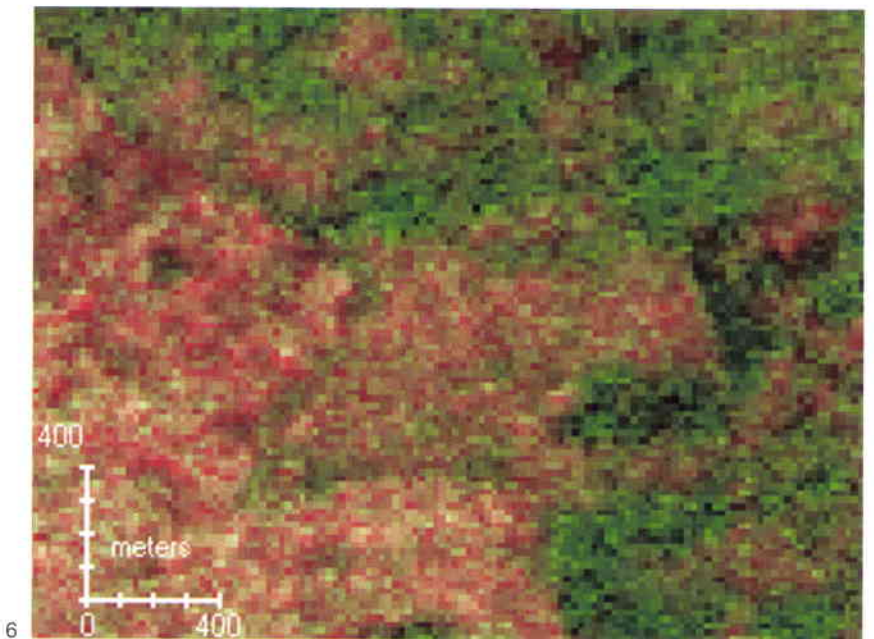

Figure 1. The dramatic damage caused by the December 1999 storms in the Haguenau forest

Figure 2. Coherence product before the storm

Figure 3. Topographic map

Figure 4. Land cover map

Figure 5. SPOT XS image

Figure 6. Coherence product after the storm

Figure 7. Damage image, in which the affected areas are highlighted in pink

ESA Annual Report

'99 ANNUAL REPORT (JUNE 2000)

BATTRICK B. (ED.)

ESA ANNUAL REPORT 1999 // 100 PAGES

NO CHARGE

'99 RAPPORT ANNUEL (JUIN 2000)

BATTRICK B. & SAWAYA H. (EDS.)

RAPPORT ANNUEL ESA 1999 // 102 PAGES

NO CHARGE

ESA Newsletters

REACHING FOR THE SKIES NO. 21

(MAY 2000)

NEWSLETTER OF THE ESA DIRECTORATE OF

LAUNCHERS

SCHÜRMANN B. (ED.)

NO CHARGE

ON STATION NO. 3 (JULY 200)

NEWSLETTER OF THE ESA DIRECTORATE OF

MANNED SPACEFLIGHT AND MICROGRAVITY

WILSON A. & SCHÜRMANN B. (EDS.)

NO CHARGE

EARTH OBSERVATION QUARTERLY NO. 66

INCL. RECORD OF IMAGES (JULY 2000)

NEWSLETTER OF THE ESA DIRECTORATE OF

APPLICATIONS

HARRIS B. & SAWAYA H. (EDS.)

NO CHARGE

PREPARING FOR THE FUTURE

(AUGUST 2000) VOL. 10, NO. 2

NEWSLETTER OF THE ESA DIRECTORATE OF

INDUSTRIAL MATTERS AND TECHNOLOGY

PROGRAMMES

BRISSON P. (ED.), M. PERRY

NO CHARGE

Publications

The documents listed here have been issued since the last publications announcement in the ESA Bulletin. Requests for copies should be made in accordance with the Table and Order Form inside the back cover

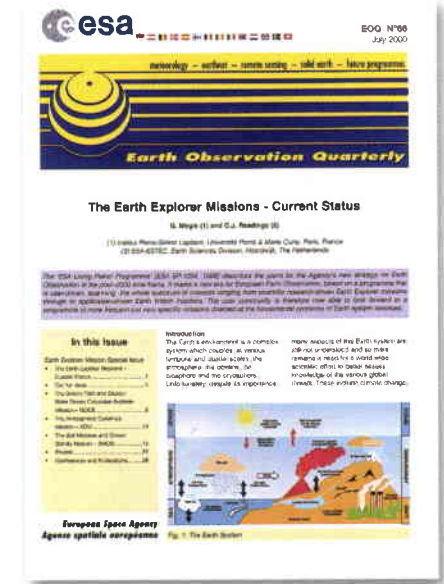
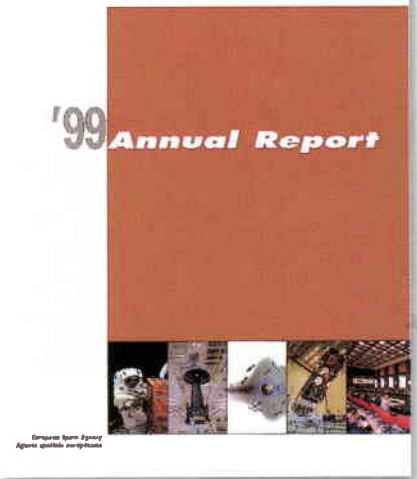

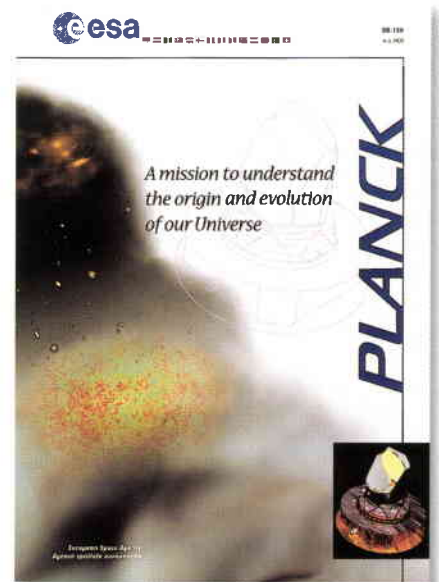
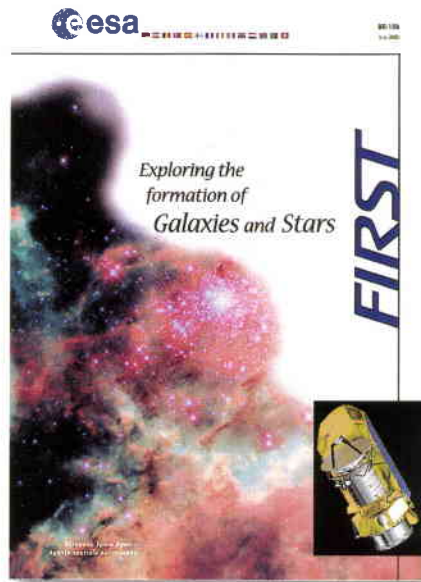

ESA Brochures

10 YEARS THAT CHANGED OUR VISION – EUROPE AND THE HUBBLE SPACE TELESCOPE (APRIL 2000)
 CHRISTENSEN L.L. (ST-ECF)
 (ED. B. BATTRICK)
 ESA BR-157 // 32 PAGES
 NO CHARGE

FIRST – EXPLORING THE FORMATION OF GALAXIES AND STARS (JULY 2000)
 SALMONE M. & PILBRATT G.
 (ED. B. BATTRICK)
 ESA BR-158 // 11 PAGES
 PRICE: 15 DFL / 7 EUROS

PLANCK – A MISSION TO UNDERSTAND THE ORIGIN AND EVOLUTION OF OUR UNIVERSE (JULY 2000)
 SALMONE M. & TAUBER J.
 (ED. B. BATTRICK)
 ESA BR-159 // 11 PAGES
 PRICE: 15 DFL / 7 EUROS

EUROPE AND CANADA – PARTNERS IN SPACE (JUNE 2000)
L'EUROPE ET LE CANADA – PARTENAIRES DANS L'ESPACE (JUIN 2000)
 BURBIDGE M. & CLEMENT J. (CSA)
 (EDS. G. LECLERC, B. BATTRICK & H. SAWAYA)
 ESA BR-160 // 28 PAGES
 NO CHARGE

METEOSAT SECOND GENERATION (MSG) PRESENTATION (AUGUST 2000)
 STRIJK S.J.G. (ED. R. HARRIS)
 ESA BR-161 // CD-ROM
 PRICE: 50 DFL / 20 EUROS

F2/F3 MISSION SUMMARIES: ASSESSMENT STUDY RESULTS
EDDINGTON – HYPER – MASTER – NGST – SOLAR ORBITER – STORMS
 MISSION TEAMS & SCIENCE PROGRAMME COORDINATION SERVICE
 (ED. B. BATTRICK)
 ESA BR-164 // 6 FOLDERS
 PRICE: 10 DFL / 5 EUROS

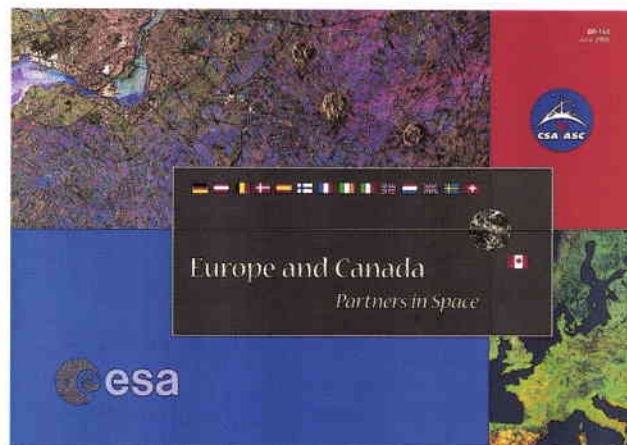
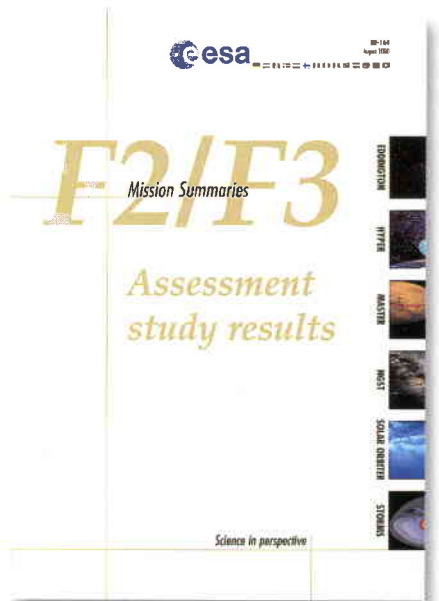

ESA Special Publications

ESA'S REPORT TO THE 33RD COSPAR MEETING - WARSAW, POLAND (JULY 2000)
HUBER M.C.E. & WILSON A. (EDS.)
ESA SP-1241 // 131 PAGES
PRICE: 70 DFL / 30 EUROS

X-RAY EVOLVING-UNIVERSE SPECTROSCOPY – THE XEUS MISSION SUMMARY (MAY 2000)
XEUS STEERING COMMITTEE
(ED. B. BATTRICK)
ESA SP-1242 // 18 PAGES
PRICE: 25 DFL / 10 EUROS

INES GUIDE NO. 2 – INTERNATIONAL ULTRAVIOLET EXPLORER (IUE) NEWLY EXTRACTED SPECTRA / NORMAL GALAXIES (AUGUST 2000)
FORMIGGINI L., BROSCHE N. & WAMSTEKER W.
(ED. R.A. HARRIS)
ESA SP-1243 // 472 PAGES
PRICE: 110 DFL / 50 EUROS

ESCON 2000 (JUNE 2000) PROCEEDINGS OF THE EUROPEAN SPACE COMPONENTS CONFERENCE, ESTEC, NOORDWIJK, THE NETHERLANDS, 21-23 MARCH 2000
SCHÜRMAN B. (ED.)
ESA SP-439 // 404 PAGES + CD-ROM
PRICE: 110 DFL / 50 EUROS

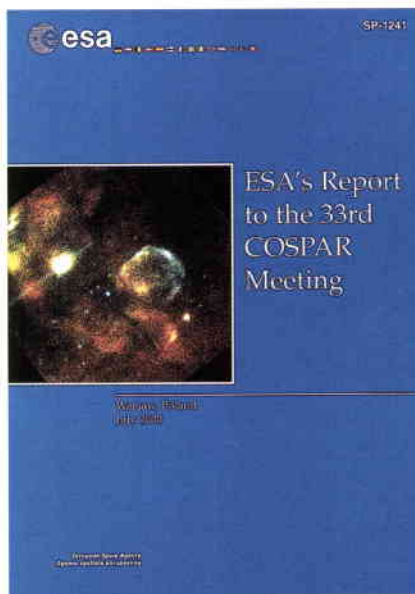

GEO-MARK 2000 (AUGUST 2000) PROCEEDINGS OF AN INTERNATIONAL SYMPOSIUM, PARIS, FRANCE, 10-12 APRIL 2000
SCHÜRMAN B. (ED.)
ESA SP-458 // 216 PAGES
PRICE: 90 DFL / 40 EUROS



Credit Card Payments for ESA Publications

It is possible to purchase the Agency's publications from the ESA Publications Division 'Bookshop' using your corporate or your personal credit card (Eurocard/Mastercard, Visa or American Express).

You can telephone or telefax your orders to the numbers given below, quoting your card's number and its expiry date.

The Bookshop (attn. Mr Frits de Zwaan)
ESA Publications Division
ESTEC
Keplerlaan 1
2200 AG Noordwijk
The Netherlands

Telephone: (31) 71 5653405
Telefax: (31) 71 5655433

Other methods of payment are also accepted. Please call or fax for details.

A list of the latest publications can be accessed via the ESA Publications Division's Home Page at the following Internet/WWW address:

<http://esapub.esrin.esa.it/>

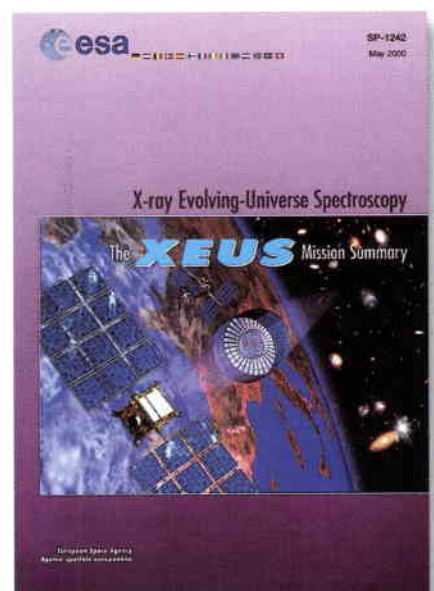

ESA Procedures, Standards and Specifications

SPACE PROJECT MANAGEMENT – TAILORING OF SPACE STANDARDS (APRIL 2000)

ECSS SECRETARIAT
ESA ECSS-M-00-02A // 34 PAGES
PRICE: 25 DFL / 10 EUROS

SPACE PROJECT MANAGEMENT – RISK MANAGEMENT (APRIL 2000)

ECSS SECRETARIAT
ESA ECSS-M-00-03A // 40 PAGES
PRICE: 25 DFL / 10 EUROS

ECSS STANDARDIZATION POLICY (APRIL 2000)

ECSS SECRETARIAT
ESA ECSS-P-00A // 52 PAGES
PRICE: 25 DFL / 10 EUROS

ESA Contractor Reports

STUDY AND DESIGN OF EXPERIMENTAL PERSONAL COMMUNICATION SYSTEM – FINAL REPORT (MARCH 2000)

ALCATEL, FRANCE
ESA CR(X)-4287 // 72 PAGES
PRICE: 50 DFL / 20 EUROS

PHASE-A STUDY OF THE ATMOSPHERIC DYNAMICS EXPLORER MISSION – FINAL REPORT AND EXECUTIVE SUMMARY (FEBRUARY 2000)

DAIMLER-CHRYSLER AEROSPACE,
GERMANY
ESA CR(P)-4288 // **CD-ROM**, + 23 PAGES
PRICE: 25 DFL / 10 EUROS

ECSS SOFTWARE PROCESS MODELS STUDY – SUMMARY REPORT (FEBRUARY 2000)

ALENIA, ITALY
ESA CR(P)-4289 // 38 PAGES
PRICE: 25 DFL / 10 EUROS

LIDAR PERFORMANCE ANALYSIS SIMULATOR (LIPAS) – PART 8: SUMMARY (SEPTEMBER 1999)

NLR, THE NETHERLANDS
ESA CR(P)-4290 // 50 PAGES
PRICE: 25 DFL / 10 EUROS

Contractor Reports

There are two types of Contractor Reports: CR(P) and CR(X) reports.

ESA CR(P) documents are available on microfiche from either of the following addresses:

British Library - Doc. Supply Centre
Customer Service
Boston Spa
Wetherby, West Yorkshire
LS23 7BQ
England

Universitaetsbibliothek und TIB
Welfengarten 1B
D-30167 Hannover
Phone: (+49) 511/762-2268
Fax: (+49) 511/715936

ESA CR(X) documents have restricted distribution and are not available on microfiche. Printed copies can be requested via ESA Publications Division

EARTH OBSERVATION SYSTEMS: GROUND DATA COMMUNICATIONS – MANUAL FOR SYSTEM DESIGNERS – FINAL REPORT (MARCH 2000)

ALCATEL, FRANCE
ESA CR(P)-4291 // 228 PAGES
PRICE: 90 DFL / 40 EUROS

CCSDS CONFORMANT INTERFACES TO ESTRACK – FINAL REPORT (MARCH 2000) SOFTLAB, AUSTRIA

ESA CR(P)-4292 // 13 PAGES
PRICE: 25 DFL / 10 EUROS

CONSTELLATION ARCHITECTURES AND TECHNOLOGIES – FINAL REPORT (AUGUST 1999)

ALCATEL, FRANCE
ESA CR(P)-4293 // 90 PAGES
PRICE: 50 DFL / 20 EUROS



A History of The European Space Agency 1958 -1987

This study traces the history of the European collaborative space programme from its beginnings in the late 1950s, to the creation of a single space agency in the early 1970s and up to the late 1980s, in the light of its main actors and policies. It provides valuable insights into the complex decision making processes in a unique multinational organisation, which often involve a delicate balancing act between the various interests of the member states.

Hardbound, 2 Volumes, 1150 pages

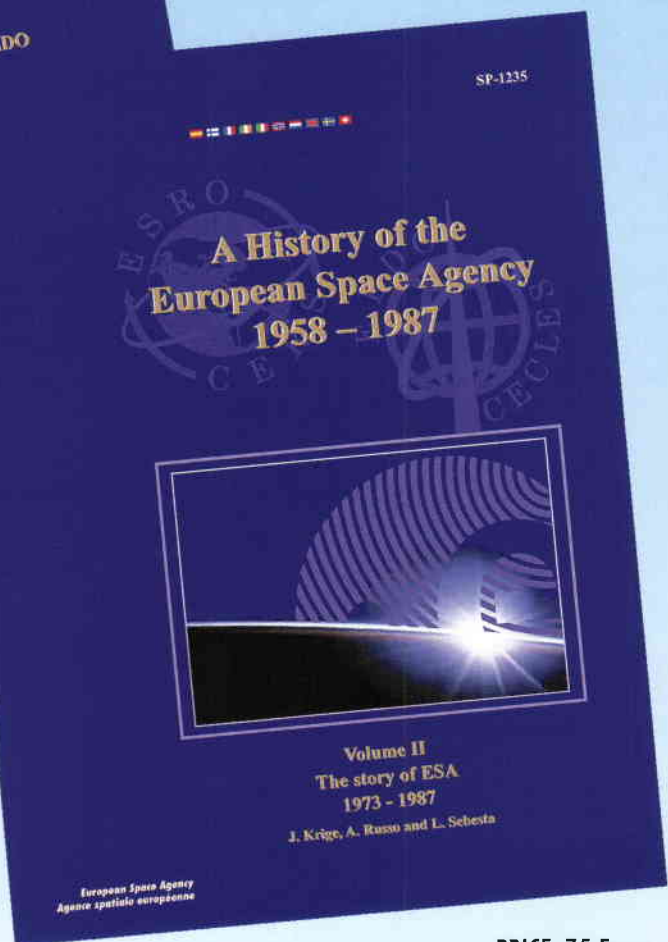
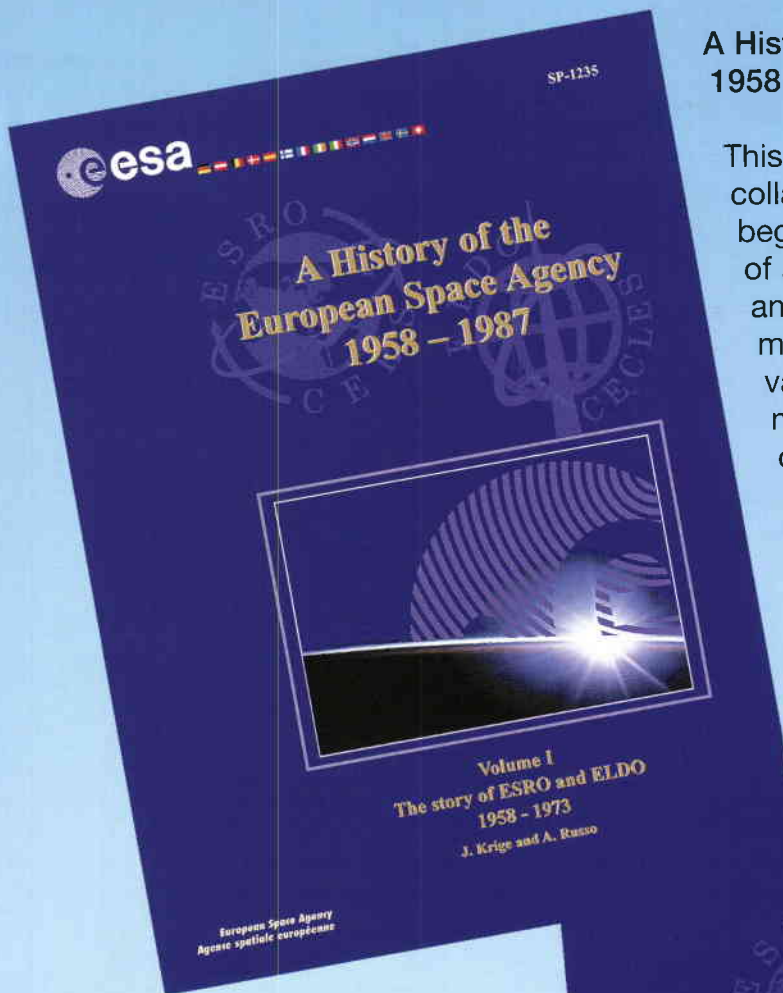

PRICE: 75 Euros

Contact: *ESA Publications Division*
c/o ESTEC, PO Box 299, 2200 AG Noordwijk, The Netherlands
Tel. (31) 71 565 3405 - Fax (31) 71 565 5433

ORDER FORM INSIDE BACK COVER



**EUROPEAN CONFERENCE
ON
SPACECRAFT STRUCTURES,
MATERIALS AND
MECHANICAL TESTING**

**29 November - 1 December 2000
ESTEC, Noordwijk
The Netherlands**

CONFERENCE SECRETARIAT

ESTEC Conference Bureau
Postbus 299
NL-2200 AG Noordwijk
The Netherlands
Tel.: +31-71-565 50 05
Fax: +31-71-565 56 58
e-mail: confburo@estec.esa.nl

<http://www.estec.esa.nl/CONFANNOUN/00a09>



Please contact for information:
ESA/PAC Secretariat
ESTEC
Postbus 299
2200 AG Noordwijk
The Netherlands

Tel.: +31.71.565-5613
Tel.: +31.71.565-3262
Fax: +31.71.565-3042

Symposium e-mail address:
pac@estec.esa.nl

Symposium Web address:
<http://www.cnes.fr/colloque>

15th ESA Symposium on European Rocket and Balloon Programmes and Related Research

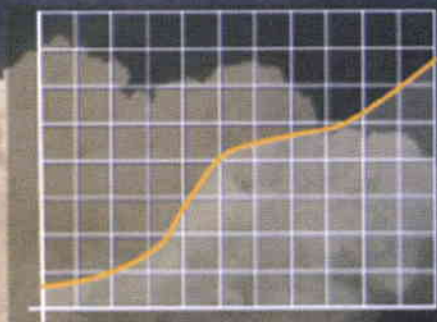

28 May – 1 June 2001 - Biarritz - France



CENTRE NATIONAL D'ETUDES SPATIALES

Available from ESA Publications Division

Publication	Number of issues per year	Scope/Contents	Price	Source
Periodicals				
ESA Bulletin	4	ESA's house magazine	Free of charge	ESA Publications Division
Earth Observation Quarterly	4	Remote-sensing newsletter	"	"
Reaching for the Skies	4	Space Transportation System newsletter	"	"
On Station	4	Space Station and Microgravity newsletter	"	"
Preparing for the Future	4	Technology Programme newsletter	"	"
ECSL News	4	News from the European Centre for Space Law (under ESA auspices)	"	"
Monographs				
	Code			
Conference Proceedings	(SP-xxx)	Collections of papers presented at ESA conferences	Prices vary	ESA Publications Division
Special Publications	(SP-xxxx)	Detailed monographs on ESA programmes/projects	"	"
Brochures	(BR-xxx)	Concise summaries on ESA programmes/projects	"	"
Scientific & Technical Reports	(STR-xxx)	Reflecting ESA's position on a given subject	"	"
Scientific & Technical Memoranda	(STM-xxx)	Latest but not finalised thinking on a given subject	"	"
Procedures, Standards & Specifications	(PSS-xxx)	Definitive requirements in support of ESA contracts	"	"
Training Manuals	(TM-xxx)	Series for education of users or potential users of ESA programmes, services or facilities	"	"
Public-relations material		General ESA literature, posters, photographs, films, etc.	ESA Communication Dept. 8-10 rue Mario-Nikis 75738 Paris 15, France	

All periodicals are also available via the Internet at:

<http://esapub.esrin.esa.it/>

Public-relations material and other ESA information is available at:

<http://www.esa.int>

Order Form for ESA Publications

No publications sent before receipt of payment in Dutch guilders (Dfl) or Euros (€).

No. of copies	ESA reference no.	Title	Price per copy Dfl./€	Total Dfl./€
Total amount:				

Mailing Address (please print carefully):

Name _____

Function _____ Organisation _____

Address _____

Post Code _____ Country _____

Date _____ Signature _____

Payment (please tick as appropriate):

Cheque enclosed (made payable to ESA Publications Division)
 Return Order Form with cheque to: ESTEC – Finance Division (ADM-FT)
 P.O.Box 299 – 2200 AG Noordwijk – The Netherlands

Items ordered are free of charge Charge to: Eurocard/Mastercard Visa AmEx

Card No. _____ Expiry date: _____

Card Holder's Name _____

Return Order Form to: The Bookshop (attn. Mr Frits de Zwaan) – ESA Publications Division – ESTEC
 P.O.Box 299 – 2200 AG Noordwijk – The Netherlands; Fax: +31 (0)71 565 5433

Telephone orders (and further information): +31 (0)71 565 3405

Information via e-mail: fdezwaan@estec.esa.nl
 Internet – list of the latest publications: <http://esapub.esrin.esa.it/>

ADVERTISE YOUR SPACE-RELATED PRODUCTS/SERVICES IN **esa bulletin**

Mechanical Requirements - Copy dates

Printing material: 1 positive offset film (right reading, emulsion side down)

Usable Material: Negative, artwork ready for reproduction.
All production charges are invoiced separately.

Copy date: Ready for printing: 30 days before publication
(in Noordwijk) Any difficulty in observing these deadlines after reservation should be notified immediately.

fax: (+31) (0)71-565-5433
tel: (+31) (0)71-565-3794

Type area: 1/1 page 185/265 mm high
1/2 page 185/131 mm high
1/4 page 185/65 mm high

Screen: 60/cm - 150/inch

Page size: 297 mm x 210 mm

Bleed amount: 3 mm

Issue dates:

ESA Bulletin: February, May, August and November

Rates in Euros

	1x	4x	8x
1/1 page	€ 1.000.-	€ 800.-	€ 600.-
1/2 page	€ 600.-	€ 500.-	€ 400.-
1/4 page	€ 400.-	€ 350.-	€ 300.-

Extra charge for 4 colour processing € 750.-

Loose inserts (by application only): one A4 sheet € 1500.- plus the binder's handling charge of (currently) € 75.- per thousand.

Advertising Management:

Brigitte Kaldeich-Schürmann
ESA Publications Division, DG-CP
ESTEC
Keplerlaan 1
2201 AZ Noordwijk
The Netherlands
Tel.: (+31) (0)71-565-3794
Fax: (+31) (0)71-565-5433
e-mail: bkaldeic@estec.esa.nl

Circulation

Albania	Germany	Philippines
Algeria	Gibraltar	Poland
Andorra	Greece	Portugal
Argentina	Guatemala	Puerto Rico
Australia	Honduras	Qatar
Austria	Hong Kong	Romania
Bahrain	Hungary	Rwanda
Bangladesh	Iceland	Sao Tome & Principe
Barbados	India	Saudi Arabia
Belgium	Indonesia	Senegal
Belize	Iran	Serbia
Benin	Iraq	Singapore
Bhutan	Ireland	Slovakia
Bolivia	Israel	Slovenia
Bosnia and Herzegovina	Italy	South Africa
Botswana	Ivory Coast	Spain
Brazil	Jamaica	Sri Lanka
Bulgaria	Japan	Sudan
Burkina Faso (Upper Volta)	Jordan	Surinam
Burma	Kenya	Swaziland
Burundi	Korea	Sweden
Cameroon	Kuwait	Switzerland
Canada	Latvia	Syria
Chile	Lebanon	Tahiti
China	Liechtenstein	Taiwan
Colombia	Libya	Tanzania
Commonwealth of Independent States	Lithuania	Thailand
Congo	Luxembourg	Togo
Costa Rica	Macedonia	Trinidad and Tobago
Croatia	Madagascar	Tunisia
Cuba	Mali	Turkey
Cyprus	Malta	Uganda
Czech Republic	Mauritania	UAE
Denmark	Mauritius	United Kingdom
Dominican Republic	Mexico	Uruguay
Dubai	Monaco	USA
Ecuador	Mongolia	Venezuela
Egypt	Montenegro	Vietnam
El Salvador	Morocco	Yemen
Estonia	Mozambique	Zaire
Ethiopia	Nepal	Zambia
Faroe Islands	Netherlands	Zimbabwe
Fiji	Netherlands Antilles	
Finland	New Caledonia	
France	New Zealand	
French Guiana	Nicaragua	
Gabon	Niger	
Gambia	Nigeria	
	Norway	
	Pakistan	
	Papua New Guinea	
	Peru	

Member States

Austria
Belgium
Denmark
Finland
France
Germany
Ireland
Italy
Netherlands
Norway
Spain
Sweden
Switzerland
United Kingdom

Etats membres

Allemagne
Autriche
Belgique
Danemark
Espagne
Finlande
France
Irlande
Italie
Norvège
Pays-Bas
Royaume-Uni
Suède
Suisse

European Space Agency
Agence spatiale européenne

Contact: ESA Publications Division
c/o ESTEC, PO Box 299, 2200 AG Noordwijk, The Netherlands
Tel (31) 71 565 3400 - Fax (31) 71 565 5433
Visit ESA Publications at: <http://www.esa.int>