



Crown Amplifiers 2007



I-Tech Series



CA Series



XTi Series



CTs Series



Maybe it's time to upgrade your music system.



LISTEN UP. WITH XM SATELLITE RADIO. XM has more of what you want to hear with 60 channels of all digital, commercial-free music. Powered by the legendary sound of Crown through an integrated XM tuner, and two included JBL speakers, the 140MAx Business Music System is ideal for coffee shops, offices, boutiques, restaurants, you name it. So ditch the old boombox and go to www.crownbusinessmusic.com. **IT'S TIME FOR AN UPGRADE.**

**Business
Music System**
SATELLITE
RADIO

**crown**

**JBL**
PROFESSIONAL

crownbusinessmusic.com

 Harman International Companies

PRESET 1:
PEP RALLY

PRESET 2:
JAZZ BAND

PRESET 3:
DJ SETUP

PRESET 4:
SPELLING BEE

PRESET 5:
GLEE CLUB

PRESET 6:
PTA

PRESET 7:
DEBATE CLUB

PRESET 8:
SOUTH PACIFIC

PRESET 9:
FULL CHOIR

PRESET 10:
ANNOUNCEMENTS

PRESET 11:
STRING ENSEMBLE

PRESET 12:
SPORTS ANNOUNCER



FINALLY, AN AMPLIFIER AS VERSATILE AS THE ROOM.

Introducing the latest technology in installed sound from Crown, the CDi Series. With three models to choose from, the CDi 1000, CDi 2000 and CDi 4000, all include built-in DSP (digital sound processing), 20 presets and, of course, the legendary Crown sound. They're easy to install, easy to use and even easier on the budget.



C R O W N C D i S E R I E S

www.crownaudio.com

H A Harman International Company



TABLE OF CONTENTS

AMPLIFIERS

Installed Sound

CTs 2-Channel Series.....	6
CTs Multi-Channel Series.....	8
CTs Multi-Channel with CobraNet.....	10
CDi Series.....	12
DSi Series.....	14
House of Worship with CDi.....	16
House of Worship with CTs.....	16
Multiple-Zone Sound System with CDi.....	17
Large House of Worship with CTs.....	17

Crown Commercial Audio Series

Preamplifier/Mixers.....	20
Amplifiers.....	22
Mixer-Amplifiers.....	26
XM Tuner-Mixer-Amplifiers.....	30
Small Pub with 180MAx PACK.....	32
Small Restaurant with 280MA.....	32
Medium Retail Store with 660A & 28M.....	33
Branded Apparel Store with CTs & 14M.....	33

Portable PA

XTi Series.....	36
XLS Series.....	38
Musician or DJ with XLS.....	40
Musician or DJ with Xs.....	40
Large Venue DJ with XTi.....	41
Regional Touring with XTi.....	41

Touring

I-Tech Series.....	44
Macro-Tech VZ Series.....	46
Macro-Tech 2402.....	48
Small System with XTi.....	50
Medium System with I-Tech.....	50

Large System with I-Tech.....	51
-------------------------------	----

Large Networked System with I-Tech.....	51
---	----

Recording/Broadcast

D Series.....	54
---------------	----

Cinema

DSi Series.....	58
DSi-8M.....	60
CTs 2-Channel Series.....	62
CTs Multi-Channel Series.....	62
XLS Series.....	62
DBC Network Bridge.....	63
Small Passive System with XLS.....	64
Medium Bi-Amplified System with DSi.....	64
Large Bi-Amplified System with DSi.....	65
DBC System with CTs.....	65

IQ NETWORK

HiQnet Software.....	68
Networked Nightclub with I-Tech & CTs.....	68
Networked Restaurant w/ CTs.....	69
PIP-LITE.....	70
PIP-USP3.....	70
PIP-USP3/CN.....	71

ACCESSORIES & REFERENCE

Accessories.....	73
Amp Feature Comparison Chart.....	75
Amplifier Specifications.....	76
Module Compatibility.....	78
Warranties and Trademarks Notice.....	78



CROWN CDi 1000

DSP OFF

Exit / Enter Prev / Up Next / Down



CROWN CDi 2000

DSP OFF

Exit / Enter Prev / Up Next / Down



INSTALLED SOUND

CTs 2-Channel Series

CTs Multi-Channel Series

CTs Multi-Channel with CobraNet™

CDi Series

DSi Series

AMPLIFIERS ▶ INSTALLED SOUND

CTs Series: The New Standard

CTs 600, CTs 1200, CTs 2000, CTs 3000



Foundation

▶ **FEATURES**

- High power density. All two channel models in a 2U chassis.
- New Crown Switching Power Supply for lighter weight.
- Selectable "Constant-Voltage" or low-impedance operation per channel.
- 100V direct outputs on CTs 2000, CTs 3000.
- Fully PIP2-compatible.

POWER OUTPUT*

Models	2-ohm Dual (per channel)	4-ohm Dual (per channel)	8-ohm Dual (per channel)	16-ohm Dual (per channel)	70V Dual (per channel)	100V Dual (per channel)	4-ohm Bridge	8-ohm Bridge	16-ohm Bridge	140V Bridge	200V Bridge
CTs 600	150W**	300W	300W	300W	300W	—	300W**	600W	600W	—	—
CTs 1200	250W**	600W	600W	300W	600W	—	500W**	1,200W	1,200W	—	—
CTs 2000	1,000W	1,000W	1,000W	625W	1,000W	1,000W	2,000W	2,000W	2,000W	2,000W	2,000W
CTs 3000	1,500W	1,500W	1,250W	625W	1,500W	1,500W	3,000W	3,000W	2,500W	3,000W	3,000W

*Maximum average power in watts at rated THD, 20 Hz - 20 kHz.

** At 1 kHz.



► SPECIFICATIONS

Performance

Frequency Response (at 1 watt) 20 Hz to 20 kHz: ± 0.25 dB.

Signal-to-Noise Ratio, A-weighted, below rated power (20 Hz to 20 kHz): 105 dB.

Total Harmonic Distortion (THD) at full rated power, from 20 Hz to 20 kHz
CTs 600 & CTs 1200: < 0.1%.
CTs 2000 & CTs 3000: < 0.35%.

Intermodulation Distortion (IMD) 60 Hz and 7 kHz at 4:1, from -40 dB to full power: < 0.1% for CTs 600/1200 and < 0.35% for CTs 2000/3000.

Damping Factor, 10 Hz to 100 Hz: > 3000.

Crosstalk (below rated power, 20 Hz to 1 kHz): > 80 dB.

Voltage Gain (at maximum level setting)
8/4-ohm operation, 1.4V sensitivity
CTs 600: 35:1 (31 dB).
CTs 1200: 50:1 (34 dB).
CTs 2000: 63.9:1 (36 dB).
CTs 3000: 71.4:1 (37 dB).

26 dB: 20:1 (26 dB).

70V operation, 1.4V sensitivity or
100V operation, 2.0V sensitivity: 50:1 (34 dB).

Common Mode Rejection (CMR) (20 Hz to 1 kHz, typical): 50 dB.

Maximum Input Level: +20 dBu before input compression, +32 dBu absolute maximum.

Load Impedance (safe with all types of loads):
CTs 600 & CTs 1200: Stereo, 2 to 16 ohms and 70V; Mono, 4 to 16 ohms and 140V.

CTs 2000 & CTs 3000: Stereo, 2 to 16 ohms, 70V and 100V; Mono, 4 to 16 ohms, 140V and 200V.

Input Impedance (nominal): 10 kilohms balanced, 5 kilohms unbalanced.

AC Line Voltage and Frequency Configurations Available ($\pm 10\%$): 120VAC, 60 Hz and 230VAC, 50 Hz.

Power Draw at Idle (120VAC mains):
CTs 600 & CTs 1200: 24W (standby mode).
CTs 2000 & CTs 3000: 35W (standby mode).

DC Output Offset (shorted input): $< \pm 2$ millivolts.

Front Panel Controls and Indicators

Power Switch: Push-on / push-off switch.

Indicators: Bridge Mode, Ready, Signal, Clip, Thermal, Fault, Data, Power.

Back Panel Controls and Connectors

Power Cord Connector: Standard 15 amp IEC inlet. Voltage is indicated above IEC inlet.

Reset Switch: Resets the circuit breaker that protects the power supply.

Speaker Connectors: One four-pole touch-proof terminal strip. Accepts up to 10 AWG terminal forks.

Input Connectors: Balanced 3-pin terminal block connectors, one per channel, on the standard PIP2-BBY module.

Channel Level Control: One 21-position detented rotary attenuator per channel, ranging from minus infinity (-70 dB) to 0 dB gain.

Mode Switch: Two-position switch is used to select the amplifier's mode of operation: Dual or Bridge-Mono.

Highpass Filter: One 3-position switch per channel selects between OFF, 35Hz and 70Hz 3rd-order filters.

"Y" Input Switch: When set to ON, this switch parallels the input signals of the two channels, for use when the input signal is mono. Also can be used to daisy-chain the signal to another amplifier.

Ventilation Grille: Front-to-rear forced airflow.

Protection

CTs Series amplifiers provide extensive protection and diagnostic capabilities, including Thermal Level Control (TLC), fault, low-pass filters, high-pass filters, AC under/over voltage protection, DC output servo, circuit breaker, inrush limiting, and Junction Temperature Simulation (JTS) in CTs 600/1200.

Construction

Ventilation: Front-to-rear forced airflow. Two continuously variable speed fans direct the airflow through the amplifier for cooling.

Dimensions: EIA Standard 19-inch (48.3-cm) rack mount width (EIA RS-310-B), 3.5-inch (8.9-cm) height and 14.25-inch (36.2-cm) depth behind the mounting surface.

Weight

Net Weight:

CTs 600: 22.8 lbs. (10.3 kg).

CTs 1200: 23.4 lbs. (10.6 kg).

CTs 2000: 27.0 lbs. (12.2 kg).

CTs 3000: 27.7 lbs. (12.6 kg).

Shipping Weight:

CTs 600: 27.7 lbs. (12.6 kg).

CTs 1200: 28.3 lbs. (12.8 kg).

CTs 2000: 32.0 lbs. (14.5 kg).

CTs 3000: 32.7 lbs. (14.8 kg).

System Solutions

IQ® PIP™ LITE, IQ-PIP USP3,
IQ-PIP USP3/CN, PIP-3632,
PIP-4622, PIP-4632 and PIP-USL.

Regulatory Certifications



Other Applications



Note: Specifications apply to units in Dual mode with 8-ohm loads and rated input sensitivity unless otherwise specified.

Crown's CTs Series amplifiers provide exceptional performance, flexibility and value for installed sound applications. CTs Series amplifiers feature independent selection of high and low impedance operation for a specific channel, plus power levels and features that were carefully chosen to match the requirements of fixed install design. Easy integration with HiQnet™ and CobraNet™ allows CTs amplifiers to deliver a comprehensive lineup of monitoring and control features along with digital audio transport for an award-winning digital audio solution.

INSTALLED SOUND

AMPLIFIERS ► INSTALLED SOUND

CTs Multi-Channel Series: The New Standard

CTs 4200, CTs 8200



Flexibility

► **FEATURES**

- High power density: Four-channel model in a 2U chassis, eight-channel model in a 3U chassis.
- New Crown Switching Power Supply for lighter weight.
- Selectable “Constant-Voltage” or low-impedance (4/8 ohm) operation per channel-pair.
- 100V direct outputs.
- New “FIT” (Fault Isolation Topology) circuitry isolates fault conditions without affecting neighboring channels.
- Accept new MC accessory modules.

POWER OUTPUT*

Models	All channels driven			1 channel driven			All channel pairs driven			1 channel pair driven		
	4-ohm Dual	8-ohm Dual	70V Dual	4-ohm Dual	8-ohm Dual	70V Dual	8-ohm Bridge	16-ohm Bridge	100V Bridge	8-ohm Bridge	16-ohm Bridge	100V Bridge
CTs 4200	260W	200W	220W[†]	270W	220W	250W[†]	520W	400W	220W[†]	560W	440W	250W[†]
CTs 8200	200W	160W	200W[†]	270W	220W	250W[†]	400W	320W	200W[†]	540W	440W	250W[†]

*Maximum average power in watts at 1kHz at 0.1% THD.

†Constant Voltage full-bandwidth power ratings support 100 Hz to 20 kHz due to automatic high-pass filters.



► SPECIFICATIONS

Performance

Frequency Response (at 1 watt, 20 Hz - 20 kHz): ± 0.5 dB.

Phase Response (at 1 watt, 10 Hz - 20 kHz): $\pm 35^\circ$.

Signal to Noise Ratio (below rated power, 20 Hz to 20 kHz): 100 dB unweighted.

Total Harmonic Distortion (THD) at 1 watt, from 20 Hz to 20 kHz: $< 0.05\%$.

Intermodulation Distortion (IMD) 60 Hz and 7 kHz at 4:1, from 163 milliwatts to full bandwidth power: $< 0.05\%$ (typical).

Damping Factor: 10 Hz to 400 Hz: > 180 .

Crosstalk (below rated power, 20 Hz to 1 kHz): > 80 dB.

Common Mode Rejection (CMR) (20 Hz to 1 kHz): > 50 dB.

DC Output Offset (shorted input): $< \pm 5$ mV.

Input Impedance (nominal): 20 kilohms balanced, 10 kilohms unbalanced.

Maximum Input Level (before input compression): $+20$ dBu.

Load Impedance: (Note: Safe with all types of loads)

Stereo: 4/8 and 25 ohms (70V).

Bridge Mono: 8/16 and 50 ohms (100V).

Voltage Gain (at maximum level setting), 1.4V sensitivity,

4/8 Ohm Operation: 20:1 (26 dB).

70V Operation: 50:1 (34 dB).

100V Operation: 71.4:1 (37 dB).

AC Line Voltage and Frequency Configurations

Available ($\pm 10\%$): 120V/60 Hz, 220/230/240V/50 Hz.

Power Draw at Idle (120VAC mains, all channels in 4/8 ohm mode): 58W.

Power Draw at Idle (120VAC mains, all channels in 70V mode): 77W.

Front Panel Controls and Indicators

Indicators: Bridge, Ready, Signal, Clip, Thermal, Fault, Data, Power.

Power Switch: Amplifier is on when the switch is in the IN position.

Back Panel Controls and Connectors

AC Power Cord Connector: IEC inlet, type 320; 100/120VAC units: 15A.

220/230/240VAC units: 10A.

Voltage is indicated above IEC inlet.

Output Connectors: One four-pole terminal strip for every two channels with touch-proof cover. Accepts up to 10 AWG terminal forks.

Accessory Panel: CTs 4200 accepts an optional VCA-MC4A module. CTs 8200 accepts an optional VCA-MC8 module.

Channel Level Controls: One 21-position detented rotary potentiometer per channel, ranging from infinity (-70 dB) to 0 dB attenuation.

Input Connectors: Removable Phoenix-style barrier connectors for balanced input.

Mode Switch: Used on each consecutive pair of channels, this four-position switch is used to select the amplifier's mode of operation: Dual 8/4 ohms, Dual 70V, Bridge-Mono 16/8 ohms, and Bridge-Mono 100V.

Protection

CTs Multi-channel Series amplifiers provide extensive protection and diagnostic capabilities, including Thermal Level Control (TLC), fault, FIT protected circuitry, AC under/over voltage protection, power fuse, and inrush limiting

Construction

Ventilation: Front-to-rear forced airflow. Continuously variable speed fans (four in the CTs 8200, one in the CTs 4200) direct the airflow through the amplifier for cooling.

Dimensions

CTs 4200: EIA Standard 19-inch (48.3-cm) rack mount width (EIA RS-310-B), 3.5-inch (8.9-cm) height and 16.25-inch (41.3-cm) depth behind the mounting surface.

CTs 8200: EIA Standard 19-inch (48.3-cm) rack mount width (EIA RS-310-B), 5.25-inch (13.3-cm) height and 16.25-inch (41.3-cm) depth behind the mounting surface.

Weight

Net Weight:

CTs 4200: 27 lb 8 oz (12.5 kg);

CTs 8200: 36 lb 6 oz (16.5 kg).

Shipping Weight:

CTs 4200: 32 lb (14.5 kg).

CTs 8200: 47 lb (21.3 kg).

System Solutions

VCA-MC4A: VCA module for CTs 4200A.

VCA-MC8: VCA module for CTs 8200.

VCA modules allow remote volume control.

Accessories

Wall-mount level control panels for use with VCA module:

1-VCAP: 1-gang panel with 1 VCA channel volume control.

4-VCAP: 2-gang panel with 4 VCA channel volume controls.

Regulatory Certifications



Other Applications



Crown's CTs Multi-channel Series offers wide flexibility for a wide range of installed sound applications. CTs Multi-channel Series amplifiers offer independent selection of high- and low-impedance operation for each channel pair, making these amps ideal for multi-zone installations.

INSTALLED SOUND

AMPLIFIERS ▶ INSTALLED SOUND

CTs Multi-Channel Series: With CobraNet
CTs 4200USP/CN, CTs 8200USP/CN



CobraNet™ Capable

▶ **FEATURES (input module)**

- 100 Mbps Ethernet single-plug solution for CobraNet audio, and HiQnet™ control and monitoring.
- Analog audio inputs allow CobraNet network audio input, CobraNet audio backup, or a hardwire emergency override of CobraNet audio.
- 24 bit digital to analog conversion with 32 bit, floating point DSP processing.
- Firmware upgrades via the network.
- 10 user selectable presets.
- Reliable FLASH memory backup of all parameters.

POWER OUTPUT*

Models	All channels driven			1 channel driven			All channel pairs driven			1 channel pair driven		
	4-ohm Dual	8-ohm Dual	70V Dual	4-ohm Dual	8-ohm Dual	70V Dual	8-ohm Bridge	16-ohm Bridge	100V Bridge	8-ohm Bridge	16-ohm Bridge	100V Bridge
CTs 4200USP/CN	260W	200W	220W[†]	270W	220W	250W[†]	520W	400W	220W[†]	560W	440W	250W[†]
CTs 8200USP/CN	200W	160W	200W[†]	270W	220W	250W[†]	400W	320W	200W[†]	540W	440W	250W[†]

*Maximum average power in watts at 1kHz at 0.1% THD.

[†]Constant Voltage full-bandwidth power ratings support 100 Hz to 20 kHz due to automatic high-pass filters.



► SPECIFICATIONS

USP/CN CobraNet Module Specifications

(for amplifier specifications, see the CTs Multi-Channel Series pages)

Connectors:

AUX Connector: Configurable for AUX input, AUX output and Listen Bus. Listen Bus is also supported through CobraNet.

Network Connector: The dual RJ45 CobraNet connectors allow a Primary & Secondary connection to the 100Mb Ethernet network. Should the Primary connection lose link activity with the network, the input module will automatically switch to the Secondary connection to ensure uninterrupted audio and control. The indicators on the RJ45 connectors display network information concerning the Ethernet and CobraNet connections.

Indicators:

Preset Indicator: Signals the number of the current preset, if active, by flashing a series of flashes equal to the current preset number.

IQ Data Indicator: Flashes when the module receives a valid command that is addressed to the CTs 4200 USP/CN and CTs 8200USP/CN.

Switches:

Reset/Preset Switch: Used to change presets, restore settings to factory default or restore all the presets to the factory defaults. During operation of the switch, the Data indicator flashes as an aid to the user. Accessible with a straightened paper clip through the rear panel, the switch selects the next user preset if pressed for less than 2 seconds, and resets the module to preset "0" if pressed for more than 2 seconds.

General:

Memory Backup: Non-volatile FLASH memory for backup of run-time parameters, presets, and program storage.

Communications: 100Mb Fast Ethernet conforming to IEEE 802.3.

Overall Audio Performance:

DSP Processing: Two processors, 32 bit, Floating Point, 724 μ s latency.

D/A and A/D Conversion: 24 bit.

Latency:

DSP processing: 1 ms or 1000 μ s.

D/A Conversion: 250 μ s.

A/D Conversion: 250 μ s.

Amplifier: 100 μ s.

Total: 1.6 ms or 1600 μ s.

Dynamic Range: 103 dB typical (A-weighted, 20Hz–20kHz, audio sourced from muted CobraNet channel).

Distortion: < 0.1% THD+N, 20Hz–20kHz.

Frequency Response: \pm 0.5 dB, 20Hz–20kHz.

Input/Output Monitor Accuracy: Typically \pm 1dB.

Maximum Input Level: + 20 dBu.

Regulatory Certifications



Other Applications



CTs 8200USP/CN Back Panel (note USP/CN CobraNet module at top left)

The Crown® CTs 4200USP/CN and CTs 8200USP/CN power amplifiers have an integrated 3rd generation, DSP-based input module. It connects the amplifier to a 100 Mbps Ethernet network allowing it to be remotely controlled and monitored via System Architect™ software. In addition, the input module allows the transport of real-time digital audio via CobraNet™ over the same Ethernet network. The amplifiers connect to a HiQnet™ audio control/monitor network using standard 100 Mbps Ethernet hardware (switches, Network Interface Cards, and cables). CobraNet™ audio is available over the same 100 Mbps Ethernet network, providing a simple-to-install, single-plug solution for audio distribution, control, and monitoring.

INSTALLED SOUND

AMPLIFIERS ▶ INSTALLED SOUND

CDi Series: 2/4/8 Ohm, 70V per channel

CDi 1000, CDi 2000



Versatility

▶ FEATURES

- Onboard digital signal processing includes crossovers, EQ filters, delay, and output limiting.
- Computer connectivity via USB allows fast setup and configuration with HiQnet™.
- Barrier strip outputs, removable Phoenix-style input.
- Extremely versatile, handling a wide range of speaker impedances and outputs.
- Switch-mode universal power supply.
- Speaker presets for crossover frequencies, EQ, limiting, compression, delay, and subharmonic synthesis.

POWER OUTPUT*

Models	2-ohm Dual (per channel)	4-ohm Dual (per channel)	8-ohm Dual (per channel)	70V Dual (per channel)	4-ohm Bridge	8-ohm Bridge
CDi 1000	700W**	500W	275W	500W	1,400W**	1,000W
CDi 2000	1,000W**	800W	475W	800W	2,000W**	1,600W

*Maximum average power in watts at 1 kHz at 0.5% THD. **With 1% THD.



► SPECIFICATIONS

Performance

Output Power: See power charts on previous page.

Voltage Gain at 1kHz, 8 ohm rated output:

CDi 1000: 30.5 dB.

CDi 2000: 32.9 dB.

Frequency Response: +0/-1 dB from 20 Hz to 20 kHz at 1 watt into 4 ohms.

Load Impedance: Safe with all types of loads. Rated for 2 to 8 ohms in Stereo mode, 4 to 16 ohms in Bridge-Mono mode.

Sensitivity: 1.4V.

Signal to Noise Ratio (below rated 8-ohm power at 1 kHz): 100 dB (A weighted).

Damping Factor: Better than 500 from 20 Hz to 400 Hz.

Crosstalk: > 70 dB below rated power, 20 Hz to 1 kHz.

Input Stage: Input is electronically balanced and employs precision 1% resistors.

Input Impedance (nominal): 20 k ohms, balanced; 10 k ohms, unbalanced.

Maximum Input Signal: +22 dBu typical.

AC Line Voltage and Frequency Configurations Available: 100V, 120V, 220-240V, 50/60 Hz.

AC Line Current:

CDi 1000: 6.5A.

CDi 2000: 6.9A.

At Idle: Draws no more than 90 watts.

Operating Temperature: 0° C to 40° C at 95% relative humidity (non-condensing).

DSP Section

Input EQ: 6 parametric filters per channel with adjustable Q, ±15 dB boost/cut. Also adjustable high and low shelving filters. This 8-filter EQ section can be bypassed.

Crossover Filters: Highpass and lowpass per channel. Butterworth 6/12/18/24 dB per octave and Linkwitz-Riley 24/48 dB per octave. Also includes ±15 dB bandpass gain and polarity control.

Output EQ: 8 parametric filters per channel with adjustable Q, ±15 dB boost/cut. This 8-filter EQ section can NOT be bypassed. Filters are enabled individually.

Delay: Up to 50 msec total delay per channel.

Output Limiter: Prevents clipping and protects loudspeakers. Choice of -3, -6, or -12 dB threshold per channel.

Presets: 20 presets. 19 are user-definable.

Front Panel Controls and Indicators

Level: Detented rotary level control, one per channel.

Power Switch: On/off switch applies AC power to the amplifier.

Sel/Prev/Next Buttons: Three buttons near the LCD screen are used to access menu items and front panel lockout.

LCD Screen: Backlit liquid crystal display shows speaker presets and signal processing.

Signal Indicator: Green LED, one per channel, illuminates when a very low-level signal is present at input.

-10 Indicator: Green LED flashes when output signal exceeds -10 dB below clip.

-20 Indicator: Green LED flashes when output signal level exceeds -20 dB below clip.

Ready Indicator: Green LED, one per channel, illuminates when the amplifier is ready to produce audio.

Clip Indicator: Red LED, one per channel, turns on at the threshold of audible distortion.

Temp Indicator: Red LED, one per channel, illuminates under excessive temperature conditions.

Power Indicator: Blue LED illuminates when the amplifier has been turned on and has power.

Rear Panel Controls and Connectors

AC Line Connector: NEMA 5-15P (15A).

Input Connector: Two 3-pin removable Phoenix-type connectors each accept a balanced line-level input signal.

Output Connectors: 4-position barrier strip with connectors for dual loudspeakers or bridge-mono loudspeaker. Dual connectors work with 2-8 ohm or 70V loads. Bridge-mono connectors work with 4-8 ohm or 140V loads.

HiQnet USB Connector: Type B, connects to a USB port on a PC.

Protection

CDi-Series amplifiers are protected against shorted, open or mismatched loads; overloaded power supplies; excessive temperature; chain destruction phenomena; excessive output current, and input overload damage. They also protect loudspeakers from input/output DC, large or dangerous DC offsets and turn-on/turn-off transients

Construction

Chassis: Steel.

Cooling: Proportional speed fan with front-to-rear airflow.

Dimensions: EIA Standard 19-in. (48.3-cm) rack mount width (EIA RS-310-B), 3.5 in. (8.9 cm) high and 12.25 in. (31.11 cm) deep behind mounting surface.

Net Weight:

19 lb (8.6 kg).

Shipping Weight:

22 lb (10.0 kg).

Regulatory Certifications



Note: All measurements apply to all models of CDi Series amplifiers in stereo mode with 8-ohm loads and an input sensitivity of 26 dB gain, 1 kHz at rated power unless otherwise specified. Specifications for units supplied outside the U.S.A. may vary slightly at different AC voltages and frequencies.



The CDi Series of Crown® amplifiers are designed for installed sound applications. The series includes two models which are identical except for output power: CDi 1000 and CDi 2000. Both are rugged and lightweight, and offer unmatched value in their class. CDi-Series amplifiers feature an LCD screen with DSP speaker presets. Other features include a switch-mode universal power supply, useful function indicators, proportional-speed fan-assisted cooling, removable Phoenix-style inputs, barrier strip outputs for low-Z or 70V/140V loads, short-circuit protection and more.

INSTALLED SOUND

AMPLIFIERS ▶ INSTALLED SOUND

DSi Series: 2, 4, 8 ohm

DSi 1000, DSi 2000, DSi 4000



One-touch Performance

▶ FEATURES

- Intuitive front-panel LCD screen, automatic presets for popular JBL speaker systems for quick, easy configuration.
- Onboard digital signal processing includes crossovers, EQ filters, delay, and output limiting.
- Computer connectivity via USB allows fast setup and configuration with HiQnet™.
- Barrier strip outputs, removable Phoenix-style input.

POWER OUTPUT

Models	2-ohm Dual (per channel)	4-ohm Dual (per channel)	8-ohm Dual (per channel)	4-ohm Bridge	8-ohm Bridge
DSi 1000	700W**	500W*	275W*	1,400W**	1,000W*
DSi 2000	1,000W**	800W*	475W*	2,000W**	1,600W*
DSi 4000	1,600W**	1,200W*	650W*	3,200W**	2,400W*

*Maximum average power in watts at 1 kHz at 0.5% THD. **With 1% THD.



► SPECIFICATIONS

Performance

Voltage Gain at 1kHz, 8 ohm rated output:

DSi 1000: 26 dB.
DSi 2000: 26 dB.
DSi 4000: 26 dB.

Frequency Response: +0/-1 dB from 20 Hz to 20 kHz at 1 watt into 4 ohms.

Load Impedance: Safe with all types of loads. Rated for 2 to 8 ohms in Stereo mode, 4 to 16 ohms in Bridge-Mono mode.

Sensitivity:

At 8 ohm rated output:
DSi 1000: 2.35V.
DSi 2000: 3.09V.
DSi 4000: 3.61V.

At 4 ohm rated output:
DSi 1000: 2.24V.
DSi 2000: 2.84V.
DSi 4000: 3.47V.

At 2 ohm rated output:
DSi 1000: 1.88V.
DSi 2000: 2.24V.
DSi 4000: 2.84V.

Signal to Noise Ratio (below rated 8-ohm power at 1 kHz): 100 dB (A weighted).

Damping Factor: Better than 500 from 20 Hz to 400 Hz.

Crosstalk: > 70 dB below rated power, 20 Hz to 1 kHz.

Input Stage: Input is electronically balanced and employs precision 1% resistors.

Input Impedance (nominal): 20 k ohms, balanced; 10 k ohms, unbalanced.

Maximum Input Signal: +22 dBu typical.

AC Line Voltage and Frequency Configurations

Available: 100V, 120V, 220-240V, 50/60 Hz.

AC Line Current:

DSi 1000: 6.5A.
DSi 2000: 6.9A.
DSi 4000: 8.0A.

At Idle: Draws no more than 90 watts.

Operating Temperature: 0° C to 40° C at 95% relative humidity (non-condensing).

DSP Section

Input EQ: 6 parametric filters per channel with adjustable Q, ±15 dB boost/cut. Also adjustable high and low shelving filters. This 8-filter EQ section can be bypassed.

Crossover Filters: Highpass and lowpass per channel. Butterworth 6/12/18/24 dB per octave, Linkwitz-Riley 24/48 dB per octave. Also includes ±15 dB bandpass gain and polarity control.

Output EQ: 8 parametric filters per channel with adjustable Q, ±15 dB boost/cut. This 8-filter EQ section can NOT be bypassed. Filters are enabled individually.

Output Limiter: Prevents clipping and protects loudspeakers. Choice of -3, -6, or -12 dB threshold per channel.

Delay: Up to 50 msec total delay per channel.

Presets: 20 presets. One is "DSP OFF." Fifteen are factory-set for JBL Cinema systems. Four are user-definable.

Front Panel Controls and Indicators

Level: Detented rotary level control, one per channel.

Power Switch: On/off switch applies AC power to the amplifier.

Sel/Prev/Next Buttons: Three buttons near the LCD screen are used to access menu items and front panel lockout.

LCD Screen: Backlit liquid crystal display shows speaker presets and signal processing.

Signal Indicator: Green LED, one per channel, illuminates when a very low-level signal is present at input.

-10 Indicator: Green LED flashes when output signal exceeds -10 dB below clip.

-20 Indicator: Green LED flashes when output signal level exceeds -20 dB below clip.

Ready Indicator: Green LED, one per channel, illuminates when the amplifier is ready to produce audio.

Clip Indicator: Red LED, one per channel, turns on at the threshold of audible distortion.

Temp Indicator: Red LED, one per channel, illuminates under excessive temperature conditions.

Power Indicator: Blue LED illuminates when the amplifier has been turned on and has power.

Back Panel Controls and Connectors

AC Line Connector: NEMA 5-15P (15A).

Input Connector: Two 3-pin removable Phoenix-type connectors each accept a balanced line-level input signal.

Output Connectors: 4-position barrier strip with connectors for dual loudspeakers or bridge-mono loudspeaker.

HiQnet USB Connector: Type B, connects to a USB port on a PC.

HD-15 Connector: For cinema I/O compatibility with DSi-8M System Monitor.

Protection

DSi-Series amplifiers are protected against shorted, open or mismatched loads; overloaded power supplies; excessive temperature; chain destruction phenomena; excessive output current, and input overload damage. They also protect loudspeakers from input/output DC, large or dangerous DC offsets and turn-on/turn-off transients

Construction

Chassis: Steel.

Cooling: Proportional speed fan with front-to-rear airflow.

Dimensions: EIA Standard 19-in. (48.3-cm) rack mount width (EIA RS-310-B), 3.5 in. (8.9 cm) high and 12.25 in. (31.11 cm) deep behind mounting surface.

Net Weight: 19 lb (8.6 kg).

Shipping Weight: 22 lb (10.0 kg).

Regulatory Certifications



Note: All measurements apply to all models of CDi Series amplifiers in stereo mode with 8-ohm loads and an input sensitivity of 26 dB gain, 1 kHz at rated power unless otherwise specified. Specifications for units supplied outside the U.S.A. may vary slightly at different AC voltages and frequencies.

Other Applications



INSTALLED SOUND

The Crown® DSi Series of power amplifiers provides onboard digital signal processing including crossovers, EQ filters, delay and output limiting. The intuitive front panel LCD screen guides installers through a setup process—featuring presets for popular JBL speaker systems—to make configuration quick and easy. At the touch of a button, Crown's DSi amplifiers deliver perfectly matched performance with each award-winning JBL loudspeaker system, making this the ultimate installed-sound solution.

INSTALLED SOUND
Product Applications

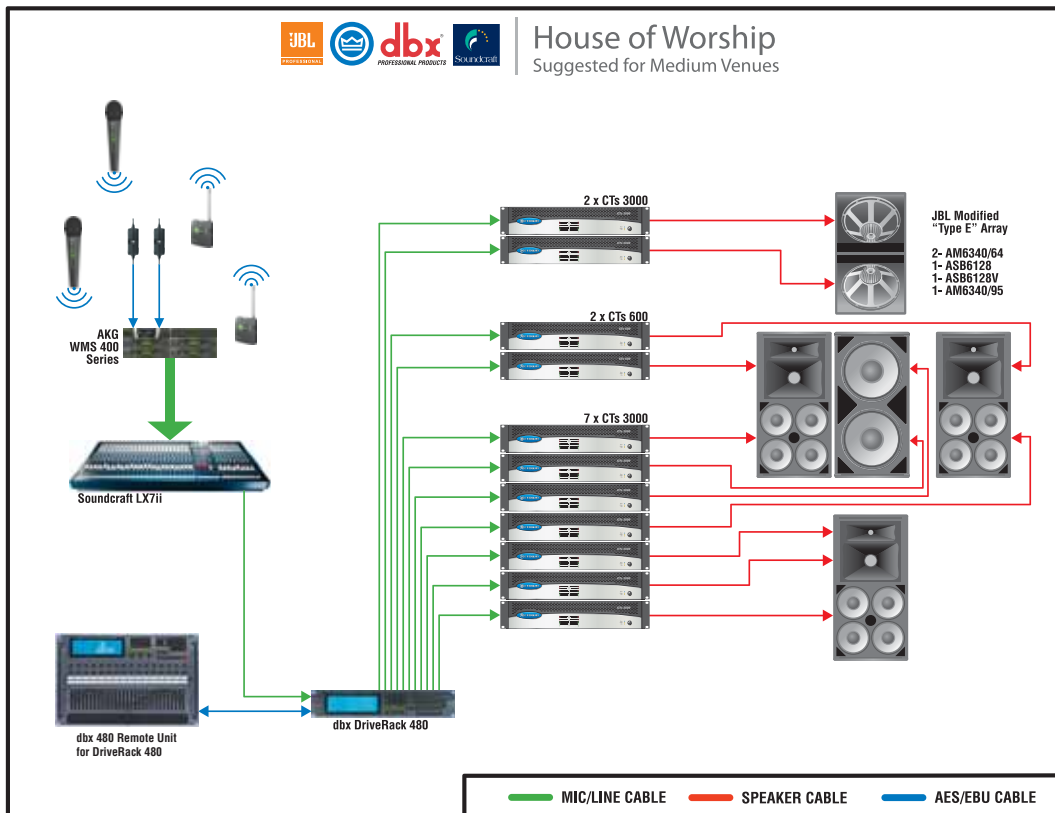
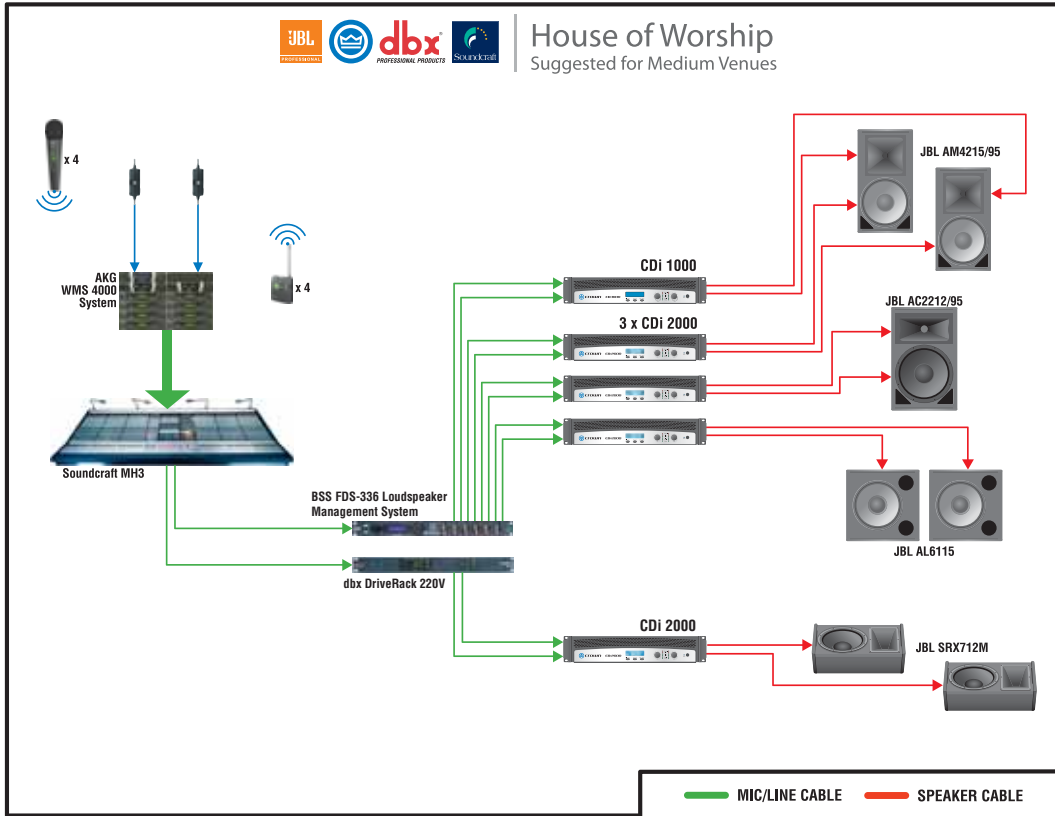

INSTALLED SOUND
Product Applications

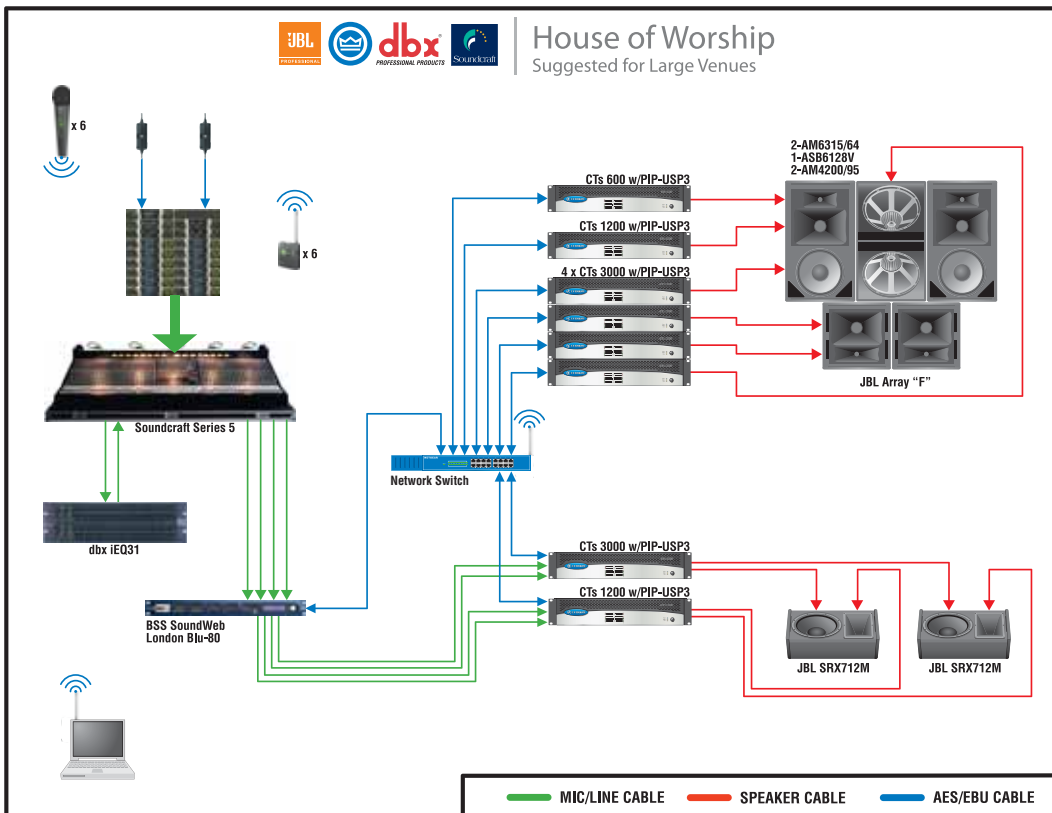
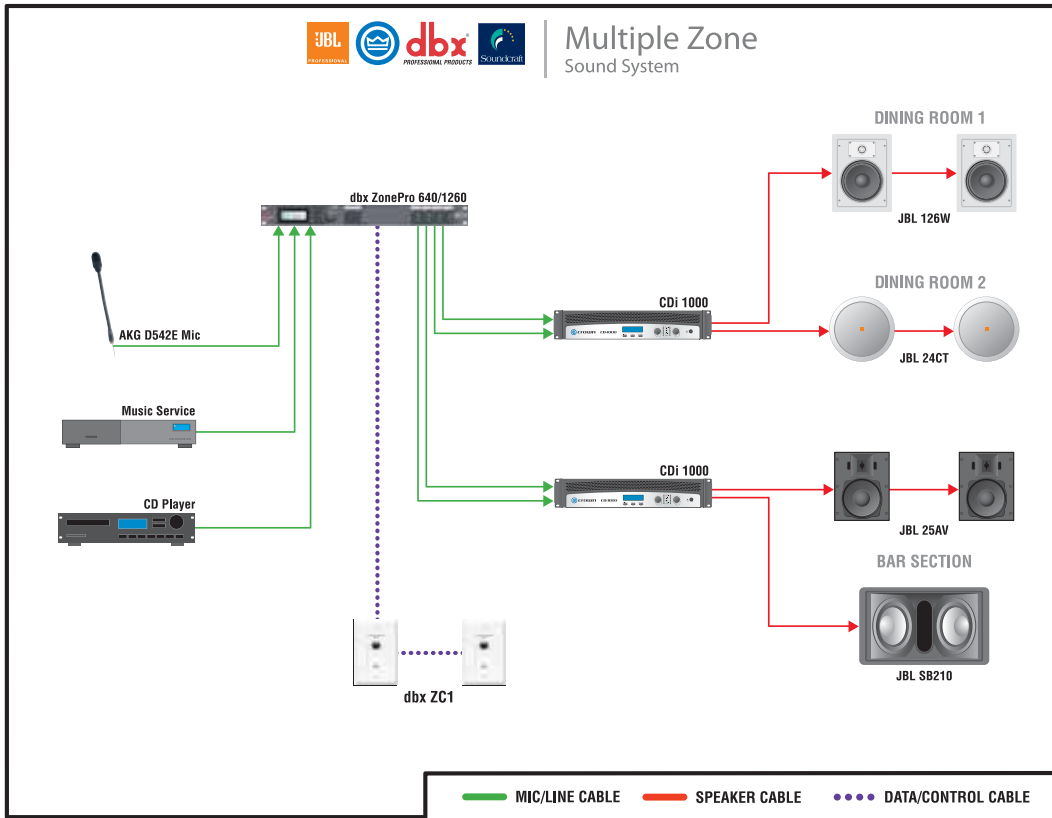





COMMERCIAL AUDIO

Preamplifier-Mixers

Amplifiers

Mixer-Amplifiers

XM Business Music Systems



Adaptable

► FEATURES

- 4 or 8 inputs, 1 or 2 output channels.
- Ideal for commercial and industrial use.
- Balanced Phoenix-type mic/line inputs; RCA inputs.
- Balanced Phoenix-type line outputs.
- Any input can be sent to any output.
- Built-in tone generator.
- Priority muting.
- Independent bass and treble controls for each input.

Model	Inputs	System Zones
14M	4	Single-zone
28M	8	Two-zone

► SPECIFICATIONS

Performance

Frequency Response (at line out): 20 Hz to 20 kHz +/- 1 dB.

Signal to Noise Ratio (master volume at minimum): 100 dB.

THD: 0.05% typical with 800 mV balanced input, 1V output.

Input Sensitivity (volts RMS for full output at maximum gain):

Balanced mic inputs: 3 mV.
Balanced line inputs: 800 mV.
RCA connectors: 400 mV.

Input Impedance (nominal):

Mic: 400 ohms.
Line: 100 kilohms.
RCA: 50 kilohms.

Crosstalk (all controls at "10"): -50 dB at 1kHz.

Line Output Level (nominal): 1.2 V into 10 kilohms.

Phantom Power: 15 VDC.

AC Line Voltage and Frequency Configurations Available:

100V 50/60 Hz.
120V 60 Hz.
220V 50/60 Hz.
230V 50/60 Hz.
240V 50/60 Hz.

Operating Temperature/Humidity: 0° C to 40° C at 95% relative humidity (non-condensing).

Storage Temperature: -20° C to 85° C.

Front Panel Controls and Indicators

Power Switch: Push-button on-off switch. The power switch does not affect the 24V DC auxiliary power input.

Input Volume Controls: Microphone/line, four in 14M, eight in 28M. Detented potentiometers with knobs.

Tone Controls: Bass and Treble non-detented potentiometers on each input channel. Bass ± 10 dB at 100 Hz, Treble ± 10 dB at 10 kHz.

Power Indicator: Blue LED indicates power on.

Input Signal Presence Indicator: Green LED, one for each input channel, illuminates when input signal exceeds -24 dBu (line) or -70 dBu (mic).

Output Signal Presence Indicator: Green LED, one for each output channel, illuminates when output signal level exceeds 100 mV.

Clip Indicators: Red LED, one per output channel. Illuminates at threshold of audible distortion.

Output Volume Controls: One per output channel. Detented potentiometer with knob.

Back Panel Controls and Connectors

Fuse: Protects the power supply.

AC Power Inlet: Detachable IEC.

Auxiliary Power Input: 2-position terminal strip for 24 VDC ($\pm 10\%$) backup power. Accepts up to 10 AWG terminal forks.

Mixer Config Switch: A DIP switch with two functions:

1. Assigns an input as the priority input for each output, thereby temporarily muting the remaining inputs. Muting is activated by contact closure.
2. Global enable switch for phantom power. Does not affect RCA inputs. Default position is off.

Priority Connector: 3-pin Phoenix-type connector allows Input 1 or Input 5 (28M only) to mute other input signals by contact closure.

Input Routing Switch (28M only): DIP switches that assign each input signal to each output. Two switches per input.

Line Out Connector: One 3-pin balanced Phoenix-type connector per output channel. Level controlled by master volume control.

Tone Generator Connector: 5-pin Phoenix-type connector. Tones include Pre-Announce Chime, Bell, Alert Tone, and Evacuate Tone. All tones are activated by contact closures on the connector.

Tone Level: One potentiometer per output channel sets the volume of the tones. Tone level is not affected by output volume controls.

Input Connectors: Mic/Line Connector: 3-pin Phoenix-type, balanced, one per input channel.

Dual RCA Input Connector: For stereo music signals, unbalanced, summed together, two connectors per input channel.

Mic/line Switch: Selects mic-level or line-level signals. One switch for each balanced input

Included Accessories

Power cord.
Detachable rack ears.
Phoenix-type connectors.
Spade lugs.

Dimensions

EIA Standard 19-inch (48.3-cm) rack mount width (EIA RS-310-B) with rack ears, 1.7-inch (4.3-cm) height and 10.7-inch (27.18-cm) depth behind the mounting surface.

Weight

Net Weight:

14M: 8.7 lb (3.9 kg).
28M: 8.7 lb (3.9 kg).

Shipping Weight:

14M: 14 lb (6.4 kg).
28M: 14 lb (6.4 kg).

Regulatory Certifications



Note: All measurements are related to 120VAC units 60 Hz unless otherwise specified. Specifications for units supplied outside the U.S.A. may vary slightly at different AC voltages and frequencies.

The Crown® 14M and 28M are high-value mixers for commercial and industrial audio. The mixers are part of Crown's Commercial Audio Series, which also includes mixer-amplifiers and power amplifiers. These low-cost units provide all necessary features in a simple building-block format. Some applications include schools, hospitals, factories, restaurant/retail, houses of worship, fitness facilities, A/V boardrooms, correctional facilities, and small offices. Typical uses are paging, background music, security and evacuation instructions. Input routing allows each input to be assigned to any output. You can add more mixers for more inputs, or add more power amps (or mixer-amps) to handle more zones. Other features include priority muting, phantom power, and a four-tone generator.

COMMERCIAL AUDIO



Power Zone

► FEATURES

- Ideal for commercial and industrial use.
- Balanced Phoenix-type line inputs; touch-proofed screw-terminal speaker outputs.
- Advanced protection system includes output current limiting, DC protection, circuit breaker/fuse, and thermal protection.
- 1 or 2 inputs; 1 to 2 amplifier output channels.

POWER OUTPUT*

Models	4-ohm	70V/100V	Inputs	System Zones
180A	80W	80W	1	Single-zone
280A	80W	80W	2	Two-zone
1160A	160W	160W	1	Single-zone

*Minimum guaranteed power in watts at 1 kHz with 0.5% THD.

► SPECIFICATIONS

Performance

Frequency Response (at 1 watt from 4-ohm tap): 70 Hz to 19 kHz +/- 1 dB.

Frequency Response (at line out): 20 Hz to 20 kHz +/- 1 dB.

Power Bandwidth (at 4-ohm tap, 2 dB below maximum 1 kHz power): 50 Hz to 20 kHz with < 0.5% THD

Signal to Noise Ratio (ref. to rated power, master volume at minimum): 85 dB.

DC Output Offset: < ±5 mV.

THD: Less than 0.5% at rated power at 1 kHz.

Input Sensitivity (for full output at maximum gain): 800 mV.

Input Impedance (nominal): 100 kilohms.

Crosstalk (all controls at "10"): -70 dB at 1kHz.

Line Output Level (nominal): 1V into 10 kilohms.

AC Line Voltage and Frequency Configurations Available:

100V 50/60 Hz.

120V 60 Hz.

220V 50/60 Hz.

230V 50/60 Hz.

240V 50/60 Hz.

Operating Temperature/Humidity: 0° C to 40° C at 95% relative humidity (non-condensing).

Storage Temperature: -20° C to 85° C.

Front Panel Controls and Indicators

Power Switch: Push-button on-off switch. The power switch does not affect the 24V DC auxiliary power input.

Power Indicator: Blue LED indicates power on.

Output Signal Presence Indicator: Green LED, one for each output channel, illuminates when output signal level exceeds 100 mV (45 dB below full power) from the 4-ohm tap.

Clip Indicators: Red LED, one per output channel. Illuminates at threshold of audible distortion.

Master Volume Controls: One per output channel. Detented potentiometer with knob.

Tone Controls: Bass and Treble non-detented potentiometers on each channel. Bass ±10 dB at 100 Hz, Treble ±10 dB at 10 kHz.

Back Panel Controls and Connectors

Reset Switch: Resets the circuit breaker that protects the power supply. 220/230/240V units have a fuse instead.

AC Power Inlet: Detachable IEC.

Auxiliary Power Input: 2-position terminal strip for 24 VDC (±10%) backup power. Accepts up to 14 AWG terminal forks.

Amplifier Outputs Connectors: One per channel, 4-position terminal strip with COM (Common), 4 ohms, 70V and 100V terminals. Accepts up to 10 AWG terminal forks. Non-touch cover included.

Output VCA Connector: One for every two channels, 4-pin Phoenix-type connector for two VCA control lines of +10 VDC and ground. Compatible with Crown 1-VCAP and 4-VCAP modules.

Line Out Connector: One 3-pin balanced Phoenix-type connector per output channel. Post master, pre-VCA. Level controlled by master volume control.

Amp Input Connector: 3-pin Phoenix-type, high-impedance balanced, one per amplifier channel.

Cooling

Convection cooled.

Protection

Current Limit Protection: Included.

Thermal Limit Protection: Over-temperature thermal cutout.

DC-Fault Load Protection: Included.

Included Accessories

Power cord.

Detachable rack ears.

Screws for rack ears.

Non-touch cover for output connectors.

Phoenix-type connectors.

Spade lugs.

Optional Accessories

1-VCAP remote volume control for one channel.

4-VCAP remote volume control for four channels.

Dimensions

EIA Standard 19-inch (48.3-cm) rack mount width (EIA RS-310-B) with rack ears, 3.5-inch (8.9-cm) height and 12.2-inch (31.0-cm) depth behind the mounting surface (not including non-touch cover). 4.1 inches (10.5 cm) high including feet. 13.9 inches (35.2 cm) deep from front of knobs to back of non-touch cover.

Weight

Net Weight:

180A: 21.0 lb (9.5 kg).

280A: 25.3 lb (11.5 kg).

1160A: 25.3 lb (11.5 kg).

Shipping Weight:

180A: 26.0 lb (11.8 kg).

280A: 30.3 lb (13.7 kg).

1160A: 30.3 lb (13.7 kg).

Regulatory Certifications

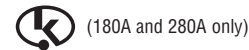

Note: All measurements are related to 120VAC units 60 Hz in stereo mode with 8-ohm loads at 1-kHz at rated power unless otherwise specified. Specifications for units supplied outside the U.S.A. may vary slightly at different AC voltages and frequencies.

COMMERCIAL AUDIO

The Crown® 180A, 280A and 1160A are high-value amplifiers for commercial and industrial audio. They provide 4-ohm and constant-voltage outputs (70V and 100V). The amps are part of Crown's Commercial Audio Series, which also includes mixers and mixer-amps. These low-cost units provide all necessary features in a simple building-block format.



6-Channel

► FEATURES

- 6 inputs; 6 amplifier output channels.
- Balanced Phoenix-type line inputs; touch-proof screw-terminal speaker outputs.
- Advanced protection system includes output current limiting, DC protection, circuit breaker/fuse, and thermal protection.
- Ideal for commercial and industrial use.

POWER OUTPUT*

Model	4-ohm	70V/100V	Inputs	System Zones
660A	60W	60W	6	Six-zone

*Minimum guaranteed power in watts at 1 kHz with 0.5% THD.

► SPECIFICATIONS

Performance

Frequency Response (at 1 watt from 4-ohm tap): 70 Hz to 19 kHz ± 1 dB.

Frequency Response (at line out): 20 Hz to 20 kHz ± 1 dB.

Power Bandwidth (at 4-ohm tap, 2 dB below maximum 1 kHz power): 50 Hz to 20 kHz with $< 0.5\%$ THD

Signal to Noise Ratio (ref. to rated power, master volume at minimum): 85 dB.

DC Output Offset: $< \pm 5$ mV.

THD: Less than 0.5% at rated power at 1 kHz.

Input Sensitivity (for full output at maximum gain): 800 mV.

Input Impedance (nominal): 100 kilohms.

Crosstalk (all controls at "10"): -70 dB at 1 kHz.

Line Output Level (nominal): 1V into 10 kilohms.

AC Line Voltage and Frequency Configurations Available:

100V 50/60 Hz.

120V 60 Hz.

220V 50/60 Hz.

230V 50/60 Hz.

240V 50/60 Hz.

Operating Temperature/Humidity: 0° C to 40° C at 95% relative humidity (non-condensing).

Storage Temperature: -20° C to 85° C.

Front Panel Controls and Indicators

Power Switch: Push-button on-off switch. The power switch does not affect the 24V DC auxiliary power input.

Power Indicator: Blue LED indicates power on.

Output Signal Presence Indicator: Green LED, one for each output channel, illuminates when output signal level exceeds 100 mV (45 dB below full power) from the 4-ohm tap.

Clip Indicators: Red LED, one per output channel. Illuminates at threshold of audible distortion.

Master Volume Controls: One per output channel. Detented potentiometer with knob.

Tone Controls: Bass and Treble non-detented potentiometers on each channel. Bass ± 10 dB at 100 Hz, Treble ± 10 dB at 10 kHz.

Back Panel Controls and Connectors

Reset Switch: Resets the circuit breaker that protects the power supply. 220/230/240V units have a fuse instead.

AC Power Inlet: Detachable IEC.

Amplifier Outputs Connectors: One per channel, 4-position terminal strip with COM (Common), 4 ohms, 70V and 100V terminals. Accepts up to 10 AWG terminal forks. Non-touch cover included.

Output VCA Connector: One for every two channels, 4-pin Phoenix-type connector for two VCA control lines of +10 VDC and ground. Compatible with Crown 1-VCAP and 4-VCAP modules.

Amp Input Connector: 3-pin Phoenix-type, high-impedance balanced, one per amplifier channel.

Cooling

Convection cooled.

Protection

Current Limit Protection: Included.

Thermal Limit Protection: Over-temperature thermal cutout.

DC-Fault Load Protection: Included.

Included Accessories

Power cord.

Detachable rack ears.

Screws for rack ears.

Non-touch cover for output connectors.

Phoenix-type connectors.

Spade lugs.

Optional Accessories

1-VCAP remote volume control for one channel.

4-VCAP remote volume control for four channels.

Dimensions

EIA Standard 19-inch (48.3-cm) rack mount width (EIA RS-310-B) with rack ears, 3.5-inch (8.9-cm) height and 12.2-inch (31.0-cm) depth behind the mounting surface (not including non-touch cover). 4.1 inches (10.5 cm) high including feet. 13.9 inches (35.2 cm) deep from front of knobs to back of non-touch cover.

Weight

Net Weight:

30.3 lb (13.7 kg).

Shipping Weight:

35.3 lb (16.0 kg).

Regulatory Certifications



Note: All measurements are related to 120VAC units 60 Hz in stereo mode with 8-ohm loads at 1 kHz at rated power unless otherwise specified. Specifications for units supplied outside the U.S.A. may vary slightly at different AC voltages and frequencies.

The Crown® 660A is a very flexible, high-value six-channel amplifier for commercial and industrial audio. It provides 4-ohm and constant-voltage outputs (70V and 100V) on channels 1 through 4, and 4-ohm outputs on channels 5 and 6. The 660A is a part of Crown's Commercial Audio Series, which also includes mixers and mixer-amps. These low-cost units provide all necessary features in a simple building-block format.

COMMERCIAL AUDIO

COMMERCIAL AUDIO ► MIXER-AMPLIFIERS

180MA, 280MA, 1160MA



Practical

► FEATURES

- 4 to 8 inputs, 1 to 2 amplifier output channels.
- Ideal for commercial and industrial use.
- Balanced Phoenix-type mic/line inputs; touch-protected screw-terminal speaker outputs.
- Any input can be sent to any output.
- Priority muting.
- Built-in four-tone generator.

POWER OUTPUT*

Models	4-ohm	70V/100V	Inputs	System Zones
180MA	80W	80W	4	Single-zone
280MA	80W	80W	8	Two-zone
1160MA	160W	160W	4	Single-zone

*Minimum guaranteed power in watts at 1 kHz with 0.5% THD.



► SPECIFICATIONS

Performance

Frequency Response: 30 Hz to 15 kHz ± 1 dB at line out.

Power Bandwidth: 50 Hz to 20 kHz with $< 0.5\%$ THD at 2 dB below maximum 1 kHz power.

Signal to Noise Ratio: 85 dB, master volume at minimum.

DC Output Offset: $< \pm 5$ mV.

THD: Less than 0.5% at rated power at 1 kHz.

Input Sensitivity (for full output at maximum gain):

- Balanced mic inputs: 3 mV.
- Balanced line inputs: 800 mV.
- RCA connectors: 400 mV.

Input Impedance:

- Mic: 400 ohms.
- Line: 100 k ohms.
- RCA: 50 k ohms.

Crosstalk: -70 dB at 1 kHz.

Line Output Level (nominal): 1V into 10 kilohms.

Phantom Power: 15 VDC.

AC Line Voltage and Frequency Configurations

Available: 100V 50/60 Hz; 120V 60 Hz; 220V 50/60 Hz; 230V 50/60 Hz; 240V 50/60 Hz.

Operating Temperature/Humidity: 0°C to 40°C at 95% relative humidity (non-condensing).

Storage Temperature: -20°C to 85°C .

Front Panel Controls and Indicators

Power Switch: Push-button on-off switch.

Input Volume Controls: Microphone/line, four in 180MA and 1160MA, eight in 280MA. Detented pots with knobs.

Tone Controls: Bass and Treble non-detented potentiometers on each input channel. Bass ± 10 dB at 100 Hz, Treble ± 10 dB at 10 kHz.

Power Indicator: Blue LED indicates power on.

Input Signal Presence Indicator: Green LED, one for each input channel, illuminates when input signal exceeds -24 dBu (line) or -70 dBu (mic).

Output Signal Presence Indicator: Green LED, one for each output channel, illuminates when output signal level exceeds 100 mV.

Clip Indicators: Red LED, one per output channel. Illuminates at threshold of audible distortion.

Output Volume Controls: One per output channel. Detented pot with knob.

Back Panel Controls and Connectors

Reset Switch: Resets the circuit breaker that protects the power supply.

AC Power Inlet: Detachable IEC.

Auxiliary Power Input: 2-position terminal strip for 24 VDC ($\pm 10\%$) backup power. Accepts up to 14 AWG terminal forks.

Amplifier Outputs Connector: One per channel, 4-position terminal strip with Com, 4 ohms, 70V and 100V terminals. Accepts up to 14 AWG terminal forks. Non-touch cover included.

Output VCA Connector: 4-pin Phoenix-type connector for two VCA control lines of +10 VDC and ground. Compatible with Crown 1-VCAP and 4-VCAP modules.

Amp Config Switch: A DIP switch with two functions:

1. Assigns one of the inputs as the priority input for each output, thereby temporarily muting the remaining inputs. Muting is activated by contact closure.
2. Global enable switch for phantom power. Does not affect RCA inputs. Default position is off.

Priority Connector: 3-pin Phoenix-type connector allows Input 1 or Input 5 (280MA only) to mute other input signals by contact closure.

Input Routing Switch (280MA only): DIP switches that assign each input signal to each output. One switch per input.

Line Out Connector: One 3-pin balanced Phoenix-type connector per output channel. Post master, pre-VCA, with level control.

Tone Generator Connector: 5-pin Phoenix-type connector. Tones include Bell, Pre-Announce Chime, Alert Tone, and Evacuate Tone. All tones are activated by contact closures on the connector.

Tone Level: One per channel, a rear-panel potentiometer that sets the volume of the tones.

Input Connectors: Mic/Line Connector, 3-pin Phoenix-type, low-impedance balanced, one per input channel. Dual RCA for stereo music signals,

unbalanced, summed together, two connectors per input channel. Amp Input Connector, 3-pin Phoenix-type, high-impedance balanced, one per amplifier channel. Used to link an additional mixer to the mixer-amplifier.

Mic/line Switch: Selects mic-level or line-level signals. One switch for each balanced input.

Link In/Out Switch: Slide switch, one per channel. With the Link Switch IN, any signal applied to the Amp Input connector will be mixed with the input signal(s). With the Link Switch OUT, only the signal from the Amp Input Connector will appear at the amplifier output.

Cooling

Convection cooled.

Protection

Current Limit Protection; Thermal Limit Protection (over-temperature thermal cutout); DC-Fault Load Protection.

Included Accessories

Power Cord. Detachable rack ears. Non-touch cover for output connectors.

Optional Accessories

1-VCAP remote volume control for one channel. 4-VCAP remote volume control for four channels.

Dimensions

EIA Standard 19-inch (48.3-cm) rack mount width (EIA RS-310-B), 3.5-inch (8.9-cm) height and 14-inch (35.6-cm) depth behind the mounting surface.

Weight:

Net Weight:

180MA: 21.0 lbs. (9.5 kg).

280MA: 25.3 lbs. (11.5 kg)

1160MA: 25.3 lbs. (11.5 kg).

Shipping Weight:

180MA: 26.0 lbs. (11.8 kg).

280MA: 30.3 lbs. (13.7 kg).

1160MA: 30.3 lbs. (13.7 kg).

Regulatory Certifications



Note: All measurements are related to 120VAC units 60 Hz in stereo mode with 8-ohm loads at 1-kHz at rated power unless otherwise specified. Specifications for units supplied outside the U.S.A. may vary slightly at different AC voltages and frequencies.

Crown's Commercial Audio mixer/amplifiers deliver legendary Crown quality to the commercial audio industry. These high-value mixer-amplifiers provide both 4-ohm and constant-voltage outputs (70V and 100V) for use in a wide range of commercial applications including schools, hospitals, factories, restaurant/retail, houses of worship, fitness facilities, A/V boardrooms, correctional facilities, and small offices. Easily configured for a range of uses such as paging, background music, security, and evacuation instructions, Crown's Commercial Audio units are the smart choice for commercial sound.

COMMERCIAL AUDIO



Music & Paging

► FEATURES

- 4 inputs (each with a volume control), one 40W amplifier output channel.
- Ideal for paging, background music, and music-on-hold.
- Balanced Phoenix-type mic/line inputs, telephone input, dual RCA stereo music inputs, touch-proof screw-terminal speaker outputs.
- Priority ducking.
- Independent bass and treble controls for each input.

POWER OUTPUT*

Model	4-ohm	70V/100V	Inputs	System Zones
140MPA	40W	40W	4	Single-zone

*Minimum guaranteed power in watts at 1 kHz with 0.5% THD.

► SPECIFICATIONS

Performance

Frequency Response (at 1 watt from 4-ohm tap): 50 Hz to 15 kHz \pm 1 dB.

Frequency Response (at line out): 50 Hz to 15 kHz \pm 1 dB.

Power Bandwidth (at 4-ohm tap, 2 dB below maximum 1 kHz power): 50 Hz to 20 kHz with $<$ 0.5% THD.

Signal to Noise Ratio (ref. to rated power, master volume at minimum): $>$ 90 dB.

DC Output Offset: $<$ \pm 5 mV.

THD: $<$ 0.5% at rated power at 1 kHz.

Input Sensitivity (for full output at maximum gain):

Balanced mic inputs: 3 mV.

Balanced line inputs: 800 mV.

RCA connectors: 400 mV.

Input Impedance (nominal):

Mic: 400 ohms.

Line: 100 kilohms.

RCA: 50 kilohms.

Crosstalk: $-$ 70dB at 1kHz.

Line Output Level (nominal): 1V into 10 kilohms.

Phantom Power: 15 VDC.

AC Line Voltage and Frequency Configurations Available (\pm 10%):

120V/60Hz.

Operating Temperature/Humidity: 0° C to 40° C at 95% relative humidity (non-condensing).

Storage Temperature: $-$ 20° C to 85° C.

Front Panel Controls and Indicators

Power Switch: Push-button on-off switch.

Input Volume Controls: Four controls, one per input. Detented potentiometers with knobs.

Tone Controls: Bass and Treble non-detented recessed potentiometer on each input channel. Bass \pm 10 dB at 100 Hz, Treble \pm 10 dB at 10 kHz.

Power Indicator: Blue LED indicates power on.

Input Signal Presence Indicator: Green LED, one for each input channel, illuminates when input signal exceeds $-$ 40 dBu.

Output Signal Presence Indicator: Green LED illuminates when output signal level exceeds 100 mV (45 dB below full power) from the 4-ohm tap.

Clip Indicator: Red LED on output illuminates at threshold of audible distortion.

Master Output Volume Control: Detented potentiometer with knob.

Back Panel Controls, Connectors and Indicators

Reset Switch: Resets the circuit breaker that protects the power supply.

AC Power Inlet: Detachable IEC.

Amplifier Output Connector: 4-position terminal strip with COM (Common), 4 ohms, 25V and 70V terminals. Accepts up to 10 AWG terminal forks. Non-touch cover included.

Output VCA Connector: 4-pin Phoenix-type connector for two VCA control lines of +10 VDC and ground. Compatible with Crown 1-VCAP module.

Priority Connector: 3-pin Phoenix-type connector for push-to-talk mic contact closure.

Preamp Line Out Connector: 3-pin balanced Phoenix-type connector. Post master, pre-VCA. Level controlled by master volume control.

MOH 1V Level Control: Trim pot adjusts level for Music-On-Hold 1V output.

MOH 1W Level Control: Trim pot adjusts level for Music-On-Hold 1W output.

MOH SPI Indicator: Flashes when MOH signal is present.

MOH 1V Phoenix Connector: 3-pin Phoenix connector for 1V, 600-ohm transformer-isolated output.

MOH 1W Phoenix Connector: 3-pin Phoenix connector for 1W output.

MOH 1V RCA Connector: Two mono RCA connectors for 1V output (in parallel with 600-ohm connections so they are isolated).

Balanced Input Connector: Detachable 3-pin Phoenix style connector for balanced line-level signals, one each for input channels 2-4.

Balanced Input Connector: Detachable 3-pin Phoenix style connector for balanced mic-level line-level signals, for input channel 1.

Tel Connector: Transformer-isolated 600-ohm input, summed into Input 1 for paging from a telephone system.

Dual RCA Input Connector: For stereo music signals, unbalanced, summed together, two connectors per input channel.

Amp Input Connector: 3-pin Phoenix-type, high impedance balanced. Used to link an additional mixer to the mixer-amplifier. Can be used to connect an external processor.

Mic/line Switch: Selects mic-level or line-level signal for Input 1.

Phantom Power Switch: Turns phantom power on or off for Input 1.

VOX Threshold: Trim pot controls how loud the voice must be before ducking occurs. Can be set for no ducking.

Link In/Out Switch: Slide switch. When set to IN, any signal applied to the Amp Input connector will be mixed with the input signal(s). When set to OUT, only the signal from the Amp Input Connector will appear at the amplifier output.

Priority Connector: 3-pin Phoenix-type connector for push-to-talk mic contact closure. Input 1 is the priority input for the amplified output, so Input 1 ducks the other inputs. Threshold of activation depends on input voltage. Ducking does not affect MOH outputs.

Active Indicator: Illuminates when VOX ducking is active.

Cooling

Convection cooled.

Protection

Current Limit Protection: Included.

Thermal Limit Protection: Over-temperature thermal cutout.

DC-Fault Load Protection: Included.

Turn On/Turn Off: No thumps or pops.

Included Accessories

Power cord.

Detachable rack ears.

Screws for rack ears.

Non-touch cover for output connectors.

Phoenix-type connectors.

Spade lugs.

Optional Accessories

1-VCAP remote volume control.

Dimensions

Width (without rack ears): 17.3 in. (43.8 cm).

Width (with rack ears): EIA Standard 19 in. (48.3 cm) W (EIA RS-310-B).

Height (front panel): 3.5 in. (8.9 cm).

Height (including feet): 4.1 in. (10.5 cm).

Depth (front panel to back panel): 12.2 in. (31.0 cm).

Depth (front of knobs to back of non-touch cover): 13.9 in. (35.2 cm).

Weight

Net Weight: 17 lb (7.7 kg).

Shipping Weight: 22 lb (9.98 kg).

Regulatory Certifications



The Crown® 140MPA is a high-value mixer-amplifier for commercial audio. It provides 4-ohm and constant-voltage outputs (25V and 70V). Typical uses are paging, background music, and music-on-hold. The unit provides 4 inputs (each with a volume control) and a 40W amplifier output. Other features include priority ducking, phantom power, and capability for remote volume control. Multiple units can be linked.

COMMERCIAL AUDIO

COMMERCIAL AUDIO ► XM TUNER-MIXER-AMPLIFIERS

180MAx Pack (180MAx tuner-mixer-amplifier also available separately)



XM Enabled

► FEATURES

- Programmable XM tuner with XM channel data display.
- Independent bass and treble controls for each input.
- Balanced Phoenix-type mic/line inputs; touch-proof screw-terminal speaker outputs.
- Priority ducking, Music-On-Hold (MOH) outputs.
- 180 MAx Pack includes four JBL Control 1ST 2-way speakers with 70V transformer and mounting brackets, remote control and XM antenna.

POWER OUTPUT*

Model	4-ohm	25V/70V	Inputs	System Zones
180MAx	80W	80W	4	Single-zone

*Minimum guaranteed power in watts at 1 kHz with 0.5% THD.



► SPECIFICATIONS

Performance

Frequency Response (at 1 watt from 4-ohm tap): 70 Hz to 19 kHz ± 1 dB.

Frequency Response (at line out): 20 Hz to 20 kHz ± 1 dB.

Power Bandwidth (at 4-ohm tap, 2 dB below maximum 1 kHz power): 50 Hz to 20 kHz with $< 0.5\%$ THD

Signal to Noise Ratio (ref. to rated power, master volume at minimum): 85 dB.

DC Output Offset: $< \pm 5$ mV.

THD: Less than 0.5% at rated power at 1 kHz.

Input Sensitivity (for full output at maximum gain):

Balanced mic inputs: 3 mV.

Balanced line inputs: 800 mV.

RCA connectors: 400 mV.

Isolated telephone input: 75 mV.

Input Impedance (nominal):

Mic: 400 ohms.

Line: 100 kilohms.

RCA: 50 kilohms.

Telephone: 600 ohms.

Crosstalk: -70 dB at 1 kHz.

Line Output Level (nominal): 1V into 10 kilohms.

Phantom Power: 15 VDC.

AC Line Voltage and Frequency Configurations Available ($\pm 10\%$): 120V, 60 Hz.

Operating Temperature/Humidity: 0° C to 40° C at 95% relative humidity (non-condensing).

Storage Temperature: -20° C to 85° C.

Front Panel Controls and Indicators

Power Switch: Push-button on-off switch.

Input Volume Controls: Four detented potentiometers with knobs.

Input 1: Microphone/line (switchable)/telephone.

Inputs 2 and 3: Line.

Input 4: XM radio.

Tone Controls: Bass and Treble non-detented recessed potentiometers on each input channel. Bass ± 10 dB at 100 Hz, Treble ± 10 dB at 10 kHz.

XM Tuner Menu Button: Selects Direct, Preset, or Category mode.

XM Tuner Category Buttons: Scrolls through categories (rock, classical, news, country, etc).

XM Tuner Scroll Knob: Lets you scroll through channels and select them.

XM Tuner Display: LCD screen displays XM channel data (channel number, channel name, artist name, song title), 16 station presets and signal strength.

Power Indicator: Blue LED indicates power on.

Input Signal Presence Indicator: Green LED illuminates when input signal exceeds -24 dBu (line) or -70 dBu (mic).

Output Signal Presence Indicator: Green LED, illuminates when output signal level exceeds 100 mV (45 dB below full power) from the 4-ohm tap.

Clip Indicator: Red LED on output illuminates at threshold of audible distortion.

Output Volume Control: Detented potentiometer with knob.

Back Panel Controls, Connectors and Indicators

Reset Switch: Resets the circuit breaker that protects the power supply.

MOH 1V Level Control: Trim pot adjusts level for Music-On-Hold 1V output.

MOH 1W Level Control: Trim pot adjusts level for Music-On-Hold 1W output.

MOH Signal Presence Indicator: Flashes when MOH signal is present.

MOH Source Switch: Switches between Input 3 or XM, and routes the source to MOH 1V Line Out and MOH 1W connectors.

MOH 1W Select Switch: Feeds 1W MOH signal either to amplifier output or internal speaker.

MOH 1V Line Output RCA Connectors: Two RCA connectors (mono) for 1-volt output (in parallel with 600-ohm connectors, so they are isolated).

MOH 1W Line Output Connector: 3-pin Phoenix connector provides Music-On-Hold signal of approximately 1 watt.

MOH 1V Line Output Phoenix Connector: 3-pin Phoenix connector, 600-ohm transformer-isolated output, provides Music-On-Hold signal of approximately 1 volt.

Phantom Power Switch: Turns phantom power on or off for Input 1.

Mic/line Switch: Selects mic-level or line-level signal for Input 1.

Link In/Out Switch: Slide switch. When set to IN, any signal applied to the Amp Input connector will be mixed with the input signal(s); when set to OUT, only the signal from the Amp Input Connector will appear at the amplifier output.

Amplifier Output Connectors: 4-position terminal strip with COM (Common), 4 ohms, 25V and 70V terminals. Accepts up to 10 AWG crimp-on terminal forks. Non-touch cover included.

XM Radio Stereo Line Out Connector: Dual RCA jacks for stereo music out from XM Radio tuner.

Preamp Line Out Connector: 3-pin balanced Phoenix-type connector. Post master, pre-VCA. Level controlled by master volume control.

Output VCA Connector: 3-pin Phoenix-type connector for two VCA control lines of +10 VDC and ground. Compatible with Crown 1-VCAP module.

Priority Connector: 3-pin Phoenix-type connector for push-to-talk mic switch. Contact closure activates ducking. Ducking does not affect Music-On-Hold outputs or XM stereo line out.

Active Indicator: LED illuminates when VOX ducking is active.

VOX Threshold: Trim pot adjusts how loud the voice must be before ducking occurs. Can be set for no ducking.

Priority Release Control: Trim pot adjusts release time of VOX ducking.

Mic/Line Input Connector (Input 1 only): 3-pin Phoenix-type, balanced.

Line Input Connectors (Inputs 2 and 3 only): 3-pin Phoenix-type, balanced.

Dual RCA Input Connector: For stereo music signals, unbalanced, summed together, two connectors per input for inputs 1, 2 and 3.

TEL Input Connector: Transformer-isolated 600-ohm input, summed into Input 1 for paging from a telephone system.

Amp Input Connector: 3-pin Phoenix-type, high-impedance balanced. Used to link an additional mixer to the mixer-amplifier. Can be used to connect an external processor.

AC Power Inlet: Detachable IEC.

XM Radio Antenna Input: Connects to the XM antenna cable.

Cooling and Protection

Convection cooled, current limiting, thermal limiting, DC Fault.

Included Accessories

Power cord, detachable rack ears, screws for rack ears, non-touch cover for output connectors, Phoenix-type connectors, spade lugs, XM antenna, remote control.

Optional Accessories

1-VCAP remote volume control.

Dimensions

Width (without rack ears): 17.3 in. (43.8 cm).

Width (with rack ears): EIA Standard 19-in. (48.3-cm) W (EIA RS-310-B).

Height (front panel): 3.5 in. (8.9 cm).

Height (including feet): 4.1 in. (10.5 cm).

Depth (front panel to back panel): 12.2 in. (31.0 cm).

Depth (front of knobs to back of non-touch cover): 13.9 in. (35.2 cm).

Weight

Net Weight: 20 lb (9.07 kg).

Shipping Weight: 25 lb (11.34 kg)

Regulatory Certifications



COMMERCIAL AUDIO

The Crown® 180Max Pack is the first tuner-mixer-amplifier and loudspeaker system designed for commercial use. It is designed for easy installation. Applications include restaurants, retail stores, coffee shops and other commercial establishments. The system includes the Crown 180Max tuner-mixer-amplifier (also available separately), four JBL® Control® 1ST 2-way loudspeakers with built-in 70V transformers, XM antenna and a wireless remote control. Built into the 180Max is an XM Radio tuner that receives satellite radio stations with digital sound quality. The unit also accepts signals from line, telephone, or microphone (phantom power included). Other features include bass and treble controls, and priority ducking.

Note: All measurements are related to 120VAC units 60 Hz in stereo mode with 4-ohm loads at 1-kHz at rated power unless otherwise specified. Specifications for units supplied outside the U.S.A. may vary slightly at different AC voltages and frequencies.

COMMERCIAL AUDIO

Product Applications

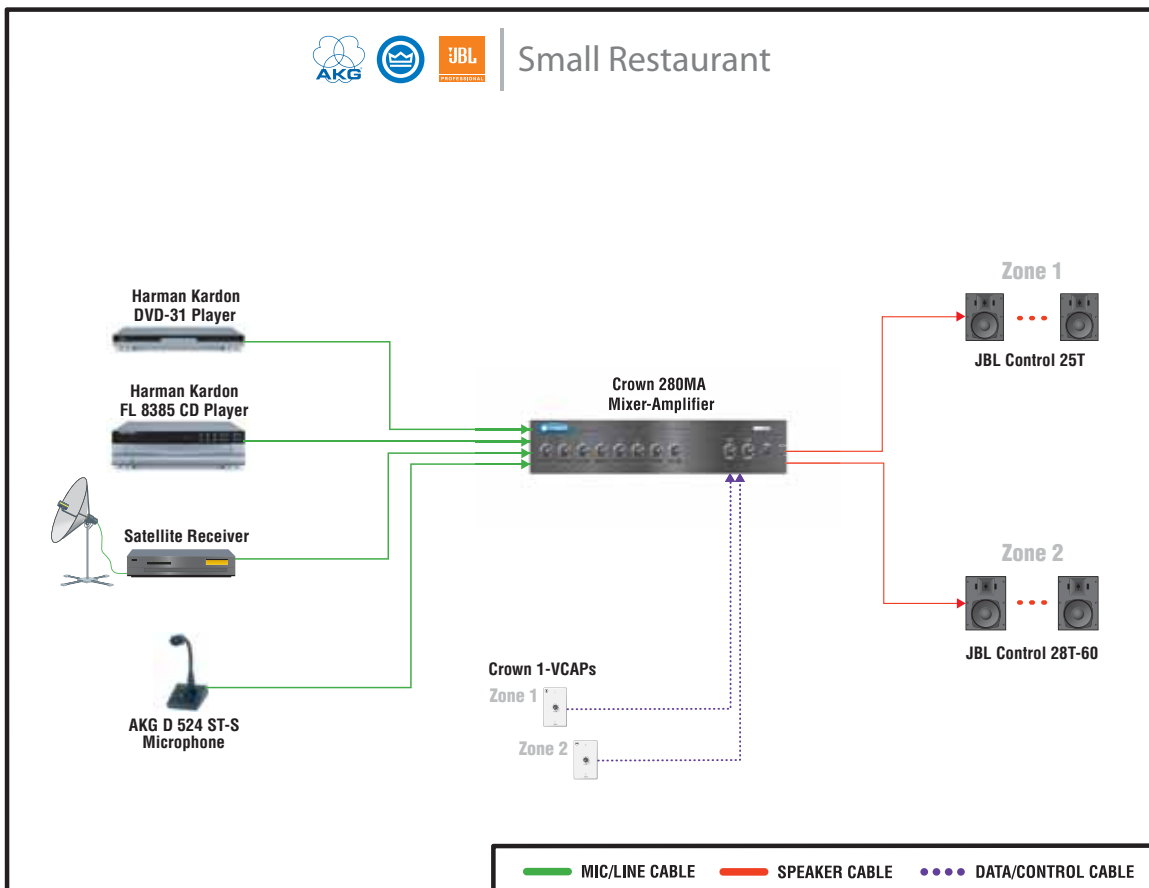
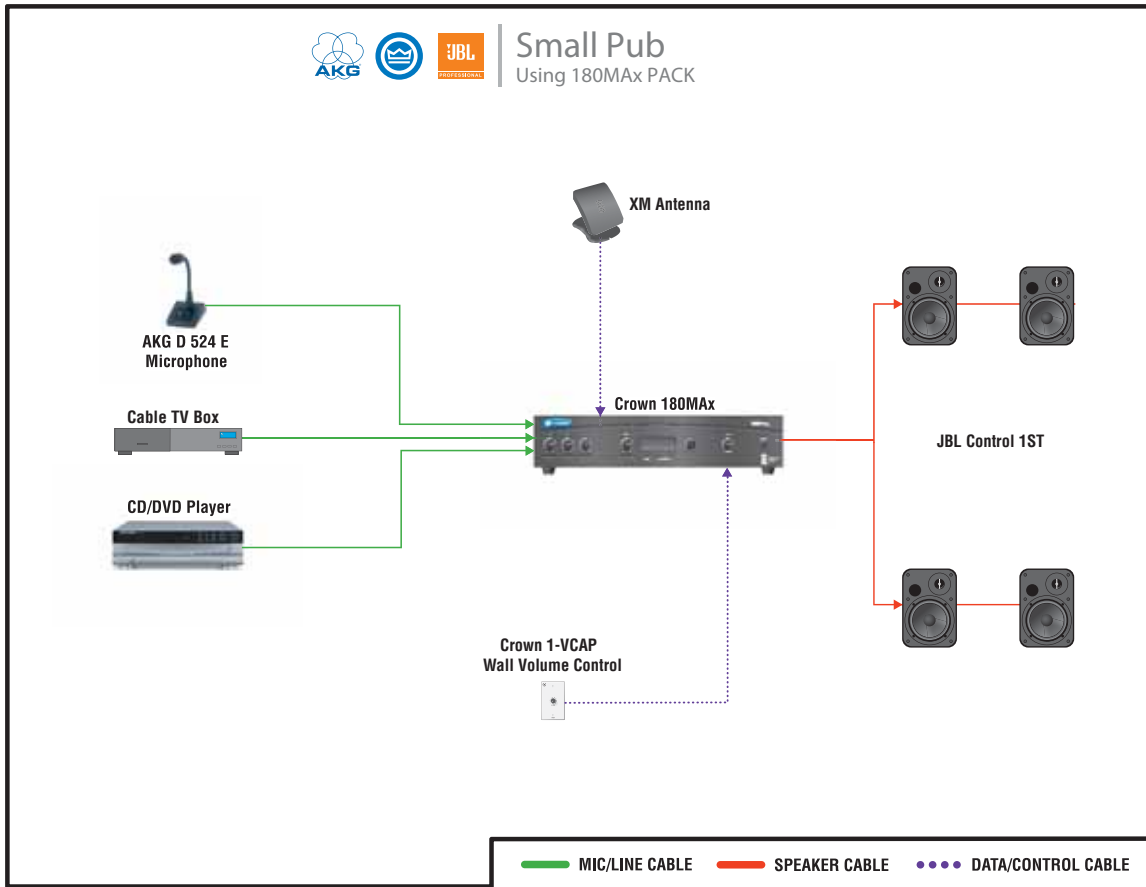

COMMERCIAL AUDIO

Product Applications

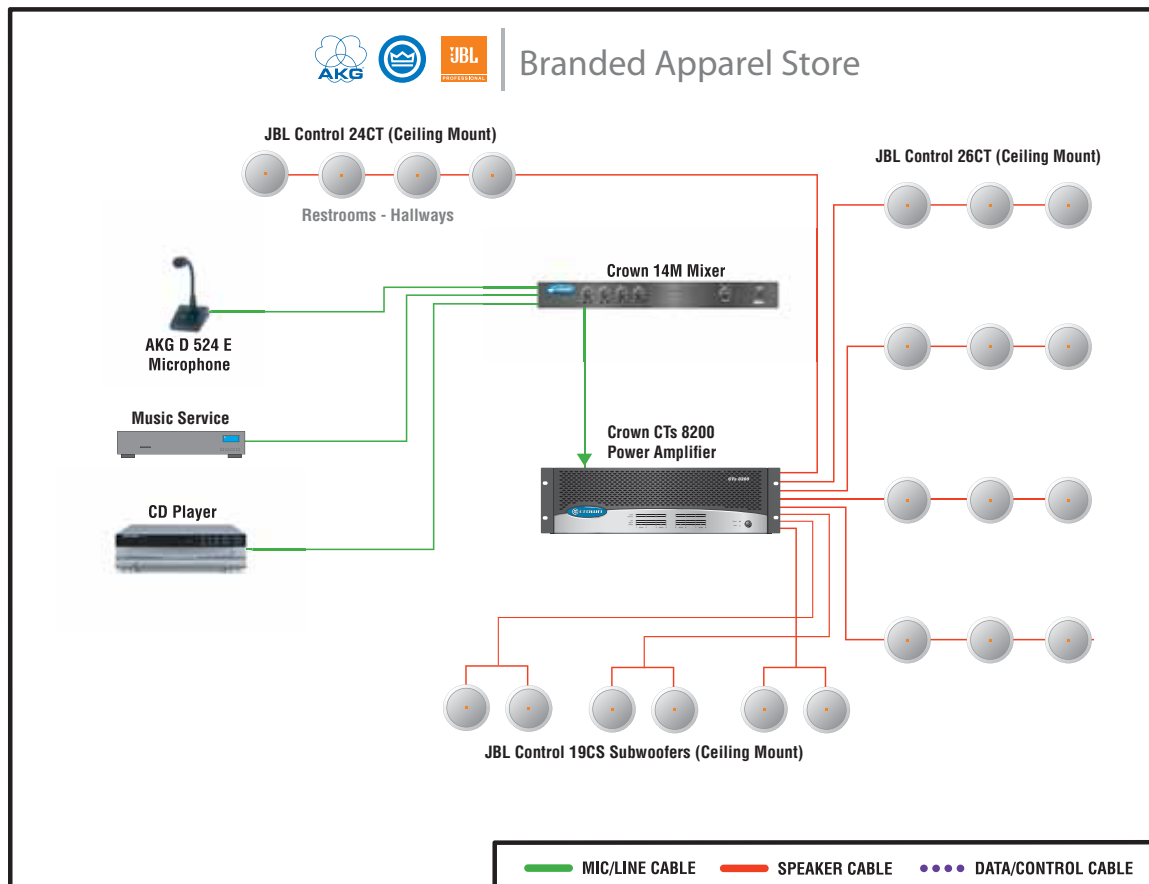
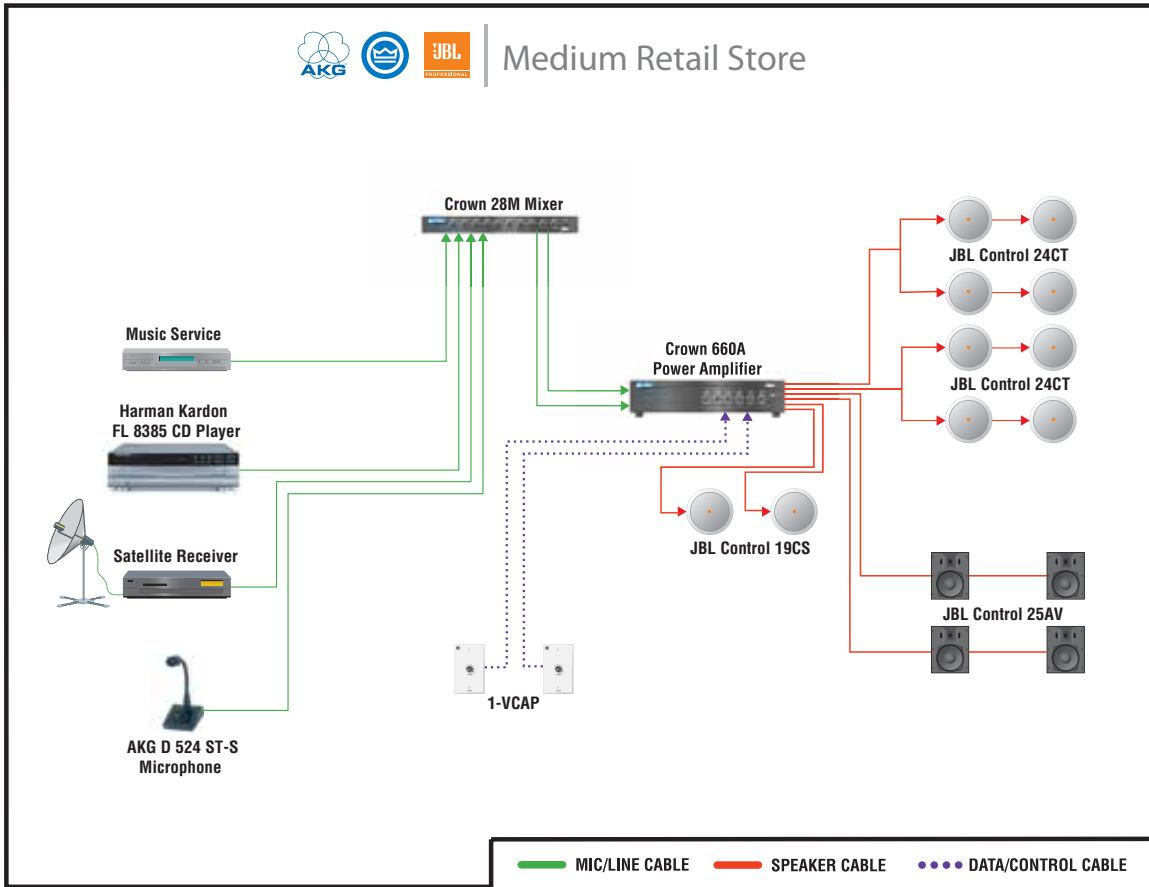





PORTABLE PA

XTi Series

XLS Series

AMPLIFIERS ► PORTABLE PA

XTi Series: World-Class

XTi 1000, XTi 2000, XTi 4000



World-Class

► FEATURES

- Computer connectivity via USB allows fast setup and configuration with HiQnet™.
- Integrated speaker presets with LCD front panel display.
- Extremely versatile, handling a wide range of speaker impedances and outputs.
- Switch-mode universal power supply.
- Speaker presets for crossover frequencies, EQ, limiting, and delay.
- All products fill 2U rack spaces and weigh under 19 pounds; weight sets a new standard in lightweight amps.
- Speakon® and binding post outputs, XLR inputs and loop-thrus.
- Comprehensive LED status per channel.

POWER OUTPUT

Model	2-ohm Dual (per channel)	4-ohm Dual (per channel)	8-ohm Dual (per channel)	4-ohm Bridge	8-ohm Bridge
XTi 1000	700W**	500W*	275W*	1,400W**	1,000W*
XTi 2000	1,000W**	800W*	475W*	2,000W**	1,600W*
XTi 4000	1,600W**	1,200W*	650W*	3,200W**	2,400W*

*1 kHz power with 0.5% THD. ** With 1% THD.



► SPECIFICATIONS

Performance

Voltage Gain at 1kHz, 8 ohm rated output:

XTi 1000: 30.5 dB.
XTi 2000: 32.9 dB.
XTi 4000: 34.2 dB.

Frequency Response: +0/-1 dB from 20 Hz to 20 kHz at 1 watt into 4 ohms.

Load Impedance: Safe with all types of loads. Rated for 2 to 8 ohms in Stereo mode, 4 to 16 ohms in Bridge-Mono mode.

Sensitivity: 1.4V.

Signal to Noise Ratio (below rated 1 kHz power at 8 ohms): 100 dB (A weighted).

Damping Factor: Better than 500 from 20 Hz to 400 Hz.

Crosstalk: > 70 dB below rated power, 20 Hz to 1 kHz.

Input Stage: Input is electronically balanced and employs precision 1% resistors.

Input Impedance (nominal): 20 k ohms, balanced; 10 k ohms, unbalanced.

Maximum Input Signal: +22 dBu typical.

AC Line Voltage and Frequency Configurations

Available: 100VAC, 120VAC, 220-240VAC, 50/60 Hz.

AC Line Current:

XTi 1000: 6.5A.
XTi 2000: 6.9A.
XTi 4000: 8.0A.

At Idle: Draws no more than 90 watts.

Operating Temperature: 0° C to 40° C at 95% relative humidity (non-condensing).

DSP Section

Input EQ: 6 parametric filters per channel with adjustable Q, ±15 dB boost/cut. Also adjustable high and low shelving filters. This 8-filter EQ section can be bypassed.

Crossover Filters: Highpass and lowpass per channel. Butterworth 6/12/18/24 dB per octave. Linkwitz-Riley 24/48 dB per octave. Also includes ±15 dB bandpass gain and polarity control.

Delay: For signal alignment of driver; 50 mS total delay.

Subharmonic Synthesizer: Takes the low-frequency content of the input signal and “synthesizes” a new signal that is the same as the input signal but one octave lower. The new synthesized signal is then mixed with the original signal to create the effect.

Output Limiter: Prevents clipping.

Presets: 20 presets, 19 of which are user-definable.

Front Panel Controls and Indicators

Level: Detented rotary level control, one per channel.

Power Switch: On/off switch applies AC power to the amplifier.

Sel/Prev/Next Buttons: Three buttons near the LCD screen are used to access menu items and front panel lockout.

LCD Screen: Backlit liquid crystal display shows speaker presets.

Signal Indicator: Green LED, one per channel, illuminates when a very low-level signal is present at input. May be used for troubleshooting cable runs.

-10 Indicator: Green LED flashes when output signal exceeds -10 dB below clip.

-20 Indicator: Green LED flashes when output signal level exceeds -20 dB below clip.

Ready Indicator: Green LED, one per channel, illuminates when the amplifier is ready to produce audio.

Clip Indicator: Red LED, one per channel, turns on at the threshold of audible distortion.

Temp Indicator: Red LED, one per channel, illuminates under excessive temperature conditions.

Power Indicator: Blue LED illuminates when the amplifier has been turned on and has power.

Back Panel Controls and Connectors

AC Line Connector: NEMA 5-15P (15A).

Input Connector: XLR, one per channel.

Link/Out Connector: Loop-thru signal from input connector for linking to another amplifier, one per channel.

Output Connectors: Two Neutrik® Speakon® NL4MP (mates with NL4FC) output connectors. Channel-1 Speakon® is wired with Ch. 1 and Ch. 2 outputs for use with optional single 4-conductor cable. Two binding post outputs (in parallel with Speakon® connectors)

HiQnet USB Connector: Type B, connects to a USB port on a PC.

Protection

XTi-Series amplifiers are protected against shorted, open or mismatched loads; overloaded power supplies; excessive temperature; chain destruction phenomena; excessive output current, input overload damage; and high-frequency blowups. They also protect loudspeakers from input/output DC, large or dangerous DC offsets and turn-on/turn-off transients.

Construction

Chassis: Steel.

Cooling

Proportional speed fan with front-to-rear airflow.

Dimensions

EIA Standard 19-in. (48.3-cm) rack mount width (EIA RS-310-B), 3.5 in. (8.9 cm) high and 12.25 in. (31.11 cm) deep behind mounting surface.

Weight

Net Weight:
18.5 lb (8.4 kg).

Shipping Weight:
21.5 lb (9.8 kg).

Regulatory Certifications



Other Applications



Note: Specifications apply to units in Stereo mode with 8-ohm loads and rated input sensitivity unless otherwise specified.

The XTi Series of Crown® amplifiers are professional tools designed and built for portable PA applications. The series includes three models which are identical except for output power: XTi 1000, 2000 and 4000. All are rugged and lightweight, and offer unmatched value in their class. XTi-Series amplifiers feature an LCD screen with speaker presets for crossover frequencies, EQ, limiting, delay, and a subharmonic synthesizer. Other features include a switch-mode universal power supply, useful function indicators, proportional-speed fan-assisted cooling, XLR inputs, Speakon® and binding-post outputs, short-circuit protection and more.

PORTABLE PA

AMPLIFIERS ► PORTABLE PA

XLS Series: Affordable and Reliable

XLS 202, XLS 402, XLS 602, XLS 802



Evolution

► FEATURES

- Housed in a rugged, all-steel 2U chassis.
- Efficient forced-air fan prevents excessive thermal buildup.
- Electronically balanced XLR inputs; touch-proof binding post and Speakon outputs.
- Precision detented level controls, power switch, and four LEDs, which indicate clip for each channel, power and fault conditions.

POWER OUTPUT*

Models	4-ohm Dual (per channel)	8-ohm Dual (per channel)	8-ohm Bridge
XLS 202	300W	200W	600W
XLS 402	450W	300W	900W
XLS 602	600W	380W	1,200W
XLS 802	800W	500W	1,600W

*Maximum average power in watts at 0.5% THD, 1 kHz.



► SPECIFICATIONS

Performance

Sensitivity (volts RMS) for full rated power at 4 ohms: 1.25 V.

Frequency Response (at 1 watt) 22 Hz to 20 kHz: +0 dB, -1 dB.

Signal-to-Noise Ratio (20 Hz to 20 kHz, inputs terminated)

A-weighted, below rated power: > 100 dB.
No weighting, below rated power: > 95 dB.

Total Harmonic Distortion (THD): < 0.5%.

Intermodulation Distortion (IMD):
(60 Hz and 7 kHz at 4:1) from full rated output to -40 dB: < 0.3%.

Damping Factor (8 ohm) 10 Hz to 400 Hz: >200.

Crosstalk (below rated power)

at 1 kHz: -75 dB.
at 20 kHz: -50 dB.

Input Impedance (nominal): 20 kilohms balanced, 10 kilohms unbalanced.

Output Power: See power charts on previous page.

Load Impedance: Rated for 4 to 8 ohms per channel in Stereo, 8 ohms in Bridge Mono.

AC Line Voltage and Frequency Configurations Available ($\pm 10\%$): 120 VAC 60 Hz, 100 VAC 50/60 Hz, 220 VAC 50 Hz, and 230-240 VAC.

Front Panel Controls and Indicators

Level: Two front-panel rotary level controls, one for each channel.

Power: Front-panel switch; on when in the IN position.

Circuit Breaker: Back-panel breaker provides overload protection.

Mode Switch: Back-panel switch selects Dual or Bridge-Mono mode.

Signal Presence Indicators: Two green LEDs, one for each channel, illuminate when the channel's input signal exceeds -40 dBu.

Clip Indicators: Two red LEDs, one for each channel, illuminate when the channel's output is being overdriven.

Power Indicator: Blue LED indicates amplifier has been turned on and AC power is available.

Fault Indicator: Two red LEDs illuminate when amplifier is in protect mode. Also illuminates briefly during normal power-up when amplifier is first switched on.

Back Panel Connectors

Input Connectors: One per channel; back-panel three-pin female XLR input connectors.

Output Connectors: Two 4-Pole Speakon[®] Output Connectors accept 2-pole or 4-pole Speakon connectors. The top Speakon connector is wired for both channels so it can be used for bridge-mono wiring or for stereo wiring of two speakers to a single Speakon connector.

One pair of binding posts per channel; accepts banana plugs or bare wire. (European models do not accept banana plugs.)

Protection

XLS Series amplifiers provide extensive protection and diagnostic capabilities, including output current limiting, DC protection, circuit breaker, and thermal protection.

Cooling

Internal heat sinks with forced-air cooling for rapid, uniform heat dissipation. Flow-through ventilation from front to back.

Dimensions

EIA Standard 19-inch (48.3-cm) rack mount width (EIA RS-310-B), 3.5-inch (8.9-cm) height and 15.2-inch (38.6-cm) depth.

Weight

Net Weight:

XLS-202: 23.0 lb (10.4 kg).
XLS-402: 25.7 lb (11.7 kg).
XLS-602: 29.0 lb (13.2 kg).
XLS-802: 35.5 lb (16.1 kg).

Shipping Weight:

XLS-202: 28.0 lb (12.7 kg).
XLS-402: 30.7 lb (13.9 kg).
XLS-602: 34.0 lb (15.4 kg).
XLS-802: 40.5 lb (18.4 kg).

Regulatory Certifications



Other Applications



Note: Specifications apply to units in Stereo mode with 8-ohm loads and rated input sensitivity unless otherwise specified.

PORTABLE PA

The XLS Series of power amplifiers from Crown represents a new era in affordable, quality power amplification. The line consists of three models in a uniform, rugged 2U chassis, incorporating the best of tried-and-true design principles and innovative features.

AMPLIFIERS ▶ PORTABLE PA

Product Applications

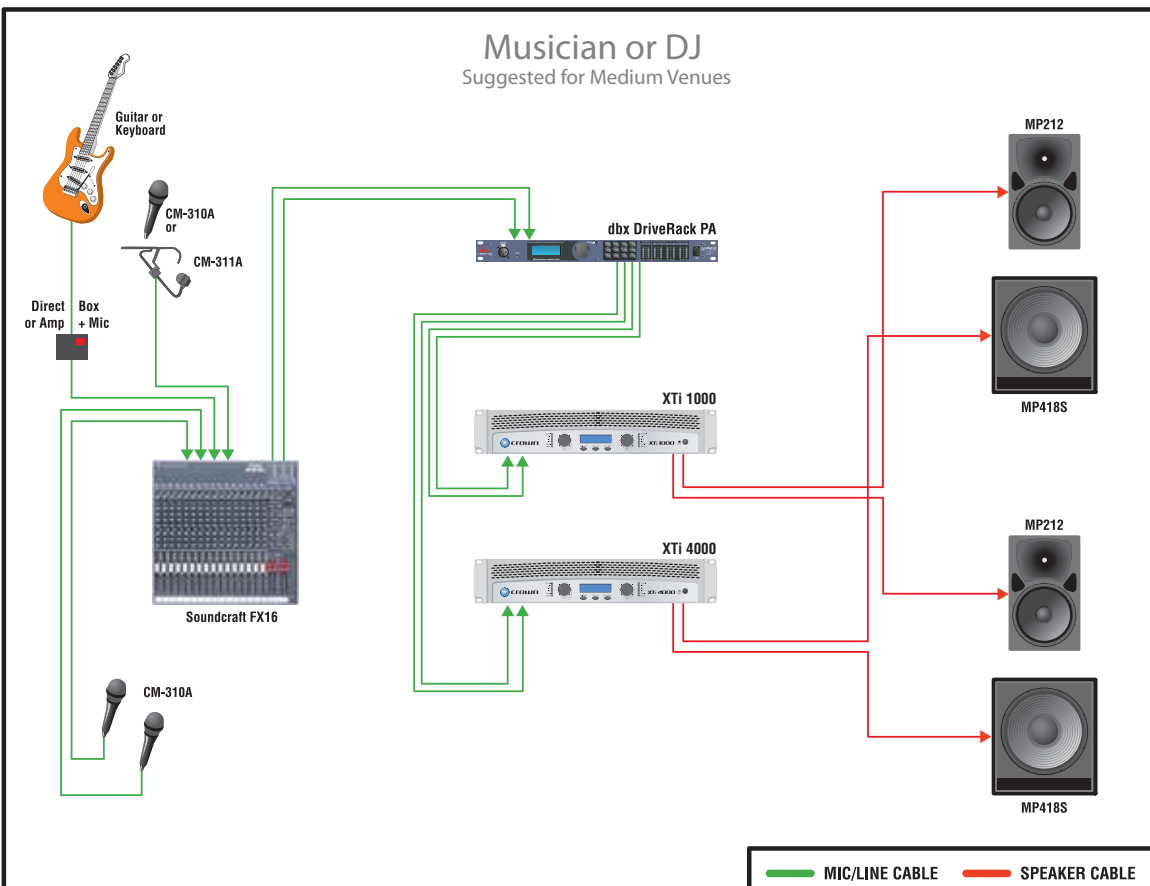
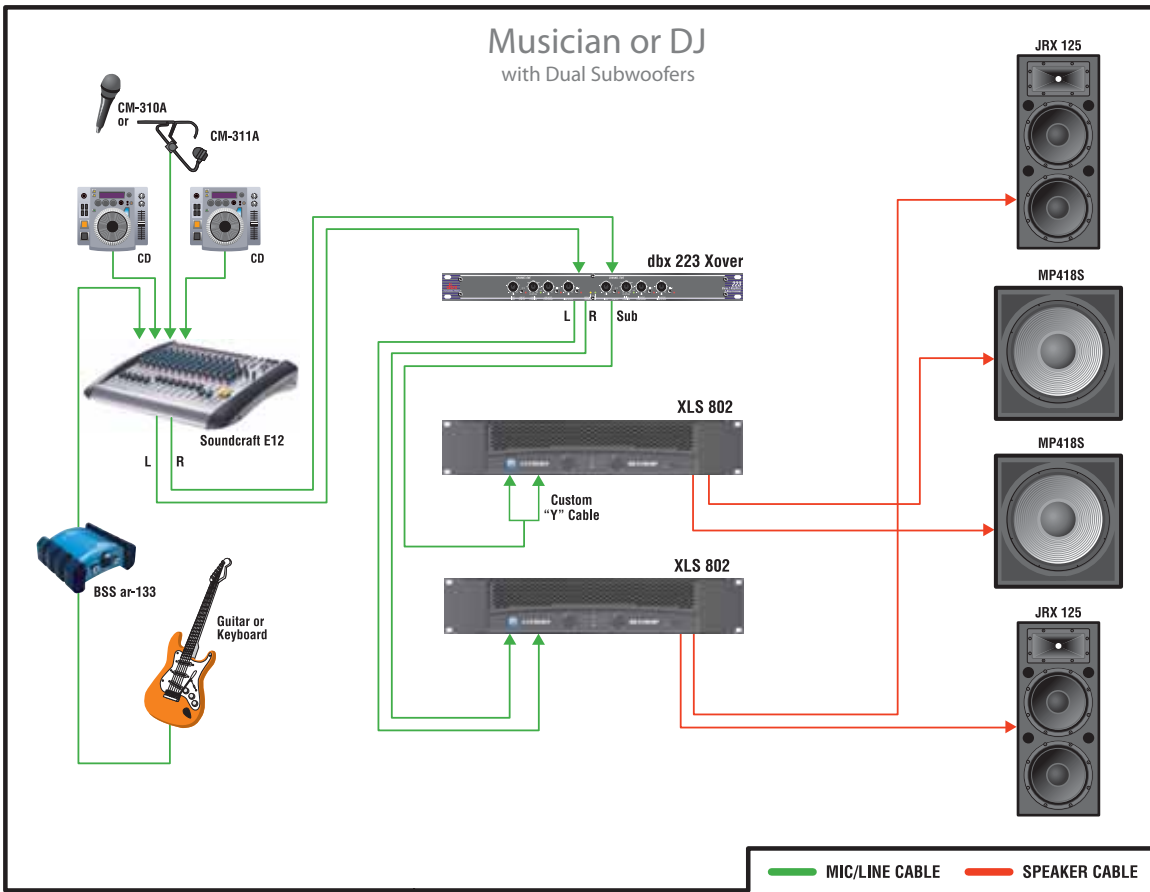

AMPLIFIERS ▶ PORTABLE PA

Product Applications

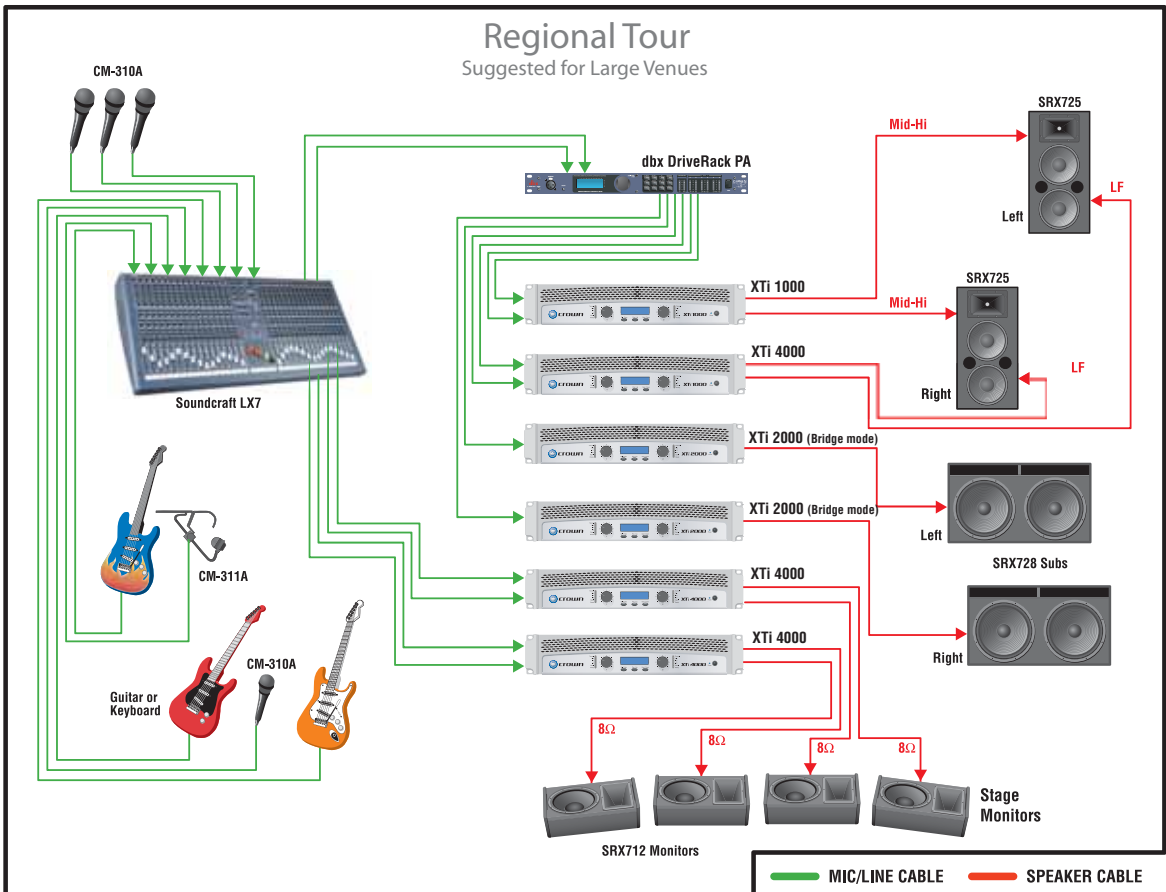
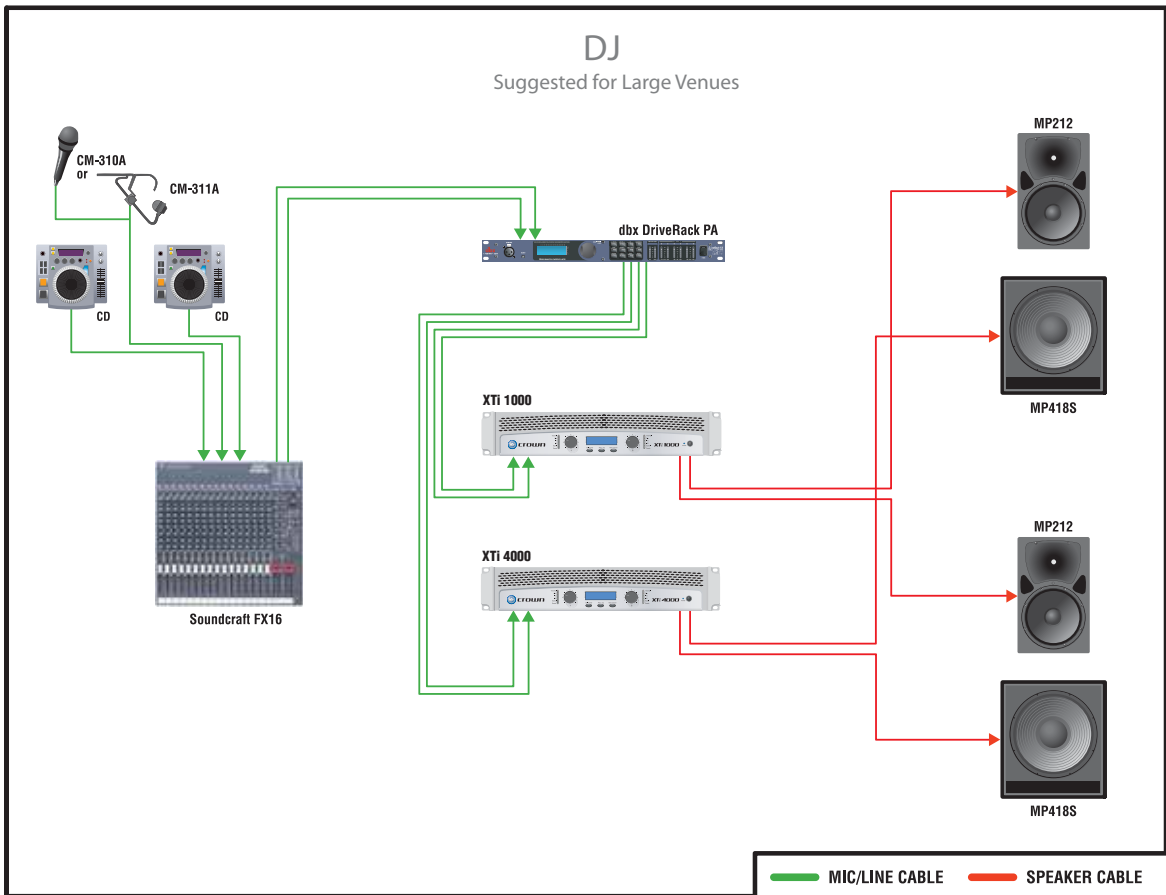





TOURING

I-Tech Series

MA-VZ Series

Macro-Tech 2402

AMPLIFIERS ► TOURING

I-Tech Series: Excellence Without Compromise

I-T4000, I-T6000, I-T8000



Excellence

► FEATURES

- Unmatched power in a 2U lightweight chassis.
- Global power supply with Power Factor Correction.
- Onboard DSP.
- Connects to Harman Pro HiQnet and Crown TCP/IQ™ network (CobraNet input available in optional CN models, coming soon).
- LCD control screen allows easy setup, diagnostics, and DSP presets for various loudspeakers.

POWER OUTPUT*

Model	2-ohm Dual (per channel)	4-ohm Dual (per channel)	8-ohm Dual (per channel)	4-ohm Bridge	8-ohm Bridge
I-T4000	1,800W	2,000W	1,250W	3,600W	4,000W
I-T6000	2,500W	3,000W	1,500W	5,000W	6,000W
I-T8000	3,500W	4,000W	2,100W	7,000W	8,000W

*Guaranteed minimum power in watts at rated THD, 20 Hz - 20 kHz

► SPECIFICATIONS

Performance

Frequency Response (at 1 watt, 20 Hz - 20 kHz): ± 0.25 dB.

Signal to Noise Ratio (below rated full-bandwidth power, A-weighted): > 105 dB.

Total Harmonic Distortion (THD) at full rated power: < 0.35%.

Intermodulation Distortion (IMD) 60 Hz and 7 kHz at 4:1, from full rated output to -35 dB: < 0.35%.

Damping Factor (20 Hz to 100 Hz, 8 ohms): > 5000.

Crosstalk (below rated power, 20 Hz to 1 kHz): > 80 dB.

Common Mode Rejection (CMR) (20 Hz to 1 kHz): > 50 dB.

DC Output Offset (shorted input): < ± 3 mV.

Input Impedance (nominal): 20 kilohms balanced, 10 kilohms unbalanced.

Maximum Input Level: +15 dBu or +22 dBu, depending on input sensitivity.

Latency (analog, digital inputs): 1.13 mS analog, 1.81 mS digital (96 kHz).

A/D, D/A Converters: 24-bit 96 kHz Cirrus Logic.

Digital Input: AES/EBU, 24-bit, 32-96 kHz. Onboard sample rate converter.

Network: Onboard HiQnet and TCP/IQ, compatible with standard 100 Mb Ethernet hardware.

DSP: 24-bit conversion with 32-bit, floating-point DSP processing. Has 64 assignable filters with 9 different filter types. Includes all-pass filters, over 2 seconds of delay available per channel, and dual uncorrelated-noise and sine-wave generators.

Load Supervision: Monitors the average impedance on the output of the amplifier. If the impedance falls outside the specified high/low limits, this function alerts the user via the front panel display, and via the IQwic software when amp is on an IQ Network.

Error Reporting: Reports clip errors, thermal errors, fault conditions and load monitoring errors for each channel via the front panel display and via Harman Pro System Architect or IQwic software when amp is on an HiQnet or IQ Network.

Attenuators: Speed-sensitive rotary encoders, 0.5 dB steps, range 0 to -100 dB.

Load Impedance (Note: Safe with all types of loads): Stereo: 1/2/4/8/16 ohms. Bridge Mono: 2/4/8 ohms.

Input Sensitivity for rated output/8 ohms: Adjustable in 0.1V steps from 1.4V to 7.75V.

Voltage Gain:
I-T4000: 37.1 dB to 22.2 dB.
I-T6000: 37.9 dB to 23.0 dB.
I-T8000: 39.3 dB to 24.5 dB.

Required AC Mains: Universal AC input, 100-240VAC, 50/60 Hz ($\pm 15\%$). Maximum AC mains voltage 277VAC.

Front Panel Controls and Indicators

Power Switch: Push-on/push-off switch with built-in green AC mains present indicator.

LCD Control Screen and Controls: These let the user adjust the amplifier's attenuation and muting, configure the amp, set up and view error monitoring (such as temperature and load supervision), and recall DSP presets. The presets allow the user to quickly reconfigure the amp for various applications.

LCD Control Screen: Integrated LCD with white LED backlight, controls amplifier setup and operation. Normal mode: Attenuation in 0.5 dB steps, Mute/Unmute, Front Panel Lockout.

Basic Menu: LCD Contrast, CH1 Sensitivity, CH2 Sensitivity, Speaker Preset, Dual/Bridge mode, Input Y.

Advanced Menu: Attenuator Limits, Attenuator Link, Clip Limiter, Peak Voltage Limiter, Average Power Limiter, Pink Noise Generator, AES/EBU Input Trim, Input Source, Maximum Analog Input, Methher Display Type.

Monitor Menu: Speaker Load, Thermal %, AC Voltage, Operating Time, Firmware, Manufacturing Info, Networking, Thermal Errors, Clip Errors, Low Limit Load Errors, High Limit Load Errors, Line Voltage Errors.

Menu/Exit Button: "Menu" enters the main menu. "Exit" gets out of the Menu.

Next Button: Selects the next item in the Menu.

Prev Button: Selects the previous item in the Menu.

Level Controls (Encoders): These two knobs affect the Channel-1 and Channel-2 output levels. They also select Menu items and adjust parameter values that are displayed on the LCD Control Screen.

Bridge Mode Indicator: Yellow LED illuminates when the amplifier is set to Bridge-Mono mode.

Ready Indicator: Green LED, one per channel, illuminates when the channel is initialized and ready to produce audio output. Indicator is off when the amplifier is in standby mode via the IQ system.

Signal Indicators: Three green LEDs per channel indicate the amplifier's input and output signal levels.

Signal: input signal is above -40 dBu.

-20 dB: amplifier output is 20 dB below clipping.

-10 dB: amplifier output is 10 dB below clipping.

Clip Indicator: Red LED, one per channel, illuminates when the channel's output signal reaches the onset of audible clipping. The Clip Indicator also will illuminate during Thermal Level Control (TLC) limiting.

Thermal Indicator: Red LED, one per channel, illuminates when the channel has shut down due to thermal stress or overload.

Fault Indicator: Red LED, one per channel, flashes when the amplifier output channel has stopped operating.

Data Indicator: Yellow LED indicates HiQnet/IQ TCP/IP data activity. Data indicator flashes only when the amplifier is polled for data, or is polled to see whether it is online.

Power Indicator: Blue LED indicates amplifier has been turned on and AC power is available. The LED

will flash when the AC line voltage is 15% above or below the nominal rated range.

AC Mains Present Indicator: Green indicator built into power switch indicates AC power is present at the power cord and the amplifier circuit breaker is in the "on" position.

Back Panel Controls, Indicators and Connectors

Reset Switch/Circuit Breaker: Resets circuit breaker that protects power supply.

Data Indicator: Yellow LED indicates HiQnet/IQ TCP/IP data activity. Data indicator flashes only when the amplifier is polled for data, or is polled to see whether it is online.

Preset Indicator: Yellow LED flashes to signal the number of the current preset if active.

Analog Input Connectors: A 3-pin female XLR connector for each channel.

Digital Input Connector: A 3-pin female XLR connector that accepts a digital signal in the AES/EBU format.

Network Connector: This Ethernet connector accepts an RJ45 connector for HiQnet or TCP/IQ networking. Built into the connector is a yellow LINK ACT indicator that shows network activity, and a green 100Mb indicator that shows a 100Mb network connection.

Output Connectors: Two high-current, 50A Neutrik® Speakon® (mates with NL4FC or NL4), one per channel. Two pairs of high-current, 60A color-coded binding posts (for banana plugs or bare wire). Two male XLR passive analog loop through. XLR active/re-clocked AES/EBU digital loop through.

Power Connector: Standard 20 amp IEC inlet. Voltage range is indicated above IEC inlet. Five cord sets supplied with amplifier (USA, UK, European, Australia, India).

Construction

Cast aluminum front panel with integrated handles.

Cooling: Dual-zone, microprocessor controlled, continuously variable speed fans, front-to-back airflow.

Dimensions: 19 in. (48.3 cm) W x 3.5 in. (8.9 cm) H x 16.2 in. (41.1 cm) D.

Weight: 28 lb (12.7 kg) net, 36 lb (16.3 kg) shipping.

Included Accessories

Rear rack ears, rack screws, operation manual, power cords, foam air filter.

Regulatory Certifications



Other Applications



The Crown® I-Tech Series offers amazing power, light weight and ease of use for touring sound and installed sound applications. Onboard DSP provides a wide array of signal processing, greatly reducing the need for rack components and rack wiring. Onboard DSP features 24-bit, 96 kHz A/D and D/A converters. All models are compatible with the HiQnet Network and TCP/IQ networking. Digital audio and HiQnet/IQ control signals connect to the amp via a single CobraNet cable in optional CN models, coming soon. Push-button DSP presets simplify the setup for various loudspeaker arrays. The Global Power Supply works anywhere in the world, and offers PFC (Power Factor Correction). I-Tech amplifiers have the highest output voltage in the industry (200V peak), which provides clean transient peaks. The 3rd-generation patented Class I (BCA®) circuitry couples power efficiently to the load and allows low AC current drain. A front-panel control screen shows advanced diagnostics and status information.

TOURING

AMPLIFIERS ► TOURING

Macro-Tech VZ[®] Series: Advanced VZ Technology

Macro-Tech 3600VZ, Macro-Tech 5002VZ



VZ Technology

► FEATURES

- Crown's Grounded Bridge™ design provides lower distortion and superior reliability.
- Patented ODEP[®] (Output Device Emulation Protection) circuitry compensates for overheating and overload to keep the amplifier working when others would fail.
- Articulated VZ[®] power supplies for each channel provide excellent crosstalk characteristics and the best power matching to your load.
- MA-3600VZ works with PIP™ modules and MA-5002VZ works with PIP2™ modules that tailor the amplifier to suit specific applications.
- Two mono modes (Bridge-Mono and Parallel-Mono) for driving a wide range of load impedances.

POWER OUTPUT*

Models	2-ohm Dual (per channel)	4-ohm Dual (per channel)	8-ohm Dual (per channel)	4-ohm Bridge	8-ohm Bridge	16-ohm Bridge
MA-3600VZ	1,800W	1,565W	1,120W	3,505W	3,140W	—
MA-5002VZ	2,500W	2,000W	1,300W	5,000W	4,000W	2,600W

*Maximum average power in watts at 0.1% THD, 1 kHz.



► SPECIFICATIONS

Performance

Frequency Response (at 1 watt) 20 Hz to 20 kHz: ± 0.1 dB.

Phase Response (at 1 watt, 10 Hz to 20 kHz): ± 10 degrees.

Signal-to-Noise Ratio (below rated full bandwidth power), A-weighted: > 105 dB.

Total Harmonic Distortion (THD) (at rated power):

MA-3600VZ: 20 Hz to 1 kHz: $< 0.05\%$.
20 kHz: $< 0.1\%$.

MA-5002VZ: $< 0.05\%$ true THD

Intermodulation Distortion (IMD) (60 Hz and 7 kHz at 4:1):

MA-3600VZ (from 368 milliwatts to full rated output): $< 0.05\%$.

MA-5002VZ (from rated power to 35 dB below rated power at 8 ohms): $< 0.05\%$.

Damping Factor (8 ohm) 10 Hz to 400 Hz: > 1000 .

Voltage Gain (8-ohm load, rated output at 1 kHz, at maximum level setting, $\pm 6\%$ or ± 0.5 dB):

MA-3600VZ: 124.6:1 or 41.9-dB at 0.775-volt sensitivity; 69.2:1 or 36.8 dB at 1.4-volt sensitivity; 20:1 or 26 dB at 26-dB sensitivity.

MA-5002VZ: 132.1:1 or 42-dB at 0.775-volt sensitivity; 71:1:1 or 37 dB at 1.4-volt sensitivity; 20:1 or 26 dB at 26-dB sensitivity.

Controlled Slew Rate: > 30 volts/microsecond.

Input Impedance: 20 kilohms balanced, 10 kilohms unbalanced.

Load Impedance:

MA-3600VZ: Safe with all types of loads. Rated for 2 to 8 ohms in Stereo, 4 to 8 ohms in Bridge-Mono, and 1 to 2 ohms in Parallel-Mono.

MA-5002VZ: Safe with all types of loads. Rated for 2 to 8 ohms in Stereo, 4 to 16 ohms in Bridge-Mono, and 1 to 4 ohms in Parallel-Mono.

DC Output Offset (shorted input): $< \pm 10$ millivolts.

Required AC Mains ($\pm 10\%$, -15%): 50/60 Hz; 100-, 120-, and 230- VAC ($\pm 10\%$) units are available. 230 VAC, 50/60 Hz units can be used with 220 and 240 VAC. 100 and 120 VAC units can draw up to 30 amps; 230 VAC units can draw up to 15 amps.

Power Draw at Idle: 90 watts or less.

Front Panel Controls and Indicators

Level: Rotary detented level control, one for each channel.

Compressor (MA-5002VZ only): Controls the channel's error-driven compression. Selections include Off; Fast (4-millisecond attack, 300-millisecond release), and Slow (12-millisecond attack, 600-millisecond release).

Enable: Push button used to turn the amplifier on and off.

Enable LED: Amber LED indicates amplifier is on and AC power is available.

Signal/IOC: Green LED for each channel flashes to show amplifier output. If a channel's output waveform differs from its input by 0.05% or more, the indicator flashes brightly to show distortion.

ODEP: Amber LED for each channel shows thermal-dynamic energy reserve. A lit indicator shows available reserve energy. If a channel has no reserve, its indicator will dim in proportion to ODEP limiting.

Iload/ILimit (MA-5002VZ only): Two-color (green/red) LED for each channel. Green indicates load current flowing out the amplifier; red indicates maximum current is being delivered to the load.

Back Panel Controls and Connectors

Input Ground Lift: A two-position switch used to isolate the input audio signal grounds from the AC (chassis) ground to help prevent ground loops. MA-3600VZ switch affects phone inputs only.

Loudspeaker Offset Integration (MA-5002VZ only): Two-position switch for each channel turns on or off the loudspeaker protection, which protects against DC, off-center woofer cone movement, and unwanted subsonic and ultrasonic frequencies.

Sensitivity: Switch for each channel selects input sensitivity: 0.775 volts or 1.4 volts for standard 1-kHz power, or a 26 dB voltage gain.

Stereo/Mono: Switch selects Stereo, Bridge-Mono or Parallel-Mono mode.

VZ Mode (MA-5002VZ only): Switch for each channel controls the switching mode of the VZ power supplies.

Input Connectors

3-pin female XLR and female TRS for each channel.

Output Connectors

MA-3600VZ: Two sets of color-coded binding posts for banana plugs or bare wire (European models do not accept banana plugs).

MA-5002VZ: High-current output block accepts banana plugs, spade lugs or bare wire. A detachable output cover protects against accidental short circuits and dangerous electrical shock.

Protection

Macro-Tech amplifiers are protected against shorted, open or mismatched loads; overloaded power supplies; excessive temperature, chain destruction phenomena, input overload damage and high-frequency blowups. They also protect loudspeakers from input/output DC and turn-on/turn-off transients.

Cooling

Internal heat sinks, forced-air cooling for rapid heat dissipation.

Dimensions

EIA Standard 19-inch (48.3-cm) rack mount width (EIA RS-310-B),

MA-3600VZ: 3.5-inch (8.9-cm) height and 16-inch (40.6-cm) depth behind the mounting surface.

MA-5002VZ: 5.25-inch (13.3-cm) height and 15.875-inch (40.3-cm) depth behind the mounting surface.

Weight

Net Weight,

MA-3600VZ: 55 lbs. 1.5 oz. (25.0 kg).

MA-5002VZ: 77 lbs. 9 oz. (35.2kg).

Shipping Weight,

MA-3600VZ: 63 lbs. 10 oz. (28.9 kg).

MA-5002VZ: 88 lbs. 10 oz. (40.2 kg).

Accessories

IQ Network Accessories: Both accept most PIP modules. The MA-5002VZ accepts all current IQ-PIP modules. The MA-3600VZ can accept IQ-PIP LITE module when paired with the IQ-PIP USP2 Adapter Kit (some functionality will be limited).

Regulatory Certifications



MA-3600VZ

Other Applications



All measurements apply to units in Stereo mode with 8-ohm loads and rated input sensitivity unless otherwise specified.



Our patented variable impedance (VZ[®]) technology permits the Macro-Tech[®] 3600VZ and the Macro-Tech 5002VZ to dynamically adapt to both signal and load requirements, providing the best power match to the widest range of loads. These models pack large amounts of power into a compact package while achieving ultra-low distortion and without generating excessive heat. Detented controls, PIP[™] expandability and comprehensive status indicators are included. The Macro-Tech 5002VZ's universal power supply adapts to available voltages around the world.

TOURING

AMPLIFIERS ► TOURING

Macro-Tech 2402: Advanced Reinforcement

Macro-Tech 2402



Advanced

► FEATURES

- Enhanced PIP2™ (Programmable Input Processor) connector accepts new accessory modules that tailor the amplifier for specific applications.
- Balanced XLR and 1/4-inch phone jacks for each channel on the standard PIP-FXQ module.
- Full Protection from shorted, open and mismatched loads, general over-heating, DC, high-frequency overloads, and full internal fault protection are provided by our “Quad-Mute” protection scheme.
- Two mono modes (Bridge-Mono and Parallel-Mono) for driving a wide range of load impedances.

POWER OUTPUT*

Model	2-ohm Dual (per channel)	4-ohm Dual (per channel)	8-ohm Dual (per channel)	4-ohm Bridge	8-ohm Bridge	16-ohm Bridge
MA-2402	1,050W	800W	520W	2,070W	1,585W	1,035W

* Maximum average power in watts at 0.1% THD, 1 kHz.



► SPECIFICATIONS

Performance

Frequency Response (at 1 watt) 20 Hz to 20 kHz: ± 0.1 dB.

Phase Response (at 1 watt, 10 Hz to 20 kHz): ± 10 degrees.

Signal-to-Noise Ratio (below rated full bandwidth power), A-weighted: > 105 dB.

Total Harmonic Distortion (THD) (at rated power), 20 Hz to 1 kHz: $< 0.05\%$.
At 20 kHz: $< 0.1\%$.

Intermodulation Distortion (IMD) (60 Hz and 7 kHz at 4:1) from 163 milliwatts to full bandwidth power: $< 0.05\%$.

Damping Factor (8 ohm) 10 Hz to 400 Hz: > 1000 .

Crosstalk (below rated power), 20 Hz to 1 kHz: > 85 dB.

Voltage Gain (at maximum level setting, $\pm 6\%$): 38-dB gain at 0.775-volt sensitivity; 33-dB gain at 1.4-volt sensitivity.

Controlled Slew Rate: > 13 volts/microsecond.

Input Impedance: (balanced, unbalanced): 20 k ohms, 10 k ohms.

Load Impedance: Safe with all types of loads. Rated for 2 to 8 ohms in Stereo, 4 to 16 ohms in Bridge-Mono, and 1 to 4 ohms in Parallel-Mono.

DC Output Offset (shorted input): $< \pm 10$ millivolts.

Required AC Mains ($\pm 10\%$, -15%): 50 /60Hz, 100-240VAC.

Power Draw at Idle: 100 watts or less.

Front Panel Controls and Indicators

Enable: A push button used to turn the amplifier on and off.

Level: A rotary control for each channel with 31 detentes used to control the output level.

Enable: This amber indicator shows the on/off status of the low-voltage power supply.

Signal/IOC: Each channel has a green indicator that flashes to show amplifier output. If a channel's output waveform differs from its input by 0.05% or more, the indicator flashes brightly to show distortion. This function provides proof of distortion-free performance. In Parallel-Mono mode, the Channel 2 light stays on.

ODEP: Each channel has an amber indicator that shows thermal-dynamic energy reserve. Normally, each ODEP indicator is lit to show available reserve energy. In the rare event that a channel has no reserve, its indicator will dim in proportion to ODEP limiting. An ODEP indicator may also turn off under other conditions.

Back Panel Controls and Connectors

Stereo/Mono: A three-position back panel switch used to select Stereo, Bridge-Mono or Parallel-Mono mode.

Reset: A push button for each channel, used to reset the circuit breaker that protects each power supply.

Input Ground Lift: This switch on the PIP2-FXQ is used to isolate input signal grounds from chassis ground to prevent ground loops.

Sensitivity: A three-position switch inside the PIP™ compartment used to select the input sensitivity for both channels: 0.775 volts or 1.4 volts for standard 1 kHz power, or a 26 dB voltage gain.

Input Connectors: Factory-installed PIP2-FXQ provides one 3-pin female XLR connector for each channel in parallel with one 1/4-inch phone jack connector for each channel.

Output Connectors: Two sets of color-coded binding posts for banana plugs or bare wire (European models do not accept banana plugs).

Protection

Macro-Tech amplifiers are protected against shorted, open or mismatched loads; overloaded power supplies; excessive temperature, chain destruction phenomena, input overload damage and high-frequency blowups. They also protect loudspeakers from input/output DC and turn-on/turn-off transients.

Cooling

Flow-through ventilation from front to side panels. Internal heat sinks with forced-air cooling for rapid, uniform heat dissipation.

Dimensions

EIA Standard 19-inch (48.3-cm) rack mount width (EIA RS-310-B), 3.5-inch (8.9-cm) height and 16-inch (40.6-cm) depth behind the mounting surface.

Weight

Net Weight: 51 lbs. 12 oz. (23.5 kg).

Shipping Weight: 65 lbs. (29.5 kg).

Accessories

Cooling fan option, level control shaft lock.

Regulatory Certifications



Other Applications



NOTE: All measurements apply to units in Stereo mode with 8-ohm loads and rated input sensitivity unless otherwise specified.



The Macro-Tech® 2402 amplifier delivers superior sonic accuracy and enormous amounts of power from a low-profile design—perfect for touring and fixed installations. Crown's patented ODEP® (Output Device Emulation Protection) and Grounded Bridge™ output circuitry enhance reliability and virtually eliminate distortion. Dual, Bridge-Mono or Parallel-Mono modes allow you to optimize power to your loads, while IOC® (Input/Output Comparator) circuitry acts as a supersensitive distortion meter, giving proof of distortion-free performance.

TOURING

AMPLIFIERS ► TOURING

Product Applications

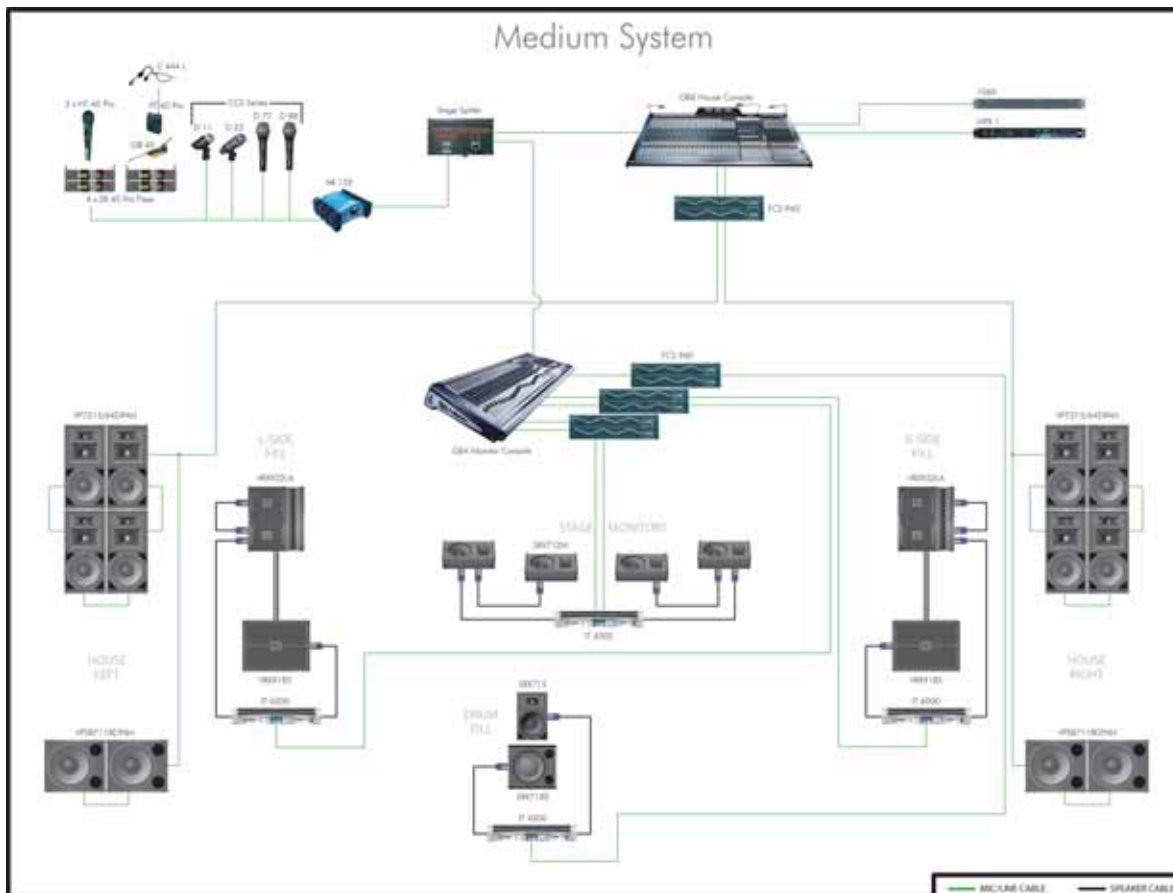
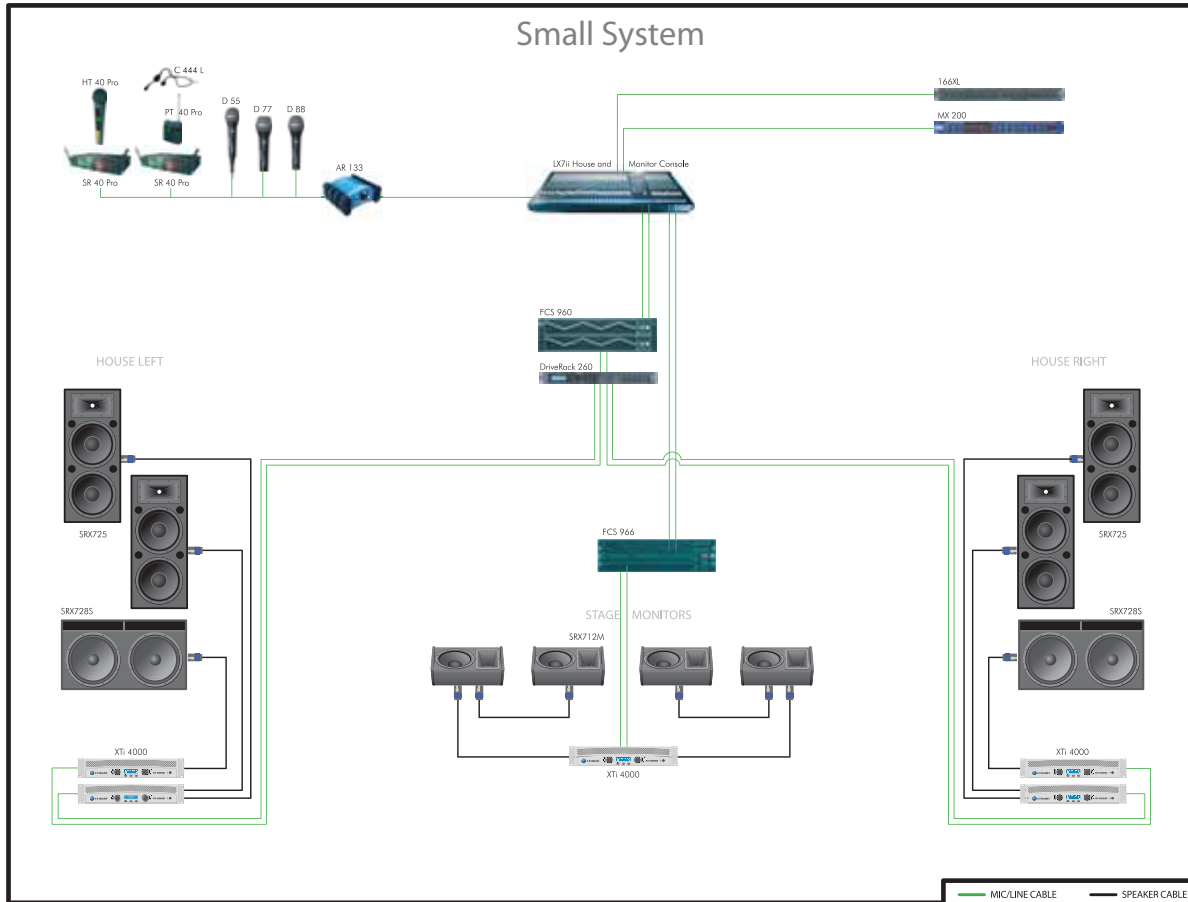

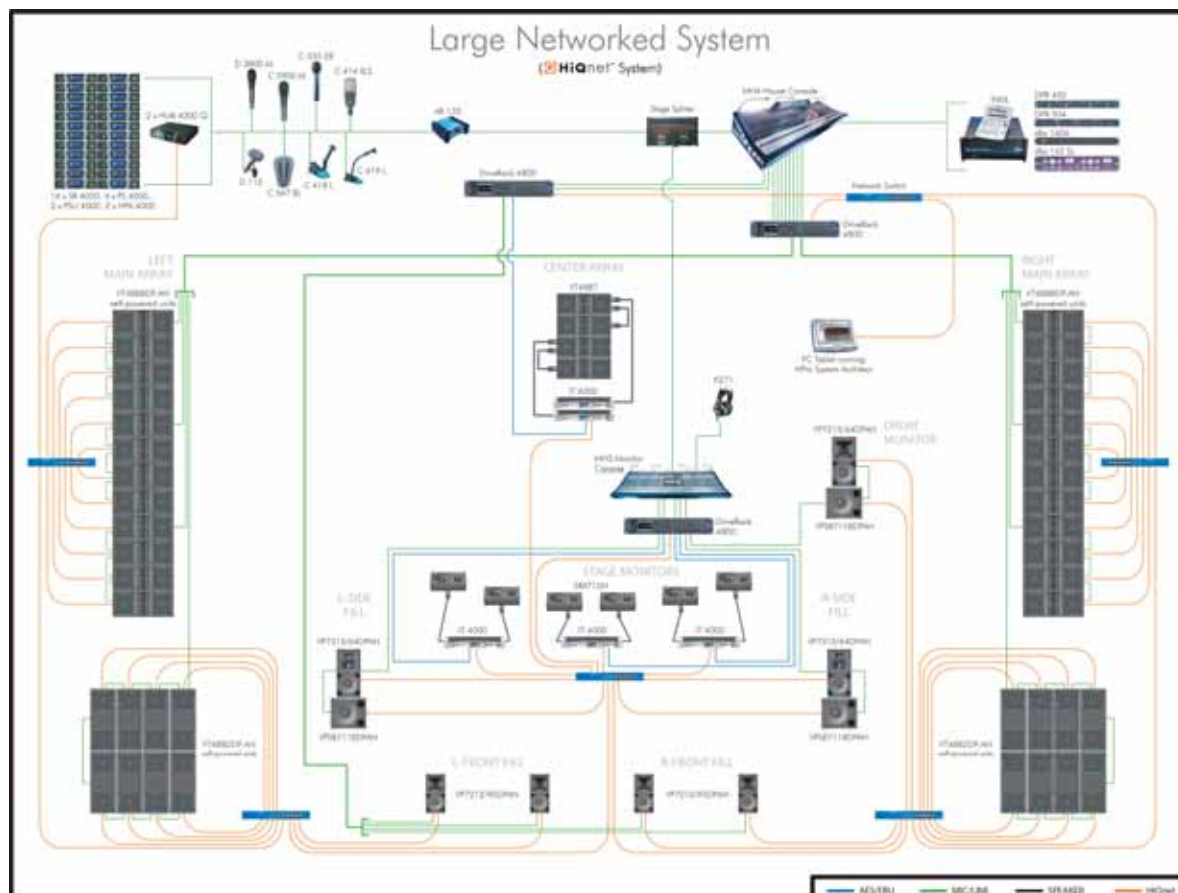
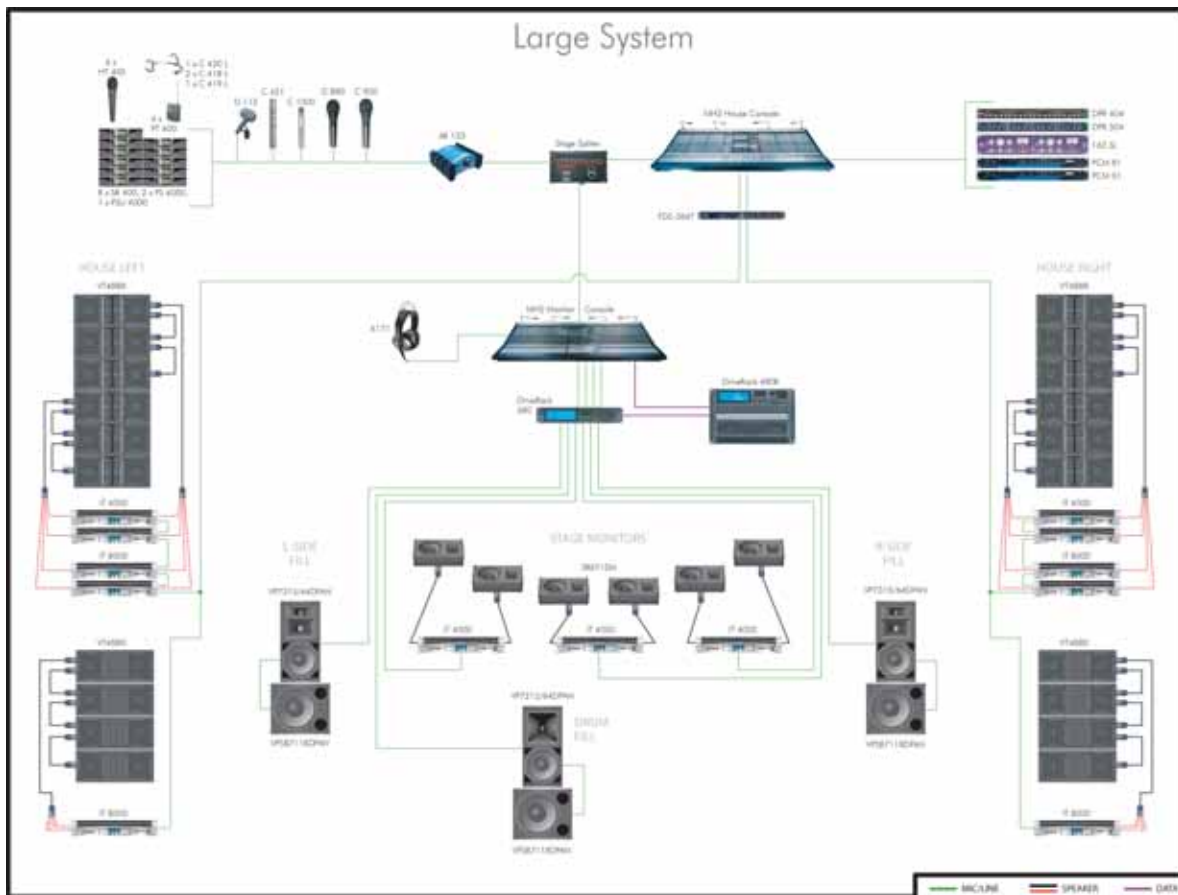





RECORDING & BROADCAST

D Series

AMPLIFIERS ► RECORDING & BROADCAST

D Series: Long-Term Favorites

D-45, D-75A



Tried & True

► FEATURES

- Powerful AB+B class circuitry yields maximum efficiency with minimum crossover “notch” distortion.
- IOC® (Input/Output Comparator) alerts of any distortion that exceeds 0.05% to provide proof of distortion-free performance.
- Ultra-low harmonic and intermodulation distortion result in the best dynamic transfer function in the industry.
- Very low noise and wide dynamic range exceed the audio specifications for digital compact discs (CDs).
- Convection cooling system dissipates heat through the heat sinks and chassis for optimal cooling and maintenance-free operation.
- Front-panel headphone jack.

POWER OUTPUT*

Models	4-ohm Dual (per channel)	8-ohm Dual (per channel)	16-ohm Dual (per channel)	8-ohm Bridge	16-ohm Bridge
D-45	35W	25W	20W	70W	50W
D-75A	55W	40W	25W	110W	80W

*Maximum average power in watts at 0.1% THD, 1 kHz.



► SPECIFICATIONS

Performance

Frequency Response (at 1 watt) 20 Hz to 20 kHz: ± 0.1 dB.

Phase Response (from 20 Hz to 20 kHz at 1 watt): +10 to -15 degrees.

Signal-to-Noise Ratio below rated power (20 Hz - 20 kHz): 106 dB.

Total Harmonic Distortion (THD) at full bandwidth power: 0.05% from 20 Hz to 20 kHz.

Intermodulation Distortion (IMD) (60 Hz and 7 kHz at 4:1) from 0.25 watts to full bandwidth power: < 0.01%. from 0.01 to 0.25 watts: < 0.05%.

Damping Factor, from DC to 400 Hz: > 400.

Crosstalk (below rated power): 100 Hz to 1 kHz, >100 dB.

Input Impedance (nominally balanced, nominally unbalanced): 20 k ohms, 10 k ohms.

Input Sensitivity: Configurable for 26 dB gain or 0.775-volt sensitivity.

Load Impedance: Safe with all types of loads. Rated for 4 to 16 ohms in Dual mode, 8 to 16 ohms in Bridge-Mono mode.

AC Line Voltage and Frequency Configurations Available ($\pm 10\%$): 100, 120, 220 and 240 VAC, 50 to 400 Hz for international units (depending on the transformer configuration). North American 120 VAC, 60 Hz units are not convertible and can only be used at the specified voltage and frequency. All units draw 15 watts or less when idle.

Front Panel Controls and Indicators

Power: A two-position rotary on/off switch.

Level: An independent detented front-panel level control for each channel.

Dual/Mono: A jumper located inside the amplifier selects between dual and mono operation.

Signal Presence: The green front-panel indicator for each channel flashes synchronously with the channel's output signal to indicate its presence.

Input/Output Comparator: The red Input/Output Comparator (IOC) indicator for each channel flashes if any type of distortion reaches 0.05%.

Back Panel Connectors

Input Connectors: A balanced 3-pin female Neutrik combination XLR and 1/4-inch phone connector for each channel.

Output Connectors: Barrier block terminals and stereo headphone jack. The headphone output is unpadded, and in parallel with the main amplifier outputs.

Protection

Input: The inputs have series resistance that provides input overload protection. Controlled slew rate voltage amplifiers protect against radio frequencies. The AC line is fused to protect against excessive current draw.

Output: Instantaneous limiting protection for short circuits, open circuits and mismatched loads.

Turn-On: Minimum thumps. Power-up is instantaneous with no program delay.

Construction

Durable black finish on aluminum front panel with gray suede Lexan insert. Aluminum chassis provides maximum heat conduction and minimum weight.

Cooling

The amplifier is totally convection cooled. The entire aluminum chassis acts as a conductor to dissipate heat. The covers and front-panel extrusion also act as heat sinks. Much of the unit's heat is conducted through the extruded front panel. This design is used so the front panel contact with the equipment rack will also dissipate heat.

Dimensions

EIA Standard 19-inch (48.3-cm) rack mount width (EIA RS-310-B), 1.75-inch (4.5-cm) height and 8.5-inch (21.6-cm) depth behind the mounting surface, and a 0.624-inch (1.6-cm) protrusion in front of the mounting surface.

Weight

Net Weight,

D-45: 8 lbs. 11 oz. (3.9 kg).

D-75A: 9 lbs. 7 oz. (4.3 kg).

Shipping Weight,

D-45: 10 lbs. 9 oz. (4.8 kg).

D-75A: 11 lbs. 4 oz. (5.1 kg).

Regulatory Certifications



Other Applications



NOTE: All measurements apply to units in Dual mode with both channels driven into 8-ohm loads and an input sensitivity of 26 dB gain unless otherwise specified.

RECORDING & BROADCAST

The D-45 and D-75A are long-term standards. They are perfect for moderate power applications such as recording or broadcast studio near-field monitoring, video suite audio monitoring, a recording/broadcast headphone amp or a small paging system. Convection cooled, the highly reliable D Series is protected against shorted, open, mismatched or low-impedance loads.





CINEMA

DSi Series

CTs 2-Channel Series

CTs Multi-Channel Series

XLS Series

DBC[®] Network Bridge

AMPLIFIERS ► CINEMA

DSi Series: 2/4/8 Ohm

DSi 1000, DSi 2000, DSi 4000



One-Touch Performance

► FEATURES

- Intuitive front-panel LCD screen, automatic presets for popular JBL cinema speaker systems for quick, easy configuration.
- Onboard digital signal processing includes crossovers, EQ filters, delay, and output limiting.
- Computer connectivity via USB allows fast setup and configuration with HiQnet™ System Architect™ software.
- Rear-panel HD-15 connector provides easy input/output connectivity between DSi amplifiers and new DSi-8M System Monitor.
- Barrier strip outputs, removable Phoenix-style input.

POWER OUTPUT

Models	2-ohm Dual (per channel)	4-ohm Dual (per channel)	8-ohm Dual (per channel)	4-ohm Bridge	8-ohm Bridge
DSi 1000	700W**	500W*	275W*	1,400W**	1,000W*
DSi 2000	1,000W**	800W*	475W*	2,000W**	1,600W*
DSi 4000	1,600W**	1,200W*	650W*	3,200W**	2,400W*

*1 kHz power with 0.5% THD. **With 1% THD.



► SPECIFICATIONS

Performance

Frequency Response: +0/-1 dB from 20 Hz to 20 kHz at 1 watt into 4 ohms.

Load Impedance: Safe with all types of loads. Rated for 2 to 8 ohms in Stereo mode, 4 to 16 ohms in Bridge-Mono mode.

Sensitivity:

At 8 ohm rated output:

DSi 1000: 2.35V.
DSi 2000: 3.09V.
DSi 4000: 3.61V.

At 4 ohm rated output:

DSi 1000: 2.24V.
DSi 2000: 2.84V.
DSi 4000: 3.47V.

At 2 ohm rated output:

DSi 1000: 1.88V.
DSi 2000: 2.24V.
DSi 4000: 2.84V.

Signal to Noise Ratio (below rated 8-ohm power at 1 kHz): 100 dB (A weighted).

Damping Factor: Better than 500 from 20 Hz to 400 Hz.

Crosstalk: > 70 dB below rated power, 20 Hz to 1 kHz.

Voltage Gain at 1kHz, 8 ohm rated output:

DSi 1000: 26 dB.
DSi 2000: 26 dB.
DSi 4000: 26 dB.

Input Stage: Input is electronically balanced and employs precision 1% resistors.

Input Impedance (nominal): 20 k ohms, balanced; 10 k ohms, unbalanced.

Maximum Input Signal: +22 dBu typical.

AC Line Voltage and Frequency Configurations

Available: 100V, 120V-240V, 50/60 Hz.

AC Line Current:

DSi 1000: 6.5A.
DSi 2000: 6.9A.
DSi 4000: 8.0A.

At Idle: Draws no more than 90 watts.

Operating Temperature: 0° C to 40° C at 95% relative humidity (non-condensing).

DSP Section

Input EQ: 6 parametric filters per channel with adjustable Q, ±15 dB boost/cut. Also adjustable high and low shelving filters. This 8-filter EQ section can be bypassed.

Crossover Filters: Highpass and lowpass per channel. Butterworth 6/12/18/24 dB per octave, Linkwitz-Riley 24/48 dB per octave. Also includes ±15 dB bandpass gain and polarity control.

Output EQ: 8 parametric filters per channel with adjustable Q, ±15 dB boost/cut. This 8-filter EQ section can NOT be bypassed. Filters are enabled individually.

Output Limiter: Prevents clipping and protects loudspeakers. Choice of -3, -6, or -12 dB threshold per channel.

Delay: Up to 50 msec total delay per channel.

Presets: 20 presets. One is "DSP OFF." Fifteen are factory-set for JBL Cinema systems. Four are user-definable.

Front Panel Indicators

Level: Detented rotary level control, one per channel.

Power Switch: On/off switch applies AC power to the amplifier.

Sel/Prev/Next Buttons: Three buttons near the LCD screen are used to access menu items and front panel lockout.

LCD Screen: Backlit liquid crystal display shows speaker presets and signal processing.

Signal Indicator: Green LED, one per channel, illuminates when a very low-level signal is present at input.

-10 Indicator: Green LED flashes when output signal exceeds -10 dB below clip.

-20 Indicator: Green LED flashes when output signal level exceeds -20 dB below clip.

Ready Indicator: Green LED, one per channel, illuminates when the amplifier is ready to produce audio.

Clip Indicator: Red LED, one per channel, turns on at the threshold of audible distortion.

Temp Indicator: Red LED, one per channel, illuminates under excessive temperature conditions.

Power Indicator: Blue LED illuminates when the amplifier has been turned on and has power.

Back Panel Controls and Connectors

AC Line Connector: NEMA 5-15P (15A).

Input Connector: Two 3-pin removable Phoenix-type connectors each accept a balanced line-level input signal.

Output Connectors: 4-position barrier strip with connectors for dual loudspeakers or bridge-mono loudspeaker.

HiQnet USB Connector: Type B, connects to a USB port in a PC.

HD-15 Connector: For cinema I/O compatibility with DSi-8M System Monitor.

Protection

DSi-Series amplifiers are protected against shorted, open or mismatched loads; overloaded power supplies; excessive temperature; chain destruction phenomena; excessive output current, and input overload damage. They also protect loudspeakers from input/output DC, large or dangerous DC offsets and turn-on/turn-off transients.

Construction

Chassis: Steel.

Cooling

Proportional speed fan with front-to-rear airflow.

Dimensions

EIA Standard 19-in. (48.3-cm) rack mount width (EIA RS-310-B), 3.5 in. (8.9 cm) high and 12.25 in. (31.11 cm) deep behind mounting surface.

Weight

Net Weight:
19 lb (8.6 kg).

Shipping Weight:
22 lb (10.0 kg).

Regulatory Certifications



Note: All measurements apply to all models of CDi series amplifiers in stereo mode with 8-ohm loads and an input sensitivity of 26-dB gain, 1-kHz at rated power unless otherwise specified. Specifications for units supplied outside the U.S.A. may vary slightly at different AC voltages and frequencies.



The Crown® DSi Series of power amplifiers provides onboard digital signal processing including crossovers, EQ filters, delay and output limiting. A rear panel HD-15 connector provides easy input/output connectivity between DSi amplifiers and the new DSi-8M System Monitor. The intuitive front panel LCD screen guides installers through a setup process—featuring presets for the industry-standard JBL cinema loudspeaker systems—to make configuration quick and easy. At the touch of a button, Crown's DSi cinema amplifiers deliver perfectly matched performance with each award-winning JBL ScreenArray® system, making this the ultimate cinema solution.

C I N E M A

AMPLIFIERS ► CINEMA

DSi-8M: Convenient Monitoring

DSi-8M



Performance Monitor

► FEATURES

- Compact 2-rack unit.
- 8 channels for monitoring processor or amplifier inputs.
- All inputs and outputs are balanced to interface with new cinema processors.
- No level jumps when switching between processor and amplifiers.
- 25-pin D-sub connectors, plus removable terminal blocks and HD-15 for quick, hassle-free connections.
- Designed to work with bi-amplified sound systems to monitor the high- and low-frequency outputs from the left, center and right channels.

► SPECIFICATIONS

Performance

Input Impedance (processor inputs): 10 kilohms.

Input Impedance (power amplifier inputs): > 50 kilohms.

Power Requirements: 100-240VAC, 50-60 Hz, 32 watts.

Front Panel Controls and Indicators

Channel Select Buttons and LEDs: Eight push-button switches, one for each input channel.

Pressing a button monitors the signal from that channel, and lights the corresponding LED. Any combination of eight channels can be selected.

Volume Control: Rotary potentiometer with knob controls the volume of the internal or external speaker. Has no effect on the VU Bargraph Meter display.

Processor/Amplifier Selector Switch and LEDs: Push-button switch with corresponding LEDs selects inputs from cinema processor or power amplifiers for monitoring.

VU Bargraph Meter: 12-segment meter displays input level of selected channels from -40 VU to +3 VU. May be calibrated by the rear panel trim adjustment. Operates independently of the Volume Control.

Test Jack: 1/4-inch phone jack lets the user monitor the audio output of the DSI-8M. Inserting a mono or stereo 1/4-inch phone plug here disables the internal speaker and routes the audio output to the Test Jack.

Internal Speaker: For convenient monitoring at the monitor panel.

Power Switch and Power LED: Rocker switch turns power on or off. LED illuminates when power is on.

Back Panel Controls and Connectors

IEC AC Power Receptacle: Connects to an IEC AC power cord.

Amplifier Outputs Connector 1: 10-pin removable terminal block connects to the power amplifier speaker outputs for the Ls, Rs, Bsl, Bsr and Sw channels.

Amplifier Outputs Connector 2: 10-pin removable terminal block connects to the power amplifier speaker output for the Lh, Ll, Ch, Cl, Rh and Rl channels.

Amplifier Level Control: Trimpot adjusts the level of the input signals from the power amplifiers.

Processor Level: Trimpot adjusts the level of the input signals from the processor.

HD-15 Connector 1: For cinema I/O compatibility. Connects to Ls/Rs amplifier.

HD-15 Connector 2: Connects to Bsl/Bsr amplifier.

HD-15 Connector 3: Connects to Rl/Rh amplifier.

HD-15 Connector 4: Connects to Sw amplifier.

HD-15 Connector 5: Connects to Ll/Lh amplifier.

HD-15 Connector 6: Connects to Cl/Ch amplifier.

Optional Input Connector: 25-pin D-sub connector connects to the EX output of the processor.

Bargraph Level: Trimpot adjusts the sensitivity of the front-panel VU Bargraph Meter.

Main Input Connector: 25-pin D-sub connector connects to the main outputs of the processor.

“EX” Selector Switch: 8-position DIP switch. Turn on switches 1-4 if system is without EX. Turn on switches 5-8 if system is with EX. This routes the correct Ls/Rs inputs to the DSI-8M circuitry.

Construction

Chassis: Steel.

Dimensions

EIA Standard 19-inch (48.3-cm) rack mount width (EIA RS-310-B), 3.5 inches (8.9 cm) high and 9.625 inches (24.4 cm) deep behind front mounting surface.

Weight

Net Weight: 10 lb 2 oz (4.63 kg).

Shipping Weight: 16 lb (7.26 kg).

Regulatory Certifications*



*pending

The Crown® DSI-8M is a projection booth monitor designed to work with bi-amplified cinema systems using the Crown DSI Series amplifiers. All controls necessary for daily operation of the DSI-8M are easily accessible on the front panel. 8-channel monitoring allows you to monitor either the processor or the power amplifier's outputs: L, C, R, Ls, Rs, Bsl, Bsr, and Sub in any combination. Input levels from the processor and power amplifier can be adjusted independently. There are no huge level jumps when switching between processor and power amplifiers. The bargraph display can be calibrated to the reference level for your theater. The projectionist can see auditorium levels instantly.

C I N E M A

CTs 2-Channel



► FEATURES

- High power density. All two channel models in a 2U chassis.
- New Crown Switching Power Supply for lighter weight.
- Selectable "Constant-Voltage" or low-impedance operation per channel.
- 100V direct outputs on CTs 2000, CTs 3000.
- Fully PIP2™-compatible.

POWER OUTPUT*

Models	2-ohm Dual (per channel)	4-ohm Dual (per channel)	70V Dual (per channel)	4-ohm Bridge
CTs 600	150W**	300W	300W	300W**
CTs 1200	250W**	600W	600W	500W**
CTs 2000	1,000W	1,000W	1,000W	2,000W
CTs 3000	1,500W	1,500W	1,500W	3,000W

*Maximum average power in watts at rated THD, 20 Hz - 20 kHz.
** At 1 kHz.

CTs Multi-Channel



► FEATURES

- High power density: Four-channel model in a 2U chassis, eight-channel model in a 3U chassis.
- New Crown Switching Power Supply for lighter weight.
- Selectable "Constant-Voltage" or low-impedance (4/8 ohm) operation per channel-pair.
- 100V direct outputs.
- New "FIT" (Fault Isolation Topology) circuitry isolates fault conditions without affecting neighboring channels.
- Accept VCA-MC accessory modules.

POWER OUTPUT*

Models	All channels driven			All channel pairs driven
	4-ohm Dual	8-ohm Dual	70V Dual	8-ohm Bridge
CTs 4200	260W	200W	220W**	520W
CTs 8200	200W	160W	200W**	400W

*Maximum average power in watts at 1kHz at 0.1% THD.
**Constant Voltage full-bandwidth power ratings support 100 Hz to 20 kHz due to automatic high-pass filters.

XLS Series



► FEATURES

- Housed in a rugged, all-steel 2U chassis.
- Efficient forced-air fan prevents excessive thermal buildup.
- Electronically balanced XLR inputs; touchproof binding post and Speakon outputs.
- Precision detented level controls, power switch, and four LEDs, which indicate clip for each channel, power and fault conditions.

POWER OUTPUT*

Model	4-ohm Dual (per channel)	8-ohm Dual (per channel)	8-ohm Bridge
XLS 202	300W	200W	600W
XLS 402	450W	300W	900W
XLS 602	600W	380W	1,200W
XLS 802	800W	500W	1,600W

*Maximum average power in watts at 0.5% THD, 1 kHz.

Regulatory Certifications

THX CTs 600, CTs 1200, CTs 2000, CTs 3000, CTs 4200, CTs 8200



CTs Series



CTs, DSI and XLS Series



CTs Series



CTs Series



DSi, XLS Series

Note: For more information about the products featured in this section, please refer to the following pages: CTs 2-Channel: page 4, CTs Multi-channel: page 6, XLS Series, page 36.



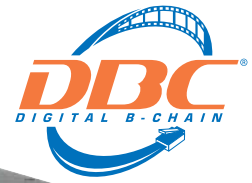

DBC[®] Network Bridge

All-Digital Cinema Solution

At the heart of a Digital B-Chain™ system, the Crown DBC[®] Network Bridge allows you to distribute multiple channels of digital audio over standard fast Ethernet hardware and cabling for use in traditional, e-cinema and d-cinema applications.

The DBC Network Bridge accepts standard analog and/or AES digital audio and CobraNet™ digital channels from other Cinema processors (Dolby®, DTS®), Cinema Servers, or Alternative Content Media Players; and bridges them to a Crown DBC network.

This network is Crown's proprietary "Single-Click" solution that provides system control, monitoring, and digital audio transport. The DBC network (fed by the DBC Network Bridge) distributes the digital audio and system-wide control protocol to Crown amplifiers. The DBC Network Bridge also provides the necessary system equalization, which is stored and recalled via a series of presets for use in both feature film and alternative content programming.



► FEATURES

- Accepts 8 inputs (7.1 surround) via one of the following formats: Analog AES/EBU CobraNet™.
- Selectable mic or line auxiliary analog XLR inputs for alternative content.
- Primary and Secondary 100 Mb Ethernet "Single-Click" connection for DBC network.
- Front-panel LCD display and control functions of internal presets and system setup.
- Full 32-channel CobraNet digital audio transmit/receive capability.
- Enhanced matrix mixer capable of full 8x32 crosspoint matrix mixing.
- 24-bit/48 kHz converters.
- Studio-grade DSP with multiple filter banks for each channel (up to 256 filters).
- 32 presets, 32 scenes, and 32 events can be stored, labeled, and recalled.
- Analog monitoring of cinema processor inputs, pre-amp, or post-amp signals.
- Multiple-function control port for third-party automation/control.
- Internal clock/calendar for scheduling events.
- Auto leveling functions for dynamic volume control of auditoriums or lobby.
- Ambient leveling functions for maintaining maximum signal-to-noise ratio.
- Three-year, no-fault, fully transferable warranty.



Digital Circus, Raleigh, North Carolina, USA.

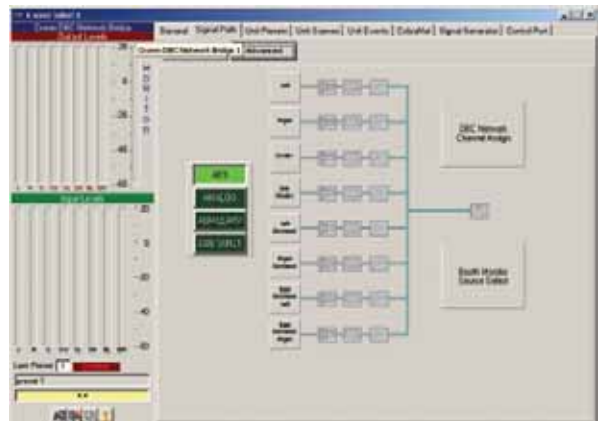

DBC Network Bridge control screen.

CINEMA

Crown Cinema Systems employ quality Crown professional amplifiers along with optional amplifier accessories for the best in cinema sound. Crown's Digital B-Chain system, which provides the first all-digital cinema solution, employs Crown's CTs Series amplifiers, IQ Networking amplifier modules, and Crown's DBC[®] Network Bridge for the first all-digital cinema solution.

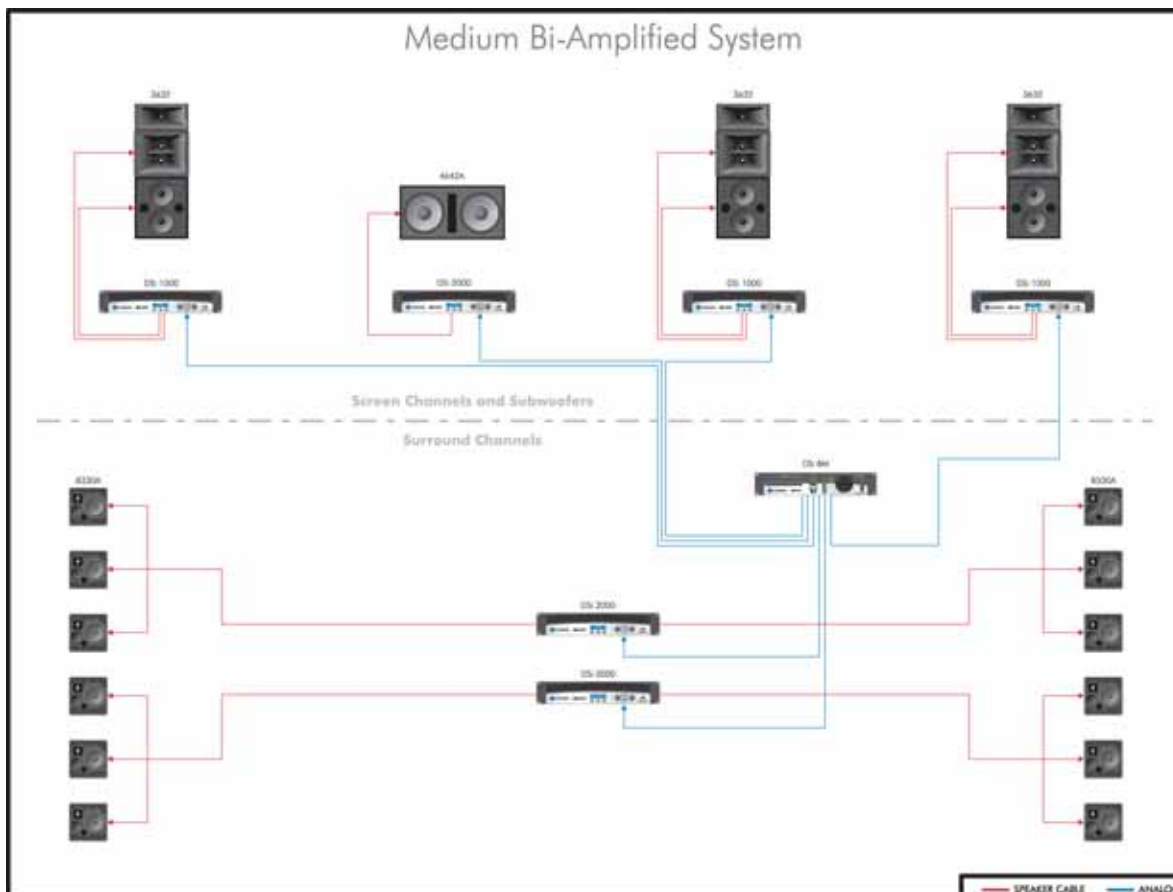
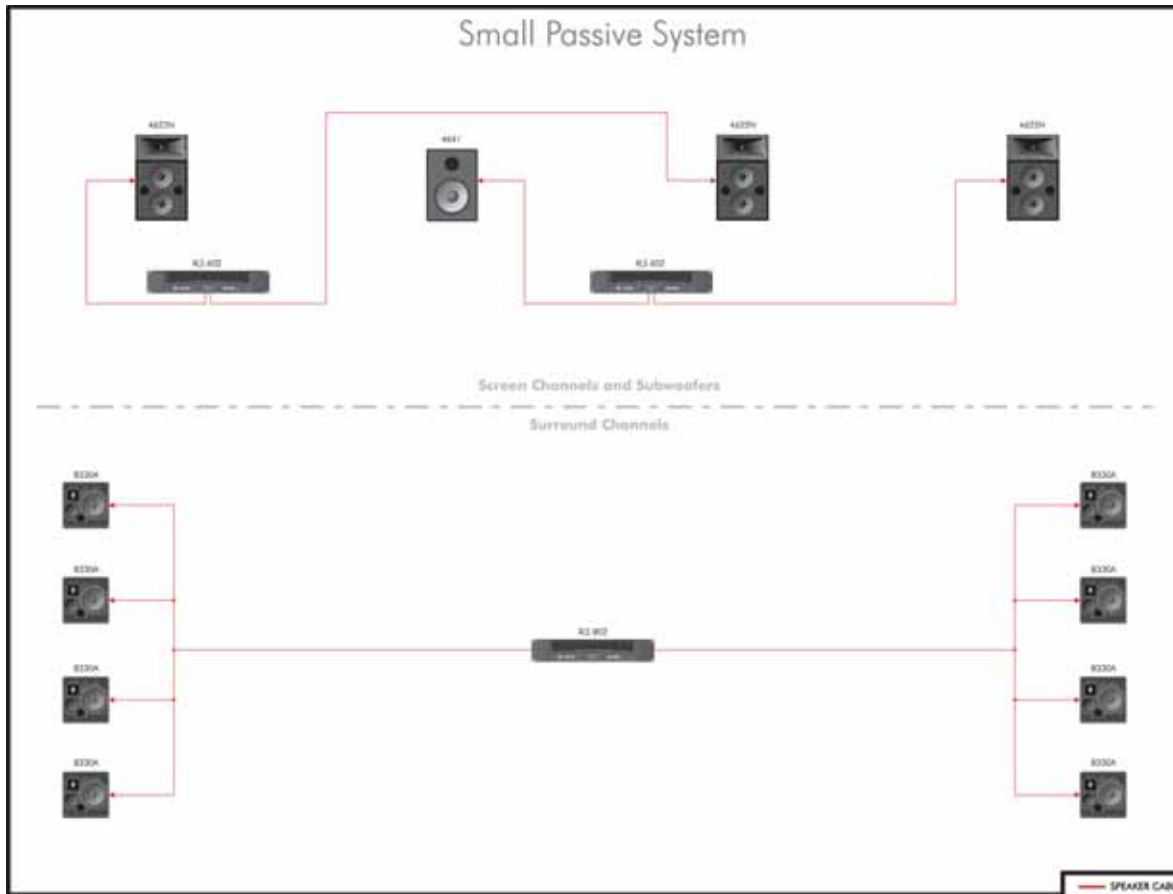

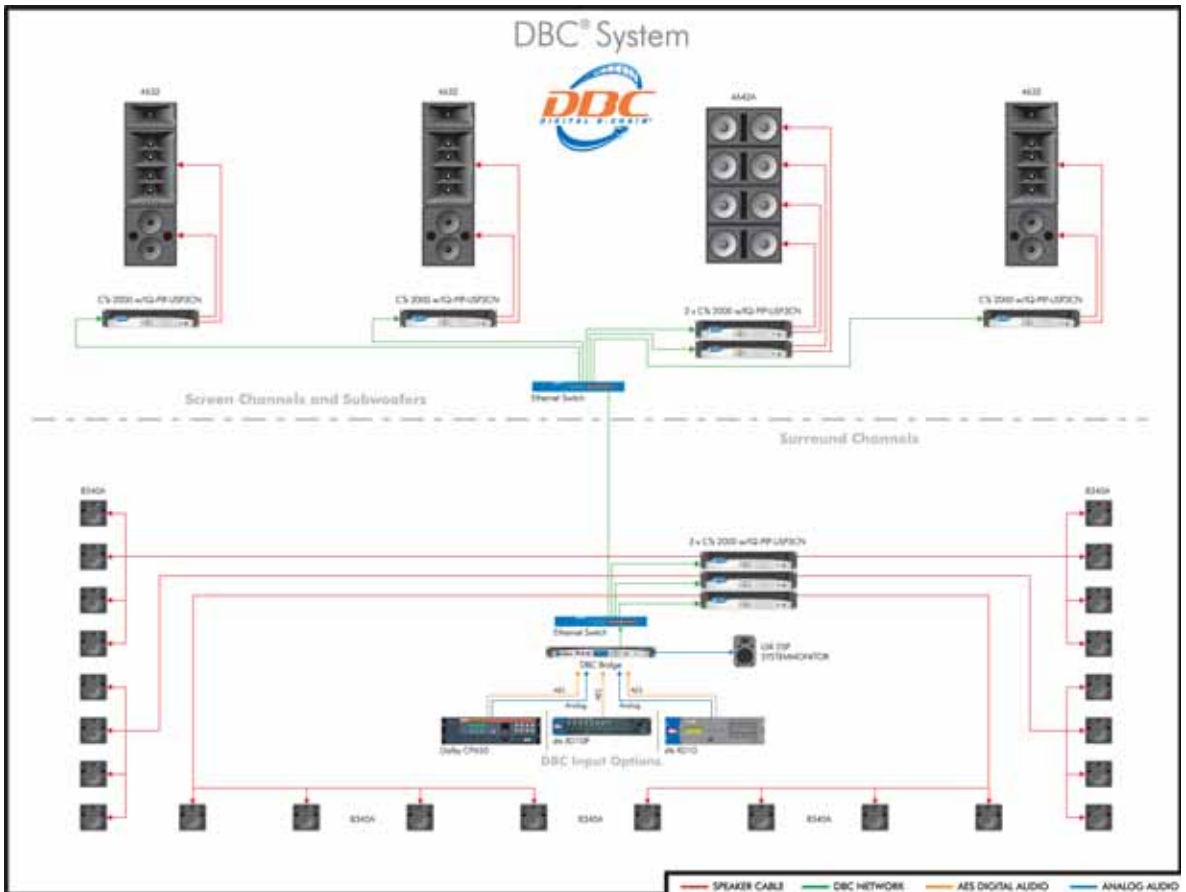
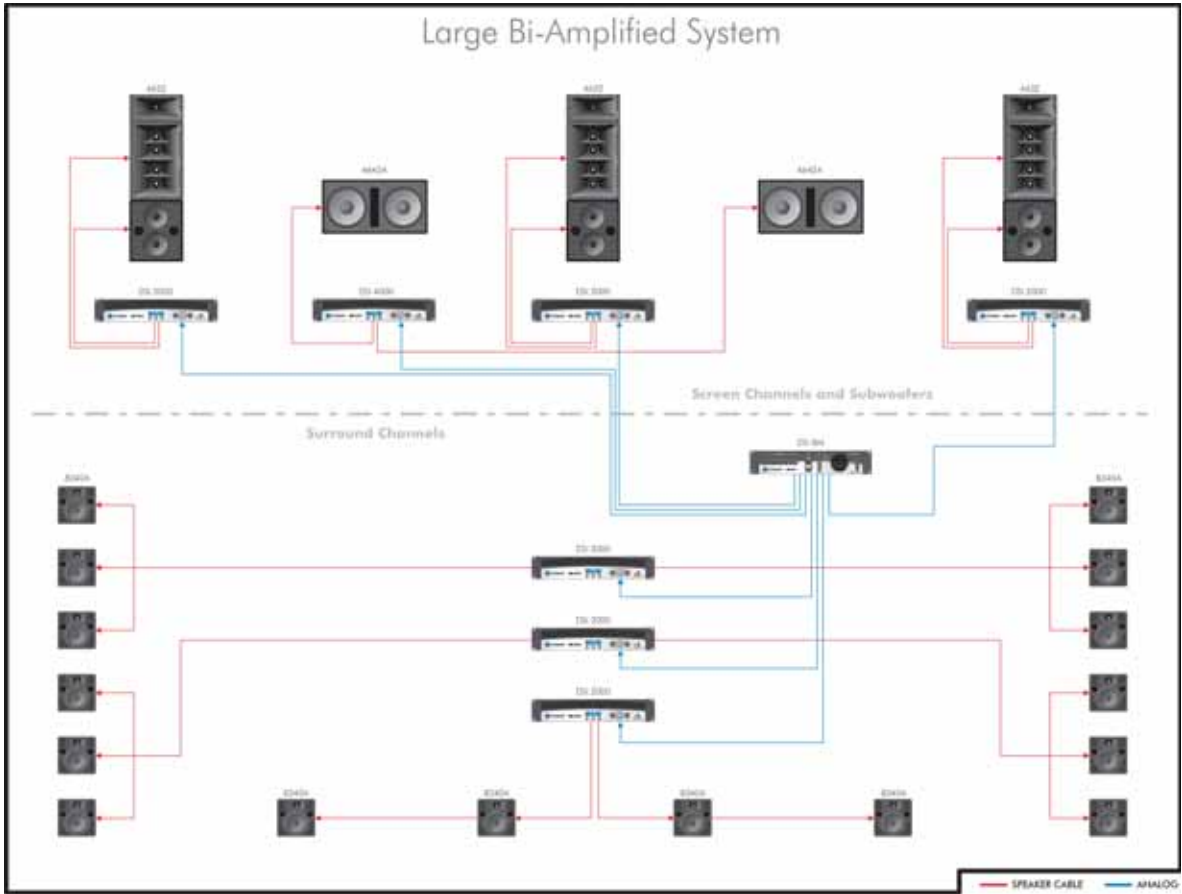





NETWORKED PRODUCTS

HiQnet™ Software

IQ® Software

PIPs

Accessories



Harman Pro System Architect is a fully-featured HiQnet™ software application that provides a seamless, easy-to-use interface for all the devices in the signal path—from microphones to speakers. Built using a modular software design,

System Architect takes full advantage of the knowledge and expertise of each audio company within the Harman Pro group. Product control panel modules and plugins are developed by each company for the products they have designed, while comprehensive control of the entire audio system is managed by the System Architect core module. This allows expertise for product operation and control to be maintained for each product type, while system-wide functions like signal routing, event logging, and venue-wide preset configuration and recall are standardized for all operations and products.

The System Architect core module also provides global operation of audio network services such as local and remote monitoring, streaming audio management, event logging, and more.

For the individual devices, System Architect provides access to extensive configuration, monitoring and control functions through a single, intuitive interface. From wireless microphone receiver setup to speaker tuning via digital speaker presets, System Architect puts you in control of your setup and configuration. Components status during operation, such as

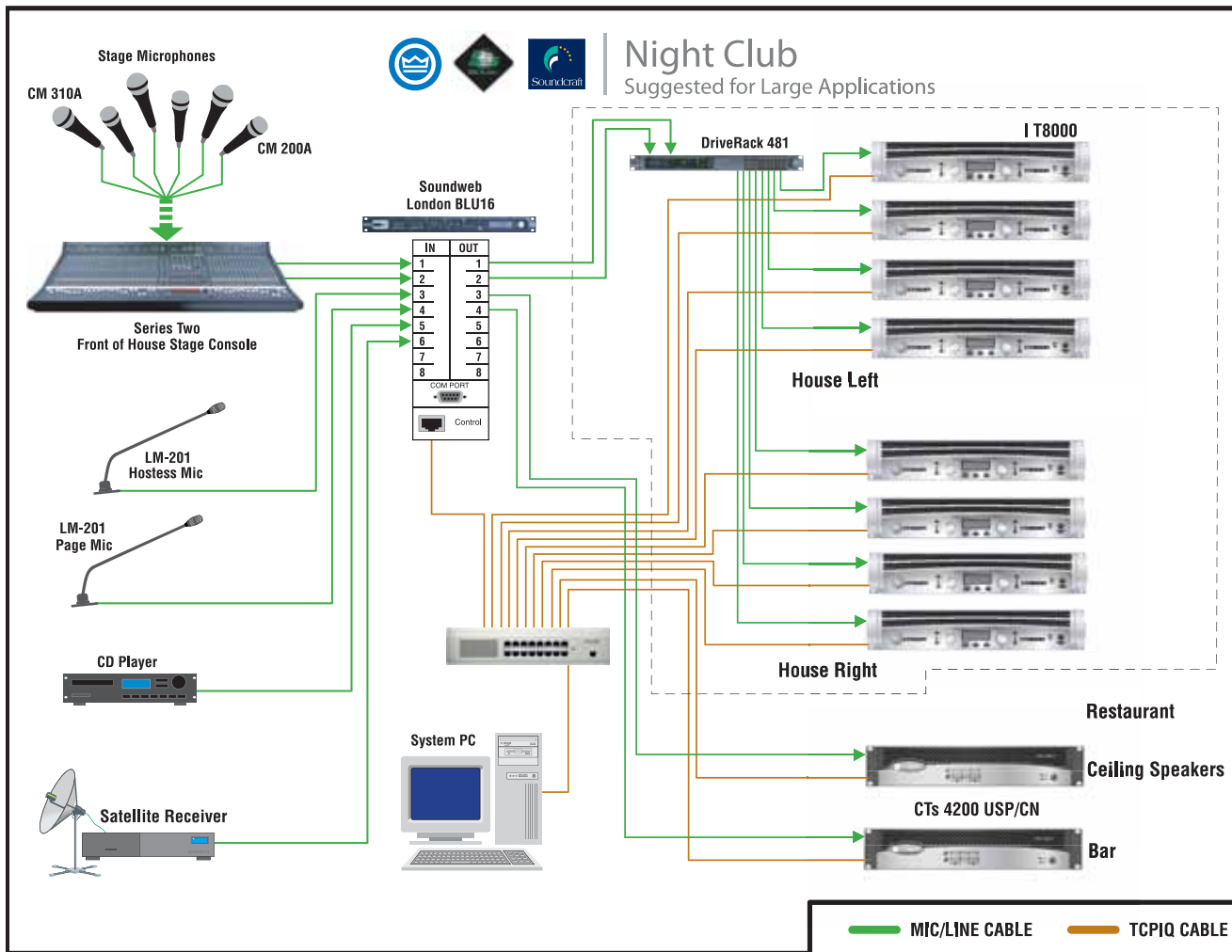

Connect. Configure. Control.



amplifier loads, signal routes and processing, are also easily monitored from a single control station. And when it's time to reconfigure, System Architect can quickly update device routing and settings, amplifier configurations and speaker tunings.

User control and configuration also reaches new levels with System Architect. The intuitive software interface provides easy customization of window sets and control-panel design, as well as a full-screen-mode option, for user touchscreen PC control. BLU-10 touchscreen wall controllers from the Soundweb London system and opti-

mized operation for tablet PC provide additional tools for creation of user-control interfaces. Once configured, system-wide parameters and presets from any connected device can be placed easily onto the same window to create single-screen, custom control panels, eliminating the need for complex programming of third-party control devices.

System Architect offers:

- Microphone control: wireless microphone receiver setup; microphone status on a single screen.

- Signal control: monitor and control signal routing and processing; multiple user signal routing groups and customizable control and monitor panels simplify operation; global update of device routing and settings.
- Amplifier control: load monitoring, output protection and limiting, error reporting.
- Speaker control: remote access via the network to digital speaker presets.

PLUS: system-wide control via customized control panels for any attached device.

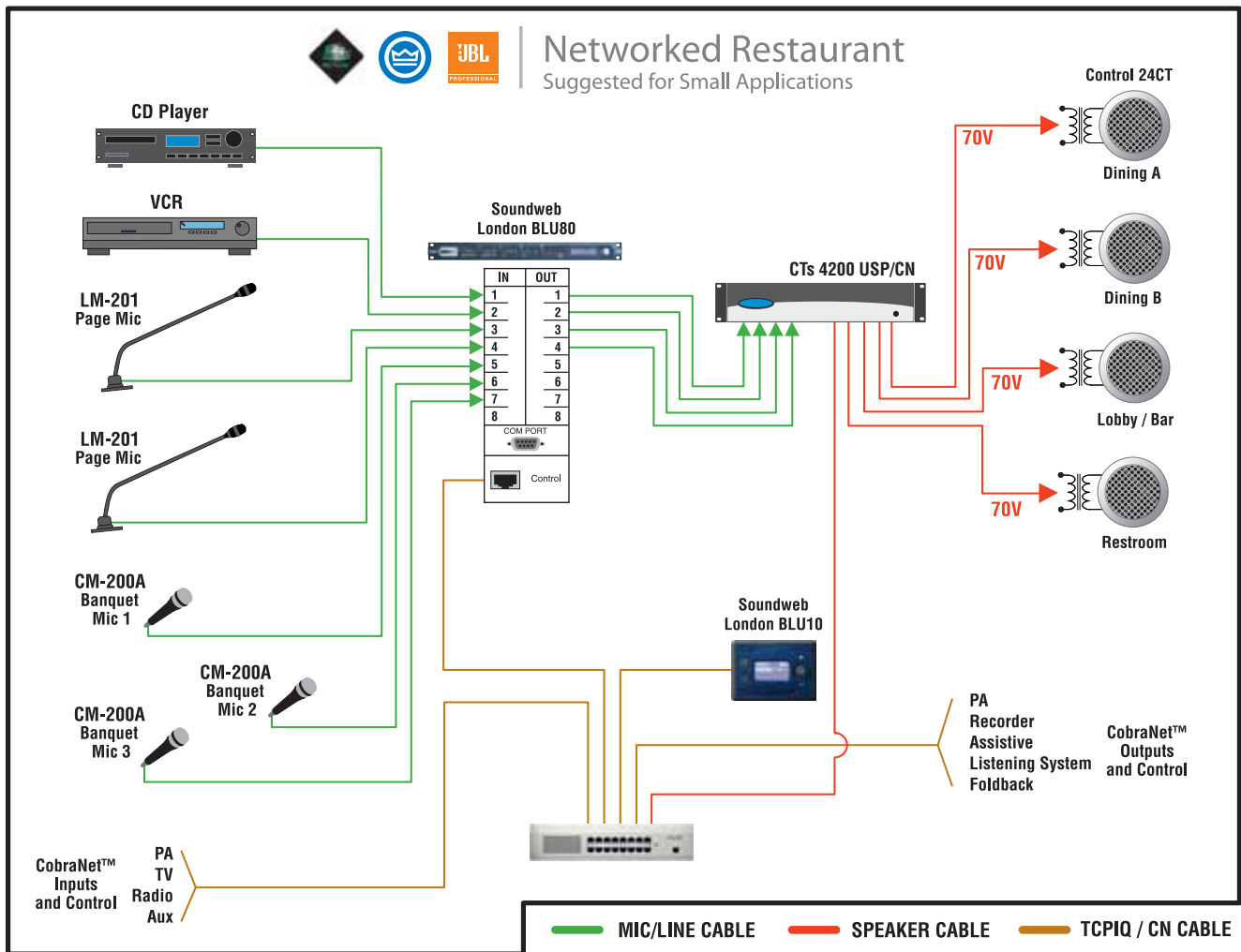

NETWORKED PRODUCTS

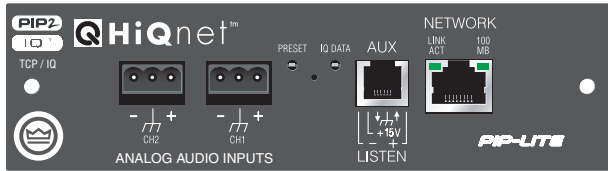

PIP LITE

SmartAmp Automation for Networked Audio



The Crown PIP LITE is a PIP (Programmable Input Processor) input module for PIP2 compatible amplifiers. The PIP-LITE connects to an audio control network via 100 Mb Ethernet. The audio path in the PIP LITE is processed totally in the analog domain. The SmartAmp™ feature set offers a range of automation functions which provide greater control over amplifier operation and helps to save both time and money.

FEATURES

- A Programmable Input Processor with system networking capabilities (connects via 100 Mb Ethernet).
- Remote control and monitoring of PIP2-compatible Crown amplifiers as well as some PIP1-compatible amplifiers.*
- Can be connected to the same network used to transmit CobraNet audio.
- Implements SmartAmp features: input compressors, multimode output limiters, error reporting and load monitoring.
- AUX connector configurable for AUX input, AUX output, or Listen Bus.

* Please refer to the module compatibility chart at the end of the System Solutions section.

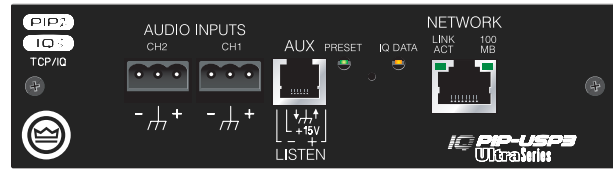

PIP USP3

Digital Signal Processing for Networked Audio



The Crown PIP USP3 is a 3rd generation DSP-based PIP (Programmable Input Processor) input module for PIP2 compatible amplifiers.* It connects the amplifier to a 100 Mb Ethernet network allowing it to be remotely controlled and monitored. This module connects to the audio control/monitor network using standard 100 Mb Ethernet hardware (switches, Network Interface Cards, and cables).

The USP3's SHARC DSP processor gives the user an enormous amount of digital signal processing. Audio routing, faders, meters, polarity & mute, input compressors, filters, delays, multimode output limiters, error reporting, and load monitoring are all available. A built-in noise generator and sine-wave generator provide noise masking and test capabilities. The enhanced AUX port capability allows the user to interface with the amplifier to provide external manual control and monitoring.

Offering crisp, clear sound and the widest dynamic range possible with full 24-bit converters, the PIP USP3 provides unprecedented power and flexibility in one compact—and very affordable—module.

FEATURES

- 100 Mb Ethernet single-plug solution for networked control and monitoring.
- Listen Bus amplifier output monitor (through CobraNet).
- 24-bit conversion with 32-bit, floating point DSP processing.
- 64 assignable filters with 9 different filter types including all-pass filters.
- Over 2 seconds of delay available per channel.
- Input compressors and output limiters for each channel.
- Dual, uncorrelated noise generators for noise masking.
- Sine-wave noise generator.
- Load supervision.
- Full error reporting.
- Firmware upgrades via the network.
- 10 user-selectable presets.
- Reliable FLASH memory backup of all parameters.

* Please refer to the module compatibility chart at the end of the System Solutions section.



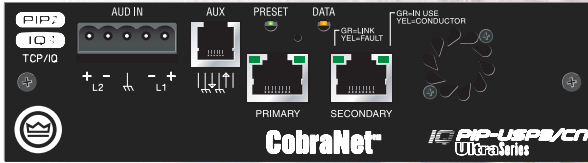

PIP USP3/CN

SmartAmp Automation for TCP/IQ



The Crown PIP-USP3/CN is a 3rd generation DSP-based PIP™ (Programmable Input Processor) input module for PIP2 compatible amplifiers.* It connects the amplifier to a 100 Mb Ethernet network allowing it to be remotely controlled and monitored. In addition, the USP3/CN allows the transport of real-time digital audio via CobraNet over the same Ethernet network.

The USP3/CN connects to the audio control/monitor network using standard 100 Mb Ethernet hardware (switches, Network Interface Cards, and cables). CobraNet audio is available over the same 100 Mb Ethernet network, providing a simple to install, single plug solution for audio distribution, control, and monitoring.

The USP3/CN's SHARC DSP processor gives the user an enormous amount of digital signal processing. Audio routing, faders, meters, polarity & mute, input compressors, filters, delays, multimode output limiters, error reporting, and load monitoring are all available. A built-in noise generator and sine-wave generator provide noise masking and test capabilities. The enhanced AUX port capability allows the user to interface with the amplifier to provide external manual control and monitoring.

FEATURES

- 100 Mb Ethernet single-plug solution for both CobraNet audio and networked control and monitoring.
- Analog audio inputs allow audio input to the CobraNet network, CobraNet audio redundancy, or a hardwire emergency override of CobraNet audio.
- Listen Bus amplifier output monitor via CobraNet.
- 24 bit digital to analog conversion with 32 bit, floating point DSP processing.
- 64 assignable filters with 9 different filter types including all-pass filters.
- Over 2 seconds of delay available per channel.
- Input compressors and output limiters for each channel.
- Dual, uncorrelated noise generators for noise masking.
- Sine-wave generator.
- Load supervision.
- Full error reporting.
- Firmware upgrades via the network.
- 10 user selectable presets.
- Reliable FLASH memory backup of all parameters.

* Please refer to the module compatibility chart at the end of the System Solutions section.

NETWORKED PRODUCTS

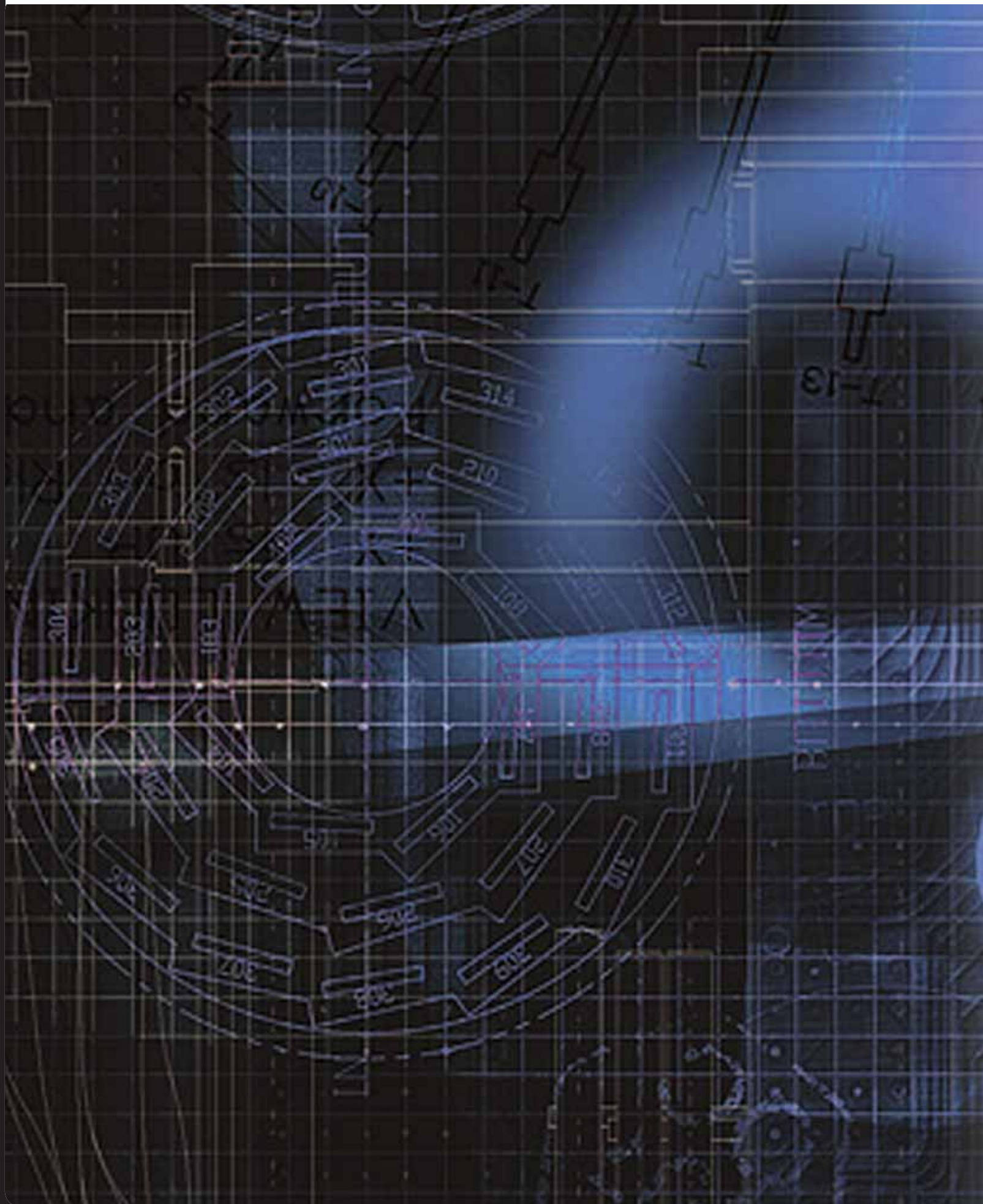



ACCESSORIES & REFERENCE

Accessories

Amplifier Feature Comparison

Amplifier Specifications

Module Compatibility

Crown Amplifier Warranty

Accessories



VCA-MC4A & VCA-MC8

► FEATURES

- Independent remote level control for each channel.
- 4-pin removable Phoenix-style barrier connectors provide the +10VDC control voltage, ground, and control lines for two amplifier channels.
- Optional wall-mount level control panels for use with VCA modules: 1-VCAP and 4-VCAP.

Remote Level Control

The Crown VCA-MC4A and VCA-MC8 are optional level-control modules for the Crown CTs multi-channel power amplifiers. The VCA-MC4A is for the CTs 4200, and the VCA-MC8 is for the CTs 8200.

A VCA-MC module provides independent remote level control for each channel. 4-pin removable Phoenix-style barrier connectors provide the +10VDC control voltage, ground, and control lines for two amplifier channels. Thus, the 4-channel CTs 4200 uses two connectors; the 8-channel CTs 8200 uses four connectors. Crown CTs 4200 and 8200 amplifiers can be supplied with a VCA-MC module already factory-installed, or your choice of MC modules can be easily added to the amplifier by any authorized Crown Service Center.

Choosing the Right Module

To order accessory modules for your amplifier, please refer to the model tag (located on the back panel of the amplifier) for your amplifier's specific model number. Then refer to the information below to select the correct accessory for your requirements.

CTs 4200: VCA-MC4 or IQ-MC4

CTs 4200A: VCA-MC4A or IQ-MC4A

CTs 8200 or CTs 8200A: VCA-MC8 or IQ-MC8

Regulatory Certifications

For all CTs Multi-Channel Amp Accessories:



P.I.P.-CLP

Is designed to detect and prevent overload. The same error detecting circuit that is used to signal the IOC indicator is used to activate this error-driven compressor. It is not a typical signal-driven compressor but a circuit to prevent an overload. It can yield up to 13 dB of additional signal safety margin without noticeable program change.

Regulatory Certifications



1-VCAP & 4-VCAP

► FEATURES

- 1-VCAP provides remote volume control for one or more CTs amplifier channels.
- Fits into a 1-gang electrical box.
- 4-VCAP provides remote volume control for four or more CTs amplifier channels.
- Fits into a 2-gang electrical box.

Wall-Mount Controllers

Crown VCAP panels are wall-mounted panels with potentiometers that provide remote control of the volume of Crown CTs amplifier channels via a VCA-MC4 or VCA-MC8 module installed in the amplifier. Two models are available: 1-VCAP and 4-VCAP.

1-VCAP: Used in conjunction with a VCA-MC module, this is a 1-gang panel with one potentiometer that provides remote volume control for one or more CTs amplifier channels. The potentiometer on the panel is wired directly to the VCA connectors on the VCA-MC.

4-VCAP: This is a 2-gang panel with four potentiometers that provide remote volume control for four or more CTs amplifier channels. The potentiometers on the panel are wired directly to the VCA connectors on the VCA-MC.



T-170V Constant-Voltage Transformer

The Crown **T-170V** is a single autoformer that provides impedance matching between an amplifier output and "constant voltage" loudspeakers. It allows amplifiers without direct 70V or 100V output capability to drive distributed speaker systems designed to operate at those voltages.

100V output capability to drive distributed speaker systems designed to operate at those voltages.



TP-170V Constant-Voltage Transformer Panel

The Crown® **TP-170V** is a rack-mountable panel with four autoformers to provide impedance matching between amplifier outputs and "constant voltage" loudspeakers. This unit allows amplifiers without direct 70V or 100V output capability to drive distributed speaker systems designed to operate at those voltages. The TP-170V is constructed of sturdy steel, and hinged on one side to allow easy access to the inside connections.

cya
(cover your amp)

3PLUS3 3+3 Extended Warranty

Crown's No-Fault, **3+3 Extended Warranty** package extends the terms of your original full warranty for an additional three years, thus covering years four through six. Available for Crown amplifiers only.



Amplifier Feature Comparison

	MA3600VZ, MA5002VZ	CTs 2-Ch.	CTs multi- ch.	CTs multi CobraNet	D	XLS	Xs	I-Tech	Dsi	CDI	XTi	2402	180A, 280A
Protection systems													
ODEP/JTS	X	600/1200 only	X	X				X	X	X	X	X	
Thermal Level Control (TLC)		X	X	X									
Automatic high-pass filter			X	X									
Switchable high-pass filter		X											
Low-pass filter (ultrasonic/RFI protect.)		X											
Power circuit breaker	MA5002VZ only	X				X	X	X					X
Proportional-speed fans	X	X	X	X				X	X	X	X	X	X
Automatic current and voltage limiting					X	X	current						X
Quad Mute												X	
Convection cooled (no fan)					X								X
Advanced Features													
Class I (BCA)		2000/3000 only						X					
Switching power supply		X	X	X			X	X	X	X	X		
Grounded Bridge	X											X	
AB+B		600/1200 only	X	X	X	X							
Bridge Mode Indicator		X	X	X			X	X					
Y input switch								X	X	X	X		
Input Sensitivity Switch	X	X						X				X	
IOC	X				X							X	
Standby mode		2000/3000 only										X	
Precision detented level controls		X	X	X		X	X	X	X	X	X		
Other (specify)	7	1	2	2	headphone jk		5	9	11				
Options													
Onboard DSP				X				X	X	X	X		
HiQnet compatible				X				X	X	X	X		
CobraNet				X				X					
Input sensitivity switch			X	X				X					
Input modules													
Output modules													
Level Control shaft lock									X	X		X	
PIP compatible	X											X	
PIP2 compatible	X											X	
Other (specify)			3	3	4								
Input													
XLR	X					X		X		X	X	X	
1/4-inch	X											X	
Combo					X		X 6						
Screw terminals		X	X	X									
Phoenix							X		X	X			X
Output													
Speakon								X			X		
Binding posts	MA3600VZ only					X	X	X			X	X	
Screw terminals	8	X	X	X	X	X			X	X			X
Other (specify)								10					

1. T-170V autoformer, TP-170V autoformer panel optional accessories.
2. Fault Isolation Topology, Hi/low Z output mode switch.
3. MC modules and VCA modules option allow remote volume control.
4. Bridge-mono option, input-sensitivity option.
5. Microprocessor-controlled protection, AC Mains indicator.
6. XLR output paralleled with XLR-1/4-inch combo and Phoenix-style inputs.
7. Both have Variable Impedance (VZ); MA5002VZ has compressor.
8. MA5002VZ has screw terminals and banana jacks.
9. Onboard IQ networking via TCP/IQ or CobraNet, AES/EBU digital input, onboard DSP, pushbutton presets, global power supply with PFC, LCD control screen shows status/diagnostics.
10. Two male XLR passive analog loop through. XLR active/re-clocked AES/EBU digital loop through.
11. Rear-panel HD-15 connector provides easy I/O connectivity between DSI amps and DSI-8M System Monitor.



REFERENCE

Amplifier Specifications

Amplifiers	Dual Power Per Channel ¹	Mono Power ²	Dimensions	Weight	Comments
CCA 180A	80W-4Ω		19 x 4.1 x 13.9"	21 lb	1 input, 1 output ch.
CCA 280A	80W-4Ω or 70V/100V		19 x 4.1 x 13.9"	25.3 lb	2 inputs, 2 output ch.
CCA 1160A	160W-4Ω or 70V/100V		19 x 4.1 x 13.9"	25.3 lb	1 input, 1 output ch.
CCA 660A	60W-4Ω or 70V/100V		19 x 4.1 x 13.9"	30.3 lb	6 input ch., 6 output ch.
CDi 1000	700W-2Ω, 500W-4Ω, 275W-8Ω	1400W-4Ω, 1000W-8Ω	19 x 3.5 x 12.25"	19 lb	Low-Z or 70V, switch-mode power supply, integrated DSP with speaker presets
CDi 2000	1000W-2Ω, 800W-4Ω, 475W-8Ω	200W-4Ω, 1600W-8Ω	19 x 3.5 x 12.25"	19 lb	
CTs 600	150W-2Ω, 300W-4Ω, 300W-8Ω, 300W-1ΩX, 300W-70V	300W-4Ω, 600W-8Ω, 600W-16Ω, 600W-140V	19 X 3.5 X 14.25"	22 lb 13 oz	Switching power supply; high power density; direct constant-voltage operation, independently selectable input sensitivity per channel; JTS protects output transistors in CTs 600/1200; AB&B topology in CTs 600/1200; Class I (BCA) topology in CTs 2000/3000, PIP compatible
CTs 1200	250W-2Ω, 600W-4Ω, 600W-8Ω, 300W-16Ω, 600W-70V	500W-4Ω, 1200W-8Ω, 1200W-16Ω, 1200W-140V	19 X 3.5 X 14.25"	23 lb 6 oz	
CTs 2000	1000W-2Ω, 1000W-4Ω, 1000W-8Ω, 625W-16Ω, 1000W-70V, 1000W-100V	2000W-4Ω, 2000W-8Ω, 2000W-16Ω, 2000W-140V, 2000W-200V	19 X 3.5 X 14.25"	27 lb	
CTs 3000	1500W-2Ω, 1500W-4Ω, 1250W-8Ω, 625W-16Ω, 1500W-70V, 1500W-100V	3000W-4Ω, 3000W-8Ω, 2500W-16Ω, 3000W-100V, 3000W-200V	19 X 3.5 X 14.25"	27 lb 11 oz	
CTs 4200	260W-4Ω, 200W-8Ω, 220W-70V	520W-8Ω, 400W-16Ω, 220W-100V	19 X 3.5 X 16.25"	27 lb 8 oz	Multichannel amps; switching power supply; JTS protects output transistors, high power density; constant voltage or low Z or each ch. pair; Fault Isolation Topology isolates faults; MC modules for remote control
CTs 8200	200W-4Ω, 160W-8Ω, 200W-70V	400W-8Ω, 320W-16Ω, 200W-100V	19 X 5.25 X 16.25"	36 lb 6 oz	
D-45	35W-4Ω, 25W-8Ω	70W-8Ω	19 x 1.75 x 9"	8 lb	AB+B circuitry; Power/Signal/IOC indicators, headphone jack; Dual/Bridge-Mono; Neutrik combo input connectors; detented front level controls, convection cooling
D-75A	55W-4Ω, 40W-8Ω	110W-8Ω	19 x 1.75 x 9"	9 lb	
DSi 1000	700W-2Ω, 500W-4Ω, 275W-8Ω	1400W-4Ω, 1000W-8Ω	19 x 3.5 x 12.15"	17 lb	Presets for JBL cinema speakers, front-panel LCD screen, onboard DSP, HiQnet System Architect compatible, HD-15 connectors interface with DSi-8M System Monitor, switch-mode universal power supply, barrier strip outputs and Phoenix input
DSi 2000	1000W-2Ω, 800W-4Ω, 475W-8Ω	2000W-4Ω, 1600W-8Ω	19 x 3.5 x 12.15"	17 lb	
DSi 4000	1600W-2Ω, 1200W-4Ω, 650W-8Ω	3200W-4Ω, 2400W-8Ω	19 x 3.5 x 12.15"	17 lb	
I-T4000	1800W-2Ω, 2000W-4Ω, 1240W-Ω	3600W-4Ω, 4000W-8Ω	19 x 3.5 x 16"	20 lb	Amazing power in a 2U lightweight chassis, global power supply with PFC, on board DSP, built-in networking to IQ System or HiQnet via TCP/IQ or CobraNet™, LCD control screen shows amplifier status and diagnostics, pushbutton DSP presets for various loudspeakers, efficient Class-I circuitry
I-T6000	2500W-2Ω, 3000W-4Ω, 1500W-8Ω	5000W-4Ω, 6000W-8Ω	19 x 3.5 x 16"	28 lb	
I-T8000	3500W-2Ω, 4000W-4Ω, 2100W-8Ω	7000W-4Ω, 8000W-8Ω	19 x 3.5 x 16"	28 lb	
MA-2402	1050W-2Ω, 800W-4Ω, 520W-8Ω	2070W-4Ω, 1585W-8Ω	19 x 3.5 x 16"	51 lb 12 oz	Grounded Bridge circuitry; ODEP, IOC/SPI indicators; separate power supplies; Dual, Bridge-Mono and Parallel-mono modes; balanced XLR input connectors; front-panel level controls; ground lift switch; forced-air cooling; PIP compatible
MA-3600VZ	1800W-2Ω, 1565W-4Ω, 1120W-8Ω	3505W-4Ω, 3140W-8Ω	19 x 3.5 x 16"	55 lb 4 oz	3-mode VZ power supply for maximum power matching; see MA2402 features
MA-5002VZ	2500W-2Ω, 2000W-4Ω, 1300W-8Ω	5000W-4Ω, 4000W-8Ω	19 x 5.25 x 16"	77 lb 13 oz	



Amplifier Specifications

XLS 202	300W-4Ω, 200W-8Ω	600W-8Ω	19 x 3.5 x 15.2"	23 lb	Rugged all-steel 2U chassis; efficient cooling fan; electronically balanced XLR inputs; touch-proof binding post and Speakon® outputs; precision detented level controls, clip/power/fault indicator LEDs
XLS 402	450W-4Ω, 300W-8Ω	900W-8Ω	19 x 3.5 x 15.2"	25.7 lb	
XLS 602	600W-4Ω, 380W-8Ω	1200W-8Ω	19 x 3.5 x 15.2"	29 lb	
XLS 802	800W-4Ω, 500W-8Ω	1600W-8Ω	19 x 3.5 x 15.2"	35.5 lb	
Xs500	750W-2Ω, 500W-4Ω, 400W-8Ω	1600W-4Ω, 1450W-8Ω	19 x 3.5 x 17"	28 lb	Rugged all-steel 2U chassis; efficient cooling fan; XLR-1/4" combo and Phoenix-style inputs; daisy-chain XLR outputs; binding post outputs and Speakon outputs; precision detented level controls; LEDs for clip, power, AC present, temperature and fault conditions; microprocessor-controlled protection system; lightweight design
Xs700	900W-2Ω, 750W-4Ω, 450W-8Ω	1900W-4Ω, 1645W-8Ω	19 x 3.5 x 17"	28 lb	
Xs900	1100W-2Ω, 900W-4Ω, 600W-8Ω	2500W-4Ω, 2100W-8Ω	19 x 3.5 x 17"	28 lb	
Xs1200	1600W-2Ω, 1100W-4Ω, 650W-8Ω	2000W-4Ω, 2300W-8Ω	19 x 3.5 x 17"	28 lb	
XTi 1000	700W-2Ω, 500W-4Ω, 275W-8Ω	1400W-4Ω, 1000W-8Ω	19 x 3.5 x 12.25"	18.5 lb	Speaker presets with LCD front panel display, onboard DSP, handles a wide range of loads, switch-mode universal power supply, Speakon and binding posts outputs; XLR inputs and loop-thrus
XTi 2000	1000W-2Ω, 800W-4Ω, 475W-8Ω	2000W-4Ω, 1600W-8Ω	19 x 3.5 x 12.25"	18.5 lb	
XTi 4000	1600W-2Ω, 1200W-4Ω, 650W-8Ω	3200W-4Ω, 2400W-8Ω	19 x 3.5 x 12.25"	18.5 lb	

1. Guaranteed minimum power in Dual mode, both channels driven
2. Guaranteed minimum power in Bridge-Mono mode

Module Compatibility

AMPLIFIER	ANALOG PIP ³	IQ-PIP-LITE	IQ-PIP-USP3	IQ-PIP-USP3/CN	IQ-MC4A, VCA-MC4A	IQ-MC8, VCA-MC8	SCREEN ARRAY PIPS	PIP-USPMC/CN
CTs 600/1200/2000/3000		X	X	X			X	
CTs 4200					X			X
CTs 8200						X		X
MA02 Series	X	X	X	X			X	
MA 3600VZ	X	1						
MA 5000VZ	X	2	2	2			X	
MA 5002VZ	X	X	X	X			X	
CCA, CDi, D, DSi, IT, XLS and Xs Series								

1. IQ-PIP LITE may be installed in older PIP1-compatible amplifiers by using the USP2 Adapter Kit (functionality slightly limited when using the Adapter Kit).
2. MA-5000VZ amplifiers with serial numbers beginning with the prefix A or B are PIP2 compatible. PIP2 compatible amplifiers bear the PIP2 logo  on the rear.
3. Analog PIPs include: P.I.P.-AMCb, P.I.P.-CLP, P.I.P.-EDCb, P.I.P.-RPA and P.I.P.-RPAT.

REFERENCE

Crown Amplifier Warranty

USA AND CANADA

SUMMARY OF WARRANTY

Crown International, 1718 West Mishawaka Road, Elkhart, Indiana 46517-4095 U.S.A. warrants to you, the ORIGINAL PURCHASER and ANY SUBSEQUENT OWNER of each NEW Crown product, for a period of three (3) years from the date of purchase by the original purchaser (the "warranty period") that the new Crown product is free of defects in materials and workmanship. We further warrant the new Crown product regardless of the reason for failure, except as excluded in this Warranty.

ITEMS EXCLUDED FROM THIS CROWN WARRANTY

This Crown Warranty is in effect only for failure of a new Crown product which occurred within the Warranty Period. It does not cover any product which has been damaged because of any intentional misuse, accident, negligence, or loss which is covered under any of your insurance contracts. This Crown Warranty also does not extend to the new Crown product if the serial number has been defaced, altered, or removed.

WHAT THE WARRANTOR WILL DO

We will remedy any defect, regardless of the reason for failure (except as excluded), by repair, replacement, or refund. We may not elect refund unless you agree, or unless we are unable to provide replacement, and repair is not practical or cannot be timely made. If a refund is elected, then you must make the defective or malfunctioning product available to us free and clear of all liens or other encumbrances. The refund will be equal to the actual purchase price, not including interest, insurance, closing costs, and other finance charges less a reasonable depreciation on the product from the date of original purchase. Warranty work can only be performed at our authorized service centers or at the factory. Warranty work for some products can only be performed at our factory. We will remedy the defect and ship the product from the service center or our factory within a reasonable time after receipt of the defective product at our authorized service center or our factory. All expenses in remedying the defect, including surface shipping costs in the United States, will be borne by us. (You must bear the expense of shipping the product between any foreign country and the port of entry in the United States including the return shipment, and all taxes, duties, and other customs fees for such foreign shipments.)

HOW TO OBTAIN WARRANTY SERVICE

You must notify us of your need for warranty service within the warranty period. All components must be shipped in a factory pack, which, if needed, may be obtained from us free of charge. Corrective action will be taken within a reasonable time of the date of receipt of the defective product by us or our authorized service center. If the repairs made by us or our authorized service center are not satisfactory, notify us or our authorized service center immediately.

DISCLAIMER OF CONSEQUENTIAL AND INCIDENTAL DAMAGES

YOU ARE NOT ENTITLED TO RECOVER FROM US ANY INCIDENTAL DAMAGES RESULTING FROM ANY DEFECT IN THE NEW CROWN PRODUCT. THIS INCLUDES ANY DAMAGE TO ANOTHER PRODUCT OR PRODUCTS RESULTING FROM SUCH A DEFECT. SOME STATES DO NOT ALLOW THE EXCLUSION OR LIMITATIONS OF INCIDENTAL OR CONSEQUENTIAL DAMAGES, SO THE ABOVE LIMITATION OR EXCLUSION MAY NOT APPLY TO YOU.

WARRANTY ALTERATIONS

No person has the authority to enlarge, amend, or modify this Crown Warranty. This Crown Warranty is not extended by the length of time which you are deprived of the use of the new Crown product. Repairs and replacement parts provided under the terms of this Crown Warranty shall carry only the unexpired portion of this Crown Warranty.

DESIGN CHANGES

We reserve the right to change the design of any product from time to time without notice and with no obligation to make corresponding changes in products previously manufactured.

LEGAL REMEDIES OF PURCHASER

THIS CROWN WARRANTY GIVES YOU SPECIFIC LEGAL RIGHTS, YOU MAY ALSO HAVE OTHER RIGHTS WHICH VARY FROM STATE TO STATE. No action to enforce this Crown Warranty shall be commenced after expiration of the warranty period.

THIS STATEMENT OF WARRANTY SUPERSEDES ANY OTHERS CONTAINED IN THIS MANUAL FOR CROWN PRODUCTS.

12/01

TRADEMARKS NOTICE: Crown, Crown Audio, Amcron, BCA, IQ, Differoid, DBC, IOC, IQ System, Macro-Tech, ODEP, P.I.P., and VZ are registered trademarks; Digital B-Chain, Grounded Bridge, Power-Tech, PIP, PIP2, TCP/IQ, IQwic, SmartAmp, IQ2 and XTi are trademarks of Crown International.

Neutrik, Speakon, Windows, Dolby, DTS, HiQnet, CobraNet, ScreenArray, dbx, System Architect, Phoenix and JBL are used for information only and are the property of their respective companies.

Crown Audio, Inc. reserves the right to make changes in specifications, software, or products without prior notice. Crown Audio, Inc. also assumes no responsibility for any error in type or print reproduction of the features or specifications in this literature. The information provided in this manual was deemed accurate as of the publication date. However, updates to this information may have occurred. To obtain the latest version of this manual, please visit the Crown website at www.crown-audio.com.

Some models may be exported under the name Amcron.



Crown Amplifier Warranty

WORLDWIDE EXCEPT USA & CANADA

SUMMARY OF WARRANTY

Crown International, 1718 West Mishawaka Road, Elkhart, Indiana 46517-4095 U.S.A. warrants to you, the ORIGINAL PURCHASER and ANY SUBSEQUENT OWNER of each NEW Crown1 product, for a period of three (3) years from the date of purchase by the original purchaser (the "warranty period") that the new Crown product is free of defects in materials and workmanship, and we further warrant the new Crown product regardless of the reason for failure, except as excluded in this Warranty.

¹ Note: If your unit bears the name "Amcron," please substitute it for the name "Crown" in this warranty.

ITEMS EXCLUDED FROM THIS CROWN WARRANTY

This Crown Warranty is in effect only for failure of a new Crown product which occurred within the Warranty Period. It does not cover any product which has been damaged because of any intentional misuse, accident, negligence, or loss which is covered under any of your insurance contracts. This Crown Warranty also does not extend to the new Crown product if the serial number has been defaced, altered, or removed.

WHAT THE WARRANTOR WILL DO

We will remedy any defect, regardless of the reason for failure (except as excluded), by repair, replacement, or refund. We may not elect refund unless you agree, or unless we are unable to provide replacement, and repair is not practical or cannot be timely made. If a refund is elected, then you must make the defective or malfunctioning product available to us free and clear of all liens or other encumbrances. The refund will be equal to the actual purchase price, not including interest, insurance, closing costs, and other finance charges less a reasonable depreciation on the product from the date of original purchase. Warranty work can only be performed at our authorized service centers. We will remedy the defect and ship the product from the service center within a reasonable time after receipt of the defective product at our authorized service center.

HOW TO OBTAIN WARRANTY SERVICE

You must notify your local Crown importer of your need for warranty service within the warranty period. All components must be shipped in the original box. Corrective action will be taken within a reasonable time of the date of receipt of the defective product by our authorized service center. If the repairs made by our authorized service center are not satisfactory, notify our authorized service center immediately.

DISCLAIMER OF CONSEQUENTIAL AND INCIDENTAL DAMAGES

YOU ARE NOT ENTITLED TO RECOVER FROM US ANY INCIDENTAL DAMAGES RESULTING FROM ANY DEFECT IN THE NEW CROWN PRODUCT. THIS INCLUDES ANY DAMAGE TO ANOTHER PRODUCT OR PRODUCTS RESULTING FROM SUCH A DEFECT.

WARRANTY ALTERATIONS

No person has the authority to enlarge, amend, or modify this Crown Warranty. This Crown Warranty is not extended by the length of time which you are deprived of the use of the new Crown product. Repairs and replacement parts provided under the terms of this Crown Warranty shall carry only the unexpired portion of this Crown Warranty.

DESIGN CHANGES

We reserve the right to change the design of any product from time to time without notice and with no obligation to make corresponding changes in products previously manufactured.

LEGAL REMEDIES OF PURCHASER

No action to enforce this Crown Warranty shall be commenced after expiration of the warranty period.

THIS STATEMENT OF WARRANTY SUPERSEDES ANY OTHERS CONTAINED IN THIS MANUAL FOR CROWN PRODUCTS.

7/01

REFERENCE



50 YEARS OF INNOVATION. REMIXED.

Introducing the new XTi Series amplifier from the experts at Crown. With integrated processing and three models from 500 to 1200 watts, we've just reinvented history.



CROWN

www.crownaudio.com

I-TECH

One World



...One Amp!

I-Tech's sound: The new universal language of tour sound professionals.



"The I-Tech Series 8000 amplifiers are light weight, great sounding, and have exceeded our staff engineer's expectations. Enough said."
- Dave Shadoan
Sound Image. Escondido, CA.



"Both the power and processing were flawless on tour!"
- Mark Radu
PA Plus. Toronto, Canada.



"The Crown Class-I switchmode and PFC technology makes I-Tech sound better than any other amplifier on the market."
- Jens Elsborg
Nordic Rentals. Denmark.



"I have never seen an amplifier output with such big power. I-Tech is the amplifier we've been waiting for."
- Ryoichi "Big Boss" Hashimoto
Hibino Sound. Tokyo, Japan.

©2006 Crown Audio, Inc.

visit us at: www.crownaudio.com

I-TECH POWER AMPLIFIERS





INTELLIGENT POWER. **UNLEASHED.** **CROWN**

1718 West Mishawaka Road
Elkhart, IN 46517-9120
Phone: (574) 294.8200
Fax: (574) 294.8329
E-mail: audioinfo@crownaudio.com

www.crownaudio.com

 A Harman International Company

136465-3 12/06



DSi Series



XLS Series



CDI Series