

MANUAL

IS-RPI
INTRINSICALLY SAFE
REMOTE PROCESS
INTERFACE

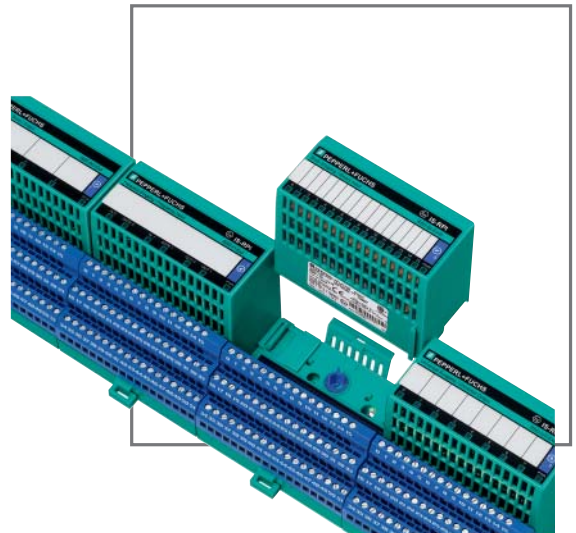

With regard to the supply of products, the current issue of the following document is applicable:
The General Terms of Delivery for Products and Services of the Electrical Industry, published by
the Central Association of the "Elektrotechnik und Elektroindustrie (ZVEI) e.V.",
including the supplementary clause: "Extended reservation of title".

1	Introduction	3
1.1	Brief overview of the Intrinsically Safe Remote Process Interface IS-RPI.	3
1.2	Requirements for working with the IS-RPI-System	4
1.3	Goals of the IS-RPI-System manual.	4
2	Information on using the IS-RPI-System manual	5
2.1	Symbols used	5
2.2	List of abbreviations used	6
3	Safety and availability	7
3.1	Safety instructions	7
3.2	Availability, functional safety and functional monitoring	8
4	System description.	9
4.1	Range of application	9
4.2	System layout and operating principle	10
4.3	Performance features	17
4.4	System components	20
4.5	Accessories	22
5	Planning and design	24
5.1	Special features of the system.	24
5.2	Planning system topology	25
5.3	Planning intrinsically safe power supplies	28
5.4	Planning the mechanical layout.	30
5.5	Galvanic isolation in the IS-RPI	36
6	Installation	37
6.1	Delivery and transport.	37
6.2	Mechanical layout	37
6.3	Assembling IS-RPI gateways and modules	38
6.4	Wiring/electrical connection.	41
7	Configuration and parameter assignment for the IS-RPI.	49
7.1	Configuration with the fieldbus	49
8	Commissioning/operation.	50
8.1	Procedure for commissioning	50
8.2	The IS-RPI in operation.	51

Date of issue 01/11/08 044174

9	Diagnostics and error handling	55
9.1	Internal diagnostics and self-test/saving the contents of memory	55
9.2	Error message and diagnostics using device LEDs	56
9.3	Error message and diagnostics via the fieldbus	59
10	Maintenance	60
11	Disassembly and disposal	60
12	IS-RPI modules	61
12.1	General information on the electrical connection	61
12.2	Generally applicable information on operating the modules	61
12.3	General data structure of modules	62
12.4	Data structure/adjustable parameters of the modules	64
13	The IS-RPI/MODBUS gateway	104
13.1	General information on operating the RSD-GW-Ex1.MOD gateway	104
13.2	Operation on the MODBUS	105
13.3	Writing/reading data	109
14	IS-RPI-/PROFIBUS gateways	115
14.1	General information	115
14.2	Commissioning	116
14.3	PROFIBUS diagnostics	141
15	HART Communication via IS-RPI.	145
15.1	Product description for RSD-CI(UO)-Ex8.H	145
15.2	System layout	148
15.3	PACTware™	149
15.4	Commissioning	162
15.5	Diagnostics and error handling	163
15.6	Appendix	164
16	Appendix	168
16.1	Structure of the real-time data table	168
16.2	Structure of the expanded data table (via the acyclic channel of IS-RPI)	168
16.3	Content of real-time data tables, module-related	168

1 Introduction

1.1 Brief overview of the Intrinsically Safe Remote Process Interface IS-RPI

In many production installations, e. g. the chemical and petrochemical industries, onshore and offshore installations, pipelines, etc., there are areas with potentially explosive atmospheres. In order to provide protection, safety and proper functioning, the signal circuits for measurement, control, regulation and monitoring must be implemented with the ignition protection class: intrinsic safety. In addition to the actual input and output components of the Programmable Logic Controller (PLC) or the Process Control System, interface components are needed to ensure that the signal circuits are protected against explosion in case of failure.

Pepperl+Fuchs has been the leading supplier of such interface components for many years. These interface units are available on Eurocard or as modular housings (K-Systems). The latest developments from Pepperl+Fuchs in this area is the Intrinsically Safe Remote Process Interface (IS-RPI).

The new approach will be to eliminate the need for IS barriers/isolators and the separation of control and process by certifying the entire IS-RPI-System as intrinsically safe. This allows the interface to be installed directly nearby the controlled equipment in the hazardous area. The IS-RPI-System is designed for use in Zone 1 (CENELEC)/group B, C&D/IIC (US) of the hazardous area, i. e. it can be used directly in the potentially explosive atmosphere. This distinguishes the IS-RPI completely from conventional interface components which must be installed in safe areas.

The primary goals in developing the IS-RPI are a high level of technical performance, avoiding additional, costly installations and making the system attractive to wide range of users. To this end, the system is also developed for operation at ambient temperatures up to 70 °C.

1.2 Requirements for working with the IS-RPI-System

The Intrinsically Safe Remote Process Interface IS-RPI operates using the latest technologies in signal processing and transmission. In order to safeguard areas with explosive atmospheres where MSR devices are installed, the IS-RPI plays a central role in the area of safety engineering.



National and local requirements regarding set-up, installation and commissioning must be observed for installation, commissioning, operation and maintenance of all devices and device components of the IS-RPI in hazardous areas (in Germany DIN EN 50020, DIN VDE 0165).

When planning and projecting systems outside of Germany, observe the applicable conditions. Especially in North America, there are other conditions than those in CENELEC member countries.

You are responsible as planner, set-up specialist or operator for maintaining all conditions and requirements for hazardous areas.

1.3 Goals of the IS-RPI-System manual

The IS-RPI-System manual gives important information and notices about

- Planning
- Installation
- Configuration
- Operation
- Safety
- Detection and elimination of problems

for the Intrinsically Safe Remote Process Interface (IS-RPI) from Pepperl+Fuchs.



2 Information on using the IS-RPI-System manual

2.1 Symbols used



Attention

This symbol draws your attention to requirements and procedures that absolutely must be followed.



Note

This symbol draws your attention to important information.

2.2 List of abbreviations used

0 _d or 0d	Decimal display
0 _h or 0h	Hexadecimal display
0 _b or 0b	Binary display
Backplane bus	Internal serial data bus
CH	Channel
CHK	Check, test
COM	Communication
DDL M	Direct Data Link Mapper
DC	Direct Current
DP	Non-central peripherals
I/O	Input/Output
EEPROM	Electrical Erasable and Programmable ROM
EMC	Electromagnetic compatibility
ERR	Error, fault
Ex-Side into	The side of the device from which electrical currents lead into areas with an explosive atmosphere.
EXT	External
FDL	Fieldbus Data Link
FMS	Fieldbus Message Specification
GND	Ground, reference potential
I/O	Input/Output
ID	Identification, detection
INT	Internal
LCD	Liquid Crystal Display
LED	Light Emitting Diode
LSAP	Link Service Access Point
LSB	Least Significant Bit
MSB	Most Significant Bit
MCF	Measurement, control and feedback technology
PA	Process Automation
PC	Personal Computer
PHY	Physical Layer
PLS	Process Guidance System
PWR	Power, power supply
RAM	Random Access Memory
ROM	Read Only Memory
RPI	Remote Process Interface
SAP	Service Access Point
PLC	Programmable Logic Controller
TAG number	Selection switch markings
UPS	Uninterruptible Power Supply

3 Safety and availability

3.1 Safety instructions

The Intrinsically Safe Remote Process Interface IS-RPI of Pepperl+Fuchs can be used directly in the hazardous area (zone 1, CENELEC, group A, B, C and D/IIC, US) since the devices themselves are designed and approved in the intrinsic safety ignition protection type. Transmission of the I/O signals between the safe and potentially explosive area is carried out using a field bus system where a field bus barrier (segment coupler) is used for separating the hazardous and safe areas.

Furthermore, an IS-RPI segment, consisting of a field bus gateway and up to eight I/O modules, can be partitioned into an intrinsically safe and a non-Ex section using an isolator module.

Power to the intrinsically safe IS-RPI devices may only be supplied using the intrinsically safe power supplies from Pepperl+Fuchs intended for such devices (see catalog IS-RPI).

IS-RPI devices should be installed and electrically connected in hazardous areas preferably using metallic, grounded top hat rails. For direct panel mounting, the additional grounding information (see section 6.4.2) must be observed for devices.

In addition to the certifications of conformity, nationally and locally applicable requirements for set-up and installation must be observed when installing, commissioning, operating and maintaining devices with intrinsically safe circuits (in Germany DIN EN 50020, DIN VDE 0165).



The gateways communicate with the IS-RPI I/O modules via the internal IS-RPI backplane bus and communicate with the primary controller or control system via an intrinsically safe field bus possessing a field bus barrier in a safe area.

Of course the intrinsically safe devices of the IS-RPI-System can also be used for applications outside of potentially explosive areas. However, the individual IS-RPI components, e. g. the field bus barriers, must only be used exclusively in safe areas.

Repairs to devices with intrinsically safe currents must only be performed by competent specialists, taking into consideration applicable requirements (Elex V).

We most strongly recommend having repairs performed by the manufacturer. In the event of repairs performed unprofessionally, Pepperl+Fuchs GmbH is unable to provide any warranty.



Please observe the applicable requirements for maintenance and commissioning tasks in hazardous areas.

Safety notices concerning further procedures can be found in the respective section of the manual.

3.2 Availability, functional safety and functional monitoring

During the development of the Intrinsically Safe Remote Process Interface from Pepperl+Fuchs, particular attention was given to the electrical safety, the operational availability, as well as the functionality:

- All IS-RPI modules provide wire breakage monitoring of the intrinsically safe signal circuits via LEDs and via the field bus.
- Error and status LED indicators for each channel are located on the front of all I/O modules.
- Internal bus system:
The IS-RPI-internal, intrinsically safe backplane bus has separate lines for sending and receiving bus cycle and module addressing, i.e. reliable data transfer.
- If the ControlNet or the PROFIBUS DP V1 field bus system is selected, then the transmission medium can be run with redundancy.
- Configuration, parameter assignment, testing and diagnostics is carried out entirely from the control system via the field bus system. Device and system faults are identified and the control system notified.
- Faulty modules can be changed in seconds without removing cables.

4 System description

4.1 Range of application

In many production industries, there are plants having areas with potentially explosive atmospheres:

- chemical and petrochemical industry
- pharmaceutical and cosmetics industries
- paint plants
- food industry
- sewage treatment

Explosion protection for electrical measurement, control and feedback of processes is frequently listed in the „Intrinsic safety" protection class. An intrinsically safe circuit, when operated in accordance to regulations and under certain error conditions, can cause neither a spark nor a thermal effect which could cause the ignition of an explosive atmosphere. The basic principle of the "Intrinsic safety" ignition protection class is limiting the output, voltage and current in the intrinsically safe circuit.

In order to also ensure protection against explosion in case of failure with intrinsically safe circuits, special interface components are now used which separate the intrinsically safe circuit from both the non-intrinsically safe circuit and circuits installed in the safe areas, e. g. K-System devices and the Remote Process Interface from Pepperl+Fuchs.

Cabling costs are an important factor with installations that are spread out over a wide area since the intrinsically safe field circuit wiring must be run out of the hazardous area to the interface components. From there, the I/O signals must then be run in the safe area to the control system. The Remote Process Interface from Pepperl+Fuchs drastically reduces the required wiring since the I/O signals are transmitted in the safe area to the control system using a field bus system.

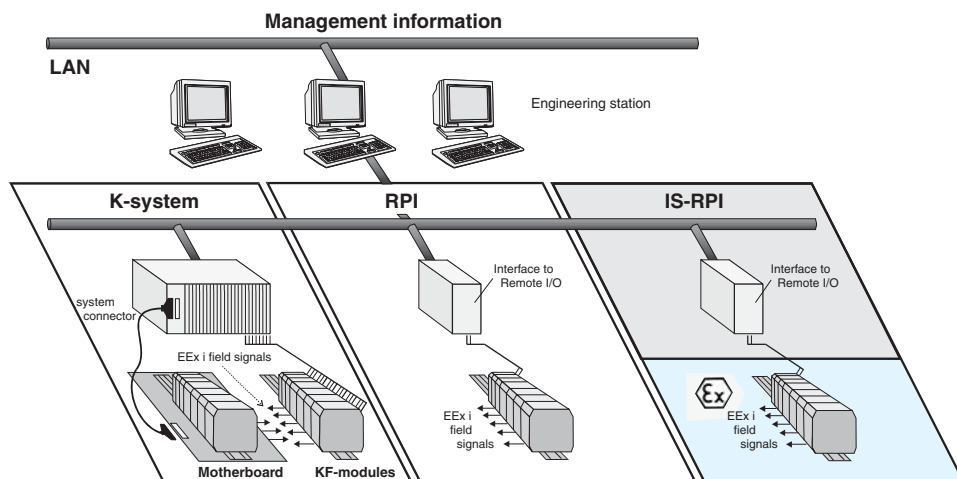

Figure 4.1 EExi interface solution from Pepperl+Fuchs

The latest development from Pepperl+Fuchs for measuring, controlling and monitoring in this area is the **Intrinsically Safe Remote Process Interface IS-RPI**, which is installed directly in the hazardous area and transmits I/O signals via an intrinsically safe fieldbus to the safe area. Only a simple field bus barrier (segment coupler) with galvanic isolation must be used to isolate the Ex and the non-Ex areas.

4.2 System layout and operating principle

4.2.1 Overview

The system fulfills the requirements according to EEx ia/ib IIC T4 (CENELEC) or class 1, division 1, T4 (US) I/O signals of modules are designed according to EEx ia IIC (CENELEC) or group A IIC (US), while the modules themselves are may be mounted in hazardous area EEx ib IIC (CENELEC) or group B, C&D/IIC (US). The signals are digitised via the modules and transmitted via a serial data bus to the gateway. This gateway, at the same time, establishes the interface to a standard bus. One gateway can address a maximum of 8 modules with up to 16 channels per unit.

IS-RPI system

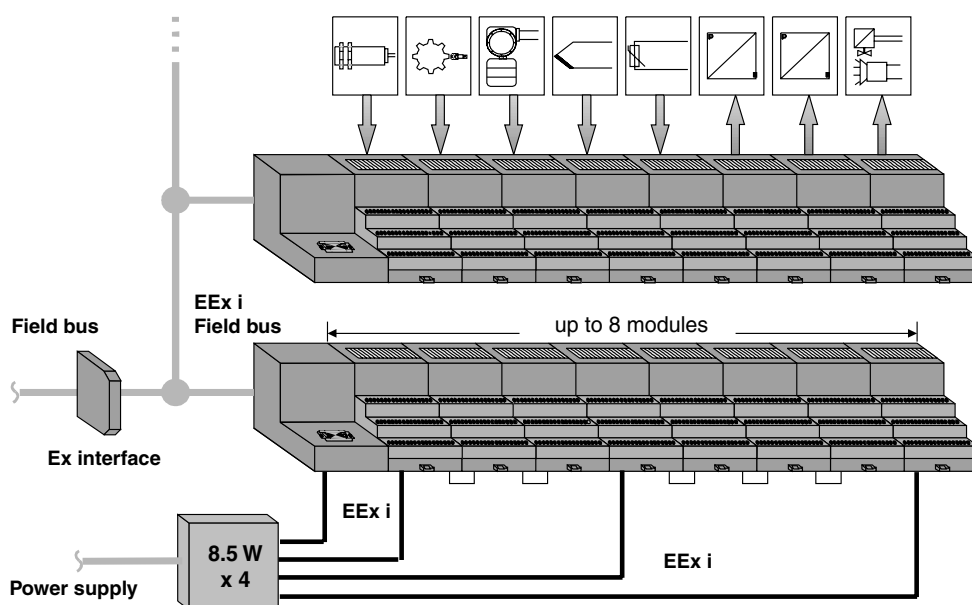

Figure 4.2 System overview IS-RPI

The intrinsically safe fieldbus going out from the gateway is first directed in the safe area (non-Ex) to a segment coupler for safe signal separation. From there, the bus is connected directly to the PLC or to the Process Control System. In this manner, there is no need for any wiring on the non-Ex side up to the bus line as it is known from conventional systems. A further potential for savings is that the I/O interfaces of the DCS or PLC are eliminated.

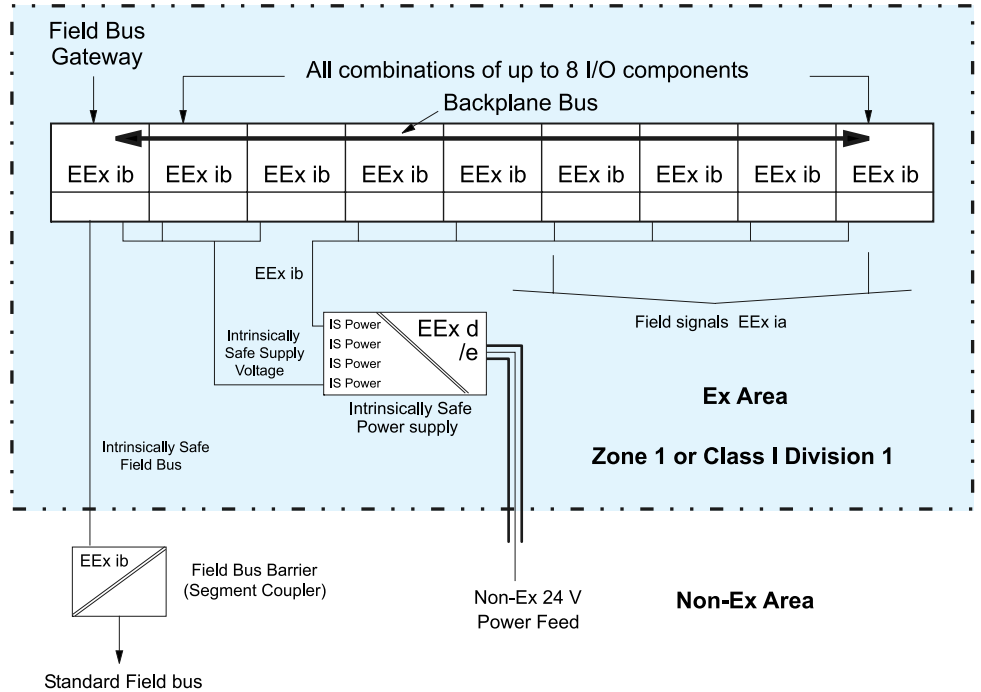

Figure 4.3 System architecture

4.2.2 Functional description

Intrinsically safe circuits can be connected to the module carrier of the interface module with self-opening screw terminals or spring catch terminals, max. wire cross-section 2.5 mm². This type of connection allows a simplified cabinet design and, should service become necessary, permits the unit to be replaced under power.

Binary input signal processing is carried out in 16 channel isolated switch amplifiers. Binary output signals are transmitted by 4 channel solenoid valve driver modules. 8-channel current repeaters, analogue drivers/repeaters and universal RTDs are available for processing measurement value signals.

The intrinsically safe signal circuits are galvanically isolated from the power supply and the backplane bus. The backplane bus is a manufacturer-specific SYSTEM and guarantees time equidistant signal transmission. The update time is dependent on the type and number of bus elements.

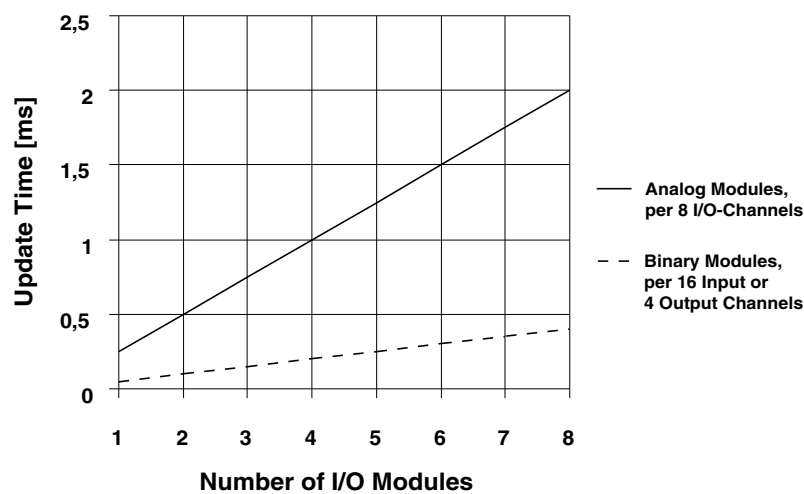

Figure 4.4 Cycle time

Example: A system with 8 analogue input modules (i. e. 64 channels) has a cycle time of about 2 ms. The gateway serves as an interface to the primary bus system. It is also possible to connect to different bus systems, for example PROFIBUS, MODBUS etc.

A system malfunction is identified and reported to the host system. If a unit fails, an identical, new unit is connected in place of the defective unit. The gateway automatically assigns the parameter set block of the original unit to the replacement unit.

4.2.3 Power supply system

The Field Power Supply has the task to limit energy available to the hazardous area. This power supply must be galvanically isolated and limit the amount of available energy from the user-provided, non-Ex power supply to the field side of the I/O modules.

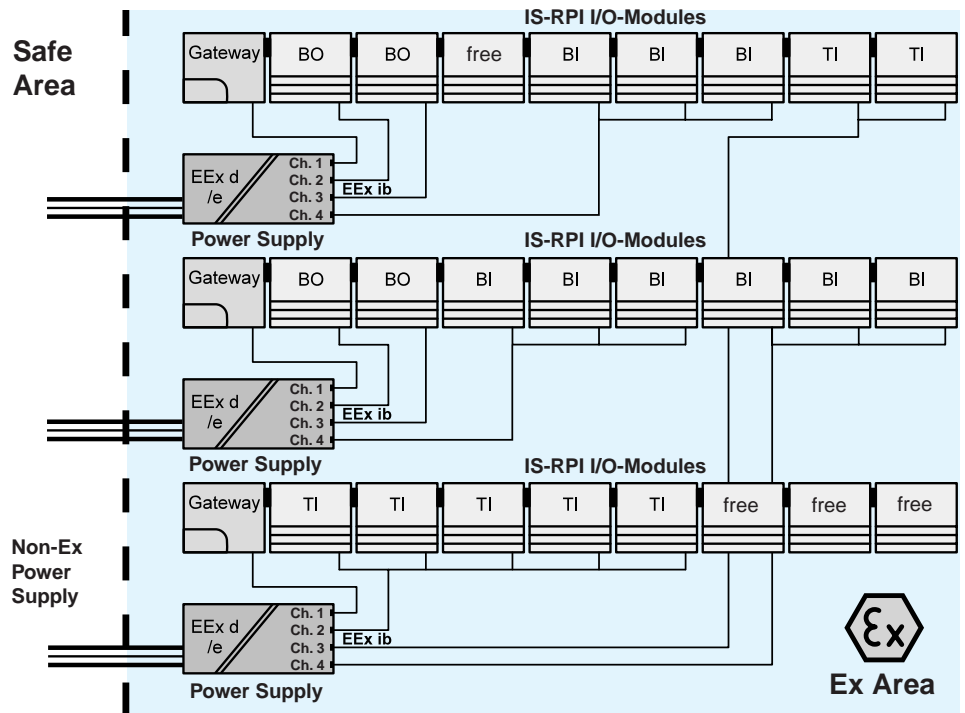

Figure 4.5 Architecture of the power supply system

There are basically two types of power supplies with four galvanically isolated channels for supplying the IS-RPI-System modules in the hazardous area which differ from each other in their connecting technique. Depending on the type of module used, 1 to 5 devices can be supplied using one power supply output channel.

The maximum ambient temperature range is -20 °C ... +70 °C.

The power supply is contained in an encapsulated, explosion protected and flame proof housing. It is possible to install a protective conduit for use in the USA.

All transmitters, actuators, sensors, etc. are supplied with power via the I/O module.

The total number of required Ex power supplies depends on the installed modules, the allowed ambient temperature and the total system configuration. Figure 4.5 illustrates how a typical power supply system can be configured.

4.2.4 Possible fieldbus systems

Only intrinsically safe bus systems can be considered for use as a field bus system. The following bus systems can be considered for use with the Remote Process Interface at this time:

- ControlNet (CNET 1.5) with Coax and/or fiber optic cable as transmission medium
- PROFIBUS PA
- MODBUS RTU
- PROFIBUS DP V1

With all bus systems, the IS-RPI is very flexible when it comes to designing the system topology.

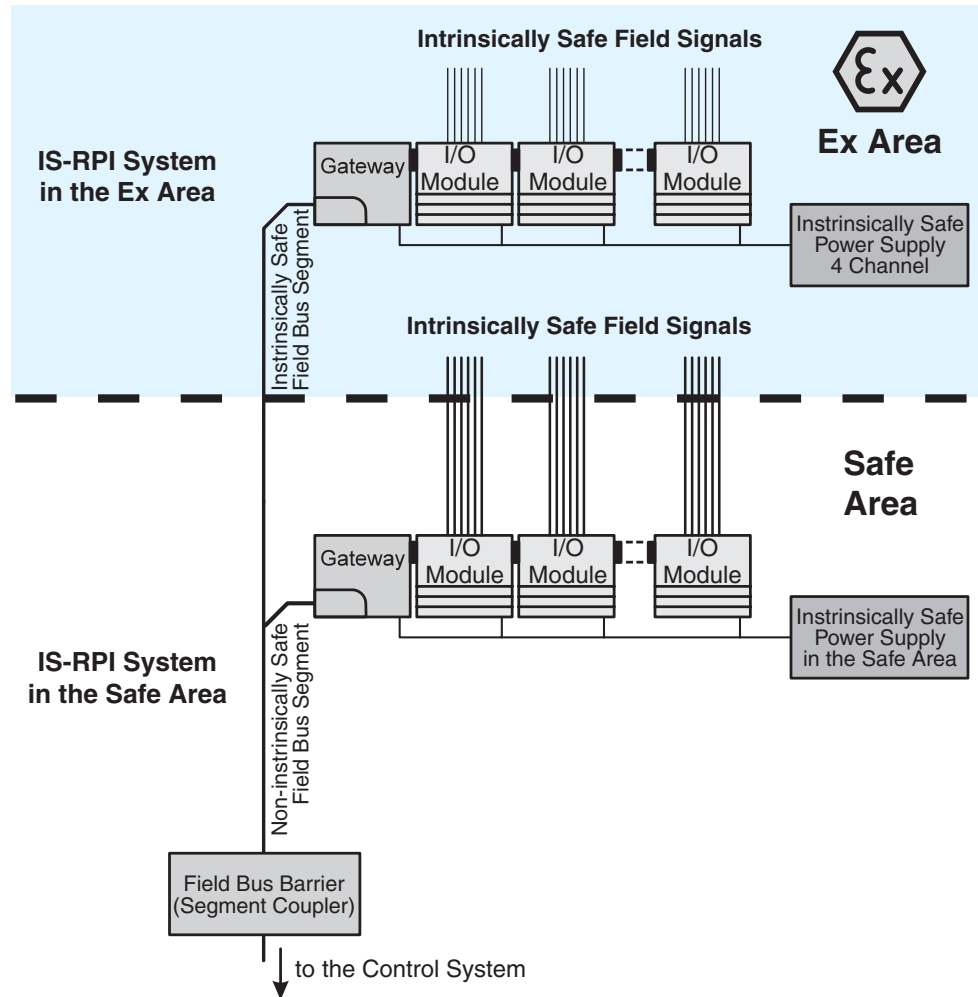

Figure 4.6 Example of the layout and networking possibilities of the IS-RPI

The various properties of the field bus systems concerning the transmission rates and bridgeable distances are shown in the following illustrations.

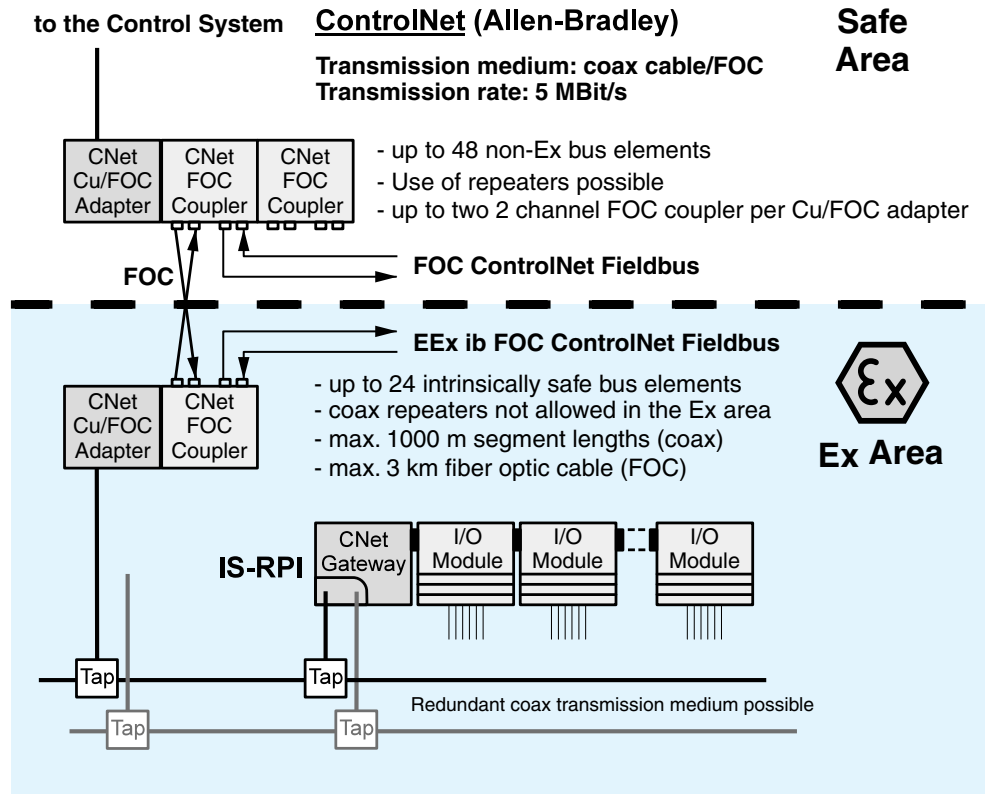

Figure 4.7 IS-RPI using ControlNet with combined coax/fiber optic transmission medium

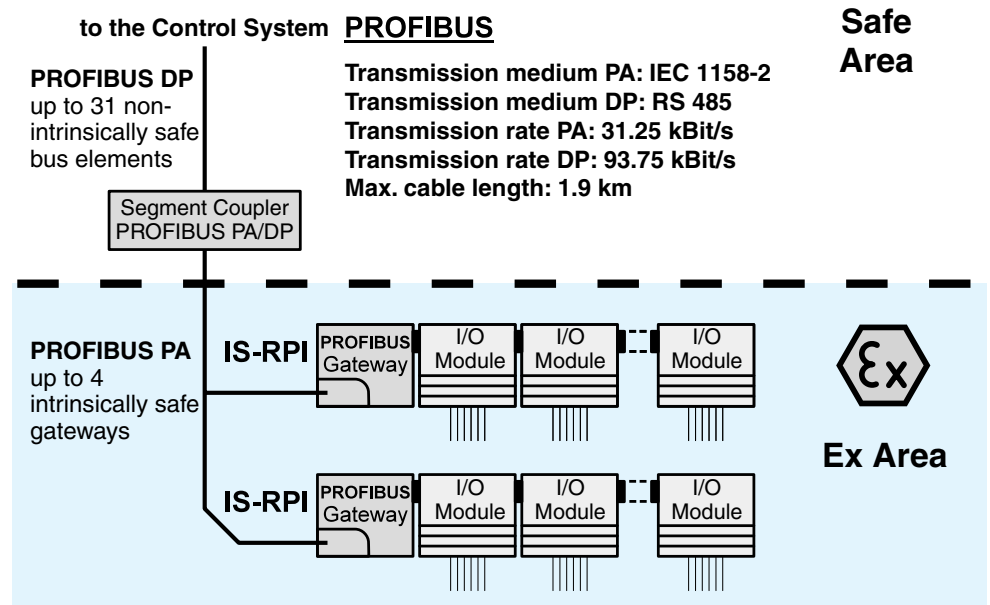

Figure 4.8 IS-RPI using MODBUS

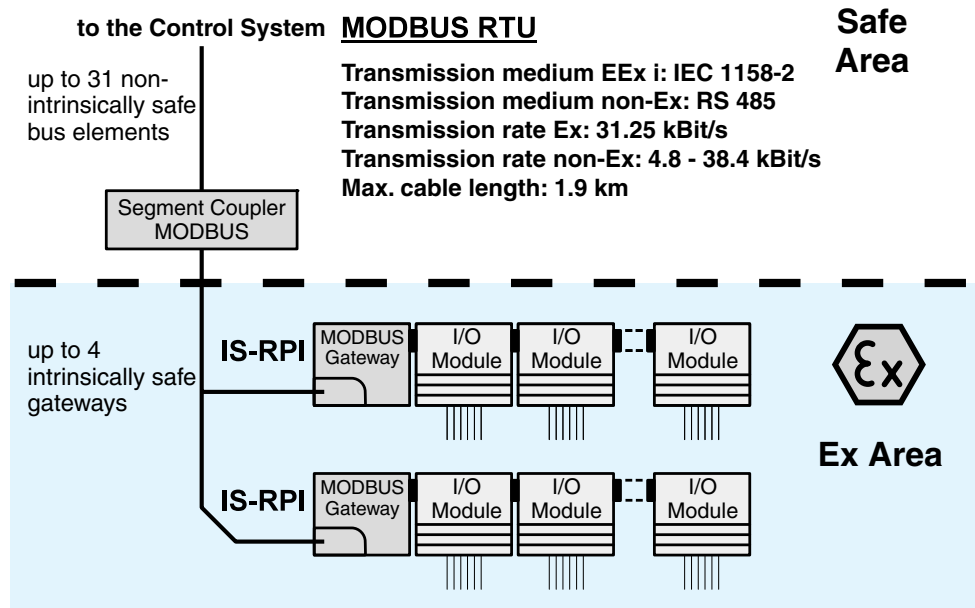

Figure 4.9 IS-RPI using MODBUS

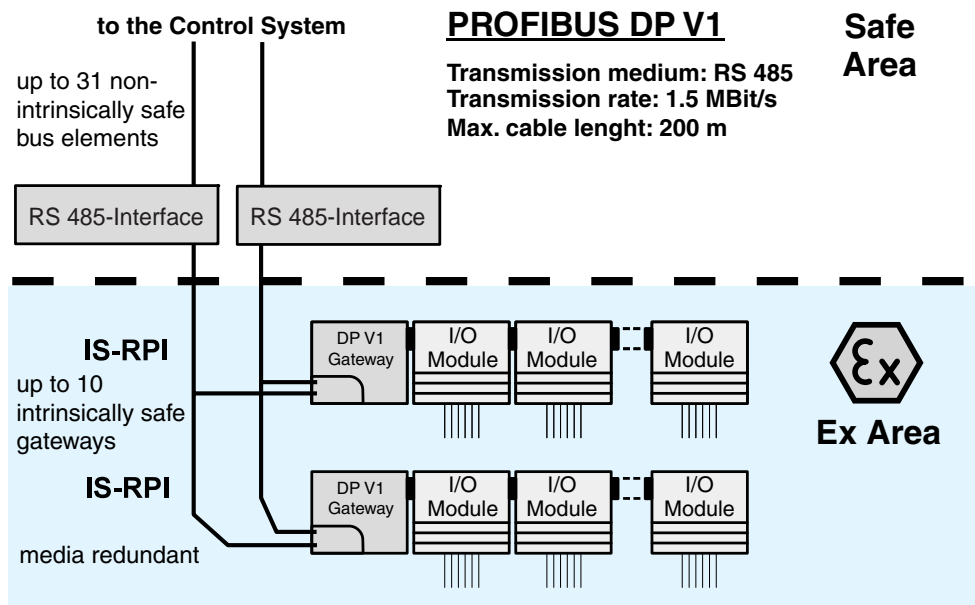

Figure 4.10 IS-RPI with PROFIBUS DP V1 fieldbus

4.3 Performance features

IS-RPI-System

Gateways

- intrinsically safe EEx ib IIC (CENELEC); PROFIBUS PA and MODBUS RTU EEx ib [ia] IIC, FISCO model
- master Function for the IS-RPI internal backplane bus
- internal bus coupled to an external bus system
- external bus systems:
 - PROFIBUS PA (EEx ia)
 - ControlNet (Allen Bradley, EEx ib)
 - MODBUS RTU ia
 - PROFIBUS DP V1 (EEx ib)
- slave function on the external bus
- saving the configuration and parameters of all IS-RPI modules in an internal EEPROM
- diagnosis and error indication using LEDs and signaling via the external bus

Modules

- modules intrinsically safe EEx ib IIC,
- field signals EEx ia IIC
- 2- ... 16-channel I/O modules for transmitting digital and analogue data between safe and hazardous areas
- special components for directly connecting transmitters, temperature measurement probes, valves, contacts, magnetic sensors and inductive proximity switches
- optionally bidirectional permeability for HART signals
- Integrated lead break and short circuit monitoring
- integration of measurement functions such as input filters, cold junction compensation etc.
- diagnosis and error indication using LEDs and signaling of the control system via the external bus

Power supplies

- 4 channel power supplies (-20 °C ... 70 °C), each channel 8.5 W
- installation in hazardous areas, EEx d [ib] IIC T4 (CENELEC), class 1 division 1 groups B, C (US)
- intrinsically safe supply voltage, EEx ib IIC (CENELEC), class 1 division 1 groups A-G (US)
- versions available for enhanced safety and with conduit screw fittings

Modularity

Device combination

- up to 8 IS-RPI modules with different functions can be arranged in any order within a IS-RPI-System
- I/O modules are plugged into terminal bases
- patching of the signal circuits is not required
- up to 128 channels per IS-RPI-System
- 1 IS-RPI gateway per IS-RPI-System
- larger units can be easily realised by networking several IS-RPI-Systems together using a field bus

Data transfer

Transmission rate, internal

- 2 Mbit/s

Transmission rate, external

- Depends on the bus system used; see section 12

Cycle time

- from the modules to the gateway, depends on the type and number of I/O modules:

1 binary I/O module	< 50 μ s
8 binary I/O modules	< 0.4 ms
1 analogue I/O module	< 0.25 ms
8 analogue I/O modules	< 2 ms
- from the gateway to the control system via the external bus: Depending on the bus system used and its transmission rate, see section 12

Electrical safety

Ex protection

- the IS-RPI-System fulfills the requirements according to EEx ia/ib IIC T4 (CENELEC) class 1, division 1, T4 (US)
- installation of the gateways and I/O modules in hazardous areas: EEx ib IIC (CENELEC) class 1, division 1, groups A-D (US)
- field circuits of the I/O modules according to EEx ia IIC (CENELEC) class 1, division 1, groups A-G (US)

Wiring

- the substantially reduced wiring requirements compared to conventional systems equally reduces the possibility of wiring errors

EMC

- All IS-RPI devices met requirements in accordance with DIN EN 50081-2, DIN EN 50082-2 and NAMUR NE 21.

System availability

Internal IS-RPI bus

- separate bus wires for transmitting, receiving, bus timing, reset and module addressing
- master slave system with cyclical addressing of all I/O modules using a bi-directional communication protocol
- error correction through resending of data

External IS field bus

- If you are using ControlNet or PROFIBUS-DP V1 as a fieldbus system, it is possible to design the transfer medium redundantly.

Troubleshooting

- reduces the time necessary for locating faults and defective devices to a minimum
- error indication using LEDs on the front side of all devices
- transmission of all diagnostic, status and error messaging to the control system via the external field bus control system

Replacing defective devices

- a defective IS-RPI component is simply replaced with an identical unit
- when replacing modules, the replacement device is automatically identified and configured by the gateway
- No cables need to be disconnected for modules which are plugged into the terminal base.
- if a module is removed, a message is send to the control system
- a replaced gateway must be reconfigured from the control system or with a configuration software

Configuring and setting parameters

Device addresses

- setting the device address of the module is not required, the address is automatically set through the physical position of the I/O module on the internal bus

Device parameters and IS-RPI configuration data

- initial configuration of the entire system using the control system via the field bus
- the configuration data of the I/O module is stored in the gateway
- the I/O modules load its configuration data automatically from the gateway after the power is switched on

4.4 System components

Overview of currently available IS-RPI devices

Within the IS-RPI-System, there are currently devices available for all measurement, control, regulation and monitoring applications.

However, the IS-RPI-System is constantly under development in order to cover all possible applications. Further development in the areas of field bus systems and gateways is being pursued in order to fulfill the demands of our customers.

The following devices are currently available:

Network parts with Intrinsically Safe Output

- RSD2-PSD(2)-Ex4.34.CON 4-channel, 4 x 8.5 W, input voltage DC 18 V ... 31.2 V
- RSA6-PSD-Ex4.34.CON 4-channel, 4 x 8.5 W, input voltage AC 85 V ... 264 V
- RSD2-PSD(2)-Ex4.34 4-channel, 4 x 8.5 W, input voltage DC 18 V ... 31.2 V
- RSA6-PSD-Ex4.34 4-channel, 4 x 8.5 W, input voltage AC 85 V ... 264 V

Current repeaters (analogue Input)

- RSD-CI-Ex8 8-channel transmitter power supply device
- RSD-CI2-Ex8. 8-channel current repeater
- RSD-CI-Ex8.H 8-channel current repeater with HART transfer

Isolated Switch Amplifier (Binary Input)

- RSD-BI-Ex16 16-channel switch amplifier

Temperature Converter (RTD)

- RSD-TI-Ex8 8-channel universal temperature converter
- RSD-TI2-Ex8 8-channel universal temperature converter

Analogue Driver/Repeater (Analogue Output)

- RSD-UO-Ex8 8-channel binary/analogue driver/repeater
- RSD-UO-Ex8.H 8-channel binary/analogue driver/repeater with HART transfer

Valve Control Modules (Binary Output)

- a. RSD-BO-Ex4 4-channel valve control module

Valve Control Modules (Binary Output)

- RSD-BO-Ex4 4-channel valve control module

Frequency Meters, Counter Modules

- RSD-FI-Ex2 2-channel frequency measuring device

IS-RPI module Carriers

- RS-TB-Ex.SC module carrier with screw terminals for plugging in IS-RPI I/O modules
- RS-TB-Ex.SP module carrier with screw terminals for plugging in IS-RPI E/A modules

IS-RPI Bus Insulator

- RSD-ISO-Ex bus isolator for the IS-RPI-internal backplane bus to distribute the IS-RPI-System into an Ex section and a non-Ex section for connecting a non-Ex gateway (in preparation)

Gateways

- RSD-GW-Ex2.CN ControlNet Gateway
- RSD-GW-Ex1.PA PROFIBUS PA Gateway
- RSD-GW2-Ex1.PA PROFIBUS PA Gateway
- RSD-GW2-Ex1.PA.ED PROFIBUS PA Gateway with extended diagnostics
- RSD-GW-Ex2.DPE PROFIBUS DP V1 Gateway
- RSD-GW2-Ex2.DPE PROFIBUS DP V1 Gateway
- RSD-GW3-Ex2.DPE PROFIBUS DP V1 Gateway
- RSD-GW3-Ex2.DPE.ED PROFIBUS DP V1 Gateway with extended diagnostics
- RSD-GW-Ex1.MOD MODBUS Gateway

Fieldbus Barriers, Segment Couplers

- KFD2-BR-Ex1.3PA.93 PROFIBUS PA segment coupler, 1st generation
- KLD2-GT-DP.xPA Gateway to segment coupler, 2nd generation with 1 or 2 channels
- KLD2-GTR-DP.4PA 4-channel gateway to segment coupler, 2nd generation with media-redundant PROFIBUS DP connection
- KLD2-PL-Ex1.PA Power Link with intrinsically safe interfaces to the segment coupler, 2nd generation
- KFD2-BR-Ex1.3MOD.38 MODBUS RTU segment coupler
- KFD2-FB2-Ex1.DP RS 485 isolator



Note

For a detailed description of the individual IS-RPI devices, see the catalogue entitled "Intrinsically Safe Remote Process Interface IS-RPI".

4.5 Accessories

4.5.1 Assembly accessories

The IS-RPI-System can be mounted on all metal mounting rails which fulfill DIN EN 50022. The rail width is 35 mm and the height of the top hat section rail can be 7.5 mm or 15 mm.

Standard designation of rails: EN 50022-35X7.5 and EN 50022-35X15.

As an additional accessory, Pepperl+Fuchs offers the KF extruded profile with integrated cable conduit and top hat rail. The KF profile saves a significant amount of space in the switch cabinet since the cable ducts for the field circuits run under the IS-RPI devices and not alongside them (see section 6.2).

For installing the IS-RPI-System, Pepperl+Fuchs offers complete solutions for the switch cabinet. The most suitable solution for your system depends strongly on the size of the installation (number of IS-RPI modules and systems) and the number of power supplies. Heat in the switch cabinet continues to play an important role (see section 5).

The following illustration shows an example cabinet layout.

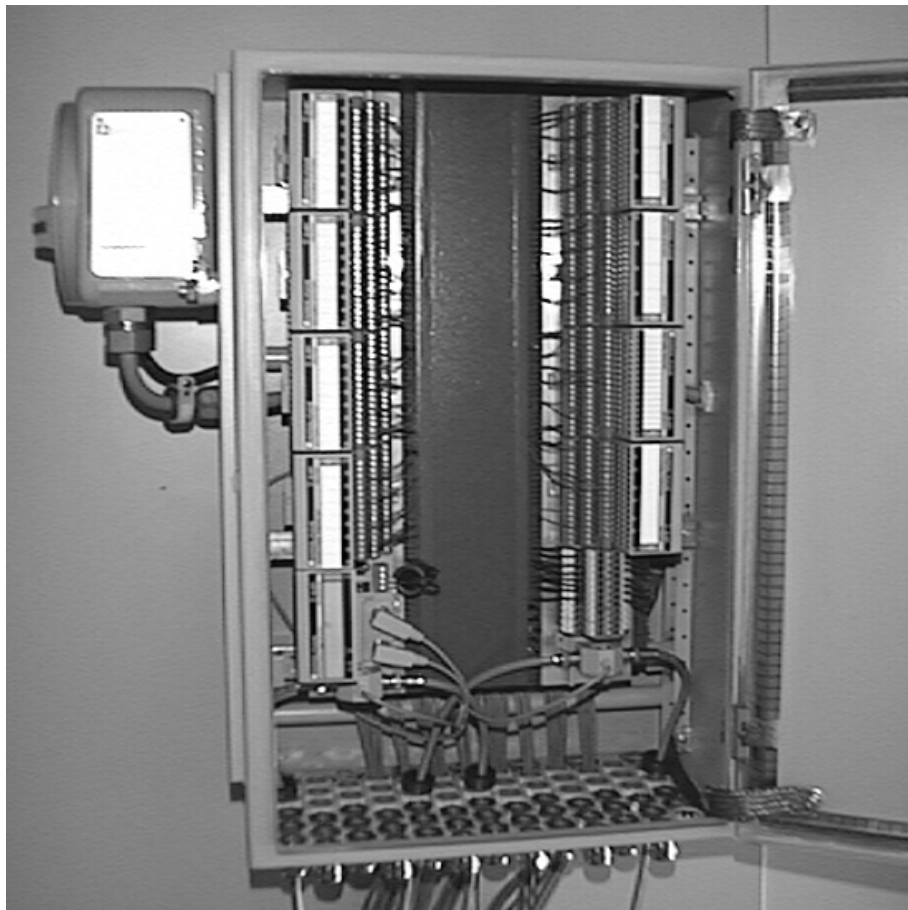

Figure 4.11 Example layout in a cabinet

Contact your local Pepperl+Fuchs sales office for information concerning suitable cabinet layouts for your applications.

4.5.2 Connection accessories

No additional connection accessories are required to make the electrical connections.

In order to arrange an IS-RPI in two rows or in one horizontal and one vertical branch or to distribute it side by side on 2 mounting rails, the following cable extensions with length 30 cm or 90 cm (only one per system allowed) are available for the backplane bus:

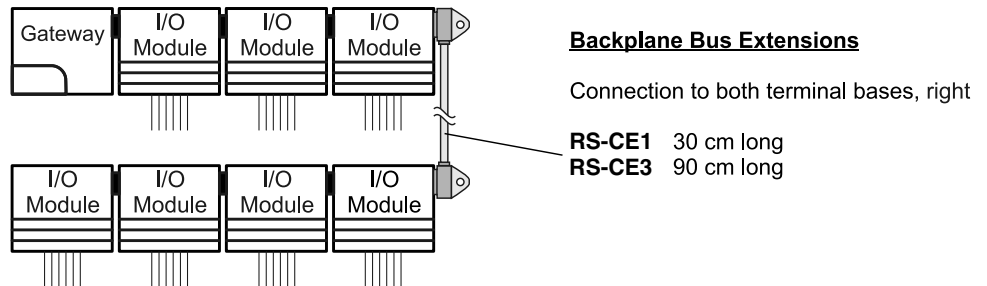

Figure 4.12 IS-RPI cable extensions for the backplane bus

4.5.3 Fieldbus accessories

Depending on which field bus system you would like to use together with the IS-RPI, you will need a special field bus accessory such as, e.g. a bus termination component, coax T-connector pieces (taps) or components for connections between coax and fiber optic cables.



You can find a description of these fieldbus-specific accessories in the description of the corresponding fieldbus gateway (see section 12).

5 Planning and design

The planning and design phase of the MC equipment determines, to a high degree, the costs for an installation using an IS-RPI-System. The use of the IS-RPI has the potential for enormous cost savings.

Thus, as a rule, different designs and layouts should be investigated in order to achieve maximum cost savings.

5.1 Special features of the system

5.1.1 Type of the external bus system

Determine which bus system is supported by your control system, as well as any special conditions which may exist for the field bus system.

The following field bus systems are supported by the IS-RPI:

- ControlNet
- PROFIBUS PA
- MODBUS RTU
- PROFIBUS DP V1, media-redundant

If you have several bus system types to choose from, select the bus system based on your particular needs, e. g. data transmission rate, supported functions, distribution or ease of use.



Note

For detailed information on fieldbus, supported features and methods of connection and transmission, please refer to section 12 of this manual and the documentation for the control system of the fieldbus master unit

5.1.2 Type and number of measurement points

Determine the type and number of signal circuits of your measurement points, as well as actuators, that you would like to connect to your control system, PLC or PC via the IS-RPI-System. Be sure to take into account the structure and topology of your installation, as well as possible expansions for the future.

When setting up the signal circuits, take into account whether you require intrinsically safe or non-Ex signals and which signals should be run together in order to minimise cabling and conduit work.

5.2 Planning system topology

5.2.1 Determining the types and number of IS-RPI modules

Based on the type and number of measurement points you have previously determined (see section 5.1), calculate the number of IS-RPI modules required.

Be sure to consider the available number of channels per module:

IS-RPI module	Function	Number of Channels
RSD-BI-Ex16	Binary input	16
RSD-BO-Ex4	Binary output	4
RSD-CI-Ex8(.H)	Analog input	8
RSD-CI2-Ex8	Analog input	8
RSD-UO-Ex8(.H)	Binary or analog output	8
RSD-TI-Ex8	RTD	8
RSD-TI2-Ex8	RTD	8
RSD-FI-Ex2	Freq. input	2

5.2.2 Redundancy

Redundant transmission medium with ControlNet

A standard feature of ControlNet is the possibility to run a second, redundant transmission medium, e. g. two coax cables. For this purpose, there are 2 coax connectors (CNET A, CNET B) on the ControlNet gateway.

When using double coax cables, heed the following:

- When using a fiber optic cable together with coax cables for bridging large distances, the ControlNet Cu/FOC coupler and fiber optic cable adapters (hubs) must be doubled if the system is to be operated with redundancy.
- Run the two redundant coax cables and/or fiber optic cables along different paths to the control system. This will prevent both cables from being damaged at the same time.

Redundant transmission medium with PROFIBUS DP V1

A standard feature of PROFIBUS DP V1 is the option to run a second, media redundant communication signal, e. g. two RS 485 lines. For this purpose, there are two ports on the DP V1 gateway. Keep in mind that when using the two RS 485 lines, two RSD-FB-Ex1.DP fieldbus barriers must also be implemented.

Redundant power supply with 24-V DC power packs

The possibility is given to supply these power packs with the tension from both SC-power supplies (24 V) in a redundant configuration (via an isolating diode network). Due to protection reasons, it is not possible to redundantly configure an AC power pack (85 V ... 264 V).

5.2.3 Determining physical arrangement

If your installation is spread over such a wide area and/or if the number of measurement points is so large that you would like to install several IS-RPI-Systems, consider now the best spatial layout for connecting the field circuits to the IS-RPI-Systems.



Note

A prime consideration here is cost. It may be significantly less expensive for you to use more IS-RPI-Systems and thereby minimize how much wire has to be laid for lines (cables, channels and work time). Weigh this against the expense of installing the fieldbus system you have selected.

Other considerations that must be kept in mind include possible expansion, renovation or conversion, inspections and repairs on the system in terms of subsequent costs.

Once the best collection points for field circuits have been determined and the location of the IS-RPI-Systems, including the type and number of modules, has been decided, please check the following points:

- Is the segmenting and physical layout of the IS-RPI-Systems possible using the chosen field bus system? Which bus system is best suited?
- Have the total wiring length, the transmission rate and the total cycle time been properly chosen, or are several, separate field busses needed? (Please note: repeaters cannot be installed in hazardous areas)

Dividing up IS-RPI-Systems Ex and non-Ex sections

The following diagram illustrates the function of the IS-RPI bus isolator RSD-ISO-Ex.

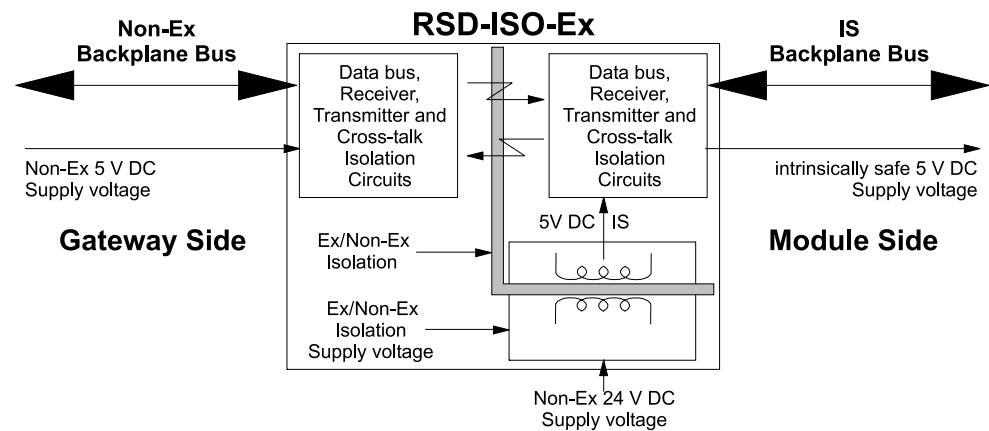

Figure 5.1 Construction of the bus isolator RSD-ISO-Ex

There are two principal possibilities for operating different kinds of field circuits in one IS-RPI branch:

Installation of the IS-RPI in the hazardous area

By using a bus isolator in the hazardous area, intrinsically safe signals (EEx i) and signals with ignition protection class enhanced safety (EEx e) can be connected to one IS-RPI-System. Therefore the IS-RPI-System can be combined with the Flex I/O modules by Rockwell Automation/Allen-Bradley (max. 3 Flex I/O modules per bus isolator).

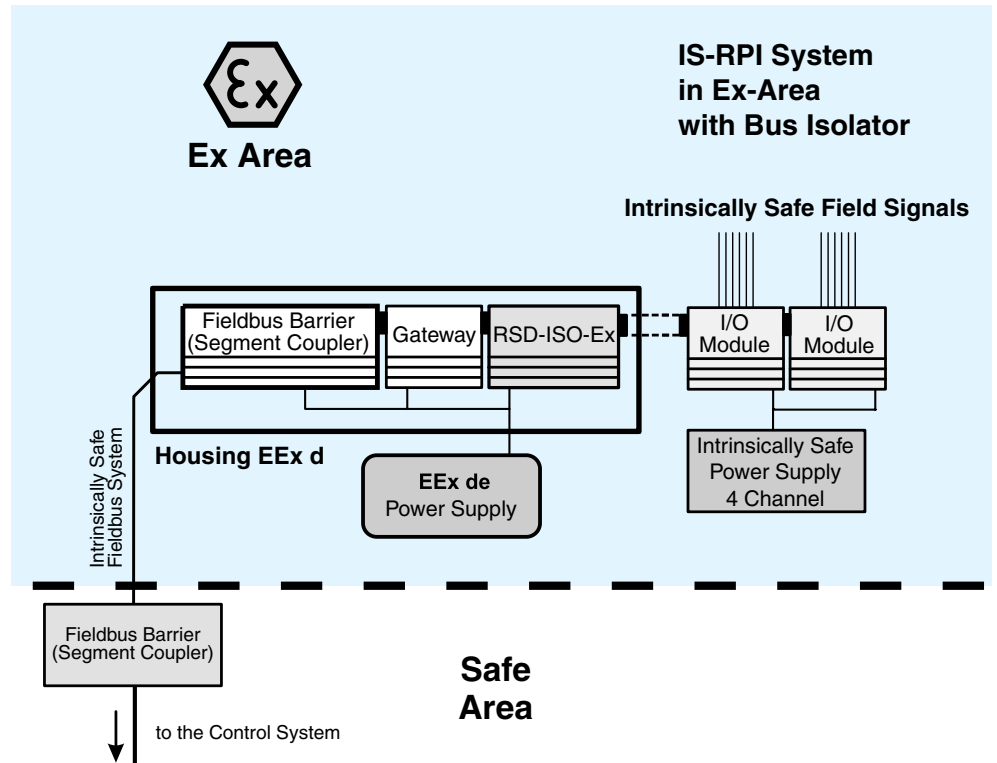

Figure 5.2 Separated IS-RPI-System in the hazardous area

The following must be heeded:

1. The part of the IS-RPI-System to which the field circuits with increased safety will be connected, including the bus isolator, must be kept in a flame proof encapsulated housing (EEx d).
2. The part of the IS-RPI-System to which field circuits with increased safety will be connected must receive its power supply through a power supply unit with increased safety.

5.3 Planning intrinsically safe power supplies

Once the type and number of needed IS-RPI modules and, if necessary, their distribution over several IS-RPI-Systems have been determined, you can move on to the type and number of intrinsically safe power supplies which will be needed.

Pepperl+Fuchs offers several types of power supplies which are specially designed for the IS-RPI, they are:

Power packs, types RS-PSD-Ex4.34*, for use in hazardous areas**

- 4 intrinsically safe outputs 8.5 W each
- Permissible ambient temperature -20 °C ... +70 °C
- Installation in the hazardous area
- 2 input voltage variants: 18 V ... 31.2 V DC (RSD2-PSD(2)-Ex4.34*)
 85 V ... 264 V AC (RSA6-PSD-Ex4.34*)
- 3 design variants:
 - encapsulated flame proof with 3/4" NPT connection threads for protective tube mounting (USA)
 - encapsulated flame proof with external connections in a separate connection box for increased safety (EEx e, CENELEC)
 - encapsulated flame proof, lead-in with cable gland for increased safety (EEx e, CENELEC)

First select the type of power supply according to

- the location of installation (hazardous or safe area)
- the model type (conduit connection, EEx e)

To determine the number of intrinsically safe power pack required, you must calculate the output requirement of all IS-RPI devices (gateways, I/O modules, copper/light wave guide adapters, etc.) in the hazardous area.

The following diagram illustrates how many IS-RPI devices can be supplied from an 8.5 W power supply channel and how high the power consumption of the devices is.

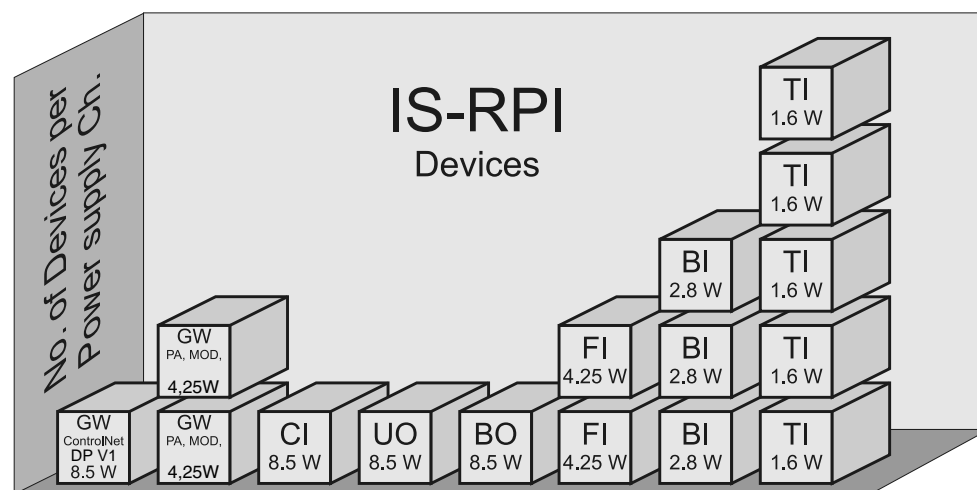

Figure 5.3 Number of devices supplied with one power pack channel



Note

Please note that when determining how many power packs will be needed, it is essential not to exceed the maximum permissible line lengths.

Make certain also to provide power supplies for any fieldbus components that may be present, for example copper/LWG adapter.

Now calculate the required number of power supply channels and determine which devices and modules should be supplied from which power supply channel.

Example:

A system consisting of 3 IS-RPI branches and the following components shall be supplied with intrinsically safe power:

- 3 ControlNet gateways
- 4 modules RSD-BO-Ex4 with 4 binary outputs each
- 9 modules RSD-BI-Ex16 with 16 binary inputs each
- 7 modules RSD-TI-Ex8 with 8 temperature/mV inputs each

4-channel power pack of type RSD2-PSD(2)-Ex4.34 should be used.

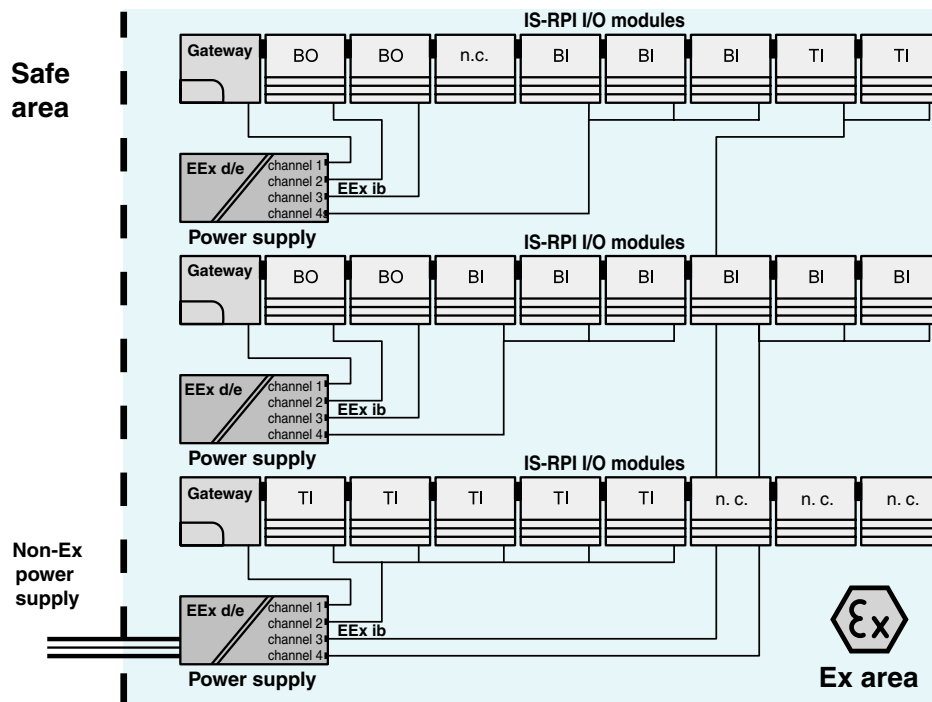

Figure 5.4 Example of calculating the number of power pack channels required

Each gateway and each binary output module requires its own power pack channel:
 $3 \times 8.5 \text{ W (GW)} + 4 \times 8.5 \text{ W (BO)} = 7 \times 8.5 \text{ W}$, i.e. 7 power pack channels

Each binary input module requires 2.8 W, i.e. one power pack channel can provide power to 3 modules:

$9 \times 2.8 \text{ W (BI)} = 3 \times 8.4 \text{ W}$, i.e. 3 power pack channels

Each temperature/mV input module requires 1.5 W, i.e. one power pack channel can supply power to 5 modules:

$7 \times 1.5 \text{ W (TI)} = 10.5 \text{ W}$, i.e. 2 power pack channels

A total of 12 power pack channels, thus 3 power packs of type RSD2-PSD(2)-Ex4.34, are required.

5.4 Planning the mechanical layout

5.4.1 Selecting the switch cabinet

Based on considerations from section 5.1 to section 5.3, the scope and physical layout of the IS-RPI-System(s) is now determined. You can now choose suitable switch cabinets.

The following questions must be answered in order to select the proper cabinet:

- How many IS-RPI-Systems will be installed in one cabinet?
- Will the power supplies also be installed in the cabinet?
- Will all the devices be installed in one large cabinet or in several smaller cabinets?
- How much heating is there in the cabinet?
- Will an inside temperature (= max. operating temperature of the IS-RPI) of 70 °C be exceeded?



Note

Since the ambient temperature has a direct effect on the service life of the modules, we recommend installing the power packs inside the switch cabinet to keep internal heating as low as possible.

5.4.2 Arrangement of the system in the switch cabinet

The arrangement of the IS-RPI components and power supplies in a cabinet saves space compared to conventional systems. Both horizontal and vertical layouts are possible in the cabinet.

The following two diagrams illustrate possible arrangements within the cabinet.

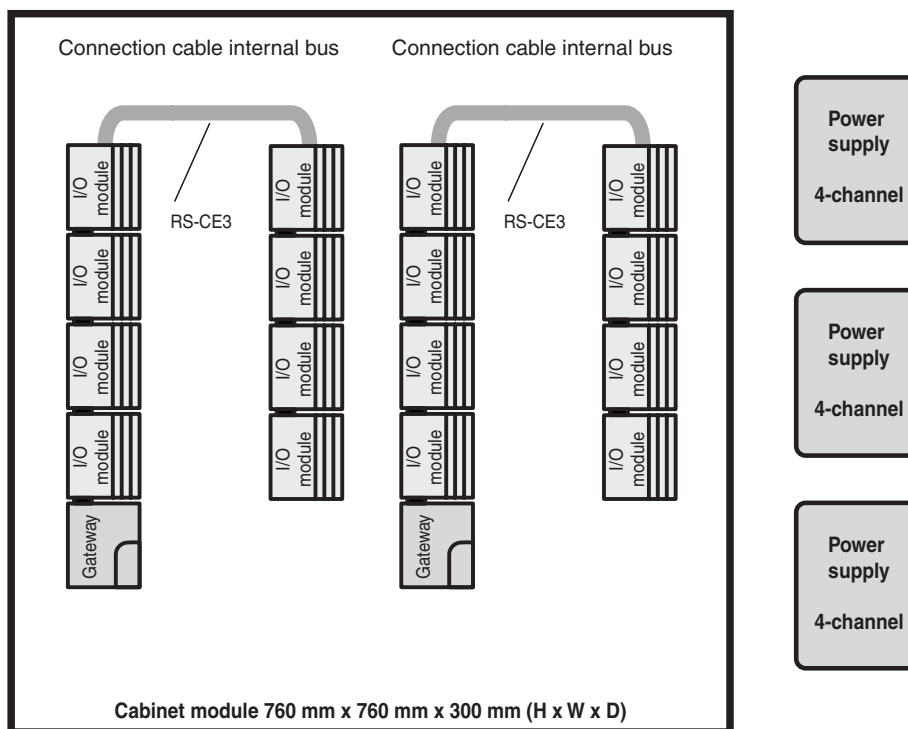

Figure 5.5 Space-saving arrangement of two IS-RPI-Systems in a switch cabinet

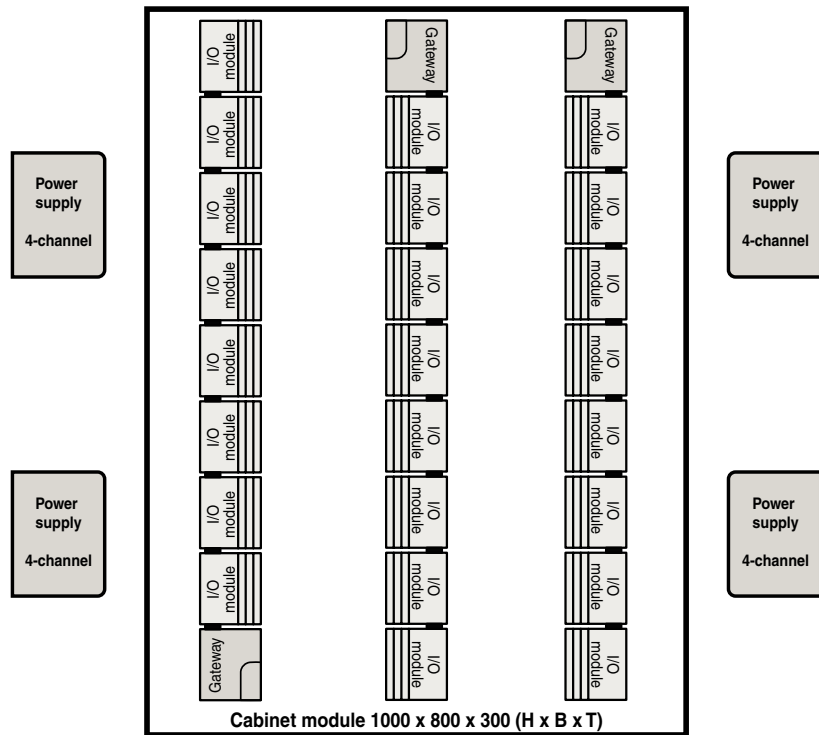

Figure 5.6 Space-saving arrangement of three IS-RPI-Systems in a switch cabinet



When laying out an IS-RPI-System, please note that the gateway must always be positioned to the left of the modules.

An alternative to the normal cable channels for intrinsically safe field circuits is the KF extruded duct from Pepperl+Fuchs, which runs underneath the I/O modules and is equipped with a top hat rail for mounting the devices.

Separate labelling strips or similar items are not required for labelling the field circuits and measurement points. The IS-RPI I/O modules have removable description labels under the front cover that allow each I/O channel to be labelled.

Contact your local Pepperl+Fuchs sales office for information concerning the optimal cabinet solution for you. Pre-mounted cabinet solutions, which save on planning work, are also available on request.

5.4.3 Local arrangement of IS-RPI

IS-RPI allows an arbitrary mix of I/O modules. Thus IS-RPI can be used as an intelligent terminal box. With this arrangement the mix of I/O modules can be tailor made for the application.

An optimum ratio of I/O signals and required space shows the following example:

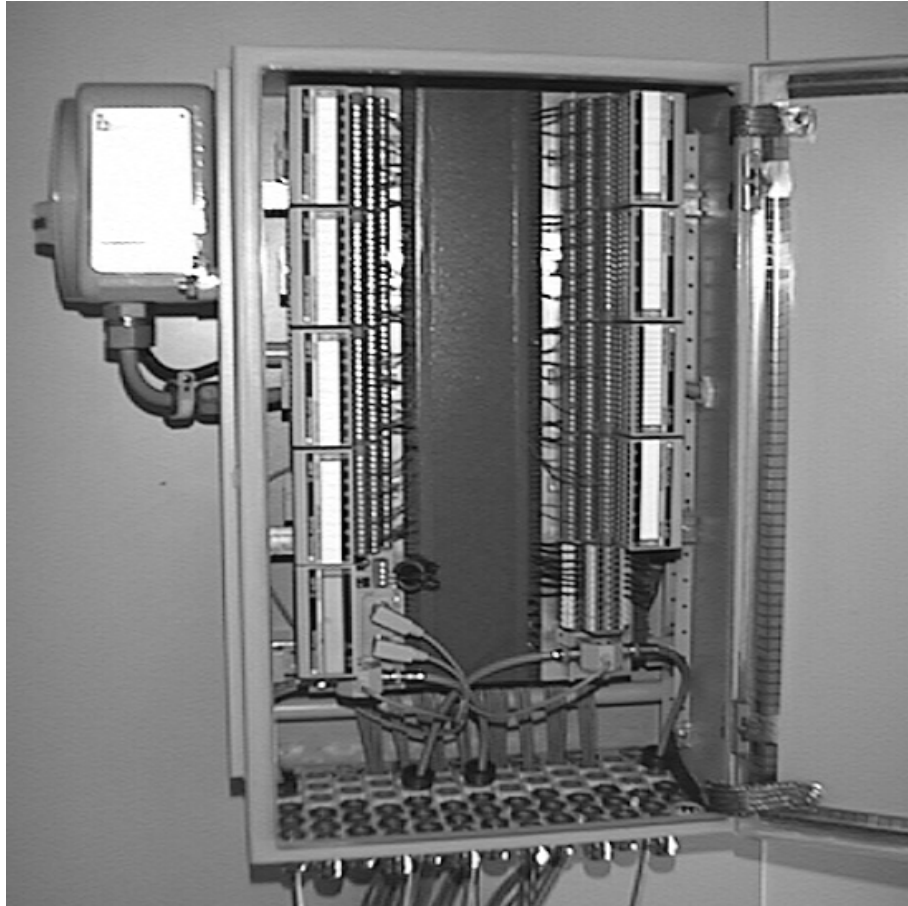

Figure 5.7 IS-RPI as an intelligent terminal box

Depending on module types, the example above allows for wiring up to 300 I/O signals per m² of surface area.

5.4.4 Calculating total internally dissipated power/heating up in switch cabinet

Operating the devices in a closed cabinet leads to heating inside of the cabinet due to power loss in the devices. However, the maximum allowed operating temperature (70 °C) of the devices and the power supplies must not be exceeded.

You must therefore calculate the total internally dissipated power of systems stored in the switch cabinet and how much the switch cabinet will heat up.

Calculating total internally dissipated power

The power consumption and the power loss for the IS-RPI power supplies, gateways and I/O modules are given in the following table.

Device	Function	Power draw	Internally dissipated power
RSD2-PSD(2)-Ex4.*	4 channel power supply	55 W	21 W
RSA6-PSD-Ex4.*	4 channel power supply	53 W	21 W
RSD-GW-Ex2.CN	ControlNet Gateway	8.5 W	8.0 W
RSD-GW-Ex1.PA	PROFIBUS PA Gateway	4.25 W	3.5 W
RSD-GW2-Ex1.PA	PROFIBUS PA Gateway	4.25 W	3.5 W
RSD-GW2-Ex1.PA.ED	PROFIBUS PA Gateway with extended diagnostics	4.25 W	3.5 W
RSD-GW-Ex1.MOD	MODBUS RTU Gateway	4.25 W	3.5 W
RSD-GW-Ex2.DPE	PROFIBUS DP V1 Gateway	8.5 W	8.0 W
RSD-GW2-Ex2.DPE	PROFIBUS DP V1 Gateway	8.5 W	8.0 W
RSD-GW3-Ex2.DPE	PROFIBUS DP V1 Gateway	8.5 W	8.0 W
RSD-GW3-Ex2.DPE.ED	PROFIBUS DP V1 Gateway with extended diagnostics	8.5 W	8.0 W
RSD-BI-Ex16	Binary input	2.8 W	2.8 W
RSD-BO-Ex4	Binary output	8.5 W	5.0 W
RSD-CI(CI2)-Ex8(.H)	Analog input	8.5 W	5.2 W
RSD-UO-Ex8(.H)	Analog output	8.5 W	5.4 W
RSD-TI(TI2)-Ex8	Temperature/mV input	1.6 W	1.6 W
RSD-FI-Ex2	Frequency measur. input	4.25 W	4.25 W

For all devices kept in the switch cabinet, multiply the internally dissipated power by the appropriate number of devices and add the result to the total internally dissipated power Q_{d} .

Example (as in Figure 5.4):

3	Power packs RSD2-PSD(2)-Ex4.34	Internally dissipated power: 3 x 21 W	= 63.0 W
3	CNet gateways RSD-GW-Ex1.PA	Internally dissipated power: 3 x 7.0 W	= 21.0 W
4	modules RSD-BO-Ex4	Internally dissipated power: 4 x 5.0 W	= 20.0 W
9	modules RSD-BI-Ex16	Internally dissipated power: 9 x 2.8 W	= 25.2 W
7	modules RSD-TI-Ex8	Internally dissipated power: 7 x 1.5 W	= 10.5 W
Total Internally Dissipated Power Q_V			= 139.7 W

Calculating how much the Switch Cabinet heats up

Because of heat radiation and internal convection, heat resulting from internally dissipated power escapes through the walls of the switch cabinet to the outside. For this to take place, the external ambient temperature must be lower than the temperature inside of the cabinet. The maximum increase in temperature ΔT_{\max} that can occur in reference to the environment of the switch cabinet may be derived according to the following formula:

$$\Delta T_{\max} = \frac{Q_V}{k \times A_{\text{eff}}}$$

- ΔT_{\max} - maximum increase in temperature
- k - Heat transfer coefficient of the switch cabinet
- Q_V - Internally dissipated power of all components in the cabinet
- A_{eff} - Effective surface of the switch cabinet

The heat transfer coefficient of the cabinet can be found in the technical documentation of the cabinet manufacturer. A typical values for a sheet metal housing is 5 W/m²K.

Calculating the effective surface area of the switch cabinet A_{eff} , in other words the surface that contributes to heat dissipation, is not a trivial matter. This value depends heavily on where the cabinet is located. In general: the more in the open the cabinet is located, the better the heat dissipation.



Note

There are precise requirements on how to calculate the effective surface area of the switching cabinet. A reference to the applicable standards will suffice here, DIN 57660 Part 500 or VDE 660 Part 500.

For example, this is how to calculate the effective surface area of the switch cabinet with A_{eff} for a single housing mounted on the wall according to the formula

$$A_{\text{eff}} [\text{m}^2] = H \times (W + 2 \times D) + 2 \times W \times D$$

- W = cabinet width [m]
- H = cabinet height [m]
- D = cabinet depth [m]

Now calculate the maximum temperature increase in the cabinet and, by adding the maximum occurring ambient temperature at the installation site of the cabinet, check that the maximum operating temperature of the device is not exceeded .

Sample Calculation:

The devices in the calculation example of total internally dissipated power will be kept in a switch cabinet with the dimensions 800 mm x 1000 mm x 300 mm (W x H x D) mounted on one wall.

The coefficient of heat transfer **k** of the housing is **5 W/m²K**. The effective surface area of the switch cabinet, according to the formula above, may be calculated as

$$A_{\text{eff}} = 1 \times (0.8 + 2 \times 0.3) + 2 \times 0.8 \times 0.3 = 1.88 \text{ m}^2$$

The total internally dissipated power **Q_v** of all devices in the switch cabinet was calculated as **139.7 W**.

The maximum allowed temperature increase in the cabinet is then calculated as

$$\Delta T_{\text{max}} = \frac{139.7 \text{ W m}^2 \text{KQ}_v}{5 \text{ W} \times 1.88 \text{ m}^2} = 14.9 \text{ K}$$

With a maximum outside temperature at the installation site of 45 °C, the maximum occurring cabinet temperature is therefore approx. 59.9 °C. With a maximum operating temperature of 70 °C for the system, the cabinet lies within allowed limits.



Always assume the most unfavourable case in your calculations. For example, you should work with a higher total internally dissipated power if you are planning on expanding the system.

You should also take other factors into consideration that could limit the heat dissipation capacity of the switch cabinet.

If the maximum allowed operating temperature of the devices is exceeded, check if the power supplies can be mounted outside of the cabinet, which we would recommend in order to increase the operating life of both the power supplies and the modules.

Carry out calculations of the total power loss and cabinet heating for all cabinets.

5.5 Galvanic isolation in the IS-RPI

The following is a summary of which circuits are galvanically isolated from each other according to DIN EN 50020.

Galvanic isolations of Fieldbusses, Segment Couplers and Gateways

Non-Ex fieldbus	/	Intrinsically safe fieldbus
Non-Ex fieldbus	/	Power supply of the segment coupler
Intrinsically safe fieldbus	/	Internal backplane bus
Intrinsically safe fieldbus	/	Intrinsically safe power supply of the gateway
Internal backplane bus	/	Intrinsically safe power supply of the gateway

Galvanic isolations of Internal Backplane Busses and I/O Modules

Internal backplane bus	/	Intrinsically safe power supply of modules
Internal backplane bus	/	Inputs/outputs of modules
Inputs/outputs of modules	/	Intrinsically safe power supply of modules

Galvanic isolations of Power Packs

Non-Ex power supply	/	Intrinsically safe power supply channels
---------------------	---	--



There is no galvanic isolation between the following two circuits:

- Inputs of I/O modules between themselves
- Outputs of I/O modules between themselves
- Power supply channels of a power pack between themselves

6 Installation

6.1 Delivery and transport

All components of the IS-RPI are packaged for protection against impact and humidity. The original packaging offers optimal protection when transporting the system at a later time. The necessary environmental conditions also must be satisfied (see Technical Data).

Inspect the contents for damage. In case of damage, notify the postal service or the forwarding agent and inform the deliverer.

Inspect the contents of the delivery package against your order and the delivery documents:

- Quantity supplied
- Device type and version according to the name plate
- Accessories
- Manual/manuals

Keep the original packaging in case the devices must be repacked and stored or reshipped. For any further questions please contact Pepperl+Fuchs GmbH.

6.2 Mechanical layout

Mount the mechanics on-site in accordance with your detail diagram. To mount IS-RPI devices in your switch cabinets, or on your mounting wall, use carrier rails (metallic 35 mm top hat rails in accordance with DIN EN 50022). Install the cable conduits for the field wiring, the cable for the intrinsically safe fieldbus and the power supplies of the IS-RPI components.

If KF extruded ducts are used, then you will have received the cable conduits, cable fasteners and mounting rail as a single piece which you need only to mount in the cabinet.

If you have function units besides the IS-RPI to install, mount them at this point.

6.3 Assembling IS-RPI gateways and modules

First the gateways and the terminal bases, into which the I/O modules are plugged, must be mounted.



Do not assemble the module carriers with the I/O modules plugged in. Doing so could damage the module carriers.

First snap the gateway onto the mounting rail. Then, starting at the gateway, mount one terminal base after the other. Mounting of the terminal bases is shown in the following figures.

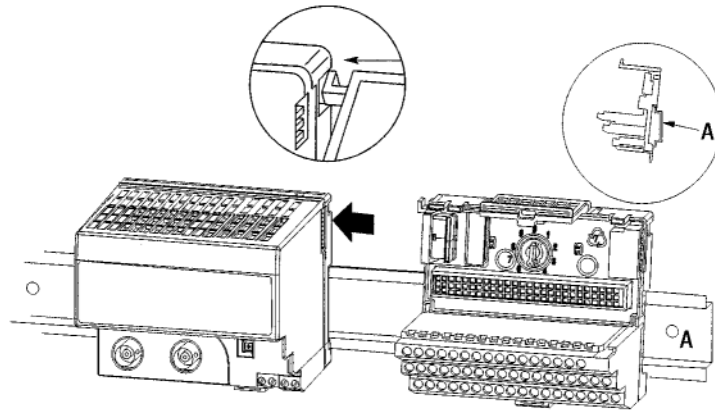

Figure 6.1 Mounting the terminal bases

Be sure that the sliding connector used to make the backplane bus connection is retracted and locked into place.

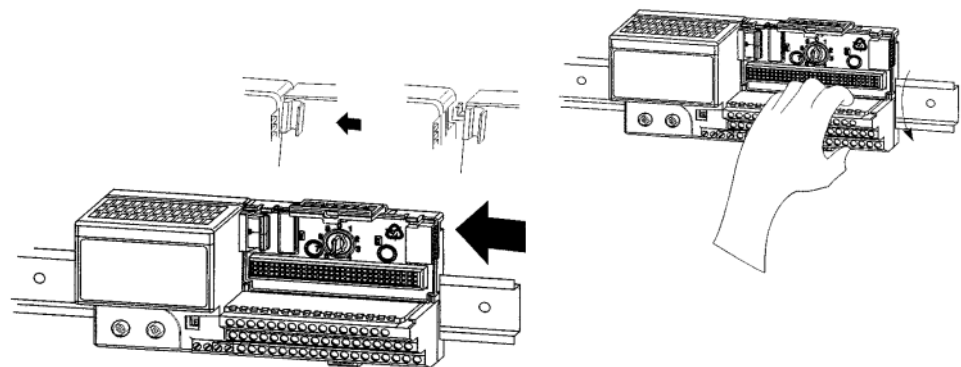

Figure 6.2 Sliding connector for making the backplane bus connection

Once the terminal base is mounted, push the sliding bus connector into the neighboring terminal base to the left in order to establish the backplane bus connection. Install all remaining terminal bases using this procedure.

Wall Mounting

It is also possible to mount the terminal bases directly to a panel. The following figure shows the positions of the two mounting holes.

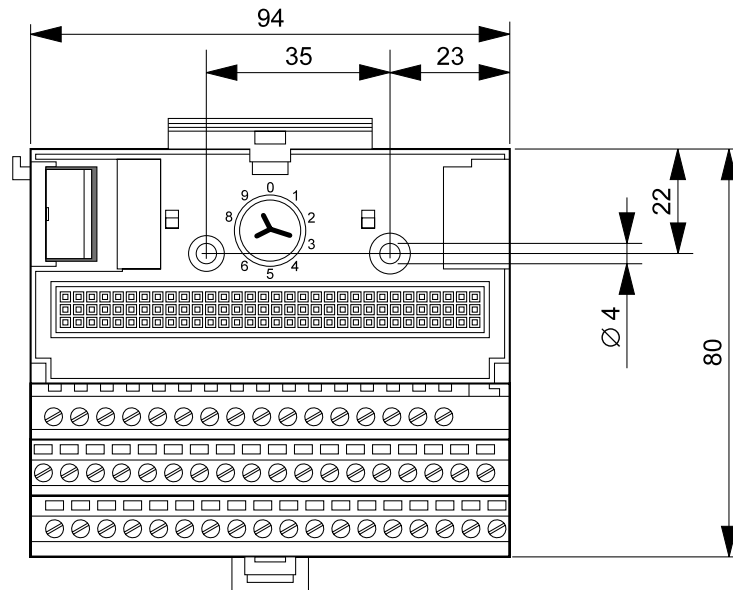

Figure 6.3 Mounting holes for panel mounting



Attention

Observe the special earthing information in section 6.4.2 if you do not want to fasten the module carriers on an earthed metal top hat rail.

Mechanical coding of the modules

As the next step, for all terminal bases which are to be plugged into I/O modules, you must turn the rotating coding key into the corresponding position for the particular I/O module type. The coding key prevents the wrong type of module to be plugged into an existing, pre-wired terminal base. Each I/O module type has its own, unalterable coding (position 1 to 7) which is given on the front of the device.

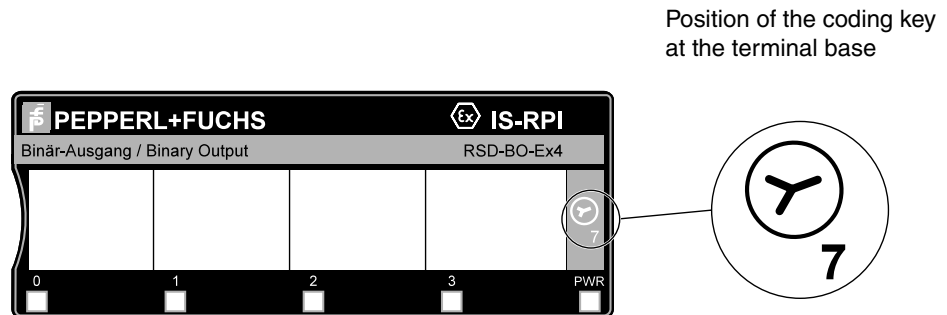

Figure 6.4 Position of the coding key shown on the front of the device

Position of the Coding Key for I/O Modules

Module Type	Position
RSD-BI-Ex16	6
RSD-BO-Ex4	7
RSD-CI-Ex8, RSD-CI2-Ex8	3
RSD-CI-Ex8.H	8
RSD-UO-Ex8, RSD-UO-Ex8.H	4
RSD-TI-Ex8, RSD-TI2-Ex8	2
RSD-FI-Ex2	1

6.4 Wiring/electrical connection

Cable

The important difference when using the Intrinsically Safe Remote Process Interface as opposed to conventional systems is that a fieldbus, rather than individual signal wires, is used to transmit data to the control system. This makes a large difference in the costs associated with cables and running cables to the control system and in wiring inside of the switch cabinet. The intrinsically safe circuits must be connected, as always, in accordance with all locally valid regulations, directives and standards for potentially explosive atmospheres.

When multiple IS-RPI-Systems are used together, the intrinsically safe fieldbus line runs from gateway to gateway and through a segment coupler (bus barrier) that separates the intrinsically safe fieldbus from the non-Ex fieldbus to the control system. There is only a single cable to the control system to be laid. When using a redundant transmission medium with ControlNet or PROFIBUS DP V1, two bus cables, separated from each other, can simply be run to the control system.

Note, that only half as many cables as usual need to be laid in the switch cabinet, and the space requirements (cable channels) are correspondingly reduced.

Control System

With respect to the control system, the IS-RPI can generally result in significant cost savings.

Connection of signal wiring is no longer needed, only a simple bus connection must be made. You do not need any I/O modules on your control system or PLC. Instead, you must provide an appropriate bus master module. Contact the manufacturer for information concerning which bus systems are available for which control system.

Connection



Jobs performed with the current on and the mains power connected must only be performed by trained professionals.

When installing and operating devices with intrinsically safe circuits, the certificates of conformity and applicable setup and installation requirements (DIN EN 50020, DIN VDE 0165) must be observed.

Please observe the special connection information for the fieldbus system in question in section 12.

The electrical connection with cables is made on module carriers of the IS-RPI-System with blue self-opening screw terminals (RS-TB-Ex.SC) or with spring tension terminals (RS-TB-Ex.SP), max. wire cross section 2 x 2.5 mm².

The power supply voltage for one power pack channel is looped through from one I/O module to the next.



The individual network changes must never be connected with each other under any circumstances!

Connection of the intrinsically safe fieldbus system is carried out at the gateway.

The connection with the IS-RPI-internal backplane bus is made by the plug-in connector while mounting the module carrier on the top hat section rail.

Connect the supply voltage, the intrinsically safe signal circuit and the bus cable of the intrinsically safe fieldbus as described in the wiring diagram and the terminal assignment list for the individual devices.



You will find the connection diagrams and terminal assignments for the individual devices in the catalogue entitled 'Intrinsically Safe Remote Process Interface IS-RPI'. For additional information on connecting special components, for example making up light wave guides, please refer to the manufacturer's documentation on the fieldbus system in question (for example Allen Bradley).

You will find special information on connecting the relevant fieldbus system, for example the recommended bus cable, permissible cable lengths, segment couplers, terminating bus resistors, etc. in section 12

For information on using and connecting the bus isolator to distribute the IS-RPI into an intrinsically safe and non-Ex section, please refer to section 5.2.3.

Update your installation and wiring diagrams so that the final installation and the documentation agree with each other.

6.4.1 Field circuits/maximum Ex values for IS-RPI modules

All IS-RPI I/O modules for connecting the intrinsically safe field circuits work on the principle of resistive current limiting.

Intrinsic safety of modules: EEx ib IIC T4

Intrinsic safety of signal circuits: EEx ia IIC

The following maximum values are permissible for the field circuits:

I/O module	Type		U _O	I _O	P _O	IIB		IIC	
						L _O	C _O	L _O	C _O
Binary input	RSD-BI-Ex16	EEX ia	14.5 V	15 mA	40 mW	10 mH	1 µF	2 mH	300 nF
Binary output	RSD-BO-Ex4	EEX ia	27.4 V	110 mA	-	5 mH	150 nF	2 mH	30 nF
		EEx ib	27.4 V	55.5 mA	753 mW	5 mH	150 nF	2 mH	30 nF
Analogue input	RSD-CI-Ex8 RSD-CI2-Ex8								
	2 wire	EEX ia	23.7 V	92.5 mA	548 mW	10 mH	560 nF	2.5 mH	66 nF
	Current source	EEX ia	U _i = 28 V	i _i = 93 mA					
Analogue input	RSD-CI-Ex8.H	EEX ia	24.4 V	92.5 mA	565 mW			4 mH	119 nF
Analogue output	RSD-UO-Ex8	EEX ia	21 V	100 mA	520 mW	10 mH	295 nF	2 mH	70 nF
		EEx ib	21 V	27.3 mA	520 mW	10 mH	295 nF	2 mH	70 nF
Analogue output	RSD-UO-Ex8.H	EEX ia	21.6 V	92 mA	500 mW	15 mH	1.18 µF	3.5 mH	164 nF
Temperature measurement converter	RSD-TI-Ex8 RSD-TI2-Ex8								
	Temperature sensor	EEX ia	9 V	37 mA	83 mW	80 mH	40 µF	20 mH	4.9 µF
	Cold junction compensation CJC1, CJC2	EEX ia	9 V	1.1 mA	3 mW	1 H	40 µF	1 H	4.9 µF
	Input + cold junction comp.	EEX ia	9 V	38 mA	86 mW	80 mH	40 µF	20 mH	4.9 µF
Frequency measuring device	RSD-FI-Ex2								
	NAMUR	EEX ia	14.7 V	15 mA	30 mW	300 mH	3.86 µF	80 mH	620 nF
	VORTEX	EEX ia	26.5 V	82 mA	520 mW	8 mH	730 nF	2 mH	92 nF
	Magnet pickup 50 mV	EEX ia	14.7 mV	10 mA	18 mW	600 mH	3.86 µF	150 mH	620 nF
	Magnet pickup 500 mV	EEX ia	14.7 mV	10 mA	18 mW	600 mH	3.86 µF	150 mH	620 nF

6.4.2 Electromagnetic compatibility and earthing

In most cases, electromagnetic compatibility can be ensured when the following 5 rules are taken into consideration.

Rule 1: Make Certain that all Inactive Metal Parts are Meticulously Earthed.

- Connect all electrically inactive metal parts (their entire surface) with earth at low resistance.
- Use special contact plates or remove all insulating protective layers on the contact point in the case of painted or anodised metal parts.
- If possible, avoid using aluminium parts for earthing. Aluminum oxidises easily and thus is not very suitable for earthing.
- Make a central connection between earth and the protective conductor.

Rule 2: Make Certain the Cable is Laid Properly.

- Divide the leads up into groups (high-current, power supply, signal leads and data leads).
- Always direct high-current leads and signal/data leads in separate channels or bundles.
- Direct the signal/data lines as close as possible along earthed areas (busbars, metal rails, switch cabinet metal).

Rule 3: If You are Using Shielded Lines

- The isolation voltage of each lead must be at least 500 V to meet Ex requirements.

Rule 4: If You are Using Shielded Lines, Make Certain that all Shielded Lines are Securely Fastened.

- Run the entire surface area of the shielded wire directly after entering the cabinet or the enclosure on a earthed busbar and affix it with a cable clamp. Lead the shielded signal leads from there to the I/O modules. To connect the signal leads to the module carrier terminals, remove the last 10 cm of the shield.
- Never use pigtailed for the connection of the cable shield to the protective conductor.
- Connect the shielded wire only to one side of earth. The shield has to be connected only in the control cabinet and not again to the field device side.
- When an additional distribution box is used e. g. for dividing a multicore cable into separate cables keep in mind that the potential of the cable shields has to be isolated from the metal enclosure of the distribution box. The distribution box must be made of metal. It's permitted to connect the metal enclosure to a protective conductor. For additional details, see Figure 6.5.

Rule 5: Create a Uniform Reference Potential.

- If there are potential differences between installations, run enough dimensional potential equaliser connections.
- Avoid earth loops by connecting the installations and cabinets with central and additional devices radially to the earth and protective conductor.

Figure 6.6 shows shield guiding within the switch cabinet.

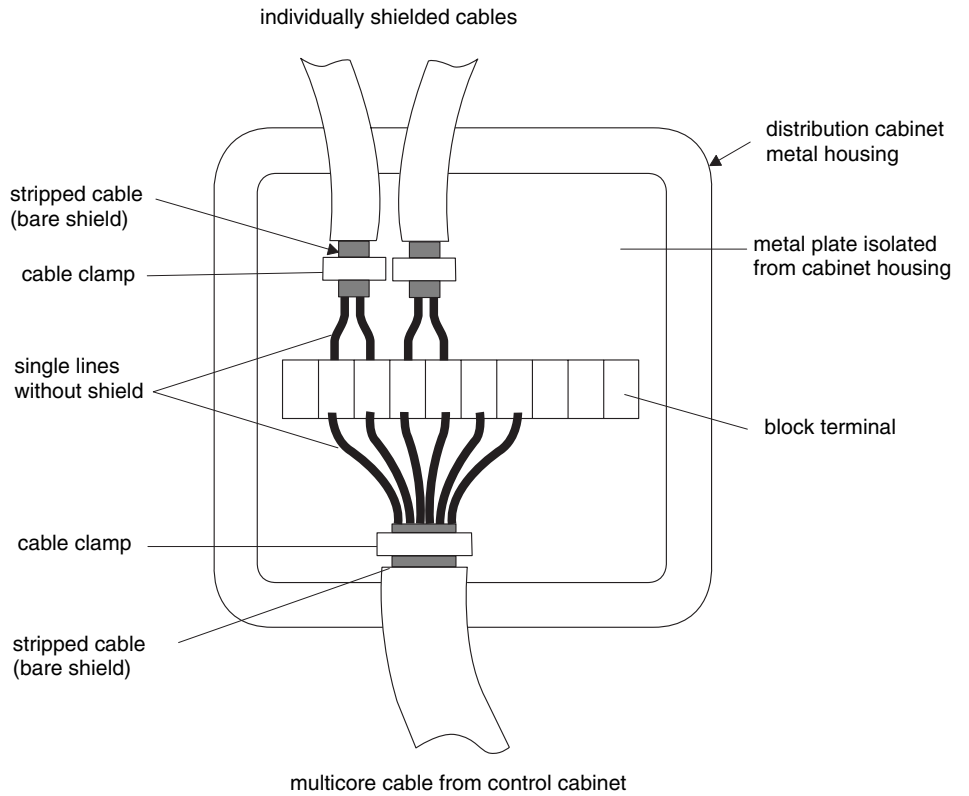

Figure 6.5 Junction box with internal wiring

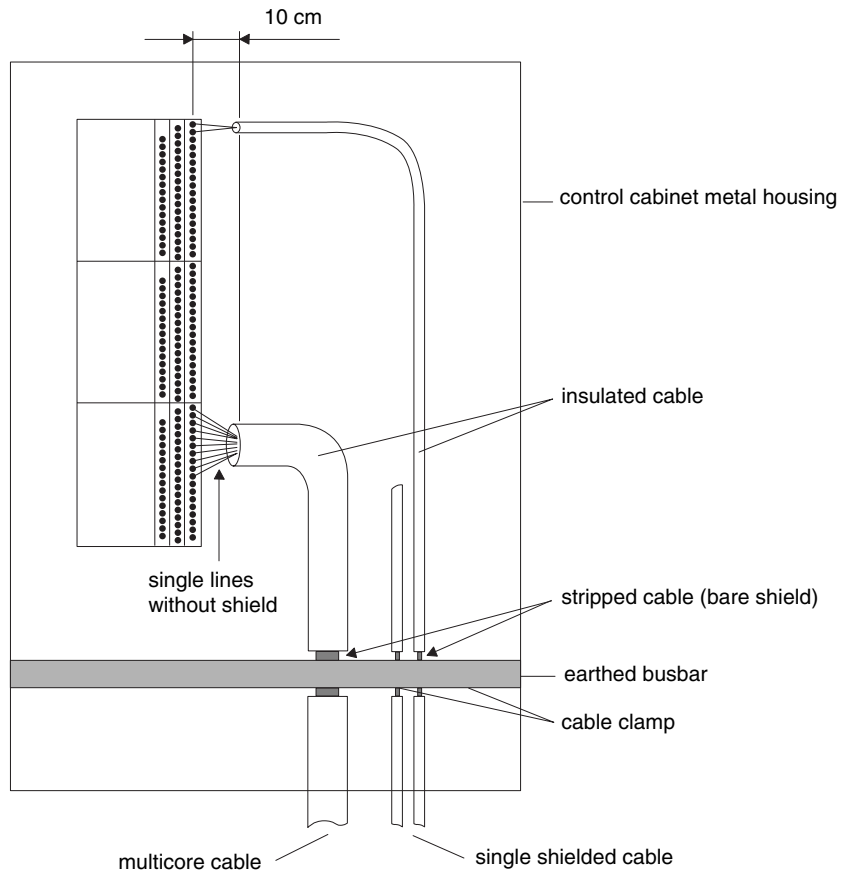

Figure 6.6 Shield guiding in the switch cabinet

1. **Earth Straps**
If no metallic connections with large surfaces are present, electrically inactive metallic parts (for example the doors of switch cabinets) must be earthed with the aid of earthing straps. Figure 6.7 shows correct earthing of the door with earthing straps. Ferrite toroids are also clearly discernable.
2. **Earthing the Busbar and the Rack**
Connect all parts of the busbar and the rack electrically with the control cabinet housing (direct metallic connections). For additional details, see Figure 6.8. The busbar must be in a 90° position in relation to the row of the module terminal bases. The position of the busbar inside of the control cabinet must be as close as possible to the cable gland.
3. **Secure Earthing of Standard Carrier Rails**
Make certain there is a reliable direct connection between the standard carriers and the racks.
4. **Signal Lines, Shielding Terminals and Potential Equalisation Rail**
Fasten the signal lines on the freely laid shields with the full surface of the shielding terminals on the potential equalisation rail. The shielding terminals must enclose the entire cable shield and create a good electrical connection (Figure 6.9). Connect the potential equalisation rail, with as much of the full surface as possible, with the rack or switch cabinet.
5. **Earth Leads**
The switch cabinet must be connected with the earth lead. This metallic connection must cover a sufficiently large surface and the cross-section of the earth lead must be at least 10 mm².
6. **Ferrite Toroids (for use with ControlNet only)**
Ferrites must be used to fully ensure electromagnetic compatibility of the IS-RPI-System. The outputs of the power packs must be equipped with type A ferrites (Figure 6.7). If you are using a ControlNet gateway, additional ferrites will be necessary. All ControlNet Koax cables that leave the switch cabinet must be directed through type B ferrite toroids. Power supply lines for the ControlNet gateway must be directed through a type C ferrite toroid, as shown in Figure 6.10, with two coils through a type C ferrite toroid.

Ferrite Toroid Type	Where?	Length
A	Power supply outputs	20 mm
B	all ControlNet cables	13 mm
C	Power supply lines of the ControlNet gateway (with 2 coilings)	28.5 mm

7. **HF Seal**
The control cabinet must be equipped with HF seals. All openings in the housing, for example slots or the gap for a door, must be sealed with HF seals. The HF seal is shown in Figure 6.7.

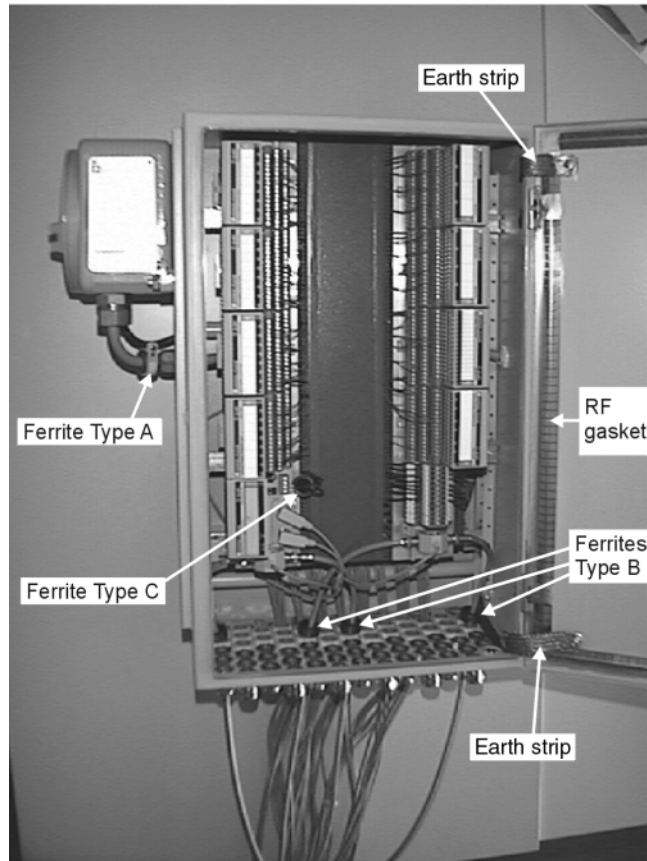

Figure 6.7 Control cabinet with HF seal in the door gap.

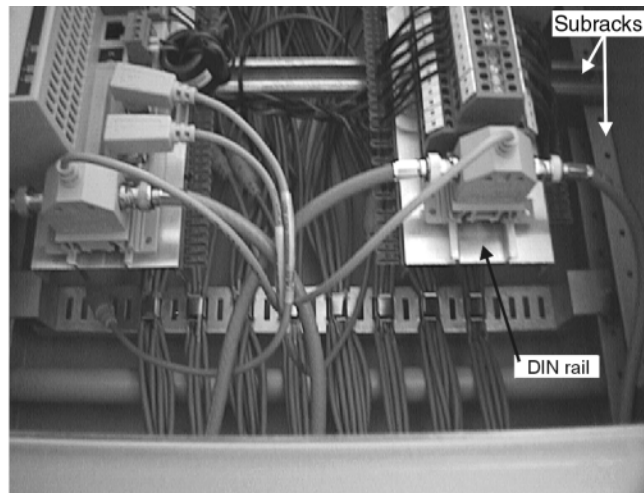

Figure 6.8 Detail view of standard carrier rails and racks

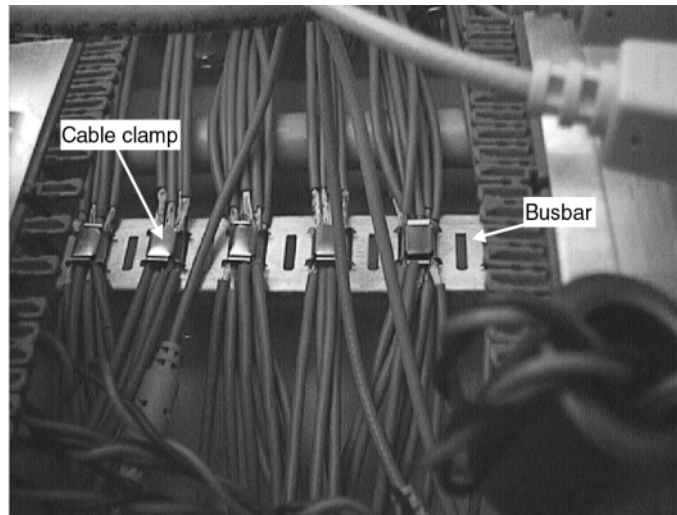

Figure 6.9 Reliable connection of cable shield with busbar

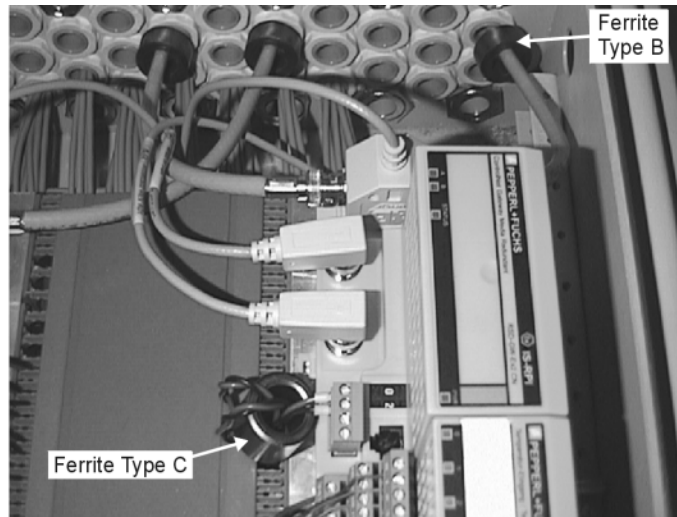

Figure 6.10 Ferrite for use with ControlNet gateways

7 Configuration and parameter assignment for the IS-RPI

7.1 Configuration with the fieldbus

The entire configuration of the system and the parameterisation of the I/O modules is made exclusively via the field bus system.

With the exception of the setting of the field bus address on the gateway and the DIP switch for the activation/deactivation of line-breakage monitoring on the RSD-BI-Ex16, no settings can be made to the devices themselves on-site.

You have extensive settings options for each I/O module type for measurement ranges, limit values, offset values and calibration, etc. They are described in detail in section 12.

All I/O-module data have a word structure (16 bit) and are organised in the form of a data table. Distinctions are made between 5 data types throughout:

1. Module status: Status of backplane bus communication D of the I/O module Structure of the module's data table (4/16 words)
2. Input data: Real-time data from the input channels of a module
3. Channel status: Status information for each channel of a module
4. Output data: Real-time data from the output channels of a module
5. Configuration data: Limit values, filter frequencies, etc. commands to an I/O module, for example for calibration

The data types for all modules are arranged within the data table in the order specified above. In addition, it is also possible to manage different configuration pages.



Note

The way data is represented and options for access from the control system differ from one fieldbus to the next.

For detailed information of the data structure of the system and how to configure it, please refer to section 12.

How flexible and clearly arranged you can configure and set parameters for your system depends on whether or not your field bus system permits multiple masters. In the case of a "Multiple Master" fieldbus you can generally use a PC with a fieldbus master card and the corresponding configuration software in addition to your control system. This in turn allows for configuration and parameter assignment. The control system is responsible for I/O data traffic and for detecting unusual situations and faults.

The following field bus systems permit multiple masters:

- ControlNet
- PROFIBUS DP/PA

Only one bus master is permitted with:

- MODBUS RTU

8 Commissioning/operation

8.1 Procedure for commissioning

Examine the previously carried-out work again for correctness.

In order to be able to configure and assign parameters to your IS-RPI-System, you must first bring the communication between the control system/configuration master and the gateway into operation. To do this, the bus connections must be made, including any bus terminations that are required, and the address of the gateway that is provided must be set; see section 13.

The address allocation of the I/O module located on the backplane bus is made automatically.

Bring each IS-RPI segment into operation via the appropriate gateway one at a time.

If you are not familiar with the commissioning of a field bus system, we recommend first assembling the system in a laboratory located in a safe area where you can calmly configure and try your IS-RPI-System.

You will find information on the configuration of the external bus in the description of the bus master of your control system and user software for it, in your PLC or PC and in section 13 of this manual.

After all modules have been mounted and all field circuits connected, switch on the intrinsically safe power supplies.

Establish the connection to the gateway from the user interface of the control system/configuration master.

If your system is not yet configured and parameterised, do not let the flashing LEDs on the IS-RPI-Systems confuse you, rather, determine what is causing the displays.

LEDs "Com" and "Status" should be permanently lit green on the gateway for proper communication. If these LEDs flash green, communication is faulty. If the LEDs flash or are permanently illuminated red, a hardware error is most likely to blame. For details, refer to the appropriate gateway description.

Among other likely causes for flashing LEDs on the I/O modules are unconnected sensors and actuators when line-breakage monitoring is activated or measured values which are out of range.

You can see the detailed diagnostic information for the gateway and modules with your configuration tools. If necessary, refer to section 12 and section 13. This will allow you to bring your IS-RPI-System into operation in the shortest possible time.

8.2 The IS-RPI in operation

8.2.1 Communication via the IS-RPI-internal backplane bus

Backplane Bus

The IS-RPI-System uses a special serial backplane bus for internal communication. The bus is provided with isolated bus wires for transmission, reception, clock and component addressing.

This backplane bus is a master/slave system. The I/O components are cyclically addressed via a bi-directional communication protocol.

Each component is actuated via an individual START sequence. A differential bus clock signal exists on each component between 2 common bus lines. An additional common bus line is used to reset all components.

In the second generation of the IS-RPI, extended data transmission is to be implemented. In this case the gateway then sends with each transmission only a part of the configuration. The remaining part of the configuration data and status information which is not time-critical is then transmitted piece-wise over several bus cycles.

Upon initialisation of the system, the gateway receives from the control system the configuration data with information regarding which I/O component is to be addressed.

Removed components are reported. Replaced components are automatically detected and configured. New components must be configured via the control system or hand terminal. A replaced gateway must be configured by the control system.

Detecting and Correcting Errors in the Serial Data Transmission

A data packet on the IS-RPI backplane bus consists of 16 data bits, one echo bit and one error/OK bit. If the echo is received with an error, the error/OK bit is set. In the case of an error, the data word is repeated. In the event of an error, error correction is made by means of repeated transmission of the I/O data.

Addressing

The component address of a backplane bus does not need to be set. The address is determined from the physical position of the component on the bus.

8.2.2 Cycle time of the overall system for data updating

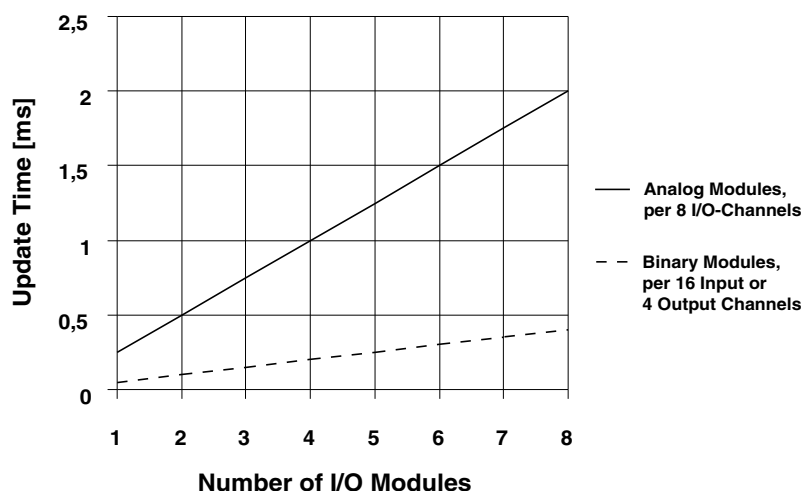

Figure 8.1 Cycle time

The cycle time of the entire system can be calculated as follows:

Module Input/Output Delay (all channels)

- Binary modules: 1 ms ... 1.2 ms
- Analogue modules: 4 ms ... 8 ms (rises to 99 % of final value)

Module/Gateway Delay:

Each module (8 modules on one gateway)

- Binary modules: 50 µs each -> 8 x 50 µs = 0.4 ms
- Analogue modules: 250 µs each -> 8 x 250 µs = 2 ms
- Replacement modules: 5 µs each

Overall Consideration

Adding the above times to obtain the worst case:

- Binary modules: 1.4 ms
- Analogue modules: 10 ms

The value of 4 ms for the power-on delay with analogue components is correct, however is only a theoretical value due to the fact that a 50 Hz or 60 Hz filter to protect against noise is usually set in the components (via software).

As a result, a realistic value for the analogue components of 30 ms or 26.7 ms, respectively, is obtained.

8.2.3 The LEDs on the front side of the device

Depending on the device type, the LEDs on the front side of the devices have the following display functionality (corresponds to NAMUR recommendations NE44):

Gateways

The LEDs on the gateways provide information on the operational readiness and the communication status via the field bus. Displayed are:

- Operation (Power on)
- Self-test/initialisation
- Bus connection present/not present
- Incorrect field bus address/incorrect bus parameter
- Communication OK./faulty/error
- Number of bus connections (with redundant transmission medium, ControlNet only)
- Incorrect I/O module reconnected
- Gateway defective

I/O Modules

The LEDs on the I/O modules provide information on the operational readiness and the status of the individual I/O channels. Each channel is assigned its own LED. The LED of channel "0" serves as an indicator for both, the power-on test and errors. The following states are displayed:

- Operation (Power on)
- Self-test/initialisation
- with binary inputs: input signal present
- with binary outputs: output active
- Channel error
- I/O module defective



Note

You can find an extensive description of LED states in the individual devices in section 9.2.

8.2.4 Adding, removing and replacing I/O modules and gateways

The IS-RPI permits the removal and addition of I/O modules during operation while under voltage. No cables need to be disconnected for modules which are plugged into the terminal base.



When removing I/O modules, make certain that no dangerous situations can arise, for example because of uncontrolled processes.

If one or more I/O modules are removed or fail, there is no effect on the functionality of the other modules.

The IS-RPI gateway stores configuration data in an EEPROM which is read after application of the operating voltage. These data comprise the number and type of the connected I/O modules and the configuration data of the individual modules. After application of the operating voltage, the presence of all modules is checked and the non-volatile configuration data are examined for correctness. Data not stored in the modules are transmitted by the gateway with every transmission.

After switching on, the IS-RPI modules automatically load respective data from the gateways, which are stored in the EEPROM. The initialisation phase of the modules, including self-test, is only a fraction of a second in duration. Data not stored in the modules are transmitted by the gateway with every transmission.

If an I/O module is removed, the gateway detects the change and transmits a message via the field bus to the control system.

If an I/O module is exchanged, the old configuration record is automatically transferred to the new module and stored in memory there.

The presence of a new module is automatically detected within one bus cycle. The maximum cycle time is 2 ms. A new, additional module must be configured via the bus master.

The replacement of a module with a module of a different type is detected and indicated by the LED on the gateway and is reported to the control system via the field bus.

9 Diagnostics and error handling

9.1 Internal diagnostics and self-test/saving the contents of memory

Internal Diagnostics and Self-Test

After switching on, all IS-RPI modules carry out a communication test via the backplane bus. This test includes a RAM and EEPROM test, a test of the memory contents and a time-out on the bus.

Restoring Data in the Event of a Failure

The IS-RPI I/O modules are addressed by the gateway in sequence. In the event of an error, the data are rejected. On the next bus cycle, the I/O component is addressed again. No additional measures are required to restore communication.

Saving the Contents of Memory

In all I/O modules, all calibration data are stored in an EEPROM (non-volatile) which is read after application of the operating voltage. The remaining configuration data are transmitted with every transmission.

The IS-RPI gateway stores configuration data in an EEPROM which is read after application of the operating voltage. These data comprise the number and type of the connected I/O modules and the configuration data of the individual components. After application of the operating voltage, all modules are checked for presence and correct configuration.

States of Inputs and Outputs in the Event of an Error

Should the fieldbus communications be interrupted, the I/O modules are instructed by the gateway to accept the user-selected condition. Possible conditions are:

- retain the last condition
- reset value (binary modules only)
- safe-state value preselected by the user during configuration (analogue modules only)

9.2 Error message and diagnostics using device LEDs

The LEDs on the IS-RPI gateways and I/O modules have the following display functions:

Gateways

RSD-GW-Ex2.CN, ControlNet Gateway

LED	Green		GREEN/RED	Red	
	Continuous	Flashing	Flashing	Flashing	Continuous
Com 1	Communication OK	Communication faulty	–	Bus wiring defective or disconnected	–
Com 2	Communication OK	Communication faulty	–	Bus wiring defective or disconnected	–
Com 1+2	–	–	In push-pull: Self test In push-push: incorrect network parameter	In push-pull: same fieldbus address as another subscriber	Communication faulty
Status	At least 1 bus connection present	No bus connections	–	Incorrect I/O module reconnected	Device defective
ON	Device operating normally	–	–	–	–

RSD-GW-Ex1.PA, RSD-GW2-Ex1.PA, RSD2-GW2-Ex1.PA.ED (PROFIBUS PA Gateways) and RSD-GW-Ex1-MOD (MODBUS Gateway)

LED	Green	Red		
	Continuous	Flashing X-X-X-X-	Triple flashing X.X.X.-	Continuous
Ext ¹⁾	–	No communication or watchdog passed	Firmware programming mode or firmware check sum error	Gateway defective
Int ²⁾	–	No communication with the gateway	Incorrect configuration	Communication faulty
PWR	Device operating normally	–	–	–

- 1) External bus: MODBUS or PROFIBUS
- 2) Internal backplane bus

RSD-GW-Ex2.DPE, RSD-GW2-Ex2.DPE, RSD-GW3-Ex2.DPE, RSD2-GW32-Ex2.DPE.ED (PROFIBUS DP V1 Gateways)

LED	Green	Red		
	Continuous	Flashing X-X-X-X-	Triple flashing X.X.X.-	Continuous
EXT ¹⁾	–	No communication or watchdog passed	Firmware programming mode or firmware check sum error	Gateway defective
RED	-	No communication or watchdog passed	Firmware programming mode or firmware check sum error	Gateway defective
Int ²⁾	–	No communication with gateway	Incorrect configuration	Communication faulty
PWR	Device operating normally	–	–	–

- 1) External bus PROFIBUS
- 2) Internal backplane bus

I/O Modules

RSD-BI-Ex16, Binary Input

LED	Meaning	Green	Yellow	Red	
		Continuous	Continuous	Flashing (1 Hz)	Continuous
0	Channel 0, input	–	Signal present	Channel fault	Power on test or module faulty
1	Channel 1, input	–	Signal present	Channel fault	–
2	Channel 2, input	–	Signal present	Channel fault	–
:	:	:	:	:	:
15	Channel 15, input	–	Signal present	Channel fault	–
PWR	Power supply	Device operating normally	–	–	–

RSD-BO-Ex4, Binary Output

LED	Meaning	Green	Yellow	Red	
		Continuous	Continuous	Flashing (1 Hz)	Continuous
0	Channel 0, output	–	Output active	Channel fault	Power on test or module faulty
1	Channel 1, output	–	Output active	Channel fault	–
2	Channel 2, output	–	Output active	Channel fault	–
3	Channel 3, output	–	Output active	Channel fault	–
PWR	Power supply	Device operating normally	–	–	–

RSD-CI-Ex8, RSD-CI2-Ex8, RSD-CI2-Ex8.H, Analogue Input

LED	Meaning	Green		Yellow	Red	
		Continuous	Flashing (1 Hz)	Continuous	Flashing (1 Hz)	Continuous
0	Channel 0, input	–	–	– ¹ Field device included in the transmitter list ²	Channel error ¹ HART communication running ²	Power on test or module faulty
1	Channel 1, input	–	–	– ¹ Field device included in the transmitter list ²	Channel error ¹ HART communication running ²	–
2	Channel 2, input	–	–	– ¹ Field device included in the transmitter list ²	Channel error ¹ HART communication running ²	–
:	:	:	:	:	:	:
7	Channel 7, input	–	–	– ¹ Field device included in the transmitter list ²	Channel error ¹ HART communication running ²	–
PWR	Power supply	Device operating normally	Power-ON, no connection to internal bus ³	–	–	–

¹ Applies to the RSD-CI-Ex8.H only if the bit "HART status LEDs" is not set.

² Applies to the RSD-CI-Ex8.H only if the bit "HART status LEDs" is set.

³ Applies to the RSD-CI-Ex8.H.

RSD-UO-Ex8, RSD-UO-Ex8.H Analogue Output

LED	Meaning	Green		Yellow	Red	
		Continuous	Flashing (1 Hz)	Continuous	Flashing (1 Hz)	Continuous
0	Channel 0, output	–	–	– ¹ Field device included in the transmitter list ²	Channel error ¹ HART communication running ²	Power on test or module faulty
1	Channel 1, output	–	–	– ¹ Field device included in the transmitter list ²	Channel error ¹ HART communication running ²	–
2	Channel 2, output	–	–	– ¹ Field device included in the transmitter list ²	Channel error ¹ HART communication running ²	–
:	:	:	:	:	:	:
7	Channel 7, output	–	–	– ¹ Field device included in the transmitter list ²	Channel error ¹ HART communication running ²	–
PWR	Power supply	Device operating normally	Power-ON, no connection to internal bus ³	–	–	–

¹ Applies to the RSD-UO-Ex8.H only if the bit "HART status LEDs" is not set.

² Applies to the RSD-UO-Ex8.H only if the bit "HART status LEDs" is set.

³ Applies to the RSD-CI-Ex8.H.

RSD-TI-Ex8, RSD-TI2-Ex8, Temperature/mV Input

LED	Meaning	Green	Yellow	Red	
		Continuous	Continuous	Flashing (1 Hz)	Continuous
0	Channel 0, input	–	–	Channel fault	Power on test or module faulty
1	Channel 1, input	–	–	Channel fault	–
2	Channel 2, input	–	–	Channel fault	–
:	:	:	:	:	:
7	Channel 7, input	–	–	Channel fault	–
PWR	Power supply	Device operating normally	–	–	–

RSD-FI-Ex8, Frequency Input

LED	Meaning	Green	Yellow	Red	
		Continuous	Continuous	Flashing (1 Hz)	Continuous
0.1	Channel 0, input	–	Signal present	Channel fault	Power on test or module faulty
0.2	Channel 0, gate	–	Signal present	Channel fault	–
0.3	Output 0	–	Output active	–	–
1.1	Channel 1, input	–	Signal present	Channel fault	–
1.2	Channel 1, gate	–	Signal present	Channel fault	–
1.3	Output 1	–	Output active	–	–
PWR	Power supply	Device operating normally	–	–	–

9.3 Error message and diagnostics via the fieldbus

Each gateway reports via the fieldbus

- if a module on the backplane bus is missing or fails, (diagnostics/fault signals are reset when the module is replaced)
- if a bus error has occurred during communication with the I/O module,
- if a module of another type is connected in the place of the old one.

In addition, each I/O module has a module status word (Word 0) and channel status words in its data table that can be evaluated by the user. They return the following diagnostics and error information:

Module Status Word

- Bus error
- The size of the module data table (4 or 16 words)
- Number of words for read data
- Module ID/module type

Channel Status Words

The information in the channel status words depends on the module type. Not all of the following information is available for every module type. For a detailed description, see section 12.

- Lead breakage error
- Lead breakage monitoring activated/deactivated
- Overload alarm
- Overrange/underrange alarm
- Configuration type (primary/secondary)
- Calibration error
- Configuration error
- Hardware error
- Failure of cold junction compensation
- Alarm for excessively high current at current output
- Alarm from connected transmitter



10 Maintenance

The components of the IS-RPI-System are maintenance free when used under the specified environmental conditions. The device LEDs and the diagnosis/error messages which can be called up through the control system/configuration tool inform you of error conditions present at the gateways and modules.

11 Disassembly and disposal

Repackaging

For later reuse, the devices and components are to be packed in such a way that they are protected against shock and humidity. Optimum protection is afforded by the original packaging.

Disposal

Electronic waste is special garbage. Observe local requirements for disposing of it.

Devices in the IS-RPI-System do not contain any batteries that would have to be removed before disposal.



Note

12 IS-RPI modules

12.1 General information on the electrical connection



When installing and operating devices with intrinsically safe circuits, the conformity certificates and set-up or installation conditions (DIN EN 50020, DIN VDE 0165) must be observed.

Intrinsically safe field circuits are connected to the three **blue** terminal series of the rack with self-opening screw terminals (rack RSD-TB-Ex.SC) or spring force terminals (rack RSD-TB-Ex.SP), max. wire cross section 2 x 2.5 mm².



You will find the connection diagram and terminal assignment for the module plugged into the rack in the data sheets of the catalogue entitled "Intrinsically Safe Remote Process Interface IS-RPI" .

12.2 Generally applicable information on operating the modules

All parameter assignment and configuration is carried out via the fieldbus system. Due to the fact that the composition of the data and the access to the modules from the control system are heavily dependent on which fieldbus is used, only generalisations will be made in this section regarding parameters, data structure and adjustment options of the I/O modules.

Fieldbus-specific access to the modules is therefore described in section 12.

The meaning and display functions of the LEDs on the front side of the modules is explained in detail in section 8.2.3 and in section 9.2.

section 8.2.4 describes how to replace defective I/O modules.



You will find block circuit diagrams, connection assignments and technical data for the I/O modules in the data sheets of the catalogue entitled "Intrinsically Safe Remote Process Interface IS-RPI" .

12.3 General data structure of modules

As already described in section 7, all data of the I/O modules is structured in the form of a data table (word structure, 16 bits).

Depending on module type, this data table consists of 4 words (binary modules) or 16 words (analogue modules/frequency meters/counters).

The data is organised in the data tables in the same order for all modules:

1. Module status: 1 word Status of backplane bus communication ID of the I/O module Structure of the modules data table (4/16 words)
2. Input data: 1, 4 or 8 words, depending on the module type Real-time data for input channels of a module
3. Channel status: 1 to 4 words, depending on the module type Status information for each channel of a module
4. Output data: 1 or 9 words, depending on the module type Real time data of the output channels of a module
5. Configuration data: 1 to 8 words, depending on the module type Limit values, filter frequencies, etc. Commands to an I/O module, for example for calibration

A distinction is made here between words with read access (R) and words with write access (W). The words with read access are always positioned first in the data table.

Module Status

The module status word is designed uniformly for all IS-RPI modules:

Word/ type	R/W	Page	Bit																
			15	14	13	12	11	10	9	8	7	6	5	4	3	2	1	0	
0/S	R	0	Bus faults bits				# W	# read words				Module ID/type							

Bus faults bits

Status of backplane bus communication of the module

00_b = normal, 110_b = error

W

Size of module data table

0_b = 4 words, 1_b = 16 words

Read Words

No. of read words in data table

Value range: 0_h ... F_h

Module ID/type

	Module ID/type	Module status word
RSD-BI-Ex16	00 _h	0200 _h
RSD-BO-Ex4	01 _h	0101 _h
RSD-CI-Ex8	00 _h	1C00 _h
RSD-CI2-Ex8	03 _h	1C03 _h
RSD-CI-Ex8.H	3F _h	1E3F _h
RSD-UO-Ex8	00 _h	1200 _h
RSD-UO-Ex8.H	3F _h	153F _h
RSD-TI-Ex8	02 _h	1B02 _h
RSD-TI2-Ex8	02 _h	1B02 _h
RSD-FI-Ex2	00 _h	1700 _h

Configuration

The modules are configured by means of a single data table. The both devices RSD-CI-Ex8.H and RSD-UO-Ex8.H have also an extended data table (about acyclic channel of the IS-RPI-System). With this configuration, all necessary parameters, e. g. data format, safe-state states, filter frequencies, etc., can be set. The settings are, however, usually made for groups of 2 or 4 channels.

12.4 Data structure/adjustable parameters of the modules

12.4.1 RSD-BI-Ex16, binary input

Data Table

Size: 4 words

- 1 module status word
- 1 input data word (1 bit per channel)
- 1 channel status word
- No output data word
- 1 configuration data word

Module Status (for a description see page 62)

Module status word = 0200_h

W = 0_h, data table with 4 words

read words = 2_h, 2 read words after the module status word

Module ID/type = 00_h

Input Data

A data bit is assigned to each of the 16 input channels with the following states:

0_b = off, (no signal, i.e. no current is flowing)

1_b = on, (signal present, i.e. current is flowing)

Channel Status

A fault bit is assigned to each of the 16 input channels with the following states:

0_b = no fault

1_b = line fault (lead break I < 0.35 mA or line short circuit I > 6 mA)



Note

If you would like to use line fault monitoring in combination with relays or switches, you must use appropriate resistors in series or contacts to ensure that the current that is flowing is greater than 0.35 mA and less than 6 mA.

Alternatively, input 15 can be used as a counter. If this option is activated, the channel status word contains the counter state (0 to 65535) of this counter.

Configuration Data

The configuration data word is structured as follows:

Word/ type	R/W	Page	Bit																	
			15	14	13	12	11	10	9	8	7	6	5	4	3	2	1	0		
3/C	W	0	-	-	CF	CR	-	-	F/C	-	-	-	Input filter K12 ... K15				Input filter K0 ... K11 alarm filter K0 ... K15			

CF = Counter Fast Mode

When input 15 is in counter mode, this selects whether it uses the Module Input Channel Filter Time Constant or bypasses the filter.

- 0_b = normal, (the filter is used)
- 1_b = fast, (the filter is bypassed)

CR = Counter Reset

Setting this bit resets the counter state stored in the channel status word to 0 if the Input 15 is working in counter mode. If this bit is zero, the counter continues. If the counter rolls over, it continues from zero.

Default: 0_b

F/C = Fault Mode/Counter Mode

- 0_b = Input 15 is working as a counter; counter state is in the channel status word (word 2)
- 1_b = channel status word with lead break fault bits for each channel

Default: 0_b

Bits 3 ... 5 Input Filter Channels 12 ... 15

These 3 bits are used to set the time constant of the input filter for channels 12 to 15. Pulses which are shorter than the adjusted filter time will not be transmitted.

Default: 0_b

Bit 0 ... 2 Input Filter Channels 0 ... 11, Alarm Filter Channels 0 ... 15

You can use these 3 bits to set the time constant of the input filter for channels 0 to 11 and for channels 0 to 15 of the alarm filter. Pulses that are shorter than the adjusted filter time will not be transmitted.

Default: 0_b

Time Constant of the Input Filter/Alarm Filter	
Value	Time constant
000b	0.25 ms (hardware)
001b	0.5 ms
010b	1 ms
011b	2 ms
100b	4 ms
101b	8 ms
110b	16 ms
111b	32 ms

Activation/Deactivation of Line Fault Monitoring via DIP Switch

On the bottom of the binary input module RSD-BI-Ex16 are 4 DIP switches each of which can be used to activate/deactivate the circuit fault detection for a group of four channels.

DIP Switch for Lead Break Detection		
Switch	Channels	Default
1	0 ... 3	ON (active)
2	4 ... 7	ON (active)
3	8 ... 11	ON (active)
4	12 ... 15	ON (active)

ON = lead break detection activated
OFF = lead break detection deactivated

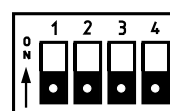

12.4.2 RSD-BO-Ex4, binary output

Data Table

Size: 4 words

- 1 module status word
- no input data word
- 1 channel status word
- 1 output data word
- 1 configuration data word

Module Status (for a description see page 62)

Module status word = 0101_h

W = 0_h, data table with 4 words

read words = 1_h, 1 read word after the module status word

Module ID/type = 0101_h

Channel Status

The channel status word is structured as follows:

Word/ type	R/W	Page	Bit															
			15	14	13	12	11	10	9	8	7	6	5	4	3	2	1	0
1/S	R	0	OA K3	OA K2	OA K1	OA K0	FA K3	FA K2	FA K1	FA K0	-	-	-	-	-	-	-	-

OA = Overload Alarm, channels 0 ... 3

0_b = normal

1_b = output channel overload (load resistance range 30 to 5000 Ω)

Default: 0_b

FA = Fault Alarm, channels 0 ... 3

0_b = no fault

1_b = channel reporting lead break fault or overload

Default: 0_b

In both bits, OA and FA, a 100 Hz (10 ms) filter is integrated.

Output Data

The output data word is structured as follows:

Word/ type	R/W	Page	Bit															
			15	14	13	12	11	10	9	8	7	6	5	4	3	2	1	0
2/O	W	0	com F	LM	Re- served	Re- served	FM K3	FM K2	FM K1	FM K0	FS K3	FS K2	FS K1	FS K0	OD K3	OD K2	OD K1	OD K0

OD = Output Data, channels 0 ... 3

Output data

0_b = OFF, output not active

1_b = ON, output active

FS = Fault State, channels 0 ... 3

These bits are used to define the states of the outputs in the event of a fault.

0_b = Reset to OFF = output not active

1_b = retain last status

Default: 0_b

FM = Fault Mode, channels 0 ... 3

These bits can be used to activate/deactivate lead-breakage detection and overload monitoring of the outputs for each channel.

0_b = lead break/overload monitoring deactivated

1_b = lead break/overload monitoring activated

Default: 0_b

LM = Latch Mode

You can use this bit to define for all channels whether the relevant fault bits should be kept when a lead break or overload fault occurs until they are reset by the user by setting the FR bit (in the configuration data word). In this way it can be ensured that, even in the event of a fault which is short in duration, a fault message is sent to the control system.

0_b = Alarms will automatically be reset

1_b = Alarms will be frozen and must be reset by setting the FR bit with the user program.

Default: 0_b

Com = Communications Fault

F

This bit must be set by the user program in the **initialisation phase** of the system for the module to go into normal operation. If communication via the fieldbus system is interrupted, the gateway in the module sets this bit to "0". The module then switches to a secure state. When network communication is reestablished, the gateway will set this bit to "1", signalling normal operation begins. If the PROFIBUS gateways are being used, this bit is automatically set.

0_b = communication interruption in fieldbus system

1_b = start normal operation

Default: 0_b

Configuration Data

The configuration data word is structured as follows:

Word/ type	R/W	Page	Bit															
			15	14	13	12	11	10	9	8	7	6	5	4	3	2	1	0
3/C	W	0	-	-	-	-	-	-	-	FR	-	-	-	-	-	Fault/overload alarm filter K0 ... K3		



FR = Fault Reset

With this bit, lead break/overload faults are reset and the latch condition of the outputs cancelled, see Latch Mode (LM). First the value is set to 1_b . A reset appears with an edge of 1_b after 0_b .

0_b = normal

1_b = reset

Default: 0_b

Bits 0 ... 2 Fault/Overload Filter, channels 0 ... 3

You can use these 3 bits to adjust the time constant of the fault/overload filter for channels 0 to 3, see the table entitled "Time constant of the input filter/alarm filter" on page 65.

Default: 0_b

12.4.3 Analogue input RSD-CI-Ex8, RSD-CI2-Ex8

Data Table

Size: 16 words

- 1 module status word
- 8 input data words
- 4 channel status words
- No output data words
- 3 configuration data words

Module Status (for a description see page 62)

Module status word = 1C00_h (RSD-CI-Ex8)

Module status word = 1C03_h (RSD-CI2-Ex8)

W = 1_h, data table with 16 words

read words = C_h, 12 read words after the module status word

Module ID/type = 00_h (RSD-CI-Ex8)

Module ID/type = 03_h (RSD-CI2-Ex8)

Input Data

Each of the 8 input channels is assigned a data word (words 1 to 8 of the data table). The data format of these data words, i. e. the measuring range and the resolution, can be defined in the configuration data.

Channel Status

The layout of channel status words is as follows:

Word/ type	R/W	Page	Bit																
			15	14	13	12	11	10	9	8	7	6	5	4	3	2	1	0	
9/S	R	0	OR AL K7	OR AL K6	OR AL K5	OR AL K4	OR AL K3	OR AL K2	OR AL K1	OR AL K0	UR AL K7	UR AL K6	UR AL K5	UR AL K4	UR AL K3	UR AL K2	UR AL K1	UR AL K0	
10/S	R	0	RE F K7	RE F K6	RE F K5	RE F K4	RE F K3	RE F K2	RE F K1	RE F K0	loc FA K7	loc FA K6	loc FA K5	loc FA K4	loc FA K3	loc FA K2	loc FA K1	loc FA K0	
11/S*	R	0	–	–	–	–	–	–	–	–	–	–	–	–	–	–	–	–	Diagnostic data
12/S*	R	0	resp flag	MODULE command response							MODULE command response data								

* When using certain GSD files the status words marked with * are **not** included in the transmission (see table page 172).

OR = Overrange Alarm, channels 0 ... 7

AL

Exceeding the measurement range

0_b = normal

1_b = Measurement range of input channel exceeded

UR = Underrange Alarm, channels 0 ... 7

AL

Value short of measurement range

0_b = normal

1_b = Actual value short of measurement range of input channel

RE = Remote Fault Alarm, channels 0 ... 7

F

Alarm message of a connected transmitter resulting from a defined fault current. This fault current is set by the field device. It can be programmed in data values 13 and 14 in increments of 0.1 mA as a module-internal limit value.

- 0_b = normal
- 1_b = transmitter alarm

loc = Local Fault Alarm, channels 0 ... 7

FA

Condition: Fault detection activated and measurement value I $\leq 22\text{ mA}$ or measurement value I >math>\ge 22\text{ mA}</math>

- 0_b = normal
- 1_b = channel reporting line fault

Bits 0 ... 3 Diagnostic Data

Diagnostic data of the module as specified by the following table

Diagnostic data (4 bits)	
Value	Meaning
0000b	No device faults
0001b	Calibration fault (in preparation)
0010b	Configuration error
0011b	Message fault (in preparation)
0100b	Fault in lead breakage detection (in preparation)
0101b	Serious hardware fault
0110b	EEPROM fault
0111b	RAM fault
1000b	ROM fault
1001b	Calculation fault (in preparation)
1010b	No meaning
:	:
1111b	No meaning

resp = Module Response Flag

flag

This bit is set by the module when it acknowledges the command if the command was not performed correctly. In this case, the command to be executed is returned as "0" and a fault message is returned in the command-data domain.

Configuration Data

The configuration data words of the standard configuration are structured as follows:

Word/ type	R/W	Page	Bit															
			15	14	13	12	11	10	9	8	7	6	5	4	3	2	1	0
13/C	W	0	com F	–	Upper and lower error limit in 0.1 mA steps K0 ... K3				RT u/d K0 ... K3	Limit frequency filter K0 ... K3			Data format K0 ... K3			FM K0 ... K3		
14/C	W	0	sqrt TH		Upper and lower error limit in 0.1 mA steps K4 ... K7				RT u/d K4 ... K7	Limit frequency filter K4 ... K7			Data format K4 ... K7			FM K4 ... K7		
15/C	W	0	cmd flag	MODULE command					MODULE command data									

Com = Communications Fault

F

This bit must be set by the user program in the **initialisation phase** of the system for the module to go into normal operation. If communication via the fieldbus system is interrupted, the gateway in the module sets this bit to "0". When network communication is reestablished, the gateway will set this bit to "1", signalling normal operation begins. If the PROFIBUS gateway is being used, this bit is automatically set.

0_b = communication interruption in fieldbus system

1_b = start normal operation

Default: 0_b

Cmd = Command Flag

flag

This bit is reserved for future command sequences, i.e. it is always "0" and does not need to be set for sending commands.

FM = Fault Mode, channels 0 ... 3, 4 ... 7

These two bits can be used to activate/deactivate line fault monitoring, consisting of lead break and short circuit monitoring by group for each of channels 0 to 3 and channels 4 to 7. The status of these bits has no effect on overrange or underrange monitoring.

0_b = lead fault monitoring deactivated

1_b = lead fault monitoring activated

Default: 0_b

Bit 1 ... 4 Data Format, channels 0 ... 3 (word 13), channels 4 ... 7 (word 14)

These 4 bits are used to define the data format of the input data for channel groups 0 to 3 and 4 to 7 as defined by the following table.

Data formats of analogue input RSD-CI-Ex8/RSD-CI2-Ex8							
Data format	Measurement range	Resolution	Expandable measurement range	Data table value	Data table value range	Digits per mA	Fault current source
0000b	0 mA ... 20 mA	0.1 % of MR ¹⁾	0 mA ... 22 mA	input x 1000	0 ... 22000	1000	programmable
0001b	0 mA ... 20 mA	0.2 % of MR	0 mA ... 20 mA	10000 x (input/20)	0 ... 11000	500	programmable
0010b	0 mA ... 20 mA	0.2 % of MR	0 mA ... 20 mA	10000 x sqrt (input/20) = 0 % ... 104,88 %	0 ... 10488	476	programmable
0011b	0 mA ... 20 mA	0.04 % of MR	0 mA ... 20 mA	65535 x (Input/20)	0 ... 65535	3277	programmable
0100b	4 mA ... 20 mA	0.16 % of MR	2 ... 22 mA	input x 1000	2000 ... 22000	1000	programmable
0101b	4 mA ... 20 mA	0.16 % of MR	2 ... 22 mA	10000 x (Input - 4)/16 = -12.5 ... 112.5 %	-1250 ... +11250	625	programmable
0110b	4 mA ... 20 mA	0.17 % of MR	4 mA ... 22 mA	10000 x sqrt (input - 4)/16 = 0 % ... 106,07 %	0 ... 10607	589	programmable no underrange
0111b	4 mA ... 20 mA	0.02 % of MR	4 mA ... 22 mA	65535 x (input - 4)/16	0 ... 65535	4095	programmable
1000b	0 mA ... 20 mA	not defined	not defined	not defined	not defined	not defined	fixed
1001b	0 mA ... 20 mA	not defined	not defined	not defined	not defined	not defined	fixed
1010b	0 mA ... 20 mA	not defined	not defined	not defined	not defined	not defined	fixed
1011b	0 mA ... 20 mA	0.04 % of MR	0 mA ... 22 mA	55000 x (input/22)	0 ... 55000	2500	fixed
1100b	4 mA ... 20 mA	0.16 % of MR	3.6 ... 21 mA	10000 x (input - 4)/16 = -2.50 % ... 106.25 %	-250 ... +10625	625	NAMUR NE 43
1101b	4 mA ... 20 mA	0.16 % of MR	4 mA ... 20 mA	10000 x (input - 4)/16 = -6.25 % ... 106.25 %	-625 ... +10625	625	fixed
1110b	4 mA ... 20 mA	0.16 % of MR	4 mA ... 20 mA	10000 x (input - 4)/16 = -12.5 % ... 112.5 %	-1250 ... +11250	625	fixed
1111b	4 mA ... 20 mA	not defined	not defined	not defined	not defined	not defined	fixed

1) % of MR = % of measurement range

Bit 5 ... 7 Limit Frequency Input Filters, channels 0 ... 3 (word 13),
channels 4 ... 7 (word 14)

These 3 bits are used to set the time constants of the input filter for channel groups 0 to 3 and 4 to 7 as defined by the following table.

Default: 000_b

Limit Frequency of the Input Filter		
Value	RSD-CI-Ex8	RSD-CI2-Ex8
000b	2.3 kHz	-
001b	6 Hz	-
010b	3.1 Hz	-
011b	1.6 Hz	10 Hz
100b	0.8 Hz	4 Hz
101b	0.4 Hz	2 Hz
110b	0.2 Hz	1 Hz
111b	0.1 Hz	0.5 Hz

RT = Remote Transmitter Error up/down, channels 0 ... 3, 4 ... 7

u/d

These bits define by group, for channels 0 to 3 and channels 4 to 7, whether there will be an alarm message caused by a fault current of a connected transmitter if the current is too great or too small.

0_b = current too great in the range of 20.1 mA ... 21.9 mA

1_b = current too small in the range of 2.1 mA ... 3.9 mA

Default: 0_b

Bits 9 ... 13 = Upper and Lower Fault Limit, channels 0 ... 3, 4 ... 7

Depending on the measurement range, these 5 bits define current ranges for the "Remote Transmitter Alarm" for channels 0 to 3 and channels 4 to 7 by group. The threshold values are specified in steps of 0.1 mA.

Range: 0_d ... 20_d, Default: 0_b (deactivated)

The adjusted value will be multiplied with 0.1 mA. Depending on the actual state of the bit "Remote Transmitter Error up/down" this value will be subtracted from 4 mA (RT u/d = "1") or added to 20 mA (RT u/d = "0").

To illustrate:

For example, a value of 4 sets the fault limit with a measurement range of 4 mA to 20 mA at 3.6 mA or 20.4 mA.

The individual data formats have the following fault current assignments:

Data formats 0, 1, 2, 3, adjustable fault current assignment, for example 0.4 mA

Measurement Range	Overrange	Transmitter Fault
4 mA ... 20 mA	20 mA ... 22 mA	20.4 mA ... 22 mA

Data formats 4, 5, adjustable fault current assignment, for example 0.4 mA

Transmitter Fault	Underrange (RT u/d = "1")	Measurement Range	Overrange (RT u/d = "0")	Transmitter Fault
0 mA ... 3.6 mA	0 mA ... 4 mA	4 mA ... 20 mA	20 mA ... 22 mA	20.4 mA ... 22 mA

Data format 12 (NAMUR NE 43), fixed fault current assignment

Transmitter Fault	Underrange (RT u/d = "1")	Measurement Range	Overrange (RT u/d = "0")	Transmitter Fault
0 mA ... 3.6 mA	0 mA ... 4 mA	4 mA ... 20 mA	20 mA ... 22 mA	21 mA ... 22 mA

Data format 13, fixed fault current assignment

Transmitter fault	Underrange (RT u/d = "1")	Measurement range	Overrange (RT u/d = "0")	Transmitter fault
2 mA ... 3 mA	0 mA ... 4 mA	4 mA ... 20 mA	20 mA ... 22 mA	21 mA ... 22 mA

Data format 14, fixed fault current assignment

Transmitter fault	Underrange (RT u/d = "1")	Measurement range	Overrange (RT u/d = "0")	Transmitter fault
< 2 mA	0 mA ... 4 mA	4 mA ... 20 mA	20 mA ... 22 mA	> 22 mA

sqrt = Square Root Threshold, channels 0 ... 7

TH

For data formats 2 and 6, a limit value is defined as a % of the measurement range. If this minimum value is not reached, the data value is set to 0.

- 00_b = deactivated
- 01_b = 2 % of the measurement range
- 10_b = 5 % of the measurement range
- 11_b = 10 % of the measurement range

12.4.4 Analogue input with HART communication RSD-CI-Ex8.H

The following description of parameter assignment using the data table of RSD-CI-Ex8.H and some assemblies is a general description. If you need to set parameters for the RSD-CI-Ex8.H in this way, please contact Pepperl+Fuchs.

For a description of how to assign parameters with **PACT^{ware}™** please refer to section 15.3.

*The module RSD-CI-Ex8.H can exclusively be operated using the PROFIBUS gateways RSD-GW2-Ex1.PA.** and RSD-GW3-Ex2.DPE.**.*



Note

Real-time Data Table

Size: 16 words

- 1 module status word
- 8 input data words
- 5 channel status words
- No output data words
- 2 communication words for the acyclic channel of IS-RPI

Expanded Data Table (via the acyclic channel of IS-RPI)

- 2 configuration data words
- 2 extended configuration data words

Module Status (for a description see page 62)

Module status word = 1E3F_h

W = 1_h, data table with 16 words

read words = E_h, 14 read words after the module status word

Module ID/type = 3F_h

Input Data

A data word is assigned to each of the 8 input channels (words 2 to 9 of the data table). The data format of these data words, i.e. the measurement range and resolution, can be defined with configuration data or with parameter assignment software (for example **PACT^{ware}™**).

Channel Status

The layout of channel status words is as follows:

Word/ type	R/W	Page	Bit															
			15	14	13	12	11	10	9	8	7	6	5	4	3	2	1	0
10/S	R	0	OR AL K7	OR AL K6	OR AL K5	OR AL K4	OR AL K3	OR AL K2	OR AL K1	OR AL K0	UR AL K7	UR AL K6	UR AL K5	UR AL K4	UR AL K3	UR AL K2	UR AL K1	UR AL K0
11/S	R	0	RE F K7	RE F K6	RE F K5	RE F K4	RE F K3	RE F K2	RE F K1	RE F K0	loc FA K7	loc FA K6	loc FA K5	loc FA K4	loc FA K3	loc FA K2	loc FA K1	loc FA K0
12/S*	R	0	reserved								HART Rebuild	-	-	-	Diagnostic data			
13/S*	R	0	HART Read Back								HART Failure							
14/S*	R	0	HART Transmitter List								HART Communication							

* When using certain GSD files the status words marked with * are **not** included in the transmission (see table page 172).

You can use PROFIBUS to gain access to channel status words by programming an identifier with status transfer (see page 127). The meaning of the individual bits or bytes is as follows:

OR = Overage Alarm, channels 0 ... 7

AL

Exceeding the measurement range

0_b = normal

1_b = Measurement range of input channel exceeded

UR = Underrange Alarm, channels 0 ... 7

AL

Value short of measurement range

0_b = normal

1_b = Actual value short of measurement range of input channel

RE = Remote Fault Alarm, channels 0 ... 7

F

Alarm message of a connected transmitter resulting from a defined fault current. This fault current is set by the field device. It can be programmed in increments of 0.1 mA as a module-internal limit value.

0_b = normal

1_b = transmitter alarm

loc = Local Fault Alarm, channels 0 ... 7

FA

Condition: Error detection must be activated and measurement value $I \leq 2$ mA or measurement value $I \geq 22$ mA

0_b = normal

1_b = channel is reporting lead break fault

Bits 0 ... 3 Diagnostic Data, Data Word 12

Diagnostic data of the module as specified by the following table

Diagnostic data (4 bits)	
Value	Meaning
0000b	No device faults
0001b	Calibration error
0010b	Configuration error
0101b	Serious hardware fault
0110b	EEPROM fault

HART Rebuild (word 12, Bit 7)

This bit indicates that the module is in the rebuild phase. During the rebuild phase, the HART transmitter list is generated and/or updated. This phase must be initiated by the host.

HART Failure

Indicates that a fault related to HART communication has occurred on a channel.

- 0_b = normal
- 1_b = channel reporting HART communication fault

HART Read Back

Compares the current analogue value with HART process variable PV1. If the difference is too great, an error is reported. The difference starting at which a fault is reported via the HART read back threshold can be set by parameter.

- 0_b = normal
- 1_b = fault

HART Communication

Indicates whether a HART communication session is currently in progress on the corresponding channel.

- 0_b = no HART communication is taking place currently
- 1_b = HART communication is taking place currently

HART Transmitter List

This list shows the channel on which a HART-capable field device is installed.

- 0_b = no HART-capable field device
- 1_b = HART-capable field device

This list will not be generated or updated unless a rebuild command is transferred.

A rebuild must be initiated after the power supply is turned on for the HART transmitter list to be generated. This list will be retained until the power supply is turned off again.

If a HART-capable field device is connected to a channel while the system is running, a specifically selected rebuild must be initiated with the HART communication system. After that, this list is updated.

Configuration Data

The configuration data is identical to the data for RSD-CI-Ex8 and RSD-CI2-Ex8 (see page 69). The data can be written via data table Word 15 Bits 0 ... 7 (communication byte of the acyclic channel of the IS-RPI).

Word/ type	R/W	Page	Bit															
			15	14	13	12	11	10	9	8	7	6	5	4	3	2	1	0
1	R	0	PUCfg	Reserved			Communication status				Communication data byte							
15	W	0	PROG/ RUN	reserved			Communication control				Communication data byte							

PACT_{ware}TM uses this type of communication automatically if parameters were assigned to the module with **PACT_{ware}**TM (section 15.3). It is also possible to implement parameter assignment with PROFIBUS by using the PROFIBUS DP user parameters (see page 127).

In addition, the PUCfg bit is available in communication Word 1 and the PROG/RUN bit is available in communication Word 15. These two bits are explained below:

PROG/RUN

This bit must be set by the user program in the **initialisation phase** of the system for the module to go into normal operation. If communication via the fieldbus system is interrupted, the gateway in the module sets this bit to "0". When communication is running with the fieldbus system again, the gateway automatically sets this bit back to "1" and normal operation begins. If the PROFIBUS gateway is being used, this bit is automatically set.

0_b = communication interruption in the fieldbus system

1_b = start normal operation

Default: 0_b

PUCfg = Power Up Configured

This bit indicates that the module has received a valid configuration and is using it.

0_b = no valid configuration received yet

1_b = valid configuration received and accepted

Assembly No. 4 (configuration data via acyclic channel of IS-RPI)

Word/ type	R/W	Page	Bit															
			15	14	13	12	11	10	9	8	7	6	5	4	3	2	1	0
1/C	R/W	0	–	–	Upper/lower fault limit K0 ... K3				RT u/d K0 ... K3	Limit frequency filter K0 ... K3			Data format K0 ... K3			FM K0 ... K3		
2/C	R/W	0	sq rt TH		Upper/lower fault limit K4 ... K7				RT u/d K4 ... K7	Limit frequency filter K4 ... K7			Data format K4 ... K7			FM K4 ... K7		

Fault Mode, channels 0 ... 3, 4 ... 7

These two bits can be used to activate/deactivate line fault monitoring, consisting of lead break and short circuit monitoring by group for each of channels 0 to 3 and channels 4 to 7. The status of these bits has no effect on overrange or underrange monitoring.

0_b = lead fault monitoring deactivated

1_b = lead fault monitoring activated

Default: 0_b

Bits 1 ... 4 Data Format, channels 0 ... 3 (word 1), channels 4 ... 7 (word 2)

These 4 bits are used to define the data format of the input data for channel groups 0 to 3 and 4 to 7 as defined by the following table.

Data Formats of Analogue Input RSD-CI-Ex8/RSD-CI2-Ex8							
Data format	Measurement range	Resolution	expandable measurement range	Data table value	Data table value range	Digits per mA	Fault current source
0000b	0 mA ... 20 mA	0.1 % of MR ¹⁾	0 mA ... 22 mA	input x 1000	0 ... 22000	1000	programmable
0001b	0 mA ... 20 mA	0.2 % of MR	0 mA ... 20 mA	10000 x (input/20)	0 ... 11000	500	programmable
0010b	0 mA ... 20 mA	0.2 % of MR	0 mA ... 20 mA	10000 x sqrt (input/20) = 0 % ... 104,88 %	0 ... 10488	476	programmable
0011b	0 mA ... 20 mA	0.04 % of MR	0 mA ... 20 mA	65535 x (Input/20)	0 ... 65535	3277	programmable
0100b	4 mA ... 20 mA	0.16 % of MR	2 ... 22 mA	input x 1000	2000 ... 22000	1000	programmable
0101b	4 mA ... 20 mA	0.16 % of MR	2 ... 22 mA	10000 x (Input - 4)/16 = -12.5 ... 112.5 %	-1250 ... +11250	625	programmable
0110b	4 mA ... 20 mA	0.17 % of M	4 mA ... 22 mA	10000 x sqrt (input - 4)/16 = 0 % ... 106,07 %	0 ... 10607	589	programmable no underrange
0111b	4 mA ... 20 mA	0.02 % of MR	4 mA ... 22 mA	65535 x (input - 4)/16	0 ... 65535	4095	programmable
1000b	0 mA ... 20 mA	not defined	not defined	not defined	not defined	not defined	Fixed
1001b	0 mA ... 20 mA	not defined	not defined	not defined	not defined	not defined	fixed
1010b	0 mA ... 20 mA	not defined	not defined	not defined	not defined	not defined	fixed
1011b	0 mA ... 20 mA	0.04 % of MR	0 mA ... 22 mA	55000 x (input/22)	0 ... 55000	2500	fixed
1100b	4 mA ... 20 mA	0.16 % of MR	3.6 ... 21 mA	10000 x (input - 4)/16 = -2.50 % ... 106.25 %	-250 ... +10625	625	NAMUR NE 43
1101b	4 mA ... 20 mA	0.16 % of MR	4 mA ... 20 mA	10000 x (input - 4)/16 = -6.25 % ... 106.25 %	-625 ... +10625	625	fixed
1110b	4 mA ... 20 mA	0.16 % of MR	4 mA ... 20 mA	10000 x (input - 4)/16 = -12.5 % ... 112.5 %	-1250 ... +11250	625	fixed
1111b	4 mA ... 20 mA	not defined	not defined	not defined	not defined	not defined	fixed

1) % of MB = of the measurement range

Bits 5 ... 7 Limit Frequency Input Filters, channels 0 ... 3 (word 1), channels 4 ... 7 (word 2)

These 3 bits are used to set the time constants of the input filter for channel groups 0 to 3 and 4 to 7 as defined by the following table.

Default: 000_b

Limit Frequency of Input Filter	
Value	RSD-CI-Ex8.H
000b	–
001b	–
010b	–
011b	10 Hz
100b	4 Hz
101b	2 Hz
110b	1 Hz
111b	0.5 Hz

RT = Remote Transmitter Error up/down, channels 0 ... 3, 4 ... 7

u/d

These bits define by group, for channels 0 to 3 and channels 4 to 7, whether there will be an alarm message caused by a fault current of a connected transmitter if the current is too great or too small.

0_b = current too great in the range of 20.1 mA ... 21.9 mA

1_b = current too small in the range of 2.1 mA ... 3.9 mA

Default: 0_b

Bits 9 ... 13 = Upper and Lower Fault Limit, channels 0 ... 3, 4 ... 7

Depending on the measurement range, these 5 bits define current ranges for the "Remote Transmitter Alarm" for channels 0 to 3 and channels 4 to 7 by group. The threshold values are specified in steps of 0.1 mA.

Range: $0_d \dots 20_d$, Default: 0_b (deactivated)

The adjusted value will be multiplied with 0.1 mA. Depending on the actual state of the bit "Remote Transmitter Error up/down" this value will be subtracted from 4 mA (RT u/d = "1") or added to 20 mA (RT u/d = "0").

To illustrate:

For example, a value of 4 sets the fault limit with a measurement range of 4 mA to 20 mA at 3.6 mA or 20.4 mA.

The individual data formats have the following fault current assignments:

Data format 0, 1, 2, 3, adjustable fault current assignment, for example 0.4 mA

Measurement range	Overrange	Transmitter fault
4 mA ... 20 mA	20 mA ... 22 mA	20.4 mA ... 22 mA

Data format 4, 5, adjustable fault current assignment, for example 0.4 mA

Transmitter fault	Underrange (RT u/d = "1")	Measurement range	Overrange (RT u/d = "0")	Transmitter fault
0 mA ... 3.6 mA	0 mA ... 4 mA	4 mA ... 20 mA	20 mA ... 22 mA	20.4 mA ... 22 mA

Data format 12 (NAMUR NE 43), fixed fault current assignment

Transmitter fault	Underrange (RT u/d = "1")	Measurement range	Overrange (RT u/d = "0")	Transmitter fault
0 mA ... 3.6 mA	0 mA ... 4 mA	4 mA ... 20 mA	20 mA ... 22 mA	21 mA ... 22 mA

Data format 13, fixed fault current assignment

Transmitter fault	Underrange (RT u/d = "1")	Measurement range	Overrange (RT u/d = "0")	Transmitter fault
2 mA ... 3 mA	0 mA ... 4 mA	4 mA ... 20 mA	20 mA ... 22 mA	21 mA ... 22 mA

Data format 14, fixed fault current assignment

Transmitter fault	Underrange (RT u/d = "1")	Measurement range	Overrange (RT u/d = "0")	Transmitter fault
< 2 mA	0 mA ... 4 mA	4 mA ... 20 mA	20 mA ... 22 mA	> 22 mA

sqrt = Square Root Threshold, channels 0 ... 7

TH

For data formats 2 and 6, a limit value is defined as a % of the measurement range. If this minimum value is not reached, the data value is set to 0.

$00_b =$ deactivated

$01_b =$ 2 % of the measurement range

$10_b =$ 5 % of the measurement range

$11_b =$ 10 % of the measurement range

Assembly No. 7 can be used to make the following settings (extended configuration data via the acyclic channel of IS-RPI):

Word/ type	R/W	Page	Bit															
			15	14	13	12	11	10	9	8	7	6	5	4	3	2	1	0
1/C	R/W	0	PMI K7	PMI K6	PMI K5	PMI K4	PMI K3	PMI K2	PMI K1	PMI K0	SME K7	SME K6	SME K5	SME K4	SME K3	SME K2	SME K1	SME K0
2/C	R/W	0				HART Read Back Threshold K4 ... K7				HART Status LEDs	HART Status Inhibit	50 Hz/ 60 Hz	HART Read Back Threshold K0 ... K3					

Two combinations of bits, **PMI** (Primary Master Inhibit) and **SME** (Secondary Master Enable), can be used to turn a large number of module functions on and off. The following table shows an overview:

Status	I	II	III	IV
PMI	0	0	1	1
SME	0	1	0	1
Rebuild	release	release	block	block
HART read back	on	on	off	off
Primary Master	release	release	block	block
Secondary Master	block	release	block	release

HART Status LED

If this bit is set, the LEDs of the module indicate whether or not a HART-capable field device is connected to the channel, or whether HART communication is currently taking place.

LED, yellow on = HART-capable field device detected

LED, yellow off = no HART-capable field device detected

LED, yellow flashing = HART communication is currently taking place.

HART Status Inhibit

If this bit is set, display of HART status information in the data table and the HART rebuild bit is blocked. Instead of the display, the area is filled with "0".

50 Hz/60 Hz Filter

You can use this bit to set the internal filter to

50 Hz = 0 or

60 Hz = 1

HART Read Back Threshold

You can use these 5 bits to define when the HART read back signal will be set in the data table by group for channels 0 to 3 or 4 to 7. The limit value is indicated as a %. The following settings are possible:

0_{dec} Function deactivated

1_{dec} to 4_{dec} not supported; the value is set internally to 5%.

5_{dec} to 31_{dec} Amount above or below limit value as a %

Data for HART Communication

Communication between the Host system and a HART-capable field device that is connected to the RSD-CI-Ex8.H is described in section 15 together with **PACTware™**.

12.4.5 RSD-UO-Ex8, analogue output

Data Table

Size: 16 words

- 1 module status word
- no input data words
- 2 channel status words
- 9 output data words
- 4 configuration data words

Module Status (for a description see page 62)

Module status word = 1200_h

W = 1_h, data table with 16 words

read words = 2_h, 2 read words after the module status word

Module ID/type = 00_h

Channel Status

The layout of channel status words is as follows:

Word/ type	R/W	Page	Bit															
			15	14	13	12	11	10	9	8	7	6	5	4	3	2	1	0
1/S	R	0	loc FA ch7	loc FA ch6	loc FA ch5	loc FA ch4	loc FA ch3	loc FA ch2	loc FA ch1	loc FA ch0	-	-	-	-	Diagnostic data			
2/S*	R	0	resp flag	MODULE command response							MODULE command response data							

* When using certain GSD files the status word marked with * are **not** included in the transmission (see table page 172).

loc = Local Fault Alarm, channels 0 ... 7

FA

Lead break fault (I < 2 mA)

0_b = normal

1_b = channel reporting lead break fault

Bits 0 ... 3 Diagnostic Data

Diagnostic data of the module according to the "Diagnostic data" table on page 70.

resp = Module Response Flag

flag

This bit is set by the module when it acknowledges the command if the command was not performed correctly. In this case, the command to be executed is returned as "0" and a fault message is returned in the command-data domain.

Output Data

A data word is assigned to each of the 8 output channels (words 4 to 11 of the data table). The data format of these data words, i. e. the measuring range and the resolution, can be defined in the configuration data. Each output channel can also be configured as a digital output ($0_b = \text{OFF} = 0 \text{ mA}$, $1_b = \text{ON} = 22 \text{ mA}$). Data table reference: Data Word 3, bits 0 to 7.

Word/ type	R/W	Page	Bit															
			15	14	13	12	11	10	9	8	7	6	5	4	3	2	1	0
3/O	W	0	com F	FR	–	–	–	–	–	–	dig out K7	dig out K6	dig out K5	dig out K4	dig out K3	dig out K2	dig out K1	dig out K0
4/O	W	0	Output data word K0															
5/O	W	0	Output data word K1															
6/O	W	0	Output data word K2															
7/O	W	0	Output data word K3															
8/O	W	0	Output data word K4															
9/O	W	0	Output data word K5															
10/O	W	0	Output data word K6															
11/O	W	0	Output data word K7															

com = Communications Fault, Bit 15, Word 3

F

This bit must be set by the user program in the **initialisation phase** of the system for the module to go into normal operation. If communication via the fieldbus system is interrupted, the gateway in the module sets this bit to "0". The module then switches to a secure state. When network communication is reestablished, the gateway will set this bit to "1", signalling normal operation begins. If the PROFIBUS gateway is being used, this bit is automatically set.

$0_b =$ communication interruption in the fieldbus system

$1_b =$ start normal operation

Default: 0_b

FR = Fault Reset

This bit is used to reset the lead fault and eliminate the Latch state (see also latch mode).

Configuration Data

The configuration data words of the standard configuration are structured as follows:

Word/ type	R/W	Page	Bit																
			15	14	13	12	11	10	9	8	7	6	5	4	3	2	1	0	
12/C	W	0	LFM	–	FM K2 ... K3	FM K0 ... K1	AFS K2 ... K3	AFS K0 ... K1	Data format K2 ... K3				Data format K0 ... K1						
13/C	W	0	LM K4 ... K7	LM K0 ... K3	FM K6 ... K7	FM K4 ... K5	AFS K6 ... K7	AFS K4 ... K5	Data format K6 ... K7				Data format K4 ... K5						
14/C	W	0	DFS K7	DFS K6	DFS K5	DFS K4	DFS K3	DFS K2	DFS K1	DFS K0	a/d K7	a/d K6	a/d K5	a/d K4	a/d K3	a/d K2	a/d K1	a/d K0	
15/C	W	0	cmd flag	MODULE command								MODULE command data							

LFM = Local Fault Mode

This bit is used to define which events cause the outputs to switch to the safe state.

$0_b =$ safe state when a bus communication fault occurs

$1_b =$ safe state when any fault occurs

Default: 0_b

FM = Fault Mode, channels 0 ... 1, 2 ... 3 (word 12),
channels 4 ... 5, 6 ... 7 (word 13)

These four bits can be used to activate/deactivate the line-breakage monitoring for channel groups 0 to 1, 2 to 3, 4 to 5 and 6 to 7.

0_b = lead break monitoring deactivated

1_b = lead break monitoring activated

Default: 0_b

AFS = Analogue Fault State, channels 0 ... 1, 2 ... 3 (word 12),
channels 4 ... 5, 6 ... 7 (word 13)

2 bits per group can be used to define the fail-safe current value of the outputs in the event of a fault for the channel pairs 0 to 1, 2 to 3, 4 to 5 and 6 to 7.

00_b = measurement range - initial value

01_b = measurement range - final value

10_b = retain last status

11_b = 50 % of measuring range width

Default: 0_b

LM = Latch Mode

You can use this bit to define for all channels whether the relevant fault bit should be kept when a lead break or overload fault occurs until it is reset by the user by setting the bit. In this way it can be ensured that, even in the event of a fault which is short in duration, a fault message is sent to the control system.

0_b = Alarms will automatically be reset

1_b = Alarms will be frozen and must be reset by setting the FR bit with the user program.

Default: 0_b

Bit 0 ... 3, 4 ... 7 Data Format, channels 0 ... 1, 2 ... 3 (word 12),
channels 4 ... 5, 6 ... 7 (word 13)

By means of these 4 bits, the data format of the output data is defined for groups of two channels as specified by the following table. If an undefined data format is set, data format 0000_b will be used.

Data Format for Analogue Output RSD-UO-Ex8						
Value	Measurement range	Resolution	expandable measurement range	Data table value (Remark)	Data table value range	Digits per mA
0000b	0 mA ... 20 mA Value in mA	0.1 % of MR ¹⁾	0 mA ... 22 mA	Output = Remark/1000	0 ... 22000	1000
0001b	0 mA ... 20 mA Value in %	0.2 % of MR	0 mA ... 22 mA	Output = 20 x Remark/10000	0 ... 11000	500
0010b	0 mA ... 20 mA	–	0 mA ... 22 mA	not defined	–	–
0011b	0 mA ... 20 mA unsigned integer	0.03 % of MR	0 mA ... 20 mA	Output = 20 x Remark/65535	0 ... 65535	3276
0100b	4 mA ... 20 mA	0.1 % of MR	2 mA ... 22 mA	Output = Remark/1000	2000 ... 22000	1000
0101b	4 mA ... 20 mA	–	4 mA ... 20 mA	not defined	–	–
0110b	4 mA ... 20 mA	–	4 mA ... 20 mA	not defined	–	–
0111b	4 mA ... 20 mA Unsigned integer	–	4 mA ... 20 mA	Output = 16 x Remark/65535 + 4	0 ... 65535	4095
1000b	0 mA ... 20 mA	–	0 mA ... 20 mA	not defined	–	–
1001b	0 mA ... 20 mA	–	0 mA ... 20 mA	not defined	–	–
1010b	0 mA ... 20 mA	–	0 mA ... 20 mA	not defined	–	–
1011b	0 mA ... 20 mA A/D converter value	0.28 % of MR	0 mA ... 22 mA	Output = 22 x Remark/8000	0 ... 8000	363
1100b	4 mA ... 20 mA Value in %	–	–	not defined	–	–
1101b	4 mA ... 20 mA Value in %	0.16 % of MR	3 mA ... 21 mA	Output = 16 x Remark/10000 + 4	-625 ... +10625	625
1110b	4 mA ... 20 mA Value in %	0.16 % of MR	2 mA ... 22 mA	Output = 16 x Remark/10000 + 4	-1250 ... +11250	625
1111b	not defined	not defined	not defined	not defined	not defined	not defined

1) % of MR = of the measurement range

DFS = Digital Fault State, channels 0 ... 7

This bit is used to define the safe state that the outputs accept if they are configured as digital outputs.

0_b = reset to OFF = 0 mA

1_b = retain last status

Default: 0_b

a/d = Analogue/Digital Output Mode, channels 0 ... 7

This bit defines whether the respective output channel functions as an analogue or digital output.

0_b = normal analogue output

1_b = digital output (OFF = 0 mA, ON = 22 mA)

Default: 0_b

cmd = Command Flag

flag

This bit is reserved for future command sequences, i. e. it is always "0" and does not need to be set for sending commands.

12.4.6 Analogue Output with HART Communication RSD-UO-Ex8.H

The following description of parameter assignment using the data table of RSD-CI-Ex8.H and some assemblies is a very superficial description. If you need to set parameters for the RSD-UO-Ex8.H in this way, please contact Pepperl+Fuchs.

You will find a description of how to set parameters with **PACTware™** in section 15.3.

*The module RSD-CI-Ex8.H can exclusively be operated using the PROFIBUS gateways RSD-GW2-Ex1.PA.** and RSD-GW3-Ex2.DPE.**.*



Note

Real-time Data Table

Size: 16 words

- 1 module status word
- no input data words
- 4 channel status words
- 9 output data words
- 2 communication words for the acyclic channel of IS-RPI

Expanded Data Table (via the acyclic channel of IS-RPI)

- 11 configuration data words
- 2 extended configuration data words

Module Status (for a description see page 62)

Module status word = 153F_h

W = 1_h, data table with 16 words

read words = 5_h, 5 read words after the module status word

Module ID/type = 3F_h

Channel Status

The layout of channel status words is as follows:

Word/ type	R/W	Page	Bit															
			15	14	13	12	11	10	9	8	7	6	5	4	3	2	1	0
2/S	R	0	FA K7	FA K6	FA K5	FA K4	FA K3	FA K2	FA K1	FA K0	HART Rebuild	–	–	–	Diagnostic data			

Fault Alarm, channels 0 ... 7

Lead break fault (I < 2 mA) and short circuit fault

0_b = normal

1_b = channel reporting lead break fault

This alarm is turned off if a data format has been selected that contains 0 mA.

Bit 7 HART Rebuild

This bit indicates that the module is in the rebuild phase. During the rebuild phase, the HART transmitter list is generated and/or updated. This phase must be initiated by the host.

Bits 0 ... 3 Diagnostic Data

Diagnostic data of the module according to the "Diagnostic data" table on page 70.

HART Status

Word/ type	R/W	Page	Bit															
			15	14	13	12	11	10	9	8	7	6	5	4	3	2	1	0
4/S*	R	0	HART Read back								HART Failure							
5/S*	R	0	HART Transmitter List								HART Communication							

* When using certain GSD files the status words marked with * are **not** included in the transmission (see table page 172).

HART Failure

Indicates that a fault related to HART communication has occurred on a channel.

0_b = normal
1_b = channel reporting HART communication fault

HART Read Back

Compares the current analogue value with HART process variable PV1. If the difference is too great, an error is reported. The difference starting at which a fault is reported via the HART read back threshold is parameterizable.

0_b = normal
1_b = fault

HART Communication

Indicates whether a HART communication session is currently in progress on the corresponding channel.

0_b = no HART communication is taking place currently
1_b = HART communication is taking place currently

HART Transmitter List

This list shows the channel on which a HART-capable field device is installed.

0_b = no HART-capable field device
1_b = HART-capable field device

This list will not be generated or updated unless a rebuild command is transferred.

A rebuild must be initiated after the power supply is turned on for the HART transmitter list to be generated. This list will be retained until the power supply is turned off again.

If a HART-capable field device is connected to a channel while the system is running, a specifically selected rebuild must be initiated with the HART communication system again. After that, this list is updated.

Output Data

A data word is assigned to each of the 8 output channels (words 8 to 15 of the data table). The data format of these data words, i. e. the measuring range and the resolution, can be defined in the configuration data. Each output channel can also be configured as a digital output. Data table reference: Data word 7, bits 0 to 7.

Word/ type	R/W	Page	Bit															
			15	14	13	12	11	10	9	8	7	6	5	4	3	2	1	0
7/O	W	0	-	FR	-	-	-	-	-	-	dig out K7	dig out K6	dig out K5	dig out K4	dig out K3	dig out K2	dig out K1	dig out K0
8/O	W	0	Output data word K0															
9/O	W	0	Output data word K1															
10/O	W	0	Output data word K2															
11/O	W	0	Output data word K3															
12/O	W	0	Output data word K4															
13/O	W	0	Output data word K5															
14/O	W	0	Output data word K6															
15/O	W	0	Output data word K7															

FR = Fault Reset

This bit is used to reset the lead fault and eliminate the Latch state (see also Latch mode).

Configuration Data

The configuration data is largely similar to that of the RDS-UO-Ex8 (see page 81). Data can be written with data table word 6 Bits 0 ... 7 (configuration byte of the acyclic channel of IS-RPI) and read with data table Word 1 Bits 0 ... 7.

Word/ type	R/W	Page	Bit															
			15	14	13	12	11	10	9	8	7	6	5	4	3	2	1	0
1	R	0	PUCfg	Reserved				Communication status				Communication data byte						
6	W	0	PROG/ RUN	Reserved				Communication control				Communication data byte						

PACT_{ware}TM uses this type of communication automatically if parameters were assigned to the module with **PACT_{ware}**TM (see page 154). It is also possible to implement parameter assignment with PROFIBUS by using the PROFIBUS DP user parameters (see page 128).

In addition, the PUCfg bit is available in communication Word 1 and the PROG/RUN bit is available in communication word 6. These two bits are explained below:

PROG/RUN

This bit must be set by the user program in the **initialisation phase** of the system for the module to go into normal operation. If communication via the fieldbus system is interrupted, the gateway in the module sets this bit to "0". The module then switches to a secure state. When communication is running with the fieldbus system again, the gateway automatically sets this bit back to "1" and normal operation begins. If the PROFIBUS gateway is being used, this bit is automatically set.

0_b = communication interruption in the fieldbus system

1_b = start normal operation

Default: 0_b

PUCfg = Power Up Configured

This bit indicates that the module has received a valid configuration and is using it.

0_b = no valid configuration received yet
 1_b = valid configuration received and accepted

Assembly No. 4 (configuration data via acyclic channel of IS-RPI)

Word/ type	R/W	Page	15	14	13	12	11	10	9	8	7	6	5	4	3	2	1	0
1/C	W	0	loc FM		FM K2 ... K3	FM K0 ... K1	AFS K2 ... K3	AFS K0 ... K1	Data format K2 ... K3				Data format K0 ... K1					
2/C	W	0	LM K4 ... K7	LM K0 ... K3	FM K6 ... K7	FM K4 ... K5	AFS K6 ... K7	AFS K4 ... K5	Data format K6 ... K7				Data format K4 ... K5					
3/C	W	0	DFS K7	DFS K6	DFS K5	DFS K4	DFS K3	DFS K2	DFS K1	DFS K0	a/d K7	a/d K6	a/d K5	a/d K4	a/d K3	a/d K2	a/d K1	a/d K0
4/C	W	0	Analogue output value for the safe state on Channel 0															
5/C	W	0	Analogue output value for the safe state on Channel 1															
6/C	W	0	Analogue output value for the safe state on Channel 2															
7/C	W	0	Analogue output value for the safe state on Channel 3															
8/C	W	0	Analogue output value for the safe state on Channel 4															
9/C	W	0	Analogue output value for the safe state on Channel 5															
10/C	W	0	Analogue output value for the safe state on Channel 6															
11/C	W	0	Analogue output value for the safe state on Channel 7															

a/d = Analogue/Digital Mode (bits 0 to 7, word 3)

You can use this bit to specify whether the channel in question works with an analogue or digital output

Data Format

You can use bits 0 through 3 or 4 through 7 of Words 1 and 2 in groups of 2 channels to select the data format for analogue outputs. For possible data formats, please refer to table on page 84. If you will be operating a HART-capable field device, please select data format 7 to ensure problem-free communication. A power supply of at least 4 mA must be provided for the field device.

FM = Fault Mode

These four bits can be used to activate/deactivate lead monitoring for channel groups 0 to 1, 2 to 3, 4 to 5 and 6 to 7.

0_b = Lead monitoring deactivated
 1_b = Lead monitoring activated

Default: 0_b

AFS = Analogue Fault State, channels 0 ... 1, 2 ... 3 (word 1),
 channels 4 ... 5, 6 ... 7 (word 2)

2 bits per group can be used to define the fail-safe current value of the outputs in the event of a fault for the channel pairs 0 to 1, 2 to 3, 4 to 5 and 6 to 7.

00_b = measurement range - initial value
 01_b = measurement range - final value
 10_b = retain last status
 11_b = user-defined values depending on the setting of "Analogue output value for safe state on channels 0 to 7". If **FACTware™** is used to assign parameters, this setting automatically corresponds to a fail-safe current value of 50 % the width of the measurement range.

Default: 0_b

DFS = Digital Fault State

These bits can be set in pairs to adjust the behavior of the digital output in the event of a fault:

- 0_b = reset (non-energised state)
- 1_b = maintain the last state

Default: 0_b

LM = Latch Mode

You can use this bit to define for all channels whether the relevant fault bit should be kept when a lead break or overload fault occurs until it is reset by the user by setting the bit. In this way it can be ensured that, even in the event of a fault which is short in duration, a fault message is sent to the control system.

- 0_b = Alarms will automatically be reset
- 1_b = Alarms will be frozen and must be reset by setting the FR bit with the user program.

Default: 0_b

LFM = Local Fault Mode

This bit is used to define which events cause the outputs to switch to the safe state.

- 0_b = safe state when a bus communication fault occurs
- 1_b = safe state when any fault occurs

Default: 0_b

Analogue Output Value for Safe State on channels 0 to 7

These 8 words are used to determine the output values that will be generated on the corresponding channel in the event the device is in the safe state. The value and range of values depend on the data format that is selected. If **PACT_{ware}**TM is used to assign parameters, these values are determined automatically and correspond to 50 % the width of the chosen data formats" measurement range. See also "AFS = Analogue Fault State".

Assembly No. 7 can be used to make the following settings (extended configuration data via the acyclic channel of IS-RPI):

Word/ type	R/W	Page	Bit															
			15	14	13	12	11	10	9	8	7	6	5	4	3	2	1	0
1/C	R/W	0	PMI K7	PMI K6	PMI K5	PMI K4	PMI K3	PMI K2	PMI K1	PMI K0	SME K7	SME K6	SME K5	SME K4	SME K3	SME K2	SME K1	SME K0
2/C	R/W	0	-	-	-	HART Read Back Threshold K4 ... K7				HART Status LEDs	HART Status Inhibit	-	HART Read Back Threshold K0 ... K3					

Two combinations of bits, **PMI** (Primary Master Inhibit) and **SME** (Secondary Master Enable), can be used to turn a large number of module functions on and off. The following table shows an overview:

Status	I	II	III	IV
PMI	0	0	1	1
SME	0	1	0	1
Rebuild	release	release	block	block
HART read back	On	On	Off	Off
Primary Master	release	release	block	block
Secondary Master	block	release	block	release



HART Status LEDs

If this bit is set, the LEDs of the module indicate whether a HART-capable field device was detected (after rebuild), or whether HART communication is currently taking place.

LED, yellow on = HART-capable field device detected

LED, yellow off = no HART-capable field device detected

LED, yellow flashing = HART communication is currently taking place.

HART Status Inhibit

If this bit is set, display of HART status information in the data table and the HART rebuild bit is blocked. Instead of the display, the area is filled with "0".

HART Read Back Threshold

You can use these 5 bits to define when the HART read back signal will be set in the data table by group for channels 0 to 3 or 4 to 7. The limit value is indicated as a %. The following settings are possible:

0 _{dec}	Function deactivated
1 _{dec} to 4 _{dec}	not supported; the value is set internally to 5%.
5 _{dec} to 31 _{dec}	Amount above or below limit value as a %

Data for HART communication

Communication between the Host system and a HART-capable field device that is connected to the RSD-UO-Ex8.H is described in section 15 together with **PACTware™**.

12.4.7 RTD (temperature measurement converter) RSD-TI-Ex-Ex8, RSD-TI2-Ex8

Data Table

Size: 16 words

- 1 module status word
- 8 input data words
- 3 channel status-words
- no output data words
- 4 configuration data words

Module Status (for a description see page 62)

Module status word = 1B02_h

W = 1_h, data table with 16 words

read words = B_h, 11 read words after the module status word

Module ID/type = 02_h

Input Data

Each of the 8 input channels is assigned a data word (words 1 to 8 of the data table). The data format of these data words, i. e. the measuring range and the resolution, can be defined in the configuration data.

Channel Status

The layout of channel status words is as follows:

Word/ type	R/W	Page	Bit															
			15	14	13	12	11	10	9	8	7	6	5	4	3	2	1	0
9/S	R	0	OR AL K7	OR AL K6	OR AL K5	OR AL K4	OR AL K3	OR AL K2	OR AL K1	OR AL K0	UR AL K7	UR AL K6	UR AL K5	UR AL K4	UR AL K3	UR AL K2	UR AL K1	UR AL K0
10/S	R	0	loc FA K7	loc FA K6	loc FA K5	loc FA K4	loc FA K3	loc FA K2	loc FA K1	loc FA K0	–	CJC AL1	CJC AL2	–	Diagnostic data			
11/S*	R	0	resp flag	MODULE command response						MODULE command response data								

* When using certain GSD files the status word marked with * are **not** included in the transmission (see table page 172).

OR = Overrange Alarm, channel 0 ... 7

AL

Measurement value underrange ($T > T_{max}$, $U > 100\text{ mV}$ or $R > 500\ \Omega$, depending on the measurement range)

0_b = normal

1_b = measurement range of input channel exceeded

UR = Underrange Alarm, channels 0 ... 7

AL

Measurement value underrange ($T < T_{min}$, $U < -40\text{ mV}$ depending on measurement range or $R = 0\ \Omega$)

0_b = normal

1_b = measurement value for input channel underrange

loc = Local Fault Alarm, channels 0 ... 7

FA

The "Local Fault Alarm" is a channel-related lead break monitoring. In any mode, if a broken/detached lead is detected, the data value is forced to maximum. In addition, it is set in mV mode for input voltages > 220 mV and when RTDs are connected in the event of a short circuit.

0_b = normal
1_b = channel reporting lead break fault

CJC = Cold Junction Compensation Alarm

AL

A bit that indicates a lead break is available for each thermistor connection of cold junction compensation (CJC AL1 and CJC AL2). This alarm is only provided if sensor type is set for "Thermocouple" and sensor mode is set to "internal". If a broken/detached lead is detected, 70 °C is substituted for the CJC temperature in all calculations. If a short circuit is detected, 0 °C is substituted internal in all calculations.

Lead break or short circuit on the cold junction compensation connection

0_b = normal
1_b = cold junction compensation connection is reporting lead fault

Bits 0 ... 3 Diagnostic Data, Word 10

Diagnostic data of the module according to the table "Diagnostic data" on page 70.

resp = Module Response Flag

flag

This bit is set by the module when it acknowledges the command if the command was not performed correctly. In this case, the command to be executed is returned as "0" and a fault message is returned in the command-data domain.

Configuration Data

The configuration data words of the standard configuration are structured as follows:

Word/ type	R/W	Page	Bit																
			15	14	13	12	11	10	9	8	7	6	5	4	3	2	1	0	
12/C	W	0	com F	-	-	-	Data format K0 ... K7				FM K4 ... K7	FM K0 ... K3	RJ K0 ... K7			Limit frequency filters K0 ... K7			
13/C	W	0	SE sel K4 ... K7		SM K4 ... K7		ST sel K4 ... K7				SE sel K0 ... K3		SM K0 ... K3		ST sel K0 ... K3				
14/C	W	0	RTD ofs K7		RTD ofs K6		RTD ofs K5		RTD ofs K4		RTD ofs K3		RTD ofs K2		RTD ofs K1		RTD ofs K0		
15/C	W	0	cmd flag	MODULE command							MODULE command data								

com = Communications Fault, Bit 15, Word 12

F

This bit must be set by the user program in the **initialisation phase** of the system for the module to go into normal operation. If communication via the fieldbus system is interrupted, the gateway in the module sets this bit to "0". When network communication is reestablished, the gateway will set this bit to "1", signalling normal operation begins. If the PROFIBUS gateway is being used, this bit is automatically set.

0_b = communication interruption in the fieldbus system

1_b = start normal operation

Default: 0_b

Bits 8 ... 11 Data Format, channels 0 ... 7 (word 12)

These 4 bits, depending on the selected sensor mode and sensor type, are used to define the data format for all channels as specified by the following table.

Default: 0000_b

Data Formats RSD-TI-Ex8/RSD-TI2-Ex8				
Value	Sensor mode, thermocouples		Sensor mode, RTD	
	mV without interruption (-40 mV ... +100 mV)	thermocouples	Ω without interruption (0 Ω ... 500 Ω)	RTD
0000b	-4000 ... +10000	°C (-XXX.X ... +XXX.X)	0 ... 5000	°C (-XXX.X ... +XXX.X)
0001b	-4000 ... +10000	°F (-XXX.X ... +XXX.X)	0 ... 5000	°F (-XXX.X ... +XXX.X)
0010b	-4000 ... +10000	°K (XXX.X)	0 ... 5000	°K (XXX.X)
0011b	-32767 ... +32767	-32767 ... +32767	-32767 ... +32767	-32767 ... +32767
0100b	0 ... 65535	0 ... 65535	0 ... 65535	0 ... 65535
0101b	not defined			
:	:			
1111b	not defined			

For data formats 0000_b (°C), 0001_b (°F), and 0002_b (Kelvin), the corresponding measurement range depends on sensor mode and sensor type. The measurement ranges of the individual sensors are specified below for data format 0000_b (°C).

thermocouples			RTD		
Type	Measurement range	Representation in data format 0000b	Type	Measurement range	Representation in data format 0000b
B	+300 °C ... +1800 °C	+3000 ... 18000	Pt100 IEC	-200 °C ... +870 °C	-2000 ... +8700
I	-250 °C ... +1000 °C	-2700 ... +10000	Pt200 IEC	-200 °C ... +400 °C	-2000 ... +4000
J	-210 °C ... +1200 °C	-2100 ... +12000	Pt100 JIS	-200 °C ... +630 °C	-2000 ... +6300
K	-250 °C ... +1372 °C	-2700 ... +13720	Pt200 JIS	-200 °C ... +400 °C	-2000 ... 4000
L	-200 °C ... +800 °C	-2000 ... +8000	Ni100 DIN	-60 °C ... +250 °C	-600 ... +2500
N	-250 °C ... +1300 °C	-2700 ... +13000	Ni200 DIN	-60 °C ... +200 °C	-600 ... +2000
R	-50 °C ... +1768 °C	-500 ... +17680	Ni120 Minco	-80 °C ... +320 °C	-800 ... +3200
S	-50 °C ... +1786 °C	-500 ... +17680	Cu10 Minco	-200 °C ... +260 °C	-2000 ... +2600
T	-250 °C ... +400 °C	-2700 ... +4000	-	-	-

FM = Fault Mode, channels 0 ... 3, 4 ... 7

By means of these two bits, the circuit fault detection (lead break monitoring and overrange of the input voltage range) can be activated/deactivated for channel groups 0 to 3 and 4 to 7.

0_b = lead break detection deactivated

1_b = lead break detection activated

Default: 0_b

RJ = Reference Junction Select, channels 0 ... 7

By means of these 3 bits, a fixed compensation temperature for thermocouples and external temperature compensation is defined for all thermocouple channels by the following table.

Default: 0_b

Compensation Temperature, Reference Element	
Value	Temperature
000b	0 °C
001b	20 °C
010b	25 °C
011b	30 °C
100b	40 °C
101b	50 °C
110b	60 °C
111b	70 °C

Bits 0 ... 2 Limit Frequency Input Filter, channels 0 ... 7 (word 12)

By means of these 3 bits, the cutoff frequency of the input filter is defined for all channels as specified by the following table.

Default: 0_b

Limit Frequency of the Input Filter		
Value	Limit frequency RSD-TI-Ex8	Limit frequency RSD-TI2-Ex8
000b	600 Hz (hardware)	–
001b	40 Hz	–
010b	10 Hz	10 Hz
011b	4 Hz	4 Hz
100b	2 Hz	2 Hz
101b	1 Hz	1 Hz
110b	0.5 Hz	0.5 Hz
111b	0.2 Hz	0.2 Hz

SE = Sensor Selection, channel 0 ... 3, 4 ... 7

sel

The sensor mode is defined by means of 2 bits for channel groups 0 to 3 and 4 to 7.

00_b = thermocouples (TC) or mV without conversion

01_b = resistance temperature measurement sensor (RTD) or Ohm without conversion

10_b = not defined

11_b = not defined

Default: 0_b

ST = Sensor Type Selection, channels 0 ... 3, 4 ... 7

sel

By means of 4 bits and depending on the sensor mode, the sensor type is defined for channel groups 0 to 3 and 4 to 7 as specified by the following table.

Default: 0_b

Sensor Types Temperature Input RSD-TI-Ex8/RSD-TI2-Ex8		
Value	Sensor mode (SE sel = 00b): Thermocouples	Sensor mode (SE sel = 01b): RTD
0000b	mV without conversion	Ω without conversion
0001b	Type B	Pt100, IEC 751, Amendment 2
0010b	Type E	Pt200, IEC 751, Amendment 2
0011b	Type J	Pt100, JIS C1604 - 1989
0100b	Type K	Pt200, JIS C1604 - 1989
0101b	Type L	Ni 100, DIN 43760 - 1987
0110b	Type N	Ni200, DIN 43760 - 1987
0111b	Type R	Ni120 Minco
1000b	Type S	Cu10 Minco
1001b	Type T	not defined
1010b	not defined	not defined
:	:	:
1110b	not defined	not defined
1111b	not defined	not defined

If undefined settings are made, the value 0010_b = configuration error will be set in the diagnostic status (Value 10, bits 0 ... 3).

SM = Sensor Mode Select, channels 0 ... 3, 4 ... 7

By means of 2 bits and depending on the sensor mode, the measuring method is defined for channel groups 0 to 3 and 4 to 7 as specified by the following table.

Default: 0_b

Sensor Types Temperature/mV Input RSD-TI-Ex8/RSD-TI2-Ex8		
Value	Sensor mode (SE sel = 00b): Thermocouples	Sensor mode (SE sel = 01b): RTD
00b	internal temperature compensation with CJC reference element (thermistor is a part of delivery package)	2-wire measurement without compensation of the lead resistance
01b	external temperature compensation (see parameter RJ)	2-wire measurement with compensation for lead resistor (see parameter RTD ofs)
10b	no temperature compensation	3-wire measurement
11b	Difference measurement between channels 0 and 1, 2 and 3, 4 and 5 and 6 and 7. (The measurement values in the input data are the same then for both channels)	4-wire measurement

If internal cold junction compensation is chosen, channels 0 and 4 will be compensated with the temperature measured by thermistor 1, channels 3 and 7 with the temperature measured by thermistor 2. For channels 1, 2, 5 and 6 the linear average of both thermistors is the compensation temperature.



RTD = RTD Loop Resistance Offset

ofs

This bit can be used to define an offset resistance value for each channel for the resistance temperature sensor to compensate for the lead resistance to the measuring point.

00_b = internal compensation value of 2-wire calibration

01_b = 5 Ω

10_b = 10 Ω

11_b = 15 Ω

Default: 0_b

cmd = Command Flag

flag

This bit is intended for future command sequences, i.e. it is always "0" and does not need to be set for sending commands.

12.4.8 Frequency measuring device RSD-FI-Ex2

Data Table

Size: 16 words

- 1 module status word
- 4 input data words
- 3 channel status words
- No output data words
- 8 configuration data words

Module Status (for a description see page 62)

Module status word = 1700_h

W = 1_h, data table with 16 words

read words = 7_h, 7 read words after the module status word

Module ID/type = 00_h

Input Data

Each of the 2 input channels is assigned two data words (words 1 to 4 of the data table). The data format of these data words, i. e. the measuring range and the resolution, can be defined in the configuration data. The input-data words are structured as follows.

Word/ type	R/W	Page	Bit															
			15	14	13	12	11	10	9	8	7	6	5	4	3	2	1	0
1/I	R	0	K0, frequency (2 data formats to select from)															
2/I	R	0	K0, frequency as % of the measuring range or acceleration value															
3/I	R	0	K1, frequency (2 data formats to select from)															
4/I	R	0	K1, frequency as % of the measuring range or acceleration value															

Channel Status

The layout of channel status words is as follows:

Word/ type	R/W	Page	Bit															
			15	14	13	12	11	10	9	8	7	6	5	4	3	2	1	0
5/S	R	0	-	-	DI K0	GS K0	FR AL K0	FA K0	MP AL K0	-	-	DI K1	GS K1	FR AL K1	FA K1	MP AL K1	-	
6/S*	R	0	-	-	-	-	Diagnostic data, K0				-	-	-	mod cfg	Diagnostic data, K1			
7/S*	R	0	resp flag	MODULE command response							MODULE command response data							

* When using certain GSD files the status words marked with * are **not** included in the transmission (see table page 172).

DI = Direction, channels 0, 1

These 2 bits indicate the rotation of direction of the encoder (frequency < 1500 Hz) by evaluating the gate and frequency input.

00_b = no rotation of encoder

01_b = clockwise rotation (the signal of the gate input comes before the signal of the gate input)

10_b = anticlockwise rotation (the signal of the frequency input comes before the signal of the frequency input)

11_b = no sensor detected

GS = Gate Input State, channels 0, 1

This bit indicates whether a signal is present at the respective gate input. Bit is only updated every 0.5 to 2 seconds. It is not a real-time display of the gate input.

0_b = no input signal

1_b = input signal present

FR = Maximum Frequency or Acceleration Alarm, channels 0, 1

AL

This bit is set when the maximum frequency or acceleration value specified by the user is exceeded. It is reset when the frequency value drops below 95 % of the alarm value or the acceleration value drops below 90 % of the alarm value (see configuration data). This bit can be used to access the relevant channel output directly (1_b = ON, 0_b = OFF).

0_b = frequency/acceleration value < maximum value

1_b = frequency/acceleration value > maximum value

FA = Fault Alarm, channels 0, 1

Lead break fault (NAMUR) at gate or frequency input of the respective channel

0_b = normal

1_b = channel reporting lead break fault

MP = Missing Pulse Alarm, channel 0, 1

AL

This bit is set if there are no frequency pulses present on the frequency input within the time period defined by the "Minimum Frequency Sampling Time" and "Missing Pulse Multiplier" parameter. If no gate input pulse is recorded, status bits "Direction" are simply set to 11_b (no sensor detected). The frequency calculation is not affected.

0_b = normal

1_b = no pulses on frequency input

Bits 0 ... 3 Diagnostic Data, word 10

Diagnostic data of the module according to the table "Diagnostic data" on page 70.

resp = Module Response Flag

flag

This bit is set by the module when it acknowledges the command if the command was not performed correctly. In this case, the command to be executed is returned as "0" and a fault message is returned in the command-data domain.

Configuration Data

The configuration data words for the primary configuration are structured as follows:

Word/ type	R/W	Page	Bit																
			15	14	13	12	11	10	9	8	7	6	5	4	3	2	1	0	
8/C	W	0	com F	FST K0 ... K1	F RA K0	NOP K0			MPM K0	-	loc FM	F RA K1	NOP K1			MPM K1			
9/C	W	0	MFA K0																
10/C	W	0	FSD K0								FSM K0								
11/C	W	0	FG K0	FF K0	inv GI K0	inv FI K0	MFS K0			IS K0	ACT K0	FAA K0	DM K0	FDM K0					
12/C	W	0	MFA K1																
13/C	W	0	FSD K1								FSM K1								
14/C	W	0	FG K1	FF K1	inv GI K1	inv FI K1	MFS K1			IS K1	ACT K1	FAA K1	DM K1	FDM K1					
15/C	W	0	cmd flag	MODULE command								MODULE command data							

com = Communications Fault

F

This bit must be set by the user program in the **initialisation phase** of the system for the module to go into normal operation. If communication via the fieldbus system is interrupted, the gateway in the module sets this bit to "0". The module then switches to a secure state. When network communication is reestablished, the gateway will set this bit to "1", signalling normal operation begins. If the PROFIBUS gateway is being used, this bit is automatically set.

0_b = communication interruption in the fieldbus system

1_b = start normal operation

Default: 0_b

FST = Fault Safe State Mode, channels 0, 1

These bits are used to define the safe state of the alarm outputs in the event of fault

0_b = reset to OFF

1_b = retain last status

Default: 0_b

loc = Local Fault Mode

FM

This bit is used to define which events cause the inputs to switch to the safe state.

0_b = safe state when a bus communication fault occurs

1_b = safe state when any fault occurs

Default: 0_b

F = Frequency Range, channels 0, 1

RA

Determines the measuring range of the respective frequency input. The frequency is accurately measured to 1 Hz. Below 1 Hz, a value of 0 is output.

0_b = 1 Hz ... 32767 Hz
1_b = 1.0 Hz ... 3276.9 Hz

Default: 0_b

NOP = Number of Pulses to Terminate Sampling, channel 0, 1

These 3 bits indicate the minimum number of input pulses after which the calculation of the frequency will be started, even before the "Minimum Frequency Sampling Time" has elapsed.

000_b = Frequency is calculated based on the "Minimum Frequency Sampling Time"
001_b = 2
010_b = 4
011_b = 8
100_b = 16
101_b = 32
110_b = 64
111_b = 128

Default: 0_b

MPM = Missing Pulse Multiplier, channels 0, 1

These 2 bits indicate the number of sampling cycles based on the "Minimum Frequency Sampling Time", after which "Missing Pulse Alarm" is set. The bandwidth is also affected. It is reduced to 1/(MPM x MFS). The maximum total sampling time is 2s, even if the product of MPM and MFS is greater.

00_b = 1 (no multiplier, alarm generated immediately)
01_b = 2
10_b = 8
11_b = 32

Default: 0_b

MFA = Maximum Frequency or Acceleration, channels 0, 1

This word indicates the maximum reliable frequency or acceleration value on an input starting at which the "Maximum Frequency or Acceleration Alarm" is set.

Value range:	1 ... 32767 or 1.0 ... 3276.9 or -32768 ... +32767	(depending on the measurement range and the state of FAA)
Data format:	FAA = 0 and F RA = 0: FAA = 0 and F RA = 1: FAA = 1:	Bits 0 ... 15, frequency in Hz (0 ... 32767) Bits 0 ... 15, frequenz in Hz (0 ... 3267.7) Bits 0 ... 15, acceleration (0 ... +32767)

Default: 0_b

FSD = Frequency Scaling Divisor, channels 0, 1

These 8 bits specify the division factor by which a frequency measurement value is scaled. The total scaling is determined by FSD and FSM. An output can only be triggered with the actual measured frequency value, not with a scaled measured frequency value.

Value range: $0_d \dots 255_d$
Default: 0_b (division factor = 1, no scaling)

FSM = Frequency Scaling Multiplier, channels 0, 1

These 8 bits specify the multiplier by which a frequency measurement value is scaled. The total scaling is determined by FSD and FSM. An output can only be triggered with the actual measured frequency value, not with a scaled measured frequency value.

Value range: $0_d \dots 255_d$
Default: 0_b (multiplier = 1, no scaling)

FG = Gate Input Fault Mode, channels 0, 1

This bit can be used to activate/deactivate NAMUR lead break detection ($I < 0.35 \text{ mA}$) for gate input.

$0_b =$ NAMUR lead break detection deactivated
 $1_b =$ NAMUR lead break detection activated

Default: 0_b

FF = Frequency Input Fault Mode, channels 0, 1

This bit can be used to activate/deactivate NAMUR lead break detection ($I < 0.35 \text{ mA}$) for the frequency input.

$0_b =$ NAMUR lead break detection deactivated
 $1_b =$ NAMUR lead break detection activated

Default: 0_b

inv = Invert Gate Input, channels 0, 1

GI

This bit can be used to invert the signal at the NAMUR gate input if a non-NAMUR sensor is to be operated at this input.

$0_b =$ normal NAMUR
 $1_b =$ signal inverted

Default: 0_b

inv = Invert Frequency Input, channels 0, 1

FI

This bit can be used to invert the signal at the NAMUR frequency input if a non-NAMUR sensor is to be operated at this input.

$0_b =$ normal NAMUR
 $1_b =$ signal inverted

Default: 0_b

MFS = Minimum Frequency Sampling Time, channels 0, 1

These 4 bits define the "Minimum Frequency Sampling Time" according to the following table.

Default: 0_b

MFS, Minimum Frequency Sampling time	
Value	Sampling time
0000b	2 ms
0001b	4 ms
0010b	5 ms
0011b	10 ms
0100b	20 ms
0101b	50 ms
0110b	100 ms
0111b	200 ms
1000b	500 ms
1001b	1000 ms
1010b	not defined
:	:
1111b	not defined

IS = Initiate Startup, channels 0, 1

This bit can be used to suppress the "Missing Pulse Alarm" for a time defined by the "Missing Pulse Delay Multiplier", for example when starting up a process.

0_b = normal operation

1_b = "Missing Pulse Alarm" suppression for 2 s + MFS x DM

Default: 0_b

ACT = Acceleration Calculation Time, channels 0, 1

These 2 bits are used to define the number of sampling cycles which are to be used for the calculation of the acceleration value.

00_b = progressive cross-section of the last 4 sampling cycles

01_b = 8 cycles

10_b = 16 cycles

11_b = 32 cycles

Default: 0_b

FAA = Frequency or Acceleration Alarm Select, channels 0, 1

This bit defines whether the value of the MFA word is that of an acceleration or frequency alarm value. If the value of this bit is 0_b, no calculation value will be calculated.

0_b = frequency alarm

1_b = acceleration alarm

Default: 0_b

DM = Missing Pulse Delay Multiplier, channels 0, 1

These 2 bits define the delay for suppressing the "Missing Pulse Alarm" when a process is being started up; see "IS". The number of alarms which are to be suppressed until the alarm bit is actually set are specified.

00_b = 0, alarm is activated immediately after standard 2 s delay

01_b = 2, alarm is suppressed for a time of 2 s + 2 x MFS

10_b = 8, alarm is suppressed for a time of 2 s + 8 x MFS

11_b = 32, alarm is suppressed for a time of 2 s + 32 x MFS

Default: 0_b

FDM = Fault Detection Mode, channels 0, 1

These 2 bits define the values of the frequency/gate inputs (safe states) when a "Missing Pulse Alarm", or lead break fault occurs or when alarms are deactivated.

00_b = deactivation of the alarms

01_b = alarm, input data words remain unchanged

10_b = alarm, input data words take on maximum values (32767 or 3276.9)

11_b = alarm, input data words take on minimum values (0 or 0.0)

Default: 0_b

This is independent of the mode of operation (frequency or acceleration measurement).

cmd = Command Flag

flag

This bit is intended for future command sequences, i.e. it is always "0" and does not need to be set for sending commands.

13 The IS-RPI/MODBUS gateway

13.1 General information on operating the RSD-GW-Ex1.MOD gateway

The following list shows the connections of the MODBUS gateway:

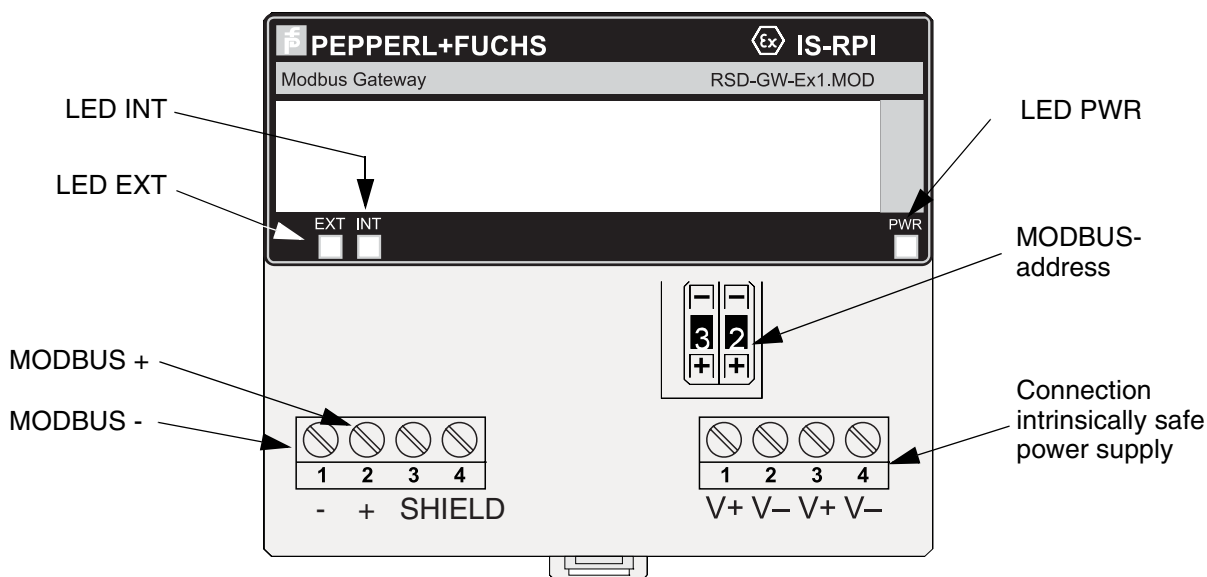

Figure 13.1 Front view of the RSD-GW-Ex1.MOD gateway



Note

For reasons of EMC safety, the shield of the MODBUS transmission line on the earthed potential compensation rail must be laid in the switch cabinet of the IS-RPI-System.

The meaning of the EXT and INT LEDs is as follows:

	LED EXT	LED INT
flashing red	no MODBUS communication or watchdog expired	Internal Serbus error, the gateway has no communication with the modules
flashing red three times	Firmware programming mode or firmware check sum error	Inconsistent configuration between gateway and modules
red	internal error in the gateway	-

In order to set up communication with the higher level control system, the address of the external bus interface must be set by means of the DIP switches.

The adjustable addresses fall within the range from 1 to 99. In state as supplied, the address is set to 0. This is not a permitted address for normal MODBUS operation.

A special physical arrangement in accordance with IEC 61158-2 is used for intrinsically safe data transfer between the MODBUS master and the IS-RPI gateway. It is generated by the necessary segment coupler. This physical interface is equipped for an EEx ia application - a maximum output length of 1000 m if applicable conditions of explosion protection are observed through intrinsic safety. If multiple devices will be connected on the intrinsically safe side of the segment coupler, there may be restrictions on the output length.

The maximum number of stations in an intrinsically safe MODBUS string depends on the proof of intrinsic safety. If more stations are operated than are permitted on a string, a new string must be opened by means of an additional segment coupler.

13.2 Operation on the MODBUS

The Modbus is a register-oriented bus system. That means that data is automatically stored in an area of memory referred to as registers of the MODBUS gateway. The user can systematically access specific data by reading these registers, or can set targeted outputs by writing to the registers. The registers are organised in four tables:

Table	Content
1	Binary outputs
2	Binary inputs
3	Analogue outputs, acyclic parameter channels
4	Analogue inputs, DEVICE_TYP and DEVICE_ID

MODBUS offers two transfer modes, the ASCII and RTU modes. The RSD-GW-Ex1.MOD supports the RTU mode only.

MODBUS also provides different adjustment options regarding to parity and stop bits. For the communication with the RSD-GW-Ex1.MOD the following adjustments are required:

- 8 data bits
- 1 stop bit
- even parity

Via the function code, the MODBUS master tells the slave which table is to be interrogated and whether values are to be read or written. The following table contains the function codes that are supported by the MODBUS gateway:

Code	Function	Description
01	Read Coil Status	Read binary outputs
02	Read input status	Read binary inputs
03	Read Holding Register	Read write/read registers, for example analogue outputs, acyclic parameter channels
04	Read Input Register	Read from read registers, for example analogue inputs, device type, device ID
05	Force Single Coil	Write binary outputs
06	Preset Single Register	Read write/read registers, for example analogue outputs, acyclic parameter channels
07	Read Exception Status	Read the gateway exception status
08	Read Diagnostic	Service functions for MODBUS
15	Force Multiple Coils	Block-wise writing of binary outputs
16	Preset Multiple Registers	Block-based writing of analogue outputs or acyclic parameter channels

These function codes are part of the Modbus message. Furthermore, the address of the first register and the total of the registers to be processed are given in the Modbus message. The following context between the transferred register address and the register that is to be processed, should be noted:

The register address transferred in the telegram always refers to zero. To be able to have access to the first addressable register (register number 1), register address 0 must be transferred.



Example: In order to be able to access the binary input 0 of the module 0, the function code 02 and the register address 24 must be transferred via the Modbus. The associated register has the number 25.



Attention

In the following description, the register addresses to be transferred are always specified. If you want to process your software register numbers, use the value "Specified register address + 1".

The IS-RPI modules are not addressed separately. The address is specified by the location on the internal bus. Note the following context here:

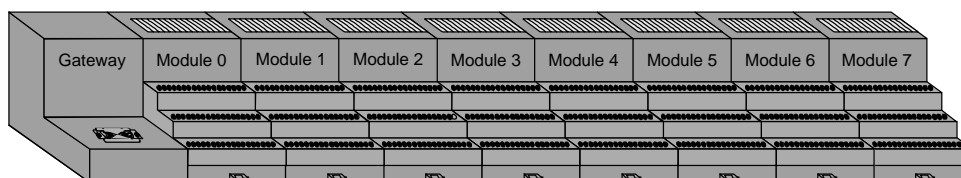

Figure 13.2 Structure of an IS-RPI string

The module number and hence the location, depend directly on the register address at which an input signal can be read, or an output signal can be read or written to.

In the following section, the calculation of register addresses is always based on the numbering system described in Figure 13.2.

The following section contains equations for calculating register addresses and a description of how data is displayed in the individual registers.

For detailed information on the MODBUS protocol, please refer to the "Modicon MODBUS Protocol, Reference Guide, PI-MBUS-300 Rev. D".

A register is 16 bits long. In this manual, the data is represented as follows:

Function	Register higher byte MSB								LSB	Register lower byte MSB								LSB
Bit	15	14	13	12	11	10	9	8	7	6	5	4	3	2	1	0		

Commissioning an IS-RPI string

The commissioning of an IS-RPI module string implies that the IS-RPI module string is specified and the individual modules are configured. Two working steps are required for this:

1. Project planning

The project planning of a gateway is the process of determining the type of module to which module locations 0 to 7 correspond. Thus a unique module identifier is established for each type of module, as given in the following table:

Module type	Identifier
RSD-BI-Ex16	0200 _{hex}
RSD-BO-Ex4	0101 _{hex}
RSD-CI-Ex8	1C00 _{hex}
RSD-CI2-Ex8	1C03 _{hex}
RSD-UO-Ex8	1200 _{hex}
RSD-TI-Ex8 and RSD-TI2-Ex8	1B02 _{hex}
RSD-FI-Ex2	1700 _{hex}

In order to specify individual modules, the Modbus function 06 "Preset Single Register" must be selected. To plan for multiple modules, we recommend you to use MODBUS function 16 "Preset Multiple Registers".

In the first case, the register address is calculated as follows:

$$\text{Register address} = \text{Module number} + 231$$

In the second case, the same equation can be used, if the lowest number to be specified is taken as the module number. Then the number of modules to be specified (max. 8) is entered in the MODBUS message, under the number of bytes.

In both cases, the identifiers represent the data to be transferred.

The modules are projected by writing register address 335 or register address 511 with value 55AA_{hex}.

2. Configuring the modules

A configuration register is available for each module. These configuration registers define whether the module will monitor the field circuit for lead break, short circuit, and overload, etc. and which measurement range will be used, etc.

The configuration data is represented in the holding registers, in the range 640 to 767. 16 registers are reserved for each module. Depending on the specified modules, the gateway releases only as many registers as the module has configuration data words.

If the unused addresses are accessed, no error message results.

The following table shows the numbers of configuration data words for all modules:

Module type	Configuration data words
RSD-BI-Ex16	1
RSD-BO-Ex4	1
RSD-CI-Ex8 and RSD-CI2-Ex8	3
RSD-CO-Ex8	4
RSD-TI-Ex8 and RSD-TI2-Ex8	4
RSD-FI-Ex2	8

This data is stored in the following register addresses, referenced to the module number

$$\text{Register address} = \text{module address} + 327$$

For the configuration options of the individual modules, please refer to section 12.4 of this manual.

The register address of a configuration word is calculated as follows:

$$\text{Register address} = 16 \times \text{module number} + \text{word number} + 640$$

The word and module numbering always starts at 0.

Configuration data is also displayed in the so-called "packed" data area. The structure of this data storage area is given in the following pages. This data storage area is variable. Thus no fixed register address is given, to which the data can be read or written. The current register address, from which the configuration data of an IS-RPI module can be derived, and which depends on the configuration of the IS-RPI module string, is stored under

Register address = module number + 279

in the holding registers. These are readable via the Modbus function code 03 and can be written to by means of function codes 6 "Preset Single Register" and 16 "Preset Multiple Registers".

So that the correct addresses of the configuration register are entered, it is necessary to specify the modules beforehand.

The current configuration is saved permanently in the gateway if value $55AA_{\text{hex}}$ is written to register address 492 or register address 768.

13.3 Writing/reading data

The RSD-GW-Ex1.MOD gateway provides the channel-related data in packed form. The channel-related method of representation should preferably be used when one targeted channel is to be read or written to.

Reading/Writing Channel-Related Binary Inputs or Outputs

The channel-related data from binary inputs or outputs, is represented as follows:



The MODBUS function codes and the addresses are given in the following table:

Action	Code	Register address
Read binary input	02	16 x module number + channel number + 24
Read binary input	02	16 x module number + channel number + 1036
Read binary output	01	8 x module number + channel number + 24
Read binary output	01	8 x module number + channel number + 1036
Read binary output	05	8 x module number + channel number + 24
Read binary output	05	8 x module number + channel number + 1036

The channel numbering always starts at 0.

If you will be reading more than one binary channel, this can be done with the function codes noted above. The address of the first channel to be read must be calculated. The number of registers to be read, which must be transferred to the Modbus message, then corresponds with the number of channels to be read. This type of data transfer is very inefficient, since one register (16 bit) must be transferred per channel.

If you will be writing to more than one binary output, you can use function code 15 "Force Multiple Coils". The remaining steps follow by analogy.

A more efficient option is offered by reading data storage areas in which the packed information is available. This type of data exchange will be described later in this manual. A further advantage of this type of data transfer is that the status information is contained in the data storage area.

Reading/Writing Analogue Inputs and Outputs, Channel-Related

The MODBUS gateway makes the data available in the 16 bit signed integer format. Here, in order to read or write the analogue value, only one register must be read or written to.

The MODBUS function codes to be used and the register addresses can be obtained from the following table:

Action	Code	Register address
Read analogue input	04	8 x module number + channel number + 4611
Read analogue input	04	8 x module number + channel number + 5126
Read analogue input	03	8 x module number + channel number + 1251
Read analogue input	03	8 x module number + channel number + 1626
Read analogue output	03	8 x module number + channel number + 1
Read analogue output	03	8 x module number + channel number + 376
Write analogue output	06	8 x module number + channel number + 1
Write analogue output	06	8 x module number + channel number + 376

The channel numbering always starts at 0.

If only analogue inputs or only analogue outputs are to be read, this can be very simply achieved, if the number of channels to be read in the MODBUS message is transferred as the number of registers to be read. The prerequisite for this is that the modules are consecutively addressed, i. e., they are installed one after the other on the IS-RPI string. Then only the register address of the first channel to be read has to be calculated. The status information can then be obtained from the separate registers.

If you will be writing to more than one channel, use MODBUS function code 16 "Preset Multiple Registers". All other details apply by analogy with the previous procedure.

Reading and Writing Input and Output Data in Packed Format with Status Transfer

The data from all input and output modules, including the status information, is available in the IS-RPI holding registers, in packed format. It can be read with MODBUS function code 03 "Read Holding Register" and can be written with function codes 06 "Preset Single Register" or 16 "Preset Multiple Registers".

The data structure is as follows:

Input data analogue	Input data binary	Status information Modules 0 ... 7	Output data analogue	Output data binary	Configuration data Modules 0 ... 7
---------------------	-------------------	------------------------------------	----------------------	--------------------	------------------------------------

The data storage area starts at register address 74 in the holding register.

Configuration data is data that was accessed in the "Commissioning" section. The current configuration of the IS-RPI modules can be read and changed in this data area.

The structure should become clear from the following example:

The order is independent of the module number. Each data field for analogue data always starts with the value of channel 0 of the module with the lowest module number. Each data field for binary data always begins with the module that has the lowest module number. Data fields for data types that are not available, drop out, without replacement.

Example: An IS-RPI string is configured as follows:

Module 0	8 channel analogue output module RSD-UO-Ex8
Module 1	4 channel binary output module RSD-BO-Ex4
Module 2	8 channel analogue input module RSD-CI-Ex8
Module 3	8 channel temperature transformer isolator RSD-TI-Ex8
Module 4	2 channel frequency input module RSD-FI-Ex2
Module 5	16 channel binary input module RSD-BI-Ex16
Module 6	16 channel binary input module RSD-BI-Ex16
Module 7	16 channel binary input module RSD-BI-Ex16

The structure of the data field in this example would appear as follows:

Register address	Contents	Corresponding word
74	Channel 0, Module 2	Word 1 of the data table for CI
:		
81	Channel 7, Module 2	Word 8 of the data table for CI
82	Channel 0, Module 3	Word 1 of the data table for CI
:		
8 9	Channel 7, Module 3	Word 8 of the data table for TI
90	Channel 0, Module 4 (Frequency)	Word 1 of the data table for FI
91	Channel 0, Module 4 (e. g. acceleration)	Word 2 of the data table for FI
92	Channel 1, Module 4 (Frequency)	Word 3 of the data table for FI
93	Channel 1, Module 4 (e. g. acceleration)	Word 4 of the data table for FI
94	Channels 0 ... 15, Module 5	Word 1 of the data table for BI
95	Channels 0 ... 15, Module 6	Word 1 of the data table for BI
96	Channels 0 ... 15, Module 6	Word 1 of the data table for BI
97	Status word 1, Module 0	Word 1 of the data table for UO
98	Status word 2, Module 0	Word 2 of the data table for UO
99	Status word 3, Module 0	Word 3 of the data table for UO
100	Status word, Module 1	Word 1 of the data table for BO
101	Status word 1, Module 2	Word 9 of the data table for CI
:		
104	Status word 4, Module 2	Word 12 of the data table for CI
105	Status word 1, Module 3	Word 9 of the data table for TI
:		
107	Status word 3, Module 3	Word 11 of the data table for TI
108	Status word 1, Module 4	Word 2 of the data table for BI
:		
110	Status word 3, Module 4	Word 7 of the data table for FI
111	Status word, Module 5	Word 2 of the data table for BI
112	Status word, Module 6	Word 2 of the data table for BI
113	Status word, Module 7	Word 2 of the data table for BI
114	Channel 0, Module 0	Word 5 of the data table for UO
:		
121	Channel 7, Module 0	Word 12 of the data table for UO
122	Channels 0 ... 3, Module 1	Word 2 of the data table for BO
1 2 3	Configuration Word 1, Module 0	Word 13 of the data table for UO
:		
125	Configuration Word 3, Module 0	Word 15 of the data table for UO
126	Configuration word, Module 1	Word 4 of the data table for BO
127	Configuration Word 1, Module 2	Word 13 of the data table for CI
:		
129	Configuration Word 3, Module 2	Word 15 of the data table for CI
130	Configuration Word 1, Module 3	Word 12 of the data table for TI
:		
133	Configuration Word 4, Module 3	Word 15 of the data table for TI
134	Configuration Word 1, Module 4	Word 8 of the data table for FI
:		
141	Configuration word 8, Module 4	Word 15 of the data table for FI
142	Configuration word, Module 5	Word 3 of the data table for BI
143	Configuration Word, Module 6	Word 3 of the data table for BI
144	Configuration Word, Module 7	Word 3 of the data table for BI

Since the data displayed in the MODBUS gateway is a mirror image of the data stored in the I/O module, the corresponding data word. of the I/O module appears in the 3rd column. The meanings of the individual bits are explained in detail in section 12.4.

The length of the data fields is variable and is uniquely aligned according to the current configuration of the IS-RPI string. Thus, a 16 channel input module occupies 1 register and likewise, each channel of an analogue input or output occupies 1 register.

All data storage areas of a module begin at word boundaries. This means that even a 4 channel binary output module occupies 1 register. Data bits that are not used are set to logic "0".

The basic address, i. e. the register in which the first data value of a module is contained, can be read out via the holding register (MODBUS function code 03). These basic addresses are automatically stored under the following register addresses, after the configuration of the IS-RPI string:

Contents	Register address
Basic address analogue input module	Module number + 239
Basic address binary input module	Module number + 247
Basic address status information	Module number + 255
Basic address analogue output data	Module number + 263
Basic address binary output data	Module number + 271

MODBUS function code 16 "Force Multiple Coils" can be used to write analogue or binary output data to the packed data area. If an attempt is made to write input data to this action register, this write access is ignored. No error message follows.

If only input data is to be read, it is possible likewise to read this in packed form, from the input registers. The data structure is analogous to the packed data in the holding register. The analogue output data and the configuration data are not represented. The packed data area begins at register address 9. The base addresses of binary input data are under

Register address = module number + 164

The base addresses of the analogue input data are to be found under

Register address = module number + 156

Diagnostics/Status Information

The IS-RPI-System provides three different types of status information, which can also be used for diagnostic purposes:

1. Das **System status word** returns information about the status of the IS-RPI-System.
2. The **module status word** returns information about the device type, length of the data table, number of words that can be read and errors in the IS-RPI-internal bus.
3. The **channel status word(s)** return(s) information about limit values being exceeded, broken line, short circuit, etc. Thus they return channel-related options for diagnostics.

The **system status word** is stored in register 73 of the holding register (MODBUS function code 03) and register 8 of the input register (MODBUS function code 04). These bits have the following meaning:

Bit	Meaning
0	EEPROM_ERR, error during nonvolatile storage
1	APPL_ERR, internal device error
2	WATCHDOG; The watchdog timer has expired (the bit will be deleted by reading).
3	Reserved
4	Reserved
5	LOCAL_ACCESS; The interface for the handheld terminal is in operation. (currently not implemented)
6	Reserved
7	Reserved
8	IS-RPI configuration error, one or more modules too many
9	IS-RPI configuration error, one or more modules too few
10	IS-RPI configuration error, one or more modules with the wrong ID
11	Reserved
12	Reserved
13	Reserved
14	Reserved
15	Reserved

A register is reserved for each bit of the system status word in register table 2 "Input Register", which can be read out via the MODBUS function code 02. The addresses are calculated as follows:

$$\text{Register address} = \text{Bit No.} + 8$$

The Module status word is identical for each module and corresponds to the word 0 in the data table of each IS-RPI module. The module status words can be read via function code 03 "Read Holding Register" at the address

$$\text{Register address} = \text{Module number} + 65$$

or with function code 04 "Read Input Register" under the address

$$\text{Register address} = \text{Module number}$$

For diagnosis, the module status word provides information on the status of the IS-RPI internal bus system. For the meaning of the individual bits, please refer to section 12.3 of this manual.

For information on the limit value, broken line, short circuit, etc., please refer to the **Channel status word**. This information is a part of the packed data area. The structure of this data area has been explained in the previous sections.

The information offered in the status area depends on the module type. For the meaning of the individual bits, please refer to section 12.4 of this manual.

Contiguous Data Area

In many applications, it is required that system information can be read out quickly and compactly and be amenable to modification. Because of this, starting at

Register address 494

the following information has been summarised in successive registers in the Write/Read register:

- System status word
- Module status words
- Programmed module identifiers
- Data word for saving the configuration in non-volatile memory
- Data tables of the modules

The following table shows you the structure of this data area

	Register address
System status word	494
Module status word	495 ... 502
Programmed module identifiers	503 ... 510
Non-volatile memory	511
Data tables	512 ... 639

The channel status words are contained in the data tables. These provide channel-related information on, for example, broken line, limit value being exceeded, etc.

MODBUS Monitoring Function

Register address = 336 or 493 can be used to configure a watchdog time in [ms]. The watchdog monitors if a MODBUS communication happens during the watchdog time.

If not, the MSB of this register is set to "1". To reset this state, the configured watchdog time must be written into one of these registers again or must be reset to "0". The default value of this register is "0", that means watchdog is deactivated.

Via the register address 204 the actual firmware version could be read (MODBUS function 4 "Read Input Register"). The two bytes of the register are interpreted as ASCII code in HEX representation.

Example:

Register content = 3144_h
Firmware version 1 (= 31_h), D (= 44_h)

14 IS-RPI-/PROFIBUS gateways

14.1 General information

This section describes commissioning and communication for the following products:

- RSD-GW-Ex1.PA and RSD-GW2-Ex1.PA, IS-RPI gateways to PROFIBUS PA.
- RSD-GW2-Ex1.PA.ED, the IS-RPI gateway to PROFIBUS PA with extended diagnostics.
- RSD-GW-Ex2.DPE, RSD-GW2-Ex2.DPE and RSD-GW3-Ex2.DPE, the IS-RPI gateways to PROFIBUS DP V1
- RSD-GW3-Ex2.DPE.ED, the IS-RPI gateway to PROFIBUS DP V1 with extended diagnostics

From the point of view of communication, the gateways behave identically. That means that all gateways support the same PROFIBUS services (Service Access Points; SAPs) and that they look identical from the point of view of the PROFIBUS. They differ from each other only in terms of their transmission physics and PROFIBUS diagnostics. The following table illustrates the differences

	RSD-GW-Ex2.DPE RSD-GW2-Ex2.DPE RSD-GW3-Ex2.DPE and RSD-GW3-Ex2.DPE.ED	RSD-GW-Ex1.PA RSD-GW2-Ex1.PA and RSD-GW2-Ex1.PA.ED
Redundant transfer line	yes	no
Transfer rate	9.6 kBd ... 1.5 MBd	31.25 kBd
Physical nature of transfer	intrinsically safe RS485	IEC 61158-2
Max. length of bus line in the Ex-zone	200 m at 1.5 MBd	1000 m
Max. number of stations in intrinsically safe bus segment (EEx ia IIC)	15	6

All gateways support acyclic communication of PROFIBUS DP V1. This acyclic communication makes it possible to assign parameters to IS-RPI modules connected to gateways via the PROFIBUS. If the PROFIBUS master in use does not support acyclic communication, IS-RPI modules can be configured and parameterised online (via the data field) or via the user parameters of the PROFIBUS.

For the IS-RPI gateway to be configured, the GSD file must be integrated into the configuration tool in use. If this is not the case, you can find gsd files available for download on the Pepperl+Fuchs Internet site at www.pepperl-fuchs.com.

The product insert, which is included with delivery, describes the most important information for mounting.

Be certain to follow the installation instructions enclosed with the product.



PROFIBUS PA Gateways RSD-GW(2)-Ex1.PA(.ED) are connected to an intrinsically safe PROFIBUS PA segment. This segment is formed by a segment coupler (for example KFD2-BR-Ex1.3PA93 or KLD2-GT(R)-DP.xPA combined with Power Link KLD2-PL-Ex1.PA of Pepperl+Fuchs - not included with delivery).



Attention

If IS-RPI gateways come in contact with non-intrinsically safe signals, they must not be used any more after that in Ex applications.

If you are using the RSD-GW-Ex2.DPE, RSD-GW2-Ex2.DPE, RSD-GW3-Ex2.DPE or RSD-GW3-Ex2.DPE.ED, an intrinsically safe RS485 isolator must also be used (for example KFD2-FB-Ex1.DP).

14.2 Commissioning

Before commissioning can be performed ensure that if for use of

- RSD-GW-Ex2.DPE, RSD-GW2-Ex2.DPE, RSD-GW3-Ex2.DPE or RSD-GW3-Ex2.DPE.ED an intrinsically safe PROFIBUS DP V1 is available
- RSD-GW-Ex1.PA, RSD-GW2-Ex1.PA or RSD-GW2-Ex1.PA.ED an intrinsically safe PROFIBUS PA is available.

In addition, both the gateway and the modules that are being used must be supplied with an intrinsically safe power supply with sufficient voltage (preferably power packs RS.-PSD... of Pepperl+Fuchs).

14.2.1 The basic principle of the process

Commissioning includes a number of steps that should be gone through in the following order:

- Mounting
- Creating the electrical connections
- Address setting
- Configuration cyclic data exchange with the configuration tool of the PROFIBUS master in use
- Configuration acyclic data exchange (optional)



Note

Acyclic data exchange is not absolutely necessary, since parameters can also be assigned to the modules with the configuration tool using GSD files or online with the PROFIBUS data field.

The PROFIBUS transmission rate does not absolutely have to be set, since the PROFIBUS PA runs at a fixed rate of 31.25 kBd or PROFIBUS DP V1 gateways have automatic baud rate detection.



Note

PROFIBUS DP V1 gateways support the following PROFIBUS DP transmission rates: 9.6 kBaud; 19.2 kBaud; 45.45 kBaud; 93.75 kBaud; 187.5 kBaud; 500 kBaud and 1.5 MBaud.

14.2.2 Mounting and installation

For an extensive introduction to mounting, please refer to section 6 of this manual. This section also contains information regarding storage, transport and shipping.

Special attention must be paid to section 6.4.2. Adherence to EMC protective regulations is only ensured if items 1 through 5 and 7 are observed. In addition, the following directives must be observed:

- For use of PROFIBUS PA gateway RSD-GW-Ex1.PA, commissioning guidelines for PROFIBUS PA. (© PROFIBUS User Organisation, Order No. 2.091)
- For use of PROFIBUS DP V1 gateways RSD-GW(2)-Ex2.DPE, the PROFIBUS DP/FMS set-up guideline. (© PROFIBUS User Organisation, Order No. 2.111)

14.2.2.1 Information on PROFIBUS PA gateways RDS-GW(2)-EX1.PA(.ED)

If one or more PROFIBUS PA gateways RDS-GW(2)-EX1.PA(.ED) are operated on an intrinsically safe PROFIBUS PA string, the following points must be considered.

An intrinsically safe segment coupler (for example KFD2-BR-Ex1.3PA93 or Power Link KLD2-PL-Ex1.PA) limits a number of variables including the maximum current on the PROFIBUS PA line. For this segment coupler described above, these are ignition protection type [EEx ia] IIC 100 mA.

All of this current can be used to supply power to PROFIBUS PA stations. This does entail the following risk, however:

If an error occurs on a PROFIBUS PA station that results in increased power drawing from the bus line, the result may be that the segment coupler reaches the limit. Then there will no longer be an adequate supply current available for the intact PA stations. They will then no longer work without problems in some cases.

To prevent this, many PROFIBUS PA field devices support the so-called FDE current (Fault Disconnect Equipment). This is an electronic circuit that ensures that the current consumption will not rise beyond a maximum of 9 mA in the event of an error.

If the FDE current is taken into consideration, the overall power drawn from the PROFIBUS PA segment is composed of the following elements:

$$I_{\text{from_segment coupler}} \geq I_{\text{FDE}} + \sum I_{\text{PA-stations}}$$

This means that the total of all currents that the PA stations draw from the PA line plus the highest FDE current available on the PROFIBUS PA segment must be less than the maximum output current of the segment coupler that is being used

The current consumption of the RDS-GW(2)-EX1.PA(.ED) is 13.2 mA.

In addition, please note that the input voltage for a PROFIBUS PA segment (the voltage between PROFIBUS PA + and PROFIBUS PA -) must be at least 9 V. If this value is not reached, the voltage drop over the PROFIBUS PA line will be too high. A solution to this problem is to use a cable with a larger cross-section or to use a power repeater (KLD2-PR-Ex1.IEC1).



Attention

Make absolutely certain that the cable you are using complies with the cable characteristics of the FISCO model (PTB report W-53).

RDS-GW(2)-EX1.PA(.ED) gateways are certified according to the FISCO model. If **all** components of the intrinsically safe PROFIBUS PA segment are approved according to the FISCO model, all that needs to be done to demonstrate intrinsic safety is prove that the values U_i , I_i and P_i of each field device are greater than or equal to the values U_0 , I_0 and P_0 of the segment coupler in use.

The following list shows the connections of the PROFIBUS PA Gateway:

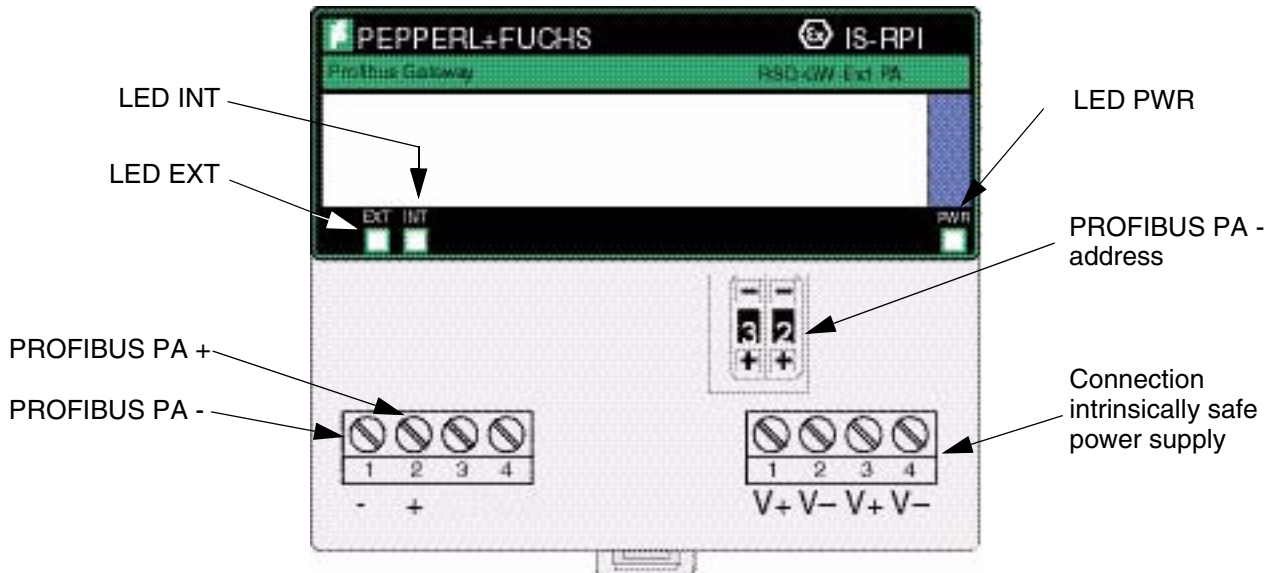

Figure 14.1 Front view of RSD-GW-Ex1.PA



Note

For reasons of EMC safety, the shield of the PROFIBUS PA transmission line on the earthed potential compensation rail must be laid in the switch cabinet of the IS-RPI-System.

The meaning of the EXT and INT LEDs is as follows:

	LED EXT	LED INT
flashing red	no PROFIBUS-communication or watchdog expired	Internal Serbus error, the gateway has no communication with the modules
flashing red three times	Firmware programming mode or firmware check sum error	Inconsistent configuration between gateway and modules
red	internal error in the gateway	-

14.2.2.2 Information on PROFIBUS DP V1 gateways RSD-GW(x)-Ex2.DPE(.ED)

If one or more PROFIBUS DP V1 gateways are operated on an intrinsically safe RS485 interface, the following points must be observed:

A certified barrier (for example the KFD2-FB-Ex1.DP of Pepperl+Fuchs) must be used to isolate the intrinsically safe RS485 segment from the non-intrinsically safe RS485 segment.

A proof of intrinsic safety must be provided for the intrinsically safe RS485 segment.

To prove intrinsic safety on an intrinsically safe RS485 segment, it must be demonstrated that all values U_0 , I_0 , and P_0 of the intrinsically safe interface are less than or equal to the values U_i , I_i , and P_i of each connected field device.

Since every station can send data with the RS485 interface and a source must be represented at the time of the data transfer, it must also be demonstrated for each field device that the values U_0 , I_0 , and P_0 of the field device are less than or equal to the values U_i , I_i , and P_i of all other field devices and the isolator module.

It must also be proved that the transfer line meets the requirements of intrinsic safety. This proof consists of demonstrating that the cable in use has distributed inductance and distributed capacitance. Under certain system requirements, this can be demonstrated with the L/R ratio. The specific points of these system requirements are:

- The system under consideration must have distributed inductance and capacitance. This is always the case for cables.
- Each connected field device must have a resistive current limit. This is so for the IS-RPI gateway RSD-GW(x)-Ex2.DPE(.ED). This also applies to the intrinsically safe isolator of Pepperl+Fuchs. If this is the case, no value is specified for I_i and P_i on the certificate.
- The following must apply for each field device: $C_i/C_0 < 0.01$. This also applies to both the gateway and the isolating module, since according to the certificate of conformity the value C_i must be negligibly small for both devices.

In accordance with EN 50020, if the conditions cited above are met, the maximum permissible ratio L_0/R_0 is determined as follows:

1. If the input inductance L_i is negligibly small for all stations

$$\frac{L_0}{R_0} \text{ (max)} = \frac{32 * e * R_i}{9 * U_0^2}$$

2. If L_i is not negligibly low for at least one station

$$\frac{L_0}{R_0} \text{ (max)} = \frac{8 * e * R_i + \sqrt{64 * e^2 * R_i^2 - 72 * U_0^2 * e * L_i}}{4.5 * U_0^2}$$

where

e = minimum ignition energy in accordance with EN 50020
(e.g. 40 μ J for EEx ia IIC)

U_0 = the highest no-load voltage U_0 available on the RS485 segment

The value R_i can be determined as follows:

$$R_i = \frac{U_{0min}}{I_{0max}} = \frac{U_{0min}}{\sum_{n=1}^x I_{n0}}$$

This means that all short circuit currents I_0 of the field devices and isolator modules will be added. Then the minimum open circuit voltage U_0 is divided by this value that is determined. The result is used as R_i in Equation 1 or 2.

The result of Equation 1 or 2 is the maximum permissible L/R ratio of the cable. You can determine the actual L/R ratio if it is not indicated from the inductance and resistance ratings of the cable.

To ensure intrinsic safety, the actual L/R ratio must be less than or equal to the maximum L/R ratio.

Once this has been ensured, the interconnection is intrinsically safe.

Example:

The intrinsically safe RS485 isolator KFD2.FB-Ex1.DP is operated with 15 IS-RPI/PROFIBUS DP V1 gateways.

In accordance with the type-examination certificate, the isolator has a U_o of 3.72 V. RSD-GW(2)-Ex2.DPEs have a U_i of 3.75 V. This is acceptable from the point of view of Ex safety.

When a resistive current limit has been integrated into all devices the result is that currents and outputs cannot reach any values that violate intrinsic safety.

Since, as was already mentioned, all conditions required to verify intrinsic safety in terms of the L/R ratio have been proved, this way is selected:

The same requirement applies to both the isolator and the IS-RPI gateways, that C_i and L_i must be negligibly small. Thus, Equation 1 (page 119) can be used to determine the maximum L_o/R_o ratio.

The total of all currents is calculated from the I_o values of the isolator and of all gateways.

In this example that would be:

$$I_{o\max} = I_{o\text{isolator}} + 15 \times I_{o\text{gateway}}$$

$$I_{o\max} = 228 \text{ mA} + 15 \times 39.5 \text{ mA} = 820.5 \text{ mA}$$

This results in the R_i to be used in Equation 1 of

$$R_i = \frac{U_{o\min}}{I_{o\max}}, \text{ with } U_{o\min} = 3.72 \text{ V}$$

$$R_i = 4.534 \text{ } \Omega$$

If this value is used for an EEx ia IIC application ($e = 40 \text{ } \mu\text{J}$) in equation 1, the result is the maximum permissible ratio of L_o/R_o , which is $46.59 \text{ } \mu\text{H}/\Omega$

If a cable is used with the identifying values:

$L' = 0.7 \text{ mH/km}$ and $R' = 100 \text{ } \Omega/\text{km}$, the result is the actual L/R ratio:

$$L/R = 7 \text{ } \mu\text{H}/\Omega$$

This value is less than the maximum permissible value. As a result, combining an RS485 isolator in the same circuit with 15 IS-RPI-/PROFIBUS DP V1 Gateways is intrinsically safe.

Assignment of the connections

The following list shows the connections and LEDs of PROFIBUS DP V1 Gateways:

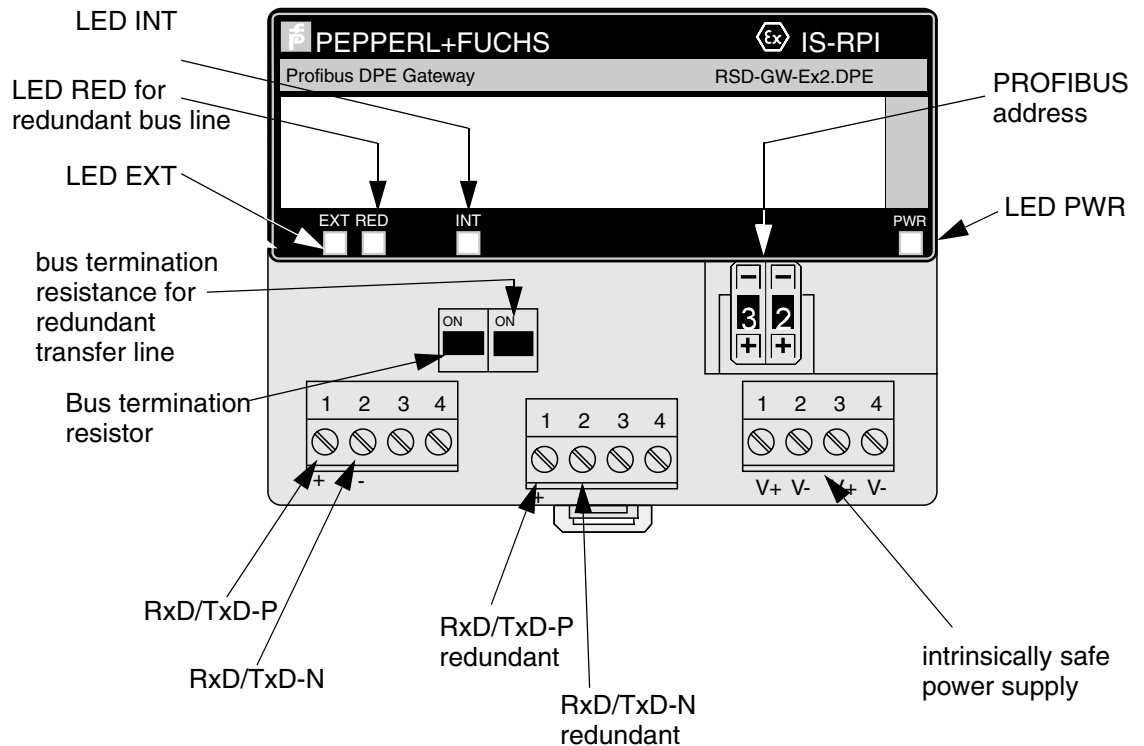

Figure 14.2 Front view of RSD-GW(x)-Ex2.DPE(.ED)



Note

The shield for the PROFIBUS DP V1-transmission line must be applied to the earthed potential compensation rail in the IS-RPI-System switch cabinet.

For the meaning of the LEDs EXT and INT, please refer to the table on page 118. The PROFIBUS DPV1 gateway is designed for media-redundant operation. The connections "RxD/TxD-P redundant" and "RxD/TxD-N redundant" are for the redundant transfer line. There are separate terminating bus resistors for each transmission line if the gateway of the last station is on the intrinsically safe PROFIBUS DP string.



Note

If the redundant transmission line is not being used, the red LED "LED RED" flashes until it has been turned off. In addition, a diagnostic alarm is triggered in this case.

Turn off LED RED:

There are several ways to turn off the LED:

1. With the user parameters. To do this, set the lowest order bit (LSB) of PROFIBUS DP user parameter bytes 11 (Byte 4 of the manufacturer-specific user parameters) to "1".
2. If **PACTware™** Edition 2 or higher is used for the configuration and/or assigning parameters, software can be used to do this (page 136).
3. With acyclic PROFIBUS DP V1 communication. To do this, the value in Slot 0, Index 23 must be $5A_{hex}$.



Note

If the RED LED was turned off by acyclic PROFIBUS DP V1 communication, it is no longer possible to use user parameters to change the behaviour of these LEDs.

The structure of a media-redundant PROFIBUS DP application is as follows:

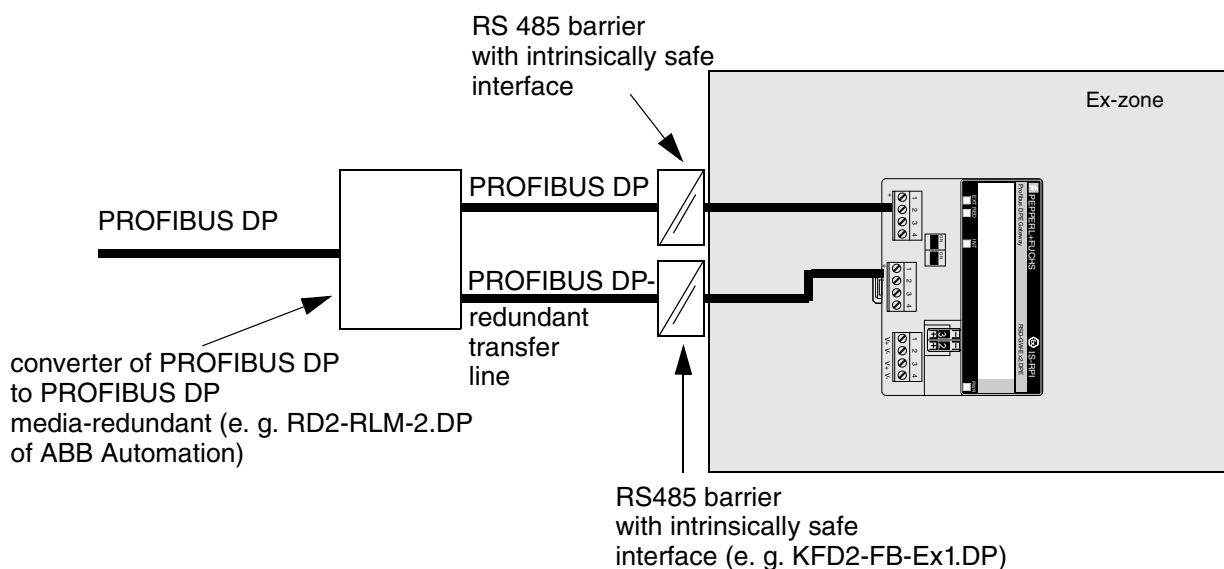

Figure 14.3 PROFIBUS DP structure, media-redundant

14.2.3 Configuration of cyclic communication



Note

All the functions described in this section use exclusively cyclic PROFIBUS communication. This means they can also be used for PROFIBUS DP masters that do not support extended functionality of PROFIBUS (PROFIBUS DP V1).

For a gateway to be configured, the connections to the bus line and the power supply must be present.

It is also essential for the gateway to have one unique PROFIBUS address. Set the desired address with the "+" or "-" buttons. The highest address that can be set is 99.



Note

If the address is not set when the power supply is turned on, the gateway must be briefly disconnected from the power supply after the setting is made.

No transmission rate needs to be set on the gateway, since the PROFIBUS PA is working at a fixed speed and the PROFIBUS DP V1 has automatic baud rate detection.

To configure the RSD-GW(2)-Ex1.PA.ED or RSD-GW(x)-Ex2.DPE.ED, the appropriate GSD file must be integrated into the configuration software of the PROFIBUS master in use.



Note

If the RSD-GW(2)-Ex1.PA(.ED) or RSD-GW(x)-Ex2.DPE (.ED) gateway is being configured and parameters are being assigned to it for the first time, the GSD file must be integrated into the configuration tool of the PROFIBUS master. Please refer to the manual of your configuration tool for the necessary information. The GSD file is enclosed with the product, or it can be downloaded from the Pepperl+Fuchs homepage at www.pepperl-fuchs.com.

The IS-RPI-System is slot-oriented. There is no addressing of modules.



Figure 14.4 Structure of an IS-RPI String

For additional information on mounting and installing the gateway and modules, please refer to section 6.2.

From the point of view of the PROFIBUS, a IS-RPI-/PROFIBUS PA or PROFIBUS DP V1 gateway represents a modular slave. Each PROFIBUS data module represents one slot. In addition, the IS-RPI gateway has a real-time clock that can be read and written to by PROFIBUS. An additional data module is available for this purpose so that a gateway can administer a maximum of 9 data modules.

The following order must be observed when data of the real-time clock is transferred:

1. IS-RPI modules
2. Real-time clock

The following example is intended to illustrate the order of the configuration:

Slots 1 and 3 to 6 are occupied on an IS-RPI gateway data must be transferred from the real-time clock.

PROFIBUS DP/PA	IS-RPI
Data module 1	Module 1
Data module 2	Without module
Data module 3	Module 3
Data module 4	Module 4
Data module 5	Module 5
Data module 6	Module 6
Data module 7	Without module
Data module 8	Without module
Data module 9	Real-time clock

In the example above, the plug-in station of module 2 is not assigned. In this case, the identification "without module" may be derived from the GSD file for the missing module.

Data modules 7 and 8 are also defined as empty modules. This simplifies future expansion. Nevertheless, there is no actual requirement for defining "empty modules" for plug-in stations at the end that are not used.

The structure and number of input and output bytes required is determined by so-called codes that are available in the GSD file.



Note

If slots between the IS-RPI modules are not assigned, they must be configured in the configuration tool with the "without module" code.

If the IS-RPI-System is not fully developed, the code is not required for slots on the end that are not used (after the last IS-RPI module that is present), regardless of whether or not the terminal bases are present.

The code for the real-time clock is inserted after the last existing IS-RPI module. The following identifiers are available:

1. Clock_read
2. Clock_write

If the "Clock_read" identifier is selected, data can be read from the real-time clock. This identifier requires 7 bytes in the input data field of the control unit. The structure of the data is as follows:

Byte	Bit	Content
1.2		0 ms ... 59999 ms
3		0 min ... 59 min
4		0h ... 23h
5	0 - 4	1st day ... 31st day of the month
	5 - 7	1st day ... 7th day of the week
6		1st month ... 12th month
7		0th year ... 99th year

If the "Clock_write" code is selected, 7 bytes will be reserved in the output data field **in addition**. They can be used to write the real-time clock.

If the GSD file is integrated into the configuration tool and gateway RSD-GW(2)-Ex1.PA(.ED) or RSD-GW(x)-Ex2.DPE(.ED) is opened in the GSD files catalogue, an alphanumeric description of available data modules is displayed.

The structure of the alphanumeric description is as follows:

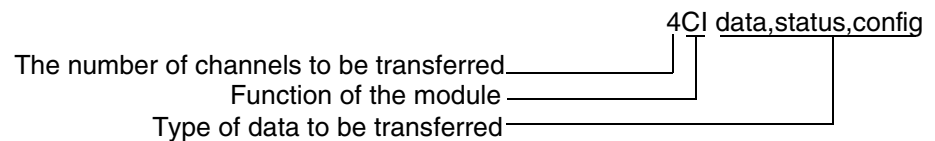

The first digit shows the number of channels to be transferred, in this example 4. The following 2 letters are identical to the second block of the type key of the IS-RPI module, here CI for RSD-CI-Ex8 (CI = Current Input). The position after the blank digit shows what data from the module will be transferred.



HART-capable modules RSD-CI-Ex8.H and RSD-UO-Ex8.H behave like current input modules (CI) or current output modules (UO) in terms of cyclic data exchange. HART communication is transmitted exclusively via acyclic communication of PROFIBUS DP V1.

In principle, 4 different identifiers are present for each IS-RPI module:

1. Identification for transmitting only effective data (only **data** after the blank).
2. Identification for transmitting effective data with status information (**data, status** after the blank).
3. Identification for transmitting effective data and assigning parameters for the modules when the master and slave are initialised (**data (user-param)** after the blank).
4. Identification for transmitting effective data with status information and to assign parameters of modules when the master and slave are initialised (**data, status (user-param)** after the blank).



Before starting the configuration and assigning parameters for the IS-RPI-System, determine which data you want to transfer via the PROFIBUS communication cyclic channel.

14.2.3.1 Transmission of only effective data

If only effective data will be transferred, parameters must be set in advance for the IS-RPI-System or parameters must be assigned online or with a PROFIBUS DP master class 2. Parameter assignment in this context means specifying whether to work with or without short circuit detection, for example, or which data format should be used for analogue current inputs, etc.

The configuration data, i. e. in this context, which module is present on which slot, is always transferred during the startup phase from the PROFIBUS master to the IS-RPI-/PROFIBUS gateway.



Note

If only effective data will be transferred and there is no PROFIBUS DP master class 2 available, the IS-RPI gateway will use the last parameter data to be saved. The default setting for parameter data is "0". For the effects of this setting for the individual modules, please refer to section 12.4.

The software package **PACT^{ware}™** is available as a configuration tool for configuring the IS-RPI with a PROFIBUS master class 2. The necessary PROFIBUS drivers and the module configuration for the IS-RPI modules can be integrated into this software package.

Effective data transferred from the IS-RPI is **word-oriented**.

The module status word of **each** IS-RPI module is always transferred. This means that output modules in the input range of the control module are also assigned to a data word. For the meaning of the module status word for the individual modules, please refer to section 12.4 of this manual.

The structure of binary input data is as shown below:

	Lower byte								Higher byte							
Dataword 1	Module status word															
Dataword 2	Channels															
	15	14	13	12	11	10	9	8	7	6	5	4	3	2	1	0

The structure of analogue input data is as follows:

Data word 1	Module status word
Data word 2	Channel 0
:	:
Data word n+2	Channel n

In the case of analogue input data (with the exception of the frequency input) it is possible to select whether 2, 4 or 8 channels will be transferred (for example 2CI..., 4CI.. or 8CI... from the GSD file). For example, if 4 analogue input channels are transferred, this module will have 5 words assigned in the input data field of the control module.

The RSD-FI-Ex2 module always has 5 input words. For the structure, please refer to section 12.4.8.

For output data, the current possibilities are the 4-channel binary output RSD-BO-Ex4 or the 8-channel analogue output RSD-UO-Ex8.

The 4-channel binary output module contains one input data word and one output data word. The order of the channels is identical to those for input data.

The 8-channel analogue output module can be configured channel by channel as binary channel or analogue channel.

To simplify representation, both the binary channels (1 output data word) and the analogue channels (8 output words) are always transferred. The structure of these output words is shown in the following diagram:

	Lower byte								Higher byte							
Dataword 1 (Binary channels)	X	X	X	X	X	X	X	X	7	6	5	4	3	2	1	0
Dataword 2 (Analog value)	Channel 0															
Dataword 3 (Analog value)	Channel 1															
⋮																
Dataword 9 (Analog value)	Channel 7															

The first word (data word 1) transfers the binary output data if parameters have been set correctly for the outputs. Analogue output data is transferred in output data words 2 to 9 if parameters have been set correctly for the outputs.

For example, if parameters have been set to make Channel 0 a binary channel, data that has been written to data word 2 will not be processed by the module.

If parameters have been set to make Channel 0 an analogue channel, bit 0 of the higher byte will not be processed by the module.

14.2.3.2 Transferring Effective Data and Status Information

The IS-RPI-System is able to return a large number of channel-related status information (for example lead break, short circuit, etc.). These can

1. be integrated into the diagnostic telegram of the PROFIBUS if the gateway in question is one with the Extension ...ED (extended diagnostics).
2. be included in the data telegram.

If the code "****data, **status**" is selected, channel-related status information will be transmitted in addition to effective data in cyclic PROFIBUS data exchange.



Note

It is possible that status information will only be transferred from individual modules.

This status information is the channel status word(s) of the IS-RPI modules. Depending on the type of module, from 1 to 4 channel status words can be supported. To find out which module supports how many channel status words and the meaning of the individual words, please consult section 12.4 of this manual.

No matter whether they are analogue or binary, channel status words are always transferred after the input data for input modules i. e. the order of data in the input field is

1. Module status word
2. Input status word(s)
3. Channel status word(s)

The same structure is found in all output modules, except that input data word(s) are missing.

14.2.3.3 Transferring only effective data, setting parameters with User_Parameter

Parameters can be set for the IS-RPI-System with PROFIBUS User_Parameter. This offers the following advantages:

- No PROFIBUS master class 2 is required
- Parameter data does not place any load on the cyclic channel of the PROFIBUS
- If the gateway fails, the parameter data must be automatically sent to the new gateway with a parameter assignment telegram. There is no need to assign parameters separately for the gateway (Plug and Play)



Note

*If parameter assignment with User_Parameter is selected, it must be performed for **all** modules connected to the IS-RPI gateway.*

Parameters can also be assigned via acyclic communication of PROFIBUS DP V1. Please note, however, that every time the PROFIBUS starts up or whenever the PROFIBUS master sends a SetPrm telegram to the IS-RPI gateway, the by parameter data modified by acyclic communication will be overwritten by user parameters and will thus be lost.

If you want parameters to be set for the IS-RPI modules with User_Parameter, select "...data (user_param)" as the code. The steps that follow now depend on the project planning tool that is used. Excerpts from SIMATIC Manager are shown below to illustrate the working principle.

If the "...data (user_param)" identifier is selected, proceed as follows:

- Select the identifier of the modules from the hardware catalogue of your project planning tool.
- Specify the projected identifier
- Select the Parameterisation item. The adjustment options are shown there in text format.
- Select the value to be modified. An additional display then appears with the adjustment options for this value.

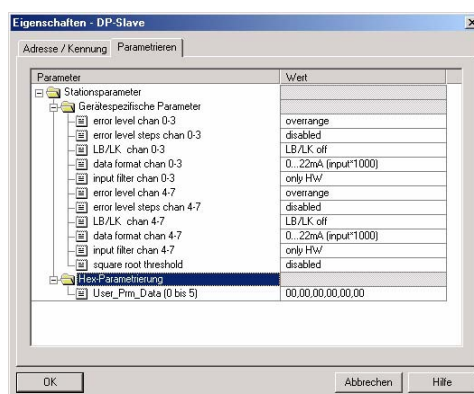

Note

If the extended functionality of GSD files is supported by the projecting tool in use (as in the illustration above) mutually contradictory settings are prevented from being made.

If this functionality is not supported, be sure not to make any mutually contradictory settings (for example current range 0 mA ... 20 mA with lead interruption monitoring)

Project all IS-RPI modules using the code "... data (user_param)" or "...data, status (user_param)", make all the settings and save your project in your projecting tool.

The following table gives an overview of the number of user parameters in use:

Product designation	Number of User_Parameter bytes
RSD-BI-Ex16	2
RSD-BO-Ex4	4
RSD-CI-Ex8	6
RSD-CI2-Ex8	6
RSD-CI-Ex8.H	4
RSD-UO-Ex8	8
RSD-UO-Ex8.H	6
RSD-TI-Ex8	8
RSD-TI2-Ex8	8
RSD-FI-Ex2	16

For information on the data structure concerning user data, please refer to page 126



Note

Note the limitation that PROFIBUS supports only a certain number User_Parameter bytes.

Max. User_Parameter bytes for:

- RSD-GW-Ex1.PA und RSD-GW-Ex2.DPE: 49
- other devices: 76

14.2.3.4 Transmission of effective data with status information; parameter assignment with User_Parameter

This identifier is distinguished from the previous item only in that channel status words are also transferred as well. Parameters are set for the modules using the User_Parameters of the PROFIBUS. For information concerning the data structure of input and output data, please refer to page 127.

14.2.4 Assigning parameters with acyclic PROFIBUS DP V1 communication

The previous section described how to integrate the IS-RPI-System into cyclic communication and how to configure the system and set parameters for it with cyclic communication.

This section explains how to implement parameter assignment with acyclic PROFIBUS DP V1 communication.



Note

This method requires that at least the PROFIBUS master class 2 used for parameter assignment support acyclic communication in accordance with the "PROFIBUS DP Extensions to EN 50170 Version 2.0" of April 1998 or higher.

Theoretically, configuration using acyclic PROFIBUS DP V1 communication can be implemented with 2 different classes of PROFIBUS DP masters:

1. PROFIBUS DP master class 1: This class includes masters that can be used for both cyclic and acyclic communication.



Note

This function is not supported by the IS-RPI-Gateway.

2. PROFIBUS DP master class 2: This type of PROFIBUS master is used in addition to the master class 1. It supports exclusively acyclic communication. Typically, the master class 1 is then responsible only for cyclic exchange of I/O data and the master class 2 is responsible for acyclic communication.



Note

If a master class 1 is used exclusively for cyclic communication, it does not need to support acyclic communication. The only requirement is that the master class 1 must support token handling.

A master class 2 of this type can also be connected when a PROFIBUS DP system is in operation. A class 1 master that supports token handling automatically detects that a new active station has been connected to the bus. The class 1 master will then automatically integrate the class 2 master into the communication cycle by assigning the token to it after the I/O data exchange is complete.

If the class 2 master does not have any current task, the token will be returned immediately. If it does have a task, it will execute the task. The time interval available to the class 2 master for this is limited. If there is not enough time, the order is executed over the course of a number of communication cycles.



Note

If a PROFIBUS DP master class 2 is used, it may happen that the bus cycle time is not constant.

If one or more IS-RPI gateways are not commissioned with acyclic PROFIBUS DP V1 communication, we recommend the following sequence:

- Establish all electrical connections with the exception of the class 1 master
- Connection and configuration of the class 1 master



Note

If a master class 1 is connected and placed in operation without the IS-RPI-System having been previously configured or without parameters having been assigned to it, the IS-RPI gateway reports a configuration error, which can result in cyclic communication being stopped. This behaviour depends on how the PROFIBUS master class 1 is programmed or what parameters are assigned.

- Configuration of PROFIBUS stations including IS-RPI gateways

Acyclic parameter assignment can be performed with software packages that support this functionality (for example **PACTware™**, PDM of Siemens, etc.).

Another possibility is programming using PROFIBUS DP V1 telegrams. The following section uses **PACTware™** as an example to show what options are available in software packages available commercially.

14.2.4.1 Assigning parameters of the IS-RPI-System with PACTware™

Online parameter assignment

To be able to access a PROFIBUS station with **PACTware™**, a PROFIBUS master card must be integrated into the configuration tool.



Attention

If parameters are not assigned by the PROFIBUS user parameters or online in the cyclic data exchange data field, then parameters must be assigned for the gateway with acyclic PROFIBUS DP V1 communication before cyclic data exchange can begin without errors.

The following section shows how to set parameters for the IS-RPI-System with **PACTware™**. If you are using another software package, please refer to its documentation for information on how to operate the software.

Make certain that **PACTware™** Edition 2 is installed with the correct IS-RPI driver (abbreviated as DTM). If it is not installed, install **PACTware™** Edition 2 with IS-RPI and the PROFIBUS driver. For information on how to do this, please refer to the "**PACTware™** Edition 2 Frame Application" manual, Part. No.: 109240.

Start **PACTware™** Edition 2. When you do, the following screen appears:



When the system arrives, the password is **manager**. The password for administrator rights and other access authorisation rights can be changed later using the tool Extras - User Administration menu item.

Next the main window opens:

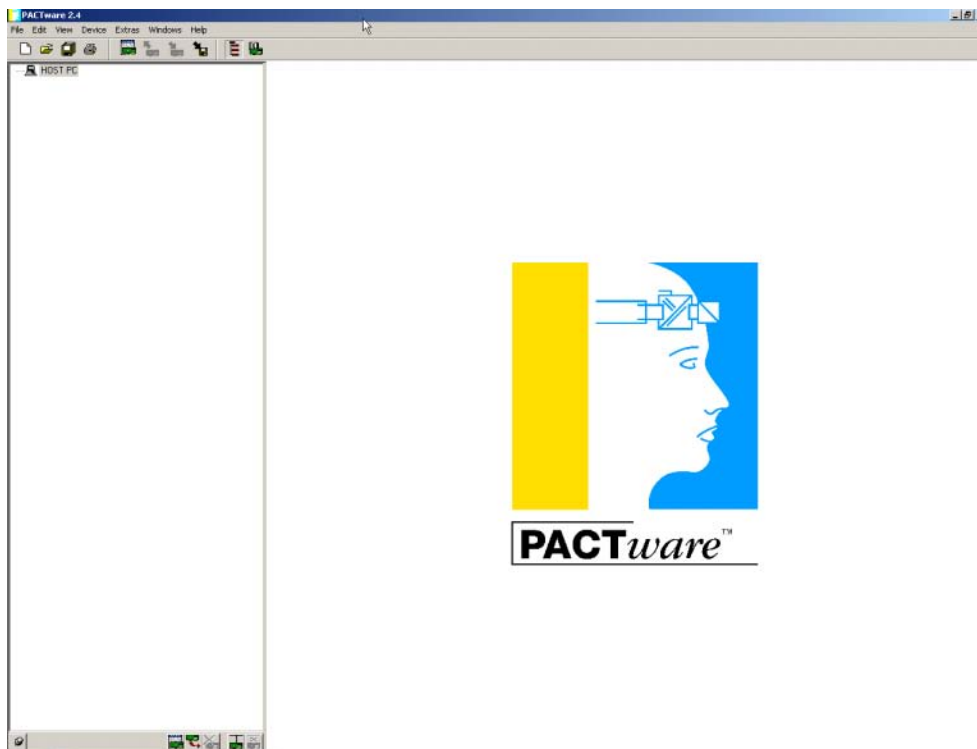

In the following section, the left column is referred to as the **project window** and the wide right column is referred to as the **processing window**.

There are a number of different ways to create an online connection to the IS-RPI gateway. The simplest way to achieve this is the following:

Press the F3 function key. The editing window for the device catalogue then appears. It can be used to gain access to all installed drivers and devices. Click on the Group tab card.

You can obtain access to the PROFIBUS drive through the PROFIBUS subdirectory. The IS-RPI subdirectory gives you access to IS-RPI gateways IS-RPI modules.

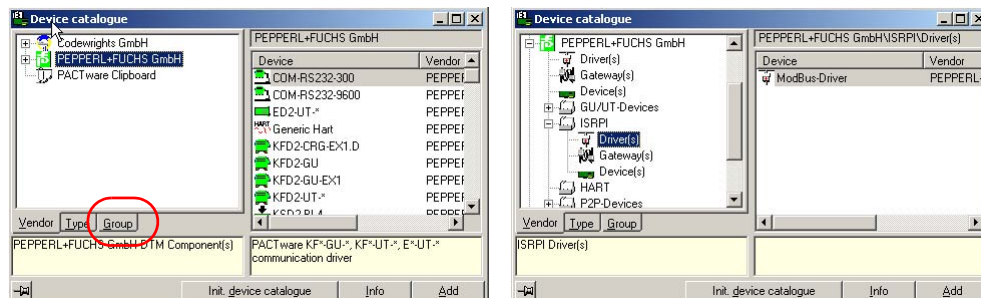

Note

This display varies depending on which devices and drivers you have installed.

Double-click on the PROFIBUS driver in the device catalogue or click on it once and then drag it onto the HOST-IBM PC entry in the project window while holding down the left mouse button.

Then right click in the project window on the PROFIBUS Driver name and select the Parameters menu item, or double-click on the PROFIBUS name. Then the following tab cards appear in the processing window:

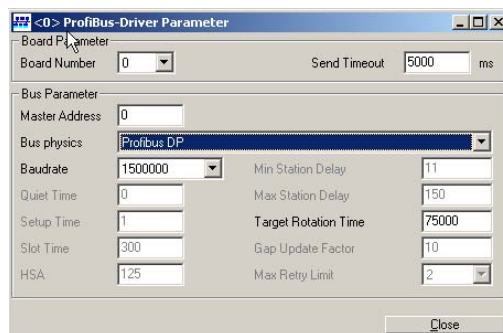

In the Board Number field, specify the slot in your PC/Notebook in which the PROFIBUS card is installed. In the Field Master address, set the PROFIBUS address of the PROFIBUS master class 2, i. e. your PROFIBUS card.



Note

Make certain that the address you select is not being used by any other PROFIBUS station.

The field "PROFIBUS Setting for" contains 2 standard settings for bus parameters.

If you are using

- an IS-RPI/PROFIBUS PA gateway together with a non-modular segment coupler of series KF...-BR-..., select the setting PA
- an IS-RPI/PROFIBUS PA gateway together with a non-modular segment coupler of series KL..., select the setting DP
- an IS-RPI/PROFIBUS DP V1 gateway together with an intrinsically safe RS485 isolator, select the setting DP



Note

The bus parameters saved here are selected so that the system runs with no problems. In the course of later improvements, the relevant bus parameters can still be changed. For more information, please refer to the applicable PROFIBUS publication.

Save your setting by clicking on the  button or selecting the File ==>Save As menu item.

Before the connection between **PACTware™** Edition 2 and PROFIBUS is established, you should deactivate the "Load only structure information during upload" field under Tools in, menu item Options . This causes **PACTware™** to read all parameter values, even those of connected modules.



Note

*Depending on how many PROFIBUS stations are connected and integrated into **PACTware™**, the following process may take a few minutes.*

Under the File menu, select the Upload menu item and confirm the query asking you whether a connection should be set up to the PROFIBUS driver with OK.

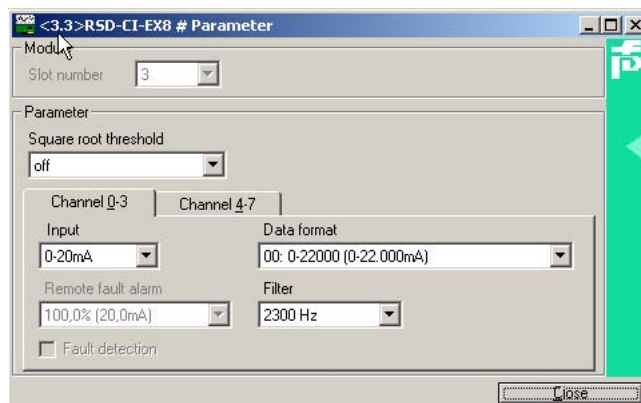

Then **PACTware™** reads the entire project connected to PROFIBUS. Only devices with drivers (DTM) integrated into **PACTware™** are displayed in the project window.

When you double-click on a specific device or module, a tab card appears in which you can set or change the parameter values. The settings can be saved directly in the device and in a file.



You can also bring up this tab card by activating the desired device/module and then pressing the F5 function key.

Now make the desired changes.

Clicking on the  button and then clicking on the  button downloads modified data directly to the device/module.

Clicking on the  button saves changes in the file assigned to the project. Information on the setting possibilities for the various parameter values and their meaning is available in section 12 of this manual.

Offline configuration

The configuration can also be performed manually offline.

- To do this, activate the device catalogue in the editing window as previously described

The design of the device catalogue is similar to the Windows® Explorer. When you click on the "+" icon, the level immediately below appears. Clicking on the "-" icon causes it to close up again.

- Click on the "+" sign on the left next to the IS-RPI name if it is visible.
- Click on the Driver entry. All drivers installed for the IS-RPI now appear in the right window of the device catalogue.
- Move the PROFIBUS driver using drag and drop onto the `HOST IBM-PC` icon in the project window or double click on the driver.
- Activate the gateways entry in the IS-RPI directory tree in the left column of the device catalogue. The device catalogue of all available IS-RPI gateways appears in the right window.
- Double-click on the type code of the gateway you are using. The gateway then appears automatically in the project window and is activated.
- Now there are 8 unassigned slots under the selected gateway, 8, in the project window. They are designated here as "Empty".

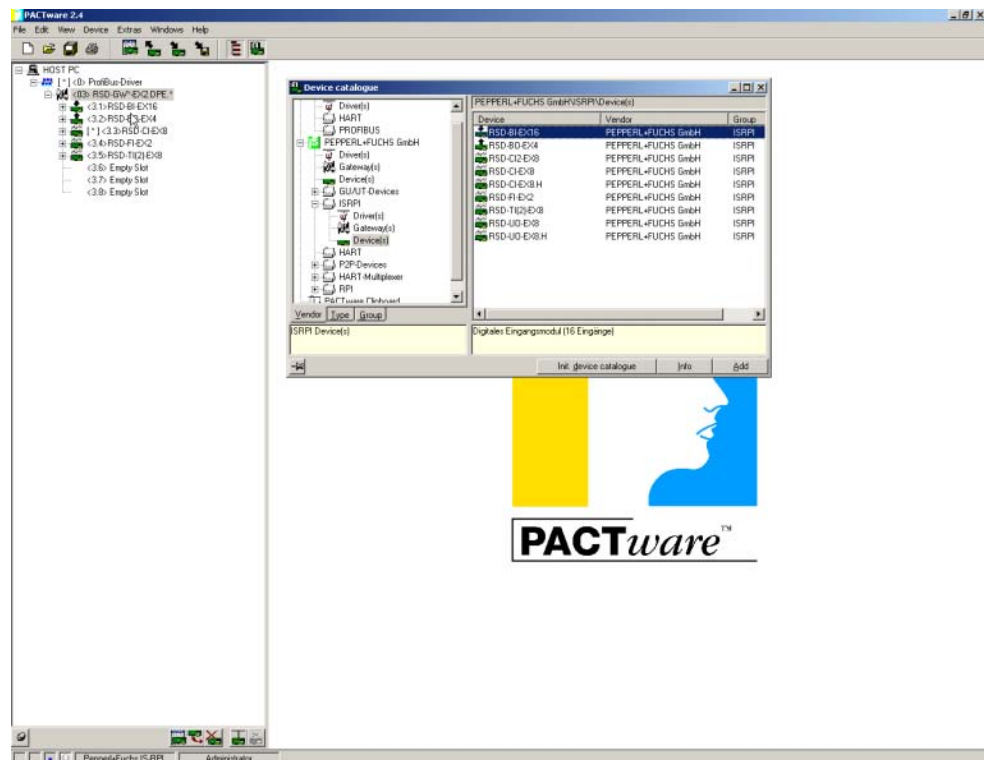

Now replicate the structure of your IS-RPI-System under the projected IS-RPI gateway. Make certain the hardware slot of the module is identical to the one you are configuring here. IS-RPI is a slot-oriented system. The structure is shown in this section on page 123.

- Move the mouse pointer to the type code of the module that is installed in Slot 1, click on the left mouse button and drag the mouse pointer while holding down the left button to the slot the module is plugged into (drag and drop).
- Repeat this process for all modules operating on this IS-RPI gateway.



Note

*Make certain that the hardware structure of your IS-RPI-System is identical with the replicated structure in **FACTware™**.*

- You can save the project by selecting the File item in the menu bar and then selecting the menu item Save As. This function behaves just like the corresponding Windows® function.

Next the driver, device and module parameters must be set.

- Double click on the PROFIBUS driver item in the project window. The Parameter tab card appears. Make the necessary PROFIBUS settings on the Parameter tab card (see page 132)
- Click with the right mouse button on the PROFIBUS driver icon and select the Properties menu item. Then the Device Info and Description properties tabs appear.

The Device Info properties tab contains information on the PROFIBUS driver itself. The information cannot be modified.

You can save your own information on the Description tab card, for example the name and description of the measurement point.



Note

*This information is only saved in the file. It is **not** saved in the driver/device/module itself.*

- Bring up the IS-RPI-/PROFIBUS gateway in the same way as the tab card for the PROFIBUS driver and set the desired PROFIBUS address of the gateway.

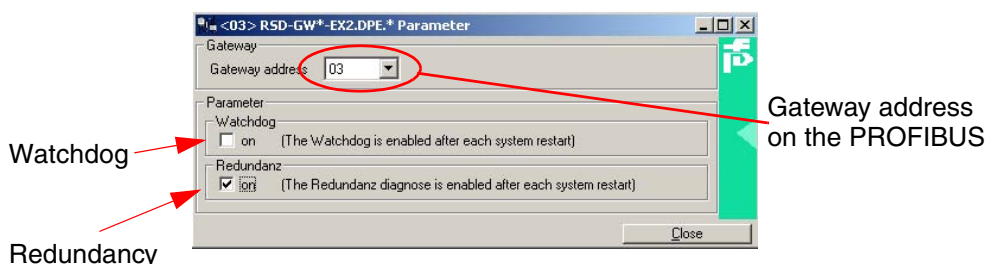

- There are two additional setting options on this properties tab
 1. The watchdog
 2. Redundanz [only for RSD-GW(x)-Ex2.DPE(.ED)]

The watchdog is a time window within which a PROFIBUS slave must receive a telegram addressed to it. This time is calculated automatically by the PROFIBUS master and is automatically transferred to each slave during the startup phase. If the watchdog for the IS-RPI gateway is activated, there are two consequences:

- 1. If the watchdog time is exceeded, the "com fault bit" is deleted inside the data tables of all I/O modules that are connected. This causes the outputs in the device driver to take on the output state defined by the device driver parameters in the event of a fault.



Attention

*For this to work, the outputs must take on a defined state if bus communication fails, the watchdog must be activated **and** error detection must be activated for each module.*

- The second consequence is that if watchdog is active, it is not possible to set output signals with **PACTware™**.

*If you want to set output signals with **PACTware™** for test purposes, the watchdog must be deactivated.*



Note

*If the watchdog is activated with **PACTware™**, it becomes active again after the next start-up, for example if the power is turned off and back on.*



Note

The watchdog can also be deactivated with the aid of your configuration tool for the class 1 master. For an explanation of how to do this, please refer to the documentation for your configuration tool.

If you select this alternative, the watchdog will be deactivated after it starts up again as well. You can overwrite at any time with **PACTware™**

The PROFIBUS DPV1 gateway is designed for media-redundant operation. If the redundant transfer line is not being used, the RED LED flashes. If the Redundancy field is deactivated, the LED stops flashing. This also prevents a diagnostic alarm from being generated by the IS-RPI/PROFIBUS gateway.

- Save your settings.
- Click once in the project window on the module to which you want to assign parameters and the double click on the module that will be receiving parameters.
- The Parameters tab card appears. Now you can make the settings for the modules on the Parameters tab card as described above, load them into the module and save them in the project. Information on the setting options for modules is available in section 12.
- Clicking with the right mouse button and selecting the menu item Properties allows you to open the properties tab Device Info and Description. On the Description properties tab you can enter a name of the measurement point again (it will be displayed in the project window after the properties tab is closed) along with a description of the measurement point.

Repeat this procedures for each module for which you want to set parameters.

To be able to download the configuration and parameter data to the IS-RPI gateway, the configuration tool must be connected with the PROFIBUS.

- Open the project to be downloaded with `Open project` if it is not already open.
- Activate the PROFIBUS driver or the gateway for which you want to set parameters in the project window.
If the driver is activated, the entire project will be transferred to all stations connected to the PROFIBUS.
If only one gateway is activated, the parameter values will only be transferred to that one gateway.
- Then select the `Project Download` menu item.
- Confirm the query about whether a connection should be established with Yes.

The project is now saved in the IS-RPI gateway(s).

14.2.4.2 Additional PACTware™ Edition 2 features

If PACTware™ Edition 2 is used to configure the IS-RPI-System and assign parameters to it, it can also be used for other functions that will be described in this section.

Measurement values or states and diagnostic data can also be displayed in connection with the IS-RPI-System. If certain conditions are met, it is also possible to have an effect on the outputs for test purposes.

To be able to use these functions, there must be a connection between PACTware™ and the corresponding IS-RPI gateway. To make this connection, open the project if it has not already been opened. Click on the gateway and select the Set up connection item under the Device data menu item. After the connection has been successfully set up, the IS-RPI gateway and the connected modules are displayed in bold in the PACTware™ project window.

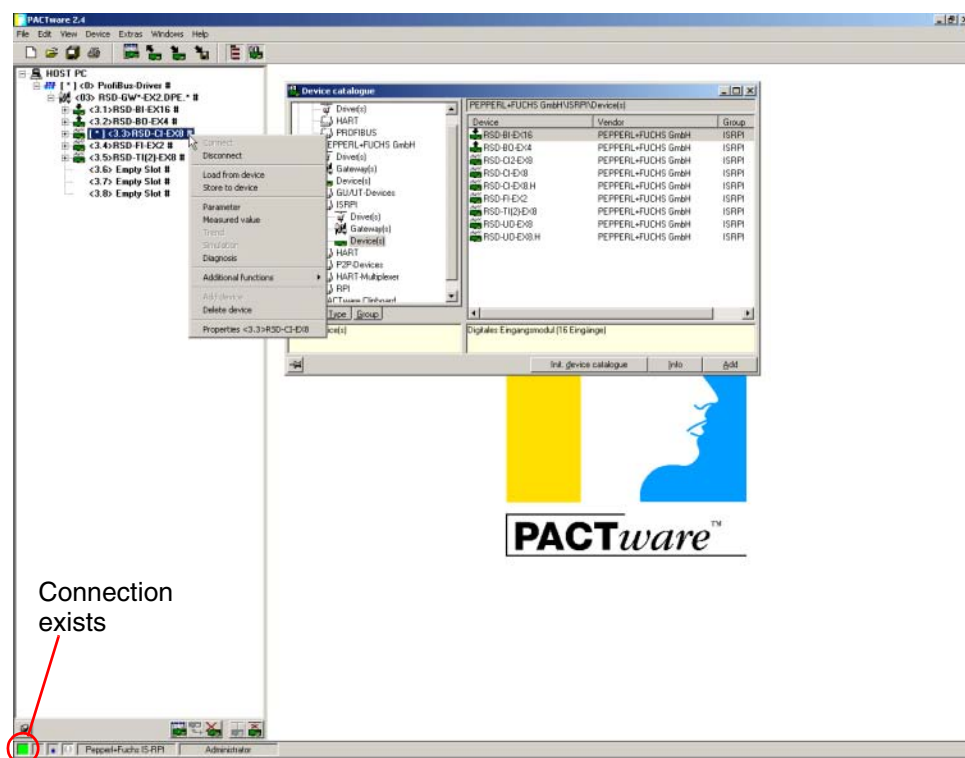

A green display continues to be illuminated in the lower left of the window.

Now move your mouse pointer to the gateway/module in the project window from which you want additional information and click with the right mouse button.

A selection menu then appears with various options. The variants of the selected gateway/module that are supported are black, while all the others are displayed in gray (see the illustration above). Select the desired function by moving to the corresponding menu item with the mouse pointer and clicking with the left mouse button.

If the Measurement Value menu item was selected, the following windows will be available, depending on module functionality:

Analogue input

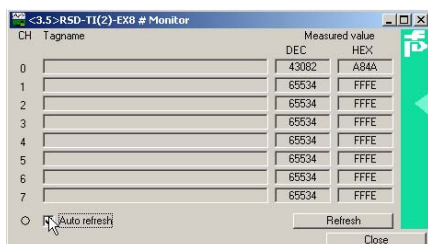

Analogue output

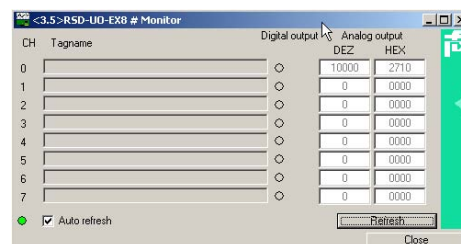

Binary input

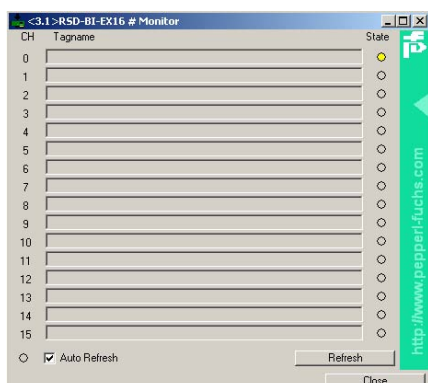

Binary output

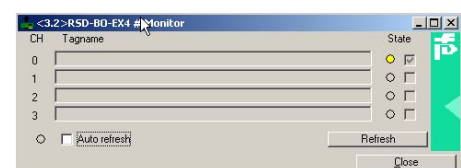

To have a display for the inputs, you must either click on the Update button or check the Update cyclically checkbox. The current output values are displayed immediately. When the Update button is selected, **PACTware™** queries the desired value a single time. Later changes are not updated automatically. If the Update cyclically action field is activated, **PACTware™** queries the station at cyclic time intervals for the current value and then sets the value in the appropriate window.

The current value is displayed for analogue inputs and outputs in both decimal and hexadecimal format. The states of the binary inputs and outputs are indicated with a yellow display.

Under specific conditions, output values can also be transferred to the modules with the Measurement Value menu item. This is useful for test purposes, etc.



Warning

*If you change **PACTware™** output data, you are becoming involved in the active process. Make certain this direct intervention does not create a hazard for persons or property.*

For the **PACTware™** output values to be changed, the following points must be ensured:

1. No cyclic exchange of data must take place.
2. The IS-RPI gateway watchdog must be deactivated.

If these two conditions are satisfied, you can transfer analogue output data by entering the desired value in the DEC field in decimal format or in the HEX field in hexadecimal format. Then click on the Update button or check the Update cyclically checkbox.

You can also bring up diagnostic information in the same manner as measurement variables. Diagnostic information is available for the gateways and all modules.

Gateway diagnosis

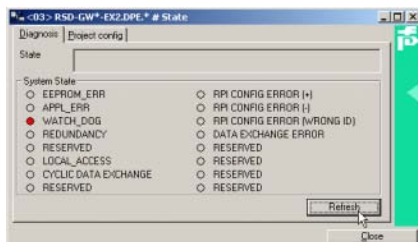

Diagnosis for analogue inputs and outputs

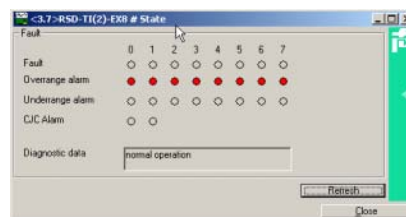

Diagnosis for binary inputs and outputs



After you have brought up this window, click on the Update button. Then **PACTware™** reads the diagnostic data from the active gateway/module.

Any errors that are present will be displayed in red. Diagnostic data that is available for the modules depends on the module and may be different than what is shown in the display above.

14.2.4.3 Acyclic configuration with PROFIBUS DP V1 telegrams

Data that will be transferred via PROFIBUS DP in acyclic data exchange, is divided up into so-called slots and indices. Theoretically, a PROFIBUS DP station is able to support up to 255 slots and up to 255 indices per slot.

RSD-GW-Ex1.PA and RSD-GW(2)-Ex2.DPE gateways support 9 slots. Slot 0 contains gateway data, while slots 1 to 8 contain IS-RPI module data. Slot 1 corresponds to Module 0, slot 2 to Module 1, etc.

The following tables provide an overview of slots and indices that are supported and of functionality:

Index	Bytes	Service	Function
16	2	Read	System status word (Byte 1 = Higher Byte; Byte 2 = Lower Byte)
17	7	Read, Write	Real-time clock
18	2+16	Data Transport ¹⁾	Identifier, module description
19	1	Write	Reset device if value 5A _{hex} is transferred
20	1	Read, Write	Watchdog on ==> value ≠ 5A _{hex} Watchdog off ==> value = 5A _{hex}
21	2	Read, Write	Counter for internal communication faults (Serbus)
22	3	Read	Software version

1) The Data Transport service is not supported by a class 1 PROFIBUS DP master. Because of this, no module descriptions can be downloaded with a class 1 master if the master is in cyclic operation.

Index	Bytes	Service	Function
16	2	Read	Actual module identifier (Byte1 = Higher Byte; Byte 2 = Lower Byte)
17	≤ 32	Read, Write	Current configuration of module (Byte1 = Higher Byte; Byte 2 = Lower Byte; ...)
18	≤ 32	Read, Write	Projected configuration of module (Byte1 = Higher Byte; Byte 2 = Lower Byte; ...)
19	2	Read	Current module status word of data table (Byte1 = Higher Byte; Byte 2 = Lower Byte; ...)
20	3	Read, Write	Projected module identifier (Byte1 = Higher Byte; Byte 2 = Lower Byte); Transmission type Byte 3 < 80hex ==> acyclic configuration data transmission; Byte 3 ≥ 80hex ==> cyclic configuration data transmission
21	≤ 32	Read	Copy of the data table (Byte1 = Lower Byte; Byte 2 = Higher Byte; ...)
22	≤ 32	Read	Input data (Byte1 = Higher Byte; Byte 2 = Lower Byte; ...)
23	≤ 32	Read, Write	Output data (Byte1 = Higher Byte; Byte 2 = Lower Byte; ...)

Projected module identifiers (index 20) cannot be written in acyclic PROFIBUS DP V1 communication if the gateway is in cyclic data exchange.

Input data of the modules can be read in index 22. Input data can always be read and depends only on the modules that are currently connected (current module identifiers).

As for index 22, reading output data with index 23 depends only on the modules that are currently connected. You can only write to the modules using this index if no cyclic communication has been set up and the last cyclic communication was disconnected correctly.

Access to the various indices is never verified in terms of the correct number of bytes. If a master requests more bytes than are currently available for the corresponding index, only as many bytes as can be read out will be returned.

14.3 PROFIBUS diagnostics

PROFIBUS transfers diagnostic information as long a diagnostic information is available for PROFIBUS stations. There are two groups of IS-RPI gateways. They differ in their diagnostic information:

- Group 1 – devices with standard diagnostics
Diagnostic information for the IS-RPI gateways consist of 6 PROFIBUS-specific diagnostic bytes in conformity with EN 50170 Part 2, plus additional devices-related diagnostic bytes. This group includes the following gateways:
 - RSD-GW-Ex2.DPE
 - RSD-GW2-Ex2.DPE
 - RSD-GW3-Ex2.DPE
 - RSD-GW-Ex1.PA
 - RSD-GW2-Ex1.PA
- Group 2 – devices with extended diagnostics
In addition to the diagnostic information from group 1, there is channel specific diagnostic information such as lead breakage or short circuit. This group includes the following gateways, all with the name affix "ED":
 - RSD-GW2-Ex2.DPE.ED
 - RSD-GW3-Ex2.DPE.ED
 - RSD-GW2-Ex1.PA.ED

14.3.1 Standard diagnostics of PROFIBUS PA gateways RSD-GW(2)-Ex.PA

Diagnostic information for the IS-RPI-/PROFIBUS PA gateway consists of 6 PROFIBUS-specific diagnostic bytes in conformity with EN 50170 Part 2, plus an additional 24 device-related diagnostic bytes. For the meaning of PROFIBUS-specific diagnostic bytes, please refer to the applicable PROFIBUS literature.

The structure of the device-specific diagnosis (starting with byte 7) is as follows:

Byte		Meaning
7	1	Number of device-specific diagnostic bytes (always 16 _{hex})
8	2	Status type, manufacturer-specific (always A0 _{hex})
9	3	Slot that reports the status
10	4	Always 0 _{hex}
11	5	Software ID high byte
12	6	Software ID low byte
13	7	System status word high byte
14	8	System status word low byte
15	9	Actual module identifier, module 0 high byte
16	10	Actual module identifier, module 0 low byte
17, 18	11, 12	Actual module identifier; module 1 high byte, low byte
19, 20	13, 14	Actual module identifier; module 2 high byte, low byte
21, 22	15, 16	Actual module identifier; module 3 high byte, low byte
23, 24	17, 18	Actual module identifier; module 4 high byte, low byte
25, 26	19, 20	Actual module identifier; module 5 high byte, low byte
27, 28	21, 22	Actual module identifier; module 6 high byte, low byte
29, 30	23, 24	Actual module identifier; module 7 high byte, low byte



Note

The left column of the table above contains the byte number if your system counts PROFIBUS-specific diagnostic bytes.

The middle column will contain the byte number if your system does not count PROFIBUS-specific diagnostic bytes.

The meaning of the bits in the system status word (13, 14 or 8, 9) is as follows:

- Bit 0 EEPROM_ERR - error during non-volatile storage
- Bit 1 APPL_ERR - internal device error
- Bit 2 WATCHDOG - watchdog timer has expired
(the bit will be deleted by writing to the watchdog time)
- Bit 3 Communication only on PROFIBUS channel A
- Bit 4 Communication only on PROFIBUS channel B
- Bit 5 reserved
- Bit 6 cyclic DP communication active
- Bit 7 reserved
- Bit 8 RPI configuration errors of one or more IS-RPI modules too many
- Bit 9 RPI configuration errors of one or more IS-RPI modules too few
- Bit 10 RPI configuration errors, incorrect module ID with one or more IS-RPI modules
- Bit 11 reserved
- Bit 12 reserved
- Bit 13 reserved
- Bit 14 reserved
- Bit 15 reserved

14.3.2 Gateways with extended diagnostics

Diagnostic information of IS-RPI/PROFIBUS gateways consists of

- 6 PROFIBUS-specific diagnostic bytes in accordance with EN 50170 Part 2
- 12 gateway-related diagnostic bytes
- 3 module-related diagnostic bytes

14.3.2.1 PROFIBUS-specific diagnostic bytes

For the meaning of PROFIBUS-specific diagnostic bytes, please refer to the applicable PROFIBUS literature.

14.3.2.2 Gateway-specific diagnostic bytes

The structure of the device-specific diagnosis (starting with byte 7) is as follows:

Byte		Meaning
7	1	Number of device-specific diagnostic bytes
8	2	Status type, manufacturer-specific (always A0 _{hex})
9	3	Slot that reports the status
10	4	Always 0 _{hex}
11	5	Software ID high byte
12	6	Software ID low byte
13	7	System status word high byte
14	8	System status word low byte



The left column of the table above contains the byte number if your system counts PROFIBUS-specific diagnostic bytes.

The middle column will contain the byte number if your system does not count PROFIBUS-specific diagnostic bytes.

The meaning of the bits in the system status word (13, 14 or 7, 8) is as follows:

- Bit 0 EEPROM_ERR - error during non-volatile storage
- Bit 1 APPL_ERR - internal device error
- Bit 2 WATCHDOG - watchdog timer has expired
(the bit will be deleted by writing to the watchdog time)
- Bit 3 Communication only on PROFIBUS channel A
- Bit 4 Communication only on PROFIBUS channel B
- Bit 5 reserved
- Bit 6 reserved
- Bit 7 reserved
- Bit 8 RPI configuration errors of one or more IS-RPI modules too many
- Bit 9 RPI configuration errors of one or more IS-RPI modules too few
- Bit 10 RPI configuration errors, incorrect module ID with one or more IS-RPI modules
- Bit 11 reserved
- Bit 12 reserved
- Bit 13 reserved
- Bit 14 reserved
- Bit 15 reserved

Bytes 15 to 18 or 9 to 12 return module-internal status information of analogue modules from data tables. The structure is as follows:

Byte		Contents	
15	9	Slot 1	Slot 2
16	10	Slot 3	Slot 4
17	11	Slot 5	Slot 6
18	12	Slot 7	Slot 8

Each byte represents 2 IS-RPI modules. For the meaning of the individual bits, please refer to the diagnostic data table on page 70.

14.3.2.3 Module-specific diagnostic bytes

Bytes 19 to 21 or 13 to 15 report which module type has a diagnosis. The data is represented as follows:

Byte		Contents
19	13	Header, always 43 _{hex}
20	14	Identifier of the module that reports a diagnosis
21	15	Identifier of the module that reports a diagnosis

14.3.2.4 Channel-specific diagnostics

The IS-RPI/PROFIBUS DP V1 gateway RSD-GW3-Ex2.DPE.ED and the IS-RPI-/PROFIBUS PA gateway RSD-GW2-Ex1.PA.ED both support channel-specific diagnostics.

The diagnostics information starting at byte 22 or 16. Advanced diagnostics consists of 3 bytes per channel and is only transferred if a channel error occurs. The entire length of channel-specific diagnostics is limited to 60 bytes.

Channel-specific diagnostics can transmit diagnostic data for a maximum of 20 channels. If there is information present on multiple channels, only the first 20 channels returning diagnostic information will be displayed.

Only one piece of diagnostic information can be transmitted for one channel. If there is more than one piece of diagnostic information present per channel, the pieces are sorted by priority and the diagnostic information with the highest priority is transmitted first.



Note

The following table illustrates the principle in the structure of channel-specific diagnostics:

Bit	7	6	5	4	3	2	1	0
Header	Connector slots 1 to 8						0	1
Channel	Channel number							Input/output
Type	Error type					Channel type		

For clarification, an example of the layout of channel-specific diagnostics is explained below for each type of module:

Example 1: channel specific diagnostics RSD-BI-Ex16

Bit	7	6	5	4	3	2	1	0	Meaning
Header	Connector slots 1 to 8						0	1	
Channel	Channel number 0 to 15						1	0	
Type	0	1	1	0	1	1	0	0	Lead break/ short circuit

Example 2: channel specific diagnostics RSD-BO-Ex4

Bit	7	6	5	4	3	2	1	0	Meaning
Header	Connector slots 1 to 8						0	1	
Channel	Channel number 0 to 15						0	1	
Type	0	1	1	0	0	1	0	0	Lead break
	1	0	0	0	0	1	0	0	Short circuit

Example 3: channel specific diagnostics RSD-TI(2)-Ex8

Bit	7	6	5	4	3	2	1	0	Meaning
Header	Connector slots 1 to 8						0	1	
Channel	Channel number 0 to 15						1	0	
Type	0	1	1	0	1	1	0	1	Lead break/ short circuit
	0	1	0	0	1	X	X	X	Overrange
	1	1	0	0	1	X	X	X	Underrange

Example 4: channel specific diagnostics RSD-CI(2)-Ex8

Bit	7	6	5	4	3	2	1	0	Meaning
Header	Connector slots 1 to 8						0	1	
Channel	Channel number 0 to 15						1	0	
Type	0	1	1	0	1	1	0	1	Lead break/ short circuit
	0	1	0	0	1	X	X	X	Overrange
	1	1	1	1	1	X	X	X	Underrange
	0	0	1	0	1	X	X	X	Transmitter alarm

Example 5: channel specific diagnostics RSD-UO-Ex8

Bit	7	6	5	4	3	2	1	0	Meaning
Header	Connector slots 1 to 8						0	1	
Channel	Channel number 0 to 15						0	1	
Type	0	1	1	0	0	1	0	1	Lead break, analogue
	0	1	1	0	0	1	0	0	Lead break, digital

Example 6: channel specific diagnostics RSD-FI-Ex2

Bit	7	6	5	4	3	2	1	0	Meaning
Header	Connector slots 1 to 8						0	1	
Channel	Channel number 0 to 15						1	0	
Type	0	1	1	0	0	1	0	1	Lead break
	1	1	1	0	0	X	X	X	Upper limit value
	1	0	1	0	1	X	X	X	Pulses are missed

15 HART Communication via IS-RPI

15.1 Product description for RSD-CI(UO)-Ex8.H

15.1.1 Description of the hardware

As many as 8 analogue HART-capable transmitters can be operated on the RSD-CI-Ex8.H.

Up to 8 analogue, HART-capable I/P transformers position controllers or similar devices can be operated on the RSD-UO-Ex8.H.

15.1.2 Galvanic isolation

The 8 channels of the RSD-CI(UO)-Ex8.H are galvanically connected with each other.

15.1.3 Device functions

HART communication should always be understood as the combined effect of the two system components I/O module RSD-CI(UO)-Ex8.H and the PC software driver. This software driver must be adjusted to match the specific properties of the two RSD-CI(UO)-Ex8.H modules. This manual does **not** contain a description of the interface.

This manual assumes the interface to the maintenance station from this PC software driver and the interface to the field device of the RSD-CI(UO)-Ex8.H. have been created.



Note

*The software functions described in this section are typically integrated into the operating software of the maintenance station, i. e. the functions are generally **not** activated and deactivated with the HART commands described here. Instead of those commands, there are functions (menu commands) in the operating software that perform those processes. In spite of this, the basic HART commands are described, since the functions are familiar to greater or lesser degrees in the individual user interfaces and the basic elementary function may not be apparent from the name. You can find a list of supported commands in section 15.6.1.*

HART: The HART protocol as digital communication for maintenance and configuration purposes is supported by many field devices with conventional analogue 4 mA ... 20 mA currents. The HART signal is modulated to the analogue current as an FSK signal. The modulator/demodulator switch (modem) required for this purpose is integrated into the RSD-CI(UO)-Ex8.H module.

The term **HART Multiplexer in RSD-CI(UO)-Ex8.H** is used below. This corresponds to the internal functionality of the RSD-CI(UO)-Ex8.H, which is based on the functionality of traditional HART Multiplexer systems (e. g. KFD2-HMM-16, MUX 2700).

Number of Channels

The RSD-CI(UO)-Ex8.H returns 8 channels for connecting "Smart" field devices that support digital communication based on the HART specification.

HART

- Only one HART field device can be connected to each HART connection (no "multidrop" functionality).
- Special procedures in respect to HART communication:
 - On the field devices side, either the polling address or the long frame address is used, depending on what is needed.
 - The operating modes "Primary Master" and "Secondary Master" and the corresponding time responses are supported on the field device side.
 - If "Secondary Master Off" is configured, no consideration is given for the special time behaviour of an access to a secondary master. "Secondary Master Off" is the basic setting of RSD-CI(UO)-Ex8.H after Power Up.
 - No commands of a secondary host are accepted on the host side.
 - Commands to connected field devices are only accepted by the primary host.
 - Burst mode is not supported.

15.1.4 Loop structure/REBUILD

When the product leaves the factory, the RSD-CI(UO)-Ex8.H module has no HART functionality, i.e. it is configured as a conventional analogue component for signals from 0(4) mA ... 20 mA. When the power is turned on, there is thus no REBUILD. REBUILD does not take place until a REBUILD is explicitly forced by the host (Command 154). The duration of this REBUILD process depends on the configuration of connected devices in use:

Best Case, all 8 field devices are connected with polling address 0: 20 sec

Worst Case, only one field device is connected with polling address 15: 3 min

During the Rebuild phase, the RSD-CI(UO)-Ex8.H traverses the following sequence:

Command	Description
0 (polling address 0)	Determination of field-device-specific data, especially the extended address and number of preambles - Repeated up to 10 times in the event of an error
0 (polling address 1 ... 15)	Single repetition in event of a fault
4	Determining the extended address in the case of pre-Rev.5 field devices
6	Sets the polling address to 0
59	Divides the number of the preamble for RSD-CI(UO)-Ex8.H by
109	Turns off Burst Mode
13	Reads the tag, descriptor and date
16	Reads "Final Assembly Number"
38	May be necessary to reset the "Configuration changed" bit

Consequences of the Rebuild Phase:

- Preambles in the telegram from the maintenance station are ignored. The number of preambles determined from the rebuild phase is used instead.
- Only field devices for which the polling address is already set to 0 or that support Command 6 can be connected.
- The polling address cannot be adjusted by the maintenance station, but the RSD-CI(UO)-Ex8.H does accept each polling address and then sets it to 0 for transfer to the field device.
- Write-protected field devices may not be detected.

15.1.5 Status monitoring

- The Loop-Status assembly can be used to monitor the states of the I/O module itself and the individual currents that are connected. Typical messages are "Disappeared (device has disappeared)", "Re-appeared (device has resurfaced)" and "Mismatched (other device found)".
- This time is deterministic in the IS-RPI-HART system.

15.1.6 Operation

The RSD-CI(UO)-Ex8.H module is also represented as a HART device (Multiplexer). Because it is integrated into the user software of the maintenance station, however, this remains largely hidden to the user. The HART commands supported by the Multiplexer are listed in section 15.6.1. The commands of the maintenance station are passed through to the field devices without any changes for HART communication (transparency).

15.1.7 LED display

- The device has eight channel-related LEDs, which are located on the front of the housing.
- If "HART status LEDs" is turned on, the meaning of the LED is as follows:

Colour	Meaning
Yellow continuous	HART field device detected
Yellow continuous with brief flashing	HART field device detected, verification of status performed on field device during brief flashing
Yellow flashing quickly	The system is currently attempting to set up a connection with a field device

15.1.8 Device parameters, parameter assignment

The RSD-CI(UO)-Ex8.H contains specific containers like those of HART field devices for identification and parameter assignment. The following list shows these parameters and how the programming must be carried out.

- Unique device identification (see Commands 0, 11)
 - The device identification returns information about the device (type, type ID, series number, revision numbers) and manufacturer that cannot be changed.
- Message (see Commands 12 and 17)
 - Any item of text 32 characters long can be stored in the device under this parameter.
- Tag, description and date (see Commands 13 and 18)
 - A tag (8 characters), description (16 characters) and date can be saved under these parameters.
- The number of telegram repetitions (retries) (see Commands 144 and 145)
 - The number of telegram repetitions can be adjusted separately for repetitions in the event of communication errors and for the "Busy" response code. The range of adjustment is 0...11 retries. In the case of communication errors, the pre-setting is 2, in the case of the response code "Busy" it is 0.

15.1.9 Connection to the maintenance station (PC, PLC/PLS)

There is no separate connection for HART to the maintenance station. Instead, Hart information is typically transferred by the same bus system that is used for I/O data transmission.

In the case of PROFIBUS, this is performed with acyclic DP V1 services.

15.2 System layout

15.2.1 System description

In process-related systems, there are many field devices distributed over a large area. Key rating data of these field devices must be monitored or logged in the context of ISO 9000, for example or must be adjusted if process variables are changed. The IS-RPI-HART system of Pepperl+Fuchs allows for online communication between a PC and "smart" field devices that support the HART protocol.

Smart field devices (transmitters, intelligent actuator controllers and similar devices) make it possible to store information such as the measurement range, tag number, ID number, manufacturer, etc. in the field device itself. Access to these data is usually obtained using a handheld terminal. That means that a connection to the field device must be established for each of the values to be changed.

If specific data must be logged as part of a quality assurance program based on ISO 9000, this means increased overhead for the process control system or for the PLC. Thus, the corresponding data must be queried cyclically and stored in a database by the system, for example.

The IS-RPI-HART system of Pepperl+Fuchs creates a link between the PC and intelligent "HART-capable" field devices. All access to the field device takes place in parallel to the transfer on the bus and the 4 mA ... 20 mA measurement signal, and therefore has no effect on the processing of measurement values by the process control system.

The system thus provides a subordinate service interface. It is also possible to record measurement values with the IS-RPI-HART system. Up to 8 HART field devices can be connected to each IS-RPI-HART-I/O module. 8 of these IS-RPI-HART-I/O modules together with a gateway form a rack with a complete structure. Up to 100 gateways can form a complete system for bus systems used by IS-RPI. In this manner, up to 6400 field devices can be addressed and data exchanged with one PC (8 x 8 x 100). It is also possible to continue working with a handheld terminal, since the HART protocol accepts two masters, for example a PC and a handheld terminal, in one system. To do this, however, "Secondary Master Enable" must be configured. This setting is turned off in the configuration in its basic factory setting.

15.2.1.1 Integration into the operating software (asset management systems)

The full functionality of the IS-RPI-HART system comes into play when modern asset management systems such as **PACTware™** and AMS (Fisher-Rosemount) are integrated.

The user control tools integrate the functions of the device in the form of menu commands into a uniform user interface and convenient control environment. The way functions are displayed and named may vary greatly from one set of operating tools to another; Even a generally valid portrayal is not possible in this publication.



Note

You will find some information on configuring, parameter assignment, operation and diagnostic options in the documentation on the operating tools.

15.3 PACTware™

PACTware™ is the first open source Process Automation Configuration Tool with an open FDT interface (Field Device Tool). It is therefore also possible for the first time to configure and assign parameters to all fieldbusses and field devices in a system independently of manufacturer with a single engineering tool.

For information on operating **PACTware™** and the individual setting options, please refer to section 14.2.4.1

To be able to set up a HART communication channel an IS-RPI gateway must be assigned to the PROFIBUS driver in **PACTware™** and the gateway must support HART communication via PROFIBUS. In addition, a HART-capable IS-RPI module must be assigned to this gateway.

15.3.1 Description of DTMs (Device Type Managers)

15.3.1.1 The project window

The structure of the project is displayed in the **PACTware™** project window with *ComDTM*, Remote I/O System IS-RPI DTMs and field device DTMs.

The starting point of the project structure is the host PC to which the corresponding communication module(s) is/are connected. The Remote I/O system IS-RPI is assigned to the communication module(s). The field devices are arranged in the hierarchical project structure underneath.

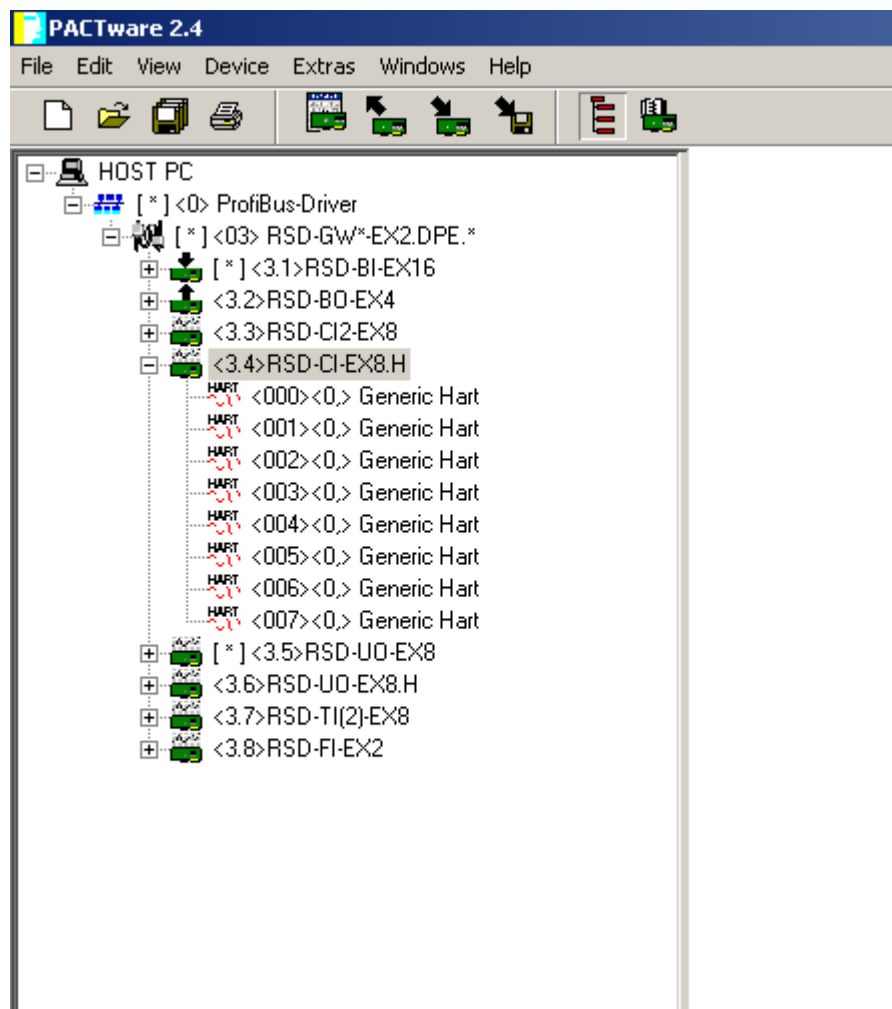

15.3.1.2 Adding a DTM

First, the position in the project structure is selected (highlighted in blue) where a DTM will be added. There are two ways to add a DTM to the project:

- with the **Add** key in the device catalogue
- by double clicking on the DTM
- with "**drag and drop**" from the device catalogue to the project window
- with the **Add device** tool icon in the project window
- with the **Add device** item in the Device data menu
- with the **Add device** item in the context menu (right mouse button)

The option for creating a project in the **context menu** with the **Add device** item is described below, since it is the easiest way and also offers the advantage that only DTMs that are permitted to be inserted at this place will be available for selection.

15.3.1.3 Adding a ComDTM in the project structure

Select Host-PC in the project structure

In the **Add device** context menu, select PROFIBUS driver.

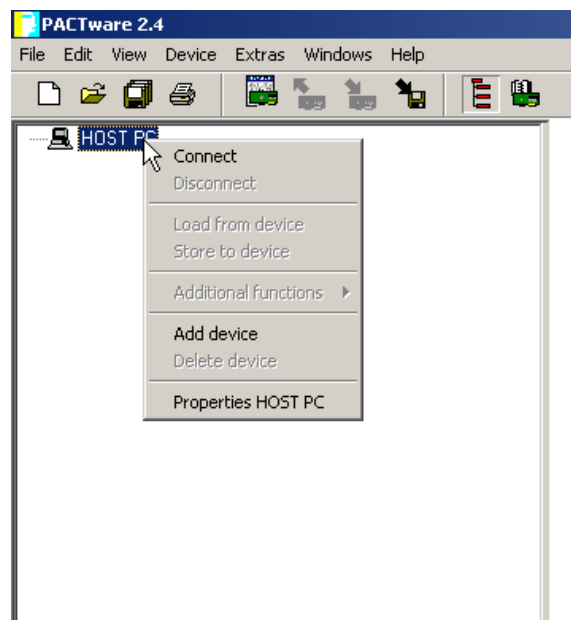

15.3.1.4 Adding an IS-RPI gateway to the project structure

Select PROFIBUS driver in the project structure.

In the **Add device** context menu, select RSD2-GW*-Ex2.DPE*.

After the gateway has been added, eight empty slots appear under the gateway. The IS-RPI-E/A modules can be inserted in these slots.

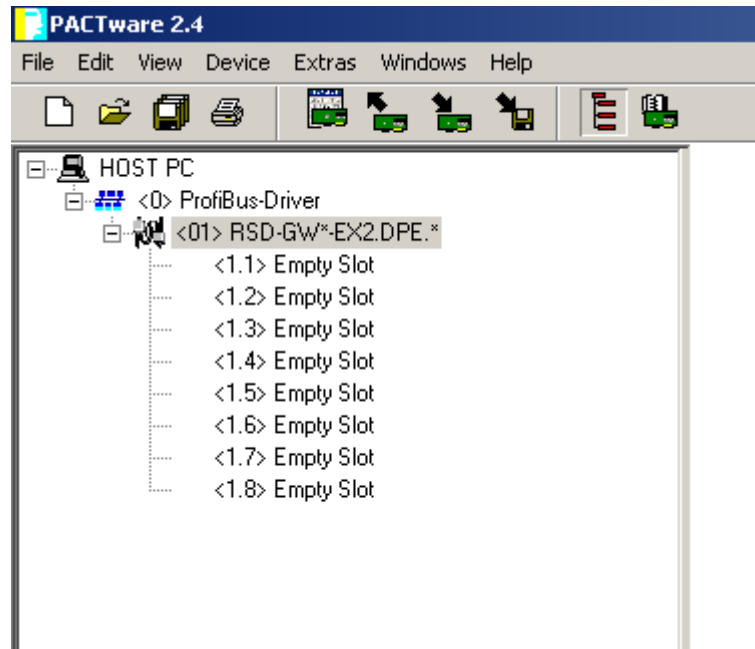

15.3.1.5 Adding HART I/O modules to the project structure

In the project structure, select Gateways.

In the **Add device** context menu select RSD-UO-Ex8.H.

In the **Add device** context menu select RSD-CI-Ex.H.

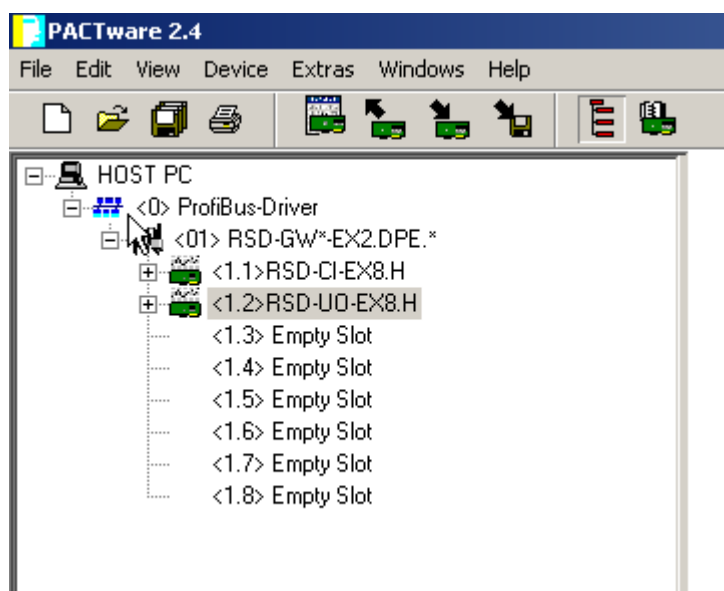

15.3.1.6 Removing a DTM

To remove a DTM from the project structure, use one of the methods below:

- With the **Del** key on the keyboard
- With the **Remove device** tool icon in the project window

A confirmation query appears before the DTM is removed from the project. If a DTM to which other DTMs are assigned is removed, the entire project will be removed.

15.3.1.7 Setting up a connection with HART I/O modules

In the project structure, select RSD-CI-Ex8.H.

In the context menu, select **Set up connection**.

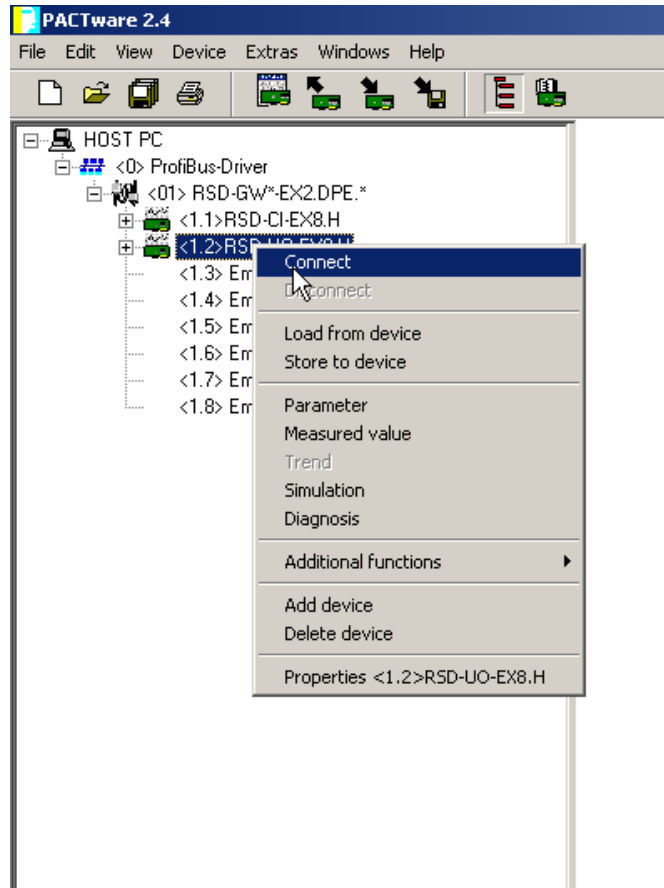

The previous section describes how to integrate I/O modules into **PACTware™**. The following section describes the parameters of I/O modules.

15.3.2 Parameters of I/O modules

15.3.2.1 I/O settings for RSD-CI-Ex8.H

The device parameters can be set in the parameter window of the RSD-CI-Ex8.H.

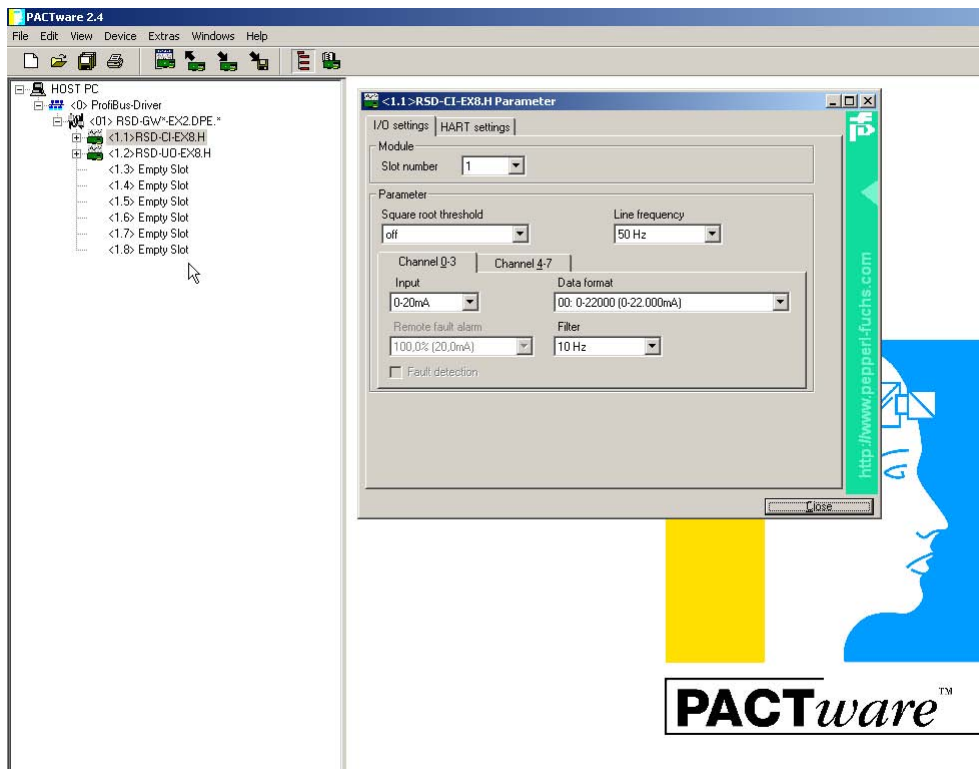

Slot number

The slot number designates the position in the rack.

Suppression of Hidden Quantities

The hidden quantity is a limit value based on a percentage of the measurement value final range of the flow. Measurement values are set to "ZERO" under this limit value.

Entering a hidden quantity prevents a non-authentic flow, for example one caused by a fluctuating column of liquid at standstill, from being measured.

The limit value can be adjusted with the Radicalise calculation value for data formats 2 and 6 as a % of the measurement range.

Mains Power Frequency

You can adjust the frequency of the power supply here. Supported frequencies are 50 Hz and 60 Hz.

Input

The range of the input signal can be selected here.

Calculation Value

The calculation value in reference to the input signal can be selected here.

Remote Fault Alarm

Alarm message of a connected transmitter resulting from a defined fault current.

Designates the limit value (for example 21 mA Hi alarm) in reference to the set range (for example 4 mA ... 20 mA) of the input signal.

Filters

A value can be selected here by group for channels 0 to 3 and channels 4 to 7 to dampen (i.e. delay) the input signal.

Error Detection

If this field is set, error detection is turned on.

15.3.2.2 I/O settings for RSD-UO-Ex8.H

The device parameters can be set in the parameter window of the RSD-UO-Ex8.H.

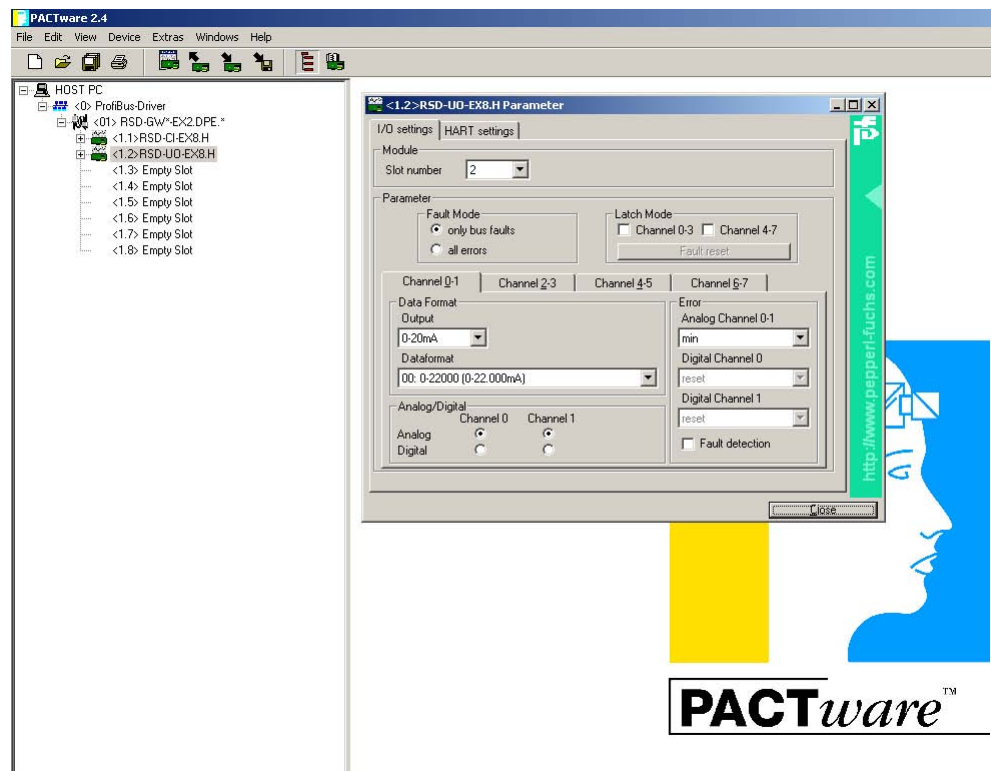

Slot Number

The slot number designates the position in the rack.

Error Mode

The field that is set indicates the setting of the error mode.

Latch Mode

Latch mode determines the effective direction of the outputs in the event of a broken line or overload. This setting can be adjusted by groups for channels 0 to 3 and 4 to 6. When Latch mode is set, the alarm status is saved until it is reset. If Latch mode is not set, the error continues to be generated until it is eliminated.

Data Format of the Outputs

The range of the output signal can be selected here.

Calculation Value

The calculation value in reference to the output signal can be selected here.

Fault

Determines the value to which the outputs will be set in analogue or digital mode.

Analogue/Digital

This setting determines whether the output should be operated as an analogue or digital switch output.

15.3.2.3 HART settings

The HART settings are identical for RSD-CI-Ex8.H and RSD-UO-Ex8.H.

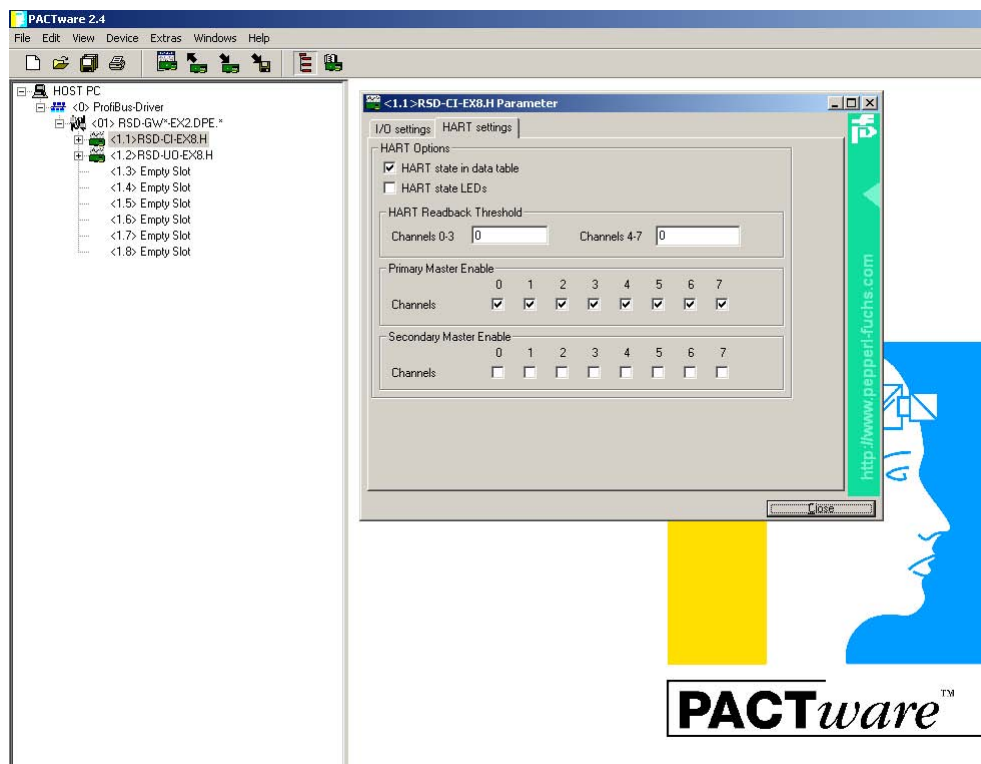

HART Status in data table

If this field is set, the status message HART channel OK/not OK is set for each channel and reported to the data table.

HART Status LEDs

If this field is set, the LEDs for HART diagnostic messages will be used. A change in status of the LEDs indicates HART communication. Each LED represents one HART channel. A flashing yellow LED indicates HART communication in the corresponding channel. A continuous yellow LED indicates that the device in question is on the device list.

HART Readback Threshold

This function can be used to compare the analogue measurement value with the digital measurement value. If the two values are different, a status message is generated.

The permissible deviation between the two values can be specified with a percentage value.

Primary Master Enable

This function can be used to turn off query of certain HART circuits. This serves to increase performance in terms of time.

Secondary Master Enable

The operating modes "Primary Master" and "Secondary Master" and the corresponding time responses are supported on the field device side. If Secondary Master is not set, no consideration will be given for the special time behaviour of an access to a secondary master. This does not minimise the HART cycle time. If Secondary Master is set, access is granted to a secondary master (for example a manual operation terminal).

15.3.3 Rebuild

You can use this function to set up the loops for all measurement circuits that were selected in the Primary Master Enable field.

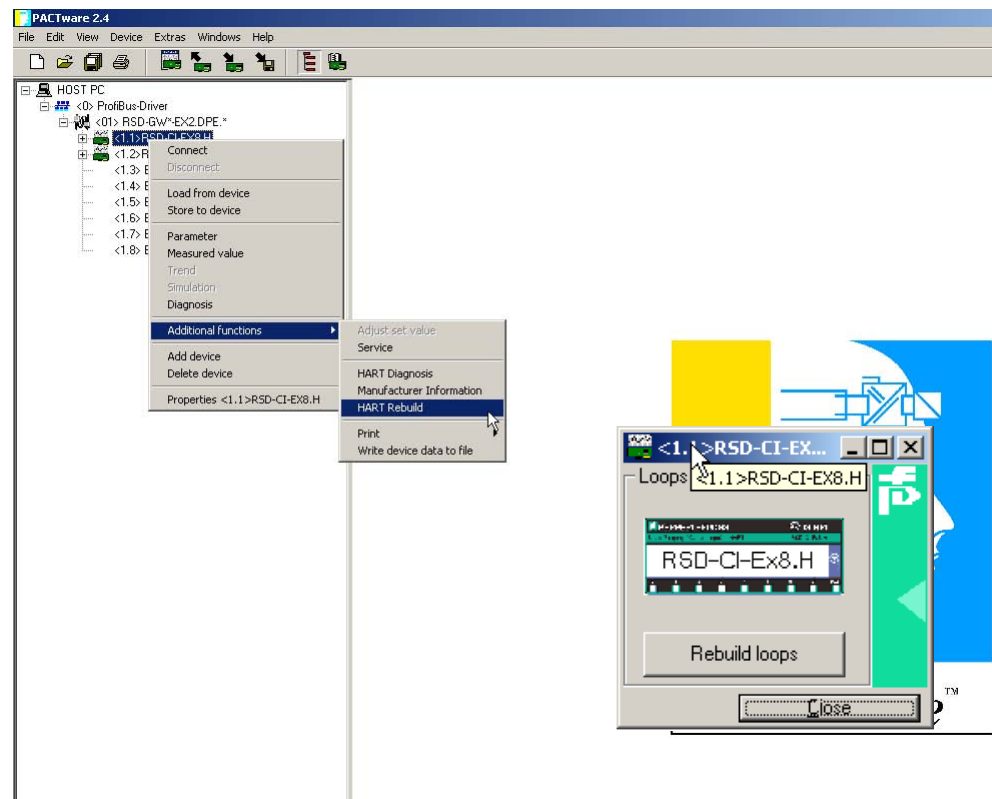

15.3.4 Field devices

15.3.4.1 Adding field devices to the project structure

In the project structure, select **RSD-CI-Ex8.H**.

In the **Add device** context menu, select an item, for example BARCON M V1.4.

15.3.4.2 Setting up a connection

To be able to download parameters from the device, a connection to the device must first be set up.

Once a connection with the device has been established, all DTMs that are involved are identified in bold type in the project window. At the same time, a green flashing area appears in the status line.

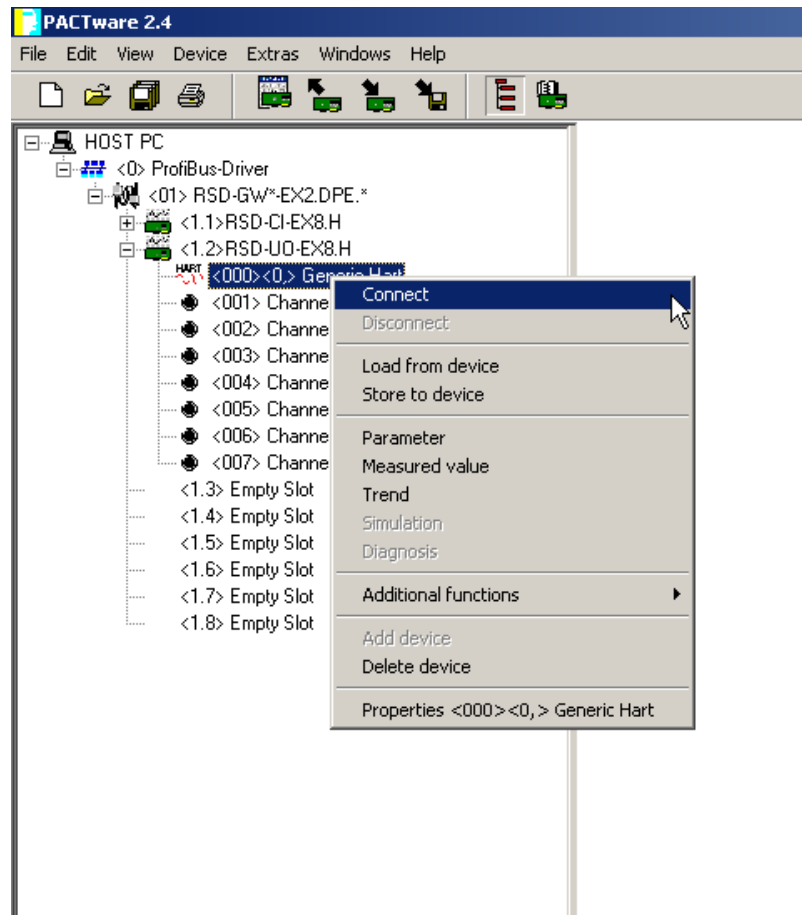

15.3.4.3 Loop address

The loop address is used to determine the position of the field device.

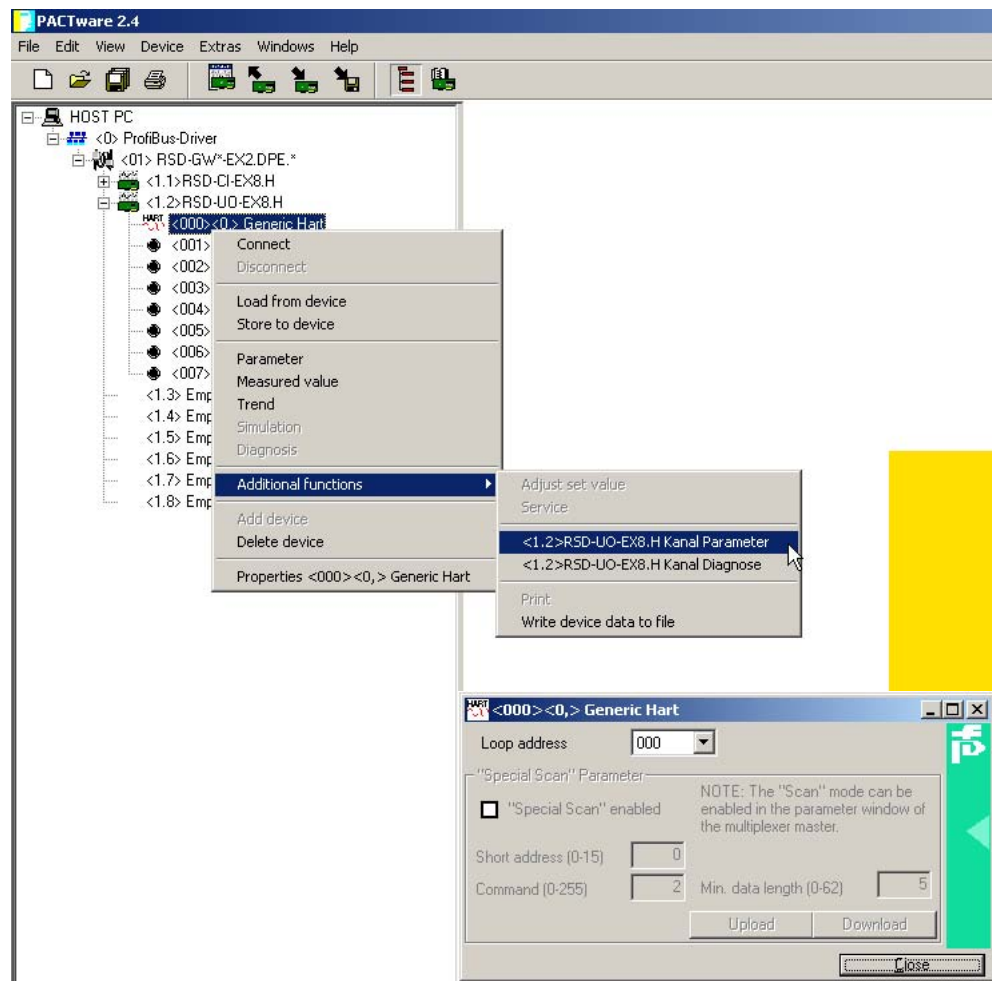

15.3.5 Diagnostics

15.3.5.1 Module diagnostics for RSD-CI-Ex8.H

The Diagnostics menu entry is used to display diagnostic information by channel for the RSD-CI-Ex8.H.

Remote Error

There is a display when a limit value is exceeded (remote fault alarm).

Local Error

There is a display for broken line or line short circuit.

Overrange Alarm

A display indicates when the measurement range has been exceeded.

Underrange Alarm

A display indicates when the actual value has fallen below the measurement range.

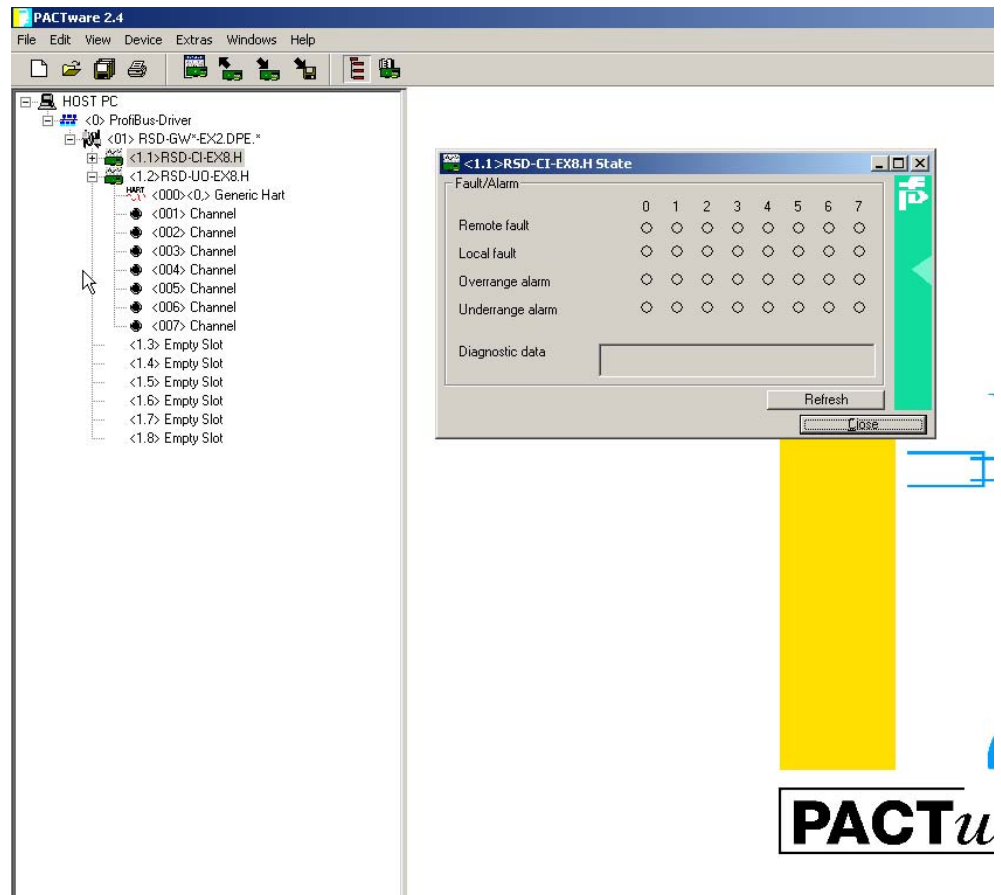

15.3.5.2 Module diagnostics for RSD-UO-Ex8.H

Error Alarm

A display indicates both broken line and line short circuit, as well as when a value has exceeded or fallen short of the measurement range.

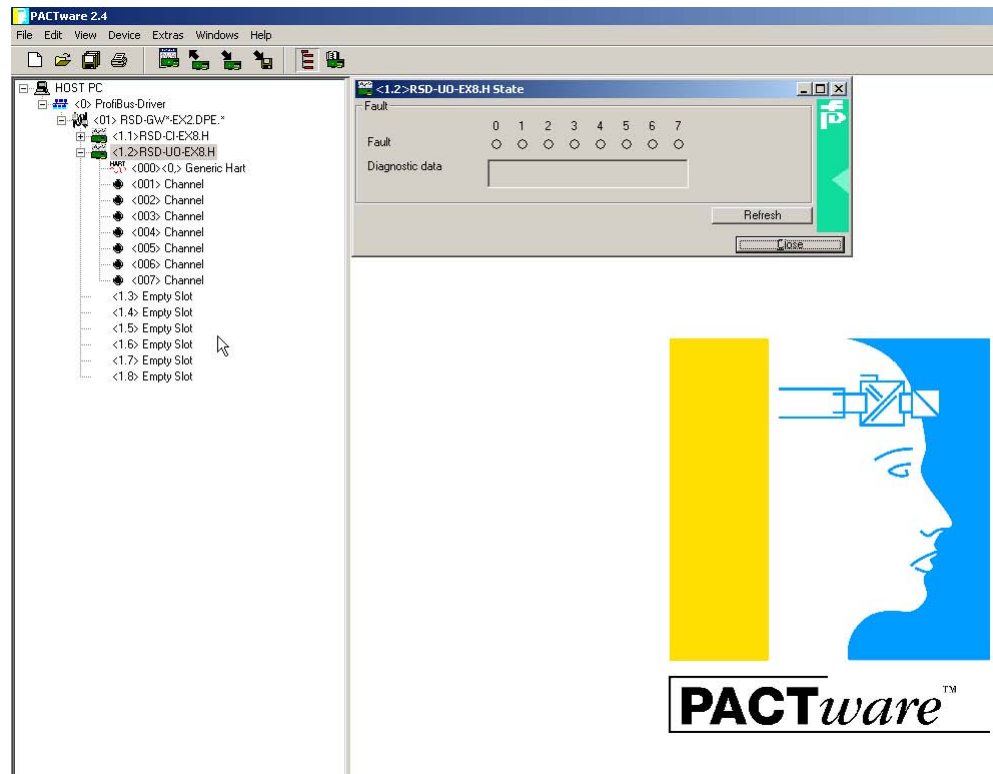

15.3.5.3 HART module diagnostics

Access to HART-related module diagnostics is possible in the following way.

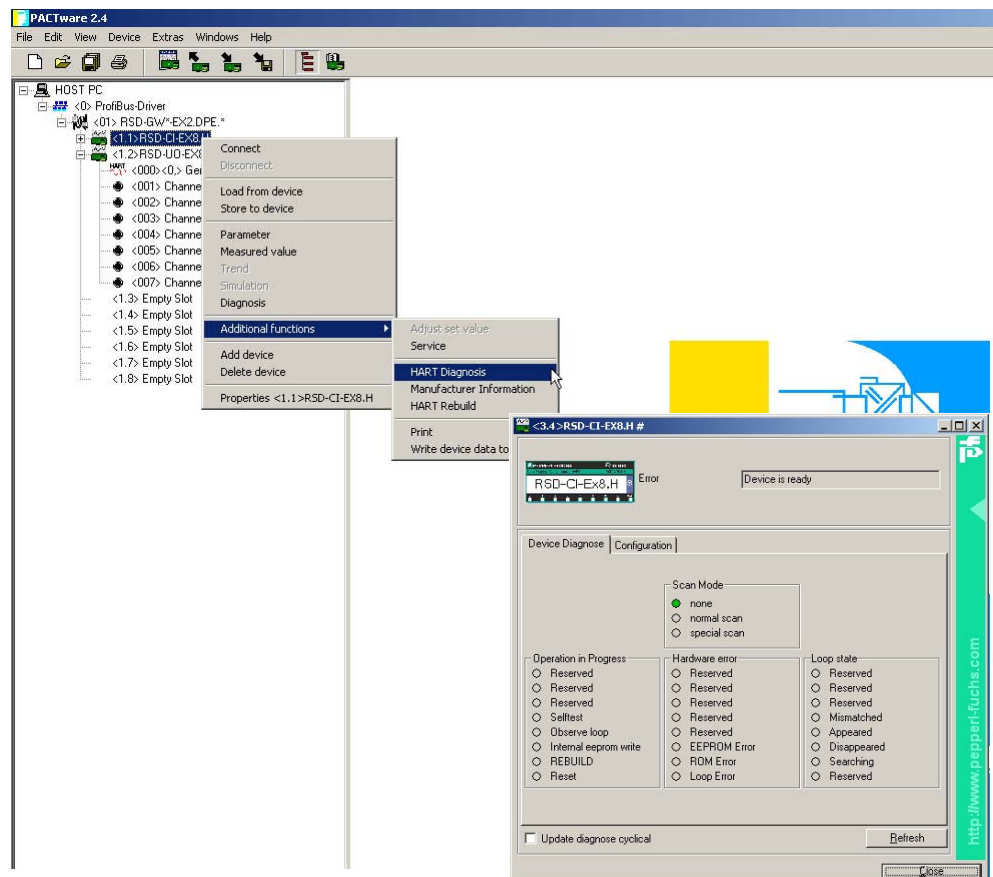

15.3.6 HART channel diagnostics

Access to HART-related diagnostics in the field device is possible in the following way.

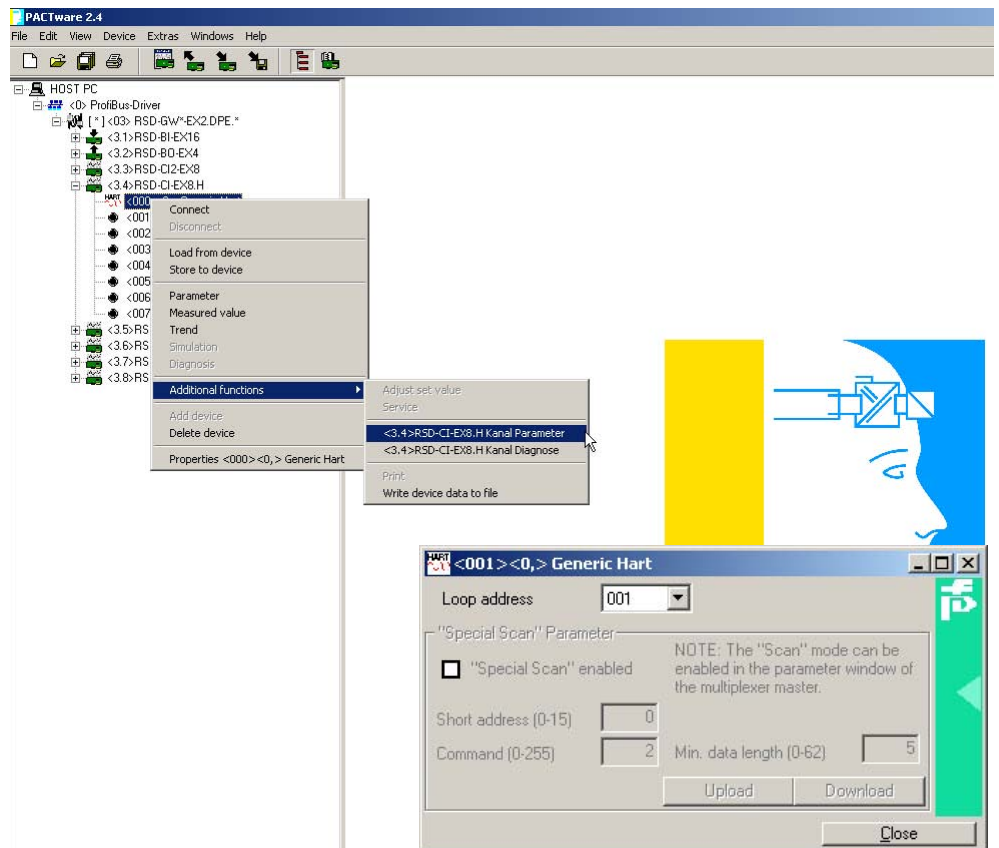

A loop can be set up to the field device connected on this channel using the HART channel diagnostics of the RSD-CI-Ex8.H. The HART long address of the field device is displayed.

15.4 Commissioning

15.4.1 Checklist for commissioning

The following checklist summarises tasks to perform to place the HART functionality of the RSD-CI(UO)-Ex8.H in service. You should follow the list through in sequence, actions that have already been carried out can be skipped. The usual commissioning procedure is as follows:

- Installation
- Installation of field devices
- Connecting the maintenance station
- Operation
- Wait for the procedure that turns the system on (I/O module, bus, PC etc.)
- Parameter assignment for the desired channels
- Perform the loop setup (REBUILD)

Commissioning monitoring on the RSD-CI(UO)-Ex8.H

You can use the configuration "HART Status LED" to monitor the REBUILD process in terms of the status LEDs on RSD-CI(UO)-Ex8.H. (see also section 15.1.7)

15.4.2 Data access to connected field devices

The way in which data access to the connected field devices can take place depends on the operator tool that is being used. Generally, however, the field devices in a project tree are located underneath the RSD-CI(UO)-Ex8.H, where access to device data, parameters and diagnostics is possible through menu functions. A project tree of this type is described in section 15.3.1.

The data, parameters and diagnostic windows accommodate data for the underlying HART commands, which differ considerably depending on the field device. Only the "universal" commands and general response codes are available for all devices in the same manner, making it possible for information about the devices themselves and process values and some diagnostics information to be displayed in a uniform way.

15.5 Diagnostics and error handling

15.5.1 General

This section provides operating information when errors occur and describes possible causes of errors.



Note

Faults and malfunctions are reported as follows:

- *Light diodes (see section 15.1.7 and section 15.5.2)*
- *Status/response code (see section 15.5.3)*

15.5.2 LEDs

You can use the configuration "HART Status LED" to monitor the REBUILD process in terms of the status LEDs on RSD-CI(UO)-Ex8.H. (see also section 15.1.7)

Colour	Meaning
Yellow continuous	HART field device detected
Yellow continuous with brief flashing	HART field device detected, verification of status performed on field device during brief flashing
Yellow flashing quickly	The current loop is currently being loaded with HART commands to establish a connection with a field device

15.5.3 Status/response code (response code)



As a rule, the following sources are available for status message in a HART system such as IS-RPI.

- a. Two status bytes, also referred to as the "Response code" are contained in every message from a field device. They contain the information types communication error and device status.
- b. An extended status that can be requested by the field device with Command 48 after the status bytes are displayed (see point a)).
- c. Command-specific response code
- d. For the IS-RPI-HART system, addition to a) ... c), the HART status of the RSD-CI-(UO)-Ex8 must be retrieved cyclically. The cycle time is deterministic. Depending on the configuration, it may last 32 ... 72 seconds.

The results of items a)..d) are recorded in a maintenance station, decoded and displayed in plain text. On **PACTware™** see section 15.3.1.









15.6 Appendix

15.6.1 Supported commands



The following tables show the HART commands that are supported by the IS-RPI-HART Multiplexer, arranged by three groups "Universal", "Common-practice" and "Device-specific". Read commands are identified with  and write commands are identified with .

The "Universal" and "Common-practice" commands are described in detail in /1/. In this section only the functions are explained, not the data structure of the lower layer of the HART protocol.







"Universal" commands:

Command	Action	Meaning	
0		Read unique device identification	The 12-byte device ID follows as a response.
11		Read unique device identification using the "tag"	The 12-byte device ID follows as a response if the specified measuring point designation (tag) matches the one stored in the Multiplexer.
12		Read "Message"	The 32-digit message is read (see also command 17).
13		Read designation of measuring point, description and date	Read the 8-digit designation of the measuring point (tag), the 16-digit description and the date.
16		Read "Final Assembly Number"	Final assembly number is read.
17		Save "message"	The 32-digit message is written (see also command 12).
18		Save designation of measurement point (tag), description and date	Save an 8-digit (tag), a 16-digit description and a date
19		Write "Final Assembly Number"	Final assembly number is written.

"Common practice" commands:

Command	Action	Meaning	
38		Reset the status of "Configuration changed"	Delete status message
42		Perform device reset	A reset of the device HART processor is performed immediately after the command is confirmed.

"Device-specific" commands:

Command	Action	Meaning
130		Field device list The addresses of field devices detected on the current loop are returned
133		Delete field devices from the field device list Field devices with the specified extended address will be deleted from the list of field devices.
144		Read number of telegram repetitions Repetitions with "Busy": 0 ... 11 (default setting is 0); Repetitions with communication errors: 0 ... 11 (default setting 2).
145		Write number of telegram repetitions
154		Perform "rebuild" of up to 8 specified loops see section 15.1.4
162		Read "HART loop medium access" Configures the access process to match the current loop 0 = HART-compliant 1 = Secondary Master OFF 2 = Secondary Master and burst mode OFF
163		Write "HART loop medium access" Configures the access process to match the current loop 0 = HART-compliant 1 = Secondary Master OFF 2 = Secondary Master and burst mode OFF

15.6.2 Literature

- /1/	- HART Communication Foundation: - HART - SMART Communications Protocol Specification - HCF SPEC-11, Revision 5.9 - www.hartcomm.org
- /2/	- HART Communication Foundation: - HART Application Guide - HCF LIT 34 - www.hartcomm.org
- /3/	- Romilly Bowden, Fisher-Rosemount: - HART- A technical Overview, August 1997 - Fisher-Rosemount

15.6.3 Glossary

Address	In communication systems, an address is used to identify the device to which a message is directed. HART uses two forms of addressing: in the range 0 to 15, the polling address, which consists of 38 bits. Polling address 0 is reserved for 4 mA ... 20 mA analogue field devices in --> point-to-point connections. Polling addresses 1 ... 15 are reserved for field devices in --> Multidrop connections.
Broadcast Mode	--> Burst Mode
Burst Mode	A communication mode in which the field devices are instructed by the Master to send process values continuously (for example the --> primary variable) without any additional prompting from the Master.
Extended address	--> Address
FSK	Abbreviation for Frequency Shift Keying. Method of coding the two digital signals "0" and "1" with two different frequencies.
HART	Abbreviation for Highway Addressable Remote Transducer. Designation for communication based on the HART protocol. HART is a --> Master-Slave system.
Host	A higher-level system, for example a maintenance station, PC or control system.
Polling address	--> Address
Master	A device (for example the control system) in a --> Master/Slave system that initiates all transmission requests and commands.
Master/Slave system	A communication system in which all transmission requests and commands are initiated by a --> Master and responded to by a --> Slave.
Multidrop	In contrast to --> Point-to-point, multiple (field) devices can be connected to a single segment (wire pair). To make it possible to access each device individually, it must have a unique --> address. Because communication can only be established to one field device, cycle times increase proportionately to the number of field devices. In HART multidrop operation the current through each field device is fixed at 4 mA to allow parallel operation of more than one device (up to 15 devices are possible).
Multimaster	Two masters may be connected for HART communication, one primary and one secondary. A high level station is configured as primary master, usually this is the process control system or the main service station. A lower level station is configured as secondary master, this may be a hand terminal or a maintenance station. The difference between primary and secondary master is the priority of the bus access: the primary master has a higher priority than the secondary master. Messages sent by the masters are characterised by a master bit, so that the masters can recognise which responses are intended for them.
Primary variable	A process measurement value of the field device. The unit is distinguished based on the HART command (see Commands 1, 2 and 3). For example, the primary variable of a pressure sensor could contain the measured process pressure in the unit "bar".
Primary master	--> Multimaster

Point-to-point	In point-to-point connections, only two communication stations can be connected to a segment (wire pair). An example of a point-to-point connection is the master/slave connection between a Multiplexer and a field device.
Secondary variable	An additional value (process measurement value) of the field device (up to four additional values are supported by HART). This variable can only be read by HART Command 3.
Secondary master Slave	--> Multimaster A device (for example a field device or valve) in a --> Master/slave system that receives commands from a --> Master. A slave is not able to initiate a transaction.
"Smart" field device	An intelligent programmable field device with a microprocessor and memory that is able to perform calculations, self-diagnostics and error reports and can communicate with a remote control unit.
Tag	Unique designation of the process measuring and control position of the field device within the process system.

16 Appendix

16.1 Structure of the real-time data table

The following table gives an overview of the length of supported module status words, input data words, output data words, channel status words and configuration data words

Module designation	Module status words	Input data words	Channel status words	Output data words	Configuration data words
RSD-BI-Ex16	1	1	1	–	1
RSD-BO-Ex4	1	–	1	1	1
RSD-CI(2)-Ex8	1	8	4	–	3
RSD-UO-Ex8	1	–	2	9	4
RSD-TI(2)-Ex8	1	8	3	–	4
RSD-FI-Ex2	1	4	3	–	8
RSD-CI-Ex8.H	1	8	5	–	2/2 (acyclic channel)
RSD-UO-Ex8.H	1	–	4	9	11/2 (acyclic channel)

16.2 Structure of the expanded data table (via the acyclic channel of IS-RPI)

If you want to set parameters for functions/settings such as data format and parameters of limit values for error messages, etc. you must do so with the acyclic channel of IS-RPI (see also section 12.4.4 and section 12.4.6).

Module designation	Configuration data words	Extended configuration data words
RSD-CI-Ex8.H	2	2
RSD-UO-Ex8.H	11*	2

* If the RSD-UO-Ex8.H configured via User_Parameter, only 3 words parameter are required. Anyway will be transferred 11 words parameters via the acyclic channel of IS-RPI. If the RSD-UO-Ex8.H configured via the acyclic PROFIBUS DP V1 telegrams, must also be transferred 11 words.

16.3 Content of real-time data tables, module-related

The following tables represent real-time data tables of individual IS-RPI modules. For additional information on the meaning or content of the individual words, please refer to section 12.4.

16.3.1 Data table for RSD-BI-Ex16 (module status word = 0200_h)

Word/ type	R/W	Page	Bit																
			15	14	13	12	11	10	9	8	7	6	5	4	3	2	1	0	
0/I	R	0	Bus faults bits				# W	# read words				module ID/type							
1/I	R	0	IN K15	IN K14	IN K13	IN K12	IN K11	IN K10	IN K9	IN K8	IN K7	IN K6	IN K5	IN K4	IN K3	IN K2	IN K1	IN K0	
2/S	R	0	FA K15	FA K14	FA K13	FA K12	FA K11	FA K10	FA K9	FA K8	FA K7	FA K6	FA K5	FA K4	FA K3	FA K2	FA K1	FA K0	
2/S	R	0	Input 15 counter																
3/C	W	0	–	–	CF	CR	–	–	F/C	–	–	–	Input filter K12 ... K15			Input filter K0 ... K11 Alarm filter K0 ... K15			

16.3.2 Data table for RSD-BO-Ex4 (module status word = 0101_h)

Word/ type	R/W	Page	Bit																
			15	14	13	12	11	10	9	8	7	6	5	4	3	2	1	0	
0/I	R	0	Bus faults bits				# W	# read words				module ID/type							
1/S	R	0	OA K3	OA K2	OA K1	OA K0	FA K3	FA K2	FA K1	FA K0	–	–	–	–	–	–	–	–	
2/O	W	0	com F	LM	Re-served	Re-served	FM K3	FM K2	FM K1	FM K0	FS K3	FS K2	FS K1	FS K0	OD K3	OD K2	OD K1	OD K0	
3/C	W	0	–	–	–	–	–	–	–	FR	–	–	–	–	–	–	–	Error/overload Alarm filter K0 ... K3	

16.3.3 Data table for RSD-CI-Ex8 (module status word = 1C00_h) and RSD-CI2-Ex8 (module status word = 1C03_h)

Word/ type	R/W	Page	Bit																
			15	14	13	12	11	10	9	8	7	6	5	4	3	2	1	0	
0/I	R	0	Bus faults bits				# W	# read words				Module ID/type							
1/I	R	0	Input data word K0																
2/I	R	0	Input data word K1																
3/I	R	0	Input data word K2																
4/I	R	0	Input data word K3																
5/I	R	0	Input data word K4																
6/I	R	0	Input data word K5																
7/I	R	0	Input data word K6																
8/I	R	0	Input data word K7																
9/S	R	0	OR AL K7	OR AL K6	OR AL K5	OR AL K4	OR AL K3	OR AL K2	OR AL K1	OR AL K0	UR AL K7	UR AL K6	UR AL K5	UR AL K4	UR AL K3	UR AL K2	UR AL K1	UR AL K0	
10/S	R	0	RE F K7	RE F K6	RE F K5	RE F K4	RE F K3	RE F K2	RE F K1	RE F K0	loc FA K7	loc FA K6	loc FA K5	loc FA K4	loc FA K3	loc FA K2	loc FA K1	loc FA K0	
11/S*	R	0	–	–	–	–	–	–	–	–	–	–	–	–	–	–	–	Diagnostic data	
12/S*	R	0	resp flag	MODULE command response							MODULE command response data								
13/C	W	0	com F	–	Upper and lower error limit in 0.1 mA steps K0 ... K3				RT u/d K0 ... K3	Limit frequency filter K0 ... K3			Data format K0 ... K3			FM K0 ... K3			
14/C	W	0	sqrt TH	–	Upper and lower error limit in 0.1 mA steps K4 ... K7				RT u/d K4 ... K7	Limit frequency filter K4 ... K7			Data format K4 ... K7			FM K4 ... K7			
15/C	W	0	cmd flag	MODULE command							MODULE command data								

* When using certain GSD files the status words marked with * are **not** included in the transmission (see table page 172).

16.3.4 Data table for RSD-CI-Ex8.H (module status word = 1E3F_h)

Word/ type	R/W	Page	Bit																
			15	14	13	12	11	10	9	8	7	6	5	4	3	2	1	0	
0/I	R	0	Bus faults bits				# W	# Read words (0xE)				Module ID/type (0x3F)							
1/I	R	0	PUCfg	Reserved				Communication status				Communication data byte							
2/I	R	0	Input data word K0																
3/I	R	0	Input data word K1																
4/I	R	0	Input data word K2																
5/I	R	0	Input data word K3																
6/I	R	0	Input data word K4																
7/I	R	0	Input data word K5																
8/I	R	0	Input data word K6																
9/I	R	0	Input data word K7																
10/S	R	0	OR AL K7	OR AL K6	OR AL K5	OR AL K4	OR AL K3	OR AL K2	OR AL K1	OR AL K0	UR AL K7	UR AL K6	UR AL K5	UR AL K4	UR AL K3	UR AL K2	UR AL K1	UR AL K0	
11/S	R	0	RE F K7	RE F K6	RE F K5	RE F K4	RE F K3	RE F K2	RE F K1	RE F K0	loc FA K7	loc FA K6	loc FA K5	loc FA K4	loc FA K3	loc FA K2	loc FA K1	loc FA K0	
12/S*	R	0	Reserved								HART Rebuild	–	–	–	Diagnostic data				
13/S*	R	0	HART Read Back								HART Failure								
14/S*	R	0	HART Transmitter List								HART Communication								
15/C	W	0	PROG/ RUN	Reserved				Communication control				Communication data byte							

* When using certain GSD files the status words marked with * are **not** included in the transmission (see table page 172).

16.3.5 Data table for RSD-UO-Ex8 (module status word = 1200_h)

Word/ type	R/W	Page	Bit																
			15	14	13	12	11	10	9	8	7	6	5	4	3	2	1	0	
0/I	R	0	Bus faults bits				# W	# read words				Module ID/type							
1/S	R	0	loc FA K7	loc FA K6	loc FA K5	loc FA K4	loc FA K3	loc FA K2	loc FA K1	loc FA K0	–	–	–	–	Diagnostic data				
2/S*	R	0	resp flag	MODULE command response							MODULE command response data								
3/O	W	0	com F	FR	–	–	–	–	–	–	dig OUT K7	dig OUT K6	dig OUT K5	dig OUT K4	dig OUT K3	dig OUT K2	dig OUT K1	dig OUT K0	
4/O	W	0	Output data word K0																
5/O	W	0	Output data word K1																
6/O	W	0	Output data word K2																
7/O	W	0	Output data word K3																
8/O	W	0	Output data word K4																
9/O	W	0	Output data word K5																
10/O	W	0	Output data word K6																
11/O	W	0	Output data word K7																
12/C	W	0	LFM	–	FM K2 ... K3	FM K0 ... K1	AFS K2 ... K3	AFS K0 ... K1	Data format K2 ... K3				Data format K0 ... K1						
13/C	W	0	LM K4 ... K7	LM K0 ... K3	FM K6 ... K7	FM K4 ... K5	AFS K6 ... K7	AFS K4 ... K5	Data format K6 ... K7				Data format K4 ... K5						
14/C	W	0	DFS K7	DFS K6	DFS K5	DFS K4	DFS K3	DFS K2	DFS K1	DFS K0	a/d K7	a/d K6	a/d K5	a/d K4	a/d K3	a/d K2	a/d K1	a/d K0	
15/C	W	0	cmd flag	MODULE command							MODULE command data								

* When using certain GSD files the status word marked with * are **not** included in the transmission (see table page 172).

16.3.6 Data table for RSD-UO-Ex8.H (module status word = 153F_h)

Word/ type	R/W	Page	Bit																
			15	14	13	12	11	10	9	8	7	6	5	4	3	2	1	0	
0/I	R	0	Bus faults bits				# W	# read words				Module ID/type							
			0			1		5				3F _{hex}							
1/I	R	0	PUCfg	Reserved			Communication status				Communication data byte								
2/S	R	0	FA K7	FA K6	FA K5	FA K4	FA K3	FA K2	FA K1	FA K0	HART Rebuild	–	–	–	Diagnostic data				
3/S*	R	0	Reserved																
4/S*	R	0	HART Read Back								HART Failure								
5/S*	R	0	HART Transmitter List								HART Communication								
6	W	0	PROG/ RUN	Reserved			Communication control				Communication data byte								
7/O	W	0	–	FR	–	–	–	–	–	–	dig OUT K7	dig OUT K6	dig OUT K5	dig OUT K4	dig OUT K3	dig OUT K2	dig OUT K1	dig OUT K0	
8/O	W	0	Output data word K0																
9/O	W	0	Output data word K1																
10/O	W	0	Output data word K2																
11/O	W	0	Output data word K3																
12/O	W	0	Output data word K4																
13/O	W	0	Output data word K5																
14/O	W	0	Output data word K6																
15/O	W	0	Output data word K7																

* When using certain GSD files the status words marked with * are **not** included in the transmission (see table page 172).

16.3.7 Data table for RSD-TI-Ex8 and RSD-TI2-Ex8 (module status word = 1B02_h)

Word/ type	R/W	Page	Bit															
			15	14	13	12	11	10	9	8	7	6	5	4	3	2	1	0
0/I	R	0	Bus faults bits			# W	# read words				Module ID/type							
1/I	R	0	Input data word K0															
2/I	R	0	Input data word K1															
3/I	R	0	Input data word K2															
4/I	R	0	Input data word K3															
5/I	R	0	Input data word K4															
6/I	R	0	Input data word K5															
7/I	R	0	Input data word K6															
8/I	R	0	Input data word K7															
9/S	R	0	OR AL K7	OR AL K6	OR AL K5	OR AL K4	OR AL K3	OR AL K2	OR AL K1	OR AL K0	UR AL K7	UR AL K6	UR AL K5	UR AL K4	UR AL K3	UR AL K2	UR AL K1	UR AL K0
10/S	R	0	loc FA K7	loc FA K6	loc FA K5	loc FA K4	loc FA K3	loc FA K2	loc FA K1	loc FA K0	–	CJC AL1	CJC AL2	–	Diagnostic data			
11/S*	R	0	resp flag	MODULE command response						MODULE command response data								
12/C	W	0	com F	–	–	–	Data format K0 ... K7				FM K4 ... K7	FM K0 ... K3	RJ K0 ... K7		Limit frequency filter K0 ... K7			
13/C	W	0	SE sel K4 ... K7	SM K4 ... K7			ST sel K4 ... K7				SE sel K0 ... K3		SM K0 ... K3		ST sel K0 ... K3			
14/C	W	0	RTD ofs K7	RTD ofs K6		RTD ofs K5		RTD ofs K4		RTD ofs K3			RTD ofs K2		RTD ofs K1		RTD ofs K0	
15/C	W	0	cmd flag	MODULE command						MODULE command data								

* When using certain GSD files the status word marked with * are **not** included in the transmission (see table page 172).

16.3.8 Data table for RSD-FI-Ex2 (module status word = 1700_h)

Word/ type	R/W	Page	Bit															
			15	14	13	12	11	10	9	8	7	6	5	4	3	2	1	0
0/I	R	0	Bus faults bits			# W	# read words				Module ID/type							
1/I	R	0	K0, frequency (2 data formats to select from)															
2/I	R	0	K0, frequency as a % of the measuring range or acceleration value															
3/I	R	0	K1, frequency (2 data formats to select from)															
4/I	R	0	K1, frequency as a % of the measuring range or acceleration value															
5/S	R	0	–	–	DI K0	GS K0	FR AL K0	FA K0	MP AL K0	–	–	DI K1	GS K1	FR AL K1	FA K1	MP AL K1		
6/S*	R	0	–	–	–	–	Diagnostic data, K0				–	–	–	mod cfg	Diagnostic data, K1			
7/S*	R	0	resp flag	MODULE command response						MODULE command response data								
8/C	W	0	com F	FST K0 ... K1	F RA K0	NOP K0		MPM K0		–	loc FM	F RA K1	NOP K1		MPM K1			
9/C	W	0	MFA K0															
10/C	W	0	FSD K0								FSM K0							
11/C	W	0	FG K0	FF K0	inv GI K0	inv FI K0	MFS K0				IS K0	ACT K0	FAA K0	DM K0	FDM K0			
12/C	W	0	MFA K1															
13/C	W	0	FSD K1								FSM K1							
14/C	W	0	FG K1	FF K1	inv GI K1	inv FI K1	MFS K1				IS K1	ACT K1	FAA K1	DM K1	FDM K1			
15/C	W	0	cmd flag	MODULE command						MODULE command data								

* When using certain GSD files the status words marked with * are **not** included in the transmission (see table page 172).



16.3.9 Status information of the GSD files

For the following GSD files some status information of the real time data tables are not included in the transmission. Details can be taken from the descriptions of the real time data tables in section 12 and section 16.

GSD-Datei	Gateway
PF04A8_3.gsd	RSD-GW3-Ex2.DPE
PF07B8_3.gsd	RSD-GW3-Ex2.DPE.ED
PF049C_2.gsd	RSD-GW2-Ex1.PA
PF07B7_2.gsd	RSD-GW2-Ex1.PA.ED

With regard to the supply of products, the current issue of the following document is applicable:
The General Terms of Delivery for Products and Services of the Electrical Industry, published by
the Central Association of the "Elektrotechnik und Elektroindustrie (ZVEI) e.V.",
including the supplementary clause: "Extended reservation of title".

PROCESS AUTOMATION – PROTECTING YOUR PROCESS



Worldwide Headquarters

Pepperl+Fuchs GmbH
68307 Mannheim · Germany
Tel. +49 621 776-0
E-mail: info@de.pepperl-fuchs.com

USA Headquarters

Pepperl+Fuchs Inc.
Twinsburg, Ohio 44087 · USA
Tel. +1 330 4253555
E-mail: sales@us.pepperl-fuchs.com

Asia Pacific Headquarters

Pepperl+Fuchs Pte Ltd.
Company Registration No. 199003130E
Singapore 139942
Tel. +65 67799091
E-mail: sales@sg.pepperl-fuchs.com

www.pepperl-fuchs.com

 **PEPPERL+FUCHS**
PROTECTING YOUR PROCESS

Subject to modifications
Copyright PEPPERL+FUCHS • Printed in Germany

DOCT-0145C

044174
01/2008