

MC3000

User Guide

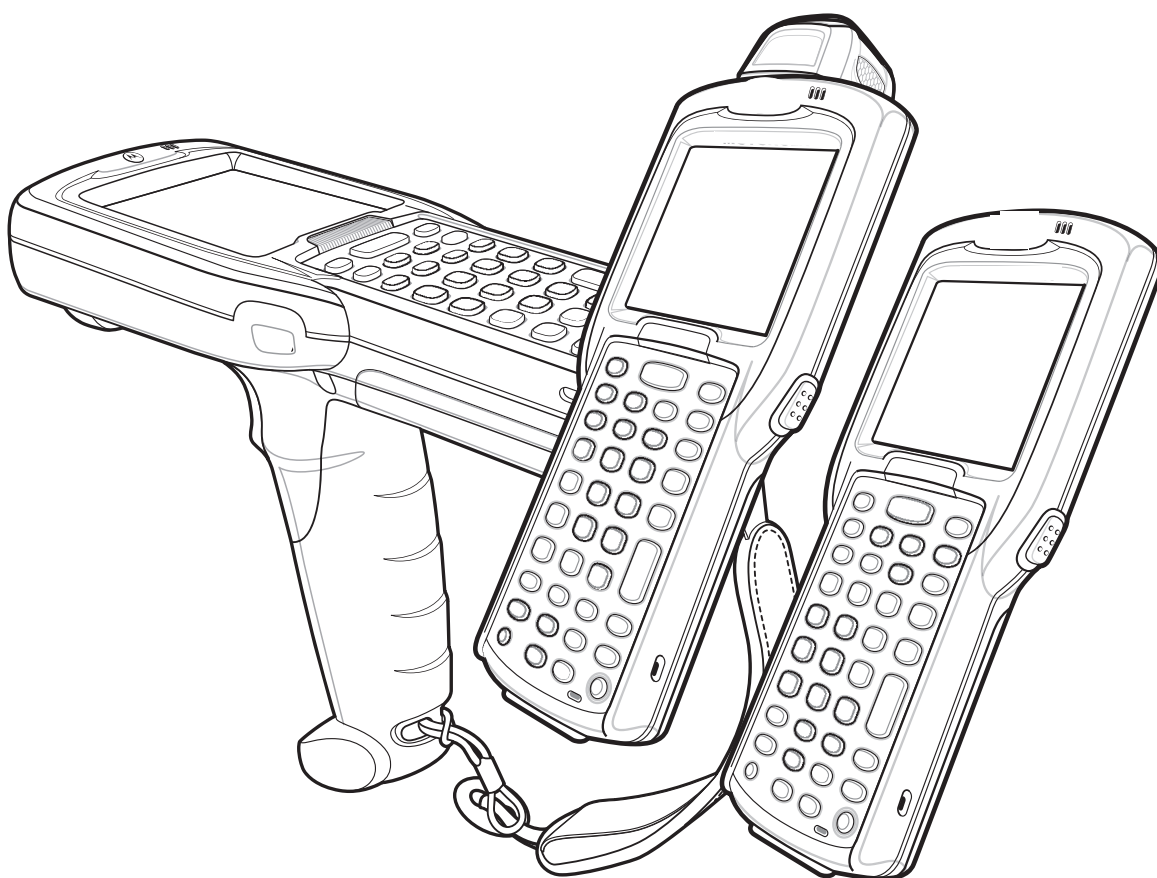

MC3000

User Guide

72E-68899-06

Revision A

April 2015

© 2015 ZIH Corp.

No part of this publication may be reproduced or used in any form, or by any electrical or mechanical means, without permission in writing from Zebra. This includes electronic or mechanical means, such as photocopying, recording, or information storage and retrieval systems. The material in this manual is subject to change without notice.

The software is provided strictly on an “as is” basis. All software, including firmware, furnished to the user is on a licensed basis. Zebra grants to the user a non-transferable and non-exclusive license to use each software or firmware program delivered hereunder (licensed program). Except as noted below, such license may not be assigned, sublicensed, or otherwise transferred by the user without prior written consent of Zebra. No right to copy a licensed program in whole or in part is granted, except as permitted under copyright law. The user shall not modify, merge, or incorporate any form or portion of a licensed program with other program material, create a derivative work from a licensed program, or use a licensed program in a network without written permission from Zebra. The user agrees to maintain Zebra’s copyright notice on the licensed programs delivered hereunder, and to include the same on any authorized copies it makes, in whole or in part. The user agrees not to decompile, disassemble, decode, or reverse engineer any licensed program delivered to the user or any portion thereof.

Zebra reserves the right to make changes to any software or product to improve reliability, function, or design.

Zebra does not assume any product liability arising out of, or in connection with, the application or use of any product, circuit, or application described herein.

No license is granted, either expressly or by implication, estoppel, or otherwise under any Zebra, intellectual property rights. An implied license only exists for equipment, circuits, and subsystems contained in Zebra products.

Revision History

Changes to the original manual are listed below:

Change	Date	Description
-01 Rev A	Dec. 2004	Initial Release
-01 Rev B	June 2005	Added Four Slot Ethernet cradle.
		Appendix A, added Accessory Specifications.
-02 Rev A	November 2005	Chapter 7, removed WZC, replaced with wireless application description. Global changes: Changed Windows CE.NET 4.2 to Windows CE.NET 5.0 Removed WZC references, replaced with wireless application references. Added 802.11a. Page 2-9 and 2-10 added Four Slot Ethernet cradle.
-02 Rev B	June 2006	Add Direct Part Marking information, MC3090S 128 MB RAM/64 MB Flash configuration and update SMDK information.
-03 Rev A	Jan 2007	Add 20-key mechanical keypad, Fusion 2.5, BT Profile application.
-04 Rev A	August 2007	Motorola re-branding, operating system update: OEM version 05.26.0000.
-05 Rev A	October 2008	Update guide to include WM6.1 configurations.
-06 Rev A	April 2015	Zebra Rebranding

Table of Contents

Revision History	iii
------------------------	-----

About This Guide

Introduction	xi
Documentation Set	xi
Configurations	xii
Software Versions	xii
Chapter Descriptions	xv
Notational Conventions	xv
Related Documents and Software	xvi
Service Information	xvi

Chapter 1: Getting Started

Introduction	1-1
Unpacking the Mobile Computer	1-1
Accessories	1-2
Parts	1-3
Rotating Scan Turret	1-4
Mobile Computer Startup	1-5
Install Main Battery	1-5
Battery Charging	1-7
Spare Battery Charging	1-9
Stylus	1-9
Starting the Mobile Computer	1-9
Calibration Screen	1-10
Waking the Mobile Computer	1-11
Main Battery Removal	1-11
Strap/Door Assembly Removal and Replacement (MC3000S/R)	1-12
Strap/Door Assembly Removal and Replacement (MC3090G)	1-13
Turning Off the Radios	1-14
On Device with Windows CE 5.0 (OEM Version 01.15 or lower)	1-14
WLAN Radio	1-14
Bluetooth Radio	1-15

On Device with Windows CE 5.0 (OEM Version 01.16 or higher)	1-15
WLAN Radio	1-15
Bluetooth Radio	1-15
On Devices with Windows Mobile 6.1	1-15

Chapter 2: Operating the MC3000

Introduction	2-1
Power Button	2-1
Keypads	2-1
Keypad Special Functions	2-2
20-Key Mechanical Keypad	2-3
28-Key Keypad	2-5
38-Key Keypad	2-8
48-Key Keypad	2-11
Windows CE Demo Window	2-13
Windows CE Desktop	2-13
Windows CE Status Icons	2-14
Battery Unknown Icon	2-15
Start Button	2-15
Programs Menu	2-16
Keyboard Input Panel Button	2-16
Desktop Display Button	2-16
Task Manager and Properties	2-17
Task Manager	2-17
Properties	2-18
Windows Mobile 6.1 Today Screen	2-19
Windows Mobile 6.1 Status Icons	2-19
Status Bar	2-19
Command Bar	2-20
Speaker Icon	2-21
Battery Icons	2-21
Connectivity Icon	2-22
Time Icon	2-22
E-Mail Icon	2-23
Multiple Notification Icon	2-23
Locking the Mobile Computer (Windows Mobile 6.1 Only)	2-24
Entering Information	2-25
Entering Information Using Keypad	2-25
Entering Information Using the Keyboard Input Panel	2-25
Entering Data via the Bar Code Scanner	2-25
Using a Bluetooth Headset	2-26
Data Capture	2-26
Laser Scanning	2-26
Scan LED Indicators	2-27
Scanning Considerations	2-27
Laser Decode Ranges	2-27
Imaging	2-29
Imager	2-29
Operational Modes	2-29

Aiming the Mobile Computer	2-30
Imager Decode Ranges	2-31
Direct Part Marking	2-33
Resetting the Mobile Computer	2-34
Windows CE Devices	2-34
Performing a Warm Boot	2-34
Performing a Cold Boot	2-34
Windows Mobile 6.1 Devices	2-35
Performing a Warm Boot	2-35
Performing a Cold Boot	2-35
Waking the Mobile Computer	2-35
File System Directory Structure	2-36
Connecting to the Internet on a Wireless LAN Network	2-36

Chapter 3: Using Bluetooth

Introduction	3-1
Security	3-2
Turning the Bluetooth Radio Mode On and Off	3-2
Disabling Bluetooth	3-2
Enabling Bluetooth	3-3
Bluetooth Power States	3-3
Cold Boot	3-3
Warm Boot	3-3
Suspend	3-4
Resume	3-4
Bluetooth Profiles	3-4
Modes	3-5
Wizard Mode	3-5
Explorer Mode	3-7
Discovering Bluetooth Device(s)	3-8
Bonding with Discovered Device(s)	3-9
Renaming a Bonded Device	3-11
Deleting a Bonded Device	3-11
Accepting a Bond	3-12
File Transfer Services	3-14
Create New File or Folder	3-14
Delete File	3-15
Get File	3-15
Put File	3-15
Connect to Internet Using Access Point	3-15
Dial-Up Networking Services	3-15
Add a Dial-up Entry	3-17
OBEX Object Push Services	3-18
Send a Picture	3-18
Headset Services	3-19
Serial Port Services	3-20
Personal Area Network Services	3-21
Bluetooth Settings	3-21
Device Info Tab	3-21

Services Tab	3-22
Dial-Up Networking Service	3-22
File Transfer Service	3-23
OBEX Object Push Service	3-24
Personal Area Networking Service	3-24
Serial Port Service	3-25
Headset Service	3-25
Security Tab	3-26
Discovery Tab	3-26
Virtual COM Port Tab	3-27
Miscellaneous Tab	3-28

Chapter 4: Accessories

Introduction	4-1
Cradles	4-1
Spare Battery Chargers	4-1
Cables	4-1
SD Card	4-2
Plastic Holster	4-2
Fabric Holster	4-2
Single Slot Serial/USB Cradle	4-2
Battery Charging	4-2
LED Charge Indications	4-3
Four Slot Cradles	4-5
Battery Charging	4-5
LED Charge Indications	4-6
Power LED	4-6
Speed LED	4-6
Link LED	4-6
Four Slot Spare Battery Charger	4-7
Spare Battery Charging	4-7
LED Charge Indications	4-8
Cables	4-8
Battery Charging and Operating Power	4-9
LED Charge Indications	4-9
Universal Battery Charger (UBC) Adapter	4-10
Spare Battery Charging	4-10
UBC Adapter LED Charge Indications	4-10
Secure Device Card (Windows CE 5.0 Only)	4-12
Plastic Holster	4-13
Fabric Holster	4-15
Belt Clip	4-15
Shoulder Strap	4-16

Chapter 5: Maintenance and Troubleshooting

Introduction	5-1
Maintaining the Mobile Computer	5-1
Battery Safety Guidelines	5-1

Troubleshooting	5-2
Mobile Computer	5-2
Single Slot Serial/USB Cradle	5-4
Four Slot Charge Only Cradle	5-5
Four Slot Ethernet Cradle	5-6
Four Slot Spare Battery Charger	5-6
UBC Adapter	5-7
Cables	5-8

Appendix A: Technical Specifications

Mobile Computer and Accessory Technical Specifications	A-1
--	-----

Appendix B: Keypad Functions/Special Characters

Introduction	B-1
Keypads	B-1

Appendix C: Regulatory

Introduction	C-1
Accessory Power Supply Regulatory Compliance	C-1

Glossary

Index

About This Guide

Introduction

This guide provides information about using the MC3000 mobile computers and accessories.

✓ **NOTE** Screens and windows pictured in this guide are samples and may differ from actual screens.

Documentation Set

The documentation set for the MC3000 is divided into guides that provide information for specific user needs.

- **Microsoft Applications for Windows Mobile and CE 5.0 User Guide** - describes how to use Microsoft developed applications.
- **Microsoft Applications for Windows Mobile 6 User Guide** - describes how to use Microsoft Windows Mobile 6 developed applications.
- **Application Guide for Zebra Devices** - describes how to use Zebra developed applications.
- **MC3000 User Guide** - describes how to use the MC3000 mobile computer.
- **MC3000 Integrator Guide** - describes how to set up the MC3000 mobile computer and the accessories.
- **EMDK Help File** - provides API information for writing applications.

Configurations

This guide covers the following configurations:

Configuration	Radios	Display	Memory	Data Capture	Operating System	Keypads
MC3000R	None	Color or monochrome	32 MB RAM/ 64 MB Flash or 64 MB RAM/ 64 MB Flash	1D laser scanner in rotating turret	Windows CE 5.0 Core or Professional	28, 38 or 48 key
MC3090G	WLAN: 802.11a/b/g WPAN: Bluetooth	Color or monochrome	32 MB RAM/ 64 MB Flash or 64 MB RAM/ 64 MB Flash	1D laser scanner or 2D imager	Windows CE 5.0 Core or Professional	28, 38 or 48 key
MC3090S	WLAN: 802.11a/b/g WPAN: Bluetooth	Color	64 MB RAM/ 64 MB Flash or 128 MB RAM/ 64 MB Flash or 128 MB RAM/ 64 MB Flash + 1GB Flash storage	1D laser scanner, 2D imager or DPM imager	Windows CE 5.0 Professional or Windows Mobile 6.1 Classic	28, 38, 48 key or 20 key Mechanical
MC3090R	WLAN: 802.11a/b/g WPAN: Bluetooth	Color or monochrome	32 MB RAM/ 64 MB Flash or 128 MB RAM/ 64 MB Flash + 1GB Flash storage	1D laser scanner in rotating turret	Windows CE 5.0 Core or Professional or Windows Mobile 6.1 Classic	28, 38, 48 key or 20 key Mechanical

Software Versions

This guide covers various software configurations and references are made to operating system or software versions for:

- Adaptation Kit Update (AKU) version
- OEM version
- BTExplorer version
- Fusion version.

AKU Version for Windows Mobile 6.1 Devices

To determine the Adaptation Kit Update (AKU) version on a Windows Mobile 6.1 device:

Tap **Start** > **Settings** > **System** tab > **About** icon > **Version** tab.

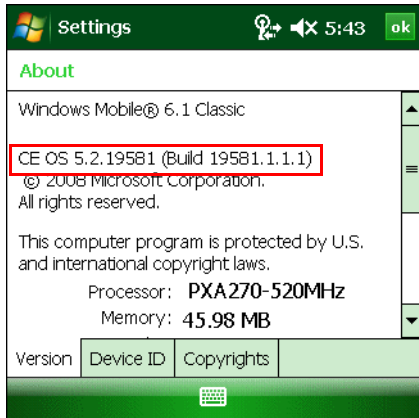

The second line lists the operating system version and the build number. The last part of the build number represents the AKU number. For example, *Build 119581.1.1.1* indicates that the device is running AKU version 1.1.1.

OEM Version on Windows Mobile 6.1 Devices

To determine the OEM software version on a Windows Mobile 6.1 device:

Tap **Start** > **Settings** > **System** tab > **System Information** icon > **System** tab.

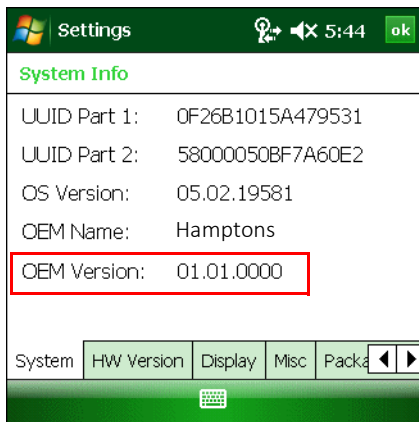

OEM Version on Windows CE 5.0 Devices

To determine the OEM software version on a Windows CE 5.0 device:

Tap **Start** > **Settings** > **Control Panel** > **System Info** icon > **System** tab.

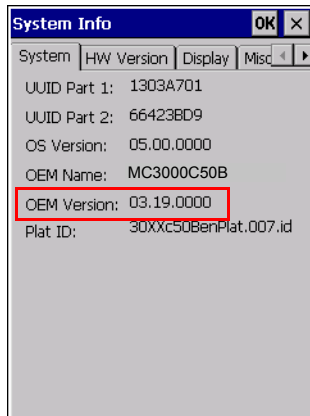

BTEplorer Software

To determine the BTEplorer software version on a Windows Mobile 6.1 or Windows CE 5.0 device:

Tap **BTEplorer** icon > **Show BTEplorer**> **File** > **About**.



Fusion Software

To determine the Fusion software version on a Windows Mobile 6.1 or Windows CE 5.0 device:

Tap **Wireless Strength** icon > **Wireless Status** > **Versions**.

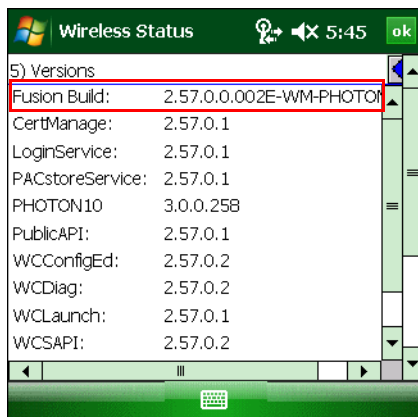

Chapter Descriptions

Topics covered in this guide are as follows:

- [Chapter 1, Getting Started](#), describes the mobile computer's physical characteristics, how to install and charge the batteries, remove and replace the Strap/Door assembly and how to start the mobile computer for the first time.
- [Chapter 2, Operating the MC3000](#), provides basic instructions for using the mobile computer and navigating the mobile computer software.
- [Chapter 3, Using Bluetooth](#), explains how to perform Bluetooth functionality on the mobile computer.
- [Chapter 4, Accessories](#), describes the accessories available for the mobile computer and how to use the accessories to charge the mobile computer.
- [Chapter 5, Maintenance and Troubleshooting](#), includes instructions on cleaning and storing the mobile computer, and provides troubleshooting solutions for potential problems during mobile computer operation.
- [Appendix A, Technical Specifications](#), includes a table listing the technical specifications for the mobile computer.
- [Appendix B, Keypad Functions/Special Characters](#), contains special character generation tables.
- [Appendix C, Regulatory](#), contains the accessory power supply regulatory compliance statements.

Notational Conventions

The following conventions are used in this document:

- The term “mobile computer” refers to the Zebra MC3000.
- *Italics* are used to highlight the following:
 - Chapters and sections in this and related documents
 - Dialog box, window and screen names
 - Drop-down list and list box names
 - Check box and radio button names
 - Icons on a screen.
- **Bold** text is used to highlight the following:
 - Key names on a keypad
 - Button names on a screen.
- Bullets (•) indicate:
 - Action items
 - Lists of alternatives
 - Lists of required steps that are not necessarily sequential.
- Sequential lists (e.g., those that describe step-by-step procedures) appear as numbered lists.

Related Documents and Software

The following items provide more information about the MC3000 mobile computers.

- *MC3000 Series Quick Start Guide*, p/n 72-68902-xx
- *MC3090G Quick Start Guide*, p/n 72-71347-xx
- *MC3000 Regulatory Guide for Windows Mobile 6*, p/n 72-114046-xx
- *MC3000 Licensing, Patent and Regulatory Information*, p/n 72-68903-xx
- *MC3000 Integrator Guide*, p/n 72E-68900-xx
- *Application Guide for Zebra Devices*, p/n 72E-68901-xx
- *Microsoft® Applications for Mobile and CE 5.0 User Guide*, p/n 72E-78456-xx
- *Microsoft® Applications for Mobile 6 User Guide*, p/n 72E-108299-xx
- *Enterprise Mobility Developer Kit (EMDK) Help File*, p/n 72E-38880-03
- *Windows CE Platform SDK for MC3000c50*, available at: <http://www.zebra.com/support>
- *Enterprise Mobility Developer Kit for C (EMDK for C)*, available at: <http://www.zebra.com/support>
- Device Configuration Package for MC3000 (DCP for MC3000), available at: <http://www.zebra.com/support>
- ActiveSync software, available at: <http://www.microsoft.com>.

For the latest version of this guide and all guides, go to: <http://www.zebra.com/support>.

Service Information

If you have a problem with your equipment, contact Zebra support for your region. Contact information is available at: <http://www.zebra.com/support>.

When contacting support, please have the following information available:

- Serial number of the unit
- Model number or product name
- Software type and version number

Zebra responds to calls by email, telephone or fax within the time limits set forth in support agreements.

If your problem cannot be solved by Zebra Support, you may need to return your equipment for servicing and will be given specific directions. Zebra is not responsible for any damages incurred during shipment if the approved shipping container is not used. Shipping the units improperly can possibly void the warranty.

If you purchased your business product from a Zebra business partner, contact that business partner for support.

Chapter 1 Getting Started

Introduction

This chapter describes the mobile computer physical characteristics, how to install and charge the batteries, how to remove and replace the Strap/Door Assembly and how to start the mobile computer for the first time.

Unpacking the Mobile Computer

Carefully remove all protective material from around the mobile computer and save the shipping container for later storage and shipping. Verify that the equipment listed below is included:

- MC3000 mobile computer
- Strap/Door Assembly, attached to the mobile computer
- Stylus
- Regulatory Guide
- Quick Start Guide.

Depending on the configuration ordered, the mobile computer shipping container or additional shipping container may include:

- Standard battery (lithium-polymer)
- Extended life battery (lithium-ion)
- Cable(s)
- Power supply
- Cradles.

Inspect the equipment for damage. If any equipment is missing or damaged, contact the Zebra Support immediately. See [Service Information on page xvi](#) for contact information.

Accessories

Table 1-1 lists the MC3000 accessories.

Table 1-1 MC3000 Accessories

Accessory	Description
Single Slot Serial/USB Cradle	Charges the mobile computer main battery and a spare battery, and synchronizes the mobile computer with a host computer through either a serial or USB connection.
Four Slot Charge Only Cradle	Charges up to four mobile computers.
Four Slot Ethernet Cradle	Charges up to four mobile computers and provides Ethernet communications.
Four Slot Spare Battery Charger	Charges up to four mobile computer spare batteries.
Power Supply	Country specific and accessory specific, power supply.
USB Client Charge Cable	Provides USB client communication capabilities and charges the mobile computer.
RS232 Charge Cable	Provides RS232 communication capabilities and charges the mobile computer.
O'Neil Printer Cable	Provides printer specific communication capabilities (provided by O'Neil).
Zebra Printer Cable	Provides printer specific communication capabilities (provided by Zebra).
Monarch Printer Cable	Provides printer specific communication capabilities (provided by Monarch).
Single Slot Cradle RS232 Cable	Provides serial host communication capabilities and charges the mobile computer.
Single Slot Cradle USB Cable	Provides USB communication capabilities and charges the mobile computer.
MC3000 Universal Battery Charger Adapter (UBC)	Adapts the UBC for use with MC3000 batteries.
Stylus	Performs pen and mouse functions.
Plastic Holster	Provides a clip on holder for the mobile computer.
Fabric Holster	Provides a soft, clip on holder and a shoulder strap for the mobile computer.
Enterprise Mobility Developer Kit for C (EMDK for C)	A development tool used to create native C and C++ applications for all Zebra mobile computers running the Microsoft Windows CE operating system. Available at: http://www.zebra.com/support .
Device Configuration Package (DCP) for MC3000	A development tool used to create and download hex images that represent flash partitions to the mobile computer. Available at: http://www.zebra.com/support .

Parts

There are three versions of the MC3000 mobile computers, the MC3000 1D/2D Imager (MC3000S or MC3090S), the MC3000 Laser with Rotating Scan Turret (MC3000R or MC3090R) and the MC3090 Gun (MC3090G). For more information on the Rotating Scan Turret, see [Figure 1-3 on page 1-4](#).

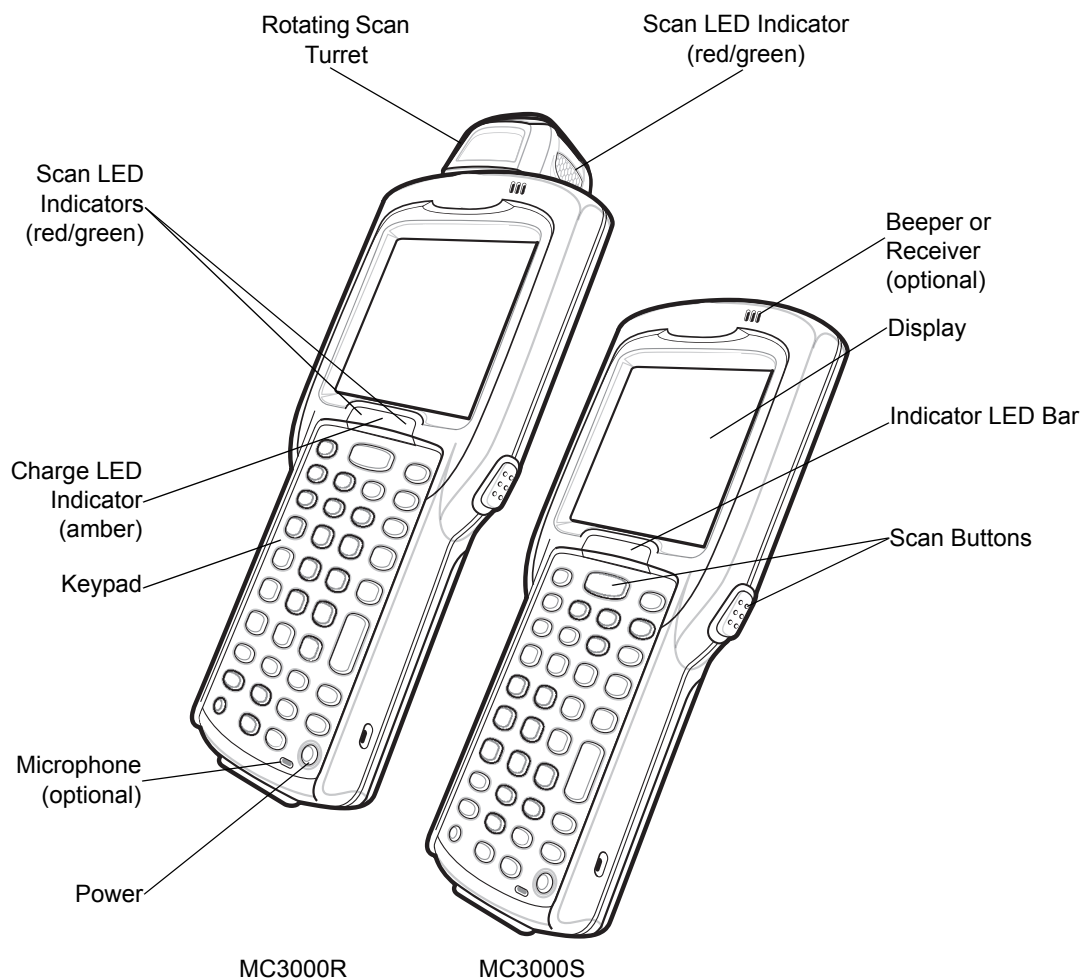

Figure 1-1 MC3000 Imager and MC3000 Laser Mobile Computers (Front View)

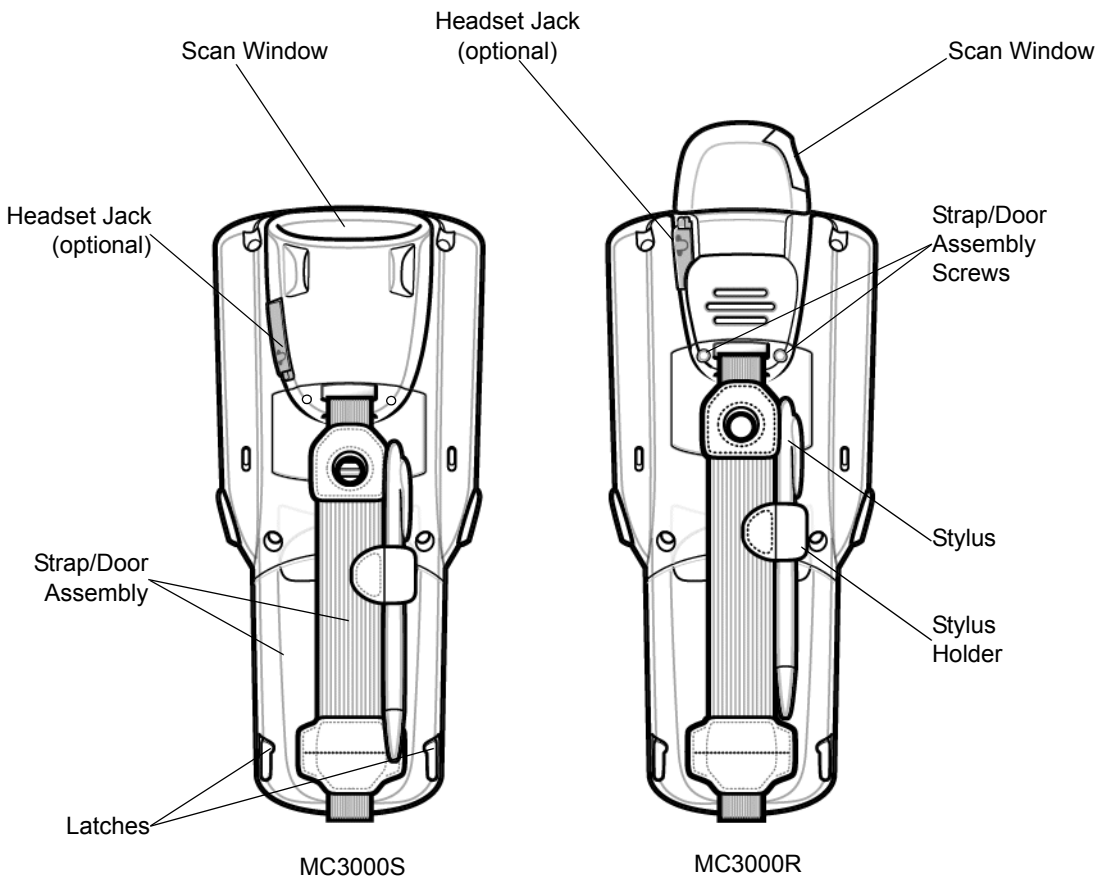

Figure 1-2 MC3000 Imager and MC3000 Laser Mobile Computers (Back View)

Rotating Scan Turret

The MC3000R mobile computer features a Rotating Scan Turret with three position stops. This feature offers greater scanning flexibility.

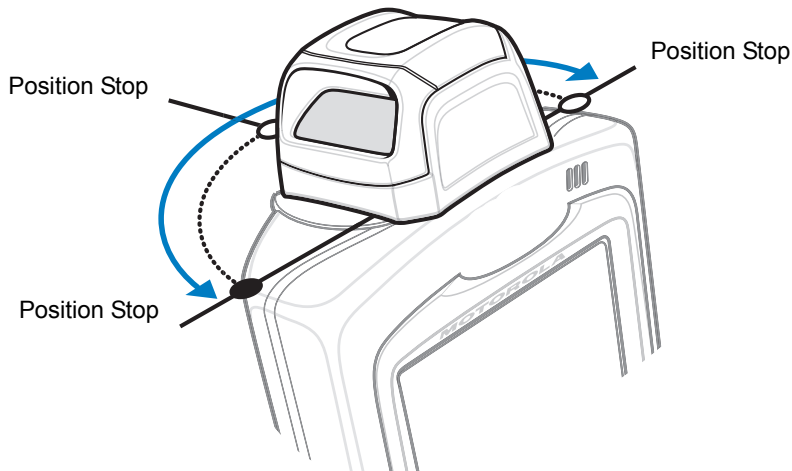

Figure 1-3 Rotating Scan Turret

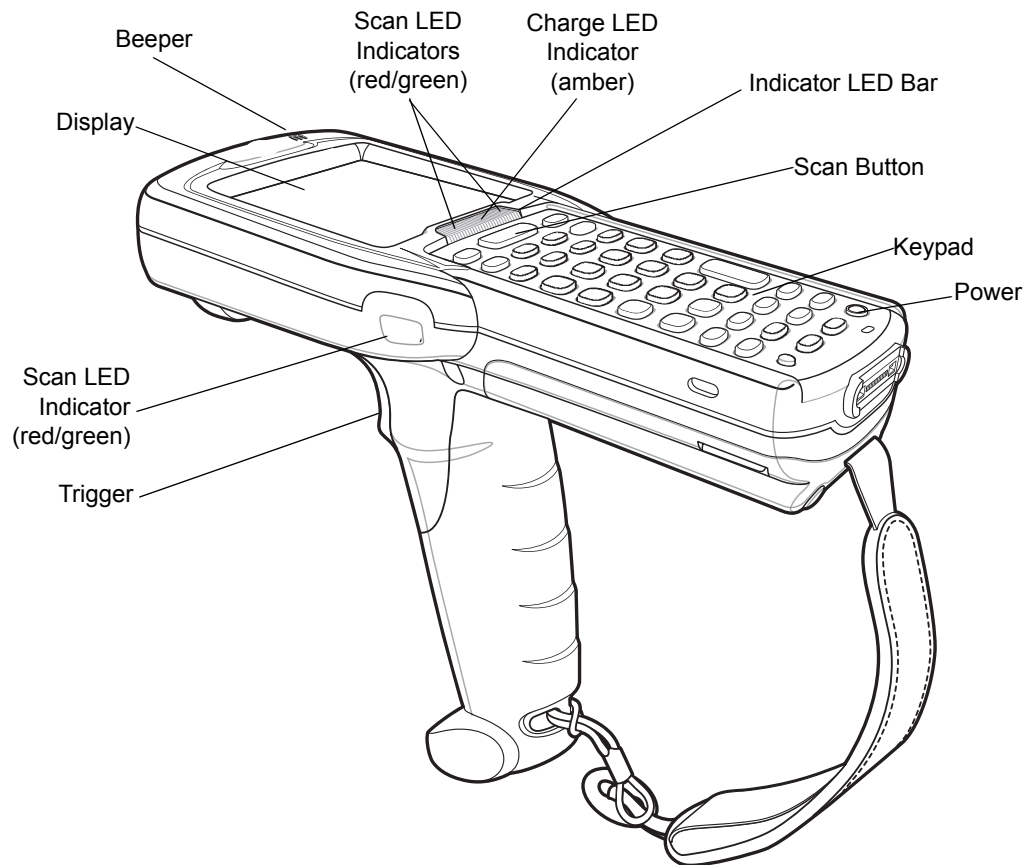

Figure 1-4 MC3090G Mobile Computer

Mobile Computer Startup

To start using the mobile computer:

- Install the main battery.
- Charge the main battery and the backup battery.
- Start the mobile computer.

Install Main Battery

If the main battery is charged, the mobile computer can be used immediately. If the main battery is not charged, see [Battery Charging on page 1-7](#). To remove the main battery, see [Main Battery Removal on page 1-11](#).

To install the main battery:

1. Rotate the latches to the open position.



CAUTION Do not lift up on the latches when removing the Strap/Door Assembly. Lift up on the Hand Strap only.

2. Pull on the strap to lift the Strap/Door Assembly off, bottom first.



CAUTION On the MC3090G battery, do not remove the battery pull tab. The pull tab is for enabling easy battery removal from the device.

3. Insert the battery into the slot, bottom first and press the battery gently into the slot. The battery clip locks the battery into place.
4. With the latches in the open position, replace the Strap/Door Assembly, top first and press to close.
5. Rotate the latches (to the lock position) to lock the Strap/Door Assembly in place.

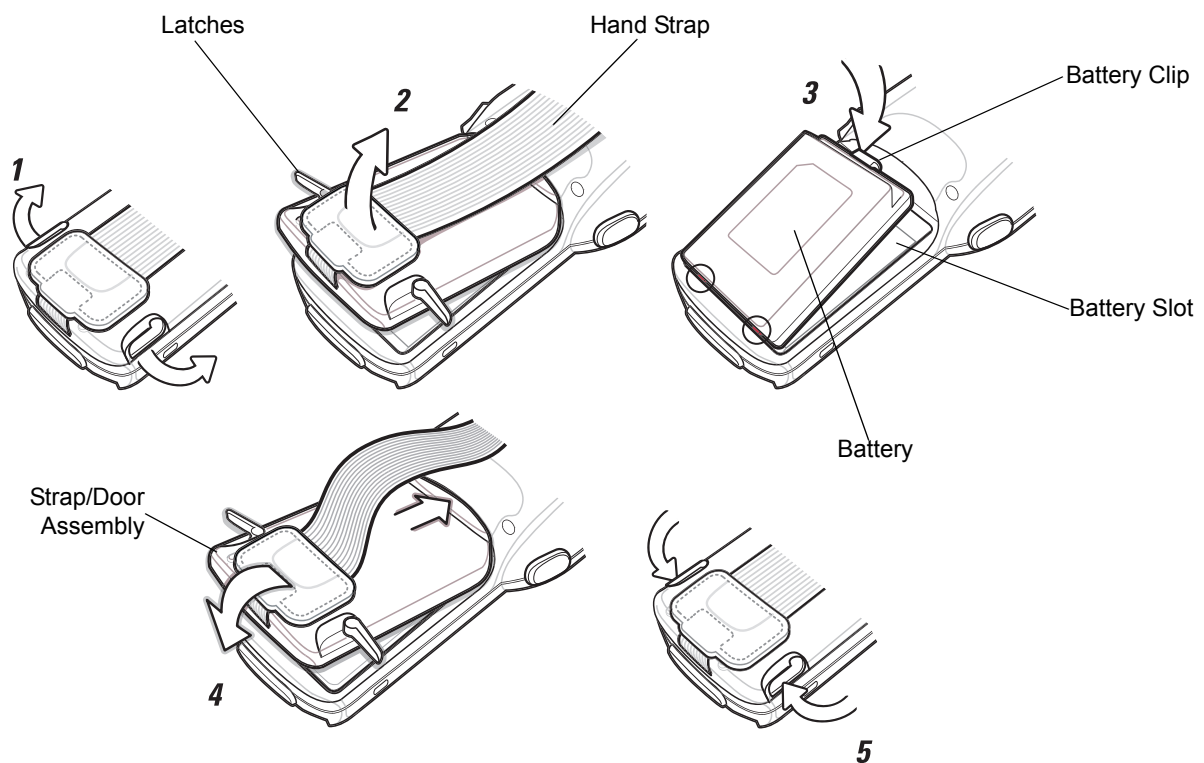

Figure 1-5 Main Battery Installation (MC3000S/R)

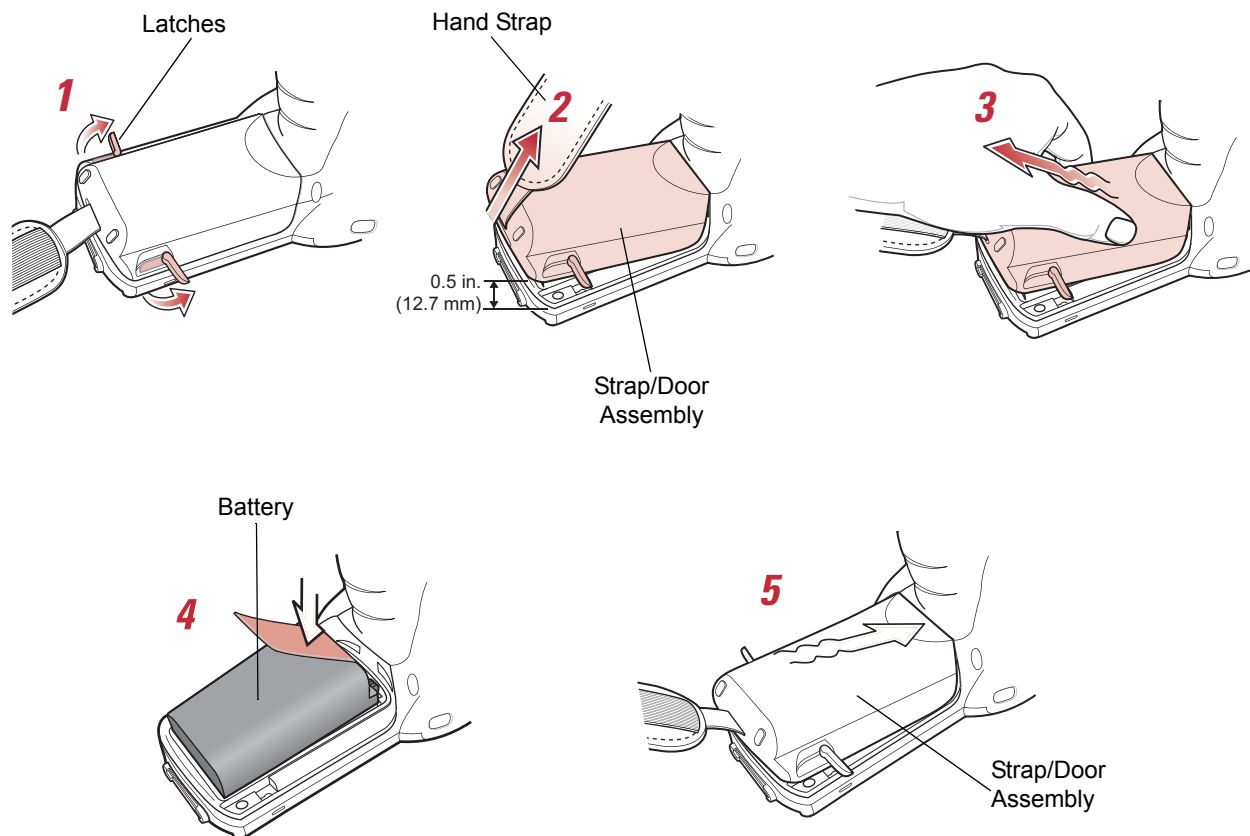

Figure 1-6 Main Battery Installation (MC3090G)

Battery Charging



CAUTION Ensure that you follow the guidelines for battery safety described in [Battery Safety Guidelines on page 5-1](#).

Use the mobile computer cradles, cables and spare battery chargers to charge the mobile computer main battery.

The main battery can be charged before insertion into the mobile computer or after it is installed. There are two main batteries for the MC3000, the Standard Battery and the Extended Life Battery. Either battery can be used, but the Extended Life Battery requires a different Strap/Door Assembly. Use one of the spare battery chargers to charge the main battery (out of the mobile computer) or one of the cradles to charge the main battery while it is installed in the mobile computer.

Before using the mobile computer for the first time, fully charge the main battery until the amber Charge LED Indicator remains lit (see [Table 1-2 on page 1-8](#) for charge status indications). The Standard Battery fully charges in less than four hours and the Extended Life Battery fully charges in less than six hours.

The mobile computer is equipped with a memory backup battery which automatically charges from the main battery whether or not the mobile computer is operating or is in suspend mode. The memory backup battery retains data in memory for at least 30 minutes when the mobile computer's main battery is removed or fully discharged. When the mobile computer is used for the first time or after the memory backup battery has fully discharged, the memory backup battery requires approximately 15 hours to fully charge. Do not remove the main battery from the mobile computer for 15 hours to ensure that the memory backup battery fully charges. If the main battery is

removed from the mobile computer or the main battery is fully discharged, the memory backup battery completely discharges in several hours.

When the main battery reaches a very low battery state, the combination of main battery and backup battery retains data in memory for at least 72 hours.

- ✓ **NOTE** Do not remove the main battery within the first 15 hours of use. If the main battery is removed before the backup battery is fully charged, data may be lost.

Batteries must be charged within the 32° to 104° F (0° to +40° C) ambient temperature range.

The following accessories can be used to charge batteries:

- Cradles (and a power supply):
 - Single Slot Serial/USB Cradle
 - Four Slot Cradles.
- Cables (and a power supply):
 - USB Client Charge Cable
 - Serial (RS232) Charge Cable.
- Spare Battery Chargers (and a power supply):
 - Single Slot Serial/USB Cradle
 - Four Slot Spare Battery Charger
 - Universal Battery Charger (UBC) Adapter.

To charge the mobile computer using the cradles:

1. Insert the mobile computer into a cradle. See [Chapter 4, Accessories](#) for accessory setup.
2. The mobile computer starts to charge automatically. The amber Charge LED Indicator indicates the charge status. See [Table 1-2 on page 1-8](#) for charging indications.

To charge the mobile computer using the cables:

1. Connect the MC3000 Communication/Charge Cable to the appropriate power source and connect to the mobile computer. See [Chapter 4, Accessories](#) for accessory setup.
2. The mobile computer starts to charge automatically. The amber Charge LED Indicator indicates the charge status. See [Table 1-2](#) for charging indications.

Table 1-2 Mobile Computer LED Charge Indicators

LED	Indication
Off	Mobile computer not placed correctly in the cradle; charge cable not connected correctly; charger is not powered.
Fast Blinking Amber	Error in charging; check placement of the mobile computer.
Slow Blinking Amber	Mobile computer is charging.
Solid Amber	Charging complete. Note: When the battery is initially inserted in the mobile computer, the amber LED flashes once if the battery power is low or the battery is not fully inserted.

Spare Battery Charging

There are three accessories that can be used to charge a spare battery:

- Single Slot Serial/USB Cradle
- Four Slot Spare Battery Charger
- UBC Adapter.

To charge a spare battery:

1. Connect the charging accessory to the appropriate power source. See [Chapter 4, Accessories](#) for setup instructions.
2. Insert the spare battery into the spare battery charging slot and gently press down on the battery to ensure proper contact.

The battery starts to charge automatically. The amber charge LED Indicator lights to indicate the charge status. See [Chapter 4, Accessories](#) for charging indications. The Standard Battery usually fully charges in less than four hours and the Extended Life Battery usually fully charges in less than six hours.

Stylus

Use the stylus for selecting items and entering information on the screen. The stylus functions as a pen and a mouse. Tap the touch screen once with the stylus to select options and open menu items.

To remove the stylus, slide the stylus out of the stylus holder. To store the stylus, push the stylus back into the stylus holder.

Starting the Mobile Computer

On 28, 38 and 48-key keypad configurations, press the **Power** button to turn on the mobile computer. On 20-key keypad configurations, simultaneously press the **Fn and MENU** buttons to turn on the mobile computer. If the mobile computer does not power on, perform a cold boot. See [Resetting the Mobile Computer on page 2-34](#).

When the mobile computer is powered on for the first time, it initializes. The *Splash* screen appears for a short period of time, followed by the *Calibration* screen.



Figure 1-7 *Splash Screen*

On Windows CE 5.0 configurations, after the calibration procedure is performed the factory settings launch the Demo window. Application specific shells may provide application specific windows instead of the Demo window. These screens also appear when a cold boot is performed.

If the mobile computer does not power on, see [Resetting the Mobile Computer on page 2-34](#).

Calibration Screen

Use the **Calibration** screen to align the touch screen:

1. Remove the stylus from the stylus holder.
2. Carefully press and briefly hold the stylus tip on the center of the **Calibration** screen target. Repeat the procedure as the target moves and stops at different locations on the screen. This enters the new calibration settings.

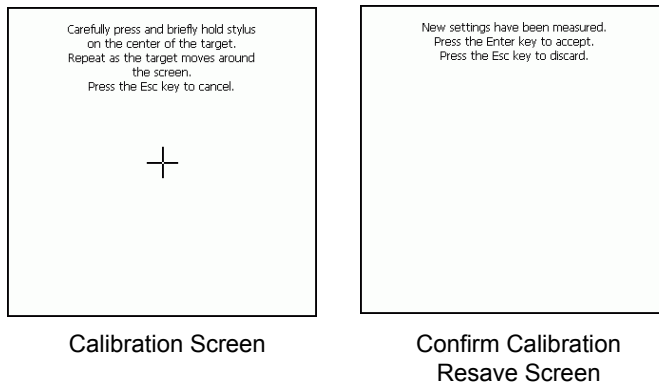

Figure 1-8 Calibration Screen

3. Once all of the new calibration settings are input, tap the screen or press the **ENTER** button to save the new calibration settings. Press **ESC** to discard the new calibration settings.

Demo Window (Windows CE Only)

The **Demo window** is the factory default menu. On initial power up (or on a warm or cold boot) the **Demo window** appears. These sample/demo applications are intended to be used by application developers as application development examples. These applications were not developed to support end users. Refer to the *Application Guide for Zebra Devices* for information about the **Demo window** applications.

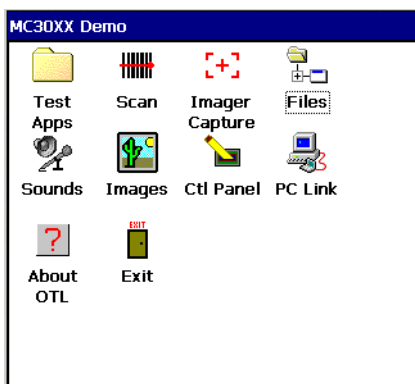

Figure 1-9 Demo Window

Waking the Mobile Computer

The wakeup condition settings are used to define what actions wake up the mobile computer. The settings are configurable so they are subject to change/update. For more information see, [Waking the Mobile Computer on page 2-35](#).

Main Battery Removal

Before removing the main battery, turn off the mobile computer.

To remove the main battery:

1. Rotate the latches to the open position.



CAUTION Do not lift up on the latches when removing the Strap/Door Assembly. Lift up on the Hand Strap only.

2. Lift the Hand Strap to lift the Strap/Door Assembly off, bottom first.
3. Release battery:
 - a. On the MC3000S/R, release the battery clip (at the top of the battery) and lift the battery out top first.
 - b. On the MC3090G, pull the battery pull tab to unclip the battery and lift the battery out top first. If the battery does not have a pull tab, use the stylus to unclip the battery and then lift the battery.



CAUTION On the MC3090G battery, do not remove the battery pull tab. The pull tab is for enabling easy battery removal from the device.

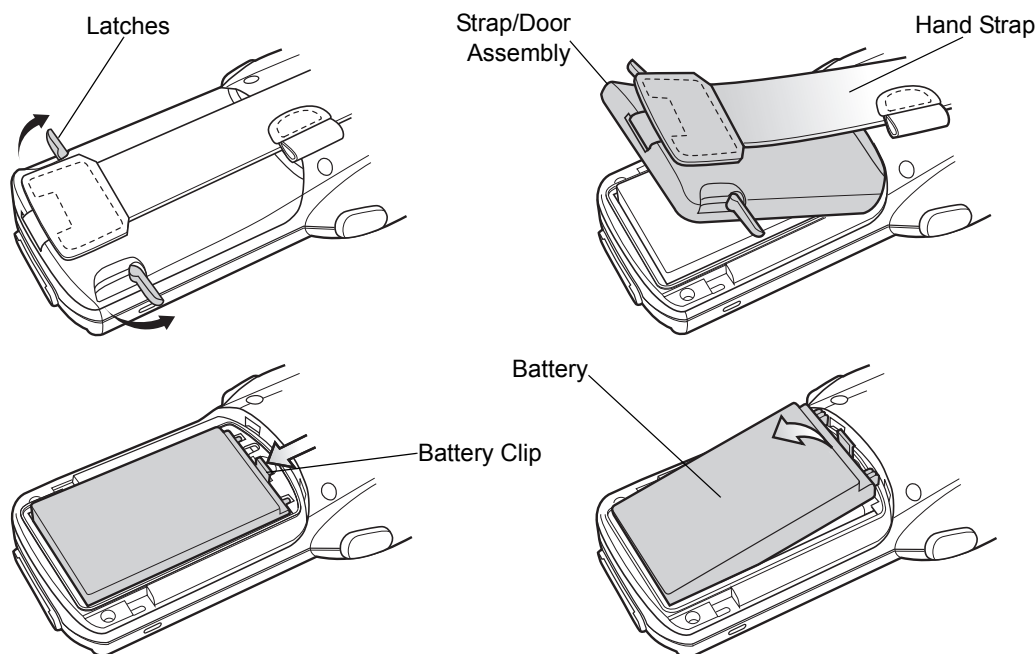

Figure 1-10 Main Battery Removal (MC3000S/R)

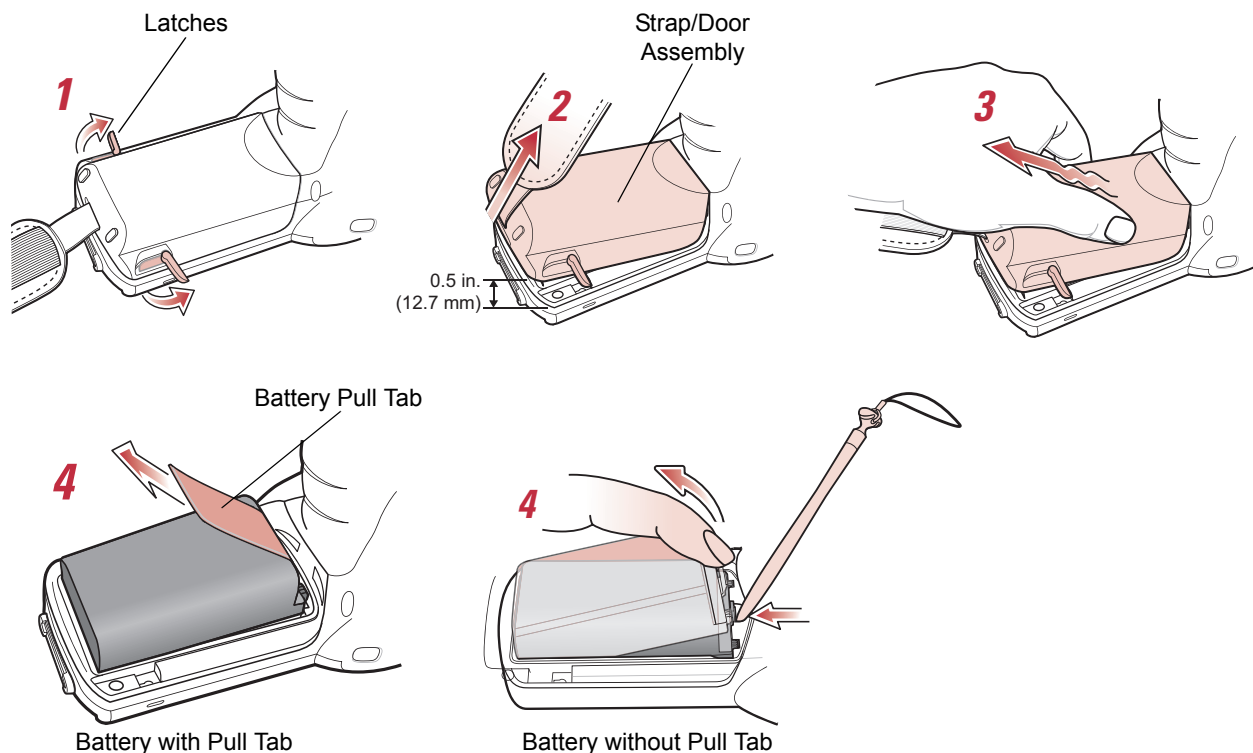

Figure 1-11 Main Battery Removal (MC3090G)



NOTE The SD card holder is located under the battery. To install the SD card, see [Secure Device Card \(Windows CE 5.0 Only\)](#) on page 4-12.

Strap/Door Assembly Removal and Replacement (MC3000S/R)

The Strap/Door Assembly consists of a hand strap and the battery door. There are two versions of this assembly, one for the Standard Battery and one for the Extended Life Battery. Before removing the Strap/Door Assembly, press the red **Power** button to turn off the screen and set the mobile computer to suspend mode.

To remove the Strap/Door Assembly:

1. Rotate the latches to the open position.



CAUTION Do not lift up on the latches when removing the Strap/Door Assembly. Lift up on the Hand Strap only.

2. Lift the Hand Strap to lift the Strap/Door Assembly off, bottom first.
3. Use a #00 Phillips screwdriver to remove the screws.
4. Lift the mounting clip.
5. Slide the mounting clip out of the strap loop.

Reverse the procedure to replace the Strap/Door Assembly.

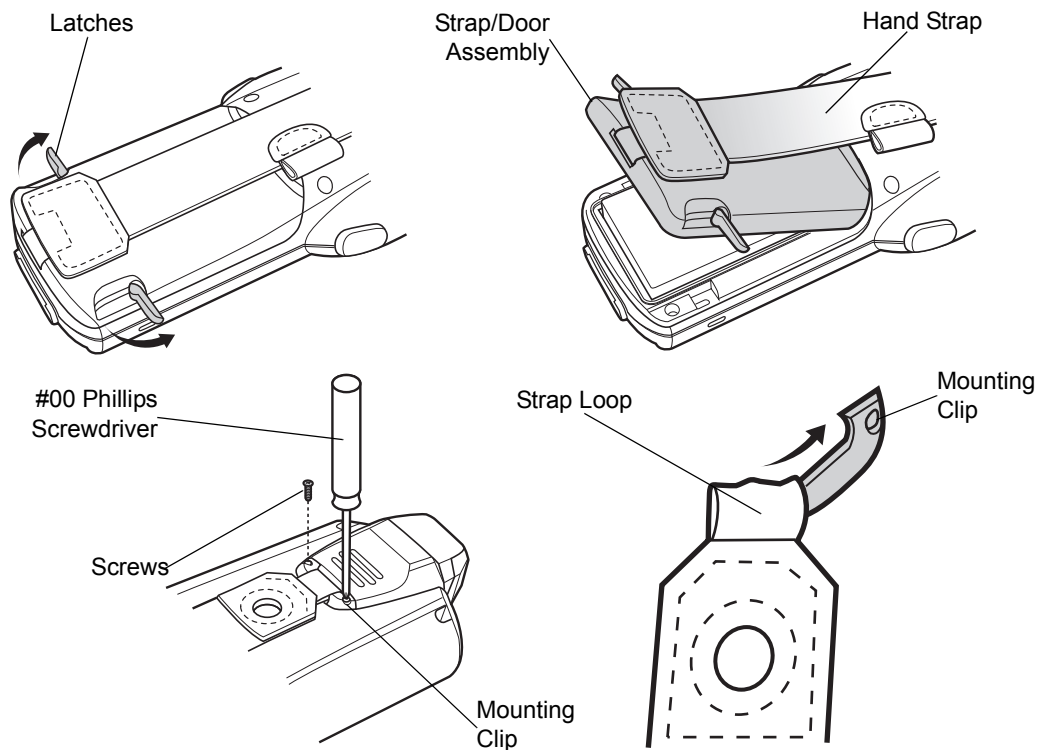

Figure 1-12 Strap/Door Removal and Replacement (MC3000S/R)

Strap/Door Assembly Removal and Replacement (MC3090G)

The Strap/Door Assembly consists of a hand strap and the battery door. Before removing the Strap/Door Assembly, press the red **Power** button to turn off the screen and set the mobile computer to suspend mode.

To remove the Strap/Door Assembly:

1. Slip the button through the loop.
2. Remove loop section from handle.
3. Rotate the latches to the open position.



CAUTION Do not lift up on the latches when removing the Strap/Door Assembly. Lift up on the Hand Strap only.

4. Lift the Hand Strap to lift the Strap/Door Assembly off, bottom first.

Reverse the procedure to replace the Strap/Door Assembly.

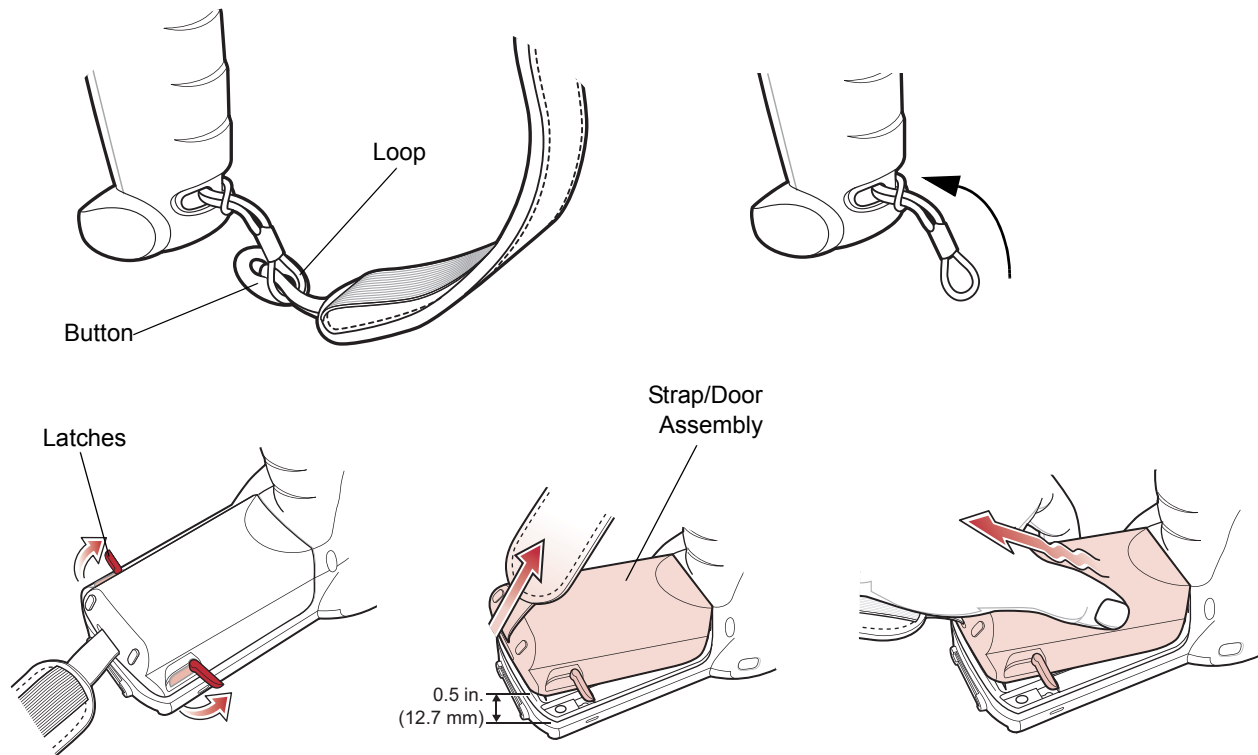

Figure 1-13 Strap/Door Removal and Replacement (MC3090G)

Turning Off the Radios

On Device with Windows CE 5.0 (OEM Version 01.15 or lower)

✓ **NOTE** To determine the operating system OEM version, see [Configurations on page xii](#).

WLAN Radio

To turn off the WLAN radio:

1. Tap **Start** > **Settings** > **Control Panel** > **Power icon** > **PwrDevices** tab.
2. In the text box, scroll down until **WLP1:** displays.
3. Select **WLP1:**. **WLP1:** displays in the text box at the top of the window.
4. In the drop-down list box, select **D4**.
5. Tap **Set**.

To turn on the radio:

1. Tap **Start** > **Settings** > **Control Panel** > **Power icon** > **PwrDevices** tab.
2. In the text box, scroll down until **WLP1:** displays.

3. Select **WLP1**: **WLP1**: displays in the text box at the top of the window.
4. In the drop-down list box, select **D0**.
5. Tap **Set**.

Bluetooth Radio

To turn off the Bluetooth radio, tap **Bluetooth** icon in the task tray and select **Disable Bluetooth**.

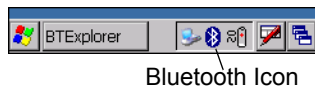

Figure 1-14 *Bluetooth Icon*

To turn on the Bluetooth radio, tap **Bluetooth** icon in the task tray and select **Enable Bluetooth**.

On Device with Windows CE 5.0 (OEM Version 01.16 or higher)

✓ **NOTE** To determine the operating system OEM version, see [Configurations on page xii](#).

WLAN Radio

To turn off the WLAN radio tap the **Wireless Connection Status** icon on the task tray and select **Disable Radio**. A red X appears across the icon indicating that the radio is disabled (off).



Figure 1-15 *Wireless Connection Status Icon*

To turn the radio back on, tap the **Wireless Connection Status** icon on the task tray and select **Enable Radio**. The red X disappears from the icon indicating that the radio is enabled (on).

Bluetooth Radio

To turn off the Bluetooth radio, tap **Bluetooth** icon in the task tray and select **Disable Bluetooth**.



Figure 1-16 *Bluetooth Icon*

To turn on the Bluetooth radio, tap **Bluetooth** icon in the task tray and select **Enable Bluetooth**.

On Devices with Windows Mobile 6.1

Windows Mobile 6.1 devices include **Wireless Manager**, which provides a simple method of enabling, disabling, and configuring all the device's wireless capabilities in one place.

To open **Wireless Manager**, tap the **Connectivity** icon.

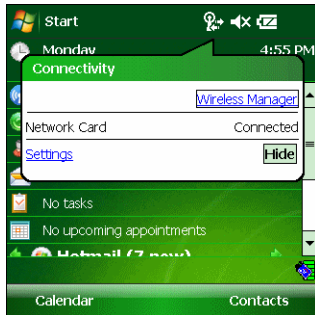

Figure 1-17 Opening Wireless Manager

Select **Wireless Manager**.



Figure 1-18 Wireless Manager Window

To enable or disable a wireless connection, tap its blue bar.

To enable or disable all wireless connections, tap and hold the **All** bar.

To configure settings for a connection, tap **Menu**.



Figure 1-19 Wireless Manager Menu

Chapter 2 Operating the MC3000

Introduction

This chapter provides basic instructions for using the mobile computer and navigating the mobile computer software.

Power Button

Press the red **Power** button to toggle the mobile computer between suspend and resume. When the screen is off the mobile computer is in suspend mode and when the screen is on the mobile computer is on.

Keypads

The mobile computer is available with the following keypad configurations:

- 20-key mechanical keypad
- 28-key keypad
- 38-key keypad
- 48-key keypad.







NOTE For information about using the soft keyboard input panel. For more information, see [Entering Information Using the Keyboard Input Panel on page 2-25](#).

Keypad Special Functions

The keypad special functions are color coded on the keypads. For example, on the 38-key keypad, the display contrast icon is blue indicating that the blue function key must be selected first along with the F6 key, to increase the display contrast.

Table 2-1 Keypad Special Functions

Icon	28-Key Keystrokes	38-Key Keystrokes	48-Key Keystrokes	Special Function
	Blue function key and period .	Blue function key and F6	Blue function key and N	Increases display contrast setting, darkens the display (on monochrome units only).
	Blue function key and BKSP .	Blue function key and F9	Blue function key and S	Decreases display contrast setting, lightens the display (on monochrome units only).
	Blue function key and the up arrow.	Blue function key and F7	Blue function key and R	Increases scan decode beeper volume.
	Blue function key and down arrow.	Blue function key and F10	Blue function key and W	Decreases scan decode beeper volume.

✓ **NOTE** Mobile computers with color screens do not have contrast settings.

20-Key Mechanical Keypad

The 20-key mechanical keypad contains a **Power** button, application keys, scroll keys and function keys. The keypad is color-coded to indicate the alternate function key (blue) values. Note, that keypad functions can be changed by an application so the mobile computer keypad may not function as described. See [Table 2-4 on page 2-8](#) for key and button descriptions.

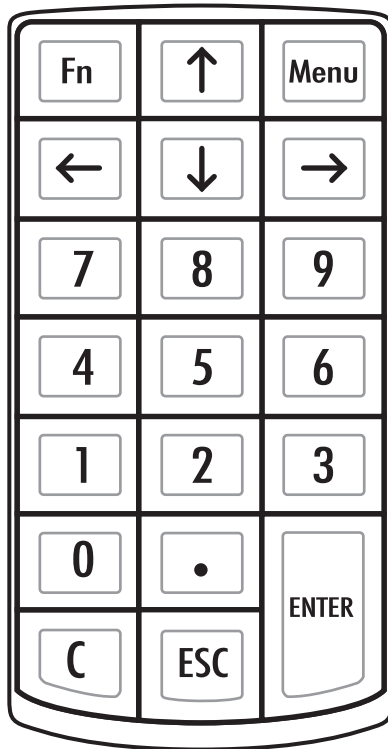

Figure 2-1 20-Key Mechanical Keypad

Table 2-2 20-Key Mechanical Keypad Descriptions







Key	Description
Menu 	Produces the lower case alphabetic f. Turns the mobile computer on and off when simultaneously pressed with the down arrow key. See Resetting the Mobile Computer on page 2-34 for warm and cold boot procedures.
Fn 	Press and release the blue FUNC key to activate the keypad alternate functions. The F icon appears on the taskbar. Press and release the blue FUNC key again to return to the default keypad functions.
Arrow keys 	Moves up and down from one item to another.

Table 2-2 20-Key Mechanical Keypad Descriptions (Continued)

Key	Description
Numeric keys 	Produces 0 - 9 numeric characters.
period 	Produces a (.) period.
C 	Produces a backspace.
ESC 	Exits the current operation.
ENTER 	Executes a selected item or function. Produces a TAB character when pressed after the Fn key.

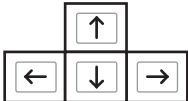
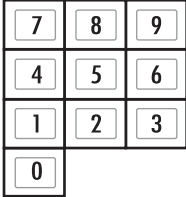
28-Key Keypad

The 28-key keypad contains a **Power** button, application keys, scroll keys and function keys. The keypad is color-coded to indicate the alternate function key (blue) values and the alternate **ALPHA** key (orange) values. Note that keypad functions can be changed by an application so the mobile computer keypad may not function as described. See [Table 2-3 on page 2-5](#) for key and button descriptions and [Table 2-1 on page 2-2](#) for the keypad special functions.

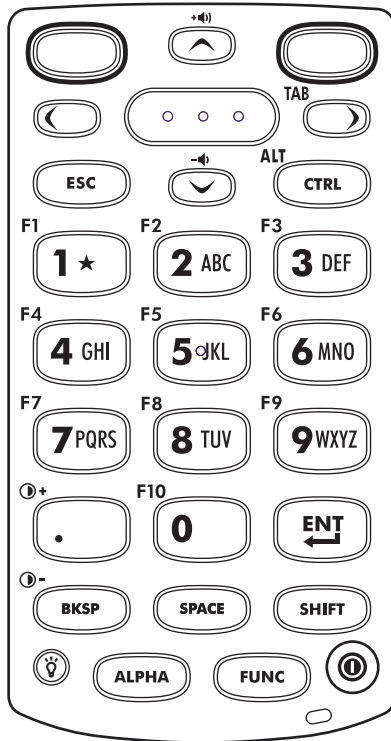

Figure 2-2 28-Key Keypad

Table 2-3 28-Key Descriptions





Key	Description
Power (red) 	Powers the mobile computer screen on and off (resume and suspend).
Green Circle 	Programmable application function key by default.
Red Circle 	Programmable application function key by default.
Scan (yellow) 	Used in scanning applications, press to scan a bar code. This key has the same function as activating the side mounted scan buttons.
Scroll Up and Down 	Moves up and down from one item to another. Increases/decreases specified values.

Table 2-3 28-Key Descriptions (Continued)



















Key	Description
Scroll Left and Right 	Moves left and right from one item to another. Increases/decreases specified values. Produces a TAB when the blue FUNC key is activated and the right arrow key is pressed.
ESC 	Produces the ESC function by default.
CTRL 	Press and release the CTRL key to activate the keypad alternate CTRL functions. The  icon appears on the taskbar on WinCE devices or the  icon appears at the bottom of the screen on Windows Mobile 6.1 devices. Press and release the CTRL key again to return to the default keypad functions.
Numeric/Alpha/Special Function 	Numeric, alpha or special function keys. Numeric by default. Produces a special function when the blue FUNC key is activated. Produces alpha values when the orange ALPHA key is activated. In Alpha state, produces the lower case alphabetic characters on the key. Each key press produces the next alphabetic character in sequence. For example, press and release the ALPHA key and then press the 4 key once to produce the letter 'g'; press and release the ALPHA key and then press the 4 key three times to produce the letter 'i'. When the SHIFT key is pressed in Alpha state, the upper case alphabetic characters on the key are produced. For example, press and release the ALPHA key, press and hold the SHIFT key and then press the 4 key once to produce the letter 'G'; press and release the ALPHA key, press and hold the SHIFT key and then press the 4 key three times to produce the letter 'I'.
Period/Decimal Point 	Produces a period for alpha entries and a decimal point for numeric entries by default. Produces the F10 function when the blue FUNC key is activated.
Enter 	Executes a selected item or function.
BKSP 	BKSP , backspace function by default.
SPACE 	SPACE , space function by default.
Shift 	Press and release the SHIFT key to activate the keypad alternate SHIFT functions. The  icon appears on the taskbar on WinCE devices and the  icon appears at the bottom of the screen on Windows Mobile 6.1 devices. Press and release the SHIFT key again to return to the default keypad functions.

Table 2-3 28-Key Descriptions (Continued)

Key	Description
ALPHA (orange) 	Press the orange ALPHA key to access the alternate ALPHA characters (shown on the keypad in orange). The ALP icon appears on the taskbar on WinCE devices and the  icon appears at the bottom of the screen on Windows Mobile 6.1 devices. Press and release the orange ALPHA key again to return to the default keypad functions.
FUNC (blue) 	Press and release the blue FUNC key to activate the keypad alternate functions (shown on the keypad in blue). The F icon appears on the taskbar on WinCE devices or the  icon appears at the bottom of the screen on Windows Mobile 6.1 devices. Press and release the blue FUNC key again to return to the default keypad functions.
Display backlight 	Toggles the display backlight on and off.

38-Key Keypad

The 38-key keypad contains a **Power** button, application keys, scroll keys and function keys. The keypad is color-coded to indicate the alternate function key (blue) values. Note that keypad functions can be changed by an application so the mobile computer keypad may not function as described. See [Table 2-4 on page 2-8](#) for key and button descriptions and [Table 2-1 on page 2-2](#) for the keypad special functions.

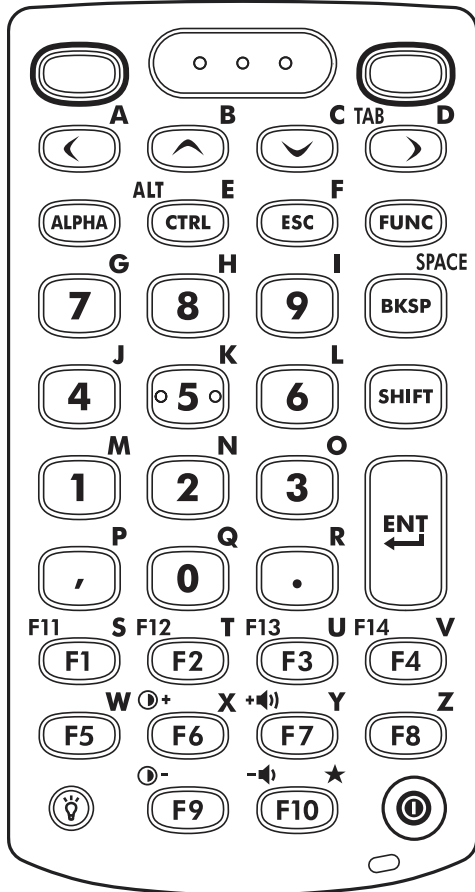

Figure 2-3 38-Key Keypad

Table 2-4 38-Key Descriptions



Key	Description
Power (red) 	Powers the mobile computer screen on and off (resume and suspend).
Green Circle 	Programmable application function key by default.
Red Circle 	Programmable application function key.

Table 2-4 38-Key Descriptions (Continued)





















Key	Description
Scan (yellow) 	Used in scanning applications, press to scan a bar code.
Scroll Left and Right 	Moves left and right from one item to another by default. Produces a TAB when the blue FUNC key is activated and the right arrow key is pressed.
Scroll Up and Down 	Moves up and down from one item to another by default.
ALPHA (orange) 	Press the orange ALPHA key to access the alternate ALPHA characters (shown on the keypad in orange). The ALP icon appears on the taskbar on WinCE devices and the  icon appears at the bottom of the screen on Windows Mobile 6.1 devices. Press and release the orange ALPHA key again to return to the default keypad functions.
CTRL 	Press and release the CTRL key to activate the keypad alternate CTRL functions. The  icon appears on the taskbar on WinCE devices or the  icon appears at the bottom of the screen on Windows Mobile 6.1 devices. Press and release the CTRL key again to return to the default keypad functions.
CLEAR 	Clears inputs.
FUNC (blue) 	Press and release the blue FUNC key to activate the keypad alternate functions (shown on the keypad in blue). The F icon appears on the taskbar on WinCE devices or the  icon appears at the bottom of the screen on Windows Mobile 6.1 devices. Press and release the blue FUNC key again to return to the default keypad functions.
Numeric/Alpha/Special Function 	Press for the default numeric value. Produces alpha values when the orange ALPHA key is activated.
BKSP/SPACE 	BKSP , backspace function by default. Produces the SPACE function when the orange ALPHA key is activated.
SHIFT 	Press and release the SHIFT key to activate the keypad alternate SHIFT functions. The  icon appears on the taskbar on WinCE devices and the  icon appears at the bottom of the screen on Windows Mobile 6.1 devices. Press and release the SHIFT key again to return to the default keypad functions.
Enter 	Executes a selected item or function.

Table 2-4 38-Key Descriptions (Continued)

Key	Description
Period/Decimal Point 	Produces a period for alpha entries and a decimal point for numeric entries. Produces alpha values when the orange ALPHA key is activated.
Comma 	Produces a comma by default. Produces alpha values when the orange ALPHA key is activated.
Special Function/Alpha 	Special function by default or when the blue FUNC key is activated. Produces alpha values when the orange ALPHA key is activated.
Display backlight 	Toggles the display backlight on and off.

48-Key Keypad

The 48-key keypad contains a **Power** button, application keys, scroll keys and function keys. The keypad is color-coded to indicate the alternate function key (blue) values. Note, that keypad functions can be changed by an application so the mobile computer keypad may not function as described. See [Table 2-4 on page 2-8](#) for key and button descriptions and [Table 2-1 on page 2-2](#) for the keypad special functions.

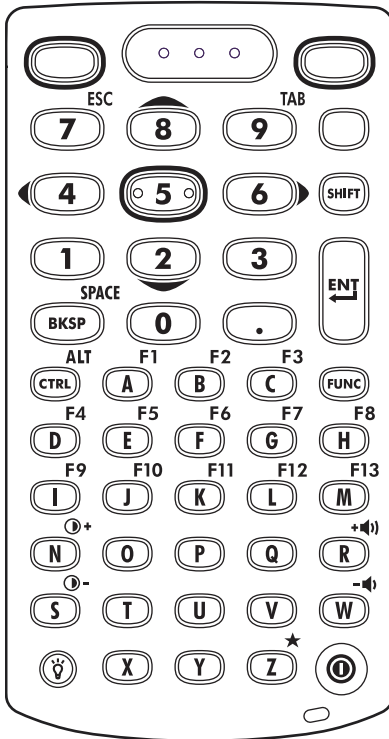

Figure 2-4 48-Key Keypad

Table 2-5 48-Key Descriptions



















Key	Description
Power (red) Ⓚ	Powers the mobile computer screen on and off (resume and suspend).
Green Circle ○	Unassigned application function key by default.
Red Circle ○	Unassigned application function key.
Scan (yellow) ○ ○ ○	Scan key, used for scanning applications.
Orange ○	Press the orange key to access the alternate navigation and selection functions. The ALP icon appears on the taskbar on WinCE devices and the  icon appears at the bottom of the screen on Windows Mobile 6.1 devices. Press and release the orange key again to return to the default keypad functions.

Table 2-5 48-Key Descriptions (Continued)

Key	Description
Numeric/Scroll/Select 	Numeric, scroll, select keys. Numeric by default. With the orange key activated, the 2 , 4 , 6 , and 8 keys produce scroll functions and the 5 key produces a select function. With the FUNC key activated, 7 produces the ESC function and 9 produces the TAB function.
Shift 	Press and release the SHIFT key to activate the keypad alternate SHIFT functions. The  icon appears on the taskbar on WinCE devices and the  icon appears at the bottom of the screen on Windows Mobile 6.1 device. Press and release the SHIFT key again to return to the default keypad functions.
Enter 	Executes a selected item or function.
BKSP/SPACE 	BKSP , backspace function by default. Produces the SPACE function when the blue FUNC key is activated.
Period/Decimal Point 	Produces a period for alpha entries and a decimal point for numeric entries.
Control 	Press and release the CTRL key to activate the keypad alternate CTRL functions. The  icon appears on the taskbar on WinCE devices or the  icon appears at the bottom of the screen on Windows Mobile 6.1 devices. Press and release the CTRL key again to return to the default keypad functions. Press and release the blue FUNC key and then the CTRL key to activate the ALT functions. The  icon appears on the taskbar on WinCE devices or the  icon appears at the bottom of the screen on Windows Mobile 6.1 devices. Press and release the CTRL key two times to return to the default keypad functions.
Alpha/Special Function 	Alpha by default. Special function by default when the blue FUNC key is activated.
FUNC (blue) 	Press and release the blue FUNC function key to activate the keypad alternate functions (shown on the keypad in blue). The  icon appears on the taskbar on WinCE devices or the  icon appears at the bottom of the screen on Windows Mobile 6.1 devices. Press and release the blue FUNC function key again to return to the default keypad functions.
Display Backlight 	Toggles the display backlight on and off.

Windows CE Demo Window

On initial power up (or on a warm or cold boot) the **Demo window** appears. This window links to the **Test Applications** window and the two windows provide the sample/demo applications. The sample/demo applications are intended to be used by application developers as application development examples. These applications were not developed to support end users. Refer to the *Application Guide for Zebra Devices* for the *Demo window* applications.

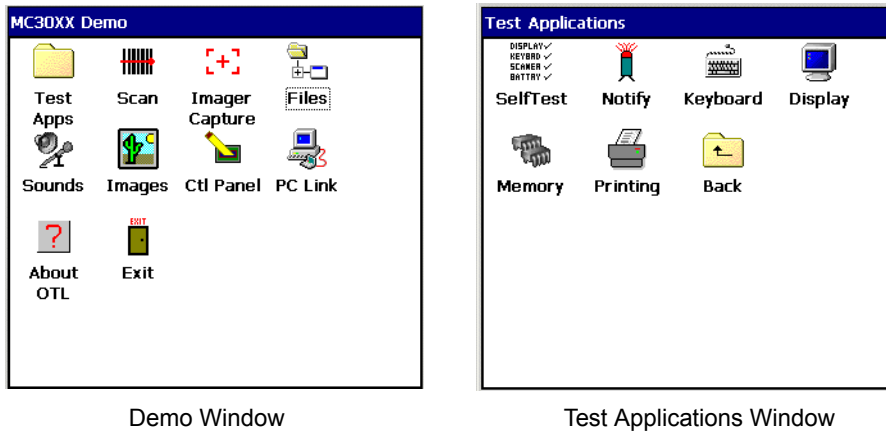
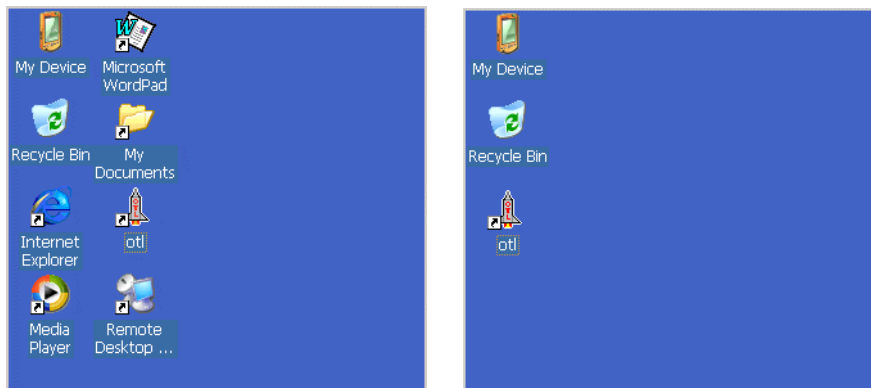

Figure 2-5 Demo Window

✓ **NOTE** The **Demo window** is the factory default launcher menu. Application specific shells may vary.

Windows CE Desktop

To access the desktop tap the **Exit** icon on the **Demo window** or tap the **Desktop Display** button. See [Figure 2-7 on page 2-14](#) for the **Desktop Display** button location. The desktop displays the applications available with the Windows CE .NET 5.0 Professional and with the Windows CE .NET 5.0 Core configurations. For information on using the Microsoft® Applications refer to the *Microsoft® Applications for Mobile and CE 5.0 User Guide*, p/n 72E-78456-xx.



Windows CE .NET 5.0 Professional Desktop Windows CE .NET 5.0 Core Desktop

Figure 2-6 Desktop Window

Windows CE Status Icons

The taskbar (at the bottom of the screen) displays the **Start** button, active programs, battery status and communication status. The taskbar icons are described in [Table 2-6](#). The taskbar icons display the function status, indicate what programs are active and indicate the battery charge status. The Taskbar buttons are used to access menus, select/deselect functions or to change display windows.

- **Status Icons:** The status icons indicate the function key status. If the **FUNC**, **SHIFT**, **CTRL**, **ALT** or **ALPHA** functions are active the appropriate status icon is displayed.
- **Active Programs Icons:** The active applications icons are displayed on the taskbar. If more than one program is active, icons can be used to toggle between the open programs (applications). Tap on a taskbar application to maximize the application.
- **AC Power/Battery Status Icons:** The AC Power/Battery Status icons are shown in the taskbar to indicate the present power supply status of the mobile computer. The main battery status icons provide the battery status in 10% increments from 10% to 100%. The backup battery low icon indicates that the backup battery charge is low. See [Battery Charging on page 1-7](#) for backup battery charging instructions.

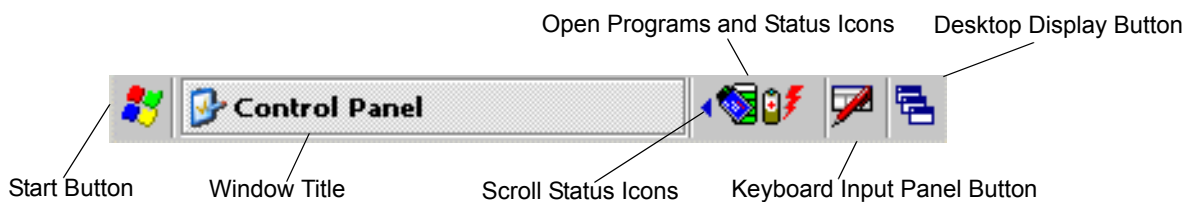











Figure 2-7 Taskbar

Table 2-6 Taskbar Icons

Icon	Description
	Indicates that the battery is charging.
	Indicates that the battery is fully charged (100% charged). The battery status icons provide the battery status in 10% increments from 10% to 100%.
	Indicates that communication with the smart battery has not been established. After a mobile computer reset, this icon may be displayed for up to 30 seconds. See, Battery Unknown Icon on page 2-15 for additional information.
	Indicates that the backup battery is low.
	Indicates that the battery is fully charged and the mobile computer is running on external power.
	Indicates IP status. Only displays when the mobile computer is in emulation mode.
	Indicates that the ActiveSync application is running.
	Indicates that the wireless application radio is connected to a wireless LAN network with excellent signal strength. See Table 2-13 on page 2-37 for all of the signal strength icons.

Table 2-6 Taskbar Icons (Continued)

Icon	Description
	Indicates that the wireless application radio is not connected to a wireless LAN network.
	The <i>Bluetooth Enabled</i> icon appears in the task tray and indicates that the Bluetooth radio is on.
	The <i>Bluetooth Disabled</i> icon appears in the task tray and indicates that the Bluetooth radio is off.
	The <i>Bluetooth Communication</i> icon appears in the task tray and indicates that the mobile computer is communicating with another Bluetooth device.
	Indicates that the SHIFT button function is selected.
	Indicates that the FUNC button function is selected.
	Indicates that the CTRL button function is selected.
	Indicates that the ALT character selection is selected.
	Indicates that the mobile computer is in ALPHA button mode is selected.

Battery Unknown Icon

The Battery Unknown icon displays when communication with the smart battery has not been established. As part of normal operation this icon may be displayed for 30 seconds following a mobile computer reset.

If the icon displays beyond this 30 second period:

1. Remove and re-seat the battery.
2. If after re-seating the battery, the icon remains, warm boot the mobile computer.
3. If after warm booting the mobile computer, the icon remains, then cold boot the mobile computer.
4. If after cold booting the mobile computer, the icon remains, install a new (tested and working) battery.
5. If the icon remains, return the mobile computer for servicing.

Start Button

Tap the **Start** button to launch the *Start* menu.

- *Programs*: Use to access available programs.
- *Favorites*: Displays files in *Favorites* directory.
- *Documents*: Displays files in *Documents* directory.
- *Settings*: Accesses the Control Panel, the Network and Dial-up Connections and the Taskbar and *Start* menu.

- *Help*: Accesses the Windows CE Help. Not available on mobile computers running Windows CE .NET 5.0 Core.
- *Run . . .*: Runs a program or application.
- *Suspend*: Places the mobile computer in the suspend state.

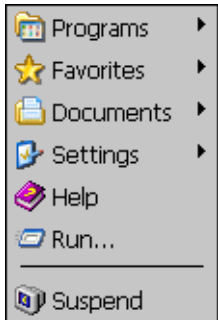
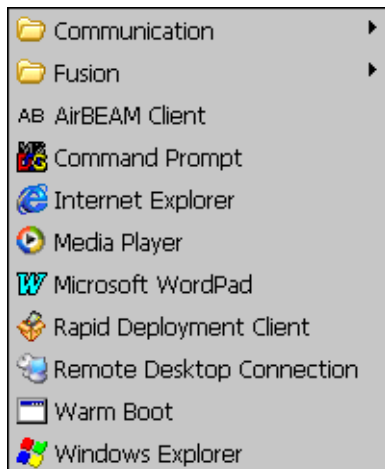

Figure 2-8 Start Menu

Programs Menu

From the *Start* menu, tap *Programs* to launch the *Programs* menu. The programs provided with Windows CE .NET 5.0 Professional and Windows CE .NET 5.0 Core are displayed in the *Programs* menu. Refer to the *Application Guide for Zebra Devices*, p/n 72-68901-xx and the *Microsoft® Applications for Mobile and CE 5.0 User Guide*, p/n 72E-78456-xx for application information.



Windows CE .NET 5.0 Professional

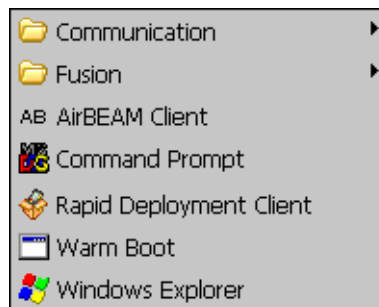

Windows CE .NET 5.0 Core

Figure 2-9 Programs Menu

Keyboard Input Panel Button

Use the Keyboard Input Panel as an alternate input device. For more information, see [Entering Information Using the Keyboard Input Panel on page 2-25](#).

Desktop Display Button

Use the *Desktop Display* button to minimize all open programs and display the desktop.

Windows CE .NET 5.0 Core desktop functions include:

- *My Computer*: Double-tap the icon to open My Computer.
- *Recycle Bin*: Deleted files remain in the recycle bin until the recycle bin is emptied. Once emptied the files cannot be retrieved.

Windows CE .NET 5.0 Professional desktop functions include:

- *My Computer*: Double-tap the icon to open My Computer.
- *Recycle Bin*: Deleted files remain in the recycle bin until the recycle bin is emptied. Once emptied the files cannot be retrieved.
- *Remote Desktop Connection*: Tap the *Remote Desktop Connection* icon to access the *Remote Desktop Connection* window.

Task Manager and Properties

Use the Task Manager to control an application's use and use the *Properties* functions to set display and clock options.

Task Manager

✓ **NOTE** The 20-key mechanical keypad does not contain a **CTRL** key.

1. Select **FUNC - CTRL**, (to activate the **ALT** state) and tap on the taskbar to display the *Task Manager, Properties Selection* menu.

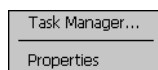

Figure 2-10 *Task Manager, Properties Selection Menu*

2. Tap *Task Manager* to display the Task Manager window.



Figure 2-11 *Task Manager Window*

3. Tap a task in the *Active Tasks* list and tap **Switch To** to make that task the primary task, or tap **End Task** to end the selected task.
4. Tap **X** to exit the *Task Manager* window.

Properties

1. Tap **Start > Control Panel > Taskbar and Start Menu ...** . The *Task Manager, Properties* window displays, see [Figure 2-10 on page 2-17](#).
2. Tap *Properties* to display the *Taskbar and Start Menu, General* tab.
3. This menu provides taskbar options:
 - Check the *Always on Top* checkbox to keep the taskbar on top of all other windows.
 - Check the *AutoHide* checkbox to make the taskbar disappear, touch the bottom of the display to make the taskbar return.
 - Check the *Show Clock* checkbox to display the clock on the taskbar.
4. Tap **OK** to save the settings and exit the window.

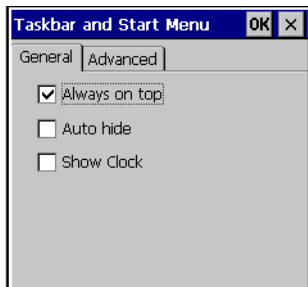

Figure 2-12 *Taskbar and Start Menu, General Tab*

Advanced Tab

1. Tap the *Advanced* tab to enter the *Taskbar and Start Menu, Advanced* tab.
2. Tap the **Clear** button to delete all of the documents listed in the **Start > Documents** entry, see [Start Button on page 2-15](#). Typically this list is empty, but if there were documents in the list the **Clear** button would delete them.
3. Tap the **Expand Control Panel** checkbox to display the entire contents of the MS control panel in list form, rather than icons.



Figure 2-13 *Taskbar and Start Menu, Advanced Tab*

4. Tap **OK** to save the settings and exit the window.

Windows Mobile 6.1 Today Screen

The Today screen displays important information, such as upcoming appointments and status indicators. Tap a section on the screen to open the associated program. Alternatively, tap **Start > Today** to display the **Today** screen.

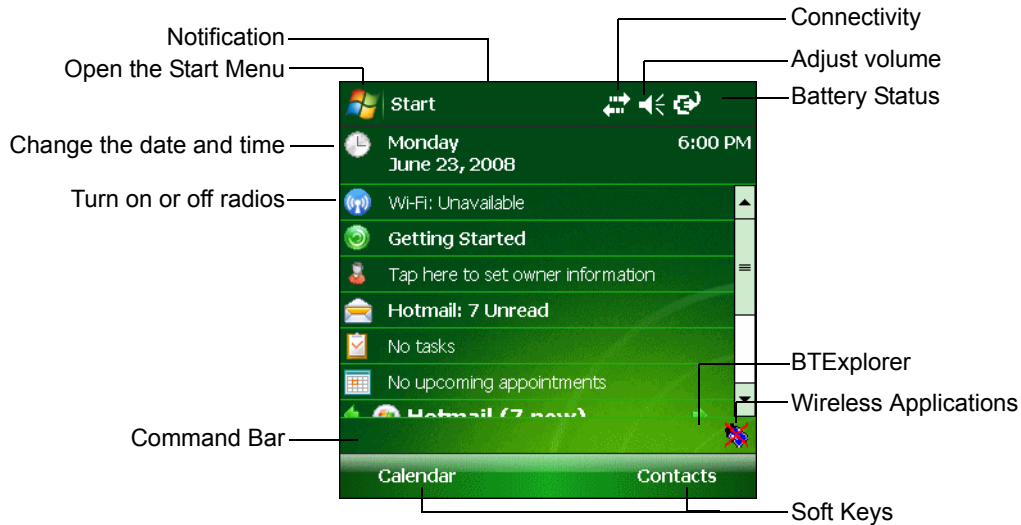

Figure 2-14 Today Screen

To customize the **Today** screen, tap **Start > Settings > Today** icon. Use the **Appearance** tab to customize the background and the **Items** tab to change the list and order of items that appear on the screen.

Windows Mobile 6.1 Status Icons

Status Bar











Status icons are shown in the **Status Bar** to indicate present status of the mobile computer. Tapping each status icon displays the corresponding dialog box and enables you to change or adjust its settings. You may see the status icons listed in [Table 2-7](#) on the **Status Bar** located at the top of the screen.

Table 2-7 Status Icons

Icon	Function	Description
	Audio	Speaker is on.
		Speaker is off.

* Only appears in the *Time and Next Appointment* dialog box.

Table 2-7 Status Icons (Continued)

Icon	Function	Description
	Battery	Backup battery is very low.
		Main battery is charging.*
		Main battery level.*
		Main battery is very low.*
	Connectivity	Connection is active.
		ActiveSync error
		Synchronization is occurring.
	Instant Message	Notification that one or more instant messages were received.
	E-Mail	Notification that one or more e-mail messages were received.
	Time and Next Appointment	Displays current time in analog or digital format.
	Multiple Notifications	There are more notification icons than can be displayed. Tap to display remaining icons.

* Only appears in the *Time and Next Appointment* dialog box.

Command Bar

You may see the icons listed in [Table 2-8](#) on the Command Bar located at the bottom of the screen.

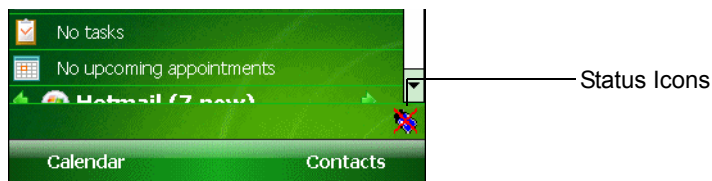

Figure 2-15 Command Bar

Table 2-8 Command Bar Icons





Icon	Description
	Wireless connection status icon. Indicates WLAN signal strength and opens the Wireless Applications menu.
	The Bluetooth Enabled icon appears in the task tray and indicates that the Bluetooth radio is on.

Table 2-8 *Command Bar Icons (Continued)*

Icon	Description
	The Bluetooth Disabled icon appears in the task tray and indicates that the Bluetooth radio is off.
	The Bluetooth Communication icon appears in the task tray and indicates that the mobile computer is communicating with another Bluetooth device.
	The ActiveSync icon appears in the task tray and indicates an active serial connection between the mobile computer and the development computer.

Speaker Icon

You can adjust the system volume using the **Speaker** icon in the Status bar.

1. Tap the **Speaker** icon. The **Volume** dialog box appears.

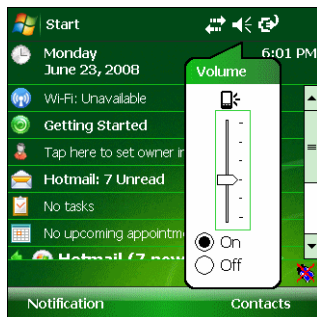
**Figure 2-16** *Volume Dialog Box*

2. Tap and move the slide bar to adjust the volume.
3. Select the **On** or **Off** radio button to turn the volume on or off.

✓ **NOTE** Use can also adjust the system volume using the **Sounds & Notifications** window or by using the keypad special functions. See [Keypad Special Functions on page 2-2](#).

Battery Icons

The **Main Battery** icon appears in the **Title Bar** when the Today screen is visible. The icon indicates the battery power level.

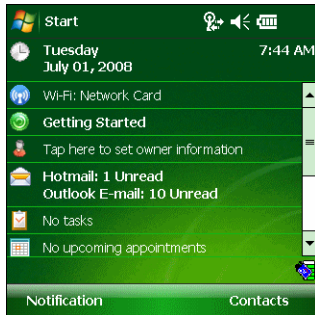

Figure 2-17 Battery Icon on the Title Bar

You can also view the battery status using the **Power** window.

When the main battery power falls below a predetermined level a **Main Battery** dialog box appears indicating the status of the main battery. When the backup battery power falls below a predetermined level a **Backup Battery** icon and dialog box appears indicating the status of the backup battery.

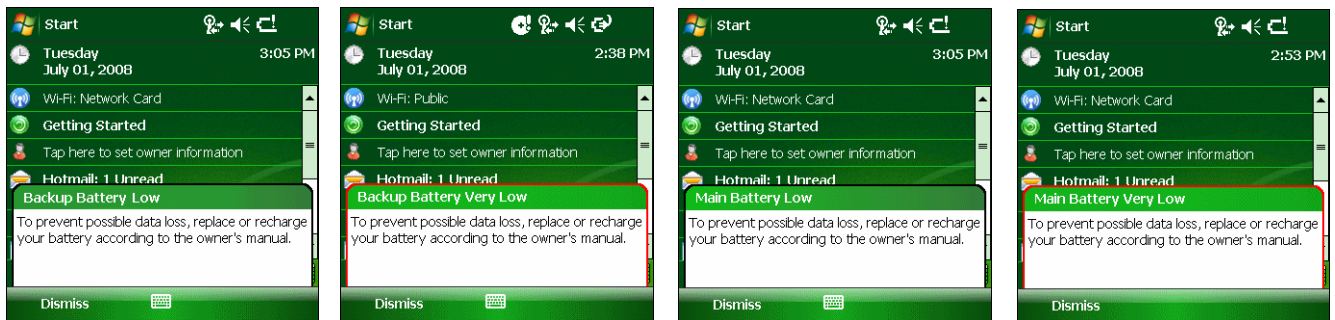

Figure 2-18 Battery Status Icons and Dialog Boxes

Connectivity Icon

The **Connectivity** icon indicates the communication status of the terminal when it's connecting to the internet or host computer.

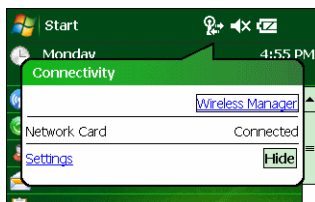

Figure 2-19 Connectivity Dialog Box

Time Icon

✓ **NOTE** The **Time** icon only appears in the **Title Bar** when an application displays. It does not appear in the **Title Bar** when the **Today** screen displays.

The **Time** icon displays the current time in a digital or analog format. To change the time format, tap and hold the **Time** icon until a menu appears. Select the format you want.

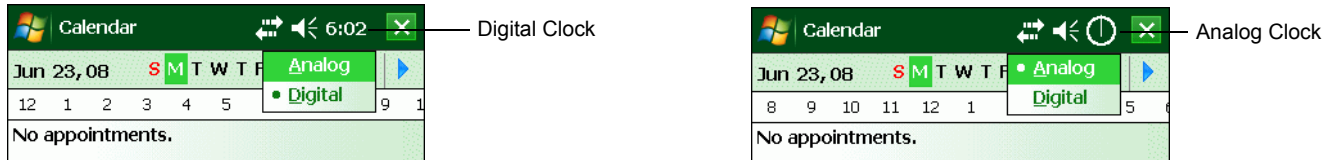

Figure 2-20 Time Icon Format Menu

To display current date, time and appointments:

1. Tap the **Time** icon to display the **Time and Next Appointment** dialog box.

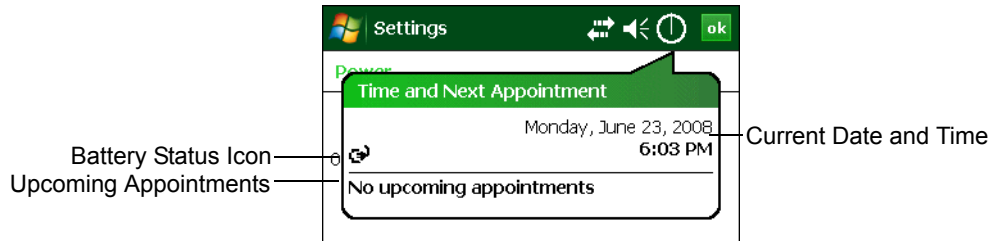

Figure 2-21 Time and Next Appointment Dialog Box

2. The dialog box displays the current date and time, the battery status and any upcoming appointments in the **Calendar**.

E-Mail Icon

The **E-Mail** icon notifies you when you have received incoming e-mails.

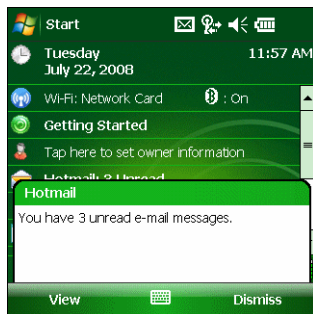

Figure 2-22 New E-mail Messages Dialog Box

Multiple Notification Icon

The **Multiple Notification** icon appears when two or more message notifications occur. Tap the icon to display the multiple notification icons.

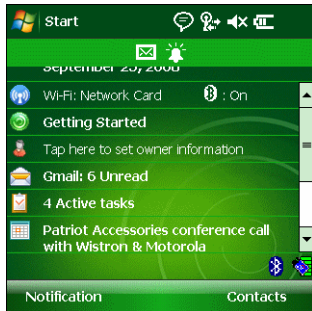

Figure 2-23 Multiple Notifications Icon

Locking the Mobile Computer (Windows Mobile 6.1 Only)

Use the Device Lock feature to prevent use of the device. Note that when locked, the mobile computer does not respond to screen or keypad input.

To lock the device, tap the **Device unlocked** icon. The icon changes to locked.

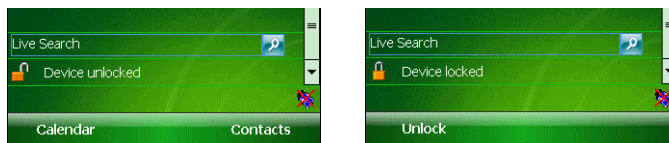

Figure 2-24 Device Locked/Unlocked Icons

To unlock the device and free it for use, tap **Unlock**.

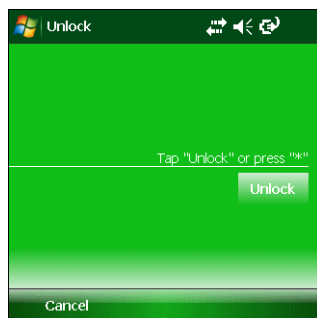

Figure 2-25 Unlock Device Window

Tap **Unlock** on the **Unlock Device** window.

Entering Information

To enter information:

- Use the keypad.
- Use the keyboard input panel (soft keyboard) to enter text.
- Scan bar code data into data fields.
- Use Microsoft® ActiveSync® to synchronize or copy information from the host computer to the mobile computer. For more information on ActiveSync, refer to the *MC3000 Integrator Guide*.

Entering Information Using Keypad

The 28, 38 and 48-key alphanumeric keypads produce the 26-character alphabet (A - Z), numbers (0 - 9), function keys and assorted characters. The keypads default characters/functions are printed black or white, the **ALPHA** character/functions are printed orange and the **FUNC** character/functions are printed blue. The 20-key mechanical keypad produces numbers (0 - 9) and function key and various characters. See [Keypads on page 2-1](#) for keypad configurations, see [Table 2-1 on page 2-2](#) for keypad special functions and see [Table B-1 on page B-2](#) for the special character generation.

Entering Information Using the Keyboard Input Panel

Use the keyboard input panel (soft keyboard) to enter information in any program. To launch the keyboard input panel, tap the  button on the taskbar. Tap a key to enter the value. Tap the keyboard input panel button to display or to hide the keyboard input panel.

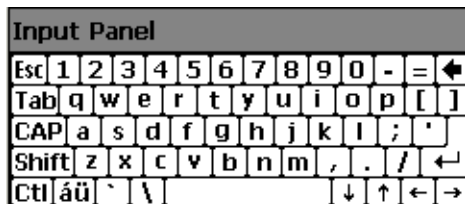

Windows CE 5.0



Windows Mobile 6.1

Figure 2-26 Keyboard Input Panel

Entering Data via the Bar Code Scanner

The sample bar code scanner application scans data into data fields in the same way data is entered via the keypad.

Using a Bluetooth Headset

You can use a Bluetooth headset for audio communication when an audio enabled application is used. See [Chapter 3, Using Bluetooth](#) for information on connecting a Bluetooth device to the mobile computer. Ensure that the mobile computer's volume is set appropriately before putting the headset on. When a Bluetooth headset is connected the speaker is muted.

✓ **NOTE** If the mobile computer goes into suspend mode the Bluetooth connection is disabled and the mobile computer automatically switches to speakerphone mode.

Data Capture

The mobile computer has an integrated scanner or imager that collects data by scanning bar codes.

Laser Scanning

To scan bar codes with the mobile computer:

1. Ensure that the mobile computer is loaded with a scanning application.
2. If the mobile computer is equipped with a rotating head, adjust the head prior to scanning.
3. Aim the scan window at the bar code.
4. Press the scan button or trigger. Ensure the red scan beam covers the entire bar code. The Scan LED Indicators illuminate red to indicate that the laser is on. The Scan LED Indicators illuminate green and a beep sounds to indicate a successful decode.

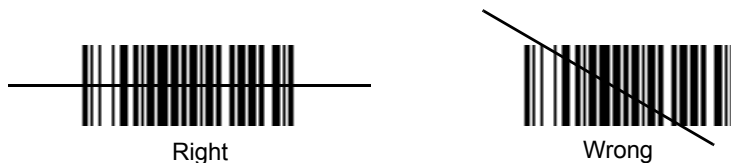

Figure 2-27 Laser Aiming

Optimal scanning distance varies with bar code density and scanner optics.

- Hold the scanner farther away for larger symbols.
- Move the scanner closer for symbols with bars that are close together.

✓ **NOTE** Scanning procedures depend on the application and mobile computer configuration. An application may use different scanning procedures from the one listed above.

Scan LED Indicators

The red/green Scan LED Indicators (located in the Indicator LED Bar and in the rotating turret) indicates the scan status. For the location of the Scan LED Indicators see, [Figure 1-1 on page 1-3](#).

Table 2-9 Scan LED Indicators

LED Status	Indication
Off	Not scanning.
Solid Red	Laser enabled, scanning in process.
Solid Green	Successful decode.

Scanning Considerations

Scanning consists of; aim, scan and decode. Scanning performance can be optimized by considering the range and the scanning angle:

- Range

Any scanning device decodes well over a particular working range (minimum and maximum distances from the bar code). This range varies according to bar code density and scanning device optics.

Scanning within range brings quick and constant decodes; scanning too close or too far away prevents decodes. Move the scanner closer and further away to find the right working range for the bar codes being scanned. However, the situation is complicated by the availability of various integrated scanning modules. The best way to specify the appropriate working range per bar code density is through a chart called a decode zone for each scan module. A decode zone simply plots working range as a function of minimum element widths of bar code symbols.

- Angle

The scan angle is important for optimizing decode performance. When laser beams reflect directly back into the scanner from the bar code, this specular reflection can “blind” the scanner.

To avoid this, scan the bar code so that the beam does not bounce directly back. But do not scan at too sharp an angle; the scanner needs to collect scattered reflections from the scan to make a successful decode. Practice quickly shows what tolerances to work within.

✓ **NOTE** Contact the Zebra Support Center if chronic scanning difficulties develop. Decoding of properly printed bar codes should be quick and effortless.

Laser Decode Ranges

The decode ranges provide the decode ranges for barcodes of specified densities. [Figure 2-28](#) shows the laser decode ranges and [Table 2-10 on page 2-28](#) lists the scan ranges for the selected bar code densities. The minimum element width (or “symbol density”) is the width in mils of the narrowest element (bar or space) in the symbol. The maximum usable length of a symbol at any given range is shown below.

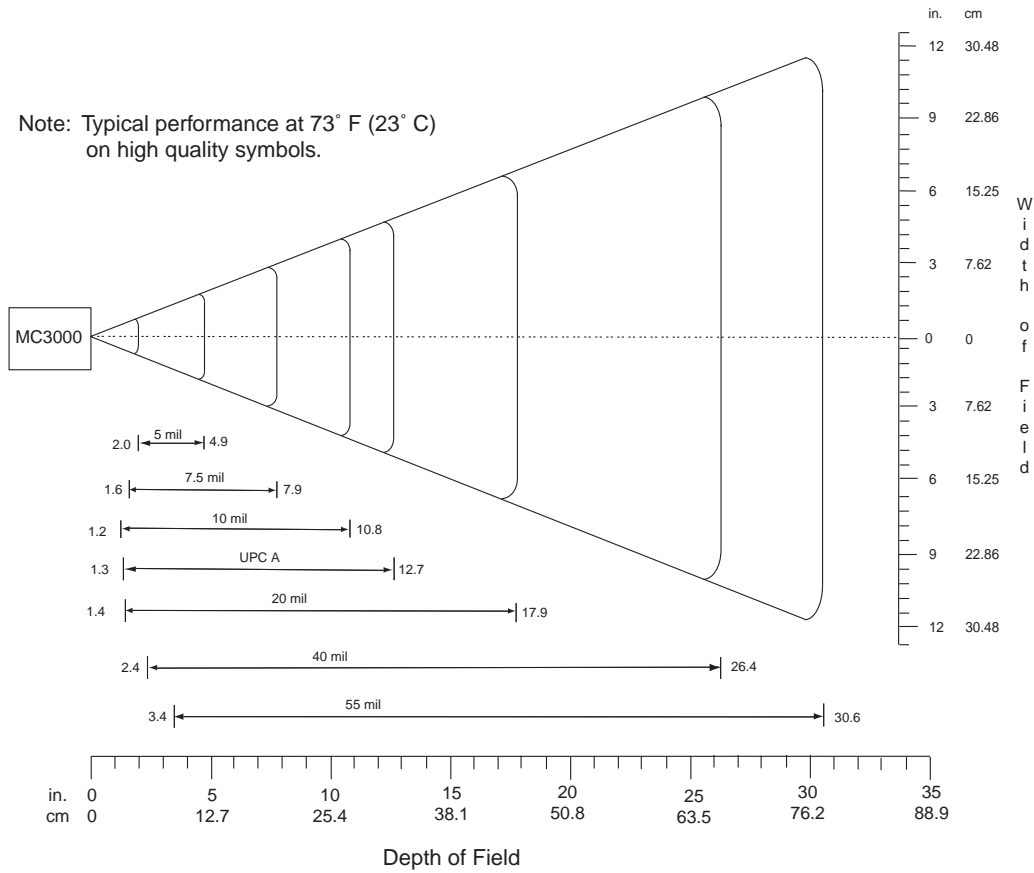

Figure 2-28 MC3000 Laser Decode Ranges

Table 2-10 MC3000 Laser Decode Ranges

Bar Code Density	Ranges	
	Near	Far
5.0 mil	2.0 in 5.08 cm	4.9 in 12.45 cm
7.5 mil	1.6 in 4.06 cm	7.9 in 20.07 cm
10 mil	1.2 in 3.05 cm	10.8 in 27.43 cm
UPC A	1.3 in 3.30 cm	12.7 in 32.26 cm

Table 2-10 MC3000 Laser Decode Ranges (Continued)

Bar Code Density	Ranges	
	Near	Far
20 mil	1.4 in 3.56 cm	17.9 in 45.47 cm
40 mil	2.4 in 6.10 cm	26.4 in 67.06 cm
55 mil	3.4 in 8.64 cm	30.6 in 77.72 cm

Imaging

The imager version of the mobile computer has the following features:

- Omnidirectional reading of a variety of bar code symbologies, including the most popular linear, postal, PDF417 and 2-D matrix code types.
- The ability to capture and download images to a host for a variety of imaging applications.
- Advanced intuitive laser aiming for easy point-and-shoot operation.

Imager

The imager uses digital camera technology to take a digital picture of a bar code, the image is stored in memory and software decoding algorithms are executed to extract the data from the image. A typical bar code decoding process is as follows:

1. Aim the mobile computer at a bar code and press the scan button or trigger.
2. The red laser aiming pattern turns on to assist in aiming the mobile computer.
3. The mobile computer turns on the secondary white LEDs to illuminate the target bar code.
4. The mobile computer takes a digital picture (image) of the bar code and stores it in memory for decoding. A beep sounds to indicate that the bar code was properly decoded.
5. Release the scan button.

This process usually occurs instantaneously. Steps 2 - 4 are repeated on poor or difficult bar codes as long as the scan button remains active.

Operational Modes

Mobile computers with an integrated imager have three modes of operation: Decode Mode, Pick List Mode and Image Capture Mode. All modes are activated by pulling the trigger or pressing the Scan button.

Decode Mode

This mode allows the user to decode a bar code when a single bar code in the mobile computer's field of view. In this mode the Imager attempts to locate and decode enabled bar codes within its field of view. The Imager remains in this mode as long as the trigger is pulled, or until a bar code is decoded.

Pick List Mode

Pick List mode allows the user to selectively decode a bar code when more than one bar code is in the mobile computer's field of view. By moving the aiming crosshair over the wanted bar code the user can selectively read only the required bar code. This feature is particularly valued for pick lists containing multiple bar codes and manufacturing or transport labels containing more than one bar code type (either 1D or 2D).

Aiming the Mobile Computer

The imager version of the mobile computer projects a laser aiming pattern (shown below) similar to those used on cameras. The aiming pattern is used to position the bar code or object within the field of view.

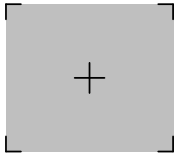

Figure 2-29 Laser Aiming Pattern

To scan a symbol using the imager:

1. Center the symbol in any orientation within the aiming pattern. Ensure the entire symbol is within the rectangular area formed by the brackets in the aiming pattern.

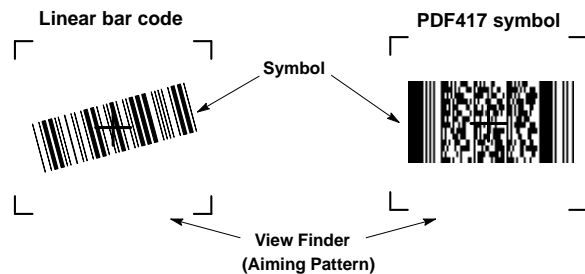

Figure 2-30 Centering Symbol in Aiming Pattern

The imager can also read a bar code presented within the aiming pattern but not centered, such as the figure below on the left. The figure on the right, however, can not be decoded.

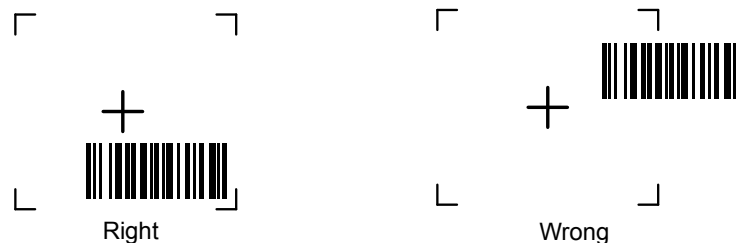

Figure 2-31 Bar Code not Centered in Aiming Pattern

Note that when the mobile computer is in Pick List Mode, the bar code is not decoded until the crosshair is touching the bar code.

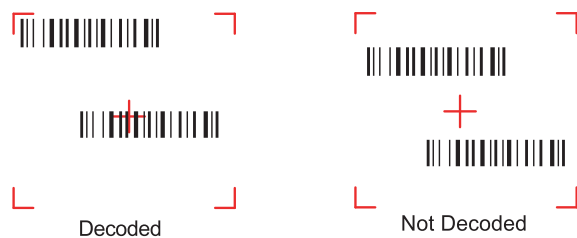

Figure 2-32 Pick List Mode with Multiple Bar Codes in Aiming Pattern

2. The aiming pattern is smaller when the Imager is closer to the symbol and larger when it is farther from the symbol. Scan symbols with smaller bars or elements (mil size) closer to the unit and those with larger bars or elements (mil size) farther from the unit.
3. Hold the mobile computer between two and nine inches (depending on symbol density) from the symbol, centering the aiming pattern cross hairs on the symbol.
4. Press the scan button. The Scan LED Indicators illuminate red to indicate that the laser is on. The Scan LED Indicators illuminate green and a beep sounds to indicate a successful decode.

Imager Decode Ranges

The decode ranges provide the decode distances for barcodes of specified densities. [Figure 2-33](#) shows the imager decode ranges and [Table 2-11 on page 2-32](#) lists the scan ranges for the selected bar code densities. The minimum element width (or “symbol density”) is the width in mils of the narrowest element (bar or space) in the symbol. The maximum usable length of a symbol at any given range is shown below.

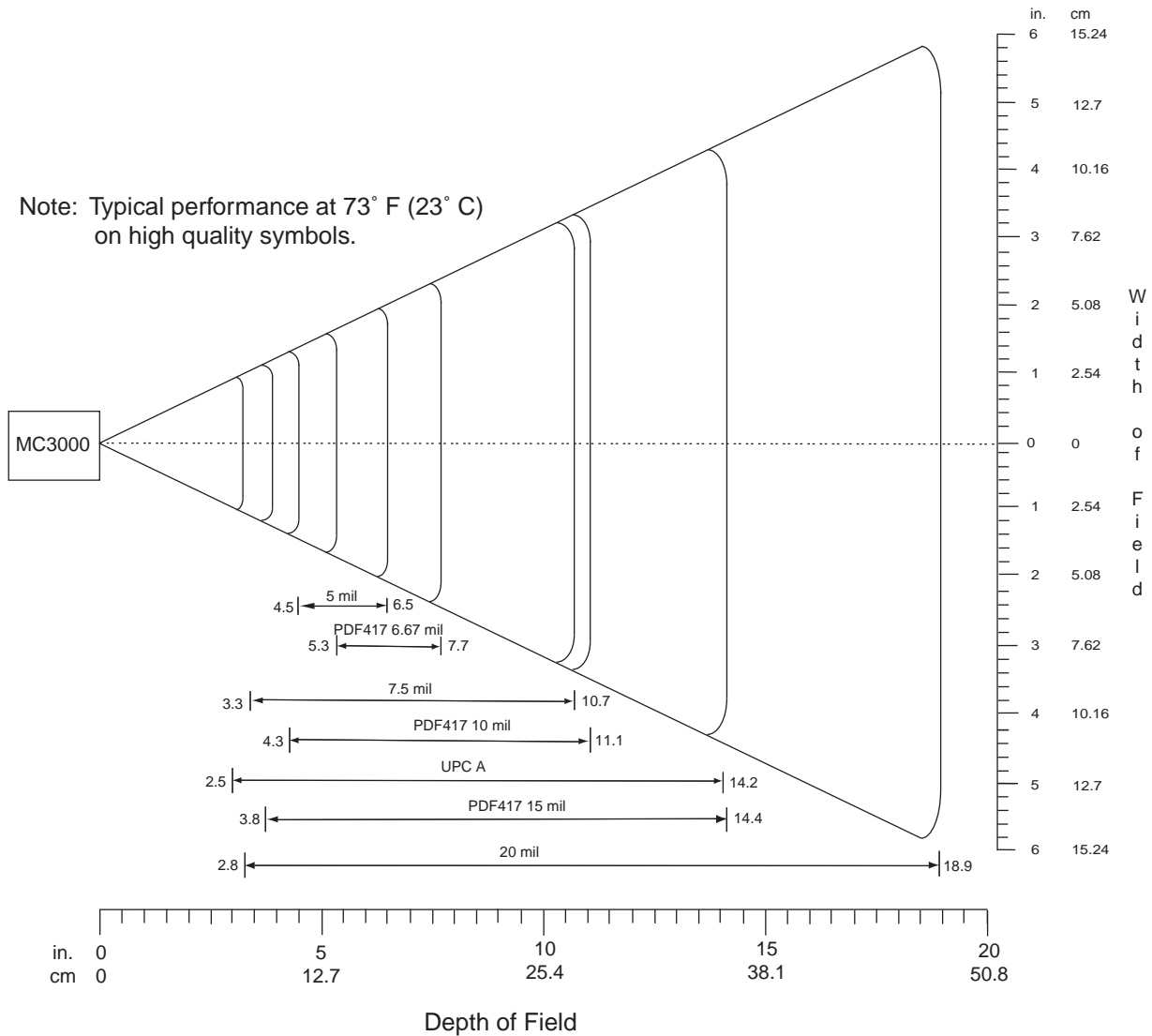

Figure 2-33 MC3000 Imager Decode Ranges

Table 2-11 MC3000 Imager Decode Ranges

Bar Code Density	Ranges	
	Near	Far
5.0 mil	4.5 in 11.43 cm	6.5 in 16.51cm
7.5 mil	3.3 in 8.38 cm	10.7 in 27.18 cm
UPC A	2.5 in 6.35 cm	14.2 in 36.07cm
20 mil	2.8 in 7.11 cm	18.9 in 48.01 cm

Table 2-11 MC3000 Imager Decode Ranges (Continued)

Bar Code Density	Ranges	
	Near	Far
PDF417 6.67 mil	5.3 in 13.46 cm	7.7 in 19.56 cm
PDF417 10 mil	4.3 in 10.92 cm	11.1 in 28.19 cm
PDF417 15 mil	3.8 in 9.65 cm	14.4 in 36.58 cm

Direct Part Marking

Direct Part Marking (DPM) is where an item is physically altered by methods such as dot peening, laser and electro-chemical etching to produce two different surface conditions. These marking result in the symbol being created by either smooth and rough (or dull and shiny) areas on the substrate or a symbol comprised “dots” below or above the substrate surface. DPM is typically used with matrix symbologies. As a result, there is often very little or no contrast between the “marked” elements of a symbol and the background.



Dot Peening

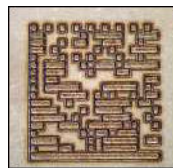

Laser

Figure 2-34 Examples of Direct Part Marking

To scan a DPM symbol using the imager:

1. Center the symbol in any orientation within the aiming pattern. Ensure the entire symbol is within the rectangular area formed by the brackets in the aiming pattern.

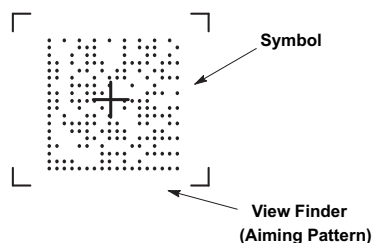

Figure 2-35 Centering Symbol in Aiming Pattern

2. The aiming pattern is smaller when the Imager is closer to the symbol and larger when it is farther from the symbol. Scan symbols with smaller elements closer to the unit and those with larger elements farther from the unit.
3. Hold the mobile computer between two and nine inches (depending on symbol density) from the symbol, centering the aiming pattern cross hairs on the symbol. Do not aim the exit window directly at the surface to avoid reflection back into the imager. Hold at a slight angle.

4. Press the scan button. The Scan LED Indicators illuminate red to indicate that the laser is on. The Scan LED Indicators illuminate green and a beep sounds to indicate a successful decode.

Resetting the Mobile Computer

Windows CE Devices

If the mobile computer stops responding to input, reset it. There are two reset functions, warm boot and cold boot. A warm boot restarts the mobile computer by closing all running programs. All data that is not saved is lost.

A cold boot also restarts the mobile computer, but erases all stored records and entries from RAM. In addition it returns formats, preferences and other settings to the factory default settings.

Perform a warm boot first. If the mobile computer still does not respond, perform a cold boot.

Performing a Warm Boot

To perform a warm boot on 28, 38 and 48-key keypad configurations:

1. Press and simultaneously hold **7**, **9** and **Power**. Do not hold down any other keys or buttons.
2. As the mobile computer initializes MC3000 demo window appears.



CAUTION Files that remain open during a warm boot may not be retained.

To perform a warm boot on 20-key keypad configurations:

1. Press and simultaneously hold the **7** and **9** keys and the press the **MENU** and **Fn** keys. Do not hold down any other keys or buttons.
2. As the mobile computer initializes MC3000 demo window appears.



CAUTION Files that remain open during a warm boot may not be retained.

Performing a Cold Boot

A cold boot restarts the mobile computer and erases all user stored records and entries from RAM. *Never perform a cold boot unless a warm boot does not solve the problem.*



CAUTION Cold boot resets the mobile computer, to the default settings. All added applications and all stored data are removed. Do not cold boot without support desk approval.

To perform a cold boot 28, 38 and 48-key keypad configurations:

1. Simultaneously press and then release the **1**, **9** and **Power** keys. Do not hold down any other keys or buttons. As the mobile computer initializes, the splash window, [Figure 1-7 on page 1-9](#), appears for about a minute.
2. Calibrate the touch screen. See [Calibration Screen on page 1-10](#) to calibrate the mobile computer screen.

To perform a cold boot on 20-key keypad configurations:

1. Simultaneously press and then release the **1** and **9**, **MENU** and **Fn** keys. Do not hold down any other keys or buttons. As the mobile computer initializes, the splash window, [Figure 1-7 on page 1-9](#), appears for about a minute.

2. Calibrate the touch screen. See [Calibration Screen on page 1-10](#) to calibrate the mobile computer screen.

Windows Mobile 6.1 Devices

There are two reset functions, warm boot and cold boot.

- A warm boot restarts the mobile computer and closes all running programs.
- A cold boot also restarts the mobile computer and closes all running programs but also resets the Real-Time-Clock (RTC).

Data saved in flash memory or a memory card is not lost. Perform a warm boot first. This restarts the mobile computer and saves all *stored* records and entries. If the mobile computer still does not respond, perform a cold boot.

Performing a Warm Boot

To perform a warm boot on 28, 38 and 48-key keypad configurations:

1. Press and simultaneously hold **7**, **9** and **Power**. Do not hold down any other keys or buttons.
2. As the mobile computer initializes Today screen appears.

Performing a Cold Boot

A cold boot restarts the mobile computer. The operating system and all applications are restarted. File storage is preserved. The Real-Time-Clock (RTC) resets. *Only perform a cold boot if a warm boot does not solve the problem.*

1. To perform a cold boot 28, 38 and 48-key keypad configurations, simultaneously press and then release the **1**, **9** and **Power** keys. Do not hold down any other keys or buttons.
2. As the mobile computer initializes, the splash window, [Figure 1-7 on page 1-9](#), appears for about a minute.

Waking the Mobile Computer

The wakeup conditions define what actions wake up the mobile computer after it has gone into suspend mode. The mobile computer can go into suspend mode by either pressing the Power button or automatically by Control Panel time-out settings. These settings are configurable and the factory default settings are shown in [Table 2-12](#).

Table 2-12 *Wakeup Default Settings*

Condition for Wakeup	Power Button	Automatic Time-out
AC power is applied.	No	Yes
Mobile computer is inserted into a cradle.	No	Yes
Mobile computer is removed from a cradle.	No	Yes
Mobile computer is connected to a serial device.	No	Yes
Mobile computer is connected to a USB device.	No	Yes
Mobile computer is disconnected from a USB device.	No	Yes
A key is pressed.	No	Yes

Table 2-12 Wakeup Default Settings (Continued)

Condition for Wakeup	Power Button	Automatic Time-out
The scan triggered is pressed.	No	Yes
The screen is touched.	No	No
Wireless LAN activity is detected.	No	No

File System Directory Structure

The mobile computer directory structure displays all of the file folders. The pre-installed folders are in flash file system memory and optional removable storage devices (SD storage cards).

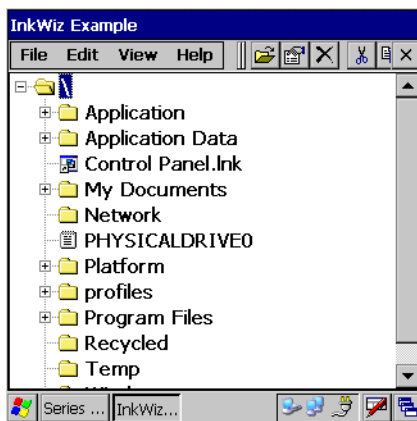
**Figure 2-36** Mobile Computer Directory Structure

- *Application* and *Platform* folders are located in flash file system memory.
- The *Windows*, *Program Files*, *profiles*, and *My Documents* folders are composites, RAM based folders generated from ROM (many of these files are marked read only).
- The *Network* folder is a link to file systems mapped using the network redirector. The files do not physically reside on the mobile computer.
- The *Temp* and *Recycled* folders typically contain RAM based files.









NOTE All files copied to the RAM based folders are lost after a cold boot.

Connecting to the Internet on a Wireless LAN Network

The mobile computer can connect to the Internet across a wireless LAN network. The *Wireless Applications* utility starts automatically when the mobile computer is turned on and the wireless application icon appears in the taskbar to indicate the connection and the signal strength status. Before attempting a wireless internet connection, confirm

that the wireless application radio is connected to a wireless LAN network. If the WLAN radio is not connected or if the signal strength is not “Good” or better, contact the network administrator.

Table 2-13 *Wireless Applications Icons, Signal Strength Descriptions*

Icon	Status	Action
	Excellent signal strength	Wireless LAN network is ready to use.
	Very good signal strength	Wireless LAN network is ready to use.
	Good signal strength	Wireless LAN network is ready to use.
	Fair signal strength	Wireless LAN network is ready to use. Notify the network administrator that the signal strength is only “Fair”.
	Poor signal strength	Wireless LAN network is ready to use. Performance may not be optimum. Notify the network administrator that the signal strength is “Poor”.
	Out-of-network range (not associated)	No wireless LAN network connection. Notify the network administrator.
	No wireless LAN network card detected.	No wireless LAN network card detected. Notify the network administrator.

To connect using Internet Explorer (IE) tap **Start > Programs > Internet Explorer** to start Internet Explorer.

✓ **NOTE** IE is not provided on mobile computers with Microsoft® Windows CE .NET 5.0 Core.



Figure 2-37 *Typical Internet Explorer (IE) Connection*

Chapter 3 Using Bluetooth

Introduction

Bluetooth-equipped devices can communicate without wires, using frequency-hopping spread spectrum (FHSS) RF to transmit and receive data in the 2.4 GHz Industry Scientific and Medical (ISM) band (802.15.1). Bluetooth wireless technology is specifically designed for short-range (30 feet/10 meters) communications and low power consumption.

Mobile computers with Bluetooth capabilities can exchange information (e.g., files, appointments and tasks) with other Bluetooth enabled devices such as phones, printers, access points and other mobile computers. In addition, a dial-up modem connection can be created between the Bluetooth mobile computer and a Bluetooth enabled phone. The Bluetooth phone can then be used as a modem.

Zebra mobile computers with Bluetooth technology use the StoneStreet One Bluetooth stack. To program Bluetooth within the mobile computer refer to the StoneStreet One SDK.

Adaptive Frequency Hopping

Adaptive Frequency Hopping (AFH) is a method of avoiding fixed frequency interferers. AFH can be used with Bluetooth voice. All devices in the piconet (Bluetooth network) must be AFH-capable in order for AFH to work. There is no AFH when connecting and discovering devices. Avoid making Bluetooth connections and discoveries during critical 802.11b communications. AFH for Bluetooth can be broken-down into four main sections:

- Channel Classification - A method of detecting an interference on a channel-by-channel basis, or pre-defined channel mask.
- Link Management - Coordinates and distributes the AFH information to the rest of the Bluetooth network.
- Hop Sequence Modification - Avoids the interference by selectively reducing the number of hopping channels.
- Channel Maintenance - A method for periodically re-evaluating the channels.

When AFH is enabled, the Bluetooth radio “hops-around” (instead of through) the 802.11b high-rate channels. AFH coexistence allows Zebra mobile computers to operate in any infrastructure. AFH is always enabled in the MC3000.

The Bluetooth radio in this mobile computer operates as a Class 2 device power class. The maximum output power is 2.5mW and the expected range is up to 32.8 feet (10 meters). A definitive definition of ranges based on power

class is difficult to obtain due to power and device differences, and whether one measures open space or closed office space.

- ✓ **NOTE** It is not recommended to perform Bluetooth wireless technology inquiry when high rate 802.11b operation is required.

Security

The current Bluetooth specification defines security at the link level. Application-level security is not specified. This allows application developers to define security mechanisms tailored to their specific need. Link-level security is really between devices not users, while application-level security can be implemented on a per-user basis. The Bluetooth specification defines security algorithms and procedures needed to authenticate devices, and if needed, encrypt the data flowing on the link between the devices. Device authentication is a mandatory feature of Bluetooth while link encryption is optional.

Pairing of Bluetooth devices is accomplished by creating an initialization key that is used to authenticate the devices and create a link key for them. Entering a common PIN number in the devices being paired generates the initialization key. The PIN number is never sent over the air. By default, the Bluetooth stack responds with no key when a key is requested (it is up to user to respond to the key request event). Authentication of Bluetooth devices is based-upon a challenge-response transaction. Bluetooth allows for a PIN number or passkey that is used to create other 128-bit keys used for security and encryption. The encryption key is derived from the link key used to authenticate the pairing devices. Also worthy of note is the limited range and fast frequency hopping of the Bluetooth radios that makes long-distance eavesdropping difficult.

It is recommended:

- Perform pairing in a secure environment
- Keep PIN codes private and don't store the PIN codes in the mobile computer
- Implement application-level security.

Turning the Bluetooth Radio Mode On and Off

Turn off the Bluetooth radio to save power or if entering an area with radio restrictions (e.g., an airplane). When the radio is off, the mobile computer can not be seen or connected to by other Bluetooth devices. Turn on the Bluetooth radio to exchange information with other Bluetooth devices (within range). Communicate only with Bluetooth radios in close proximity.

- ✓ **NOTE** To achieve the best battery life in mobile computers with multiple radios, turn off the radios that are not being used.

Disabling Bluetooth

To disable Bluetooth, tap **Bluetooth** icon > **Disable Bluetooth**. The **Bluetooth** icon changes to indicate that Bluetooth is disabled. An exclamation point appears with the icon.

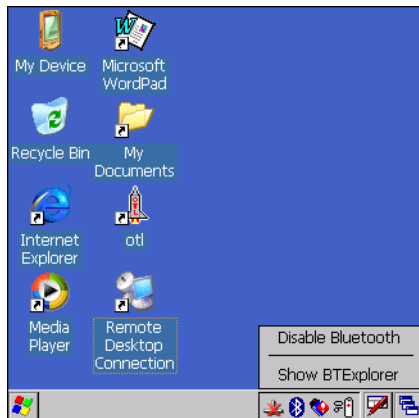

Figure 3-1 Disable Bluetooth

Enabling Bluetooth

To enable Bluetooth, tap **Bluetooth** icon > **Enable Bluetooth**. The **Bluetooth** icon changes to indicate that Bluetooth is enabled.

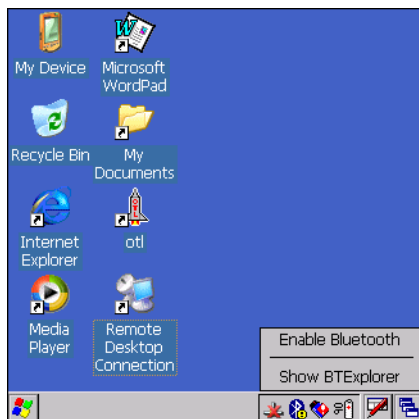

Figure 3-2 Enable Bluetooth

Bluetooth Power States

Cold Boot

When a cold boot is performed on the mobile computer, Bluetooth turns off. It is normal to see the **Bluetooth** icon appear and disappear, as well as a wait cursor, when initialization proceeds in all modes.

Warm Boot

When a warm boot is performed on the mobile computer, Bluetooth returns to the disabled state (off).

Suspend

When the mobile computer suspends, Bluetooth turns off.

- ✓ **NOTE** When the mobile computer is placed in suspend mode, the Bluetooth radio mode powers off and the piconet (Bluetooth connection) is dropped. When the mobile computer resumes, it could take up to 10 seconds for the Bluetooth radio driver to re-initialize the radio.

Resume

When the mobile computer resumes, Bluetooth turns on if it was on prior to suspend. Note that any Bluetooth connection that was dropped during a suspend needs to be reconnected after a resume.

Bluetooth Profiles

The mobile computer is loaded with a number of Bluetooth services profiles. These profiles can be loaded or removed from memory. If a profile is not used, it can be removed to save memory. To load or remove profiles:

1. If **BTE Explorer** is running, tap  > **Disable Bluetooth**.
2. Tap  > **Programs** > **BTProfileSelector**. The **ProfileSelector** window appears.

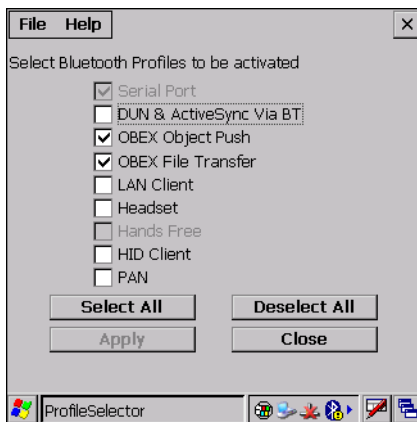



Figure 3-3 Bluetooth Profile Selector Window

3. Tap a check box next to the profile to load (activate).
The Serial Port profile is always active and cannot be removed.
4. Tap **Select All** to select all profiles or tap **Deselect All** to deselect all profiles.
5. Tap **Apply** to activate the profiles and then **Close** to exit the application.
6. Tap  > **Enable Bluetooth** to enable **BTE Explorer** application.

See [Services Tab on page 3-22](#) for more information on selecting services.

Modes

The BTE Explorer application has two modes for managing Bluetooth connections: Wizard Mode and Explorer Mode. The Wizard Mode is for novice Bluetooth users and the Explorer Mode is for experienced Bluetooth users.

Wizard Mode

Wizard Mode provides a simple step by step process for discovering and connecting to Bluetooth devices. The wizard takes you through the entire process.

✓ **NOTE** When switching between Wizard Mode and Explorer Mode, all active connections are closed.

The following steps provide an example for using the Wizard to services for remote devices.

1. Tap the **Bluetooth** icon and select **Show BTE Explorer**. The **BTE Explorer** window appears.
2. Tap **File > New Connection**. The **New Connection Wizard** window appears.



Figure 3-4 New Connection Wizard Window

3. Select an action from the drop-down list. In this example, **Explore Services on Remote Device** is selected.
4. Tap **Next**. The **BTE Explorer** searches for Bluetooth devices in the area and displays the devices in the **Select Remote Device** window.

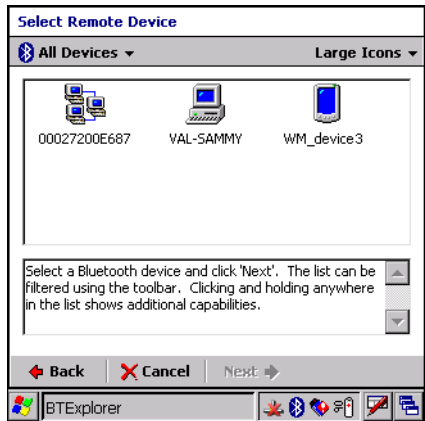

Figure 3-5 Select Remote Device Window

- ✓ **NOTE** Devices discovered previously are listed to save time. To start a new device discovery, tap and hold and select **Discover Devices** from the menu.

5. Select a device from the list and then tap **Next**. The **Connection Favorite Options** window appears.



Figure 3-6 Connection Favorite Options Window

6. Select **Save As Favorite** check box to save this service in the **Favorite** view.
7. In the **Favorite Name** text box, enter a name for this service that will appear in the **Favorite** list.
8. Tap **Next**. The **Connection Summary** window appears.

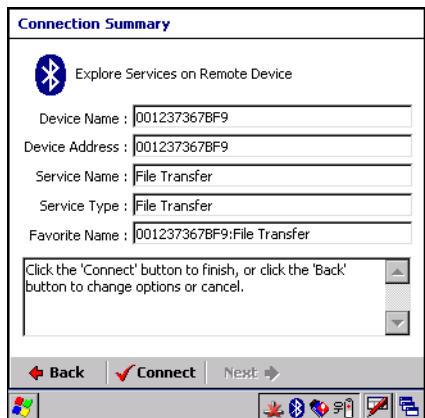

Figure 3-7 Connection Summary Window

9. Tap **Connect** to connect to the service.

The following actions are available in the drop-down list (actions may vary depending upon configurations):

- Explore Services on Remote Device
- Pair with a Remote Device
- ActiveSync via Bluetooth
- Browse Files on Remote Device
- Connect to Internet Using Access Point
- Connect to Internet Using Phone/Modem
- Connect to a Personal Area Network
- Send or Exchange Objects
- Associate Serial Port.

Explorer Mode

The **BTE Explorer** window is streamlined and easy to navigate and provides greater control to users familiar with Bluetooth functionality. The menu bar provides quick access to the options and tools used to connect to devices.

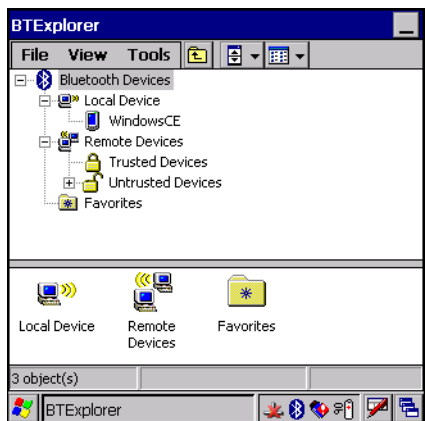

Figure 3-8 Explorer Mode Window

You can also use the “tap and hold” technique to view available options. Scroll bars and view options are like those you’re familiar with on your Windows desktop. The tree structure lists the following sub-items:

- Local Device - This MC3000 mobile computer
- Remote Device - Other Bluetooth devices
 - Trusted Devices - Bonded (paired) Bluetooth devices
 - Untrusted Devices - Discovered devices that are not bonded
- Favorites - Selected services that are set as being **Favorite** for quick access.

✓ **NOTE** When switching between Wizard Mode and Explorer Mode, all active connections are closed.

Discovering Bluetooth Device(s)

Follow the steps below to discover Bluetooth devices. The mobile computer can receive information from discovered devices, without bonding. However, once bonded, an exchange of information between the mobile computer and a bonded device occurs automatically when the Bluetooth radio is turned on.

To find Bluetooth devices in the area:

1. Ensure that the Bluetooth device being looked for is in discoverable mode.
2. Ensure that the two devices are within 30 feet (10 meters) of one another.
3. Tap the **Bluetooth** icon and select **Show BTE Explorer**. The **BTE Explorer** window appears.

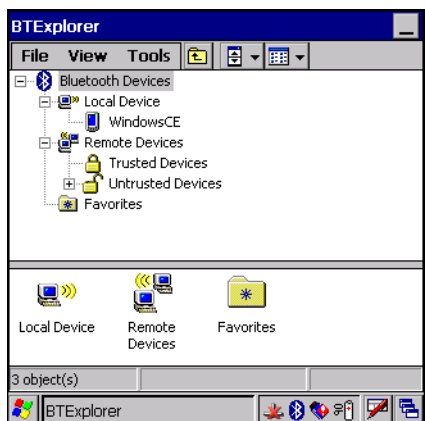

Figure 3-9 BTE Explorer Window

4. Tap and hold **Remote Devices** and select **Discover Devices** from the pop-up menu. The mobile computer searches for Bluetooth devices in the area.

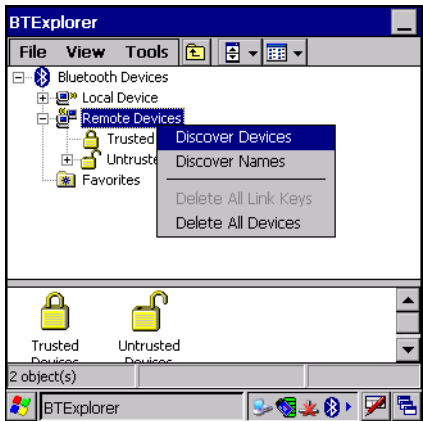

Figure 3-10 Discover Devices

5. The discovered devices display in the **Untrusted Devices** folder.

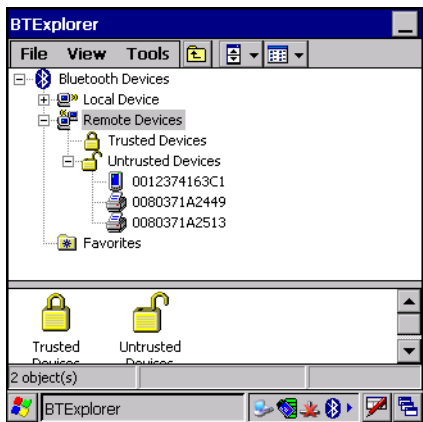

Figure 3-11 Discovered Devices Listed in Untrusted Folder

Bonding with Discovered Device(s)

A bond is a relationship created between the mobile computer and another Bluetooth device in order to exchange information in a secure manner. Creating a bond involves entering the same PIN on the two devices to bond. Once a bond is created, and the Bluetooth radios are turned on, the devices recognize the bond and are able to exchange information without re-entering a PIN.

To bond with a discovered Bluetooth device:

1. Discover remote devices. See [Discovering Bluetooth Device\(s\) on page 3-8](#).
2. In the **Untrusted Devices** folder, tap and hold on a device to pair with.

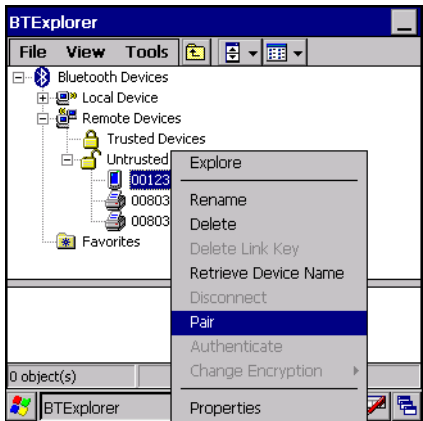

Figure 3-12 Pair a Remote Device

3. Select **Pair** from the pop-up menu.
4. On the mobile computer, the **PIN Code Request** window appears.

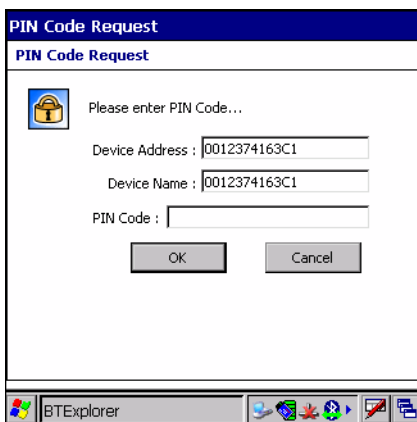

Figure 3-13 PIN Code Request Window

5. In the **PIN Code:** text box, enter the PIN number (between 1 and 16 characters) and then tap **OK**.
6. On the remote device, enter the same PIN number.
7. The devices are successfully paired. The device name moves to the **Trusted Devices** folder.

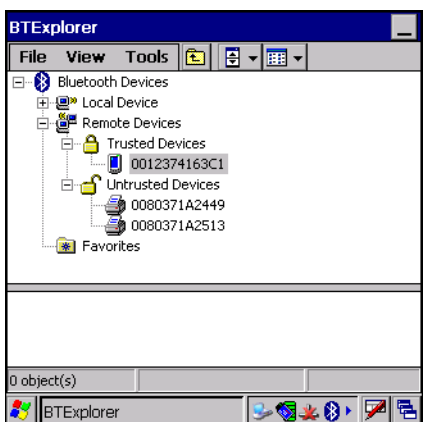

Figure 3-14 Bonded (Paired) Discovered Device

Renaming a Bonded Device

If it is necessary to rename a bonded device, it can be done from the **BTE Explorer** window.

1. Launch **BTE Explorer**.
2. Tap and hold the device to rename and select **Rename** in the pop-up menu.

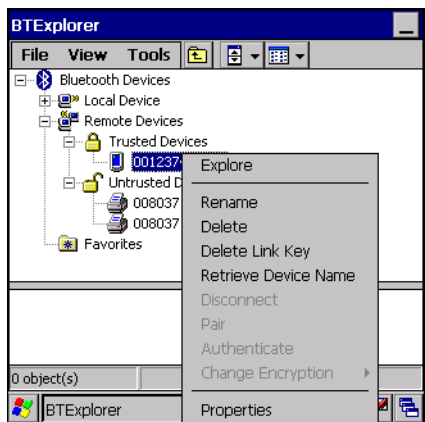

Figure 3-15 Rename Device Selection Dialog Box

3. The **Change Device Name** window appears.



Figure 3-16 Change Device Name Window

4. Enter a new name for the bonded device in the text box. Tap **OK**.

Deleting a Bonded Device

If it is no longer necessary to connect with a device, delete it from the **Bluetooth Bonded Devices** window.

1. Launch **BTE Explorer**.
2. Tap and hold the device to delete and select **Delete** in the pop-up menu.

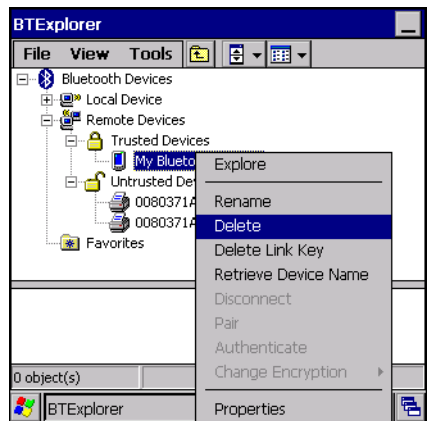

Figure 3-17 Delete a Bonded Device

3. A confirmation dialog appears. Tap **Yes**.

Accepting a Bond

When a remote device wants to bond with a mobile computer you give permission by entering a PIN when requested.

1. Ensure that the mobile computer is set to discoverable and connectable. See [Bluetooth Settings on page 3-21](#).
2. When prompted to bond with the remote device the **PIN Code Request** window appears.

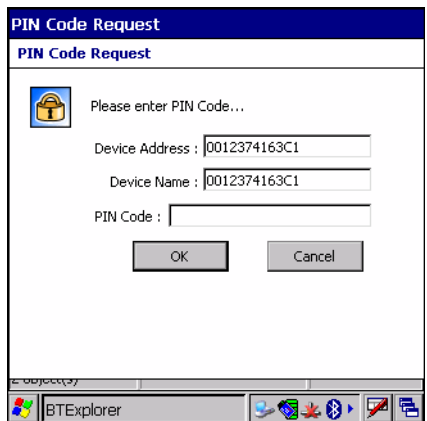

Figure 3-18 PIN Code Request Window

✓ **NOTE** Connections to untrusted devices are a security risk.

3. In the **PIN Code:** text box, enter the same PIN that was entered on the device requesting the bond. The PIN must be between 1 and 16 characters.
4. In the **Device Name:** text box, edit the name of the device requesting the bond, if desired.
5. Tap **OK**.
6. The bond is created and the mobile computer can now exchange information with the other device.

Discovering Services

Before services can be used, you must first discover remote devices and then bond to those devices.

To determine what services are available on a bonded remote device:

1. Tap the **Bluetooth** icon and select **Show BTE Explorer**.
2. In **BTE Explorer** window, tap and hold on the remote device and select **Explore** from the pop-up menu.

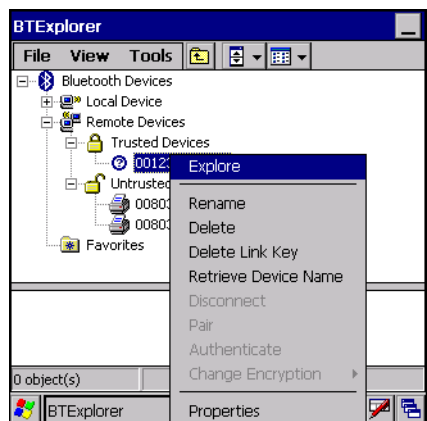

Figure 3-19 Discovering Services

3. The mobile computer communicates with the remote device and then lists the services under the device name.

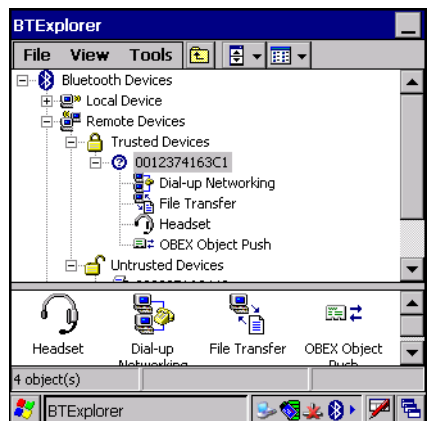

Figure 3-20 List of Discovered Services

Some examples of available services are:

- File Transfer Services
- Dial-Up Networking Services
- Headset or Hands-Free Services
- OBEX Object Push Services
- Serial Port Services

These services are discussed in the following paragraphs.

File Transfer Services

✓ **NOTE** Shared folders are a security risk.

To transfer files between the mobile computer and another Bluetooth enabled device:

1. Ensure the mobile computer is discoverable and connectable. See [Bluetooth Settings on page 3-21](#).
2. Discover and bond (pair) with the remote access point. See [Bonding with Discovered Device\(s\) on page 3-9](#).
3. In **BTE Explorer**, select the **Remote Devices** folder.
4. Select the **Trusted Devices** folder.
5. Tap the remote device folder.
6. Tap and hold on the remote device and select **Explore** from the pop-up menu.
7. Tap and hold on **File Transfer** and select **Connect**. The remote device's accessible folders appear.
8. Select a folder. The contents of the folder appear in the sub-window.

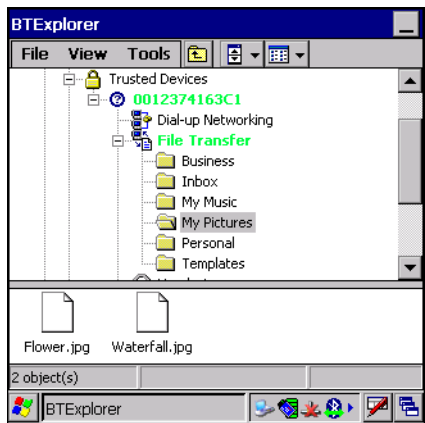

Figure 3-21 Remote Device Folders

9. Tap and hold on the file. A pop-up menu appears.
10. Select the action to perform:
 - a. *New* - create a new file or folder. on the remote device
 - b. *Delete* - delete the selected file on the remote device.
 - c. *Get File* - copy the file from the remote device to the mobile computer.
 - d. *Put File* - copies a file from the mobile computer to the remote device.

Create New File or Folder

To create a new folder or file on the remote device:

1. Tap and hold on the file and select **New > Folder** or **New > File**. The **Create New Folder** or **Create New File** window appears.
2. Enter the name for the new folder or file. Tap **OK**.
3. A new folder or file is created on the remote device.

Delete File

To delete a file from the remote device:

1. Tap and hold on the file and select **Delete**.
2. In the **Delete Remote Device File** dialog box tap **OK**.

Get File

To copy a file from a remote device:

1. Tap and hold on the file and select **Get**. The **Save Remote File** window appears.
2. Navigate to the directory to save the file.
3. Tap **Save**. The file is transferred from the remote device to the mobile computer.

Put File

To copy a file to a remote device:

1. Tap and hold on the file and select **Put**. The **Send Local File** window appears.
2. Navigate to the directory to save the file and select a file.
3. Tap **Open**. The file is transferred from the mobile computer to the remote device.

Connect to Internet Using Access Point

This section explains how to access a Bluetooth-enabled LAN access point (AP) for a network connection. With this method of communication the Internet Explorer can be used to connect to a server.

1. Ensure the mobile computer is discoverable and connectable. See [Bluetooth Settings on page 3-21](#).
2. Discover and bond (pair) with the remote access point. See [Bonding with Discovered Device\(s\) on page 3-9](#).
3. In **BTEplorer**, select the **Remote Devices** folder.
4. Select the **Trusted Devices** folder.
5. Tap the remote device folder.
6. Tap and hold on the remote device and select **Explore** from the pop-up menu.
7. Tap and hold **LAN Access using PPP** service and select **Connect** from the pop-up menu.
8. The mobile computer connects with the Access Point.
9. Tap **Start > Internet Explorer**. The **Internet Explorer** window appears.
10. In the address field, enter an internet address and tap the **Enter** button. The web page loads.

Dial-Up Networking Services

To use a phone that has Bluetooth capabilities as a modem for the mobile computer, create a Bluetooth modem connection on the mobile computer and send information to the phone using Bluetooth. The phone relays the information over the phone line and sends back to the mobile computer any information that was requested over the connection. Once a modem connection is created to the Bluetooth phone, it can be reused.

Prior to creating a connection, ensure the following:

- Bluetooth phone is turned on.
- Bluetooth phone is discoverable. (Some phones may also need to be pairable in order to accept a bonding request. For more information, refer to the phone documentation.)
- Mobile computer's and phone's Bluetooth radios are turned on.
- Mobile computer and phone are within range of each other (30 feet/10 meters).

Complete the following steps to create a new Bluetooth connection. Before setting up dial-up networking, obtain dial-up information and other necessary settings for the office network or ISP.

1. Ensure the mobile computer is discoverable and connectable. See [Bluetooth Settings on page 3-21](#).
2. Discover and bond (pair) with the remote device. See [Bonding with Discovered Device\(s\) on page 3-9](#).
3. In **BTExplorer**, select the **Remote Devices** folder.
4. Select the **Trusted Devices** folder.
5. Tap the remote device folder.
6. Tap and hold on **Dial-up Networking** and select **Connect** from the pop-up menu. The **Select Dial-up Networking Entry** window appears.



Figure 3-22 Select Dial-up Networking Entry Window

✓ **NOTE** If a dial-up entry is not listed, see [Add a Dial-up Entry on page 3-17](#).

7. Select a dial-up entry.
8. Tap **OK**. The mobile computer begins to communicate with the phone. If required, the phone requests permission to communicate with the mobile computer.
9. Confirm the connection on the phone. The **Network Log On** window appears.



Figure 3-23 Network Log On Window

10. In the **User name:** text box, enter the user name for this connection.
11. In the **Password:** text box, enter the password for this connection.
12. In the **Domain:** text box, enter the domain for this connection, if required.
13. Tap **OK**.
14. The phone begins dialing.
15. The phone connects to the network.
16. To end a session, tap the **Connection** icon and then tap **Disconnect** in the dialog box.

Add a Dial-up Entry

To add a dial-up entry:

1. In the **Select Dial-up Networking Entry** window, tap and hold and then select **Add Entry** from the pop-up menu.

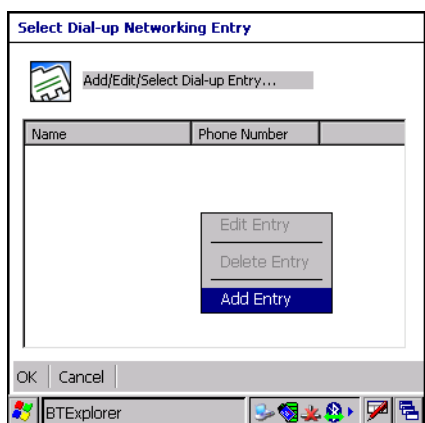
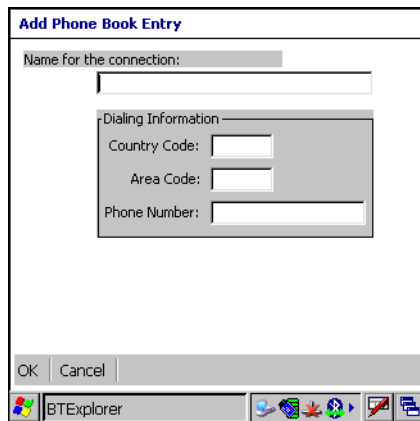

Figure 3-24 Add Dial-Up Entry

2. The **Add Phone Book Entry** window appears.



3. In the **Name for the connection** text box, enter a name for this connection.
4. In the **Country Code** text box, enter the country code for the country that you are calling.
5. In the **Area Code** text box, enter the area code.
6. In the **Phone Number** text box, enter the phone number.
7. Tap **OK**.

OBEX Object Push Services

Object Exchange (OBEX) is a set of protocols allowing objects such as pictures to be shared using Bluetooth.

To exchange information with another Bluetooth enabled device:

1. Ensure the mobile computer is discoverable and connectable. See [Bluetooth Settings on page 3-21](#).
2. Discover and bond (pair) with the remote device. See [Bonding with Discovered Device\(s\) on page 3-9](#).
3. In **BTE Explorer**, select the **Remote Devices** folder.
4. Select the **Trusted Devices** folder.
5. Tap the remote device folder.
6. Tap and hold on **OBEX Object Push** and select **Connect**. The **OBEX Object Push** window appears.
7. In the **Action** drop-down list, select one of the options: **Send Contact Information**, **Swap Contact Information**, **Fetch Contact Information** or **Send a Picture**.

Send a Picture

To send a picture to another device:

1. Ensure the mobile computer is discoverable and connectable. See [Bluetooth Settings on page 3-21](#).
2. Discover and bond (pair) with the remote device. See [Bonding with Discovered Device\(s\) on page 3-9](#).
3. In **BTE Explorer**, select the **Remote Devices** folder.
4. Select the **Trusted Devices** folder.
5. Tap the remote device folder.
6. Tap and hold on **OBEX Object Push** and select **Connect**. The **OBEX Object Push** window appears.

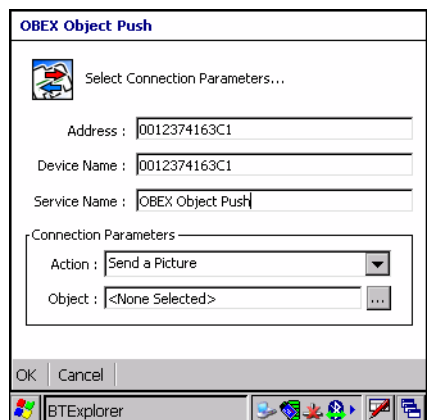



Figure 3-25 OBEX Object Push Window

7. In the **Action** drop-down list, select **Send A Picture**.
8. Tap . The **Send Local Picture** window appears.

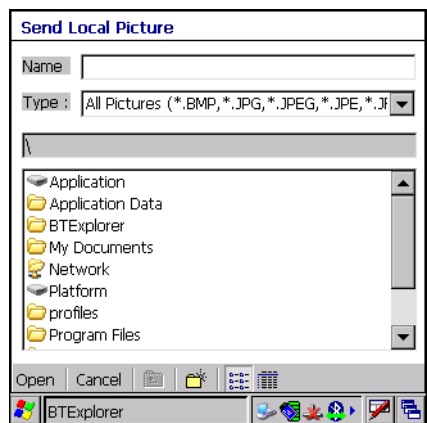

Figure 3-26 Send Local Picture Window

9. Navigate to the picture that you want to send to the other device.
10. Tap **Open**.
11. Tap **OK**. The picture is sent to the other device and a confirmation dialog box appears on the other device to accept the picture. A **Send Picture** dialog appears.
12. Tap **Ok**.

Headset Services

To connect to a Bluetooth headset:

1. Ensure the mobile computer is discoverable and connectable. See [Bluetooth Settings on page 3-21](#).
2. Discover and bond (pair) with the headset. See [Bonding with Discovered Device\(s\) on page 3-9](#).
3. In **BTE Explorer**, select the **Remote Devices** folder.
4. Select the **Trusted Devices** folder.

5. Tap the remote device folder.
6. Tap and hold on the remote device and select **Explore**. A headset service item appears.
7. Tap and hold on the headset service name and select **Connect**.
8. The mobile computer connects to the headset. Refer to your headset user manual for instruction on communicating with a Bluetooth device.

To adjust the microphone gain:

1. Tap and hold on the headset service item and select **Adjust Microphone** from the pop-up menu. The **Microphone Properties** window appears.
2. Select the slider and adjust the gain.
3. Tap **OK**.

Serial Port Services

- ✓ **NOTE** By default, COM ports COM4, COM5 and COM9 are Bluetooth virtual ports. If an application opens one of these ports, the Bluetooth driver activates and guides you through a Bluetooth connection.

Use the wireless Bluetooth serial port connection just as you would a physical serial cable connection. You must configure the application that will use the connection to the correct serial port.

To establish a serial port connection:

1. Ensure the mobile computer is discoverable and connectable. See [Bluetooth Settings on page 3-21](#).
2. Discover and bond (pair) with the remote device. See [Bonding with Discovered Device\(s\) on page 3-9](#).
3. In **BTE Explorer**, select the **Remote Devices** folder.
4. Select the **Trusted Devices** folder.
5. Tap the remote device folder.
6. Tap and hold **Serial Port** and select **Connect** in the pop-up menu. The **Remote Service Connection** window appears.

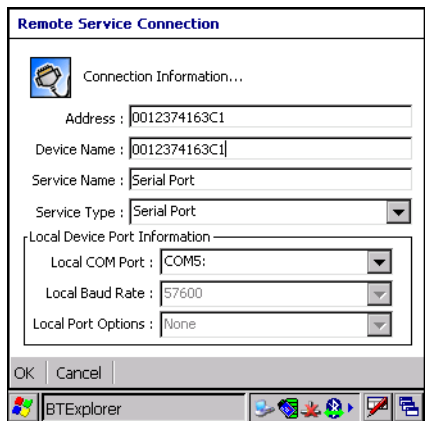

Figure 3-27 Remote Service Connection Window

7. In the **Local COM Port** drop-down list select a COM port.
8. Tap **OK**.

Personal Area Network Services

Connect two or more Bluetooth devices to share files, collaborate or play multi player games.

To establish a Personal Area Network connection:

1. Ensure the mobile computer is discoverable and connectable. See [Bluetooth Settings on page 3-21](#).
2. Discover and bond (pair) with the remote device. See [Bonding with Discovered Device\(s\) on page 3-9](#).
3. In **BTE Explorer**, select the **Remote Devices** folder.
4. Select the **Trusted Devices** folder.
5. Tap the remote device folder.
6. Tap and hold **Personal Area Network** and select **Connect** in the pop-up menu.

Bluetooth Settings

Use the **BTE Explorer Settings** window to configure the operation of the **BTE Explorer** application. Tap **Tools > Settings**. The **BTE Explorer Settings** window appears.

Device Info Tab

Use the **Device Info** tab to configure the mobile computer's Bluetooth connection modes.



Figure 3-28 BTE Explorer Settings - Device Info Tab

Device Name	Displays the name of the mobile computer.
Discoverable Mode	Allows you to set the mobile computer to be discoverable by other Bluetooth devices or not be discoverable. Note: For security reasons, the default is set to Non Discoverable .
Connectable Mode	Allows you to set the mobile computer to be connectable by other Bluetooth devices or not be connectable. Note: For security reasons, the default is set to Non Connectable .

Services Tab

For security reason, by default services are not enabled.

Use the **Services** tab to add or delete Bluetooth services.

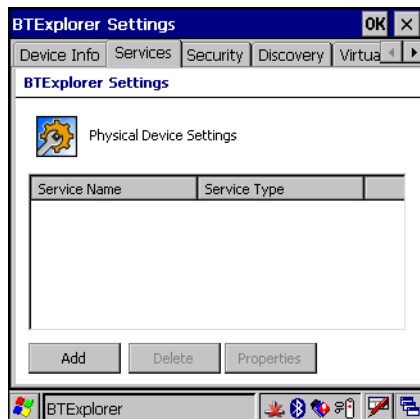

Figure 3-29 BTE Explorer Settings - Services Tab

To add a service:

1. Tap **Add**. The **Add Local Service** window displays.

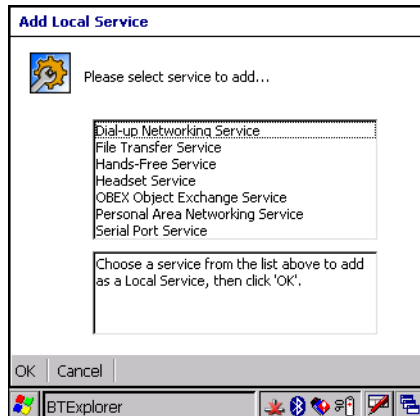

Figure 3-30 Add Local Service Window

2. In the list, select a service to add.
3. Tap **OK**. The **Edit Local Service** window displays for the selected service.
4. Select the appropriate information and then tap **OK**. See the following paragraphs for detailed information on the available services.

Dial-Up Networking Service

Dial-up Networking allows a dial-up modem to be accessed by other Bluetooth devices.

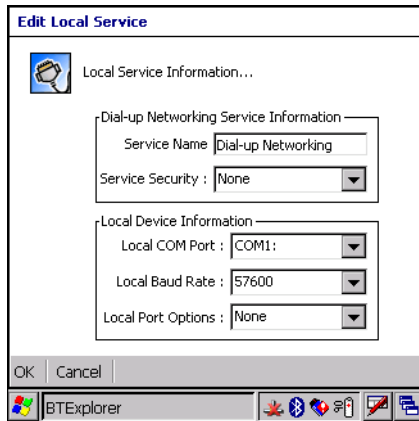

Figure 3-31 Add Local Service Window

Service Name	Displays the name of the service.
Service Security	Select the type of security from the drop-down list; None , Authenticate or Authenticate/Encrypt .
Local COM Port	Select the COM port. Select COM1 to use a modem or other device that is connected to the connector on the bottom of the mobile computer.
Local Baud Rate	Select the communication baud rate.
Local Port Options	Select the port option.

File Transfer Service

File transfer allows files to be browsed by other Bluetooth devices.

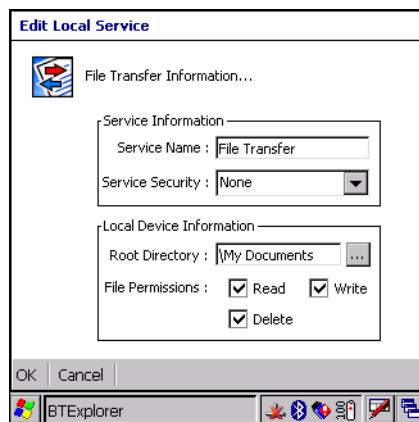

Figure 3-32 File Transfer Information Window

Service Name	Displays the name of the service.
Service Security	Select the type of security from the drop-down list; None , Authenticate or Authenticate/Encrypt .
Root Directory	Select the directory that other Bluetooth devices can access.
File Permissions	Select the file permissions for the selected directory. Check the appropriate box to grant Read access, write access and delete access.

OBEX Object Push Service

OBEX Object Push allows contacts, business cards, pictures, appointments, and tasks to be pushed to the device by other Bluetooth devices.

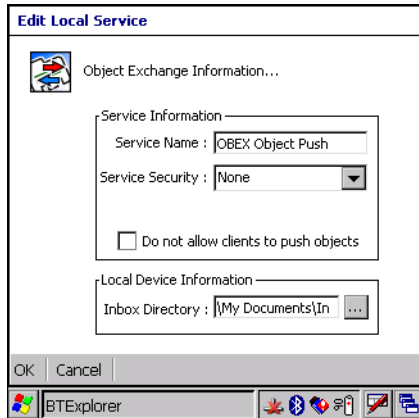

Figure 3-33 OBEX Exchange Information Window

Service Name	Displays the name of the service.
Service Security	Select the type of security from the drop-down list; None , Authenticate or Authenticate/Encrypt .
Do not allow clients to push objects	Disables clients from pushing objects to the mobile computer.
Inbox Directory	Select a directory where another Bluetooth device can store files.

Personal Area Networking Service

Personal Area Networking hosts a Personal Area Network which allows communication with other Bluetooth devices.

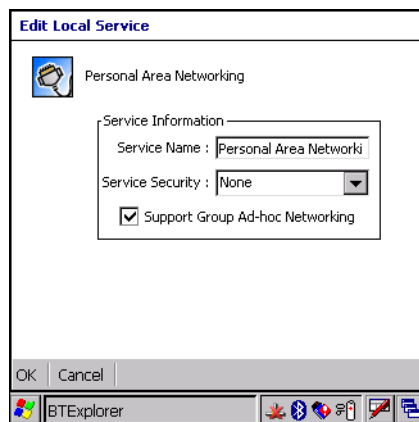

Figure 3-34 Personal Area Networking Window

Service Name	Displays the name of the service.
--------------	-----------------------------------

Service Security	Select the type of security from the drop-down list; None , Authenticate or Authenticate/Encrypt .
Support Group Ad-Hoc Networking	Select to enable Ad-Hoc networking.

Serial Port Service

Serial port allows COM ports to be accessed by other Bluetooth devices.

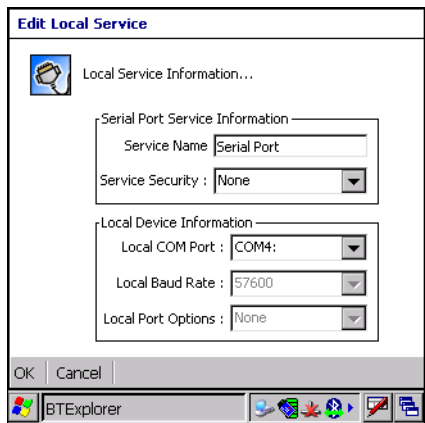

Figure 3-35 Serial Port Service Window

Service Name	Displays the name of the service.
Service Security	Select the type of security from the drop-down list; None , Authenticate or Authenticate/Encrypt .
Local COM Port	Select the COM port. Select COM1 to use a modem or other device that is connected to the connector on the bottom of the mobile computer.
Local Baud Rate	Select the communication baud rate.
Local Port Options	Select the port option.

Headset Service

Serial port allows COM ports to be accessed by other Bluetooth devices.

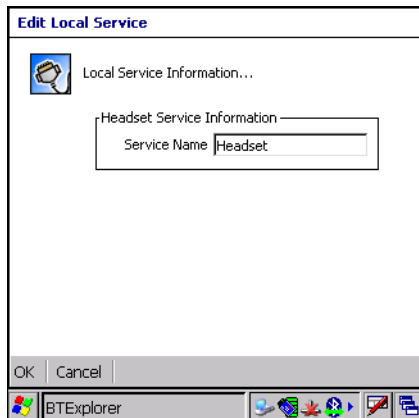

Figure 3-36 Headset Service Window

Service Name Displays the name of the service.

Security Tab

To adjust the security settings for an individual service, select the **Services** tab first, then select the individual service, then **Properties**.

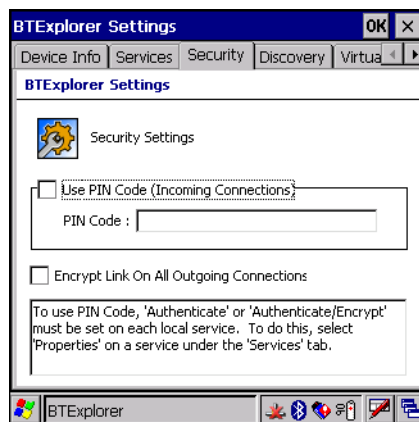

Figure 3-37 BTExplorer Settings - Security Tab

Use PIN Code (Incoming
Connecting)

Select for automatic use of the PIN code entered in the **PIN Code** text box. It is recommended not to use this automatic PIN code feature. See [Security on page 3-2](#) for more information.

PIN Code

Enter the PIN code.

Encrypt Link On All Outgoing
Connections

Select to enable or disable encryption. Use encryption whenever possible.

Discovery Tab

Use the **Discovery** tab to set and modify discovered devices.



Figure 3-38 BTE Explorer Settings - Discovery Tab

Inquiry Length	Sets the amount of time that the mobile computer takes to discover Bluetooth devices in the area.
Name Discovery Mode	Select either Automatic or manual.
Discovered Devices	Deletes all discovered devices and link keys.

Virtual COM Port Tab

Use the **Virtual COM Port** tab to select the COM ports for Bluetooth communication.

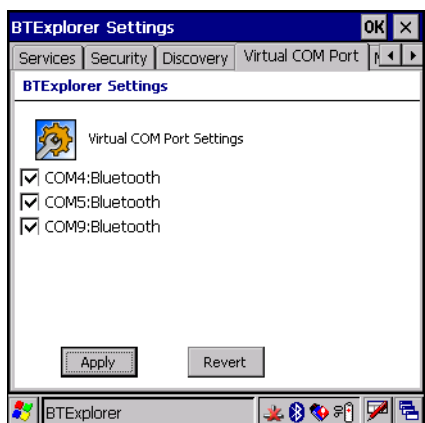

Figure 3-39 BTE Explorer Settings - Virtual COM Port Tab

COM4:Bluetooth	Enable or disable COM Port 4.
COM5:Bluetooth	Enable or disable COM Port 5
COM9:Bluetooth	Enable or disable COM Port 9



NOTE If an application uses one of the COM ports assigned to Bluetooth, opening this port causes the Bluetooth stack to activate and guide you through the connection process.

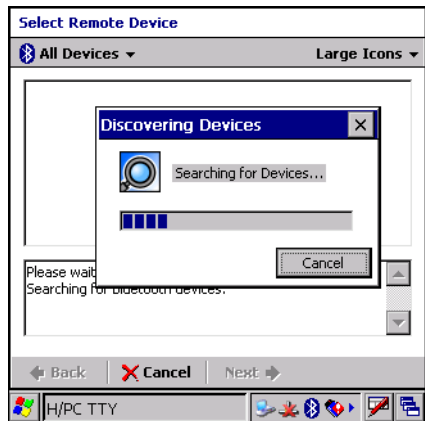

Figure 3-40 COM Port Connection

Miscellaneous Tab

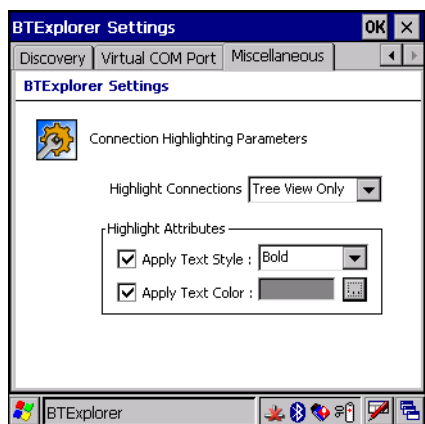

Figure 3-41 BTExplorer Settings - Miscellaneous Tab

Highlight Connections

Select the connection type to highlight when connected. In the Wizard Mode, the only option is Favorites or None. In the Explorer Mode the options are **None**, **Tree View Only**, **List View Only** or **Tree and List View**.

Apply Text Style

Select the text style to be applied to the connection text.

Apply Text Color

Select the text color to be applied to the connection text.

Chapter 4 Accessories

Introduction

The MC3000 accessories provide a variety of product support capabilities. Accessories include cradles, cables, spare battery chargers and SD cards.

Cradles

- The Single Slot Serial/USB cradle charges the mobile computer main battery and/or a spare battery. It also synchronizes the mobile computer with a host computer through either a serial or a USB connection.
- The Four Slot Charge Only cradle charges up to four mobile computers.
- The Four Slot Ethernet cradle charges up to four mobile computers and provides Ethernet communication.

Spare Battery Chargers

- Four Slot Spare Battery Charger charges up to four MC3000 spare batteries.
- UBC Adapter adapts the UBC2000 for use with the MC3000 batteries.



NOTE The accessory power supply regulatory compliance statements are provided in [Table C-1 on page C-1](#).

Cables

The cables snap on to the mobile computer and are used to connect external devices to the mobile computer.

- USB client charge cable
- RS232 Charge cable
- O'Neil printer cable
- Zebra printer cable
- Monarch printer cable.

SD Card

The SD card provides additional storage capacity for the mobile computer.

Plastic Holster

The Plastic Holster provides a clip on holder for the mobile computer.

Fabric Holster

The Fabric Holster provides a clip on holder for the mobile computer.

Single Slot Serial/USB Cradle



CAUTION Ensure that you follow the guidelines for battery safety described in [Battery Safety Guidelines on page 5-1](#).

The Single Slot Serial/USB cradle:

- Provides 5.4VDC power for operating the mobile computer, charging the battery and charging a spare battery.
- Provides a serial port and a USB port for data communication between the mobile computer and a host computer or other serial devices (e.g., a printer).
- Synchronizes information between the mobile computer and a host computer. With customized or third party software, it can also synchronize the mobile computer with corporate databases.
- Provides serial connection through the serial pass-through port for communication with a serial device, such as a host computer. For communication setup procedures, refer to the *MC3000 Integrator Guide*.
- Provides USB connection through the USB pass-through port for communication with a USB device, such as a host computer. For communication setup procedures, refer to the *MC3000 Integrator Guide*.



CAUTION Use only an approved power supply output rated 12 VDC and minimum 3.3 A. Use of an alternative power supply will void the product warranty and may cause product damage. See [Appendix C, Regulatory](#) for the power supply regulatory compliance statement.

Battery Charging

The Single Slot Serial/USB cradle can charge the mobile computer main battery and a spare battery simultaneously.

To charge the mobile computer:

1. Slide the mobile computer into the mobile computer slot. The mobile computer amber Charge LED Indicator, indicates the mobile computer battery charging status. The Standard Battery charges in less than four hours and the Extended Life Battery charges in less than six hours. See [Table 4-1](#) for charging status indications.

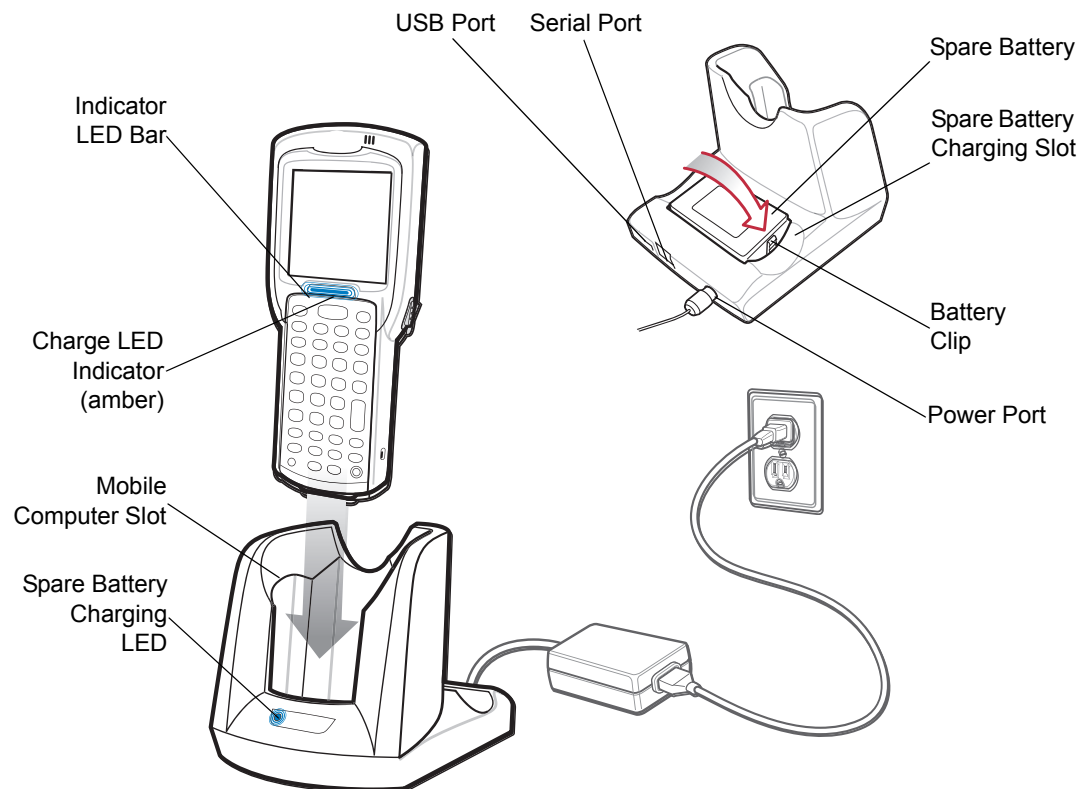

Figure 4-1 Single Slot Serial/USB Cradle

2. When charging is complete, remove the mobile computer from the mobile computer slot.

To charge the spare battery:

1. Insert the spare battery into the spare battery charging slot, bottom first, and pivot the top of the battery down onto the contact pins.
2. Gently press down on the battery to ensure proper contact.
3. The Spare Battery Charging LED (see [Figure 4-1 on page 4-3](#)) indicates the spare battery charging status. The Standard Battery charges in less than four hours and the Extended Life Battery charges in less than six hours. See [Table 4-1](#) for charging status indications.
4. When charging is complete, press the battery clip and lift the battery out of the slot.

LED Charge Indications

The Single Slot Serial/USB cradle uses the mobile computer amber Charge LED Indicator to indicate the battery charging status and the Spare Battery Charging LED to indicate spare battery charging status. See [Table 4-1](#) for charging status indications.

Table 4-1 LED Charging Status Indicators

LED	Indication
Mobile Computer Charging (LED on mobile computer)	
Off	Mobile computer not placed correctly in the cradle; cable not connected correctly; charger is not powered.
Fast Blinking Amber	Error in charging; check placement of mobile computer.
Slow Blinking Amber	Mobile computer is charging.
Solid Amber	Charging complete. Note: When the battery is initially inserted in the mobile computer, the amber LED flashes once if the battery power is low or the battery is not fully inserted.
Spare Battery Charging (LED on cradle)	
Off	No spare battery in slot; spare battery not placed correctly; cradle is not powered.
Fast Blinking Amber	Error in charging; check placement of spare battery.
Slow Blinking Amber	Spare battery is charging.
Solid Amber	Charging complete.

Four Slot Cradles



CAUTION Ensure that you follow the guidelines for battery safety described in [Battery Safety Guidelines on page 5-1](#).

There are two four slot cradles, *Four Slot Charge Only* cradle and *Four Slot Ethernet* cradle. The Four Slot Ethernet cradle provides Ethernet communications. Both four slot cradles:

- Provide 5.4 VDC power for operating the mobile computer and charging the battery.
- Simultaneously charges up to four mobile computers.



CAUTION Use only an approved power supply output rated 12 VDC and minimum 9 A. Use of an alternative power supply will void the product warranty and may cause product damage. See [Appendix C, Regulatory](#) for the power supply regulatory compliance statement.

Battery Charging

The four slot cradle can charge up to four mobile computers simultaneously. To charge the mobile computer:

1. Slide the mobile computer into the mobile computer slot.

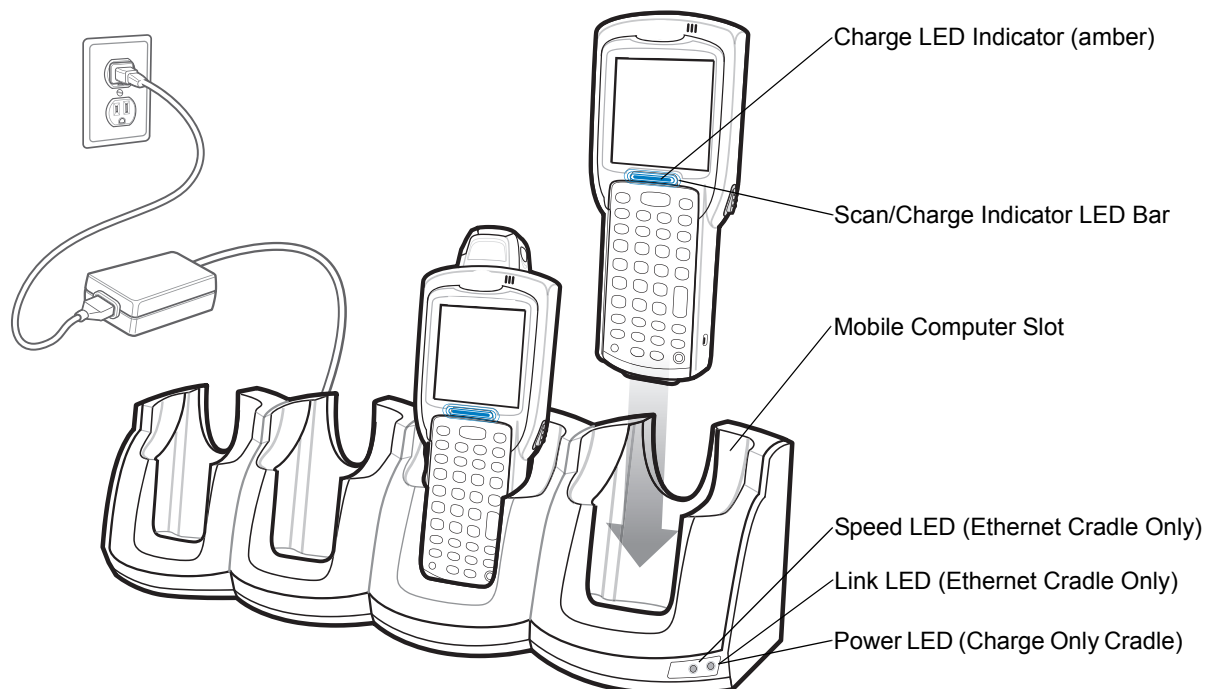

Figure 4-2 Four Slot Cradles

2. The mobile computer amber Charge LED Indicator, indicates the mobile computer battery charging status. The Standard Battery usually charges in less than four hours and the Extended Life Battery usually charges in less than six hours. See [Table 4-1](#) for charging status indications.
3. When charging is complete, remove the mobile computer from the cradle.

LED Charge Indications

The Four Slot cradles use the mobile computer amber Charge LED Indicator to indicate the battery charging status. See [Table 4-1 on page 4-4](#) for charging status indications.

Power LED

The green Power LED (only on the Four Slot Charge Only cradle) lights to indicate that the Four Slot Charge Only cradle is connected to a power source.

Speed LED

The green Speed LED (only on the Four Slot Ethernet cradle) lights to indicate that the transfer rate is 100 Mbps. When it is not lit it indicates that the transfer rate is 10 Mbps.

Link LED

The yellow Link LED (only on the Four Slot Ethernet cradle) blinks to indicate activity, or stays lit to indicate that a link is established. When it is not lit, it indicates that there is no link.

Four Slot Spare Battery Charger



CAUTION Ensure that you follow the guidelines for battery safety described in [Battery Safety Guidelines on page 5-1](#).

The Four Slot Spare Battery Charger simultaneously charges up to four spare batteries.



CAUTION Use only an approved power supply output rated 12 VDC and minimum 3.3 A. Use of an alternative power supply will void the product warranty and may cause product damage. See [Appendix C, Regulatory](#) for the power supply regulatory compliance statement.

Spare Battery Charging

To charge up to four MC3000 spare batteries:

1. Insert the spare battery into the spare battery charging slot, bottom first.
2. Pivot the top of the battery down onto the contact pins.

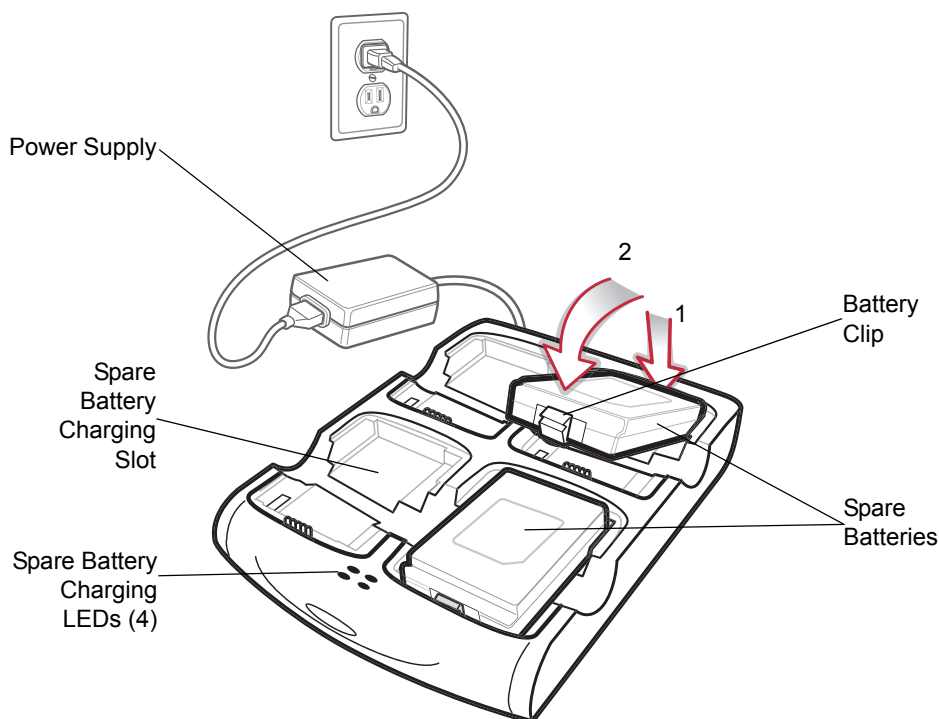

Figure 4-3 Four Slot Spare Battery Charger

3. Gently press down on the battery to ensure proper contact. The Standard Battery usually charges in less than four hours and the Extended Life Battery usually charges in less than six hours. See [Table 4-1 on page 4-4](#) for charging status indications.
4. When charging is complete, press the battery clip and lift battery out of the slot.

LED Charge Indications

The Spare Battery Charging LEDs indicate the spare battery charging status. The Spare Battery Charging LEDs are arranged in the same pattern as the spare battery charging slots so that the charging status of each battery can be identified. See [Table 4-1 on page 4-4](#) for charging status indications.

Cables

The cables are available with a variety of connection capabilities.



CAUTION Use only an approved power supply output rated 5.4 VDC and minimum 3 A. Use of an alternative power supply will void the product warranty and may cause product damage. See [Appendix C, Regulatory](#) for the power supply regulatory compliance statement.

MC3000 Communication/Charge cables:

- Provide the mobile computer with operating and charging power when used with the approved power supply.
- Synchronize information between the mobile computer and a host computer. With customized or third party software, it can also synchronize the mobile computer with corporate databases.
- Provide serial connection through the serial pass-through port for communication with a serial device, such as a host computer. For communication setup procedures, refer to the *MC3000 Integrator Guide*.
- Provide USB connection through the USB pass-through port for communication with a USB device, such as a host computer. For communication setup procedures, refer to the *MC3000 Integrator Guide*.

The following MC3000 Communication/Charge cables are available:

- Serial (RS232) Charge cable (9-pin D female with power input receptacle)
- USB Client Charge cable (standard-A connector and a barrel receptacle for power).

Dedicated Printer cables, provide communication with a dedicated printer.

The following printer cables are available directly from the printer manufacturer:

- O'Neil printer cable
- Zebra printer cable
- Monarch printer cable.

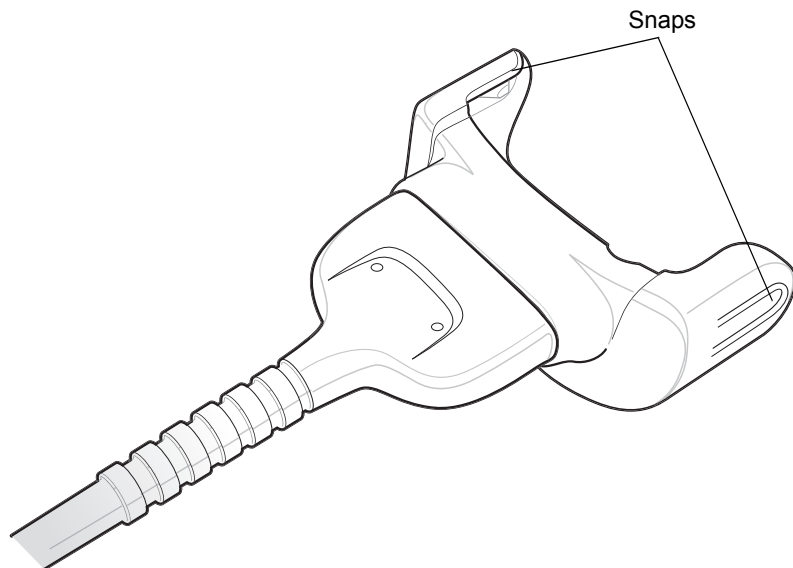

Figure 4-4 Cables

Battery Charging and Operating Power



CAUTION Ensure that you follow the guidelines for battery safety described in [Battery Safety Guidelines on page 5-1](#).

The MC3000 Communication/Charge cables can charge the mobile computer battery and supply operating power.

To charge the mobile computer battery:

1. Connect the MC3000 Communication/Charge cable power input connector to the approved power source.
2. Slide the bottom of the mobile computer into the MC3000 connector end of the MC3000 Communication/Charge cable and gently press in until the snaps latch into the mobile computer.
3. The mobile computer amber Charge LED Indicator indicates the mobile computer battery charging status. The Standard Battery usually charges in less than four hours and the Extended Life Battery usually charges in less than six hours. See, [Table 4-1 on page 4-4](#) for charging status indications.
4. When charging is complete, remove the cable by gently pulling the mobile computer and the cable apart until the snaps release the mobile computer.

LED Charge Indications

The MC3000 Communication/Charge cables use the amber Charge LED Indicator to indicate the MC3000 battery charging status. See, [Table 4-1 on page 4-4](#) for charging status indications.

Universal Battery Charger (UBC) Adapter



CAUTION Ensure that you follow the guidelines for battery safety described in [Battery Safety Guidelines on page 5-1](#).

The UBC Adapter can be used with a power supply as a standalone spare battery charger or it can be used with the four station UBC2000 to simultaneously charge up to four spare batteries. For additional information on the UBC 2000, refer to the *UBC 2000 Quick Reference Guide p/n 70-33188-xx*.



CAUTION Use only an approved power supply output rated 15 VDC and minimum 1.5 A. Use of an alternative power supply will void the product warranty and may cause product damage. See [Appendix C, Regulatory](#) for the power supply regulatory compliance statement.

Spare Battery Charging

To charge spare batteries:

1. Insert the spare battery into the spare battery charging slot, bottom first.
2. Pivot the top of the battery down onto the contact pins.

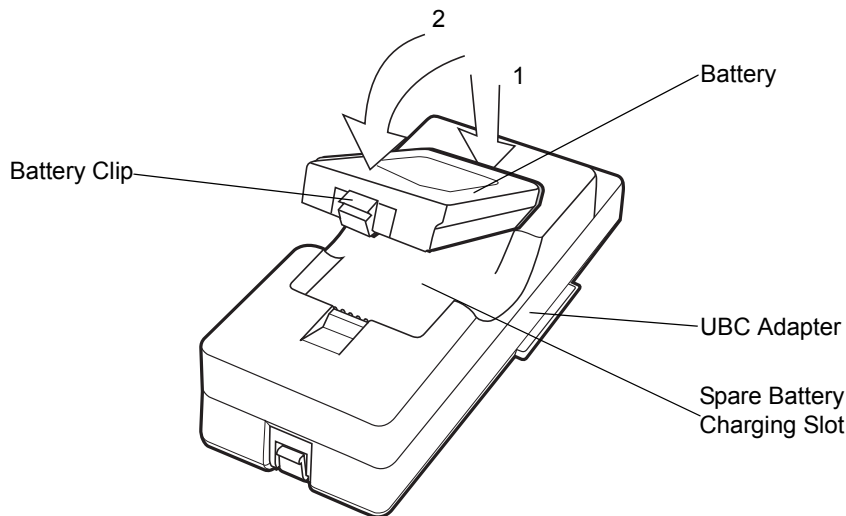

Figure 4-5 UBC Adapter Battery Insertion

3. Gently press down on the battery to ensure proper contact. The Standard Battery usually charges in less than four hours and the Extended Life Battery usually charges in less than six hours. See, [Table 4-2 on page 4-11](#) for charging status indications.
4. When charging is complete, press the battery clip and lift the battery out of the slot.

UBC Adapter LED Charge Indications

The UBC Adapter charging LEDs indicate the battery charging status. The Standard Battery usually charges in less than four hours and the Extended Life Battery usually charges in less than six hours.

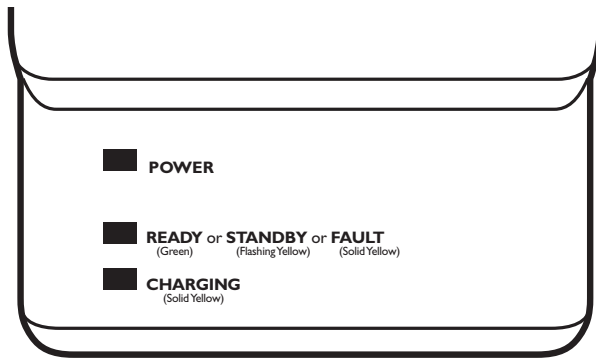

Figure 4-6 UBC Adapter LEDs

Table 4-2 UBC Adapter Charge LED Status Indications

LED	Indication	Description
POWER	Green	Power is connected to the UBC Adapter.
READY or	Green	Charging complete.
STANDBY or	Flashing-Yellow	The battery was deeply discharged and is being trickle charged to bring the voltage up to the operating level. After operating level voltage is achieved, the battery charges normally.
FAULT	Yellow	Charging error, check placement of mobile computer/spare battery.
CHARGING	Yellow	Normal charge.

Secure Device Card (Windows CE 5.0 Only)

The Secure Device (SD) card provides secondary non-volatile storage (the flash memory is slower than RAM). The SD card holder is located under the battery.



CAUTION Follow proper Electro-Static Discharge (ESD) precautions to avoid damaging the SD card. Proper ESD precautions include, but are not limited to, working on an ESD mat and ensuring that the operator is properly grounded.

Do not use the SD card slot for any other accessories.



NOTE Select SD cards with environmental and/or the write cycle performance specifications that meet or exceed the application requirements.

2GB SD Memory Cards are supported on MC3000 with OEM Version 05.26.0000 and higher.

To insert the SD card:

1. Remove the battery (see [Main Battery Removal on page 1-11](#)).
2. Lift the SD card retaining door.
3. Position the SD card, with the contacts down, into the SD card slot. The SD card corner notch fits into the slot only one way.
4. Close SD card retaining door.

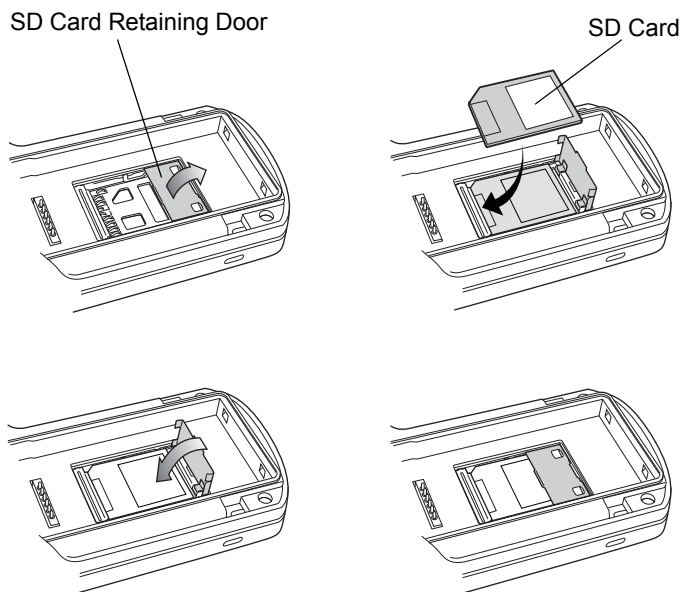

Figure 4-7 Inserting the SD Card

5. Replace the battery (see [Install Main Battery on page 1-5](#)).

Plastic Holster

The Plastic Holster provides a holder for the mobile computer. It consists of a mobile computer holder and a detachable belt clip. Press the release button to remove the detachable belt clip.

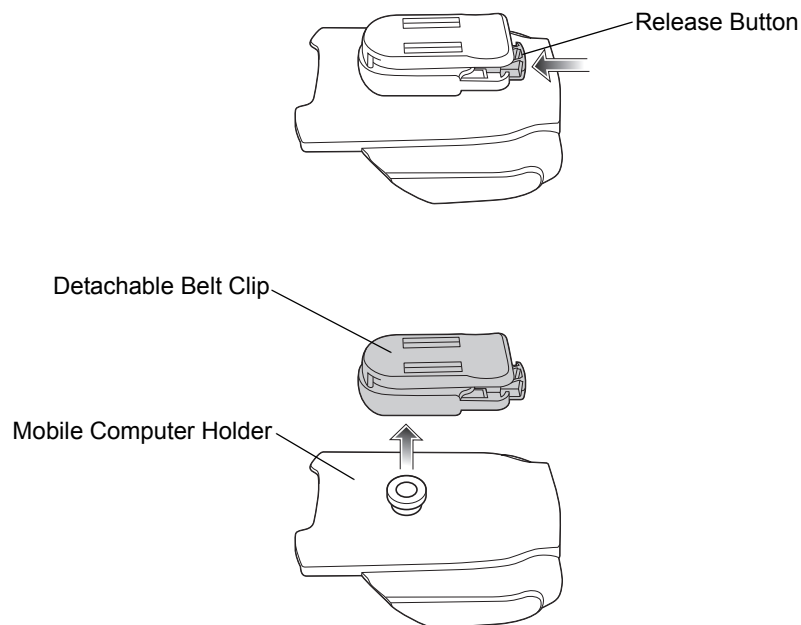

Figure 4-8 Plastic Holster

Pinch the clip release and attach the Plastic Holster to a belt or waist band.

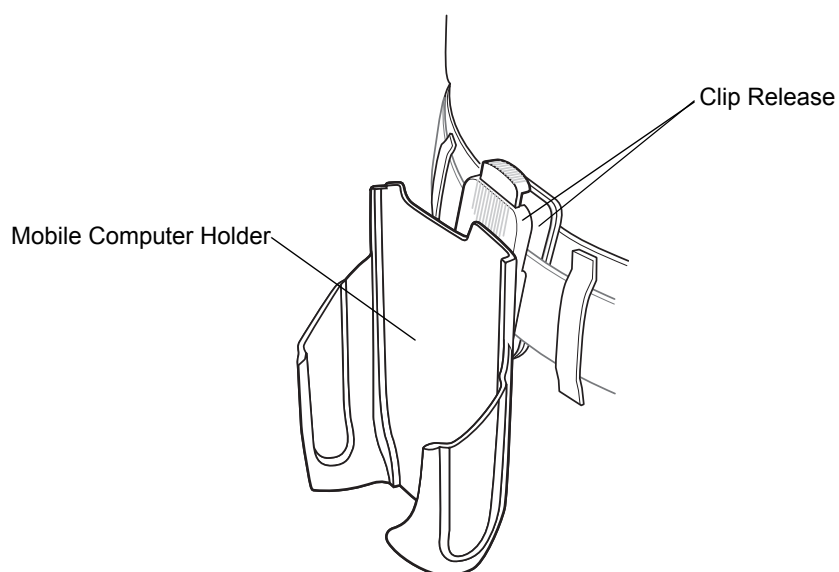
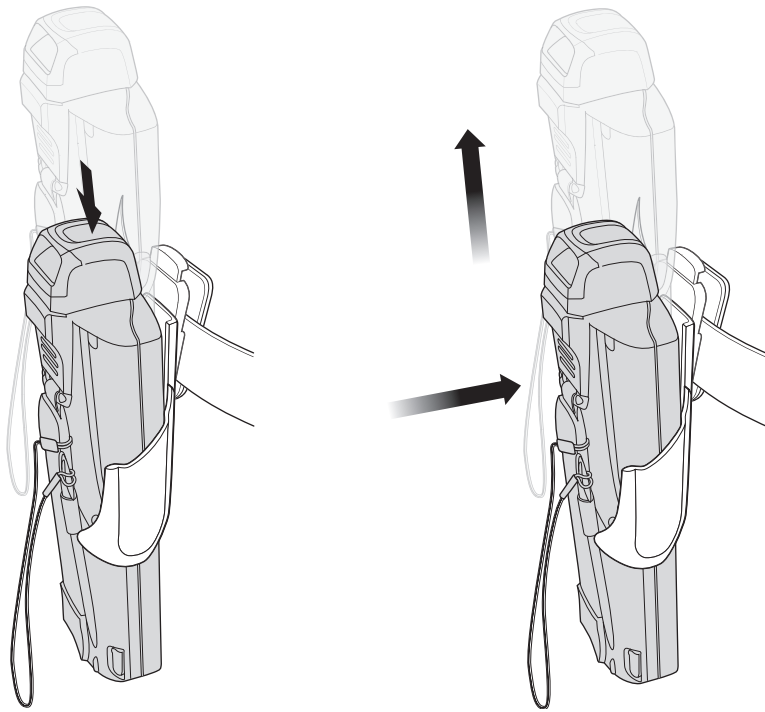

Figure 4-9 Attaching the Plastic Holster

The Plastic Holster holds the mobile computer on a belt or waist band.

To insert the mobile computer, slide the mobile computer into the Plastic Holster with the screen facing the user.

To remove the mobile computer, press and lift to remove the mobile computer.



Insert Mobile Computer

Remove Mobile Computer

Figure 4-10 Insert and Remove the Mobile Computer

Fabric Holster

The Fabric Holster provides a soft holder for the mobile computer. It consists of a fabric mobile computer holder, a detachable shoulder strap and a detachable belt clip. Press the release button to remove the detachable belt clip. See [Figure 4-11](#) to remove the detachable clip see [Figure 4-12 on page 4-15](#) to attach the Fabric Holster to a belt and see [Figure 4-13 on page 4-16](#) to attach the Fabric Holster to a shoulder strap.

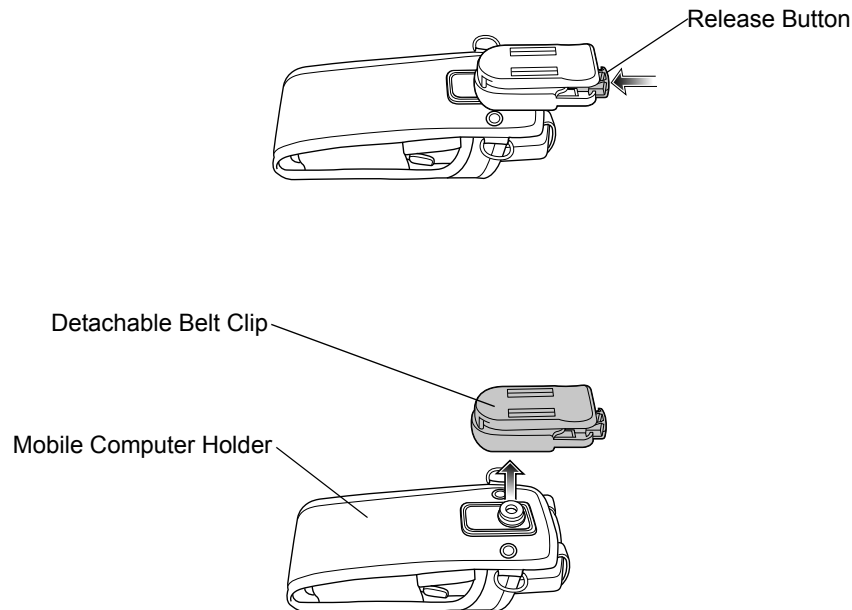

Figure 4-11 Fabric Holster Detachable Belt Clip

Belt Clip

Pinch the clip release and attach the Fabric Holster to a belt or waist band.

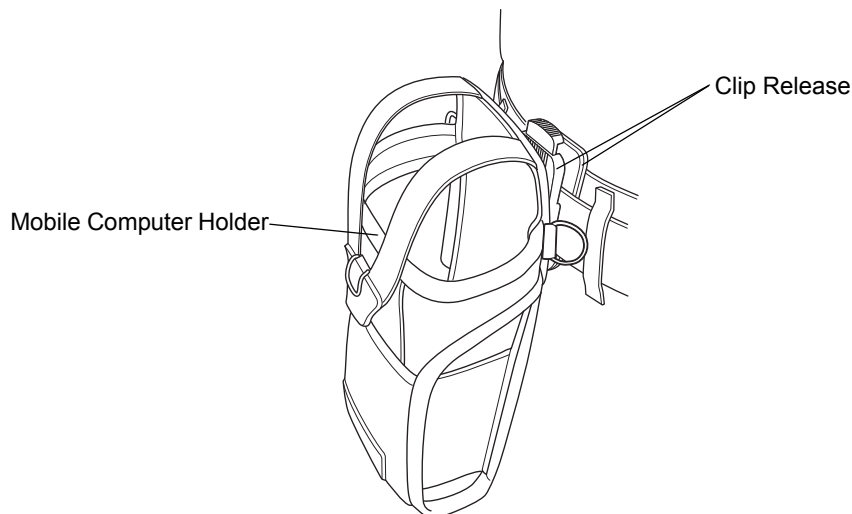

Figure 4-12 Attaching the Fabric Holster To a Belt

Shoulder Strap

Remove the detachable belt clip (see [Figure 4-11 on page 4-15](#)) and attach the shoulder strap.

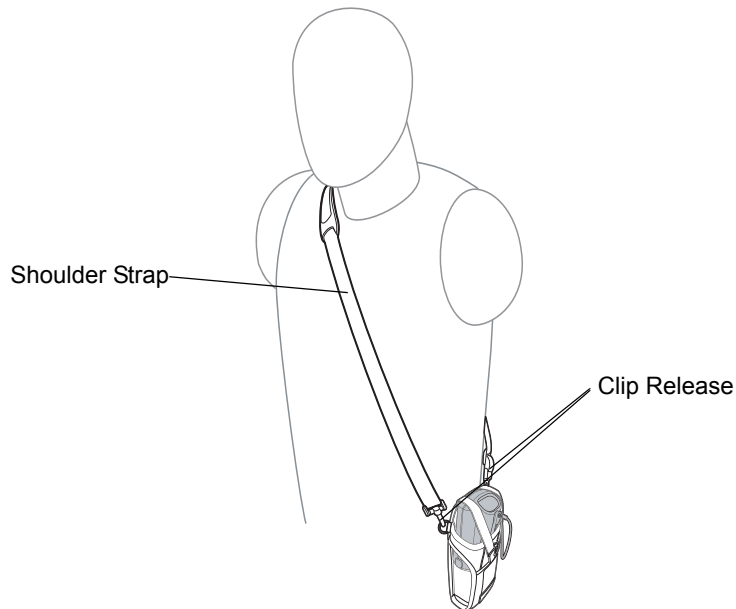

Figure 4-13 Attach the Fabric Holster To the Shoulder Strap

The Fabric Holster holds the mobile computer on a belt or waist band.

1. To insert the mobile computer, slide the mobile computer into the Fabric Holster with the screen facing the user.
2. Pull restraining strap over mobile computer and secure in the clip.
3. To remove the mobile computer, pull down on restraining strap to release from clip and lift retaining strap clear.
4. Lift mobile computer out of Fabric Holster.

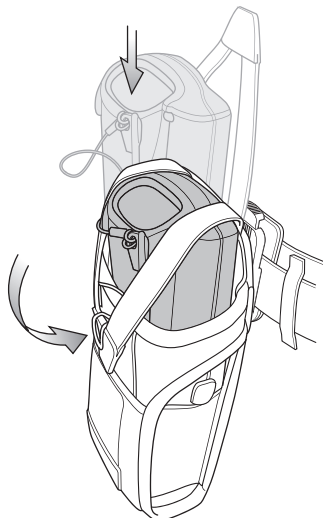

Figure 4-14 Insert and Remove the Mobile Computer

Chapter 5 Maintenance and Troubleshooting

Introduction

This chapter includes instructions on cleaning and storing the mobile computer, and provides troubleshooting solutions for potential problems during mobile computer operation.

Maintaining the Mobile Computer

For trouble-free service, observe the following tips when using the mobile computer:

- Do not scratch the screen of the mobile computer. When working with the mobile computer, use the supplied stylus or plastic-tipped pens intended for use with a touch-sensitive screen. Never use an actual pen or pencil or other sharp object on the surface of the mobile computer screen.
- Although the mobile computer is water and dust resistant, do not expose it to rain or moisture for an extended period of time. In general, treat the mobile computer as a pocket calculator or other small electronic instrument.
- The touch-sensitive screen of the mobile computer is glass. Do not drop the mobile computer or subject it to strong impact.
- Protect the mobile computer from temperature extremes. Do not leave it on the dashboard of a car on a hot day, and keep it away from heat sources.
- Do not store or use the mobile computer in any location that is extremely dusty, damp, or wet.
- Use a soft lens cloth to clean the mobile computer. If the surface of the mobile computer screen becomes soiled, clean it with a soft cloth moistened with a diluted window-cleaning solution.

Battery Safety Guidelines

- The area in which the units are charged should be clear of debris and combustible materials or chemicals. Particular care should be taken where the device is charged in a non-commercial environment.
- Do not use incompatible batteries and chargers. If you have any questions about the compatibility of a battery or a charger, contact Zebra support. See [Service Information on page xvi](#) for contact information.

- Do not crush, puncture, or place a high degree of pressure on the battery.
- Severe impact from dropping any battery-operated device on a hard surface could cause the battery to overheat.
- Do not leave or store the equipment in or near areas that might get very hot, such as in a parked vehicle or near a radiator or other heat source. Do not place battery into a microwave oven or dryer.
- Do not dispose of batteries in fire.
- If you suspect damage to your equipment or battery, contact Zebra support to arrange for inspection. See [Service Information on page xvi](#) for contact information.

Troubleshooting

Mobile Computer

Table 5-1 Troubleshooting the Mobile Computer

Problem	Cause	Solution
Mobile computer does not turn on.	Main battery not charged.	Charge or replace the main battery.
	Main battery not installed properly.	Ensure the battery is installed properly. See Install Main Battery on page 1-5 .
	System crash.	Perform a warm boot. If the mobile computer still does not turn on, perform a cold boot. For more information see, Resetting the Mobile Computer on page 2-34 .
Battery did not charge.	Battery failed.	Replace battery. If the mobile computer still does not operate, try a warm boot, then a cold boot. For more information see, Resetting the Mobile Computer on page 2-34 .
	Mobile computer removed from cradle while battery was charging.	Insert mobile computer in cradle and begin charging. The Standard Battery requires up to four hours to recharge fully and the Extended Life Battery requires up to six hours to recharge fully.
	Extreme battery temperature.	Battery does not charge if ambient temperature is below 32°F (0°C) or above 104°F (40°C).
Cannot see characters on screen.	Mobile computer not powered on.	Press the Power button.

Table 5-1 Troubleshooting the Mobile Computer (Continued)

Problem	Cause	Solution
During data communication, no data was transmitted, or transmitted data was incomplete.	Mobile computer removed from cradle or unplugged from host computer during communication.	Replace the mobile computer in the cradle, or reattach the cable and re-transmit.
	Incorrect cable configuration.	See the system administrator or refer to the <i>MC3000 Integrator Guide</i> .
	Communication software was incorrectly installed or configured.	See the system administrator or refer to the <i>MC3000 Integrator Guide</i> .
Mobile computer does not emit sound.	Volume setting is low or turned off.	Mobile computer may be a beeper only configuration or incorrect setting is programmed into device.
Mobile computer turns itself off.	Mobile computer is inactive.	The mobile computer turns off after a period of inactivity. This period can be set from one to five minutes, in one-minute intervals.
	Battery is depleted.	Recharge or replace the battery.
	Battery is not inserted properly.	Insert the battery properly. For more information see, Install Main Battery on page 1-5 .
Tapping the window buttons or icons does not activate the corresponding feature.	Touch screen not calibrated correctly.	Re-calibrate the screen. From the mobile computer, <i>Demo window</i> double-tap the <i>Ctl Panel</i> icon and double-tap on <i>Touch Calibrate</i> . Follow the screen prompts.
	The system crashed.	Warm boot the system. To perform a warm boot, see Resetting the Mobile Computer on page 2-34 .
A message appears stating that the mobile computer memory is full.	Too many files stored on the mobile computer.	Delete unused memos and records. If necessary, save these records on the host computer.
	Too many applications installed on the mobile computer.	Remove unused installed applications from the mobile computer to recover memory.

Table 5-1 Troubleshooting the Mobile Computer (Continued)

Problem	Cause	Solution
The mobile computer does not accept scan input.	Scanning application is not loaded.	Verify that the mobile computer is loaded with a scanning application. See the system administrator.
	Unreadable bar code.	Ensure the symbol is not defaced.
	Distance between scan window and bar code is incorrect.	Ensure the mobile computer is within proper scanning range.
	Mobile computer is not programmed for the bar code type.	Ensure the mobile computer is programmed to accept the type of bar code scanned.
	Mobile computer is not programmed to generate a beep.	If a beep on a good decode is expected and a beep is not heard, check that the application is set to generate a beep on good decode.
	Battery is low.	Check the battery level. When the battery is low, the mobile computer automatically goes into suspend mode.

Single Slot Serial/USB Cradle

Table 5-2 Troubleshooting the Single Slot Serial/USB Cradle

Symptom	Possible Cause	Solution
Mobile computer amber Charge LED Indicator does not light when mobile computer inserted.	Cradle is not receiving power.	Ensure the power cable is connected securely to both the cradle and to AC power.
	Mobile computer is not correctly seated.	Remove and re-insert the mobile computer into the cradle, ensuring it is correctly seated.
Spare Battery Charging LED does not light when spare battery is inserted.	Spare battery is not correctly seated.	Remove and re-insert the spare battery into the charging slot, ensuring it is correctly seated.
Mobile computer battery is not charging.	Mobile computer was removed from cradle or cradle was unplugged from AC power too soon.	Ensure cradle is receiving power. Ensure the mobile computer is seated correctly. If the mobile computer battery is fully depleted, it can take up to four hours to fully recharge a Standard Battery and it can take up to six hours to fully recharge an Extended Life Battery.
	Battery is faulty.	Verify that other batteries charge properly. If so, replace the faulty battery.
	The mobile computer is not fully seated in the cradle.	Remove and re-insert the mobile computer into the cradle, ensuring it is correctly seated.

Table 5-2 Troubleshooting the Single Slot Serial/USB Cradle (Continued)

Symptom	Possible Cause	Solution
Spare battery is not charging.	Battery not fully seated in charging slot.	Remove and re-insert the spare battery into the cradle, ensuring it is correctly seated.
	Battery inserted incorrectly.	Ensure the contacts are facing down and toward the back of the cradle.
	Battery is faulty.	Verify that other batteries charge properly. If so, replace the faulty battery.
During data communication, no data was transmitted, or transmitted data was incomplete.	Mobile computer removed from cradle during communication.	Replace mobile computer in cradle and retransmit.
	Incorrect cable configuration.	See the system administrator or refer to the <i>MC3000 Integrator Guide</i> .
	Communication software is not installed or configured properly.	See the system administrator or refer to the <i>MC3000 Integrator Guide</i> .

Four Slot Charge Only Cradle

Table 5-3 Troubleshooting the Four Slot Charge Only Cradle

Problem	Cause	Solution
Mobile computer amber Charge LED Indicator does not light when mobile computer inserted.	Cradle is not receiving power.	Ensure the power cable is connected securely to both the cradle and to AC power.
	Mobile computer is not correctly seated.	Remove and re-insert the mobile computer into the cradle, ensuring it is correctly seated.
Mobile computer battery is not charging.	Mobile computer was removed from cradle or cradle was unplugged from AC power too soon.	Ensure cradle is receiving power. Ensure the mobile computer is seated correctly. If the mobile computer battery is fully depleted, it can take up to four hours to fully recharge a Standard Battery and it can take up to six hours to fully recharge an Extended Life Battery.
	Battery is faulty.	Verify that other batteries charge properly. If so, replace the faulty battery.
	The mobile computer is not fully seated in the cradle.	Remove and re-insert the mobile computer into the cradle, ensuring it is correctly seated.

Four Slot Ethernet Cradle

Table 5-4 Troubleshooting the Four Slot Ethernet Cradle

Problem	Cause	Solution
Mobile computer amber Charge LED Indicator does not light when mobile computer inserted.	Cradle is not receiving power.	Ensure the power cable is connected securely to both the cradle and to AC power.
	Mobile computer is not correctly seated.	Remove and re-insert the mobile computer into the cradle, ensuring it is correctly seated.
Mobile computer battery is not charging.	Mobile computer was removed from cradle or cradle was unplugged from AC power too soon.	Ensure cradle is receiving power. Ensure the mobile computer is seated correctly. If the mobile computer battery is fully depleted, it can take up to four hours to fully recharge a Standard Battery and it can take up to six hours to fully recharge an Extended Life Battery.
	Battery is faulty.	Verify that other batteries charge properly. If so, replace the faulty battery.
	The mobile computer is not fully seated in the cradle.	Remove and re-insert the mobile computer into the cradle, ensuring it is correctly seated.
During data communication, no data was transmitted, or transmitted data was incomplete.	Mobile computer removed from cradle during communication.	Replace mobile computer in cradle and retransmit.
	Incorrect cable configuration.	See the system administrator or refer to the <i>MC3000 Integrator Guide</i> .
	Ethernet connection error. Link LED is not lit (see Link LED on page 4-6).	See the system administrator. Probable Ethernet connection error.

Four Slot Spare Battery Charger

Table 5-5 Troubleshooting the Four Slot Spare Battery Charger

Symptom	Possible Cause	Solution
Spare Battery Charging LED does not light when spare battery is inserted.	Spare battery is not correctly seated.	Remove and re-insert the spare battery into the charging slot, ensuring it is correctly seated.

Table 5-5 Troubleshooting the Four Slot Spare Battery Charger (Continued)

Symptom	Possible Cause	Solution
Spare battery is not charging.	Charger is not receiving power.	Ensure the power cable is connected securely to both the charger and to AC power.
	Spare battery is not correctly seated.	Remove and re-insert the battery into the charger, ensuring it is correctly seated.
	Spare battery was removed from charger or charger was unplugged from AC power too soon.	Ensure charger is receiving power. Ensure the spare battery is seated correctly. If a battery is fully depleted, it can take up to four hours to fully recharge a Standard Battery and it can take up to six hours to fully recharge an Extended Life Battery.
	Spare battery is faulty.	Verify that other batteries charge properly. If so, replace the faulty battery.

UBC Adapter

Table 5-6 Troubleshooting the UBC Adapter

Symptom	Possible Cause	Solution
Battery Charging LED does not light when spare battery is inserted.	Spare battery is not correctly seated.	Remove and re-insert the spare battery into the charging slot, ensuring it is correctly seated.
Battery not charging.	Charger is not receiving power.	Ensure the power cable is connected securely to both the charger and to AC power.
	Spare battery is not correctly seated.	Remove and re-insert the spare battery into the charger, ensuring it is correctly seated.
	Spare battery was removed from charger or charger was unplugged from AC power too soon.	Ensure charger is receiving power. Ensure the spare battery is seated correctly. If a battery is fully depleted, it can take up to four hours to fully recharge a Standard Battery and it can take up to six hours to fully recharge an Extended Life Battery.
	Spare battery is faulty.	Verify that other batteries charge properly. If so, replace the faulty battery.

Cables

Table 5-7 Troubleshooting the Cables

Symptom	Possible Cause	Solution
Mobile computer amber Charge LED Indicator does not light when mobile computer attached.	Cable is not receiving power.	Ensure the power cable is connected securely to both the cable and to AC power.
	Mobile computer is not seated correctly in the cable.	Remove and re-attach the mobile computer to the MC3000 connector, ensuring it is correctly seated.
Mobile computer battery is not charging.	Mobile computer was detached from cable or cable was unplugged from AC power too soon.	Ensure cable is receiving power. Ensure the mobile computer is seated correctly. If the mobile computer battery is fully depleted, it can take up to four hours to fully recharge a Standard Battery and it can take up to six hours to fully recharge an Extended Life Battery.
	Battery is faulty.	Verify that other batteries charge properly. If so, replace the faulty battery.
	The mobile computer is not fully seated in the cable.	Remove and re-attach the mobile computer to the cable, ensuring it is correctly seated.
During data communication, no data was transmitted, or transmitted data was incomplete.	Cable removed from mobile computer during communication.	Reattach cable to mobile computer and retransmit.
	Incorrect cable configuration.	See the system administrator or refer to the <i>MC3000 Integrator Guide</i> .
	Communication software is not installed or configured properly.	See the system administrator or refer to the <i>MC3000 Integrator Guide</i> .

Appendix A Technical Specifications

Mobile Computer and Accessory Technical Specifications

[Table A-1](#) summarizes the mobile computer technical specifications and intended operating environments.

[Table A-2](#) summarizes the accessory technical specifications and the intended operating environments.

Table A-1 Mobile Computer Technical Specifications

Item	Description
Operating Temperature	Color 14° to 122°F (-10° to +50°C) Monochrome -4° to 122°F (-20° to +50°C)
Storage Temperature	-22° to 158°F (-30° to 70°C)
Battery Charging Temperature	32° to 104° F (0° to +40° C) ambient temperature
Humidity	5% to 95% non-condensing
Electrostatic Discharge (ESD)	+/- 15 kV air discharge +/- 8 kV direct discharge +/- 8 kV indirect discharge
Sealing	IP54 category 2
Drop	Multiple 4-foot (1.2 m) drops to concrete across operating temperature
Tumble	500 one-half meter tumbles at room temperature (1000 drops)

Table A-1 Mobile Computer Technical Specifications (Continued)

Item	Description
Dimensions	MC3000S: 7.43 in L x 3.18 in W x 1.76 in D (188.7 mm L x 80.8 mm W x 44.6 mm D) MC3000R: 8.33 in L x 3.18 in W x 1.57 in D (211.6 mm L x 80.8 mm W x 39.9 mm D) MC3090G: 7.60 in L x 3.18 in W x 6.54 in D (193 mm L x 80.8 mm W x 166 mm H)
Weights	MC3000R (with standard battery)* - 12.9 oz (366 g) MC3000S (with extended battery)* - 14.6 oz (414 g) MC3090G (with extended battery)* - 18.6 oz (527 g) *For WLAN mobile computers add approximately 0.5 oz (14 g).
Display	Transflective color TFT-LCD, 65K colors, 324 x 324 Monochrome FSTN, 16 shades, 320 x 320
Touch Panel	Glass, analog resistive touch
Main Battery	Standard: Rechargeable Lithium-Polymer 2600 mAh minimum (3.7V) Extended Life: Rechargeable Lithium-Ion 4400 mAh minimum (3.7V)
Backup Battery	Ni-MH battery (rechargeable), 20mAh (3.6V) 3 cells
Operating Platform	Microsoft® Windows CE .NET 5.0 Professional Microsoft® Windows CE .NET 5.0 Core Microsoft® Windows Mobile 6.1 Classic
Processor/Memory	Intel® XScale™ PXA270 312 MHz with 32 MB RAM/64 MB Flash or Intel® XScale™ PXA270 520 MHz with 64 MB RAM/64 MB Flash or Intel® XScale™ PXA270 520 MHz with 128 MB RAM/64 MB Flash or Intel® XScale™ PXA270 520 MHz with 128 MB RAM/64 MB Flash + 1GB Flash storage
Interface	RS232 (115.2 kbps max), USB and Bluetooth
WLAN	802.11a/b/g
Keypad Options	20-key mechanical, 28-key, 38-key and 48-key.

Table A-1 Mobile Computer Technical Specifications (Continued)

Item	Description
Data Capture:	
1-D Decode Capability*	Code 39, code 128, code 93, codabar, code 11, discrete 2 of 5, EAN-3, EAN-13, EAN-128, interleaved 2 of 5, UPCA, UPCE and UPC/EAN supplements, chinese 2 of 5 (OEM version 05.26.000 and higher).
Imaging Decode Capability*	Code 39, code 128, code 93, codabar, code 11, discrete 2 of 5, EAN-3, EAN-13, EAN-128, interleaved 2 of 5, TLC39 (telecommunications, UPCA, UPCE, UPC/EAN supplements composite code (retail), coupon code (retail), macro PDF-417, (macro) micro PDF-417 (T&L), micro PDF-417 (telecommunications), MSI Plessey, PDF-417 (automotive), RSS expanded, RSS limited and RSS-14Maxi Code (UPS), Data matrix (electronics industry, US Planet (USPS), UK 4-state, Australian 4-state, Canadian 4-state, Japanese 4-state, Dutch Kix Aztec, USPS 4-state(US4CB) and microQR (OEM version 05.26.000 and higher). *Go to http://software.symbol.com/ for a list of the latest supported symbologies.
SD cards (Windows CE 5.0 only)	Select SD cards with environmental and/or the write cycle performance specifications that meet or exceed the application requirements.

Table A-2 Accessory Specifications

	Single Slot Serial/USB Cradle	Cables	Four Slot Charge Only and Ethernet Cradles	Four Slot Spare Battery Charger	Universal Battery Charger (UBC) Adapter
Operating Temperature	32° to 122°F (0° to +50°C)			32° to 104°F (0° to +40°C)	
Storage Temperature	-40° to 158°F (-40° to 70°C)				
Battery Charging Temperature	32° to 104° F (0° to +40° C) ambient temperature				
Humidity	5% to 95% non-condensing				
Size (L x D x H)	4.4 in x 5.7 in x 4.7 in (11.2 cm x 14.5 cm x 12 cm)	6 feet (1.83 m)	18 in x 4 in x 5 in (45.7 cm x 10.1 cm x 12 cm)	8.25 in x 6.0 in x 1.7 in (20.96 cm x 15.24 cm x 4.32 cm)	2.5 in x 6.1 in x 1.5 in (6.4 cm x 15.5 cm x 3.8 cm)
Weight	0.60 lbs (0.27 kg)	N/A	Charge only: 2.25 lbs (1.02 kg) Ethernet: 2.38 lbs (1.08 kg)	13.6 oz (386 g)	0.25 lbs (0.11 kg)

Table A-2 Accessory Specifications (Continued)

	Single Slot Serial/USB Cradle	Cables	Four Slot Charge Only and Ethernet Cradles	Four Slot Spare Battery Charger	Universal Battery Charger (UBC) Adapter
Power	12V, 3.3 A	5.4V, 3 A	12V, 9 A	12V, 3.3 A	15V, 1.5 A
Drop	30 inches (76.2 centimeter) to vinyl covered concrete				
Electrostatic Discharge (ESD)	+/-15 kV air discharge, +/- 8 kV direct discharge, +/- 8 kV indirect discharge				

Appendix B Keypad Functions/Special Characters

Introduction

This appendix contains the keypad functions/special characters for the MC3000 keypads. Each function/special character is included in the table along with how the function/special character is generated.

Keypads

The mobile computer is available with one of four keypads:

- 20-key keypad
- 28-key keypad
- 38-key keypad
- 48-key keypad.

✓ **NOTE** Special characters are not available on the 20-key keypad.

The keypads can be selected as necessary to support specialized applications. The 28, 38 and 48-key keypads contain a **Power** button, application keys, scroll keys and function keys. The keypads are color-coded to indicate the alternate function key (blue) values and the alternate ALPHA key (orange) values. See [Table B-1](#) for the special character generation. Characters can also be generated using the keyboard input panel. For more information see, [Entering Information Using the Keyboard Input Panel on page 2-25](#).

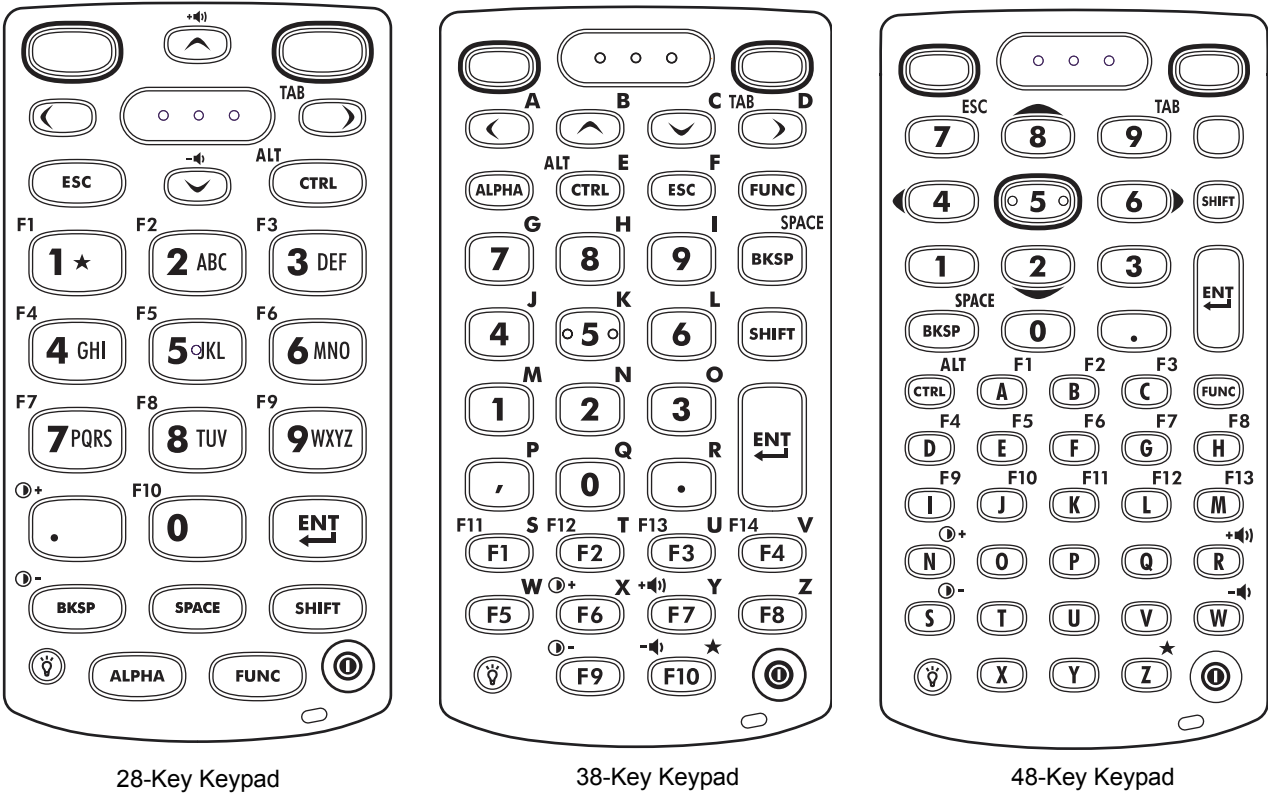

Figure B-1 Keypads

Table B-1 Special Character Generation Map

Special Character	28-Key Keypad Key Sequence, Special Character Generation	38-Key Keypad Key Sequence, Special Character Generation	48-Key Keypad Key Sequence, Special Character Generation
[Use the Keyboard Input Panel*	FUNC + 4	FUNC + T
]	Use the Keyboard Input Panel*	FUNC + 5	FUNC + U
/	Use the Keyboard Input Panel*	FUNC + 9	FUNC + Q
\	Use the Keyboard Input Panel*	FUNC + 3	Use the Keyboard Input Panel*
=	Use the Keyboard Input Panel*	FUNC + 8	FUNC + P

* See *Entering Information Using the Keyboard Input Panel* on page 2-25.

Table B-1 Special Character Generation Map (Continued)

Special Character	28-Key Keypad Key Sequence, Special Character Generation	38-Key Keypad Key Sequence, Special Character Generation	48-Key Keypad Key Sequence, Special Character Generation
;	Use the Keyboard Input Panel*	FUNC + 6	FUNC + V
-	Use the Keyboard Input Panel*	FUNC + 7	FUNC + O
`	Use the Keyboard Input Panel*	FUNC + 2	FUNC + Y
"	Use the Keyboard Input Panel*	SHIFT + FUNC + 1	Use the Keyboard Input Panel*
!	SHIFT + 1	SHIFT + 1	SHIFT + 1
@	SHIFT + 2	SHIFT + 2	SHIFT + 2
#	SHIFT + 3	SHIFT + 3	SHIFT + 3
\$	SHIFT + 4	SHIFT + 4	SHIFT + 4
%	SHIFT + 5	SHIFT + 5	SHIFT + 5
^	SHIFT + 6	SHIFT + 6	SHIFT + 6
&	SHIFT + 7	SHIFT + 7	SHIFT + 7
*	SHIFT + 8	SHIFT + 8	SHIFT + 8
(SHIFT + 9	SHIFT + 9 or FUNC + SHIFT + 9	SHIFT + 9
)	SHIFT + 0	SHIFT + 0 or FUNC + SHIFT + 0	SHIFT + 0
'	Use the Keyboard Input Panel*	FUNC + 1	FUNC + X
"	Use the Keyboard Input Panel*	Use the Keyboard Input Panel*	Use the Keyboard Input Panel*
+	Use the Keyboard Input Panel*	SHIFT + FUNC + 8	Use the Keyboard Input Panel*
:	Use the Keyboard Input Panel*	SHIFT + FUNC + 6	Use the Keyboard Input Panel*
<	Use the Keyboard Input Panel*	FUNC + SHIFT + ,	Use the Keyboard Input Panel*
>	Use the Keyboard Input Panel*	FUNC + SHIFT + .	SHIFT + .

* See *Entering Information Using the Keyboard Input Panel* on page 2-25.

Table B-1 Special Character Generation Map (Continued)

Special Character	28-Key Keypad Key Sequence, Special Character Generation	38-Key Keypad Key Sequence, Special Character Generation	48-Key Keypad Key Sequence, Special Character Generation
?	Use the Keyboard Input Panel*	SHIFT + FUNC + 9	Use the Keyboard Input Panel*
_	Use the Keyboard Input Panel*	SHIFT + FUNC + 7	Use the Keyboard Input Panel*
{	Use the Keyboard Input Panel*	SHIFT + FUNC + 4	Use the Keyboard Input Panel*
}	Use the Keyboard Input Panel*	SHIFT + FUNC + 5	Use the Keyboard Input Panel*
~	Use the Keyboard Input Panel*	SHIFT + FUNC + 2	Use the Keyboard Input Panel*
	N/A	SHIFT + FUNC + 3	N/A

* See [Entering Information Using the Keyboard Input Panel](#) on page 2-25.

Appendix C Regulatory

Introduction

This appendix contains the accessory power supply regulatory compliance statements.

Accessory Power Supply Regulatory Compliance

Table C-1 Accessory Power Supplies, Regulatory Compliance Statements

Accessory	Power Supplies Regulatory Compliance Statements
Single Slot Serial/USB Cradle Power Supply	Use only a Symbol-approved power supply output rated 12 VDC and minimum 3.3 A. The power supply is certified to EN60950 with SELV outputs. Use of alternative power supply will invalidate any approval given to this device and may be dangerous.
Four Slot Spare Battery Charger Power Supply	

Table C-1 Accessory Power Supplies, Regulatory Compliance Statements

Accessory	Power Supplies Regulatory Compliance Statements
Four Slot Charge Only Cradle Power Supply	Use only a Symbol-approved power supply output rated 12 VDC and minimum 9 A. The power supply is certified to EN60950 with SELV outputs. Use of alternative power supply will invalidate any approval given to this device and may be dangerous.
Four Slot Ethernet Cradle Power Supply	Hinweis: Benutzen Sie nur eine von Symbol Technologies genehmigte Stromversorgung mit einer Ausgangsleistung von 12 V (Gleichstrom) und mindestens 9 A. Die Stromversorgung ist nach EN60950 für die Verwendung in SELV-Stromkreisen zertifiziert. Bei Verwendung eines anderen Netzteils werden alle für das Gerät gewährten Genehmigungen außer Kraft gesetzt, und der Betrieb kann gefährlich sein.
Universal Battery Charger (UBC) Adapter Power Supply	Use only a Symbol-approved power supply output rated 15 VDC and minimum 1.5 A. The power supply is certified to EN60950 with SELV outputs. Use of alternative power supply will invalidate any approval given to this device and may be dangerous.
	Hinweis: Benutzen Sie nur eine von Symbol Technologies genehmigte Stromversorgung mit einer Ausgangsleistung von 15 V (Gleichstrom) und mindestens 1.5 A. Die Stromversorgung ist nach EN60950 für die Verwendung in SELV-Stromkreisen zertifiziert. Bei Verwendung eines anderen Netzteils werden alle für das Gerät gewährten Genehmigungen außer Kraft gesetzt, und der Betrieb kann gefährlich sein.
Charging Cables Power Supply	Use only a Symbol-approved power supply output rated 5.4 VDC and minimum 3 A. The power supply is certified to EN60950 with SELV outputs. Use of alternative power supply will invalidate any approval given to this device and may be dangerous.
	Hinweis: Benutzen Sie nur eine von Symbol Technologies genehmigte Stromversorgung mit einer Ausgangsleistung von 5.4 V (Gleichstrom) und mindestens 3 A. Die Stromversorgung ist nach EN60950 für die Verwendung in SELV-Stromkreisen zertifiziert. Bei Verwendung eines anderen Netzteils werden alle für das Gerät gewährten Genehmigungen außer Kraft gesetzt, und der Betrieb kann gefährlich sein.

Glossary

Numeric

802.11/802.11abg. A radio protocol that may be used by the WLAN radio card.

A

Access Point. Access Point (AP) refers to Zebra's Ethernet Access Point. It is a piece of communications equipment that manages communications between the host computer system and one or more wireless terminals. An AP connects to a wired Ethernet LAN and acts as a bridge between the Ethernet wired network and IEEE 802.11 interoperable radio-equipped mobile units, such as a mobile computer. The AP allows a mobile user to roam freely through a facility while maintaining a seamless connection to the wired network.

AirBEAM® Manager. AirBEAM® Manager is a comprehensive wireless network management system that provides essential functions that are required to configure, monitor, upgrade and troubleshoot the wireless network and its components (including networked mobile computers). Some features include event notification, access point configuration, diagnostics, statistical reports, auto-discovery, wireless proxy agents and monitoring of access points and mobile units.

AirBEAM® Smart Client. AirBEAM® Smart Client is part of Zebra's AirBEAM® suite, which also includes AirBEAM® Safe and AirBEAM® Manager. The AirBEAM® Smart Client system uses the network accessible host server to store software files that are to be downloaded to the mobile computers. The AirBEAM® Smart Client provides the mobile computers with the "smarts" to request software from the host. It allows them to request, download and install software, as well as to upload files and status data. The AirBEAM® Smart Client uses the industry standard FTP or TFTP file transfer protocols to check the host system for updates, and if necessary, to transfer updated software. Most often, AirBEAM® Smart Client is used with wireless networks, but any TCP/IP connection can be used. For more information, refer to the AirBEAM® Smart Windows® CE Client Product Reference Guide (p/n 72-63060-xx).

AP. See **Access Point**.

Aperture. The opening in an optical system defined by a lens or baffle that establishes the field of view.

ASCII. American Standard Code for Information Interchange. A 7 bit-plus-parity code representing 128 letters, numerals, punctuation marks and control characters. It is a standard data transmission code in the U.S.

B

Bar. The dark element in a printed bar code symbol.

Bar Code. A pattern of variable-width bars and spaces which represents numeric or alphanumeric data in machine-readable form. The general format of a bar code symbol consists of a leading margin, start character, data or message character, check character (if any), stop character, and trailing margin. Within this framework, each recognizable symbology uses its own unique format. See **Symbology**.

Bar Code Density. The number of characters represented per unit of measurement (e.g., characters per inch).

Bar Height. The dimension of a bar measured perpendicular to the bar width.

Bar Width. Thickness of a bar measured from the edge closest to the symbol start character to the trailing edge of the same bar.

Bit. Binary digit. One bit is the basic unit of binary information. Generally, eight consecutive bits compose one byte of data. The pattern of 0 and 1 values within the byte determines its meaning.

Bits per Second (bps). Bits transmitted or received.

Bit. Binary digit. One bit is the basic unit of binary information. Generally, eight consecutive bits compose one byte of data. The pattern of 0 and 1 values within the byte determines its meaning.

bps. See **Bits Per Second**.

Byte. On an addressable boundary, eight adjacent binary digits (0 and 1) combined in a pattern to represent a specific character or numeric value. Bits are numbered from the right, 0 through 7, with bit 0 the low-order bit. One byte in memory is used to store one ASCII character.

boot or boot-up. The process a computer goes through when it starts. During boot-up, the computer can run self-diagnostic tests and configure hardware and software.

C

CDRH. Center for Devices and Radiological Health. A federal agency responsible for regulating laser product safety. This agency specifies various laser operation classes based on power output during operation.

CDRH Class 1. This is the lowest power CDRH laser classification. This class is considered intrinsically safe, even if all laser output were directed into the eye's pupil. There are no special operating procedures for this class.

CDRH Class 2. No additional software mechanisms are needed to conform to this limit. Laser operation in this class poses no danger for unintentional direct human exposure.

Character. A pattern of bars and spaces which either directly represents data or indicates a control function, such as a number, letter, punctuation mark, or communications control contained in a message.

Character Set. Those characters available for encoding in a particular bar code symbology.

Check Digit. A digit used to verify a correct symbol decode. The scanner inserts the decoded data into an arithmetic formula and checks that the resulting number matches the encoded check digit. Check digits are required for UPC but are optional for other symbologies. Using check digits decreases the chance of substitution errors when a symbol is decoded.

Codabar. A discrete self-checking code with a character set consisting of digits 0 to 9 and six additional characters: (“-”, “\$”, “:”, “/”, “,”, and “+”).

Code 128. A high density symbology which allows the controller to encode all 128 ASCII characters without adding extra symbol elements.

Code 3 of 9 (Code 39). A versatile and widely used alphanumeric bar code symbology with a set of 43 character types, including all uppercase letters, numerals from 0 to 9 and 7 special characters (“-”, “:”, “/”, “+”, “%”, “\$” and space). The code name is derived from the fact that 3 of 9 elements representing a character are wide, while the remaining 6 are narrow.

Code 93. An industrial symbology compatible with Code 39 but offering a full character ASCII set and a higher coding density than Code 39.

Code Length. Number of data characters in a bar code between the start and stop characters, not including those characters.

Cold Boot. A cold boot restarts the mobile computer and erases all user stored records and entries.

COM port. Communication port; ports are identified by number, e.g., COM1, COM2.

Continuous Code. A bar code or symbol in which all spaces within the symbol are parts of characters. There are no intercharacter gaps in a continuous code. The absence of gaps allows for greater information density.

Cradle. A cradle is used for charging the terminal battery and for communicating with a host computer, and provides a storage place for the terminal when not in use.

D

Dead Zone. An area within a scanner's field of view, in which specular reflection may prevent a successful decode.

Decode. To recognize a bar code symbology (e.g., UPC/EAN) and then analyze the content of the specific bar code scanned.

Decode Algorithm. A decoding scheme that converts pulse widths into data representation of the letters or numbers encoded within a bar code symbol.

Decryption. Decryption is the decoding and unscrambling of received encrypted data. Also see, **Encryption** and **Key**.

Depth of Field. The range between minimum and maximum distances at which a scanner can read a symbol with a certain minimum element width.

Discrete Code. A bar code or symbol in which the spaces between characters (intercharacter gaps) are not part of the code.

Discrete 2 of 5. A binary bar code symbology representing each character by a group of five bars, two of which are wide. The location of wide bars in the group determines which character is encoded; spaces are insignificant. Only numeric characters (0 to 9) and START/STOP characters may be encoded.

E

EAN. European Article Number. This European/International version of the UPC provides its own coding format and symbology standards. Element dimensions are specified metrically. EAN is used primarily in retail.

Element. Generic term for a bar or space.

EMDK. Enterprise Mobility Developer's Kit.

Encoded Area. Total linear dimension occupied by all characters of a code pattern, including start/stop characters and data.

ESD. Electro-Static Discharge

ESN. Electronic Serial Number. The unique hardware number associated with a cellular device, which is transmitted to the system when the device communicates with the cellular system.

Ethernet. Ethernet communication port. Allows a wired interface to a radio network.

F

Flash Memory. Flash memory is nonvolatile, semi-permanent storage that can be electronically erased in the circuit and reprogrammed. Mobile computers may use Flash memory to store the operating system (ROM-DOS), the terminal emulators, and the Citrix ICA Client for DOS.

FTP. See **File Transfer Protocol**.

Flash Memory. Flash memory is responsible for storing the system firmware and is non-volatile. If the system power is interrupted the data is not be lost.

G

Gateway Address. An IP address for a network gateway or router. A mobile computer may be part of a subnet as specified by its IP address and Netmask. It can send packets directly to any node on the same subnet. If the destination node is on a different subnet, then the terminal sends the packet to the gateway first. The gateway determines how to route the packet to the destination subnet. This field is an option used by networks that require gateways.

H

Hard Reset. See **Cold Boot**.

Hz. Hertz; A unit of frequency equal to one cycle per second.

Host Computer. A computer that serves other terminals in a network, providing such services as computation, database access, supervisory programs and network control.

I

IEC. International Electrotechnical Commission. This international agency regulates laser safety by specifying various laser operation classes based on power output during operation.

IEC (825) Class 1. This is the lowest power IEC laser classification. Conformity is ensured through a software restriction of 120 seconds of laser operation within any 1000 second window and an automatic laser shutdown if the scanner's oscillating mirror fails.

Interleaved 2 of 5. A binary bar code symbology representing character pairs in groups of five bars and five interleaved spaces. Interleaving provides for greater information density. The location of wide elements (bar/spaces) within each group determines which characters are encoded. This continuous code type uses no intercharacter spaces. Only numeric (0 to 9) and START/STOP characters may be encoded.

imaging scanning . Mobile computers with an integrated imager use digital camera technology to take a digital picture of a bar code, store the resulting image in memory and execute state-of-the-art software decoding algorithms to extract the data from the image.

Intercharacter Gap. The space between two adjacent bar code characters in a discrete code.

Interleaved Bar Code. A bar code in which characters are paired together, using bars to represent the first character and the intervening spaces to represent the second.

Interleaved 2 of 5. A binary bar code symbology representing character pairs in groups of five bars and five interleaved spaces. Interleaving provides for greater information density. The location of wide elements (bar/spaces) within each group determines which characters are encoded. This continuous code type uses no intercharacter spaces. Only numeric (0 to 9) and START/STOP characters may be encoded.

IP. Internet Protocol. The IP part of the TCP/IP communications protocol. IP implements the network layer (layer 3) of the protocol, which contains a network address and is used to route a message to a different network or subnetwork. IP accepts "packets" from the layer 4 transport protocol (TCP or UDP), adds its own header to it and delivers a "datagram" to the layer 2 data link protocol. It may also break the packet into fragments to support the maximum transmission unit (MTU) of the network.

IP Address. (Internet Protocol address) The address of a computer attached to an IP network. Every client and server station must have a unique IP address. A 32-bit address used by a computer on a IP network. Client workstations have either a permanent address or one that is dynamically assigned to them each session. IP addresses are written as four sets of numbers separated by periods; for example, 204.171.64.2.

L

LAN. Local area network. A radio network that supports data communication within a local area, such as within a warehouse of building.

laser scanner. A type of bar code reader that uses a beam of laser light.

LASER. Light Amplification by Stimulated Emission of Radiation. The laser is an intense light source. Light from a laser is all the same frequency, unlike the output of an incandescent bulb. Laser light is typically coherent and has a high energy density.

Laser Diode. A gallium-arsenide semiconductor type of laser connected to a power source to generate a laser beam. This laser type is a compact source of coherent light.

LED Indicator. A semiconductor diode (LED - Light Emitting Diode) used as an indicator, often in digital displays. The semiconductor uses applied voltage to produce light of a certain frequency determined by the semiconductor's particular chemical composition.

Light Emitting Diode. See **LED**.

M

MC. Mobile Computer.

MIL. 1 mil = 1 thousandth of an inch.

MIN. Mobile Identification Number. The unique account number associated with a cellular device. It is broadcast by the cellular device when accessing the cellular system.

Misread (Misdecode). A condition which occurs when the data output of a reader or interface controller does not agree with the data encoded within a bar code symbol.

Mobile Computer. In this text, *mobile computer* refers to the Symbol portable computer. It can be set up to run as a stand-alone device, or it can be set up to communicate with a network, using wireless radio technology.

N

Nominal. The exact (or ideal) intended value for a specified parameter. Tolerances are specified as positive and negative deviations from this value.

Nominal Size. Standard size for a bar code symbol. Most UPC/EAN codes are used over a range of magnifications (e.g., from 0.80 to 2.00 of nominal).

NVM. Non-Volatile Memory.

P

Parameter. A variable that can have different values assigned to it.

PDT. Portable Data Terminal.

Percent Decode. The average probability that a single scan of a bar code would result in a successful decode. In a well-designed bar code scanning system, that probability should approach near 100%.

Q

Quiet Zone. A clear space, containing no dark marks, which precedes the start character of a bar code symbol and follows the stop character.

R

RAM. Random Access Memory. Data in RAM can be accessed in random order, and quickly written and read.

Reflectance. Amount of light returned from an illuminated surface.

Resolution. The narrowest element dimension which is distinguished by a particular reading device or printed with a particular device or method.

RF. Radio Frequency.

ROM. Read-Only Memory. Data stored in ROM cannot be changed or removed.

Router. A device that connects networks and supports the required protocols for packet filtering. Routers are typically used to extend the range of cabling and to organize the topology of a network into subnets. See **Subnet**.

RS232. An Electronic Industries Association (EIA) standard that defines the connector, connector pins, and signals used to transfer data serially from one device to another.

S

Scan Area. Area intended to contain a symbol.

Scanner. An electronic device used to scan bar code symbols and produce a digitized pattern that corresponds to the bars and spaces of the symbol. Its three main components are:

1. Light source (laser or photoelectric cell) - illuminates a bar code.
2. Photodetector - registers the difference in reflected light (more light reflected from spaces).
3. Signal conditioning circuit - transforms optical detector output into a digitized bar pattern.

Scanning Mode. The scanner is energized, programmed and ready to read a bar code.

Scanning Sequence. A method of programming or configuring parameters for a bar code reading system by scanning bar code menus.

SDK. Software Development Kit

Self-Checking Code. A symbology that uses a checking algorithm to detect encoding errors within the characters of a bar code symbol.

Shared Key. Shared Key authentication is an algorithm where both the AP and the MU share an authentication key.

SID. System Identification code. An identifier issued by the FCC for each market. It is also broadcast by the cellular carriers to allow cellular devices to distinguish between the home and roaming service.

Soft Reset. See **Warm Boot**.

Space. The lighter element of a bar code formed by the background between bars.

Specular Reflection. The mirror-like direct reflection of light from a surface, which can cause difficulty decoding a bar code.

Spring Radio Protocol. A radio protocol that may be used by the Symbol radio card. Symbol Radio cards that use the Spring protocol also have an Net ID.

Start/Stop Character. A pattern of bars and spaces that provides the scanner with start and stop reading instructions and scanning direction. The start and stop characters are normally to the left and right margins of a horizontal code.

Subnet. A subset of nodes on a network that are serviced by the same router. See **Router**.

Subnet Mask. A 32-bit number used to separate the network and host sections of an IP address. A custom subnet mask subdivides an IP network into smaller subsections. The mask is a binary pattern that is matched up with the IP address to turn part of the host ID address field into a field for subnets. Default is often 255.255.255.0.

Substrate. A foundation material on which a substance or image is placed.

SVTP. Symbol Virtual Terminal Program.

Symbol. A scannable unit that encodes data within the conventions of a certain symbology, usually including start/stop characters, quiet zones, data characters and check characters.

Symbol Aspect Ratio. The ratio of symbol height to symbol width.

Symbol Height. The distance between the outside edges of the quiet zones of the first row and the last row.

Symbol Length. Length of symbol measured from the beginning of the quiet zone (margin) adjacent to the start character to the end of the quiet zone (margin) adjacent to a stop character.

Symbology. The structural rules and conventions for representing data within a particular bar code type (e.g. UPC/EAN, Code 39, PDF417, etc.).

T

Tolerance. Allowable deviation from the nominal bar or space width.

U

UPC. Universal Product Code. A relatively complex numeric symbology. Each character consists of two bars and two spaces, each of which is any of four widths. The standard symbology for retail food packages in the United States.

V

Visible Laser Diode (VLD). A solid state device which produces visible laser light.

W

WAN. Wide-Area Network. A radio network that supports data communication beyond a local area. That is, information can be sent across a city, state, or even nationwide.

Warm Boot. A warm boot restarts the mobile computer by closing all running programs. All data that is not saved to flash memory is lost.

Wireless Local Area Network (WLAN). See **LAN**.

Wireless Wide Area Network (WWAN). See **WAN**.

WNMP. (Wireless Network Management Protocol) This is Symbol's proprietary MAC layer protocol used for inter access point communication and other MAC layer communication.

Index

Numerics

20-key keypad	2-1, B-1
20-key mechanical keypad	2-3
28-key keypad	2-5, B-1
38-key keypad	2-8, B-1
48-key keypad	2-11, B-1
802.11	A-2

A

accessories	1-2
cables	4-8
four slot charge only cradle	4-1, 4-5
LED indicators	4-6
four slot cradles	
battery charging	4-5
four slot spare battery charger	4-1
battery charging	4-7
LED indicators	4-8
MC3000 communication/charge cables	
battery charging	4-9
LED indicators	4-9
plastic holster	4-13, 4-15
SD card	4-12
single slot serial/USB cradle	4-1, 4-2
battery charging	4-2
LED indicators	4-3
stylus	1-2
UBC adapter	4-1
battery charging	4-10
LED indicators	4-10
active and indicate programs	2-14
active tasks	2-17
ActiveSync	xvi
icon	2-21
Adaptive Frequency Hopping	3-1

AFH	3-1
aiming options	
aiming pattern	2-30
attaching strap/door assembly	1-12, 1-13

B

backup battery specification	A-2
battery	
charging	1-7
temperature range	A-1, A-3
install	1-5
removal	1-11
specification	A-2
status	2-14
battery charge status	2-14
battery chargers	
four slot spare battery charger	
battery charging	4-7
LED indicators	4-8
MC3000 communication/charge cables	
battery charging	4-9
LED indicators	4-9
UBC adapter	
battery charging	4-10
LED indicators	4-10
battery charging	1-7
backup battery	1-7
four slot cradles	4-5
four slot spare battery charger	4-7
main battery	1-7
MC3000 communication/charge cables	4-9
battery charging	4-9
temperature range	1-8
UBC adapter	4-10
battery status	2-14
beeper	1-3

beeper volume 2-2
 Bluetooth 3-1
 ActiveSync 3-7
 bonding 3-9
 deleting bonded device 3-11
 dial-up networking services 3-15
 disable 3-2
 discovering devices 3-8
 discovering services 3-13
 enable 3-3
 file transfer services 3-14
 OBEX object push services 3-18
 personal area network services 3-21
 renaming bonded device 3-11
 turning off 3-2
 turning on 3-3
 wizard mode 3-5
 bluetooth
 adaptive frequency hopping 3-1
 communicating icon 2-21
 disabled icon 2-21
 enabled icon 2-20
 icon 2-15
 Bluetooth security 3-2
 bonding, Bluetooth 3-9
 boot
 cold 2-35, 3-3
 warm 2-35, 3-3
 bullets xv

C

cables 4-1
 calibration screen 1-10
 characters, special B-2
 charge battery 1-7
 charge LED indicator 1-3, 1-5
 charging
 spare batteries 1-9
 temperature range A-1, A-3
 charging battery 1-7
 charging, temperature range 1-8
 cleaning 5-1
 clock, display 2-18
 cold boot 2-34, 2-35, 3-3
 command bar 2-20
 icons 2-19, 2-20
 command bar icons 2-20
 communication status 2-14
 configuration xii
 contrast settings 2-2
 conventions
 notational xv
 cradles

 four slot charge only cradle 4-1, 4-5
 LED indicators 4-6
 four slot cradles
 battery charging 4-5
 single slot serial/USB cradle 4-1
 battery charging 4-2
 LED indicators 4-3
 troubleshooting 5-6

D

data capture xii
 imager operational modes
 decode mode 2-29
 pick list mode 2-30
 data capture specifications A-3
 DCP xvi, 1-2
 decode ranges 2-27, 2-31
 deleting Bluetooth bond 3-11
 demo window 1-10, 2-13
 desktop window 2-13
 device configuration package 1-2
 Device Configuration Package, see DCP
 dimensions A-2
 directory structure 2-36
 display xii
 display clock 2-18
 display contrast 2-2
 display specification A-2
 documentation updates xvi
 documents 2-15

E

electro-static discharge 2-20
 email notification icon 2-20
 end task 2-17
 entering data with scanner 2-25
 entering information 2-25
 scanning 2-25
 Enterprise Mobility Developer Kit 1-2
 Enterprise Mobility Developer Kit for .NET, see EMDK
 ESD 4-12, A-1

F

fabric holster 1-2, 4-15
 favorites 2-15
 file folders 2-36
 file system directory structure 2-36
 four slot charge only cradle 1-2, 4-1, 4-5
 LED indicators 4-6
 four slot cradles 1-8
 battery charging 4-5

four slot Ethernet cradle	1-2
four slot spare battery charger	1-2, 1-8, 1-9
battery charging	4-7
LED indicators	4-8
troubleshooting	5-6
frequency-hopping spread spectrum	3-1
function status	2-14

H

hard reset	2-34, 2-35, 3-3
headset	2-26
headset jack	1-4
help	2-16
holster, fabric	1-2, 4-15
holster, plastic	1-2, 4-13
humidity	A-1

I

icons	
ActiveSync	2-21
battery	2-20
bluetooth	2-15
bluetooth communicating	2-21
bluetooth disabled	2-21
bluetooth enabled	2-20
connectivity	2-20
e-mail	2-20
instant message	2-20
speaker	2-19
status	2-19, 2-20
wireless applications	2-20
imager	2-29
aiming	2-30
function	2-29
imager decode ranges	2-32
imager scanning	2-29
indicator LED bar	1-3, 1-5, 4-3
Industry Scientific and Medical	3-1
information, service	xvi
internet	
wireless connection	2-36
internet connection	2-36

K

keypad	
20-key	B-1
28-key	2-1, 2-5, B-1
38-key	2-1, 2-8, B-1
48-key	2-1, 2-3, 2-11, B-1
keypad configurations	2-1
keypad functions	B-1

keypad special functions	2-2
keypads	xii

L

laser decode ranges	2-28
laser scanning	2-26
locking the mobile computer	2-24

M

main battery	1-8
charging	1-5
temperature range	A-1, A-3
inserting	1-5
main battery removal	1-11
maintenance	5-1
MC3000 communication/charge cables	4-8
battery charging	4-9
LED indicators	4-9
MC3000R parts	1-3, 1-4
MC3000S parts	1-3, 1-4
memory	xii
microphone	1-3
mobile computer	
cold boot	2-34, 2-35
hard reset	2-34
power on	2-1
reset	2-34
scanning	2-26
soft reset	2-34
warm boot	2-34, 2-35
Monarch printer cable	1-2, 4-8

N

navigating software	2-1
---------------------	-----

O

O'Neil printer cable	1-2, 4-8
operating	
environment	A-1
platforms	A-2
temperature	A-1
operating system	xii
OS	A-2

P

pair with a remote device	3-7
parts	1-3, 1-4, 1-5
PDF417	
slab raster option	2-29

smart raster 2-29
 plastic holster 1-2, 4-13
 platform SDKxvi
 power button 2-1
 power supply 1-2
 power supply regulatory compliance C-1
 processor/memory specifications A-2
 program menu 2-16
 properties 2-17

R

radio module specifications A-2
 radios xii
 receiver 1-3
 receiver volume 2-2
 regulatory compliance, power supply C-1
 remove battery 1-11
 remove the Strap/Door Assembly 1-12, 1-13
 renaming Bluetooth bond 3-11
 replace the strap/door assembly 1-12, 1-13
 reset
 hard 2-35, 3-3
 soft 2-35, 3-3
 resetting 2-34
 resume 3-4
 rotating scan head 1-3
 rotating scan turret 1-4
 RS232 charge cable 1-2, 1-8, 4-8
 run 2-16

S

scan 2-25
 scan buttons 1-3, 1-5
 scan LED indicators 1-3, 1-5, 2-27
 scan status 2-27
 scan window 1-4
 scanning 2-25, 2-26
 adjusting the distance 2-26
 angle 2-27
 indicator 2-27
 LED indicators 2-27
 range 2-27
 scanning considerations 2-27
 screen
 calibration 1-10
 contrast 2-2
 specifications A-2
 SD card 4-12
 installation 4-12
 specifications A-3
 sealing specification A-1
 secure device card 4-12

serial charge cable 1-8, 4-8
 series 3000 demo window 2-13
 service 5-1
 settings 2-15
 shoulder strap 4-15, 4-16
 show clock 2-18
 single slot cradle RS232 cable 1-2
 single slot cradle USB cable 1-2
 single slot serial/USB cradle 1-2, 1-8, 1-9, 4-1, 4-2
 battery charging 4-2
 LED indicators 4-3
 soft reset 2-34, 2-35, 3-3
 spare battery
 charging 1-9
 special characters B-2
 special functions, keypad 2-2
 start menu 2-15
 starting the mobile computer 1-5, 1-9
 startup 1-5
 status 2-19
 status icon 2-14, 2-19
 status icons 2-19, 2-20
 StoneStreet One 3-1
 storage temperature A-1
 storing 5-1
 strap/door assembly 1-4
 attaching 1-12, 1-13
 strap/door assembly removal 1-12, 1-13
 stylus 1-2, 1-4, 1-9
 stylus holder 1-4
 suspend 1-12, 1-13, 2-16, 3-4

T

task manager 2-17
 taskbar 2-14
 technical specifications A-1
 temperature
 battery charging A-1, A-3
 operating A-1
 storage A-1
 Today screen 2-19
 troubleshooting 5-2
 cables 5-8
 four slot charge only cradle 5-5
 four slot spare battery charger 5-6
 mobile computer 5-2
 single slot serial/USB cradle 5-4
 UBC adapter 5-7
 turning the radios off
 WLAN 1-14, 1-15

U

- UBC adapter 1-2, 1-8, 1-9, 4-1
 - battery charging 4-10
 - LED indicators 4-10
 - UBC adapter
 - LED indicators 4-10
- UBC adapter LED charge indications 4-10
- universal battery charger adapter 1-2, 1-8
- unlock the mobile computer 2-24
- unpacking 1-1
- updates, documentation xvi
- USB client charge cable 1-2, 1-8, 4-8
- using headset 2-26
- using stylus 1-9

V

- volume 2-2

W

- wakeup condition settings 1-11
- wakeup conditions 2-35
- warm boot 2-34, 2-35, 3-3
- weight A-2
- Windows CE .NET 5.0 Core 2-13, 2-16
- Windows CE .NET 5.0 Professional 2-13, 2-16
- Windows Mobile 6.1 2-19
- Wireless 1-15
- wireless
 - internet 2-36
- wireless application 2-37
- wireless applications 2-36
- Wireless Manager 1-15
- wireless status 2-20
- WLAN A-2
- WLAN 802.11a/b/g xii
- WPAN Bluetooth xii

Z

- Zebra printer cable 1-2, 4-8



Zebra Technologies Corporation
Lincolnshire, IL U.S.A
<http://www.zebra.com>

Zebra and the stylized Zebra head are trademarks of ZIH Corp., registered in many jurisdictions worldwide. All other trademarks are the property of their respective owners. ©2015 ZIH Corp and/or its affiliates. All rights reserved.