

MC55 Enterprise Digital Assistant

Integrator Guide

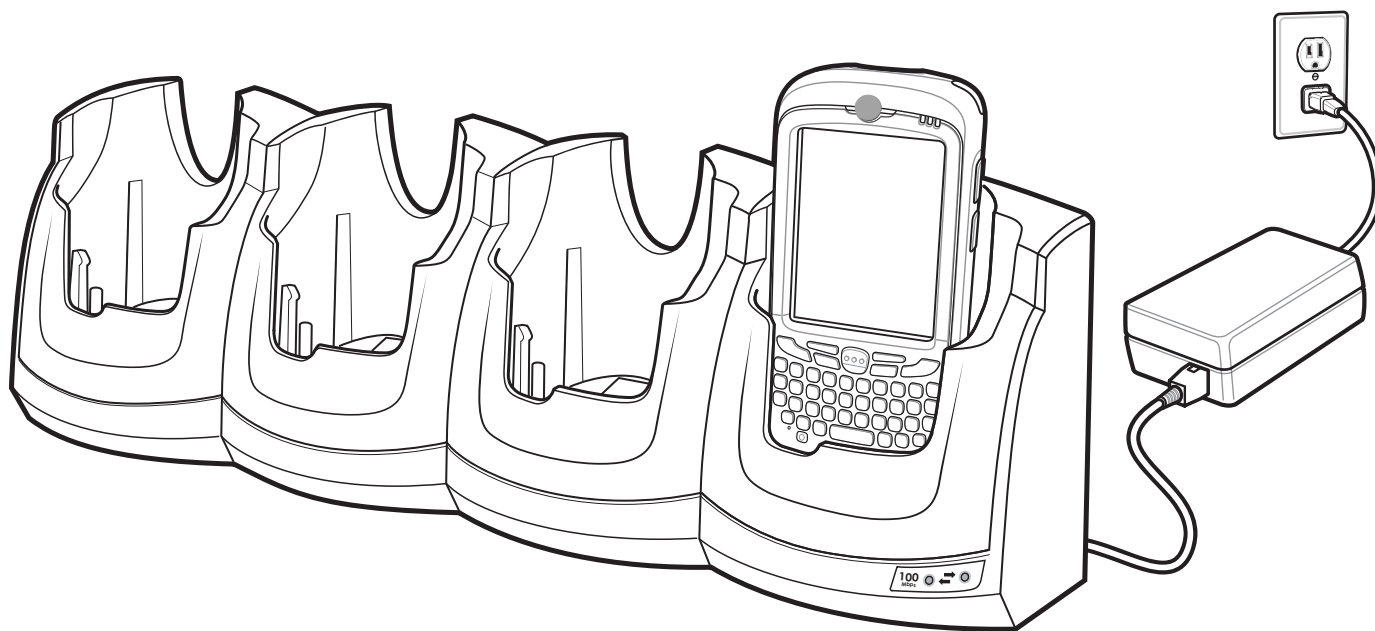

***MC55 Enterprise Digital Assistant
Integrator Guide***

72E-108861-06

Rev. A

July 2015

© 2015 Symbol Technologies, Inc.

No part of this publication may be reproduced or used in any form, or by any electrical or mechanical means, without permission in writing from Zebra. This includes electronic or mechanical means, such as photocopying, recording, or information storage and retrieval systems. The material in this manual is subject to change without notice.

The software is provided strictly on an “as is” basis. All software, including firmware, furnished to the user is on a licensed basis. Zebra grants to the user a non-transferable and non-exclusive license to use each software or firmware program delivered hereunder (licensed program). Except as noted below, such license may not be assigned, sublicensed, or otherwise transferred by the user without prior written consent of Zebra. No right to copy a licensed program in whole or in part is granted, except as permitted under copyright law. The user shall not modify, merge, or incorporate any form or portion of a licensed program with other program material, create a derivative work from a licensed program, or use a licensed program in a network without written permission from Zebra. The user agrees to maintain Zebra’s copyright notice on the licensed programs delivered hereunder, and to include the same on any authorized copies it makes, in whole or in part. The user agrees not to decompile, disassemble, decode, or reverse engineer any licensed program delivered to the user or any portion thereof.

Zebra reserves the right to make changes to any software or product to improve reliability, function, or design.

Zebra does not assume any product liability arising out of, or in connection with, the application or use of any product, circuit, or application described herein.

No license is granted, either expressly or by implication, estoppel, or otherwise under any Zebra, intellectual property rights. An implied license only exists for equipment, circuits, and subsystems contained in Zebra products.

Zebra Technologies Corporation
Lincolnshire, IL U.S.A
<http://www.zebra.com>

Revision History

Changes to the original manual are listed below:

Change	Date	Description
-01 Rev. A	11/20/08	Initial release.
-02 Rev. A	03/06/09	Add MC5574 configuration support.
-03 Rev. A	03/15/10	Add correct Vehicle Cradle input voltage. Remove reference to backup battery. Add support for OEM version 02.35.000 and 02.35.001.
-04 Rev. A	12/31/10	Add support for MC55A0 configuration.
-05 Rev. A	4/2015	Zebra Rebranding
-06 Rev. A	7/2015	Remove ActiveSync reference in Four Slot Ethernet Cradle Troubleshooting table.

Table of Contents

Revision History	iii
About This Guide	
Introduction	xi
Documentation Set	xi
Configurations.....	xii
Software Versions	xii
Chapter Descriptions	xv
Notational Conventions.....	xv
Related Documents	xvi
Service Information.....	xvi
Chapter 1: Getting Started	
Introduction	1-1
Unpacking the MC55	1-1
Getting Started	1-1
Installing a microSD Card	1-2
Installing the SIM Card	1-3
Installing the Battery	1-4
Charging the Battery	1-5
Charging the Main Battery	1-5
Charging Spare Batteries	1-6
Charging Temperature	1-6
Powering On the MC55	1-6
Calibrating the Screen	1-7
Resetting the MC55	1-7
Performing a Warm Boot	1-7
Performing a Cold Boot	1-7
Performing a Clean Boot	1-8
Waking the MC55	1-8

Chapter 2: Accessories

Introduction	2-1
Single Slot USB Cradle	2-2
Setup	2-2
Charging the MC55 Battery	2-2
Charging the Spare Battery	2-4
Battery Charging Indicators	2-4
Charging Temperature	2-4
Single Slot Ethernet/Modem/USB Cradle	2-6
Required Software	2-6
Country Settings	2-6
Setup	2-7
Indicators	2-7
MC55 Software Setup	2-8
Ethernet Setup	2-8
Modem Setup	2-8
Four Slot Ethernet Cradle	2-10
Setup	2-10
Daisy chaining Ethernet Cradles	2-10
Ethernet Cradle Drivers	2-11
Charging and Communication	2-13
LED Charging Indicators	2-13
Charge LED	2-13
Speed LED	2-13
Link LED	2-13
Charging Temperature	2-13
Four Slot Charge Only Cradle	2-14
Setup	2-14
Charging Temperature	2-14
Wall Mount Bracket	2-15
VCD5500 Vehicle Cradle	2-17
Requirements	2-17
Connector Pin-Outs	2-17
Mounting the Cradle	2-17
Power Connection	2-18
Charging the MC55 Battery	2-20
Removing the MC55	2-20
Battery Charging Indicators	2-21
Charging Temperature	2-21
Four Slot Battery Charger	2-22
Spare Battery Charging	2-22
Battery Charging Indicators	2-22
Charging Temperature	2-22
Cables	2-23
USB Charging Cable	2-23
Charge Only Cable	2-24
Auto Charge Cable	2-24
Connecting to the MC55	2-24
Battery Charging Indicators	2-25
Charging Temperature	2-25

Vehicle Holder	2-27
Installation Reminders	2-27
Device Mounting Precautions	2-27
Installation	2-27
Assembly	2-28
Windshield Installation	2-28
Flat Surface Installation	2-29
Trigger Handle	2-31
Install Trigger Handle Software on the MC55	2-31
Inserting the MC55 into the Trigger Handle	2-31
Removing the MC55	2-31
Scanning	2-32
Charging and Communication	2-32
Using the Serial Charging/Communication Cable	2-32
Using a Cradle	2-33

Chapter 3: ActiveSync

Introduction	3-1
Installing ActiveSync	3-1
Mobile Computer Setup	3-2
USB Configuration	3-2
Setting Up an ActiveSync Connection on the Host Computer	3-4
Synchronization with a Windows Mobile 6.1 Device	3-5

Chapter 4: Application Deployment

Introduction	4-1
Security	4-1
Application Security	4-1
Digital Signatures	4-1
Locking Down a Mobile Computer	4-2
Installing Certificates	4-3
Device Management Security	4-3
Remote API Security	4-3
Packaging	4-4
Deployment	4-4
Installation Using ActiveSync	4-4
Installation Using Storage Card	4-4
Installation Using USB Connection	4-5
Installation Using AirBEAM	4-6
Mobility Services Platform	4-6
Update Loader Image	4-6
Download Update Loader Package	4-6
ActiveSync	4-6
microSD Card	4-7
Creating a Splash Screen	4-7
XML Provisioning	4-8
Creating an XML Provisioning File	4-8
XML Provisioning vs. RegMerge and Copy File	4-8

RegMerge	4-8
CopyFiles	4-9
Storage	4-10
Random Access Memory	4-10
Volatile File Storage (Cache Disk)	4-10
Persistent Storage	4-10
Application Folder	4-10
Enterprise Mobility Developer Kits	4-11

Chapter 5: Wireless Applications

Introduction	5-1
Signal Strength Icon	5-2
Turning the WLAN Radio On and Off	5-3

Chapter 6: MC5574 - GSM Configuration

Introduction	6-1
Quick Startup Steps	6-1
MC5574 Service Verification	6-2
Ensuring Network Coverage	6-2
Configuring a Data Connection	6-3
MC5574 Settings	6-6
Phone Tab	6-6
Sounds	6-6
Security Tab	6-7
Services	6-8
Call Barring (Call Blocking)	6-8
Caller ID	6-9
Call Forwarding	6-9
Call Waiting	6-10
Voice Mail and Text Messages	6-10
Fixed Dialing	6-11
Network	6-12
Changing Networks Manually	6-12
Viewing Available Networks	6-12
Setting Preferred Networks	6-13
Phone Info	6-14
Network Time Synchronization	6-15
Enhanced Operator Name String	6-15
Service Provider Name Display	6-15
SMS Cell Broadcast	6-16

Chapter 7: Maintenance & Troubleshooting

Introduction	7-1
Maintaining the MC55	7-1
Battery Safety Guidelines	7-2
Cleaning	7-3
Approved Cleanser Active Ingredients	7-3

Harmful Ingredients	7-3
Cleaning Instructions	7-3
Special Cleaning Notes	7-3
Materials Required	7-3
Cleaning the MC55	7-4
Housing	7-4
Display	7-4
Scanner Exit Window	7-4
Connector	7-4
Cleaning Cradle Connectors	7-4
Cleaning Frequency	7-5
Troubleshooting	7-5
MC55	7-5
Bluetooth Connection	7-7
Single Slot USB Cradle	7-8
Four Slot Ethernet Cradle	7-9
Vehicle Cradle	7-9
Four Slot Spare Battery Charger	7-10
Cables	7-10
Trigger Handle	7-11

Appendix A: Technical Specifications

MC55 Technical Specifications	A-1
Decode Zones	A-7
SE950 Decode Zones	A-7
SE960 Decode Zones	A-10
SE4400 Decode Zones	A-12
Near Focus	A-12
Far Focus	A-14
SE4500 Decode Zones	A-16
SE4500-SR	A-16
SE4500-DL	A-18
SE4500-HD	A-20
MC55 External Connector Pin-Outs	A-22
MC55 Accessory Specifications	A-23
Single Slot USB Cradle	A-23
Four Slot Battery Charger Cradle	A-23
Four Slot Charge Only Cradle	A-24
Four Slot Ethernet Cradle	A-24
Vehicle Cradle	A-25
Magstripe Reader	A-26
Cables	A-26

Appendix B: Special Software Configurations

Bluetooth Configuration Settings	B-1
Battery Usage Threshold Setting	B-1
Registry Setting	B-2

Appendix C: Windows Mobile 6.5

Introduction	C-1
Finger Scrolling	C-1
Home Screen	C-2
Classic Today Screen	C-4
Status Bar	C-5
Tile Bar	C-8
Start Screen	C-8
Speaker Icon	C-14
Battery Icons	C-14
Connectivity Icon	C-14
Locking the MC55	C-15
Locking without PIN or Password	C-15
Locking with Simple PIN	C-16
Locking with Strong Password	C-16
Password Locking Setup	C-17
Using the RS507 Hands-free Imager	C-18
Assisted GPS	C-18
UI Settings	C-20
Start Screen Settings	C-20
IE Zoom Mapping	C-20

Glossary**Index**

About This Guide

Introduction

This *Integrator Guide* provides information about setting up and configuring the MC55 and its accessories.



NOTE Screens and windows pictured in this guide are samples and can differ from actual screens.

For configurations with OEM version 03.38.000X and higher and Windows Mobile 6.5 operating system, refer to [Appendix C, Windows Mobile 6.5](#) for more information about new features.

Documentation Set

The documentation for the MC55 is divided into guides that provide information for specific user needs.

- **MC55 Quick Start Guide** - describes how to get the MC55 up and running.
- **MC55 User Guide** - describes how to use the MC55.
- **MC55 Integrator Guide** - describes how to set up the MC55 and its accessories.
- **Microsoft Applications for Windows Mobile 6 User Guide** - describes how to use Microsoft developed applications.
- **Application Guide for Zebra Devices** - describes how to use Zebra developed sample applications.
- **Enterprise Mobility Developer Kit (EMDK) Help File** - provides API information for writing applications.

Configurations

This guide covers the following configurations:

Configuration	Radios	Display	Memory	Data Capture	Operating System	Keypads
MC5574	WLAN: 802.11 b/g WPAN: Bluetooth 2.0 EDR WWAN: EGPRS/EDGE GPS: SiRF III	3.5" QVGA Color	128 MB RAM/ 256 MB Flash or 128 MB RAM/512 MB Flash	1D laser scanner, 2D imager, 1D laser scanner and camera or 2D imager and camera	Windows Mobile 6.X Professional	Numeric, QWERTY, QWERTZ, AZERTY or PIM
MC5590	WLAN: 802.11a/b/g WPAN: Bluetooth 2.0 EDR	3.5" QVGA Color	128 MB RAM/ 256 MB Flash or 128 MB RAM/512 MB Flash	1D laser scanner, 2D imager, 1D laser scanner and camera or 2D imager and camera	Windows Mobile 6.X Classic	Numeric, QWERTY, QWERTZ, AZERTY or PIM
MC55A0	WLAN: 802.11a/b/g WPAN: Bluetooth 2.0 EDR	3.5" VGA Color	256 MB RAM / 1 GB Flash	1D laser scanner, 2D imager, 1D laser scanner and camera or 2D imager and camera	Windows Mobile 6.5.X Classic	Numeric, QWERTY, QWERTZ, AZERTY or PIM
MC55A0-HC	WLAN: 802.11a/b/g WPAN: Bluetooth 2.0 EDR	3.5" VGA Color	256 MB RAM / 1 GB Flash	2D imager (SE4500-DL only) and camera	Windows Mobile 6.5.X Classic	Numeric QWERTY

Software Versions

This guide covers various software configurations and references are made to operating system or software versions for:

- Adaptation Kit Update (AKU) version
- OEM version
- Phone version
- BTExplorer version
- Fusion version.

AKU Version

To determine the Adaptation Kit Update (AKU) version:

Tap **Start > Settings > System tab > About icon > Version tab.**

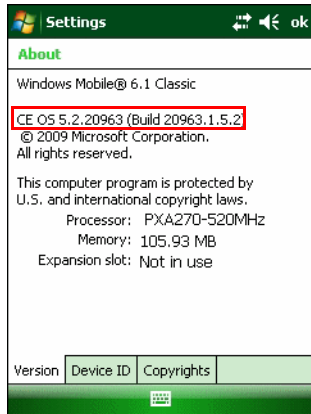

The second line lists the operating system version and the build number. The last part of the build number represents the AKU number. For example, *Build 20963.1.5.2* indicates that the device is running AKU version 1.5.2.

OEM Version

To determine the OEM software version:

Tap **Start > Settings > System tab > System Info icon > System tab.**

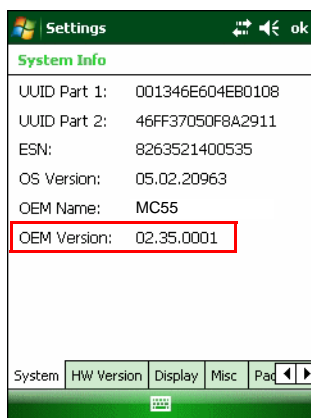

BTE Explorer Software

To determine the BTE Explorer software version:



NOTE For configurations with Windows Mobile 6.5 operating system, tap **Start > BTE Explorer > Menu > About** to view version information.

Tap **BTE Explorer icon > Show BTE Explorer > File > About.**

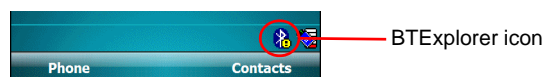



Fusion Software

To determine the Fusion software version:

Tap **Wireless Strength** icon > **Wireless Status** > **Versions**.

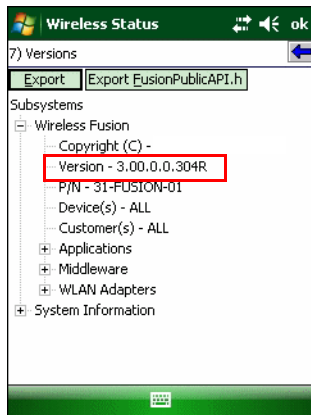

Phone Software

To determine the Phone software version:

Tap **Start** > **Phone** > **Menu** > **Options** > **Version Information** tab.

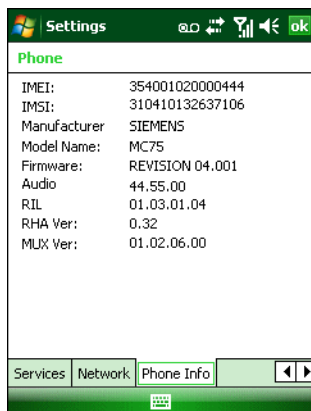

Chapter Descriptions

Topics covered in this guide are as follows:

- [Chapter 1, Getting Started](#) provides information on MC55 configurations and accessories, charging the battery, and resetting the device.
- [Chapter 2, Accessories](#) describes the accessories available for the MC55 and how to set up power connections and battery charging capabilities, where applicable.
- [Chapter 3, ActiveSync](#) provides instructions on installing ActiveSync and setting up a partnership between the MC55 and a host computer.
- [Chapter 4, Application Deployment](#) provides information for provisioning and deploying applications to the MC55.
- [Chapter 5, Wireless Applications](#) describes how to configure the wireless LAN connection.
- [Chapter 6, MC5574 - GSM Configuration](#) explains how to verify MC5574 service on an Enhanced Data rates for Global Evolution (EDGE) wireless network and establish settings.
- [Chapter 7, Maintenance & Troubleshooting](#) includes instructions on cleaning and storing the MC55, and provides troubleshooting solutions for potential problems during MC55 operation.
- [Appendix A, Technical Specifications](#) includes tables listing the technical specifications for the MC55 and its accessories.
- [Appendix B, Special Software Configurations](#) includes registry settings required for configuring the use of the Bluetooth stack.
- [Appendix C, Windows Mobile 6.5](#) explains the new features in Windows Mobile 6.5.X.

Notational Conventions

The following conventions are used in this document:

- “EDA” refers to Zebra MC55 family of hand-held computers.
- *Italics* are used to highlight the following:
 - chapters and sections in this and related documents
 - dialog box, window, and screen names
 - drop-down list and list box names
 - check box and radio button names
 - icons on a screen.
- **Bold** text is used to highlight the following:
 - key names on a keypad
 - button names on a screen.
- Bullets (•) indicate:
 - action items
 - lists of alternatives
 - lists of required steps that are not necessarily sequential.

- Sequential lists (e.g., those that describe step-by-step procedures) appear as numbered lists.

Related Documents

- *MC55 Quick Start Guide*, p/n 72-114971-xx.
- *MC55 Windows Mobile 6 Regulatory Guide*, p/n 72-108860-xx.
- *MC55 User Guide*, p/n 72E-108859-xx.
- *Mobility Services Platform 3.2 User Guide*, p/n 72E-100158-xx.
- *AirBEAM Smart Windows CE Client Product Reference Guide*, p/n 72-63060-01.
- *Wireless Fusion Zebra Suite User Guide for Version 2.61*, p/n 72E-113153-02.
- *Microsoft® Applications for Windows Mobile 6 User Guide*, p/n 72E-108299-xx.
- *Application Guide for Zebra Devices*, p/n 72E-68901-xx.
- *Zebra Developer Kits (ZDKs)*, available at: <http://www.zebra.com/support>.
- Latest ActiveSync software, available at: <http://www.microsoft.com>.

For the latest version of this guide and all guides, go to: <http://www.zebra.com/support>.

Service Information

If you have a problem with your equipment, contact Zebra support for your region. Contact information is available at: <http://www.zebra.com/support>

When contacting support, please have the following information available:

- Serial number of the unit (found on manufacturing label)
- Model number or product name (found on manufacturing label)
- Software type and version number.

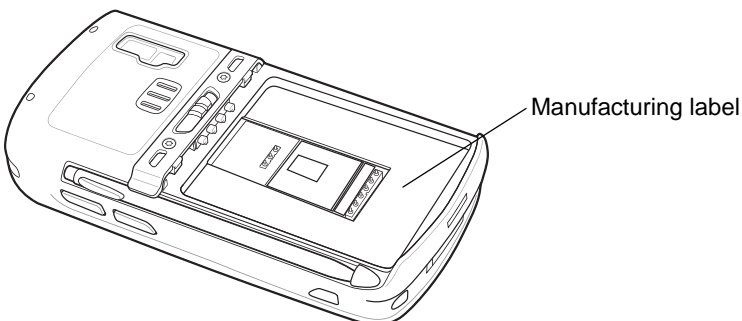

Zebra responds to calls by e-mail, telephone or fax within the time limits set forth in support agreements.

If your problem cannot be solved by Zebra Support, you may need to return your equipment for servicing and will be given specific directions. Zebra is not responsible for any damages incurred during shipment if the approved shipping container is not used. Shipping the units improperly can possibly void the warranty.

If you purchased your business product from a Zebra business partner, contact that business partner for support.

Chapter 1 Getting Started

Introduction

This chapter provides information about the MC55, accessories, charging, and resetting the MC55.

Unpacking the MC55

Carefully remove all protective material from the MC55 and save the shipping container for later storage and shipping. Verify that you received the following equipment:

- MC55
- Lithium-ion battery
- Tethered stylus
- Screen protector, installed on display window
- Regulatory Guide
- Quick Start Guide.

Inspect the equipment. If any equipment is missing or damaged, contact the Zebra support immediately. See [Service Information on page xvi](#) for contact information.

Prior to using the MC55 for the first time, remove the protective shipping film that covers the scan window, display and camera window.

Getting Started

To start using the MC55 for the first time:

- Install a microSD card (optional)
- Install the SIM card (MC5574 only)
- Install the main battery.

- Charge the MC55.
- Power on the MC55.

Installing a microSD Card

The microSD card slot provides secondary non-volatile storage. The slot is located under the battery pack. Refer to the documentation provided with the card for more information, and follow the manufacturer's recommendations for use.



CAUTION Follow proper ESD precautions to avoid damaging the SD card. Proper ESD precautions include, but are not limited to, working on an ESD mat and ensuring that the operator is properly grounded.

To install the microSD card:

1. Lift rubber access door.
2. Slide the SIM card holder door up to unlock.
3. Lift SIM card holder door.

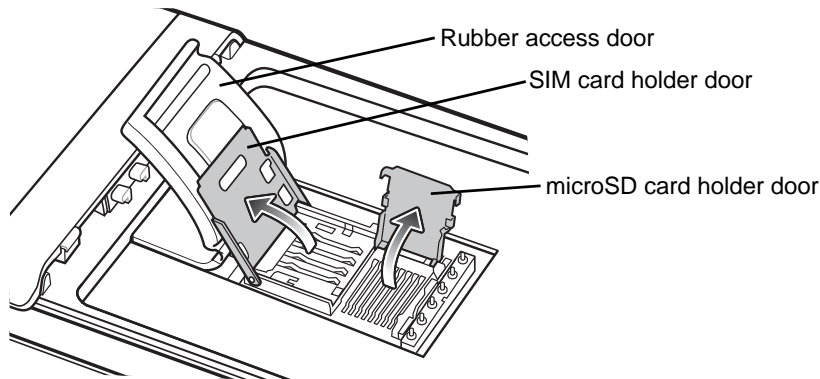

Figure 1-1 Lift SIM Slot Holder Door

4. Lift microSD card holder door.
5. Insert the microSD card into card holder door ensuring that the card slides into the holding tabs on each side of the door.

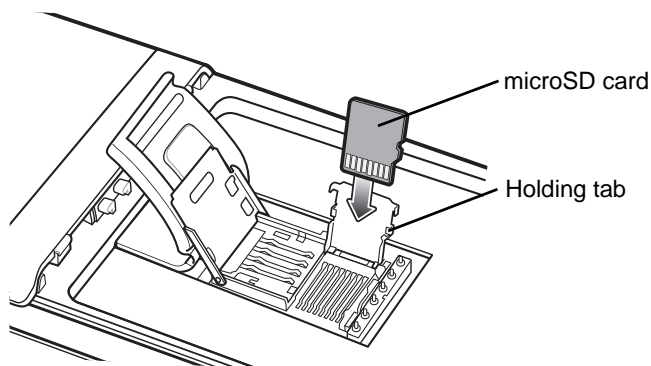

Figure 1-2 Insert microSD Card in Holder

6. Close the card holder door and push down until it is securely in place.

7. Close SIM card holder door and slide down to lock into place.
8. Close rubber access door.

Installing the SIM Card

✓ **NOTE** MC5574 configurations only.

GSM phone service requires a Subscriber Identification Module (SIM) card, or smart card. Obtain the card from the your service provider. The card can contain the following information:

- Mobile phone service provider account details.
- Information regarding service access and preferences.
- Contact information, which can be moved to Contacts on the MC55.
- Any additional services to which you have subscribed.

✓ **NOTE** For more information about SIM cards, refer to the service provider's documentation.

To install the SIM card:

1. Lift rubber access door.
2. Slide the SIM card holder up to unlock.
3. Lift the SIM card holder door.

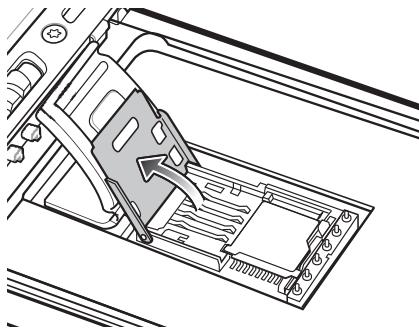

Figure 1-3 *Lifting the SIM Cover*

4. Insert the SIM card, as shown in [Figure 1-4](#) ensuring that the card slides into the holding tabs on each side of the door.

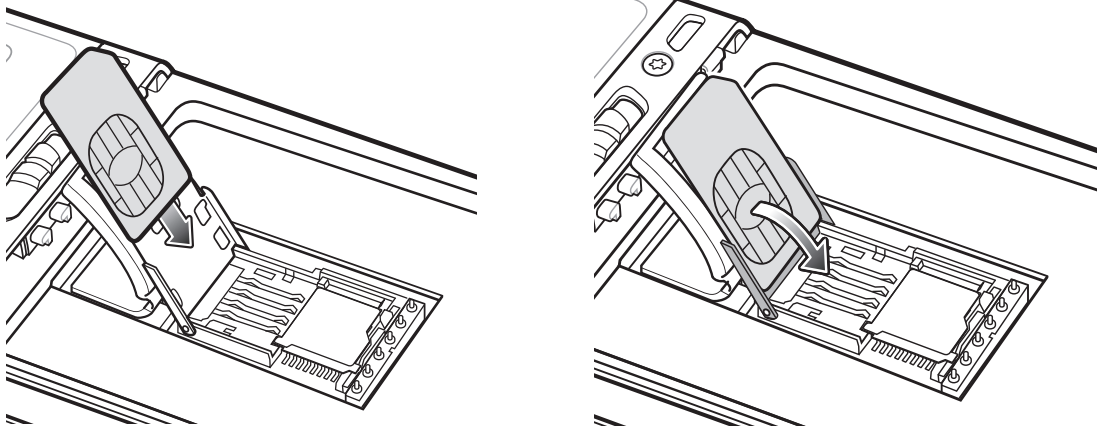

Figure 1-4 *Inserting the SIM Card*

5. Close SIM card holder door and slide down to lock into place.
6. Close the rubber access door.
7. Install the battery.

Installing the Battery



NOTE The MC55 ships with either a 2400 mAh or 3600 mAh battery. The 2400 mAh battery is shown in this installation procedure.

To install the battery.

1. Insert the battery, bottom first, into the battery compartment in the back of the MC55.
2. Press the battery down into the battery compartment until the battery release latch snaps into place.

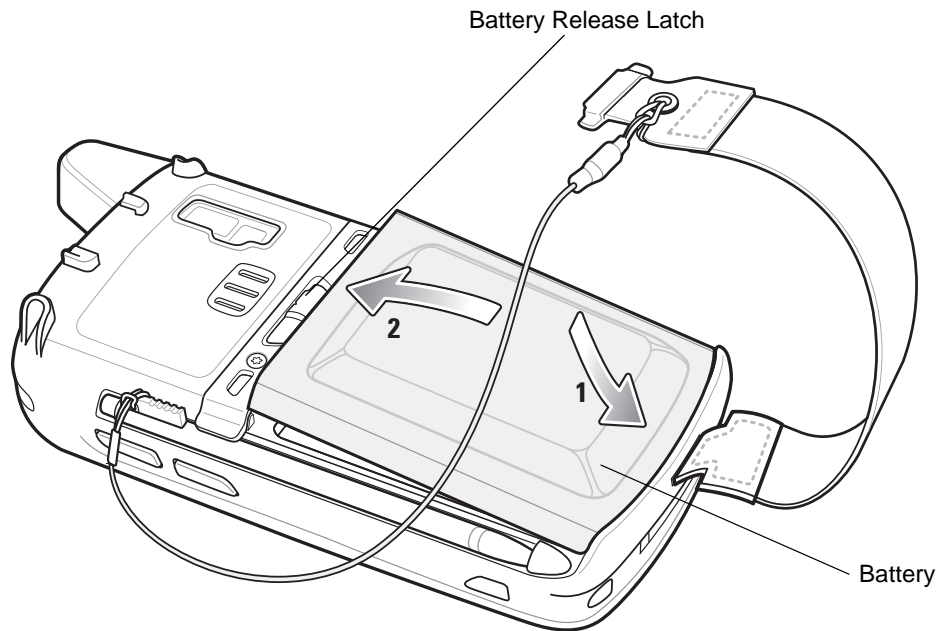

Figure 1-5 Inserting the Battery

The MC55 automatically powers up after inserting the battery if the battery has been previously charged.

Charging the Battery



CAUTION Ensure that you follow the guidelines for battery safety described in [Battery Safety Guidelines on page 7-2](#).

Charging the Main Battery

Before using the MC55 for the first time, charge the main battery until the amber Charging/Battery Status LED remains lit (see [Table 1-1 on page 1-6](#) for charge status indications). To charge the MC55, use a cable or a cradle with the appropriate power supply. For information about the accessories available for the MC55, see [Chapter 2, Accessories](#).



NOTE Only the MC55A0 contains a backup battery.

The MC55A0 is equipped with a memory backup battery which automatically charges from the fully-charged main battery. When using the MC55A0 for the first time, the backup battery requires approximately 40 hours to fully charge. This is also true any time the backup battery is discharged, which occurs when the main battery is removed for several hours. The backup battery retains RAM data in memory for at least 15 minutes (at room temperature) when the MC55A0's main battery is removed. When the MC55A0 reaches a very low battery state, the combination of main battery and backup battery retains RAM data in memory for at least 48 hours.

For cable and cradle setup and charging procedures see [Chapter 2, Accessories](#) for more information.

- USB Charging Cable
- Charge Only Cable
- Single Slot USB Cradle

- Four Slot Charge Only Cradle
- Four Slot Ethernet Cradle.

To charge the main battery:

1. Connect the charging accessory to the appropriate power source.
2. Insert the MC55 into a cradle or attach to a cable. The MC55 begins charging. The Charging/Battery Status LED blinks amber while charging, then turns solid amber when fully charged. See [Table 1-1](#) for charging indications.

The 2400 mAh battery fully charges in approximately four hours and the 3600 mAh battery fully charges in approximately six hours.

Table 1-1 LED Charge Indicators

Charging/Battery Status LED	Indication
Off	MC55 is not charging. MC55 is not inserted correctly in the cradle or connected to a power source. Charger/cradle is not powered.
Slow Blinking Amber (1 blink every 2 seconds)	MC55 is charging.
Solid Amber	Charging complete. Note: When the battery is initially inserted in the MC55, the amber LED flashes once if the battery power is low or the battery is not fully inserted.
Fast Blinking Amber (2 blinks/second)	Charging error, e.g.: <ul style="list-style-type: none"> • Temperature is too low or too high. • Charging has gone on too long without completion (typically eight hours).
Single Blink Amber (when Power button pressed)	Battery depleted.
Blinking Amber (when Power button pressed)	Battery over-temperature condition.

Charging Spare Batteries

See [Chapter 2, Accessories](#) for information on using accessories to charge spare batteries.

Charging Temperature

Charge batteries in temperatures from 0°C to 40°C (32°F to 104°F). Note that charging is intelligently controlled by the MC55.

To accomplish this, for small periods of time, the MC55 or accessory alternately enables and disables battery charging to keep the battery at acceptable temperatures. The MC55 or accessory indicates when charging is disabled due to abnormal temperatures via its LED. See [Table 1-1](#).

Powering On the MC55

After inserting the battery or when turning the MC55 on for the first time, the splash screen displays for about a minute as the MC55 boots, then the calibration window appears.

Calibrating the Screen

✓ **NOTE** The Calibration screen can be accessed by pressing **Blue** key - **Backspace** key.

To calibrate the screen so the cursor on the touch screen aligns with the tip of the stylus:

1. Remove the stylus from its holder on the side of the MC55.
2. Carefully press and briefly hold the tip of stylus on the center of each target that appears on the screen.
3. Repeat as the target moves around the screen, then tap the screen to continue.

Resetting the MC55

There are three reset functions, warm boot, cold boot and clean boot. A warm boot restarts the MC55 by closing all running programs. A cold boot also restarts the MC55, and also initializes some drivers. Data saved in flash memory or a memory card is not lost.

If the MC55 is not functioning properly, perform a warm boot first. If the MC55 still does not respond, perform a cold boot.

Performing a Warm Boot

Hold down the red **Power** button for approximately five seconds. As soon as the MC55 starts to boot release the **Power** button.

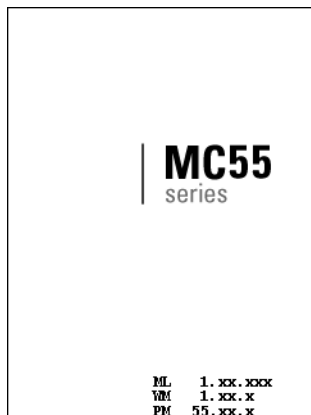







Figure 1-6 Splash Screen (Warm Boot)

Performing a Cold Boot

To perform a cold boot:

- On a numeric keypad, simultaneously press the red **Power** button and the  and  keys.
- On an alphanumeric keypad, simultaneously press the red **Power** button and the  and  keys.
- On an PIM keypad, simultaneously press the red **Power** button and the  and  keys.

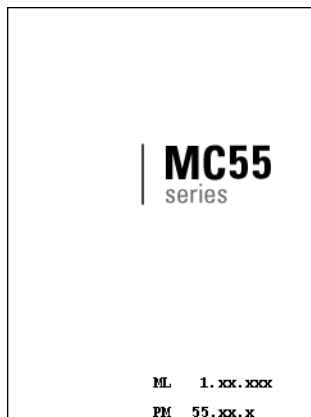

Figure 1-7 Splash Screen (Cold Boot)

Performing a Clean Boot



CAUTION A clean boot should only be performed by an authorized system administrator. You must connect the MC55 to AC power during a clean boot.

Removing AC power from the MC55 during a clean boot may render the MC55 inoperable.

A clean boot resets the MC55 to the factory default settings. All data in the Application folder is retained. You must download the Clean Boot Package file from the Support Central web site, <http://www.zebra.com/support> and install on the MC55.

To perform a clean boot:

1. Download the Clean Boot Package from the Support Central web site. Follow the instructions included in the package for installing the package onto the MC55.
2. Perform a cold boot.
3. Immediately, as soon as the device starts to boot and before the splash screen is visible, press and hold the left scan button.
4. Insert the MC55 into a powered cradle.
5. The MC55 updates and then re-boots.
6. Calibrate the screen.

Waking the MC55

The wake-up conditions define what actions wake up the mobile computer after it has gone into suspend mode. The mobile computer can go into suspend mode by either pressing the Power button or automatically by Control Panel time-out settings. These settings are configurable and the factory default settings are shown in [Table 1-2](#) are

subject to change/update. To access the Wakeup settings, tap **Start > Settings > System > Power icon > Wakeup** tab.

Table 1-2 Wake-up Default Settings

Condition for Wake-up	Power Button	Automatic Time-out
AC power is applied.	No	Yes
Mobile computer is inserted into a cradle.	No	Yes
Mobile computer is removed from a cradle.	No	Yes
Mobile computer is connected to a USB device.	No	Yes
Mobile computer is disconnected from a USB device.	No	Yes
A key is pressed.	No	Yes
The scan triggered is pressed.	No	Yes
The screen is touched.	No	No
Bluetooth communication	Yes	Yes
Incoming phone call	Yes	Yes

Chapter 2 Accessories

Introduction

This chapter provides set up information for the following MC55 accessories:

- Single Slot USB Cradle - Charges the MC55 main battery and a spare battery. Synchronizes the MC55 with a host computer through a USB connection.
- Single Slot Ethernet/Modem/USB Cradle - Charges the MC55 main battery and a spare battery. Synchronizes the MC55 with a host computer through an Ethernet, Modem or USB connection.
- Four Slot Charge Only Cradle - Charges up to four MC55 devices.
- Four Slot Ethernet Cradle - Charges up to four MC55 devices and connects the MC55 with an Ethernet network.
- Four Slot Battery Charger - Charges up to four spare batteries.
- Vehicle Cradle - Provides secure mounting of the MC55 in a vehicle. Charges the MC55.
- Cables
 - Auto Charge Cable - Plugs into a vehicle cigarette lighter to charge the MC55 while on the road.
 - Charge Only Cable - Provides power to the MC55.
 - USB Charging Cable - Provides power to the MC55 and USB communication with a host computer.
- Vehicle Holder - Provides mounting for the MC55 inside a vehicle using a mounted suction cup.
- Magnetic Stripe Reader - Snaps on to the MC55 and adds magnetic stripe reading capabilities.
- DEX Cable - Connects the MC55 to a vending machine.
- Trigger Handle - Adds a gun-style handle with scanning trigger to the MC55.

Single Slot USB Cradle

This section describes how to set up and use a Single Slot USB cradle with the MC55. For USB communication setup procedures see [Chapter 3, ActiveSync](#).

The Single Slot USB cradle:

- Provides 5.4 VDC power for operating the MC55.
- Synchronizes information between the MC55 and a host computer. See [Chapter 3, ActiveSync](#) for information on setting up a partnership between the MC55 and a host computer.
- Charges the MC55's battery.
- Charges a spare battery.

Setup

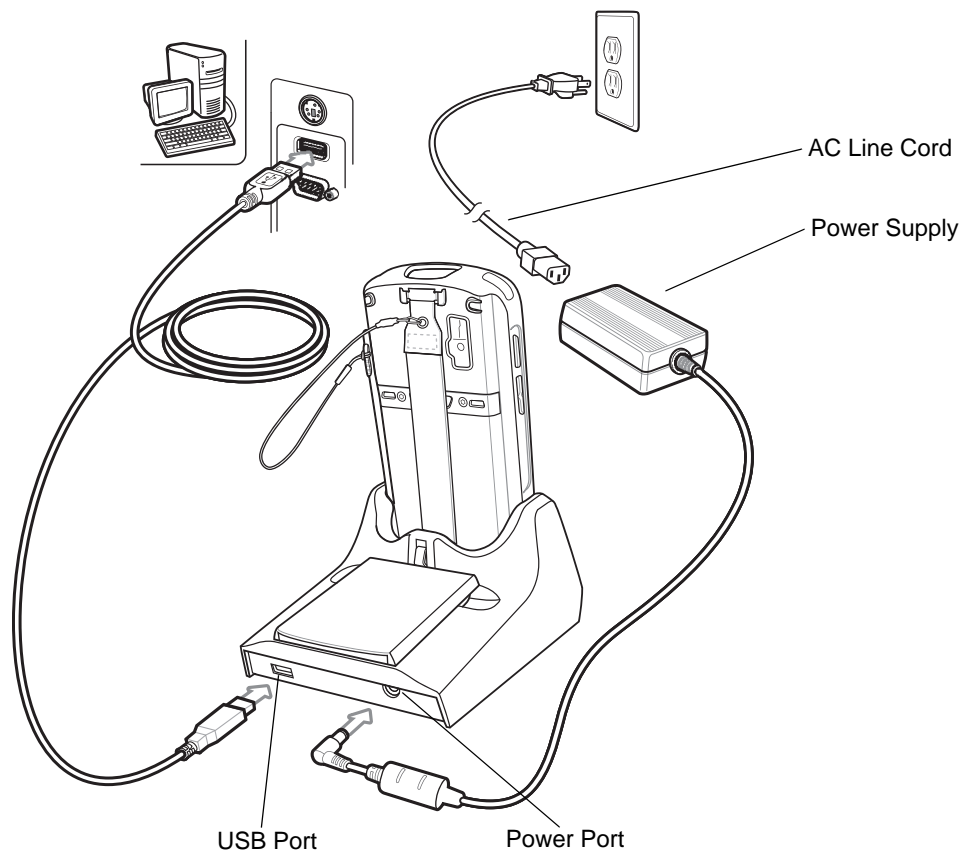

Figure 2-1 Single Slot USB Cradle Power and USB Connections

Charging the MC55 Battery

Connect the cradle to power. Insert the MC55 into the MC55 slot to begin charging.

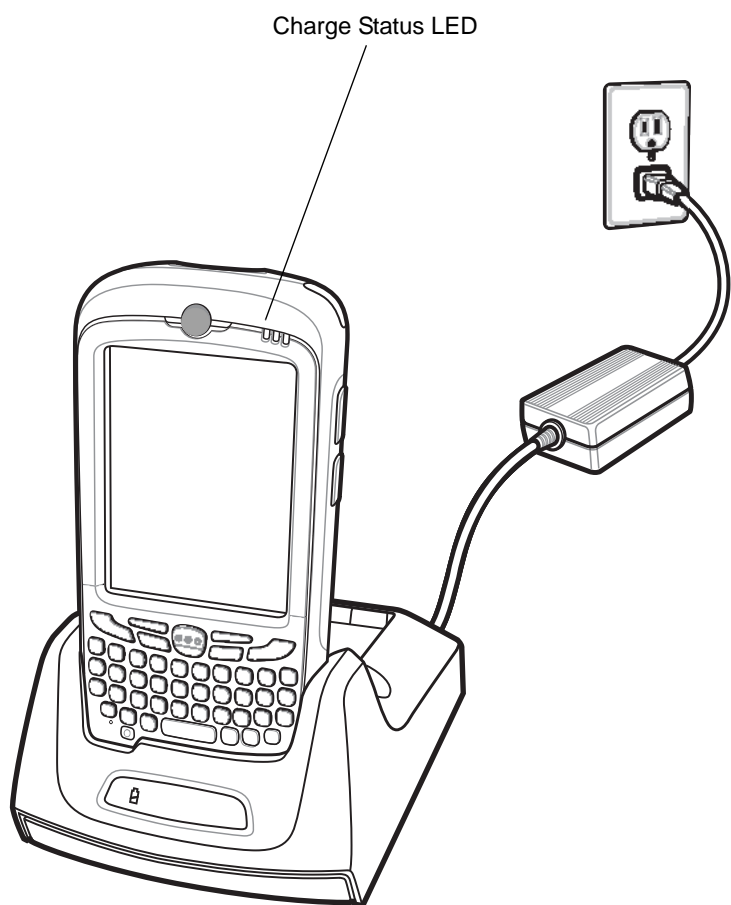

Figure 2-2 *MC55 Battery Charging*

Charging the Spare Battery

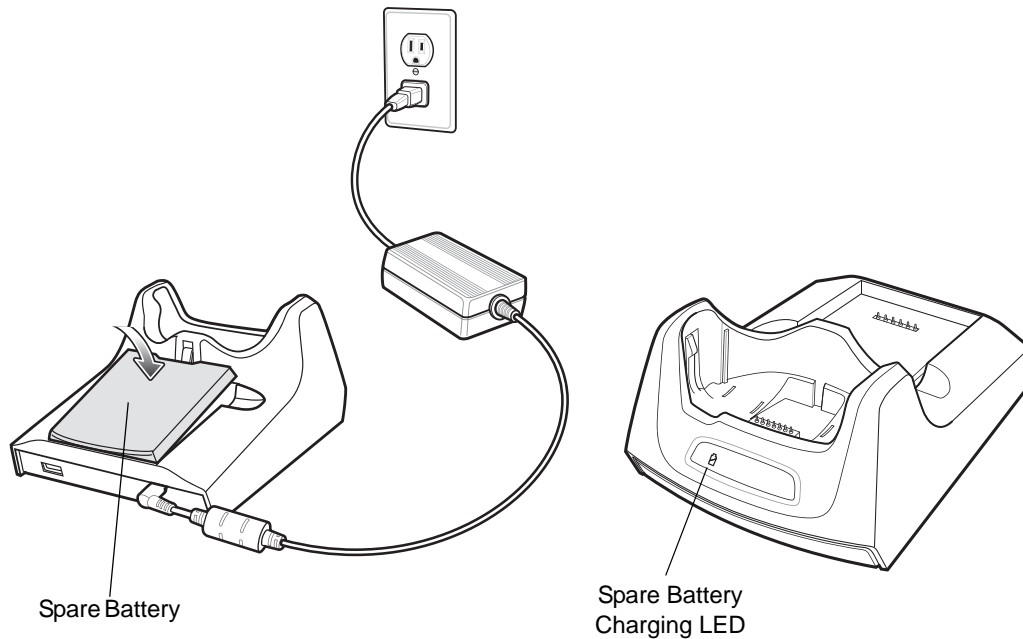

Figure 2-3 Spare Battery Charging

Battery Charging Indicators

The Single Slot USB cradle charges the MC55's main battery and a spare battery simultaneously.

The MC55's Charging/Battery Status LED indicates the status of the battery charging in the MC55. See [Table 1-1 on page 1-6](#) for charging status indications.

The spare battery charging LED on the cradle indicates the status of the spare battery charging in the cradle. See [Table 2-1](#) for charging status indications.

The 2400 mAh battery fully charges in approximately four hours and the 3600 mAh battery fully charges in approximately six hours.

Charging Temperature

Charge batteries in temperatures from 0°C to 40°C (32°F to 104°F). Charging is intelligently controlled by the MC55.

To accomplish this, for small periods of time, the MC55 or accessory alternately enables and disables battery charging to keep the battery at acceptable temperatures. The MC55 or accessory indicates when charging is disabled due to abnormal temperatures via its LED. See [Table 1-1 on page 1-6](#) and [Table 2-1](#).

Table 2-1 Spare Battery LED Charging Indicators

Spare Battery LED (on cradle)	Indication
Slow Blinking Amber	Spare battery is charging.

Table 2-1 Spare Battery LED Charging Indicators (Continued)

Spare Battery LED (on cradle)	Indication
Solid Amber	Spare battery is fully charged.
Fast Blinking Amber	Charging error.
Off	Not charging.

Single Slot Ethernet/Modem/USB Cradle

This section describes how to set up and use a Single Slot Ethernet/Modem/USB cradle with the MC55. For USB communication setup procedures see [Chapter 3, ActiveSync](#).

The Single Slot Ethernet/Modem/USB cradle:

- Provides 5.4 VDC power for operating the MC55.
- Connects the MC55 to a host computer using USB, a dial-up network using the modem or an Ethernet network.
- Charges the MC55's battery.
- Charges a spare battery.

Required Software

Download the *USB Modem Driver and Update Loader Image Keyboard Micro Firmware for MC55xx* package from the Zebra Support Central web site: <http://www.zebra.com/support>.

First ensure that the MC55 has Keyboard Firmware version 4.2 or higher. To determine the Keyboard Firmware version, tap **Start > Settings > System > System Info** icon > **HW Version** tab. If the **Kbd FW Ver:** is 4.1 or lower, install the Keyboard Firmware 4.2 upgrade.

Install the Micro USB Modem Driver software. Following the instructions with the software package to install the software.

Country Settings

The modem defaults to operation with US telephone networks. To operate the modem with other country telephone networks, it must be configured using an application on the MC55. Download the *Cradle Modem Country Configurator Application Software for MC55xx* package from the Zebra Support Central web site: <http://www.zebra.com/support>.

Following the instructions with the software package to install the application on the MC55. The application includes country selections for all supported countries and automatically programs the modem and adjust its operating parameters to comply with the telephone network in the selected country.

Setup

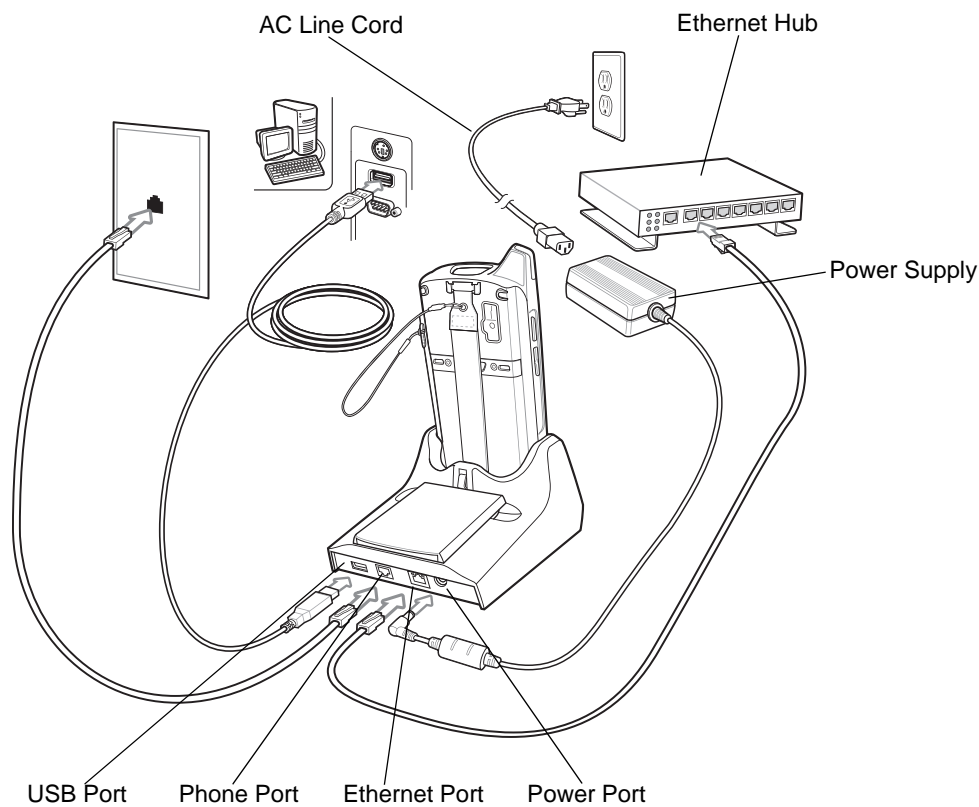

Figure 2-4 Cradle Setup

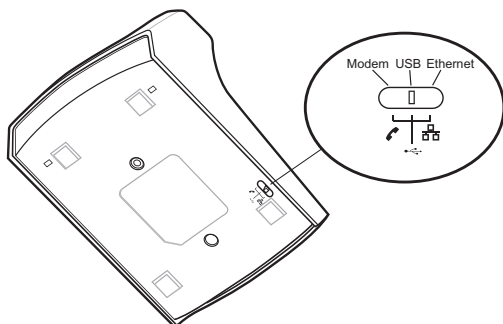

Figure 2-5 Connection Switch

Indicators

- **Spare Battery Charging LED** - Indicates the charging status of the spare battery.
- **Ethernet/Modem LED** - Blinks whenever Ethernet or modem connectivity is established.
- **Speed LED** - Lights green indicating that the transfer rate is 100 Mbps. When it is not lit, indicates that the transfer rate is 10Mbps.
- **Link LED** - Blinks yellow to indicate activity, or stays lit to indicate that a link is established. When it is not lit, indicates there is no link.

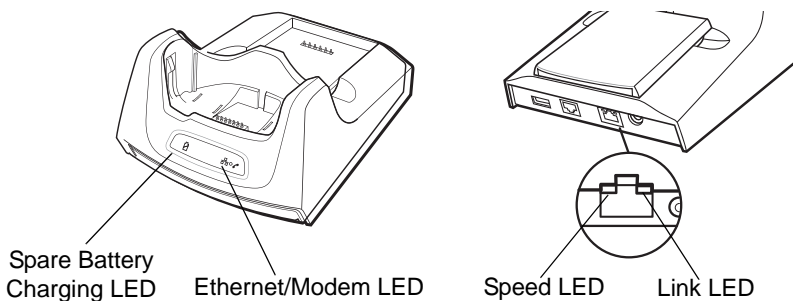

Figure 2-6 Cradle Indicators

MC55 Software Setup

Ethernet Setup

1. Tap **Start > Settings > Connections** tab > **Wi-Fi** icon.
2. Select **Work** from the drop-down menu.
3. Select **USB/Ethernet Series Adapter** from the list box.
4. Tap **Ok**.
5. Tap **Start > Settings > Connections** tab > **Connections** icon.
6. Tap **Advanced** tab.
7. Tap **Select Networks** button.
8. Select **My Work Network** from both drop-down menus.
9. Tap **Ok**.
10. Tap the **Tasks** tab.
11. Select **Edit my proxy server**.
12. Enable both checkboxes.
13. Tap **Advanced...** button.
14. Tap **HTTP** type.
15. In the **Server** text box, enter the proxy server name.
16. In the **Port** text box, enter the port number.
17. In the **User name** text box, enter the user name for the proxy server.
18. In the **Password** text box, enter the password for the proxy server.
19. Tap **ok** three times.
20. Perform a warm boot.

Modem Setup

1. Tap **Start > Settings > Connections** tab > **Connections** icon.

2. Tap **Add a new modem connection**.
3. In the **Enter a name for the connection** text box, enter a name for the connection.
4. In the **Select a modem** drop-down list, select Modem Cradle on USB.
5. Tap **Next**.
6. In the text box, enter the phone number to dial.
7. Tap **Next**.
8. In the **User name** text box, enter the user name, if required.
9. In the **Password** text box, enter the password, if required.
10. Tap **Finish**.
11. To test the connection, tap **Start > Programs > Internet Explorer**. Enter a web address.

Four Slot Ethernet Cradle

This section describes how to set up and use a Four Slot Ethernet cradle with the MC55.

The Four Slot Ethernet cradle:

- Provides 5.4 VDC power for operating the MC55.
- Connects the MC55 (up to four) to an Ethernet network.
- Simultaneously charges up to four MC55s.

You cannot ActiveSync using the Four Slot Ethernet cradle. To ActiveSync with a host computer, use the Single Slot USB/Serial cradle, USB Charging cable or Serial Charging cable.

Setup

Connect the Ethernet cradle to a power source and to an Ethernet switch, router, or hub, or a port on the host device.

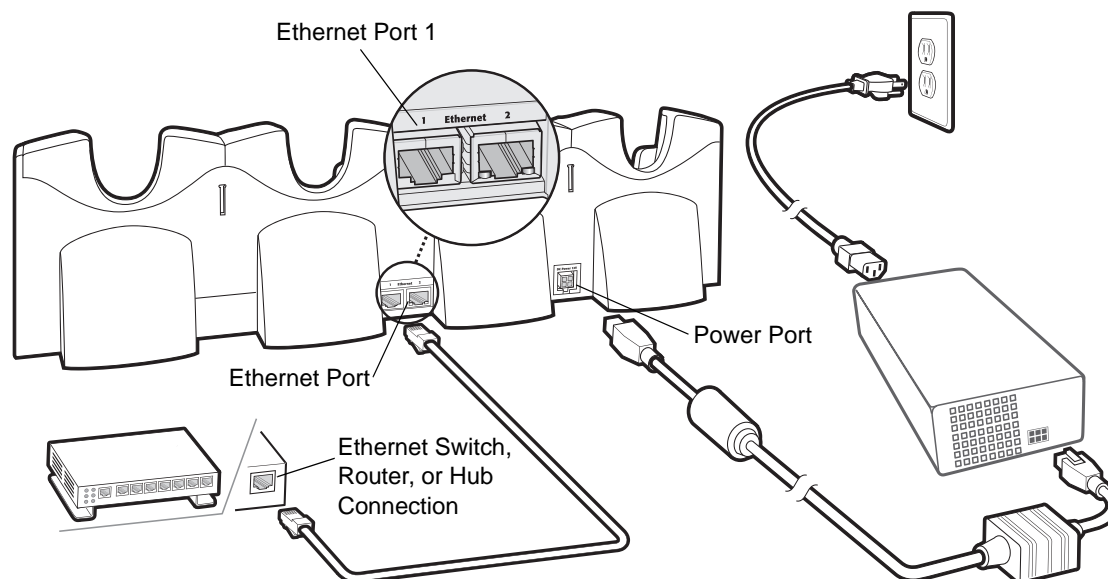

Figure 2-7 Four Slot Ethernet Cradle Connection

Daisy chaining Ethernet Cradles

Daisychain up to four Ethernet cradles to connect several cradles to an Ethernet network. Use either a straight or crossover cable. Daisy-chaining should not be attempted when the main Ethernet connection to the first cradle is 10 Mbps as throughput issues will almost certainly result.

To daisychain more than one Ethernet cradle:

1. Connect power to each Ethernet cradle to daisychain.
2. Connect an Ethernet cable to Port 1 of the first cradle as shown in [Figure 2-7](#).
3. Connect a second Ethernet cable between Port 2 of the first cradle, and Port 1 of the second cradle.
4. Connect additional cradles as described in Step 3.

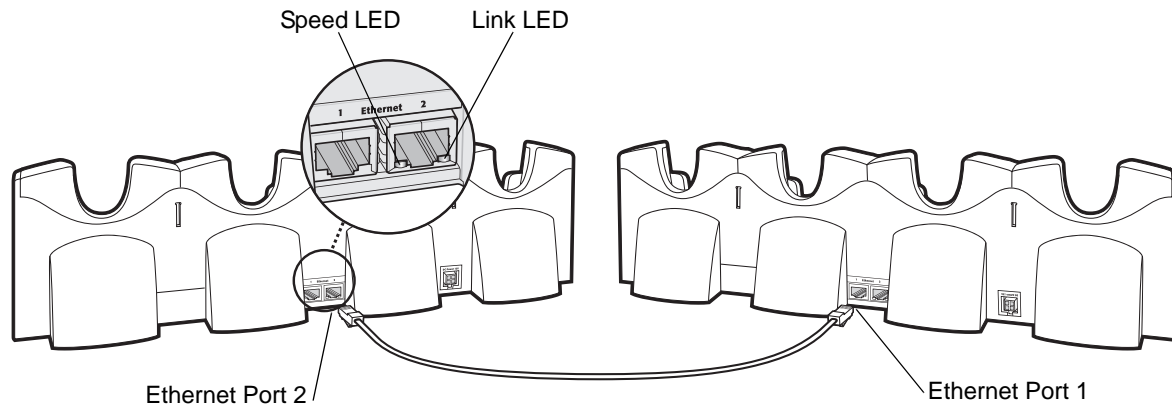

Figure 2-8 *Daisy-chaining Four Slot Ethernet Cradles*

Ethernet Cradle Drivers

The MC55 includes Ethernet cradle drivers that initiate automatically when you place the MC55 in a properly connected Four Slot Ethernet cradle. After inserting the MC55, configure the Ethernet connection:

1. Tap **Start > Settings > Connections** tab > **WiFi** icon. The **Configure Network Adapters** window appears.

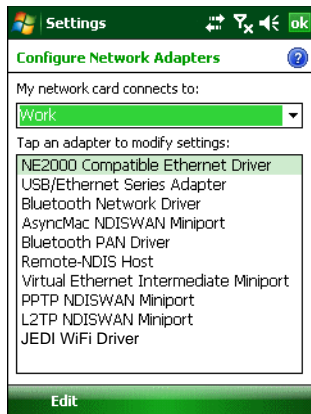

Figure 2-9 *Configure Network Adapters Window*

2. In the **My network card connects to:** drop-down list, select the appropriate connection.
3. In the **Tap an adapter to modify settings:** list, select **USB/Ethernet Series Adapter**.

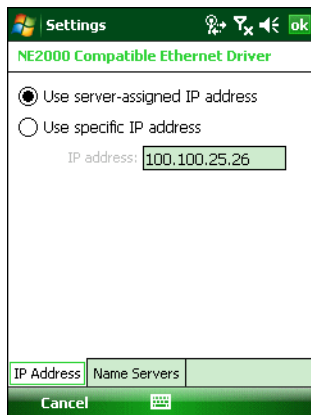

Figure 2-10 *IP Address Tab*

4. In the **IP address** window, select the appropriate radio button:
 - **Use server-assigned IP address**
 - OR
 - **Use specific IP address.** Enter the IP address, Subnet mask, and Default gateway, as needed.
5. Tap the **Name Servers** tab.

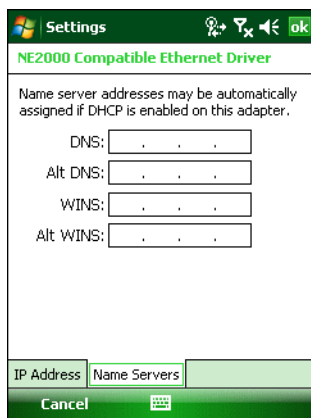

Figure 2-11 *Name Servers Tab*

6. Enter the appropriate DNS, Alt DNS, WINS, and Alt WINS server addresses.
7. Tap **ok**.

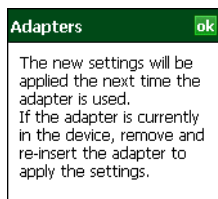

Figure 2-12 *Adapters Dialog Box*

8. Tap **ok** to confirm the setup.
9. Tap **ok** to exit.

Charging and Communication

Insert the MC55 into a slot to begin charging.

LED Charging Indicators

Charge LED

The MC55's charge LED shows the status of the battery charging in the MC55. See [Table 1-1 on page 1-6](#) for charging status indications.

The 2400 mAh battery fully charges in approximately four hours and the 3600 mAh battery fully charges in approximately six hours.

Speed LED

The cradle's green Speed LED lights to indicate that the transfer rate is 100 Mbps. When it is not lit it indicates that the transfer rate is 10Mbps.

Link LED

The cradle's yellow Link LED blinks to indicate activity, or stays lit to indicate that a link is established. When it is not lit it indicates there is no link.

Charging Temperature

Charge batteries in temperatures from 0°C to 40°C (32°F to 104°F). Charging is intelligently controlled by the MC55.

To accomplish this, for small periods of time, the MC55 alternately enables and disables battery charging to keep the battery at acceptable temperatures. The MC55 indicates when charging is disabled due to abnormal temperatures via its LED. See [Table 1-1 on page 1-6](#).

Four Slot Charge Only Cradle

This section describes how to set up and use a Four Slot Charge Only cradle with the MC55.

The Four Slot Charge Only cradle:

- Provides 5.4 VDC power for operating the MC55.
- Simultaneously charges up to four MC55s.

You cannot ActiveSync using the Four Slot Charge Only cradle. To ActiveSync with a host computer, use the Single Slot USB cradle.

Setup

Connect the Four Slot Charge Only cradle to a power source.

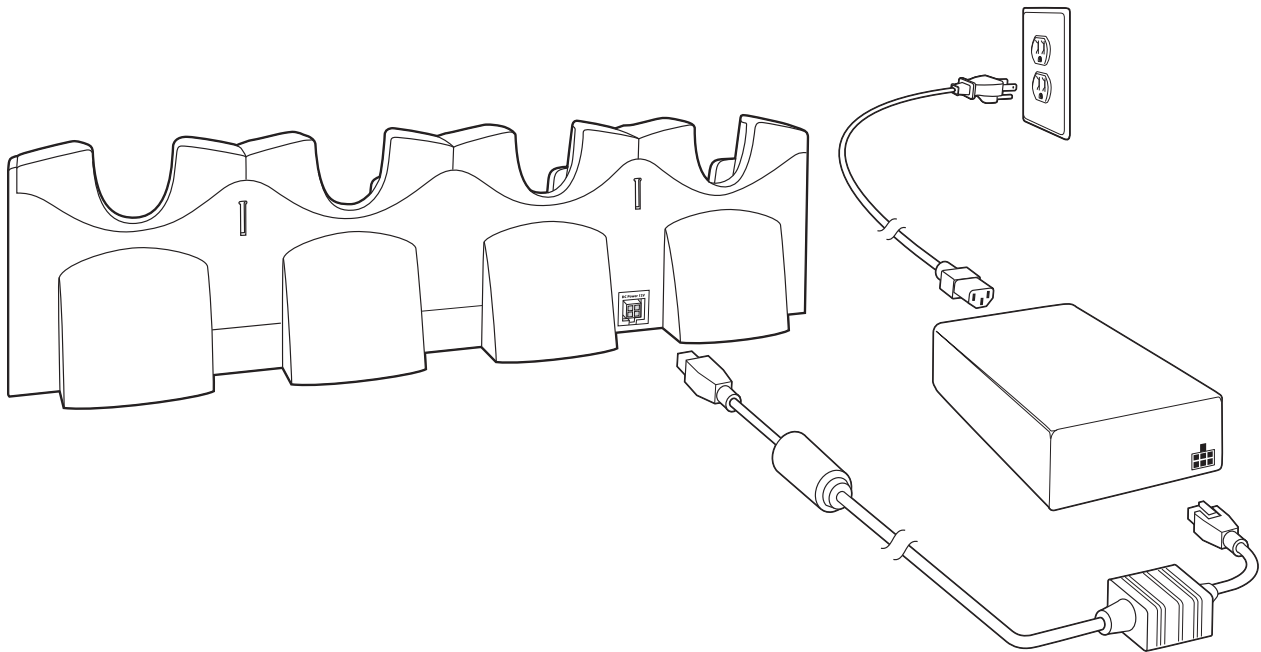

Figure 2-13 Four Slot Charge Only Cradle Connection

Charging Temperature

Charge batteries in temperatures from 0°C to 40°C (32°F to 104°F). Charging is intelligently controlled by the MC55.

To accomplish this, for small periods of time, the MC55 alternately enables and disables battery charging to keep the battery at acceptable temperatures. The MC55 indicates when charging is disabled due to abnormal temperatures via its LED. See [Table 1-1 on page 1-6](#).

Wall Mount Bracket

Use the optional Wall Mount Bracket to mount a four slot cradle to a wall. To attach the Wall Mount Bracket:

1. Use the Wall Mount Bracket as a template and mark the locations of the four mounting screws.

✓ **NOTE** Use fasteners appropriate for the type of wall and the Wall Mount Bracket mounting slots. The Wall Mount Bracket mounting slots are designed for a fastener with a #8 pan head. Fasteners must be able to hold a minimum of 4.9 Kg (10.8 lbs).

2. Mount the fasteners to the wall. The screw heads should protrude about a half of an inch from the wall.
3. Slip the Wall Mount Bracket over the screw heads and slide the bracket down over the screw heads.
4. Tighten the screws to secure the bracket to the wall.

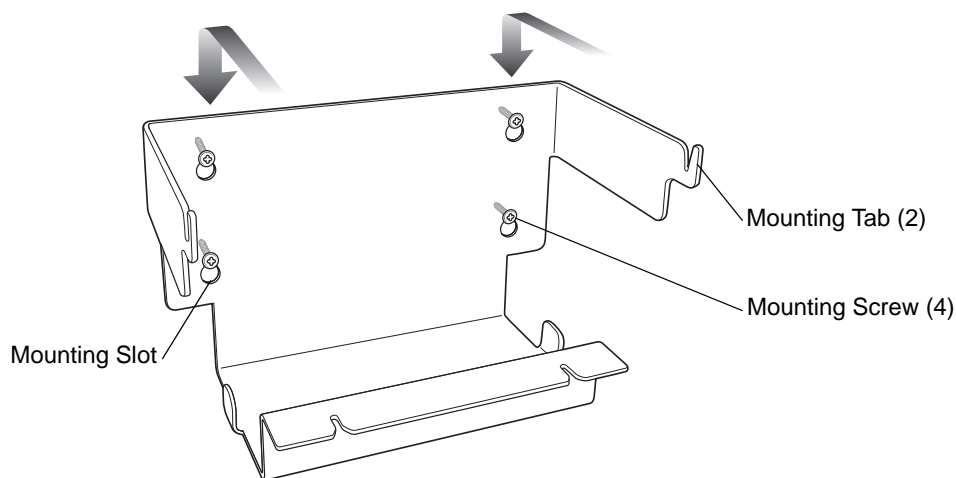

Figure 2-14 Wall Mount Bracket

To mount a four slot cradle:

1. Screw the supplied screws into the bottom of the four slot cradle. The screw heads should protrude about a quarter of an inch from the cradle.

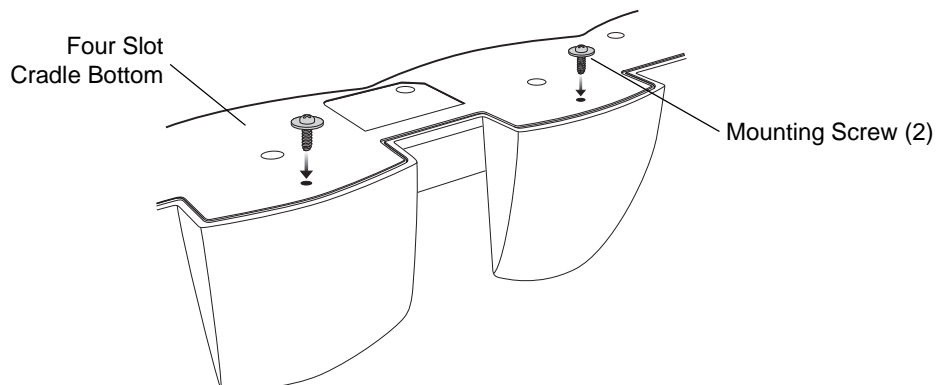

Figure 2-15 Cradle Mounting Screws

2. Align the Wall Mount Bracket mounting tabs with the mounting slots in the back of the four slot cradle. Slip the two mounting tabs into mounting slots.

3. Swing the four slot cradle down onto the mounting bracket and align the mounting screws so that they fit into the screw slots.

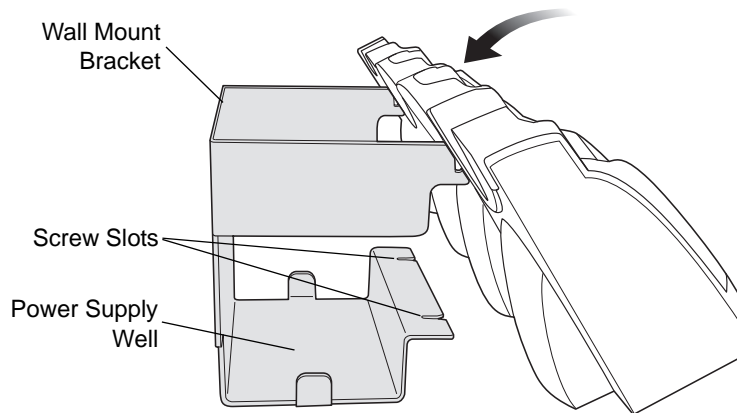

Figure 2-16 Wall Mount Bracket

4. Tighten the mounting screws to secure the four slot cradle to the bracket.

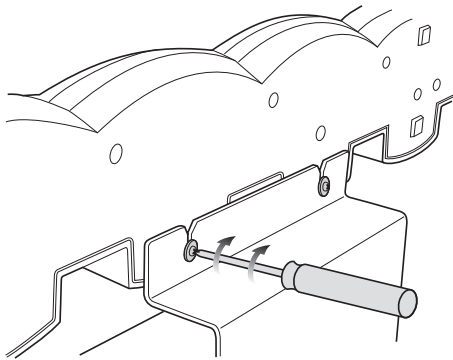

Figure 2-17 Mounting Screws

5. Connect power (see [Figure 2-13 on page 2-14](#)). The power supply should be located in the power supply well.

VCD5500 Vehicle Cradle

This section describes how to set up and use a VCD5500 vehicle cradle with the MC55.

Once installed in a vehicle, the cradle:

- holds the MC55 securely in place
- provides power for operating the MC55
- re-charges the battery in the MC55.

Requirements

For mounting:

- four #8-32 self-locking nuts
- four #8 washers
- a drill with a #6 drill bit (.204").

For power connection:

- power input cable (included), p/n 25-61987-01R
- UL Listed in-line fuse rated 250V, 5A (included), must be used if not connecting to vehicle's fuse panel
- in-line fuse holder (included), must be used if not connecting to vehicle's fuse panel.

Connector Pin-Outs

Table 2-2 Power Input Cable

Pin	Signal
1	Chassis ground (Black Wire)
2	Chassis ground (Bare Wire)
3	V+ (Red Wire)
4	V+ (Red Wire)

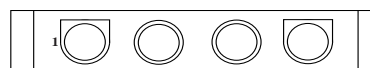

Connector on Power Cable



CAUTION ROAD SAFETY - Do not use the MC55 while driving. Park the vehicle first. Always ensure the MC55 is fully inserted into the cradle. Do not place it on the seat or where it can break loose in a collision or sudden stop. Lack of proper insertion may result in property damage or personal injury. Zebra is not responsible for any loss resulting from the use of the products while driving. Remember: Safety comes first.

Mounting the Cradle



CAUTION Only mount the Vehicle Cradle in a vertical position with the release level at the top or in a horizontal position with the MC55 display facing up. Never mount the vehicle cradle on the side or upside down or on a wall that can be subject to impact or collision of greater than 40Gs, in accordance with SAE J1455 Section 4.10.3.5

1. Select a mounting location for the cradle. It should be flat, and must provide adequate support for the cradle.

✓ **NOTE** If using the GPS functionality of the MC55 mobile computer, ensure that the vehicle cradle is positioned so that the MC55 has a clear unobstructed view of the sky.

2. Prepare the mounting surface to accept four #8-32 studs, using the mounting template below. Drill four holes with a #6 drill bit.

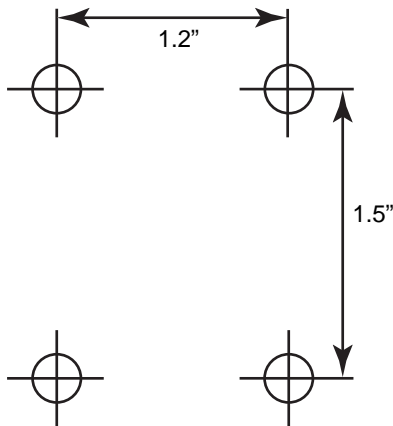

Figure 2-18 Vehicle Cradle Mounting Template

3. Position the cradle on the mounting surface.
4. Fasten it using four #8 washers and four #8-32 self-locking nuts.



CAUTION Do not install a VCD5500 Vehicle Cradle on or near an air bag cover plate or within an aerobic zone. Also, do not install it in a location that affects vehicle safety or driveability.

Power Connection

Please read all of the following instructions before beginning.



WARNING! A properly trained technician must perform the power connection. Improper connection can damage your vehicle, cradle or MC55. Refer to the vehicle's Owner's Manual for instructions for removing power.

To connect the cradle to power:



CAUTION When setting up connection for this cradle, only use the power input cable provided with this cradle.

1. Locate the vehicle power source.



NOTE The ideal location for connecting the vehicle cradle power input cable would be an accessory output in your vehicle's fuse panel. The vehicle cradle should be added to a circuit with a maximum load capacity for the cradle and the original circuit. Refer to the vehicle's *Owner's Manual* for identification of the circuit. If a fused output is not available, the vehicle cradle must be installed with the provided in-line fuse holder and UL Listed 5A fuse. The fuse protects the vehicle from an electrical short on the power line to the cradle. To use the cradle to charge the MC55 and spare battery, when the vehicle's ignition is off, connect the cradle to unswitched power.

2. Route the power input cable from the cradle's power port to the connection point for the vehicle's power source.



CAUTION The means of routing and securing the power input cable from the cradle through to the vehicle power source is extremely important. Hazards associated with improper wiring can be severe. To avoid unintentional contact between the wire and any sharp edges, provide the cable with proper bushings and clamping where it passes through openings. If the wire is subjected to sharp surfaces and excess engine vibration, the wiring harness insulation can wear away, causing a short between the bare wire and chassis. This can start a fire. To avoid any mishaps, all wiring should be routed away from moving parts, high temperature areas and any contaminants.

3. When using the supplied in-line fuse holder (which must be used if not connecting to vehicle's fuse panel):
 - a. Ensure the fuse holder contains a 5A UL Listed slow-blow fuse.
 - b. Splice the fuse holder to the end of the red V+ wire, as shown above. Make the distance from the fuse to the power connection point as short as possible.

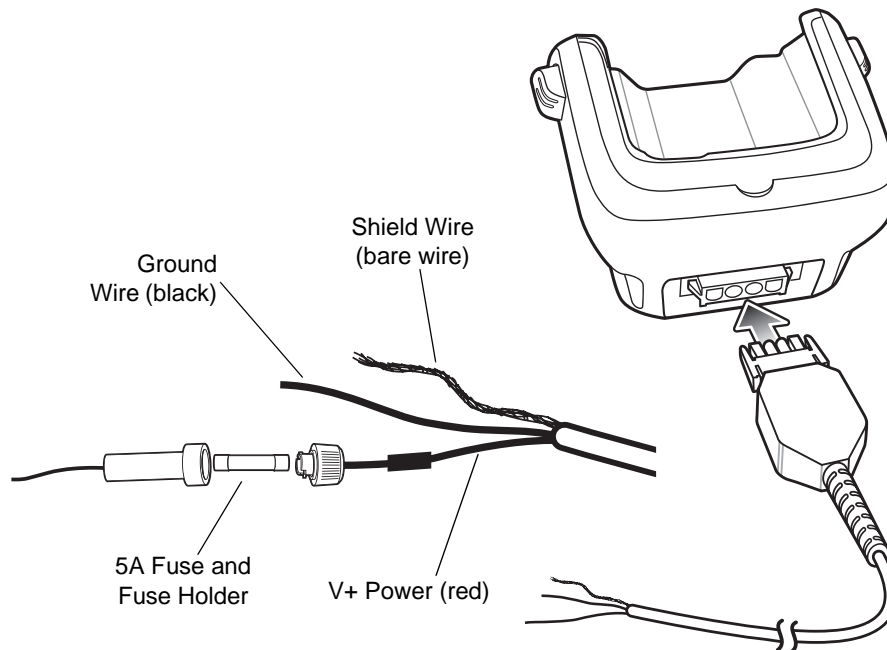

Figure 2-19 Vehicle Cradle Power Connection

4. Prepare the cable termination.
 - a. Red wire: connect to a +12/24 V vehicle power source.
 - b. Black wire and Shield wire: connect to vehicle ground wire or chassis ground.



NOTE How the cable terminates depends on the vehicle. If the vehicle has a power output connector, then you must attach a mating connector to the end of the power cable. You may be able to connect to a fuse panel with a simple blade terminal or commercially available connector. Consult the vehicle *Owner's Manual* for information on how to access the power supply in the vehicle.

5. Connect the power input cable into the power port on the cradle.

To see if the cradle has power, insert the MC55. The Charging LED on the MC55 blinks slowly to indicate charging and turns solid amber when the battery is completely charged. See [Table 1-1 on page 1-6](#) for other indications.

Charging the MC55 Battery

Insert the MC55 into the vehicle cradle to begin charging. A click indicates that the MC55 button release locking mechanism is enabled and the MC55 is locked in place.

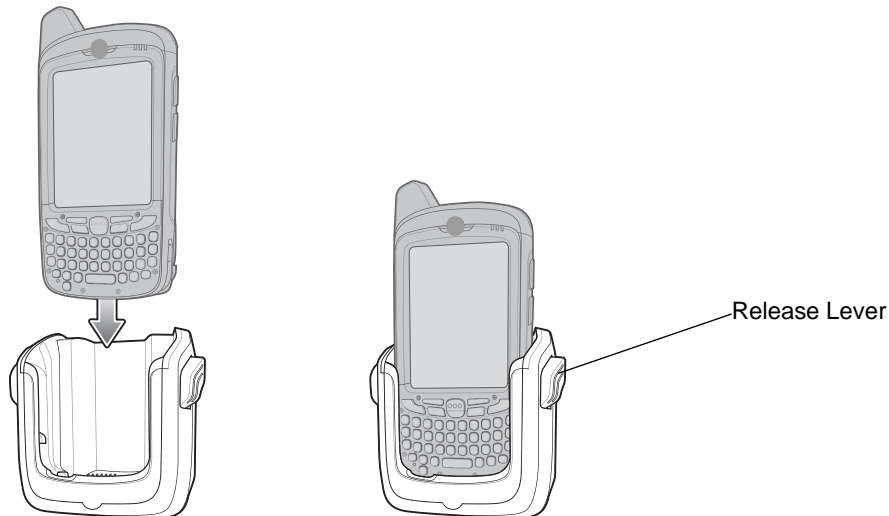



Figure 2-20 MC55 Battery Charging

 **CAUTION** Ensure the MC55 is fully inserted in the cradle. Lack of proper insertion may result in property damage or personal injury. Zebra is not responsible for any loss resulting from the use of the products while driving.

Removing the MC55

To remove the MC55, press the release levers on the cradle and pull the MC55 up and out of the cradle.

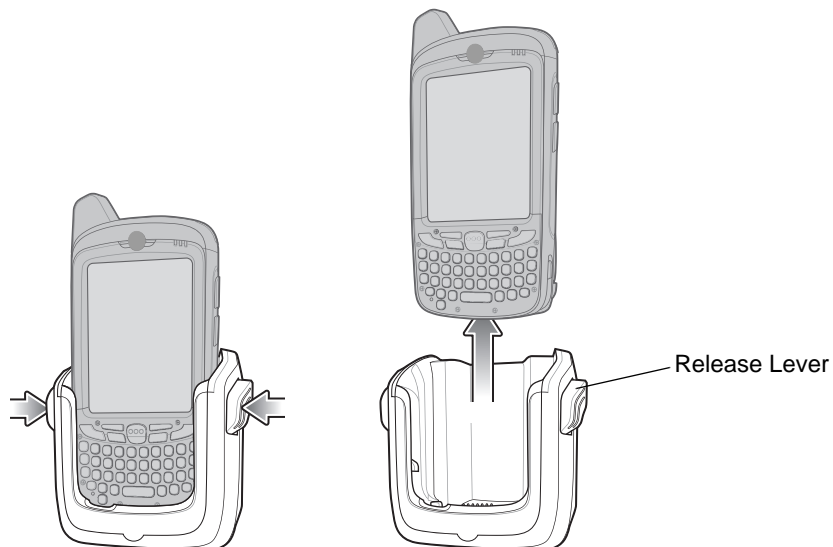

Figure 2-21 Removing the MC55

Battery Charging Indicators

The MC55's charge LED indicates the status of the battery charging in the MC55. See [Table 1-1 on page 1-6](#) for charging status indications.

The 2400 mAh battery fully charges in approximately four hours and the 3600 mAh battery charges in approximately six hours.

Charging Temperature

Charge batteries in temperatures from 0°C to 40°C (32°F to 104°F). Charging is intelligently controlled by the MC55.

To accomplish this, for small periods of time, the MC55 alternately enables and disables battery charging to keep the battery at acceptable temperatures. The MC55 indicates when charging is disabled due to abnormal temperatures via its LED. See [Table 1-1 on page 1-6](#).

Four Slot Battery Charger

This section describes how to use the Four Slot Battery Charger to charge up to four MC55 spare batteries.

Spare Battery Charging

1. Connect the charger to a power source.
2. Insert the spare battery into a spare battery charging well and gently press down on the battery to ensure proper contact.

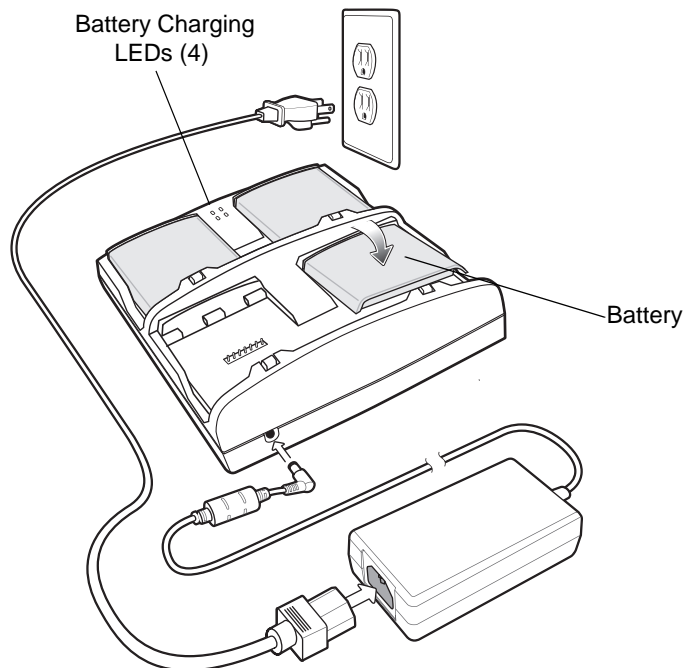

Figure 2-22 Four Slot Spare Battery Charger

Battery Charging Indicators

An amber LED is provided for each battery charging well. See [Table 2-3](#) for charging status indications. The 2400 mAh battery fully charges in approximately four hours and the 3600 mAh battery charges in approximately six hours.

Charging Temperature

Charge batteries in temperatures from 0°C to 40°C (32°F to 104°F). Charging is intelligently controlled by the charger in order to ensure safe operation and optimize long-term battery life.

To accomplish this, for small periods of time, the charger alternately enables and disables battery charging to keep the battery at acceptable temperatures. The charger indicates when charging is disabled due to abnormal temperatures via its LED. See [Table 2-3](#).

Table 2-3 Spare Battery LED Charging Indicators

LED	Indication
Off	No spare battery in slot; spare battery not placed correctly; cradle is not powered.
Fast Blinking Amber	Error in charging; check placement of spare battery.
Slow Blinking Amber	Spare battery is charging.
Solid Amber	Charging complete.

Cables

This section describes how to set up and use the cables. The cables are available with a variety of connection capabilities.

The following communication/charge cables are available:

- USB Charging cable
- Charge Only cable
- Auto Charge cable.

USB Charging Cable

The USB Charging cable provides the MC55 with operating and charging power when used with the Zebra approved power supply and AC line cord and synchronize information between the MC55 and a host computer.

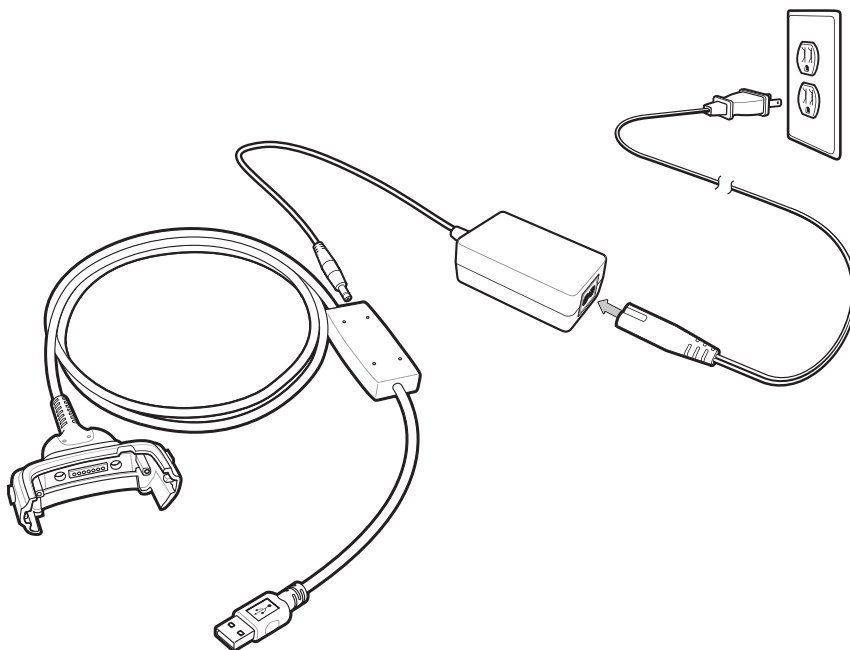
**Figure 2-23** USB Charging Cable

Charge Only Cable

The Charge Only cable provide the MC55 with operating and charging power when used with the Zebra approved power supply.

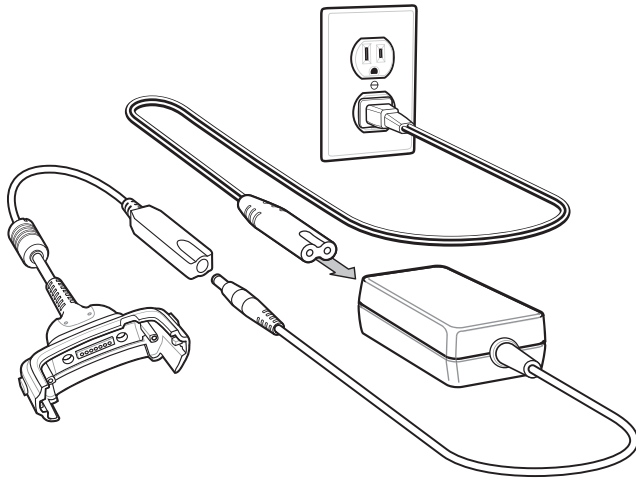

Figure 2-24 Charge Only Cable

Auto Charge Cable

The Auto Charge cable plugs into a vehicle cigarette lighter and provide the MC55 with operating and charging power.

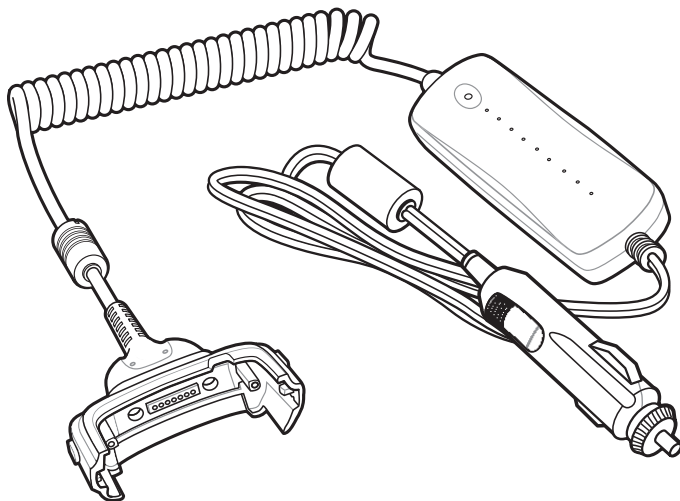

Figure 2-25 Auto Charge Cable

Connecting to the MC55

1. If required, connect the cable power input connector to the Zebra approved power source.
2. Slide the bottom of the MC55 into the connector cup of the cable until the MC55 is firmly seated in the cup.
3. Slide the two locking tabs up until they both lock into position.

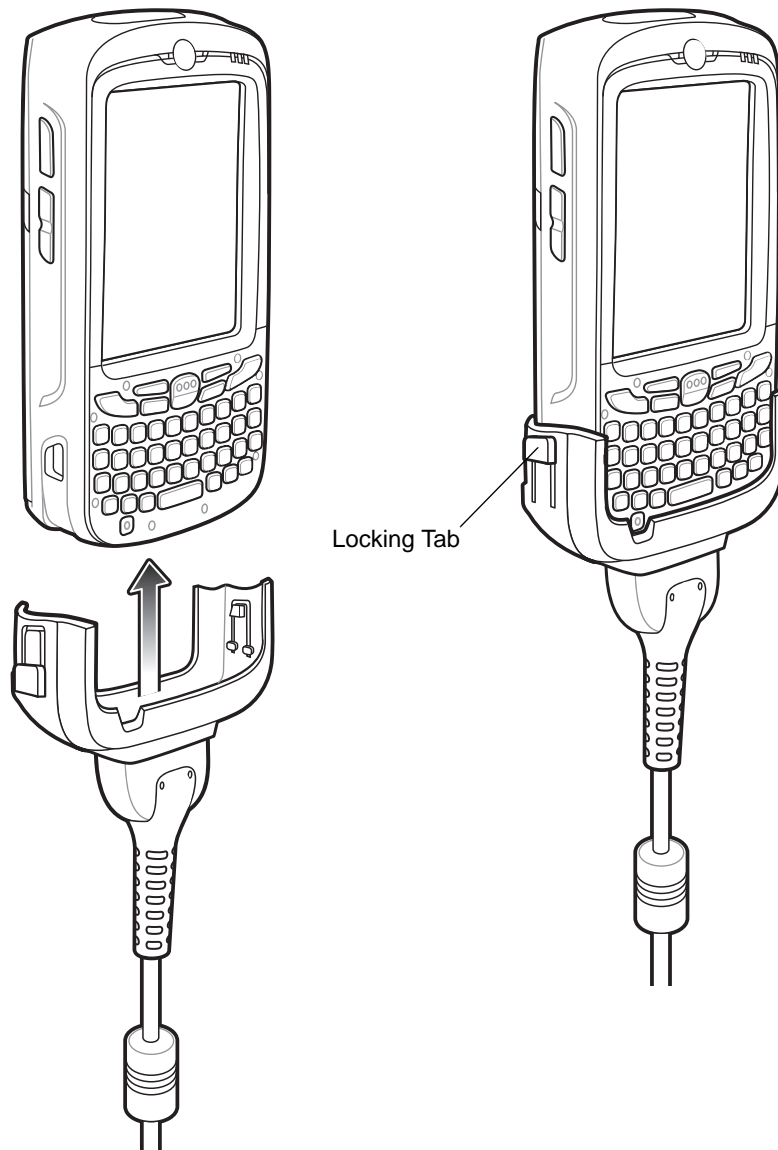

Figure 2-26 Cable Cup Locking Tabs

4. To remove, slide the two locking tab down and remove the cable from the MC55.

Battery Charging Indicators

The MC55 amber Charge LED indicates the MC55 battery charging status. The 2400 mAh battery charges in less than four hours and the 3600 mAh battery charges in less than six hours. See [Table 1-1 on page 1-6](#) for charging status indications.

Charging Temperature

Charge batteries in temperatures from 0°C to 40°C (32°F to 104°F). Charging is intelligently controlled by the MC55.

To accomplish this, for small periods of time, the MC55 alternately enables and disables battery charging to keep the battery at acceptable temperatures. The MC55 indicates when charging is disabled due to abnormal temperatures via its LED. See [Table 1-1 on page 1-6](#).

Vehicle Holder



WARNING! Some countries prohibit the mounting of any electronic device in any location on the vehicle dashboard. Be sure to check your local laws acceptable mounting areas before installing the auto mounting kit.

Installation Reminders

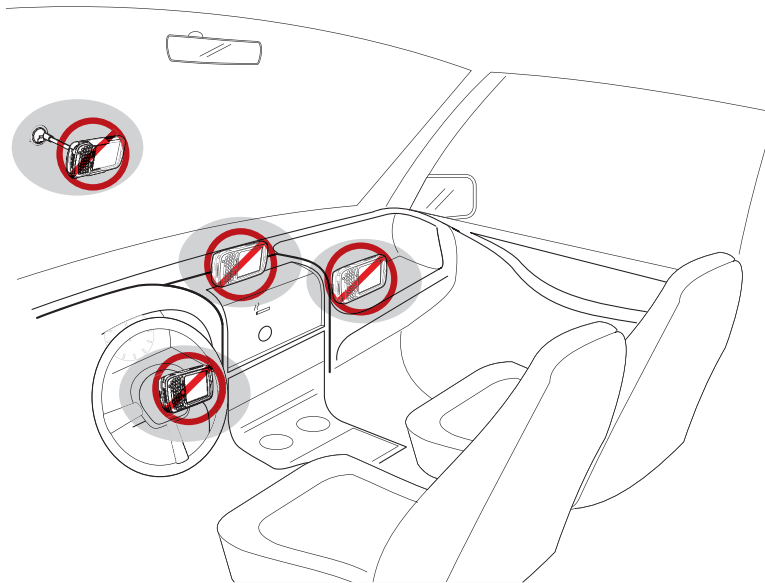

Figure 2-27 Vehicle Holder Mounting

- Do not mount the vehicle holder where it will obscure the driver's view of the road.
- Do not mount the vehicle holder near the driver seat air bag deployment area.
- Do not place the MC55 on top of the dashboard or anywhere without securing it in the vehicle holder.
- Do not mount the vehicle holder near the passenger seat air bag deployment area.
- Install the vehicle holder on the surface of your vehicle that is reasonably flat and free of dirt and oil.

Device Mounting Precautions

- Some countries prohibit the mounting of any electronic device in any location on the vehicle dashboard. Be sure to check your local laws acceptable mounting areas before installing the vehicle holder.
- The heating and cooling cycle of a vehicle's interior will in some cases loosen the adhesion of the suction cup. Check the vacuum seal of the vehicle mount kit for adequate adhesion each time you use the unit, and reinstall if necessary.
- If the vehicle holder has problems staying on, clean the plastic suction cup with alcohol, then reinstall.

Installation

Install the vehicle mount on the surface of your vehicle that is reasonably flat and free of dirt and oil. Clean the mounting surface with a glass cleaner and a clean cotton cloth. Install the vehicle mount on the windshield or other flat car surface using the supplied mounting disc.

Assembly

1. Insert the vehicle holder's cradle plate to the holes on the back of the cradle.
2. Push the cradle down until both parts are engaged.

Windshield Installation

1. Fix the suction cup mount to the selected area with the suction lever facing up.

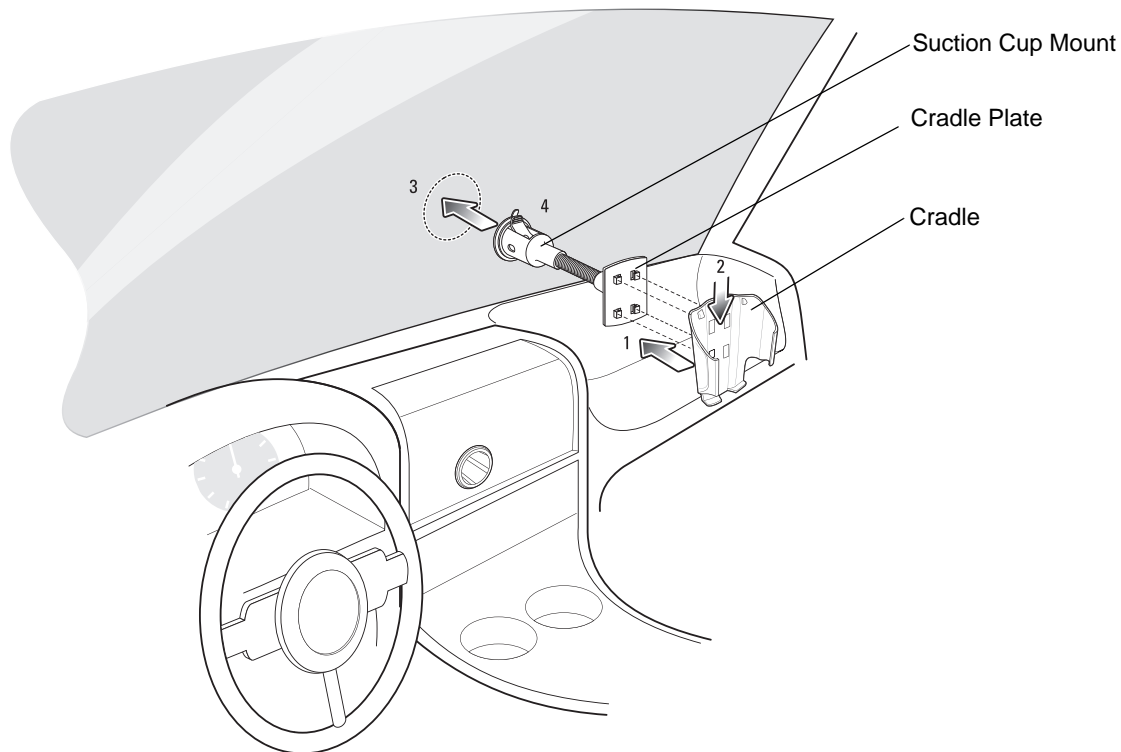

Figure 2-28 *Windshield Installation*

2. Flip the lever down to create a vacuum between the suction cup and the mounting surface.
3. Make sure that the suction bond is strong enough before proceeding to the next step.
4. Slide the MC55 into the cradle.

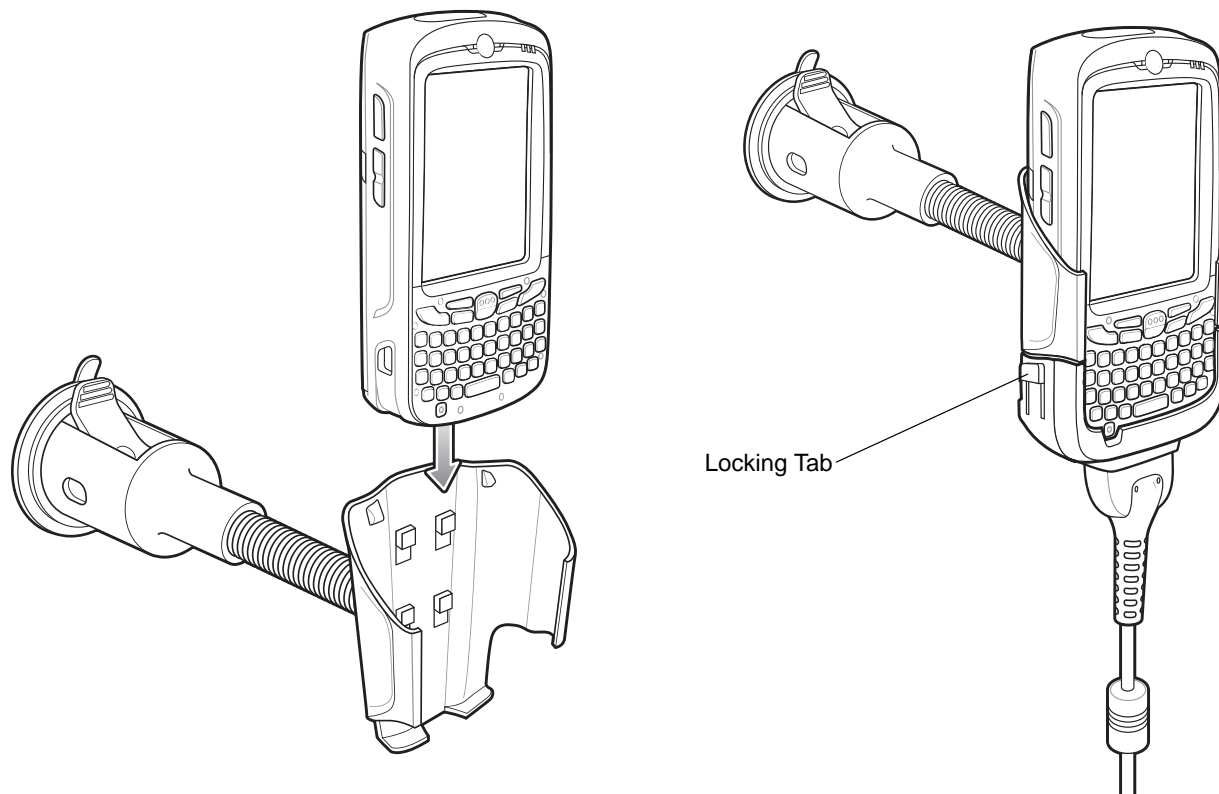

Figure 2-29 Insert MC55 into Vehicle Holder

5. Connect the auto charger cable to the MC55 and slide the two locking tabs up to secure the cable cup to the MC55.
6. Connect the other end to the cigarette lighter socket.

The LED indicator on the right side of the touch screen lights up orange during charging.

✓ **NOTE** Prior to removing the MC55 from the vehicle holder, disconnect the auto-charge cable from the MC55.

Flat Surface Installation

1. Remove the plastic sheet on the bottom of the mounting disc.
2. Place the disc, sticky side down, on a clean flat surface.

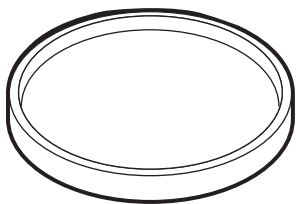

Figure 2-30 Mounting Disc

3. Fix the suction cup mount to the disc with the suction lever facing up.
4. Flip the lever down to create a vacuum between the suction cup and the disc.

5. Make sure that the suction bond is strong enough before proceeding to the next step.
6. Slide the MC55 into the cradle.

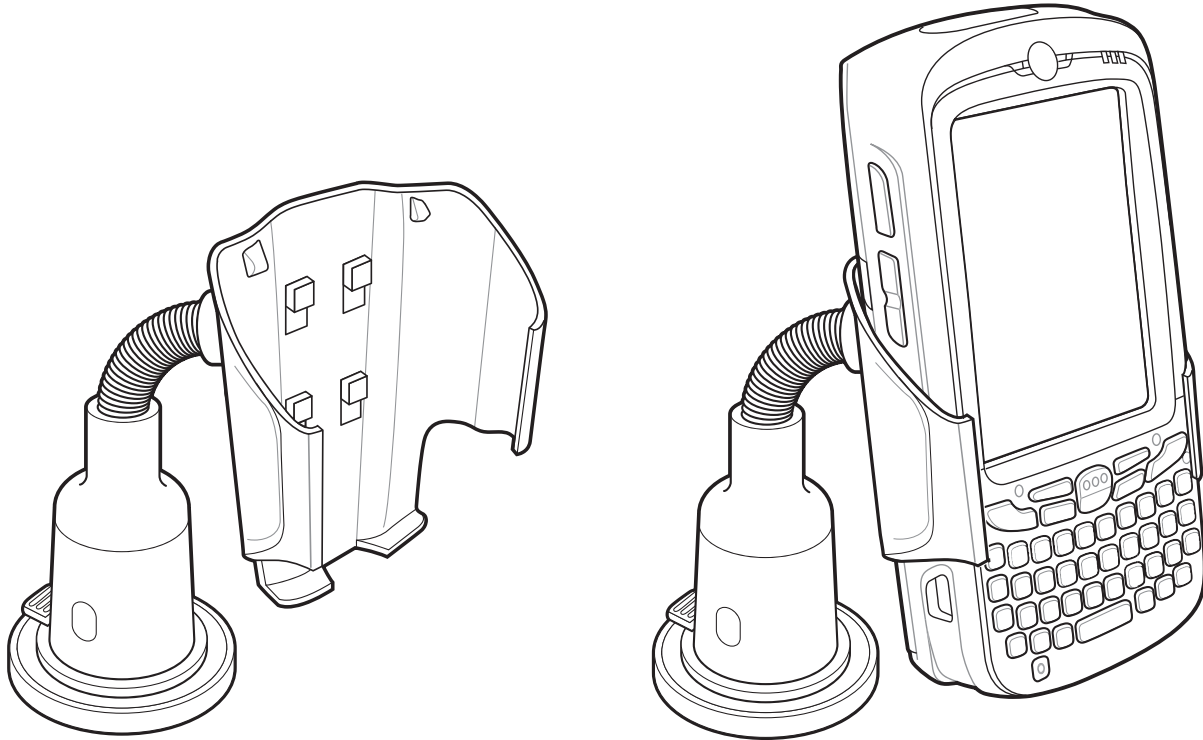

Figure 2-31 *Vehicle Holder Mounted on Flat Surface*

7. Connect the auto charger cable to the MC55 and slide the two locking tabs up to secure the cable cup to the MC55.
8. Connect the other end to the cigarette lighter socket.
The LED indicator on the right side of the touch screen lights up orange during charging.

Trigger Handle

The TRG5500 Trigger Handle adds a gun-style handle with a scanning trigger to the MC55. It increases comfort when using the MC55 in scan-intensive applications for extended periods of time.

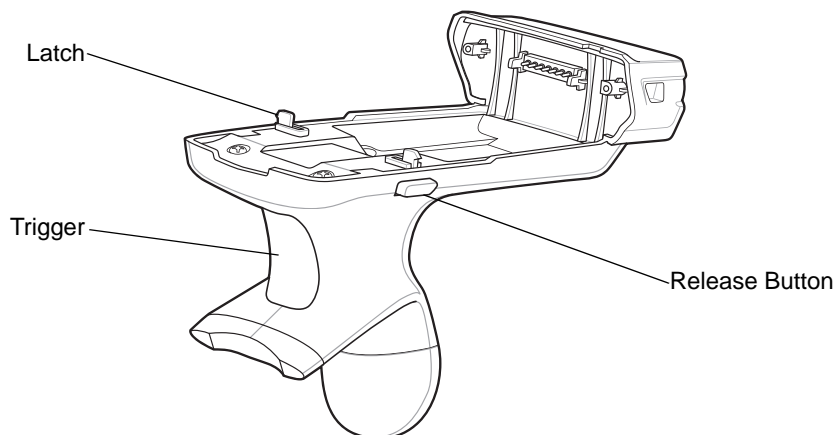

Figure 2-32 *Trigger Handle Features*

Install Trigger Handle Software on the MC55

In order to use the Trigger Handle with the MC5574 or MC5590 (pre-installed on the MC55A0), software installation is required. Download the *Trigger Handle Software V1.0* file from the Zebra Support Central web site: <http://www.zebra.com/support>. Follow the directions provided with the software and install the file onto the MC55 using ActiveSync.

Note that on MC55 devices with Windows Mobile 6.1, if installing MSR software, install the MSR software first and then install the Trigger Handle software.

Inserting the MC55 into the Trigger Handle

Slide the MC55 into the Trigger Handle until it locks in place. The latches secure the MC55 to the Trigger Handle.

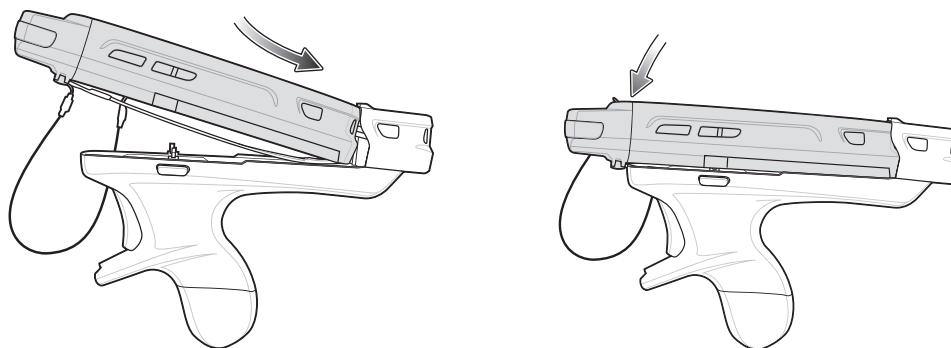

Figure 2-33 *Installing the MC55*

Removing the MC55

To remove the MC55, press the release buttons and pull the MC55 forward.

Scanning

To scan bar codes:

✓ **NOTE** A scanning application must be installed prior to scanning a bar code.

1. Start the MC55's scanning application.
2. Aim the MC55 at the bar code.
3. Press the trigger on the handle. The Scan/Decode LED lights and a beep sounds to indicate a successful decode.

For more information on MC55 scanner functions, refer to the *MC55 User Guide*.

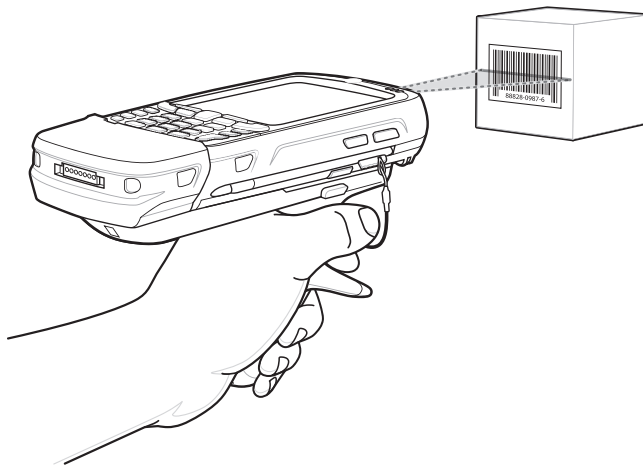

Figure 2-34 Scanning with the Trigger Handle

Charging and Communication

The Trigger Handle can be used to charge the MC55 and communicate with a host computer using either the Serial Charging Cable or a cradle, or connect to a peripheral such as a printer.

Using the Serial Charging/Communication Cable

To charge the MC55's battery or communicate with a host computer while the MC55 is in the Trigger Handle, use the Serial Charging Cable setup below:

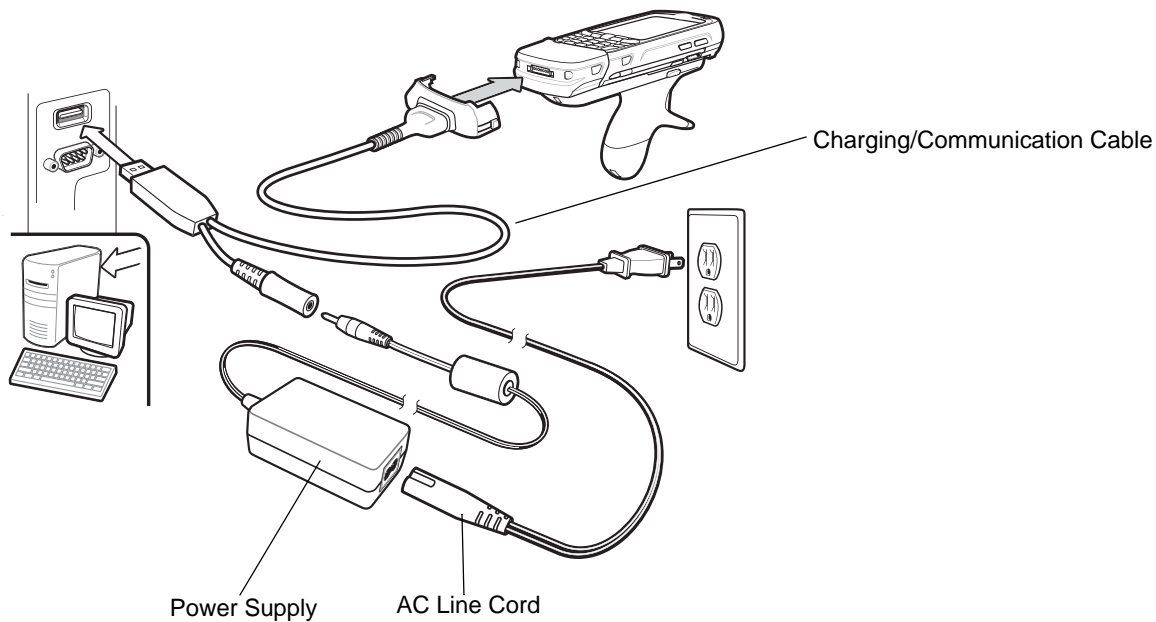

Figure 2-35 *Charging/Communication Setup*

Using a Cradle



CAUTION Do not place a Trigger Handle with an attachment, such as a Magnetic Stripe Reader (MSR) into a cradle. Remove the attachment before inserting the Trigger Handle into the cradle.

To charge the MC55's battery while the MC55 is in the Trigger Handle, use either a Single-Slot or Four-Slot cradle.

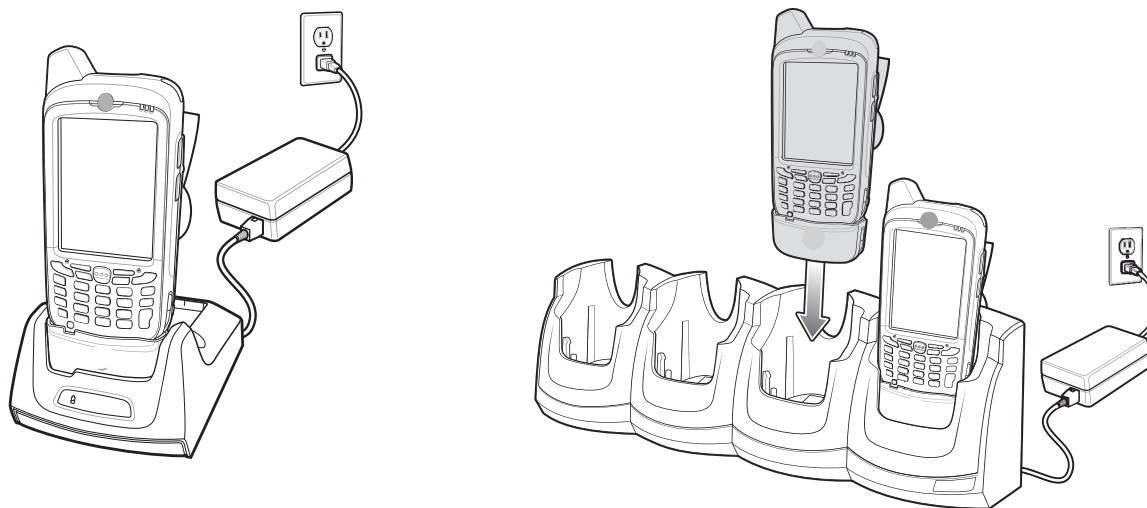

Figure 2-36 *Using with a Cradle*

Chapter 3 ActiveSync

Introduction

To communicate with various host devices, install Microsoft ActiveSync (version 4.5 or higher) on the host computer. Use ActiveSync to synchronize information on the mobile computer with information on the host computer. Changes made on the mobile computer or host computer appear in both places after synchronization.

- ✓ **NOTE** When a mobile computer with Windows Mobile 6.1 is connected to a host computer and an ActiveSync connection is made, the WLAN radio (if applicable) is disabled. This is a Microsoft security feature to prevent connection to two networks at the same time.

ActiveSync software:

- Allows working with mobile computer-compatible host applications on the host computer. ActiveSync replicates data from the mobile computer so the host application can view, enter, and modify data on the mobile computer.
- Synchronizes files between the mobile computer and host computer, converting the files to the correct format.
- Backs up the data stored on the mobile computer. Synchronization is a one-step procedure that ensures the data is always safe and up-to-date.
- Copies (rather than synchronizes) files between the mobile computer and host computer.
- Controls when synchronization occurs by selecting a synchronization mode, e.g., set to synchronize continually while the mobile computer is connected to the host computer, or set to only synchronize on command.
- Selects the types of information to synchronize and control how much data is synchronized.

Installing ActiveSync

To install ActiveSync on the host computer, download version 4.5 or higher from the Microsoft web site at <http://www.microsoft.com>. Refer to the installation instructions included with the ActiveSync software.

Mobile Computer Setup

- ✓ **NOTE** Microsoft recommends installing ActiveSync on the host computer before connecting the mobile computer.

The mobile computer by default is set up to communicate through a USB connection. [Chapter 2, Accessories](#) provides the accessory setup and cable connection information for use with the mobile computer. The mobile computer communication settings must be set to match the communication settings used with ActiveSync.

1. On the mobile computer tap **Start > ActiveSync** icon. The **ActiveSync** window appears.

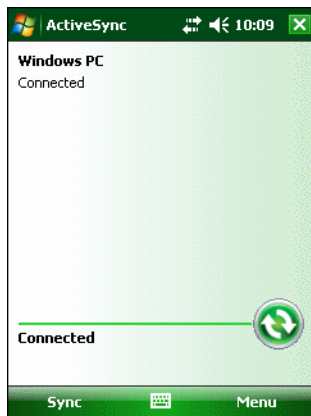

Figure 3-1 *ActiveSync Window*

2. Tap **Menu > Connections**.
3. Select the connection type from the drop-down list.
4. Tap **OK** to exit the **Connections** window and tap **OK** to exit the **ActiveSync** window.
5. Proceed with installing ActiveSync on the host computer and setting up a partnership.

USB Configuration

To configure the USB connection for ActiveSync:

1. Tap **Start > Settings > System > USBConfig** icon.

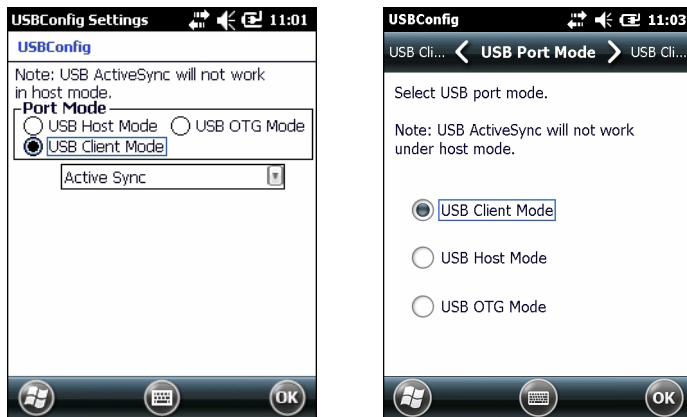

Figure 3-2 *USBConfig Window*

2. Ensure that the **USB Client Mode** radio button is selected.
3. On the MC5574 and MC5590, in the drop-down list, select **ActiveSync**.
4. Tap **Ok**.

Setting Up an ActiveSync Connection on the Host Computer

To start ActiveSync:

1. Select **Start > Programs > Microsoft ActiveSync** on the host computer. The **ActiveSync** Window displays.

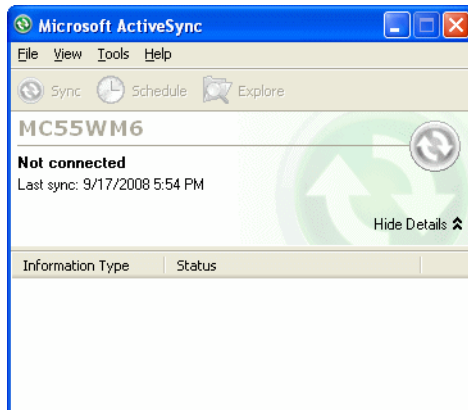

Figure 3-3 ActiveSync Window

- ✓ **NOTE** Assign each mobile computer a unique device name. Do not try to synchronize more than one mobile computer to the same name.

2. In the **ActiveSync** window, select **File > Connection Settings**. The **Connection Settings** window appears.



Figure 3-4 Connection Settings Window

3. Select **Allow USB connections** checkbox.
4. Select the **Show status icon in Taskbar** check box.
5. Select **OK** to save any changes made.

Synchronization with a Windows Mobile 6.1 Device

- ✓ **NOTE** When a mobile computer with Windows Mobile 6.1 is connected to a host computer and an ActiveSync connection is made, the WLAN radio (if applicable) is disabled. This is a Microsoft security feature to prevent connection to two networks at the same time.

To synchronize with a Windows Mobile 6.1 device:

1. If the **Get Connected** window does not appear on the host computer, select **Start > All Programs > Microsoft ActiveSync**.

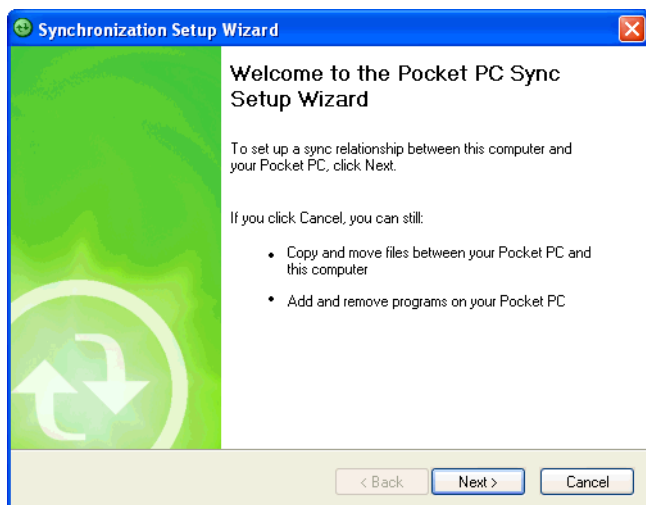

Figure 3-5 Synchronization Setup Wizard Window

2. Click **Next**.

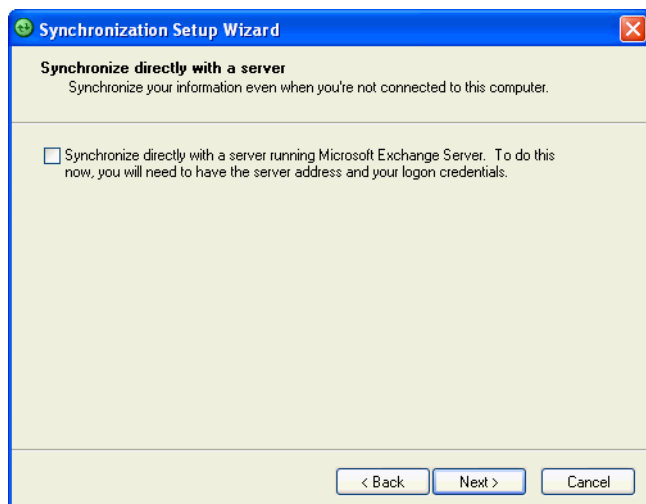

Figure 3-6 Synchronization Directly With a Server Window

3. Select the check box to synchronize with a server running Microsoft Exchange if applicable.
4. Click **Next**.

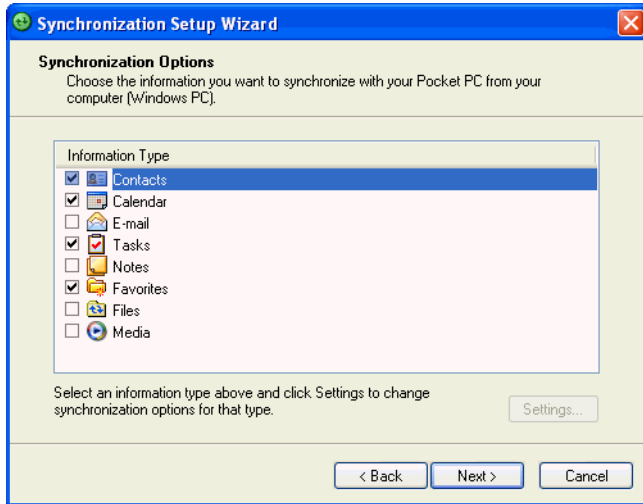

Figure 3-7 Synchronization Option Window

5. Select the appropriate settings and click **Next**.

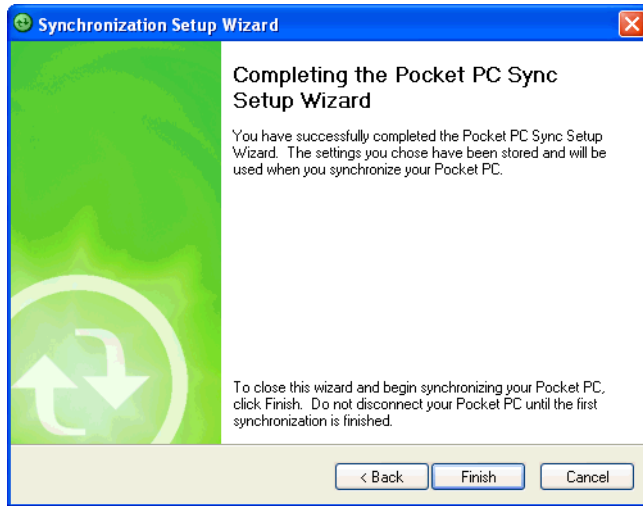

Figure 3-8 Wizard Complete Window

6. Click **Finish**.

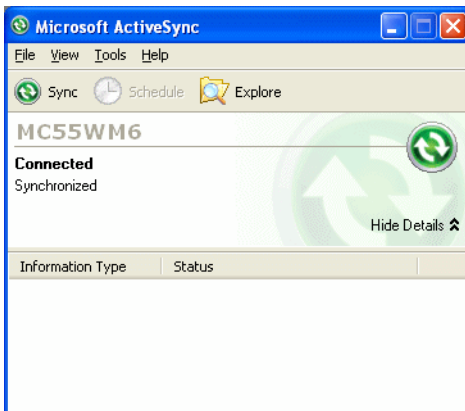

Figure 3-9 ActiveSync Connected Window

During the first synchronization, information stored on the mobile computer is copied to the host computer. When the copy is complete and all data is synchronized, the mobile computer can be disconnect from the host computer.



NOTE The first ActiveSync operation must be performed with a local, direct connection. Windows Mobile retains partnerships information after a cold boot.

For more information about using ActiveSync, start ActiveSync on the host computer, then see ActiveSync Help.

Chapter 4 Application Deployment

Introduction

This chapter describes features in Windows Mobile including new security features, how to package applications, and procedures for deploying applications onto the MC55.

Security

The MC55 implements a set of security policies that determine whether an application is allowed to run and, if allowed, with what level of trust. To develop an application, you must know the security configuration of the device, and how to sign an application with the appropriate certificate to allow the application to run (and to run with the needed level of trust).

Application Security

Application security controls the applications that can run on the MC55.

- Trusted - All applications must be digitally signed by a certificate on the MC55.
- Prompted - User is prompted to allow unsigned applications to run.
- Open - All applications run.

Developers can include their own certificates and provision the device to “trusted.”

Digital Signatures

Digital signatures provide a way to authenticate the author of EXEs, DLLs, and packages. Digitally signed applications give users confidence that an application comes from where they think it comes from. For example, if an end-user downloads an update package from the internet that is digitally signed with Zebra’s software certificate, they are assured that the package is authentic and that it was created by Zebra. By enforcing the use of digital signatures, users can also prevent malicious applications from executing on the MC55. For example, users can provision the MC55 to only execute “trusted” applications (digitally signed).

Zebra ships all Windows Mobile 6 based products in an “open” state, which means all signed and unsigned applications should work. However, customers can still reconfigure their MC55 to operate in the “trusted” mode.

This means that only applications signed with a certificate from the Privileged Execution Trust Certificate Store can run.

To support the broadest number of deployments, third-party software developers should perform the following when releasing software for a Windows Mobile 6 devices:

- Sign all their EXEs & DLLs with their private key
- Provide the corresponding public certificate to end-users so that it can be installed into Privileged Execution Trust Certificate Store.

If the software is installed via a .CAB file, developer should also:

- Sign the .CAB file with their private key
- Provide the corresponding public certificate to end-users so that it can be installed into SPC Certificate Store.

Locking Down a Mobile Computer

Like most configuration options in Windows Mobile, security settings are set via XML provisioning. For example, to enforce the “trusted” model and only allow applications signed with a privileged certificate to run, use the following provisioning document:

```
<wap-provisioningdoc>
  <characteristic type="SecurityPolicy">
    <!-- Disallow unsigned apps -->
    <parm name= "4102" value= "0"/>

    <!-- No Prompt -->
    <parm name= "4122" value= "1"/>
  </characteristic>
</wap-provisioningdoc>
```

For more information on various security options, refer to the Security Policy Settings topic in the latest Windows Mobile documentation.

Installing Certificates

Use XML provisioning to query and delete certificates from certificate stores. To add a new certificate the Privileged Execution Trust Certificate Store, use the following sample provisioning document:

```
<wap-provisioningdoc>
  <characteristic type= "CertificateStore">
  <characteristic type= "Privileged Execution Trust Authorities">
  <characteristic type= "657141E12FA45786F6A57CA6464032D4B3A55475">
  <parm name= "EncodedCertificate" value= "
This is sample text. This is sample text. This is sample text. This is sample text.
This is sample text. This is sample text. This is sample text. This is sample text.
This is sample text. This is sample text. This is sample text. This is sample text. = "/>
</characteristic>
</characteristic>
</characteristic>
</wap-provisioningdoc>
```

To create your own provisioning document with real certificate information:

1. Obtain a certificate from a security provider such as VeriSign.
2. Double-click on the certificate file (.CER) to open it.
3. Click on the *Details* tab and locate the *Thumbprint* field.
4. Copy the contents of the *Thumbprint* field and replace the value in the XML example above.
5. Click the **Copy to File...** button.
6. Click **Next** to start the Certificate Export Wizard.
7. Select *Base-64 encoded X.509 (.CER)* and then click **Next**.
8. Set the File Name to CertOutput.xml and click **Next**.
9. Click **Finish** to export the certificate.
10. Open the exported file, CertOutput.xml, in a text editor (i.e., NotePad).
11. Copy the contents of the file (excluding the first line, last line, and CR/LF) and replace the value of the *"EncodedCertificate"* parameter in the xml example above.

Device Management Security

You can control access to certain device settings and security levels, such as installing applications and changing security settings. Refer to the *Windows Mobile Version 6 Help* file for information on device management security.

Remote API Security

The Remote API (RAPI) enables applications that run on a desktop to perform actions on a remote device. RAPI provides the ability to manipulate the file system on the remote device, including the creation and deletion of files and directories. By default, Zebra ships with RAPI in the restricted mode. Certain tools, such as RAPIConfig, may

not work properly. Refer to the *Windows Mobile Version 6 Help* file for finding information on Remote API security policies.

Packaging

✓ **NOTE** Applications compiled for Windows Mobile 6 are not backward-compatible with previous versions.

Packaging combines an application's executable files into a single file, called a package. This makes it easier to deploy and install an application to the MC55. Package new applications and updates, such as new DLL files, as CAB files, then deploy them to devices. Refer to the *Microsoft Windows Mobile 6 Help* file for information on CAB files.

Deployment

To install applications onto the MC55, developers package the application and all required files into a CAB file, then load the file onto the MC55 using one of the following options:

- Microsoft ActiveSync 4.5 or higher
- Storage Card
- MSP 3.2
- AirBEAM
- Image Loader Image (for updating the operating system).

Refer to the *Microsoft Windows Mobile 6 Help* file for information on CAB files.

Installation Using ActiveSync

To install an application package:

- Connect the MC55 to a host computer using ActiveSync. See [Chapter 3, ActiveSync](#) for more information.
- Locate the package file on the host computer.
- In ActiveSync on the host computer, open *Explorer* for the MC55.
- Copy the CAB file from the host computer to the \temp directory on the MC55.
- On the MC55, navigate to the \temp directory.
- Tap on the application CAB file. The application installs on the MC55.

Installation Using Storage Card

To install an application package:

- Copy the package CAB file to a microSD storage card using an appropriate storage card reader.
- Install the storage card into the MC55. See [Installing a microSD Card on page 1-2](#) for more information.
- On the MC55, open **File Explorer**.

- Open the *Storage Card* directory.
- Tap the package CAB file. The application installs on the MC55.

Installation Using USB Connection

To install an application or copy files to the MC55 using a USB connection:

1. On the MC55, tap **Start > Settings > System > USB Config** icon.

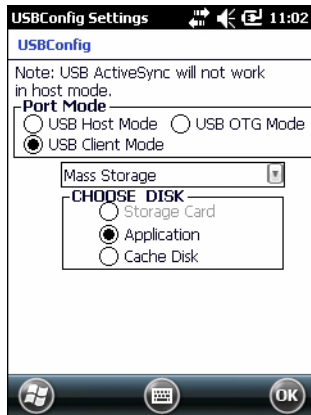

MC5574/90

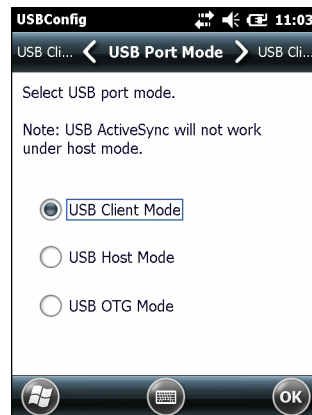

MC55A0

Figure 4-1 *USBConfig Window*

2. Tap **USB Client** radio button.
3. On the MC5574/90:
 - a. In the drop-down list, select **Mass Storage**.
 - b. In the **Choose Disk** section, select either **Storage Card**, **Application** or **Cache Disk**.
 - c. Tap **OK**.
4. On the MC55A0:
 - a. Tap **USB Client Mode** tab.
 - b. Select **Mass Storage**.
 - c. In the drop-down list, select either **Storage Card**, **Application** or **Cache Disk**.
 - d. Tap **OK**.
5. Connect the MC55 to a host computer using either a single slot cradle or a USB cable.
6. On the host computer, open **Windows Explorer**. The MC55 appears as a hard disk drive in **Windows Explorer**.
7. Double-click the drive letter to open the folder. Note that if \Application folder is selected, the folder **__TFAT_HIDDEN_ROOT_DIR__** appears. Double click to open the folder.
8. On the host computer, open another **Windows Explorer** window and locate the files to copy to the MC55.
9. Drag the files from the new window to the MC55 folder window.
10. When complete, disconnect the MC55 from the host computer.

Installation Using AirBEAM

The AirBEAM Smart Client provides backward-compatible legacy AirBEAM functionality and backward-compatible legacy MSP 2.x Level 2 Agent functionality.

Refer to the AirBEAM Smart Windows CE Client Product Reference Guide, p/n 72-63060-xx, for instructions for AirBEAM Smart client.

Mobility Services Platform

The MSP 3 Client Software is a set of software components that come pre-installed on the MC55. The MSP 3 Client software consists of the following components:

The RD Client provides support for MSP 3 Staging functionality, provides support for the MSP 3 Legacy Staging process, and provides support for backward-compatible legacy MSP 2.x Legacy Staging functionality.

The MSP 3 Agent provides MSP 3 Provisioning functionality and Control functionality when used with MSP 3.2 Control Edition.

Refer to the Mobility Services Platform 3.2 User's Guide, p/n 72E-100158-xx, for instructions for using the Rapid Deployment and MSP3 Agent clients.

Update Loader Image

Windows Mobile contains an Image Update feature that updates all operating system components. All updates are distributed as update packages. Update packages can contain either partial or complete updates for the operating system. Zebra distributes the update packages on the Support Central Web Site, <http://www.zebra.com/support>.

To update an operating system component, copy the update package to the MC55 using one of a variety of transports, including ActiveSync, an microSD card, AirBEAM or MSP.

Download Update Loader Package

1. Go to the Zebra Support Central web site, <http://www.zebra.com/support>.
2. Download the appropriate update loader package to a host computer.
3. Locate the update loader package file on the host computer and un-compress the file into a separate directory.

ActiveSync

To install an update loader package using ActiveSync:

1. Connect the MC55 to a host computer using ActiveSync. See [Chapter 3, ActiveSync](#) for more information.
2. In ActiveSync on the host computer, open **Explorer** for the MC55.
3. Copy all the update loader package files from the host computer to the \temp directory on the MC55.
4. On the MC55, navigate to the \temp directory.
5. Tap on the update loader file, **STARTUPDLDR.EXE**. The Update Loader application installs the update loader package on the MC55.

A progress bar displays until the update completes.

6. The MC55 re-boots.
7. The calibration screen appears.

microSD Card

To install an update loader package using a microSD card:

1. Copy all the update loader package files to the root directory of a microSD card.
2. Install the microSD card into the MC55. See [Installing a microSD Card on page 1-2](#) for installation instructions.
3. Connect the MC55 to AC power. See [Chapter 2, Accessories](#).
4. Perform a cold boot.
5. Immediately, as soon as the device starts to boot and before the splash screen is visible, press and hold the left scan button.
6. The Update Loader application looks for the update loader file in the root directory of the microSD card. When it finds the file, it loads the update loader package onto the MC55. A progress bar displays until the update completes.
7. The MC55 re-boots.
8. The calibration screen appears.

Creating a Splash Screen

Use a bitmap file to create a customized splash screens for the MC55. Use Image Update with a bitmap file, rather than a package file, to update the splash screen.

To create a custom splash screen:

1. Create a .bmp file using a graphic program with the following specifications:
 - Size: 296 x 240.
 - Colors: 16 bits per pixel (65536 colors) for color displays.
2. Modify the bitmap file and save.

To load the splash screen on the MC55:

1. Create a text file named pkgs.lst which contains the name of the bmp file. For example, *mysplash.bmp*.
2. Copy the bmp file and the pkgs.lst file to one of the following:
 - SD card root directory
 - MC55's \temp directory
 - MC55's \Windows directory.
3. If using a microSD card, insert the microSD card into the MC55.
4. Perform a cold boot.
5. Immediately, as soon as the device starts to boot and before the splash screen is visible, press and hold the left scan button.

XML Provisioning

To configure the settings on an MC55, use XML provisioning. To install an XML provisioning file on the MC55, create a Cabinet Provisioning File (CPF). A CPF file is similar to a CAB file and contains just one file: `_setup.xml`. Like a CAB file, the CPF extension is associated with `WCELoad.EXE`. Opening a CPF extracts the XML code and uses it to provision and configure the MC55. The user receives an e-mail notification indicating success or failure.

XML provisioning provides the ability to configure various features of the MC55 (i.e., registry and file system). However, some settings require security privileges. To change registry settings via a CPF file, you must have certain privileges (roles). Some registry keys require you to simply be an *Authenticated User*, while other registry keys require you to be a *Manager*. Refer to the *Microsoft Windows Mobile 6 Help* file, *Metabase Settings for Registry Configuration Service Provider* section, for the default role settings in Windows Mobile 6.

For those registry settings that require the *Manager* role, the CPF file must be signed with a privileged certificate installed on the device. Refer to the *Microsoft Windows Mobile 6 Help* file and the *Windows Mobile 6 SDK* for instructions and sample test certificates.

Creating an XML Provisioning File

To create a `.cpf` file:

1. Create a valid provisioning XML file named `_setup.xml` using an XML editor or the tools supplied with Visual Studio 2005. (For example, use the `SampleReg.xml` sample created in the [RegMerge on page 4-8](#) section and rename it `_setup.xml`.) Ensure the file contains the required parameters for the operation. Refer to the *Microsoft Windows Mobile 6 Help* file for information.
2. In the Windows Mobile 6 tools directory on the desktop computer (typically `\Program Files\Windows CE Tools\wce500\Windows Mobile 6 Pocket PC SDK\Tools`), run the `Makecab.exe` utility, using the following syntax to create a `.cpf` file from the `_setup.xml` file:

```
MakeCab.exe /D COMPRESS=OFF _setup.xml myOutCpf
```



NOTE COMPRESS=OFF is required for backward compatibility with Pocket PC.

3. Optionally, use the Authenticode tools to sign the `.cpf` file.
4. Tap the filename to install.
5. Certain applications and settings require a cold boot to take affect. In these cases, cold boot the MC55. Refer to the *Windows Mobile Version 6 Help* file for more information.

XML Provisioning vs. RegMerge and Copy File

Prior to Windows Mobile 5.0, Zebra used two drivers (`RegMerge` and `CopyFiles`) to update the registry and to copy files during a cold boot. With Windows Mobile 6, Zebra recommends using XML provisioning instead. `RegMerge` and `CopyFiles` are supported for backward compatibility but Zebra may eliminate support in the future. The following sections provide examples of how `RegMerge` and `CopyFiles` were used, and how to perform the same function using XML provisioning.

RegMerge

`RegMerge.dll` is a built-in driver that allows updating the registry during a clean boot. `RegMerge` runs very early in the boot process and looks for registry files (`.reg` files) in certain Flash File System folders (i.e., `\Application`) during a clean boot. It then merges the registry changes into the system registry located in RAM.

The following example uses RegMerge to set a registry key:

SampleReg.reg

```
[HKEY_LOCAL_MACHINE\Hardware\DeviceMap\Backlight]
"BacklightIntensity"=dword:00000036
```

The following example uses XML provisioning to perform the same task:

SampleReg.xml

```
<wap-provisioningdoc>
  <characteristic type= "Registry">
    <characteristic type= "HKLM\Hardware\DeviceMap\Backlight">
      <parm name= "BacklightIntensity" value= "54" datatype= "integer" />
    </characteristic>
  </characteristic>
</wap-provisioningdoc>
```

CopyFiles

CopyFiles copies files from one folder to another on a clean boot. During a clean boot CopyFiles looks for files with a .CPY extension in the root of the Application FFS partition. These files are text files containing the source and destination for the desired files to copy, separated by ">".

The following example uses CopyFiles to copy a file from the \Application folder to the \Windows folder:

SampleCpy.cpy

```
\Application\example.txt > \Windows\example.txt
```

The following example uses XML provisioning to perform the same task:

SampleCpy.xml

```
<wap-provisioningdoc>
  <characteristic type= "FileOperation">
    <characteristic type= "\Windows" translation= "filesystem">
      <characteristic type= "MakeDir"/>
      <characteristic type= "example.txt" translation= "filesystem">
        <characteristic type= "Copy">
          <parm name= "Source" value= "\Application\example.txt" translation= "filesystem"/>
        </characteristic>
      </characteristic>
    </characteristic>
  </characteristic>
</wap-provisioningdoc>
```

Storage

Mobile 6 contains three types of file storage:

- Random Access Memory (RAM)
- Persistent Storage
- Application folder.

Random Access Memory

Executing programs use RAM to store data. Data stored in RAM is lost upon a warm boot. RAM also included a volatile file storage area called *Cache Disk*.

Volatile File Storage (Cache Disk)

Windows Mobile 6 memory architecture uses persistent storage for all files, registry settings, and database objects to ensure data is retained even after a power failure. Persistent storage is implemented using Flash memory technology which is generally slower than volatile RAM memory. In certain situations the speed of the operation is more important than the integrity of the data. For these situations, Zebra has provided a small volatile File Storage volume, accessed as the *Cache Disk* folder. Disk operations to the *Cache Disk* folder are much faster than to any of the persistent storage volumes, but data is lost across warm boots and power interruptions.

DO NOT use the *Cache Disk* as a method to improve application performance. Analyze applications that perform slower in persistent storage to optimize disk access. Common areas for optimization include minimizing the number of reads and writes to a file, removing unneeded debug logging, and minimizing file flushing or closing files.

Persistent Storage

Windows Mobile 6 protects all data and applications from power-related loss. Because Windows Mobile 6 mounts the entire file system and registry in persistent storage (rather than using RAM), MC55 devices provide a reliable storage platform even in the absence of battery power.

Persistent storage provides application developers with a reliable storage system available through the standard file system and registry APIs. Persistent storage is optimized for large reads and writes; therefore, applications reading and writing data in large chunks tend to outperform those applications reading and writing small blocks of data. Data in persistent storage is lost upon a clean boot.

Persistent storage contains all the directories under the root directory except for Application, Cache Disk, and Storage Card (if a storage card is installed). Persistent storage is approximately:

- 128 MB RAM/256 MB Flash configurations: 60 MB (formatted)
- 128 MB RAM/512 MB Flash configurations: 360 MB (formatted)
- 256 MB RAM/1 GB Flash configurations (MC55A0 only): 703 MB (formatted)

Application Folder

The Application folder is a super-persistent storage that is persistent even after a clean boot. Accessing data in the Application folder is slower than accessing persistent storage. The Application folder is used for deployment and device-unique data. For example, network profiles can be stored in the Application folder so that connection to the network is available after a cold boot. The Application folder is approximately:

- 128 MB RAM/256 MB Flash configurations: 32 MB (formatted)
- 128 MB RAM/512 MB Flash configurations: 32 MB (formatted)
- 256 MB RAM/1 GB Flash configurations (MC55A0 only): 118 MB (formatted).

Enterprise Mobility Developer Kits

The Zebra Mobility Developer Kit (EMDK) family of products allows you to write applications that take advantage of the capture, move and manage capabilities of the MC55. Go to the Support Central (<http://www.zebra.com/support>) to download the appropriate developer kit.

Chapter 5 Wireless Applications

Introduction

Wireless Local Area Networks (WLANs) allow mobile computers to communicate wirelessly and send captured data to a host device in real time. Before using the MC55 on a WLAN, the facility must be set up with the required hardware to run the wireless LAN and the MC55 must be configured. Refer to the documentation provided with the access points (APs) for instructions on setting up the hardware.

802.11d is enabled by default. When enabled, the AP must be configured the same in order to connect.

To configure the MC55, a set of wireless applications provide the tools to configure and test the wireless radio in the MC55. Refer to the *Wireless Fusion Enterprise Mobility Suite User Guide for Version X.XX* for information on configuring wireless profiles; where X.XX is the Fusion version. Goto <http://www.zebra.com/support> for the latest version of this guide. See *Fusion Software on page xiv* to determine the Fusion version on the MC55.

The **Wireless Application** menu on the task tray provides the following wireless applications:

- Find WLANs
- Manage Profiles
- Manage Certs
- Manage PACs
- Options
- Wireless Status
- Wireless Diagnostics
- Log On/Off
- Enable/Disable Radio.

Tap the **Signal Strength** icon to display the **Wireless Applications** menu.



NOTE On devices with Windows Mobile 6.5.3, access the Wireless Launcher from the Home screen. Select the Fusion plug-in and then tap the Fusion **Menu** button. See *Home Screen on page C-2* for more information.

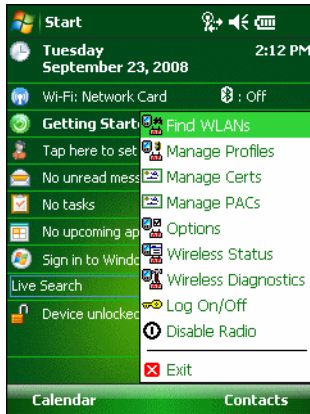









Figure 5-1 Wireless Applications Menu

Signal Strength Icon

The **Signal Strength** icon in the task tray indicates the MC55's wireless signal strength as follows:

Table 5-1 Signal Strength Icons Descriptions

Icon	Status	Action
	Excellent signal strength	Wireless LAN network is ready to use.
	Very good signal strength	Wireless LAN network is ready to use.
	Good signal strength	Wireless LAN network is ready to use.
	Fair signal strength	Wireless LAN network is ready to use. Notify the network administrator that the signal strength is only "Fair".
	Poor signal strength	Wireless LAN network is ready to use. Performance may not be optimum. Notify the network administrator that the signal strength is "Poor".
	Out-of-network range (not associated)	No wireless LAN network connection. Notify the network administrator.
	No wireless LAN network card detected	No wireless LAN network card detected, Wireless LAN disabled or radio disabled. Notify the network administrator.
None	No wireless LAN network card detected or Wireless LAN disabled	No wireless LAN network card detected or Wireless LAN disabled or radio disabled. Notify the network administrator.

Turning the WLAN Radio On and Off

To turn off the WLAN radio tap the **Signal Strength** icon and select **Disable Radio**.

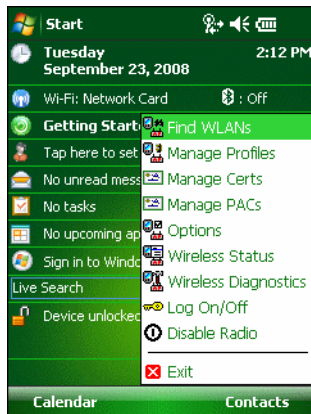

Figure 5-2 *Disable Radio*

To turn on the WLAN radio tap the **Signal Strength** icon and select **Enable Radio**.

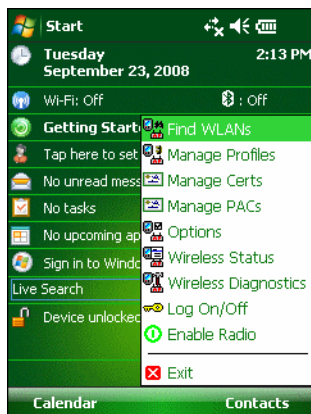

Figure 5-3 *Enable Radio*

Chapter 6 MC5574 - GSM Configuration

Introduction

This chapter explains how to verify MC5574 service on an Global System for Mobile communications (GSM) wireless network and establish settings.

GSM networks deliver mobile voice and data services, such as Short Message Service (SMS)/Text Messaging, with full roaming capabilities across the world. GPRS enabled networks offer Internet-based content and packet-based data services. This enables services such as internet browsing, e-mail on the move, powerful visual communications, multimedia messages, and location-based services.

When using the MC55 as a phone, services can include speed dialing, call tracking, voice mail, call forwarding, conference calling, and caller ID, depending on the type of service.

Also use the integrated phone as a modem to connect the MC55 to an ISP or work network. The GSM enabled MC55 can connect to the Internet or work network using Cellular Line, or using the modem specified by the mobile phone service provider.

- ✓ **NOTE** Before using an MC55 on a wireless network, first select a provider, establish a voice and data-enabled service plan, and configure the MC55 (where applicable). Refer to the *MC55 User Guide* for information on how to use the phone and services.

Quick Startup Steps

To use the MC55 for phone and data connections:

1. Install the MC55 main battery. See [Installing the Battery on page 1-4](#).
2. Fully charge the main battery. See [Charging the Battery on page 1-5](#).
3. Press the red **Power** button to suspend the MC55.
4. Remove the battery.
5. Install a SIM card. See for [Installing the SIM Card on page 1-3](#) installation procedures.
6. Replace the battery.
7. Press the red **Power** button.

8. Ensure network coverage ([page 6-2](#)).
9. Configure a data connection ([page 6-3](#)).

✓ **NOTE** Data connection configuration is pre-packaged with T-Mobile service. Other service providers may require data connection configuration.

10. Configure settings ([page 6-6](#)).
11. Use the phone.

MC5574 Service Verification

MC5574 phone and data services require a live SIM card, obtained from a service provider, installed in the MC55 phone. The SIM card has embedded circuitry on one side of its surface which, when inserted into an MC55 phone, provides phone service. The SIM card provides a phone number, determines the features or services available to the subscriber, and identifies the subscriber to the network.

In addition to SIM card installation, the MC55 may require various settings to operate as a phone with data connection features.

Ensuring Network Coverage

1. Ensure an activated SIM card, from the phone service provider, is installed in the MC55.

✓ **NOTE** The SIM card must be enabled to connect to the network.

On devices with Windows Mobile 6.5.X, see [Status Bar on page C-5](#) for more information on accessing the **Phone** dialog box.

2. Verify active phone and data services by tapping  to display the **Phone** dialog. The Carrier name appears in the dialog box.

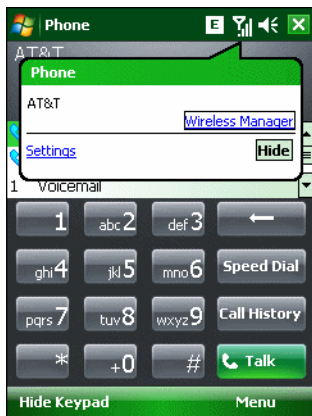

Figure 6-1 Connectivity Dialog

3. Verify SIM card functionality:
 - a. Tap **Start** > **Settings** > **Personal** tab > **Phone** icon > **Network** tab.

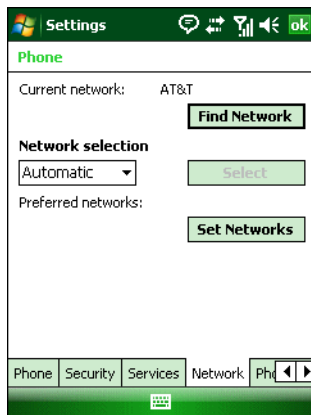

Figure 6-2 Phone Settings Window - Network Tab

- b. Ensure the service provider's network appears in the **Current network:** field.
- c. If the network does not appear, tap **Find Network**. If the network still does not appear, verify that the SIM card was installed correctly. If it was, and no network appears, contact the service provider.

Configuring a Data Connection

A data connection allows Internet access across a wireless network.

To set up a new data connection:

1. Acquire an Access Point Name (APN) from the service provider.
2. Tap **Start > Settings > Connections** tab > **Connections** icon > **Tasks** tab.

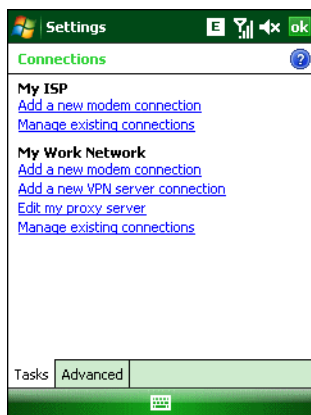

Figure 6-3 Connections Window

3. Under **My ISP** select **Add a new modem connection**.

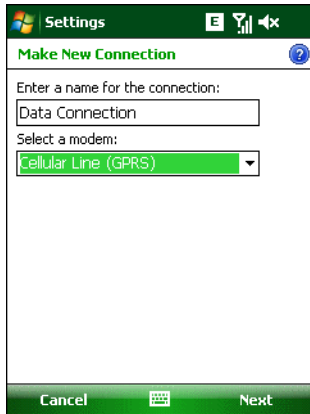

Figure 6-4 Connections Window - Make New Connection

4. Enter a connection name in the *Enter a name for the connection:* text box.
5. Select **Cellular Line (GPRS)** from the **Select a modem:** drop-down list.
6. Tap **Next**.

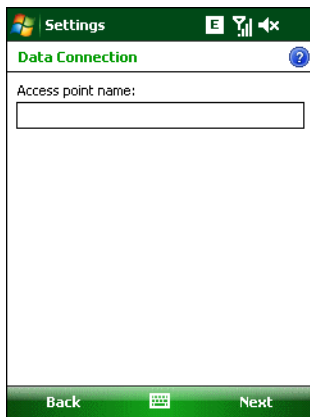

Figure 6-5 Connections Window - Access Point Name

7. Enter the APN from the service provider in the **Access point name:** text box.
8. Tap **Next**.

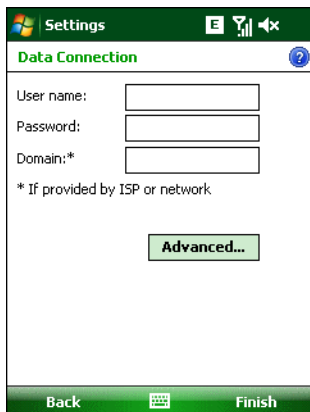

Figure 6-6 Connections Window - User Name & Password

9. Enter a username in the User name text box, if required by the service provider.
10. Enter a password in the Password text box, if required by the service provider.
11. Enter a domain name in the Domain text box, if required by the service provider.
12. Tap **Finish**.
13. Tap **ok** to exit **Connections**.

MC5574 Settings

Use the **Phone Settings** window to customize settings, such as the ring type and ring tone for incoming calls, security options, and other options depending on the type of service.

Phone Tab

Use the **Phone** tab to customize ring type, ring tone, keypad tone, and security options.

Tap **Start > Settings > Personal tab > Phone icon > Phone tab**

or

Start > Phone > Menu > Options > Phone tab.

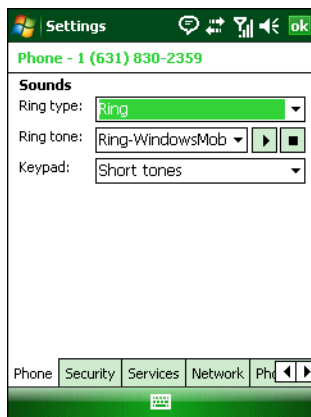



Figure 6-7 MC55 Phone Window - Phone Tab

Sounds

1. **Phone Number** automatically displays on the **Phone** tab when a live SIM card is installed.
2. Select a ring type from the **Ring type:** drop-down list. The ring type changes the way the MC55 rings when you receive an incoming call. Regardless of the ring type selected, a dialog box appears on the MC55's display for incoming calls.
3. Select a ring tone for incoming calls from the **Ring tone:** drop-down list. To hear a sample of the selected ring tone, tap . Tap  to end the ring tone.

✓ **NOTE** To use custom .wav, .mid, or .wma files as ring tones, use ActiveSync on the host computer to copy the file to the /Windows/Rings folder on the MC55. Then select the sound from the ring tone list.

4. Select a keypad tone from the **Keypad:** drop-down list. This selection determines the tone that sounds when entering a phone number on the keypad.

Select **Short tones** or **Long tones** to specify the duration of the sound when you press a number on the keypad. Select **Off** to disable tones.

✓ **NOTE** Turning off sounds saves power and prolongs battery life.

Security Tab

Enabling a PIN

✓ **NOTE** Place emergency calls at any time, without requiring a PIN or a SIM card.

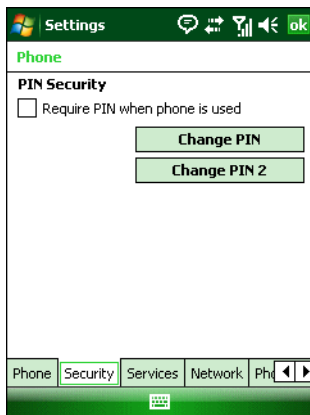

Figure 6-8 Security Tab

To require a PIN when using the phone:

1. From the **Security** tab, select the **Require PIN when phone is used** check box under **PIN Security**.

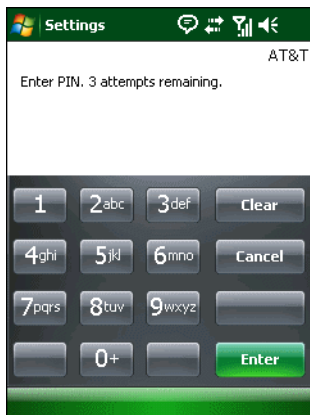

Figure 6-9 Enter PIN

2. Use the touch keypad to enter a four to eight digit PIN.
3. Tap **Enter** to enable the PIN and return to the **Phone** tab.

Changing a PIN



CAUTION If you enter an incorrect PIN, the message “SIM PIN incorrect: Try again” appears. After three consecutive incorrect attempts, the SIM card is blocked. The phone does not allow you to attempt to enter your PIN again and you must obtain a PIN Unblock Key from your service provider.

1. From the **Security** tab ([Figure 6-7](#)), tap **Change PIN**.
2. Use the touch keypad to enter the current PIN.

3. Tap **Enter**.
4. Use the touch keypad to enter a new four to eight digit PIN.
5. Tap **Enter**.
6. Reenter the new PIN for confirmation and tap **Enter**.
7. Tap **ok** to confirm the change.

Disabling a PIN

1. From the **Security** tab, deselect the **Require PIN when phone is used** check box.
2. Use the touch keypad to enter the current PIN.
3. Tap **Enter**.
4. Tap **ok** to confirm the change.
5. Tap **ok** to exit settings.

Services

Use the *Services* tab to configure settings for subscribed phone services. For example, block certain types of incoming and/or outgoing calls ([page 6-8](#)), disclose the caller's identity when making outgoing calls ([page 6-9](#)), forward incoming calls to a different phone number ([page 6-9](#)), receive notification of incoming calls when a phone session is in use ([page 6-10](#)), and set up voice mail and short message service ([page 6-10](#)).

1. Tap **Start > Settings > Personal** tab > **Phone** icon > **Services** tab.

or

Start > Phone > Menu > Options > Services tab.

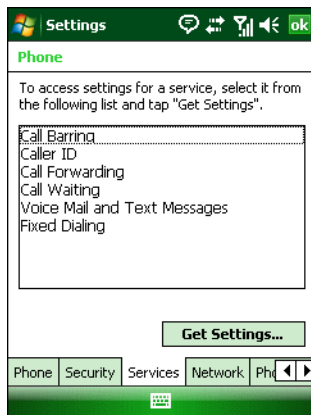

Figure 6-10 MC55 Phone Window - Services Tab

2. Select a service from the list and tap **Get Settings...**
3. Change services settings as follows.

Call Barring (Call Blocking)

Use call barring to block certain types of incoming and/or outgoing calls. Select the type of incoming and/or outgoing calls to block.

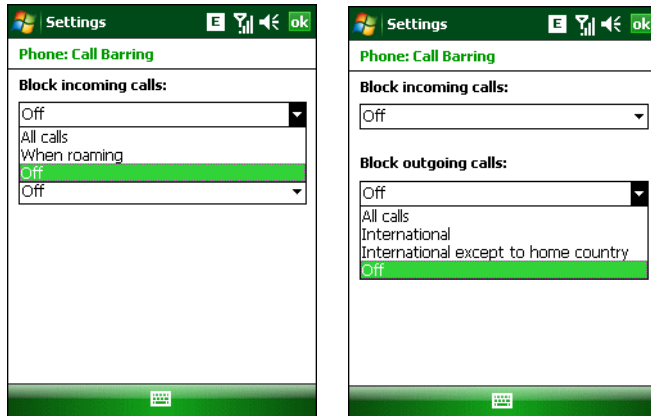

Figure 6-11 Call Barring/Call Blocking

Caller ID

Enable caller ID to reveal the identity of the person making an outgoing call. Select the **Everyone** radio button to always display the caller ID. Select the **No one** radio button to prevent the caller's identity from appearing to others.

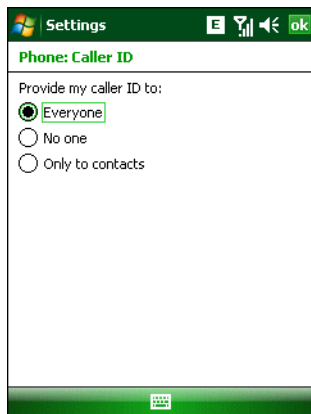

Figure 6-12 Caller ID

Call Forwarding

✓ **NOTE** Call Forwarding may not be available on all networks. Check with your service provider for availability.

Use call forwarding to forward incoming calls to a different phone number.

- To forward all calls to a different phone number:
 - select the **Forward all incoming phone calls** check box.
 - enter the phone number to receive forwarded calls in the **To:** text box.

- To forward incoming calls to a different phone number based on a specific situation, select one or more of the check boxes under **Forward phone calls only if:**
 - **No answer:** enter the phone number to receive forwarded calls only when the phone cannot be answered. Then select a time period from the **Forward after:** drop-down list. Options are 5, 10, 15, 20, 25, and 30 seconds.
 - **Unavailable:** enter the phone number to receive forwarded calls only when the phone is turned off or the user is unreachable.
 - **Busy:** enter the phone number to receive forwarded calls only when the line is busy.

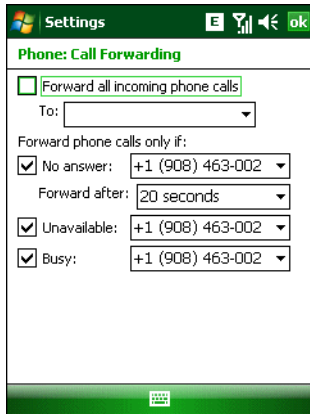

Figure 6-13 Call Forwarding

Call Waiting

✓ **NOTE** Call Waiting may not be available on all networks. Check with your service provider for availability.

Call waiting notifies you of an incoming call when the phone is in a phone session. Select the **Notify me** radio button to enable call waiting. Select the **Do not notify me** radio button to disable call waiting.

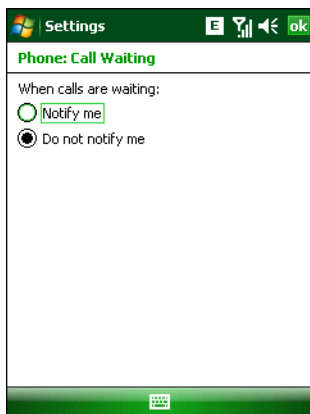

Figure 6-14 Call Waiting

Voice Mail and Text Messages

To use voice mail and send short messages, enter the voice mail and/or text message phone number in the appropriate text boxes.

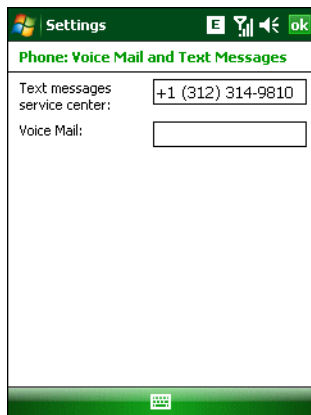

Figure 6-15 Voice Mail and Text Messages

Fixed Dialing

Use Fixed Dialing to restrict the phone to dial only the phone number(s) or area code(s) specified in a Fixed Dialing list.

1. Select **Fixed Dialing** and tap **Get Settings**.

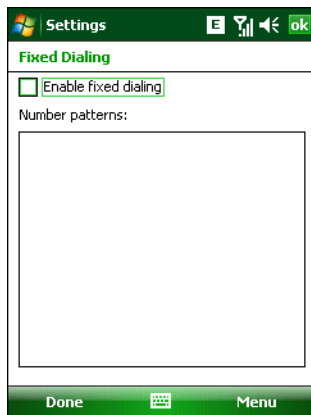

Figure 6-16 Fixed Dialing Window

2. Select the **Enable fixed dialing** check box.
3. To add a number to the list, tap **Menu > Add**.
4. Enter the phone number or area code to restrict and tap **Done**.
5. Repeat steps 3 and 4 to add more numbers, and tap **Done** twice when complete.
6. Enter **PIN2** and tap **Done**.



NOTE PIN2 is buffered in the MC55 for seven minutes after entry and will not be requested again during this period. Should entry of PIN2 be required then the user must either wait for seven minutes to expire or alternatively perform a warm boot of the MC55.

Network

Use the **Network** tab to view available networks, determine the order in which the phone accesses another network if the current network is unavailable, and specify whether to change networks manually or automatically. The current network remains active until it's changed, the signal is lost, or the SIM card is changed.

The network the MC55 currently uses appears in the **Current network:** field at the top of the window.

Changing Networks Manually

1. Tap **Start > Settings > Personal tab > Phone icon > Network tab**

or

Start > Phone > Menu > Options > Network tab.

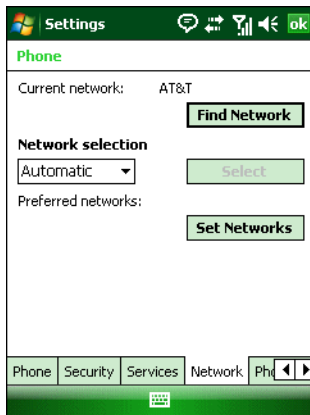

Figure 6-17 MC55 Phone Window - Network Tab

2. From the **Network selection** drop-down list, select **Manual**.

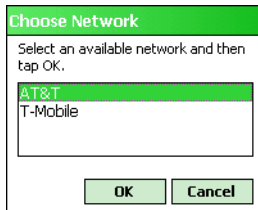

Figure 6-18 Choose Network

3. From the **Choose Network** window, select the network to use.
4. Tap **OK**.

Viewing Available Networks

To view all wireless networks available:

1. Tap **Start > Settings > Personal tab > Phone icon > Network tab**.

or

Start > Phone > Options > Network tab.

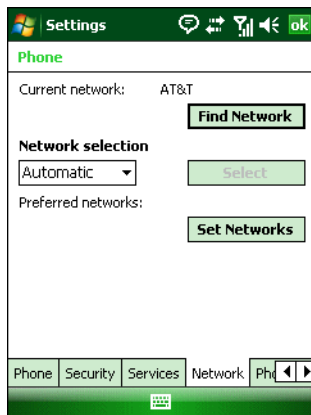

Figure 6-19 MC55 Phone Window - Network Tab

2. Tap Find Network.

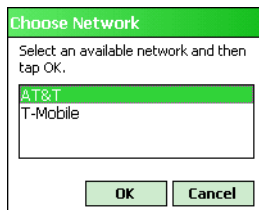

Figure 6-20 Choose Network

3. From the **Choose Network** window, select the network to use.

4. Tap **OK**.

Setting Preferred Networks

Set networks in a preferred order of access. Setting preferred networks allows the MC55 to access a second preferred network if the first is unavailable.

1. Tap **Start > Settings > Personal tab > Phone icon > Network tab**

or

Start > Phone > Menu > Options > Network tab.

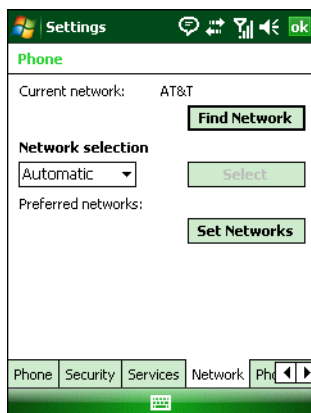

Figure 6-21 MC55 Phone Window - Network Tab

2. Tap **Set Networks** to view all available networks.

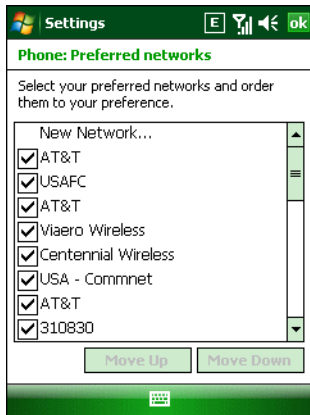

Figure 6-22 Preferred Networks

3. Select the preferred networks by tapping one or more check boxes.
4. Tap **Move Up** and **Move Down**, as necessary, to place the selected networks in the preferred order.
5. Tap **ok** to send the new settings to the network.
6. From the **Network** tab, select **Automatic** from the **Network selection** drop-down list.
7. Tap **ok** to exit settings.

Phone Info

Use the *Phone Info* tab to view hardware and software information about the phone.

1. Tap **Start > Settings > Personal tab > Phone icon > Phone Info tab**

or

Start > Phone > Menu > Options > Phone Info tab.

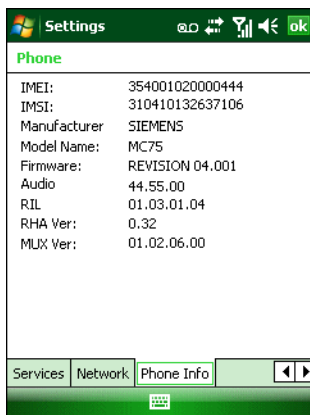

Figure 6-23 MC55 Phone Window - Phone Info Tab

2. Tap **ok** to exit settings.

Network Time Synchronization

The MC55 can be configured to synchronize the clock with the time from the carrier network. A registry key on the MC55 has to be created to enable this feature.

Using a registry editor, navigate to the following:

```
[HKEY_LOCAL_MACHINE\SOFTWARE\Symbol\RIL\RHAMC75]
```

Create the following key:

```
"SyncSystemTime"=dword:00000001
```

where:

```
dword:0 = disabled
```

```
dword:1 = enabled
```

After setting the registry key, warm boot the MC55.

Enhanced Operator Name String

The MC55 is enabled to download and display the name of the GSM network currently logged in to. Four registry keys on the MC55 have to be edited to disable this feature.

Using a registry editor, navigate to each of the following:

```
[HKEY_LOCAL_MACHINE\Software\Microsoft\RIL]
```

```
[HKEY_LOCAL_MACHINE\Software\Microsoft\RIL\Configurations\GSM_MC75]
```

```
[HKEY_LOCAL_MACHINE\Comm\Cellular\Ril]
```

```
[HKEY_LOCAL_MACHINE\Comm\Cellular\Ril\Configurations\GSM_MC75]
```

Edit the following key:

```
"EonsEnable"=dword:1
```

where:

```
dword:0 = disabled
```

```
dword:1 = enabled (default)
```

After setting the registry key, warm boot the MC55.

Service Provider Name Display

The reg key ("UseServiceProviderName") originally was used to fix the dual-line SIM card issue with value 2. But for the Italian Post, the value 1 should be used to show the virtual carrier name (Poste Mobile).

```
[HKEY_LOCAL_MACHINE\Software\Microsoft\RIL]
```

```
"UseServiceProviderName"=dword:1
```

where:

dword:0 = Display provider name

dword:1 - Display service provider name (default)

dword:2 - Display both provider and service provider name

SMS Cell Broadcast

The MC55 can be configured to receive SMS Cell Broadcast messages from the carrier network. Registry keys on the MC55 have to be modified to enable and control this feature.

Using a registry editor, navigate to the following:

[HKEY_LOCAL_MACHINE\Software\Microsoft\RIL\Configurations\GSM_MC75]

Create the following keys:

“EnableCBM”=dword:0

where:

0 = disabled (default)

1 = enabled

“EnableCBMChannels”=“0-65535”

where:

0-65535 = Channel Identifier

“EnableCBMDCS”=“0-255”

where:

0-255 = Message Handling, Coding Scheme and Language settings

After setting the registry key, warm boot the MC55.

Chapter 7 Maintenance & Troubleshooting

Introduction

This chapter includes instructions on cleaning and storing the MC55, and provides troubleshooting solutions for potential problems during MC55 operation.

Maintaining the MC55

For trouble-free service, observe the following tips when using the MC55:

- Do not scratch the screen of the MC55. When working with the MC55, use the supplied stylus or plastic-tipped pens intended for use with a touch-sensitive screen. Never use an actual pen or pencil or other sharp object on the surface of the MC55 screen.

Zebra recommends using a screen protector, p/n KT-67525-01R.

- The touch-sensitive screen of the MC55 is glass. Do not drop the MC55 or subject it to strong impact.
- Protect the MC55 from temperature extremes. Do not leave it on the dashboard of a car on a hot day, and keep it away from heat sources.
- Do not store or use the MC55 in any location that is dusty, damp, or wet.
- Use a soft lens cloth to clean the MC55. If the surface of the MC55 screen becomes soiled, clean it with a soft cloth moistened with a diluted window-cleaning solution.
- Periodically replace the rechargeable battery to ensure maximum battery life and product performance. Battery life depends on individual usage patterns.

- A screen protector is applied to the MC55. Zebra recommends using this to minimize wear and tear. Screen protectors enhance the usability and durability of touch screen displays. Benefits include:
 - Protection from scratches and gouges
 - Durable writing and touch surface with tactile feel
 - Abrasion and chemical resistance
 - Glare reduction
 - Keeping the device's screen looking new
 - Quick and easy installation.

Battery Safety Guidelines

- The area in which the units are charged should be clear of debris and combustible materials or chemicals. Particular care should be taken where the device is charged in a non commercial environment.
- Follow battery usage, storage, and charging guidelines found in the user's guide.
- Improper battery use may result in a fire, explosion, or other hazard.
- To charge the mobile device battery, the battery and charger temperatures must be between +32 °F and +104 °F (0 °C and +40 °C)
- Do not use incompatible batteries and chargers. Use of an incompatible battery or charger may present a risk of fire, explosion, leakage, or other hazard. If you have any questions about the compatibility of a battery or a charger, contact Zebra support.
- To enable authentication of an approved battery, as required by IEEE1725 clause 10.2.1, all batteries will carry a Zebra hologram. Do not fit any battery without checking it has the Zebra authentication hologram.
- Do not disassemble or open, crush, bend or deform, puncture, or shred.
- Severe impact from dropping any battery-operated device on a hard surface could cause the battery to overheat.
- Do not short circuit a battery or allow metallic or conductive objects to contact the battery terminals.
- Do not modify or remanufacture, attempt to insert foreign objects into the battery, immerse or expose to water or other liquids, or expose to fire, explosion, or other hazard.
- Do not leave or store the equipment in or near areas that might get very hot, such as in a parked vehicle or near a radiator or other heat source. Do not place battery into a microwave oven or dryer.
- Battery usage by children should be supervised.
- Please follow local regulations to properly dispose of used re-chargeable batteries.
- Do not dispose of batteries in fire.
- In the event of a battery leak, do not allow the liquid to come in contact with the skin or eyes. If contact has been made, wash the affected area with large amounts of water and seek medical advice.
- If you suspect damage to your equipment or battery, contact Zebra support to arrange for inspection.

Cleaning



CAUTION Always wear eye protection.

Read warning label on compressed air and alcohol product before using.

If you have to use any other solution for medical reasons please contact Zebra for more information.



WARNING! Avoid exposing this product to contact with hot oil or other flammable liquids. If such exposure occurs, unplug the device and clean the product immediately in accordance with these guidelines.

Approved Cleanser Active Ingredients

100% of the active ingredients in any cleaner must consist of one or some combination of the following: isopropyl alcohol, bleach/sodium hypochlorite, hydrogen peroxide or mild dish soap.

Harmful Ingredients

The following chemicals are known to damage the plastics on the MC55 and should not come in contact with the device: ammonia solutions, compounds of amines or ammonia; acetone; ketones; ethers; aromatic and chlorinated hydrocarbons; aqueous or alcoholic alkaline solutions; ethanolamine; toluene; trichloroethylene; benzene; carbolic acid and TB-lysoform.

Cleaning Instructions

Do not apply liquid directly to the MC55. Dampen a soft cloth or use pre-moistened wipes. Do not wrap the device in the cloth or wipe, but gently wipe the unit. Be careful not to let liquid pool around the display window or other places. Allow the unit to air dry before use.

Special Cleaning Notes

Many vinyl gloves contain phthalate additives, which are often not recommended for medical use and are known to be harmful to the housing of the MC55. The MC55 should not be handled while wearing vinyl gloves containing phthalates, or before hands are washed to remove contaminant residue after gloves are removed. If products containing any of the harmful ingredients listed above are used prior to handling the MC55, such as hand sanitizers that contain ethanolamine, hands must be completely dry before handling the MC55 to prevent damage to the plastics.

Materials Required

- Alcohol wipes
- Lens tissue
- Cotton tipped applicators
- Isopropyl alcohol
- Can of compressed air with a tube.

Cleaning the MC55

Housing

Using the alcohol wipes, wipe the housing including keys and in-between keys.

Display

The display can be wiped down with the alcohol wipes, but care should be taken not to allow any pooling of liquid around the edges of the display. Immediately dry the display with a soft, non-abrasive cloth to prevent streaking.

Scanner Exit Window

Wipe the scanner exit window periodically with a lens tissue or other material suitable for cleaning optical material such as eyeglasses.

Connector

1. Remove the main battery from mobile computer.
2. Dip the cotton portion of the cotton tipped applicator in isopropyl alcohol.
3. Rub the cotton portion of the cotton tipped applicator back-and-forth across the connector on the bottom of the MC55. Do not leave any cotton residue on the connector.
4. Repeat at least three times.
5. Use the cotton tipped applicator dipped in alcohol to remove any grease and dirt near the connector area.
6. Use a dry cotton tipped applicator and repeat steps 4 through 6.
7. Spray compressed air on the connector area by pointing the tube/nozzle about ½ inch away from the surface. CAUTION: Do not point nozzle at yourself and others, ensure the nozzle or tube is away from your face.
8. Inspect the area for any grease or dirt, repeat if required.

Cleaning Cradle Connectors

To clean the connectors on a cradle:

1. Remove the DC power cable from the cradle.
2. Dip the cotton portion of the cotton tipped applicator in isopropyl alcohol.
3. Rub the cotton portion of the cotton tipped applicator along the pins of the connector. Slowly move the applicator back-and-forth from one side of the connector to the other. Do not let any cotton residue on the connector.
4. All sides of the connector should also be rubbed with the cotton tipped applicator.
5. Spray compressed air in the connector area by pointing the tube/nozzle about ½ inch away from the surface. CAUTION: do not point nozzle at yourself and others, ensure the nozzle or tube is pointed away from your face.
6. Ensure that there is no lint left by the cotton tipped applicator, remove lint if found.
7. If grease and other dirt can be found on other areas of the cradle, use lint free cloth and alcohol to remove.

8. Allow at least 10 to 30 minutes (depending on ambient temperature and humidity) for the alcohol to air dry before applying power to cradle.

If the temperature is low and humidity is high, longer drying time is required. Warm temperature and dry humidity requires less drying time.

Cleaning Frequency

The cleaning frequency is up to the customer's discretion due to the varied environments in which the mobile devices are used. They may be cleaned as frequently as required. However when used in dirty environments it may be advisable to periodically clean the scanner exit window to ensure optimum scanning performance.

Troubleshooting

MC55

Table 7-1 *Troubleshooting the MC55*

Problem	Cause	Solution
MC55 does not turn on.	Lithium-ion battery not charged.	Charge or replace the lithium-ion battery in the MC55.
	Lithium-ion battery not installed properly.	Ensure battery is installed properly. See Installing the Battery on page 1-4 .
	System crash.	Perform a warm boot. If the MC55 still does not turn on, perform a cold boot. See Resetting the MC55 on page 1-7 .
Rechargeable lithium-ion battery did not charge.	Battery failed.	Replace battery. If the MC55 still does not operate, perform a warm boot, then a cold boot. See Resetting the MC55 on page 1-7 .
	MC55 removed from cradle while battery was charging.	Insert MC55 in cradle. The 2400 mAh battery fully charges in approximately four hours and the 3600 mAh battery charges in approximately six hours.
	Extreme battery temperature.	Battery does not charge if ambient temperature is below 0°C (32°F) or above 40°C (104°F).
Cannot see characters on display.	MC55 not powered on.	Press the Power button.

Table 7-1 Troubleshooting the MC55 (Continued)

Problem	Cause	Solution
During data communication, no data transmitted, or transmitted data was incomplete.	MC55 removed from cradle or disconnected from host computer during communication.	Replace the MC55 in the cradle, or reattach the communication cable and re-transmit.
	Incorrect cable configuration.	See the system administrator.
	Communication software was incorrectly installed or configured.	Perform setup. See Chapter 2, Accessories for details.
No sound.	Volume setting is low or turned off.	Adjust the volume. Adjust the volume. Refer to the <i>MC55 User Guide</i> .
MC55 shuts off.	MC55 is inactive.	The MC55 turns off after a period of inactivity. If the MC55 is running on battery power, set this period from 1 to 5 minutes, in one-minute intervals. If the MC55 is running on external power, set this period to 1, 2, 5, 10, 15, or 30 minutes. Check the Power window by selecting Start > Settings > System tab and tapping the Power icon. Select the Advanced tab and change the setting for a longer delay before the automatic shutoff feature activates.
	Battery is not inserted properly.	Insert the battery properly. See Installing the Battery on page 1-4 .
	Battery is depleted.	Replace the battery.
Tapping the window buttons or icons does not activate the corresponding feature.	Screen is not calibrated correctly.	Re-calibrate the screen. Press Blue key - Backspace key or tap Start > Settings > System tab > Screen icon > Align Screen button.
	The system is not responding.	Warm boot the system. See Resetting the MC55 on page 1-7 .
A message appears stating that the MC55 memory is full.	Too many files stored on the MC55.	Delete unused memos and records. If necessary, save these records on the host computer (or use an SD card for additional memory).
	Too many applications installed on the MC55.	Remove user-installed applications on the MC55 to recover memory. Select Start > Settings > System tab and tap the Remove Programs icon. Select the unused program and tap Remove .
The Charging/Battery Status LED flashes with the Power button is pressed and the MC55 does not turn on.	The MC55's battery is low.	Recharge the battery.

Table 7-1 *Troubleshooting the MC55 (Continued)*

Problem	Cause	Solution
Camera application does not launch.	DataWedge application running.	Stop DataWedge application. Tap Start > Settings > System > Task Manager . Select DataWedge application and tap End Task .
The MC55 does not decode with reading bar code.	Scanning application is not loaded.	Load a scanning application on the MC55. See the system administrator.
	Unreadable bar code.	Ensure the symbol is not defaced.
	Distance between exit window and bar code is incorrect.	Place the MC55 within proper scanning range.
	MC55 is not programmed for the bar code.	Program the MC55 to accept the type of bar code being scanned. Refer to the EMDK or Control Panel application.
	MC55 is not programmed to generate a beep.	If the MC55 does not beep on a good decode, set the application to generate a beep on good decode.
	Battery is low.	If the scanner stops emitting a laser beam upon a trigger press, check the battery level. When the battery is low, the scanner shuts off before the MC55 low battery condition notification. Note: If the scanner is still not reading symbols, contact the distributor or Zebra.
Cannot connect to service provider.	SIM not installed properly.	Re-install SIM card.

Bluetooth Connection

Table 7-2 *Troubleshooting Bluetooth Connection*

Problem	Cause	Solution
MC55 cannot find any Bluetooth devices nearby.	Too far from other Bluetooth devices.	Move closer to the other Bluetooth device(s), within a range of 10 meters.
	The Bluetooth device(s) nearby are not turned on.	Turn on the Bluetooth device(s) to find.
	The Bluetooth device(s) are not in discoverable mode.	Set the Bluetooth device(s) to discoverable mode. If needed, refer to the device's user documentation for help.
There is a delay in the Bluetooth stack re-initializing during a resume from suspend.	This is normal behavior.	No solution required.

Single Slot USB Cradle

Table 7-3 Troubleshooting the Single Slot USB Cradle

Symptom	Possible Cause	Action
LEDs do not light when MC55 or spare battery is inserted.	Cradle is not receiving power.	Ensure the power cable is connected securely to both the cradle and to AC power.
	MC55 is not seated firmly in the cradle.	Remove and re-insert the MC55 into the cradle, ensuring it is firmly seated.
	Spare battery is not seated firmly in the cradle.	Remove and re-insert the spare battery into the charging slot, ensuring it is firmly seated.
MC55 battery is not charging.	MC55 was removed from cradle or cradle was unplugged from AC power too soon.	Ensure cradle is receiving power. Ensure MC55 is seated correctly. Confirm main battery is charging under Start > Settings > System > Power . The 2400 mAh battery fully charges in approximately four hours and the 3600 mAh battery charges in approximately six hours.
	Battery is faulty.	Verify that other batteries charge properly. If so, replace the faulty battery.
	The MC55 is not fully seated in the cradle.	Remove and re-insert the MC55 into the cradle, ensuring it is firmly seated.
	Ambient temperature of the cradle is too warm.	Move the cradle to an area where the ambient temperature is between 0°C and 35°C.
Spare battery is not charging.	Battery not fully seated in charging slot.	Remove and re-insert the spare battery in the cradle, ensuring it is firmly seated.
	Battery inserted incorrectly.	Re-insert the battery so the charging contacts on the battery align with the contacts on the cradle.
	Battery is faulty.	Verify that other batteries charge properly. If so, replace the faulty battery.
During data communication, no data transmits, or transmitted data was incomplete.	MC55 removed from cradle during communication.	Replace MC55 in cradle and retransmit.
	Communication software is not installed or configured properly.	Perform setup as described in Chapter 3, ActiveSync .

Four Slot Ethernet Cradle

Table 7-4 Troubleshooting the Four Slot Ethernet Cradle

Symptom	Cause	Solution
Battery is not charging.	Battery was removed from the charger or charger was unplugged from AC power too soon.	Replace the MC55 in the cradle. The 2400 mAh battery fully charges in approximately four hours and the 3600 mAh battery charges in approximately six hours. Tap Start > Settings > System > Power to view battery status.
	Battery is faulty.	Verify that other batteries charge properly. If so, replace the faulty battery.
	MC55 is not inserted correctly in the cradle.	Remove the MC55 and reinsert it correctly. Verify charging is active. Tap Start > Settings > System > Power to view battery status.
	Ambient temperature of the cradle is too warm.	Move the cradle to an area where the ambient temperature is between 0°C and 35°C.
During communication, no data was transmitted, or transmitted data was incomplete.	MC55 removed from cradle during communication.	Replace MC55 in cradle and retransmit.
	MC55 has no active connection.	An icon is visible in the status bar if a connection is active.

Vehicle Cradle

Table 7-5 Troubleshooting the Vehicle Cradle

Symptom	Possible Cause	Action
MC55 battery charging LED does not light up.	Cradle is not receiving power.	Ensure the power input cable is securely connected to the cradle's power port.
MC55 battery is not recharging.	MC55 was removed from the cradle too soon.	Replace the MC55 in the cradle. The 2400 mAh battery fully charges in approximately four hours and the 3600 mAh battery charges in approximately six hours.
	Battery is faulty.	Replace the battery.
	MC55 is not placed correctly in the cradle.	Remove the MC55 from the cradle, and re-insert correctly. If the battery still does not charge, contact customer support. The MC55 battery charging LED slowly blinks amber when the MC55 is correctly inserted and charging.
	Ambient temperature of the cradle is too warm.	Move to an area where the ambient temperature is between 0°C and 35°C.

Four Slot Spare Battery Charger

Table 7-6 *Troubleshooting the Four Slot Spare Battery Charger*

Symptom	Possible Cause	Action
Battery not charging.	Battery was removed from the charger or charger was unplugged from AC power too soon.	Re-insert the battery in the charger or re-connect the charger's power supply. The 2400 mAh battery fully charges in approximately four hours and the 3600 mAh battery charges in approximately six hours.
	Battery is faulty.	Verify that other batteries charge properly. If so, replace the faulty battery.
	Battery contacts not connected to charger.	Verify that the battery is seated in the battery well correctly with the contacts facing down.

Cables

Table 7-7 *Troubleshooting the Cables*

Symptom	Possible Cause	Action
MC55 battery is not charging.	MC55 was disconnected from AC power too soon.	Connect the power cable correctly. Confirm main battery is charging under Start > Settings > System > Power . The 2400 mAh battery fully charges in approximately four hours and the 3600 mAh battery charges in approximately six hours.
	Battery is faulty.	Verify that other batteries charge properly. If so, replace the faulty battery.
	The MC55 is not fully attached to power.	Detach and re-attach the power cable to the MC55, ensuring it is firmly connected.
During data communication, no data transmits, or transmitted data was incomplete.	Cable was disconnected from MC55 during communications.	Re-attach the cable and retransmit.
	Incorrect cable configuration.	See the system administrator.
	Communication software is not installed or configured properly.	Perform setup as described in <i>the Chapter 3, ActiveSync</i> .

Trigger Handle

Table 7-8 *Trigger Handle*

Problem	Cause	Solution
Scan line does not appear when trigger is pressed.	MC55 is not attached properly to the Trigger Handle and is not making contact with the connector.	Remove the MC55 from the Trigger Handle and reinsert.
	MC55 does not contain a scanning application.	Load a scanning application on the MC55. Refer to the <i>MC55 Integrator Guide</i> .
	Scanning application is not active.	Start the scanning application.
	MC55 Trigger Setting not installed or set properly.	See Install Trigger Settings Software on MC55 for instructions on installing the software.
MC55 battery does not charge when Trigger Handle is placed in a cradle.	Trigger Handle is not properly seated in the cradle.	Remove the Trigger Handle from the cradle and reinsert.
	Power is not available to the cradle.	Ensure that power connections to the cradle are connected properly.
Cannot print to printer.	Printer cable not connected properly.	Ensure cable is connected properly to the printer and Trigger Handle.
MC55 does not wake from suspend mode when trigger is pressed.	The trigger only wakes the MC55 from the suspend mode if a scanning application is active.	Press a key on the MC55 to wake from the suspend mode.

Appendix A Technical Specifications

MC55 Technical Specifications

The following table summarizes the MC55's intended operating environment and technical hardware specifications.

Table A-1 MC55 EDA Technical Specifications

Item	Description
Physical Characteristics	
Dimensions	MC5574 (3600 mAh battery): Height: 15.2 cm (6.0 in.) Width: 7.7 cm (3.03 in.) Depth: 2.7 cm (1.10 in.) MC5590 (2400 mAh battery): Height: 14.7 cm (5.78 in.) Width: 7.7 cm (3.03 in.) Depth: 2.6 cm (1.06 in.) MC5590/MC55A0 (3600 mAh battery): Height: 14.7 cm (5.78 in.) Width: 7.7 cm (3.03 in.) Depth: 2.7 cm (1.10 in.)
Weight	MC5574: 359 g (12.5 oz.) with 3600 mAh battery MC5590: 315.0 g (11.11 oz.) with 2400 mAh battery 338.2 g (11.93 oz.) with 3600 mAh battery MC55A0: 338.2 g (11.93 oz.) with 3600 mAh battery

Table A-1 MC55 EDA Technical Specifications (Continued)

Item	Description
Display	MC5574/MC5590: Transflective color 3.5" QVGA with backlight, TFT-LCD, 65K colors, 240 W x 320 H MC55A0: Pentile 3.5" VGA with backlight, TFT-LCD, 65k colors, 480 x 640 H, 650 nits
Touch Panel	Glass analog resistive touch
Backlight	LED backlight
Battery Pack	Rechargeable Lithium Ion 3.7V, 2400 or 3600 mAh Smart battery MC55A0-HC: Rechargeable Lithium Ion 3.7V, 3600 mAh Smart battery
Backup Battery	MC55A0: Ni-MH battery (rechargeable) 18 mAh 2.4 V (not user accessible).
Expansion Slot	User accessible microSD slot MC5574/MC5590: up to 16 GB. MC55A0: up to 32 GB.
Network Connections	High-speed USB, host or client, Bluetooth and WiFi. USB host mode available with custom cables only.
Notification	LED and audible alert
Keypad Options	MC5574, MC5590, MC55A0: 26-key numeric, 44-key QWERTY, 44-key AZERTY, 44-key QWERTZ, PIM MC55A0-HC: 26-key numeric, 44-key QWERTY
Audio	Speaker, receiver, microphone, software support for full duplex capability, Bluetooth stereo.
Performance Characteristics	
CPU	MC5574 and MC5590: XScale™ Bulverde PXA270 processor at 520 MHz MC55A0: XScale PXA320 processor at 806 MHz
Operating System	MC5574: Microsoft® Windows Mobile™ 6.X Professional MC5590: Microsoft® Windows Mobile™ 6.X Classic MC55A0: Microsoft® Windows Mobile™ 6.5.X Classic
Memory	MC5574/MC5590: 128 MB RAM/256 MB Flash or 128 MB RAM/512 MB Flash MC55A0: 256 MB RAM/1 GB Flash
Interface/Communications	USB 1.1 Full-speed
Output Power	USB: 5 VDC @ 200 mA max.
User Environment	
Operating Temperature	-10°C to 50°C (14°F to 122°F)
Storage Temperature	-40°C to 70°C (-40°F to 158°F)
Charging Temperature	32°F to 104°F / 0° C to 40° C
Humidity	95% non-condensing

Table A-1 MC55 EDA Technical Specifications (Continued)

Item	Description
Drop Specification	MC5574/MC5590: Multiple 1.2 m (4 ft.) drops to concrete across operating temperature range. Meets and exceeds MIL-STD 810G. MC55A0: Multiple 1.8 m (6 ft.) drops to concrete across the operating temperature range per MIL-STD 810G specifications.
Tumble	MC5574/MC5590: 250 0.5 m (1.6 ft.) tumbles (500 drops) MC55A0: 1000 0.5 m (1.6 ft.) tumbles (2000 drops) per IEC tumble specifications
Electrostatic Discharge (ESD)	+/-15kVdc air discharge, +/-8kVdc direct discharge, +/-8kVdc indirect discharge
Sealing	MC5574/MC5590: IP54 MC55A0: IP64 per IEC sealing specifications
Wireless WAN Data and Voice Communications	
Wireless Wide Area Network (WWAN) radios	MC5574: GSM: GPRS/EDGE (850, 900, 1800 and 1900 MHz)
Antenna	External
Wireless LAN Data and Voice Communications	
Wireless Local Area Network (WLAN) radio	MC5574: Dual-mode IEEE® 802.11b/g MC5590/MC55A0: Tri-mode IEEE® 802.11a/b/g
Data Rates Supported	1, 2, 5.5, 6, 9, 11, 12, 18, 24, 36, 48, and 54 Mbps
Operating Channels	MC5574: Chan 1-13 (2412-2472 MHz), Chan 14 (2484 MHz) Japan only; actual operating channels/frequencies depend on regulatory rules and certification agency MC5590/MC55A0: Chan 34-165 (5040 – 5825 MHz), Chan 1-13 (2412-2472 MHz), Chan 14 (2484 MHz) Japan only; actual operating channels/frequencies depend on regulatory rules and certification agency
Security	WEP (40 or 128 bit), TKIP, AES, WPA (Personal or Enterprise), WPA2 (Personal or Enterprise), 802.1x, EAP-TLS, TTLS (CHAP, MS-CHAP, MS-CHAPv2, PAP or MD5), PEAP (TLS, MSCHAPv2, EAP-GTC), LEAP, EAP-FAST (TLS, MS-CHAPv2, EAP-GTC) On OEM Versions 02.35.000 and above: CCXv4 certified; support for IPv6; FIPS 140-2 Certified.
Spreading Technique	Direct Sequence Spread Spectrum (DSSS) and Orthogonal Frequency Division Multiplexing (OFDM)
Antenna	Internal
Voice Communication	Voice-over-IP ready (with P2P, PBX, PTT clients), Wi-Fi™-certified, IEEE 802.11 a/b/g direct sequence wireless LAN

Table A-1 MC55 EDA Technical Specifications (Continued)

Item	Description
Wireless PAN Data and Voice Communications	
Bluetooth	Class II, v 2.0 EDR; on-board antenna.
Global Positioning System	
GPS	SiRF III. On-board antenna.
Data Capture Specifications	
Options	1D laser scanner 2D imager 1D laser scanner and color camera 2D imager and color camera
Linear 1D Scanner (SE950) Specifications (MC5574 and MC5590 only)	
Optical Resolution	0.005 in. minimum element width
Roll	+/- 30° from vertical
Pitch Angle	+/- 65° from normal
Skew Tolerance	+/- 60° from normal
Ambient Light	Sunlight: 8,000 ft. candles (86,112 Lux) Artificial Light: 450 ft. candles (4,844 Lux)
Shock	2,000 +/- 5% G
Scan Rate	50 (+/- 6) scans/sec (bidirectional)
Scan Angle	46.5° (typical)
Laser Power	1.0 mW nominal
Linear 1D Scanner (SE960) Specifications (MC55A0 only)	
Optical Resolution	0.005 in. minimum element width
Roll	+/- 35° from vertical
Pitch Angle	+/- 65° from normal
Skew Tolerance	+/- 40° from normal
Ambient Light	Sunlight: 10,000 ft. candles (107,640 Lux) Artificial Light: 450 ft. candles (4,844 Lux)
Shock	2,000 +/- 5% G
Scan Rate	104 (+/- 12) scans/sec (bidirectional)
Scan Angle	47° (typical)
Laser Power	1.7 mW nominal

Table A-1 MC55 EDA Technical Specifications (Continued)

Item	Description
2D Imager Engine (SE4400) Specifications (MC5574 only)	
Field of View	Horizontal - 32.2° Vertical - 24.5°
Optical Resolution	640 H x 480 V pixels (gray scale)
Roll	360°
Pitch Angle	+/- 60° from normal
Skew Tolerance	+/- 50° from normal
Ambient Light	Total darkness to 9,000 ft. candles (96,900 Lux)
Shock	2,000 +/- 5% G
Focal Distance from Front of Engine	Near: 5 inches Far: 9 inches
Aiming Element (VLD)	650 nm +/- 5 nm
Illumination Element (LED)	635 nm +/- 20 nm
2D Imager Engine (SE4500-SR) Specifications (MC5590 and MC55A0 only)	
Field of View	Horizontal - 40° Vertical - 25°
Optical Resolution	752 H x 480 V pixels (gray scale)
Roll	360°
Pitch Angle	+/- 60° from normal
Skew Tolerance	+/- 60° from normal
Ambient Light	9,000 ft. candles (96,900 Lux)
Shock	2,000 +/- 5% G
Focal Distance from Front of Engine	Near: 5 inches Far: 9 inches
Aiming Element (VLD)	655 nm +/- 10 nm
Illumination Element (LED)	625 nm +/- 5 nm LEDs (2x)
2D Imager Engine (SE4500-HD) Specifications (MC5590 and MC55A0 only)	
Field of View	Horizontal - 38.4° Vertical - 24.9°
Optical Resolution	752 H x 480 V pixels (gray scale)
Roll	360°

Table A-1 MC55 EDA Technical Specifications (Continued)

Item	Description
Pitch Angle	+/- 60° from normal
Skew Tolerance	+/- 60° from normal
Ambient Light	9,000 ft. candles (96,900 Lux)
Shock	2,000 +/- 5% G
Aiming Element (VLD)	655 nm +/- 10 nm
Illumination Element (LED)	625 nm +/- 5 nm LEDs (2x)
2D Imager Engine (SE4500-DL) Specifications (MC5590 and MC55A0 only)	
Field of View	Horizontal - 39.2° Vertical - 25.4°
Optical Resolution	752 H x 480 V pixels (gray scale)
Roll	360°
Pitch Angle	+/- 60° from normal
Skew Tolerance	+/- 60° from normal
Ambient Light	9,000 ft. candles (96,900 Lux)
Shock	2,000 +/- 5% G
Aiming Element (VLD)	655 nm +/- 10 nm
Illumination Element (LED)	625 nm +/- 5 nm LEDs (2x)
Camera Specifications	
Resolution	2 Mega pixel with flash and auto focus.

Decode Zones

SE950 Decode Zones

The decode zones for the SE950 scan engines are shown in *Figure A-1* and *Figure A-3*. The figures shown are typical values. *Table A-3* lists the typical distances for selected bar code densities. The minimum element width (or “symbol density”) is the width in mils of the narrowest element (bar or space) in the symbol.

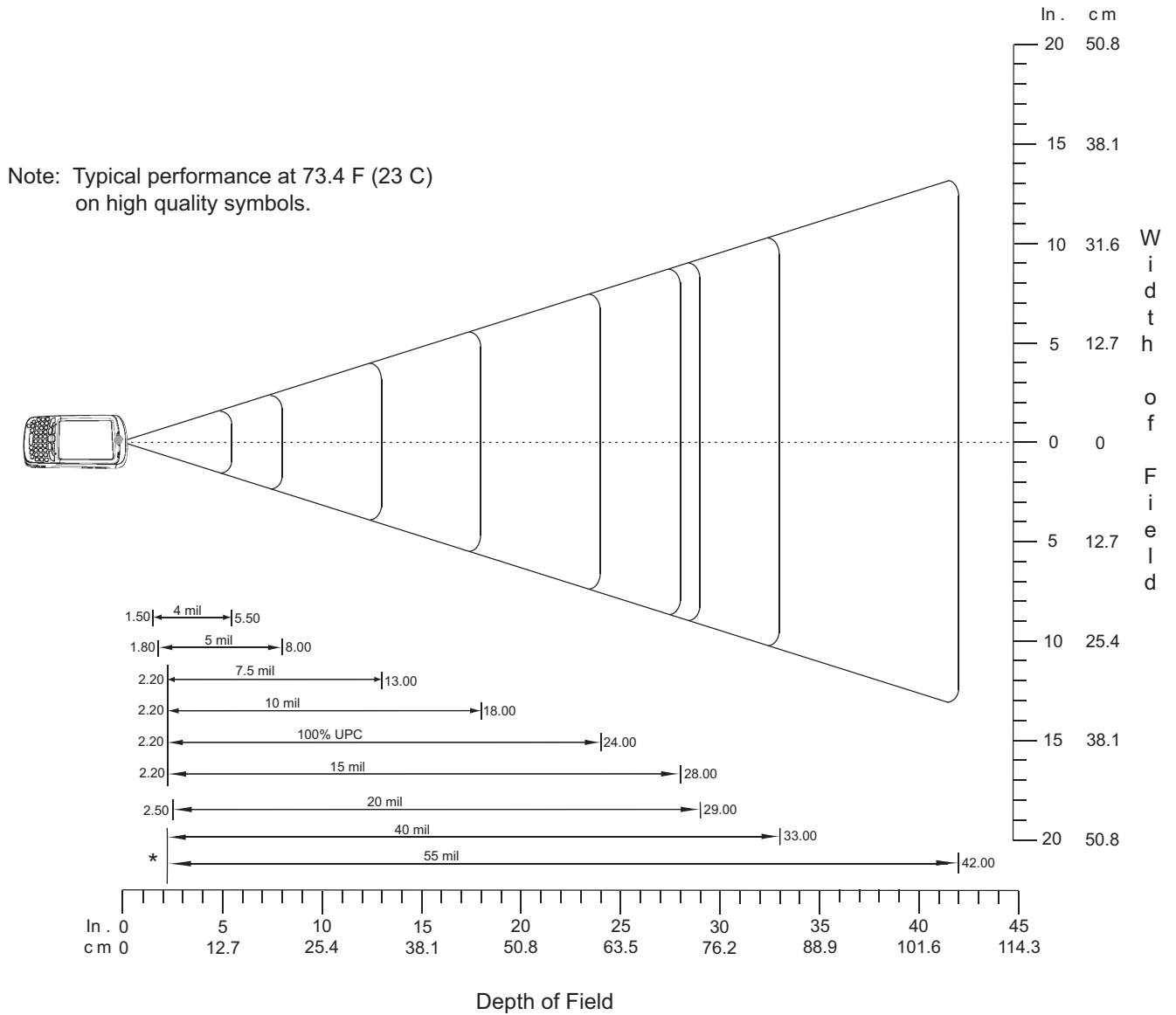
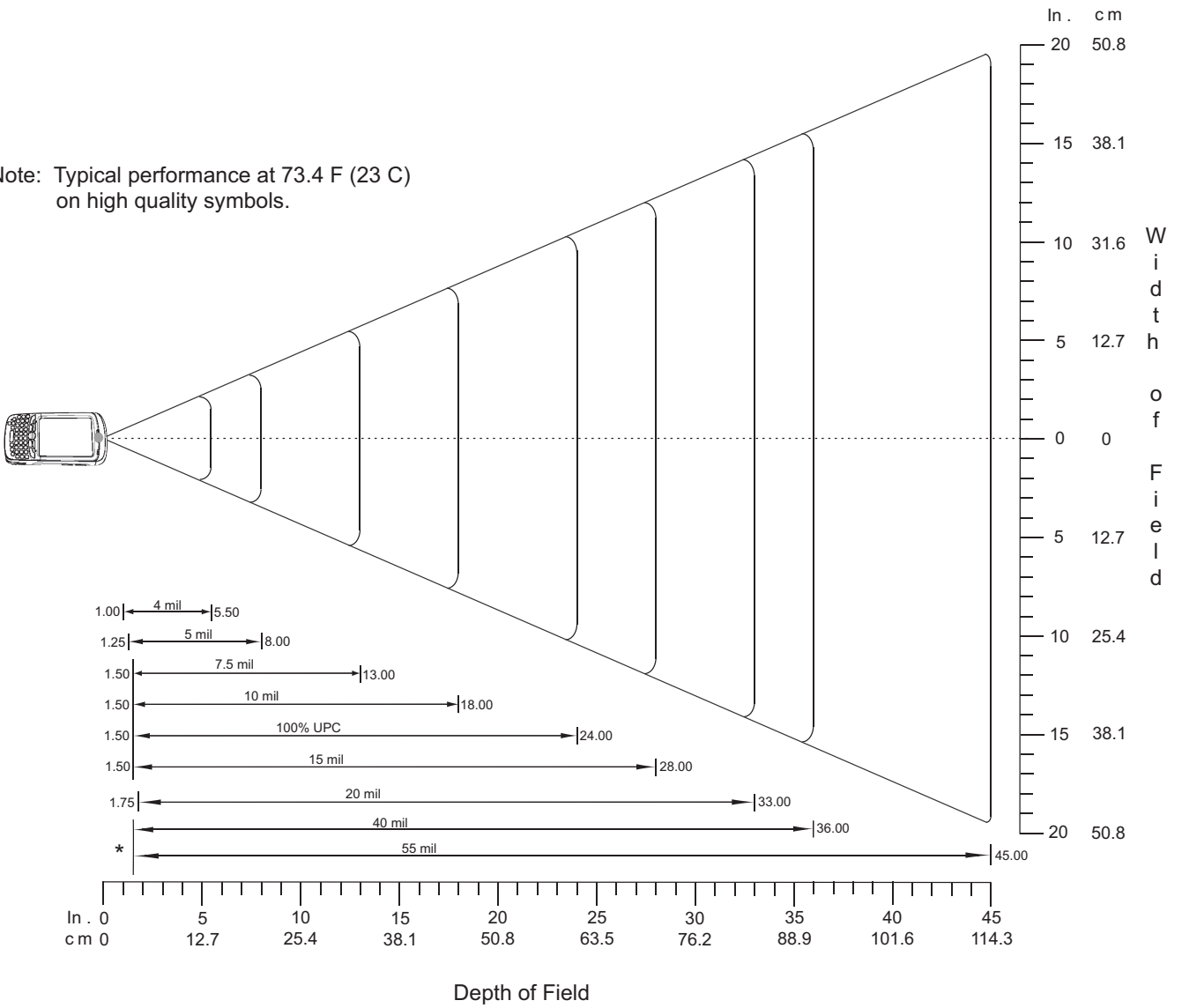

Figure A-1 SE950 35° Decode Zone

Note: Typical performance at 73.4 F (23 C)
on high quality symbols.



*Minimum distance determined by symbol length and scan angle

Figure A-2 SE950 47° Decode Zone

Table A-2 SE950 Decode Distances

Symbol Density/ Bar Code Type/ W-N Ratio	Bar Code Content/ Contrast ¹	35 ° Typical Working Ranges		47 ° Typical Working Ranges	
		Near	Far	Near	Far
4.0 mil Code 39; 2.5:1	ABCDEFGH 80% MRD	1.50 in 3.81 cm	5.50 in 13.97 cm	1.00 in 2.50 cm	5.50 in 13.97 cm
5.0 mil Code 39; 2.5:1	ABCDEFGH 80% MRD	1.80 in 4.57 cm	8.00 in 20.32 cm	1.25 in 3.18 cm	8.00 in 20.32 cm
7.5 mil Code 39; 2.5:1	ABCDEF 80% MRD	2.20 in 5.59 cm	13.00 in 33.02 cm	1.50 in 3.81 cm	13.00 in 33.02 cm
10 mil Code 39; 2.5:1	ABCDE 90% MRD	2.20 in 5.59 cm	18.00 in 45.72 cm	1.50 in 3.81 cm	18.00 in 45.72 cm
13 mil 100% UPC	12345678905 90% MRD	2.20 in 5.59 cm	24.00 in 60.96 cm	1.50 in 3.81 cm	24.00 in 60.96 cm
15 mil Code 39; 2.5:1	ABCD 80% MRD	2.20 in 5.59 cm	28.00 in 71.12 cm	1.50 in 3.81 cm	28.00 in 71.12 cm
20 mil Code 39; 2.2:1	123 80% MRD	2.50 in 6.35 cm	29.00 in 73.66 cm	1.75 in 4.45 cm	33.00 in 83.82 cm
40 mil Code 39; 2.2:1	AB 80% MRD	X	33.00 in 83.82 cm	X	36.00 in 91.44 cm
55 mil Code 39; 2.2:1	CD 80% MRD	X	42.00 in 106.68 cm	X	45.00 in 114.30 cm

Notes:
 1. CONTRAST measured as Mean Reflective Difference (MRD) at 650 nm.
 2. Near ranges on lower densities (not specified) are largely dependent upon the width of the bar code and the scan angle.
 3. Working range specifications at ambient temperature (23°C), Photographic quality symbols. pitch=10°, roll=0°, skew=0°, ambient light < 150 ft-candles.
 4. X - Dependent on width of bar code.
 5. Distances measured from front edge of scan engine chassis.

SE960 Decode Zones

Figure A-3 shows the decode zone for the SE960 scan engine. The figures are typical values. Table A-3 lists the typical distances for selected bar code densities. The minimum element width (or "symbol density") is the width in mils of the narrowest element (bar or space) in the symbol.

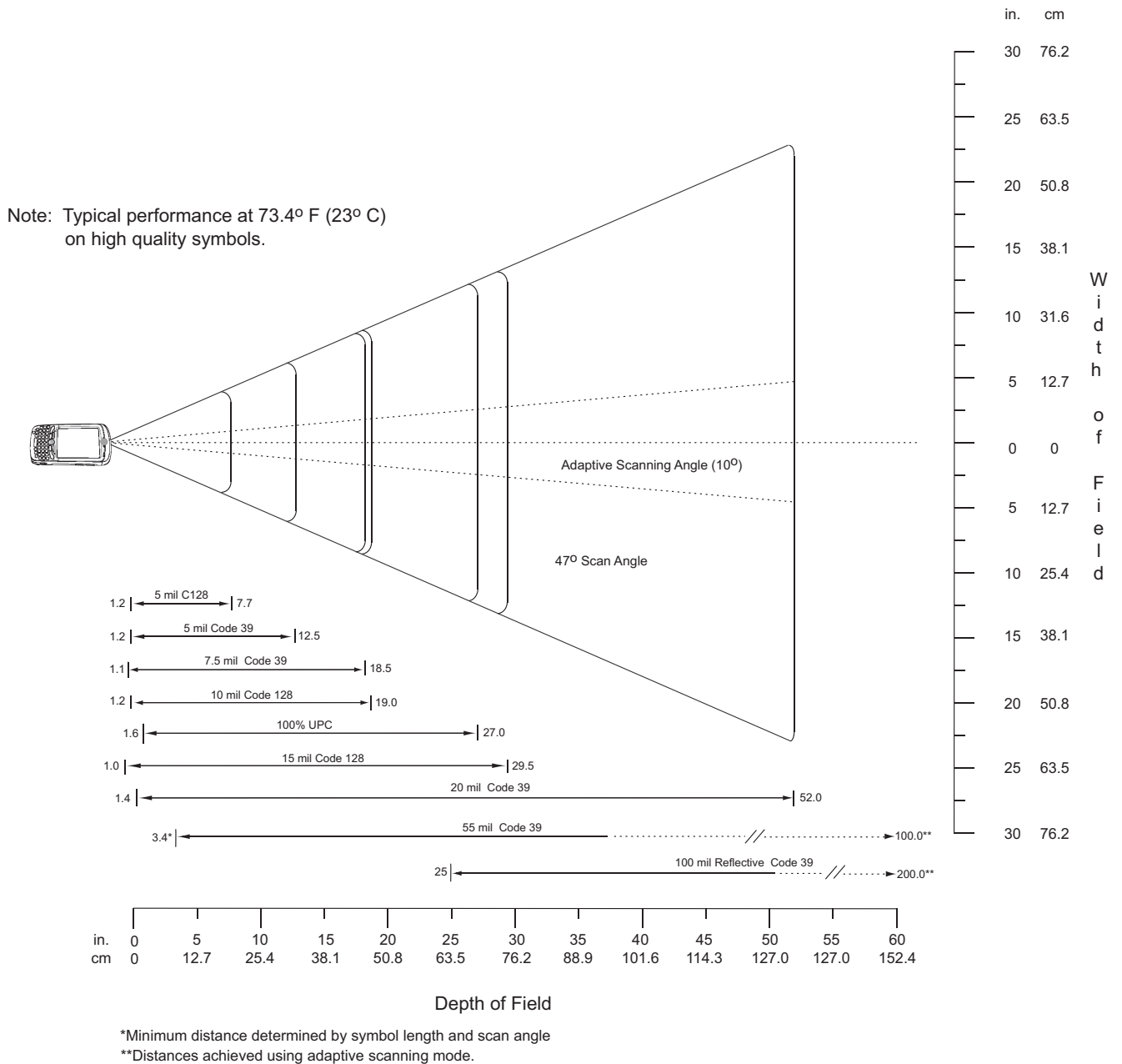

Figure A-3 SE960 Decode Zone

Table A-3 SE960 Decode Distances

Symbol Density/ Bar Code Type/ W-N Ratio	Bar Code Content/ Contrast ^{Note 1}	Typical Working Ranges	
		Near	Far
5.0 mil Code 128	1234 80% MRD	1.2 in 3.05 cm	7.7 in 19.56 cm
5.0 mil Code 39; 2.5:1	ABCDEFGH 80% MRD	1.2 in 3.05 cm	12.5 in 31.75 cm
7.5 mil Code 39; 2.5:1	ABCDEF 80% MRD	1.1 in 2.79 cm	18.5 in 46.99 cm
10 mil Code 128	1234 80% MRD	1.2 in 3.05 cm Note 3	19.0 in 48.26 cm
13 mil 100% UPC	12345678905 80% MRD	1.6 in 4.06 cm	27.0 in 68.58 cm
15 mil Code 128	1234 80% MRD	1.0 in 2.54 cm Note 3	29.5 in 74.93 cm
20 mil Code 39; 2.2:1	123 80% MRD	1.4 in 3.56 cm Note 3	52.0 in 132.08 cm
55 mil Code 39; 2.2:1	CD 80% MRD	3.4 in 8.64 cm Note 3	100.0 in 254.00 cm
100 mil Code 39; 3.0:1 reflective	123456 80% MRD	2 ft 60.96cm Note 3	17 ft 518.16 cm

Notes:

1. Contrast measured as Mean Reflective Difference (MRD) at 650 nm.
2. Working range specifications at ambient temperature (23°C), photographic quality symbols. Pitch=10°, roll=0°, skew=0°, ambient light < 150 ft-candles using Zebra or equivalent decoder.
3. Dependent on width of bar code.
4. Distances measured from front edge of scan engine chassis.

SE4400 Decode Zones

Near Focus

Figure A-4 shows the decode zone for the Near Focus SE4400. Typical values appear. Table A-3 lists the typical distances for selected bar code densities. The minimum element width (or “symbol density”) is the width in mils of the narrowest element (bar or space) in the symbol.

Note: Typical performance at 73°F (23°C)
on high quality symbols in normal room light.
Vcc = 3.3V

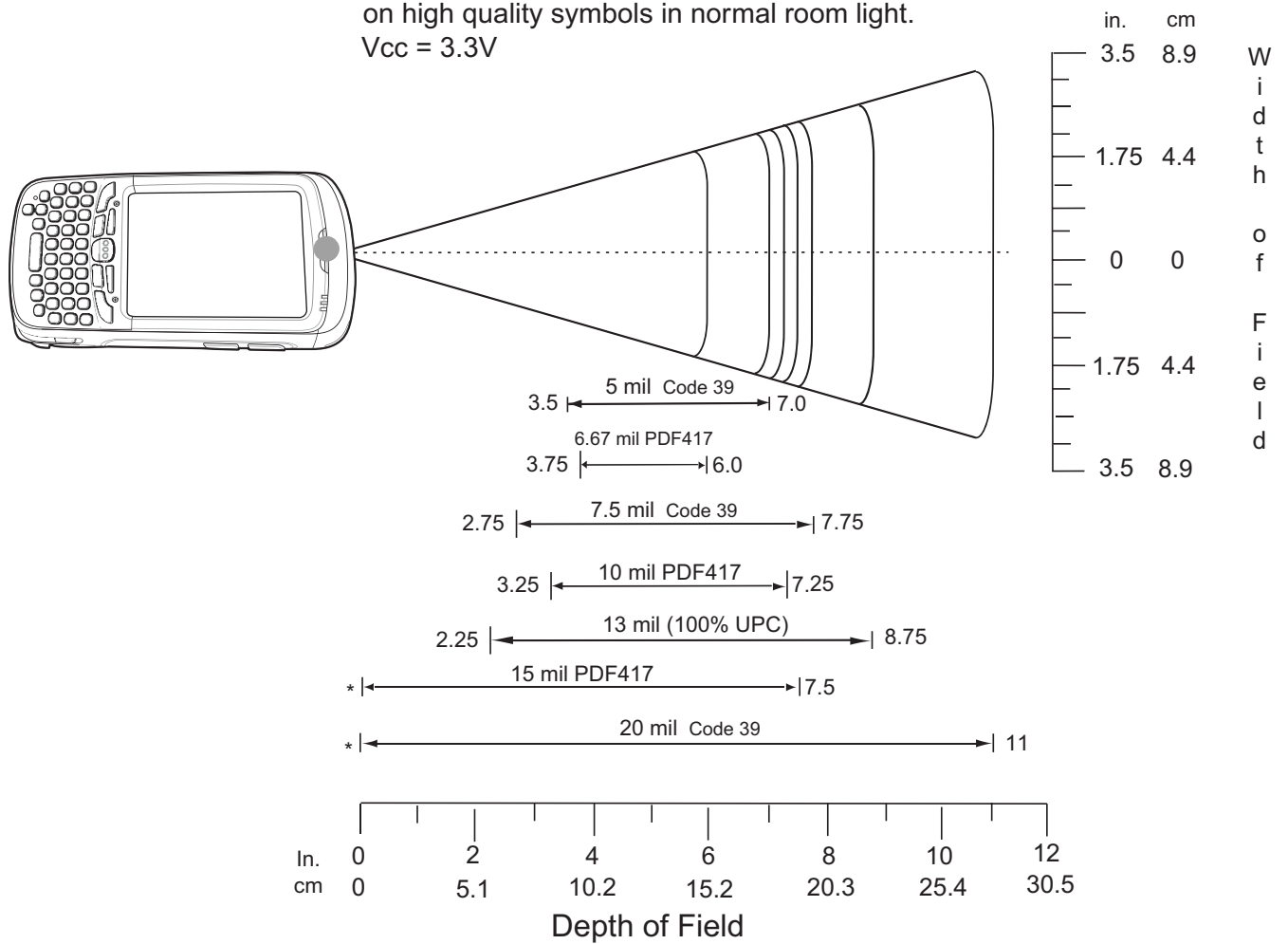

* Minimum distance determined by symbol length and scan angle.

Figure A-4 SE4400 Near Focus Decode Zone

Table A-4 SE4400 Near Focus Decode Distances

Symbol Density/ Bar Code Type	Bar Code Content/ Contrast ^{Note 2}	Typical Working Ranges	
		Near	Far
5.0 mil Code 39	ABCDEFGH 80% MRD	3.5 in 8.9 cm	7.0 in 17.8 cm
6.67 mil PDF417	4 Col, 20 Rows 80% MRD	3.75 in 9.5 cm	6.0 in 15.2 cm
7.5 mil Code 39	ABCDEF 80% MRD	2.75 in 7.0 cm	7.75 in 19.7 cm
10 mil PDF417	3 Col, 17 Rows 80% MRD	3.25 in 8.3 cm	7.25 in 18.4 cm
13 mil UPC-A	012345678905 80% MRD	2.25 in 5.7 cm	8.75 in 22.2 cm
15 mil PDF417	80% MRD	Note 1	7.5 in 19.1 cm
20 mil Code 39	123 80% MRD	Note 1	11.0 in 27.9 cm

Notes:

1. Near distances are field-of-view (FOV) limited.
2. Contrast is measured as Mean Reflective Difference (MRD) at 670 nm.
3. Working range specifications at temperature = 23°C, pitch=15°, roll=0°, skew=0°, photographic quality, ambient light ~30 ft-c, humidity 45-70% RH.
4. Distances measured from front edge of scan engine chassis.

Far Focus

Figure A-8 shows the decode zone for the Far Focus SE4400. Typical values appear. Table A-8 lists the typical distances for selected bar code densities. The minimum element width (or “symbol density”) is the width in mils of the narrowest element (bar or space) in the symbol.

Note: Typical performance at 73°F (23°C)
 on high quality symbols in normal room light.
 Vcc = 3.3V

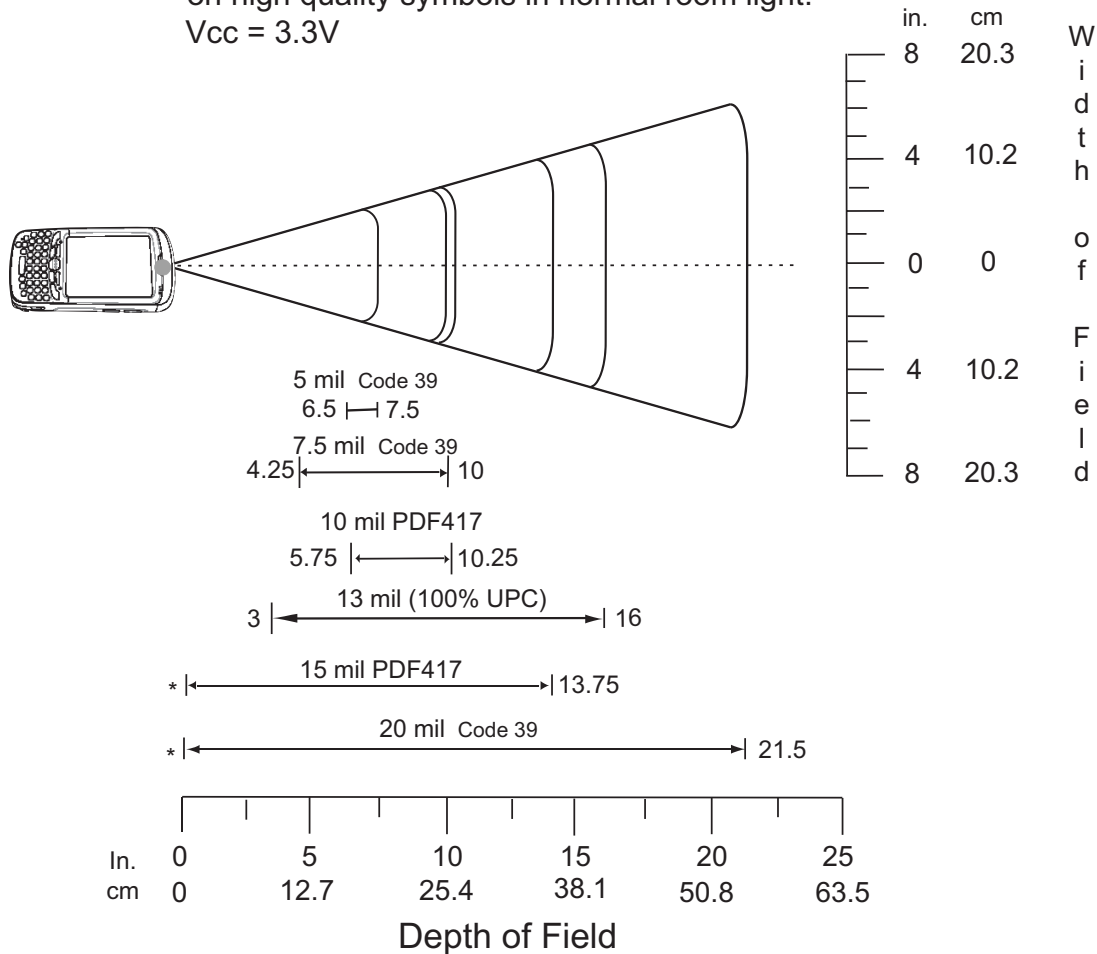

* Minimum distance determined by symbol length and scan angle.

Figure A-5 SE4400 Far Focus Decode Zone

Table A-5 SE4400 Far Focus Decode Distances

Symbol Density/ Bar Code Type	Bar Code Content/ Contrast ^{Note 2}	Typical Working Ranges	
		Near	Far
5.0 mil Code 39	ABCDEFGH 80% MRD	6.5 in 16.5 cm	7.5 in 19.1 cm
7.5 mil Code 39	ABCDEF 80% MRD	4.25 in 10.8 cm	10.0 in 25.4 cm
10 mil PDF417	3 Col, 17 Rows 80% MRD	5.75 in 14.6 cm	10.25 in 26.0 cm
13 mil UPC-A	012345678905 80% MRD	3.0 in 7.6 cm	16.0 in 40.6 cm
15 mil PDF417	80% MRD	Note 1	13.75 in 34.9 cm
20 mil Code 39	123 80% MRD	Note 1	21.5 in 51.6 cm

Notes:

1. Near distances are FOV limited.
2. Contrast is measured as Mean Reflective Difference (MRD) at 670 nm.
3. Working range specifications at temperature = 23°C, pitch=15°, roll=0°, skew=0°, photographic quality, ambient light ~30 ft-c, humidity 45-70% RH.
4. Distances measured from front edge of scan engine chassis.

SE4500 Decode Zones

SE4500-SR

Figure A-4 shows the decode zone for the SE4500-SR. Typical values appear. Table A-3 lists the typical distances for selected bar code densities. The minimum element width (or “symbol density”) is the width in mils of the narrowest element (bar or space) in the symbol.

Note: Typical performance at 73°F (23°C)
on high quality symbols in normal room light.

Vcc = 3.3V

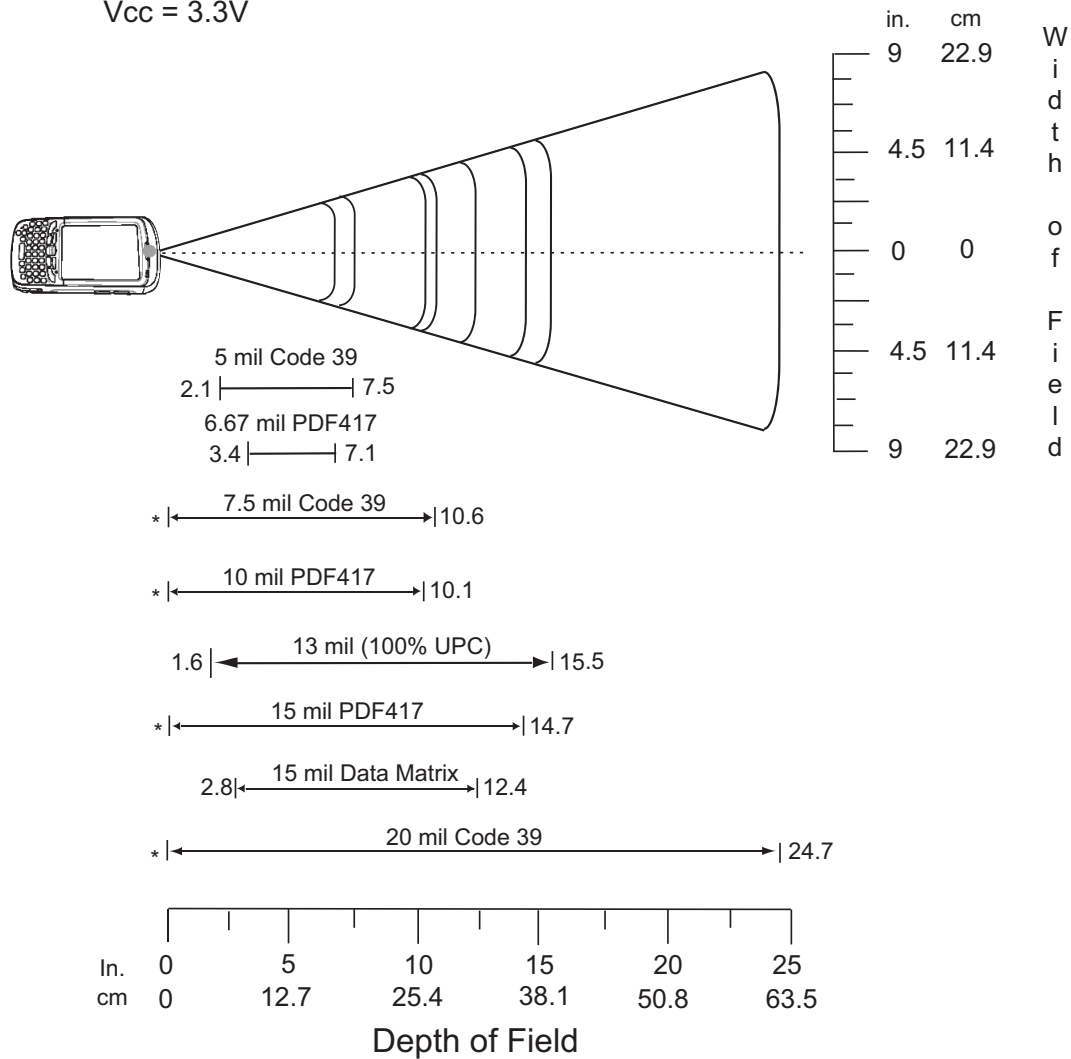

* Minimum distance determined by symbol length and scan angle.

Figure A-6 SE4500-SR Decode Zone

Table A-6 SE4500-SR Decode Distances

Symbol Density/ Bar Code Type	Bar Code Content/ Contrast ^{Note 2}	Typical Working Ranges	
		Near	Far
5.0 mil Code 39	ABCDEFGH 80% MRD	2.1 in 5.33 cm	7.5 in 19.05 cm
6.67 mil PDF417	4 Col, 20 Rows 80% MRD	3.4 in 8.64 cm	7.1 in 18.03 cm
7.5 mil Code 39	ABCDEF 80% MRD	Note 1	10.6 in 26.92 cm
10 mil PDF417	3 Col, 17 Rows 80% MRD	Note 1	10.1 in 25.65 cm
13 mil UPC-A	012345678905 80% MRD	1.6 in 5.08 cm	15.5 in 39.37 cm
15 mil PDF417	80% MRD	Note 1	14.7 in 37.34 cm
15 mil Data Matrix	18 x 18 Modules 80% MRD	2.8 in 7.11 cm	12.4 in 31.50 cm
20 mil Code 39	123 80% MRD	Note 1	24.7 in 62.74 cm

Notes:

1. Near distances are field-of-view (FOV) limited.
2. Contrast is measured as Mean Reflective Difference (MRD) at 670 nm.
3. Working range specifications at temperature = 23°C, pitch=18°, roll=0°, skew=0°, photographic quality, ambient light ~30 ft-c, humidity 45-70% RH.
4. Distances measured from front edge of scan engine chassis.

SE4500-DL

Figure A-7 shows the decode zone for the SE4500-DL. Typical values appear. Table A-7 lists the typical distances for selected bar code densities. The minimum element width (or “symbol density”) is the width in mils of the narrowest element (bar or space) in the symbol.

Note: Typical performance at 73°F (23°C)
on high quality symbols in normal room light.
Vcc = 3.3V

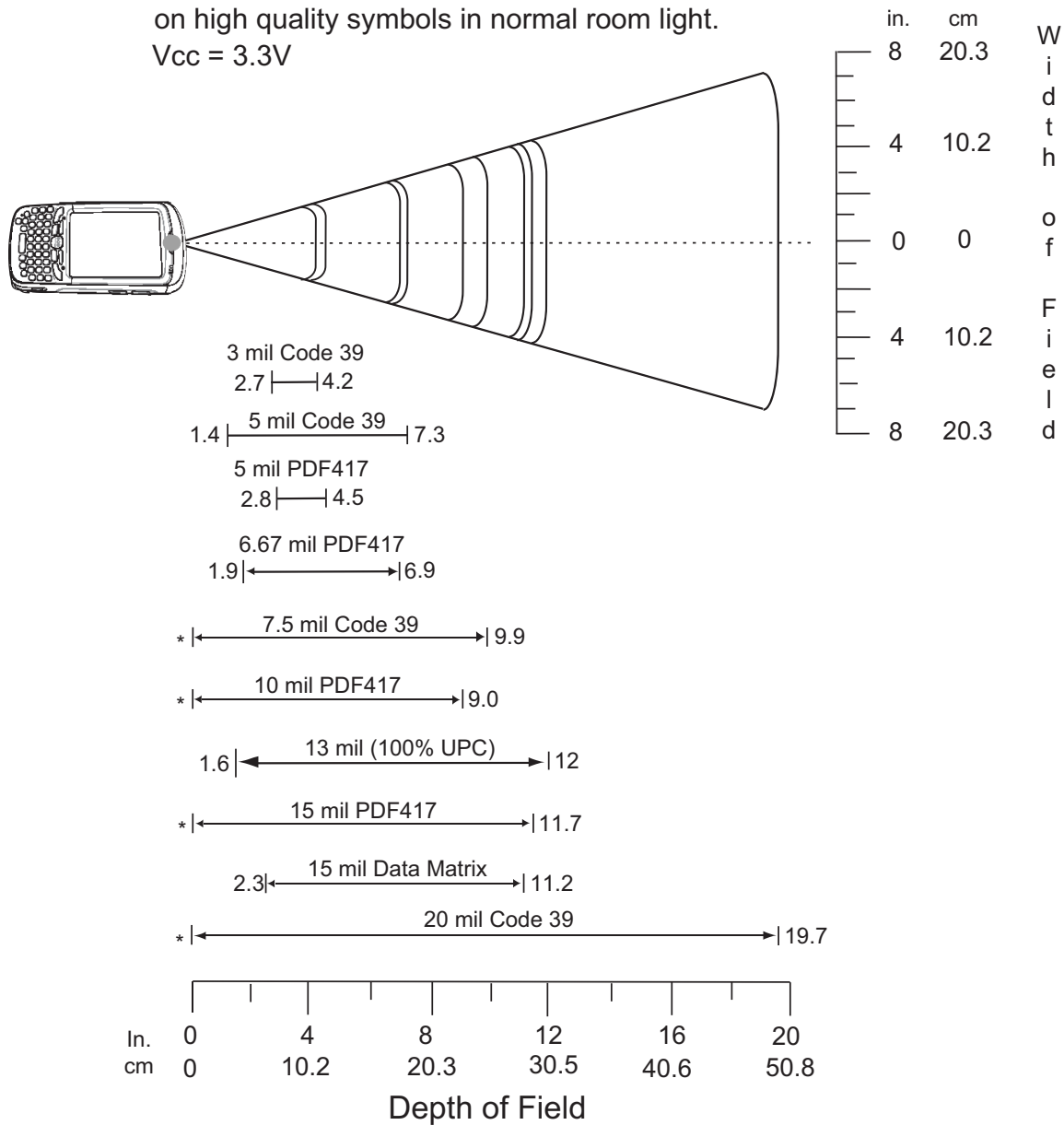

* Minimum distance determined by symbol length and scan angle.

Figure A-7 SE4500-DL Decode Zone

Table A-7 SE4500-DL Decode Distances

Symbol Density/ Bar Code Type	Bar Code Content/ Contrast ^{Note 2}	Typical Working Ranges	
		Near	Far
3.0 mil Code 39	80% MRD	2.7 in 6.86 cm	4.2 in 10.67 cm
5.0 mil Code 39	ABCDEFGH 80% MRD	1.4 in 3.56 cm	7.3 in 18.54 cm
5.0 mil PDF417	80% MRD	2.8 in 7.11 cm	4.5 in 11.43 cm
6.67 mil PDF417	4 Col, 20 Rows 80% MRD	1.9 in 4.83 cm	6.9 in 17.53 cm
7.5 mil Code 39	ABCDEF 80% MRD	Note 1	9.9 in 25.15 cm
10 mil PDF417	3 Col, 17 Rows 80% MRD	Note 1	9.0 in 22.86 cm
13 mil UPC-A	012345678905 80% MRD	1.6 in 5.08 cm	12.0 in 30.48 cm
15 mil PDF417	80% MRD	Note 1	11.7 in 29.72 cm
15 mil Data Matrix	18 x 18 Modules 80% MRD	2.3 in 5.84 cm	11.2 in 28.45 cm
20 mil Code 39	123 80% MRD	Note 1	19.7 in 50.04 cm

Notes:

1. Near distances are FOV limited.
2. Contrast is measured as Mean Reflective Difference (MRD) at 670 nm.
3. Working range specifications at temperature = 23°C, pitch=18°, roll=0°, skew=0°, photographic quality, ambient light ~30 ft-c, humidity 45-70%RH.
4. Distances measured from front edge of scan engine chassis.

SE4500-HD

Figure A-8 shows the decode zone for the SE4500-HD. Typical values appear. Table A-8 lists the typical distances for selected bar code densities. The minimum element width (or “symbol density”) is the width in mils of the narrowest element (bar or space) in the symbol.

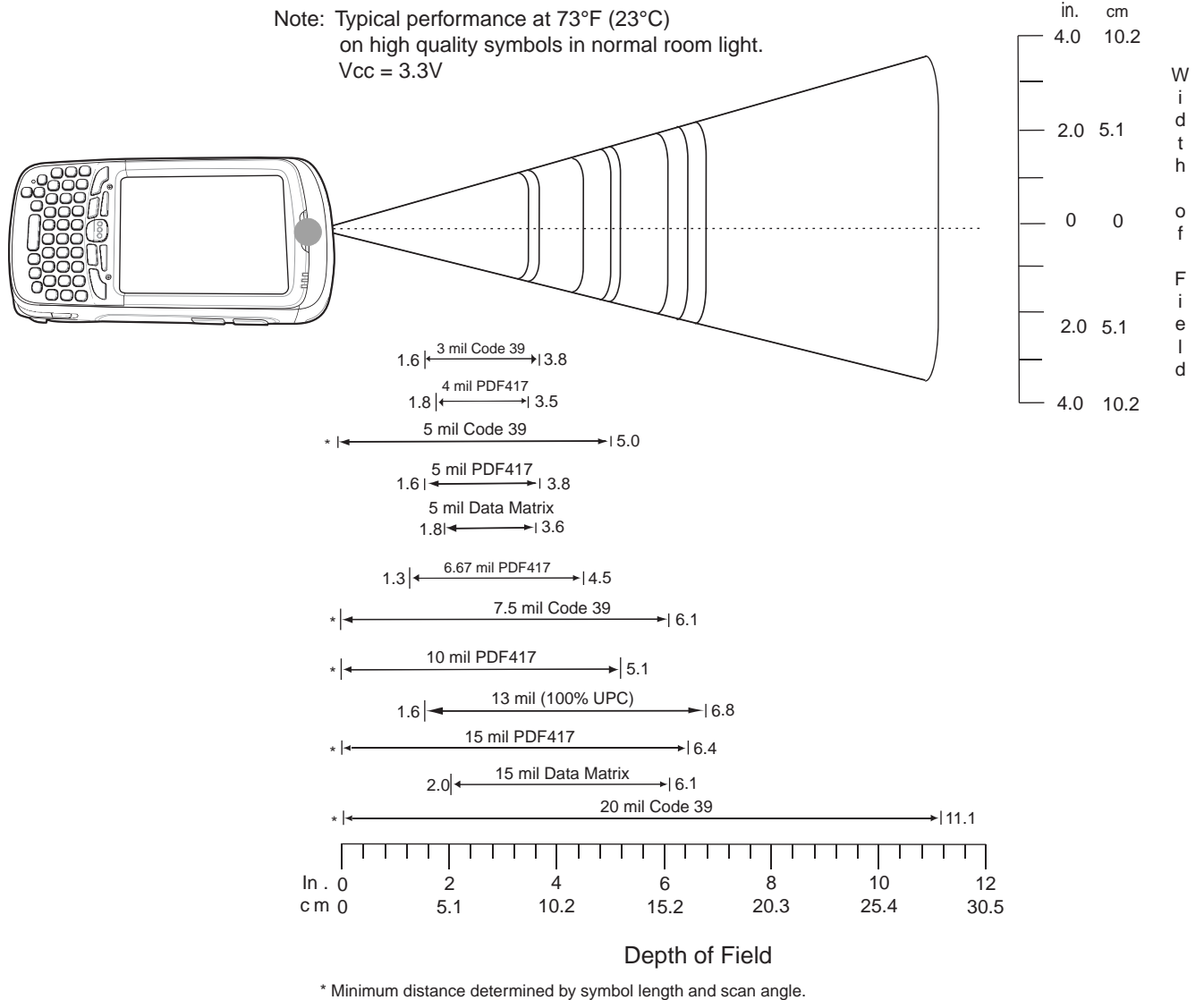

Figure A-8 SE4500-HD Decode Zone

Table A-8 SE4500-HD Decode Distances

Symbol Density/ Bar Code Type	Bar Code Content/ Contrast ^{Note 2}	Typical Working Ranges	
		Near	Far
3.0 mil Code 39	80% MRD	1.6 in 4.06 cm	3.8 in 9.65 cm
4.0 mil PDF417	80% MRD	1.8 in 4.57 cm	3.5 in 8.89 cm
5.0 mil Code 39	ABCDEFGH 80% MRD	Note 1	5.0 in 12.70 cm
5.0 mil PDF417	80% MRD	1.6 in 4.06 cm	3.8 in 9.65 cm
5 mil Data Matrix	18 x 18 Modules 80% MRD	1.8 in 4.57 cm	3.6 in 9.15 cm
6.67 mil PDF417	4 Col, 20 Rows 80% MRD	1.3 in 3.30 cm	4.5 in 11.43 cm
7.5 mil Code 39	ABCDEF 80% MRD	Note 1	6.1 in 15.49 cm
10 mil PDF417	3 Col, 17 Rows 80% MRD	Note 1	5.1 in 12.95 cm
13 mil UPC-A	012345678905 80% MRD	1.6 in 4.06 cm	6.8 in 17.27 cm
15 mil PDF417	80% MRD	Note 1	6.4 in 16.26 cm
15 mil Data Matrix	18 x 18 Modules 80% MRD	2.0 in 5.08 cm	6.1 in 15.49 cm
20.0 mil Code 39	123 80% MRD	Note 1	11.1 in 28.19 cm

Notes:

1. Near distances are FOV limited.
2. Contrast is measured as Mean Reflective Difference (MRD) at 670 nm.
3. Working range specifications at temperature = 23°C, pitch=18°, roll=0°, skew=0°, photographic quality, ambient light ~30 ft-c, humidity 45-70% RH.
4. Distances measured from front edge of scan engine chassis.

MC55 External Connector Pin-Outs

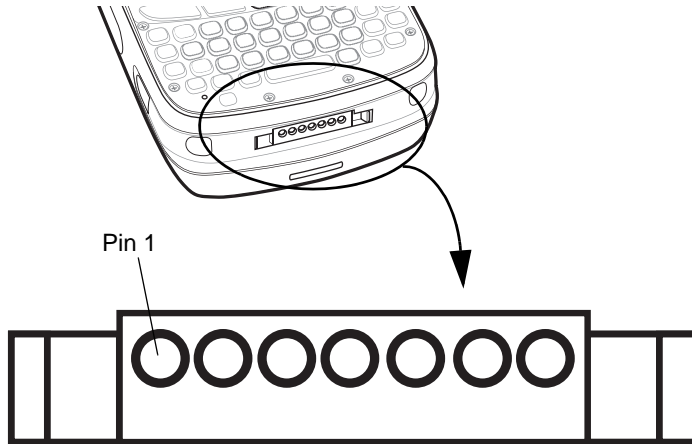

Figure A-9 External Connector

Table A-9 External Connector Pin-Outs

Pin	Description
1	External Trigger/Cradle Detect
2	USB_ID
3	5.4 VDC
4	USB_VCC
5	USB_D-
6	USB_D+
7	Ground

MC55 Accessory Specifications

Single Slot USB Cradle

Table A-10 *Single Slot USB Cradle Technical Specifications*

Feature	Description
Dimensions	Height: 7.1 cm (2.80 in.) Width: 11.0 cm (4.33 in.) Depth: 15.0 cm (5.91 in.)
Weight	210 g (7.41 oz)
Input Voltage	12 VDC
Power Consumption	30 watts
Interface	USB
Operating Temperature	0°C to 50°C (32°F to 122°F)
Storage Temperature	-40°C to 70°C (-40°F to 158°F)
Charging Temperature	0°C to 40°C (32°F to 104°F)
Humidity	5% to 95% non-condensing
Drop	76.2 cm (30.0 in.) drops to vinyl tiled concrete at room temperature
Electrostatic Discharge (ESD)	+/- 15 kV air +/- 8 kV contact

Four Slot Battery Charger Cradle

Table A-11 *Four Slot Battery Charger Technical Specifications*

Feature	Description
Dimensions	Height: 4.7 cm (1.85 in.) Width: 15.5 cm (6.10 in.) Depth: 21.0 cm (8.27 in.)
Weight	384 g (13.55 oz)
Input Voltage	12 VDC
Power Consumption	30 watts
Operating Temperature	0°C to 40°C (32°F to 104°F)
Storage Temperature	-40°C to 70°C (-40°F to 158°F)
Charging Temperature	0°C to 40°C (32°F to 104°F)

Table A-11 *Four Slot Battery Charger Technical Specifications (Continued)*

Feature	Description
Humidity	5% to 95% non-condensing
Drop	76.2 cm (30.0 in.) drops to vinyl tiled concrete at room temperature
Electrostatic Discharge (ESD)	+/- 15 kV air +/- 8 kV contact

Four Slot Charge Only Cradle

Table A-12 *Four Slot Charge Only Cradle Technical Specifications*

Feature	Description
Dimensions	Height: 13.7 cm (5.39 in.) Width: 46.8 cm (18.43 in.) Depth: 9.9 cm (3.90 in.)
Weight	1115 g (39.33 oz)
Input Voltage	12 VDC
Power Consumption	100 watts
Operating Temperature	0°C to 50°C (32°F to 122°F)
Storage Temperature	-40°C to 70°C (-40°F to 158°F)
Charging Temperature	0°C to 40°C (32°F to 104°F)
Humidity	5% to 95% non-condensing
Drop	76.2 cm (30.0 in.) drops to vinyl tiled concrete at room temperature
Electrostatic Discharge (ESD)	+/- 15 kV air +/- 8 kV contact

Four Slot Ethernet Cradle

Table A-13 *Four Slot Ethernet Cradle Technical Specifications*

Feature	Description
Dimensions	Height: 13.7 cm (5.39 in.) Width: 46.8 cm (18.43 in.) Depth: 9.9 cm (3.90 in.)
Weight	1115 g (39.33 oz)
Input Voltage	12 VDC
Power Consumption	100 watts

Table A-13 *Four Slot Ethernet Cradle Technical Specifications (Continued)*

Feature	Description
Operating Temperature	0°C to 50°C (32°F to 122°F)
Storage Temperature	-40°C to 70°C (-40°F to 158°F)
Charging Temperature	0°C to 40°C (32°F to 104°F)
Humidity	5% to 95% non-condensing
Drop	76.2 cm (30.0 in.) drops to vinyl tiled concrete at room temperature
Electrostatic Discharge (ESD)	+/- 15 kV air +/- 8 kV contact

Vehicle Cradle

Table A-14 *Vehicle Cradle Technical Specifications*

Feature	Description
Dimensions	Height: 10.4 cm (4.09 in.) Width: 11.1 cm (4.37 in.) Depth: 6.9 cm (2.72 in.)
Weight	240 g (8.47 oz)
Input Power	9 - 32 VDC
Operating Temperature	-20°C to 50°C (-4°F to 122°F)
Storage Temperature	-40°C to 70°C (-40°F to 158°F)
Charging Temperature	0°C to 40°C (32°C to 104°F)
Humidity	10% to 95% non-condensing
Drop	76.2 cm (30.0 in.) drops to vinyl tiled concrete at room temperature
Electrostatic Discharge (ESD)	+/- 15 kV air +/- 8 kV contact

Magstripe Reader

Table A-15 *Magstripe Reader (MSR) Technical Specifications*

Feature	Description
Dimensions	8.4 cm x 9.4 cm (3.3 inches x 3.7 inches)
Weight	79.4 g (2.8 oz.)
Interface	Serial with baud rate up to 19,200
Format	ANSI, ISO, AAMVA, CA DMV, user-configurable generic format
Swipe Speed	5 to 50 in. (127 to 1270 mm) /sec, bi-directional
Decoders	Generic, Raw Data
Mode	Buffered, unbuffered
Track Reading Capabilities	Tracks 1 and 3: 210 bpi Track 2: 75 and 210 bpi, autodetect
Operating Temperature	32° to 122° F (-10° to 50° C)
Storage Temperature	-40° to 158° F (-40° to 70° C)
Humidity	5% to 95% non-condensing
Drop	4 ft. (1.22 m) drops to concrete
Electrostatic Discharge (ESD)	+/- 15 kV air +/- 8 kV contact

Cables

Table A-16 *USB Charging Cable Technical Specifications*

Feature	Description
Length	161.9 cm (63.74 in.)
Operating Temperature	-10°C to 50°C (14°F to 122°F)
Storage Temperature	-40°C to 70°C (-40°F to 158°F)
Humidity	10% to 95% non-condensing
Electrostatic Discharge (ESD)	+/- 15 kV air +/- 8 kV contact

Table A-17 Charge Only Cable Technical Specifications

Feature	Description
Length	28.0 cm (11.0 in.)
Operating Temperature	-10°C to 50°C (14°F to 122°F)
Storage Temperature	-40°C to 70°C (-40°F to 158°F)
Humidity	10% to 95% non-condensing
Electrostatic Discharge (ESD)	+/- 15 kV air +/- 8 kV contact

Table A-18 Auto Charge Cable Technical Specifications

Feature	Description
Length	169 cm (66.5 in.)
Input Voltage	12 - 24 VDC
Operating Temperature	-10°C to 50°C (14°F to 122°F)
Storage Temperature	-40°C to 70°C (-40°F to 158°F)
Humidity	10% to 95% non-condensing
Electrostatic Discharge (ESD)	+/- 15 kV air +/- 8 kV contact

Table A-19 DEX Cable Technical Specifications

Feature	Description
Length	111.76 cm (44.0 in.)
Operating Temperature	-10°C to 50°C (14°F to 122°F)
Storage Temperature	-40°C to 70°C (-40°F to 158°F)
Humidity	10% to 95% non-condensing
Electrostatic Discharge (ESD)	+/- 15 kV air +/- 8 kV contact

Appendix B Special Software Configurations

Bluetooth Configuration Settings

The MC55 supports both the Microsoft Bluetooth stack and the StoneStreet One Bluetooth stack. Only one Bluetooth stack can be used at a time. By default, the StoneStreet One Bluetooth stack is enabled. A registry key on the MC55 can be modified to disable the StoneStreet One stack and enable the Microsoft stack.

Using a registry editor, navigate to the following:

[HKEY_LOCAL_MACHINE\Software\SymbolBluetooth

Edit the following key:

“SSStack”=dword:1

where:

0 = disable StoneStreet One stack and enable Microsoft stack

1 = enable StoneStreet One stack and disable Microsoft stack (default)

After setting the registry key, warm boot the MC55.

Battery Usage Threshold Setting

✓ **NOTE** Battery Usage Threshold setting is only available on MC55A0 configurations.

By default the Battery Usage Threshold value is set to a pre-defined value (400 by default). To change the threshold value, a registry key must be created to allow changing this value.

A battery becomes unhealthy when the *Battery Usage Indication* reach a predefined threshold (end of usable life).

✓ **NOTE** The point at which a battery becomes unhealthy may vary depending upon the environment and charging conditions

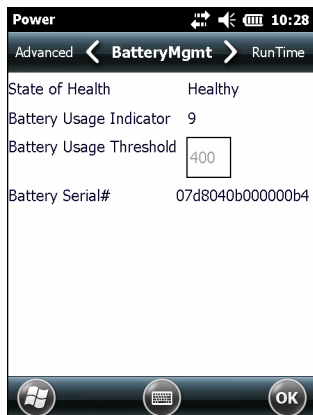

Figure B-1 Power BatteryMgmt Tab

Registry Setting

Create the following registry key:

[HKEY_LOCAL_MACHINE\ControlPanel\Power]

“EnableCycleCntThresholdEdit”=DWORD:0

where:

dword:0 = Enable threshold change

Warm boot the MC55A0 to have the registry setting take effect.

1. Tap **Start > Settings > System > Power > BatteryMgmt** tab.

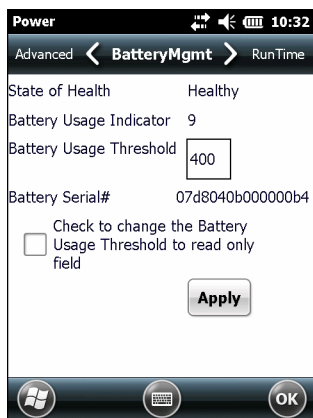

Figure B-2 BatteryMgmt Tab with Threshold Change Checkbox

2. In the **Battery Usage Threshold** text box, enter a new value.
3. Select the **Check to change the Battery Age Threshold to read only field** checkbox.
4. Tap **Apply**.

Tap **ok**. The new value is set and then the registry key is deleted.

Appendix C Windows Mobile 6.5

Introduction

This appendix describes the new features in the latest version of the operating system OEM version with Windows Mobile 6.5. These include:

- Finger scrolling functionality
- New Home screen
- New Start menu
- New Lock screen
- RS507 support
- Assisted GPS support
- USB Configuration
- Custom UI Settings.

Finger Scrolling

Windows Mobile 6.5 adds finger scrolling capabilities to the display. Finger scrolling can be used to scroll up and down web pages, documents, and lists such as the contacts list, file list, message list, calendar appointments list, and more.

When finger scrolling, swipe or flick your finger on the screen.

To scroll down, swipe your finger upward on the screen. To scroll up, swipe your finger downward on the screen.

To auto-scroll, flick your finger upward or downward on the screen. Touch the screen to stop scrolling.

Home Screen

The default home screen on the MC55 is the Windows Mobile Home screen. The Home screen contains a Status Bar at the top of the screen and a Tile Bar at the bottom of the screen.

The Home screen is scrollable and contains a list of application plug-ins and an Information Status bar. The Information Status bar highlights the application plug-in that is under it and provides additional information.

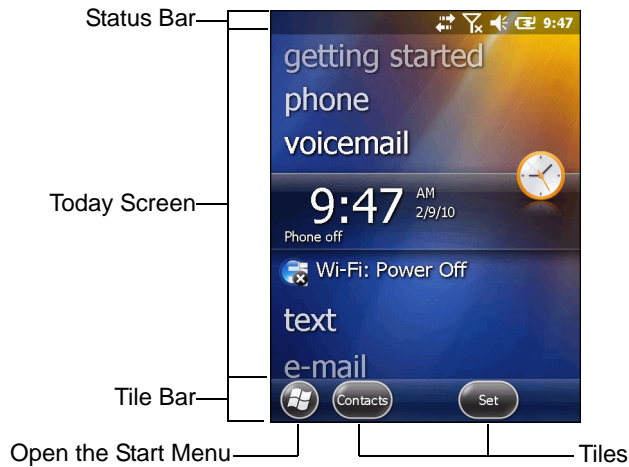

Figure C-1 Windows Mobile Home Screen

Touch and hold the screen with your finger and move the Home screen up and down. As the application names move under the Information Status bar, information relevant to that application appear in the bar.

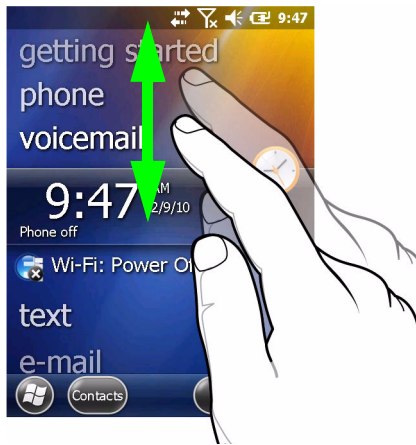

Figure C-2 Moving Today Screen

You can also touch and hold the Information Status bar and move it up and down over an application name. Remove your finger and the Information Status bar and application name center in the screen.

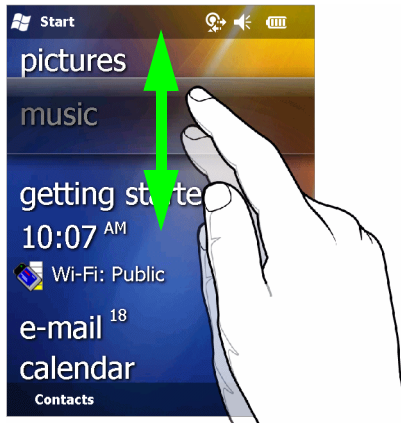

Figure C-3 *Moving Information Status Bar*

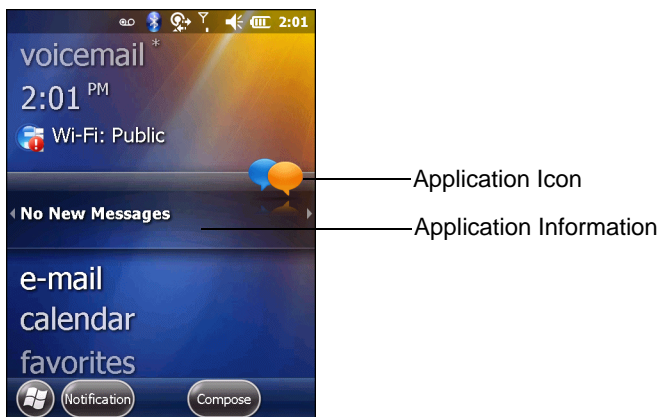



Figure C-4 *Information Bar Example*

To customize the Home screen, tap  > **Settings** > **Today**. On the horizontal scroll, use **Appearance** to customize the background and the **Items** to change the display format.

Classic Today Screen

The user can change to the classic Today screen layout that is used in Windows Mobile 6.1.

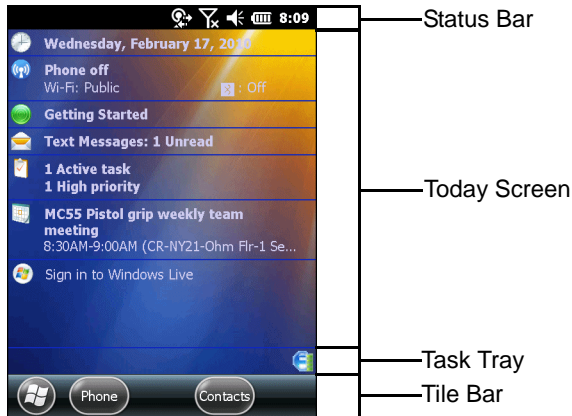

Figure C-5 Classic Today Screen

To change to the classic view tap > **Settings** > **Home** > **Items**.

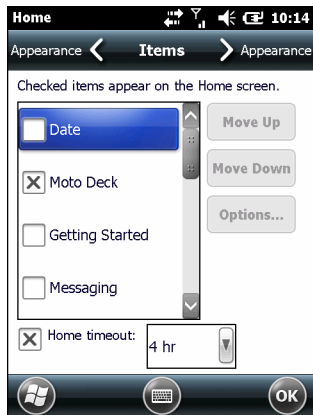







Figure C-6 Home Screen Settings

Deselect the **Windows Default** checkbox and select any of the other checkboxes.

Tap .

The task bar at the bottom of the screen can contain the task tray icons listed in [Table C-1](#).

Table C-1 *Task Tray Icons*

Icon	Name	Description
	Wireless connection status	Wireless connection status icon. Indicates WLAN signal strength and opens the Wireless Applications menu.
	Bluetooth Enabled	The Bluetooth Enabled icon appears in the task tray and indicates that the Bluetooth radio is on (Displays only if the StoneStreet One Bluetooth stack is enabled).
	Bluetooth Disabled	The Bluetooth Disabled icon appears in the task tray and indicates that the Bluetooth radio is off (Displays only if the StoneStreet One Bluetooth stack is enabled).
	Bluetooth Communication	The Bluetooth Communication icon appears in the task tray and indicates that the mobile computer is communicating with another Bluetooth device (Displays only if the StoneStreet One Bluetooth stack is enabled).
	IST	Opens the IST control panel.
	ActiveSync	The ActiveSync icon appears in the task tray and indicates an active serial connection between the mobile computer and the development computer.

Status Bar

The **Status Bar** at the top of the screen displays the status icons listed in [Table C-2](#).

**Figure C-7** *Status Bar Icons*

Table C-2 Status Bar Icons







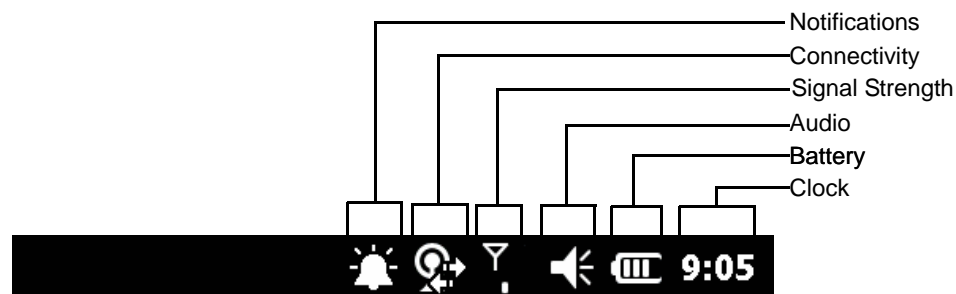









































Icon	Description	Icon	Description
Notifications			
	Indicates a reminder of an upcoming calendar event.		Notification that one or more instant messages were received.
	Notification that one or more e-mail/text messages were received.		Notification that one or more voice messages were received.
	There are more notification icons than can be displayed.		
Connectivity			
	Connection is active.		Connection is not active.
	Synchronization is occurring.		Wi-Fi available.
	Wi-Fi in use.		HSDPA available. (GSM only)
	3G available. (GSM only)		GPRS available. (GSM only)
	EGPRS available. (GSM only)		1xRTT available. (CDMA only)
	EVDO Rev. 0 available. (CDMA only)		EVDO Rev. A available. (CDMA only)
	Dormant State - no data transmission during a 1x or EVDO connection. (CDMA only)		Roaming.
WAN			
	Call missed.		Dialing while no SIM card is installed.
	Voice call in progress.		Calls are forwarded.
	Call on hold.		Speakerphone is on.
	Wi-Fi on/good signal.		Wi-fi off.
	No Wi-Fi service or searching.		HSDPA connecting. (GSM only)
	HSDPA in use. (GSM only)		3G connecting. (GSM only)

Table C-2 Status Bar Icons (Continued)

Icon	Description	Icon	Description
	3G in use. (GSM only)		GPRS connecting. (GSM only)
	GPRS in use. (GSM only)		EGPRS connecting. (GSM only)
	EGPRS in use. (GSM only)		EVDO connecting. (CDMA only)
	EVDO in use. (CDMA only)		SIM Card not installed. (GSM only)
Audio			
	All sounds are on.		All sounds are off.
	Vibrate is on.		
Battery			
	Battery is charging.		Battery has a full charge.
	Battery has a high charge.		Battery has a medium charge.
	Battery has a low charge.		Battery has a very low charge.

Tap the Status Bar to display an icon bar. Tap an icon to get additional notification or status information.

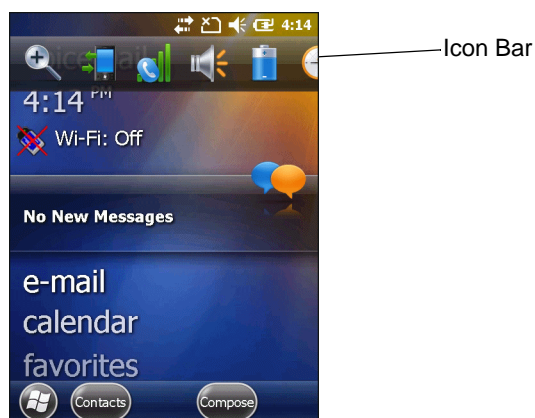









Figure C-8 Icon Bar

Table C-3 *Task Tray Icons*

Icon	Name	Description
	Magnify	Enlarges the screen.
	Connectivity	Displays the Connectivity dialog box.
	Phone	Displays the Phone dialog box.
	Volume	Displays the Volume dialog box.
	Power	Displays the Power window.
	Clock & Alarms	Opens the Clocks & Alarms window.

Tile Bar

The **Tile Bar**, located at the bottom of the screen, contains the **Start** tile  to open the **Start Menu**. It also displays tiles that vary depending upon the open application.

**Figure C-9** *Tile Bar Examples*

Start Screen

To open the **Start** screen, tap  at the bottom left corner of the screen, or press the START key on the keypad.

Swipe upward to view more program and folder icons.

You can move often-used program and folder icons anywhere on the Start screen for easy access. Press and hold the icon that you want to move. Drag the icon to a new location and release.

[Table C-4](#) lists the default icons available on the Start screen.

Table C-4 Programs on the Start Screen





















Icon	Name	Description	Icon	Name	Description
	Home	Displays the Home screen.		Text	Send an SMS text message.
	Phone	Make calls.		E-mail	Send an Email.
	Contacts	Keep track of friends and colleagues.		Settings	Open the Settings folder. Table C-4 lists the default icons available on the Settings folder.
	Internet Explorer	Browse Web and WAP sites as well as download new programs and files from the Internet.		Getting Started	Launch the Getting Started application.
	Calendar	Keep track of appointments and create meeting requests.		Alarms	Set the device clock to the date and time of your locale. Alarms can also be set at specified days and times of a week.
	Pictures & Videos	View and manage pictures, animated GIFs, and video files.		Messenger	Use this mobile version of Windows Live Messenger.
	Windows Media	Play back audio and video files.		Microsoft My Phone	Synchronizes the MC55's contacts, calendar, tasks, text messages, music, photos videos and documents with a Microsoft My Phone account.
	Marketplace	Purchase applications from the Marketplace.		MSN Weather	Check the local weather.
	Windows Live	Use this mobile version of Windows Live™ to find information on the web.		Games	Play games.
	MSN Money	Keep track of your finances.		Notes	Create handwritten or typed notes, drawings, and voice recordings.
	Calculator	Perform basic arithmetic and calculations, such as addition, subtraction, multiplication, and division.		Tasks	Keep track of your tasks.

Table C-4 Programs on the Start Screen















Icon	Name	Description	Icon	Name	Description
	Office Mobile	Use the complete suite of Microsoft® Office applications for your mobile device.		Internet Sharing	Connect a notebook computer to the Internet using the MC55's data connection.
	File Explorer	Organize and manage files on your device.		Task Manager	Enables viewing of memory and CPU allocations and stops running processes. Refer to the <i>Microsoft Applications for Windows Mobile 6 User Guide</i> for more information.
	ActiveSync	Synchronize information between the MC55 and a host computer or the Exchange Server.		Search Phone	Search contacts, data, and other information on the MC55. Refer to the Microsoft Applications for Windows Mobile 6 User Guide for more information.
	Help	Access on-line Help topics.		BT Information	Display information about the Bluetooth radio and generate a Bluetooth address bar code.
	Wireless Companion	Open the Wireless Companion folder.		BTScanner CtlPanel	Set com port to use with a Bluetooth scanner.
	AirBEAM Client	Allows legacy customers to deploy AirBEAM Smart™ packages to devices.		Adobe Reader	View pdf files.
	Modem Link	Enables the MC55 to be used as a modem.		Remote Desktop	Log onto Windows NT server type computers and use all of the programs that are available on that computer from the MC55.

Table C-4 Programs on the Start Screen







Icon	Name	Description	Icon	Name	Description
	MSP Agent	Enables management of the MC55 from an MSP Server. Requires the purchase of an appropriate MSP client license per device to suit the level of management functionality required.		SIM Toolkit	Manage the contacts that are stored on your SIM card. Copy SIM contents to Contacts on the MC55.
	Rapid Deployment Client	Allows the MC55 user to stage a device for initial use by initiating the deployment of settings, firmware, and software. Requires the purchase of an MSP client license per device.		BTE Explorer	Manages StoneStreet One Bluetooth connections. Refer to the <i>MC55 Series Mobile Computer Integrator Guide</i> for more information. Appears only if the StoneStreet One Bluetooth stack is enabled.
	SMS Staging	Receives and processes SMS messages from an MSP Server and allows the user to stage an MC55 based on them. Requires the purchase of an MSP client license per device.		Display_BD_Address	Displays a bar code that contains the Bluetooth address for the device.

Table C-5 Setting Applications









Icon	Name	Description	Icon	Name	Description
	Clock & Alarms	Set the device clock to the date and time of your locale. Alarms can also be set at specified days and times of a week.		Lock	Set a password for the MC55.
	Home	Customize the appearance of the Home screen and the information to display on it.		Sounds & Notifications	Enable sounds for events, notifications, and more, and set the type of notification for different events.
	Personal Folder	Contains personal setting applications.		Connections Folder	Contains connection setting applications.
	System Folder	Contains system setting applications.		Microsoft My Phone	Synchronizes the phone's contacts, calendar, tasks, text messages, music, photos, videos and other documents with your My Phone account at www.microsoft.com .

Table C-5 *Setting Applications (Continued)*































Icon	Name	Description	Icon	Name	Description
	Power	Check battery power and set the time-out for turning off the display to conserve battery power.			
Connections Folder					
	Beam	Set the MC55 to receive incoming IrDA beams. Not supported on MC55.		Connections	Set up one or more types of modem connections for your device, such as phone dial-up, GPRS, Bluetooth, and more, so that your device can connect to the Internet or a private local network.
	Bluetooth	Open the Bluetooth application, set the MC55 to visible mode and scan for other Bluetooth devices in the area.		Domain Enroll	Make your device an AD domain member for device management and security. Refer to the <i>Microsoft Applications for Windows Mobile 6 User Guide</i> for more information.
	Wi-Fi	Setup wireless network connection and customize settings.		USB to PC	Enables or disables the enhanced network connectivity.
	Wireless Manager	Enables or disables the MC55's wireless radios and customizes Wi-Fi, Bluetooth and Phone settings.			
Personal Folder					
	Buttons	Assign a program to a button.		Phone	Configure the phone.
	Owner Information	Enter personal information on the MC55.			
System Folder					
	About	View basic information such as the Windows Mobile® version and type of processor used on the MC55.		Certificates	See information about certificates installed on the MC55.
	Backlight	Set backlight settings.		Customer Feedback	Submit feedback on the Windows Mobile 6 software.

Table C-5 Setting Applications (Continued)

Icon	Name	Description	Icon	Name	Description
	Error Reporting	Enable or disable the Microsoft's error reporting function.		Encryption	Allow files on a storage card to be encrypted. Encrypted files are readable only on your device.
	External GPS	Set the appropriate GPS communication ports, if required. See <i>MC55 User Guide</i> .		GPS Setup	View GPS SUPL information.
	Managed Programs	Displays the programs that were installed on the MC55 using Mobile Device Manager.		Keylight	Set the keypad backlight time-out.
	Memory	Check the device memory allocation status and memory card information and stop currently running programs.		Regional Settings	Set the regional configuration to use, including the format for displaying numbers, currency, date, and time on the MC55.
	Phone Info	View phone information.		Remove Programs	Remove programs that you installed on the MC55.
	Screen	Change the screen orientation, re-calibrate the screen, and change the screen text size.		System Info	Displays the MC55's software and hardware information.
	Task Manager	Stop running programs.		USBConfig	Configure the MC55 USB port.
	UI Settings	Set Start Screen layout and IE zoom feature.		DataWedge	Sample scanning application.

Speaker Icon

You can adjust the system volume using the **Speaker** icon.

1. Tap the Status Bar and then tap the **Speaker** icon. The **Volume** dialog box appears.

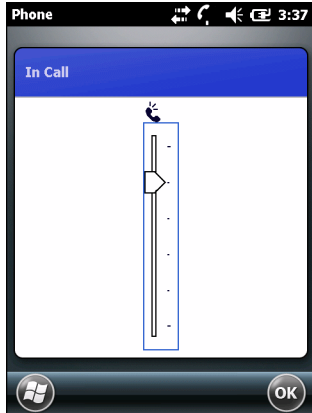

Figure C-10 Volume Dialog Box

2. Tap and move the slide bar to adjust the volume.
3. Select the **On** or **Off** radio button to turn the volume on or off.

✓ **NOTE** Use can also adjust the system volume using the **Sounds & Notifications** window or by using the keypad.

Battery Icons

The **Main Battery** icon appears in the **Title Bar** when the Today screen is visible. The icon indicates the battery power level.

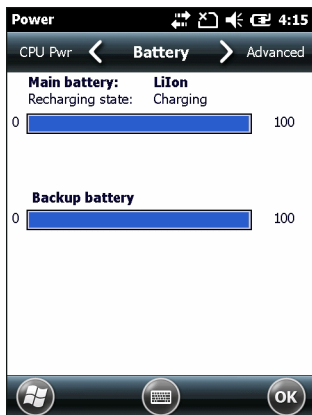

Figure C-11 Battery Icon on the Title Bar

Connectivity Icon

The **Connectivity** icon indicates the communication status of the terminal when it's connecting to the internet or host computer.

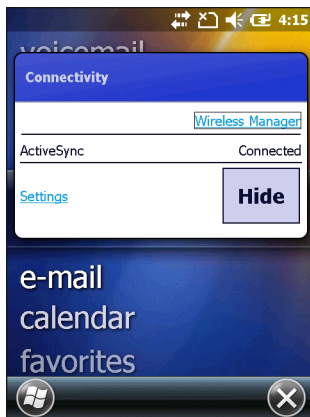

Figure C-12 Connectivity Dialog Box

Locking the MC55

You can lock the MC55 by disabling key presses and screen tap or by requiring a password.

✓ **NOTE** You can make emergency calls even when the MC55 is locked.

Locking the MC55 turns off keyboard and touch screen functionality. This is helpful when the MC55 is turned on and you want to prevent accidental key presses.

To lock the device, tap  > .

Locking without PIN or Password

When the MC55 is locked, the **Lock** screen appears.

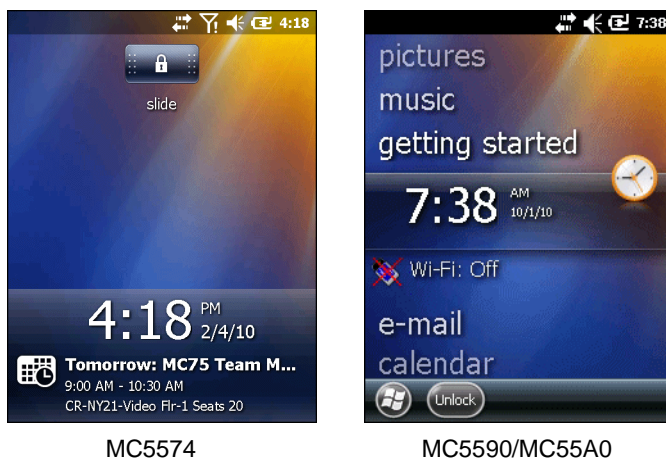

MC5574

MC5590/MC55A0

Figure C-13 Lock Screen

On an MC5574, drag  to either the right or left side of the screen.

On an MC5590, tap **Unlock** and then tap **Unlock** again.



Locking with Simple PIN

When the MC55 is locked, the **Lock** screen appears.



Figure C-14 Simple PIN Lock Screen

On the MC5574, drag  to either the right or left side of the screen.

Enter the PIN and then tap  to unlock and display the Home screen, tap  to unlock and display the Contacts window, tap  to unlock and display the Messaging window.

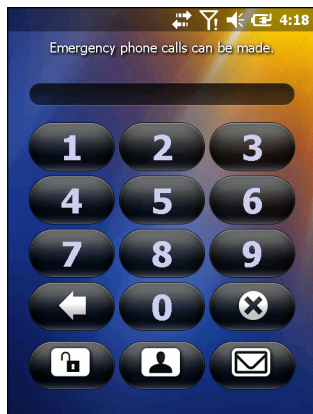

Figure C-15 Simple PIN Password Window

On the MC5590, enter the PIN and then tap **Unlock**.

Locking with Strong Password

When the MC55 is locked, the **Lock** screen appears.

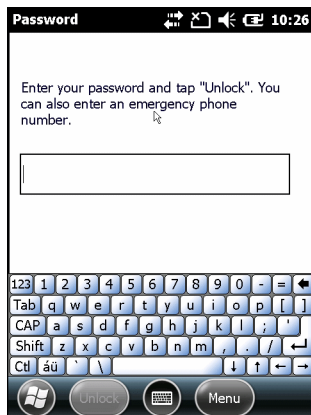

Figure C-16 Strong Password Lock Screen

Enter the strong password and then tap **Unlock**.

Password Locking Setup

Use the **Password** window to set a password to disable unauthorized access to the MC55.

- ✓ **NOTE** If the device is configured to connect to a network, use a strong (difficult to figure out) password to help protect network security. Password cracking tools continue to improve and the computers used to crack passwords are more powerful than ever.

1. Tap  > **Settings** > **Lock** > **Password**.

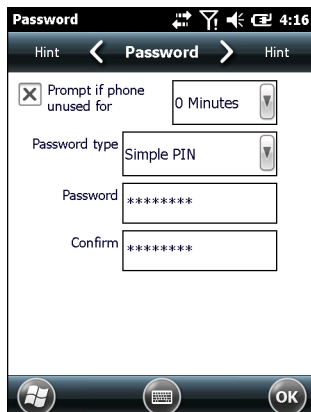





Figure C-17 Password Window

2. Select **Prompt if device unused for** check box to enable password protection.
3. From the drop-down list, select a time value for the protection to take affect after non-use.
4. From the **Password type**: drop-down list, select either **Simple PIN** or **Strong alphanumeric**.
5. For a simple password, enter a four-digit password in the **Password** field.
For a stronger password:
 - a. Enter a seven character password in the **Password**: field. A strong password must contain at least seven characters and contain at least three of the following: uppercase and lowercase letters, numerals, and punctuation.

- b. Re-enter the password in the **Confirm:** field.
6. Tap .
7. In the horizontal scroll, select **Hint**. Enter a hint to remember the password if you forget it.
8. Tap .
9. In the text box, enter a hint for a password reminder.
10. Tap .

Using the RS507 Hands-free Imager

An RS507 Hands-free Imager can be used with the MC55 to capture bar code data.

To set up the MC55 and RS507:

1. Tap **Start** > **BTScannerCtlPanel** icon.
2. Select the **BT Scanner** checkbox and then select the appropriate Com port from the drop-down list.
3. Tap **Save and Exit**.
4. Tap **Start** > **Display_BD_Address** icon. A bar code displays.
5. Point the RS507 to the bar code. The RS507 reads the bar code and begins pairing with the MC55. If required, enter PIN (12345).
6. Launch a scanning enabled application.
7. Point the RS507 at a bar code to read the bar code data.

Refer to the *RS507 Hands-free Imager Product Reference Guide* for more information.

Assisted GPS

GPS can be used in stand-alone or Assisted GPS (A-GPS) modes. A Stand-alone GPS receiver downloads data from GPS satellites. It can take several minutes to get a fix. By using GPS Location servers, A-GPS dramatically improves the performance of the Time To First Fix (TTFF) of GPS receivers by providing them with data that they would ordinarily have to download from the GPS satellites and other aiding data that helps the acquisition. With the A-GPS data, GPS receivers can operate faster and more reliably.

A-GPS follows the Secure User Plane Location (SUPL) protocol which allows the MC55 to communicate with a location server.

To configure SUPL on the MC55:

1. Tap **Start** > **Settings** > **System** > **GPS Setup** icon.

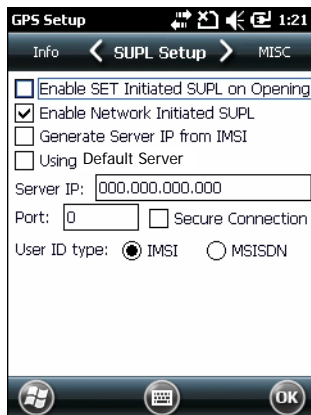

Figure C-18 SUPL Setup Tab

2. Select **Enable SET Initiated SUPL on Opening** to enable the MC55 to initiate SUPL upon opening the GPS port.
3. Select **Enable Network Initiated SUPL** to enable the network to initiate SUPL.
4. Select **Generate Server IP from IMSI** to automatically generate the server IP address from the IMSI (on GSM WAN devices only) or select **Using Default Server** to use the SUPL server.
5. Enter the SUPL Server IP address in the **Server IP** field. The server IP address is not required when generating the server IP address from the IMSI or when using the default server.
6. Enter the SUPL Server port number in the **Port** field. The port number is not required when using the Motorola server.
7. Select **Secure Connection** to enable the TLS connection between the MC55 and the server. This option is not available when using the default server.
8. **User ID type** is to choose which ID type to use during the SUPL session. This option is not available when using the default server.

Use the **MISC** tab to enable Smart Re-aiding and Timing Control on Opening. These options are only available when **Enable SET Initiated SUPL on Opening** is enabled on the **SUPL Setup** tab.

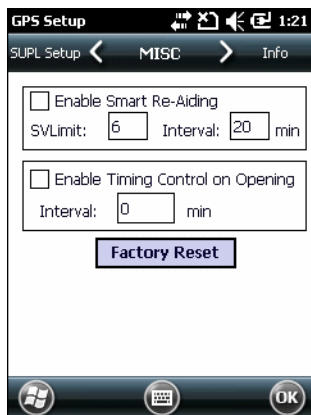

Figure C-19 MISC Tab

Smart Re-Aiding causes the MC55 to reconnect to the SUPL server and download new A-GPS data if there are satellites in view and the number of satellites in use fall below the **SVLimit** value and the length of time passed since the IfCast SUPL session is more than the value set in the **Interval** field.

Timing Control on Opening determines whether a SUPL session is established when the GPS port is opened. If the length of time passed since the last successful SUPL session is less than the set interval, a SUPL session is not established when the GPS port is opened.

Tap the **Factory Reset** button to perform a factory reset on the GPS chip.

UI Settings

Use the **UI Settings** application to change the grid view in the **Start** screen and to control Zooming in Internet Explorer.

Start Screen Settings

To change the grid view of the **Start** screen:

1. Tap **Start** > **Settings** > **UI Settings**.
2. Tap the **Start Screen Settings** tab.

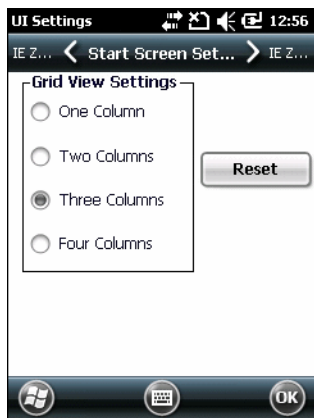

Figure C-20 Start Screen Settings Tab

3. Select the number of columns.
4. Tap **OK**.

✓ **NOTE** Tap **Reset** to return to the default **3 Column** setting.

5. Tap **OK**.
6. Perform a warm boot.

IE Zoom Mapping

With Windows 6.5, when Internet Explorer opens the volume keys on the side of the MC55 are used to zoom in and out. To disable IE Zoom Mapping:

1. Tap **Start** > **Settings** > **System** > **UI Settings**.

2. Tap the **IE Zoom Mapping** tab.

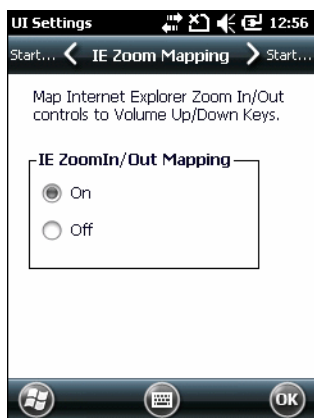

Figure C-21 *IE Zoom Mapping Tab*

3. Select **Off**.
4. Tap **OK**.
5. Tap **OK** to turn off mapping.

Glossary

A

ActiveSync. ActiveSync is a data synchronization program developed by Microsoft for use with Windows Mobile operating systems.

AFH. Adaptive Frequency Hopping

AKU. (Adaptation Kit Update) Updates to the Windows Mobile operating system.

API. (Application Programming Interface) An interface by means of which one software component communicates with or controls another. Usually used to refer to services provided by one software component to another, usually via software interrupts or function calls

AZERTY. A standard keyboard commonly used on French keyboards. "AZERTY" refers to the arrangement of keys on the top row of keys.

B

Bar Code. A pattern of variable-width bars and spaces which represents numeric or alphanumeric data in machine-readable form. The general format of a bar code symbol consists of a leading margin, start character, data or message character, check character (if any), stop character, and trailing margin. Within this framework, each recognizable symbology uses its own unique format. See **Symbology**.

Bit. Binary digit. One bit is the basic unit of binary information. Generally, eight consecutive bits compose one byte of data. The pattern of 0 and 1 values within the byte determines its meaning.

Bits per Second (bps). Bits transmitted or received.

Bluetooth. A wireless protocol utilizing short-range communications technology facilitating data transmission over short distances.

boot or boot-up. The process a computer goes through when it starts. During boot-up, the computer can run self-diagnostic tests and configure hardware and software.

bps. See **Bits Per Second**.

Byte. On an addressable boundary, eight adjacent binary digits (0 and 1) combined in a pattern to represent a specific character or numeric value. Bits are numbered from the right, 0 through 7, with bit 0 the low-order bit. One byte in memory is used to store one ASCII character.

C

CDRH. Center for Devices and Radiological Health. A federal agency responsible for regulating laser product safety. This agency specifies various laser operation classes based on power output during operation.

CDRH Class 1. This is the lowest power CDRH laser classification. This class is considered intrinsically safe, even if all laser output were directed into the eye's pupil. There are no special operating procedures for this class.

CDRH Class 2. No additional software mechanisms are needed to conform to this limit. Laser operation in this class poses no danger for unintentional direct human exposure.

Character. A pattern of bars and spaces which either directly represents data or indicates a control function, such as a number, letter, punctuation mark, or communications control contained in a message.

Codabar. A discrete self-checking code with a character set consisting of digits 0 to 9 and six additional characters: ("-", "\$", ":", "/", ",", and "+").

Code 128. A high density symbology which allows the controller to encode all 128 ASCII characters without adding extra symbol elements.

Code 3 of 9 (Code 39). A versatile and widely used alphanumeric bar code symbology with a set of 43 character types, including all uppercase letters, numerals from 0 to 9 and 7 special characters ("-", ".", "/", "+", "%", "\$" and space). The code name is derived from the fact that 3 of 9 elements representing a character are wide, while the remaining 6 are narrow.

Code 93. An industrial symbology compatible with Code 39 but offering a full character ASCII set and a higher coding density than Code 39.

Cold Boot. A cold boot restarts the mobile computer and initializes some drivers.

COM port. Communication port; ports are identified by number, e.g., COM1, COM2.

Cradle. A cradle is used for charging the terminal battery and for communicating with a host computer, and provides a storage place for the terminal when not in use.

D

DCP. See **Device Configuration Package**.

Decode. To recognize a bar code symbology (e.g., UPC/EAN) and then analyze the content of the specific bar code scanned.

Decode Algorithm. A decoding scheme that converts pulse widths into data representation of the letters or numbers encoded within a bar code symbol.

Decryption. Decryption is the decoding and unscrambling of received encrypted data. Also see, **Encryption** and **Key**.

Depth of Field. The range between minimum and maximum distances at which a scanner can read a symbol with a certain minimum element width.

Device Configuration Package. The Zebra Device Configuration Package provides the Product Reference Guide (PRG), flash partitions, Terminal Configuration Manager (TCM) and the associated TCM scripts. With this package hex images that represent flash partitions can be created and downloaded to the mobile computer.

Discrete 2 of 5. A binary bar code symbology representing each character by a group of five bars, two of which are wide. The location of wide bars in the group determines which character is encoded; spaces are insignificant. Only numeric characters (0 to 9) and START/STOP characters may be encoded.

E

EAN. European Article Number. This European/International version of the UPC provides its own coding format and symbology standards. Element dimensions are specified metrically. EAN is used primarily in retail.

EMDK. Enterprise Mobility Developer's Kit.

ESD. Electro-Static Discharge

F

File Transfer Protocol (FTP). A TCP/IP application protocol governing file transfer via network or telephone lines. See **TCP/IP**.

Flash Memory. Flash memory is nonvolatile, semi-permanent storage that can be electronically erased in the circuit and reprogrammed.

FHSS (Frequency Hopping Spread Spectrum). A method of transmitting radio signals by rapidly switching a carrier among many frequency channels, using a pseudorandom sequence known to both transmitter and receiver.

G

GPS (Global Positioning System). A satellite-based navigation system made up of a network of 24 satellites. GPS satellites circle the earth and transmit signal information to earth. GPS receivers take this information and use triangulation to calculate the user's exact location.

H

Hard Reset. See **Cold Boot**.

Hz. Hertz; A unit of frequency equal to one cycle per second.

Host Computer. A computer that serves other terminals in a network, providing such services as computation, database access, supervisory programs and network control.

I

IEC. International Electrotechnical Commission. This international agency regulates laser safety by specifying various laser operation classes based on power output during operation.

IEC (825) Class 1. This is the lowest power IEC laser classification. Conformity is ensured through a software restriction of 120 seconds of laser operation within any 1000 second window and an automatic laser shutdown if the scanner's oscillating mirror fails.

IEEE Address. See **MAC Address**.

Input/Output Ports. I/O ports are primarily dedicated to passing information into or out of the terminal's memory. MC55 mobile computers include USB ports.

Interleaved 2 of 5. A binary bar code symbology representing character pairs in groups of five bars and five interleaved spaces. Interleaving provides for greater information density. The location of wide elements (bar/spaces) within each group determines which characters are encoded. This continuous code type uses no intercharacter spaces. Only numeric (0 to 9) and START/STOP characters may be encoded.

Internet Protocol Address. See **IP**.

I/O Ports. The connection between two devices, defined by common physical characteristics, signal characteristics, and signal meanings. Types of interfaces include RS-232 and USB.

IP. Internet Protocol. The IP part of the TCP/IP communications protocol. IP implements the network layer (layer 3) of the protocol, which contains a network address and is used to route a message to a different network or subnetwork. IP accepts "packets" from the layer 4 transport protocol (TCP or UDP), adds its own header to it and delivers a "datagram" to the layer 2 data link protocol. It may also break the packet into fragments to support the maximum transmission unit (MTU) of the network.

IP Address. (Internet Protocol address) The address of a computer attached to an IP network. Every client and server station must have a unique IP address. A 32-bit address used by a computer on a IP network. Client workstations have either a permanent address or one that is dynamically assigned to them each session. IP addresses are written as four sets of numbers separated by periods; for example, 204.171.64.2.

IPX/SPX. Internet Package Exchange/Sequential Packet Exchange. A communications protocol for Novell. IPX is Novell's Layer 3 protocol, similar to XNS and IP, and used in NetWare networks. SPX is Novell's version of the Xerox SPP protocol.

ISM. Industry Scientific and Medical

K

Key. A key is the specific code used by the algorithm to encrypt or decrypt the data. Also see, **Encryption** and **Decrypting**.

L

LASER. Light Amplification by Stimulated Emission of Radiation. The laser is an intense light source. Light from a laser is all the same frequency, unlike the output of an incandescent bulb. Laser light is typically coherent and has a high energy density.

laser scanner. A type of bar code reader that uses a beam of laser light.

LCD. See **Liquid Crystal Display**.

LED Indicator. A semiconductor diode (LED - Light Emitting Diode) used as an indicator, often in digital displays. The semiconductor uses applied voltage to produce light of a certain frequency determined by the semiconductor's particular chemical composition.

Light Emitting Diode. See **LED**.

Liquid Crystal Display (LCD). A display that uses liquid crystal sealed between two glass plates. The crystals are excited by precise electrical charges, causing them to reflect light outside according to their bias. They use little electricity and react relatively quickly. They require external light to reflect their information to the user.

M

MC. Mobile Computer.

MDN. Mobile Directory Number. The directory listing telephone number that is dialed (generally using POTS) to reach a mobile unit. The MDN is usually associated with a MIN in a cellular telephone -- in the US and Canada, the MDN and MIN are the same value for voice cellular users. International roaming considerations often result in the MDN being different from the MIN.

MIN. Mobile Identification Number. The unique account number associated with a cellular device. It is broadcast by the cellular device when accessing the cellular system.

Mobile Computer. In this text, *mobile computer* refers to the MC55. It can be set up to run as a stand-alone device, or it can be set up to communicate with a network, using wireless radio technology.

N

Nominal. The exact (or ideal) intended value for a specified parameter. Tolerances are specified as positive and negative deviations from this value.

NVM. Non-Volatile Memory.

O

Open System Authentication. Open System authentication is a null authentication algorithm.

P

PAN . Personal Area Network. Using Bluetooth wireless technology, PANs enable devices to communicate wirelessly. Generally, a wireless PAN consists of a dynamic group of less than 255 devices that communicate within about a 33-foot range. Only devices within this limited area typically participate in the network.

PING. (Packet Internet Groper) An Internet utility used to determine whether a particular IP address is online. It is used to test and debug a network by sending out a packet and waiting for a response.

Q

QWERTY. A standard keyboard commonly used on North American and some European keyboards. "QWERTY" refers to the arrangement of keys on the top row of keys.

QWERTZ. A standard keyboard commonly used on German keyboards. "QWERTZ" refers to the arrangement of keys on the top row of keys.

R

RAM. Random Access Memory. Data in RAM can be accessed in random order, and quickly written and read.

RF. Radio Frequency.

ROM. Read-Only Memory. Data stored in ROM cannot be changed or removed.

Router. A device that connects networks and supports the required protocols for packet filtering. Routers are typically used to extend the range of cabling and to organize the topology of a network into subnets. See **Subnet**.

S

Scanner. An electronic device used to scan bar code symbols and produce a digitized pattern that corresponds to the bars and spaces of the symbol. Its three main components are: 1) Light source (laser or photoelectric cell) - illuminates a bar code.; 2) Photodetector - registers the difference in reflected light (more light reflected from spaces); 3) Signal conditioning circuit - transforms optical detector output into a digitized bar pattern.

SDK. Software Development Kit

Shared Key. Shared Key authentication is an algorithm where both the AP and the MU share an authentication key.

SID. System Identification code. An identifier issued by the FCC for each market. It is also broadcast by the cellular carriers to allow cellular devices to distinguish between the home and roaming service.

Soft Reset. See **Warm Boot.**

Space. The lighter element of a bar code formed by the background between bars.

Specular Reflection. The mirror-like direct reflection of light from a surface, which can cause difficulty decoding a bar code.

Start/Stop Character. A pattern of bars and spaces that provides the scanner with start and stop reading instructions and scanning direction. The start and stop characters are normally to the left and right margins of a horizontal code.

Subnet. A subset of nodes on a network that are serviced by the same router. See **Router.**

Subnet Mask. A 32-bit number used to separate the network and host sections of an IP address. A custom subnet mask subdivides an IP network into smaller subsections. The mask is a binary pattern that is matched up with the IP address to turn part of the host ID address field into a field for subnets. Default is often 255.255.255.0.

Substrate. A foundation material on which a substance or image is placed.

Symbol. A scannable unit that encodes data within the conventions of a certain symbology, usually including start/stop characters, quiet zones, data characters and check characters.

Symbol Aspect Ratio. The ratio of symbol height to symbol width.

Symbol Height. The distance between the outside edges of the quiet zones of the first row and the last row.

Symbol Length. Length of symbol measured from the beginning of the quiet zone (margin) adjacent to the start character to the end of the quiet zone (margin) adjacent to a stop character.

Symbology. The structural rules and conventions for representing data within a particular bar code type (e.g. UPC/EAN, Code 39, PDF417, etc.).

T

TCP/IP. (Transmission Control Protocol/Internet Protocol) A communications protocol used to internetwork dissimilar systems. This standard is the protocol of the Internet and has become the global standard for communications. TCP provides transport functions, which ensures that the total amount of bytes sent is received correctly at the other end. UDP is an alternate transport that does not guarantee delivery. It is widely used for real-time voice and video transmissions where erroneous packets are not retransmitted. IP provides the routing mechanism. TCP/IP is a routable protocol, which means that all messages contain not only the address of the destination station, but the address of a destination network. This allows TCP/IP messages to be sent to multiple networks within an organization or around the world, hence its use in the worldwide Internet. Every client and server in a TCP/IP network requires an IP address, which is either permanently assigned or dynamically assigned at startup.

Telnet. A terminal emulation protocol commonly used on the Internet and TCP/IP-based networks. It allows a user at a terminal or computer to log onto a remote device and run a program.

Terminal. See **Mobile Computer.**

Terminal Emulation. A “terminal emulation” emulates a character-based mainframe session on a remote non-mainframe terminal, including all display features, commands and function keys. The VC5000 Series supports Terminal Emulations in 3270, 5250 and VT220.

TFTP. (Trivial File Transfer Protocol) A version of the TCP/IP FTP (File Transfer Protocol) protocol that has no directory or password capability. It is the protocol used for upgrading firmware, downloading software and remote booting of diskless devices.

Tolerance. Allowable deviation from the nominal bar or space width.

Transmission Control Protocol/Internet Protocol. See **TCP/IP.**

Trivial File Transfer Protocol. See **TFTP.**

U

UDP. User Datagram Protocol. A protocol within the IP protocol suite that is used in place of TCP when a reliable delivery is not required. For example, UDP is used for real-time audio and video traffic where lost packets are simply ignored, because there is no time to retransmit. If UDP is used and a reliable delivery is required, packet sequence checking and error notification must be written into the applications.

UPC. Universal Product Code. A relatively complex numeric symbology. Each character consists of two bars and two spaces, each of which is any of four widths. The standard symbology for retail food packages in the United States.

V

Visible Laser Diode (VLD). A solid state device which produces visible laser light.

W

Warm Boot. A warm boot restarts the mobile computer by closing all running programs. All data that is not saved to flash memory is lost.

Index

A

- accessories
 - cables 2-23
 - four slot battery charger 2-1
 - four slot Ethernet cradle 2-1, 2-10
 - four slot spare battery charger 2-2, 2-22
 - MMC 1-2
 - mounting bracket 2-15
 - SIM card 1-3
 - single slot USB cradle 2-1, 2-2
 - specifications A-23
 - vehicle cradle 2-17
- ActiveSync 3-1, C-10
 - deploying CAB files 4-4
 - icon C-5
 - installing 3-1
 - setting up a connection 3-4
- AirBEAM C-10
 - deploying CAB files 4-6
- APN 6-3
- application deployment 4-1, 4-4
 - CAB files 4-4
- application folder 4-10
- application packaging 4-4
- application security 4-1
- assisted GPS C-18
- auto charge cable 2-1, 2-23, 2-24

B

- battery
 - charging 1-5
 - installing 1-4
- battery chargers
 - four slot 2-22
- battery charging 1-5

- four slot Ethernet cradle 2-13
- single slot cradle 2-2
- spare 2-22
- vehicle cradle 2-20
- battery icon C-7
- bluetooth
 - communicating icon C-5
 - disabled icon C-5
 - enabled icon C-5
 - troubleshooting 7-7
- boot
 - clean 1-8
 - cold 1-7
 - warm 1-7
- bullets xv
- buttons
 - power 1-7

C

- CAB files 4-4, 4-8
 - deployment via ActiveSync 4-4
 - deployment via AirBEAM 4-6
 - deployment via image update 4-6
 - deployment via storage card 4-4
- cables 2-23
 - pinouts A-22
 - troubleshooting 7-10
- cache disk 4-10
- calculator C-9
- calendar C-9
- calibrating the screen 1-7
- call blocking See call barring 6-8
- call forwarding 6-9
- call waiting 6-10
- caller id 6-9
- certificates 4-3

changing a PIN for phone use 6-7

charge only cable 2-1, 2-23

charger

- four slot battery charger 2-1

charging

- four slot Ethernet cradle 2-13
- single slot cradle 2-2
- spare batteries 1-6, 2-22
- vehicle cradle 2-20

charging temperature 1-6

clean boot 1-8

cleaning 7-1

clock & alarms C-11

cold boot 1-7

command bar

- icons C-5, C-8

communication 2-23

communication/charge cables 2-23

configuration xii

Contacts C-9

contacts C-9

conventions

- notational xv

copyfile 4-9

cpf file 4-8

cradles

- daisy chaining 2-10
- Ethernet drivers 2-11
- four slot Ethernet 2-1, 2-10
 - charging 2-13
 - charging indicators 2-13
 - setup 2-10, 2-14
- four slot spare battery charger 2-2, 2-22
 - charging 2-22
 - charging indicators 2-22
 - setup 2-22
- mounting bracket 2-15
- single slot USB 2-1, 2-2
 - charging indicators 2-4
 - setup 2-2
- troubleshooting 7-8, 7-9, 7-10
- vehicle 2-17
 - charging 2-20
 - charging indicators 2-21
 - setup 2-17

creating cpf file 4-8

creating splash screen 4-7

D

data capture xii

data connection 6-3

decode distances A-11

- DL focus A-19

- far focus A-15
- HD focus A-21
- near focus A-13
- SE950-I100R A-9
- SR focus A-17

decode zone A-10

- SE950-I100R Standard Version 35° A-7
- SE950-I100R Standard Version 47° A-8

decode zones A-16

- DL focus A-18
- far focus A-14
- HD focus A-20
- near focus A-12

deployment 4-1, 4-4

- CAB files 4-4

digital signatures 4-1

disabling PIN for phone use 6-8

display xii

E

EMDK 4-11

enabling PIN for phone use 6-7

enhanced operator name string 6-15

Enterprise Mobility Developer Kit 4-11

EONS 6-15

ESD 1-2

Ethernet cradle 2-1

F

file explorer C-10

flash file system

- copyfile 4-9
- regmerge 4-8

focus positions

- far focus decode distances A-15
- far focus decode zone A-14
- near focus decode distances A-13
- near focus decode zone A-12

four slot battery charger 2-1

four slot charge only cradle 2-1

four slot Ethernet cradle 2-1, 2-10

- charging 2-13
- charging indicators 2-13
- daisy chaining 2-10
- drivers 2-11
- link indicator 2-13
- setup 2-10, 2-14
- speed indicator 2-13
- troubleshooting 7-9

four slot spare battery charger 2-2, 2-22

- charging 2-22
- charging indicators 2-22

setup 2-22
troubleshooting 7-10

G

GPRS

data connection 6-2, 6-3
registry file 6-3
WAN configuration 6-3

GSM

access point name 6-3
configure GPRS data connection 6-2, 6-3
ensuring network coverage 6-2
settings
networks 6-12
phone 6-6
phone info 6-14
PIN 6-7, 6-8
security 6-7
services 6-8, 6-9, 6-10
sound 6-6

H

hard reset 1-7, 1-8
HD focus decode distances A-21

I

icons

ActiveSync C-5
battery C-7
bluetooth communicating C-5
bluetooth disabled C-5
bluetooth enabled C-5
status C-6
task tray C-5, C-8
wireless applications C-5
wireless status C-5

image update

deploying CAB files 4-6

information, service xvi

installing battery 1-4

internet

wireless connection 6-3

Internet Explorer Mobile C-9

internet sharing C-10

K

keypads xii

L

lithium-ion battery 1-1
locking EDA 4-2

M

main battery

charging 1-2, 1-5
installing 1-1

maintenance 7-1

Media Player C-9

memory xii

messaging C-9

MMC 1-2

mounting bracket 2-15

MSP Agent C-11

multi media card 1-2

N

navigation bar

icons C-6

network

configuring GPRS WAN 6-3

GSM 6-12

network coverage, GSM 6-2

notes C-9

O

operating environment A-1

operating system xii

P

packaging 4-4

passwords C-17

persistent storage 4-10

phone security 6-7, 6-8

phone settings 6-6

pictures C-9

PIN, changing for phone 6-7

PIN, disabling for phone use 6-8

PIN, enabling for phone use 6-7

pinouts A-22

power button 1-7

powering on EDA 1-6

R

radios xii

RAM 4-10

random access memory 4-10

RAPI 4-3
 rapid deployment C-11
 regmerge 4-8
 remote API 4-3
 reset 1-7
 hard 1-7, 1-8
 soft 1-7

S

screen
 calibration 1-7
 security 4-1
 application 4-1
 certificates 4-3
 device management 4-3
 digital signatures 4-1
 locking device 4-2
 remote API 4-3
 service information xvi
 service provider name display 6-15
 services, GSM
 call barring 6-8
 call forwarding 6-9
 call waiting 6-10
 caller id 6-9
 text messages 6-10
 voice mail 6-10
 settings
 about C-12
 buttons C-12
 certificates C-12
 connections C-12
 customer feedback C-12
 encryption C-13
 error reporting C-13
 external GPS C-13
 GSM 6-2
 GSM/GPRS 6-6
 keylight C-13
 lock C-11
 memory C-13
 owner information C-12
 power C-12
 regional settings C-13
 remove programs C-13
 screen C-13
 sounds & notifications C-11
 system info C-13
 USB to PC C-12
 Wi-Fi C-12
 wireless manager C-12
 SIM card
 accessories 1-3

 activation 6-2
 install 1-3
 network access 6-12
 SIM Toolkit C-11
 single slot USB cradle 2-1, 2-2
 charging 2-2
 charging indicators 2-4
 troubleshooting 7-8
 soft reset 1-7
 spare battery
 charging 1-6
 spare battery charger 2-2
 charging 2-22
 charging indicators 2-22
 setup 2-22
 splash screen
 creating 4-7
 SR focus decode distances A-17
 starting EDA 1-6
 starting the EDA 1-2
 status icon C-6
 battery C-7
 storage 4-10
 application folder 4-10
 cache disk 4-10
 persistent 4-10
 volatile 4-10
 storage card
 deploying CAB files 4-4
 strap 1-1
 stylus 1-1
 subscriber identification module 1-3

T

task tray icons C-4
 tasks C-9
 technical specifications A-1
 accessories A-23
 temperature A-2
 charging 1-6
 text messages 6-10
 Time To First Fix C-18
 troubleshooting 7-5
 bluetooth 7-7
 cables 7-10
 EDA 7-5
 four slot Ethernet cradle 7-9
 four slot spare battery charger 7-10
 single slot USB cradle 7-8
 vehicle cradle 7-9

U

unpacking	1-1
USB charge cable	2-23
USB charging cable	2-1, 2-23
USB client charge cable	2-23

V

vehicle cradle	2-17
charging indicators	2-21
troubleshooting	7-9
vehicle holder	2-1
videos	C-9
voice mail	6-10
volatile storage	4-10

W

wakeup conditions	1-8
waking EDA	1-8
wall mount bracket	2-15
warm boot	1-7
Windows Live	C-9
Windows Live Messenger	C-9
wireless	
internet	6-3
wireless manager	C-12
wireless status	C-5
WLAN 802.11a/b/g	xii
WPAN Bluetooth	xii
WWAN	
configuring GPRS	6-3

X

XML provisioning	4-8
certificates	4-3



Zebra Technologies Corporation
Lincolnshire, IL U.S.A
<http://www.zebra.com>

Zebra and the stylized Zebra head are trademarks of ZIH Corp., registered in many jurisdictions worldwide. All other trademarks are the property of their respective owners.

© 2015 ZIH Corp and/or its affiliates. All rights reserved.