

**hp officejet
5100 series
all-in-one**



i n v e n t



reference guide

© Copyright Hewlett-Packard Company 2002

All rights are reserved. No part of the document may be photocopied, reproduced, or translated to another language without the prior written consent of Hewlett-Packard Company.

This product incorporates Adobe's PDF technology, which contains an implementation of LZW licensed under U.S. Patent 4,558,302.



Adobe and the Acrobat logo are either registered trademarks or trademarks of Adobe Systems Incorporated in the United States and/or other countries.

Portions Copyright © 1989-2002 Palomar Software Inc. The HP Officejet 5100 Series includes printer driver technology licensed from Palomar Software, Inc. www.palomar.com

Copyright © 1999-2002 Apple Computer, Inc.

Apple, the Apple logo, Mac, Mac logo, Macintosh, and Mac OS are trademarks of Apple Computer, Inc., registered in the U.S. and other countries.

Publication number: Q1678-90158

First edition: October 2002

Printed in U.S.A., Germany, or Singapore

Windows®, Windows NT®, Windows ME®, Windows XP®, and Windows 2000® are U.S.-registered trademarks of Microsoft Corporation.

Intel® and Pentium® are registered trademarks of Intel Corporation.

notice

The information contained in this document is subject to change without notice and should not be construed as a commitment by the Hewlett-Packard Company.

Hewlett-Packard assumes no responsibility for any errors that may appear in this document, nor does it make expressed or implied warranty of any kind with regard to this material, including, but not limited to, the implied warranties of merchantability and fitness for a particular purpose.

The Hewlett-Packard Company shall not be liable for incidental or consequential damages in connection with, or arising out of the furnishing, performance, or use of this document and the program material which it describes.

Note: Regulatory information can be found in the **technical information** section of this guide.



It is not lawful in many places to make copies of the following items. When in doubt, check with a legal representative first.

- Governmental paper or documents:
 - Passports
 - Immigration papers
 - Selective service papers
 - Identification badges, cards, or insignias
- Governmental stamps:
 - Postage stamps
 - Food stamps
- Checks or drafts drawn on governmental agencies
- Paper currency, traveler's checks, or money orders
- Certificates of deposit
- Copyrighted works

safety information



Warning! To prevent fire or shock hazard, do not expose this product to rain or any type of moisture.

Always follow basic safety precautions when using this product to reduce risk of injury from fire or electric shock.

WARNING: potential shock hazard

- 1 Read and understand all instructions in the setup poster.
- 2 Use only a grounded electrical outlet when connecting the unit to a power source. If you do not know whether the outlet is grounded, check with a qualified electrician.
- 3 Observe all warnings and instructions marked on the product.
- 4 Unplug this product from wall outlets before cleaning.
- 5 Do not install or use this product near water or when you are wet.
- 6 Install the product securely on a stable surface.
- 7 Install the product in a protected location where no one can step on or trip over the line cord, and where the line cord will not be damaged.
- 8 If the product does not operate normally, see the online Troubleshooting help.
- 9 No operator-serviceable parts inside. Refer servicing to qualified service personnel.
- 10 Use in a well-ventilated area.

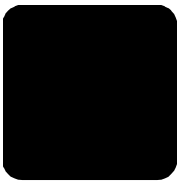

contents

| | | |
|----------|---------------------------------------------------------------|-----------|
| 1 | get help | 1 |
| 2 | quick start | 3 |
| | front panel features | 3 |
| | use your hp officejet with a computer | 4 |
| | review the hp director | 4 |
| 3 | load originals and load paper | 7 |
| | load originals | 7 |
| | load paper | 7 |
| | load envelopes | 9 |
| | tips for loading other types of paper in the paper tray | 9 |
| | set the paper type | 10 |
| | set the paper size | 10 |
| 4 | use the copy features | 11 |
| | make copies | 11 |
| | make a copy | 11 |
| | increase copy speed or quality | 12 |
| | set the number of copies | 12 |
| | reduce or enlarge a copy | 12 |
| | make copies lighter or darker | 12 |
| | enhance text sharpness and photo colors | 13 |
| | change settings for all copy tasks | 13 |
| | perform special copy jobs | 13 |
| | copy a photo | 13 |
| | fit a copy to the page | 14 |
| | prepare a color t-shirt transfer | 14 |
| | copy options | 16 |
| 5 | use the scan features | 17 |
| | scan an original | 17 |
| | stop a scan | 17 |
| 6 | use the fax features | 19 |
| | enable fax confirmation | 19 |
| | send a fax | 19 |
| | initiate the fax process from your hp officejet | 20 |
| | receive a fax | 20 |
| | receive a fax automatically | 20 |
| | receive a fax manually | 21 |
| | save frequently-used fax numbers | 21 |
| | set basic fax settings using the front panel | 21 |
| | set the date and time | 22 |
| | set the fax header | 22 |
| | enter text | 23 |
| | set the answer mode | 23 |
| | set the rings to answer setting | 23 |
| | check for dial tone | 24 |

| | | |
|-----------|-----------------------------------------------------------------------------|-----------|
| 7 | maintain your hp officejet | 25 |
| | clean the exterior | 25 |
| | work with print cartridges | 25 |
| | print a self-test report | 25 |
| | handle print cartridges | 25 |
| | replace the print cartridges | 25 |
| | align cartridges | 26 |
| | clean the print cartridges | 27 |
| | restore factory defaults | 27 |
| | setup menu options | 28 |
| 8 | additional setup information | 29 |
| | possible installation problems | 29 |
| | set the language and country/region | 29 |
| | connect your hp officejet to your computer | 30 |
| | connect your usb port | 30 |
| | connect your hp officejet to a phone, modem, or answering machine | 31 |
| | remove and reinstall your hp officejet software | 31 |
| 9 | technical information | 33 |
| | system requirements | 33 |
| | specifications | 34 |
| | paper specifications | 34 |
| | print specifications | 35 |
| | print margin specifications | 35 |
| | copy specifications | 36 |
| | scan specifications | 36 |
| | fax specifications | 36 |
| | physical specifications | 37 |
| | power specifications | 37 |
| | environmental specifications | 37 |
| | additional specifications | 37 |
| | environmental product stewardship program | 37 |
| | regulatory notices | 38 |
| | notice to users of the U.S. telephone network: FCC requirements | 38 |
| | doc statement / déclaration de conformité (Canada) | 40 |
| | notice to users of the Canadian telephone network | 40 |
| | notice to all users of the European Economic Area (EEA) | 40 |
| | notice to users of the German telephone network | 41 |
| | VCCI-2 (Japan) | 41 |
| | notice to Korean customers | 41 |
| | declaration of conformity | 41 |
| 10 | get hp officejet 5100 support | 43 |
| | get support and other information from the internet | 43 |
| | hp customer support | 43 |
| | prepare your hp officejet for shipment | 46 |
| | hp distribution center | 47 |
| | hp officejet 5100 series warranty | 47 |
| | warranty service | 48 |
| | return your hp officejet 5100 series for service | 48 |
| | hewlett-packard limited global warranty statement | 48 |
| | index | 51 |



get help

| help | description |
|-------------------------------------|-------------------------------------------------------------------------------------------------------------------------------------------------------------------------------------------------------------------------------------------------------------------------------------------------------------------------------------------------------------------------------------------------------------------------------------------------------------------------------------------------------------------------------------------------------------------------------------------------------------------------------------------------------------------------|
| Setup Poster | The Setup Poster provides instructions for setting up and configuring your HP Officejet. Make sure you use the correct poster for your operating system (Windows PC or Macintosh). |
| Product Tour | The tour provides a brief introduction to the HP Officejet and its capabilities, so you can start using it immediately. You can take the tour immediately after installing the HP Officejet software, or to take the tour at any time, see the product specific online help. |
| HP Photo & Imaging Help | The HP Photo & Imaging Help provides detailed information on using the software for your HP Officejet. For Windows PC users: Go to the HP Director , and click Help . For Macintosh users: Go to the HP Director , and click Help , then select hp photo & imaging help . |
| Reference Guide | The Reference Guide contains information on using your HP Officejet and provides additional troubleshooting assistance for the installation process. The Reference Guide also contains information on how to order supplies and accessories, technical specifications, support, and warranty information. |
| Troubleshooting Help | To access troubleshooting information, go to the HP Director , then click Help . Open the Troubleshooting book in the HP Photo & Imaging Help, then follow the links to general troubleshooting as well as links to Troubleshooting help that is specific to your HP Officejet. Troubleshooting is also available from the Help button that appears on some error messages. |
| Internet Help and Technical Support | If you have Internet access, you can get more information from the HP website at: http://www.hp.com/support The website also provides answers to frequently-asked questions. |
| Readme File | After you install your software, you can access the Readme file from either the HP Officejet 5100 Series CD-ROM or the HP Officejet 5100 Series program folder. The Readme file contains late-breaking information that does not appear in the Reference Guide or the online help. To access the Readme file, do the following: For Windows PC: go to the Windows PC taskbar, click Start , point to Programs or All Programs (XP), point to Hewlett-Packard , point to hp officejet 5100 series , and then select Readme . For Macintosh: go to the HD:Applications:HP Officejet Software folder. |

help

Dialog Box Help
(Windows PC only)

description

For Windows PC: Clicking **Help** in a dialog box displays information about options and settings within the dialog box.

Fax To

Title First Name Last Name
Mr. Freeman Dyson

Fax Number Voice Number Company
990-011-0101

Clear Entry Recent Faxes

Recipient List

| Name | Fax Number |
|-----------------------|--------------|
| Ms. Abigail Adams | 767-447-1776 |
| Mr. Olesegun Obasanjo | 077-678-4346 |
| Carson McCullers | 125-665-2315 |

Add to List Remove

Quality: Standard Photo Fine

Color: Black and White Color

Log and Settings Help

Send Fax Now Send Fax Later Preview Fax Cancel

To get help while working in a dialog box, click **Help**.

2

quick start

You can perform many functions using either the front panel or the HP Officejet software.

Even if you do not connect your HP Officejet to a computer, you can use the front panel to copy and fax documents or photos. You can change a wide variety of settings using the front-panel buttons and menu system.

front panel features

Review the illustrations below and identify the location of the buttons on the front panel.

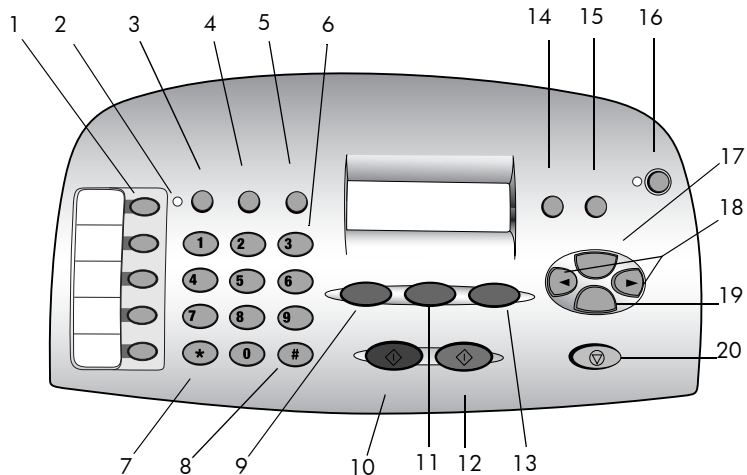

| feature | purpose |
|---------|-----------------------------------------------------------------------------------------------------|
| 1 | One-touch speed-dial buttons: Enter and label speed-dial numbers for quick access. |
| 2 | Auto Answer light: If lit, automatic answering is on. |
| 3 | AUTO ANSWER button: Turn automatic answering for fax on or off. |
| 4 | SPEED DIAL button: Access speed-dial numbers. |
| 5 | REDIAL PAUSE button: Dial the last number again, or insert a pause in a number to be dialed. |
| 6 | Keypad: Dial fax numbers or enter text. |
| 7 | STAR/SYMBOLS key: Enter punctuation characters or use as directed in voice mail. |
| 8 | POUND/SPACE key: Enter spaces or use as directed in voice mail. |

| feature | purpose |
|---------|--------------------------------------------------------------------------------------------------------------------------|
| 9 | SCAN button: Press to begin the scanning process. |
| 10 | START, BLACK button: Start a black-and-white scan, fax, or copy. |
| 11 | FAX button: Press to begin the faxing process. |
| 12 | START, COLOR button: Start a color scan, fax, or copy. |
| 13 | COPY button: Press to begin the copy process. |
| 14 | PHOTO FIT TO PAGE button: Enlarge and copy a photo to a full-size page. |
| 15 | SETUP button: Access various unit settings. |
| 16 | ON button: Turn unit on and off. |
| 17 | OPTIONS button: Access various scan, copy, and fax options. |
| 18 | Left and Right arrows: Scroll through scan, fax, and copy option settings, or move forward and backward in a text entry. |
| 19 | ENTER button: Select or save displayed setting. |
| 20 | CANCEL button: Stop job or exit menu. |

use your hp officejet with a computer

If you installed the HP Officejet software on your computer according to the Setup Poster, you can access all the features of the HP Officejet using the HP Director.

review the hp director

The HP Director is available through the desktop shortcut (Windows PC only).

for Windows PC users

- 1 Do one of the following:
 - Double-click the **hp director** icon on the desktop.
 - In the Windows PC taskbar, click **Start**, point to **Programs** or **All Programs** (XP), point to **Hewlett-Packard**, point to **hp officejet 5100 series**, then select **hp director**.

The Director displays only the buttons that are appropriate for the selected device.

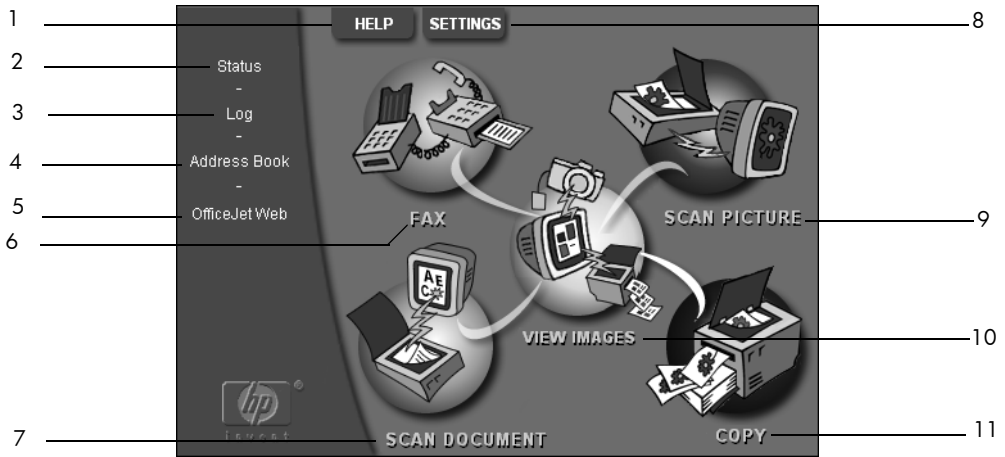

hp director for Windows PC

| feature | purpose |
|---------|------------------------------------------------------------------------------------------------------------------------------------------|
| 1 | Help: Provides access to the HP Photo View Center, which provides software help, a product tour, and troubleshooting information. |
| 2 | Status: Describes the HP Officejet's current status and displays the current front panel text. |
| 3 | Log: Lists received, sent, pending, or blocked faxes. |
| 4 | Address Book: Opens the Microsoft Windows address book. |
| 5 | Officejet Web: Opens the HP Officejet Product and Services web page. |
| 6 | Fax: Opens the Send Fax dialog box. |
| 7 | Scan Document: Scans text and displays it in the selected destination text editing software program. |
| 8 | Settings: Lets you view or change various settings for your HP device, such as print, scan, copy, or image unload. |
| 9 | Scan Picture: Scans an image and displays it in the HP Photo View Center. |
| 10 | View Images: Opens the HP Photo View Center. |
| 11 | Copy: Opens the Copy dialog box. |

for Macintosh users

- ▶ Do one of the following:
 - For OS 9.x, double-click the **HP Director** icon on the desktop.
 - For OS X, click the **HP Director** icon on the dock.

The following figure shows some of the features available through the HP Director for Macintosh. Consult the legend for a brief explanation of a specific feature.

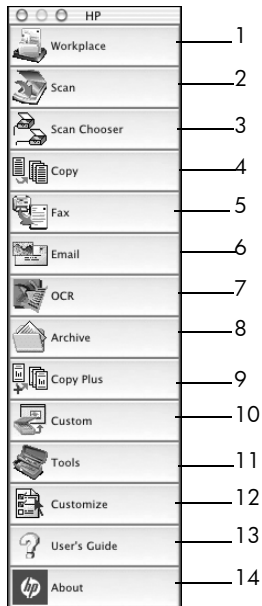

hp director for Macintosh

| feature | purpose |
|---------|---------------------------------------------------------------------------------------------------------------------------------|
| 1 | Workplace: Allows you to access the Workplace for annotating image documents, custom printing, viewing the fax log, etc. |
| 2 | Scan: Allows you to quickly scan documents and images into many applications. |
| 3 | Scan Chooser: Allows you to select or change your scan device. |
| 4 | Copy: Allows you to use your HP Officejet as a copier. |
| 5 | Fax: Allows you to fax a document or photo to someone else. |
| 6 | Email: Allows you to quickly scan a document and e-mail it to someone else. |
| 7 | OCR: Allows you to scan a document and convert it to text for editing in a text processor. |
| 8 | Archive: Allows you to quickly scan a document and save it in your archive folder. |
| 9 | Copy Plus: Allows you to scan a document and print a copy of it on another printer on your network. |
| 10 | Custom: Allows you to quickly scan a document and process the resulting image using any application of your choosing. |
| 11 | Tools: Allows you to access to the HP Toolbox for device maintenance and configuration. |
| 12 | Customize: Allows you to add, remove, and resize buttons in the Director. |
| 13 | User's Guide: Allows you to access the onscreen User's Guide for assistance with the HP software. |
| 14 | About: Displays the version and copyright information about the application. |

3

load originals and load paper

You can make copies from originals loaded in the automatic document feeder (ADF). You can also print and copy onto a variety of paper types, weights, sizes, and transparency films. It is important, however, that you select the right paper and make sure that it is loaded correctly and not damaged.

load originals

You can copy or scan any original by loading it in the ADF.

If you are working with originals that are printed on 16-24 lb. (60-90 gsm) plain paper or HP Premium Inkjet Paper, you can load more than one in the ADF. If you are working with photos or originals of an odd size (no smaller than 3.25 x 3.25 inches or 82 x 82 millimeters), load them in the ADF one at a time. When working with fragile, torn, or odd-sized originals, we recommend that you use a document sleeve or sheet protector (available from most office-product stores) for the original. Place a single sleeve into the ADF with the sealed edge first and the transparent side down.

Note: If you have trouble with originals feeding incorrectly, make sure the ADF tray is snapped into position.

- 1 Place the original(s) in the ADF with the printed side facing toward the back and with the top of the document pointing down.
- 2 Adjust the document guides to fit your document.

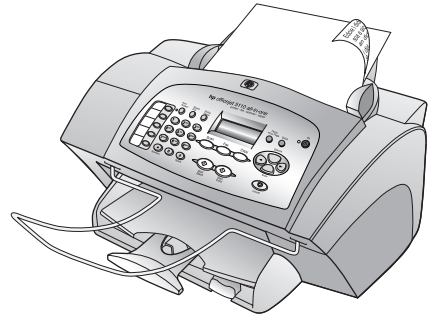

load paper

Following is the basic procedure for loading paper. There are specific considerations for loading certain types of paper, transparency film, postcards, and envelopes. After you review this procedure, see **tips for loading other types of paper in the paper tray** on page 9 and **load envelopes** on page 9.

For best results, adjust the paper settings each time you change paper types or paper sizes. For more information, see **set the paper type** on page 10.

to load the input tray

- 1 Slide the paper-width and -length guides to their outermost positions.
- 2 Tap the stack on a flat surface to align the edges of the paper, and then check the paper for the following:
 - Make sure it is free of rips, dust, wrinkles, and curled or bent edges.
 - Make sure all the paper in the stack is the same size and type.

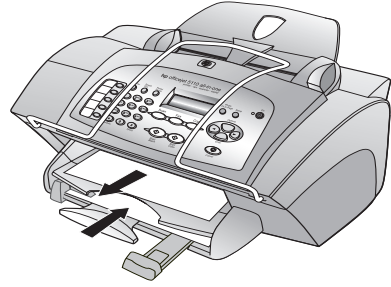

- 3 With the output tray raised, insert paper into the input tray until it stops. The print side should be facing down, and the letterhead or top of page should be facing forward. Do not overfill the input tray as this may cause paper jams.
- 4 Slide the paper-width and -length guides in until they stop at the edges of the paper. Make sure that the paper stack lies flat in the input tray and fits under the tab of the paper-length guide.

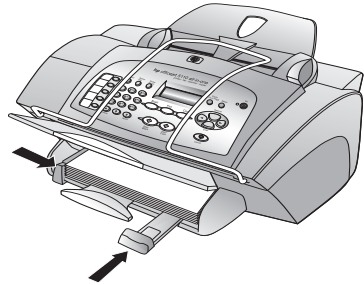

- 5 To prevent paper from falling off the tray, fully extend the output-tray extender.

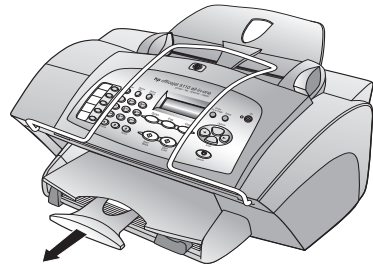

load envelopes

Use the print feature of your software to print to envelopes with your HP Officejet. Your HP Officejet provides two methods for working with envelopes. Do *not* use shiny or embossed envelopes, or envelopes that have clasps or windows.

- If you are printing one envelope, slide the envelope into the envelope slot, which is located on the right side toward the back of the output tray. Insert the envelope with the flap up and on the left, as shown in the illustration. Slide the envelope on the top until it stops.

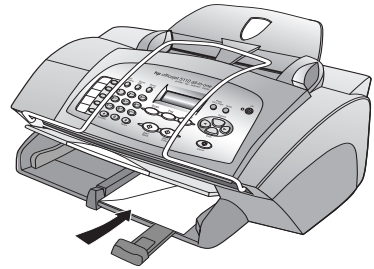

- If you are printing multiple envelopes, remove all paper from the paper tray. Slide a stack of envelopes into the tray, with the envelope flaps up and to the left (print-side down), until they stop. Adjust the paper-width guide against the envelopes (be careful not to bend the envelopes). Make sure the envelopes fit within the tray (do not overload it).

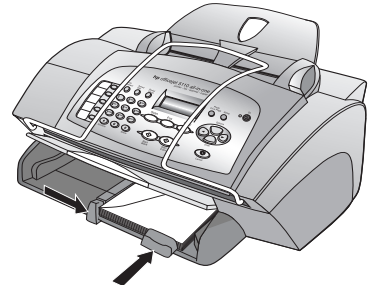

Consult the help files in your word-processing software for details on how to format text for printing on envelopes.

tips for loading other types of paper in the paper tray

This section provides guidelines for loading special types of paper and transparency film. For best results, adjust the paper settings each time you change paper types and paper sizes. For more information, see **set the paper type** on page 10.

HP Inkjet T-Shirt Transfer Iron-On

Flatten the transfer sheet completely before using it; do not load curled sheets. To prevent curling, keep transfer sheets sealed in the original package until you are ready to use them. Manually feed one sheet at a time, with the unprinted side facing down and the blue stripe facing up.

HP Premium or Premium Plus Inkjet Transparency Film

Insert the film so that the white transparency strip with arrows and the HP logo is on top and goes into the tray first.

Labels (use only for printing)

- Always use letter-size or A4-size label sheets designed for use with HP Inkjet products (like Avery Inkjet Labels), and make sure that the labels are not over two years old.
- Fan the stack of labels to make sure none of the pages are sticking together.
- Place a stack of label sheets on top of standard paper in the paper tray, print-side down. Do *not* insert labels one sheet at a time.



set the paper type

If you want to use a different type of paper, such as photo paper, transparency film, t-shirt transfer paper, or brochures, simply load that paper in the paper tray. You should then change the paper type settings to ensure the best print quality.

HP recommends paper type settings according to the type of paper you're using.



This section refers to copy options only. If you want to set the paper type for printing, set the properties from the Print dialog box.

to set the paper type for current and future copy jobs

- 1 On the front panel press **COPY** until **Paper Type** appears.
- 2 Press  until the appropriate paper type appears, and then press **ENTER** to select it.
- 3 Press **COPY** again until **Set New Defaults** appears, and then press  until **Yes** appears. Press **ENTER** to set the new defaults.

set the paper size

The HP Officejet can copy and print onto letter, legal, or A4 paper. Use the following procedure to set the paper size for copying.

- 1 Select one of the following:
 - To change the size for a copy job, press **COPY** until **Paper Size** appears.
 - To change the size for a fax job, press **SETUP** until **3: Basic Fax Setup** appears, and then press **ENTER** to select it. After **1:Date and Time** appears, press  until **4:Paper Size** appears, and then press **ENTER** to select it.
- 2 Press  until the desired paper size appears, and then press **ENTER** to select it.

4

use the copy features

The copy features let you do the following:

- Produce high-quality color and black-and-white copies using a variety of paper types and sizes, including iron-on transfers.
- Reduce or enlarge the size of the copies you make from 25% to 200% of the copy's original size. This varies based on your HP Officejet model.
- Make the copy lighter or darker, adjust the color intensity, select the number of copies, and specify the quality of the copies you make.
- Use special copying features to make many sizes of photos, make high-quality copies of photos using special photo paper, or create transparencies.

make copies

You can make copies using the front panel of your HP Officejet or by using the HP Officejet software on your computer. Many copy features are available using either method. However, you may find that the software offers easier access to special copy features.

All copy settings that you select on the front panel are reset **two minutes** after the HP Officejet completes the copy, unless you save the settings as the default settings as described in **change settings for all copy tasks** on page 13.

make a copy

- 1 Load the input tray with the appropriate paper.
For more information, see **load paper** on page 7.
- 2 Load your original in the ADF.
For more information, see **load originals** on page 7.
- 3 If you want to make more than one copy (the default), do the following:
 - a. Press **COPY**.
 - b. After **Number of Copies** appears, use the keypad or arrow keys to enter the number of copies, and then press **ENTER**.For more information, see **set the number of copies** in the onscreen User's Guide. You can make up to 99 copies.
- 4 If you are using anything other than plain paper, do the following:
 - a. Press **COPY** until **Paper Type** appears.
 - b. Press  until the appropriate paper type appears, and then press **ENTER** to select it.
- 5 Press the **COPY** button and arrow keys to change any other applicable settings, such as reduction or enlargement.
- 6 Press **START, BLACK** or **START, COLOR**.

increase copy speed or quality



The HP Officejet provides three options that affect copy speed and quality.

- **Best** produces the highest quality for all paper and eliminates the banding (striping) effect that sometimes occurs in solid areas. **Best** copies more slowly than the other quality settings.
- **Normal** delivers high-quality output and is the recommended setting for most of your copying. **Normal** copies faster than **Best**.
- **Fast** copies faster than the **Normal** setting. The text is of comparable quality to the **Normal** setting, but the graphics may be of lower quality. Using **Fast** also cuts down on the frequency of replacing your print cartridges, because it uses less ink.

- 1 Load your original in the ADF.
- 2 Press **COPY** until **Copy Quality** appears.
- 3 Press  until the desired quality setting appears, and then press **ENTER** to select it.
- 4 Press **START, BLACK** or **START, COLOR**.

set the number of copies

You can set the number of copies using the front panel.

- 1 Press **COPY**. After **Number of Copies** appears, use the keypad (or press  or ) to enter the number of copies, and then press **ENTER**.
If you hold down the right arrow button, then after reaching 10 the number of copies changes by increments of 5 to make it easier to set a large number of copies.
- 2 Press **START, BLACK** or **START, COLOR**.

reduce or enlarge a copy

You can reduce or enlarge a copy of an original using **Reduce/Enlarge**.



For more information about additional copy options such as **Photo Fit to Page**, see **perform special copy jobs** on page 13.

- 1 Press **COPY** until **Reduce/Enlarge** appears.
- 2 Press  until the appropriate reduce/enlarge option appears, and then press **ENTER** to select it.
- 3 If you select **Custom**, **Set custom size** appears. Use the arrow keys or type a % on the number keypad. Press **ENTER** when the desired percentage is displayed.
- 4 Press **START, BLACK** or **START, COLOR**.

make copies lighter or darker

Use **Lighter/Darker** to adjust the lightness and darkness of the copies you make.

- 1 Press **COPY** until **Lighter/Darker** appears.
The range of **Lighter/Darker** values appears as a circle on a scale on the front-panel display.

- 2 Press  to lighten the copy or  to darken it. The circle moves to the left or right, depending on the button you press. Press **ENTER** to select the setting.
- 3 Press **START, BLACK** or **START, COLOR**.

enhance text sharpness and photo colors

Use **Text** enhancements to sharpen edges of black text. Use **Photo** enhancements for photographs or pictures to enhance light colors that may otherwise appear white.

Text enhancement is the default option. You can turn off **Text** enhancement by selecting **Photo** or **None** if the following occur:

- Stray dots of color surround some text on your copies.
- Large, black typefaces look splotchy (not smooth).
- Thin, colored objects or lines contain black sections.
- Horizontal grainy or white bands appear in light- to medium-gray areas.

- 1 Press **COPY** until **Enhancement** appears.
- 2 Press  until the desired enhancement (**Text**, **Photo**, or **None**) appears. Press **ENTER** to select the setting.
- 3 Press **START, BLACK** or **START, COLOR**.

change settings for all copy tasks

Save the copy settings you use most often by setting them as the default. This includes changes to copy options such as **Paper Type** and **Paper Size**, as well as other copy settings on the front panel, such as **Number of Copies** and **Copy Quality**.

- 1 Make any desired changes to the copy options.
- 2 Press **COPY** until **Set New Defaults** appears.
- 3 Press  until **Yes** appears.
- 4 Press **ENTER** to set the options as a default.
Your settings are saved.

perform special copy jobs

In addition to supporting standard copying, your HP Officejet can also do the following:



- **copy a photo**
- **fit a copy to the page**
- **prepare a color t-shirt transfer**

copy a photo

When copying a photo, you should select options for the correct paper type and photo enhancement.

- 1 Load the photo in the ADF.
- 2 If you are using photo paper, load it in the paper tray.

use the copy features

- 3 Press **COPY** until **Paper Type** appears.
- 4 Press  until the desired photo paper option appears, then press **ENTER** to select it.
- 5 Press **COPY** until **Enhancements** appears.
- 6 Press  until **Photo** appears, then press **ENTER** to select it.
- 7 Press **START, BLACK** or **START, COLOR**.

Tip — To enlarge a photo automatically to a full page, see **fit a copy to the page**.

fit a copy to the page

Use the **PHOTO FIT TO PAGE** button when you want to automatically enlarge or reduce your original to fit the paper size you have loaded. You can enlarge a small photo to fit a full-size page, as shown below, or you can use this feature to easily copy a legal-size original to letter-size paper or vice versa. Using **PHOTO FIT TO PAGE** may prevent unwanted cropping of text or images around the margins.

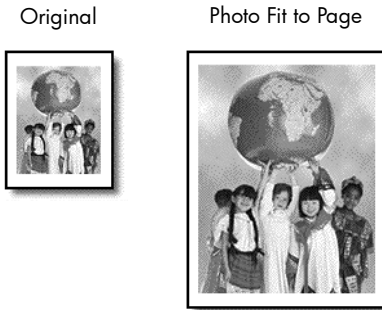

- 1 Load your original photo or document in the ADF.
- 2 Press the **PHOTO FIT TO PAGE** button.
- 3 Press  until the appropriate paper type appears, and then press **ENTER** to select it.
- 4 Press **START, BLACK** or **START, COLOR**.

prepare a color t-shirt transfer

Use the **Iron-On** feature to reverse text and images so that they appear backwards. After you iron a transfer onto a T-shirt, the picture appears properly on the shirt.

Original



Iron-On



Tip — We recommend that you practice applying a T-shirt transfer to an old garment first.

- 1 Load your original in the ADF.
- 2 Load the T-shirt transfer paper in the paper tray.
- 3 Press **COPY** until **Paper Type** appears.
- 4 Press  until **Iron-On** appears and then press **ENTER** to select it. Selecting this option automatically copies a mirror-image of your original.
- 5 Press **START, BLACK** or **START, COLOR**.

copy options

The following diagram shows the options that are available when you press **COPY**.

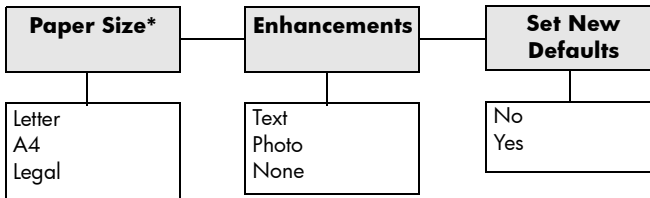
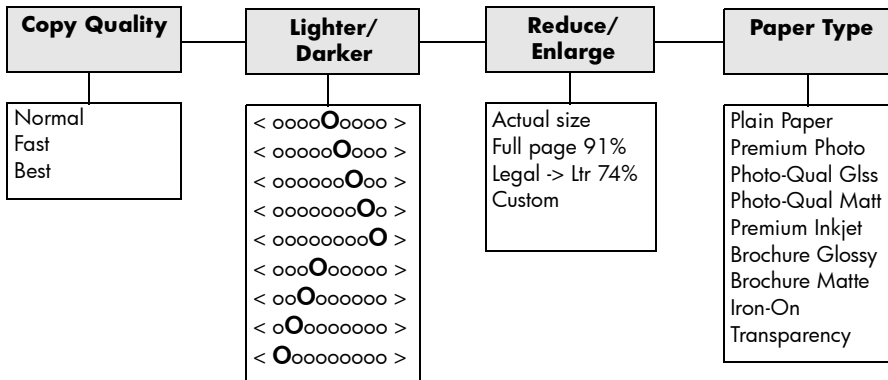

*The sizes vary by country/region.

To cycle through the copy options, press **COPY** repeatedly, or press **COPY** and then press **OPTIONS** repeatedly.

Press **→** and **←** to move to a setting within one of the copy options

Press **ENTER** to select the displayed setting.

5

use the scan features

Scanning is the process of converting text and pictures into an electronic format for your computer. You can scan just about anything:

- Photos
- Magazine articles
- Text documents

Because the scanned image or text is in an electronic format, you can bring it into your word processor or graphics program and modify it to suit your needs. You can do the following:

- Scan text from an article into your word processor and quote it in a report, saving you a lot of retyping.
- Scan in a logo and use it in your publishing software, allowing you to print business cards and brochures for yourself.
- Scan in photos of your kids and e-mail them to relatives, create a photographic inventory of your house or office, or create an electronic scrapbook.

To use the scan features, your HP Officejet and computer must be connected and turned on. The HP Officejet software should also be installed and running on your computer prior to scanning. To verify that the HP Officejet software is running, look for a status icon in the system tray.

scan an original

You can start a scan from your computer or from your HP Officejet.

to scan an original from your hp officejet

- 1 Load your original in the ADF.
For more information, see **load originals** on page 7.
- 2 Choose one of the following:
 - Press **SCAN**, then press  until the desired program appears.
 - Press **START, BLACK** or **START, COLOR**.
The scan appears in the program you selected.

to scan an original from your computer

See **scan a picture** or **scan a document or text** in the onscreen User's guide.
create a custom button on page 14

stop a scan

- ▶ You can stop a scan by pressing the **CANCEL** button located on the front panel.

use the scan features

6

use the fax features

Using your HP Officejet, you can:

- Send and receive paper faxes, and send computer faxes. A computer fax (also called a *computer-generated fax*) is a file that you fax from your Windows PC or Macintosh computer.
- Send and receive color faxes. If you send a color fax and your HP Officejet determines that the recipient has a black-and-white fax unit, your HP Officejet will interrupt the send process and resend the fax in black and white.

For comprehensive information, see the fully-searchable onscreen User's Guide. To access the guide, go to the Director, click **Help**, and choose **User's Guide**.

enable fax confirmation

Your HP Officejet is set to print a report only if there is a problem with sending or receiving a fax. A confirmation message that indicates whether an item was successfully sent appears briefly on the front-panel display after each transaction. If you need printed confirmation that your faxes are successfully sent, follow these instructions *before* sending any faxes.

If you want to print a report on your last fax transaction, see **print reports** in the onscreen User's Guide.

to do this using the front panel

- 1 Press **SETUP** until **1:Print Report** appears, then press **ENTER**.
- 2 Press **▶** until **6:Automatic Reports Setup** appears, and then press **ENTER**.
- 3 Press **▶** until **Send Only** appears, and then press **ENTER** to select it.

to do this using the computer

- ▶ See **enable fax confirmation** in the onscreen User's Guide.

send a fax

Your HP Officejet lets you send a fax in a variety of configurations. These include:

- Send a paper fax (using the front panel or computer).
- Send a paper fax with a computer-generated cover page (using the computer).
- Send a computer file with or without a cover page (using the computer).
- Send a computer-generated cover page as a single-page fax (using the computer).

For the above fax procedures that involve your computer, see **send a fax** in the onscreen User's Guide.

initiate the fax process from your hp officejet

Follow these steps to use your HP Officejet to fax an item from the front panel.

to send a fax without changing settings

- 1 Load your original in the ADF.
For more information, see **load originals** on page 7.
- 2 Enter the fax number using the keypad, use one of the one-touch speed-dial buttons or press **SPEED DIAL** until the desired speed-dial entry appears.
For more information on speed-dialing, see **set up speed dialing** in the onscreen User's Guide.
- 3 Press **START, BLACK** or **START, COLOR**.

to send a fax after changing settings

- 1 Load your original in the ADF.
For more information, see **load originals** on page 7.
- 2 Enter the fax number using the keypad, use one of the one-touch speed-dial buttons, or press **SPEED DIAL** until the desired speed-dial entry appears.
For more information on speed-dialing, see **set up speed dialing** in the onscreen User's Guide.
- 3 Press **FAX** to scroll through the fax options.
- 4 When you reach the option you want to change, press  to scroll through the setting options.
- 5 When you reach the setting you want to change, press **ENTER** to accept the setting.
For more information on changing fax settings, see **use fax features on the front panel** in the onscreen User's Guide.
- 6 Press **START, BLACK** or **START, COLOR**.

receive a fax



Depending on how you set up your HP Officejet, you will either receive faxes automatically or manually. For more information, see **set the answer mode** on page 23.

Your HP Officejet is automatically set to print received faxes (unless you have turned the auto-answer feature off). If you receive a legal-size fax and your HP Officejet is not currently set to use legal-size paper, the unit automatically reduces the fax so that it fits on the paper that is loaded (unless you disabled the automatic-reduction feature). For more information, see **set automatic reduction** in the onscreen User's Guide.

receive a fax automatically

to do this using the front panel

- 1 Verify that **Auto Answer** is turned on.
- 2 The light next to **Auto Answer** is on when the feature is turned on. Press the **AUTO ANSWER** button to turn it on or off.
- 3 First, set the number of rings to answer.

- a. Press **SETUP** until **3:Basic Fax Setup** appears, and then press **ENTER**.
 - b. Press  until **3:Rings to Answer** appears. Use the keypad or the arrow keys to choose the number of rings, and then press **ENTER**.
- 4** Next, choose the distinctive ring pattern.
- a. Press **SETUP** until **4:Advanced Fax Setup** appears, and then press **ENTER**.
 - b. Press  until **2:Answer Ring Pattern** appears, and then press **ENTER**.
 - c. Press  to scroll through the available ring patterns and press **ENTER** when the ring pattern you want to use appears.

to do this using the computer

- ▶ See **receive a fax automatically** in the onscreen User's Guide.

receive a fax manually

Before manually receiving a fax to your HP Officejet, we recommend that you remove any originals from the ADF so that they are not accidentally processed.

to do this using the front panel

- 1** Verify that **Auto Answer** is turned *off*.
- 2** The light next to **Auto Answer** is off when the feature is disabled. Press the **AUTO ANSWER** button to turn it on or off.

to do this using the computer

- ▶ See **receive a fax manually** in the onscreen User's Guide.

to receive a fax manually

- 1** When your HP Officejet rings, pick up the handset of a telephone that is on the same telephone line as your HP Officejet.
- 2** If you hear fax tones, press **START, BLACK** or **START, COLOR** or, if you are receiving from an extension phone (on the same telephone line as your HP Officejet, but not connected directly to it), press **1 2 3** on your phone.
- 3** After you are finished, hang up the telephone.

save frequently-used fax numbers

There are two ways of storing fax numbers that you use frequently. You can assign numbers that can be used in speed-dialing from the front panel, and you can save numbers in the address book for use with the software.

For information on setting up speed-dialing, see **set up speed dialing** in the onscreen User's Guide.

set basic fax settings using the front panel

We recommend that you use the Fax Setup Wizard in the HP Officejet software to configure all your basic fax settings; however, you can also access these settings from the front panel.

Note: In the U.S., regulations require that your name and number appear on every fax. The minimum settings that we recommend are described in the following topics.

set the date and time

Follow these steps to set the date and time manually.

- 1 Press **SETUP** until **3:Basic Fax Setup** appears, and then press **ENTER**.
- 2 After **1:Date and Time** appears, press **ENTER**, and then enter the date and time using the keypad.

Tip — Use only the last two digits for the year.

Tip — When you enter a single-digit date or time, type a leading zero before the single digit: for example, 03:45, or 08-03-02.

After you are finished, the date and time appear on the display.

set the fax header

Follow these steps to enter your name and fax number.

Note: In Hungary, the subscriber identification code (fax header) can be set or changed only by authorized personnel. For more information, contact your authorized HP dealer.

- 1 Press **SETUP** until **3:Basic Fax Setup** appears, and then press **ENTER**.
- 2 After **1:Date and Time** appears, press  until **2:Fax Header** appears, and then press **ENTER**.
- 3 After **Your Name** appears, enter your name using the guidelines provided in the next section, **enter text**. Press **ENTER**.
- 4 Using the keypad, enter your fax number.
- 5 Press **ENTER**.

enter text



The following list provides tips for entering text using the front-panel keypad.

- Press the keypad numbers that correspond to the letters of a name.



- Press a button multiple times to see a letter first in uppercase and then in lowercase.

| | | | | | | | | |
|-----|-------------------------|---|---|---|---|---|---|---|
| JKL | To get this character: | J | j | K | k | L | l | 5 |
| (5) | Press 5 this many times | 1 | 2 | 3 | 4 | 5 | 6 | 7 |

- After the correct letter appears, press , and then press the number that corresponds to the next letter in the name. Again, press multiple times until the correct letter appears.
- To insert a space, press **SPACE (#)**.
- To enter a symbol, such as @, press **SYMBOLS (*)** to scroll through the list of available symbols.
- If you make a mistake, press  to clear it, and then make the correct entry.
- After you are finished entering text, press **ENTER** to store your entries.

set the answer mode



To set the answer mode, choose one of the following:

- If you want your HP Officejet to answer every fax call automatically, verify that **Auto Answer** is enabled. The light next to **Auto Answer** on the front panel is on when the feature is enabled. Press the **AUTO ANSWER** button to turn it on or off.
- If you want to answer fax calls manually, turn **Auto Answer** off.

set the rings to answer setting

This setting tells your HP Officejet how many rings should occur before it answers an incoming call. Follow these steps to change the **Rings to Answer** setting manually.

To use this feature, **Auto Answer** must be enabled. The light next to **Auto Answer** is on when the feature is enabled. Press the **AUTO ANSWER** button to turn it on or off.

- 1 Press **SETUP** until **3:Basic Fax Setup** appears, and then press **ENTER**.
- 2 After **1:Date and Time** appears, press  until **3:Rings to Answer** appears, and then press **ENTER**.
- 3 After **Answer on Ring** appears, press  to scroll to the desired number of rings.
- 4 After the number you want appears, press **ENTER**.

use the fax features

check for dial tone

Before using the fax features, verify that the connections are correctly established.

- 1 Press **FAX**, and then press **START, BLACK** or **START, COLOR**.
- 2 Listen for a dial tone.
- 3 If you do not hear a dial tone, check the connections.
- 4 Press **CANCEL** to hang up.

7

maintain your hp officejet

This section provides instructions for keeping your HP Officejet in top working condition. Perform these maintenance procedures as necessary.

clean the exterior

Use a soft, damp, lint-free cloth to wipe dust, smudges, and stains off the case. The interior of the HP Officejet does not require cleaning. Keep fluids away from the interior of the HP Officejet as well as the front panel.

work with print cartridges

To ensure the best print quality from your HP Officejet, you will need to perform some simple maintenance procedures, and when prompted by a front-panel message, replace the print cartridges.

print a self-test report

If you are experiencing problems with printing, before cleaning or replacing the print cartridges, you should print a self-test report. This report provides useful information about your print cartridges, including status information and ink levels.

- 1 Press **SETUP** until **1:Print Report** appears, and then press **ENTER**.
- 2 Press  until **5:Self-Test Report** appears, and then press **ENTER**.

A self-test report is printed for your HP Officejet, which may indicate the source of any problems you may be having.

handle print cartridges

Before you replace or clean a print cartridge, you should know the part names and how to handle the print cartridge.

Caution! Do not touch the copper contacts or the ink nozzles.

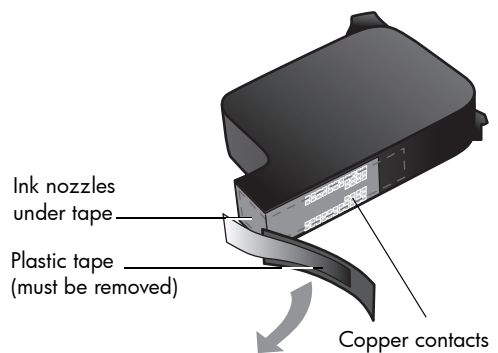

replace the print cartridges

Front-panel display messages appear to let you know that you should replace your print cartridges.

See **order print cartridges** on page 53 for information on ordering replacement print cartridges.

- 1 Turn on the HP Officejet, then open the print-cartridge access door.
- 2 The print carriage moves into view.
- 3 After the carriage stops moving, lift the latch to release the print cartridge, then pull it toward you out of its slot.

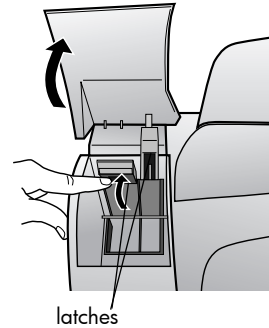

- 4 Remove the new print cartridge from its packaging and, being careful to touch only the black plastic, gently remove the plastic tape.

Caution! Do not touch the copper contacts or ink nozzles.

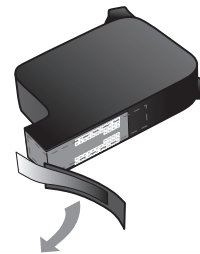

- 5 Push the new print cartridge into the appropriate slot.
The tri-color (#78) print cartridge goes on the left and the black (#15) cartridge goes on the right.

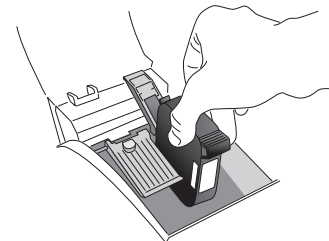

- 6 Close the latch.
- 7 Close the print-cartridge access door.

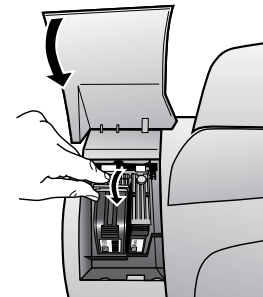

align cartridges

The HP Officejet prompts you to align cartridges every time you install or replace a print cartridge. Aligning the cartridges ensures high-quality output.

to align the print cartridges when prompted

- 1 Press **ENTER** on the front panel.
The HP Officejet prints a text page that contains instructions and an align cartridges page that contains test patterns.
- 2 Following the instructions on the text page, place the align cartridges (test pattern) page face down in the ADF. Adjust the paper-width guides to ensure that the page feeds in straight. Press **ENTER**.
The HP Officejet aligns the cartridges and displays the message "Alignment Complete." Discard or recycle the text page and align cartridges page.

to align the cartridges at any other time

- 1 Press **SETUP** until **5:Maintenance** appears, and then press **ENTER**.
- 2 Press  until **2:Align Print Cartridges** appears, and then press **ENTER**.
The HP Officejet prints a text page that contains instructions and an align cartridges page that contains test patterns.
- 3 Following the instructions on the text page, place the align cartridges (test pattern) page face down in the ADF. Adjust the paper-width guides to ensure that the page feeds in straight. Press **ENTER**.
The HP Officejet aligns the cartridges and displays the message "Alignment Complete." Discard or recycle the text page and align cartridges page.

clean the print cartridges

Use this feature when the Self-Test Report shows streaking or white lines through any of the colored bars. Do not clean print cartridges unnecessarily. This wastes ink and shortens the life of the ink nozzles.

- 1 Press **SETUP** until **5:Maintenance** appears, and then press **ENTER**.
- 2 Press  until **1:Clean Print Cartridges** appears, and then press **ENTER**.
If copy or print quality still seem poor after you clean the print cartridges, replace the print cartridge that is affected.

restore factory defaults

You can restore the original factory settings to what they were when you purchased your HP Officejet. You can perform this process from the front panel only.

- 1 Press **SETUP** until **5:Maintenance** appears, and then press **ENTER**.
- 2 Press  until **3:Restore Factory Defaults** appears, and then press **ENTER**.
The factory default settings are restored.

setup menu options

The following diagram shows the options that are available when you press

SETUP.

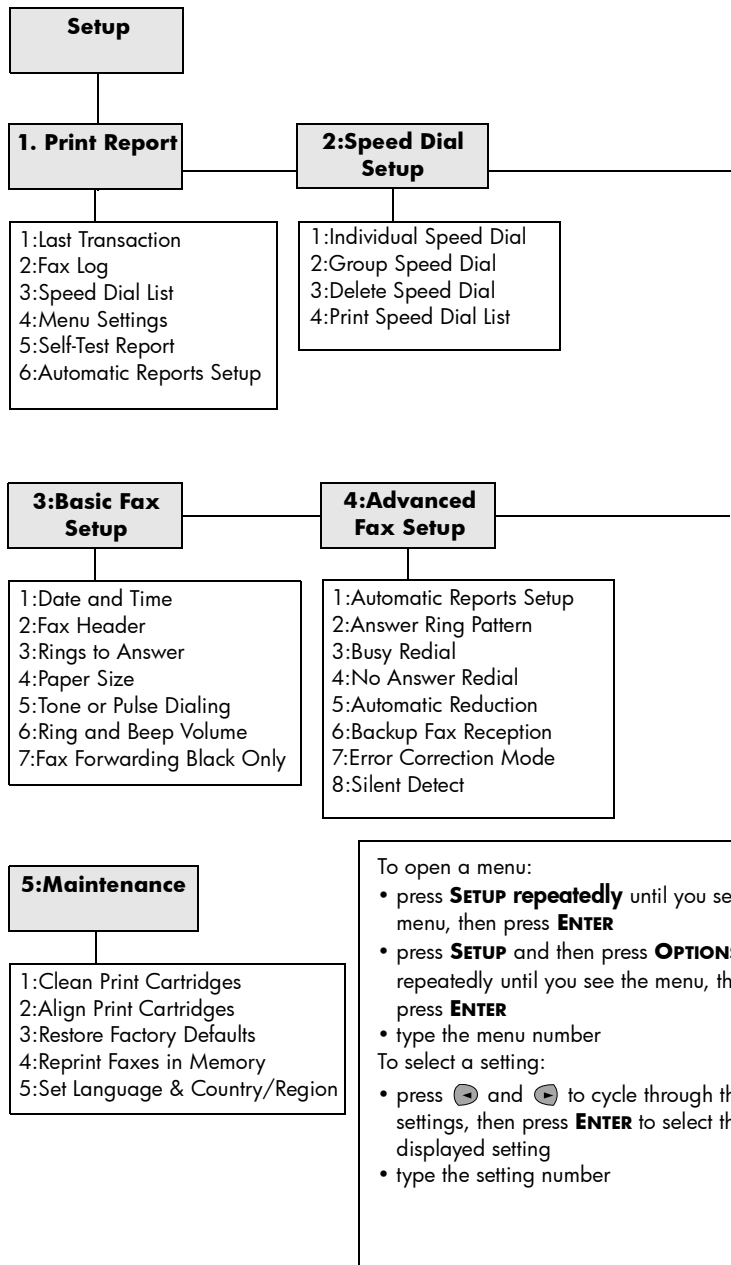

8

additional setup information

This section covers how to handle messages that may or may not appear during installation, how to set up the connection between your computer and your HP Officejet, and how to add and remove the HP Officejet software. The standard installation instructions are provided in your Setup Poster, which you should keep for later use.

possible installation problems

If you follow the instructions in the Setup Poster correctly, you should not have any problems with the installation of your HP Officejet. If you do not follow the instructions, you may encounter any of the following problems:

if the previous version installed message appears

If you receive a message that you have a previously installed version, you will not be able to finish installing the HP Officejet software.

You will have to uninstall the previously installed version in order to install the HP Officejet software.

if your computer is unable to communicate with your hp officejet

You may want to refer to the Readme file for more information on possible installation problems. On Windows PC, you can access the readme file from the **Start** button on the taskbar; select **Programs, Hewlett-Packard, hp officejet 5100 series, Readme**. On Macintosh, you can access the Readme file by double-clicking on the icon located in the top-level folder of the HP Officejet software CD-ROM.

set the language and country/region

Usually, you set the language and country/region when you install the HP Officejet. If you set the country/region or language incorrectly during installation, use the following procedure.

Tip — If you are unable to read the front-panel display language, but need to reset it, press **SETUP, 5, 5**. Follow the onscreen instructions.

- 1 Press **SETUP** until **5:Maintenance** appears, and then press **ENTER**.
- 2 Press **5** until **5:Set Language & Country/Region** appears, and then press **ENTER**.
- 3 Watch the display until the desired language appears. Enter the language code on the keypad. Press **1** for yes or **2** for no when the display asks you to confirm your selection.

After the language is selected, you are prompted with all the countries/regions for that selected language.

- 4 Watch the display until the desired country/region appears. Enter the country/region code on the keypad. Press **1** for yes or **2** for no when the display asks you to confirm your selection.

You can confirm the country/region and language by printing a Self-Test Report.

- 1 Press **SETUP** until **1:Print Report** appears, then press **ENTER**.
- 2 Press **←** until **5:Self-Test Report** appears, then press **ENTER**.

connect your hp officejet to your computer

Your HP Officejet supports HOT Swapping, meaning you can connect to the HP Officejet while the power is on at your computer and on the HP Officejet.

connect your usb port

Connecting to your HP Officejet with USB is straightforward. Simply plug one end of the USB cable into the back of your computer and the other in the back of the HP Officejet.

| what works | what does not work |
|--------------------------------------------------------------------------------|----------------------------------------------------|
| Plugging into the USB port on your computer | Plugging into the USB port located on the keyboard |
| Plugging into a powered hub that is connected to the USB port on your computer | Plugging into a non-powered USB hub |

Note: AppleTalk is not supported.

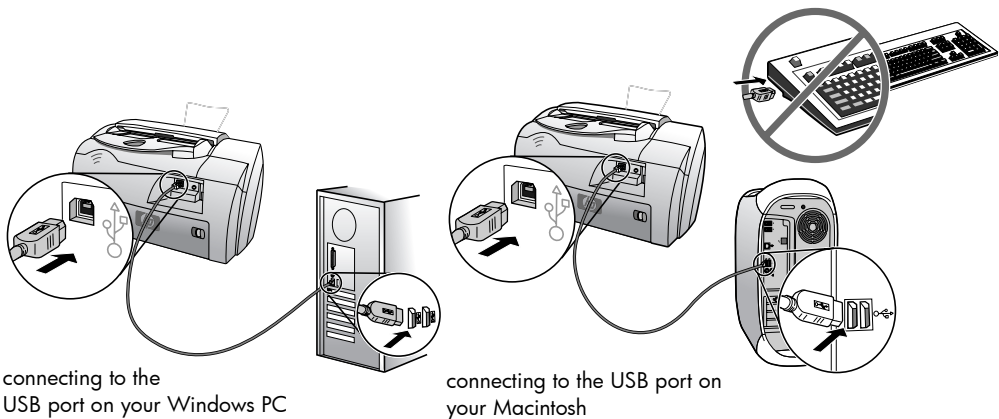

connect your hp officejet to a phone, modem, or answering machine

This section explains how to connect your HP Officejet to various office devices:

- **phone:** connect a phone to the HP Officejet so it can use the same phone connection as the fax line
- **modem:** connect a modem to your HP Officejet so it can use the same phone connection
- **answering machine:** set your HP Officejet to direct voice calls to the answering machine and fax calls to the HP Officejet

Note: For information on connecting your HP Officejet to your computer and phone system, see the Setup Poster that came with the unit.

to connect your hp officejet to a phone, modem, or answering machine

- 1 Remove the white plastic stopper from connector 2 on the back of the HP Officejet.



connector 2 on the HP Officejet

- 2 If you want to connect more than one device to connector 2 on the HP Officejet, purchase a Y-splitter and plug it into connector 2.
- 3 Connect the phone cord from the phone, modem, or answering machine to connector 2 (or Y-splitter).

Caution! Do *not* use the phone cord that came with the HP Officejet for this purpose. That phone cord must connect connector 1 on the HP Officejet to the wall jack for your phone system. See the Setup Poster for details.



connector 1 on the HP Officejet

- 4 If you are connecting an answering machine, see **set the rings to answer setting** for information on correctly setting the number of rings, or **change the answer ring pattern (distinctive ringing)** in the onscreen User's Guide for information on detecting incoming ring patterns.
- 5 If you are connecting a modem, turn off its fax-receive feature. See your onscreen User's Guide for information on tone versus pulse dialing and phone services.

remove and reinstall your hp officejet software

Do *not* simply delete the HP Officejet program files from your hard drive. Be sure to remove them properly using the uninstall utility provided in the HP Officejet program group.



system requirements

The following specifications are subject to change without notice.

| Windows PC requirements | | |
|--------------------------------------------------------------------|--------------------------------------------------------|-----------------------------|
| item | minimum | recommended |
| Processor Windows 98, 98SE, 2000, Millennium Edition, XP | Any Intel Pentium II, Celeron, or compatible processor | Intel Pentium III or higher |
| RAM Windows 98, 98SE, 2000, Millennium Edition, XP | 64 MB | 128 MB or more |
| Disk space needed for installation | 300 MB | |
| Additional disk space needed for scanned images | 50 MB | |
| Monitor | SVGA 800 x 600 with 16-bit color | |
| Media | CD-ROM drive | |
| I/O | Available USB port | |
| Internet access | | Recommended |
| Sound card | | Recommended |
| Other | I.E. 5.0 or higher Adobe Acrobat 4 or higher | |

| Macintosh requirements | | |
|--------------------------------------------------|-----------------|------------------------|
| item | minimum | recommended |
| Processor | G3 Processor | G4 Processor or higher |
| RAM Macintosh OS 9.x Macintosh OS X | 64 MB 128 MB | 128 MB 256 MB |
| Disk space needed for installation | 200 MB | |
| Additional disk space needed for scanned images | 50 MB | |
| Monitor | SVGA 800 x 600 | |
| Media | CD-ROM drive | |

| Macintosh requirements | | |
|------------------------|--------------------|-------------|
| item | minimum | recommended |
| I/O | Available USB port | |
| Internet access | | Recommended |
| Sound card | | Recommended |

specifications

paper specifications

paper-tray capacities

| type | paper weight | input tray* | output tray† | ADF |
|-------------------|-----------------------------|-------------|--------------------|-----|
| Plain paper | 16 to 24 lb. (60 to 90 gsm) | 100 | 50 black, 20 color | 20 |
| Legal paper | 20 to 24 lb. (75 to 90 gsm) | 100 | 50 black, 20 color | 20 |
| Cards | 110 lb. index max (200 gsm) | 40 | 10 | N/A |
| Envelopes | 20 to 24 lb. (75 to 90 gsm) | 15 | 10 | N/A |
| Transparency film | N/A | 25 | 30 | N/A |
| Labels | N/A | 20 | 20 | N/A |

* Maximum capacity

† Output tray capacity is affected by the type of paper and the amount of ink you are using. HP recommends emptying the tray frequently.

paper sizes

| Type | Size |
|--------------------|---------------------------------------------------------------------------------------------------------------------------------------------------------------------------------------------------|
| Paper | Letter: 8.5 x 11 inch (215.9 x 279.4 mm) Legal: 8.5 x 14 inch (215.9 x 355.6 mm) Executive: 7.25 x 10.5 inch (184.2 x 266.7 mm) A4: 210 x 297 mm A5: 148 x 210 mm B5: 182 x 257 mm |
| Envelopes | U.S. #10: 4.12 x 9.5 inch (104.8 x 241.3 mm) A2: 4.37 x 5.75 inch (111 x 146 mm) DL: 4.33 x 8.66 inch (110 x 220 mm) C6: 4.49 x 6.38 inch (114 x 162 mm) |
| Transparency films | Letter: 8.5 x 11 inch (216 x 279 mm) A4: 210 x 297 mm |
| Cards | 3 x 5 inch (76.2 x 127 mm) 4 x 6 inch (101.6 x 152 mm) 5 x 8 inch (127 x 203.2 mm) A6: 105 x 148.5 mm |
| Labels | Letter: 8.5 x 11 inch (216 x 279 mm) A4: 210 x 297 mm |
| Custom | 3 x 5 inch to 8.5 x 14 inch (76.2 x 127 mm to 216 x 356 mm) |

print specifications

- 600 dpi black with resolution enhancement technology (REt)
- 4800 dpi color with HP PhotoREt III
- Method: Drop-on-demand thermal inkjet
- Language: HP PCL Level 3, PCL3 GUI or PCL 10
- Print speeds vary according to the complexity of the document
- Up to 12 ppm black, 10 ppm color (varies by model)
- Duty cycle: 3000 printed pages per month (maximum)

| mode | | resolution (dpi) | speed (ppm) |
|--------|-------|---------------------------------------------|-------------|
| Best | Black | 600 x 600 | 4 |
| | Color | 1200 x 1200 (up to 4800 dpi optimized*) | 3 |
| Normal | Black | 600 x 600 | 6 |
| | Color | 600 x 600 | 5 |
| Fast | Black | 300 x 300 | up to 12.0 |
| | Color | 300 x 600 | up to 10.0 |

* Up to 4800 x 1200 optimized dpi color printing on premium photo papers, 1200 x 1200 input dpi.

print margin specifications

| | Top (leading edge) | Bottom (trailing edge)* | Left | Right |
|-------------------------------------------------------------------|-----------------------|----------------------------|------------------|------------------|
| Sheet Paper | | | | |
| U.S. Letter, U.S. Legal, U.S. Executive, | .07 in. (1.8 mm) | .46 in. (11.7 mm) | .25 in. (6.4 mm) | .25 in. (6.4 mm) |
| ISO A4, ISO A5, JIS B5 | .07 in. (1.8 mm) | .46 in. (11.7 mm) | .13 in. (3.4 mm) | .13 in. (3.4 mm) |
| Envelopes | | | | |
| U.S. No. 10, A2 (5.5 baronial), Intl. DL, Intl. C6 | .13 in. (3.2 mm) | .46 in. (11.7 mm) | .13 in. (3.2 mm) | .13 in. (3.2 mm) |
| Cards | | | | |
| U.S. 3 x 5 inch, U.S. 4 x 6 inch, U.S. 5 x 8 inch, ISO and JIS A6 | .07 in. (1.8 mm) | .46 in. (11.7 mm) | .13 in. (3.2 mm) | .13 in. (3.2 mm) |

* This margin is not LaserJet-compatible; however, the total writing area is compatible. The writing area is offset from center by .21 inches (5.4 mm), which causes asymmetric top and bottom margins.

copy specifications

- Digital image processing
- Up to 99 copies from original
- Digital zoom from 25 to 200% (varies by model)
- Photo Fit to Page
- Up to 12 cpm black, 8 cpm color (varies by model)
- Copy speeds vary according to the complexity of the document

| mode | | speed (ppm) | print resolution (dpi) | scan resolution (dpi)* |
|--------|-------|-------------|------------------------|------------------------|
| Best | Black | up to 3 | 1200 x 1200† | 600 x 1200 |
| | Color | up to 1 | 1200 x 1200† | 600 x 1200 |
| Normal | Black | up to 6 | 600 x 600 | 300 x 1200 |
| | Color | up to 4 | 600 x 600 | 300 x 1200 |
| Fast | Black | up to 12 | 300 x 600 | 300 x 1200 |
| | Color | up to 8 | 600 x 600 | 300 x 1200 |

* Maximum at 200% scaling

† On photo paper or premium inkjet paper

scan specifications

- Image editor included
- OCR software automatically converts to editable text
- Scan speeds vary according to the complexity of the document

| Item | Description |
|---------------|------------------------------------------------------|
| Resolution | 600 x 1200 dpi optical, up to 1200 dpi enhanced |
| Color | 36-bit color 8-bit grayscale (256 levels of gray) |
| Interface | TWAIN-compliant |
| Scanning Area | US Letter, US Legal, A4 |

fax specifications

- Walk-up color fax
- Up to 80 speed-dials (varies by model)
- Up to 80-page memory (varies by model) (based on ITU-T Test Image #1 at standard resolution. More complicated pages or higher resolution will take longer and use more memory)
- 20-page automatic document feeder (ADF)
- Automatic redial (up to five times)
- Confirmation and activity reports
- CCITT/ITU Group 3 fax with Error Correction Mode
- 33.6 Kbps transmission
- 3 seconds/page speed at 33.6 Kbps (based on ITU-T Test Image #1 at standard resolution. More complicated pages or higher resolution will take longer and use more memory)

- Broadcast to 20 locations
- Ring detect with automatic fax/answering machine switching
- Delayed faxing

| | 300 dpi | Photo (dpi) | Fine (dpi) | Standard (dpi) |
|-------|----------------|--------------------|-------------------|-----------------------|
| Black | 300 x 300 | 200 x 200 | 200 x 200 | 200 x 100 |
| Color | 300 x 300 | 300 x 300 | 200 x 200 | 200 x 200 |

physical specifications

- Height: 9.22 inch (23.4 cm)
- Width: 17.8 inch (45.2 cm)
- Depth: 14.62 inch (37.1 cm)
- Weight: 15.42 lb (7.0 kg)

power specifications

- Power consumption: 50W maximum
- Source (Input) Voltage: 100 to 240 VAC, grounded
- Input Frequency: 50 to 60 Hz
- Current: 1.0 A maximum
- Figures are based on using the AC adapter that came with your unit (HP part number 0950-3807).

environmental specifications

- Recommended Operating Temperature Range: 15° to 32° C (59° to 90° F), 15% to 85% humidity, RH non-condensing
- Allowable Operating Temperature Range: 5° to 40° C (41° to 104° F)
- Non-operating (Storage) Temperature Range: -30° to 60° C (-22° to 140° F)

additional specifications

- Memory: 8.0-MB ROM, 8.0-MB RAM (HP Officejet 5100 Series)

If you have Internet access, you can get acoustic information from the HP website at www.hp.com/support.

environmental product stewardship program

protecting the environment

Hewlett-Packard is committed to providing quality products in an environmentally sound manner. This product has been designed with several attributes to minimize impacts on our environment.

For more information, visit HP's Commitment to the Environment website at www.hp.com/abouthp/environment.

ozone production

This product generates no appreciable ozone gas (O₃).

paper use

This product is suited for the use of recycled paper according to DIN 19309.

plastics

Plastic parts over 25 grams are marked according to international standards that enhance the ability to identify plastics for recycling purposes at the end of the product's life.

recycling program

HP offers an increasing number of product return and recycling programs in many countries, as well as partnering with some of the largest electronic recycling centers throughout the world. HP also conserves resources by refurbishing and reselling some of its most popular products.

energy consumption

This product qualifies for ENERGY STAR[®], which is a voluntary program established to encourage the development of energy-efficient office products.



ENERGY STAR is a U.S. registered service mark of the U.S. EPA. As an ENERGY STAR partner, HP has determined that this product meets ENERGY STAR guidelines for energy efficiency.

For more information on ENERGY STAR guidelines, visit the following web site:

www.energystar.gov.

material safety data sheets

Material safety data sheets (MSDS) can be obtained from the HP web site at **www.hp.com/go/msds**.

If you are in the United States or Canada and do not have access to the Internet, call the U.S. HP FIRST fax-on-demand service at (800) 231-9300. Use Index number 7 for a listing of the material safety data sheets.

International customers without Internet access should call (404) 329-2009 for further information.

regulatory notices

The following sections are statements from various regulatory agencies.

notice to users of the U.S. telephone network: FCC requirements

This equipment complies with FCC rules, Part 68. On this equipment is a label that contains, among other information, the FCC Registration Number and Ringer Equivalent Number (REN) for this equipment. If requested, provide this information to your telephone company.

An FCC-compliant telephone cord and a modular plug are provided with this equipment. This equipment is designed to be connected to the telephone network or premises wiring using a compatible modular jack which is Part 68-compliant. This equipment connects to the telephone network through the following standard network interface jack: USOC RJ-11C.

Use the REN to determine the quantity of devices you may connect to your telephone line and still have all of those devices ring when your number is called. Too many devices on one line may result in failure to ring in response to an incoming call. In most, but not all, areas the sum of the RENs of all devices should not exceed five (5). To be certain of the number of devices you may connect to your line, as determined by the REN, you should call your local telephone company to determine the maximum REN for your calling area.

If this equipment causes harm to the telephone network, your telephone company may discontinue your service temporarily. If possible, they will notify you in advance. If advance notice is not practical, you will be notified as soon as possible. You will also be advised of your right to file a complaint with the FCC. Your telephone company may make changes in its facilities, equipment, operations, or procedures that could affect the proper operation of your equipment. If they do, you will be given advance notice so you will have the opportunity to maintain uninterrupted service.

If you experience trouble with this equipment, please contact the manufacturer or look elsewhere in this manual for warranty or repair information. Your telephone company may ask you to disconnect this equipment from the network until the problem has been corrected or until you are sure that the equipment is not malfunctioning.

This equipment may not be used on coin service provided by the telephone company. Connection to party lines is subject to state tariffs. Contact your state's public utility commission, public service commission, or corporation commission for more information.

This equipment includes automatic dialing capability. When programming and/or making test calls to emergency numbers:

- Remain on the line and explain to the dispatcher the reason for the call.
- Perform such activities in the off-peak hours, such as early morning or late evening.

Notice: The FCC hearing aid compatibility rules for telephones are not applicable to this equipment.

The Telephone Consumer Protection Act of 1991 makes it unlawful for any person to use a computer or other electronic device, including fax machines, to send any message unless such message clearly contains in a margin at the top or bottom of each transmitted page or on the first page of transmission, the date and time it is sent and an identification of the business, other entity, or other individual sending the message and the telephone number of the sending machine or such business, other entity, or individual. (The telephone number provided may not be a 900 number or any other number for which charges exceed local or long-distance transmission charges.) In order to program this information into your fax machine, you should complete the steps described in the software.

The United States Federal Communications Commission (in 47 CFR 15.105) has specified that the following notice be brought to the attention of users of this product.

Declaration of Conformity: This equipment has been tested and found to comply with the limits for a Class B digital device, pursuant to part 15 of the FCC Rules. Operation is subject to the following two conditions: (1) this device may not cause harmful interference, and (2) this device must accept any interference received, including interference that may cause undesired operation. Class B limits are designed to provide reasonable protection against harmful interference in a residential installation. This equipment generates, uses, and can radiate radio frequency energy, and, if not installed and used in accordance with the instructions, may cause harmful interference to radio communications. However, there is no guarantee that interference will not occur in a particular installation. If this equipment does cause harmful interference to radio or television reception, which can be determined by turning the equipment off and on, the user is encouraged to try to correct the interference by one or more of the following measures:

- Reorient the receiving antenna.
- Increase the separation between the equipment and the receiver.
- Connect the equipment into an outlet on a circuit different from that to which the receiver is connected.
- Consult the dealer or an experienced radio/TV technician for help.

Product Regulations Manager, Hewlett-Packard Company, San Diego, (858) 655-4100.

The user may find the following booklet prepared by the Federal Communications Commission helpful: *How to Identify and Resolve Radio-TV Interference Problems*. This booklet is available from the U.S. Government Printing Office, Washington DC, 20402. Stock No. 004-000-00345-4.

Pursuant to Part 15.21 of the FCC Rules, any changes or modifications to this equipment not expressly approved by the Hewlett-Packard Company may cause harmful interference and void the FCC authorization to operate this equipment.

doc statement / déclaration de conformité (Canada)

Le présent appareil numérique n'émet pas de bruit radioélectrique dépassant les limites applicables aux appareils numériques de la classe B prescrites dans le Règlement sur le brouillage radioélectrique édicté par le ministère des Communications du Canada.

This digital apparatus does not exceed the Class B limits for radio noise emissions from digital apparatus set out in the Radio Interference Regulations of the Canadian Department of Communications.

notice to users of the Canadian telephone network

Notice: This equipment meets the applicable Industry Canada Terminal Equipment Technical Specifications. This is confirmed by the registration number. The abbreviation, IC, before the registration number signifies that registration was performed based on a Declaration of Conformity indicating that Industry Canada technical specifications were met. It does not imply that Industry Canada approved the equipment.

Note: The Ringer Equivalence Number (REN) assigned to each terminal device provides an indication of the maximum number of terminals allowed to be connected to a telephone interface. The termination on an interface may consist of any combination of devices subject only to the requirement that the sum of the Ringer Equivalence Numbers of all the devices does not exceed 5.

notice to all users of the European Economic Area (EEA)



This product is designed to interwork with the analogue telephone networks in the following countries:

| | | |
|---------|------------|-------------|
| Germany | UK | Netherlands |
| France | Spain | Italy |
| Belgium | Luxembourg | Sweden |
| Austria | Denmark | Ireland |
| Norway | Finland | Switzerland |
| Greece | Portugal | |

Network compatibility depends on customer-selected settings, which must be reset to use the equipment on a telephone network in a country other than where the product was purchased. Contact the vendor or Hewlett-Packard Company if additional product support is necessary.

This equipment has been certified by the manufacturer in accordance with Directive 1999/5/EC (annex II) for Pan-European single-terminal connection to the public switched telephone network (PSTN). However, due to differences between the individual PSTNs provided in different countries, the approval does not, of itself, give an unconditional assurance of successful operation on every PSTN network termination point.

In the event of problems, you should contact your equipment supplier in the first instance.

This equipment is designed for DTMF tone dialing and loop disconnect dialing. In the unlikely event of problems with loop disconnect dialing, it is recommended that you use this equipment only with the DTMF tone dial setting.

notice to users of the German telephone network

The HP Officejet 5100 Series products are designed to connect only to the analogue public-switched telephone network (PSTN). Please connect the TAE N telephone connector plug, provided with the HP Officejet 5100 Series, into the wall socket (TAE 6) code N. The HP Officejet 5100 Series products can be used as a single device and/or in combination (in serial connection) with other approved terminal equipment.

geräuschemission

LpA < 70 dB

am Arbeitsplatz

im Normalbetrieb

nach DIN 45635 T. 19

VCCI-2 (Japan)

この装置は、情報処理装置等電波障害自主規制協議会（VCCI）の基準に基づくクラスB情報技術装置です。この装置は、家庭環境で使用することを目的としていますが、この装置がラジオやテレビジョン受信機に近接して使用されると受信障害を引き起こすことがあります。
取り扱い説明書に従って正しい取り扱いをして下さい。

notice to Korean customers

사용자 안내문 (B급 기기)
이 기기는 비업무용으로 전자파장애검정을 받은 기기로서, 주거지역에서는 물론 모든 지역에서 사용할 수 있습니다.

declaration of conformity

According to ISO/IEC Guide 22 and EN 45014

Manufacturer's Name and Address:

Hewlett-Packard Company, 16399 W. Bernardo Drive, San Diego, CA 92127-1899, USA

declares that the product

| | |
|------------------|-------------------------------------------------------------------|
| Product Name: | hp officejet 5100 series (Q1679A, Q1680A, Q1681A, Q1682A) |
| Model Number(s): | officejet 5110, officejet 5110xi, officejet 5110v, officejet 5105 |
| Product Options: | All |

conforms to the following Product Specifications:

| | | | |
|----------------|------------------------------------------------------------------------------------------------------------------------------------------------------------------------------------------------------|-------------|------------------------------------------------------------------------------------------------------------------------------------------------------------------------------------------------------------------------------------------------------------------------------------|
| Safety: | EN60950:1992 +A1, A2, A3, A4 & A11 IEC60950:1991 +A1, A2, A3 & A4 UL1950/CSA 22.2 No. 950, 3rd Edn: 1995 NOM-019-SCFI-1993 IEC 60825-1:1993 +A1/EN 60825-1:1994 +A11 Class 1 (Laser/LED) | EMC: | CISPR22:1993 +A1 & A2 / EN55022:1994, +A1 & A2 -Class B CISPR24:1997/EN55024:1998 IEC 61000-3-2:1995 / EN61000-3-2:1995 IEC 61000-3-3:1994 / EN61000-3-3:1995 AS/NZS 3548: 1992 Taiwan CNS13438 FCC Part 15-Class B / ICES-003, Issue 2 / VCCI-2 GB 9254-1998 |
| Telecom | TBR21:1998 | | |

Supplementary Information:

The Product herewith complies with the requirements of the Low Voltage Directive 73/23/EEC, and the EMC Directive 89/336/EEC and the R+TTE Directive 1999/5/EC (annex II) carries the CE marking accordingly.

European Contact for regulatory topics only: Your local Hewlett-Packard Sales and Service Office or Hewlett-Packard GmbH, Department HQ-TRE, Herrenberger Strasse 130, D-71034 Böblingen, Germany (Fax + 49-7031-14-3143)

This section explains the service information provided by Hewlett-Packard.

If you are unable to find the answer you need in the printed or onscreen documentation supplied with your product, you can contact one of the HP support services listed in the following pages. Some support services are available only in the U.S. and Canada, while others are available in many countries worldwide. If a support service number is not listed for your country or region, contact your nearest authorized HP dealer for help.

get support and other information from the internet

If you have Internet access, you can get more information from the HP website at www.hp.com/support. The website offers technical support, drivers, supplies, and ordering information.

hp customer support

Software programs from other companies may be included with your HP Officejet. If you experience problems with any of those programs, you will receive the best technical assistance by calling the experts at that company.

If you need to contact HP Customer Support, do the following before you call.

- 1 Make sure that:
 - a. Your HP Officejet is plugged in and turned on.
 - b. The specified print cartridges are installed correctly.
 - c. The recommended paper is properly loaded in the input tray.
- 2 Reset your HP Officejet:
 - a. Turn off the HP Officejet using the **ON** button located on the unit's front panel.
 - b. Unplug the power cord from the back of the HP Officejet.
 - c. Plug the power cord back into the HP Officejet.
 - d. Turn on the HP Officejet using the **ON** button.
- 3 For more information, see the HP website at www.hp.com/support.
- 4 If you are still experiencing problems and need to speak with an HP Customer Support Representative:
 - Have your serial number and service ID ready. To display your serial number, on the front panel, press **ENTER** and **START, BLACK** at the same time, until the serial number appears in the front-panel display.

To display your service ID, on the front panel, press **ENTER** and **START, COLOR** at the same time, until **SERV ID:** and the number appear in the front-panel display.

- Print a Self-Test Report. See **print a self-test report** on page 25 for information on printing this report.
- Make a color copy.
- Be prepared to describe your problem in detail.

5 Call HP Customer Support. Be near your unit when you call.

call in the U.S. during warranty

Call (208) 323-2551 Monday through Friday from 6:00 A.M. to 10:00 P.M. Mountain Standard Time (MST) and Saturdays from 9:00 A.M. to 4:00 P.M. MST. This service is free during the warranty period; however, your standard long-distance phone charges still apply. A fee may apply outside the warranty period.

call elsewhere in the world

The numbers listed below are current as of the printing date of this guide. For a list of current international HP Support Service numbers, visit www.hp.com/support and choose your own country, region or language.

For Korea, you can also visit www.hp.co.kr/.

You can call the HP support center in the following countries or regions. If your country or region is not listed, contact your local dealer or nearest HP Sales and Support Office to find out how to obtain services.

Support service is free during the warranty period; however, your standard long-distance phone charges will apply. In some cases, a flat fee per single incident will also apply.

For phone support in Europe, please check for the details and conditions of phone support in your country or region by consulting www.hp.com/cposupport/loc/regional.html.

Alternatively, you can ask your dealer or call HP at the phone number indicated in this booklet.

As part of our constant efforts to improve our phone support service, we advise you to check our website on a regular basis for new information regarding service features and delivery.

| country/region | hp technical support | country/region | hp technical support |
|------------------|---------------------------------|----------------------|----------------------|
| Algeria | +212 22404 747* | Malaysia | 1-800-805405 |
| Argentina | 0810-555-5520 | Mexico | 01-800-472-6684 |
| Australia | +61 3 8877 8000 1902 910 910 | Mexico (Mexico City) | 5258-9922 |
| Austria | +43 (0) 810 00 6080 | Morocco | +212 22404 747* |
| Bahrain (Dubai) | +971 4 883 8454 | Netherlands | +31 (0) 20 606 8751 |
| Belgium (Dutch) | +32 (0) 2 626 8806 | New Zealand | 0800 441 147 |
| Belgium (French) | +32 (0) 2 626 8807 | Norway | +47 22 11 6299 |

| country/region | hp technical support | country/region | hp technical support |
|----------------------------------------|------------------------------------|--------------------------------|----------------------------------|
| Brazil (Grande Sao Paulo) | (11) 3747 7799 | Oman | +971 4 883 8454 |
| Brazil (Demais Localidades) | 0800 157751 | Palestine | +971 4 883 8454 |
| Canada during warranty | (905) 206 4663 | Panama | 001-800-7112884 |
| Canada post-warranty (per-call charge) | 1-877-621-4722 | Peru | 0-800-10111 |
| Caribbean & Central America | 1-800-711-2884 | Philippines | 632-867-3551 |
| Chile | 800-10111 | Poland | +48 22 865 98 00 |
| China | 86 10 6564 5959 86 800 810 5959 | Portugal | +351 21 3176333 |
| Colombia | 9-800-114-726 | Puerto Rico | 1-877-232-0589 |
| Costa Rica | 0-800-011-0524 | Qatar | +971 4 883 8454 |
| Czech Republic | +42 (0) 2 6130 7310 | Romania | +40 1 315 44 42 01 3154442 |
| Denmark | +45 39 29 4099 | Russia, Moscow | +7 095 797 3520 |
| Ecuador | 1-800-225528 | Russia, St. Petersburg | +7 812 346 7997 |
| Europe (English) | +44 (0) 207 512 5202 | Saudi Arabia | +800 897 14440 |
| Egypt | 02 532 5222 | Singapore | (65) 272-5300 |
| Finland | +358 (0) 203 47 288 | Slovakia | +421 2 682 08080 |
| France (0.34 Euro/min.) | 0836696022 | South Africa (RSA) | 086 000 1030 |
| Germany (0.12 Euro/min.) | +49 (0) 180 52 58 143 | South Africa, Outside Republic | +27-11 258 9301 |
| Greece | +30 1060 73 603 | Spain | +34 902 321 123 |
| Hong Kong | +85 (2) 3002 8555 | Sweden | +46 (0)8 619 2170 |
| Guatemala | 1800-995-5105 | Switzerland † | +41 (0) 84 880 1111 |
| Hungary | +36 (0) 1 382 1111 | Taiwan | +886-2-2717-0055 0800 010 055 |
| India | 1-600-112267 91 11 6826035 | Thailand | +66 (2) 661 4000 |
| Indonesia | 62-21-350-3408 | Tunisia | +216 1891 222* |
| Ireland | +358 (0) 1 662 5525 | Turkey | +90 216 579 7171 |
| Israel | +972 (0) 9 9524848 | Ukraine | +7 (380-44) 490-3520 |
| Italy | +39 0226410350 | United Arab Emirates | +971 4 883 8454 |
| Japan | 0570 000 511 +81 3 3335 9800 | United Kingdom | +44 (0) 207 512 52 02 |

| country/region | hp technical support | country/region | hp technical support |
|----------------|----------------------|---------------------|----------------------|
| Jordan | +971 4 883 8454 | Venezuela | 0800-47468368 |
| Korea | +82 (2) 3270 0700 | Venezuela (Caracas) | (502) 207-8488 |
| Kuwait | +971 4 883 8454 | Vietnam | 84-8-823-4530 |
| Lebanon | +971 4 883 8454 | Yemen | +971 4 883 8454 |

* This Call Center supports French speaking customers from the following countries: Morocco, Tunisia, and Algeria.

† This Call Center supports German, French and Italian speaking customers in Switzerland.

call in Australia post-warranty

If your product is not under warranty, you can call 03 8877 8000. A per-incident, out-of-warranty support fee of \$27.50 (inc. GST) will be charged to your credit card. You can also call 1902 910 910 (\$27.50 charged to your phone account) from 9:00 A.M. to 5:00 P.M. Monday through Friday. (Charges and support hours are subject to change without notice.)

prepare your hp officejet for shipment

If after contacting HP Customer Support or returning to the point of purchase, you are requested to send your unit in for service, please follow the power off and rebox steps below to avoid further damage to the HP product.

- 1 Turn on the HP Officejet.
Disregard steps 1 through 6 if your unit will not turn on and the print carriage is in the home position. You will not be able to remove the print cartridges. Proceed to step 7.
- 2 Open the print-cartridge access door.
- 3 Remove the print cartridges from their holders, and lower the latches.
Caution! Remove both print cartridges and lower both latches. Failure to do so may damage your unit.
See **replace the print cartridges** on page 25 for information on removing the print cartridges.
- 4 Place the print cartridges in an airtight bag so they will not dry out, and put them aside (do not send them with the unit, unless instructed to by the HP customer support call agent).
- 5 Turn off the HP Officejet.
- 6 Close the print-cartridge access door.

7 Remove the front-panel cover as follows:

a. Slip your hand into the ADF, behind the front panel, and lift up.

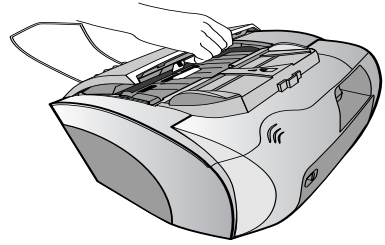

b. Insert a small screwdriver into the round hole behind the keypad and press firmly to pop off the front panel.

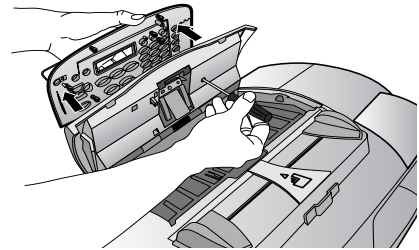

8 Retain the front-panel cover. Do not return the front-panel cover with the unit.

9 If available, pack the unit for shipment using the original packing materials or the packaging materials that came with your exchange unit.

If you do not have the original packaging materials, please use other adequate packaging materials. Shipping damage caused by improper packaging and/or improper transportation is not covered under the warranty.

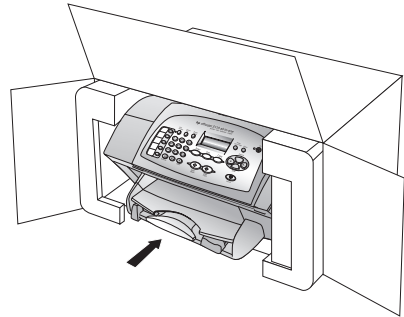

10 Include the following items in the box:

- A brief description of symptoms for service personnel (samples of print quality problems are helpful).
- A copy of the sales slip or other proof of purchase to establish the warranty coverage period.
- Your name, address, and a phone number where you can be reached during the day.

11 Place the return shipping label on the outside of the box.

hp distribution center

To order HP Officejet software, a copy of the printed *Reference Guide*, a Setup Poster, or other customer-replaceable parts, do one of the following:

- In the U.S. or Canada, call (208) 323 2551.
- Visit https://warp2.external.hp.com/Driver/dr_country_select.asp

hp officejet 5100 series warranty

Duration of Limited Warranty (hardware and labor): 1 Year

Duration of Limited Warranty (CD media): 90 Days

Duration of Limited Warranty (ink cartridges): 90 Days

warranty service

express service

To obtain HP express repair service, the customer must contact an HP service office or an HP Customer Support Center for basic troubleshooting first. See **hp customer support** on page 43 for steps to take before calling Customer Support.

If a customer unit needs a minor part replacement and these parts can normally be replaced by the customer, the customer-replaceable components may be serviced through expedited part shipment. In this event, HP will prepay shipping charges, duty and taxes; provide telephone assistance on replacement of the component; and pay shipping charges, duty, and taxes for any part that HP asks to be returned.

The HP Customer Support Center may direct customers to designated authorized service providers who are certified by HP to service the HP product.

warranty upgrades

Upgrade your standard factory warranty to a total of three years with the HP SUPPORTPACK. Service coverage begins on product purchase date and the pack must be purchased within the first 180 days of product purchase. This program offers phone support from 6:00 A.M. to 10:00 P.M. Mountain Standard Time (MST) Monday through Friday and 9:00 A.M. to 4:00 P.M. (MST) on Saturdays. If during your technical support call it is determined that you need a replacement product, then HP will ship you this product next business day free of charge. Available in U.S. only.

For more information, please call 1-888-999-4747 or visit the following HP website:
www.hp.com/go/hpsupportpack.

Outside the U.S., please call your local HP Customer Support office. See **call elsewhere in the world** on page 44 for a list of international Customer Support numbers.

return your hp officejet 5100 series for service

Before returning your HP Officejet for service, you must call HP Customer Support. See **hp customer support** on page 43 for steps to take before calling Customer Support.

hewlett-packard limited global warranty statement

extent of limited warranty

Hewlett-Packard ("HP") warrants to the end-user customer ("Customer") that each HP Officejet 5100 Series product ("Product"), including related software, accessories, media, and supplies, shall be free from defects in material and workmanship for the duration, which begins on the date of purchase by the Customer.

For each hardware Product, the duration of HP's limited warranty is one year for parts and one year for labor. For all other Products, the duration of HP's limited warranty for both parts and labor is ninety days.

For each software Product, HP's limited warranty applies only to a failure to execute programming instructions. HP does not warrant that the operation of any Product shall be uninterrupted or error free.

HP's limited warranty covers only those defects which arise as a result of normal use of a Product, and does not cover any other problems, including those which arise as a result of (a) improper maintenance or modification, (b) software, accessories, media, or supplies not provided or supported by HP, or (c) operation outside the Product's specifications.

For any hardware Product, the use of a non-HP ink cartridge or a refilled ink cartridge does not affect either the warranty to the Customer or any HP support contract with the Customer. However, if Product failure or damage is attributable to the use of a non-HP or refilled ink cartridge, HP shall charge its standard labor and materials charges to service the Product for the failure or damage.

If HP receives, during the applicable warranty period, notice of a defect in any Product, HP shall either repair or replace the defective Product, at HP's option. Where labor charges are not covered by HP's limited warranty, repairs shall be at HP's standard charges for labor.

If HP is unable to repair or replace, as applicable, a defective Product which is covered by HP's warranty, HP shall, within a reasonable time after being notified of the defect, refund the purchase price for the Product.

HP shall have no obligation to repair, replace, or refund until the Customer returns the defective Product to HP.

Any replacement product may be either new or like-new, provided that it has functionality at least equal to that of the Product being replaced.

HP products, including each Product, may contain remanufactured parts, components, or materials equivalent to new in performance.

HP's limited warranty for each Product is valid in any country or locality where HP has a support presence for the Product and where HP has marketed the Product. The level of warranty service may vary according to local standards. HP shall have no obligation to alter the form, fit, or function of the Product in order to make it operate in a country or locality for which the Product was never intended to operate.

limitations of warranty

TO THE EXTENT ALLOWED BY LOCAL LAW, NEITHER HP NOR ITS THIRD PARTY SUPPLIERS MAKE ANY OTHER WARRANTY OR CONDITION OF ANY KIND, WHETHER EXPRESS OR IMPLIED, WITH RESPECT TO THE COVERED HP PRODUCTS, AND SPECIFICALLY DISCLAIM THE IMPLIED WARRANTIES OR CONDITIONS OF MERCHANTABILITY, SATISFACTORY QUALITY, AND FITNESS FOR A PARTICULAR PURPOSE.

limitations of liability

To the extent allowed by local law, the remedies provided in this Limited Warranty Statement are the Customer's sole and exclusive remedies.

TO THE EXTENT ALLOWED BY LOCAL LAW, EXCEPT FOR THE OBLIGATIONS SPECIFICALLY SET FORTH IN THIS LIMITED WARRANTY STATEMENT, IN NO EVENT SHALL HP OR ITS THIRD PARTY SUPPLIERS BE LIABLE FOR DIRECT, INDIRECT, SPECIAL, INCIDENTAL, OR CONSEQUENTIAL DAMAGES, WHETHER BASED ON CONTRACT, TORT, OR ANY OTHER LEGAL THEORY AND WHETHER ADVISED OF THE POSSIBILITY OF SUCH DAMAGES.

local law

This Limited Warranty Statement gives the Customer specific legal rights. The Customer may also have other rights which vary from state to state in the United States, from province to province in Canada, and from country to country elsewhere in the world.

To the extent this limited Warranty Statement is inconsistent with local law, this Statement shall be deemed modified to be consistent with such local law. Under such local law, certain disclaimers and limitations of this Statement may not apply to the Customer. For example, some states in the United States, as well as some governments outside the United States (including provinces in Canada), may:

Preclude the disclaimers and limitations in this Statement from limiting the statutory rights of a consumer (e.g. the United Kingdom);

Otherwise restrict the ability of a manufacturer to enforce such disclaimers or limitations;
or

Grant the Customer additional warranty rights, specify the duration of implied warranties which the manufacturer cannot disclaim, or not allow limitations on the duration of implied warranties.

FOR CONSUMER TRANSACTIONS IN AUSTRALIA AND NEW ZEALAND, THE TERMS IN THIS LIMITED WARRANTY STATEMENT, EXCEPT TO THE EXTENT LAWFULLY PERMITTED, DO NOT EXCLUDE, RESTRICT, OR MODIFY, AND ARE IN ADDITION TO, THE MANDATORY STATUTORY RIGHTS APPLICABLE TO THE SALE OF THE COVERED HP PRODUCTS TO SUCH CUSTOMERS.

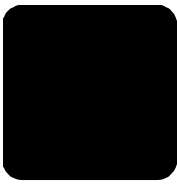

A

ADF (automatic document feeder), **7**
align print cartridges, **26**
answer mode, **23**
Auto Answer
 answer mode, **23**
 receive faxes automatically, **20**

B

best copy quality, **12**
buttons, front panel, **3**

C

cartridges, *see* print cartridges
clean
 exterior, **25**
 print cartridges, **27**
color
 enhance, **13**
confirm faxes, **19**
contrast
 improve photo color, **13**
copy, **11–16**
 default settings, **13**
 enhance, **13**
 fit to page, **14**
 iron-on transfers, **14**
 lighten or darken, **12**
 menu options, **16**
 number of copies, **12**
 photos, **13**
 quality, **12**
 reduce or enlarge, **12**
 set default paper size, **10**
 set default paper type, **10**
 settings, **12–13**
 specifications, **36**
 speed, **12**
country/region setup, **29**
customer support, **43–50**

D

darken copies, **12**
date, set, **22**
declaration of conformity, **41**
director, **4–6**
documentation, **1**

E

enhance copies, **13**
enlarge copies, **12**
envelopes - load, **9**
environmental specifications, **37**

F

factory defaults, restore, **27**
fast copy quality, **12**
fax, **19–24**
 answer mode, **23**
 change settings, **20**
 confirmation, **19**
 date and time, **22**
 fit to page, **20**
 from the front panel, **20**
 header, **22**
 receive, **20**
 ring pattern, **20**
 rings to answer, **23**
 save frequently-used numbers, **21**
 send, **19**
 settings, **21–24**
 specifications, **36**
 speed-dial numbers, **20**
 test, **24**
fit to page, **14**
front panel
 buttons, **3**
 enter text, **23**

H

hp customer support, **43–50**
hp director, **4–6**
hp distribution center, **47**
hp documentation, **1**

I

ink cartridges, *see* print cartridges
install software, **29**
iron-on t-shirt transfers, **14**

K

keypad, enter text, **23**

L

labels - load, **10**

language setup, **29**
legal-size paper, fax, **20**
lighten copies, **12**
load
 envelopes, **9**
 originals in the ADF, **7**
 paper, **7**
 print cartridges, **25**
 special paper, **9**

M

Macintosh system requirements, **33**
maintenance
 align print cartridges, **26**
 clean exterior, **25**
 clean print cartridges, **27**
 replace print cartridges, **25**
 restore factory settings, **27**
 self-test report, **25**
menus
 copy options, **16**
 setup options, **28**

N

normal copy quality, **12**
number of copies, **12**

O

order print cartridges, **53**

P

paper
 default copy size, **10**
 default copy type, **10**
 fragile, load, **7**
 load, **7**
 specifications, **34**
 tips on loading, **9**
photos
 copy, **13**
 enhance, **13**
 fit to page, **14**
 fragile, load, **7**
physical specifications, **37**
power specifications, **37**
print
 envelopes, **9**
 self-test report, **25**

- specifications, **35**
- print cartridges
 - align, **26**
 - clean, **27**
 - order, **53**
 - replace, **25**
 - test, **25**

R

- receive faxes, **20**
- reduce
 - copies, **12**
- regulatory information, **38**
- reinstall software, **31**
- remove software, **31**
- reports
 - last fax, **19**
 - self-test, **25**
- restore factory settings, **27**

S

- scan, ??–**17**
 - from front panel, **17**
 - specifications, **36**

- self-test report, **25**
- send faxes, **19**
- settings
 - copy, **12–13**
 - fax, **21–24**
 - language and country/
region, **29**
- setup menu options, **28**
- software
 - install, **29**
 - remove and reinstall, **31**
- specifications
 - copy, **36**
 - environmental, **37**
 - fax, **36**
 - physical, **37**
 - power, **37**
 - print, **35**
 - print margin, **35**
 - scan, **36**
- speed-dial numbers, **20**
- subscriber identification
code, **22**

- support services, **43–50**
- system requirements, **33**

T

- text
 - enhance, **13**
 - enter on keypad, **23**
- time, set, **22**
- transparency film
 - load, **9**
- troubleshooting
 - installation problems, **29**
 - remove and reinstall
software, **31**
- t-shirt transfers, **9, 14**

U

- USB cable installation, **30**

W

- warranty information, **47–50**
- Windows PC system
requirements, **33**

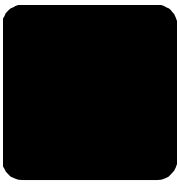

order supplies

Use the following information for ordering supplies for your HP Officejet 5100 Series.

order media

To order media such as HP Premium Inkjet Paper, HP Premium Inkjet Transparency Film, HP Iron-On T-shirt Transfer paper, or HP Greeting Cards, see one of the following:

- For orders in the U.S. and Canada, go to www.hpshopping.com.
- For orders in all other countries, go to www.hpshopping.com.
Select **other countries**, then click **Yes** to leave www.hpshopping.com.
From this website, you can access hpshopping.com for your specific language or region.

order print cartridges

The following table lists the print cartridges that you can use with the HP Officejet 5100 Series. Use the following information to determine which print cartridge to order.

| print cartridges | hp reorder number |
|------------------------------|------------------------------------------------------------------------------------------------|
| HP black print cartridge | #15, 25 ml black print cartridge (C6615d) |
| HP tri-color print cartridge | #78, 19 ml tri-color print cartridge (C6578d) #78, 38 ml tri-color print cartridge (C6578a) |

If you have Internet access, you can get more information from the HP website at:
<http://www.hp.com/support>

Visit the hp officejet information center

It has everything you need to get the most value from your HP Officejet.

- Technical Support
- Supplies and Ordering Information
- Project Tips
- Ways to Enhance Your Product

www.hp.com/support

© 2002 Hewlett-Packard Company

Printed in the U.S.A., Germany, or Singapore.



Q1678-90158