

HP 530 Notebook PC

Maintenance and Service Guide

© Copyright 2007 Hewlett-Packard
Development Company, L.P.

Bluetooth is a trademark owned by its proprietor and used by Hewlett-Packard Company under license. Intel, Core, and Celeron are trademarks or registered trademarks of Intel Corporation or its subsidiaries in the United States and other countries. Java is a U.S. trademark of Sun Microsystems, Inc. Microsoft, Windows, and Windows Vista are either trademarks or registered trademarks of Microsoft Corporation in the United States and/or other countries.

The information contained herein is subject to change without notice. The only warranties for HP products and services are set forth in the express warranty statements accompanying such products and services. Nothing herein should be construed as constituting an additional warranty. HP shall not be liable for technical or editorial errors or omissions contained herein.

First Edition: April 2007

Document Part Number: 446951-001

Safety warning notice

- ⚠ **WARNING!** To reduce the possibility of heat-related injuries or of overheating the computer, do not place the computer directly on your lap or obstruct the computer air vents. Use the computer only on a hard, flat surface. Do not allow another hard surface, such as an adjoining optional printer, or a soft surface, such as pillows or rugs or clothing, to block airflow. Also, do not allow the AC adapter to contact the skin or a soft surface, such as pillows or rugs or clothing, during operation. The computer and the AC adapter comply with the user-accessible surface temperature limits defined by the International Standard for Safety of Information Technology Equipment (IEC 60950).
-

Table of contents

1 Product description

2 External component identification

Front components	5
Top components	6
Buttons and lights	6
Keys	7
Pointing devices	8
Right-side components	8
Left-side components	9
Bottom components	10

3 Illustrated parts catalog

Serial number location	11
Computer major components	12
Display assembly components	16
Plastics/Hardware Kit	17
Mass storage devices	18
Miscellaneous parts	19
Sequential part number listing	20

4 Removal and replacement procedures

Preliminary replacement requirements	25
Tools required	25
Service considerations	25
Plastic parts	25
Cables and connectors	26
Drive handling	26
Grounding guidelines	26
Electrostatic discharge damage	26
Packaging and transporting guidelines	28
Workstation guidelines	28
Equipment guidelines	29
Unknown user password	30
Component replacement procedures	31
Serial number	31
Battery	32
Hard drive	33

Computer feet	35
Memory module	35
WLAN module	37
Optical drive	39
Switch cover	41
Keyboard	43
Button board	46
Display assembly	47
Base enclosure	52
RTC battery	54
Fan assembly	55
Heat sink	57
Processor	59
Speaker	60
System board	62
PC Card assembly	65
TouchPad cable	67

5 Computer Setup

Starting Computer Setup	69
Using Computer Setup	70
Navigating and selecting in Computer Setup	70
Restoring factory settings in Computer Setup	70
Computer Setup menus	71
File menu	71
Security menu	72
Diagnostics menu	72
System Configuration menu	73

6 Specifications

Computer specifications	75
15.4-inch, WXGA display specifications	76
Hard drive specifications	77
Primary 4-cell, Li-ion battery specifications	78
DVD±RW and CD-RW Super Multi Double-Layer Combo Drive specifications	79
DVD/CD-RW Combo Drive specifications	80
System DMA specifications	81
System interrupt specifications	82
System I/O address specifications	83
System memory map specifications	85

7 Screw listing

Phillips PM2.5×6.0 captive screw	88
Phillips PM3.0×3.0 screw	89
Phillips PM2.0×9.0 screw	90
Phillips PM2.0×3.0 screw	93
Phillips PM2.0×2.0 screw	96
Phillips PM2.0×7.0 screw	97
Phillips PM2.5×6.0 screw	98

Phillips PM2.5×4.0 screw	100
8 Backup and recovery in Windows Vista	
Creating recovery discs	101
Backing up your information	102
When to back up	102
Backup suggestions	102
Backing up specific files or folders	103
Backing up the entire hard drive	103
Creating recovery points	104
Scheduling backups	104
Performing a recovery	105
Performing a recovery from the recovery discs	105
Performing a recovery from the hard drive	105
Initiating a recovery in Windows	106
Initiating a recovery from the hard drive recovery partition	106
9 Backup and recovery in Windows XP	
Creating recovery discs	107
Backing up your information	108
When to back up	108
Backup suggestions	108
Backing up specific files or folders	109
Backing up the entire hard drive	109
Creating recovery points	110
Scheduling backups	110
Performing a recovery	111
Performing a recovery from the recovery discs	111
Performing a recovery from the hard drive	111
Initiating a recovery in Windows	112
Initiating a recovery from the hard drive recovery partition	112
10 Connector pin assignments	
Audio-out (headphone)	113
Audio-in (microphone)	113
External monitor	114
RJ-11 (modem)	115
RJ-45 (network)	115
Universal Serial Bus	116
11 Power cord set requirements	
Requirements for all countries or regions	117
Requirements for specific countries or regions	118
12 Recycling	
Battery	119
Display	119

Index 125

1 Product description

Category	Description	940GML system board without wireless local area network (WLAN)	940GML system board with WLAN	945GM system board with WLAN
Product Name	HP 530 Notebook PC	✓	✓	✓
Processors	<ul style="list-style-type: none"> Intel® Core™ Duo T2300 (1.66-GHz) processor with 667-MHz front side bus (FSB), 2 MB of L2 cache, socketed 			✓
	<ul style="list-style-type: none"> Intel® Core Duo T2300E (1.66-GHz) processor 667-MHz FSB, 2 MB of L2 cache, socketed 			✓
	<ul style="list-style-type: none"> Intel Core Solo T1400 (1.83-GHz) processor 667-MHz FSB, 2 MB of L2 cache, socketed 			✓
	<ul style="list-style-type: none"> Intel Core Solo T1300 (1.1.66-GHz) processor 667-MHz FSB, 2 MB of L2 cache, socketed 			✓
	<ul style="list-style-type: none"> Intel Celeron® M 420M (1.60-GHz) processor 533-MHz FSB, 512 KB of L2 cache, socketed 	✓	✓	
	<ul style="list-style-type: none"> Intel Celeron M 410M (1.46-GHz) processor 533-MHz FSB, 512 KB of L2 cache, socketed 	✓	✓	
Chipsets	<ul style="list-style-type: none"> Northbridge: Intel 945GM 			✓
	<ul style="list-style-type: none"> Northbridge: Intel 940GML 	✓	✓	
	<ul style="list-style-type: none"> Southbridge: Intel ICH-7M 	✓	✓	✓
Graphics	Unified Memory Architecture (UMA) – graphics subsystem shares memory resources with main system memory	✓	✓	✓
Panels	<ul style="list-style-type: none"> 15.4-inch, WXGA (16:10 aspect ratio) BrightView with wireless antenna transceivers and cables 		✓	✓
	<ul style="list-style-type: none"> 15.4-inch, WXGA (16:10 aspect ratio) BrightView without wireless antenna transceivers and cables 	✓		
Memory	<ul style="list-style-type: none"> Two SODIMM slots Customer-accessible/upgradable 	✓	✓	✓

Category	Description	940GML system board without wireless local area network (WLAN)	940GML system board with WLAN	945GM system board with WLAN
	<ul style="list-style-type: none"> • DDRII PC2-5300 (667-MHz) • Supports the following configurations: <ul style="list-style-type: none"> ◦ 2048 MB total system memory (1024-MB × 2) ◦ 1536 MB total system memory (1024-MB + 512-MB) ◦ 1024 MB total system memory (1024-MB × 1, 512-MB × 2) ◦ 768 MB total system memory (512-MB + 256-MB) ◦ 512 MB total system memory (512-MB × 1, 256-MB × 2) ◦ 256 MB total system memory (256-MB × 1) 			
Hard drives	<ul style="list-style-type: none"> • Supports all 9.5-mm, 2.5-inch hard drives • Parallel ATA • Supports the following drives: <ul style="list-style-type: none"> ◦ 120-GB, 5400-rpm ◦ 80-GB, 5400-rpm 	√	√	√
Optical drives (fixed)	<ul style="list-style-type: none"> • 12.7-mm tray load • Parallel ATA • Fixed, no modular requirements (1 screw removal) • Supports the following drives: <ul style="list-style-type: none"> ◦ DVD±RW and CD-RW Super Multi Double-Layer Combo Drive ◦ DVD/CD-RW Combo Drive 	√	√	√
Diskette drive	Supports external USB drive only	√	√	√
Audio	<ul style="list-style-type: none"> • Conexant CX20549 • Single speaker • Headphone and microphone jacks 	√	√	√
Modem	<ul style="list-style-type: none"> • Conexant CX20548-11 • Modem cable included 	√	√	√
Ethernet	Intel 82562GT	√	√	√

Category	Description	940GML system board without wireless local area network (WLAN)	940GML system board with WLAN	945GM system board with WLAN
Wireless	Integrated wireless options by way of WLAN module: <ul style="list-style-type: none"> WLAN antennae (2, configured in display assembly) Intel 802.11a/b/g Broadcom and Intel 802.11b/g 		√	√
External media card	One Type I/II PC Card slot, 16-bit PCMCIA and 32-bit CardBus	√	√	√
Ports	<ul style="list-style-type: none"> 2-pin AC jack Audio-out (stereo microphone) jack Audio-in (stereo headphone) jack RJ-11 modem jack RJ-45 Ethernet jack (includes link and activity LEDs) USB 2.0 ports (2) VGA port (Dsub 15-pin) 	√	√	√
Docking	No docking support			
Keyboard/pointing devices	<ul style="list-style-type: none"> Keyboard with embedded numeric keypad TouchPad with 2 buttons and one-way scroll 	√	√	√
Power requirements	<ul style="list-style-type: none"> 4-cell, 2.2-Ah, 32-Wh, Li-ion battery <p>NOTE: The HP 530 Notebook PC does not support Smart Battery technology.</p> <ul style="list-style-type: none"> 65-W AC adapter with localized cable plug support (2-wire plug with ground pin, supports 2-pin DC connector) <p>NOTE: The HP 530 Notebook PC does not support Smart AC adapter technology.</p>	√	√	√
Security	Security cable slot	√	√	√
Operating system	Preinstalled: <ul style="list-style-type: none"> Windows Vista™ Home Basic Windows Vista Business 32 Microsoft® Windows® XP Pro (in Japan only) FreeDOS 	√	√	√

Category	Description	940GML system board without wireless local area network (WLAN)	940GML system board with WLAN	945GM system board with WLAN
Serviceability	End-user replaceable parts:			
	• AC adapter	√	√	√
	• Battery (system)	√	√	√
	• Hard drive	√	√	√
	• Memory module	√	√	√
	• WLAN module		√	√

2 External component identification

Front components



Item	Component	Function
(1)	Wireless antennae (select models only)	Send and receive signals from one or more wireless devices. These antennae are not visible from the outside of the computer. NOTE: To see wireless regulatory notices, refer to the section of the <i>Regulatory, Safety, and Environmental Notices</i> that applies to your country or region. These notices are located in Help and Support.
(2)	Battery light	<ul style="list-style-type: none">• Amber: A battery is charging.• Green: A battery is close to full charge capacity.• Blinking amber: A battery that is the only available power source has reached a low battery level. When the battery reaches a critical battery level, the battery light begins to blink rapidly.• Off: If the computer is plugged into an external power source, the light turns off when all batteries in the computer are fully charged. If the computer is not plugged into an external power source, the light stays off until the battery reaches a low battery level.
(3)	Audio-out (headphone) jack	Produces sound when connected to optional stereo speakers, headphones, ear buds, a headset, or television audio.
(4)	Audio-in (microphone) jack	Connects an optional computer headset microphone, stereo array microphone, or monaural microphone.

Top components

Buttons and lights

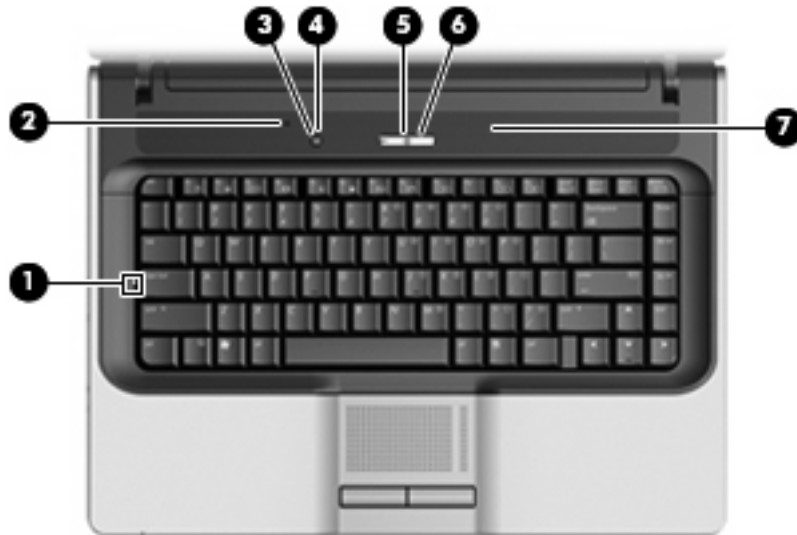

Item	Component	Function
(1)	Caps lock light	On: Caps lock is on.
(2)	Internal display switch	Turns off the display if the display is closed while the power is on.
(3)	Wireless button (select models only)	Turns the wireless feature on or off, but does not create a wireless connection. NOTE: A wireless network must be set up in order to establish a wireless connection.
(4)	Wireless light (select models only)	<ul style="list-style-type: none">On: An integrated wireless device, such as a wireless local area network (WLAN) device, the HP Broadband Wireless Module, and/or a Bluetooth® device, is on.Off: All wireless devices are turned off.
(5)	Power button*	<ul style="list-style-type: none">When the computer is off, press the button to turn on the computer.When the computer is on, press the button to initiate the Sleep state (Windows Vista) or shut down the computer (Windows XP).When the computer is in the Sleep state (Windows Vista) or in Standby (Windows XP), press the button briefly to exit Sleep or Standby.When the computer is in Hibernation, press the button briefly to exit Hibernation. <p>If the computer has stopped responding and Windows® shutdown procedures are ineffective, press and hold the power button for at least 5 seconds to turn off the computer.</p>

Item	Component	Function
		<p>To learn more about power settings, follow these steps:</p> <ul style="list-style-type: none"> In Windows Vista, select Start > Control Panel > System and Maintenance > Power Options. In Windows XP, select Start > Control Panel > Performance and Maintenance > Power Options.
(6)	Power light	<ul style="list-style-type: none"> On: The computer is on. Blinking: The computer is in the Sleep state (Windows Vista) or in Standby (Windows XP). Off: The computer is off or in Hibernation.
(7)	Speaker	Produces sound.

*This table describes factory settings. For information about changing factory settings, refer to the user guides located in Help and Support.

Keys

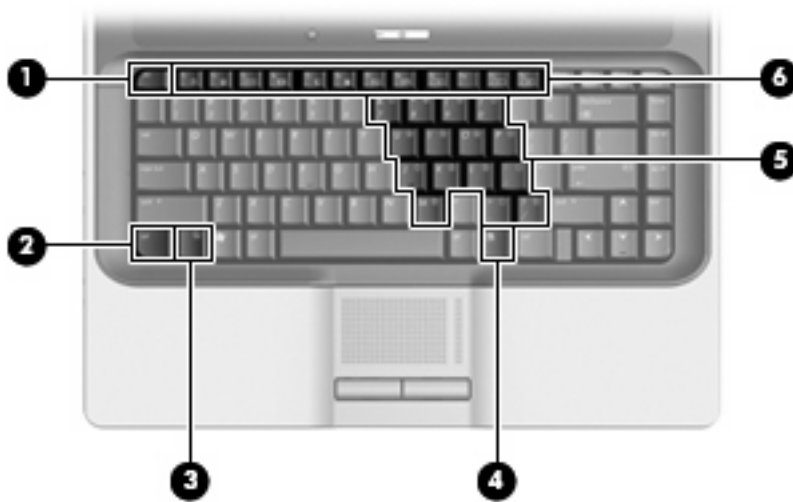

Item	Component	Function
(1)	esc key	Displays system information when pressed in combination with the fn key.
(2)	fn key	Executes frequently used system functions when pressed in combination with a function key or the esc key.
(3)	Windows logo key	Displays the Windows Start menu.
(4)	Windows applications key	Displays a shortcut menu for items beneath the pointer.
(5)	Embedded numeric keypad keys	Can be used like the keys on an external numeric keypad.
(6)	Function keys	Execute frequently used system functions when pressed in combination with the fn key.

Pointing devices

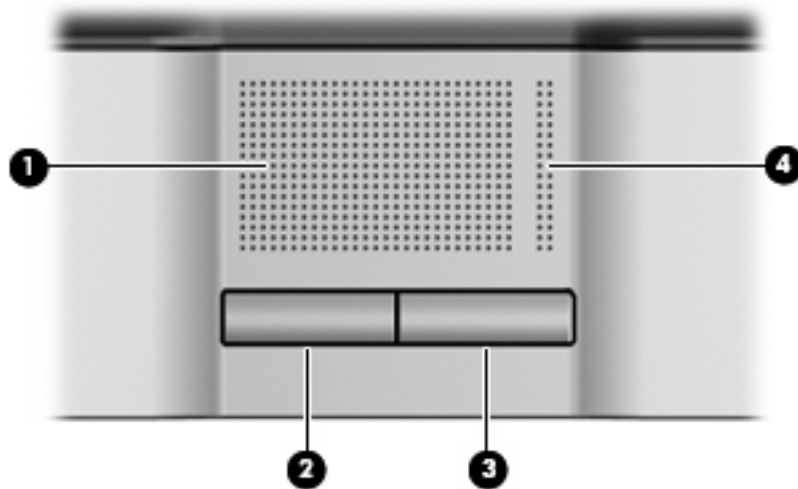

Item	Component	Function
(1)	TouchPad*	Moves the pointer and selects or activates items on the screen.
(2)	Left TouchPad button*	Functions like the left button on an external mouse.
(3)	Right TouchPad button*	Functions like the right button on an external mouse.
(4)	TouchPad scroll zone	Scrolls up or down.

*This table describes factory settings. View or change pointing device preferences as follows:

- In Windows Vista, select **Start > Control Panel > Hardware and Sound > Mouse**.
- In Windows XP, select **Start > Control Panel > Printers and Other Hardware > Mouse**.

Right-side components

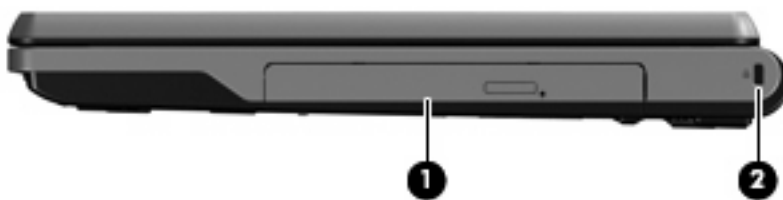

Item	Component	Function
(1)	Optical drive	Reads an optical disc.
(2)	Security cable slot	Attaches an optional security cable to the computer.

NOTE: The security cable is designed to act as a deterrent, but it may not prevent the computer from being mishandled or stolen.

Left-side components

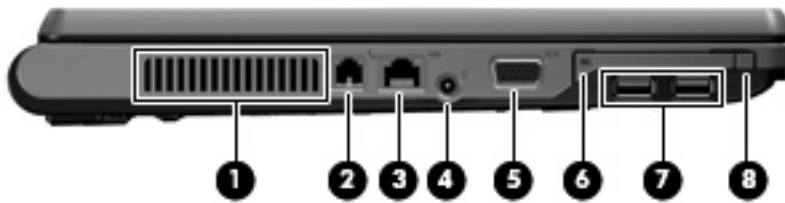

Item	Component	Function
(1)	Vent	Enables airflow to cool internal components. NOTE: The computer fan starts up automatically to cool internal components and prevent overheating. It is normal for the internal fan to cycle on and off during routine operation.
(2)	RJ-11 (modem) jack (select models only)	Connects a modem cable.
(3)	RJ-45 (network) jack	Connects a network cable.
(4)	Power connector	Connects an AC adapter. NOTE: The HP 530 Notebook PC does not support Smart AC adapter technology.
(5)	External monitor port	Connects an optional VGA external monitor or projector.
(6)	PC Card slot	Supports optional Type I or Type II 32-bit (CardBus) or 16-bit PC Cards.
(7)	USB ports (2)	Connect optional USB devices.
(8)	PC Card eject button	Ejects the PC Card from the PC Card slot.

Bottom components

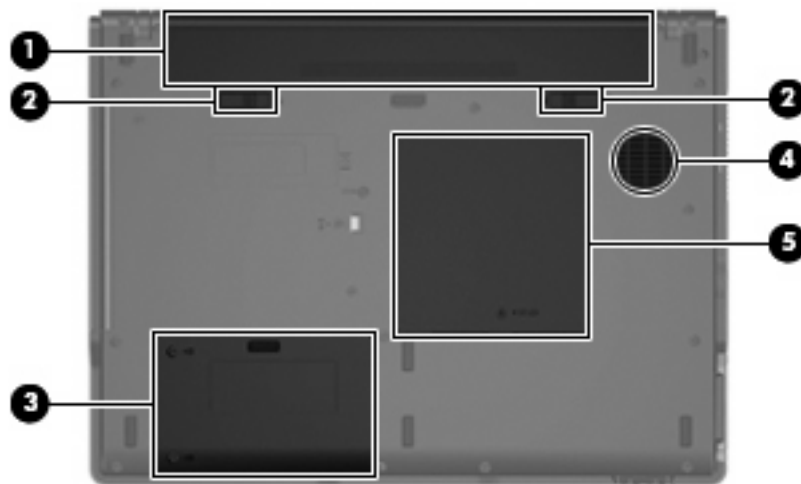

Item	Component	Function
(1)	Battery bay	Holds the battery. NOTE: The HP 530 Notebook PC does not support Smart Battery technology.
(2)	Battery release latches (2)	Release the battery from the battery bay.
(3)	Hard drive bay	Holds the hard drive.
(4)	Vent	Enables airflow to cool internal components. NOTE: The computer fan starts up automatically to cool internal components and prevent overheating. It is normal for the internal fan to cycle on and off during routine operation.
(5)	Memory/WLAN module compartment	Contains two memory module slots and the WLAN module slot. CAUTION: To prevent an unresponsive system, replace the wireless module only with a wireless module authorized for use in the computer by the governmental agency that regulates wireless devices in your country or region. If you replace the module and then receive a warning message, remove the module to restore computer functionality, and then contact technical support through Help and Support.

3 Illustrated parts catalog

Serial number location

When ordering parts or requesting information, provide the computer serial number and model number located on the bottom of the computer.



Computer major components

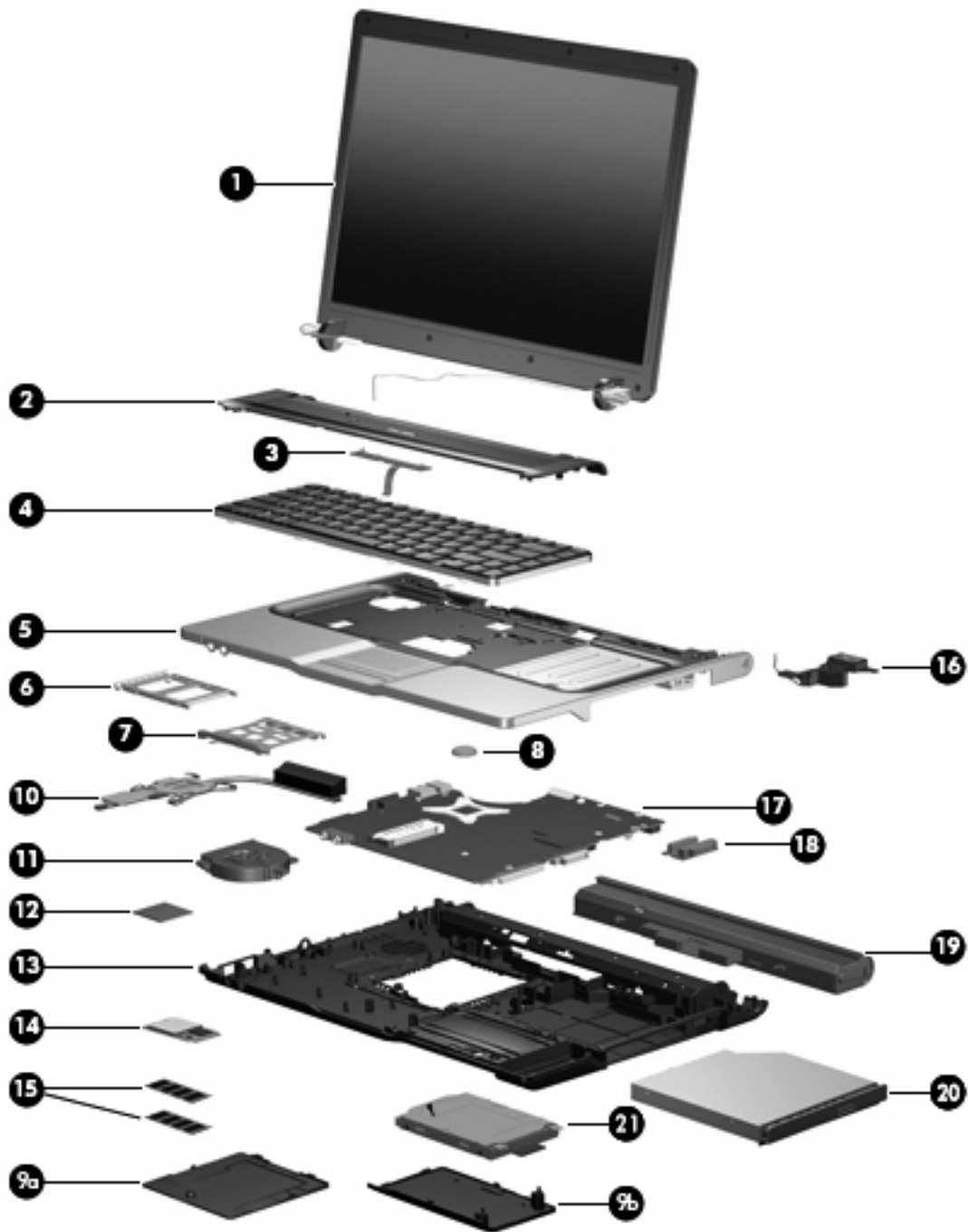

Item	Description	Spare part number
(1)	Display assemblies	
	15.4-inch, WXGA BrightView display assembly for use only with computer models with WLAN capability (includes wireless antenna transceivers and cables)	440716-001
	15.4-inch, WXGA BrightView display assembly for use only with computer models without WLAN capability	440715-001

Item	Description	Spare part number
(2)	Switch covers	
	For use only with computer models with WLAN capability (includes wireless button and wireless light)	441623-001
	For use only with computer models without WLAN capability	441624-001
(3)	Button board	441632-001
(4)	Keyboards	
	Belgium	444340-A41
	The Czech Republic	444340-221
	Denmark	444340-081
	The Netherlands and Europe	444340-021
	France	444340-051
	French Canada	444340-121
	Germany	444340-041
	Greece	444340-151
	Hungary	444340-211
	Israel	444340-BB1
	Italy	444340-061
	Norway	444340-091
	Poland	444340-241
	Portugal	444340-131
	Russia	444340-251
	Saudi Arabia	444340-171
	Slovakia	444340-231
	Slovenia	444340-BA1
	South Africa	444340-AR1
	Spain	444340-071
	Sweden and Finland	444340-B71
	Turkey	444340-141
	The United Kingdom	444340-031
	The United States	444340-001
(5)	Top cover (includes TouchPad and TouchPad cable)	441626-001
	TouchPad cable (not illustrated)	441638-001
(6)	PC Card slot bezel	438527-001
(7)	PC Card assembly	438551-001

Item	Description	Spare part number
(8)	RTC battery	438556-001
	Plastics/Hardware Kit	448431-001
(9a)	Memory/WLAN module compartment cover (includes 1 captive screw, secured by a C-clip)	
(9b)	Hard drive cover (includes 2 captive screws, secured by C-clips)	
(10)	Heat sink (includes thermal paste)	448336-001
(11)	Fan assembly	438528-001
(12)	Processors (include thermal paste)	
	Intel Core Solo T1400 1.83-GHz processor	448326-001
	Intel Core Solo T1300 1.66-GHz processor	448325-001
	Intel Core Duo T2300E 1.66-GHz processor	448324-001
	Intel Core Duo T2300 1.66-GHz processor	448323-001
	Intel Celeron M 420 1.60-GHz processor	448322-001
	Intel Celeron M 410 1.46-GHz processor	448321-001
(13)	Base enclosure (includes 6 rubber feet, not illustrated)	441625-001
	Rubber Feet Kit (includes 8 rubber feet, not illustrated)	438557-001
(14)	WLAN modules	
	802.11a/b/g WLAN modules:	
	<ul style="list-style-type: none"> For use in Antigua and Barbuda, Argentina, Australia, the Bahamas, Barbados, Brunei, Canada, Chile, the Dominican Republic, Guam, Guatemala, Hong Kong, India, Indonesia, Malaysia, Mexico, New Zealand, Panama, Paraguay, Saudi Arabia, Taiwan, the United States, and Vietnam 	407576-001
	<ul style="list-style-type: none"> For use in Aruba, Austria, Azerbaijan, Bahrain, Belgium, Bermuda, Brazil, Bulgaria, the Cayman Islands, Colombia, Croatia, Cyprus, the Czech Republic, Denmark, Egypt, El Salvador, Estonia, Finland, France, Georgia, Germany, Greece, Hungary, Iceland, Ireland, Italy, Jordan, Latvia, Lebanon, Liechtenstein, Lithuania, Luxembourg, Malta, Monaco, the Netherlands, Norway, Oman, the Philippines, Poland, Portugal, Romania, Russia, Serbia and Montenegro, Singapore, Slovakia, Slovenia, South Africa, Spain, Sri Lanka, Sweden, Switzerland, Turkey, the United Kingdom, and Uzbekistan 	407576-002
	<ul style="list-style-type: none"> For use in Ecuador, Haiti, Honduras, Pakistan, the People's Republic of China, Peru, Qatar, South Korea, Uruguay, and Venezuela 	407576-003
	<ul style="list-style-type: none"> For use in Japan 	407576-291
	802.11b/g WLAN modules:	
	<ul style="list-style-type: none"> For use in Canada and the United States 	407107-001
	<ul style="list-style-type: none"> For use in Algeria, Andorra, Argentina, Australia, Austria, Bahrain, Bangladesh, Belarus, Belgium, Bolivia, Brazil, Brunei, Bulgaria, Chile, Colombia, Costa Rica, Croatia, Cyprus, Czech Republic, Denmark, Ecuador, Egypt, El Salvador, Estonia, Finland, France, Germany, Gibraltar, Greece, Guatemala, Honduras, Hong Kong, Hungary, Iceland, India, Indonesia, Ireland, Israel, Italy, Jordan, Kuwait, Latvia, Lebanon, Liberia, Liechtenstein, Lithuania, Luxembourg, Macedonia, Malaysia, Mexico, Morocco, Netherlands, New Zealand, Nicaragua, Norway, Oman, Pakistan, Panama, Paraguay, People's Republic of China, Peru, Philippines, Poland, Portugal, Qatar, Romania, Russia, Saudi Arabia, Singapore, Slovakia, 	407107-002

Item	Description	Spare part number
	Slovenia, South Africa, South Korea, Spain, Sri Lanka, Sweden, Switzerland, Taiwan, Thailand, Tunisia, Turkey, Ukraine, United Arab Emirates, United Kingdom, Uruguay, Venezuela, Vietnam, and Yemen	
	<ul style="list-style-type: none"> For use in Japan 	407107-291
(15)	Memory modules (667-MHz, PC2-5300, 1-DIMM)	
	1024-MB	409060-001
	512-MB	447518-001
	256-MB	447517-001
(16)	Speaker	441627-001
(17)	System boards	
	For use only with computer models with Intel Core processors and WLAN capability	448434-001
	For use only with computer models with Intel Celeron M processors and WLAN capability	448433-001
	For use only with computer models without WLAN capability	448432-001
(18)	Optical drive connector board	441631-001
(19)	4-cell, 2.2-Ah, 32-Wh battery	440704-001
(20)	Optical drives (include bezel and bracket)	
	DVD±RW and CD-RW Super Multi Double-Layer Combo Drive	438523-001
	DVD/CD-RW Combo Drive	438524-001
(21)	Hard drives (include bracket and connector)	
	120-GB, 5400-rpm	435775-001
	80-GB, 5400-rpm	435773-001

Display assembly components



Item	Description	Spare part number
(1)	Display bezel	440706-001
(2)	Display Bracket/Hinge Kit	440707-001
(3)	15.4-inch, WXGA, BrightView display panel	440711-001
(4)	Display inverter	441628-001
(5)	Wireless Antenna Kit (includes wireless antenna transceivers and cables)	441639-001
(6)	Display enclosures	
	For use only with computer models with WLAN capability (includes logo and wireless antenna transceivers and cables)	440710-001
	For use only with computer models without WLAN capability (includes logo)	440709-001
	Display Cable Kit (not illustrated)	440708-001
	Display Label Kit (not illustrated)	448430-001
	Display Screw Kit (not illustrated)	440714-001

Plastics/Hardware Kit

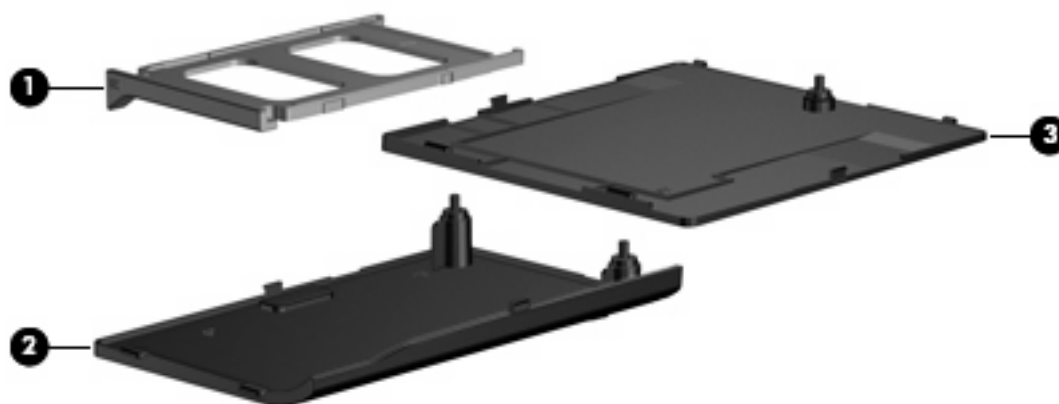

Item	Description	Spare part number
	Plastics/Hardware Kit	448431-001
(1)	PC Card slot bezel	
(2)	Hard drive cover (includes 2 captive screws, secured by C-clips)	
(3)	Memory/WLAN module compartment cover (includes 1 captive screw, secured by a C-clip)	

Mass storage devices



Item	Description	Spare part number
(1)	Hard drives (include bracket and connector)	
	5400-rpm, 120-GB	435775-001
	5400-rpm, 80-GB	435773-001
(2)	Optical drives (include bezel and bracket)	
	DVD±RW and CD-RW Super Multi Double-Layer Combo Drive	438523-001
	DVD/CD-RW Combo Drive	438524-001

Miscellaneous parts

Description	Spare part number
65-watt AC adapter	417220-001
Power cords:	
Australia	350055-011
Brazil	350055-201
Denmark	350055-081
Europe	350055-021
French Canada	350055-DB1
Israel	350055-BB1
Italy	350055-061
Japan	350055-291
Korea	350055-AD1
People's Republic of China	350055-AA1
Switzerland	350055-BG1
The United Kingdom	350055-031
The United States	350055-001
Screw Kit	441629-001
<ul style="list-style-type: none">• Phillips PM3.0×3.0 screw• Phillips PM2.5×6.0 captive screw• Phillips PM2.5×6.0 screw• Phillips PM2.5×4.0 screw• Phillips PM2.0×9.0 screw• Phillips PM2.0×7.0 screw• Phillips PM2.0×3.0 screw• Phillips PM2.0×2.0 screw	

Sequential part number listing

Spare part number	Description
350055-001	Power cord use in the United States
350055-011	Power cord for use in Australia
350055-021	Power cord for use in Europe
350055-031	Power cord for use in the United Kingdom
350055-061	Power cord for use in Italy
350055-081	Power cord for use in Denmark
350055-201	Power cord for use in Brazil
350055-291	Power cord for use in Japan
350055-AA1	Power cord for use in the People's Republic of China
350055-AD1	Power cord for use in Korea
350055-BB1	Power cord for use in Israel
350055-BG1	Power cord for use in Switzerland
350055-DB1	Power cord for use in French Canada
407107-001	802.11b/g WLAN module for use in Canada and the United States
407107-002	802.11b/g WLAN module for use in Algeria, Andorra, Argentina, Australia, Austria, Bahrain, Bangladesh, Belarus, Belgium, Bolivia, Brazil, Brunei, Bulgaria, Chile, Colombia, Costa Rica, Croatia, Cyprus, Czech Republic, Denmark, Ecuador, Egypt, El Salvador, Estonia, Finland, France, Germany, Gibraltar, Greece, Guatemala, Honduras, Hong Kong, Hungary, Iceland, India, Indonesia, Ireland, Israel, Italy, Jordan, Kuwait, Latvia, Lebanon, Liberia, Liechtenstein, Lithuania, Luxembourg, Macedonia, Malaysia, Mexico, Morocco, Netherlands, New Zealand, Nicaragua, Norway, Oman, Pakistan, Panama, Paraguay, People's Republic of China, Peru, Philippines, Poland, Portugal, Qatar, Romania, Russia, Saudi Arabia, Singapore, Slovakia, Slovenia, South Africa, South Korea, Spain, Sri Lanka, Sweden, Switzerland, Taiwan, Thailand, Tunisia, Turkey, Ukraine, United Arab Emirates, United Kingdom, Uruguay, Venezuela, Vietnam, and Yemen
407107-291	802.11b/g WLAN module for use in Japan
407576-001	802.11a/b/g WLAN module for use in Antigua and Barbuda, Argentina, Australia, the Bahamas, Barbados, Brunei, Canada, Chile, the Dominican Republic, Guam, Guatemala, Hong Kong, India, Indonesia, Malaysia, Mexico, New Zealand, Panama, Paraguay, Saudi Arabia, Taiwan, the United States, and Vietnam
407576-002	802.11a/b/g WLAN module for use in Aruba, Austria, Azerbaijan, Bahrain, Belgium, Bermuda, Brazil, Bulgaria, the Cayman Islands, Colombia, Croatia, Cyprus, the Czech Republic, Denmark, Egypt, El Salvador, Estonia, Finland, France, Georgia, Germany, Greece, Hungary, Iceland, Ireland, Italy, Jordan, Latvia, Lebanon, Liechtenstein, Lithuania, Luxembourg, Malta, Monaco, the Netherlands, Norway, Oman, the Philippines, Poland, Portugal, Romania, Russia, Serbia and Montenegro, Singapore, Slovakia, Slovenia, South Africa, Spain, Sri Lanka, Sweden, Switzerland, Turkey, the United Kingdom, and Uzbekistan
407576-003	802.11a/b/g WLAN module for use in Ecuador, Haiti, Honduras, Pakistan, the People's Republic of China, Peru, Qatar, South Korea, Uruguay, and Venezuela
407576-291	802.11a/b/g WLAN module for use in Japan
409060-001	1024-MB, 667-MHz, PC2-5300, 1-DIMM memory module
417220-001	65-watt AC adapter

Spare part number	Description
435773-001	80-GB, 5400-rpm hard drive (includes hard drive bracket and connector)
435775-001	120-GB, 5400-rpm hard drive (includes hard drive bracket and connector)
438523-001	DVD±RW and CD-RW Super Multi Double-Layer Combo Drive (includes bezel and optical drive bracket)
438524-001	DVD/CD-RW Combo Drive (includes bezel and optical drive bracket)
438527-001	PC Card slot bezel
438528-001	Fan assembly
438551-001	PC Card assembly
438556-001	RTC battery
438557-001	Rubber Feet Kit
440704-001	4-cell, 2.2-Ah, 32-Wh battery
440706-001	Display bezel
440707-001	Display Bracket/Hinge Kit
440708-001	Display Cable Kit
440709-001	Display enclosure for use only with computer models without WLAN capability (includes logo)
440710-001	Display enclosure for use only with computer models with WLAN capability (includes logo and wireless antenna transceivers and cables)
440711-001	15.4-inch WXGA BrightView display panel
440714-001	Display Screw Kit
440715-001	15.4-inch WXGA BrightView display assembly for use only with computer models without WLAN capability (includes wireless antenna transceivers and cables)
440716-001	15.4-inch WXGA BrightView display assembly for use only with computer models with WLAN capability
441623-001	Switch cover for use only with computer models with WLAN capability (includes wireless button and wireless light)
441624-001	Switch cover for use only with computer models without WLAN capability
441625-001	Base enclosure (includes 6 rubber feet)
441626-001	Top cover (includes TouchPad and TouchPad cable)
441627-001	Speaker
441628-001	Display inverter
441629-001	Screw Kit
441631-001	Optical drive connector board
441632-001	Button board
441638-001	TouchPad cable
441639-001	Wireless Antenna Kit (includes wireless antenna transceivers and cables)
444340-001	Keyboard for use in the United States
444340-021	Keyboard for use in the Netherlands and Europe

Spare part number	Description
444340-031	Keyboard for use in the United Kingdom
444340-041	Keyboard for use in Germany
444340-051	Keyboard for use in France
444340-061	Keyboard for use in Italy
444340-071	Keyboard for use in Spain
444340-081	Keyboard for use in Denmark
444340-091	Keyboard for use in Norway
444340-121	Keyboard for use in French Canada
444340-131	Keyboard for use in Portugal
444340-141	Keyboard for use in Turkey
444340-151	Keyboard for use in Greece
444340-171	Keyboard for use in Saudi Arabia
444340-211	Keyboard for use in Hungary
444340-221	Keyboard for use in the Czech Republic
444340-231	Keyboard for use in Slovakia
444340-241	Keyboard for use in Poland
444340-251	Keyboard for use in Russia
444340-A41	Keyboard for use in Belgium
444340-AR1	Keyboard for use in South Africa
444340-B71	Keyboard for use in Sweden and Finland
444340-BA1	Keyboard for use in Slovenia
444340-BB1	Keyboard for use in Israel
447517-001	256-MB, 667-MHz, PC2-5300, 1-DIMM memory module
447518-001	512-MB, 667-MHz, PC2-5300, 1-DIMM memory module
448321-001	Intel Celeron M 410 1.46-GHz processor
448322-001	Intel Celeron M 420 1.60-GHz processor
448323-001	Intel Core Duo T2300 1.66-GHz processor
448324-001	Intel Core Duo T2300E 1.66-GHz processor
448325-001	Intel Core Solo T1300 1.66-GHz processor
448326-001	Intel Core Solo T1400 1.83-GHz processor
448336-001	Heat sink (includes thermal material)
448430-001	Display Label Kit
448431-001	Plastics/Hardware Kit
448432-001	System board for use only with computer models without WLAN capability

Spare part number	Description
448433-001	System board for use only with computer models with Intel Celeron M processors and WLAN capability
448434-001	System board for use only with computer models with Intel Core processors and WLAN capability

4 Removal and replacement procedures

Preliminary replacement requirements

Tools required

You will need the following tools to complete the removal and replacement procedures:

- Magnetic screwdriver
- Phillips PO and P1 screwdrivers
- Flat-bladed screwdriver

Service considerations

The following sections include some of the considerations that you must keep in mind during disassembly and assembly procedures.

 **NOTE:** As you remove each subassembly from the computer, place the subassembly (and all accompanying screws) away from the work area to prevent damage.

Plastic parts

Using excessive force during disassembly and reassembly can damage plastic parts. Use care when handling the plastic parts. Apply pressure only at the points designated in the maintenance instructions.

Cables and connectors

-
- △ **CAUTION:** When servicing the computer, be sure that cables are placed in their proper locations during the reassembly process. Improper cable placement can damage the computer.
-

Cables must be handled with extreme care to avoid damage. Apply only the tension required to unseat or seat the cables during removal and insertion. Handle cables by the connector whenever possible. In all cases, avoid bending, twisting, or tearing cables. Be sure that cables are routed in such a way that they cannot be caught or snagged by parts being removed or replaced. Handle flex cables with extreme care; these cables tear easily.

Drive handling

-
- △ **CAUTION:** Drives are fragile components that must be handled with care. To prevent damage to the computer, damage to a drive, or loss of information, observe these precautions:
-

Before removing or inserting a hard drive, shut down the computer. If you are unsure whether the computer is off or in Hibernation, turn the computer on, and then shut it down through the operating system.

Before handling a drive, be sure that you are discharged of static electricity. While handling a drive, avoid touching the connector.

Before removing a diskette drive or optical drive, be sure that a diskette or disc is not in the drive and be sure that the optical drive tray is closed.

Handle drives on surfaces covered with at least one inch of shock-proof foam.

Avoid dropping drives from any height onto any surface.

After removing a hard drive, an optical drive, or a diskette drive, place it in a static-proof bag.

Avoid exposing a hard drive to products that have magnetic fields, such as monitors or speakers.

Avoid exposing a drive to temperature extremes or liquids.

If a drive must be mailed, place the drive in a bubble pack mailer or other suitable form of protective packaging and label the package "FRAGILE."

Grounding guidelines

Electrostatic discharge damage

Electronic components are sensitive to electrostatic discharge (ESD). Circuitry design and structure determine the degree of sensitivity. Networks built into many integrated circuits provide some protection, but in many cases, ESD contains enough power to alter device parameters or melt silicon junctions.

A discharge of static electricity from a finger or other conductor can destroy static-sensitive devices or microcircuitry. Even if the spark is neither felt nor heard, damage may have occurred.

An electronic device exposed to ESD may not be affected at all and can work perfectly throughout a normal cycle. Or the device may function normally for a while, then degrade in the internal layers, reducing its life expectancy.

△ **CAUTION:** To prevent damage to the computer when you are removing or installing internal components, observe these precautions:

Keep components in their electrostatic-safe containers until you are ready to install them.

Use nonmagnetic tools.

Before touching an electronic component, discharge static electricity by using the guidelines described in this section.

Avoid touching pins, leads, and circuitry. Handle electronic components as little as possible.

If you remove a component, place it in an electrostatic-safe container.

The following table shows how humidity affects the electrostatic voltage levels generated by different activities.

△ **CAUTION:** A product can be degraded by as little as 700 V.

Typical electrostatic voltage levels			
Event	Relative humidity		
	10%	40%	55%
Walking across carpet	35,000 V	15,000 V	7,500 V
Walking across vinyl floor	12,000 V	5,000 V	3,000 V
Motions of bench worker	6,000 V	800 V	400 V
Removing DIPS from plastic tube	2,000 V	700 V	400 V
Removing DIPS from vinyl tray	11,500 V	4,000 V	2,000 V
Removing DIPS from Styrofoam	14,500 V	5,000 V	3,500 V
Removing bubble pack from PCB	26,500 V	20,000 V	7,000 V
Packing PCBs in foam-lined box	21,000 V	11,000 V	5,000 V

Packaging and transporting guidelines

Follow these grounding guidelines when packaging and transporting equipment:

- To avoid hand contact, transport products in static-safe tubes, bags, or boxes.
- Protect ESD-sensitive parts and assemblies with conductive or approved containers or packaging.
- Keep ESD-sensitive parts in their containers until the parts arrive at static-free workstations.
- Place items on a grounded surface before removing items from their containers.
- Always be properly grounded when touching a component or assembly.
- Store reusable ESD-sensitive parts from assemblies in protective packaging or nonconductive foam.
- Use transporters and conveyors made of antistatic belts and roller bushings. Be sure that mechanized equipment used for moving materials is wired to ground and that proper materials are selected to avoid static charging. When grounding is not possible, use an ionizer to dissipate electric charges.

Workstation guidelines

Follow these grounding workstation guidelines:

- Cover the workstation with approved static-shielding material.
- Use a wrist strap connected to a properly grounded work surface and use properly grounded tools and equipment.
- Use conductive field service tools, such as cutters, screwdrivers, and vacuums.
- When fixtures must directly contact dissipative surfaces, use fixtures made only of static-safe materials.
- Keep the work area free of nonconductive materials, such as ordinary plastic assembly aids and Styrofoam.
- Handle ESD-sensitive components, parts, and assemblies by the case or PCM laminate. Handle these items only at static-free workstations.
- Avoid contact with pins, leads, or circuitry.
- Turn off power and input signals before inserting or removing connectors or test equipment.

Equipment guidelines

Grounding equipment must include either a wrist strap or a foot strap at a grounded workstation.

- When seated, wear a wrist strap connected to a grounded system. Wrist straps are flexible straps with a minimum of one megohm $\pm 10\%$ resistance in the ground cords. To provide proper ground, wear a strap snugly against the skin at all times. On grounded mats with banana-plug connectors, use alligator clips to connect a wrist strap.
- When standing, use foot straps and a grounded floor mat. Foot straps (heel, toe, or boot straps) can be used at standing workstations and are compatible with most types of shoes or boots. On conductive floors or dissipative floor mats, use foot straps on both feet with a minimum of one megohm resistance between the operator and ground. To be effective, the conductive strips must be worn in contact with the skin.

The following grounding equipment is recommended to prevent electrostatic damage:

- Antistatic tape
- Antistatic smocks, aprons, and sleeve protectors
- Conductive bins and other assembly or soldering aids
- Nonconductive foam
- Conductive tabletop workstations with ground cords of one megohm resistance
- Static-dissipative tables or floor mats with hard ties to the ground
- Field service kits
- Static awareness labels
- Material-handling packages
- Nonconductive plastic bags, tubes, or boxes
- Metal tote boxes
- Electrostatic voltage levels and protective materials

The following table lists the shielding protection provided by antistatic bags and floor mats.

Material	Use	Voltage protection level
Antistatic plastic	Bags	1,500 V
Carbon-loaded plastic	Floor mats	7,500 V
Metallized laminate	Floor mats	5,000 V

Unknown user password

If the computer you are servicing has an unknown user password, follow these steps to clear the password.

 **NOTE:** These steps also clear CMOS.

Before disassembling the computer, follow these steps:

1. Shut down the computer. If you are unsure whether the computer is off or in Hibernation, turn the computer on, and then shut it down through the operating system.
2. Disconnect all external devices connected to the computer.
3. Disconnect the power from the computer by first unplugging the power cord from the AC outlet and then unplugging the AC adapter from the computer.
4. Remove the battery (see [Battery on page 32](#)).
5. Remove the real-time clock (RTC) battery (see [RTC battery on page 54](#)).
6. Wait approximately 5 minutes.
7. Replace the RTC battery and reassemble the computer.
8. Connect AC power to the computer. Do not reinsert any batteries at this time.
9. Turn on the computer.

All passwords and all CMOS settings have been cleared.

Component replacement procedures

This chapter provides removal and replacement procedures.

There are as many as 73 screws, in 8 different sizes, that must be removed, replaced, or loosened when servicing the computer. Make special note of each screw and screw lock size and location during removal and replacement.

Serial number

Report the computer serial number to HP when requesting information or ordering spare parts. The serial number is located on the bottom of the computer.



Battery

Description	Spare part number
4-cell, 2.2-Ah, 32-Wh battery	440704-001

Before disassembling the computer, follow these steps:

1. Shut down the computer. If you are unsure whether the computer is off or in Hibernation, turn the computer on, and then shut it down through the operating system.
2. Disconnect all external devices connected to the computer.
3. Disconnect the power from the computer by first unplugging the power cord from the AC outlet and then unplugging the AC adapter from the computer.

Remove the battery:

1. Turn the computer upside down on a flat surface, with the rear panel toward you.
2. Slide the battery release latches **(1)** to release the battery.
3. Remove the battery **(2)**.

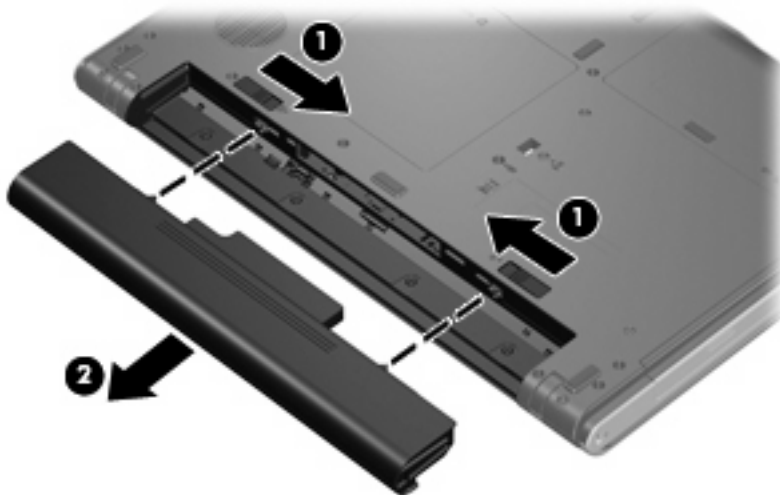

Install the battery by inserting it into the battery bay until you hear a click.

Hard drive

Description	Spare part number
120-GB, 5400-rpm	435775-001
80-GB, 5400-rpm	435773-001

Before disassembling the computer, follow these steps:

1. Shut down the computer. If you are unsure whether the computer is off or in Hibernation, turn the computer on, and then shut it down through the operating system.
2. Disconnect all external devices connected to the computer.
3. Disconnect the power from the computer by first unplugging the power cord from the AC outlet and then unplugging the AC adapter from the computer.
4. Remove the battery (see [Battery on page 32](#)).

Remove the hard drive:

1. Position the computer with the front toward you.
2. Loosen the two Phillips PM2.5×6.0 screws **(1)** that secure the hard drive cover to the computer.
3. Lift the left side of the hard drive cover **(2)**, swing it to the right, and remove the cover. The hard drive cover is included in the Plastics/Hardware Kit, spare part number 448431-001.

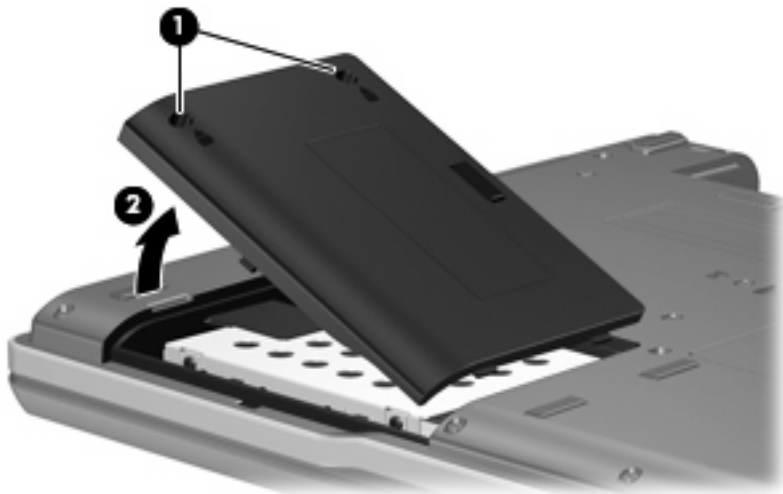

4. Grasp the Mylar tab **(1)** on the hard drive and pull the hard drive **(2)** to the left to disconnect it from the system board.

5. Remove the hard drive **(3)** from the hard drive bay.

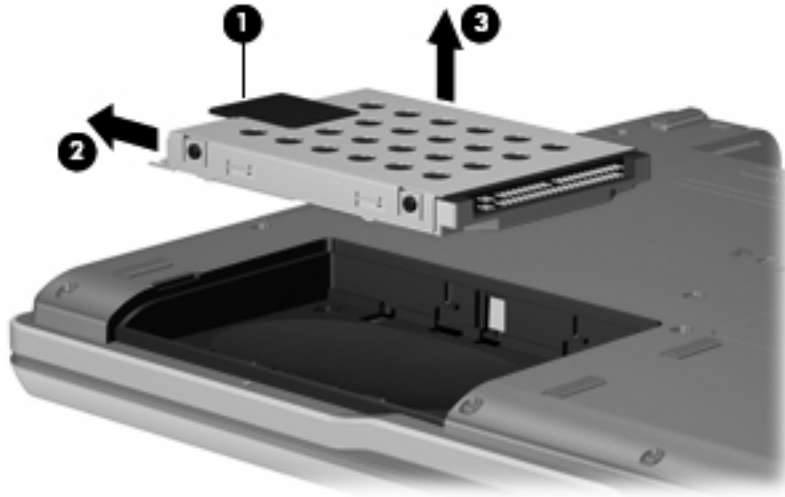

6. If it is necessary to replace the hard drive bracket, remove the four Phillips PM3.0x3.0 hard drive bracket screws **(1)** from each side of the hard drive.
7. Lift the bracket **(2)** straight up to remove it from the hard drive.

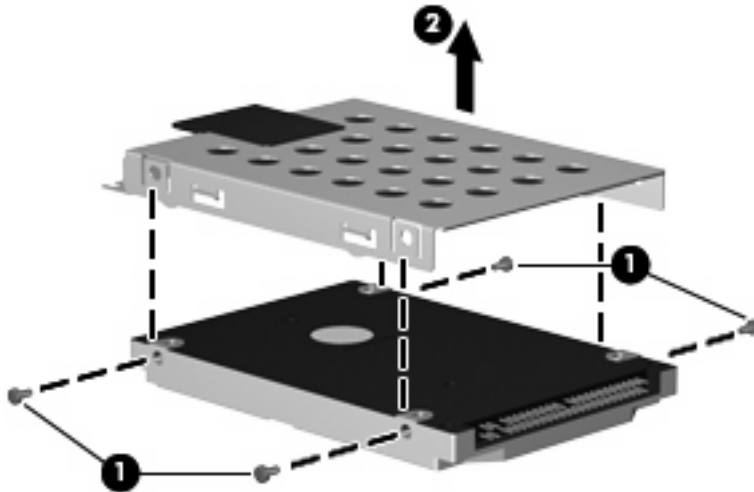

Reverse this procedure to reassemble and install the hard drive.

Computer feet

Description	Spare part number
Rubber Feet Kit	438557-001

The computer feet are adhesive-backed rubber pads. There are 8 rubber feet. The feet attach to the base enclosure in the locations illustrated below.

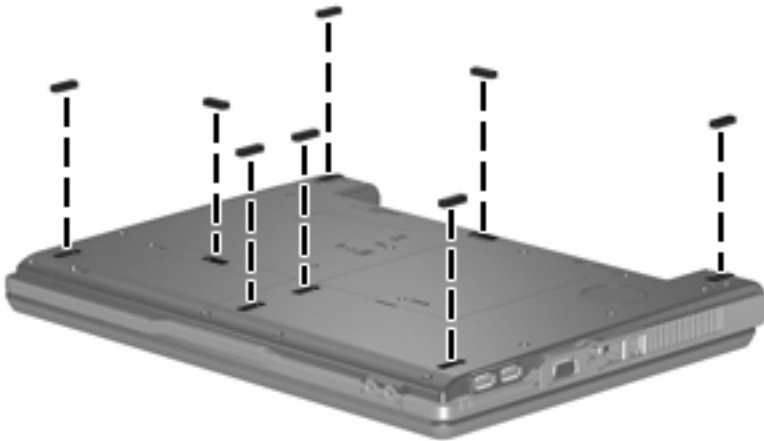

Memory module

Description	Spare part number
1024-MB, 667-MHz, PC2-5300, 1-DIMM	409060-001
512-MB, 667-MHz, PC2-5300, 1-DIMM	447518-001
256-MB, 667-MHz, PC2-5300, 1-DIMM	447517-001

Before removing the memory module, follow these steps:

1. Shut down the computer. If you are unsure whether the computer is off or in Hibernation, turn the computer on, and then shut it down through the operating system.
2. Disconnect all external devices connected to the computer.
3. Disconnect the power from the computer by first unplugging the power cord from the AC outlet and then unplugging the AC adapter from the computer.
4. Remove the battery (see [Battery on page 32](#)).

Remove the external memory module:

1. Position the computer with the rear panel toward you.
2. Loosen the Phillips PM2.5×6.0 screw **(1)** that secures the memory/WLAN module compartment cover to the computer.

3. Lift the front edge of the cover **(2)**, swing it toward you, and remove the cover. The memory/WLAN module compartment cover is included in the Plastics/Hardware Kit, spare part number 448431-001.

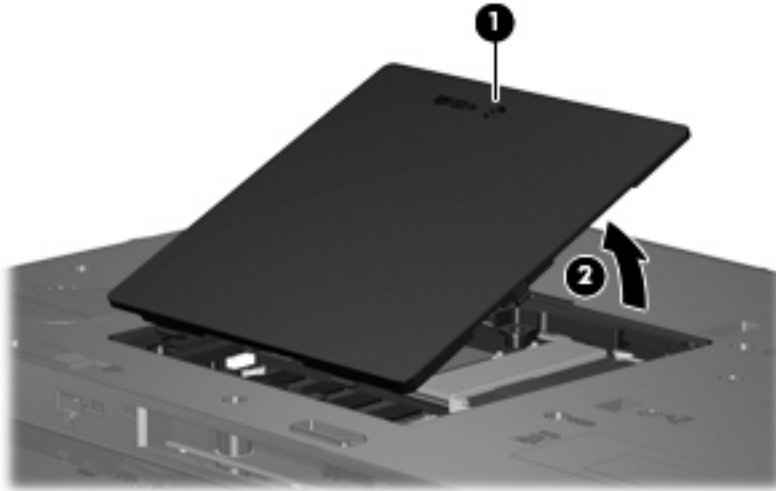

4. Spread the retaining tabs **(1)** on each side of the memory module slot to release the memory module. (The edge of the module opposite the slot rises away from the computer.)
5. Remove the memory module **(2)** by pulling the module away from the slot at an angle.



NOTE: Memory modules are designed with a notch **(3)** to prevent incorrect installation into the memory module slot.

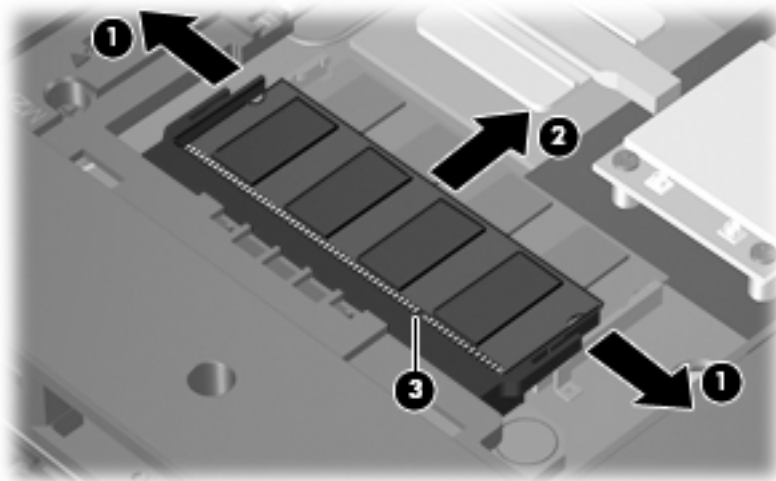

Reverse this procedure to install a memory module.

WLAN module

Description	Spare part number
802.11a/b/g WLAN modules:	
<ul style="list-style-type: none"> For use in Antigua and Barbuda, Argentina, Australia, the Bahamas, Barbados, Brunei, Canada, Chile, the Dominican Republic, Guam, Guatemala, Hong Kong, India, Indonesia, Malaysia, Mexico, New Zealand, Panama, Paraguay, Saudi Arabia, Taiwan, the United States, and Vietnam 	407576-001
<ul style="list-style-type: none"> For use in Aruba, Austria, Azerbaijan, Bahrain, Belgium, Bermuda, Brazil, Bulgaria, the Cayman Islands, Colombia, Croatia, Cyprus, the Czech Republic, Denmark, Egypt, El Salvador, Estonia, Finland, France, Georgia, Germany, Greece, Hungary, Iceland, Ireland, Italy, Jordan, Latvia, Lebanon, Liechtenstein, Lithuania, Luxembourg, Malta, Monaco, the Netherlands, Norway, Oman, the Philippines, Poland, Portugal, Romania, Russia, Serbia and Montenegro, Singapore, Slovakia, Slovenia, South Africa, Spain, Sri Lanka, Sweden, Switzerland, Turkey, the United Kingdom, and Uzbekistan 	407576-002
<ul style="list-style-type: none"> For use in Ecuador, Haiti, Honduras, Pakistan, the People's Republic of China, Peru, Qatar, South Korea, Uruguay, and Venezuela 	407576-003
<ul style="list-style-type: none"> For use in Japan 	407576-291
802.11b/g WLAN modules:	
<ul style="list-style-type: none"> For use in Canada and the United States 	407107-001
<ul style="list-style-type: none"> For use in For use in Algeria, Andorra, Argentina, Australia, Austria, Bahrain, Bangladesh, Belarus, Belgium, Bolivia, Brazil, Brunei, Bulgaria, Chile, Colombia, Costa Rica, Croatia, Cyprus, Czech Republic, Denmark, Ecuador, Egypt, El Salvador, Estonia, Finland, France, Germany, Gibraltar, Greece, Guatemala, Honduras, Hong Kong, Hungary, Iceland, India, Indonesia, Ireland, Israel, Italy, Jordan, Kuwait, Latvia, Lebanon, Liberia, Liechtenstein, Lithuania, Luxembourg, Macedonia, Malaysia, Mexico, Morocco, Netherlands, New Zealand, Nicaragua, Norway, Oman, Pakistan, Panama, Paraguay, People's Republic of China, Peru, Philippines, Poland, Portugal, Qatar, Romania, Russia, Saudi Arabia, Singapore, Slovakia, Slovenia, South Africa, South Korea, Spain, Sri Lanka, Sweden, Switzerland, Taiwan, Thailand, Tunisia, Turkey, Ukraine, United Arab Emirates, United Kingdom, Uruguay, Venezuela, Vietnam, and Yemen 	407107-002
<ul style="list-style-type: none"> For use in Japan 	407107-291

Before removing the WLAN module, follow these steps:

1. Shut down the computer. If you are unsure whether the computer is off or in Hibernation, turn the computer on, and then shut it down through the operating system.
2. Disconnect all external devices connected to the computer.
3. Disconnect the power from the computer by first unplugging the power cord from the AC outlet and then unplugging the AC adapter from the computer.
4. Remove the battery (see [Battery on page 32](#)).
5. Remove the memory/WLAN module compartment cover (see [Memory module on page 35](#)).

Remove the WLAN module:

1. Disconnect the WLAN antenna cables **(1)** from the terminals on the WLAN module.

 **NOTE:** The black WLAN antenna cable is connected to the WLAN module “Main” terminal. The gray WLAN antenna cable is connected to the WLAN module “Aux” terminal.

2. Remove the two Phillips PM2.0×4.0 screws **(2)** that secure the WLAN module to the system board. (The edge of the module opposite the slot rises away from the computer.)
3. Remove the WLAN module **(3)** by pulling the module away from the slot at an angle.

 **NOTE:** WLAN modules are designed with a notch **(4)** to prevent incorrect installation.

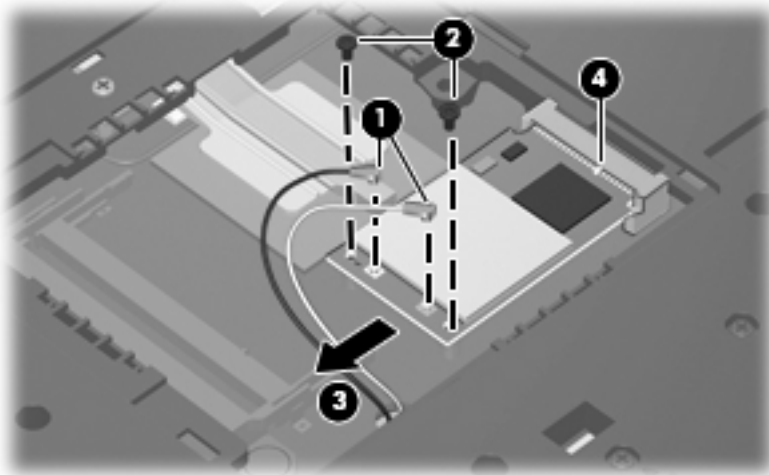

Reverse this procedure to install a WLAN module.

Optical drive

 **NOTE:** All optical drive spare part kits include an optical drive bezel and optical drive bracket.

Description	Spare part number
DVD±RW and CD-RW Super Multi Double-Layer Combo Drive	438523-001
DVD/CD-RW Combo Drive	438524-001

Before removing the optical drive, follow these steps:

1. Shut down the computer. If you are unsure whether the computer is off or in Hibernation, turn the computer on, and then shut it down through the operating system.
2. Disconnect all external devices connected to the computer.
3. Disconnect the power from the computer by first unplugging the power cord from the AC outlet and then unplugging the AC adapter from the computer.
4. Remove the battery (see [Battery on page 32](#)).
5. Remove the memory/WLAN module compartment cover (see [Memory module on page 35](#)).

Remove the optical drive:

1. Position the computer with left side toward you.
2. Remove the Phillips PM2.0×9.0 screw **(1)** that secures the optical drive to the computer.
3. Use a flat-bladed tool to push the metal tab **(2)** toward the left side of the computer. (The optical drive partially removes from the optical drive bay.)
4. Remove the optical drive **(3)** from the computer.

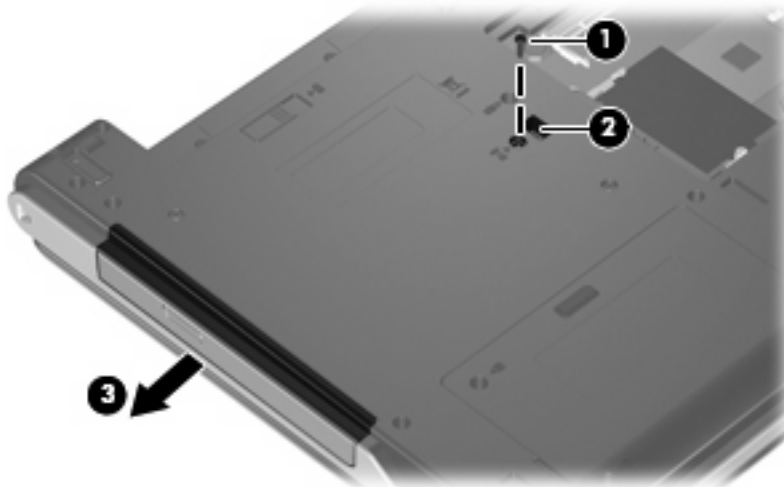

5. If it is necessary to replace the optical drive bracket, remove the two Phillips PM2.0×3.0 screws **(1)** that secure the bracket to the optical drive.

6. Remove the optical drive bracket **(2)**.

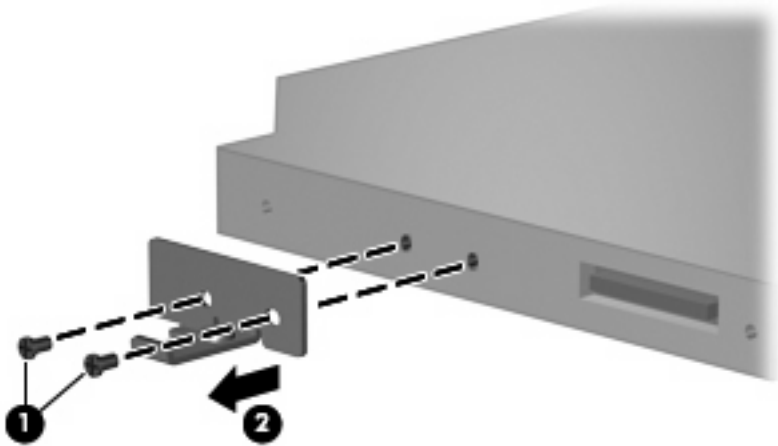

Reverse this procedure to reassemble and install the optical drive.

Switch cover

Description	Spare part number
For use only with computer models with WLAN capability (includes wireless button and wireless light)	441623-001
For use only with computer models without WLAN capability	441624-001

Before removing the switch cover, follow these steps:

1. Shut down the computer. If you are unsure whether the computer is off or in Hibernation, turn the computer on, and then shut it down through the operating system.
2. Disconnect all external devices connected to the computer.
3. Disconnect the power from the computer by first unplugging the power cord from the AC outlet and then unplugging the AC adapter from the computer.
4. Remove the battery (see [Battery on page 32](#)).

Remove the switch cover:

1. Turn the computer upside down, with the rear panel toward you.
2. Remove the seven Phillips PM2.0×9.0 screws **(1)** and the four Phillips PM2.0×2.0 screws **(2)** that secure the switch cover to the computer.

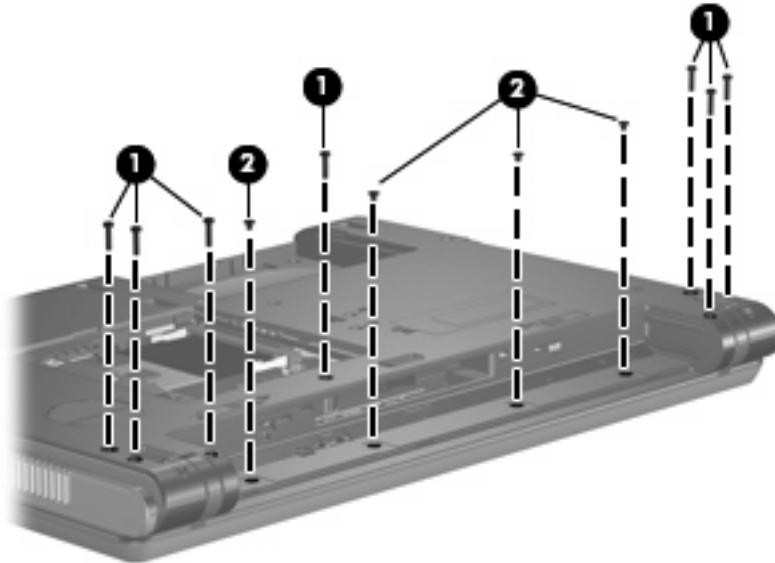

3. Turn the computer display-side up, with the front toward you.
4. Open the computer as far as possible.
5. Lift the rear edge of the switch cover and swing it forward.

6. Remove the switch cover.



Reverse this procedure to install the switch cover.

Keyboard

For use in:	Spare part number	For use in:	Spare part number
Belgium	444340-A41	Poland	438531-241
The Czech Republic	444340-221	Portugal	438531-131
Denmark	444340-081	Russia	438531-251
The Netherlands and Europe	444340-021	Saudi Arabia	438531-171
France	444340-051	Slovakia	438531-231
French Canada	444340-121	Slovenia	438531-BA1
Germany	444340-041	South Africa	438531-AR1
Greece	444340-151	Spain	438531-071
Hungary	444340-211	Sweden and Finland	438531-B71
Israel	444340-BB1	Turkey	438531-141
Italy	444340-061	The United Kingdom	438531-031
Norway	444340-091	The United States	438531-001

Before removing the keyboard, follow these steps:

1. Shut down the computer. If you are unsure whether the computer is off or in Hibernation, turn the computer on, and then shut it down through the operating system.
2. Disconnect all external devices connected to the computer.
3. Disconnect the power from the computer by first unplugging the power cord from the AC outlet and then unplugging the AC adapter from the computer.
4. Remove the battery (see [Battery on page 32](#)).
5. Remove the memory/WLAN module compartment cover (see [Memory module on page 35](#)).
6. Remove the switch cover (see [Switch cover on page 41](#)).

Remove the keyboard:

1. Position the computer with the front toward you.

2. Remove the two Phillips PM2.0x9.0 screws that secure the keyboard to the computer.

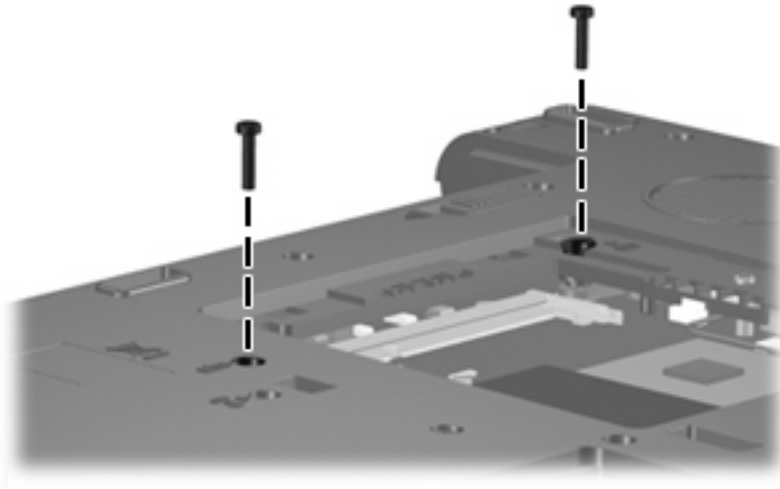

3. Turn the computer display-side up, with the front toward you.
4. Open the computer as far as possible.
5. Lift the rear edge of the keyboard and swing it toward you until it rests on the palm rest.



6. Release the zero insertion force (ZIF) connector **(1)** to which the keyboard cable is attached, and disconnect the keyboard cable **(2)** from the system board.

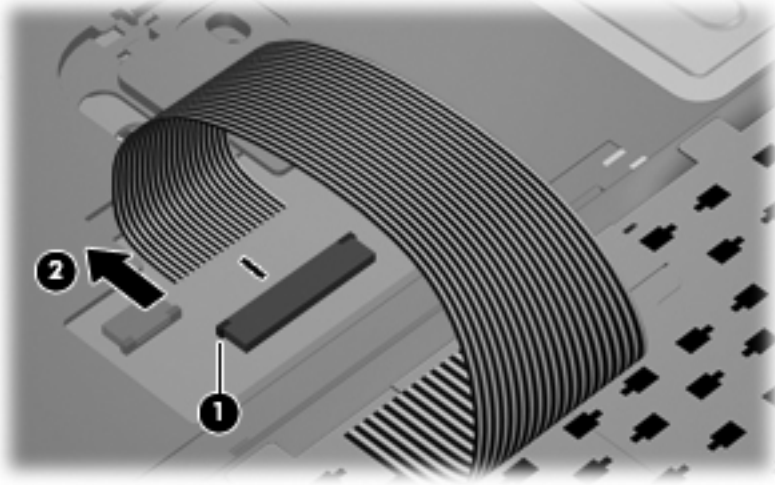

7. Remove the keyboard.

Reverse this procedure to install the keyboard.

Button board

Description	Spare part number
Button board	441632-001

Before removing the button board, follow these steps:

1. Shut down the computer. If you are unsure whether the computer is off or in Hibernation, turn the computer on, and then shut it down through the operating system.
2. Disconnect all external devices connected to the computer.
3. Disconnect the power from the computer by first unplugging the power cord from the AC outlet and then unplugging the AC adapter from the computer.
4. Remove the battery (see [Battery on page 32](#)).
5. Remove the memory/WLAN module compartment cover (see [Memory module on page 35](#)).
6. Remove the following components:
 - a. Switch cover (see [Switch cover on page 41](#))
 - b. Keyboard (see [Keyboard on page 43](#))

Remove the button board:

1. Release the ZIF connector **(1)** to which the button board cable is connected, and disconnect the cable **(2)** from the system board.
2. Remove the Phillips PM2.0×3.0 screw **(3)** that secures the button board to the computer.
3. Remove the button board **(4)**.

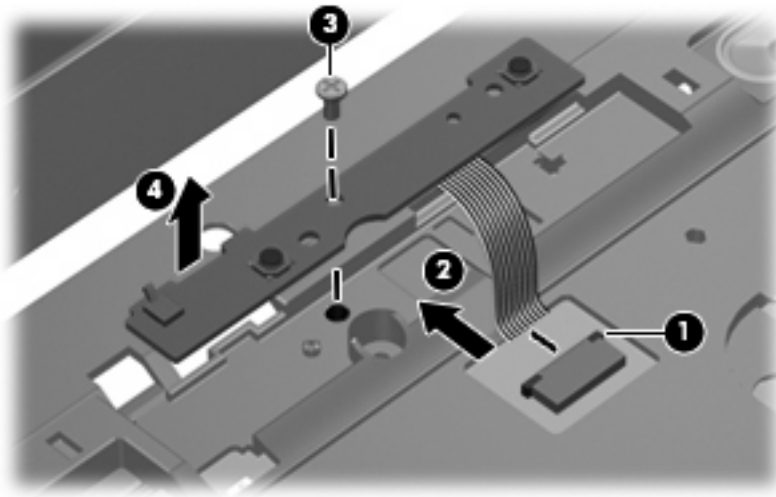

Reverse this procedure to reassemble and install the button board.

Display assembly

Description	Spare part number
15.4-inch, WXGA BrightView display assembly for use only with computer models with WLAN capability (includes wireless antenna transceivers and cables)	440716-001
15.4-inch, WXGA BrightView display assembly for use only with computer models without WLAN capability	440715-001

Before removing the display assembly, follow these steps:

1. Shut down the computer. If you are unsure whether the computer is off or in Hibernation, turn the computer on, and then shut it down through the operating system.
2. Disconnect all external devices connected to the computer.
3. Disconnect the power from the computer by first unplugging the power cord from the AC outlet and then unplugging the AC adapter from the computer.
4. Remove the battery (see [Battery on page 32](#)).
5. Remove the memory/WLAN module compartment cover (see [Memory module on page 35](#)) and disconnect the wireless antenna cables from the WLAN module (see [WLAN module on page 37](#)).
6. Remove the following components:
 - a. Switch cover (see [Switch cover on page 41](#))
 - b. Keyboard (see [Keyboard on page 43](#))

Remove the display assembly:

1. Close the computer and turn it upside down, with the rear panel toward you.
2. Remove the two Phillips PM2.0×7.0 screws that secure the display assembly to the computer.

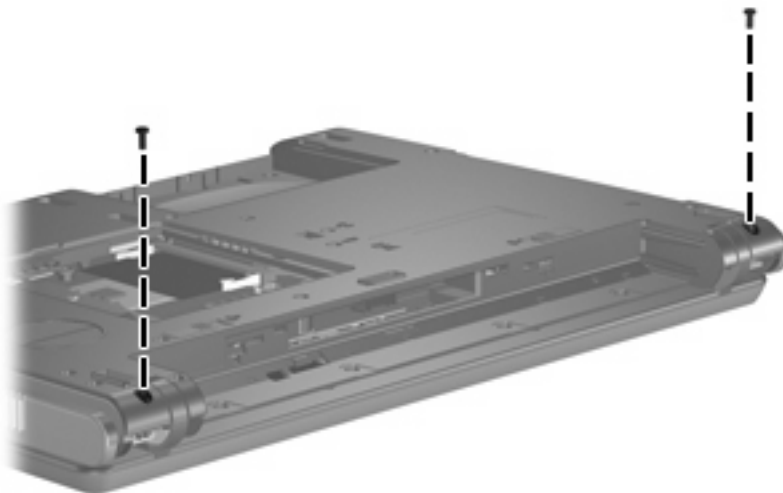

3. Turn the computer display-side up, with the front toward you.
4. Open the computer until the display assembly is in an upright position.

5. Disconnect the display panel cable **(1)** from the system board and remove the display panel cable **(2)** from the clips and routing channel built into the top cover.
6. Remove the wireless antenna cables **(3)** from the clips and routing channel built into the top cover.
7. Remove the two Phillips PM2.0×9.0 screws **(4)** that secure the display assembly to the computer.

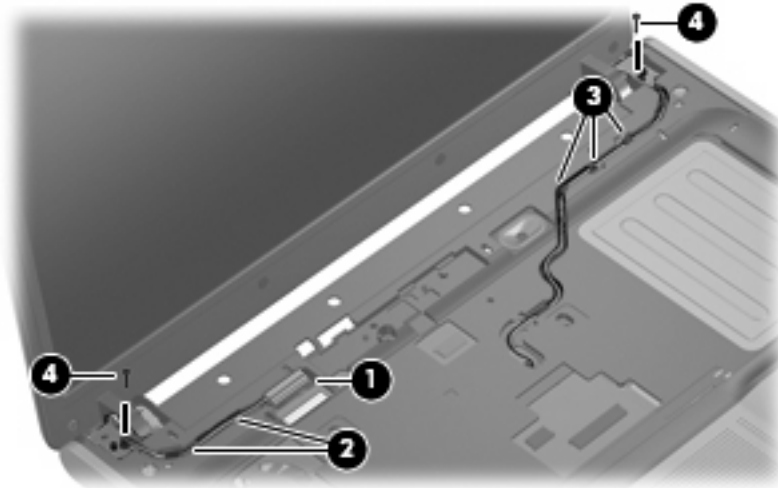

8. Lift the display assembly straight up and remove it.



9. If it is necessary to replace the display bezel or any of the display assembly internal subcomponents, remove the following display bezel screw covers and screws:

(1) Four round rubber screw covers on the top edge of the display bezel. The display bezel screw covers and all screws used to secure display assembly internal subcomponents are available in the Display Screw Kit, spare part number 404714-001.

(2) Four flat rubber screw covers on the bottom edge of the display bezel.

(3) Eight Phillips PM2.5×6.0 screws.

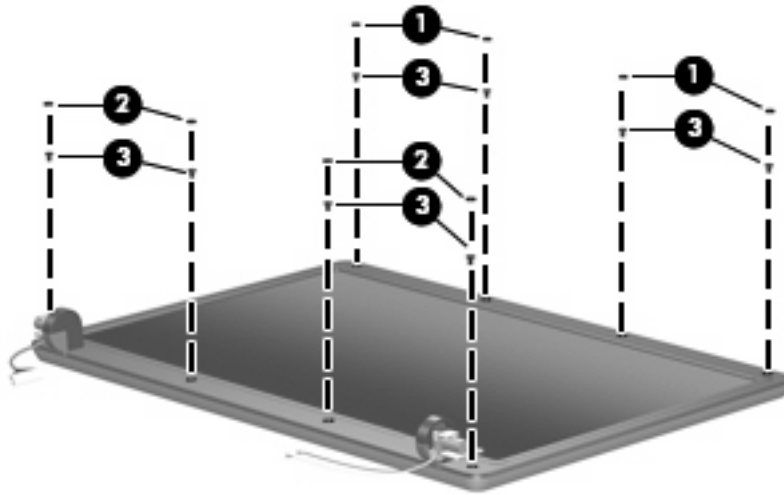

10. Flex the inside edges of the top side **(1)**, the left and right sides **(2)**, and then the bottom side **(3)** of the display bezel until the bezel disengages from the display assembly.

11. Remove the display bezel **(4)**. The bezel is available using spare part number 440706-001.

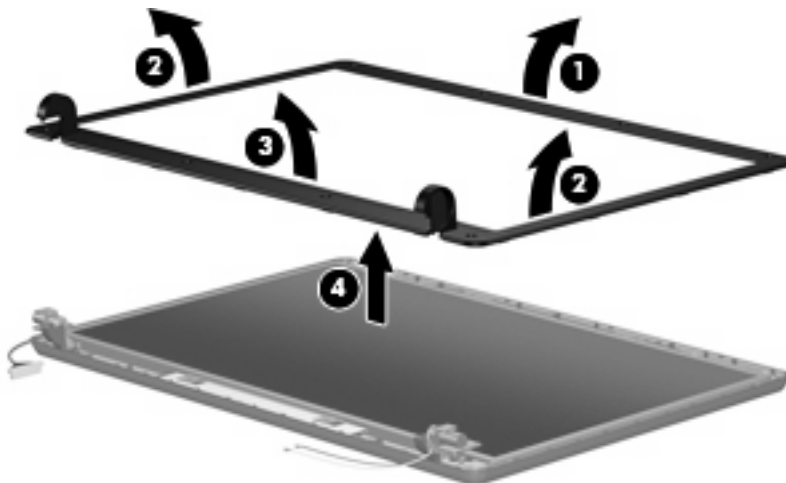

12. If it is necessary to replace the display inverter, disconnect the display panel cable **(1)** and the backlight cable **(2)** from the inverter.

13. Remove the display inverter (3). The inverter is available using spare part number 441628-001.

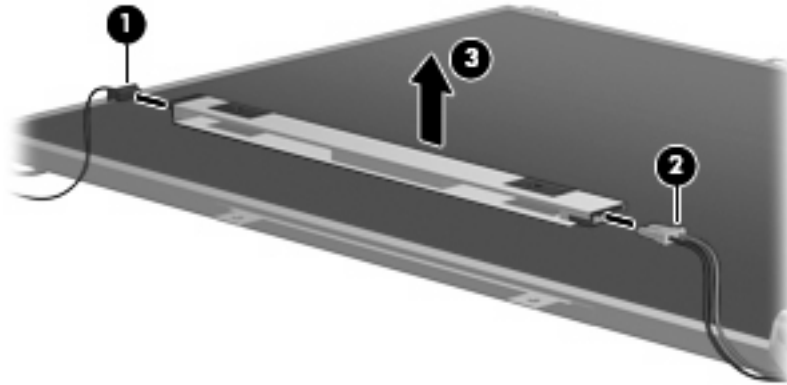

14. If it is necessary to replace the display panel, remove the four Phillips PM2.5×6.0 screws (1) that secure the panel to the display enclosure.
15. Remove the display panel (2). The panel is available using spare part number 440711-001.

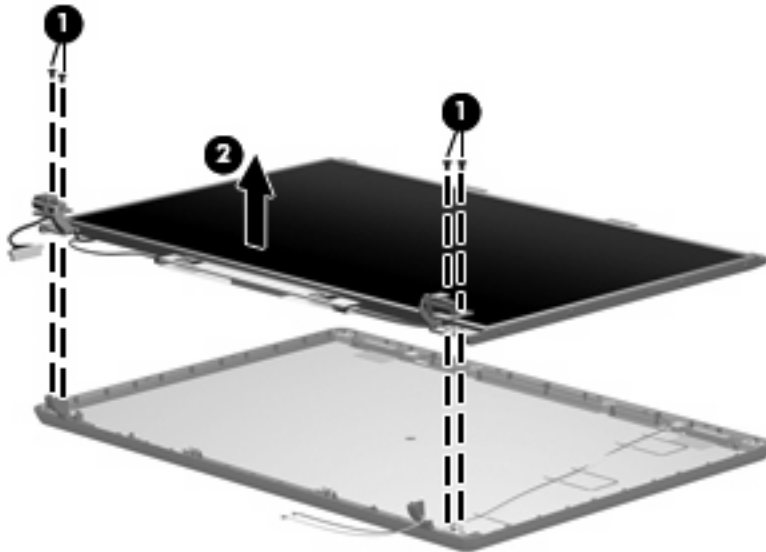

16. If it is necessary to replace either of the display hinges, remove the four Phillips PM2.0×3.0 screws (1) that secure each hinge to the display panel.

17. Remove the display hinges (**2**). The hinges are available in the Display Bracket/Hinge Kit, spare part number 440707-001.

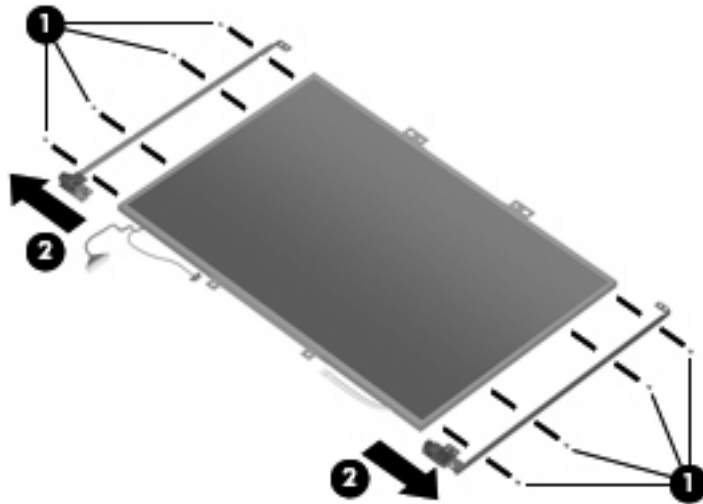

18. If it is necessary to replace the wireless antenna transceivers, remove the Phillips PM2.5×4.0 screws (**1**) that secure each transceiver (**2**) to the display enclosure. The wireless antenna transceivers and cables are available in the Wireless Antenna Kit, spare part number 441639-001.

 **NOTE:** The wireless antenna transceivers are also attached to the display enclosure with a thin layer of adhesive. It may be necessary to use a flat-bladed tool to pry the transceivers away from the display enclosure.

19. Remove the wireless antenna transceivers (**2**) and cables (**3**) from the display enclosure.

 **NOTE:** The wireless antenna cables are attached to the display enclosure by a series of pliable tabs (**4**) built into the enclosure shielding. Lift the tabs to release the cables.

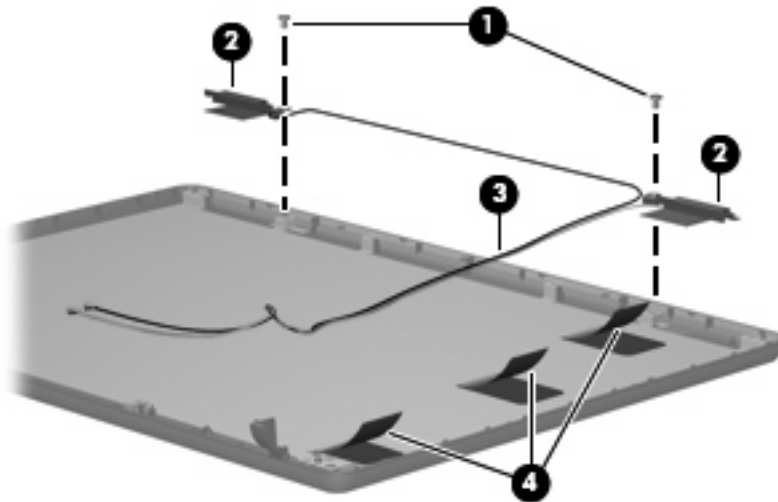

Reverse this procedure to reassemble and install the display assembly.

Base enclosure

Description	Spare part number
Base enclosure	441625-001
Rubber Feet Kit	438557-001

Before removing the base enclosure, follow these steps:

1. Shut down the computer. If you are unsure whether the computer is off or in Hibernation, turn the computer on, and then shut it down through the operating system.
2. Disconnect all external devices connected to the computer.
3. Disconnect the power from the computer by first unplugging the power cord from the AC outlet and then unplugging the AC adapter from the computer.
4. Remove the battery (see [Battery on page 32](#)).
5. Remove the following components:
 - a. Hard drive (see [Hard drive on page 33](#))
 - b. Memory/WLAN module compartment cover (see [Memory module on page 35](#))
 - c. Optical drive (see [Optical drive on page 39](#))
 - d. Switch cover (see [Switch cover on page 41](#))
 - e. Keyboard (see [Keyboard on page 43](#))
 - f. Display assembly (see [Display assembly on page 47](#))

Remove the base enclosure:

1. Release the ZIF connector **(1)** to which the TouchPad cable is attached, and disconnect the TouchPad cable **(2)** from the system board.

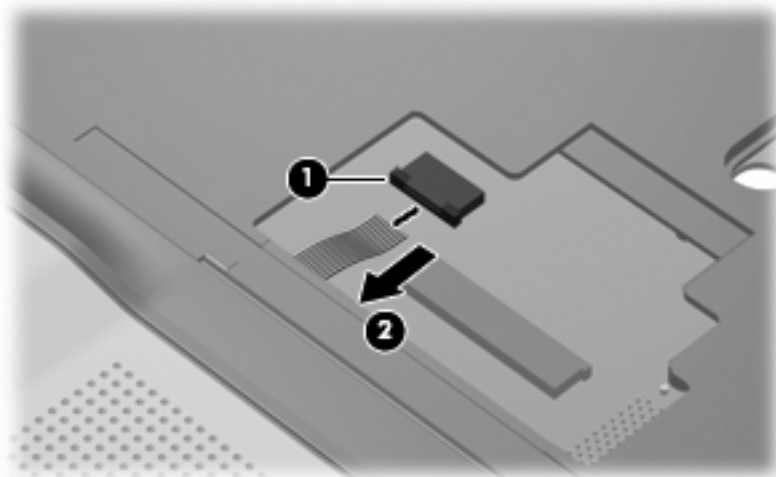

2. Turn the computer upside down, with the front toward you.

3. Remove the two Phillips PM2.0×3.0 screws **(1)** and the twelve Phillips PM2.0×9.0 screws **(2)** that secure the base enclosure to the computer.

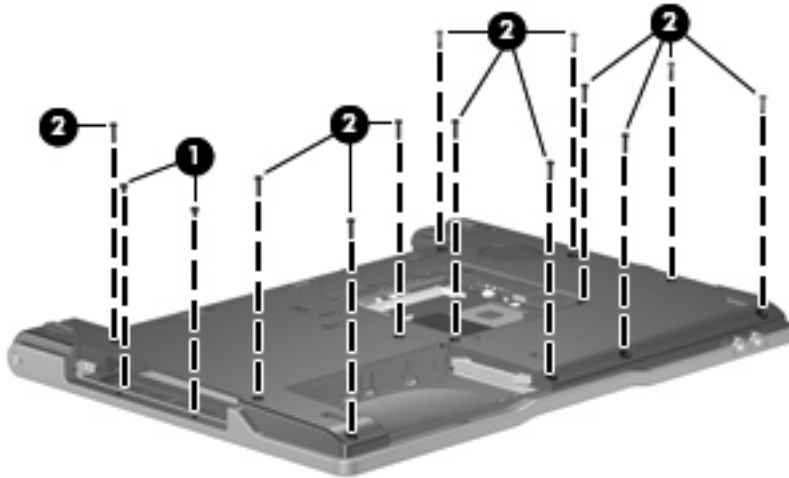

4. Lift the left side of the base enclosure **(1)** until the USB connectors **(2)** disengage from their openings in the base enclosure.



5. Remove the base enclosure.

Reverse this procedure to install the base enclosure.

RTC battery

 **NOTE:** Removing the RTC battery and leaving it uninstalled for 5 or more minutes causes all passwords and CMOS settings to be cleared.

Description	Spare part number
RTC battery	438556-001

Before removing the RTC battery, follow these steps:

1. Shut down the computer. If you are unsure whether the computer is off or in Hibernation, turn the computer on, and then shut it down through the operating system.
2. Disconnect all external devices connected to the computer.
3. Disconnect the power from the computer by first unplugging the power cord from the AC outlet and then unplugging the AC adapter from the computer.
4. Remove the battery (see [Battery on page 32](#)).
5. Remove the following components:
 - a. Hard drive (see [Hard drive on page 33](#))
 - b. Memory/WLAN module compartment cover (see [Memory module on page 35](#))
 - c. Optical drive (see [Optical drive on page 39](#))
 - d. Switch cover (see [Switch cover on page 41](#))
 - e. Keyboard (see [Keyboard on page 43](#))
 - f. Display assembly (see [Display assembly on page 47](#))
 - g. Base enclosure (see [Base enclosure on page 52](#))

Remove the RTC battery:

- ▲ Use a non-conductive, flat-bladed tool to pry the RTC battery out of the socket.

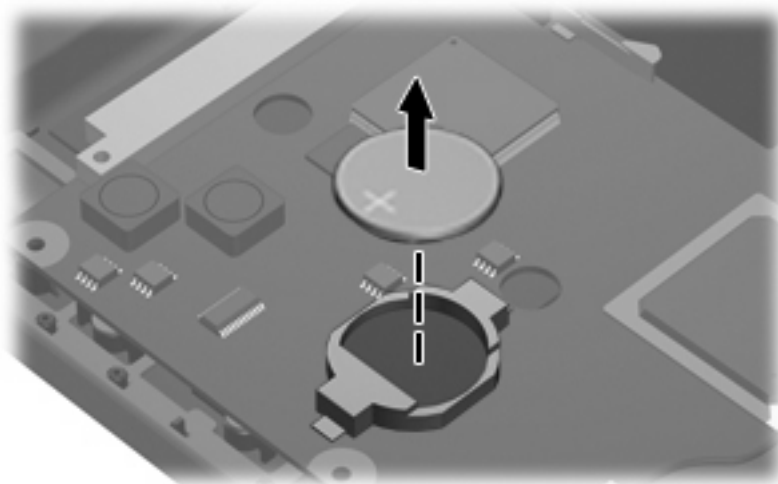

Reverse this procedure to install the RTC battery. Be sure the RTC battery is installed with the “+” sign facing up.

Fan assembly

Description	Spare part number
Fan assembly	438528-001

Before removing the fan assembly, follow these steps:

1. Shut down the computer. If you are unsure whether the computer is off or in Hibernation, turn the computer on, and then shut it down through the operating system.
2. Disconnect all external devices connected to the computer.
3. Disconnect the power from the computer by first unplugging the power cord from the AC outlet and then unplugging the AC adapter from the computer.
4. Remove the battery (see [Battery on page 32](#)).
5. Remove the following components:
 - a. Hard drive (see [Hard drive on page 33](#))
 - b. Memory/WLAN module compartment cover (see [Memory module on page 35](#))
 - c. Optical drive (see [Optical drive on page 39](#))
 - d. Switch cover (see [Switch cover on page 41](#))
 - e. Keyboard (see [Keyboard on page 43](#))
 - f. Display assembly (see [Display assembly on page 47](#))
 - g. Base enclosure (see [Base enclosure on page 52](#))

Remove the fan assembly:

1. Disconnect the fan cable **(1)** from the system board.
2. Remove the Phillips PM2.0×9.0 screw **(2)** that secures the fan assembly to the top cover.

3. Remove the fan assembly (3).

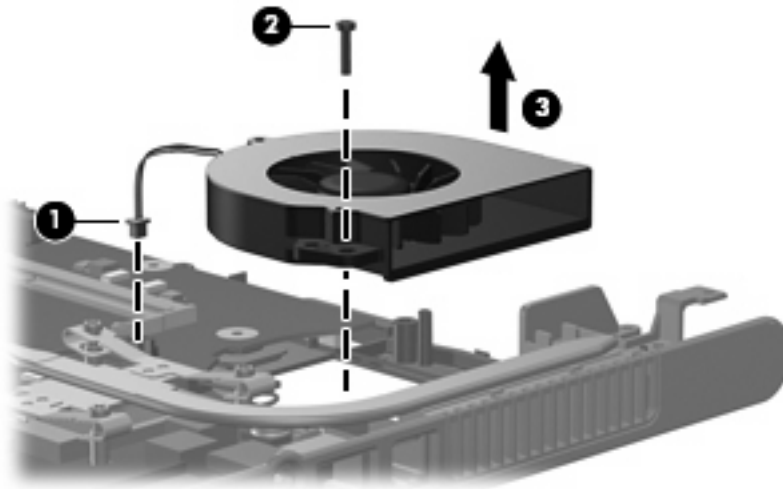

Reverse this procedure to install the fan assembly.

 **NOTE:** To properly ventilate the computer, allow at least a 7.6-cm (3-inch) clearance on the left and right sides of the computer.

The computer uses an electric fan for ventilation. The fan is controlled by a temperature sensor and is designed to turn on automatically when high temperature conditions exist. These conditions are affected by high external temperatures, system power consumption, power management/battery conservation configurations, battery fast charging, and software applications. Exhaust air is displaced through the ventilation grill located on the left side of the computer.

Heat sink

Description	Spare part number
Heat sink (includes thermal material)	448336-001

Before removing the heat sink, follow these steps:

1. Shut down the computer. If you are unsure whether the computer is off or in Hibernation, turn the computer on, and then shut it down through the operating system.
2. Disconnect all external devices connected to the computer.
3. Disconnect the power from the computer by first unplugging the power cord from the AC outlet and then unplugging the AC adapter from the computer.
4. Remove the battery (see [Battery on page 32](#)).
5. Remove the following components:
 - a. Hard drive (see [Hard drive on page 33](#))
 - b. Memory/WLAN module compartment cover (see [Memory module on page 35](#))
 - c. Optical drive (see [Optical drive on page 39](#))
 - d. Switch cover (see [Switch cover on page 41](#))
 - e. Keyboard (see [Keyboard on page 43](#))
 - f. Display assembly (see [Display assembly on page 47](#))
 - g. Base enclosure (see [Base enclosure on page 52](#))
 - h. Fan assembly (see [Fan assembly on page 55](#))

Remove the heat sink:

1. Remove the four Phillips PM2.5×6.0 screws **(1)** that secure the heat sink to the system board.
2. Slide the heat sink **(2)** to the left until the right side of the heat sink clears the top cover.

 **NOTE:** Due to the adhesive quality of the thermal paste located between the heat sink and processor, it may be necessary to move the heat sink from side to side to detach the heat sink from the processor.

3. Lift the left side of the heat sink **(3)** and remove it.

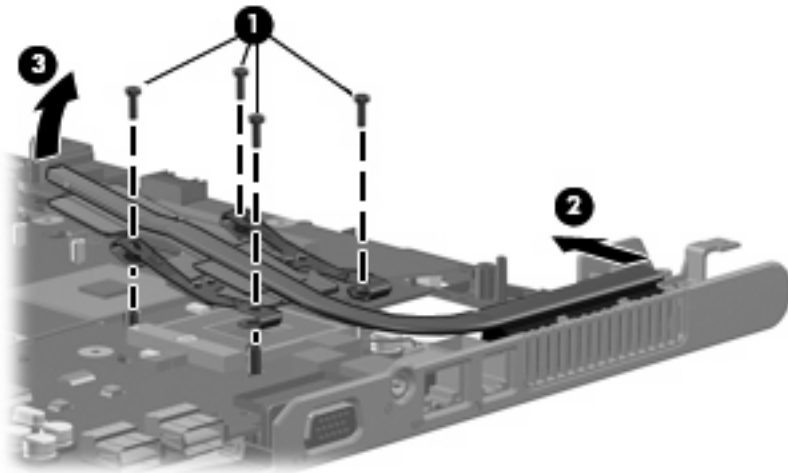

 **NOTE:** The thermal material must be thoroughly cleaned from the surfaces of the video processor **(1)**, the processor **(2)**, and the heat sink surfaces **(3)** and **(4)** each time the heat sink is removed. Reapply the thermal material when the heat sink is replaced. Thermal material is included with all heat sink, processor, and system board spare part kits.

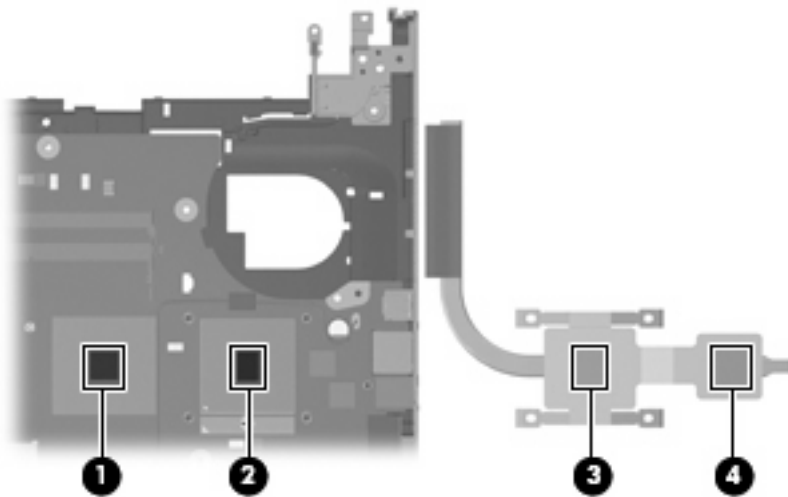

Reverse this procedure to install the heat sink.

Processor

 **NOTE:** All processor spare part kits include thermal paste.

Description	Spare part number
Intel Core Solo T1400 1.83-GHz processor	448326-001
Intel Core Solo T1300 1.66-GHz processor	448325-001
Intel Core Duo T2300E 1.66-GHz processor	448324-001
Intel Core Duo T2300 1.66-GHz processor	448323-001
Intel Celeron M 420 1.60-GHz processor	448322-001
Intel Celeron M 410 1.46-GHz processor	448321-001

Before removing the processor, follow these steps:

1. Shut down the computer. If you are unsure whether the computer is off or in Hibernation, turn the computer on, and then shut it down through the operating system.
2. Disconnect all external devices connected to the computer.
3. Disconnect the power from the computer by first unplugging the power cord from the AC outlet and then unplugging the AC adapter from the computer.
4. Remove the battery (see [Battery on page 32](#)).
5. Remove the following components:
 - a. Hard drive (see [Hard drive on page 33](#))
 - b. Memory/WLAN module compartment cover (see [Memory module on page 35](#))
 - c. Optical drive (see [Optical drive on page 39](#))
 - d. Switch cover (see [Switch cover on page 41](#))
 - e. Keyboard (see [Keyboard on page 43](#))
 - f. Display assembly (see [Display assembly on page 47](#))
 - g. Base enclosure (see [Base enclosure on page 52](#))
 - h. Fan assembly (see [Fan assembly on page 55](#))
 - i. Heat sink (see [Heat sink on page 57](#))

Remove the processor:

1. Use a flat-bladed screwdriver to turn the processor locking screw **(1)** one-half turn counterclockwise until you hear a click.

2. Lift the processor **(2)** straight up and remove it.

 **NOTE:** The gold triangle **(3)** on the processor must be aligned with the triangle **(4)** embossed on the processor socket when you install the processor.

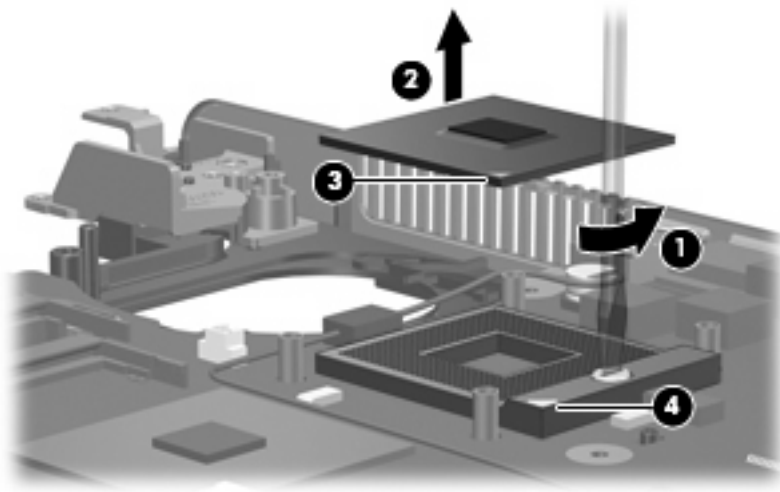

Reverse this procedure to install the processor.

Speaker

Description	Spare part number
Speaker	441627-001

Before removing the speaker, follow these steps:

1. Shut down the computer. If you are unsure whether the computer is off or in Hibernation, turn the computer on, and then shut it down through the operating system.
2. Disconnect all external devices connected to the computer.
3. Disconnect the power from the computer by first unplugging the power cord from the AC outlet and then unplugging the AC adapter from the computer.
4. Remove the battery (see [Battery on page 32](#)).
5. Remove the following components:
 - a. Hard drive (see [Hard drive on page 33](#))
 - b. Memory/WLAN module compartment cover (see [Memory module on page 35](#))
 - c. Optical drive (see [Optical drive on page 39](#))
 - d. Switch cover (see [Switch cover on page 41](#))
 - e. Keyboard (see [Keyboard on page 43](#))

- f. Display assembly (see [Display assembly on page 47](#))
- g. Base enclosure (see [Base enclosure on page 52](#))

Remove the speaker:

1. Disconnect the speaker cable **(1)** from the system board.
2. Remove the Phillips PM2.0×9.0 screw **(2)** that secures the speaker to the top cover.
3. Remove the speaker **(3)**.

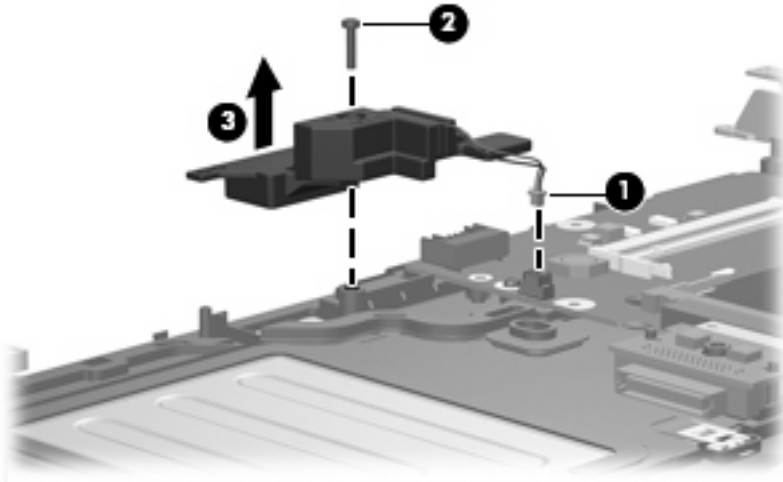

Reverse this procedure to install the speaker.

System board

Description	Spare part number
For use only with computer models with Intel Core processors and WLAN capability	448434-001
For use only with computer models with Intel Celeron M processors and WLAN capability	448433-001
For use only with computer models without WLAN capability	448432-001

Before removing the system board, follow these steps:

1. Shut down the computer. If you are unsure whether the computer is off or in Hibernation, turn the computer on, and then shut it down through the operating system.
2. Disconnect all external devices connected to the computer.
3. Disconnect the power from the computer by first unplugging the power cord from the AC outlet and then unplugging the AC adapter from the computer.
4. Remove the battery (see [Battery on page 32](#)).
5. Remove the following components:
 - a. Hard drive (see [Hard drive on page 33](#))
 - b. Memory/WLAN module compartment cover (see [Memory module on page 35](#))
 - c. Optical drive (see [Optical drive on page 39](#))
 - d. Switch cover (see [Switch cover on page 41](#))
 - e. Keyboard (see [Keyboard on page 43](#))
 - f. Display assembly (see [Display assembly on page 47](#))
 - g. Base enclosure (see [Base enclosure on page 52](#))
 - h. Fan assembly (see [Fan assembly on page 55](#))
 - i. Heat sink (see [Heat sink on page 57](#))

When replacing the system board, be sure that the following components are removed from the defective system board and installed on the replacement system board:

- Memory module (see [Memory module on page 35](#))
- WLAN module (see [WLAN module on page 37](#))
- RTC battery (see [RTC battery on page 54](#))
- Processor (see [Processor on page 59](#))
- PC Card assembly (see [PC Card assembly on page 65](#))

Remove the system board:

1. Remove the Phillips PM2.0×3.0 screw that secures the system board to the top cover.

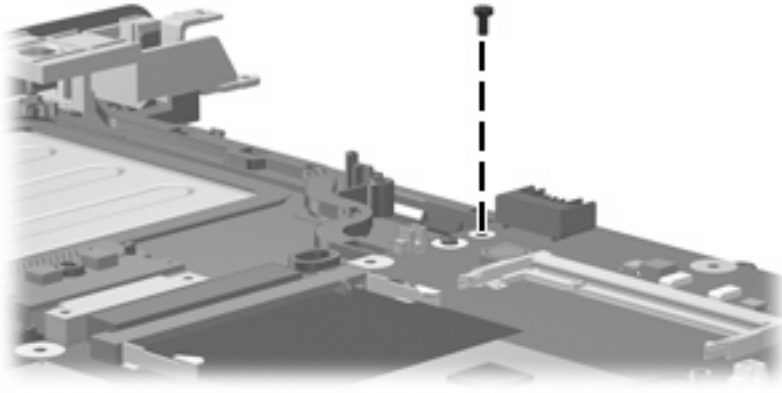

2. Lift the left side of the system board **(1)** until it rests at an angle.
3. Flex the right side of the top cover **(2)** until the external monitor connector clears the opening in the top cover.
4. Remove the system board **(3)** by pulling it away from the top cover at an angle until it clears the top cover.

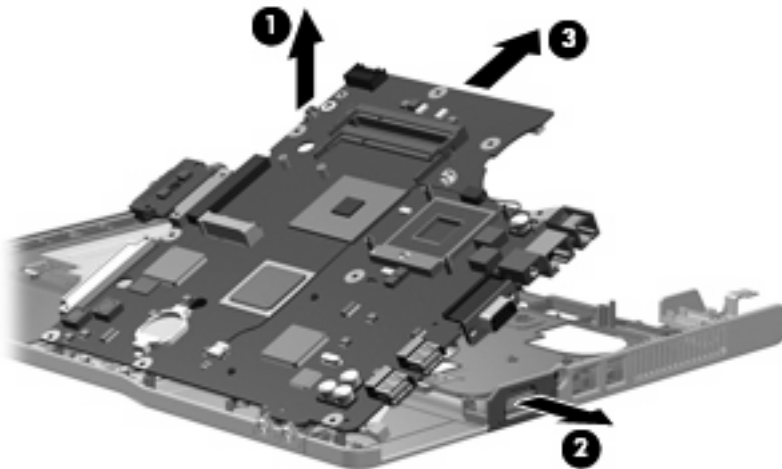

5. If it is necessary to replace the optical drive connector board, pull the board away from the system board until it disconnects from the system board.

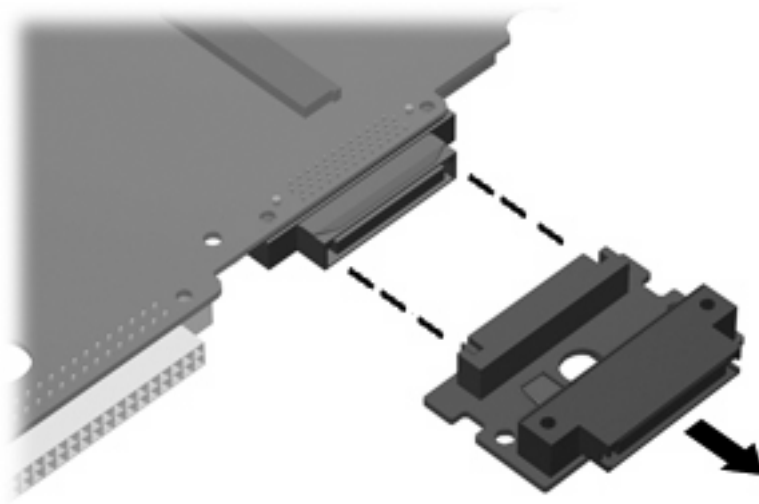

 **NOTE:** The optical drive connector board is available using spare part number 441631-001.

Reverse this procedure to install the system board.

PC Card assembly

Description	Spare part number
PC Card assembly	438551-001
PC Card slot bezel	438527-001

Before removing the PC Card assembly, follow these steps:

1. Shut down the computer. If you are unsure whether the computer is off or in Hibernation, turn the computer on, and then shut it down through the operating system.
2. Disconnect all external devices connected to the computer.
3. Disconnect the power from the computer by first unplugging the power cord from the AC outlet and then unplugging the AC adapter from the computer.
4. Remove the battery (see [Battery on page 32](#)).
5. Remove the following components:
 - a. Hard drive (see [Hard drive on page 33](#))
 - b. Memory/WLAN module compartment cover (see [Memory module on page 35](#))
 - c. Optical drive (see [Optical drive on page 39](#))
 - d. Switch cover (see [Switch cover on page 41](#))
 - e. Keyboard (see [Keyboard on page 43](#))
 - f. Display assembly (see [Display assembly on page 47](#))
 - g. Base enclosure (see [Base enclosure on page 52](#))
 - h. Fan assembly (see [Fan assembly on page 55](#))
 - i. Heat sink (see [Heat sink on page 57](#))
 - j. System board (see [System board on page 62](#))

Remove the PC Card assembly:

1. Position the system board with the PC Card eject button toward you.

2. Remove the two Phillips PM2.0×8.0 screws **(1)** and the two Phillips PM2.0×4.0 screws **(2)** that secure the PC Card assembly to the system board.

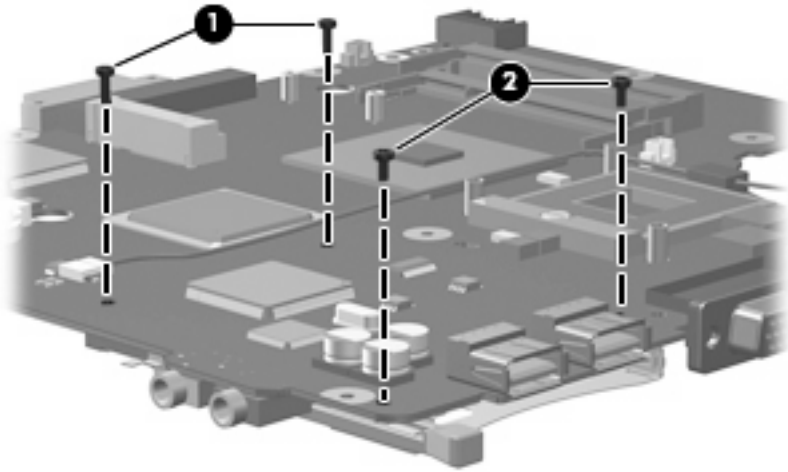

3. Turn the system board top-side up, with the PC Card eject button toward you.
4. Disengage the slots on the PC Card assembly from the tabs **(1)** on the PC Card connector.
5. Remove the PC Card assembly **(2)** from the system board.

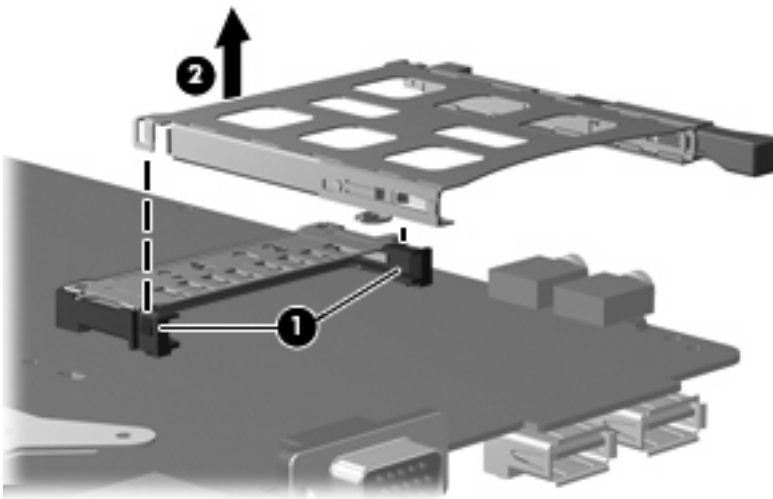

Reverse this procedure to install the PC Card assembly.

TouchPad cable

Description	Spare part number
TouchPad cable	441638-001

Before removing the TouchPad cable, follow these steps:

1. Shut down the computer. If you are unsure whether the computer is off or in Hibernation, turn the computer on, and then shut it down through the operating system.
2. Disconnect all external devices connected to the computer.
3. Disconnect the power from the computer by first unplugging the power cord from the AC outlet and then unplugging the AC adapter from the computer.
4. Remove the battery (see [Battery on page 32](#)).
5. Remove the following components:
 - a. Hard drive (see [Hard drive on page 33](#))
 - b. Memory/WLAN module compartment cover (see [Memory module on page 35](#))
 - c. Optical drive (see [Optical drive on page 39](#))
 - d. Switch cover (see [Switch cover on page 41](#))
 - e. Keyboard (see [Keyboard on page 43](#))
 - f. Display assembly (see [Display assembly on page 47](#))
 - g. Base enclosure (see [Base enclosure on page 52](#))
 - h. Fan assembly (see [Fan assembly on page 55](#))
 - i. Heat sink (see [Heat sink on page 57](#))
 - j. System board (see [System board on page 62](#))

Remove the TouchPad cable:

1. Position the top cover with the front toward you.

2. Release the ZIF connector **(1)** to which the TouchPad cable is connected, and disconnect the TouchPad cable **(2)** from the TouchPad board.

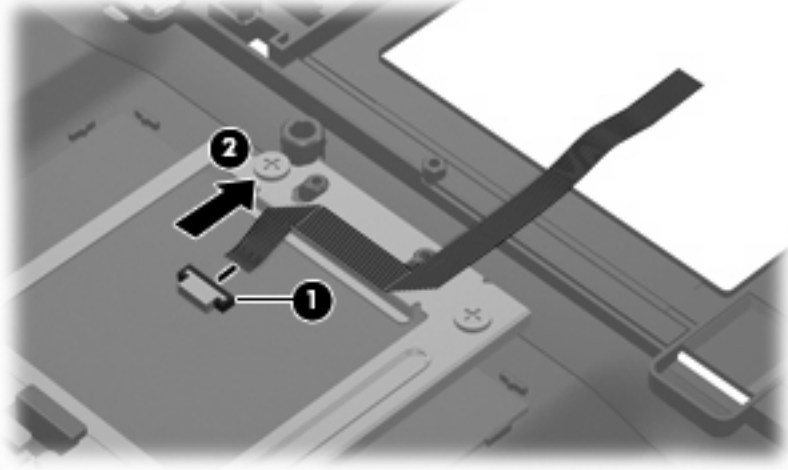

Reverse this procedure to install the TouchPad cable.

5 Computer Setup

Starting Computer Setup

Computer Setup is a preinstalled, ROM-based utility that can be used even when the operating system is not working or will not load.

 **NOTE:** Some of the Computer Setup menu items listed in this guide may not be supported by your computer.

NOTE: Pointing devices are not supported in Computer Setup. You must use the keyboard to navigate and make selections.

NOTE: An external keyboard connected by USB can be used with Computer Setup only if USB legacy support is enabled.

To start Computer Setup:

1. Turn on or restart the computer.
2. Before Windows® opens and while the "F10 = ROM Based Setup" message is displayed in the lower-left corner of the screen, press **f10**.

Using Computer Setup

Navigating and selecting in Computer Setup

The information and settings in Computer Setup are accessed from the File, Security, Diagnostics, and System Configuration menus.

1. Open Computer Setup by turning on or restarting the computer, and then pressing **f10** while the "F10 = ROM Based Setup" message is displayed in the lower-left corner of the screen.

Because Computer Setup is not Windows-based, it does not support the TouchPad. Navigation and selection are by keystroke:

- To choose a menu or a menu item, use the arrow keys.
 - To select an item, press **enter**.
 - To close open dialog boxes and return to the main Computer Setup screen, press **esc**.
 - To view navigation information, press **f1**.
 - To change the language, press **f2**.
2. Select the **File, Security, Diagnostics,** or **System Configuration** menu.
 3. To exit Computer Setup, choose one of the following methods:
 - To exit Computer Setup without saving your preferences, use the arrow keys to select **File > Ignore Changes and Exit**. Then follow the instructions on the screen.
 - To save your preferences and exit Computer Setup, use the arrow keys to select **File > Save Changes and Exit**. Then follow the instructions on the screen.

Your preferences go into effect when the computer restarts.

Restoring factory settings in Computer Setup

To return all settings in Computer Setup to the values that were set at the factory, follow these steps:

1. Open Computer Setup by turning on or restarting the computer, and then pressing **f10** while the "F10 = ROM Based Setup" message is displayed in the lower-left corner of the screen.
2. Use the arrow keys to select File > Restore defaults, and then press **enter**.
3. When the confirmation dialog box opens, press **f10**.
4. To save your preferences and exit Computer Setup, use the arrow keys to select **File > Save Changes and Exit**. Then follow the instructions on the screen.

Your preferences go into effect when the computer restarts.

 **NOTE:** Your password settings and security settings are not changed when you restore the factory settings.

Computer Setup menus

The menu tables in this section provide an overview of Computer Setup options.

 **NOTE:** Some of the Computer Setup menu items listed in this chapter may not be supported by your computer.

File menu

Select	To do this
System information	<ul style="list-style-type: none">• View identification information for the computer and the batteries in the system.• View specification information for the processor, cache and memory size, system ROM, video revision, and keyboard controller version.
Restore defaults	Replace the configuration settings in Computer Setup with the original factory settings. (Password settings and security settings are not changed when you restore the factory settings.)
Ignore changes and exit	Cancel any changes entered during the current session. Then exit and restart the computer.
Save changes and exit	Save any changes entered during the current session. Then exit and restart the computer. Your changes go into effect when the computer restarts.

Security menu

Select	To do this
Setup password	Enter, change, or delete a setup password.
Power-On password	Enter, change, or delete a power-on password.
Password options	<ul style="list-style-type: none">• Enable/disable stringent security.• Enable/disable password requirement on computer restart.
DriveLock passwords	<ul style="list-style-type: none">• Enable/disable DriveLock on any computer hard drive and on optional MultiBay hard drives.• Change a DriveLock user password or master password. <p>NOTE: DriveLock settings are accessible only when you enter Computer Setup by turning on (not restarting) the computer.</p>
Smart Card security	Enable/disable support for smart card and Java™ Card power-on authentication. <p>NOTE: Power-on authentication for smart cards is supported only on computers with optional smart card readers.</p> <p>NOTE: You must have an administrator password to change this setting.</p>
TPM Embedded Security	Enable/disable support for Trusted Platform Module (TPM) Embedded Security, which protects the computer from unauthorized access to owner functions available in Embedded Security for ProtectTools. For more information, refer to the ProtectTools software Help. <p>NOTE: You must have a setup password to change this setting.</p>
System IDs	Enter user-defined computer asset tracking number and ownership tag.
Disk Sanitizer	Run Disk Sanitizer to destroy all existing data on the primary hard drive. The following options are available: <ul style="list-style-type: none">• Fast: Runs the Disk Sanitizer erase cycle once.• Optimum: Runs the Disk Sanitizer erase cycle 3 times.• Custom: Allows you to select the desired number of Disk Sanitizer erase cycles from a list. <p>CAUTION: If you run Disk Sanitizer, the data on the primary hard drive is destroyed permanently.</p>

Diagnostics menu

Select	To do this
Hard Drive Self-Test options	Run a comprehensive self-test on any hard drive in the system or on any optional MultiBay hard drive.
Memory Check	Run a comprehensive check on system memory.
Startup Check (select models only)	Verify the system components needed for starting the computer.

System Configuration menu

 **NOTE:** Some of the listed System Configuration options may not be supported by your computer.

Select	To do this
Language (or press f2)	Change the Computer Setup language.
Boot options	<ul style="list-style-type: none">• Set f9, f10, and f12 delay when starting up.• Enable/disable CD-ROM boot.• Enable/disable floppy boot.• Enable/disable internal network adapter boot and set the boot mode (PXE or RPL).• Enable/disable MultiBoot, which sets a boot order that can include most boot devices in the system.• Set the Express Boot Popup delay in seconds.• Set the boot order.
Device configurations	<ul style="list-style-type: none">• Swap the functions of the fn key and left ctrl key.• Enable/disable multiple standard pointing devices at startup. (To set the computer to support only a single, usually nonstandard, pointing device at startup, select Disable.)• Enable/disable USB legacy support. When enabled, USB legacy support allows the following:<ul style="list-style-type: none">◦ Use of a USB keyboard, mouse, and hub in Computer Setup even when a Windows operating system is not running.◦ Startup from bootable USB devices, including a hard drive, diskette drive, or optical drive connected by a USB port to the computer or to an optional docking device (select models only).• Select a parallel port mode: EPP (Enhanced Parallel Port), standard, bidirectional, or ECP (Enhanced Capabilities Port).• Enable/disable BIOS DMA data transfers.• Enable/disable fan always on while connected to an AC outlet.• Enable/disable Intel® Data Execution Prevention or AMD® PSAA Execution Disable. When enabled, the processor can disable some virus code execution, which helps to improve computer security.• Enable/disable LAN Power Save. When enabled, saves power by turning off the LAN when not in use.• Enable/disable SATA Native Mode.• Enable/disable Dual Core CPU.• Enable/disable Secondary Battery Fast Charge.• Choose Bit-shift or LBA assisted HDD Translation Mode.• Enable/disable Windows direct application launcher.• Enable/disable HP Lockout.
Built-In Device Options	<ul style="list-style-type: none">• Enable/disable embedded WWAN Device Radio.• Enable/disable embedded WLAN Device Radio.

Select	To do this
	<ul style="list-style-type: none"> • Enable/disable embedded Bluetooth® Device Radio. • Enable/disable LAN/WLAN Switching. When enabled, switches to a WLAN when a LAN is either unavailable or disconnected. • Enable/disable Wake on LAN from Off. • Enable/disable the ambient light sensor.
Port Options	<ul style="list-style-type: none"> • Enable/disable the serial port. • Enable/disable the parallel port. • Enable/disable the flash media reader. • Enable/disable the USB port. <p>CAUTION: Disabling the USB port also disables MultiBay devices and ExpressCard devices on the advanced port replicator.</p> <ul style="list-style-type: none"> • Enable/disable the 1394 port. • Enable/disable the cardbus slot. • Enable/disable the ExpressCard slot. • Enable/disable the infrared port. • Enable/disable the optical disk drive. • Enable/disable the network controller.

6 Specifications

Computer specifications

	Metric	U.S.
Dimensions		
Height (front to back)	3.19 to 3.59 cm	1.26 to 1.41 in
Width	35.79 cm	14.09 in
Depth	25.70 cm	10.12 in
Weight (with optical drive, hard drive, and battery)	2.67 kg	5.88 lbs
Input power		
Operating voltage	18.5 V dc @ 3.5 A – 65 W	
Operating current	3.5 A	
Temperature		
Operating (not writing to optical disc)	0°C to 35°C	32°F to 95°F
Operating (writing to optical disc)	5°C to 35°C	41°F to 95°F
Nonoperating	-20°C to 60°C	-4°F to 140°F
Relative humidity		
Operating	10% to 90%	
Nonoperating	5% to 95%	
Maximum altitude (unpressurized)		
Operating (14.7 to 10.1 psia)	-15 m to 3,048 m	-50 ft to 10,000 ft
Nonoperating (14.7 to 4.4 psia)	-15 m to 12,192 m	-50 ft to 40,000 ft
Shock		
Operating	125 g, 2 ms, half-sine	
Nonoperating	200 g, 2 ms, half-sine	
Random vibration		
Operating	0.75 g zero-to-peak, 10 Hz to 500 Hz, 0.25 oct/min sweep rate	

	Metric	U.S.
Nonoperating	1.50 g zero-to-peak, 10 Hz to 500 Hz, 0.5 oct/min sweep rate	

NOTE: Applicable product safety standards specify thermal limits for plastic surfaces. The computer operates well within this range of temperatures.

15.4-inch, WXGA display specifications

	Metric	U.S.
Dimensions		
Height	20.7 cm	8.15 in
Width	33.1 cm	13.03 in
Diagonal	39.1 cm	15.39 in
Number of colors	Up to 16.8 million	
Contrast ratio	200:1 (typical)	
Brightness	160 nits (typical)	
Pixel resolution		
Pitch	0.259 × 0.259 mm	
Format	1280 × 800	
Configuration	RGB vertical stripe	
Backlight	Edge lit	
Refresh rate	60 Hz	
PPI	107	
Viewing angle	+/-65° horizontal, +/-50° vertical (typical)	

Hard drive specifications

	120-GB*	80-GB*
Dimensions		
Height	9.5 mm	9.5 mm
Width	70 mm	70 mm
Weight	101 g	101 g
Interface type		
	ATA-7	ATA-7
Transfer rate		
Synchronous (maximum)	100 MB/sec	100 MB/sec
Security	ATA security	ATA security
Seek times (typical read, including setting)		
Single track	3 ms	3 ms
Average	13 ms	13 ms
Maximum	24 ms	24 ms
Logical blocks		
	234,420,480	156,280,320
Disc rotational speed		
	5400-rpm	5400-rpm
Operating temperature		
	5°C to 55°C (41°F to 131°F)	
*1 GB = 1 billion bytes when referring to hard drive storage capacity. Actual accessible capacity is less.		
NOTE: Certain restrictions and exclusions apply. Contact technical support for details.		

Primary 4-cell, Li-ion battery specifications

	Metric	U.S.
Dimensions		
Height	2.00 cm	0.79 in
Width	26.80 cm	3.70 in
Depth	5.30 cm	5.28 in
Weight	0.34 kg	0.75 lb
Energy		
Voltage	14.4 V	
Amp-hour capacity	2.2 Ah	
Watt-hour capacity	32 Wh	
Temperature		
Operating	5°C to 45°C	41°F to 113°F
Nonoperating	0°C to 60°C	32°F to 140°F

DVD±RW and CD-RW Super Multi Double-Layer Combo Drive specifications

Applicable disc	Read:	Write:
	CD-DA, CD+(E)G, CD-MIDI, CD-TEXT, CD-ROM, CD-ROM XA, MIXED MODE CD, CD-I, CD-I Bridge (Photo-CD, Video CD), Multisession CD (Photo-CD, CD-EXTRA, Portfolio, CD-R, CD-RW), CD-R, CD-RW, DVD-ROM (DVD-5, DVD-9, DVD-10, DVD-18), DVD-R, DVD-RW, DVD+R, DVD+RW, DVD-RAM	CD-R and CD-RW DVD+R, DVD+RW, DVD-R, DVD-RW, DVD-RAM
Center hole diameter	1.5 cm (0.59 in)	
Disc diameter		
Standard disc	12 cm (4.72 in)	
Mini disc	8 cm (3.15 in)	
Disc thickness	1.2 mm (0.047 in)	
Track pitch	0.74 μm	
Access time	CD	DVD
Random	< 175 ms	< 230 ms
Full stroke	< 285 ms	< 335 ms
Audio output level	Audio-out, 0.7 Vrms	
Cache buffer	2 MB	
Data transfer rate		
24X CD-ROM	3,600 KB/sec	
8X DVD	10,800 KB/sec	
24X CD-R	3,600 KB/sec	
16X CD-RW	2,400 KB/sec	
8X DVD+R	10,800 KB/sec	
4X DVD+RW	5,400 KB/sec	
8X DVD-R	10,800 KB/sec	
4X DVD-RW	5,400 KB/sec	
2.4X DVD+R(9)	2,700 KB/sec	
5X DVD-RAM	6,750 KB/sec	
Transfer mode	Multiword DMA Mode	
Startup time	< 15 seconds	
Stop time	< 6 seconds	

DVD/CD-RW Combo Drive specifications

Applicable disc	Read: CD-DA, CD+(E)G, CD-MIDI, CD-TEXT, CD-ROM, CD-ROM XA, MIXED MODE CD, CD-I, CD-I Bridge (Photo-CD, Video CD), Multisession CD (Photo-CD, CD-EXTRA, Portfolio, CD-R, CD-RW), CD-R, CD-RW, DVD-ROM (DVD-5, DVD-9, DVD-10, DVD-18), DVD-R, DVD-RW, DVD+R, DVD+RW, DVD-RAM	Write: CD-R and CD-RW
Center hole diameter	1.5 cm (0.59 in)	
Disc diameter		
Standard disc	12 cm (4.72 in)	
Mini disc	8 cm (3.15 in)	
Disc thickness	1.2 mm (0.047 in)	
Track pitch	0.74 μ m	
Access time	CD	DVD
Random	< 110 ms	< 130 ms
Full stroke	< 210 ms	< 225 ms
Audio output level	Line-out, 0.7 Vrms	
Cache buffer	2 MB	
Data transfer rate	24X CD-ROM 3,600 KB/s 8X DVD 10,800 KB/s 24X CD-R 3,600 KB/s 24X CD-RW 3,600 KB/s	
24X CD-ROM	3,600 KB/sec	
8X DVD	10,800 KB/sec	
24X CD-R	3,600 KB/sec	
24X CD-RW	3,600 KB/sec	
Transfer mode	Multiword DMA mode 2	
Startup time	< 15 seconds	
Stop time	< 6 seconds	

System DMA specifications

Hardware DMA	System function
DMA0	Not applicable
DMA1*	Not applicable
DMA2*	Not applicable
DMA3	Not applicable
DMA4	Direct memory access controller
DMA5*	Available for PC Card
DMA6	Not assigned
DMA7	Not assigned

*PC Card controller can use DMA 1, 2, or 5.

System interrupt specifications

Hardware IRQ	System function
IRQ0	System timer
IRQ1	Standard 101-/102-Key or Microsoft® Natural Keyboard
IRQ2	Cascaded
IRQ3	Intel 82801DB/DBM USB2 Enhanced Host Controller—24CD
IRQ4	COM1
IRQ5*	Conexant AC—Link Audio Intel 82801DB/DBM SMBus Controller—24C3 Data Fax Modem with SmartCP
IRQ6	Diskette drive
IRQ7*	Parallel port
IRQ8	System CMOS/real-time clock
IRQ9*	Microsoft ACPI-compliant system
IRQ10*	Intel USB UHCI controller—24C2 Intel 82852/82855 GM/GME Graphic Controller Realtek RTL8139 Family PCI Fast Ethernet Controller
IRQ11	Intel USB EHCI controller—24CD Intel USB UHCI controller—24C4 Intel USB UHCI controller—24C7 Intel Pro/Wireless 2200BG TI OHCI 1394 host controller TI PCI1410 CardBus controller
IRQ12	Synaptics PS/2 TouchPad
IRQ13	Numeric data processor
IRQ14	Primary IDE channel
IRQ15	Secondary IDE channel

*Default configuration; audio possible configurations are IRQ5, IRQ7, IRQ9, IRQ10, or none.

NOTE: PC Cards may assert IRQ3, IRQ4, IRQ5, IRQ7, IRQ9, IRQ10, IRQ11, or IRQ15. Either the infrared or the serial port may assert IRQ3 or IRQ4.

System I/O address specifications

I/O address (hex)	System function (shipping configuration)
000 - 00F	DMA controller no. 1
010 - 01F	Unused
020 - 021	Interrupt controller no. 1
022 - 024	Opti chipset configuration registers
025 - 03F	Unused
02E - 02F	87334 "Super I/O" configuration for CPU
040 - 05F	Counter/timer registers
044 - 05F	Unused
060	Keyboard controller
061	Port B
062 - 063	Unused
064	Keyboard controller
065 - 06F	Unused
070 - 071	NMI enable/RTC
072 - 07F	Unused
080 - 08F	DMA page registers
090 - 091	Unused
092	Port A
093 - 09F	Unused
0A0 - 0A1	Interrupt controller no. 2
I/O Address (hex)	System Function (shipping configuration)
0A2 - 0BF	Unused
0C0 - 0DF	DMA controller no. 2
0E0 - 0EF	Unused
0F0 - 0F1	Coprocessor busy clear/reset
0F2 - 0FF	Unused
100 - 16F	Unused
170 - 177	Secondary fixed disk controller
178 - 1EF	Unused
1F0 - 1F7	Primary fixed disk controller
1F8 - 200	Unused
201	JoyStick (decoded in ESS1688)
202 - 21F	Unused

I/O address (hex)	System function (shipping configuration)
220 - 22F	Entertainment audio
230 - 26D	Unused
26E - 26	Unused
278 - 27F	Unused
280 - 2AB	Unused
2A0 - 2A7	Unused
2A8 - 2E7	Unused
2E8 - 2EF	Reserved serial port
2F0 - 2F7	Unused
2F8 - 2FF	Infrared port
300 - 31F	Unused
320 - 36F	Unused
370 - 377	Secondary diskette drive controller
378 - 37F	Parallel port (LPT1/default)
380 - 387	Unused
388 - 38B	FM synthesizer—OPL3
38C - 3AF	Unused
3B0 - 3BB	VGA
3BC - 3BF	Reserved (parallel port/no EPP support)
3C0 - 3DF	VGA
3E0 - 3E1	PC Card controller in CPU
3E2 - 3E3	Unused
3E8 - 3EF	Internal modem
3F0 - 3F7	"A" diskette controller
3F8 - 3FF	Serial port (COM1/default)
CF8 - CFB	PCI configuration index register (PCIDIVO-1)
CFC - CFF	PCI configuration data register (PCIDIVO-1)

System memory map specifications

Size	Memory address	System function
640 KB	00000000-0009FFFF	Base memory
128 KB	000A0000-000BFFFF	Video memory
48 KB	000C0000-000CBFFF	Video BIOS
160 KB	000C8000-000E7FFF	Unused
64 KB	000E8000-000FFFFF	System BIOS
15 MB	00100000-00FFFFFF	Extended memory
58 MB	04800000-07FFFFFF	Super extended memory
58 MB	04800000-07FFFFFF	Unused
2 MB	08000000-080FFFFF	Video memory (direct access)
4 GB	08200000-FFFFFF	Unused
64 KB	FFFF0000-FFFFFFFF	System BIOS

7 Screw listing

This section provides specification and reference information for the screws and screw locks used in the computer. All screws and screw locks listed in this section are available in the Screw Kit, spare part number 441629-001, and the Display Screw Kit, spare part number 440714-001.

Phillips PM2.5×6.0 captive screw

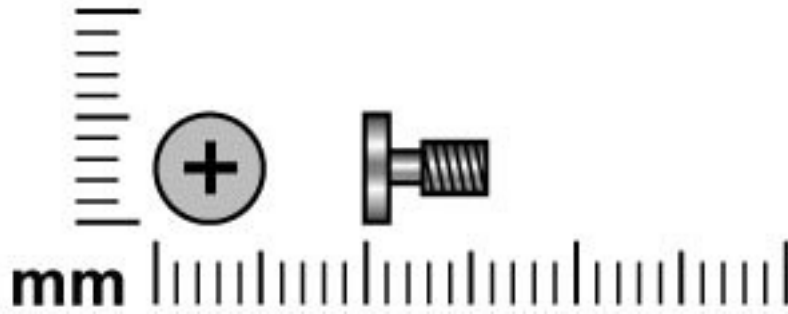

Color	Quantity	Length	Thread	Head width
Black	3	6.0 mm	2.5 mm	5.0 mm

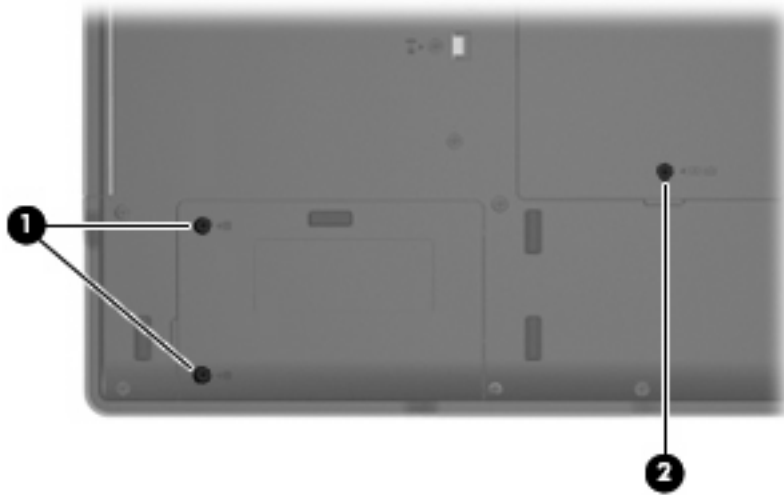

Where used:

(1) Two screws that secure the hard drive cover to the computer (screws are captured on the cover by C-clips)

(2) One screw that secures the memory/WLAN module compartment cover to the computer (screw is captured on the cover by a C-clip)

Phillips PM3.0×3.0 screw

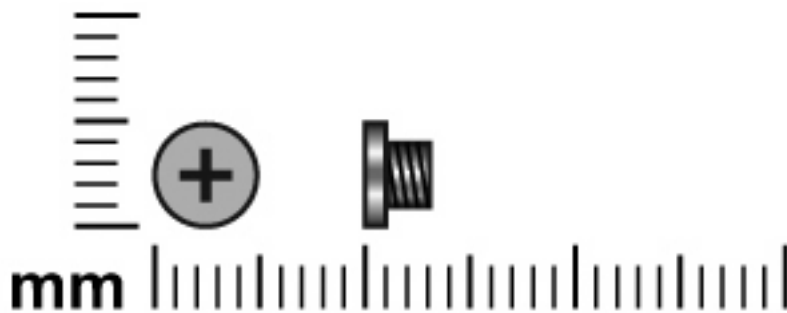

Color	Quantity	Length	Thread	Head width
Silver	4	3.0 mm	3.0 mm	5.0 mm

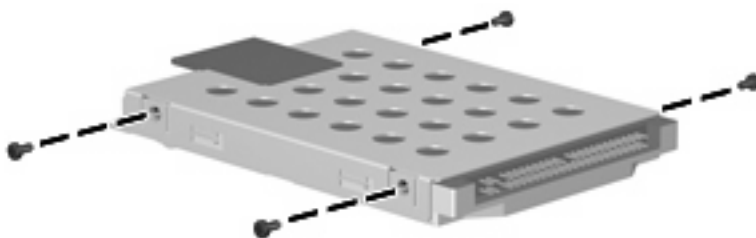

Where used: 4 screws that secure the hard drive bracket to the hard drive

Phillips PM2.0×9.0 screw

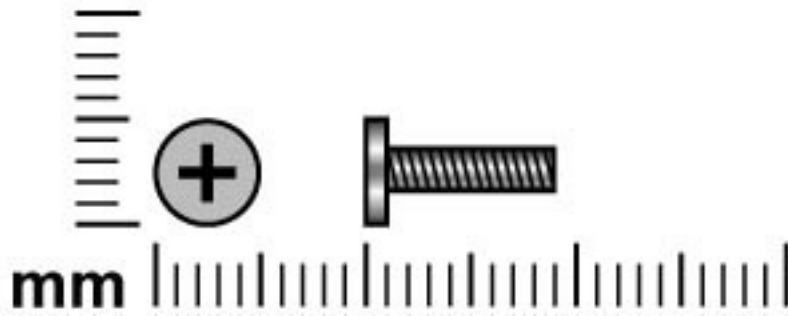

Color	Quantity	Length	Thread	Head width
Black	26	9.0 mm	2.0 mm	5.0 mm

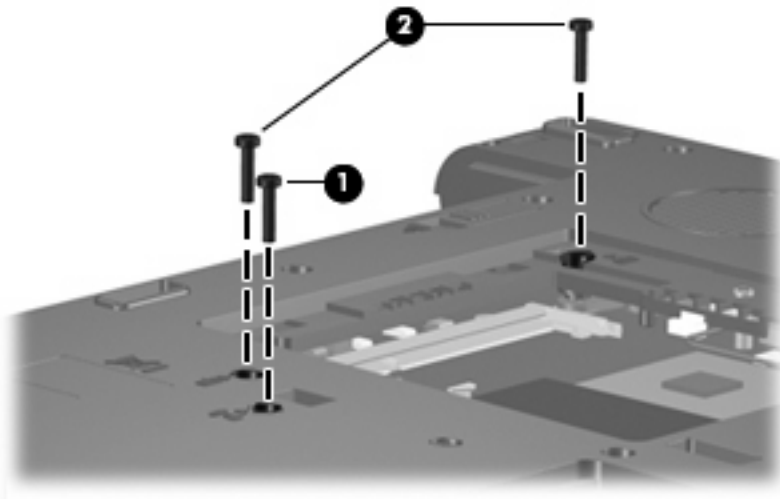

Where used:

- (1) One screw that secures the optical drive to the computer
- (2) Two screws that secure the keyboard to the computer

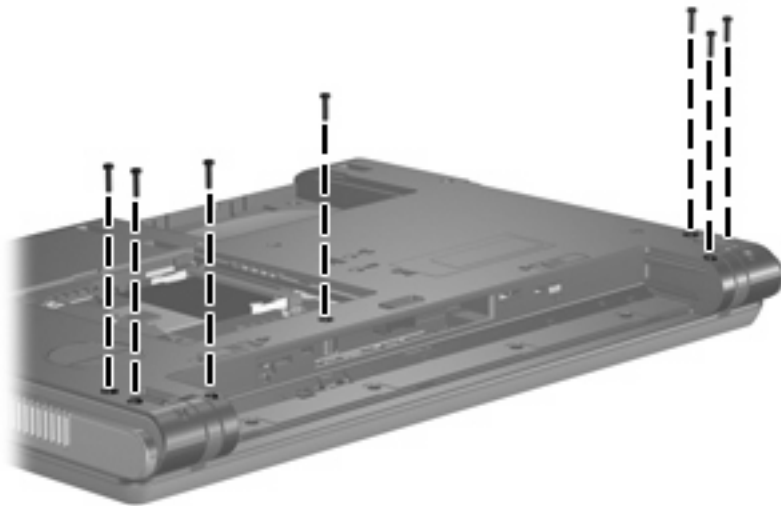

Where used: 7 screws that secure the switch cover to the computer

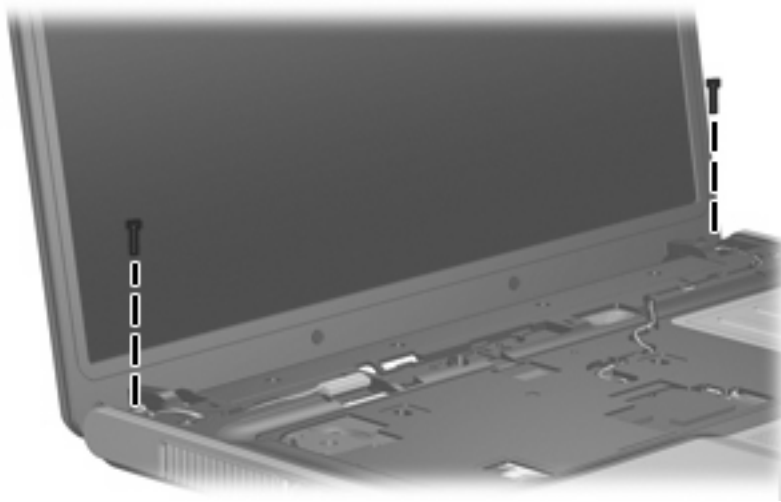

Where used: 2 screws that secure the display assembly to the computer

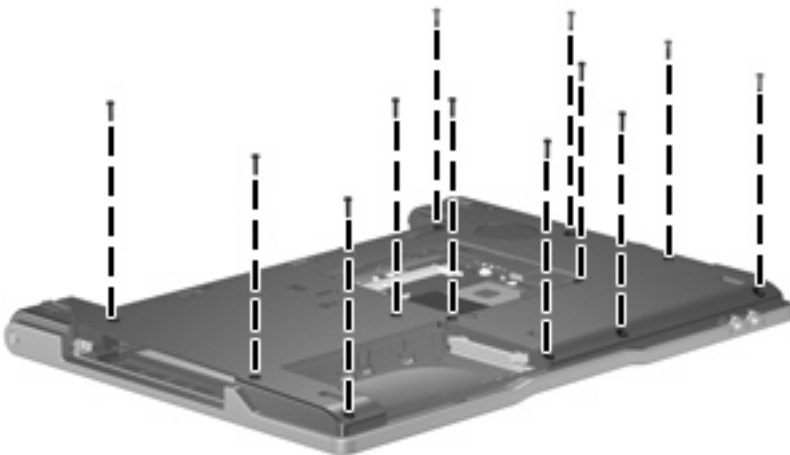

Where used: 12 screws that secure the base enclosure to the computer

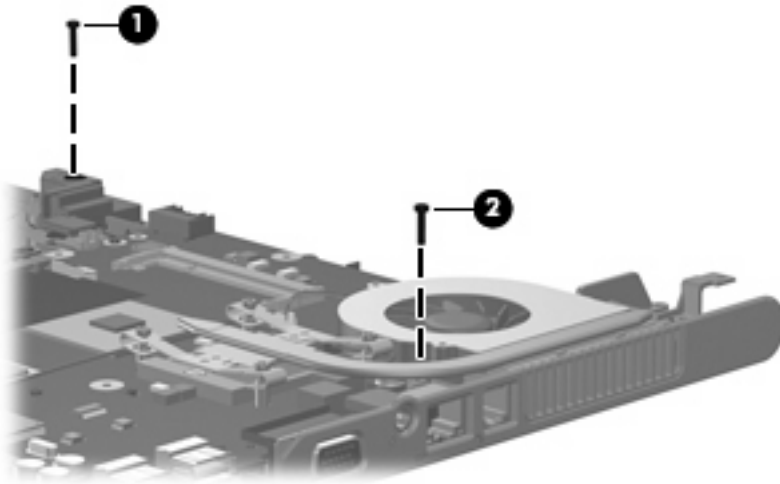

Where used:

- (1) One screw that secures the fan assembly to the computer
- (2) One screw that secures the speaker to the computer

Phillips PM2.0×3.0 screw

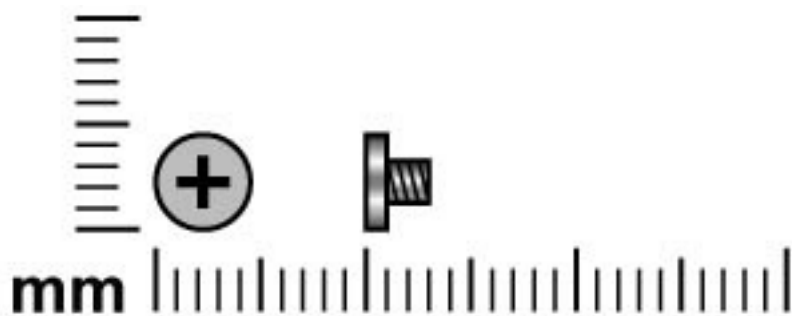

Color	Quantity	Length	Thread	Head width
Silver	16	3.0 mm	2.0 mm	4.5 mm

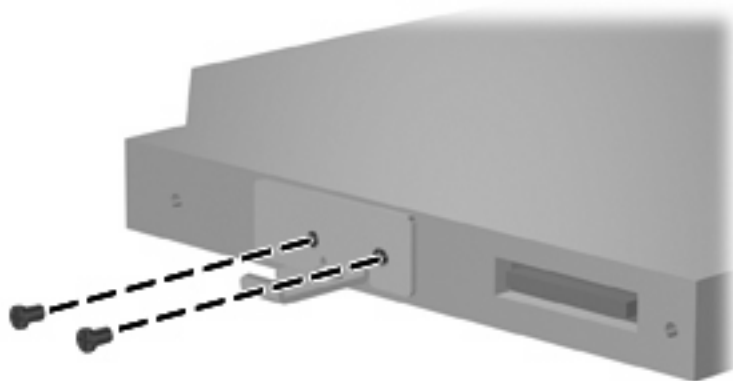

Where used: 2 screws that secure the optical drive bracket to the optical drive

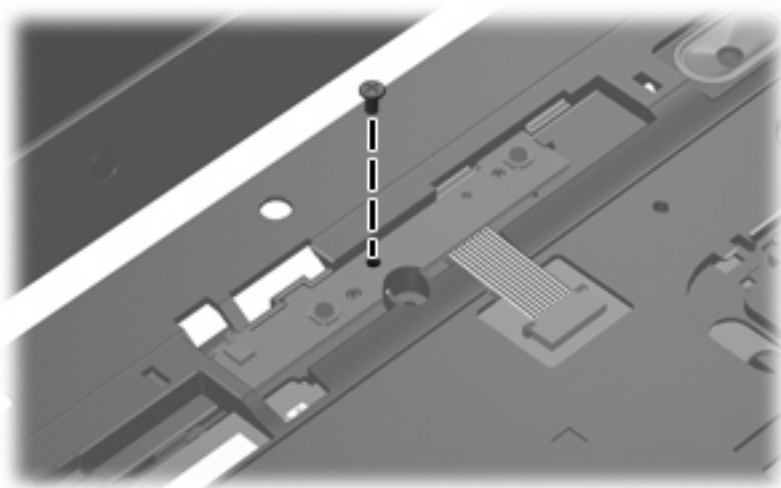

Where used: One screw that secures the button board to the computer

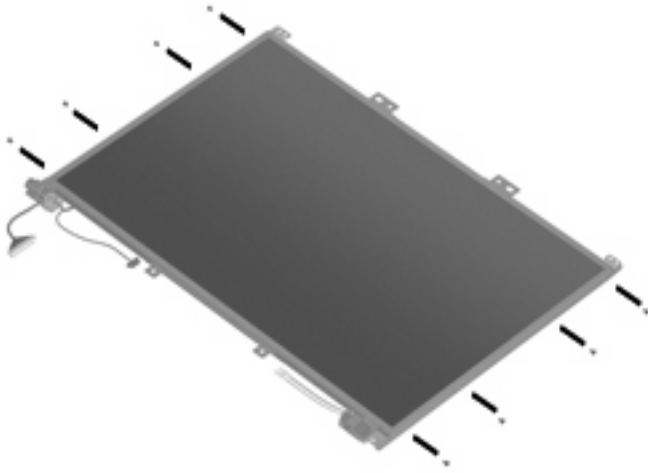

Where used: 4 screws that secure each display hinge to the display panel

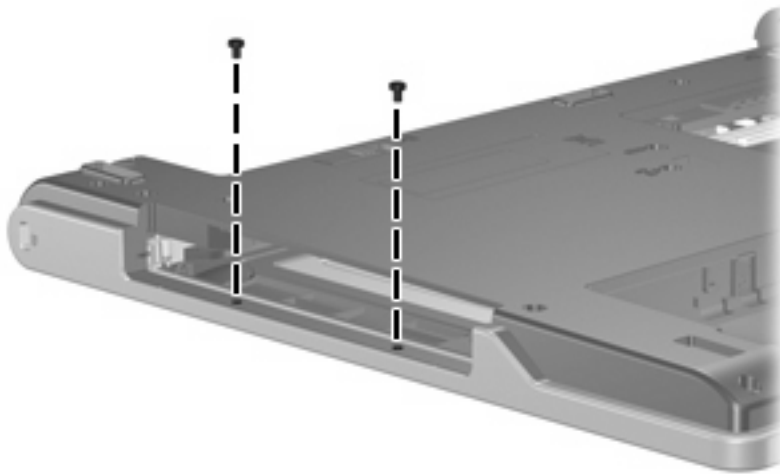

Where used: 2 screws that secure the base enclosure to the top cover

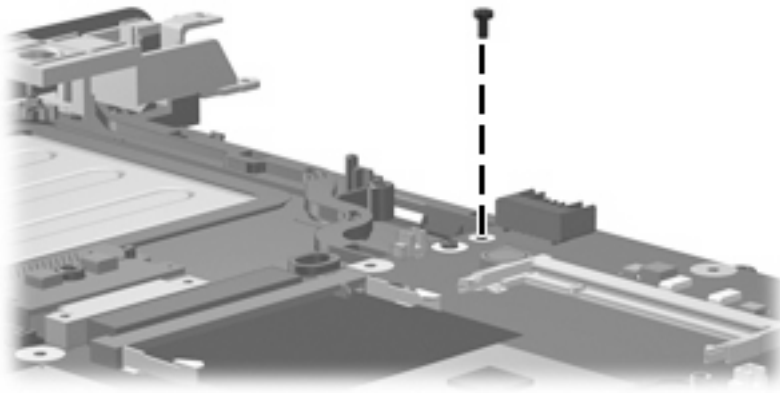

Where used: One screw that secures the system board to the base enclosure

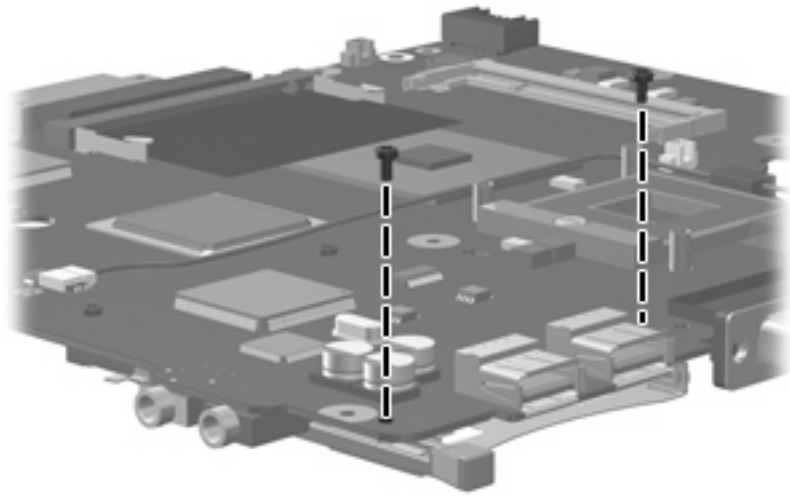

Where used: 2 screws that secure the PC Card assembly to the system board

Phillips PM2.0×2.0 screw

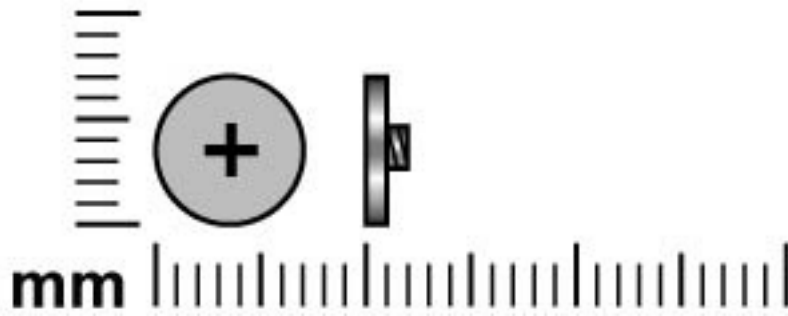

Color	Quantity	Length	Thread	Head width
Black	4	2.0 mm	2.0 mm	7.0 mm

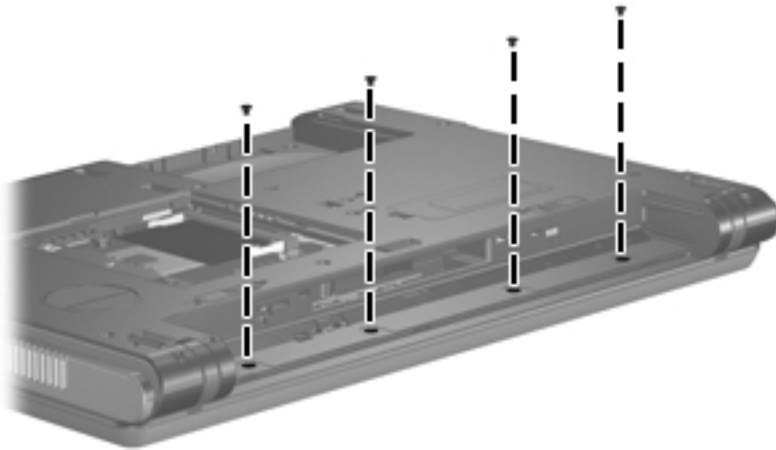

Where used: 4 screws that secure the switch cover to the computer

Phillips PM2.0×7.0 screw

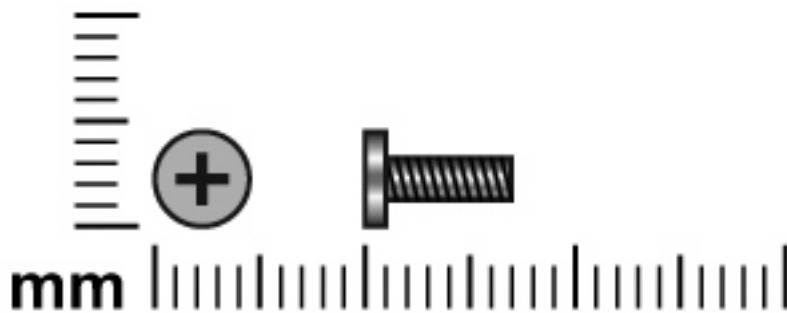

Color	Quantity	Length	Thread	Head width
Black	2	7.0 mm	2.0 mm	5.0 mm

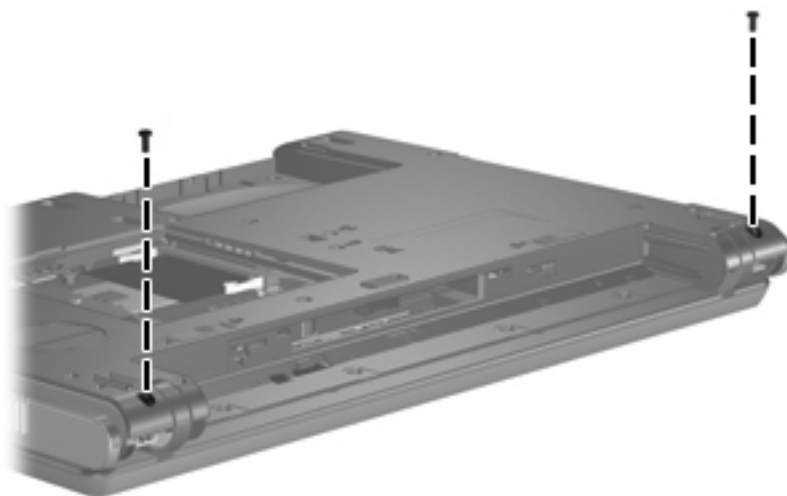

Where used: 2 screws that secure the display assembly to the computer

Phillips PM2.5×6.0 screw

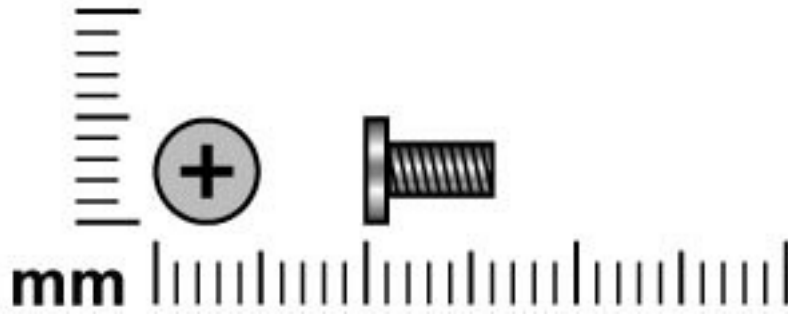

Color	Quantity	Length	Thread	Head width
Silver	16	6.0 mm	2.5 mm	5.0 mm

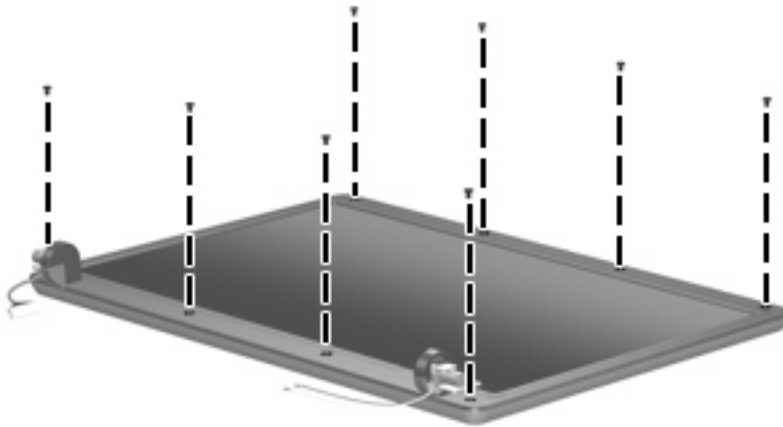

Where used: 8 screws that secure the display bezel to the display assembly

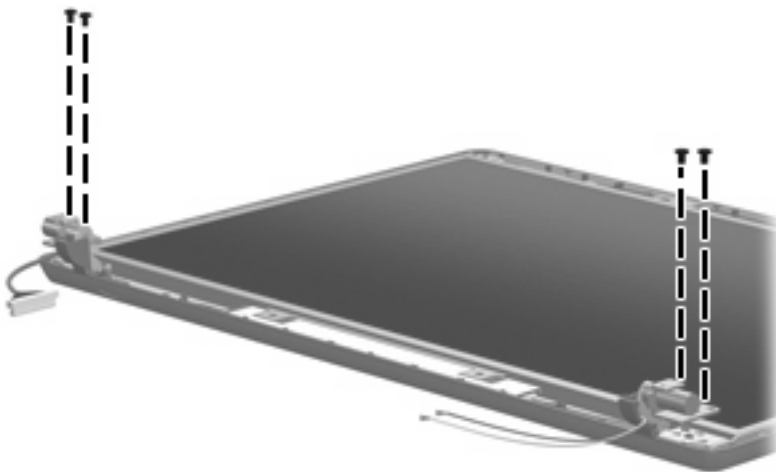

Where used: 4 screws that secure the display panel to the display enclosure

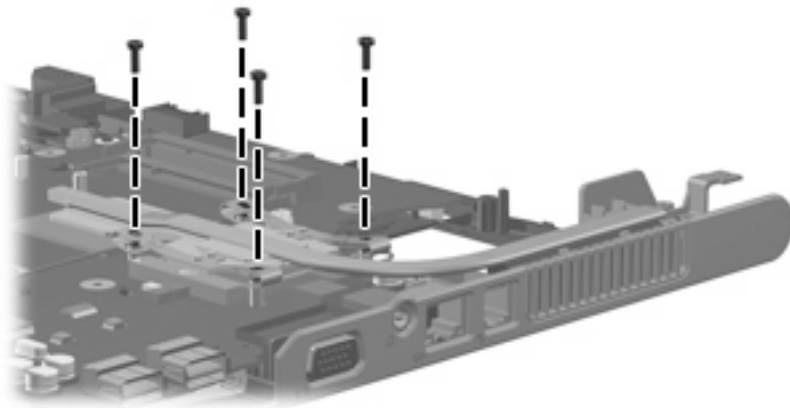

Where used: 4 screws that secure the heat sink to the base enclosure

Phillips PM2.5×4.0 screw

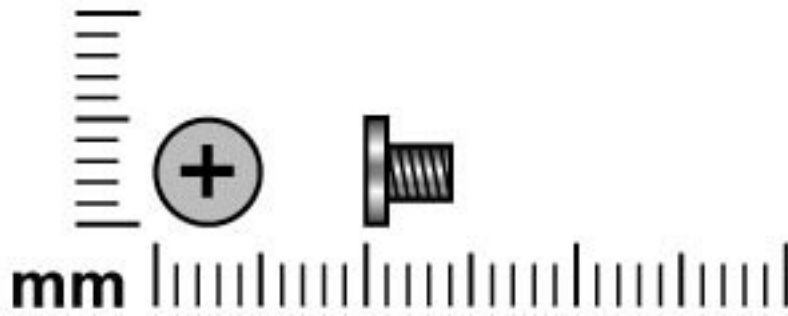

Color	Quantity	Length	Thread	Head width
Silver	2	4.0 mm	2.5 mm	5.0 mm

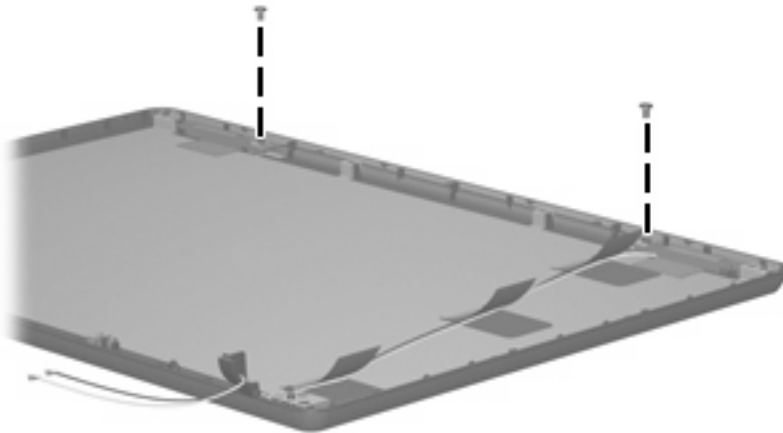

Where used: 2 screws that secure the wireless antenna transceivers to the display enclosure

8 Backup and recovery in Windows Vista

Creating recovery discs

After setting up the computer for the first time, be sure to create a set of recovery discs of the full factory image. The recovery discs are used to start up (boot) the computer and recover the operating system and software to factory settings in case of system instability or failure.

Note the following guidelines before creating recovery discs:

- You will need high-quality CD-R, DVD-R, or DVD+R discs (purchased separately).
-
-  **NOTE:** Read-write discs, such as CD-RW and DVD±RW discs, are not compatible with HP Backup & Recovery Manager.
-
- The computer must be connected to AC power during the process.
 - Only one set of the recovery discs can be created per computer.
 - Number each disc before inserting it into the optical drive of the computer.
 - If necessary, you can cancel the disc creation before you have finished creating the recovery discs. The next time you select **Create a set of recovery discs (Recommended)**, you will be prompted to continue the disc creation.

To create a set of recovery discs:

1. Select **Start > All Programs > HP Backup & Recovery > Backup & Recovery Manager**.
2. Click **Next**.
3. Click **Create a set of recovery discs (Recommended)**, and then click **Next**.
4. Follow the on-screen instructions.

Backing up your information

 **NOTE:** You can only recover files that you have previously backed up. HP recommends that you use HP Backup & Recovery Manager to create an entire drive backup as soon as you set up your computer.

With HP Backup & Recovery Manager, you can perform the following tasks:

- Backing up your information regularly to protect your important system files
- Creating system recovery points that allow you to reverse undesirable changes to your computer by restoring the computer to an earlier state
- Scheduling backups at specific intervals or events

When to back up

- On a regularly scheduled basis

 **NOTE:** Set reminders to back up your information periodically.

- Before the computer is repaired or restored
- Before you add or modify hardware or software

Backup suggestions

- Create a set of recovery discs using HP Backup & Recovery Manager.
- Create system recovery points using HP Backup & Recovery Manager, and periodically copy them to disc.
- Store personal files in the Documents folder and back up these folders periodically.
- Back up templates stored in their associated programs.
- Save customized settings in a window, toolbar, or menu bar by taking a screen shot of your settings.

The screen shot can be a time saver if you have to reset your preferences.

To copy the screen and paste it into a word-processing document:

- a. Display the screen.
- b. Copy the screen.
To copy only the active window, press **alt+fn+prt sc**.
To copy the entire screen, press **fn+prt sc**.
- c. Open a word-processing document, and then select **Edit > Paste**.

 **NOTE:** Before you can perform Backup & Recovery procedures, the computer must be connected to external power.

NOTE: Drivers, utilities, and applications installed by HP can be copied to a CD or to a DVD using HP Backup & Recovery Manager.

Backing up specific files or folders

You can back up specific files or folders to the recovery partition on the hard drive, to an optional external hard drive, or to optical discs (CDs or DVDs).

 **NOTE:** This process will take several minutes, depending on the file size and the speed of the computer.

To back up specific files or folders:

1. Select **Start > All Programs > HP Backup & Recovery > Backup & Recovery Manager**.
2. Click **Next**.
3. Click **Create or manage backups**, and then click **Next**.
4. Click **Back up user created files and folders**, and then click **Next**.
5. Follow the on-screen instructions.

Backing up the entire hard drive

When you perform a complete backup of the hard drive, you are saving the full factory image, including the Windows® operating system, software applications, and all personal files and folders.

 **NOTE:** A copy of the entire hard drive image can be stored on another hard drive, on a network drive, or on recovery discs that you create.

NOTE: This process may take over an hour, depending on your computer speed and the amount of data being stored.

To back up your entire hard drive:

1. Select **Start > All Programs > HP Backup & Recovery > Backup & Recovery Manager**.
2. Click **Next**.
3. Click **Create or manage backups**, and then click **Next**.
4. Click **Create or manage Entire Drive Backups**, and then click **Next**.
5. Follow the on-screen instructions.

Creating recovery points

When you back up modifications since your last backup, you are creating system recovery points. This allows you to save a snapshot of your hard drive at a specific point in time. You can then recover back to that point if you want to reverse subsequent changes made to your system.

 **NOTE:** The first system recovery point, a snapshot of the entire image, is automatically created the first time you perform a backup. Subsequent recovery points make copies of changes made after that time.

HP recommends that you create recovery points at the following times:

- Before you add or extensively modify software or hardware
- Periodically, whenever the system is performing optimally

 **NOTE:** Recovering to an earlier recovery point does not affect data files or e-mails created since that recovery point.

To create a system recovery point:

1. Select **Start > All Programs > HP Backup & Recovery > Backup & Recovery Manager**.
2. Click **Next**.
3. Click **Create or manage backups**, and then click **Next**.
4. Click **Create or manage Recovery Points**, and then click **Next**.
5. Follow the on-screen instructions.

Scheduling backups

Use HP Backup Scheduler to schedule backups for the entire system, for recovery points, or for specific files and folders. With this tool, you can schedule backups at specific intervals (daily, weekly, or monthly) or at specific events, such as at system restart or when you dock to an optional docking station (select models only).

To schedule backups:

1. Select **Start > All Programs > HP Backup & Recovery > HP Backup Scheduler**.
2. Follow the on-screen instructions.

Performing a recovery

 **NOTE:** You can only recover files that you have previously backed up. HP recommends that you use HP Backup & Recovery Manager to create an entire drive backup as soon as you set up your computer.

HP Backup & Recovery Manager helps you with the following tasks for safeguarding your information and restoring it in case of a system failure:

- Recovering important files—This feature helps you reinstall important files without performing a full system recovery.
- Performing a full system recovery—With HP Backup & Recovery Manager, you can recover your full factory image if you experience system failure or instability. HP Backup & Recovery Manager works from a dedicated recovery partition on the hard drive or from recovery discs you create.

Performing a recovery from the recovery discs

To perform a recovery from the recovery discs, follow these steps:

1. Back up all personal files.
2. Insert the first recovery disc into the optical drive and restart the computer.
3. Follow the on-screen instructions.

Performing a recovery from the hard drive

There are 2 ways to initiate a recovery from the hard drive:

- From within Windows
- From the recovery partition

Initiating a recovery in Windows

To initiate a recovery in Windows, follow these steps:

1. Back up all personal files.
2. Select **Start > All Programs > HP Backup & Recovery > Backup & Recovery Manager**.
3. Click **Next**.
4. Click **Perform a recovery**, and then click **Next**.
5. Follow the on-screen instructions.

Initiating a recovery from the hard drive recovery partition

To initiate a recovery from the hard drive recovery partition, follow these steps:

1. Back up all personal files.
2. Restart the computer, and then press **f11** before the Windows operating system loads.
3. Click a recovery option, and then click **Next**.
4. Follow the on-screen instructions.

9 Backup and recovery in Windows XP

Creating recovery discs

After setting up the computer for the first time, be sure to create a set of recovery discs of the full factory image. The recovery discs are used to start up (boot) the computer and recover the operating system and software to factory settings in case of system instability or failure.

Note the following guidelines before creating recovery discs:

- You will need high-quality CD-R, DVD-R, or DVD+R media (purchased separately).
-
-  **NOTE:** Read-write discs, such as CD-RW and DVD±RW discs, are not compatible with HP Backup and Recovery Manager.
-
- The computer must be connected to AC power during the process.
 - Only one set of the recovery discs can be created per computer.
 - Number each disc before inserting it into the optical drive of the computer.
 - If necessary, you can cancel the disc creation before you have finished creating the recovery discs. The next time you select **Create factory software recovery CDs or DVDs to recover the system (Highly recommended)**, you will be prompted to continue the disc creation.

To create a set of recovery discs:

1. Select **Start > All Programs > HP Backup & Recovery > HP Backup and Recovery Manager**.
2. Click **Next**.
3. Click **Create factory software recovery CDs or DVDs to recover the system (Highly recommended)**, and then click **Next**.
4. Follow the on-screen instructions.

Backing up your information

 **NOTE:** You can only recover files that you have previously backed up. HP recommends that you use HP Backup and Recovery Manager to create an entire drive backup as soon as you set up your computer.

With HP Backup and Recovery Manager, you can perform the following tasks:

- Backing up your information regularly to protect your important system files
- Creating system recovery points that allow you to reverse undesirable changes to your computer by restoring the computer to an earlier state
- Scheduling backups at specific intervals or events

When to back up

- On a regularly scheduled basis

 **NOTE:** Set reminders to back up your information periodically.

- Before the computer is repaired or restored
- Before you add or modify hardware or software

Backup suggestions

- Create a set of recovery discs using HP Backup and Recovery Manager.
- Create system recovery points using HP Backup and Recovery Manager, and periodically copy them to disc.
- Store personal files in the My Documents folder and back up these folders periodically.
- Back up templates stored in their associated programs.
- Save customized settings in a window, toolbar, or menu bar by taking a screen shot of your settings.

The screen shot can be a time saver if you have to reset your preferences.

To copy the screen and paste it into a word-processing document:

- a. Display the screen.
- b. Copy the screen.
To copy only the active window, press **alt+fn+prt sc**.
To copy the entire screen, press **fn+prt sc**.
- c. Open a word-processing document, and then select **Edit > Paste**.

 **NOTE:** Before you can perform Backup and Recovery procedures, the computer must be connected to external power.

NOTE: Drivers, utilities, and applications installed by HP can be copied to a CD or to a DVD using HP Backup and Recovery Manager.

Backing up specific files or folders

You can back up specific files or folders to the recovery partition on the hard drive, to an optional external hard drive, or to optical discs (CDs or DVDs).

 **NOTE:** This process will take several minutes, depending on the file size and the speed of the computer.

To back up specific files or folders:

1. Select **Start > All Programs > HP Backup & Recovery > HP Backup and Recovery Manager**.
2. Click **Next**.
3. Click **Back up to protect system settings and important data files**, and then click **Next**.
4. Click **Back up individual files and folders**, and then click **Next**.
5. Follow the on-screen instructions.

Backing up the entire hard drive

When you perform a complete backup of the hard drive, you are saving the full factory image, including the Windows® operating system, software applications, and all personal files and folders.

 **NOTE:** A copy of the entire hard drive image can be stored on another hard drive, on a network drive, or on recovery discs that you create.

NOTE: This process may take over an hour, depending on your computer speed and the amount of data being stored.

To back up your entire hard drive:

1. Select **Start > All Programs > HP Backup & Recovery > HP Backup and Recovery Manager**.
2. Click **Next**.
3. Click **Back up to protect system settings and important data files**, and then click **Next**.
4. Click **Back up entire hard drive**, and then click **Next**.
5. Follow the on-screen instructions.

Creating recovery points

When you back up modifications since your last backup, you are creating system recovery points. This allows you to save a snapshot of your hard drive at a specific point in time. You can then recover back to that point if you want to reverse subsequent changes made to your system.

 **NOTE:** The first system recovery point, a snapshot of the entire image, is automatically created the first time you perform a backup. Subsequent recovery points make copies of changes made after that time.

HP recommends that you create recovery points at the following times:

- Before you add or extensively modify software or hardware
- Periodically, whenever the system is performing optimally

 **NOTE:** Recovering to an earlier recovery point does not affect data files or e-mails created since that recovery point.

To create a system recovery point:

1. Select **Start > All Programs > HP Backup & Recovery > HP Backup and Recovery Manager**.
2. Click **Next**.
3. Click **Back up to protect system settings and important data files**, and then click **Next**.
4. Click **Create or manage Recovery Points**, and then click **Next**.
5. Follow the on-screen instructions.

Scheduling backups

Use HP Backup Scheduler to schedule backups for the entire system, for recovery points, or for specific files and folders. With this tool, you can schedule backups at specific intervals (daily, weekly, or monthly) or at specific events, such as at system restart or when you dock to an optional docking station (select models only).

To schedule backups:

1. Select **Start > All Programs > HP Backup & Recovery > HP Backup Scheduler**.
2. Follow the on-screen instructions.

Performing a recovery

 **NOTE:** You can only recover files that you have previously backed up. HP recommends that you use HP Backup and Recovery Manager to create an entire drive backup as soon as you set up your computer.

HP Backup and Recovery Manager helps you with the following tasks for safeguarding your information and restoring it in case of a system failure:

- Recovering important files—This feature helps you reinstall important files without performing a full system recovery.
- Performing a full system recovery—With HP Backup and Recovery Manager, you can recover your full factory image if you experience system failure or instability. HP Backup and Recovery Manager works from a dedicated recovery partition on the hard drive or from recovery discs you create.

Performing a recovery from the recovery discs

To perform a recovery from the recovery discs, follow these steps:

1. Back up all personal files.
2. Insert the first recovery disc into the optical drive and restart the computer.
3. Follow the on-screen instructions.

Performing a recovery from the hard drive

There are 2 ways to initiate a recovery from the hard drive:

- From within Windows
- From the recovery partition

Initiating a recovery in Windows

To initiate a recovery in Windows, follow these steps:

1. Back up all personal files.
2. Select **Start > All Programs > HP Backup & Recovery > HP Backup and Recovery Manager**.
3. Click **Next**.
4. Click **Recover important files or the entire system**, and then click **Next**.
5. Follow the on-screen instructions.

Initiating a recovery from the hard drive recovery partition

To initiate a recovery from the hard drive recovery partition, follow these steps:

1. Back up all personal files.
2. Restart the computer, and then press **f11** before the Windows operating system loads.
3. Click a recovery option, and then click **Next**.
4. Follow the on-screen instructions.

10 Connector pin assignments

Audio-out (headphone)

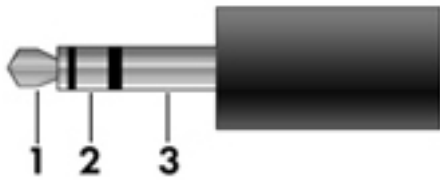

Pin	Signal
1	Audio out, left channel
2	Audio out, right channel
3	Ground

Audio-in (microphone)

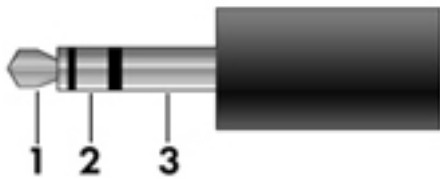

Pin	Signal
1	Audio signal in
2	Audio signal in
3	Ground

External monitor

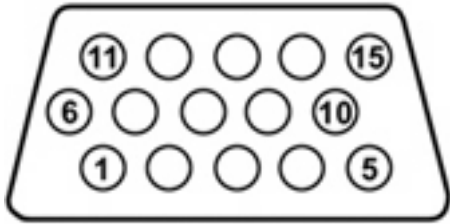

Pin	Signal
1	Red analog
2	Green analog
3	Blue analog
4	Not connected
5	Ground
6	Ground analog
7	Ground analog
8	Ground analog
9	+5 VDC
10	Ground
11	Monitor detect
12	DDC 2B data
13	Horizontal sync
14	Vertical sync
15	DDC 2B clock

RJ-11 (modem)

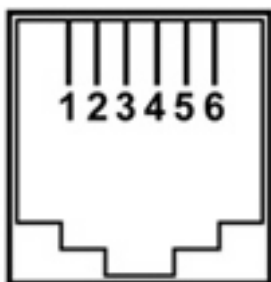

Pin	Signal
1	Unused
2	Tip
3	Ring
4	Unused
5	Unused
6	Unused

RJ-45 (network)

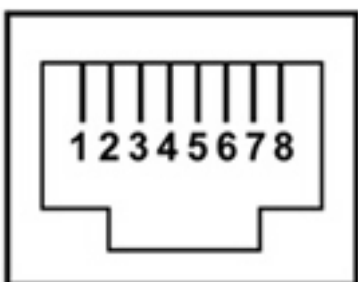

Pin	Signal
1	Transmit +
2	Transmit -
3	Receive +
4	Unused
5	Unused
6	Receive -
7	Unused
8	Unused

Universal Serial Bus

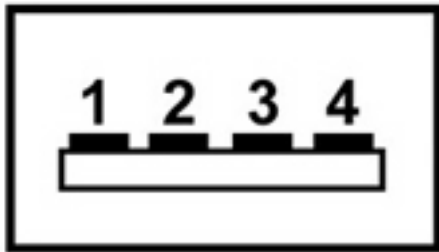

Pin	Signal
1	+5 VDC
2	Data -
3	Data +
4	Ground

11 Power cord set requirements

The wide range input feature of the computer permits it to operate from any line voltage from 100 to 120 volts AC or from 220 to 240 volts AC.

The 3-conductor power cord set included with the computer meets the requirements for use in the country or region where the equipment is purchased.

Power cord sets for use in other countries or regions must meet the requirements of the country or region where the computer is used.

Requirements for all countries or regions

The requirements listed below are applicable to all countries or regions:

- The length of the power cord set must be at least 1.5 m (5.0 ft) and no more than 2.0 m (6.5 ft).
- All power cord sets must be approved by an acceptable accredited agency responsible for evaluation in the country or region where the power cord set will be used.
- The power cord sets must have a minimum current capacity of 10 amps and a nominal voltage rating of 125 or 250 V AC, as required by each country or region's power system.
- The appliance coupler must meet the mechanical configuration of an EN 60 320/IEC 320 Standard Sheet C13 connector for mating with the appliance inlet on the back of the computer.

Requirements for specific countries or regions

Country/region	Accredited agency	Applicable note number
Australia	EANSW	1
Austria	OVE	1
Belgium	CEBC	1
Canada	CSA	2
Denmark	DEMKO	1
Finland	FIMKO	1
France	UTE	1
Germany	VDE	1
Italy	IMQ	1
Japan	METI	3
Korea	EK	4
The Netherlands	KEMA	1
Norway	NEMKO	1
The People's Republic of China	CCC	5
Sweden	SEMKO	1
Switzerland	SEV	1
Taiwan	BSMI	4
The United Kingdom	BSI	1
The United States	UL	2

1. The flexible cord must be Type HO5VV-F, 3-conductor, 1.0-mm² conductor size. Power cord set fittings (appliance coupler and wall plug) must bear the certification mark of the agency responsible for evaluation in the country or region where it will be used.
2. The flexible cord must be Type SPT-3 or equivalent, No. 18 AWG, 3-conductor. The wall plug must be a two-pole grounding type with a NEMA 5-15P (15 A, 125 V) or NEMA 6-15P (15 A, 250 V) configuration.
3. The appliance coupler, flexible cord, and wall plug must bear a "T" mark and registration number in accordance with the Japanese Dentori Law. The flexible cord must be Type VCT or VCTF, 3-conductor, 1.00-mm² conductor size. The wall plug must be a two-pole grounding type with a Japanese Industrial Standard C8303 (7 A, 125 V) configuration.
4. The flexible cord must be Type RVV, 3-conductor, 0.75-mm² conductor size. Power cord set fittings (appliance coupler and wall plug) must bear the certification mark of the agency responsible for evaluation in the country or region where it will be used.
5. The flexible cord must be Type VCTF, 3-conductor, 0.75-mm² conductor size. Power cord set fittings (appliance coupler and wall plug) must bear the certification mark of the agency responsible for evaluation in the country or region where it will be used.

12 Recycling

Battery

When a battery has reached the end of its useful life, do not dispose of the battery in general household waste. Follow the local laws and regulations in your area for computer battery disposal.

Display

-
- ⚠ **WARNING!** The backlight contains mercury. Exercise caution when removing and handling the backlight to avoid damaging this component and causing exposure to the mercury.
 - ⚠ **CAUTION:** The procedures in this appendix can result in damage to display components. The only components intended for recycling purposes are the liquid crystal display (LCD) panel and the backlight. Careful handling must be exercised when removing these components. When you remove these components, handle them carefully.
 - 📄 **NOTE: Materials Disposal.** This HP product contains mercury in the backlight in the display assembly that might require special handling at end-of-life. Disposal of mercury may be regulated because of environmental considerations. For disposal or recycling information, contact your local authorities, or see the Electronic Industries Alliance (EIA) Web site at <http://www.eiae.org>.
-

This section provides disassembly instructions for the display assembly. The display assembly must be disassembled to gain access to the backlight **(1)** and the liquid crystal display (LCD) panel **(2)**.



-
- 📄 **NOTE:** The procedures provided in this appendix are general disassembly instructions. Specific details, such as screw sizes, quantities, and locations, and component shapes and sizes, can vary from one computer model to another.
-

Perform the following steps to disassemble the display assembly:

1. Remove all screw covers **(1)** and screws **(2)** that secure the display bezel to the display assembly.

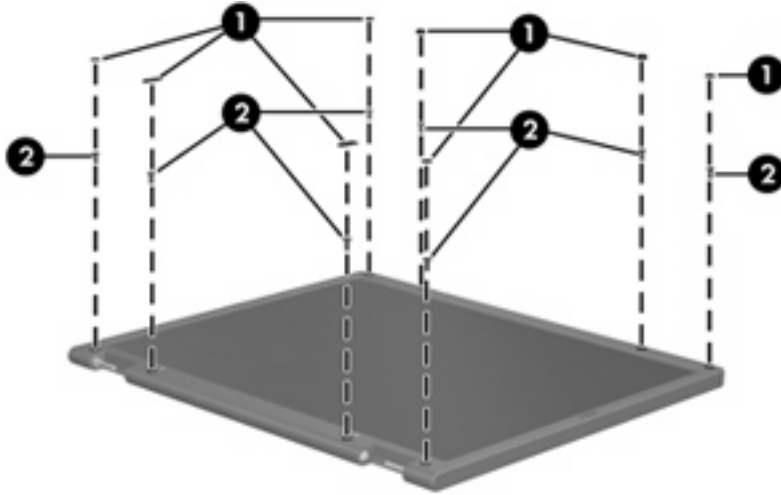

2. Lift up and out on the left and right inside edges **(1)** and the top and bottom inside edges **(2)** of the display bezel until the bezel disengages from the display assembly.
3. Remove the display bezel **(3)**.

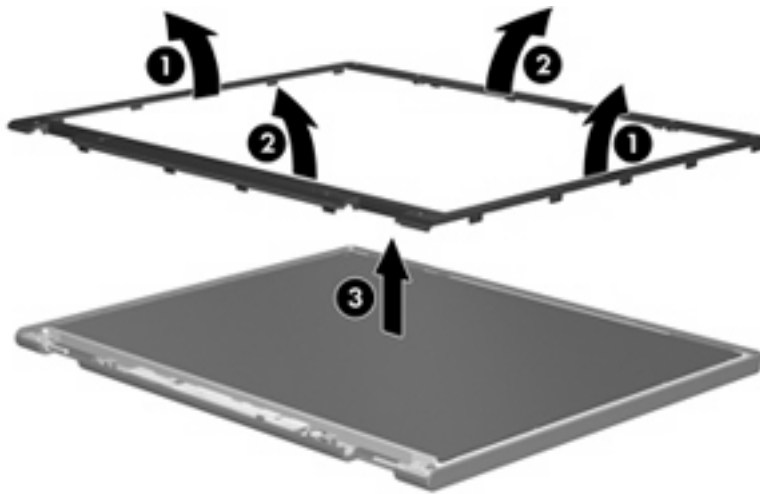

4. Disconnect all display panel cables **(1)** from the display inverter and remove the inverter **(2)**.

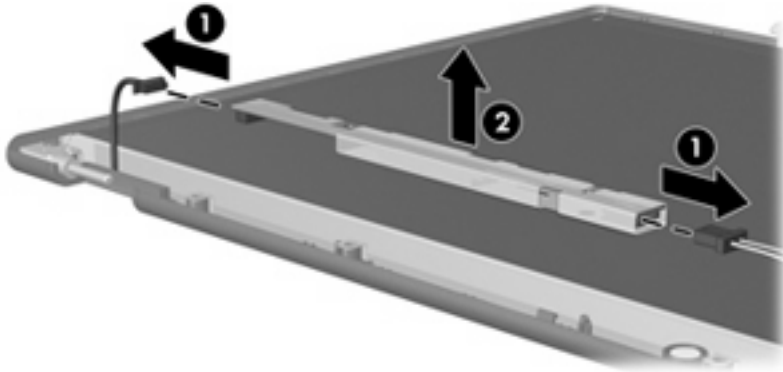

5. Remove all screws **(1)** that secure the display panel assembly to the display enclosure.
6. Remove the display panel assembly **(2)** from the display enclosure.

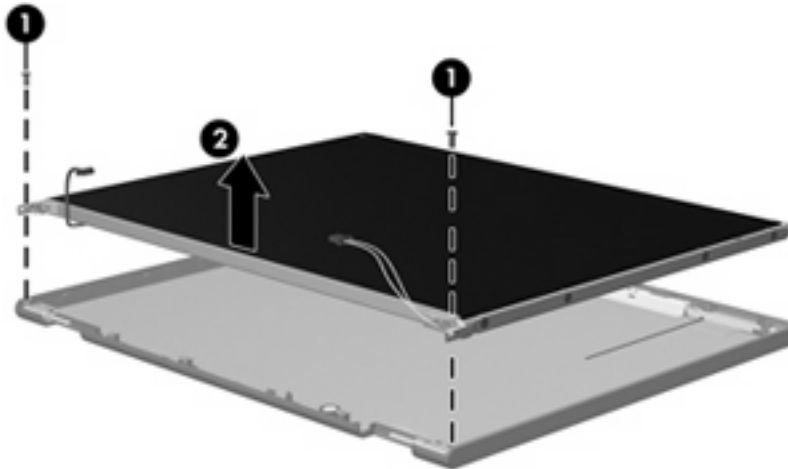

7. Turn the display panel assembly upside down.
8. Remove all screws that secure the display panel frame to the display panel.

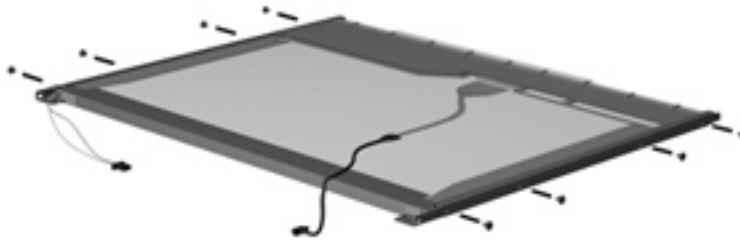

9. Use a sharp-edged tool to cut the tape **(1)** that secures the sides of the display panel to the display panel frame.

10. Remove the display panel frame (2) from the display panel.

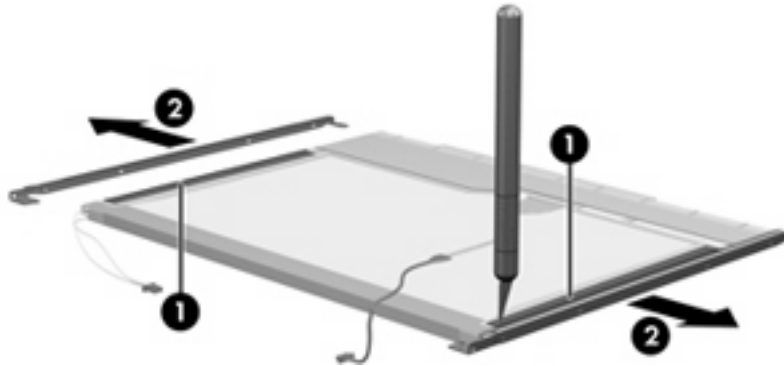

11. Remove the screws (1) that secure the backlight cover to the display panel.
12. Lift the top edge of the backlight cover (2) and swing it outward.

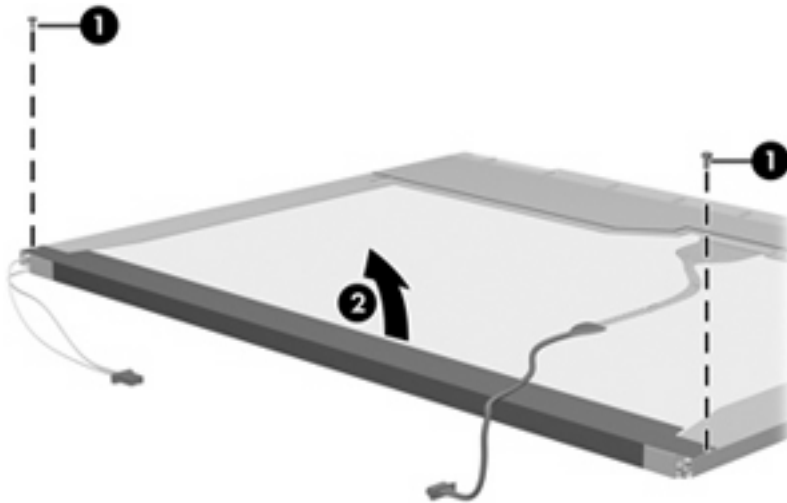

13. Remove the backlight cover.
14. Turn the display panel right-side up.

15. Remove the backlight cables **(1)** from the clip **(2)** in the display panel.

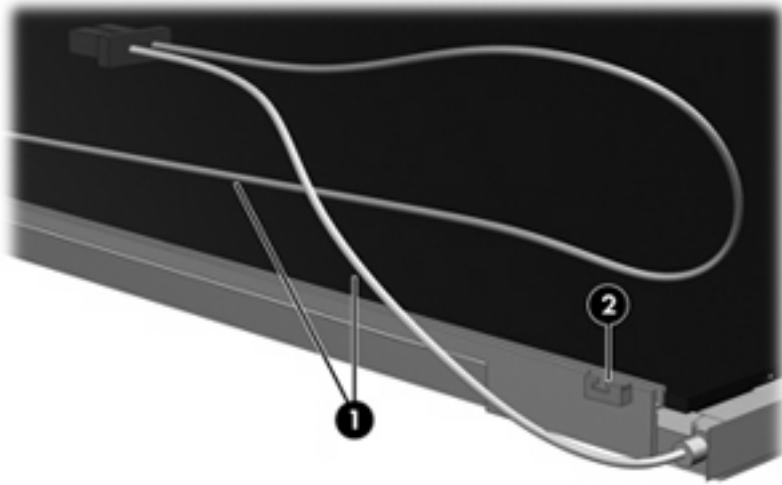

16. Turn the display panel upside down.
17. Remove the backlight frame from the display panel.

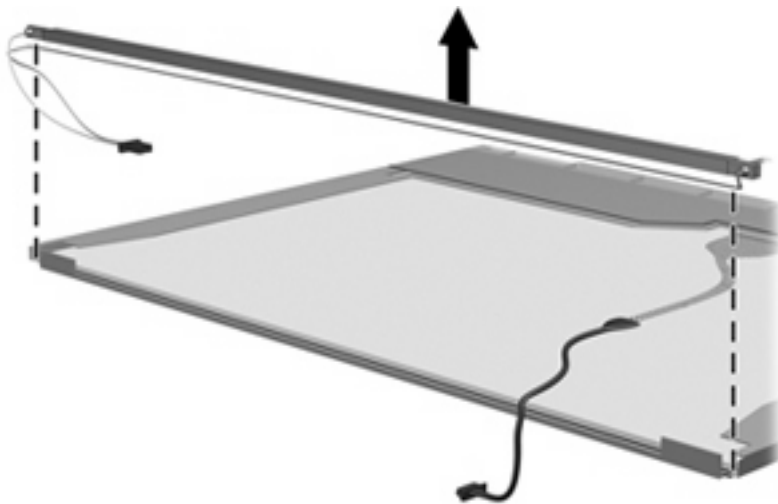

⚠ WARNING! The backlight contains mercury. Exercise caution when removing and handling the backlight to avoid damaging this component and causing exposure to the mercury.

18. Remove the backlight from the backlight frame.

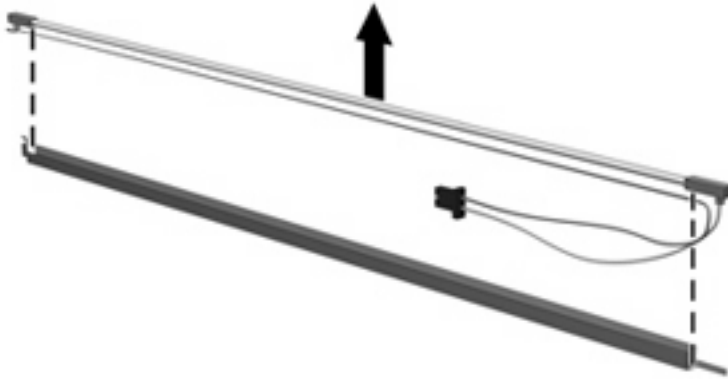

19. Disconnect the display cable (1) from the LCD panel.
20. Remove the screws (2) that secure the LCD panel to the display rear panel.
21. Release the LCD panel (3) from the display rear panel.
22. Release the tape (4) that secures the LCD panel to the display rear panel.

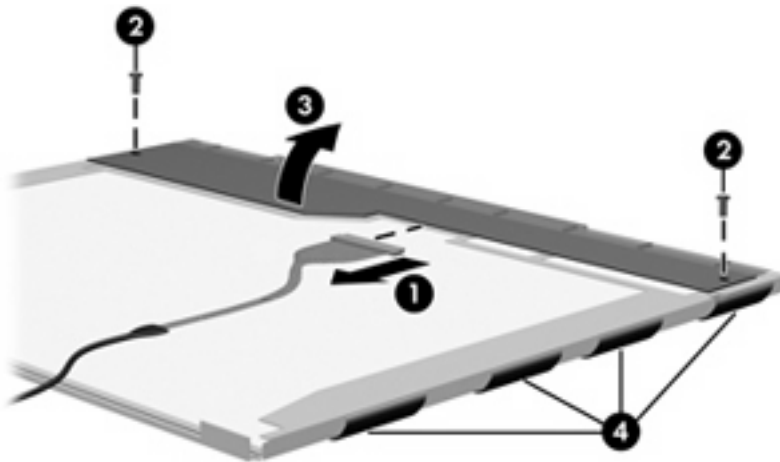

23. Remove the LCD panel.

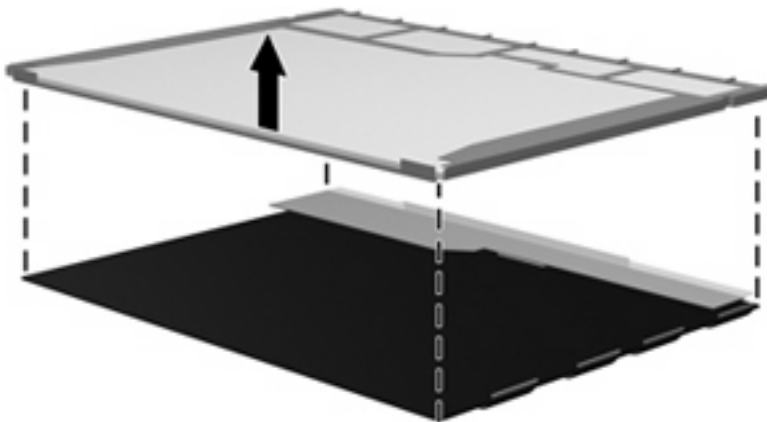

24. Recycle the LCD panel and backlight.

Index

A

- AC adapter, spare part number 19, 20
- antennae
 - disconnecting 38
 - illustrated 16
 - location 5
 - spare part number 16
- applications key, Windows 7
- audio, product description 2
- audio-in jack
 - location 5
 - pin assignments 113
- audio-out jack
 - location 5
 - pin assignments 113

B

- backing up 102, 108
- backup
 - files and folders 103, 109
 - hard drive 103, 109
 - modifications made to the system 104, 110
 - scheduling 104, 110
- base enclosure
 - removal 52
 - spare part number 14, 21, 52
- battery
 - removal 32
 - spare part number 15, 21, 32
 - specifications 78
- battery bay 10
- battery light 5
- battery release latch 10
- bezel
 - removal 49
- boot options 73

- boot order 73
- bottom components 10
- button board
 - removal 46
 - spare part number 13, 21, 46

C

- cables, service considerations 26
- caps lock light 6
- chipset, product description 1
- CMOS clearing 30
- components
 - bottom 10
 - front 5
 - keyboard 7
 - left-side 9
 - pointing device 8
 - right-side 8
 - top 6
- computer feet
 - locations 35
 - spare part number 14, 21, 35
- Computer Setup
 - accessing 69
 - Diagnostics menu 72
 - File menu 71
 - navigating and selecting 70
 - restoring factory settings 70
 - Security menu 72
 - System Configuration menu 73
 - using 70
- computer specifications 75
- connector pin assignments
 - audio-in 113
 - audio-out 113
 - external monitor 114
 - headphone 113
 - microphone 113

- modem 115
- monitor 114
- network 115
- RJ-11 115
- RJ-45 115
- Universal Serial Bus (USB) 116

- connectors, service considerations 26
- creating recovery points 104, 110

D

- Diagnostics menu 72
- Disk Sanitizer 72
- diskette drive
 - precautions 26
 - product description 2
- display assembly
 - removal 47
 - spare part numbers 12, 21, 47
- display bezel
 - illustrated 16
 - removal 49
 - spare part number 16, 21, 49
- Display Bracket/Hinge Kit, spare part number 16, 21, 51
- Display Cable Kit, spare part number 16, 21
- display component recycling 119
- display enclosure
 - illustrated 16
 - spare part numbers 16, 21
- display hinge
 - illustrated 16
 - spare part number 16, 21, 51
- display inverter
 - illustrated 16

- removal 50
- spare part number 16, 21, 50
- Display Label Kit, spare part number 16, 22
- display panel
 - illustrated 16
 - removal 50
 - spare part number 16, 21, 50
- Display Screw Kit, spare part number 16, 21
- display specifications 76
- display switch 6
- docking support, product description 3
- DriveLock password 72
- drives, boot order 73
- drives, preventing damage 26
- DVD/CD-RW Combo Drive
 - precautions 26
 - removal 39
 - spare part number 15, 18, 21, 39
 - specifications 80
- DVD±RW and CD-RW Combo Drive
 - precautions 26
 - removal 39
 - spare part number 15, 18, 21, 39
 - specifications 79

E

- electrostatic discharge 26
- Ethernet, product description 2
- Execution Disable 73
- external media cards, product description 3
- external monitor port
 - location 9
 - pin assignments 114

F

- fan assembly
 - removal 55
 - spare part number 14, 21, 55

- feet
 - locations 35
 - spare part number 14, 21, 35
- File menu 71
- front components 5
- function keys 7

G

- graphics, product description 1
- grounding equipment and methods 29

H

- hard drive
 - precautions 26
 - product description 2
 - removal 33
 - spare part numbers 15, 18, 21, 33
 - specifications 77
- hard drive backup 103, 109
- hard drive bay 10
- hard drive bracket, removal 34
- hard drive cover
 - illustrated 17
 - removal 33
- hard drive recovery 105, 111
- hard drive test 72
- headphone jack
 - location 5
 - pin assignments 113

- heat sink
 - removal 57
 - spare part number 14, 22, 57

- hinge
 - illustrated 16
 - removal 51
 - spare part number 16, 21, 51

I

- I/O address specifications 83
- interrupt specifications 82
- inverter
 - illustrated 16
 - removal 50
 - spare part number 16, 21, 50

K

- keyboard
 - product description 3
 - removal 43
 - spare part numbers 13, 21, 43
- keyboard components 7
- keypad keys 7
- keys
 - esc 7
 - fn 7
 - function 7
 - Windows applications 7
 - Windows logo 7

L

- LAN Power Save 73
- language, changing in Computer Setup 73
- left-side components 9
- legacy support, USB 69, 73

M

- mass storage devices, spare part numbers 18
- memory check 72
- memory map specifications 85
- memory module
 - product description 1
 - removal 35
 - spare part numbers 15, 20, 22, 35
- memory/WLAN module
 - compartment 10
- memory/WLAN module
 - compartment cover
 - illustrated 17
 - removal 36
- microphone jack
 - location 5
 - pin assignments 113
- model name 1
- modem jack
 - location 9
 - pin assignments 115
- modem module, product description 2
- monitor port
 - location 9
 - pin assignments 114

N

navigating in Computer Setup 70
network jack
 location 9
 pin assignments 115

O

operating system, product
 description 3
optical drive
 location 8
 precautions 26
 product description 2
 removal 39
 spare part numbers 15, 18,
 39
 specifications 79, 80
optical drive bracket, removal 40
optical drive connector board
 removal 64
 spare part number 15, 21,
 64

P

packing guidelines 28
panels, product description 1
parallel port mode 73
password clearing 30
passwords 72
PC Card assembly
 removal 65
 spare part number 13, 21,
 65
PC Card eject button 9
PC Card slot 9
PC Card slot bezel
 illustrated 17
 spare part number 13, 21,
 65
plastic parts 25
Plastics/Hardware Kit
 contents 17
 spare part number 14, 17,
 22
pointing device
 components 8
 product description 3
ports, product description 3
power button 6
power connector 9

power cord
 set requirements 117
 spare part numbers 19, 20
power light 7
power requirements, product
 description 3
power-on password 72
processor
 product description 1
 removal 59
 spare part numbers 14, 22,
 59
product description
 audio 2
 chipset 1
 diskette drive 2
 docking support 3
 Ethernet 2
 external media cards 3
 graphics 1
 hard drives 2
 keyboard 3
 memory module 1
 modem module 2
 operating system 3
 optical drives 2
 panels 1
 pointing device 3
 ports 3
 power requirements 3
 processors 1
 product name 1
 security 3
 serviceability 4
 wireless 3
product name 1

R

recovery discs
 creating 101, 107
 using 105, 111
recovery partition 106, 112
recovery points 104, 110
removal/replacement
 preliminaries 25
 procedures 31
restoring Computer Setup factory
 settings 70
right-side components 8

RJ-11 jack
 location 9
 pin assignments 115
RJ-45 jack
 location 9
 pin assignments 115
RTC battery
 removal 54
 spare part number 14, 21,
 54
Rubber Feet Kit, spare part
 number 14, 21, 35, 52

S

scheduling backups 104, 110
Screw Kit
 contents 87
 spare part number 19, 21
screw listing 87
security cable slot 8
Security menu 72
security, product description 3
selecting in the Computer
 Setup 70
serial number 11, 31
service considerations 25
serviceability, product
 description 4
smart card security 72
speaker
 location 7
 removal 60
 spare part number 15, 21,
 60
specifications
 battery 78
 computer 75
 display 76
 DVD/CD-RW Combo Drive 80
 DVD±RW and CD-RW Combo
 Drive 79
 hard drive 77
 I/O addresses 83
 interrupts 82
 memory map 85
 optical drive 79, 80
 system DMA 81
startup check 72
static-shielding materials 29
stringent security 72

- switch cover
 - removal 41
 - spare part numbers 13, 21, 41
- system backup 103, 109
- system board
 - removal 62
 - spare part numbers 15, 22, 62
- System Configuration menu 73
- system DMA 81
- system fan 73
- system information 71
- system memory map 85
- system recovery points 104, 110
- removal 51
- spare part number 16, 21, 51
- wireless button 6
- wireless light 6
- wireless, product description 3
- WLAN module
 - removal 37
 - spare part numbers 14, 20, 37
- workstation guidelines 28

T

- thermal material, replacement 58
- tools required 25
- top components 6
- top cover, spare part number 13, 21
- TouchPad 8
- TouchPad cable
 - removal 67
 - spare part number 13, 21, 67
- TouchPad left button 8
- TouchPad right button 8
- TouchPad scroll zone 8
- transporting guidelines 28

U

- Universal Serial Bus (USB) port
 - location 9
 - pin assignments 116
- unknown password 30
- USB legacy support 69, 73

V

- vents 9, 10

W

- Windows applications key 7
- Windows logo key 7
- wireless antennae
 - disconnecting 38
 - illustrated 16
 - location 5

