

HP Photosmart A520 Series - Help



Contents

1 HP Photosmart A520 series Help	5
2 Get started	
How do I?	7
Find more information	8
The HP Photosmart at a glance	9
Control panel buttons and indicator lights	9
Printer menus	10
How to use the Printer menu	11
Printer menu options	12
3 Paper basics	
Choose the best paper for the job	15
Load your paper	15
4 Print without a computer	
Print from a memory card without a computer	17
Supported memory cards	17
Print photos from a memory card	18
Remove a memory card	18
Print from a PictBridge-certified camera or device	19
Print from a Bluetooth device	19
Configure Bluetooth	20
Print photos from a Bluetooth device	21
Enhance your photos	21
5 Print from a computer	
Printer software	23
Printer Properties dialog box	23
What's This? help	24
Download printer software updates	24
Transfer photos to a computer	24
Transfer photos from a camera or other device	24
Transfer photos and files from a memory card	25
Save photos from a memory card to the computer	25
Transfer non-photo files from a memory card to the computer	25
Delete photos and other files from a memory card	26
Enhance your photos	26
HP Real Life technology options	26
Maximum dpi	27

Change the print settings for the print job.....	27
Change the print quality.....	28
Change the paper type.....	28
Change the paper size.....	29
Resize a photo	29
Use advanced color settings.....	29
Create printing shortcuts.....	30
Print preview.....	31
Print photos.....	31
Print borderless photos.....	31
Print photos with a border.....	33
Print postcards.....	34
Print black and white photos.....	34
Print panoramic photos.....	35
Print on index cards and other small media.....	36
HP Photosmart software.....	36
6 Maintenance	
Toolbox dialog box.....	37
Open the Toolbox.....	37
Use the Toolbox.....	37
Align the print cartridge.....	38
Clean the print cartridge automatically.....	38
View estimated ink levels.....	39
Insert or replace the print cartridge.....	39
Remove ink from your skin and clothing.....	40
Get print cartridge ordering information.....	41
Print a test page.....	41
Print a sample page.....	41
HP Digital Imaging Monitor icon.....	42
Store the printer and print cartridge.....	42
Storing the printer.....	42
Store the print cartridges.....	43
7 Troubleshooting	
Software installation issues.....	45
Printing and hardware issues.....	46
Bluetooth printing problems.....	54
Device messages.....	55
8 Shop for ink supplies	59
9 HP support and warranty	
Check the HP support Web site first.....	61
HP support by phone.....	61
Phone support period.....	61
Placing a call.....	62
After the phone support period.....	62
HP Warranty.....	63
Additional warranty options.....	63

10 Specifications

System requirements.....65
Printer specifications.....65

11 Regulatory and environmental information

Regulatory notices.....67
 FCC statement.....68
 LED indicator statement.....68
 VCCI (Class B) compliance statement for users in Japan.....68
 Notice to users in Japan about power cord.....69
 Notice to users in Korea.....69
 Notice to users in the European Economic Area.....69
Environmental product stewardship program.....69
 Paper use.....70
 Plastics.....70
 Material safety data sheets.....70
 Recycling program.....70
 HP inkjet supplies recycling program.....70
 Energy consumption.....70
 Disposal of Waste Equipment by Users in Private Households in the European
 Union.....71

1 HP Photosmart A520 series Help



Welcome to the HP Photosmart A520 series Help! For more information about the HP Photosmart printer, see:

- [“Get started”](#) on page 7
- [“Paper basics”](#) on page 15
- [“Print without a computer”](#) on page 17
- [“Print from a computer”](#) on page 23
- [“Maintenance”](#) on page 37
- [“Shop for ink supplies”](#) on page 59
- [“HP support and warranty”](#) on page 61
- [“Specifications”](#) on page 65
- [“Regulatory and environmental information”](#) on page 67

You can print information at any time from the HP Photosmart Help. Just click **Print** in the top navigation bar of the HP Photosmart Help window.

2 Get started

This section provides introductory information about the HP Photosmart A520 series printer. This section contains the following topics:

- [How do I?](#)
- [Find more information](#)
- [The HP Photosmart at a glance](#)
- [Control panel buttons and indicator lights](#)
- [Printer menus](#)

How do I?





Click any of the following links to get more information on how to perform creative and common tasks using the HP Photosmart printer and software.

- [“Print borderless photos”](#) on page 31
- [“Print photos with a border”](#) on page 33
- [“Print postcards”](#) on page 34
- [“Paper basics”](#) on page 15
- [“Clear a paper jam”](#) on page 57
- [“Insert or replace the print cartridge”](#) on page 39
- [“Transfer photos”](#) on page 25

Click any of the following links to view an animation on how to perform common tasks.

Find more information

Your new HP Photosmart A520 series printer comes with the following documentation:

	<p>Setup instructions: The setup instructions explain how to set up the printer, install the HP Photosmart software, and print a photo. Read this document first. This document may be called Quick Start Guide or Setup Guide, depending on your country/region, language, or printer model.</p>
	<p>Basics Guide: The <i>Basics Guide</i> describes the features of the printer, explains how to use the printer without connecting it to a computer, and contains troubleshooting tips and support information.</p>
	<p>Onscreen Help: The onscreen Help describes how to use the printer with or without a computer and contains troubleshooting information.</p> <p>After you have installed the HP Photosmart software on your computer, you can view the electronic Help on your computer:</p>
	<p>Help from your device: Help is available from your device and contains additional information on select topics.</p> <p>See "How to use the Printer menu" on page 11 for information on accessing these help topics.</p>
<p>www.hp.com/support</p>	<p>If you have Internet access, you can get help and support from the HP Web site. This Web site offers product documentation, technical support, drivers, supplies, and ordering information.</p>

The HP Photosmart at a glance

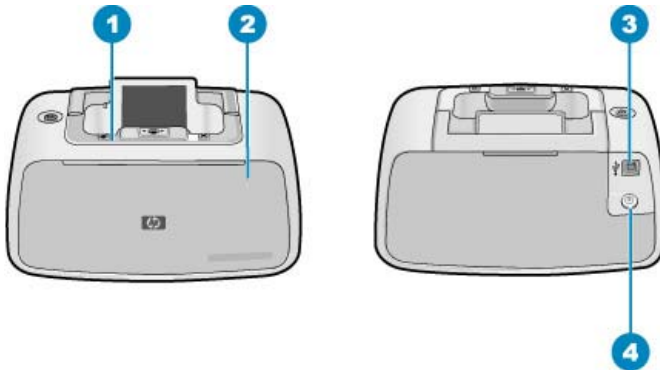

Figure 2-1 Printer parts

Label	Description
1	Control panel: Control the basic functions of the printer from here.
2	Output tray (closed): Open this to print, insert a memory card, connect a compatible digital camera, or access the print cartridge area.
3	USB port: Use this port to connect the printer to a computer using the supplied USB cable.
4	Power cord connection: Connect the power cord here.

Control panel buttons and indicator lights

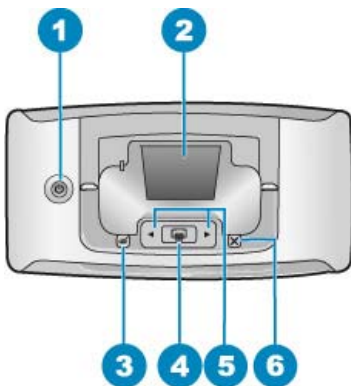

Figure 2-2 Control panel

Label	Description
1	Power: Press to turn the printer on or off. The power button will glow when the power is on. When the printer is idle, the button will pulse softly.
2	Color graphic display: View photos and menus here.
3	Red Eye: The Red Eye feature reduces the red-eye effect you sometime see in flash photos. This feature is on by default. Press this button to turn the feature on or off.
4	Print: Press to print the currently viewed image from a memory card. The Print button glows when the printer power is on.
5	Navigation arrows: Press ◀ or ▶ to scroll through photos on a memory card or to navigate the printer menu.
6	Cancel: Press to stop an action, exit a menu, or to cancel printing a queued image.

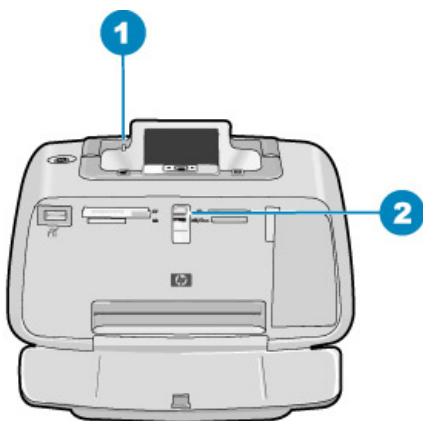

Figure 2-3 Indicator lights

Label	Description
1	Attention LED: Flashes red when the printer requires attention.
2	Memory card LED: This light turns aqua blue after the memory card is correctly inserted. It flashes blue when the printer is communicating with the memory card or when a connected computer is performing a read, write, or delete operation.

Printer menus

This section contains the following topics:

- [How to use the Printer menu](#)
- [Printer menu options](#)

How to use the Printer menu

The Printer menu gives you many print options, allows you to change the printer defaults, provides maintenance and troubleshooting tools, and provides how-to information for common printing tasks.

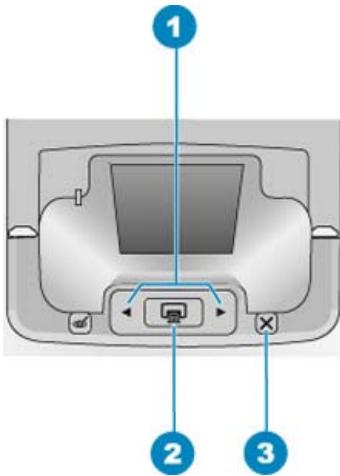

1	Navigation arrows
2	Print
3	Cancel

 **TIP:** The menu contains many useful commands and options, but common functions, such as printing, are usually available with a single button press on the printer control panel.

To use the Printer menu

 **NOTE:** If there is a memory card inserted in the card slots, remove it to access the Printer menu.

1. Press **◀** or **▶** to open the Printer menu.



2. Pressing **▶** will move to the next option and pressing **◀** will move to the previous menu option.
3. Press **Print** to select an option. Menu options that are not accessible are dimmed.
4. To exit a menu, press the **Cancel** button.

 **NOTE:** For a list of printer menu options, see [“Printer menu options”](#) on page 12.

Printer menu options

Printer menu structure

- **Print test page:** Select to print a test page containing information about the printer that can help in troubleshooting problems.
- **Print sample page:** Select to print a sample page, which is useful for checking the print quality of the printer.
- **Clean cartridge:** Select to clean the print cartridge. After cleaning, you will be asked if you want to continue to a second-level cleaning (select **Yes** or **No**). If you select **Yes**, another cleaning cycle will be completed. Next you will be asked if you want to continue to a third-level cleaning (select **Yes** or **No**).
- **Align cartridge:** Select to align the print cartridge.
- **Photo Fix:** Select to enhance your photos.
 - On (default)
 - Off
- **Print quality:** Select to change the print quality. Choose between **Best**, which produces the highest quality, **Normal** which uses less ink and prints faster, or **Fast Normal**. The default print quality depends on the paper type selected.
- **Paper type:** Select to choose paper type. Select **HP Advanced Photo Paper** (default), **HP Premium Photo Paper**, **Other**, **Plain** or **Other, Photo**.
- **Borderless:** Select to turn borderless printing **On** (default) or **Off**. When borderless printing is turned off, all pages print with a narrow white border around the outside edges of the paper.

- **Dry Time:** Select to turn the dry time feature **On** (default) or **Off**. If the dry time feature is turned off the dry time dialog will not be displayed.
- **Demo:** Select to put the printer into the demo mode.
- **Set Language:** Select to change the language or country/region setting. Choose from **Select language** and **Select country/region**. The printer screen displays text in the language you choose. The menu lists paper sizes and other options specific to the chosen language.
- **Restore defaults:** Select to restore printer defaults: **Yes** or **No**. Selecting **Yes** restores the original factory preferences.
- **Help**
 - **Photo printing tips:** Select to read tips that can help you obtain the best possible prints.
 - **Printer features:** Select to read about using the printer features.
 - **Print from imaging devices:** Select to read about printing from memory cards, PictBridge cameras, or USB flash/thumb drives.
 - **Printing specialty projects:** Select to read about printing panoramic photos.
 - **Troubleshooting and maintenance:** Select to read about troubleshooting and printer maintenance.
 - **Getting assistance:** Select to read how to obtain help with the printer.

3 Paper basics

Learn how to choose the right paper for your print job and how to load it into the input tray for printing.

- [Choose the best paper for the job](#)
- [Load your paper](#)

Choose the best paper for the job

Use HP Advanced Photo Paper. It is especially designed to work with the inks in your printer to create beautiful photos. Other photo papers will produce inferior results.

For a list of available HP-designed inkjet paper, or to purchase supplies, go to:

- www.hpshopping.com (U.S.)
- www.hpshopping.ca (Canada)
- www.hp.com/eur/hpoptions (Europe)
- www.hp.com (All other countries/regions)

The printer is set by default to print the best quality photos on HP Advanced Photo Paper. If you print on a different type of paper, be sure to change the paper type. For information on changing the paper type in the printer menu, see "[Load your paper](#)" on page 15. For information on changing the paper type when printing from a computer, see "[Change the print settings for the print job](#)" on page 27.

Load your paper

Paper loading tips

- You can print photos on small media, such as 10 x 15 cm (4 x 6 inch) photo paper, index cards, L-size cards, or Hagaki cards. Use plain paper, such as index cards, only for drafts or when print quality is not important.
- Before loading paper, slide out the paper-width guide to make room for the paper. After loading paper, set the paper width guide gently against the edge of the paper, so that it guides the paper in straight.
- Load only one type and size of paper at a time. Do not mix paper types or sizes in the input tray.



To load paper

1. Open the output tray. The input tray opens automatically.



2. Load up to 20 sheets of photo paper with the print side or glossy side facing the front of the printer. If you are using tabbed paper, load the paper so tab feeds in last. When loading, slide the paper to the left side of the input tray and push the paper down firmly until it stops.
3. Adjust the paper-width guide to fit close to the edge of the paper without bending the paper.

If you are printing from a computer, change the paper type and other printer settings in the print dialog box. For more information, see [“Print from a computer”](#) on page 23 and [“Change the print settings for the print job”](#) on page 27.

You can select from a greater number of paper sizes when you print from a computer than when you print without a computer. When you print without a computer, the printer senses the paper size being used.

4 Print without a computer

This section contains information on the following topics:

- [Print from a memory card without a computer](#)
- [Print from a PictBridge-certified camera or device](#)
- [Print from a Bluetooth device](#)
- [Enhance your photos](#)

Print from a memory card without a computer

This section explains how to print digital photos that are stored on a memory card.

- [Supported memory cards](#)
- [Print photos from a memory card](#)
- [Remove a memory card](#)

Supported memory cards

The HP Photosmart printer can read a variety of memory cards. These cards are manufactured by several vendors and are available in a variety of storage capacities.

- CompactFlash Type I and II
- MultiMediaCard
- Secure Digital
- Memory Sticks
- xD-Picture Card
- miniSD Card with SD adapter

△ **CAUTION:** Using unsupported memory cards may damage the memory card and the printer.

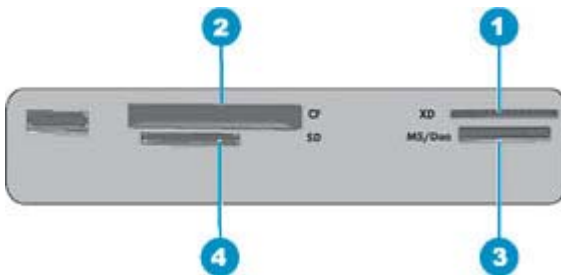

Label	Description
1	xD-Picture Card
2	Compact Flash I and II

(continued)

Label	Description
3	Memory Stick
4	Secure Digital, MultiMediaCard (MMC)

Print photos from a memory card

Important: Your photos are instantly dry, and can be handled immediately after they are printed. However, HP recommends that you leave the printed surface of your photos exposed to the air for 3 minutes after printing to allow the colors to fully develop before you stack them with other photos or place them in albums.

To print a single photo

1. Navigate through the photos on the inserted memory card.
2. Display the photo you want to print.
3. Press **Print**.



NOTE: To print additional copies of the current image, press **Print** again.

To print multiple photos

1. Navigate through the photos on the inserted memory card.
2. Press **Print** to print the current photo.



NOTE: To print additional copies of the current image, press **Print** again.

3. Press ◀ or ▶ to browse to the next photo you want to print. You do not have to wait for the first photo to finish printing.

To print camera-selected photos

1. Insert a memory card that contains camera-selected (DPOF) photos.
2. Select **Yes** when the printer asks you whether you want to print the camera-selected photos, and then press **Print**.



NOTE: To print additional copies of the current image, press **Print** again.

Remove a memory card

⚠ **CAUTION:** Do not pull out the memory card while the memory card light is flashing. A flashing light means the printer or computer is accessing the memory card. Wait until the light remains solid. Removing a memory card while it is being accessed may corrupt information on the card or damage the printer and card.

To remove a memory card

- ▲ When the memory card light on the printer is solid, it is safe to pull the card out of the slot.

Print from a PictBridge-certified camera or device

This section describes the procedure for printing from a PictBridge digital camera. The procedure for printing from other PictBridge devices—such as camera phones and other image capture devices—is very similar. Review the documentation that came with your PictBridge device for specific information.



NOTE: If you disconnect the camera while printing, all print jobs are cancelled.

To print using a PictBridge-certified camera

1. Load HP Advanced Photo Paper into the printer.
2. Turn on the PictBridge-certified digital camera.
3. Make sure the USB configuration setting of the camera is set to Digital Camera, and then connect the camera to the camera port of the printer using the USB cable that came with the PictBridge-certified camera. The PictBridge light flashes green while the camera establishes a connection to the printer, and then turns solid green. See the camera documentation for more information about the USB configuration setting. The name of the setting and its options may differ on non-HP digital cameras.
4. If you already selected photos for printing on the camera, the **Print DPOF Photos?** dialog box is displayed on the camera. Select **No** to bypass printing pre-selected photos. DPOF (Digital Print Order Format) lets the user mark photos on a digital camera for printing and include other image information, such as number of copies to be printed.
5. Use the options and controls on your camera to print your photos. See the camera documentation for more information. The On light and the PictBridge light flash while the photos are printing.

Important: Your photos are instantly dry, and can be handled immediately after they are printed. However, HP recommends that you leave the printed surface of your photos exposed to the air for 3 minutes after printing to allow the colors to fully develop before you stack them with other photos or place them in albums.

Print from a Bluetooth device

This section describes how to print from any device with Bluetooth wireless technology, a short-range communications technology that enables a wide range of devices to connect with each other without the clutter of cables.

To use Bluetooth connectivity with the HP Photosmart A520 series printer, you must purchase and connect the optional HP Bluetooth® wireless printer adapter to the camera port on the front of the printer. To learn how to print from a Bluetooth device, see the documentation that came with your Bluetooth adapter.

This section contains the following topics:

- [Configure Bluetooth](#)
- [Print photos from a Bluetooth device](#)



NOTE: For more information on Bluetooth wireless technology and HP, go to www.hp.com/go/bluetooth.

Configure Bluetooth

To use Bluetooth wireless technology, you must configure both the printer and your computer. The way you configure Bluetooth depends on the Bluetooth software you use. This section provides Bluetooth instructions using the Widcomm software.

 **NOTE:** Before you configure the printer, verify that Bluetooth connectivity functions correctly on the device you want the printer to communicate with. Refer to the documentation that came with the Bluetooth device for instructions.

To configure Bluetooth settings on the printer

1. Open the Toolbox dialog box. For more information, see "[Toolbox dialog box](#)" on page 37.
2. Click the **Configure Bluetooth Settings** tab.
3. Make changes and then click **Apply**.

To configure Widcomm Bluetooth software on the computer

1. Right-click the Bluetooth icon in the Bluetooth tray, and select **Explore My Bluetooth Places**.
2. In Bluetooth Tasks, click **View devices in Range**.
3. When the printer appears in the device list, click the Printer icon, then click **OK**.
4. Select **Yes** or **No** to choose the encryption options:
If the security level is set to **High**, select **Yes**, then click **Next**. You will be prompted to enter a passkey.
 - a. To find the passkey, press the **Menu** button on the printer control panel.
 - b. Select **Bluetooth**, then select **Display Passkey**.
The passkey appears on the printer screen.
 - c. Enter the passkey in the **Bluetooth Pin Code** field, and then click **OK**.
5. From the Windows Control Panel, click **Printers & Faxes**, then click **Add Printer**.
6. Click **Local Printer**, then click **Next**. The Printer Properties dialog box appears.
7. Click the **General** tab, and enter a name for the printer.
8. Click **OK**.

Print photos from a Bluetooth device

The basic procedure for printing from any device with Bluetooth wireless technology is the same. For more detailed instructions, see the documentation that came with your Bluetooth device.

To print from a Bluetooth device

1. Connect the Bluetooth adapter to the camera port on the printer.



Figure 4-1 Control panel

1	Bluetooth adapter
---	-------------------

2. Have the device search for available Bluetooth printers.
3. Select the HP Photosmart A520 series printer when it appears on the device.
4. Send the print job from the Bluetooth device to the printer. See the documentation for your Bluetooth device for specific instructions on starting a print job.

Enhance your photos

Your HP Photosmart A520 series includes two on-board features for enhancing your images: red-eye reduction and Photo Fix.

The red-eye reduction feature is on by default when you turn on the printer. It reduces the red-eye effect that sometimes occurs in flash photos. If you want to print a photo without using this feature, you can turn it off by pressing the **Red Eye** button on the control panel. Pressing the button again will turn the red-eye feature back on.

Photo Fix automatically enhances your photos using HP Real Life Technologies that:

- Sharpen blurred photos.
- Improve the dark areas of a photo without affecting the light areas of a photo.
- Improve the overall brightness, color, and contrast of photos.

Photo Fix is on by default when you turn on the printer for the first time. If you want to print a photo without using the Photo Fix improvements, turn off Photo Fix from the printer menu. See [“Printer menus”](#) on page 10 for more information.

Photo Fix remains off until you turn it on again.

5 Print from a computer

This section describes how to print photos when the HP Photosmart A520 series printer is connected to a computer, and you want to print an image from an imaging application such as Photosmart Essential.

This section contains the following topics:

- [Printer software](#)
- [Transfer photos to a computer](#)
- [Enhance your photos](#)
- [Change the print settings for the print job](#)
- [Print preview](#)
- [Print photos](#)
- [HP Photosmart software](#)

Printer software

This section contains the following topics:

- [Printer Properties dialog box](#)
- [What's This? help](#)
- [Download printer software updates](#)

Printer Properties dialog box

When connected to a computer, the printer is controlled by the printer software you installed on the computer. Use this software, also known as the printer driver, to change the print settings and to begin print jobs.

To change the print settings, open the Printer Properties dialog box.

 **NOTE:** The Printer Properties dialog box is also referred to as the Printing Preferences dialog box.

To open the Printer Properties dialog box

1. Open the file that you want to print.
2. Click **File**, click **Print**, and then click **Properties** or **Preferences**.
The Printer Properties dialog box is displayed.

 **NOTE:** The path to the Printer Properties dialog box can vary depending on the software program you are using.

What's This? help

Use the What's This? help to learn about the features that you see on the Printer Properties dialog box. For more information, see "[What's This? help](#)" on page 24.

What's This? help

Use What's This? help to learn more about the available printing options.

To use What's This? help

1. Move the cursor over the feature that you want to learn more about.
2. Click the right mouse button.
The What's This box is displayed.
3. Move the cursor over the **What's This?** box, and then click the left mouse button.
An explanation of the feature is displayed.

Download printer software updates

Download the latest printer software update every few months to ensure you have the latest features and improvements.

To download a printer software update

1. Make sure you are connected to the Internet.
2. From the Windows **Start** menu, click **Programs** or **All Programs**, point to **HP**, and then click **HP Software Update**.
The HP Software Update window is displayed.
3. Click **Next**.
HP Software Update searches the HP Web site for printer software updates.
 - If the computer has the most recent version of the printer software installed, **No updates are available for your system at this time** is displayed in the HP Software Update window.
 - If the computer does not have the most recent version of the printer software installed, a software update is displayed in the HP Software Update window.
4. If a software update is available, select the check box beside the update name.
5. Click **Install**.
6. Follow the onscreen instructions.

Download HP Photosmart software

Installing the printer software update you download from the HP Web site does not update the HP Photosmart software you might have installed on the computer. For information about updating the HP Photosmart software, see the HP Photosmart Software Help.

Transfer photos to a computer

This section describes how to transfer photos and other files from cameras and memory cards to a computer, and contains the following topics:

- [Transfer photos from a camera or other device](#)
- [Transfer photos and files from a memory card](#)

Transfer photos from a camera or other device

You can transfer photos to a computer from a connected camera or USB device (like a Flash drive). To transfer photos, the device must be connected to the printer, and the

printer must be connected to your computer with an appropriate USB cable. In addition you must have installed the HP Photosmart software. You need to transfer the photos to your computer to use them in image editing software, including the HP Photosmart software that came with the printer.

To transfer photos to a computer

1. Connect the printer to the computer with a USB cable.
2. Turn off the camera if it is on.
3. Connect a camera or another device that contains the photos you wish to transfer to the printer. You can connect to the printer through USB or through PictBridge, if the camera or device supports PictBridge.
4. HP Solution Center opens on the computer. Click **Transfer Photos**, and then follow the prompts on the computer. For more information, see the HP Photosmart Software Help.

Transfer photos and files from a memory card

This section describes how to transfer photos and non-photo files from a memory card inserted into the printer to a computer, and contains the following topics:

- [Save photos from a memory card to the computer](#)
- [Transfer non-photo files from a memory card to the computer](#)
- [Delete photos and other files from a memory card](#)

Save photos from a memory card to the computer

Follow these steps to transfer photos from a memory card to the computer.

1. Make sure the printer is connected to the computer.
2. Insert a memory card that contains photos into the correct memory card slot in the printer.
3. The HP Photosmart transfer software opens and prompts you to designate a location on the computer where the images will be saved. For more information, see the HP Photosmart Help.

See how to transfer photos on the HP Photosmart A520 series printers.



Transfer non-photo files from a memory card to the computer

Follow these steps to save non-photo files from a memory card to the computer.

To transfer files from a memory card to a computer

1. Make sure the printer is connected to the computer.
2. Insert a memory card that contains non-photo files into the correct memory card slot in the printer.

3. Right-click the HP Digital Imaging Monitor  icon in the Windows taskbar, and select **HP Photosmart A520 series > Open E.**

 **NOTE:** E may not be the drive letter the computer assigns.

Windows Explorer opens and shows the contents of the card.

4. Drag and drop files from the memory card to a location on the computer.

 **NOTE:** You can also use Windows Explorer to copy files from the computer to the memory card.

Delete photos and other files from a memory card

Follow these steps to delete photos and other files from a memory card.

To delete photos or files from a memory card

1. Make sure the printer is connected to the computer.
2. Insert a memory card that contains files into the correct memory card slot in the printer.
3. Right-click the HP Digital Imaging Monitor  icon in the Windows taskbar, and select **HP Photosmart A520 series > Open E.**

 **NOTE:** E may not be the drive letter the computer assigns.

Windows Explorer opens and shows the contents of the card.

4. Select the files you want to delete, then select **File > Delete.**

Enhance your photos

The printer software offers several features to make printing digital photos easier and to improve photo quality:

- Use the HP Real Life technology options to touch up photos. For more information, see [“HP Real Life technology options” on page 26](#).
- Achieve the highest resolution with Maximum dpi. For more information, see [“Maximum dpi” on page 27](#).

Learn how to add professional touches to digital photographs:

- Use [“advanced color settings” on page 29](#) to improve printed colors.
- Print black and white photos. For more information, see [“Print black and white photos” on page 34](#).
- Use HP Advanced Photo Paper for easy to handle, sturdy, glossy photo paper with an instant-dry finish resistant to water, smears, fingerprints and humidity. For more information, see [“Choose the best paper for the job” on page 15](#).

HP Real Life technology options

HP Real Life technologies enhance the quality of your printed photos.

In most cases, you do not need to change the **Basic** default print setting. The Basic setting sharpens the images that you print, and improves the quality and clarity of low resolution images, such as those downloaded from the Internet.

You can change the setting to **Full** if the images that you print are under exposed or over exposed, contain dark areas or red eye, or have colors that appear washed out.

You can also select the **Off** setting if you prefer to edit the image manually in a software program such as HP Photosmart software.

To change the HP Real Life technologies setting

1. Open the Printer Properties dialog box. For more information, see "[Printer Properties dialog box](#)" on page 23.
2. Click the **Features** tab.
3. In the HP Real Life technologies **Photo fix** drop-down list, select the appropriate setting for the photo you are printing.

Maximum dpi

Use maximum dpi mode to print high-quality, sharp images.

To get the most benefit from maximum dpi mode, use it to print high-quality images such as digital photographs. When you select the maximum dpi setting, the printer software displays the optimized dots per inch (dpi) that the HP Photosmart printer will print.

Printing in maximum dpi takes longer than printing with other settings and requires a large amount of disk space.

To print in Maximum dpi mode

1. Open the Printer Properties dialog box. For more information, see "[Printer Properties dialog box](#)" on page 23.
2. Click the **Features** tab.
3. In the **Paper Type** drop-down list, click **More**, and then select the appropriate paper type.
4. In the **Print Quality** drop-down list, click **Maximum dpi**.



NOTE: To view the maximum dpi that the HP Photosmart printer will print, click **Resolution**.

5. Select any other print settings that you want, and then click **OK**.

Change the print settings for the print job

This section describes how to change print settings, such as paper type or paper quality, when printing from a computer. This section contains the following topics:

- [Change the print quality](#)
- [Change the paper type](#)
- [Change the paper size](#)
- [Resize a photo](#)
- [Use advanced color settings](#)
- [Create printing shortcuts](#)

Change the print quality

Choose the print quality and speed to optimize your photo printing.

To select a print quality and speed

1. Open the Printer Properties dialog box. For more information, see [“Printer Properties dialog box” on page 23](#).
2. Click the **Features** tab.
3. In the **Paper Type** drop-down list, select the type of paper that you have loaded.
4. In the **Print Quality** drop-down list, select the appropriate quality setting for your project.

Print quality settings

- **Draft** produces draft-quality output at the fastest printing speed, while using the least amount of ink.
- **Fast Normal** produces higher quality output than the Draft setting and prints more quickly than the Normal setting.
- **Normal** provides the best balance between print quality and speed and is appropriate for most documents.
- **Best** provides the best balance between high quality and speed and can be used for high quality prints. For most documents, the Best setting prints more slowly than the Normal setting.
- **Maximum dpi** optimizes the dots per inch (dpi) that the HP Photosmart prints. Printing in maximum dpi takes longer than printing with other settings and requires a large amount of disk space. For more information, see [“Maximum dpi” on page 27](#).



NOTE: To see the print resolution for the selected print quality, click the **Resolution** button on the **Features** tab.

Change the paper type

For best results, always select a specific paper type that matches the media you are using for the print job.

To select a specific paper type

1. Open the Printer Properties dialog box. For more information, see [“Printer Properties dialog box” on page 23](#).
2. Click the **Features** tab.
3. Click **More** in the **Paper Type** drop-down list, and then select the paper type that you want to use.
4. Click **OK**.
5. Select any other print settings that you want, and then click **OK**.

Change the paper size

Use the Printer Properties dialog box instead of the software application's Page Setup dialog box to select a paper size. Some software applications do not list all the paper sizes the printer supports.

To select a paper size

1. Open the Printer Properties dialog box. For more information, see [“Printer Properties dialog box” on page 23](#).
2. Click the **Features** tab.
3. Select a paper size from the **Size** drop-down list.
For borderless printing, select a borderless paper size, or select a paper size, then click the **Borderless** check box.
4. Select any other print settings that you want, and then click **OK**.

Resize a photo

Use the printer software to print a photo that is formatted for one paper size on another paper size. Doing this can be useful if you do not have the correct paper size available.

To resize a photo for a different paper size

1. Open the Printer Properties dialog box. For more information, see [“Printer Properties dialog box” on page 23](#).
2. Click the **Features** tab.
3. Click **Scale to paper size**, and then select the target paper size in the drop-down list.
The target paper size is the size of the paper on which you are printing, not the size for which the document was formatted.
4. Select any other print settings that you want, and then click **OK**.

Use advanced color settings

Use the **More color options** dialog box to adjust how printed colors appear.

Adjusting these settings causes the printed colors to differ from the colors that appear on the computer monitor. These settings do not affect the original photo; they only affect how it prints.

Follow these steps to specify advanced color settings:

To specify advanced color settings

1. Open the Printer Properties dialog box. For more information, see [“Printer Properties dialog box” on page 23](#).
2. Click the **Color** tab, and then click the **More color options** button.
The More color options dialog box is displayed.

3. You can adjust the following settings:
 - Adjust the **Brightness**, **Saturation**, and **Color Tone** to affect how overall colors are printed.
 - Adjust the **Cyan**, **Magenta**, **Yellow**, and **Black** sliders to specify the level of each color that is used in printing.



NOTE: When you adjust color settings, the changes are reflected in the Preview box.

4. After specifying the color settings, click **OK**.
5. Select any other print settings that you want, and then click **OK**.

Use the What's This? help to learn about the features that you see on the Printer Properties dialog box. For more information, see "[What's This? help](#)" on page 24.

Create printing shortcuts

In addition to the printing shortcuts that are available in the Printing Shortcuts list in the print driver, you can create your own printing shortcuts to save time and ensure consistency between print jobs.

If you frequently print on transparency film, for example, you can create a printing shortcut by selecting the Presentation Printing shortcut, changing the paper type to HP Premium Inkjet Transparency Film, and then saving the modified shortcut under a new name; for example, Transparency Presentations. After creating the printing shortcut, simply select it when printing on transparency film rather than changing the print settings each time.

To create a printing shortcut

1. Open the Printer Properties dialog box. For more information, see "[Printer Properties dialog box](#)" on page 23.
2. Click the **Printing Shortcuts** tab.
3. In the **Printing Shortcuts** list, click a printing shortcut.
The print settings for the selected printing shortcut are displayed.
4. Change the print settings to those you want in the new printing shortcut.
5. In the **Type new shortcut name here** box, type a name for the new printing shortcut, and then click **Save**.
The printing shortcut is added to the list.

To delete a printing shortcut

1. Open the Printer Properties dialog box. For more information, see "[Printer Properties dialog box](#)" on page 23.
2. Click the **Printing Shortcuts** tab.
3. In the **Printing Shortcuts** list, click the printing shortcut that you want to delete.
4. Click **Delete**.
The printing shortcut is removed from the list.



NOTE: Only the shortcuts that you have created can be deleted. The original HP shortcuts cannot be deleted.

Print preview

You can preview a document on the computer before printing it. If the print preview does not look the way you want it to, close the preview window and make the necessary adjustments to the document or to the print settings. For more information on changing the print settings, see [“Change the print settings for the print job”](#) on page 27.

To preview a printed document

1. Open the Printer Properties dialog box. For more information, see [“Printer Properties dialog box”](#) on page 23.
2. Click the **Features** or the **Color** tab.
3. Select the **Show preview before printing** check box.
4. Select any other print settings that you want, and then click **OK**.
Before the document prints, a preview is displayed.
5. Do one of the following:
 - Click **OK** to print the document.
 - Click **Cancel** to cancel the print job. Adjust the print settings as needed before printing the document.

Print photos

This sections describes how to print several types of photos and contains the following topics:

- [Print borderless photos](#)
- [Print photos with a border](#)
- [Print postcards](#)
- [Print black and white photos](#)
- [Print panoramic photos](#)
- [Print on index cards and other small media](#)

Print borderless photos

Use borderless printing to print to the edges of 10 x 15 cm (4 x 6 inch) paper.

Guidelines

- To learn how to use the photo printing features, see [“photo enhancing”](#) on page 26.
- Verify that the photo paper you are using is not rippled or curled.
- Do not exceed the paper tray capacity when loading media. For more information, see [“Printer specifications”](#) on page 65.

Prepare to print

1. Verify that the printer is turned on.
2. Load photo paper. For more information, see [“Paper basics”](#) on page 15.

Print

 **NOTE:** If your software program includes a photo printing feature, follow the instructions that are provided with the software program. Otherwise, follow these instructions.

1. Open the photo in a software program that allows editing, such as HP Photosmart software.
2. Open the Print Properties dialog box. For more information, see [“Printer Properties dialog box” on page 23](#).
3. Click the **Printing Shortcuts** tab.
4. In the **Printing Shortcuts** list, click **Photo Printing-Borderless**, and then select the following options:

- **Print Quality: Normal or Best**

 **NOTE:** For maximum dpi quality, go to the **Features** tab, and then click **Maximum dpi** in the **Print Quality** drop-down list.

- **Paper Type:** An appropriate photo paper type
 - **Paper Size:** An appropriate borderless photo paper size
 - **Orientation: Portrait or Landscape**
5. If necessary, change the HP Real Life technology options setting. For more information, see [“HP Real Life technology options” on page 26](#).
 6. Select any other print settings that you want, and then click **OK**.
If you printed on photo paper with a tear-off tab, remove the tab to make the document completely borderless.



Use the What's This? help to learn about the features that you see on the Printer Properties dialog box. For more information, see [“What's This? help” on page 24](#).

Related topics

[“Change the print settings for the print job” on page 27](#)

Print photos with a border

Guidelines

- To learn how to use the photo printing features, see the [“photo enhancing” on page 26](#) page.
- Verify the photo paper you are using is not rippled or curled.
- Do not exceed the paper tray capacity when loading media. For more information, see [“Printer specifications” on page 65](#).

Prepare to print

1. Verify that the printer is turned on.
2. Load photo paper. For more information, see [“Paper basics” on page 15](#).

Print

 **NOTE:** If your software program includes a photo printing feature, follow the instructions that are provided with the software program. Otherwise, follow these instructions.

1. Open the photo in a software program that allows editing, such as HP Photosmart software.
2. Open the Print Properties dialog box. For more information, see [“Printer Properties dialog box” on page 23](#).
3. Click the **Printing Shortcuts** tab.
4. In the **Printing Shortcuts** list, click **Photo Printing-with white borders**, and then select the following options:
 - **Print Quality: Normal or Best**

 **NOTE:** For maximum dpi quality, go to the **Features** tab, and then click **Maximum dpi** in the **Print Quality** drop-down list.

- **Paper Type:** An appropriate photo paper type
 - **Paper Size:** An appropriate photo paper size
 - **Orientation: Portrait or Landscape**
5. If necessary, change the HP Real Life technology options setting. For more information, see [“HP Real Life technology options” on page 26](#).
 6. Select any other print settings that you want, and then click **OK**.

Use the What's This? help to learn about the features that you see on the Printer Properties dialog box. For more information, see [“What's This? help” on page 24](#).

Related topics

[“Change the print settings for the print job” on page 27](#)

Print postcards

Guidelines

- Use only cards and small media that meet the printer paper-size specifications. For more information, see [“Printer specifications” on page 65](#).
- Do not exceed the paper tray capacity when loading media. For more information, see [“Printer specifications” on page 65](#).

Prepare to print

1. Verify the printer is turned on.
2. Load cards. For more information, see [“Paper basics” on page 15](#).

Print

1. Open the Print Properties dialog box. For more information, see [“Printer Properties dialog box” on page 23](#).
2. Click the **Features** tab, and then specify the following print settings:
 - **Paper Type**: Click **More**, click **Specialty Papers**, and then select an appropriate card type.
 - **Print Quality**: **Normal** or **Best**
 - **Size**: An appropriate card size
3. Select any other print settings that you want, and then click **OK**.

Use the What's This? help to learn about the features that you see on the Printer Properties dialog box. For more information, see [“What's This? help” on page 24](#).

 **NOTE:** If an out-of-paper message is displayed, see [“Paper basics” on page 15](#) for help in resolving the problem.

Related topics

[“Change the print settings for the print job” on page 27](#)

Print black and white photos

Guidelines

- To print a photo that is already black and white you do not need to adjust the color settings; simply follow the instructions for the type and size of photo you want to print. See [“Print from a computer” on page 23](#) for some basic photo print options.
- To print a color photo in black and white, use the **Print in grayscale** color option.

To print in grayscale

1. Open the Print Properties dialog box. For more information, see [“Printer Properties dialog box” on page 23](#).
2. Click the **Color** tab.
3. Select the **Print in grayscale** option.
4. Select any other print settings that you want, and then click **OK**.

Print panoramic photos

For true panoramic printing, you must have taken a panoramic photo. Also, use HP panorama paper 10 x 30 cm (4 x 12 inch).

Guidelines

- To learn how to use the photo printing features, see [“photo enhancing”](#) on page 26.
- Verify that the photo paper you are using is not rippled or curled.
- Do not exceed the paper tray capacity when loading media. For more information, see [“Printer specifications”](#) on page 65.
- For maximum fade resistance, use HP Advanced Photo Paper.

Prepare to print

1. Verify the printer is turned on.
2. Load paper. For more information, see the [“Paper basics”](#) on page 15 section.

Print

 **NOTE:** If the software program you are using includes a photo printing feature, follow the instructions that are provided with the software program. Otherwise, follow these instructions.

1. Open the Print Properties dialog box. For more information, see [“Printer Properties dialog box”](#) on page 23.
2. On the **Printing Shortcuts** tab, select **Photo printing-borderless** or **Photo printing-with white borders** in the **Printing Shortcuts** list, then set the following options:
 - **Print quality: Best**
 - **Paper type:** The appropriate photo paper type
 - **Paper size:** The appropriate borderless photo panorama paper size
 - **Orientation: Portrait** or **Landscape**
3. Set the following options as appropriate:
 - [“HP Real Life technology options”](#) on page 26
 - [“Use advanced color settings”](#) on page 29
 - [“Print black and white photos”](#) on page 34
4. Select any other print settings you want, then click **OK**.
Use What's This? help to learn more details about each of the features in the Printer Properties dialog box. For more information, see [“What's This? help”](#) on page 24.

Related topics

[“Change the print settings for the print job”](#) on page 27

Print on index cards and other small media

Guidelines

- Use only cards and small media that meet the printer paper-size specifications.
- Do not exceed the paper tray capacity when loading media. For more information, see [“Printer specifications” on page 65](#).
- Print quality decreases when printing on plain paper such as index cards. This is to be expected and does not indicate a problem. Printing on plain paper is useful for print jobs, such as drafts, where print quality is not important.

Prepare to print

1. Verify the printer is turned on.
2. Load paper. For more information, see the [“Paper basics” on page 15](#) section.

Print

1. Open the Print Properties dialog box. For more information, see [“Printer Properties dialog box” on page 23](#).
2. Click the **Features** tab, and then specify the following print settings:
 - **Paper Type:** Plain Paper
 - **Size:** An appropriate card size
3. Select any other print settings that you want, and then click **OK**.

Use the What's This? help to learn about the features that you see on the Printer Properties dialog box. For more information, see [“What's This? help” on page 24](#).

 **NOTE:** If an out-of-paper message is displayed, see [“Paper basics” on page 15](#) for help in resolving the problem.

Related topics

[“Change the print settings for the print job” on page 27](#)

HP Photosmart software

The HP Photosmart software coordinates the functions of HP imaging devices: scanners, cameras, printers, and all-in-one devices. Depending on the devices you have installed and their capabilities, you can quickly and easily organize, edit, and share digital images.

Organize, edit, and share digital images in creative ways

If you performed the default installation of the printer software, you also installed the Photosmart Essential software. This software lets you easily:

- Print photos and digital images
- Transfer images from a camera or memory card
- Edit images
- Share photos with friends and family

For more information, see the HP Photosmart Software Help.

6 Maintenance

This section contains basic maintenance procedures that can help keep your printer performing well and producing top-quality photos.

- [Toolbox dialog box](#)
- [Align the print cartridge](#)
- [Clean the print cartridge automatically](#)
- [View estimated ink levels](#)
- [Insert or replace the print cartridge](#)
- [Remove ink from your skin and clothing](#)
- [Get print cartridge ordering information](#)
- [Print a test page](#)
- [Print a sample page](#)
- [HP Digital Imaging Monitor icon](#)
- [Store the printer and print cartridge](#)

Toolbox dialog box

The Toolbox contains useful tools to enhance printer performance.

- [Open the Toolbox](#)
- [Use the Toolbox](#)

Open the Toolbox

From the Windows taskbar

1. Double-click the HP Digital Imaging Monitor  icon.
2. Make sure the correct printer is selected, and then click the **Settings** button in the HP Solution Center.
3. Select **Print Settings > Printer Toolbox**.

Use the Toolbox



Use the **Toolbox** to do the following:

- “[Align the print cartridge](#)” on page 38
- “[Clean the print cartridge automatically](#)” on page 38
- “[Print a sample page](#)” on page 41
- “[Print a test page](#)” on page 41
- “[View estimated ink levels](#)” on page 39
- “[Get print cartridge ordering information](#)” on page 41
- “[Configure Bluetooth](#)” on page 20

Align the print cartridge

The printer automatically aligns the print cartridge after a new one is installed. You can also align the print cartridge at other times to ensure optimal print quality. Indications that you need to align the print cartridge manually include documents that print at an angle, colors not printing satisfactorily, or poor print quality.

To align the print cartridge from the printer

1. Remove any memory card, if inserted.
2. Press  or  to highlight **Align cartridge**.
3. Press **Print** to begin aligning the print cartridge.
4. Follow the onscreen instructions.

To align the print cartridge from a connected computer

1. Load a sheet of HP Advanced Photo Paper in the input tray.
2. Open the Toolbox dialog box. For more information, see "[Toolbox dialog box](#)" on page 37.
3. Click **Align the Print Cartridges**.
4. Click **Align**, and follow the onscreen instructions.



Clean the print cartridge automatically

If the printed pages are missing lines or dots or contain ink streaks, the print cartridge might be low on ink or need to be cleaned.

 **CAUTION:** Clean the print cartridge only when necessary. Unnecessary cleaning wastes ink and shortens the life of the cartridge.

If the print cartridge is not low on ink, follow these steps to clean the cartridge automatically:

To clean the print cartridge from the printer

1. Remove any memory card, if inserted.
2. Press  or  to highlight **Clean cartridge**.
3. Press **Print** to begin cleaning the print cartridge.
4. Follow the onscreen instructions.





To clean the print cartridge from a connected computer

1. Open the Toolbox dialog box. For more information, see "[Toolbox dialog box](#)" on page 37.
2. Click **Clean the Print Cartridge**.
3. Click **Clean**.
4. Follow the onscreen instructions.

If the documents are still missing lines or dots after cleaning, replace the print cartridge.

View estimated ink levels

You can view the estimated ink level of the print cartridge installed in the printer either from a connected computer or on the printer itself. The printer screen displays an ink-level icon that shows the approximate amount of ink remaining in the cartridge (100%, 75%, 50%, 25%, and nearly empty):

	100%
	75%
	50%
	25%
	Low on ink (less than 25%).

 **NOTE:** Ink from the cartridges is used in the printing process in a number of different ways, including in the initialization process, which prepares the device and cartridges for printing, and in printhead servicing, which keeps print nozzles clear and ink flowing smoothly. In addition, some residual ink is left in the cartridge after it is used. For more information see www.hp.com/go/inkusage.

To view the estimated ink level of the print cartridge from a connected computer

1. Open the Toolbox dialog box. For more information, see “[Toolbox dialog box](#)” on page 37.
2. Click the **Estimated Ink Levels** tab.

Insert or replace the print cartridge

Use the HP 110 Tri-color Inkjet print cartridge to print black-and-white and color photos. HP Vivera Inks deliver true-to-life photo quality and exceptional fade resistance, resulting in vivid colors that last. HP Vivera Inks are specially formulated and scientifically tested for quality, purity, and fade resistance.

 **CAUTION:** Check that you are using the correct print cartridges. Also, note that HP does not recommend modifying or refilling HP cartridges. Damage that results from modifying or refilling HP cartridges is not covered by the HP warranty.

For best print quality, HP recommends that you install all retail print cartridges before the date stamped on the box.

To insert or replace a print cartridge

1. Make sure the power is on and you have removed the cardboard from inside the printer.
2. Open the print cartridge door of the printer.
3. Remove the bright pink tape from the cartridge.



NOTE: Do not touch the copper-colored contacts on the print cartridge.

4. If you are replacing a cartridge, push down and pull outward on the cartridge in the cradle to remove it.
5. Hold the replacement cartridge with the label on top. Slide the cartridge at a slight upward angle into the cradle so the copper-colored contacts go in first. Push the cartridge until it snaps into place.
6. Close the print cartridge door.

The printer starts print cartridge alignment. See [“Align the print cartridge” on page 38](#) for more information.

Recycle the old cartridge. The HP Inkjet Supplies Recycling Program is available in many countries/regions and lets you recycle used print cartridges free of charge. For more information, go to www.hp.com/hpinfo/globalcitizenship/environment/recycle/inkjet.html.

Remove ink from your skin and clothing

Follow these instructions to remove ink from your skin and clothing:

Surface	Remedy
Skin	Wash the area with an abrasive soap.
White fabric	Wash the fabric in <i>cold</i> water and use chlorine bleach.
Color fabric	Wash the fabric in <i>cold</i> water and use sudsy ammonia.

CAUTION: Always use cold water to remove ink from fabric. Warm or hot water can set the ink into the fabric.

Get print cartridge ordering information

To view print cartridge ordering information and order cartridges online

1. Open the Toolbox dialog box. For more information, see [“Toolbox dialog box” on page 37](#).
2. Click the **Estimated Ink Levels** tab.
3. Click **Print Cartridge Information**.
If you are connected to the Internet, you can click the **Shop Online** button to order cartridges online.

To order HP papers and other supplies, go to www.hp.com/buy/supplies. If prompted, choose your country/region, follow the prompts to select your product, and then click one of the shopping links on the page.

Print a test page

The information on a test page can be helpful if you need to contact HP support. It also contains information about ink levels, print or ink cartridge performance, printer serial number, and so on.

To print a test page from the printer

1. Remove any memory card, if inserted.
2. Press ◀ or ▶ to highlight **Print test page**.
3. Press **Print** to begin printing a test page.

To print a test page from a computer

1. Open the Toolbox dialog box. For more information, see [“Toolbox dialog box” on page 37](#).
2. Click the **Device Services** tab.
3. Click **Print a Test Page**.
4. Click **Print Page**.

Print a sample page

To print a sample page from the printer

1. Remove any memory card, if inserted.
2. Press ◀ or ▶ to highlight **Print sample page**.
3. Press **Print** to begin printing a sample page.

To print a sample page from a computer



1. Load paper in the paper tray.
2. Open the Toolbox dialog box. For more information, see [“Toolbox dialog box” on page 37](#).
3. Click the **Device Services** tab.

4. Click **Print A Sample Page**.
5. Click **Print Page**.

HP Digital Imaging Monitor icon

After you install the printer software, the HP Digital Imaging Monitor icon appears in the Windows taskbar. This icon helps you perform a variety of tasks.

The HP Digital Imaging Monitor icon shows the status of the printer:

	The HP Digital Imaging Monitor icon has a green check mark when the printer is in an idle state.
	The HP Digital Imaging Monitor icon has an exclamation mark when there is an error. An error message also appears. Click the error message or HP Digital Imaging Monitor icon to return the icon to its idle state.

- Double-click the HP Digital Imaging Monitor icon to open the HP Solution Center.
- Right-click the HP Digital Imaging Monitor icon to select from the following menu items:
 - **HP Photosmart A520 series > About:** View the printer software version, installed printers, and the printer name and serial number.
 - **Launch/Show HP Solution Center:** Opens the HP Solution Center.
 - **About:** Shows the version of the HP Digital Imaging Monitor icon.
 - **Close HP Digital Imaging Monitor:** Removes the HP Digital Imaging Monitor icon from the Windows taskbar. The icon reappears when you restart the computer.
 - **HP Photosmart A520 series > Display Status:** Describes the current status of the printer.

Store the printer and print cartridge

This section contains information on storing your printer and print cartridges.

- [Storing the printer](#)
- [Store the print cartridges](#)

Storing the printer

The printer is built to withstand long or short periods of inactivity.

- Store the printer indoors out of direct sunlight in a place without temperature extremes.
- If the printer and print cartridges have not been used for one month or more, clean the print cartridges before printing. For more information, see [“Clean the print cartridge automatically”](#) on page 38.

Store the print cartridges

When you store the printer, always leave the active print cartridges inside the printer. The printer stores the print cartridges in a protective cap during the power-down cycle.

△ **CAUTION:** Make sure the printer completes its power-down cycle before you unplug the power cord. This allows the printer to store the print cartridges properly.

Follow these tips to help maintain HP print cartridges and ensure consistent print quality:

- When you remove a print cartridge from the printer, store it in a print cartridge protector to prevent the ink from drying out.
- Keep all unused print cartridges in their original sealed packages until they are needed. Store print cartridges at room temperature (15–35 degrees C or 59–95 degrees F).
- Do not remove the plastic tape covering the ink nozzles until you are ready to install the print cartridge in the printer. If the plastic tape has been removed from the print cartridge, do not attempt to reattach it. Reattaching the tape damages the print cartridge.

7 Troubleshooting

Before contacting HP support, read this section for troubleshooting tips or go to the online support services at www.hp.com/support.

Before you begin, make sure:

- All the cable connections between the printer and computer are secure.
- You are using the most recent version of the printer software.

 **TIP:** HP recommends using a USB cable 3 meters (10 feet) or less in length. Using a longer USB cable may cause errors.

This section contains troubleshooting information for the HP Photosmart A520 series printer.

- [Software installation issues](#)
- [Printing and hardware issues](#)
- [Bluetooth printing problems](#)
- [Device messages](#)

Software installation issues

- [The printer software did not install successfully](#)
- [A "There was an error writing to Dot4" message appeared](#)
- [Missing HP Photosmart Software](#)

The printer software did not install successfully

Cause: There may be a conflict with the virus protection application or another software application that is running in the background on the computer that prevented a successful software installation.

Solution:

1. Uninstall the printer software:
 - a. From the Windows **Start** menu, go to **Programs > HP > HP Photosmart A520 series > Uninstall Devices**.
 - b. Follow the onscreen instructions.
2. Pause or disable any active virus protection applications.
3. Quit all software applications.
4. Reinstall the printer software according to the setup instructions that came with the printer.

A "There was an error writing to Dot4" message appeared

Cause: The printer software may have not installed correctly.

Solution:

- Unplug the USB cable from the computer, then plug it in again.
- Make sure the cable is securely attached to the computer and to the USB port on the back of the printer.
- Restart the computer.

If this does not resolve the issue, follow these steps:

1. Disconnect the USB cable from the printer.
 2. Uninstall the printer software:
 - a. From the Windows **Start** menu, go to **Programs > HP > HP Photosmart A520 series > Uninstall Devices**.
 - b. Follow the onscreen instructions.
 3. When the uninstall is complete, restart the computer.
 4. Reinstall the printer software. Follow the onscreen installation instructions.
 5. Connect the power cord to the back of the printer and turn on the printer.
 6. When the computer prompts you, connect the USB cable to the USB port on the back of the printer.
-

Missing HP Photosmart Software

Cause: The HP Photosmart Software is not installed.

Solution: Install the HP Photosmart Software that came with the HP Photosmart. If it is installed, restart your computer.

To install the HP Photosmart Software

1. Insert the HP Photosmart CD-ROM into your computer's CD-ROM drive and then start the Setup program.
 2. When prompted, click **Install More Software** to install the HP Photosmart Software.
 3. Follow the onscreen instructions and the setup instructions provided in the box with the HP Photosmart.
-

Printing and hardware issues

- [The printer is plugged in, but it will not turn on.](#)
- [The printout did not appear](#)
- [The computer and printer lost communication](#)
- [The Found New Hardware Wizard did not recognize the printer when it was connected to the computer](#)
- [The New Hardware Wizard did not appear when the printer and computer were connected with a USB cable](#)
- [The HP Digital Imaging Monitor icon does not appear in the Windows taskbar](#)
- [The printer would not print when it was connected to the computer with a USB cable through another USB device](#)

- [A small red circle appeared on the HP Digital Imaging Monitor icon in the Windows taskbar](#)
- [An Unknown device message appeared](#)
- [The document or photo did not print using the selected default print settings](#)
- [The printer did not print borderless photos](#)
- [Could not save photos from the computer to the memory card](#)
- [Printing is very slow](#)
- [The printout is rippled or curled](#)
- [A blank page came out of the printer](#)
- [The printer ejected the paper when preparing to print.](#)
- [Parts of the printed document are missing or are in the wrong place](#)
- [Print quality is poor](#)
- [The photo printout appears cropped](#)
- [The printout does not appear as it should](#)

The printer is plugged in, but it will not turn on.

Solution:

- The printer may be plugged into a power strip that is turned off. Turn on the power strip, and then turn on the printer.
- The printer may be plugged into an incompatible power source. If you are traveling abroad, make certain the power source in the country/region you are visiting complies with the power requirements and power cord of the printer.
- Check that the power adapter is functioning properly. To check the power adapter:
 - Make sure the power adapter is connected to your printer and a compatible power source.
 - Press and hold down the **On** button on the printer. If the **On** button lights up, then the power cord is working properly. If it fails to light, go to www.hp.com/support or contact HP support.

The printout did not appear

Cause: The paper jammed while printing.

Solution: Try the following steps to clear the paper jam:

- If the paper came part way through the front of the printer, gently pull the paper towards you to remove it.
- If the paper did not come part way through the front of the printer, try removing it from the back of the printer:
 - Remove the paper from the input tray, then gently pull down on the input tray until it pops open more fully. Do not attempt to extend it to a full horizontal position. Doing so could damage the printer.
 - Gently pull the jammed paper to remove it from the back of the printer.
 - Lift the input tray up until it snaps back into paper-loading position.

- If you cannot grasp the edge of the jammed paper to remove it, try the following:
 - Turn off the printer.
 - Turn on the printer. The printer checks for paper in the paper path and will automatically eject the jammed paper.
- Press **OK** to continue.



The computer and printer lost communication

Cause:

- The computer might not be connected to the printer.
- The printer might be turned off.
- The printer might not be connected to a power source.
- You might be using a USB hub or docking station that has multiple devices connected to it. Accessing another device can temporarily break the connection to the printer.

Solution:

- Make sure the USB cable is securely attached to both the computer and to the USB port on the back of the printer.
- Make sure that the printer power cord is securely attached and the printer is turned on.
- Wait until the other device is no longer being accessed or connect the printer directly to the computer.
If an HP Photosmart dialog box is displayed, click **Retry** to try to re-establish a connection.

The Found New Hardware Wizard did not recognize the printer when it was connected to the computer

Cause: You connected the printer to the computer before installing the software or before the software prompted you to connect.

Solution:

1. Disconnect the USB cable from the printer and close the Found New Hardware Wizard.
2. Insert the HP Photosmart CD that came with the printer. When the Install Wizard appears, click **Cancel**.
3. From the **Start** menu, click **Run**.
4. Click **Browse** and navigate to the CD-ROM drive.
5. Select the **Uninstaller.bat** file and click **Open**.
6. Click **OK** to launch the Uninstaller.

7. Click **Continue** to uninstall the files created when you connected the printer to the computer.
 8. Click **Restart**. When the computer restarts, remove the HP Photosmart CD and follow the installation instructions in the setup instructions that came in the box with the printer.
-

The New Hardware Wizard did not appear when the printer and computer were connected with a USB cable

Cause: You may not be using the proper version of Windows, or there may be something wrong with the USB cable or the USB cable connection.

Solution: Make sure the computer's operating system is the proper version of Windows and that the computer is connected to the USB port on the back of the printer with a USB cable.

If that isn't the problem, try the following:

1. Disconnect the USB cable and power cord from the back of the printer.
 2. Uninstall the printer software:
 - a. From the Windows **Start** menu, go to **Programs > HP > HP Photosmart A520 series > Uninstall Devices**.
 - b. Follow the onscreen instructions.
 3. When the uninstall is complete, restart the computer.
 4. Reinstall the printer software. Follow the onscreen installation instructions.
 5. Connect the power cord to the back of the printer and turn on the printer.
 6. When the computer prompts you, connect the USB cable to the USB port on the back of the printer.
-

The HP Digital Imaging Monitor icon does not appear in the Windows taskbar

Cause: You may have selected **Close HP Digital Imaging Monitor** from the menu when you right-clicked the HP Digital Imaging Monitor icon in the Windows Taskbar. For more information, see "[HP Digital Imaging Monitor icon](#)" on page 42.

Solution: Restart the computer.

The printer would not print when it was connected to the computer with a USB cable through another USB device

Cause: Two-way communication between the printer and the computer was interrupted by another device attached to the hub.

Solution:

1. Turn off the computer.
2. Connect the printer directly to a USB port on the computer.
3. Make sure the cable is securely attached to the computer and to the USB port on the back of the printer.

4. Disconnect all USB devices (including the hub) from the computer.
 5. Turn on the computer.
 6. Try printing again. If the problem persists, repeat steps 1–5 using a different USB port on the computer.
-

A small red circle appeared on the HP Digital Imaging Monitor icon in the Windows taskbar

Cause: There is a connection or communication problem between the printer and the computer.

Solution:

1. Connect the printer directly to a USB port on the computer.
 2. Unplug the USB cable from the computer, then plug it in again.
 3. Disconnect all USB devices (including the hub) from the computer.
 4. If you are using a USB hub to connect the printer and computer, unplug the printer from the USB hub and connect it directly to the computer to verify communication.
 5. Try printing the document again. If the problem persists, repeat steps 1–5 using a different USB port on the computer.
-

An Unknown device message appeared

Cause:

- Static electricity may have built up in the cable between the computer and printer.
- The software could not identify the printer because the printer-USB connection may be defective.

Solution:

1. Disconnect the USB cable from the printer.
2. Disconnect the power cord from the printer.
3. Wait about 10 seconds.
4. Plug the power cord back into the printer.
5. Plug the USB cable back into the USB port on the back of the printer.
6. If the problem persists, unplug the power cord and the USB cable and uninstall the printer software:
 - a. From the Windows **Start** menu, go to **Programs > HP > HP Photosmart A520 series > Uninstall Devices**.
 - b. Follow the onscreen instructions.
7. Restart the computer.
8. Reinstall the printer software and follow the onscreen instructions. Do not connect the USB cable to the printer until prompted.

If “Unknown device” continues to appear, check www.hp.com/support for more information, or contact HP support.

The document or photo did not print using the selected default print settings

Cause: The printer default settings may be different than those in the software application. The software application print settings override any that you set on the printer.

Solution: From the software application's **File** menu, select **Print**, then click **Properties** and choose the desired print settings.

The printer did not print borderless photos

Cause: The printer cannot print borderless photos on all sizes of paper. You need to select a paper size that supports borderless printing.

Solution:

1. Open the Printer Properties dialog box. For more information, see [“Printer Properties dialog box” on page 23](#).
 2. Click the **Printing Shortcuts** tab.
 3. In the **Printing Shortcuts** list, click **Photo Printing-Borderless**, and choose an appropriate borderless photo paper size.
For more information, see [“Print borderless photos” on page 31](#).
-

Could not save photos from the computer to the memory card

Cause: The memory card may be locked.

Solution: If the memory card has a lock switch, make sure it is in the unlocked position.

Printing is very slow

Cause:

- You may be printing a high-resolution image. These take longer to print.
- You may have chosen **Maximum dpi**.
- The system resources may be too low. You may have chat, music download, or virus software running in the background.
- You may be using outdated printer software.
- A page may be drying in the output tray.

Solution:

- In the **Features** tab of the Printer Properties dialog box, set the Print Quality to **Best** or **Normal** instead of **Maximum dpi**, and try printing again.
 - See [“View estimated ink levels” on page 39](#) for information on checking the level of ink in the print cartridge. Replace the cartridge if necessary.
-

- See [“Download printer software updates”](#) on page 24 for information on updating the printer software. To check the version of the software, select **About** from the HP Digital Imaging Monitor  icon in the taskbar.
- Remove the wet page and simply wait. Printing continues when the page is dry.

To improve the system resources, close all open programs except Windows Explorer and Systray, then try printing again:

1. Press **Ctrl+Alt+Delete**.
2. Select all programs except Windows Explorer and Systray. Hold **Ctrl** or **Shift** to select multiple programs.
3. Click **End Task**. If a second message appears, click **End Task** again.
4. Repeat steps 1–3 until all programs except Windows Explorer and Systray are closed.
5. Try printing again.

The printout is rippled or curled

Cause: The project you are printing is using a larger amount of ink than normal.

Solution: Lower the ink saturation using the Printer Properties dialog box.

1. Open the Printer Properties dialog box. For more information, see [“Printer Properties dialog box”](#) on page 23.
2. Click the **Color** tab.
3. Click **More color options**.
4. Reset the ink attributes by moving the **Saturation** slider closer to **Muted**.
5. Try printing again.

A blank page came out of the printer

Cause: The print cartridge may be out of ink.

Solution: Print a test page. For more information, see [“Print a test page”](#) on page 41. Replace the print cartridge if necessary. For more information, see [“Insert or replace the print cartridge”](#) on page 39.



The printer ejected the paper when preparing to print.

Cause: The printer might be in direct sunlight, which affects the operation of the automatic paper sensor.

Solution: Move the printer out of direct sunlight.

Parts of the printed document are missing or are in the wrong place

Cause:

- You may have selected the incorrect paper orientation.
- You may have selected an incorrect paper size.

Solution:

- Make sure you have selected the correct orientation on the **Features** tab of the Printer Properties dialog box.
 - Make sure you have selected the correct paper size. For more information, see [“Change the paper size” on page 29](#).
-

Print quality is poor

Cause:

- You may have magnified the photo too much.
- The print cartridge may be running out of ink.
- You may not be using the best paper type for the output.
- You may be printing on the wrong side of the paper.
- You may have selected a low-resolution setting on the digital camera.
- You may need to clean the print cartridge.

Solution:

- Reduce the magnification.
 - Print a test page. For more information, see [“Print a test page” on page 41](#). Replace the print cartridge if necessary. For more information, see [“Insert or replace the print cartridge” on page 39](#).
-

- Check the ink levels of the print cartridge from the **Estimated Ink Level** tab of the Toolbox. For more information, see [“Toolbox” on page 37](#)
 - Make sure you are using a paper type intended for the printer. Use HP-designed photo paper for best results when printing photos.
 - Choose paper that is specifically designed for the output rather than plain paper.
 - Make sure the paper is loaded with the side to be printed facing up.
 - Reduce the size of the image and try printing again. For better results in the future, set the digital camera to a higher photo resolution.
 - From the **Device Services** tab of the Toolbox, click **Clean the Print Cartridge**.
-

The photo printout appears cropped

Cause: You may have used the software application’s Page Setup dialog box to select the paper size or type.

Solution: Select paper size and type from the **Features** tab of the Printer Properties dialog box.

The printout does not appear as it should

Cause: The paper may be marked, scratched, or wrinkled, or the paper may be dark in color or contain metallic fibers.

Solution: If the paper is damaged, dark in color, or contains metallic fibers, the sensor may not detect paper type and size accurately. Make sure the paper is clear, free of scratches or wrinkles, light colored, and does not contain metallic fibers. Select the appropriate paper type on the **Features** tab of the Printer Properties dialog box.

Bluetooth printing problems

Before contacting HP support, read this section for troubleshooting tips, or go to the online support services at www.hp.com/support. Be sure to also read the documentation that came with your HP Bluetooth wireless printer adapter (if you are using one) and your device with Bluetooth wireless technology.

- [My Bluetooth device cannot find the printer.](#)
- [No page came out of the printer.](#)
- [Print quality is poor.](#)
- [The photo printed with borders.](#)
- [My computer cannot set the device name using the Bluetooth wireless connection.](#)

My Bluetooth device cannot find the printer.

Solution:

- If you are using the optional HP Bluetooth wireless printer adapter, make sure the adapter is plugged into the camera port on the front of the printer. The light on the adapter flashes when the adapter is ready to receive data.
If the printer has integrated Bluetooth wireless technology, check the Bluetooth light on the printer. The light flashes when the printer is ready to receive data.
- Bluetooth **Visibility** may be set to **Not visible**. Change this setting to **Visible to all** as follows:
 - Press **Menu**.
 - Select **Bluetooth**, and then press **OK**.
 - Select **Visibility**, and then press **OK**.
 - Select **Visible to all**, and then press **OK**.
- Bluetooth **Security level** may be set to **High**. Change this setting to **Low** as follows:
 - Press **Menu**.
 - Select **Bluetooth**, and then press **OK**.
 - Select **Security level**, and then press **OK**.
 - Select **Low**, and then press **OK**.

- The passkey (PIN) that the device with Bluetooth wireless technology is using for the printer may be incorrect. Make sure the correct passkey for the printer is entered in the device with Bluetooth wireless technology.
 - You may be too far from the printer. Move the device with Bluetooth wireless technology closer to the printer. The maximum recommended distance between the device with Bluetooth wireless technology and the printer is 10 meters (30 feet).
-

No page came out of the printer.

Solution: The printer may not recognize the type of file sent by the device with Bluetooth wireless technology. For a list of the file formats that the printer supports, see "[Specifications](#)" on page 65.

Print quality is poor.

Solution: The photo you printed may be low resolution. For better results, set the digital camera to a higher resolution. Photos taken with VGA-resolution cameras, such as those found in wireless phones, may not have high enough resolution to produce a high-quality print.

The photo printed with borders.

Solution: The printing program installed on your device with Bluetooth wireless technology may not support borderless printing. Contact the vendor of the device, or go to their support Web site to obtain the latest updates for the printing program.

My computer cannot set the device name using the Bluetooth wireless connection.

Solution: Use a USB cable to connect your computer to the printer in order to set the printer Bluetooth device name using the printer Toolbox. The printer software must already be installed on the computer.

Use the following instructions to get to the printer Toolbox.

Windows users only: Right-click the small monitor icon on the far right of the Windows taskbar and select **Launch/Show HP Solution Center**. Click **Settings**, **Print Settings**, and then **Printer Toolbox**. Click the **Configure Bluetooth Settings** tab and enter the Bluetooth device name in the Device Name box

Device messages

The following is a list of error messages that may appear while your printer is connected to a computer:

- [Low on ink](#)
- [The print cartridge is old or damaged](#)
- [The print cartridge is missing or incorrect](#)

- [The print carriage has stalled](#)
- [The printer is out of paper](#)
- [There is a paper jam](#)
- [The paper loaded does not match the paper size selected](#)
- [The memory card has been inserted upside down](#)
- [The memory card is not inserted properly](#)
- [Insert only one memory card at a time](#)
- [There was a problem with the memory card](#)
- [Communication with the printer has been lost](#)

Low on ink

Cause: The print cartridge is estimated to be low on ink and may need to be replaced soon.

Solution: Have a replacement cartridge on hand to avoid printing interruptions. You do not have to replace the cartridge until print quality deteriorates. If you have installed a refilled or remanufactured print cartridge, or a cartridge that has been used in another printer, the ink level indicator will be inaccurate or unavailable.

The print cartridge is old or damaged

Solution: The print cartridge may be old or damaged. Try the following:

- Replace refilled cartridges with genuine HP products.
 - Make sure the cartridge is compatible with the printer.
 - Clean the electrical contacts.
 - Remove the cartridge and then reinstall it. For more information, see [“Insert or replace the print cartridge” on page 39](#).
 - If this does not work, replace the cartridge.
-

The print cartridge is missing or incorrect

Solution: The print cartridge is not installed, is installed incorrectly, or is not supported by your printer’s country/region settings. Try the following:

- Replace refilled cartridges with genuine HP products.
 - Make sure the cartridge is compatible with the printer.
 - Clean the electrical contacts.
 - Remove the cartridge and then reinstall it. For more information, see [“Insert or replace the print cartridge” on page 39](#).
 - If this does not work, replace the cartridge.
-

The print carriage has stalled

Solution: There is an obstruction blocking the path of the print carriage or the cartridge service station. Contact HP support for help, or go to the online support services at www.hp.com/support.

The printer is out of paper

Solution: Check that paper has been loaded in the correct paper tray. See "[Paper basics](#)" on page 15 and refer to the setup instructions that came with your printer for more information on loading paper.

There is a paper jam

Solution: Try the following steps to clear the paper jam:

1. Turn off the printer, and then unplug it from the power source.
 2. Open the input tray and output tray and pull out any paper that is jammed in the printer.
 3. Remove any wrinkled or torn paper from the input tray or output tray. Reload new paper in the input tray.
 4. Plug the printer back in, and turn it on. Try printing your document again.
-
-

The paper loaded does not match the paper size selected

Solution: The paper loaded does not match the paper size selected. Try the following:

1. Change the type of paper selected for the print job.
 2. Make sure the correct paper is loaded in the paper tray.
-

The memory card has been inserted upside down

Solution: The memory card has been inserted upside down. Remove the memory card and reinsert it with the gold contacts facing down.

The memory card is not inserted properly

Solution: The printer can detect the memory card but cannot read it. Push the memory card gently into the memory card slot until it stops.

Insert only one memory card at a time

Solution: The printer has two or more different types of memory cards inserted simultaneously. Alternatively, a memory card may be inserted while a digital camera is connected to the camera port. Remove memory cards or disconnect the camera until only one card is in the printer or only the camera is connected.

There was a problem with the memory card

Solution: There was a problem with the memory card. Try to copy your pictures directly to a computer and then reformat the card using the camera.

Communication with the printer has been lost

Solution: Check that your printer is on and that the cover is closed, and then try the following:

1. Make sure the printer cable is firmly connected to both the printer and computer.
 2. Check the printer for a paper jam.
 3. Try turning the printer off and then on again.
 4. Press the **OK** button to start printing. If the printer is off line, this will bring it back on line.
 5. Make sure the printer cable you are using is designed for two-way (also known as bi-directional) communication (IEEE-1284 compliant).
-

8 Shop for ink supplies

For a list of print cartridge numbers, see the printed documentation that came with the HP Photosmart. You can also use the software that came with the HP Photosmart to find out the reorder number for all the print cartridges. You can order print cartridges online from the HP Web site. Additionally, you can contact a local HP reseller to find out the correct print cartridge reorder numbers for your device and purchase print cartridges.

To order HP papers and other supplies, go to www.hp.com/buy/supplies. If prompted, choose your country/region, follow the prompts to select your product, and then click one of the shopping links on the page.

 **NOTE:** At this time, some portions of the HP Web site are available in English only.

NOTE: Ordering print cartridges online is not supported in all countries/regions. If it is not supported in your country/region, contact a local HP reseller for information about purchasing print cartridges.

To order print cartridges from your desktop

- ▲ Click the **Shop for HP Supplies** icon on your desktop to connect to HP SureSupply. You will see a list of original HP printing supplies that are compatible with your device, as well as options to conveniently purchase the supplies you need (options vary by country/region).

If you deleted this icon from your desktop, click the **Start** menu, point to the **HP** folder, then click **Shop for Supplies**.

For more information, go to www.hp.com/buy/supplies.

To order print cartridges through the HP Photosmart Software

1. In the HP Solution Center, click **Settings**, point to **Print Settings**, and then click **Printer Toolbox**.

 **NOTE:** You can also open the **Printer Toolbox** from the **Print Properties** dialog box. In the **Print Properties** dialog box, click the **Services** tab, and then click **Service this device**.

2. Click the **Estimated Ink Levels** tab.
3. Click **Print Cartridge Ordering Information**.
The print cartridge reorder numbers appear.
4. Click **Order Online**.

HP sends detailed printer information, including model number, serial number, and ink supply levels, to an authorized online reseller. The supplies you need are preselected; you can change quantities, add or remove items, and then check out.

9 HP support and warranty

This section contains information on the following:

- [Check the HP support Web site first](#)
- [HP support by phone](#)
- [HP Warranty](#)
- [Additional warranty options](#)

Check the HP support Web site first

Check the documentation that came with the printer. If you do not find the information you need, check out the HP support Web site.

To check for online support

1. Visit the HP online support Web site at www.hp.com/support. HP online support is available to all HP customers. It is the fastest source for up-to-date device information and expert assistance and includes the following features:
 - Fast access to qualified online support specialists
 - Software and driver updates for the HP Photosmart
 - Valuable HP Photosmart and troubleshooting information for common problems
 - Proactive device updates, support alerts, and HP newsletters that are available when you register the HP Photosmart
2. For Europe only: Contact your local point of purchase. If the HP Photosmart has a hardware failure, you will be asked to bring it back to your local point of purchase. (Service is provided at no charge during the device limited warranty period. After the warranty period, you will be quoted a service charge.)
3. If you do not find the information you need online, call HP support. Support options and availability vary by device, country/region, language, and phone support period.

HP support by phone

For a list of support phone numbers, see the phone number list in the printed documentation.

This section contains information on the following:

- [Phone support period](#)
- [Placing a call](#)
- [After the phone support period](#)

Phone support period

One year of phone support is available in North America, Asia Pacific, and Latin America (including Mexico). To determine the duration of phone support in Europe, the Middle East, and Africa, go to www.hp.com/support. Standard phone company charges apply.

Placing a call

Call HP support while you are in front of the computer and the HP Photosmart. Be prepared to provide the following information:

- Device model number (located on the label on the front of the device)
- Device serial number (located on the back or bottom of the device)
- Messages that appear when the situation occurs
- Answers to these questions:
 - Has this situation happened before?
 - Can you re-create it?
 - Did you add any new hardware or software to your computer at about the time that this situation began?
 - Did anything else occur prior to this situation (such as a thunderstorm, device was moved, etc.)?

After the phone support period

After the phone support period, help is available from HP at an additional cost. Help may also be available at the HP online support Web site: www.hp.com/support. Contact your HP dealer or call the support phone number for your country/region to learn more about support options.

HP Warranty

HP product	Duration of limited warranty
Software Media	90 days
Printer	1 year
Print or Ink cartridges	Until the HP ink is depleted or the "end of warranty" date printed on the cartridge has been reached, whichever occurs first. This warranty does not cover HP ink products that have been refilled, remanufactured, refurbished, misused, or tampered with.
Printheads	1 year

A. Extent of limited warranty

- Hewlett-Packard (HP) warrants to the end-user customer that the HP products specified above will be free from defects in materials and workmanship for the duration specified above, which duration begins on the date of purchase by the customer.
- For software products, HP's limited warranty applies only to a failure to execute programming instructions. HP does not warrant that the operation of any product will be interrupted or error free.
- HP's limited warranty covers only those defects that arise as a result of normal use of the product, and does not cover any other problems, including those that arise as a result of:
 - Improper maintenance or modification;
 - Software, media, parts, or supplies not provided or supported by HP;
 - Operation outside the product's specifications;
 - Unauthorized modification or misuse.
- For HP printer products, the use of a non-HP cartridge or a refilled cartridge does not affect either the warranty to the customer or any HP support contract with the customer. However, if printer failure or damage is attributable to the use of a non-HP or refilled cartridge or an expired ink cartridge, HP will charge its standard time and materials charges to service the printer for the particular failure or damage.
- If HP receives, during the applicable warranty period, notice of a defect in any product which is covered by HP's warranty, HP shall either repair or replace the product, at HP's option.
- If HP is unable to repair or replace, as applicable, a defective product which is covered by HP's warranty, HP shall, within a reasonable time after being notified of the defect, refund the purchase price for the product.
- HP shall have no obligation to repair, replace, or refund until the customer returns the defective product to HP.
- Any replacement product may be either new or like-new, provided that it has functionality at least equal to that of the product being replaced.
- HP products may contain remanufactured parts, components, or materials equivalent to new in performance.
- HP's Limited Warranty Statement is valid in any country where the covered HP product is distributed by HP. Contracts for additional warranty services, such as on-site service, may be available from any authorized HP service facility in countries where the product is distributed by HP or by an authorized importer.

B. Limitations of warranty

TO THE EXTENT ALLOWED BY LOCAL LAW, NEITHER HP NOR ITS THIRD PARTY SUPPLIERS MAKES ANY OTHER WARRANTY OR CONDITION OF ANY KIND, WHETHER EXPRESS OR IMPLIED WARRANTIES OR CONDITIONS OF MERCHANTABILITY, SATISFACTORY QUALITY, AND FITNESS FOR A PARTICULAR PURPOSE.

C. Limitations of liability

- To the extent allowed by local law, the remedies provided in this Warranty Statement are the customer's sole and exclusive remedies.
- TO THE EXTENT ALLOWED BY LOCAL LAW, EXCEPT FOR THE OBLIGATIONS SPECIFICALLY SET FORTH IN THIS WARRANTY STATEMENT, IN NO EVENT SHALL HP OR ITS THIRD PARTY SUPPLIERS BE LIABLE FOR DIRECT, INDIRECT, SPECIAL, INCIDENTAL, OR CONSEQUENTIAL DAMAGES, WHETHER BASED ON CONTRACT, TORT, OR ANY OTHER LEGAL THEORY AND WHETHER ADVISED OF THE POSSIBILITY OF SUCH DAMAGES.

D. Local law

- This Warranty Statement gives the customer specific legal rights. The customer may also have other rights which vary from state to state in the United States, from province to province in Canada, and from country to country elsewhere in the world.
- To the extent that this Warranty Statement is inconsistent with local law, this Warranty Statement shall be deemed modified to be consistent with such local law. Under such local law, certain disclaimers and limitations of this Warranty Statement may not apply to the customer. For example, some states in the United States, as well as some governments outside the United States (including provinces in Canada), may:
 - Preclude the disclaimers and limitations in this Warranty Statement from limiting the statutory rights of a consumer (e.g., the United Kingdom);
 - Otherwise restrict the ability of a manufacturer to enforce such disclaimers or limitations; or
 - Grant the customer additional warranty rights, specify the duration of implied warranties which the manufacturer cannot disclaim, or allow limitations on the duration of implied warranties.
- THE TERMS IN THIS WARRANTY STATEMENT, EXCEPT TO THE EXTENT LAWFULLY PERMITTED, DO NOT EXCLUDE, RESTRICT, OR MODIFY, AND ARE IN ADDITION TO, THE MANDATORY STATUTORY RIGHTS APPLICABLE TO THE SALE OF THE HP PRODUCTS TO SUCH CUSTOMERS.

HP Limited Warranty

Dear Customer,

You will find below the name and address of the HP entity responsible for the performance of the HP Limited Warranty in your country.

You may have additional statutory rights against the seller based on your purchase agreement. Those rights are not in any way affected by this HP Limited Warranty.

Ireland: Hewlett-Packard Ireland Ltd, 30 Herbert Street IRL-Dublin 2

United Kingdom: Hewlett-Packard Ltd, Cain Road, Bracknell, GB-Berks RG12 1HN

Additional warranty options

Extended service plans are available for the printer at additional costs. Go to www.hp.com/support, select your country/region and language, then explore the services and warranty area for information about the extended service plans.

10 Specifications

This section lists the minimum system requirements for installing the HP Photosmart software, and provides selected printer specifications.

- [System requirements](#)
- [Printer specifications](#)

System requirements

Operating System

Windows XP Home, XP Professional, x64 Edition, or Vista

Processor

- **Windows XP Home & XP Professional:** Any Intel® Pentium® II, Celeron®, or compatible processor, 233 MHz (Pentium III, 300 MHz or higher recommended)
 - **x64 Edition:** Pentium 4 with Intel EM64T support
 - **Vista:** 800 MHz 32-bit (x86) or 64-bit processor (1 GHz or higher recommended)
-

RAM

- **Windows XP Home & XP Professional:** 128 MB (256 MB or higher recommended)
 - **x64 Edition:** 256 MB (512 MB or higher recommended)
 - **Vista:** 512 MB (1 GB or higher recommended)
-

Free Disk Space

400 MB

Video Display

SVGA 800 x 600, 16-bit color (32-bit color recommended)

Optical Drive

CD-ROM or DVD-ROM

Browser

Microsoft® Internet Explorer® 5.01 Service Pack 2 or higher

Connectivity

- Available USB port and USB cable
 - Internet access recommended
-

Printer specifications

Media Types HP Advanced Photo Paper (recommended) Cards (index, A6, L-size)	Paper Tray One 10 x 15 cm (4 x 6 inches) photo paper tray
Media Sizes Photo paper 10 x 15 cm (4 x 6 inches)	Paper Tray Capacity

(continued)

<p>Photo paper with tab 10 x 15 cm with 1.25 cm tab (4 x 6 inches with 0.5 inch tab)</p> <p>Index cards 10 x 15 cm (4 x 6 inches)</p> <p>A6 cards 105 x 148 mm (4.1 x 5.8 inches)</p> <p>L-size cards 90 x 127 mm (3.5 x 5 inches)</p> <p>L-size cards with tab 90 x 127 mm with 12.5 mm tab (3.5 x 5 inches with 0.5 inch tab)</p> <p>Supported only when printing from a computer: Hagaki, 101 x 203 mm (4 x 8 inches), Panorama photo paper 10 x 30 cm (4 x 12 inches).</p>	<p>20 sheets of photo paper, maximum thickness 292 µm (11.5 mil) per sheet</p> <p>10 sheets of 10 x 30 cm (4 x 12 inches) photo paper for panoramic printing</p>
<p>Margins</p> <p>Borderless printing: Top 0.0 mm (0.0 inch); Bottom 12.5 mm (0.50 inch); Left/right 0.0 mm (0.0 inch)</p> <p>Bordered printing: Top 3 mm (0.12 inches); Bottom 12.5 mm (0.50 inches); Left/right 3 mm (0.12 inches)</p>	<p>Print Cartridge</p> <p>HP 110 Tri-color Inkjet print cartridge</p> <p>Visit www.hp.com/pageyield/ for information on estimated cartridge yields.</p>
<p>Connectivity</p> <p>USB 2.0 full-speed: Windows XP Home, XP Professional, or x64 Edition</p> <p>HP recommends that the USB cable be less than 3 meters (10 feet) in length</p> <p>PictBridge: Using the front camera port</p>	<p>Environmental Specifications: In the presence of high electromagnetic fields, it is possible that the output may be slightly distorted.</p> <p>Maximum during operation: 5–40° C (41–104° F), 5–90% RH</p> <p>Recommended during operation: 15–35 ° C (59–95° F), 20–80% RH</p>
<p>Power Consumption</p> <p>U.S.</p> <p>Printing: 14.46 W</p> <p>Idle: 8.67 W</p> <p>Off: 6.63 W</p> <p>International</p> <p>Printing: 13.56 W</p> <p>Idle: 8.41 W</p> <p>Off: 7.19 W</p>	<p>Power Supply Model Number</p> <p>HP Part # 0957–2121 (North America), 100-240 Vac (±10%) 50/60 Hz (±3 Hz)</p> <p>HP Part # 0957–2120 (Rest of world), 100-240 Vac (±10%) 50/60 Hz (±3 Hz)</p>

11 Regulatory and environmental information

The following regulatory and environmental information applies to the HP Photosmart A520 series printers.

- [Regulatory notices](#)
- [Environmental product stewardship program](#)

Regulatory notices

The following regulatory notices apply to the HP Photosmart A520 series printers.

- [FCC statement](#)
- [LED indicator statement](#)
- [VCCI \(Class B\) compliance statement for users in Japan](#)
- [Notice to users in Japan about power cord](#)
- [Notice to users in Korea](#)
- [Notice to users in the European Economic Area](#)

FCC statement

FCC statement

The United States Federal Communications Commission (in 47 CFR 15.105) has specified that the following notice be brought to the attention of users of this product.

This equipment has been tested and found to comply with the limits for a Class B digital device, pursuant to Part 15 of the FCC Rules. These limits are designed to provide reasonable protection against harmful interference in a residential installation. This equipment generates, uses and can radiate radio frequency energy and, if not installed and used in accordance with the instructions, may cause harmful interference to radio communications. However, there is no guarantee that interference will not occur in a particular installation. If this equipment does cause harmful interference to radio or television reception, which can be determined by turning the equipment off and on, the user is encouraged to try to correct the interference by one or more of the following measures:

- Reorient the receiving antenna.
- Increase the separation between the equipment and the receiver.
- Connect the equipment into an outlet on a circuit different from that to which the receiver is connected.
- Consult the dealer or an experienced radio/TV technician for help.

For further information, contact:

Manager of Corporate Product Regulations
Hewlett-Packard Company
3000 Hanover Street
Palo Alto, Ca 94304
(650) 857-1501

Modifications (part 15.21)

The FCC requires the user to be notified that any changes or modifications made to this device that are not expressly approved by HP may void the user's authority to operate the equipment.

This device complies with Part 15 of the FCC Rules. Operation is subject to the following two conditions: (1) this device may not cause harmful interference, and (2) this device must accept any interference received, including interference that may cause undesired operation.

LED indicator statement

LED indicator statement

The display LEDs meet the requirements of EN 60825-1.

VCCI (Class B) compliance statement for users in Japan

この装置は、情報処理装置等電波障害自主規制協議会（VCCI）の基準に基づくクラスB情報技術装置です。この装置は、家庭環境で使用することを目的としていますが、この装置がラジオやテレビジョン受信機に近接して使用されると受信障害を引き起こすことがあります。

取り扱い説明書に従って正しい取り扱いをして下さい。

Notice to users in Japan about power cord

製品には、同梱された電源コードをお使い下さい。
同梱された電源コードは、他の製品では使用出来ません。

Notice to users in Korea

사용자 안내문(B급 기기)

이 기기는 비업무용으로 전자파 적합 등록을 받은 기기로서, 주거지역에서는 물론 모든 지역에서 사용할 수 있습니다.

Notice to users in the European Economic Area

European Union Regulatory Notice

Products bearing the CE marking comply with the following EU Directives:

- Low Voltage Directive 73/23/EEC
- EMC Directive 89/336/EEC

CE compliance of this product is valid only if powered with the correct CE-marked AC adapter provided by HP.

If this product has telecommunications functionality, it also complies with the essential requirements of the following EU Directive:

- R&TTE Directive 1999/5/EC

Compliance with these directives implies conformity to harmonized European standards (European Norms) that are listed in the EU Declaration of Conformity issued by HP for this product or product family. This compliance is indicated by the following conformity marking placed on the product.



The telecommunications functionality of this product may be used in the following EU and EFTA countries:

Austria, Belgium, Cyprus, Czech Republic, Denmark, Estonia, Finland, France, Germany, Greece, Hungary, Iceland, Ireland, Italy, Latvia, Liechtenstein, Lithuania, Luxembourg, Malta, Netherlands, Norway, Poland, Portugal, Slovak Republic, Slovenia, Spain, Sweden, Switzerland, and United Kingdom.

Environmental product stewardship program

Hewlett-Packard is committed to providing quality products in an environmentally sound manner. Design for recycling has been incorporated into this product. The number of materials has been kept to a minimum while ensuring proper functionality and reliability. Dissimilar materials have been designed to separate easily. Fasteners and other connections are easy to locate, access, and remove using common tools. High priority parts have been designed to access quickly for efficient disassembly and repair.

For more information, visit HP's Commitment to the Environment Web site at:

www.hp.com/hpinfo/globalcitizenship/environment/index.html

This section contains the following topics:

- [Paper use](#)
- [Plastics](#)
- [Material safety data sheets](#)
- [Recycling program](#)
- [HP inkjet supplies recycling program](#)
- [Energy consumption](#)
- [Disposal of Waste Equipment by Users in Private Households in the European Union](#)

Paper use

This product is suited for the use of recycled paper according to DIN 19309 and EN 12281:2002.

Plastics

Plastic parts over 25 grams are marked according to international standards that enhance the ability to identify plastics for recycling purposes at the end of product life.

Material safety data sheets

Material safety data sheets (MSDS) can be obtained from the HP Web site at:

www.hp.com/go/msds

Recycling program

HP offers an increasing number of product return and recycling programs in many countries/regions, and partners with some of the largest electronic recycling centers throughout the world. HP conserves resources by reselling some of its most popular products. For more information regarding recycling of HP products, please visit:

For more information regarding recycling of HP products, please visit:

www.hp.com/hpinfo/globalcitizenship/environment/recycle/

HP inkjet supplies recycling program

HP is committed to protecting the environment. The HP Inkjet Supplies Recycling Program is available in many countries/regions, and lets you recycle used print cartridges and ink cartridges free of charge. For more information, go to the following Web site:

www.hp.com/hpinfo/globalcitizenship/environment/recycle/

Energy consumption

This product is designed to reduce power consumption and save natural resources without compromising product performance. It has been designed to reduce total energy consumption both during operation and when the device is not active. Specific information on power consumption may be found in the product specifications.

Disposal of Waste Equipment by Users in Private Households in the European Union



Disposal of Waste Equipment by Users in Private Households in the European Union
This symbol on the product or on its packaging indicates that this product will not be disposed of with your other household waste. Instead, it is your responsibility to dispose of your waste equipment by handing it over to a designated collection point for the recycling of waste electrical and electronic equipment. The separate collection and recycling of your waste equipment of the type of symbol will help to conserve natural resources and ensure that it is recycled in a manner that protects human health and the environment. For more information about where you can drop off your waste equipment for recycling, please contact your local city office, your household waste disposal service or the shop where you purchased the product.

Evacuazione dei apparecchi elettrici e elettronici negli usi in privato nelle famiglie in Europa
Questo simbolo sul prodotto o sul suo imballaggio indica che non si possono più smaltire questi apparecchi con i rifiuti domestici. È responsabilità dell'utente smaltire questi apparecchi elettrici ed elettronici in modo appropriato. La raccolta e il riciclaggio separati di questi apparecchi contribuiranno a conservare le risorse naturali e a garantire che il riciclaggio avvenga in modo che protegga la salute umana e l'ambiente. Per maggiori informazioni su dove portare i rifiuti elettrici ed elettronici, si prega di contattare l'ufficio locale, il servizio di gestione dei rifiuti domestici o il negozio in cui sono stati acquistati.

Entsorgung von Elektrogeräten durch Benutzer in privaten Haushalten in der EU
Dieses Symbol auf dem Produkt oder dessen Verpackung gibt an, dass dieses Produkt nicht zusammen mit dem Restmüll entsorgt werden darf. Es obliegt Ihnen Ihre Verantwortung, das Gerät an einer entsprechenden Stelle für die Entsorgung oder Wiederverwertung von Elektrogeräten (z.B. an Wertstoffhof), die separate Sammlung und das Recycling Ihrer alten Elektrogeräte zum Zweck der Wiederverwertung zu bringen. Die getrennte Sammlung und das Recycling dieser Geräte wird dazu beitragen, natürliche Ressourcen zu schonen und zu gewährleisten, dass diese Informationen umweltfreundlich sind. Für weitere Informationen über die Orte, an denen Sie Ihre alten Elektrogeräte zum Recycling abgeben können, wenden Sie sich an Ihren örtlichen Behörden, Müllabfuhr oder dort, wo Sie das Gerät erworben haben.

Smaltimento di apparecchiature da rottamare da parte di privati nell'Unione Europea
Questo simbolo sul prodotto o sulla confezione indica che il prodotto non deve essere smaltito insieme agli altri rifiuti domestici. Gli utenti devono provvedere allo smaltimento delle apparecchiature da rottamare partecole del tipo di simbolo in modo che il riciclaggio delle apparecchiature elettriche ed elettroniche si realizzi e il riciclaggio separato delle apparecchiature da rottamare in fase di smaltimento contribuirà a conservare le risorse naturali e a garantire che tali apparecchiature vengano smaltite nel rispetto dell'ambiente e della salute umana. Per ulteriori informazioni sui punti di raccolta delle apparecchiature da rottamare, contattare il proprio comune di residenza, il servizio di smaltimento rifiuti o il negozio presso il quale il prodotto è stato acquistato.

Élimination de résidus de appareils électriques et électroniques par partie des utilisateurs domestiques en Europe
Ce symbole sur le produit ou sur son emballage indique que ce produit ne peut pas être jeté avec les autres déchets. Pour ce produit, il doit éliminer dans un lieu de recyclage approprié. La collecte et le recyclage séparés de ces équipements électriques et électroniques aideront à préserver les ressources naturelles et à garantir que ces équipements soient recyclés de manière à protéger la santé humaine et l'environnement. Pour plus d'informations sur les lieux de collecte des équipements usagés, veuillez contacter votre mairie, votre service de traitement des déchets ménagers ou le magasin où vous avez acheté le produit.

Likvidacija vretenih odpadkov z uporabo v domácnostih v zvezi s EU
Toto oznako na izdelku ali na njegovih embalaži kaže, da tega izdelka ne smemo znebiti skupaj s ostalimi odpadki. Za odpadke elektronske in električne je potrebno poseben postopek zbiranja in recikliranja. Ločeno zbiranje in recikliranje odpadkov elektronske in električne narave bo pomagalo pri ohranjanju naravnih virov in zagotovilo, da bodo odpadki reciklirani na način, ki ne škoduje zdravju ljudi in okolju. Za več informacij o mestih, kjer lahko svoje stare elektronske in električne odpadke prinesete, se obrnite na lokalne oblasti, službo za odpadke ali trgovino, v kateri ste izdelka kupili.

Eliminación de residuos de aparatos eléctricos y electrónicos por parte de usuarios domésticos en la Unión Europea
Este símbolo en el producto o en su embalaje indica que no se puede desechar el producto junto con los residuos domésticos. Por el contrario, si debe eliminar este tipo de residuos, es responsable de hacerlo en un punto de recogida específico de residuos de aparatos eléctricos y electrónicos. El reciclaje y la recogida separada de estos residuos en el momento de la eliminación contribuirán a preservar los recursos naturales y a garantizar que tal equipamiento sea reciclado de manera que proteja la salud y el medio ambiente. Si desea información adicional sobre los lugares donde puede dejar sus residuos para su reciclaje, póngase en contacto con las autoridades locales de su ciudad, con el servicio de gestión de residuos domésticos o con la tienda donde adquirió el producto.

Eliminacja odpadów elektrycznych i elektronicznych w domach w UE
Ten symbol na produkcie lub na jego opakowaniu oznacza, że ten produkt nie należy wyrzucać do zwykłych odpadów domowych. Odpadki elektryczne i elektroniczne należy oddać w specjalny punkt zbierania i recyklingu. Oddzielne zbieranie i recykling odpadków elektrycznych i elektronicznych pomoże w oszczędzaniu zasobów naturalnych i zapewni, że te urządzenia zostaną recyklowane w sposób, który nie szkodzi zdrowiu ludzi i środowisku. Aby uzyskać więcej informacji o miejscach, gdzie można oddać swoje stare urządzenia elektryczne i elektroniczne, skontaktuj się z lokalnymi władzami, służbą do spraw odpadów lub sklepem, w którym zakupiłeś ten produkt.

Eliminazione di rifiuti elettrici ed elettronici per i privati in Europa
Questo simbolo sul prodotto indica che non si può smaltire questo prodotto con i rifiuti domestici. Per questo tipo di rifiuti, è necessario un luogo di raccolta e riciclaggio separato. La raccolta e il riciclaggio separati di questi rifiuti elettrici ed elettronici contribuiranno a conservare le risorse naturali e a garantire che questi apparecchi siano riciclati in modo da proteggere la salute umana e l'ambiente. Per maggiori informazioni sui punti di raccolta, si prega di contattare l'ufficio locale, il servizio di gestione dei rifiuti domestici o il negozio in cui sono stati acquistati.

Eliminación de residuos de aparatos eléctricos y electrónicos en particular en los hogares de la UE
Este símbolo en el producto o en su embalaje indica que este producto no se puede desechar con los residuos domésticos. En su lugar, es responsable de llevarlo a un punto de recogida específico de residuos de aparatos eléctricos y electrónicos. El reciclaje y la recogida separada de estos residuos en el momento de la eliminación contribuirán a preservar los recursos naturales y a garantizar que este equipamiento sea reciclado de manera que proteja la salud y el medio ambiente. Si desea información adicional sobre los lugares donde puede dejar sus residuos para su reciclaje, póngase en contacto con las autoridades locales de su ciudad, con el servicio de gestión de residuos domésticos o con la tienda donde adquirió el producto.

Eliminazione di rifiuti elettrici ed elettronici per i privati in Europa
Questo simbolo sul prodotto indica che non si può smaltire questo prodotto con i rifiuti domestici. Per questo tipo di rifiuti, è necessario un luogo di raccolta e riciclaggio separato. La raccolta e il riciclaggio separati di questi rifiuti elettrici ed elettronici contribuiranno a conservare le risorse naturali e a garantire che questi apparecchi siano riciclati in modo da proteggere la salute umana e l'ambiente. Per maggiori informazioni sui punti di raccolta, si prega di contattare l'ufficio locale, il servizio di gestione dei rifiuti domestici o il negozio in cui sono stati acquistati.

Eliminación de residuos de aparatos eléctricos y electrónicos en particular en los hogares de la UE
Este símbolo en el producto o en su embalaje indica que este producto no se puede desechar con los residuos domésticos. En su lugar, es responsable de llevarlo a un punto de recogida específico de residuos de aparatos eléctricos y electrónicos. El reciclaje y la recogida separada de estos residuos en el momento de la eliminación contribuirán a preservar los recursos naturales y a garantizar que este equipamiento sea reciclado de manera que proteja la salud y el medio ambiente. Si desea información adicional sobre los lugares donde puede dejar sus residuos para su reciclaje, póngase en contacto con las autoridades locales de su ciudad, con el servicio de gestión de residuos domésticos o con la tienda donde adquirió el producto.

Eliminazione di rifiuti elettrici ed elettronici per i privati in Europa
Questo simbolo sul prodotto indica che non si può smaltire questo prodotto con i rifiuti domestici. Per questo tipo di rifiuti, è necessario un luogo di raccolta e riciclaggio separato. La raccolta e il riciclaggio separati di questi rifiuti elettrici ed elettronici contribuiranno a conservare le risorse naturali e a garantire che questi apparecchi siano riciclati in modo da proteggere la salute umana e l'ambiente. Per maggiori informazioni sui punti di raccolta, si prega di contattare l'ufficio locale, il servizio di gestione dei rifiuti domestici o il negozio in cui sono stati acquistati.

Eliminación de residuos de aparatos eléctricos y electrónicos en particular en los hogares de la UE
Este símbolo en el producto o en su embalaje indica que este producto no se puede desechar con los residuos domésticos. En su lugar, es responsable de llevarlo a un punto de recogida específico de residuos de aparatos eléctricos y electrónicos. El reciclaje y la recogida separada de estos residuos en el momento de la eliminación contribuirán a preservar los recursos naturales y a garantizar que este equipamiento sea reciclado de manera que proteja la salud y el medio ambiente. Si desea información adicional sobre los lugares donde puede dejar sus residuos para su reciclaje, póngase en contacto con las autoridades locales de su ciudad, con el servicio de gestión de residuos domésticos o con la tienda donde adquirió el producto.

Eliminazione di rifiuti elettrici ed elettronici per i privati in Europa
Questo simbolo sul prodotto indica che non si può smaltire questo prodotto con i rifiuti domestici. Per questo tipo di rifiuti, è necessario un luogo di raccolta e riciclaggio separato. La raccolta e il riciclaggio separati di questi rifiuti elettrici ed elettronici contribuiranno a conservare le risorse naturali e a garantire che questi apparecchi siano riciclati in modo da proteggere la salute umana e l'ambiente. Per maggiori informazioni sui punti di raccolta, si prega di contattare l'ufficio locale, il servizio di gestione dei rifiuti domestici o il negozio in cui sono stati acquistati.

Eliminación de residuos de aparatos eléctricos y electrónicos en particular en los hogares de la UE
Este símbolo en el producto o en su embalaje indica que este producto no se puede desechar con los residuos domésticos. En su lugar, es responsable de llevarlo a un punto de recogida específico de residuos de aparatos eléctricos y electrónicos. El reciclaje y la recogida separada de estos residuos en el momento de la eliminación contribuirán a preservar los recursos naturales y a garantizar que este equipamiento sea reciclado de manera que proteja la salud y el medio ambiente. Si desea información adicional sobre los lugares donde puede dejar sus residuos para su reciclaje, póngase en contacto con las autoridades locales de su ciudad, con el servicio de gestión de residuos domésticos o con la tienda donde adquirió el producto.

Eliminazione di rifiuti elettrici ed elettronici per i privati in Europa
Questo simbolo sul prodotto indica che non si può smaltire questo prodotto con i rifiuti domestici. Per questo tipo di rifiuti, è necessario un luogo di raccolta e riciclaggio separato. La raccolta e il riciclaggio separati di questi rifiuti elettrici ed elettronici contribuiranno a conservare le risorse naturali e a garantire che questi apparecchi siano riciclati in modo da proteggere la salute umana e l'ambiente. Per maggiori informazioni sui punti di raccolta, si prega di contattare l'ufficio locale, il servizio di gestione dei rifiuti domestici o il negozio in cui sono stati acquistati.

Eliminación de residuos de aparatos eléctricos y electrónicos en particular en los hogares de la UE
Este símbolo en el producto o en su embalaje indica que este producto no se puede desechar con los residuos domésticos. En su lugar, es responsable de llevarlo a un punto de recogida específico de residuos de aparatos eléctricos y electrónicos. El reciclaje y la recogida separada de estos residuos en el momento de la eliminación contribuirán a preservar los recursos naturales y a garantizar que este equipamiento sea reciclado de manera que proteja la salud y el medio ambiente. Si desea información adicional sobre los lugares donde puede dejar sus residuos para su reciclaje, póngase en contacto con las autoridades locales de su ciudad, con el servicio de gestión de residuos domésticos o con la tienda donde adquirió el producto.

Eliminazione di rifiuti elettrici ed elettronici per i privati in Europa
Questo simbolo sul prodotto indica che non si può smaltire questo prodotto con i rifiuti domestici. Per questo tipo di rifiuti, è necessario un luogo di raccolta e riciclaggio separato. La raccolta e il riciclaggio separati di questi rifiuti elettrici ed elettronici contribuiranno a conservare le risorse naturali e a garantire che questi apparecchi siano riciclati in modo da proteggere la salute umana e l'ambiente. Per maggiori informazioni sui punti di raccolta, si prega di contattare l'ufficio locale, il servizio di gestione dei rifiuti domestici o il negozio in cui sono stati acquistati.

Eliminación de residuos de aparatos eléctricos y electrónicos en particular en los hogares de la UE
Este símbolo en el producto o en su embalaje indica que este producto no se puede desechar con los residuos domésticos. En su lugar, es responsable de llevarlo a un punto de recogida específico de residuos de aparatos eléctricos y electrónicos. El reciclaje y la recogida separada de estos residuos en el momento de la eliminación contribuirán a preservar los recursos naturales y a garantizar que este equipamiento sea reciclado de manera que proteja la salud y el medio ambiente. Si desea información adicional sobre los lugares donde puede dejar sus residuos para su reciclaje, póngase en contacto con las autoridades locales de su ciudad, con el servicio de gestión de residuos domésticos o con la tienda donde adquirió el producto.

Eliminazione di rifiuti elettrici ed elettronici per i privati in Europa
Questo simbolo sul prodotto indica che non si può smaltire questo prodotto con i rifiuti domestici. Per questo tipo di rifiuti, è necessario un luogo di raccolta e riciclaggio separato. La raccolta e il riciclaggio separati di questi rifiuti elettrici ed elettronici contribuiranno a conservare le risorse naturali e a garantire che questi apparecchi siano riciclati in modo da proteggere la salute umana e l'ambiente. Per maggiori informazioni sui punti di raccolta, si prega di contattare l'ufficio locale, il servizio di gestione dei rifiuti domestici o il negozio in cui sono stati acquistati.