

Copy using the automatic document feeder (ADF)

| How do I? | Steps to perform |
|---|--|
| <p data-bbox="86 373 579 443">Load originals using the automatic document feeder (ADF)</p> <p data-bbox="86 624 705 762">CAUTION: To prevent damage to the product, do not use an original that contains correction tape, correction fluid, paper clips, or staples. Also, do not load photographs, small originals, or fragile originals into the ADF. Use the flatbed glass to scan these items.</p> | <ol data-bbox="716 347 1346 1193" style="list-style-type: none"><li data-bbox="716 347 1346 459">1 Insert the top-end of the stack of originals into the automatic document feeder input tray, with the media stack face-up and the first page to be copied on top of the stack.<li data-bbox="716 624 1346 715">2 Slide the stack into the ADF until it does not move any farther. Document loaded appears on the control-panel display.<li data-bbox="716 842 1346 906">3 Adjust the media guides until they are snug against the media.<li data-bbox="716 1134 1346 1193">4 Press Start Copy on the product control panel to start copying.     |

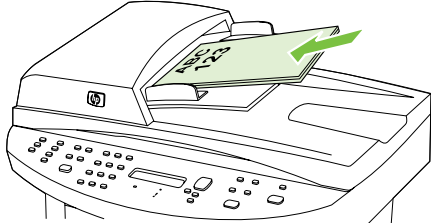

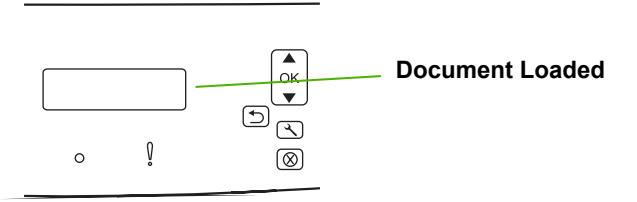
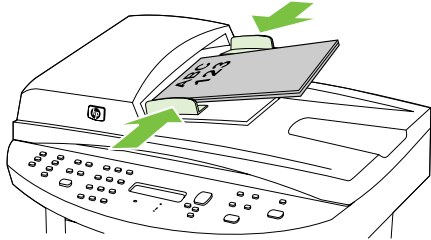
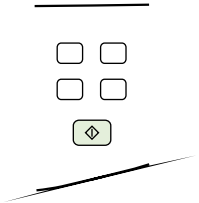
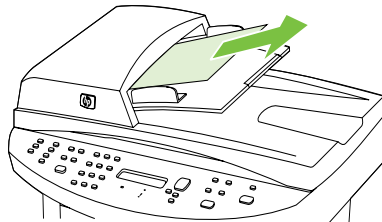
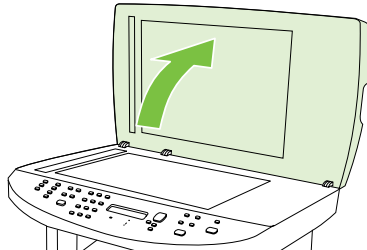
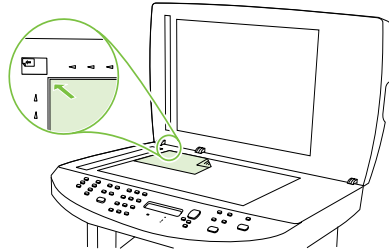
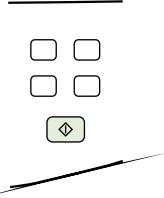

Copy using the flatbed scanner

| How do I? | Steps to perform |
|-------------------------------------|---|
| Load originals in a flatbed scanner | <ol style="list-style-type: none"><li data-bbox="730 347 1333 399">1 Make sure that the automatic document feeder (ADF) contains no media. <li data-bbox="730 587 1081 614">2 Lift the flatbed scanner cover. <li data-bbox="730 858 1333 941">3 Place the original document face-down on the flatbed scanner with the upper-left corner of the document at the corner indicated by the icon on the scanner. <li data-bbox="730 1129 976 1157">4 Gently close the lid.<li data-bbox="730 1177 1333 1228">5 Press Start Copy on the product control panel to start copying.  |



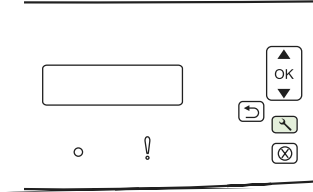
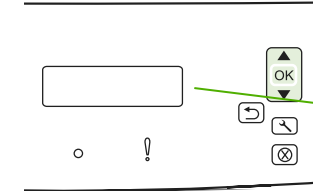
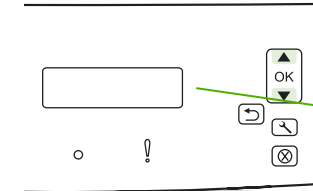

Collate my copy job

| How do I? | Steps to perform |
|---|---|
| <p data-bbox="86 371 569 411">Change the copy-collation setting</p> <p data-bbox="86 592 716 647">NOTE: The factory-set default for automatic copy collation is On.</p> | <ol style="list-style-type: none"><li data-bbox="716 347 1346 379">1 On the product control panel, press Setup (⏏).<li data-bbox="716 592 1346 647">2 Use the arrow buttons to select Copy setup, and then press OK.<li data-bbox="716 836 1346 892">3 Use the arrow buttons to select Def. Collation, and then press OK.<li data-bbox="716 1080 1346 1112">4 Use the arrow buttons to select On or Off.<li data-bbox="716 1329 1346 1361">5 Press OK to save the selection.     |



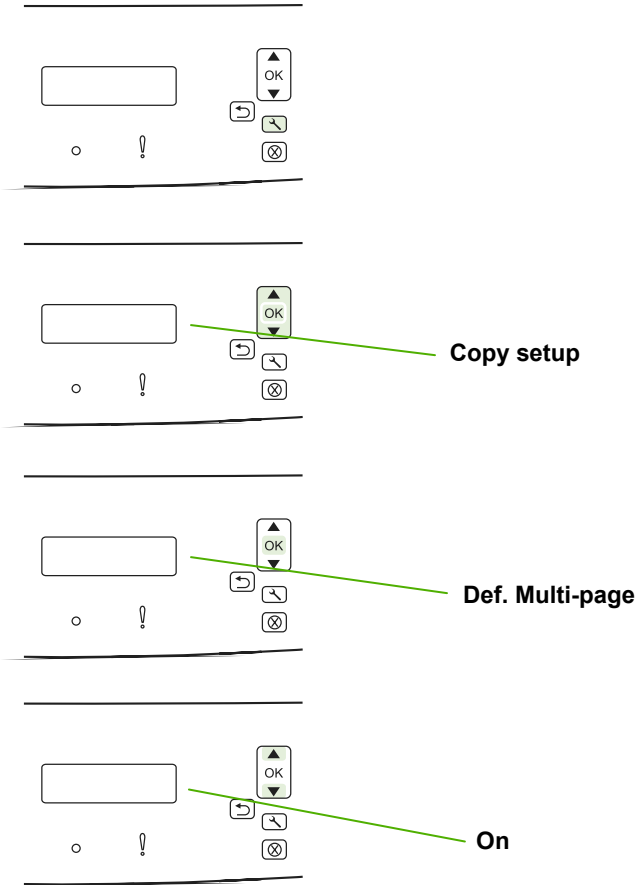

Copy on both sides (Duplex)

| How do I? | Steps to perform |
|---|--|
| <p data-bbox="86 373 617 408">Copy two-sided documents manually</p> <p data-bbox="86 501 709 555">NOTE: The factory-set default for automatic copy collation is On.</p> | <p data-bbox="716 357 1205 384">Set the multiple-page flatbed copy setting</p> <p data-bbox="716 400 1335 480">The multiple-page flatbed copy setting must be set to On before the product will produce two-sided copies from the flatbed scanner.</p> <ol style="list-style-type: none"><li data-bbox="716 501 1255 528">1 On the product control panel, press Setup (⏏).<li data-bbox="716 740 1335 794">2 Use the arrow buttons to select Copy setup, and then press OK.<li data-bbox="716 975 1146 1002">3 Press OK to select Def. Multi-page.<li data-bbox="716 1203 1136 1230">4 Use the arrow buttons to select On.  |



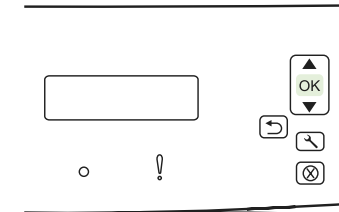
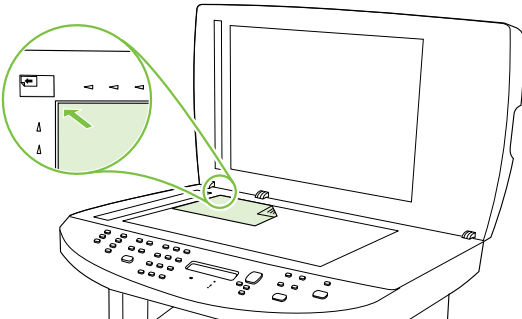
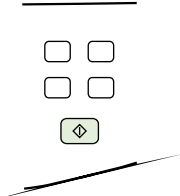

| How do I? | Steps to perform |
|--|---|
| <p>Copy two-sided documents manually (continued)</p> | <p>5 Press OK to save the selection.</p>  <p>6 Load the first page of the document on the flatbed scanner.</p>  <p>7 Press Start Copy.</p>  <p>8 Remove the first page, and then load the second page onto the flatbed scanner.</p> |





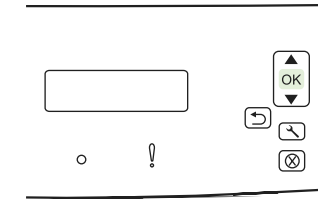
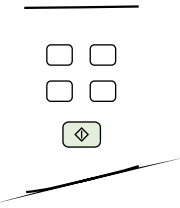

| How do I? | Steps to perform |
|--|--|
| <p>Copy two-sided documents manually (continued)</p> | <p>9 Press OK, and then repeat the process until all of the pages in the original have been copied.</p>  <p>10 When the copy job is completed, press Start Copy to return the product to Ready mode.</p>  |



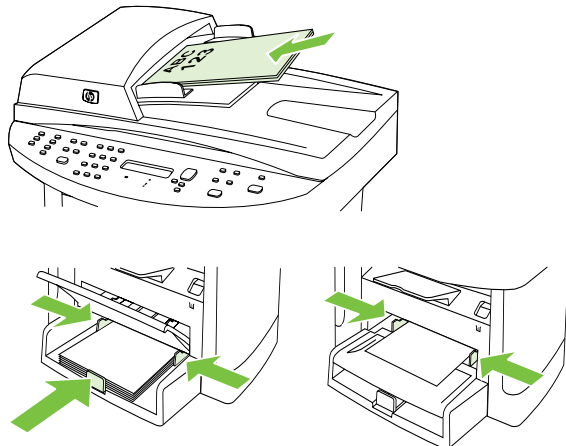

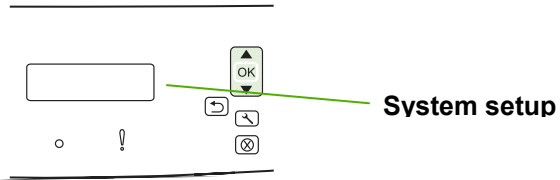
Copy on special paper, labels, or transparencies

| How do I? | Steps to perform |
|---|--|
| <p>Copy on special paper, labels, or transparencies</p> | <p>1 Load the documents to be copied into the document feeder input tray with the first page facing up, and with the top of the page leading into the document feeder.</p> <p>-Or-</p> <p>2 Load the special media into the priority input tray or tray 1.</p>  |
| | <p>Change the default media-size setting</p> <p>3 On the product control panel, press Setup (⚙️).</p>  <p>4 Use the arrow buttons to select System setup, and then press OK.</p>  |



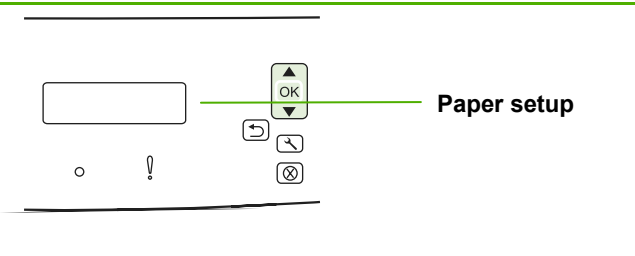
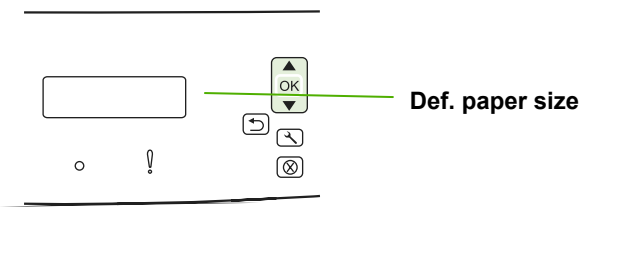
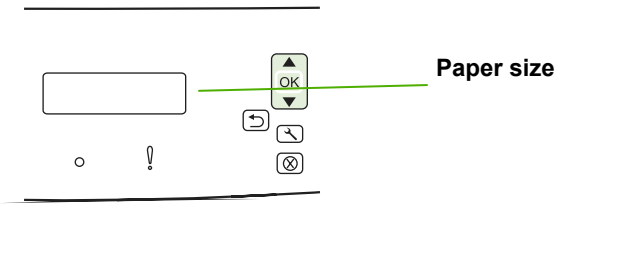

| How do I? | Steps to perform | |
|---|---|---|
| <p>Copy on special paper, labels, or transparencies (continued)</p> | <p>5 Use the arrow buttons to select Paper setup, and then press OK.</p> |  |
| | <p>6 Use the arrow buttons to select Def. paper size, and then press OK.</p> |  |
| | <p>7 Use the arrow buttons to select a media size, and then press OK.</p> |  |
| | <p>8 Press OK to save the selection.</p> <p>9 Press Start Copy on the product control panel to start copying.</p> |  |



Copy on pre-printed letterhead or forms

| How do I? | Steps to perform |
|---|---|
| Copy on pre-printed letterhead or forms | <ol style="list-style-type: none"><li data-bbox="730 347 1346 432">1 Load the documents to be copied into the document feeder input tray with the first page facing up, and with the top of the page leading into the document feeder.<li data-bbox="730 644 1346 729">2 Load the letterhead or form into the priority input tray or tray 1. Load media with the top forward and the side to be printed on facing up. <p data-bbox="730 948 1226 975">Change the default paper-type to letterhead</p> <ol style="list-style-type: none"><li data-bbox="730 1002 1346 1029">3 On the product control panel, press Setup (⚙️). |

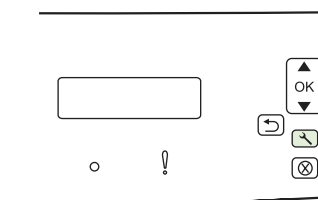
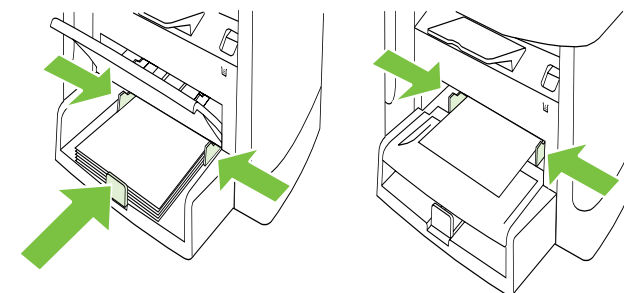

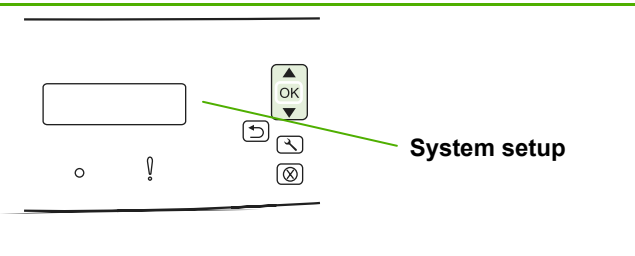
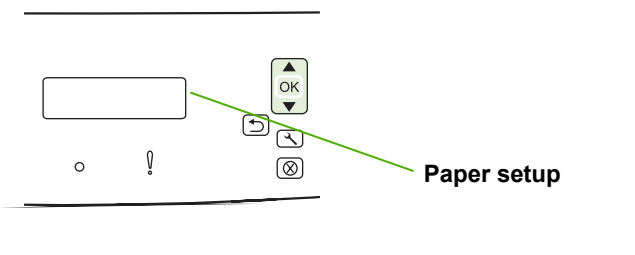
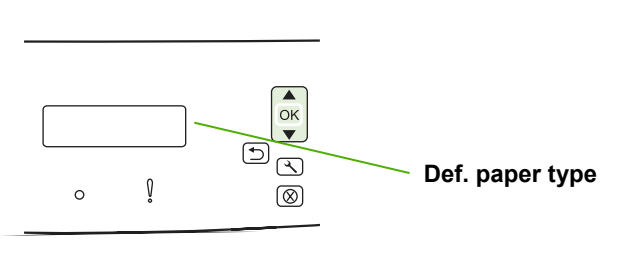
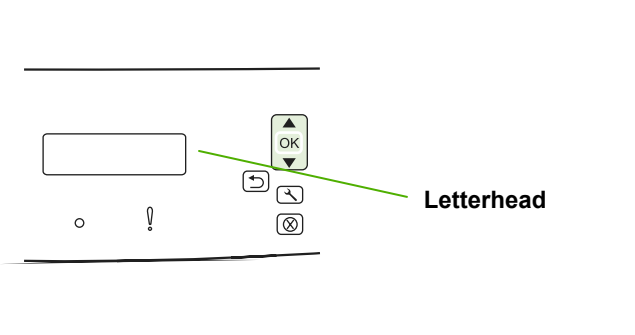

| How do I? | Steps to perform | |
|--|---|---|
| <p>Copy on pre-printed letterhead or forms (continued)</p> | <p>4 Use the arrow buttons to select System setup, and then press OK.</p> |  |
| | <p>5 Use the arrow buttons to select Paper setup, and then press OK.</p> |  |
| | <p>6 Use the arrow keys to select Paper type, and then press OK.</p> |  |
| | <p>7 Use the arrow buttons to select Letterhead, and then press OK.</p> |  |



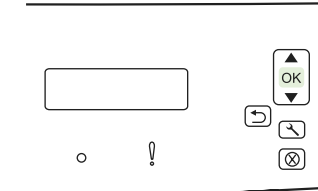
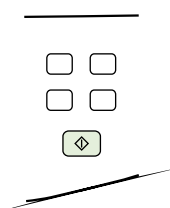

| How do I? | Steps to perform |
|--|---|
| <p>Copy on pre-printed letterhead or forms (continued)</p> | <p>8 Press OK to save the selection.</p>  <p>9 Press Start Copy on the product control panel to start copying.</p>  <p>Change the default paper-type to a preprinted form</p> <p>10 Follow the above steps selecting Preprinted for the paper type.</p> |



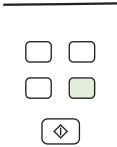
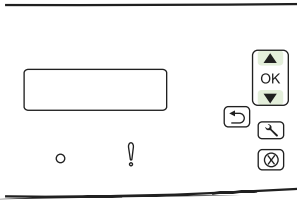
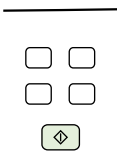

Make my copy look better

| How do I? | Steps to perform |
|--|---|
| <p>Adjust the copy quality for the current job</p> | <ol style="list-style-type: none"><li data-bbox="730 347 1344 406">1 On the product control panel, press Quality to see the current quality setting for the copy. <li data-bbox="730 590 1291 649">2 Use the arrow buttons to scroll through the quality setting options. <li data-bbox="730 837 1344 925">3 Select a setting, and then press Start Copy to save the selection and immediately start the copy job, or press OK to save the selection without starting the job.  |



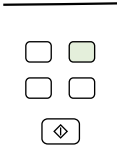
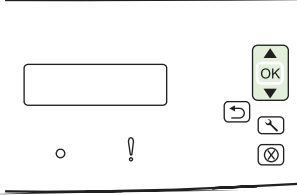
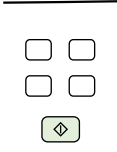

Reduce or enlarge the image

| How do I? | Steps to perform |
|---|---|
| <p>Reduce or enlarge copies for the current job</p> | <ol style="list-style-type: none"><li data-bbox="720 347 1344 375">1 On the product control panel, press Reduce/Enlarge. <li data-bbox="720 595 1312 646">2 Select the size to which you would like to reduce or enlarge the copies in this job. <li data-bbox="720 845 1312 925">3 Press Start Copy to save the selection and immediately start the copy job, or press OK to save the selection without starting the job.  |

