

HP Designjet H35000/H45000 Printer series

# Release Notes

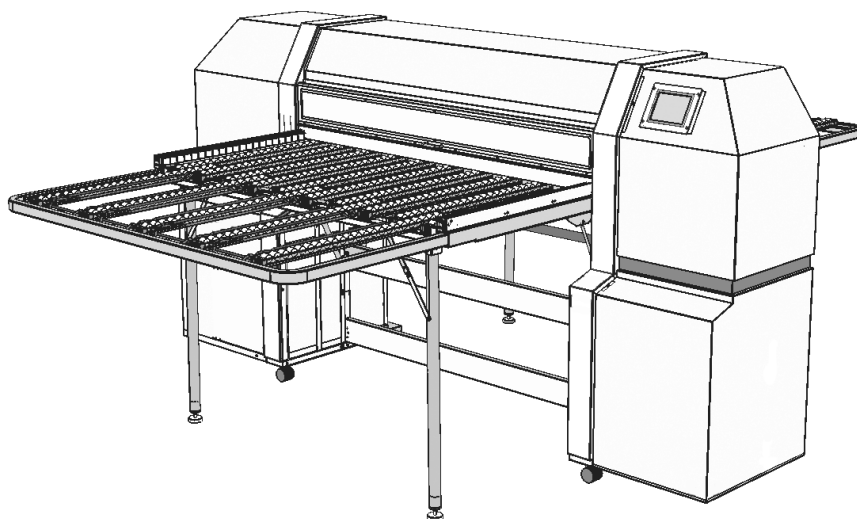

# Update instructions

The printer embedded software is updated by copying the new version from the RIP to the printer.

1. Make sure the printer is online.
2. Wait until the printer has finished printing.
3. If you are using the Caldera or Onyx RIPs, configure and load media before proceeding to the next step.
4. Locate the update file DJHxxxxx.BIN (on disc provided by your reseller or downloaded from the HP web site at [www.hp.com/go/graphicarts](http://www.hp.com/go/graphicarts) > Support and Drivers) that matches the model of your printer (for example, DJH35500.BIN for the DesignJet H35500 printer).
5. Copy the file to the printer according to the RIP you are using:
  - HP RIP Software — Copy the update file to a Hot Folder that is routed to the printer.
  - Onyx — Select Configure Printer from the top menu bar. Select the Device tab and the select Features. With Update Printer Firmware highlighted, select Configure. Finally, locate the update file using the browse for file option, and select Open.
  - Scanvec — Select Setup from the top menu bar, and then select Color Profile. Select Create ICC Output. Select Driver Options. Finally, select Browse to locate the update file, and then select Open.
  - Caldera — Select the printer from the main application box, click the wrench icon.



## Note

After restarting (or powering up) the printer, it will be approximately 30 seconds before the software displays anything on the control panel.

6. Verify the software update.

To display the software version number on the printer's control panel, press the top center area of the Front Page display. The version number appears:

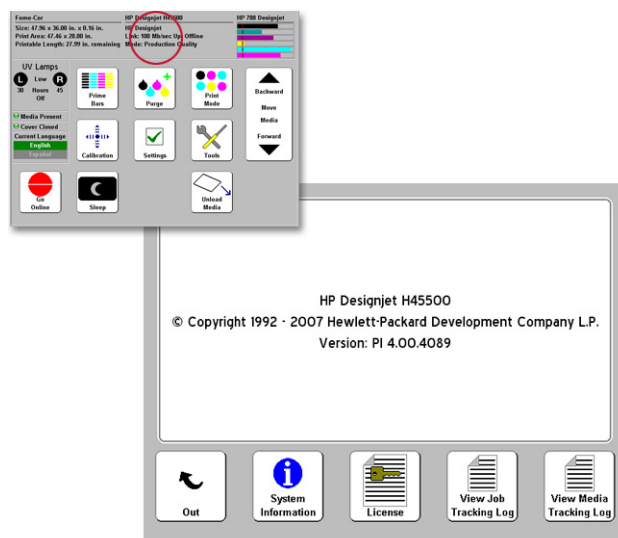

---

# Version 4.00

- **NEW Production Plus mode** — this is a 600x600 dpi print mode that uses an additional print pass compared to 600x600 Production print mode. This may help to improve images with heavy ink coverage in Production mode. (Note: In this mode, the Jet Out Lines pattern will have a blank section near the top of the pattern.)
- **NEW Maintenance reminders** — the control panel will now display maintenance reminders for the following items, to help keep your printer maintained and performing well:
  - Clean the rail
  - Oil the rail
  - Replace/Clean the UV lamp filters
  - Clean service station
  - Replace service station wipers
- **NEW Troubleshooters** — the following automated troubleshooting routines have been added to the control panel menu, to further enable you to troubleshoot printer issues:
  - Service Station
  - UV System
  - LVDS
  - Image Quality
  - Rail Motion

In addition, the following troubleshooters have been improved:

- Head Motion
- Vacuum Pressure
- **NEW Serial numbers displayed** — prime bar prints now include the serial number of the printer and each print-head. The printhead serial numbers are also shown on a new Front Page information page. This data is useful for technical support personnel.
- **NEW Second language support** — the control panel supports switching between English and one other language (French, German, Italian, Portuguese, and Spanish). The second language desired must be downloaded from the HP web site (<http://www.hp.com/go/graphicarts> > Support and Drivers) and installed according to the instructions included with the downloaded language files (available after July 15, 2009). If no second language is installed, the language switch button on the control panel Front Page will display "None Installed."
- **More informative error messages** — the text displayed for the error codes has been revised with more meaningful diagnostic information. Any errors are now also listed on the control panel along with Action and Warning messages.
- **Service station improvements** — to reduce ink odor, the service station vacuum now operates for shorter periods. In addition to cleaning the printheads, the vacuum now cleans the bottom of the carriage between the printheads (**Menu > Tools > Maintenance > Clean Bottom of Carriage**). Home positioning is now more accurate. The control panel displays an error if the wiper's home position is incorrect by more than 0.5 in (1.3 cm).

- Software improvements to increase reliability and performance in the following areas:
  - Ink delivery system (including ink tracking for large print jobs)
  - Jet replacement algorithms
  - Motor control
  - Onboard color sensor

# Version 4.00 Menu Tree

New Option = item added since version 2.04

~~Old Option~~ = item deleted since version 2.04

*Italic* = dynamically hidden, depending on mode

## Calibrate Printer

- Auto Calibrations
  - AutoBidi Calibration
  - AutoH2H Calibration
  - AutoJet Calibration
  - Full AutoSet
- Manual Calibrations
  - Media Feed
  - Manual Bidi Registration
  - Manual X Head Registration
  - Manual Jet Mapping
  - Print Jet-Out Lines
  - Default Registration Data
- Service Calibrations
  - Head Height Calibration
  - Media Thickness Sensor Calibration
  - Service Station Calibration
- AutoTune (roll-fed media only)*
- Calibration Summary
  - AutoSet Summary
  - Log Head Registration Data
  - Log Jet Data
- Configure for Profile Creation*

## Printer Settings

- Platen Vacuum Control
- Printing Delay
- Gutter Settings
  - Top Gutters
  - Side Gutters
- Margin Settings
  - Space Between Prints
  - Right and Left Margin
  - Leading Margin
  - Trailing Margin
- Print Position
- Print White Space
- Head Height Off Media
- Media Out Sensor
- Measure Media Type
  - Measure Media Frequency
  - Measure Media Type
- Quality Check
- Sleep Wait Time
- Expert/Novice Messages
- Localization
  - Units of Measure
  - Time Format
  - Date Format

- Vacuum Pressure Units
- Language (if installed)*
- Delete language (if installed)*
- Automatic Eject
- Low Ink Warning
- UV Lamps Idle Time
- Purge Type
- SS Vacuum Warning Level
- Printer Name
- Restore All Defaults

## Tools

- Turn UV Lamps On*
- Turn UV Lamps Off*
- System Information
- Maintenance*
  - Access Printheads
  - Perform An Air Purge
  - Print Recover Jets Pattern
  - Print Jet-Out Lines
  - Print Media Skew Lines
  - Reset UV Lamp Hours
  - Clean Grit Rollers
  - Clean Bottom of Carriage
  - Printhead Procedures
    - Load Ink In All Heads
    - Fill Heads with Ink
    - Empty Heads (Fill with Air)
- User Diagnostics
  - Printhead Jet Statistics
  - VideoNet Status
  - VideoNet Connection
  - Carriage Motion
  - Calibration
  - Vacuum Pressure
  - Service Station
  - UV System
  - UVDS
  - Print Quality
  - Rail Motion
  - Warnings and Actions List
  - Error History
  - Log Error History
- Print Menus
- Service Printer
- Warnings and Actions (in Expert mode)*

---

# HP Customer Care Centers

For service and support, contact your local reseller, who can provide prompt and personalized support. For issues that cannot be resolved by your reseller, contact Hewlett-Packard:

- North America
  - Tel: 800 925 0563
  - Fax: 952 944 8509
  
- Latin America: Please dial Option 2/Option 6 on selection menu
  - México: 52 55 5258-9922
  - Argentina:5411 470 816 00
  - Brasil:52 55 5258-9922
  - Chile:562 436 2610; 800 360 999
  - Colombia:571 602 9191; 01 8000 51 4746 8368
  - Perú:511 411 2443; 0 800 10111
  - Venezuela:58 212 278 8666; 0 800 474 68368
  - Costa Rica:0 800 011 0524
  - El Salvador:800 6160
  - Guatemala:1 800 999 5105
  - Honduras:800 0 123/1 800 711 2884
  - Nicaragua:1 800 0164/800 711 2884
  - Panamá:001 800 711 2884
  - República Dominicana:1 800 711 2884
  - CC LAR Nextel:(5255) 1088 0884; ID 52\*20115\*51
  - CC LAR e-Mail:carecenter.ipgjf.lar@hp.com
  - CC LAR Fax: +52 55 5258 6377
  
- Asia, Pacific, Japan
  - Tel: +852 8103 2666
  - Tel (Taiwan only Toll free): 00 801 85 5945
  - Fax: +852 2187 2218
  - E-mail: hsap.carecenter@hp.com
  
- Europe, Middle East, Africa
  - Fax: +31 20 7157536
  - E-mail: LF.MV.Support@hp.com

---

# Version 2.04

- **Top gutter additions, corrections** — the factory now enters the printer's serial number into the printer's memory. This enables the serial number to be printed in the top gutter legend of printed output. The direction of printing in unidirectional mode now appears in the top gutter. Sharp Edge mode was being indicated twice in the top gutter; this version removes the second occurrence.
- **Quality Check failure raises Warning message** — if Quality Check is set to "unattended," and a print job fails the Quality Check, the printer now raises the Warning, "W-PC-9 Quality Check Denied a Job." For details, press the info button on the Warning screen. The Warning is not raised if Quality Check is set to "attended," because in this case the printer waits for the user to acknowledge that the job is being rejected.
- **Lamps can be shuttered in the non-printing direction in unidirectional mode** — when setting unidirectional print mode, the printer presents the option to completely shutter the UV lamps in the non-printing direction, or keep them at the same setting as during printing (the default setting). This option reverts to the default if the printer is restarted.
- **Media thickness can be entered manually** — the Media Wizard now allows you to use or not use the media thickness sensor during the media load process. If you choose not to use the sensor, you manually enter the media thickness via the control panel. This value is stored in the Media Wizard settings as in previous versions.
- **Service Station check** — if the service station height is not calibrated, the printhead carriage rail will not lower, and an error message will be displayed on the control panel.
- **Canceling service station calibrations** — you can now cancel the service station calibrations after confirming that the service station is below the platen. The rail will stay at the home position and the carriage will be sent home.
- **Slow carriage motion test can be skipped** — during the Carriage Motion test (**Tools > User Diagnostics > Carriage Motion**), you can choose to perform or skip the "slow speed motion test."
- **Camera height calibration warning** — after calibrating the head height and media thickness sensor, a reminder to calibrate the camera height now appears on the control panel, and a warning is placed in the Attention queue.
- **Shutter aperture settings now work when printing in Sharp Edge mode** — when a print job was received with Sharp Edge mode enabled, the shutter aperture settings were being ignored if they were different from the settings stored in the Media Wizard. This version uses the settings stored in the print job.
- **ATTN key no longer pauses printing** — pressing the ATTN (Attention) key during printing no longer causes printing to pause.

---

## Version 2.03

This version fixes a bug that caused the shutter aperture settings to not work as expected when printing in Sharp Edge mode.

---

## Version 2.02

- **NEW Service Station Vacuum Warning Level** — you can now set the level at which the warning to empty the service station vacuum reservoir will appear. The level ranges from 3.75 liters (approximately 1.0 gallons) to 11.25 liters (approximately 3 gallons) in 250 ml increments. When you increase this setting, more time elapses between warnings. (**Front Page > Printer Settings > SS Vacuum Warning Level**)
- **NEW Purge Type** — you can now set the default purge type (Standard or Performance), in addition to selecting one of these types when you initiate a purge. (**Front Page > Printer Settings > Purge Type**)
- **Autojet now reports mapped-out jets correctly** — Autojet was incorrectly reporting that some light cyan and magenta jets were mapped out, when they were not.
- **Overprint setting is now correct in both English and metric units** — the software was incorrectly using an overprint setting of zero when the units of measure was set to metric.

---

## Version 2.01

- **NEW HP Branding** — this version of the software “rebrands” your ColorSpan product to a Hewlett-Packard product, to reflect the acquisition of MacDermid ColorSpan, Inc. by Hewlett-Packard Company:

MacDermid ColorSpan product name	Hewlett-Packard product name
ColorSpan 5440UV Printer	HP Designjet H35100 Printer
ColorSpan 5445UV Printer	HP Designjet H45100 Printer
ColorSpan 5460UV Printer	HP Designjet H35500 Printer
ColorSpan 5465UV Printer	HP Designjet H45500 Printer
SolaChrome UV Ink	HP Designjet 788 Ink
3M Series 5400UV Ink	HP Designjet 788 Specialty Ink

After applying this software update, the product names shown by the software will not match the physical product labeling, and you will not be able to “downgrade” to a previous version.

- **NEW Current ink volume reporting** — the amount of ink used by each color channel is now included in the job log.
- **NEW Media Out indication on control panel** — the control panel now displays whether media is present.



- **Media leading edge found on the right side** — when measuring the media, the leading edge is found on the right side (user end) to avoid overheating the media.
- **Recovery from carriage motion errors while in Sleep Mode** — the printer is now able to recover from carriage motion errors, such as when the cover is raised, that occur during Sleep Mode.
- **Printhead service during Sleep Mode** — the printer now remembers if the printer was in Sleep Mode before an automatic printhead service. If it was, the software returns the printer Sleep Mode after the service is complete.
- **Side gutters print at correct size** — the side gutters now print at a consistent size, regardless of the resolution.
- **Changing the media advance during printing** — when you change the media advance during printing, the amount of change has been reduced to enable more precise adjustments.
- **Improved UV lamp information page** — this information screen on the control panel has been reorganized for clarity.

## Version 2.0

- **NEW Hewlett-Packard splash screen** — the Hewlett-Packard logo now appears when the printer embedded software is first started, to reflect the acquisition of MacDermid ColorSpan by Hewlett-Packard Company on November 1, 2007.
- **NEW Service station calibration controls** — the Service Station Calibration screen now provides arrow keys to move the service station up and down, and wipers forward and back, at either of two speeds. This enables you to align them with greater precision. (**Front Page > Calibration > Service Calibrations > Service Station Calibration**)

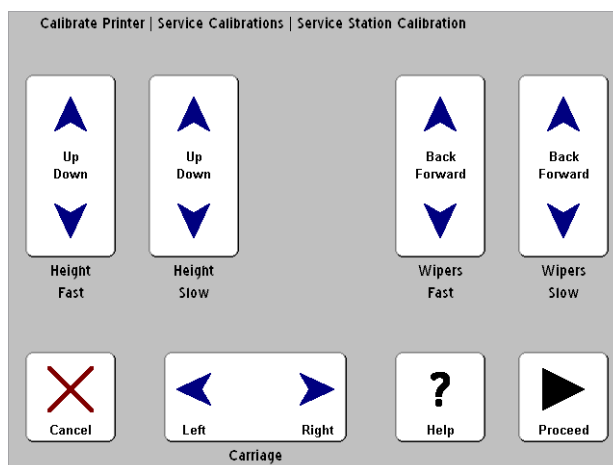

- **NEW Service station vacuum warning** — a Warning message appears on the control panel when the user should check the service station vacuum to determine whether it should be emptied of ink, before and after certain printhead maintenance procedures, and whenever the printer has detected that enough ink has been used in printhead maintenance since the last time the vacuum was emptied.
- **NEW Valid margin checking** — the software now verifies that the sum of the right and left margins is less than the width of the media.
- **NEW Progress bar** — a progress bar graph is now displayed on the control panel to report the percentage complete of certain processes:
  - Printing

- Printhead servicing (purge and wipe)
- Auto calibrations
- Cooling the photodiode
- **Print mode used with internal print jobs** — since the user print mode is unchanged, the print mode used for internal jobs is no longer reported on the control panel. This issue affects the following reports and test patterns:
  - Print Menus
  - Print Info Pages
  - Image Sensor Height Calibration Pattern
  - Take and Print Picture Patterns (Image Sensor Tests)
- **Reconciling settings in equivalent print modes** — from the standpoint of UV curing and temperature, the Billboard 600x600 dpi print mode is equivalent to Production 600x300 dpi mode. If you set the **Lamp Mode**, **Lamp Shutter Aperture**, or **Printing Delay** settings for these modes to different values, the values for Billboard 600x600 dpi are automatically used. To clarify this condition and to inform the user which resolutions are not supported by certain print modes, a new screen appears at the end of the Print Mode setting process:

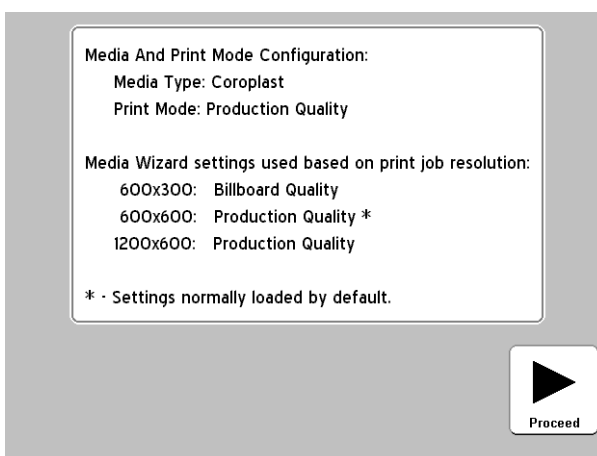

- **Improved handling of one-inch thick media** — the printer now more reliably loads one-inch thick media.
- **Improved recovery from carriage motion failures** — you must now confirm at the control panel that the carriage is in the home position when recovering from a carriage motion failure.
- **Lamp settings loaded correctly** — the printer will now check the printing direction setting (bidirectional or unidirectional), and load the corresponding lamp settings (UV Lamp Mode, UV Lamp Aperture, and Print Delay) when loading a new media type in the printer.
- **Eject sheet motion improved** — when a sheet of media is ejected from the printer, it now happens in a single smooth motion rather than with a series of start-stop motions.
- **Manually-initiated sleep mode no longer requires control panel keypress** — previous versions of the software required you to press a key on the control panel before the printer would enter Sleep mode when manually initiated at the control panel. This is no longer required.
- **Printhead servicing no longer occurs during calibrations** — an automatic printhead service (purge and wipe) during a calibration that was initiated from an Attention screen is no longer allowed.

- **Aperture settings included** — the UV Lamps Apertures settings, omitted from the Media Wizard settings screen in previous versions of the software, now appear on this screen.

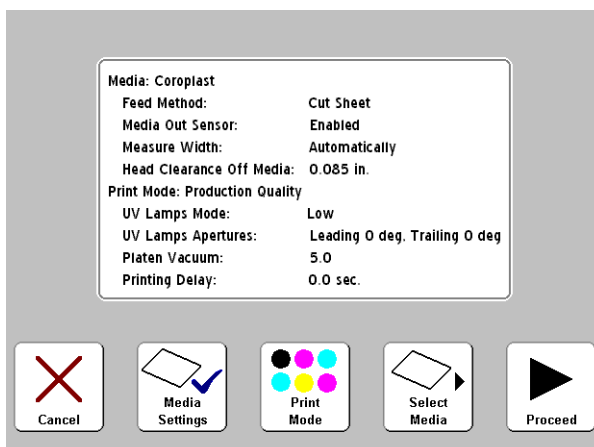

- **Service station vacuum switched off after head motion failure** — after a head motion failure, the service station vacuum now shuts off immediately, rather than waiting for the user to press a key on the control panel.
- **Media Wizard settings for 3M inks** — for standard media types, the Media Wizard settings are optimized for 3M inks if 3M profilers are present, to compensate for differences in curing compared to SolaChrome UV inks.

---

## Version 1.11

- **NEW Service Calibrations** — a new menu called Service Calibrations has been added, which contains the head height, service station and media thickness sensor calibrations. Refer to the *User Manual Revision C* for instructions.
- **AutoTune message added** — when the printer is automatically performing AutoJet calibrations, the control panel displays the message "Performing AutoTune Service."
- **Wiping during Performance Purge** — to extend the service life of the wipers, during a Performance Purge the wipers now wipe in one direction only, and do not maintain contact with the printheads when changing direction.
- **Clear all bad jets for a head** — you can now clear all of the bad jets on a single printhead. This is useful when a printhead is replaced. The existing **Clear all bad jets** function still clears all of the bad jets on all printheads. Refer to the *User Manual Revision C* for instructions. (**Calibration > Manual Calibrations > Manual Jet Mapping**)
- **Lamps set to low power when carriage is paused during printing** — this has been implemented to extend the life of the UV lamps and prevent overheating.
- **Revision C User Manual** — a revised user manual is being released at the same time as this software version.
- **Various issues resolved, including:**
  - Carriage striking edge guards or platen during auto calibrations — the minimum focus height of the camera (digital imaging sensor) has been raised to avoid this situation.
  - When a new media type is created with a head height of 0.065 inches, the setting is now saved.
  - False "Media Out" condition — adjustments have been made to prevent the Input side light-blocking brushes from causing a false Media Out condition.

- Printer stuck at “Finishing Job” — to prevent the printer from remaining in the “Finishing Job” state after a job has printed, the control panel will display a Cancel button if an end-of-job indication is not received from the RIP after one minute. If no such indication is received for ten minutes, or if the VideoNet cable connection is lost during this time, the printer will close the connection and go back to the ready state.
- Rail moved to home during startup — this has been implemented to ensure that the carriage will not strike the service station or platen during the printer’s power-on cycle, and ensure accurate head height positioning.
- After a purge & wipe of the printheads is canceled, vacuum is now switched off as expected.
- Camera (digital imaging sensor) errors have been reduced.
- When reloading media with the optional foot pedal switch, the control panel now properly reports the media status as loaded, and accurately reports the length of the media.
- If specified, a print delay is now applied to calibration prints as well as print jobs sent from the RIP.
- Lamp current detection has been improved when only one lamp is on. This should ensure better curing when using one lamp.

---

## Version 1.10

- **Sheet-fed media loading improvements** — this version of the embedded software detects when the media drive rollers are down but no media is present, and raises the rollers so that media can be loaded.
- **Media reload workflow improved** — the previous version of the embedded software required the user to press the Proceed key on the control panel after successfully unloading the media prior to reloading a new sheet. This is no longer required by the current version of the software.
- **Ink counting accuracy** — ink counting accuracy has been improved.
- **Media width reporting accuracy** — the media width reported by the control panel was sometimes 0.1 inch (2.5 mm) under the actual width. This has been corrected.
- **“No current sensed” error** — erroneous “No current sensed” Action messages have been corrected.
- **3M ink colors shown in gutter message** — all 3M ink colors are now reported in the gutter message. The previous embedded software version omitted some of the colors.
- **Ink dripping on media** — ink leftover from a “micropurge” of the printheads, which is designed to keep the inkjets operating reliably, is now serviced (wiped at the service station) before moving the printhead carriage over the media.
- **Prep for Shipping** — this function has been added to the Service menu, to guide you through emptying the heads and flushing them out using a flush bottle, prior to shipping the printer.

---

## Version 1.09

- **NEW Measure Media Frequency** (cut sheet media only) — you now have the option **Full Measure only on first load**, which measures the first sheet of media using the method selected in Measure Media Type, and subsequent

sheets using the Minimal method; or **Full Measure on all loads**, which always uses the method selected in Measure Media Type.

**Full Measure only on first load** can increase the throughput speed of multiple-copy print jobs when the media dimensions are known to be uniform. It is not recommended for jobs that require very precise placement of images relative to the edges of the media. (**Menu > Printer Settings > Measure Media Type**) For further information about Measure Media Types, refer to Chapter 3 of the *User Manual*.

- **NEW Head height added to the Media Wizard** — the print head height off the media is now stored in the Media Wizard record for each media type. If the printer's current head height off the media is different from that stored in the Media Wizard for the selected media, the printer prompts you to change one or the other.
- **NEW Sleep/Wake menu option moved to Front Page** — Enter Sleep Mode and Recover from Sleep Mode been removed from the Tools menu, and replaced with a Sleep/Wake key on the Front Page screen. The Sleep/Wake function otherwise works as before.
- **Media Reload** — this feature now takes less time due to changes in how the edges and height of the media are detected.
- **Extra swaths to ensure complete curing** — at the end of a print, the printhead carriage will continue moving past the print zone a few times with the lamps on to ensure complete curing.
- **Manual bidi calibration pattern improved** — this pattern is now easier to read. The vertical reference marks are longer, so it is easier to see how the lines printed in each direction align with each other.

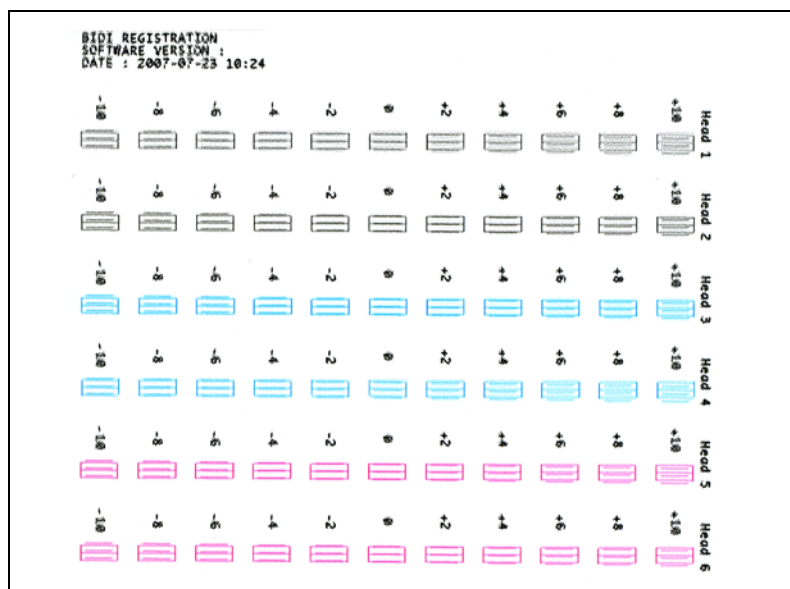

- **User Manual revised** — the user manual has been revised to describe all software features through version 1.09. The current revision of the *User Manual* is Revision B. It can be downloaded from the ColorSpan web site ([www.colorsprint.com](http://www.colorsprint.com)).

## Version 1.08

- **NEW 3M™ Matched Component System (MCS™) option** — this version supports the field conversion of the printer to use 3M ink and graphic media for the HP Designjet H35000/H45000 Printer series. Printed output from converted printers is covered by a 3M MCS Warranty. The field conversion requires a conversion kit, part number 0901583.

- **NEW Sharp Edge** — Sharp Edge reduces overspray at the edges of images and blocks of color. It is available for all resolutions in Production mode, and 1200x600 and 600x600 dpi in High Quality mode. Fine Text and Sharp Edge usage are reported in the gutter on printed output (when the gutter is enabled). You can enable or disable Sharp Edge mode via the Print Mode button on the Front Page screen.
- **NEW Media Tracking Log** — you can display the amount of roll-fed and sheet-fed media used by pressing the printer status area of the Front Page screen (near the center top edge of the screen), then pressing the View Media Tracking Log key. The counts can also be reset to zero from this screen.
- **Minimum trailing margin reduced** — the minimum trailing margin for rigid media is now 6 inches (15.2 cm).

**Leading edge static control** — reduces overspray in areas of fine text in the first 0.6 inches (15 mm) leading edge of a rigid media print. You can disable or enable this feature in the control panel menu when you set the platen vacuum level.

---

## Version 1.07

- **NEW UV lamp controls** — the UV lamps area (“info panel”) on the Front Page screen of the control panel has been enhanced:
  - Whenever the UV lamps are warming up or cooling down, the time remaining until they are finished is displayed.
  - Touching the UV lamps info panel reveals a UV lamps settings screen, where you can turn on and off the lamps and adjust the lamps (power and shutter apertures, see next item).

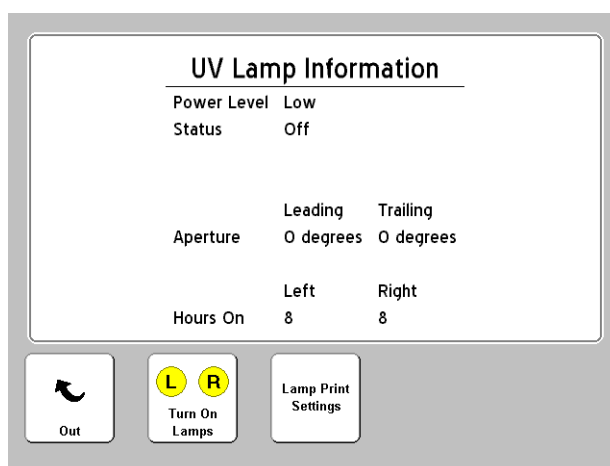

- **NEW User-selectable shutter apertures** — you can select the aperture (opening amount) for each shutter, and/or completely close one of the shutters, during printing. This enables you to reduce the warping of rigid media by reducing the amount of light and heat emitted by the lamps. The aperture can be set in the Print Modes function or by touching the UV lamps info panel (see previous item).

The UV lamp shutters are vertical when completely opened, and rotate to change the aperture. An aperture setting of 0 degrees is completely open; 20 degrees is half open, 40 degrees is the maximum closed setting. You cannot set both shutters to closed while printing. During printing, the lamp icons on the control panel are dynamically shaded to indicate the aperture setting. The icons will change as the carriage direction changes if the leading and trailing aperture settings are different from each other.

- **Error handling improvements** — Error, Action, and Warning messages are now more informative, and include shortcuts that take the user directly to a software function for further diagnosis or resolution to the problem. The list of active Action and Warning messages is now updated dynamically, even while they are being displayed on the control panel.

- **Print head warming errors** — various improvements have been made to ensure that the printheads are warmed to the correct temperature for printing.
- **Media settings adjustments while printing is paused** — media settings can now be adjusted while printing is paused.
- **Unidirectional print modes** — the left-only and right-only print modes now print in the correct directions.

---

## Version 1.06

- **Carriage pauses over the media** — if a printing delay was set, or if the RIP is not sending print data to the printer fast enough to keep up with printing, the carriage no longer pauses over the media. It will advance to the nearest side first, then pause.
- **Media Wizard** — the media thickness setting has been removed from the Media Wizard. Several default settings for the standard medias have been updated.
- **Embedded software update protected** — if you switch off the printer by the power switch at the rear of the printer during an embedded software update, the printer will finish the update before beginning its shutdown process. Suddenly cutting the power during a software update could corrupt the software or printer settings.
- **Media advance after viewing a calibration print** — a “stop” key now appears on the control panel, allowing you to stop the media from backing up to the print zone after you have viewed a calibration print. You may want to stop the media from reversing all the way if you encounter media feed problems, especially with roll-fed media.
- **Lamps must be on during printing** — the option to turn off the UV curing lamps while printing has been removed from the printer menu.

---

## Version 1.05

- **Improved Media Load/Unload switch** — the functionality of the Media Load/Unload rocker switch at the rear of the printer is now easier to understand and more useful:
  - The switch is active only when the Front Page screen appears on the control panel. Switch presses are ignored when any other screen is displayed.
  - When the printer is configured for roll-fed printing, pressing the Media Load/Unload switch to the Load position (or pressing the Reload Media key on the Front Page screen of the control panel) turns on the platen vacuum fans to hold the media in place as you feed it over the platen. This eliminates the need to feed an excessive length of media over the platen to prevent the media from falling back toward the supply spool. The control panel then prompts you to position the media and edge guards (if used) before measuring it with the camera on the printhead carriage.
  - For either rigid or roll-fed media, after any media type has been printed or unloaded, pressing the Media Load/Unload switch to the Load position has the same effect as pressing the Reload Media key on the control panel. The media settings for the previously loaded media will be used.
- **Sheet fed media length** — the option to manually enter a media length (“Input Manually”) has been moved to the top of the menu that appears during the media load process.

- **NEW Job Tracking Log** — you can view a list of the last ten print jobs by pressing the printer status area of the Front Page screen (near the center top edge of the screen), then pressing the View Job Tracking Log key. If the job failed to print, an error code is listed, which can be reported to Technical Services for diagnosis.

---

## Version 1.04

- **NEW Advance Media Past Brushes** — a new key on the control panel Front Page screen advances roll-fed media forward for trimming, then retracts the media back to printing position.
- **NEW standard media lengths for sheet-fed media** — when loading sheet-fed media, you can select its length from a list of common lengths, or enter the length manually.
- **Load/Unload ignored during printing** — the printer now ignores the media Load/Unload rocker switch on the back panel of the printer unless the printer is idle.





© Copyright 2008, 2009 Hewlett-Packard Development Company, L.P.

Confidential computer software. Valid license from HP required for possession, use or copying. Consistent with FAR 12.211 and 12.212, Commercial Computer Software, Computer Software Documentation, and Technical Data for Commercial Items are licensed to the U.S. Government under vendor's standard commercial license.

The information contained herein is subject to change without notice. The only warranties for HP products and services are set forth in the express warranty statements accompanying such products and services. Nothing herein should be construed as constituting an additional warranty. HP shall not be liable for technical or editorial errors or omissions contained herein.



0706430



i n v e n t

Revision M