LSI SAS 3041E Serial Attached SCSI RAID Host Bus Adapter installation

Introduction

This document describes how to install an LSI SAS 3041E Serial Attached SCSI (SAS) Redundant Array of Independent Disks (RAID) Host Bus Adapter (HBA) in HP Z and xw Workstation series. Procedures are included for hard drives mounted in hard drive bays and optical drive bays.

Kit contents

- LSI SAS 3041E SAS RAID HBA (RAID controller card)
- SAS driver CD
- Hard drive activity LED cables
- Installation instructions (this document)
- Warranty information

Before you begin











To view *QuickSpecs* and determine the compatibility of this product with your HP workstation, see <http://www.hp.com/go/productbulletin>.



405023-003

© 2006–2009 Hewlett-Packard Development Company, L.P. Printed in the U.S.

Warnings and cautions

-
-  **WARNING!**  Any surface or area of the equipment marked with this symbol indicates the presence of an electrical shock hazard. To reduce the risk of injury from electrical shock, do not open any enclosed area marked with this symbol.
-
-  **WARNING!** To reduce the risk of electric shock or damage to your equipment:
- Do not disable the power cord grounding plug. The grounding plug is an important safety feature.
 - Plug the power cord in a grounded (earthed) outlet that is easily accessible at all times.
 - Disconnect power from the equipment by unplugging the power cord from the electrical outlet.
-
-  **WARNING!**  Any surface or area of the equipment marked with this symbol indicates the presence of a hot surface or hot component. If this surface is contacted, the potential for injury exists. To reduce the risk of injury from a hot component, enable the surface to cool before touching.
-
-  **WARNING!** If a product is shipped in packaging marked with this symbol, , the product must always be lifted by two persons to avoid personal injury due to product weight.
-
-  **WARNING!** To reduce the risk of serious injury, read the *Safety & Comfort Guide*. It describes proper workstation setup, posture, health, and work habits for computer users, and provides important electrical and mechanical safety information. This guide is located at <http://www.hp.com/ergo> and on the documentation CD (if one is included with the product).
-
-  **CAUTION:** Static electricity can damage the electronic components of the workstation. Before beginning these procedures, be sure you discharge static electricity by briefly touching a grounded metal object.
-
-  **CAUTION:** To prevent damage to the workstation, observe the following Electrostatic Discharge (ESD) precautions while performing the system parts removal and replacement procedures:
- Work on a static-free mat.
 - Wear a static strap to ensure that any accumulated electrostatic charge is discharged from your body to the ground.
 - Create a common ground for the equipment you are working on by connecting the static-free mat, static strap, and peripheral units to that piece of equipment.
-
-  **NOTE:** HP accessories are for use in HP Workstation products. They have been extensively tested for reliability and are manufactured to high quality standards.
-

Step 1—Preparing for component installation

 **NOTE:** Workstation models vary. All illustrations are examples only.

Download and install updates

1. Check for available system BIOS updates specified for your HP workstation model and operating system at <http://www.hp.com/go/workstationsupport>.
2. Install the system BIOS updates, if available.

Accessing the internal components of the workstation

1. If you need help preparing the workstation for this installation, consult the removal and replacement procedures in the service guide for your workstation at http://www.hp.com/support/workstation_manuals.

 **NOTE:** For the HP Z Workstation series, these procedures are also available in the *User Guide* on the *Documentation and Diagnostics CD* that shipped with your workstation.

2. Power down the workstation, and then disconnect the power cord.
3. Power down all external devices, and then disconnect them from the workstation.
4. Remove the side access panel.

Removing components

1. If present, remove the card support to enable access to the expansion slots and system board connectors.
2. Select an unused PCI Express (PCIe) x4, x8, or x16 expansion slot on the system board.

 **NOTE:** To identify an available PCIe expansion slot, see the service label on the side access panel.

Figure 1 Removing the expansion slot cover



Step 2—Installing the RAID controller card

Install the RAID controller card into the selected slot on the system board. Verify that the keyed components of the card align with the slot.

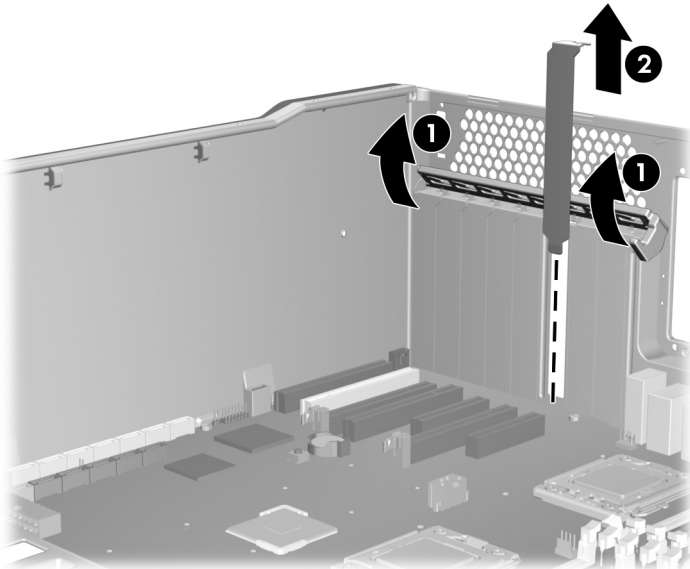
Figure 2 Installing the SAS-SATA controller

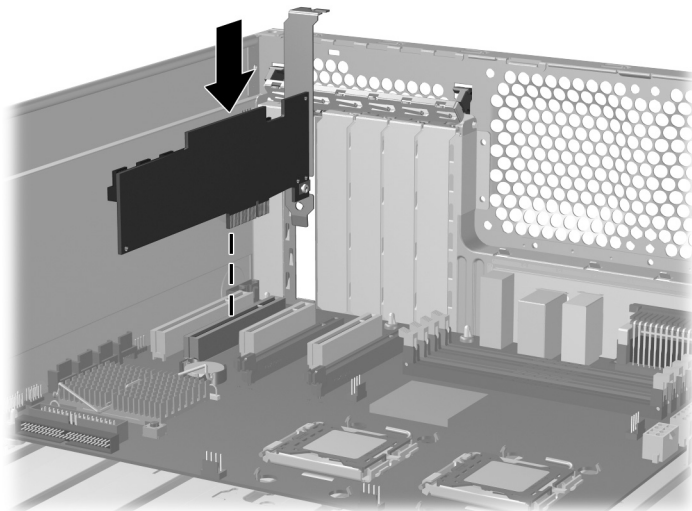

Step 3—Configuring the cabling

The RAID controller card may be used to control hard drives located in the internal hard drive bays and hard drives located in the optical bays.

The data cable connections for RAID differ between workstation models. To determine the correct connection for your hard drives, identify the applicable HP workstation model and the location of the hard drive being connected in the following table. To connect existing hard drives, disconnect the existing single data cables from the system board and choose the correct connection type.

The LED cable connection is similar for all HP workstation models.

Table 1 Data cable configuration guide

HP workstation model	Location of hard drive	Connection type	Description
HP xw Workstation series HP Z400 Workstations	<ul style="list-style-type: none">Internal hard drive bayOptical bay	Connecting standard data cables on page 6	Use the data cable provided with the hard drive to connect the hard drive to the RAID controller card.
HP Z600 Workstations	<ul style="list-style-type: none">Internal hard drive bay	Connecting blind-mate data cables on page 5	The blind-mate data cables from the internal hard drives are disconnected from the system board and connected to the appropriate port connectors on the RAID controller card.
HP Z600 Workstations	<ul style="list-style-type: none">Optical bay	Connecting standard data cables on page 6	Use the data cable provided with the hard drive to connect the hard drive to the RAID controller card.

Connecting blind-mate data cables

HP Z600 Workstations have pre-installed blind-mate cabling plugged into the system board. For workstations with this cabling configuration, use the following procedure to connect internal hard drives to the RAID controller card.

 **NOTE:** To connect hard drives located in the optical bays of HP Z600 Workstations, see [Connecting standard data cables on page 6](#).

1. Locate and disconnect the HDD BAY 0 cable from the system board.

 **NOTE:** This procedure assumes that the primary hard drive is located in HDD-BAY-0.

Figure 3 Locating the hard drive cables on the system board



2. Connect the HDD BAY 0 cable to Port 0 on the RAID controller card.

Figure 4 SAS-SATA controller ports

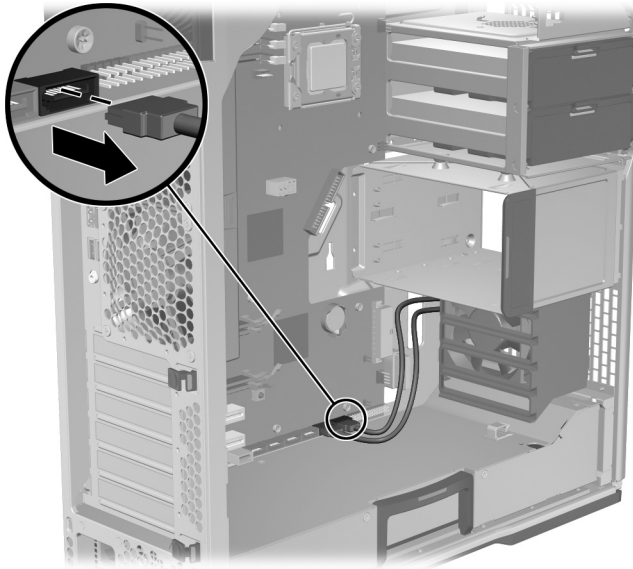
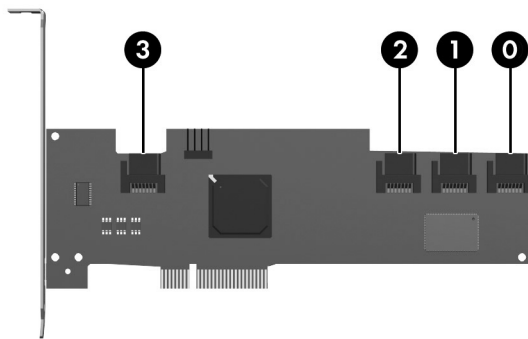

3. Attach any subsequent hard drives to ports 1–3 on the RAID controller card.

Figure 5 Connecting the blind-mate data cables to the RAID card



4. Continue with [Connecting the LED activity indicator on page 7](#).

Connecting standard data cables

Hard drives installed in HP **z400** Workstations, HP **xw** Workstation series, and all optical drive bays do not have blind-mate cabling preinstalled on the system board. To connect the RAID cabling for these configurations:

1. If connecting a SAS hard drive, ensure that there is a SAS-to-SATA interconnect cable adapter (supplied with the HP workstation SAS hard drive kit) attached to the data connector on the SAS hard drive.

Figure 6 Attaching the SAS-SATA adapter

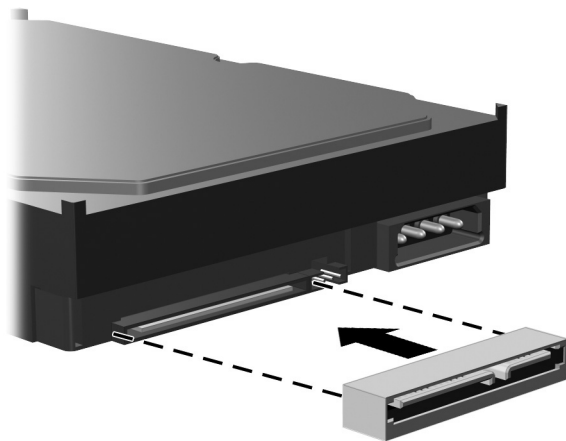

2. Select the data cable for the workstation from those shipped with the hard drive.
 - a. Connect one end to port 0 on the SAS RAID controller card ❶.
 - b. Attach the other end of the data cable to the data cable connector on the primary hard drive ❷.

Figure 7 Attaching the data cable

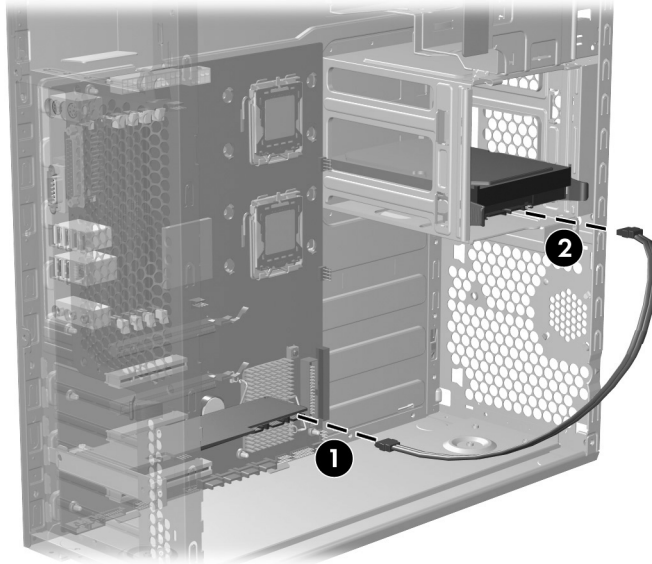

3. Attach any subsequent hard drives to ports 1–3 on the RAID controller card.

Figure 8 RAID controller ports

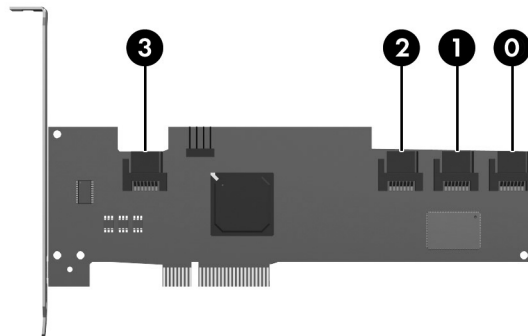

4. Continue with [Connecting the LED activity indicator on page 7](#).

Connecting the LED activity indicator

This section applies to all HP workstations shown above.

Attach one end of the hard drive activity LED cable to the RAID controller ❶ card. Attach the other end of the hard drive activity LED cable to the hard drive LED activity connector on the system board ❷. (An HP xw6000 series workstation system board is shown in the illustration for reference.)

 **NOTE:** To locate the hard drive activity LED (HDD-LED) connector on the system board, see the service label inside the workstation side access panel. Use the LED cable appropriate for the workstation.

Figure 9 Attaching the HDD LED cable



Step 4—Reassembling the workstation

1. Reinstall the card support, if applicable.
2. Reinstall the side access panel.
3. Reconnect power to the workstation and all external devices.
4. Restore power to the workstation and all external devices.

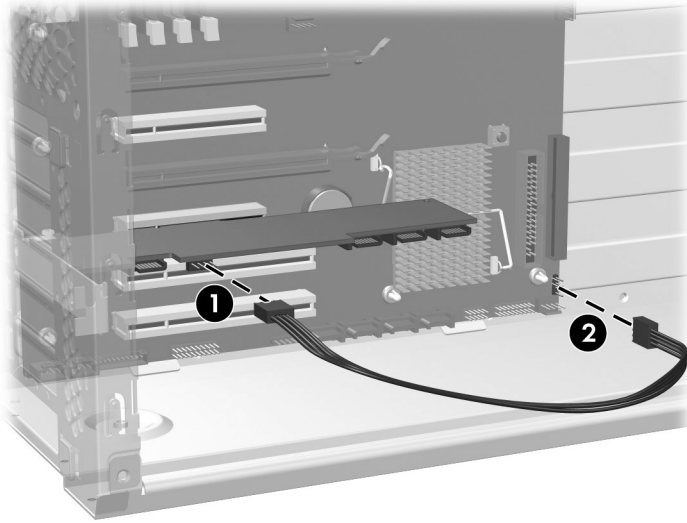
Step 5—Loading and setting up driver software

For instructions on loading and setting up the drivers for use with your workstation, see the manufacturer's documentation shipped with the RAID controller card.

At the time of component installation, look for device firmware and driver updates, designated for your workstation model and operating system. Obtain updates from <http://www.hp.com/go/workstationsupport>.

Step 6—Configuring RAID devices

For detailed instruction on configuring RAID devices, see the service guide for your HP workstation model at http://www.hp.com/support/workstation_manuals.

Additional information is available at http://www.hp.com/support/RAID_FAQs

Japanese 日本語

This document is available in Japanese. See http://www.hp.com/support/workstation_manuals, then select your workstation product and select **Japanese** from the drop down **Manual Language** menu.

このドキュメントは日本語版が用意されています。http://www.hp.com/support/workstation_manuals にアクセスし、ご使用のワークステーション製品を選択し、**Manual Language** ドロップダウンメニューから **Japanese** を選択してください。