



HP ENVY 4 Sleekbook

HP ENVY 4 Ultrabook

HP ENVY TouchSmart 4 Sleekbook

HP ENVY TouchSmart 4 Ultrabook

Maintenance and Service Guide

**IMPORTANT!** This document is intended for HP  
authorized service providers only.

© Copyright 2012 Hewlett-Packard  
Development Company, L.P.

Bluetooth is a trademark owned by its proprietor and used by Hewlett-Packard Company under license. Intel is a trademark of Intel Corporation in the U.S. and other countries. Microsoft and Windows are U.S. registered trademarks of Microsoft Corporation. SD Logo is a trademark of its proprietor.

The information contained herein is subject to change without notice. The only warranties for HP products and services are set forth in the express warranty statements accompanying such products and services. Nothing herein should be construed as constituting an additional warranty. HP shall not be liable for technical or editorial errors or omissions contained herein.

First Edition: December 2012

Document Part Number: 683019-001

## Safety warning notice

---

 **WARNING!** To reduce the possibility of heat-related injuries or of overheating the device, do not place the device directly on your lap or obstruct the device air vents. Use the device only on a hard, flat surface. Do not allow another hard surface, such as an adjoining optional printer, or a soft surface, such as pillows or rugs or clothing, to block airflow. Also, do not allow the AC adapter to contact the skin or a soft surface, such as pillows or rugs or clothing, during operation. The device and the AC adapter comply with the user-accessible surface temperature limits defined by the International Standard for Safety of Information Technology Equipment (IEC 60950).

---



---

# Table of contents

<b>1 Product description .....</b>	<b>1</b>
<b>2 External component identification .....</b>	<b>5</b>
Display .....	5
Button, speakers, and subwoofer .....	6
Keys — Windows 8 models .....	8
Keys — Ubuntu Linux models .....	9
Lights .....	10
TouchPad .....	11
Left side .....	12
Right side .....	14
Bottom .....	15
<b>3 Illustrated parts catalog .....</b>	<b>17</b>
Service tag and PCID label .....	17
Service tag .....	17
PCID label .....	17
Computer major components .....	19
Mass storage devices .....	25
Miscellaneous parts .....	26
Sequential part number listing .....	27
<b>4 Removal and replacement procedures .....</b>	<b>35</b>
Preliminary replacement requirements .....	35
Tools required .....	35
Service considerations .....	35
Plastic parts .....	35
Cables and connectors .....	35
Drive handling .....	36
Grounding guidelines .....	36
Electrostatic discharge damage .....	36

Packaging and transporting guidelines .....	37
Component replacement procedures .....	39
Display panel .....	39
Base enclosure .....	42
Battery .....	43
Hard drive .....	46
RTC battery .....	49
Memory module .....	50
WLAN module .....	52
TouchPad module .....	54
Fan .....	55
System board .....	56
Heat sink .....	61
RJ-45 module cover .....	62
Media card reader assembly (smart card reader) .....	63
Subwoofer .....	64
Security bracket .....	65
USB/Audio board .....	66
Power connector cable .....	67
Speakers .....	68
Power button board .....	69
Keyboard .....	70
Top cover .....	74
WLAN antenna cables .....	75
Display panel cable assembly .....	75
Webcam assembly .....	76
Display hinges and hinge covers .....	77
<b>5 Setup Utility (BIOS) and System Diagnostics .....</b>	<b>79</b>
Windows 8 – Computer Setup (BIOS) and Advanced System Diagnostics .....	79
Using Setup Utility .....	79
Starting Setup Utility (BIOS) .....	79
Updating the BIOS .....	79
Determining the BIOS version .....	79
Downloading a BIOS update .....	80
Using System Diagnostics .....	81
Ubuntu Linux – Setup Utility (BIOS) and AdvancedSystem Diagnostics .....	81
Using Setup Utility .....	81
Starting Setup Utility .....	81
Changing the language of Setup Utility .....	81
Using Setup Utility .....	82

	Navigating and selecting in Setup Utility .....	82
	Displaying system information .....	82
	Restoring factory default settings in Setup Utility .....	82
	Exiting Setup Utility .....	82
	Updating the BIOS .....	82
<b>6</b>	<b>Specifications .....</b>	<b>85</b>
	Computer specifications .....	85
	14.0-inch display specifications .....	86
<b>7</b>	<b>Backing up, restoring, and recovering .....</b>	<b>87</b>
	Windows 8 — Backing up, restoring, and recovering .....	87
	Creating recovery media and backups .....	87
	Creating HP Recovery media .....	88
	Restore and recovery .....	89
	Using Windows Refresh for quick and easy recovery .....	90
	Remove everything and reinstall Windows .....	90
	Recovering using HP Recovery Manager .....	91
	What you need to know .....	91
	Using the HP Recovery partition to recover a minimized image (select models only) .....	92
	Using HP Recovery media to recover .....	92
	Changing the computer boot order .....	92
	Removing the HP Recovery partition .....	93
	Ubuntu Linux — Backing up, restoring, and recovering .....	93
	Performing a system recovery .....	93
	Creating the restore DVDs .....	93
	Creating a restore image on a USB device .....	94
	Performing recovery using the restore DVD .....	94
	Backing up your information .....	95
<b>8</b>	<b>Power cord set requirements .....</b>	<b>97</b>
	Requirements for all countries .....	97
	Requirements for specific countries and regions .....	98
<b>9</b>	<b>Recycling .....</b>	<b>101</b>
	<b>Index .....</b>	<b>103</b>





# 1 Product description

Category	Description
<b>Product Name</b>	HP ENVY4 Sleekbook PC
	HP ENVY 4 Ultrabook PC
	HP ENVY TouchSmart 4 Sleekbook PC
	HP ENVY TouchSmart 4 Ultrabook PC
<b>Processors</b>	Intel® Core™ i5-3337U 1.8 GHz processor SC turbo up to 2.7 GHz (3-MB cache, dual core 17 W)
	Intel® Core™ i5-3317U 1.7 GHz processor SC turbo up to 2.6 GHz (3-MB L3 cache, dual core 17 W)
	Intel® Core™ i3-3227U 1.9 GHz processor (3-MB cache, dual core 17 W)
	Intel® Core™ i3-3217U 1.8 GHz processor (3-MB L3 cache, dual core 17 W)
	Intel® Core™ i3-2377M 1.5 GHz processor (3-MB L3 cache, dual 17W)
<b>Chipset</b>	Intel® HM77 Express platform controller hub (PCH)
<b>Graphics</b>	Intel® HD Graphics 4000 discrete-class graphics. Supports BD and or HD-DVD playback with HD decode, DX11 support and HDMI support
	Intel® HD Graphics 3000 discrete-class graphics. Supports BD and or HD-DVD playback with HD decode, DX11 support, and HDMI support
	AMD Mars XT (RadeonT HD 8750M) switchable discrete graphics with 2GB of dedicated video memory (128Mx16). Supports BD and or HD-DVD playback with HD decode, DX11 support, and HDMI support
<b>Panel</b>	14.0" high-definition (HD) light-emitting diode (LED), BrightView (1366x768) display; (3.2mm) Slim, Shuriken, 200 nits, Supports LVDS
	Touchscreen, multitouch enabled, 160 nits (select models only)
	All display assemblies include 2 wireless local area network (WLAN) antenna cables.
	Supports 16:9 wide aspect ratio
	Support for non-flush glass panel cover (non-PMMA)
<b>Memory</b>	Two memory module slots
	DDR3-1600MHz single channel support
	DDR3-1333MHz single channel support (DDR3-1600 downgrade to 1333)
	DDR3L-1600MHz Dual Channel Support (DDR3L-1600 bridge to DDR3-1600)

Category	Description
	Supports up to 16384-GB of system RAM
	Supports the following configurations: <ul style="list-style-type: none"> <li>• 2048-MB total system memory (2048×1)</li> <li>• 4096-MB total system memory (2048×2)</li> <li>• 4096-MB total system memory (4096×1)</li> <li>• 6144-MB total system memory (2048×1 + 4096×1)</li> <li>• 8192-MB total system memory (4096×2)</li> <li>• 8192-MB total system memory (8192×1)</li> <li>• 12288-MB total system memory (8192×1 + 4096×1)</li> <li>• 16384-MB total system memory (8192×2)</li> </ul>
<b>Hard drives</b>	HDD (7mm SATA 2.5") configurations: <ul style="list-style-type: none"> <li>• 320-GB 7200 RPM 7mm SATA</li> <li>• 320-GB 5400 RPM 7mm SATA</li> <li>• 500-GB 5400 RPM 7mm SATA</li> </ul>
	mSATA SSD configurations: <ul style="list-style-type: none"> <li>• 32-GB SSD (select models only)</li> <li>• 24-GB SSD (select models only)</li> </ul>
<b>Optical drive</b>	External USB optical drive (computer USB ports support 2A current)
	SATA
	12.7 mm tray load
	Supports the following external optical drives: <ul style="list-style-type: none"> <li>• Blu-ray ROM DVD±R/RW Super Multi Double-Layer Drive</li> <li>• DVD±RW Super Multi Double-Layer Combo Drive</li> </ul>
<b>Audio and video</b>	Dual array digital microphones
	Two integrated stereo speakers and subwoofer
	HP TrueVision high-definition webcam (fixed, no tilt, 1280×720 by 30 frames per second)
<b>Ethernet</b>	Integrated 10/100/1000 GB network interface card (NIC)
<b>Wireless</b>	Integrated WLAN options by way of wireless module
	Two WLAN antennas built into display assembly
	Supports the following WLAN formats: <ul style="list-style-type: none"> <li>• Intel® Centrino® Wireless-N 2230 + Bluetooth combo w/ *2 antennas (802.11 b/g/n, Bluetooth 3.0)</li> <li>• Atheros 9485GN 802.11b/g/n 1×1 WiFi and 3012 Bluetooth 4.0 Combo Adapter</li> <li>• Broadcom 4313GN 802.11b/g/n 1×1 WiFi and 20702 Bluetooth 4.0 Combo Adapter</li> </ul>

Category	Description
<b>External media card</b>	<p>Push-push insertion/removal</p> <p>HP Multi-Format Digital Media Reader supports the following digital card formats:</p> <ul style="list-style-type: none"> <li>• MultiMediaCard</li> <li>• Secure Digital (SD) Card</li> <li>• Secure Digital High-Capacity (SDHC) Card</li> <li>• Secure Digital Extended Capacity (SDxC) Card</li> </ul>
<b>Ports</b>	<ul style="list-style-type: none"> <li>• 3-pin AC power (non-smart pin)</li> <li>• Audio-in (mono microphone), supports jack detection</li> <li>• Audio-out (stereo headphone), supports jack detection</li> <li>• HDMI version 1.4b supporting 1920p, 1920 × 1200 @ 60Hz</li> <li>• RJ-45 (Ethernet, includes link and activity lights)</li> <li>• USB 3.0 (2 ports)</li> <li>• USB 2.0 (1 port)</li> </ul>
<b>Keyboard/pointing devices</b>	<ul style="list-style-type: none"> <li>• 97% Duracoat, island-style keyboard, no spill-resistance (in black finish)</li> <li>• Backlit, island-style keyboard in black finish (NA CTO only)</li> <li>• Backlit, island-style keyboard in silver finish</li> <li>• 97% Duracoat, island-style keyboard, no spill-resistance (in silver finish)</li> </ul> <p>TouchPad with multi-touch gestures</p> <p>Taps enabled as default</p> <p>ClickPad with Imaging sensor</p> <p>Support Windows 8 Modern Trackpad Gestures</p>
<b>Power requirements</b>	<p><b>Supports the following HP AC adapters:</b></p> <ul style="list-style-type: none"> <li>• 65-W (non-smart) PFC RC V EM 3-wire HP AC adapter</li> </ul> <p><b>Supports the following batteries:</b></p> <ul style="list-style-type: none"> <li>• 4-cell, 52WHr 3.55 AH Li-ion battery</li> </ul>
<b>Operating system</b>	<p><b>Preinstalled:</b></p> <ul style="list-style-type: none"> <li>• Windows 8 Standard (64-bit)</li> <li>• Windows 8 Professional (64-bit)</li> <li>• Ubuntu Linux</li> </ul>
<b>Serviceability</b>	<p><b>End-user replaceable part:</b> AC adapter</p>



## 2 External component identification

### Display





Component	Description
(1) Internal display switch	Turns off the display and initiates Sleep/Suspend if the display is closed while the power is on. <b>NOTE:</b> The internal display switch is not visible from the outside of the computer.
(2) WLAN antennas (2)*	Send and receive wireless signals to communicate with wireless local area networks (WLANs).
(3) Internal microphones (2)	Record sound.
(4) Webcam light	On: The webcam is in use.

Component	Description
(5) HP TrueVision HD Webcam	<p>Records video, captures still photographs, and allows video conferences and online chat by means of streaming video.</p> <p>To use the webcam in Windows 8, from the Start screen, type <code>c</code>, and then select <b>CyberLink YouCam</b>.</p> <p>For details about using your webcam in Ubuntu Linux, click the Help menu in the <code>gucvview</code> software.</p>

\*The antennas are not visible from the outside of the computer. For optimal transmission, keep the areas immediately around the antennas free from obstructions. For wireless regulatory notices, see the section of the *Regulatory, Safety and Environmental Notices* that applies to your country or region.

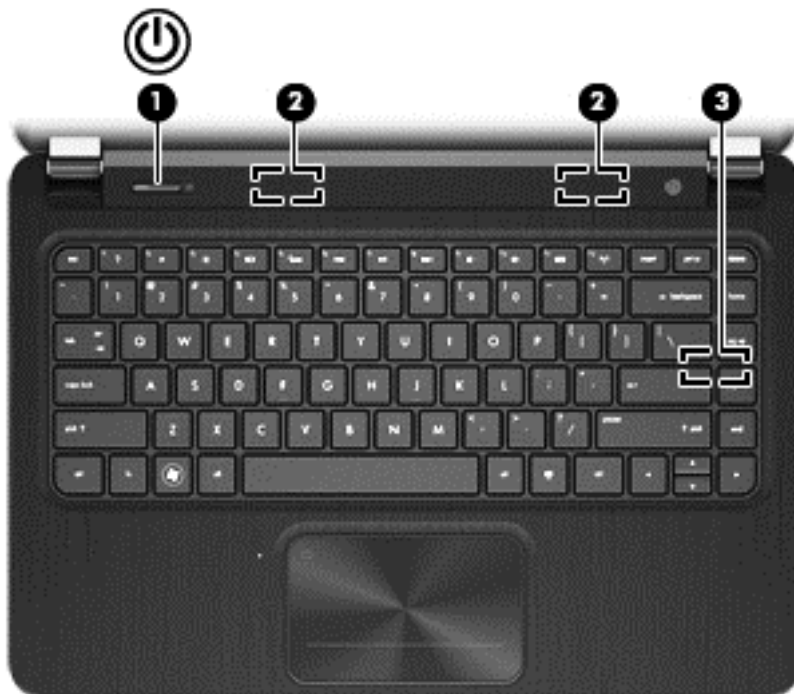

## Button, speakers, and subwoofer

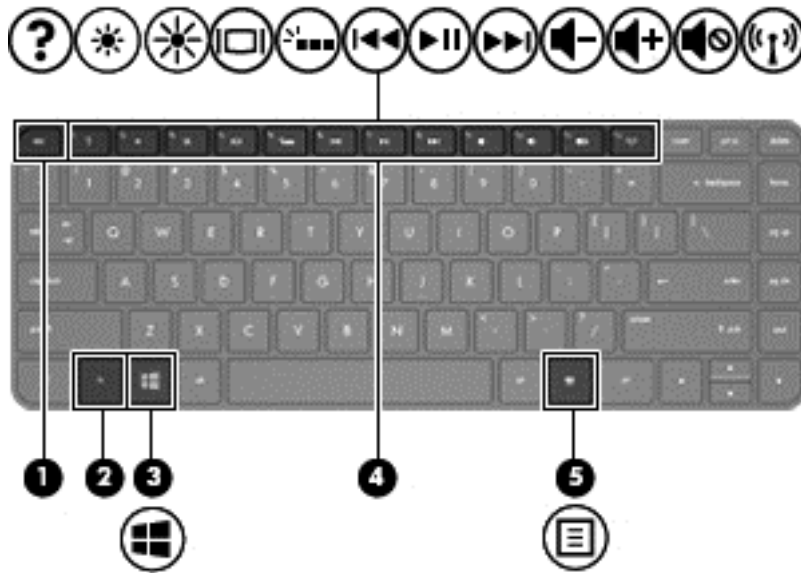

Component	Description
(1)  Power button	<ul style="list-style-type: none"> <li>• When the computer is off, press the button to turn on the computer.</li> <li>• When the computer is in the Sleep/Suspend state, press the button briefly to exit Sleep/Suspend.</li> <li>• When the computer is in Hibernation, press the button down briefly to exit Hibernation</li> </ul> <p><b>CAUTION:</b> Pressing and holding down the power button will result in the loss of unsaved information.</p> <p>If the computer has stopped responding and Microsoft® Windows® shutdown procedures are ineffective, press and hold the power button down for at least 5 seconds to turn off the computer.</p> <p><b>NOTE:</b> For select models, the Intel® Rapid Start Technology feature is enabled at the factory. Rapid Start Technology allows your computer to resume quickly from inactivity. For more information, see the <i>User Guide</i>.</p> <p>To learn more about your power settings:</p> <p>In Windows 8:</p> <ul style="list-style-type: none"> <li>• From the Start screen, type <code>power</code>, select <b>Settings</b>, and then select <b>Power options</b>, or see the <i>User Guide</i>.</li> </ul> <p>In Ubuntu Linux:</p> <ul style="list-style-type: none"> <li>• Click the System menu icon at the far right of the top panel, and then click <b>System Settings &gt; Power</b> icon.</li> </ul>
(2) Speakers (2)	Produce sound.
(3) HP Triple Bass Reflex Subwoofer	Provides superior bass sound.

## Keys — Windows 8 models





Component	Description
(1) <code>esc</code> key	Displays system information when pressed in combination with the <code>fn</code> key.
(2) <code>fn</code> key	Executes frequently used system functions when pressed in combination with the <code>b</code> key or the <code>esc</code> key.
(3)  Windows 8 logo key	Returns you to the Start screen from an open app or the Windows desktop. <b>NOTE:</b> Pressing the Windows logo key again will return you to the previous screen.
(4) Action keys	Execute frequently used system functions. <b>NOTE:</b> On select models, the <code>f5</code> action key turns the radiance backlight keyboard feature off or on.
(5)  Windows 8 applications key	Displays a shortcut menu for a selected object.



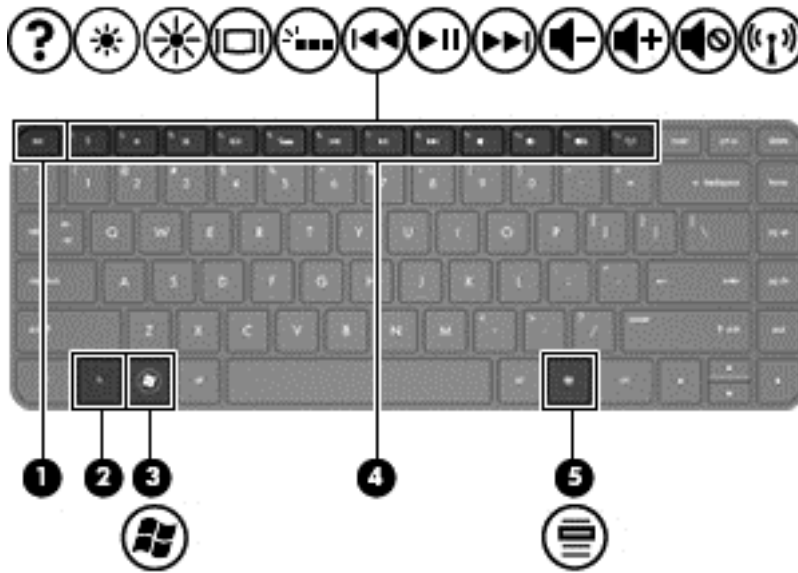



# Keys — Ubuntu Linux models

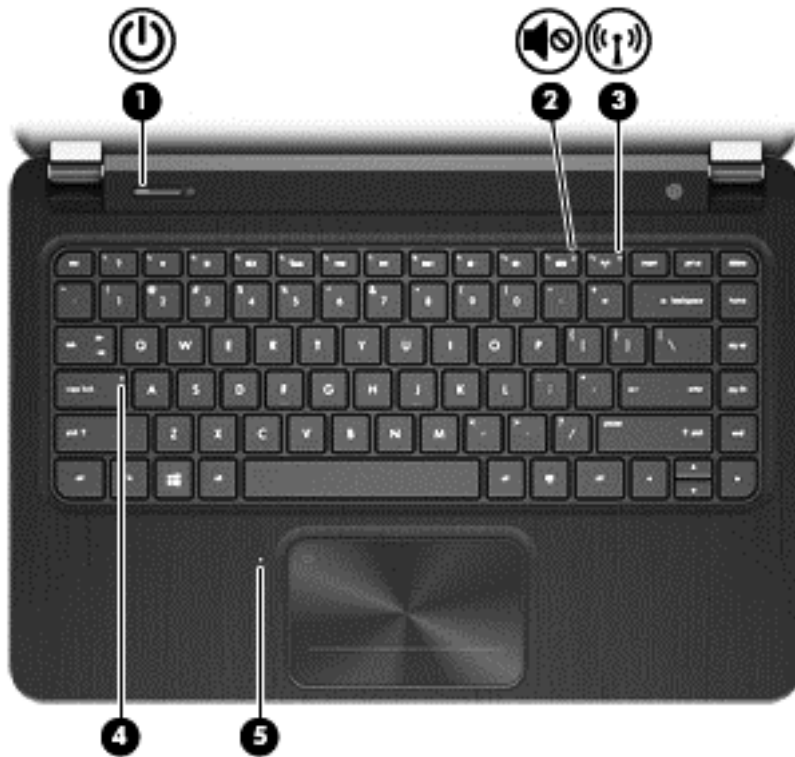

Component	Description
(1) <code>esc</code> key	Displays system information when pressed in combination with the <code>fn</code> key.
(2) <code>fn</code> key	Executes frequently used system functions when pressed in combination with the <code>b</code> key or the <code>esc</code> key.
(3)  Operating system logo key	Displays the operating system menu.
(4) Action keys	Execute frequently used system functions. <b>NOTE:</b> On select models, the <code>f5</code> action key turns the radiance backlight keyboard feature off or on.
(5)  Operating system applications key	Displays a shortcut menu for items beneath the cursor.

# Lights



Component	Description
(1)  Power light	<ul style="list-style-type: none"> <li>• White: The computer is on.</li> <li>• Blinking white: The computer is in the Sleep/Suspend state, which is an energy-saving mode. The computer shuts off power to the display and other unneeded components.</li> <li>• Off: The computer is off or in Hibernation. Hibernation is an energy-saving mode that uses the least amount of power.</li> </ul> <p><b>NOTE:</b> For select models, the Intel® Rapid Start Technology feature is enabled at the factory. RapidStart Technology allows your computer to resume quickly from inactivity.</p>
(2)  Mute light	<ul style="list-style-type: none"> <li>• Amber: Computer sound is off.</li> <li>• Off: Computer sound is on.</li> </ul>
(3)  Wireless light	<ul style="list-style-type: none"> <li>• White: An integrated wireless device, such as a wireless local area network (WLAN) device and/or a Bluetooth® device, is on.</li> <li>• Amber: All wireless devices are off.</li> </ul>
(4) Caps lock light	On: Caps lock is on, which switches the keys to all capital letters.
(5) TouchPad light	<ul style="list-style-type: none"> <li>• On: The TouchPad is off.</li> <li>• Off: The TouchPad is on.</li> </ul>



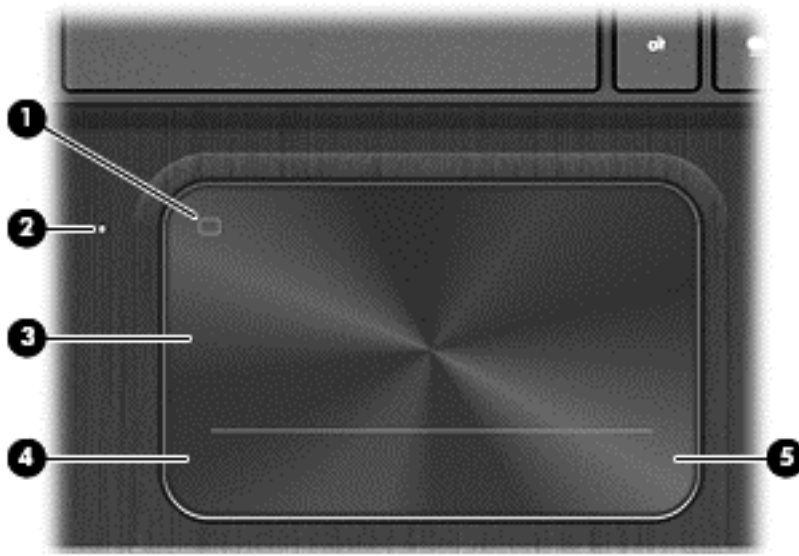

# TouchPad



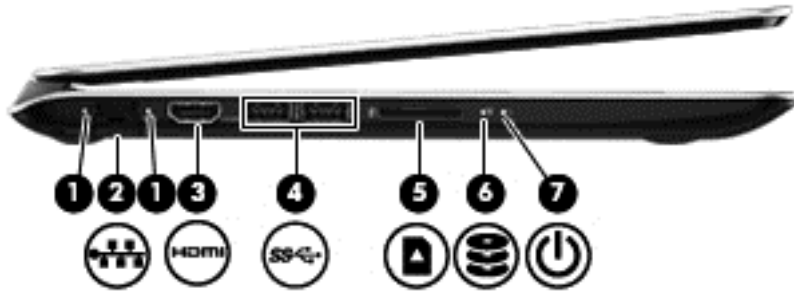

Component	Description
(1) TouchPad on/off button	Turns the TouchPad on or off.
(2) TouchPad light	<ul style="list-style-type: none"><li>• On: The TouchPad is off.</li><li>• Off: The TouchPad is on.</li></ul>
(3) TouchPad zone	Moves the on-screen pointer and selects or activates items on the screen.
(4) Left TouchPad button	Functions like the left button on an external mouse.
(5) Right TouchPad button	Functions like the right button on an external mouse.

## Left side





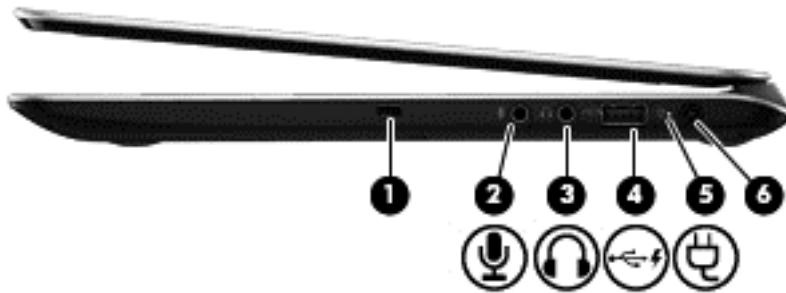

Component	Description
(1)	RJ-45 (network) status lights (2) <ul style="list-style-type: none"> <li>• White (left): The network is connected.</li> <li>• Amber (right): Activity is occurring on the network.</li> </ul>
(2) 	RJ-45 (network) jack Connects a network cable.
(3) 	HDMI port Connects an optional video or audio device, such as a high-definition television, or any compatible digital or audio device.
(4) 	USB 3.0 ports (2) Connect optional USB 3.0 devices and provide enhanced USB power performance. <b>NOTE:</b> For details about different types of USB ports, see the <i>User Guide</i> .
(5) 	Digital Media slot Supports the following digital card formats: <ul style="list-style-type: none"> <li>• Secure Digital (SD) Memory Card</li> <li>• Secure Digital High Capacity (SDHC) Memory Card</li> <li>• Secure Digital Extended Capacity (SDxC) Memory Card</li> <li>• Ultra High Speed MultiMediaCard (UHS/MMC)</li> </ul>

Component	Description
(6)  Hard drive light	<ul style="list-style-type: none"><li>• Blinking white: The hard drive is being accessed.</li><li>• Amber: HP 3D DriveGuard has temporarily parked the hard drive.</li></ul> <p><b>NOTE:</b> For information about HP 3D DriveGuard, see the <i>User Guide</i>.</p>
(7)  Power light	<ul style="list-style-type: none"><li>• White: The computer is on.</li><li>• Blinking white: The computer is in the Sleep/Suspend state, which is an energy-saving mode. The computer shuts off power to the display and other unneeded components.</li><li>• Off: The computer is off or in Hibernation. Hibernation is an energy-saving mode that uses the least amount of power.</li></ul> <p><b>NOTE:</b> For select models, the Intel® Rapid Start Technology feature is enabled at the factory. RapidStart Technology allows your computer to resume quickly from inactivity.</p>

## Right side



Component	Description
(1) 	<p>Security cable slot</p> <p>Attaches an optional security cable to the computer.</p> <p><b>NOTE:</b> The security cable is designed to act as a deterrent, but it may not prevent the computer from being mishandled or stolen.</p>
(2) 	<p>Audio-in (microphone) jack</p> <p>Connects an optional computer headset microphone, stereo array microphone, or monaural microphone.</p>
(3) 	<p>Audio-out (headphone) jack</p> <p>Connects optional powered stereo speakers, headphones, earbuds, a headset, or a television audio cable.</p> <p><b>WARNING!</b> To reduce the risk of personal injury, adjust the volume before using headphones, earbuds, or a headset. For additional safety information, see the <i>Regulatory, Safety and Environmental Notices</i>.</p> <p><b>NOTE:</b> When a device is connected to a headphone jack, the computer speakers are disabled.</p>
(4) 	<p>USB 2.0 charging port</p> <p>Connects an optional USB device. The USB 2.0 charging port can also charge select models of cell phones and MP3 players, even when the computer is off.</p> <p><b>NOTE:</b> A charging USB port (also referred to as a powered USB port) allows you to charge connected USB devices. Standard USB ports will not charge all USB devices or will charge using a low current. Some USB devices require power and require you to use a powered port.</p> <p><b>NOTE:</b> For details about different types of USB ports, see the <i>User Guide</i>.</p>
(5) 	<p>AC adapter light</p> <ul style="list-style-type: none"> <li>• White: The AC adapter is connected and the battery is charged.</li> <li>• Amber: The AC adapter is connected and the battery is charging.</li> <li>• Off: The computer is using DC power.</li> </ul>
(6)	<p>Power connector</p> <p>Connects an AC adapter.</p>

## Bottom

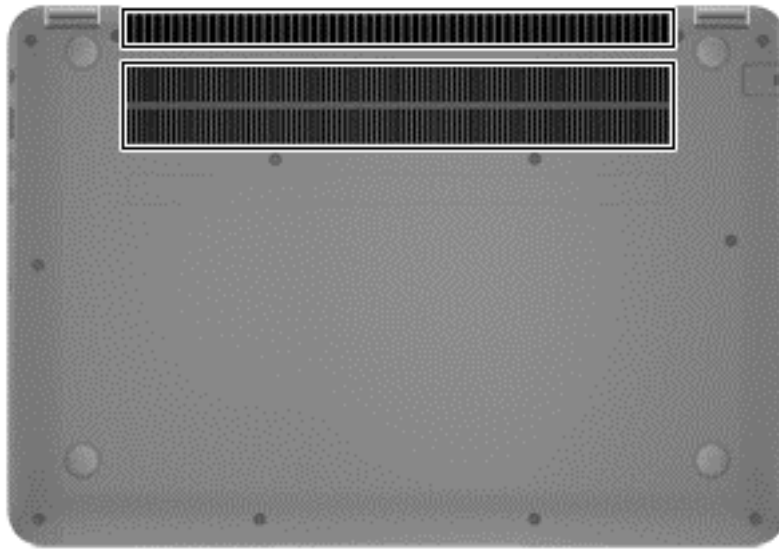

Component	Description
Vents (2)	Enable airflow to cool internal components.  <b>NOTE:</b> The computer fan starts up automatically to cool internal components and prevent overheating. It is normal for the internal fan to cycle on and off during routine operation.





# 3 Illustrated parts catalog

## Service tag and PCID label

### Service tag

When ordering parts or requesting information, provide the computer serial number and model description provided on the service tag, which is located on the bottom of the computer.

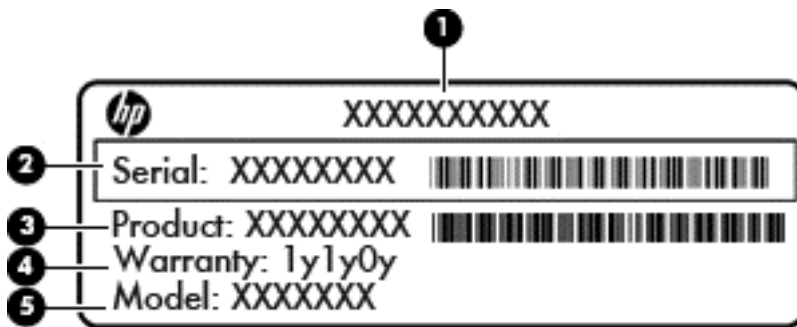

Item	Description	Function
(1)	Product name	This is the product name affixed to the front of the computer.
(2)	Serial number	This is an alphanumeric identifier that is unique to each product.
(3)	Part number/Product number	This number provides specific information about the product's hardware components. The part number helps a service technician to determine what components and parts are needed.
(4)	Warranty period	This number describes the duration of the warranty period for the computer.
(5)	Model description (select models only)	This is the alphanumeric identifier used to locate documents, drivers, and support for the computer.

### PCID label

The PCID label provides the information required to properly reset the notebook firmware (BIOS) back to factory shipped specifications when replacing the system board. The label may have a different number of characters depending on the operating system on the computer.

 **NOTE:** Computer details may vary from images.

**Windows 8 models**

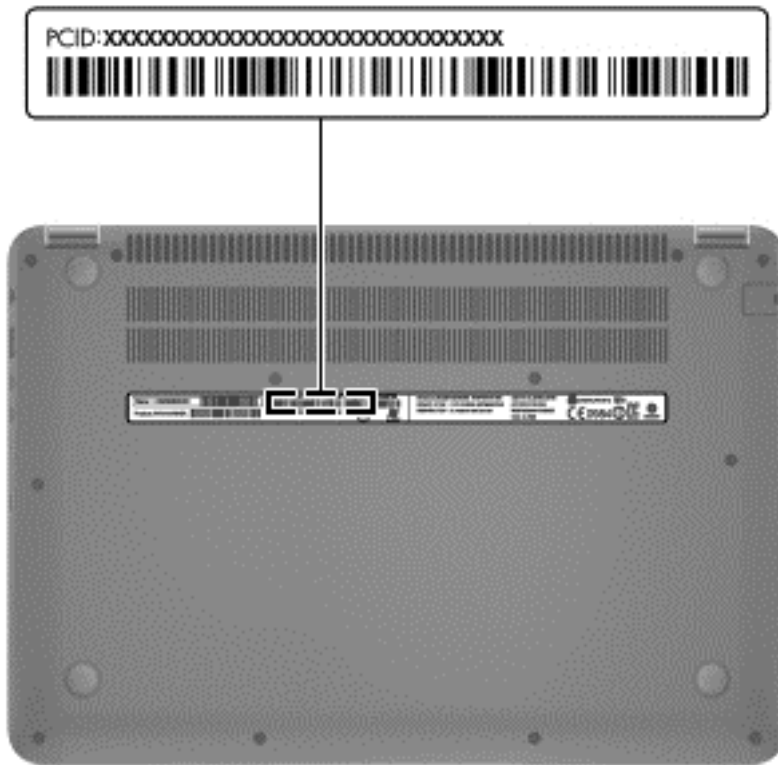

**Non-Windows 8 models**

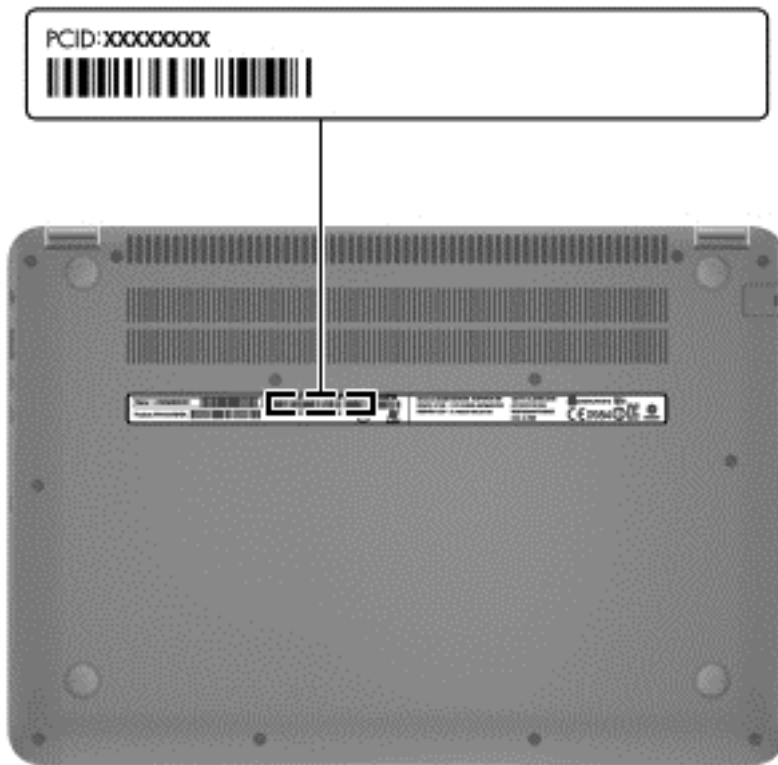

# Computer major components

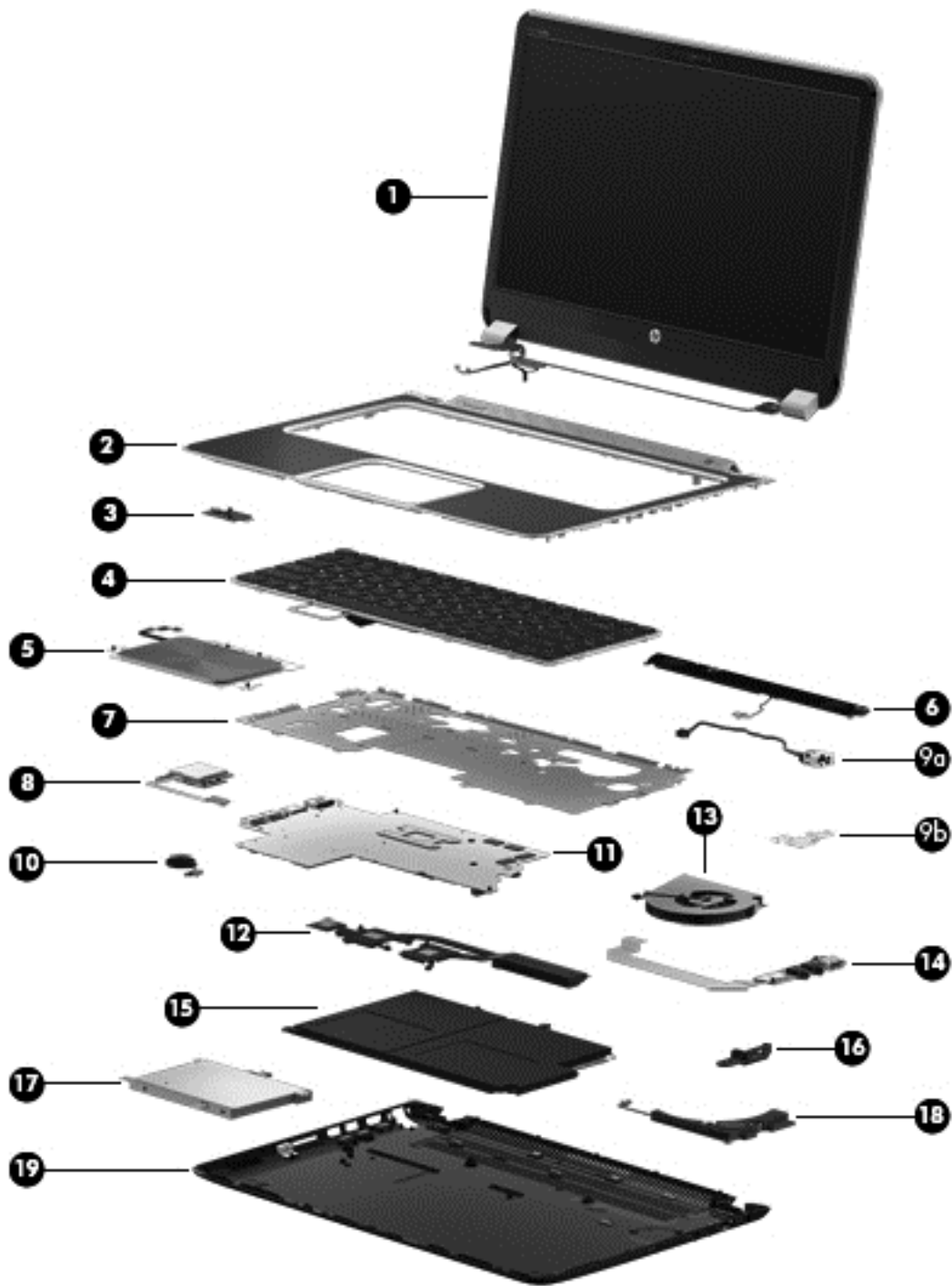

Item	Component	Spare part number
(1)	Display panel	
	In black finish for use with touch models only	699378-001
		716398-001

<b>Item</b>	<b>Component</b>	<b>Spare part number</b>
	In black finish for use with non-touch models only	702683-001
		716399-001
	In black and silver finish for use with non-touch models only	702684-001
		716400-001
<b>(2)</b>	<b>Top cover</b>	686093-001
		690194-001
<b>(3)</b>	<b>Power button board</b> (includes cable)	688000-001
<b>(4)</b>	<b>Keyboard</b> (includes keyboard cable):	
	In black finish for use with Windows 8	
	For use in the United States	698679-001
	For use in the United Kingdom and Singapore	698679-031
	For use in Germany	698679-041
	For use in France	698679-051
	For use in Italy	698679-061
	For use in Latin America	698679-161
	For use in Thailand	698679-281
	For use in Japan	698679-291
	For use in Taiwan	698679-AB1
	For use in Korea	698679-AD1
	For use in the Netherlands	698679-B31
	For use in Slovenia	698679-BA1
	For use in India	698679-D61
	For use in the Czech Republic	698679-FL1
	Backlit keyboard in black finish for use with Windows 8	
	For use in the United States	698680-001
	For use in Spain	698680-071
	For use in Turkey	698680-141
	For use in Latin America	698680-161
	For use in Saudi Arabia	698680-171
	For use in Russia	698680-251
	For use in Belgium	698680-A41
	For use in the Netherlands	698680-B31
	For use in Switzerland	698680-BG1

<b>Item</b>	<b>Component</b>	<b>Spare part number</b>
	For use in Canada	698680-DB1
	For use in Denmark, Finland, Norway in black/silver finish for use with Windows 8	698680-DH1
	For use in the United States	698681-001
	For use in the United Kingdom and Singapore	698681-031
	For use in Germany	698681-041
	For use in France	698681-051
	For use in Italy	698681-061
	For use in Latin America	698681-161
	For use in Thailand	698681-281
	For use in Japan	698681-291
	For use in Taiwan	698681-AB1
	For use in Korea	698681-AD1
	For use in the Netherlands	698681-B31
	For use in Slovenia	698681-BA1
	For use in India	698681-D61
	For use in the Czech Republic	698681-FL1
	Backlit keyboard In black/silver finish for use with Windows 8	
	For use in the United States	698682-001
	For use in Spain	698682-071
	For use in Turkey	698682-141
	For use in Latin America	698682-161
	For use in Saudi Arabia	698682-171
	For use in Brazil	698682-201
	For use in Russia	698682-251
	For use in Belgium	698682-A41
	For use in the Netherlands	698682-B31
	For use in Switzerland	698682-BG1
	For use in Canada	698682-DB1
	For use in Denmark, Finland, Norway	698682-DH1
<b>(5)</b>	<b>TouchPad button board</b> (includes cable)	
	In black finish	687997-001
	In silver finish	691640-001
<b>(6)</b>	<b>Speaker kit (includes subwoofer)</b>	686585-001

<b>Item</b>	<b>Component</b>	<b>Spare part number</b>
(7)	<b>Keyboard bracket</b>	687998-001
(8)	<b>Smart card reader</b>	687097-001
	For use with touch models only	702928-001
(9a)	<b>Power connector cable</b> (includes bracket)	686577-001
(9b)	<b>Power connector cable bracket</b>	686577-001
(10)	<b>RTC battery</b>	686922-001
(11)	<b>System board</b>	
	For non-touch models:	
	System board for use only with computer models equipped with an Intel 1.9 GHz processor (includes processor and replacement thermal material).	713810-001 713814-001
	System board for use only with computer models equipped with an Intel 1.9 GHz processor and Windows 8 Standard (includes processor and replacement thermal material).	713810-501 713814-501
	System board for use only with computer models equipped with an Intel 1.9 GHz processor and Windows 8 Pro (includes processor and replacement thermal material).	713810-601 713814-601
	System board for use only with computer models equipped with an Intel 1.8 GHz processor (includes processor and replacement thermal material).	686086-002 693657-001 708961-001 708966-001 712354-001 712355-001 713809-001 713813-001 716306-001
	System board for use only with computer models equipped with an Intel 1.8 GHz processor and Windows 8 Standard (includes processor and replacement thermal material).	708966-501 712354-501 712355-501 713809-501 713813-501 716306-501

Item	Component	Spare part number
	System board for use only with computer models equipped with an Intel 1.8 GHz processor and Windows 8 Pro (includes processor and replacement thermal material).	708966-601
		712354-601
		712355-601
		713809-601
		713813-601
		716306-601
	System board for use only with computer models equipped with an Intel 1.7GHz processor (includes processor and replacement thermal material).	686087-002
		708963-001
		716307-001
	System board for use only with computer models equipped with an Intel 1.7 GHz processor and Windows 8 Standard (includes processor and replacement thermal material).	716307-501
	System board for use only with computer models equipped with an Intel 1.7 GHz processor and Windows 8 Pro (includes processor and replacement thermal material).	716307-601
	System board for use only with computer models equipped with an Intel 1.6 GHz processor (includes processor and replacement thermal material).	686089-002
		686091-002
	System board for use only with computer models equipped with an Intel 1.5 GHz processor (includes processor and replacement thermal material).	693655-001
		693656-001
		708964-001
		708965-001
		712356-001
		716308-001
	System board for use only with computer models equipped with an Intel 1.5 GHz processor and Windows 8 Standard (includes processor and replacement thermal material)	702922-501
		708964-501
		708965-501
		712356-501
		716308-501
	System board for use only with computer models equipped with an Intel 1.5 GHz processor and Windows 8 Pro (includes processor and replacement thermal material)	702922-601
		708964-601
		708965-601
		712356-601
		716308-601
	System board for use only with computer models equipped with an Intel 1.4GHz processor (includes processor and replacement thermal material).	686088-002
	System board for use only with computer models equipped with an Intel 1.4GHz processor and Windows 8 Standard (includes processor and replacement thermal material).	686088-002

<b>Item</b>	<b>Component</b>	<b>Spare part number</b>
	System board for use only with computer models equipped with an Intel 1.4GHz processor and Windows 8 Pro (includes processor and replacement thermal material).	686088-002
	For non-touch models:	
	System board for use only with touch models equipped with an Intel 1.8 GHz processor (includes replacement thermal material)	702925-001
	System board for use only with touch models equipped with an Intel 1.8 GHz processor and Windows 8 Standard (includes replacement thermal material)	702925-501 708961-501
	System board for use only with touch models equipped with an Intel 1.8 GHz processor and Windows 8 Pro (includes replacement thermal material)	702925-601 708961-601
	System board for use only with touch models equipped with an Intel 1.7 GHz processor (includes processor and replacement thermal material)	702926-001 708962-001
	System board for use only with touch models equipped with an Intel 1.7 GHz processor and Windows 8 Standard (includes processor and replacement thermal material)	702926-501 708962-501
	System board for use only with touch models equipped with an Intel 1.7 GHz processor and Windows 8 Pro (includes processor and replacement thermal material)	702926-601 708962-601
<b>(12)</b>	<b>Fan—Heat sink</b>	686578-001 686579-001
<b>(13)</b>	<b>Fan</b>	691641-001
<b>(14)</b>	<b>USB/Audio board</b>	686584-001
<b>(15)</b>	<b>Battery:</b>	
	4-cell, 52 WHr 3.55AH Li-ion battery	681949-001
<b>(16)</b>	<b>Security lock</b>	686577-001
<b>(17)</b>	<b>Hard drive (7mm SATA 2.5")</b>	
	320-GB, 7200-rpm hard drive	634862-005
	320-GB, 5400-rpm hard drive	645193-005
	320-GB, 5400-rpm hard drive	683802-005
<b>(18)</b>	<b>Subwoofer (included in Speaker Kit)</b>	686586-001
<b>(19)</b>	<b>Base enclosure</b>	
	Base enclosure in red finish	686092-001
	Base enclosure in black finish	690193-001
	Base enclosure for use with touch models only	702927-001



## Mass storage devices



Item	Component	Spare part number
(1)	<b>Hard drive (7mm SATA 2.5")</b>	
	320-GB, 7200-rpm hard drive	634862-005
	320-GB, 5400-rpm hard drive	645193-005
	500-GB 5400-rpm hard drive	683802-005
(2a)	Hard drive bracket	686581-001
(2b)	Hard drive cable	686581-001
(3)	<b>Hard drive (mSATA solid-state drive)</b>	
	32-GB solid-state (SSD) drive	687100-001
	24-GB solid-state (SSD) drive	717097-001
(4)	<b>Optical drive</b>	
	Blu-ray ROM DVD±R/RW Super Multi Double-Layer Drive	659941-001
	DVD±RW and CD-RW Super Multi Double-Layer Combo Drive	659940-001
	Screws (not illustrated)	

## Miscellaneous parts

Component	Spare part number
<b>AC adapter (non-smart):</b>	
65-W PFC RC V 2-wire AC adapter (non-smart) for use in all countries and regions	693715-001
65-W PFC 2-wire AC adapter (non-smart) for use in all countries and regions	707750-001
<b>Power cord (3-pin, black, 1.83-m):</b>	
For use in North America	490371-001
For use in Australia	490371-011
For use in Europe	490371-021
For use in the United Kingdom and Singapore	490371-031
For use in Italy	490371-061
For use in Denmark, Finland, Norway	490371-081
For use in Switzerland	490371-111
For use in Thailand	490371-201
For use in Brazil	490371-202
For use in Japan	490371-291
For use in the People's Republic of China	490371-AA1
For use in Taiwan	490371-AB1
For use in South Korea	490371-AD1
For use in South Africa	490371-AR1
For use in Argentina	490371-D01
For use in India	490371-D61
<b>Screw Kit</b>	687098-001

## Sequential part number listing

Spare part number	Description
490371-001	Power cord for use in North America (3-pin, black, 1.83-m)
490371-011	Power cord for use in Australia (3-pin, black, 1.83-m)
490371-021	Power cord for use in Europe (3-pin, black, 1.83-m)
490371-031	Power cord for use in the United Kingdom and Singapore (3-pin, black, 1.83-m)
490371-061	Power cord for use in Italy (3-pin, black, 1.83-m)
490371-081	Power cord for use in Denmark, Finland, Norway (3-pin, black, 1.83-m)
490371-111	Power cord for use in Switzerland (3-pin, black, 1.83-m)
490371-201	Power cord for use in Thailand (3-pin, black, 1.83-m)
490371-202	Power cord for use in Brazil (3-pin, black, 1.83-m)
490371-291	Power cord for use in Japan (3-pin, black, 1.83-m)
490371-AA1	Power cord for use in the People's Republic of China (3-pin, black, 1.83-m)
490371-AB1	Power cord for use in Taiwan (3-pin, black, 1.83-m)
490371-AD1	Power cord for use in South Korea (3-pin, black, 1.83-m)
490371-AR1	Power cord for use in South Africa (3-pin, black, 1.83-m)
490371-D01	Power cord for use in Argentina (3-pin, black, 1.83-m)
490371-D61	Power cord for use in India (3-pin, black, 1.83-m)
634862-005	320-GB, 7200-rpm hard drive
641369-005	4-GB memory module (PC3, 12800, 1600-MHz)
645193-005	320-GB, 5400-rpm hard drive
652972-005	2-GB memory module (PC3, 12800, 1600-MHz)
655795-005	Atheros 9485GN 802.11b/g/n 1×1 WiFi and 3012 Bluetooth 4.0 Combo Adapter
657325-005	Broadcom 4313GN 802.11b/g/n 1×1 WiFi and 20702 Bluetooth 4.0 Combo Adapter
659940-001	DVD±RW and CD-RW Super Multi Double-Layer Combo Drive
659941-001	Blu-ray ROM DVD±R/RW Super Multi Double-Layer Drive
670034-005	8-GB memory module (PC3, 12800, 1600-MHz)
670290-005	Intel® Centrino® Wireless-N 1030 + Bluetooth combo w/ *2 antennas (802.11 b/g/n, Bluetooth 3.0)
675794-005	802.11 b/g/n HMC 1×1 WiFi adapter
681949-001	4-cell, 50 WHr 4.1AH Li-ion battery
683802-005	500-GB, 5400-rpm hard drive
686086-002	System board for use only with computer models equipped with an Intel 1.8GHz processor (includes processor and replacement thermal material)
686087-002	System board for use only with computer models equipped with an Intel 1.7GHz processor (includes processor and replacement thermal material)

<b>Spare part number</b>	<b>Description</b>
686088-002	System board for use only with computer models equipped with an Intel 1.4GHz processor (includes processor and replacement thermal material)
686089-002	System board for use only with computer models equipped with an Intel 1.6GHz processor (includes processor and replacement thermal material)
686090-002	System board for use only with computer models equipped with an Intel 1.4GHz processor (includes processor and replacement thermal material)
686091-002	System board for use only with computer models equipped with an Intel 1.6GHz processor (includes processor and replacement thermal material)
686092-001	Base enclosure in red finish
686093-001	Top cover in black finish (includes power button board and cable and TouchPad and TouchPad cable)
686573-001	WLAN antennas
686575-001	Display bezel
686577-001	Power connector (includes cable)
686578-001	Thermal module
686579-001	Thermal module
686581-001	Hardware kit (hard drive, includes cable)
686584-001	USB/Audio board
686585-001	Speaker kit (includes subwoofer)
686586-001	Subwoofer (included in Speaker kit)
686836-251	Keyboard in black finish for use in Russia (includes keyboard cable)
686922-001	RTC battery
687097-001	Smart card reader
687098-001	Screw kit
687100-001	32-GB solid-state drive only (does not include bracket, connector cable, isolators, or screws)
687997-001	TouchPad assembly (includes bracket) in black finish
687998-001	Keyboard bracket
688000-001	Power button board (includes cable)
689844-002	System board for use only with computer models equipped with an Intel 1.7GHz processor (includes processor and replacement thermal material)
690019-005	Atheros AR9565 802.11 b/g/n 1×1 WiFi Adapter
690020-005	Ralink 802.11 b/g/n 1×1 WiFi + Bluetooth 4.0 Combo Adapter
690193-001	Base enclosure in black finish
690194-001	Top cover in silver finish
691640-001	TouchPad assembly (includes bracket) in silver finish
691641-001	Fan (with foil)
692758-251	Keyboard in black or silver finish for use in Russia (includes keyboard cable)

<b>Spare part number</b>	<b>Description</b>
693655-001	System board for use only with computer models equipped with an Intel 1.5GHz processor (includes processor and replacement thermal material)
693656-001	System board for use only with computer models equipped with an Intel 1.5GHz processor (includes processor and replacement thermal material)
693657-001	System board for use only with computer models equipped with an Intel 1.8GHz processor (includes processor and replacement thermal material)
693715-001	AC Adapter (non-smart) 65 W RC V 2-wire for use in all countries and regions except India
698679-001	Keyboard in black finish for use with computer models with Windows 8 in the United States (includes keyboard cable)
698679-031	Keyboard in black finish for use with computer models with Windows 8 in the United Kingdom and Singapore (includes keyboard cable)
698679-041	Keyboard in black finish for use with computer models with Windows 8 in Germany (includes keyboard cable)
698679-051	Keyboard in black finish for use with computer models with Windows 8 France (includes keyboard cable)
698679-061	Keyboard in black finish for use with computer models with Windows 8 in Italy (includes keyboard cable)
698679-161	Keyboard in black finish for use with computer models with Windows 8 in Latin America (includes keyboard cable)
698679-281	Keyboard in black finish for use with computer models with Windows 8 in Thailand (includes keyboard cable)
698679-291	Keyboard in black finish for use with computer models with Windows 8 in Japan (includes keyboard cable)
698679-AB1	Keyboard in black finish for use with computer models with Windows 8 in Taiwan (includes keyboard cable)
698679-AD1	Keyboard in black finish for use with computer models with Windows 8 in Korea (includes keyboard cable)
698679-B31	Keyboard in black finish for use with computer models with Windows 8 in the Netherlands (includes keyboard cable)
698679-BA1	Keyboard in black finish for use with computer models with Windows 8 in Slovenia (includes keyboard cable)
698679-D61	Keyboard in black finish for use with computer models with Windows 8 in India (includes keyboard cable)
698679-FL1	Keyboard in black finish for use with computer models with Windows 8 in the Czech Republic (includes keyboard cable)
698680-001	Backlit keyboard in black finish for use with computer models with Windows 8 in the United States (includes keyboard cable)
698680-071	Backlit keyboard in black finish for use with computer models with Windows 8 in Spain (includes keyboard cable)
698680-141	Backlit keyboard in black finish for use with computer models with Windows 8 in Turkey (includes keyboard cable)
698680-161	Backlit keyboard in black finish for use with computer models with Windows 8 in Latin America (includes keyboard cable)

<b>Spare part number</b>	<b>Description</b>
698680-171	Backlit keyboard in black finish for use with computer models with Windows 8 in Saudi Arabia (includes keyboard cable)
698680-251	Backlit keyboard in black finish for use with computer models with Windows 8 in Russia (includes keyboard cable)
698680-A41	Backlit keyboard in black finish for use with computer models with Windows 8 in Belgium (includes keyboard cable)
698680-B31	Backlit keyboard in black finish for use with computer models with Windows 8 in the Netherlands (includes keyboard cable)
698680-BG1	Backlit keyboard in black finish for use with computer models with Windows 8 in Switzerland (includes keyboard cable)
698680-DB1	Backlit keyboard in black finish for use with computer models with Windows 8 in Canada (includes keyboard cable)
698680-DH1	Backlit keyboard in black finish for use with computer models with Windows 8 in Denmark, Finland, Norway (includes keyboard cable)
698681-001	Keyboard in black/silver finish for use with computer models with Windows 8 in the United States (includes keyboard cable)
698681-031	Keyboard in black/silver finish for use with computer models with Windows 8 in the United Kingdom and Singapore (includes keyboard cable)
698681-041	Keyboard in black/silver finish for use with computer models with Windows 8 in Germany (includes keyboard cable)
698681-051	Keyboard in black/silver finish for use with computer models with Windows 8 in France (includes keyboard cable)
698681-061	Keyboard in black/silver finish for use with computer models with Windows 8 in Italy (includes keyboard cable)
698681-161	Keyboard in black/silver finish for use with computer models with Windows 8 in Latin America (includes keyboard cable)
698681-281	Keyboard in black/silver finish for use with computer models with Windows 8 in Thailand (includes keyboard cable)
698681-291	Keyboard in black/silver finish for use with computer models with Windows 8 in Japan (includes keyboard cable)
698681-AB1	Keyboard in black/silver finish for use with computer models with Windows 8 in Taiwan (includes keyboard cable)
698681-AD1	Keyboard in black/silver finish for use with computer models with Windows 8 in Korea (includes keyboard cable)
698681-B31	Keyboard in black/silver finish for use with computer models with Windows 8 in the Netherlands (includes keyboard cable)
698681-BA1	Keyboard in black/silver finish for use with computer models with Windows 8 in Slovenia (includes keyboard cable)
698681-D61	Keyboard in black/silver finish for use with computer models with Windows 8 in India (includes keyboard cable)
698681-FL1	Keyboard in black/silver finish for use with computer models with Windows 8 in the Czech Republic (includes keyboard cable)
698682-001	Backlit keyboard in black/silver finish for use with computer models with Windows 8 in the United States (includes keyboard cable)

<b>Spare part number</b>	<b>Description</b>
698682-071	Backlit keyboard in black/silver finish for use with computer models with Windows 8 in Spain (includes keyboard cable)
698682-141	Backlit keyboard in black/silver finish for use with computer models with Windows 8 in Turkey (includes keyboard cable)
698682-161	Backlit keyboard in black/silver finish for use with computer models with Windows 8 in Latin America (includes keyboard cable)
698682-171	Backlit keyboard in black/silver finish for use with computer models with Windows 8 in Saudi Arabia (includes keyboard cable)
698682-201	Backlit keyboard in black/silver finish for use with computer models with Windows 8 in Brazil (includes keyboard cable)
698682-251	Backlit keyboard in black/silver finish for use with computer models with Windows 8 in Russia (includes keyboard cable)
698682-A41	Backlit keyboard in black/silver finish for use with computer models with Windows 8 in Belgium (includes keyboard cable)
698682-B31	Backlit keyboard in black/silver finish for use with computer models with Windows 8 in the Netherlands (includes keyboard cable)
698682-BG1	Backlit keyboard in black/silver finish for use with computer models with Windows 8 in Switzerland (includes keyboard cable)
698682-DB1	Backlit keyboard in black/silver finish for use with computer models with Windows 8 in Canada (includes keyboard cable)
698682-DH1	Backlit keyboard in black/silver finish for use with computer models with Windows 8 in Denmark, Finland, Norway (includes keyboard cable)
699378-001	Display panel for use with touch models only
699379-001	Hard drive hardware kit
699834-201	Atheros HB125 802.11 b/g/n 1x1 WiFi + Bluetooth 4.0 Combo Adapter for use in Brazil
702683-001	Display panel in black finish for use with non-touch computer models
702684-001	Display panel in black and silver finish for use with non-touch computer models
702925-001	System board for use only with computer models equipped with an Intel 1.8 GHz processor and Windows 8 Standard (includes processor and replacement thermal material)
702925-501	System board for use only with computer models equipped with an Intel 1.8 GHz processor and Windows 8 Standard (includes processor and replacement thermal material)
702925-601	System board for use only with computer models equipped with an Intel 1.8 GHz processor and Windows 8 Professional (includes processor and replacement thermal material)
702926-001	System board for use only with computer models equipped with an Intel 1.7 GHz processor and Windows 8 Standard (includes processor and replacement thermal material)
702926-501	System board for use only with computer models equipped with an Intel 1.7 GHz processor and Windows 8 Standard (includes processor and replacement thermal material)
702926-601	System board for use only with computer models equipped with an Intel 1.7 GHz processor and Windows 8 Professional (includes processor and replacement thermal material)
702927-001	Base enclosure for use with touch models only
702928-001	Smart card reader for use only with touch models only

<b>Spare part number</b>	<b>Description</b>
707750-001	AC Adapter (non-smart) 65 W RC V 2-wire for use in all countries and regions except India
708961-001	For use only with computer models equipped with an Intel 1.8 GHz processor (includes replacement thermal material)
708961-501	For use only with computer models equipped with an Intel 1.8 GHz processor and Windows 8 Standard (includes replacement thermal material)
708961-601	For use only with computer models equipped with an Intel 1.8 GHz processor and Windows 8 Pro (includes replacement thermal material)
708962-001	For use only with computer models equipped with an Intel 1.7 GHz processor (includes processor and replacement thermal material)
708962-501	For use only with computer models equipped with an Intel 1.7 GHz processor and Windows 8 Standard (includes processor and replacement thermal material)
708962-601	For use only with computer models equipped with an Intel 1.7 GHz processor and Windows 8 Pro (includes processor and replacement thermal material)
708963-001	For use only with computer models equipped with an Intel 1.7 GHz processor (includes processor and replacement thermal material)
708963-501	For use only with computer models equipped with an Intel 1.7 GHz processor and Windows 8 Standard (includes processor and replacement thermal material)
708963-601	For use only with computer models equipped with an Intel 1.7 GHz processor and Windows 8 Pro (includes processor and replacement thermal material)
708964-001	For use only with computer models equipped with an Intel 1.5 GHz processor (includes processor and replacement thermal material)
708964-501	For use only with computer models equipped with an Intel 1.5 GHz processor and Windows 8 Standard (includes processor and replacement thermal material)
708964-601	For use only with computer models equipped with an Intel 1.5 GHz processor and Windows 8 Pro (includes processor and replacement thermal material)
708965-001	For use only with computer models equipped with an Intel 1.5 GHz processor (includes processor and replacement thermal material)
708965-501	For use only with computer models equipped with an Intel 1.5 GHz processor and Windows 8 Standard (includes processor and replacement thermal material)
708965-601	For use only with computer models equipped with an Intel 1.5 GHz processor and Windows 8 Pro (includes processor and replacement thermal material)
708966-001	For use only with computer models equipped with an Intel 1.8 GHz processor (includes processor and replacement thermal material)
708966-501	For use only with computer models equipped with an Intel 1.8 GHz processor and Windows 8 Standard (includes processor and replacement thermal material)
708966-601	For use only with computer models equipped with an Intel 1.8 GHz processor and Windows 8 Pro (includes processor and replacement thermal material)
712354-001	For use only with computer models equipped with an Intel 1.7 GHz processor (includes processor and replacement thermal material)
712354-501	For use only with computer models equipped with an Intel 1.7 GHz processor and Windows 8 Standard (includes processor and replacement thermal material)
712354-601	For use only with computer models equipped with an Intel 1.7 GHz processor and Windows 8 Pro (includes processor and replacement thermal material)



<b>Spare part number</b>	<b>Description</b>
712355-001	For use only with computer models equipped with an Intel 1.8 GHz processor (includes processor and replacement thermal material)
712355-501	For use only with computer models equipped with an Intel 1.8 GHz processor and Windows 8 Standard (includes processor and replacement thermal material)
712355-601	For use only with computer models equipped with an Intel 1.8 GHz processor and Windows 8 Pro (includes processor and replacement thermal material)
712356-001	For use only with computer models equipped with an Intel 1.5 GHz processor (includes processor and replacement thermal material)
712356-501	For use only with computer models equipped with an Intel 1.5 GHz processor and Windows 8 Standard (includes processor and replacement thermal material)
712356-601	For use only with computer models equipped with an Intel 1.5 GHz processor and Windows 8 Pro (includes processor and replacement thermal material)
713809-001	For use only with computer models equipped with an Intel 1.8 GHz processor (includes processor and replacement thermal material)
713809-501	For use only with computer models equipped with an Intel 1.8 GHz processor and Windows 8 Standard (includes processor and replacement thermal material)
713809-601	For use only with computer models equipped with an Intel 1.8 GHz processor and Windows 8 Pro (includes processor and replacement thermal material)
713810-001	For use only with computer models equipped with an Intel 1.9 GHz processor (includes processor and replacement thermal material)
713810-501	For use only with computer models equipped with an Intel 1.9 GHz processor and Windows 8 Standard (includes processor and replacement thermal material)
713810-601	For use only with computer models equipped with an Intel 1.9 GHz processor and Windows 8 Pro (includes processor and replacement thermal material)
713813-001	For use only with computer models equipped with an Intel 1.8 GHz processor (includes processor and replacement thermal material)
713813-501	For use only with computer models equipped with an Intel 1.8 GHz processor and Windows 8 Standard (includes processor and replacement thermal material)
713813-601	For use only with computer models equipped with an Intel 1.8 GHz processor and Windows 8 Pro (includes processor and replacement thermal material)
713814-001	For use only with computer models equipped with an Intel 1.9 GHz processor (includes processor and replacement thermal material)
713814-501	For use only with computer models equipped with an Intel 1.9 GHz processor and Windows 8 Standard (includes processor and replacement thermal material)
713814-601	For use only with computer models equipped with an Intel 1.9 GHz processor and Windows 8 Pro (includes processor and replacement thermal material)
716306-001	For use only with computer models equipped with an Intel 1.8 GHz processor (includes processor and replacement thermal material)
716306-501	For use only with computer models equipped with an Intel 1.8 GHz processor and Windows 8 Standard (includes processor and replacement thermal material)
716306-601	For use only with computer models equipped with an Intel 1.8 GHz processor and Windows 8 Pro (includes processor and replacement thermal material)
716307-001	For use only with computer models equipped with an Intel 1.87 GHz processor (includes processor and replacement thermal material)

<b>Spare part number</b>	<b>Description</b>
716307-501	For use only with computer models equipped with an Intel 1.7 GHz processor and Windows 8 Standard (includes processor and replacement thermal material)
716307-601	For use only with computer models equipped with an Intel 1.7 GHz processor and Windows 8 Pro (includes processor and replacement thermal material)
716308-001	For use only with computer models equipped with an Intel 1.5 GHz processor (includes processor and replacement thermal material)
716308-501	For use only with computer models equipped with an Intel 1.5 GHz processor and Windows 8 Standard (includes processor and replacement thermal material)
716308-601	For use only with computer models equipped with an Intel 1.5 GHz processor and Windows 8 Pro (includes processor and replacement thermal material)
716398-001	Display panel in black finish for use with touch models only
716399-001	Display panel in black finish for use with non-touch models only
716400-001	Display panel in black and silver finish for use with non-touch models only
717097-001	24-GB mSATA solid-state drive (SSD)

---

# 4 Removal and replacement procedures

---

 **CAUTION:** This computer does not have user-replaceable parts. Only HP authorized service providers should perform the removal and replacement procedures described here. Accessing the internal part could damage the computer or void the warranty.

---

## Preliminary replacement requirements

### Tools required

You will need the following tools to complete the removal and replacement procedures:

- Flat-bladed screwdriver
- Magnetic screwdriver
- Phillips P0 and P1 screwdrivers

### Service considerations

The following sections include some of the considerations that you must keep in mind during disassembly and assembly procedures.

---

 **NOTE:** As you remove each subassembly from the computer, place the subassembly (and all accompanying screws) away from the work area to prevent damage.

---

### Plastic parts

---

 **CAUTION:** Using excessive force during disassembly and reassembly can damage plastic parts. Use care when handling the plastic parts. Apply pressure only at the points designated in the maintenance instructions.

---

### Cables and connectors

---

 **CAUTION:** When servicing the computer, be sure that cables are placed in their proper locations during the reassembly process. Improper cable placement can damage the computer.

---

Cables must be handled with extreme care to avoid damage. Apply only the tension required to unseat or seat the cables during removal and insertion. Handle cables by the connector whenever possible. In all cases, avoid bending, twisting, or tearing cables. Be sure that cables are routed in such a way that they cannot be caught or snagged by parts being removed or replaced. Handle flex cables with extreme care; these cables tear easily.

## Drive handling

---

**⚠ CAUTION:** Drives are fragile components that must be handled with care. To prevent damage to the computer, damage to a drive, or loss of information, observe these precautions:

Before removing or inserting a hard drive, shut down the computer. If you are unsure whether the computer is off or in Hibernation, turn the computer on, and then shut it down through the operating system.

Before handling a drive, be sure that you are discharged of static electricity. While handling a drive, avoid touching the connector.

Before removing a diskette drive or optical drive, be sure that a diskette or disc is not in the drive and be sure that the optical drive tray is closed.

Handle drives on surfaces covered with at least one inch of shock-proof foam.

Avoid dropping drives from any height onto any surface.

After removing a hard drive, an optical drive, or a diskette drive, place it in a static-proof bag.

Avoid exposing an internal hard drive to products that have magnetic fields, such as monitors or speakers.

Avoid exposing a drive to temperature extremes or liquids.

If a drive must be mailed, place the drive in a bubble pack mailer or other suitable form of protective packaging and label the package "FRAGILE."

---

## Grounding guidelines

### Electrostatic discharge damage

Electronic components are sensitive to electrostatic discharge (ESD). Circuitry design and structure determine the degree of sensitivity. Networks built into many integrated circuits provide some protection, but in many cases, ESD contains enough power to alter device parameters or melt silicon junctions.

A discharge of static electricity from a finger or other conductor can destroy static-sensitive devices or microcircuitry. Even if the spark is neither felt nor heard, damage may have occurred.

An electronic device exposed to ESD may not be affected at all and can work perfectly throughout a normal cycle. Or the device may function normally for a while, then degrade in the internal layers, reducing its life expectancy.

---

**⚠ CAUTION:** To prevent damage to the computer when you are removing or installing internal components, observe these precautions:

Keep components in their electrostatic-safe containers until you are ready to install them.

Before touching an electronic component, discharge static electricity by using the guidelines described in this section.

Avoid touching pins, leads, and circuitry. Handle electronic components as little as possible.

If you remove a component, place it in an electrostatic-safe container.

---

The following table shows how humidity affects the electrostatic voltage levels generated by different activities.

**⚠ CAUTION:** A product can be degraded by as little as 700 V.

Typical electrostatic voltage levels			
Event	Relative humidity		
	10%	40%	55%
Walking across carpet	35,000 V	15,000 V	7,500 V
Walking across vinyl floor	12,000 V	5,000 V	3,000 V
Motions of bench worker	6,000 V	800 V	400 V
Removing DIPS from plastic tube	2,000 V	700 V	400 V
Removing DIPS from vinyl tray	11,500 V	4,000 V	2,000 V
Removing DIPS from Styrofoam	14,500 V	5,000 V	3,500 V
Removing bubble pack from PCB	26,500 V	20,000 V	7,000 V
Packing PCBs in foam-lined box	21,000 V	11,000 V	5,000 V

### Packaging and transporting guidelines

Follow these grounding guidelines when packaging and transporting equipment:

- To avoid hand contact, transport products in static-safe tubes, bags, or boxes.
- Protect ESD-sensitive parts and assemblies with conductive or approved containers or packaging.
- Keep ESD-sensitive parts in their containers until the parts arrive at static-free workstations.
- Place items on a grounded surface before removing items from their containers.
- Always be properly grounded when touching a component or assembly.
- Store reusable ESD-sensitive parts from assemblies in protective packaging or nonconductive foam.
- Use transporters and conveyors made of antistatic belts and roller bushings. Be sure that mechanized equipment used for moving materials is wired to ground and that proper materials are selected to avoid static charging. When grounding is not possible, use an ionizer to dissipate electric charges.

### Workstation guidelines

Follow these grounding workstation guidelines:

- Cover the workstation with approved static-shielding material.
- Use a wrist strap connected to a properly grounded work surface and use properly grounded tools and equipment.
- Use conductive field service tools, such as cutters, screwdrivers, and vacuums.
- When fixtures must directly contact dissipative surfaces, use fixtures made only of static-safe materials.

- Keep the work area free of nonconductive materials, such as ordinary plastic assembly aids and Styrofoam.
- Handle ESD-sensitive components, parts, and assemblies by the case or PCM laminate. Handle these items only at static-free workstations.
- Avoid contact with pins, leads, or circuitry.
- Turn off power and input signals before inserting or removing connectors or test equipment.

### Equipment guidelines

Grounding equipment must include either a wrist strap or a foot strap at a grounded workstation.

- When seated, wear a wrist strap connected to a grounded system. Wrist straps are flexible straps with a minimum of one megohm  $\pm 10\%$  resistance in the ground cords. To provide proper ground, wear a strap snugly against the skin at all times. On grounded mats with banana-plug connectors, use alligator clips to connect a wrist strap.
- When standing, use foot straps and a grounded floor mat. Foot straps (heel, toe, or boot straps) can be used at standing workstations and are compatible with most types of shoes or boots. On conductive floors or dissipative floor mats, use foot straps on both feet with a minimum of one megohm resistance between the operator and ground. To be effective, the conductive must be worn in contact with the skin.

The following grounding equipment is recommended to prevent electrostatic damage:

- Antistatic tape
- Antistatic smocks, aprons, and sleeve protectors
- Conductive bins and other assembly or soldering aids
- Nonconductive foam
- Conductive tabletop workstations with ground cords of one megohm resistance
- Static-dissipative tables or floor mats with hard ties to the ground
- Field service kits
- Static awareness labels
- Material-handling packages
- Nonconductive plastic bags, tubes, or boxes
- Metal tote boxes
- Electrostatic voltage levels and protective materials

The following table lists the shielding protection provided by antistatic bags and floor mats.

Material	Use	Voltage protection level
Antistatic plastics	Bags	1,500 V
Carbon-loaded plastic	Floor mats	7,500 V
Metallized laminate	Floor mats	5,000 V

# Component replacement procedures

This chapter provides removal and replacement procedures.

There are as many as 77 screws that must be removed, replaced, or loosened when servicing the computer. Make special note of each screw size and location during removal and replacement.

## Display panel

Description	Spare part number
14.0 in, WLED, BrightView SVA display panel	
In black finish for use with touch models only	699378-001 716398-001
In black finish for use with non-touch models only	702683-001 716399-001
In black and silver finish for use with non-touch models only	702684-001 716400-001

Before removing the display panel, follow these steps:

1. Shut down the computer. If you are unsure whether the computer is off or in Hibernation, turn the computer on, and then shut it down through the operating system.
2. Disconnect all external devices connected to the computer.
3. Disconnect the power from the computer by first unplugging the power cord from the AC outlet and then unplugging the AC adapter from the computer.

Remove the display panel:

1. Turn the computer right-side up, with the rear toward you.
2. Open the computer.
3. Remove the 2 screw covers **(1)** on the left and right side base of the display panel.

 **NOTE:** Use a sharp probe to pop the covers out to avoid scratching the bezel

4. Remove the 2 Phillips PM 2.5x3 screws **(2)** on the left and right hinges that secure the display panel to the computer.

 **NOTE:** Support the display panel as you are removing the screws.

5. Loosen the edges of the plastic bezel cover **(3)** from all four sides of the display panel.

6. Lift the display bezel cover (4), and then remove the cover (5).

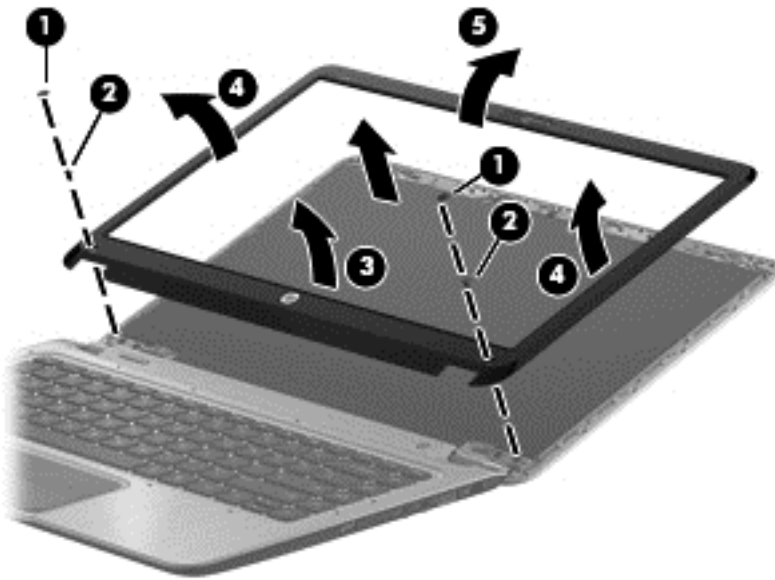

7. Remove the 4 Phillips PM 2x2 display panel screws (2 on the top and 2 on the bottom).



**NOTE:** Remove any tabs or tape adhering to the display panel.

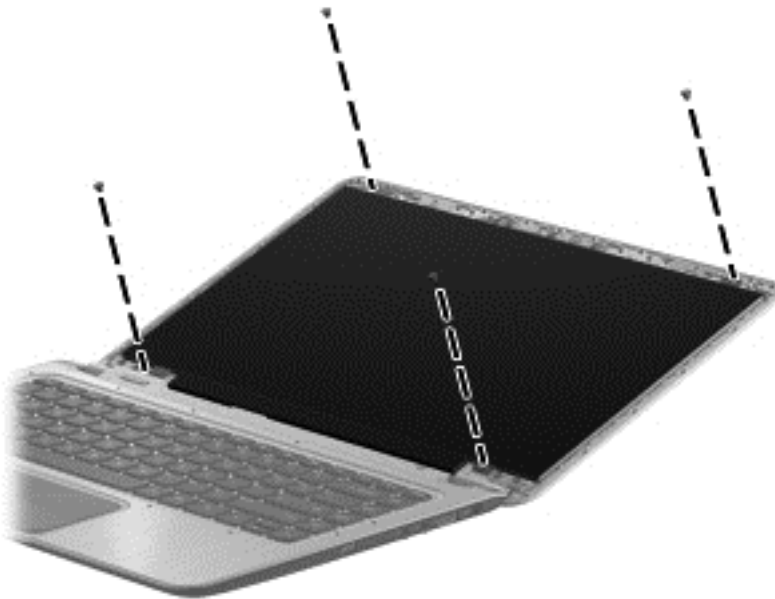



8. Disconnect the display panel cable (1), and then move the panel towards the keyboard (2).

 **NOTE:** Support the display panel as you lean the panel forward.

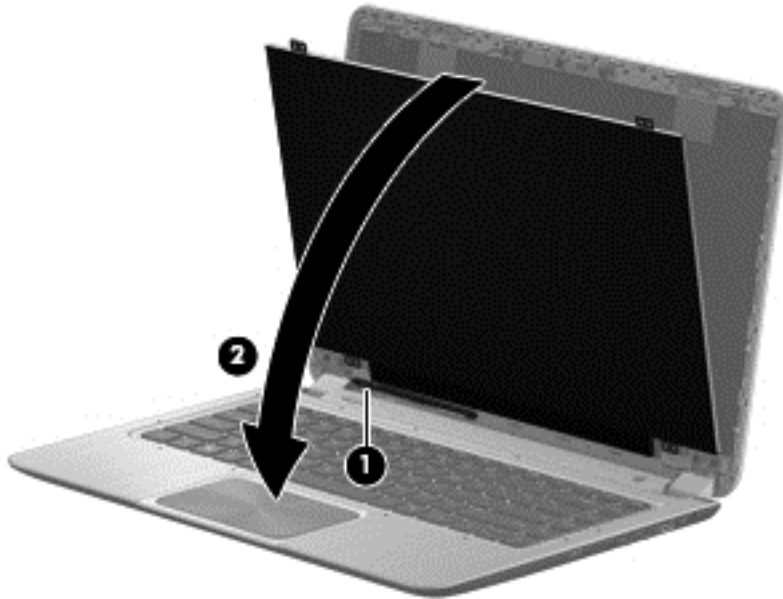

9. Release the support strip (1) that secures the display panel connector. Disconnect the display panel cable from the display panel (2), and then remove the panel (3).

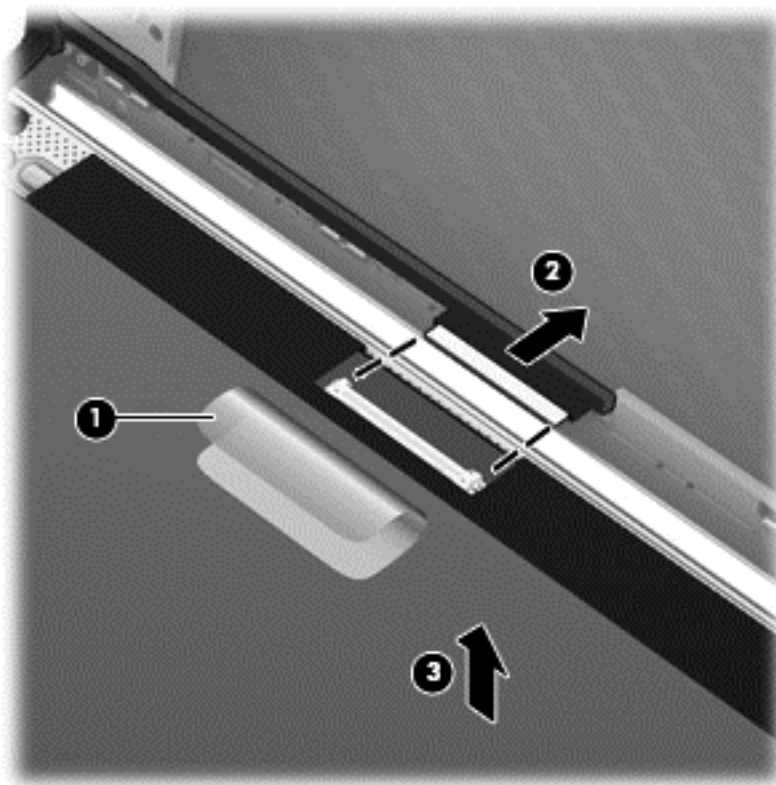

Reverse this procedure to install the display panel.

## Base enclosure

Description	Spare part number
Base enclosure (Red)	686092-001
Base enclosure (Black)	690193-001
Base enclosure for touch models only	702927-001

Before disassembling the computer, follow these steps:

1. Shut down the computer. If you are unsure whether the computer is off or in Hibernation, turn the computer on, and then shut it down through the operating system.
2. Disconnect all external devices connected to the computer.
3. Disconnect the power from the computer by first unplugging the power cord from the AC outlet and then unplugging the AC adapter from the computer.
4. Remove the display panel (see [Display panel on page 39](#)).

Remove the base enclosure:

1. Turn the computer face down, remove the 12 Phillips PM 7.5 millimeter long screws.

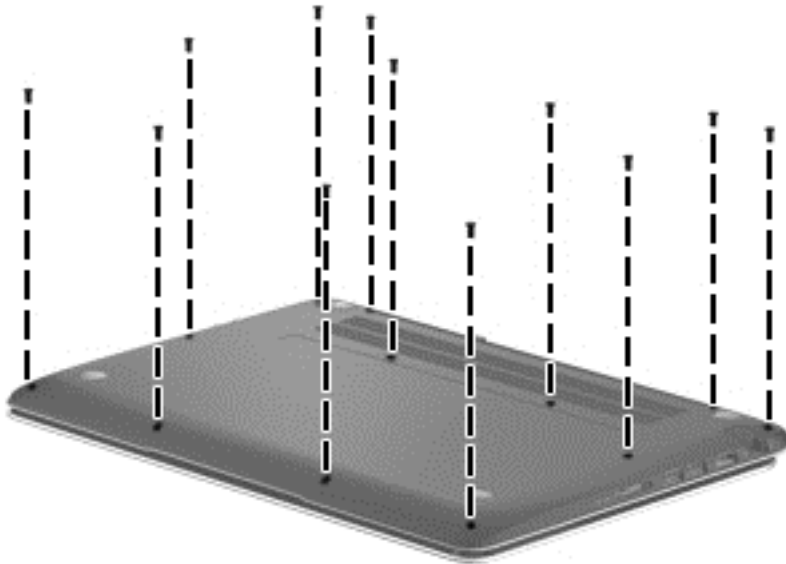

2. Remove the bottom enclosure.



**NOTE:** To remove the bottom enclosure, use a thin, non-conductive tool such as the HP Tool Shroud separator, available on the HP website.



## Battery

Description	Spare part number
4-cell, 52WHr 3.55AH Li-ion battery	681949-001

Before removing the battery, follow these steps:

1. Shut down the computer. If you are unsure whether the computer is off or in Hibernation, turn the computer on, and then shut it down through the operating system.
2. Disconnect all external devices connected to the computer.
3. Disconnect the power from the computer by first unplugging the power cord from the AC outlet and then unplugging the AC adapter from the computer.
4. Remove the display panel (see [Display panel on page 39](#)).
5. Remove the base enclosure (see [Base enclosure on page 42](#)).

Remove the battery:

1. Turn the computer right-side up, with the front toward you.

2. Disconnect the battery cable.

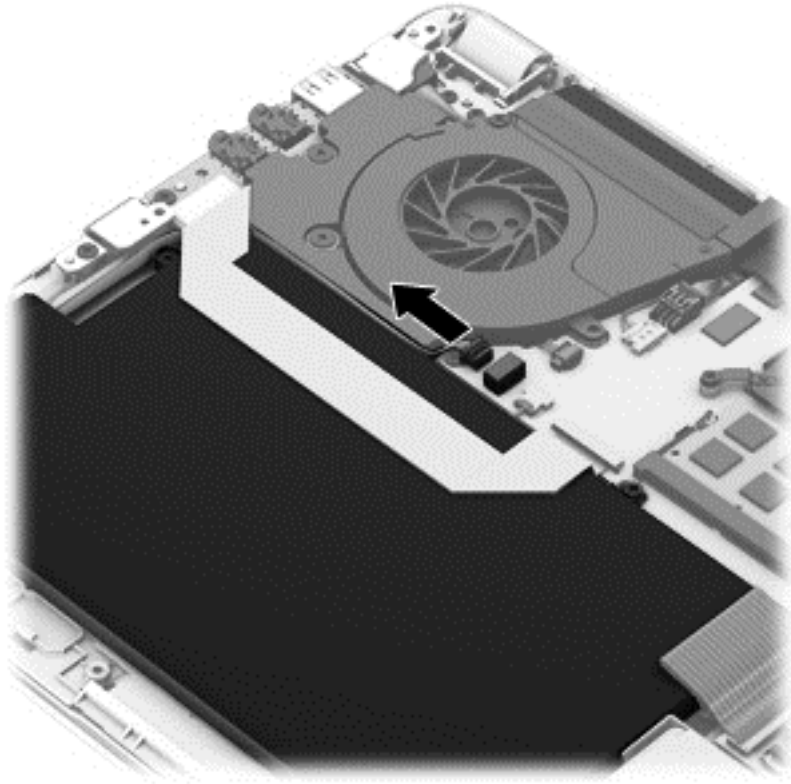

3. Move the battery cable to the side **(1)**, and then remove the 3 Phillips PM 2.5×4.2 screws **(2)** that secure the battery to the top cover.

4. Remove the battery from the computer (3).

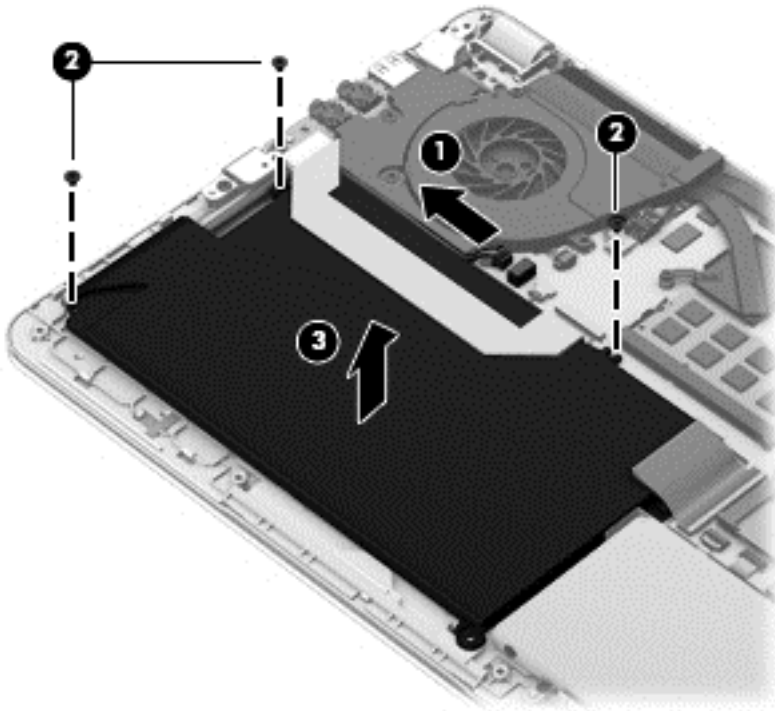

Reverse this procedure to install the battery.

## Hard drive

Description	Spare part number
320-GB 7200RPM SATA 7mm	634862-005
320-GB 5400RPM SATA 7mm	645193-005
500-GB 5400RPM SATA 7mm	683802-005
32-GB mSATA solid-state drive (SSD)	687100-001
24-GB mSATA solid-state drive (SSD)	717097-001

Before removing the hard drive or SSD, follow these steps:

1. Shut down the computer. If you are unsure whether the computer is off or in Hibernation, turn the computer on, and then shut it down through the operating system.
2. Disconnect all external devices connected to the computer.
3. Disconnect the power from the computer by first unplugging the power cord from the AC outlet and then unplugging the AC adapter from the computer.
4. Remove the display panel (see [Display panel on page 39](#)).
5. Remove the base enclosure (see [Base enclosure on page 42](#)).
6. Disconnect the battery cable (see [Battery on page 43](#)).

Remove the hard drive:

1. Disconnect the hard drive cable from the system board **(1)**, and then remove the 4 screws **(2)** securing the hard drive to the top cover.

2. Remove the hard drive (3).

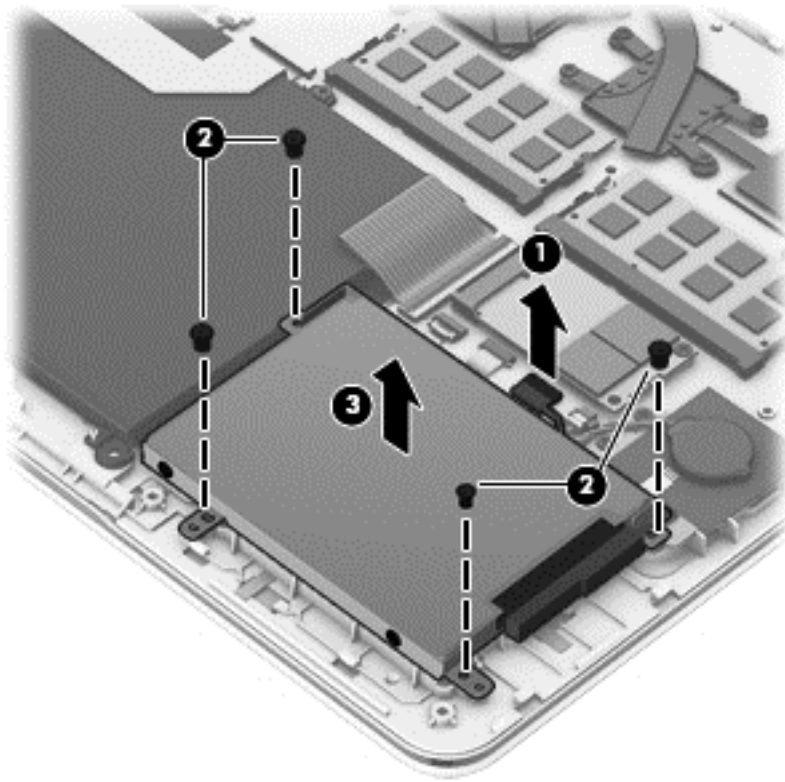

3. Remove the hard drive connector cable (1). Remove the 4 screws (2) securing the hard drive bracket to the hard drive, and then remove the hard drive bracket (3).
4. Remove the hard drive (3).

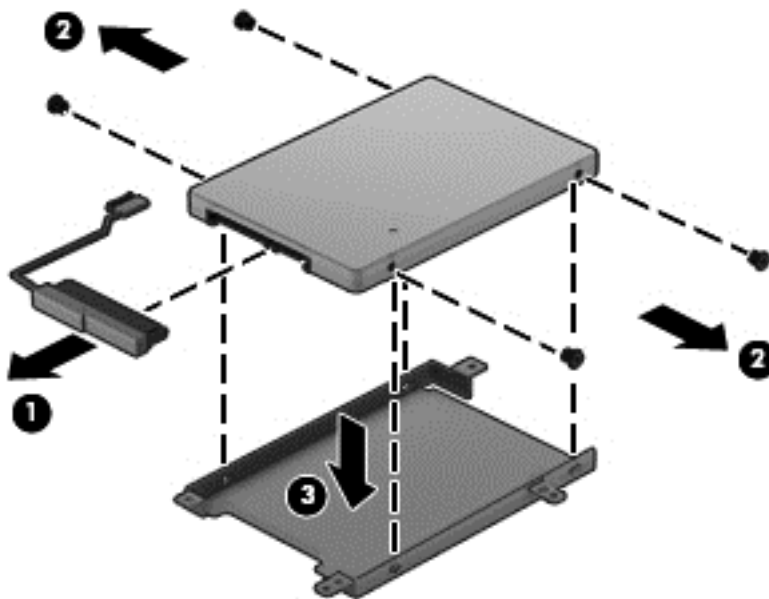

Remove the mSATA solid-state drive:

- ▲ Remove the screw (1), and then remove the mSATA solid-state drive (2).

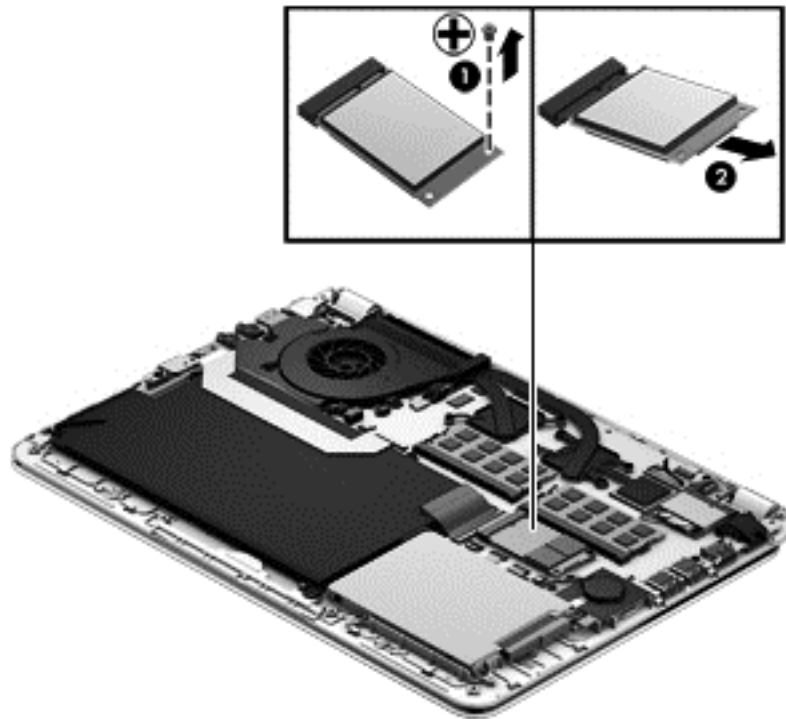

Reverse these procedures to reassemble and install the hard drive.



## RTC battery

Description	Spare part number
RTC battery	686922-001

Before removing the RTC battery, follow these steps:

1. Shut down the computer. If you are unsure whether the computer is off or in Hibernation, turn the computer on, and then shut it down through the operating system.
2. Disconnect all external devices connected to the computer.
3. Disconnect the power from the computer by first unplugging the power cord from the AC outlet and then unplugging the AC adapter from the computer.
4. Remove the display panel (see [Display panel on page 39](#)).
5. Remove the base enclosure (see [Base enclosure on page 42](#)).
6. Disconnect the battery cable (see [Battery on page 43](#)).

Remove the RTC battery:

1. Disconnect the RTC battery cable from the system board **(1)**. Use a thin, non-conductive tool to remove the RTC battery from the socket on the system board.

2. Gently hold down the media card reader board (2), and remove the RTC battery (3).

 **NOTE:** The RTC battery is attached to the system board by foam material rather than double-sided adhesive.

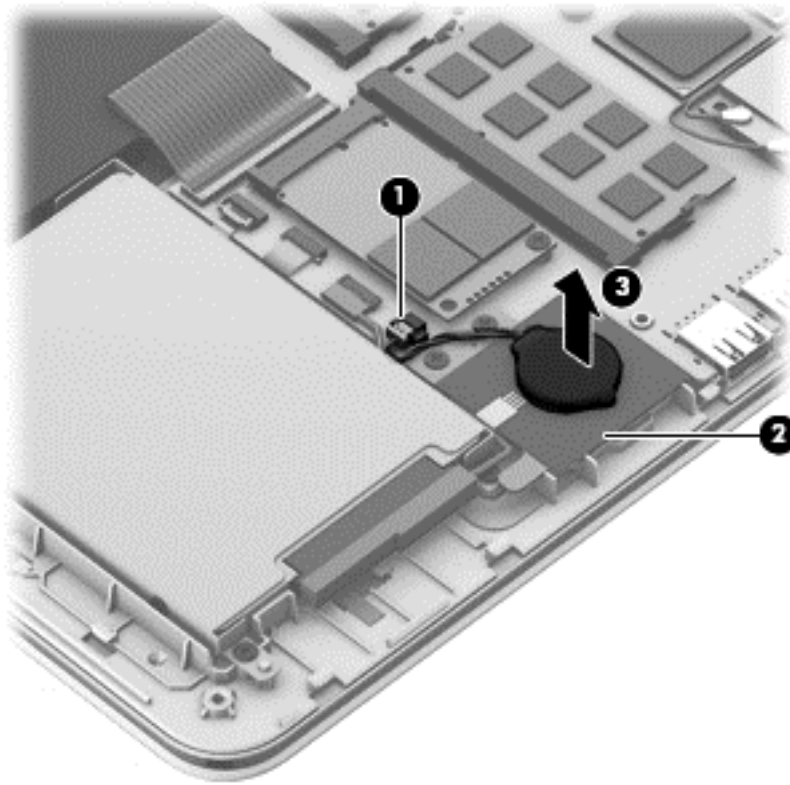

Reverse this procedure to install the RTC battery on computer models. When installing the RTC battery, make sure the “+” sign faces up.

## Memory module

Description	Spare part number
4-GB memory module (PC3, 12800, 1600-MHz)	641369-005
2-GB memory module (PC3, 12800, 1600-MHz)	652972-005
8-GB memory module (PC3, 12800, 1600-MHz)	670034-005

Before removing a memory module, follow these steps:

1. Shut down the computer. If you are unsure whether the computer is off or in Hibernation, turn the computer on, and then shut it down through the operating system.
2. Disconnect all external devices connected to the computer.
3. Disconnect the power from the computer by first unplugging the power cord from the AC outlet and then unplugging the AC adapter from the computer.
4. Remove the display panel (see [Display panel on page 39](#)).

5. Remove the base enclosure (see [Base enclosure on page 42](#)).
6. Remove the keyboard (see [Keyboard on page 70](#)).
7. Remove the top cover (see [Top cover on page 74](#)).
8. Disconnect the battery cable (see [Battery on page 43](#)).

Remove the memory module:

1. Spread the retaining tabs **(1)** on each side of the memory module slot to release the memory module. (The memory module tilts up.)

**⚠ CAUTION:** To prevent damage to the memory module, hold it by the edges only. Do not touch the components on the memory module.

2. Slide the memory module forward **(2)**.
3. Remove the memory module **(3)**.

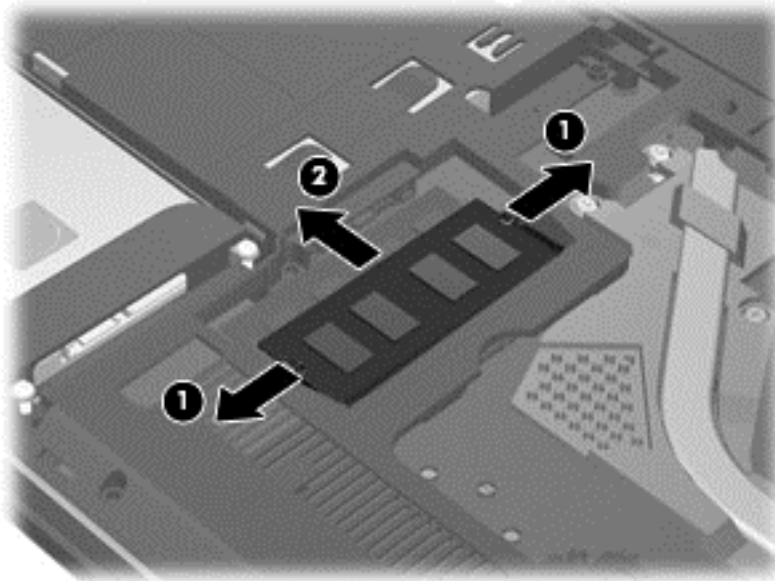

Reverse this procedure to install a memory module.

## WLAN module

Description	Spare part number
Intel® Centrino® Wireless-N 1030 + Bluetooth combo w/ *2 antennas (802.11 b/g/n, Bluetooth 3.0)	670290-005
Atheros 9485GN 802.11b/g/n 1×1 WiFi and 3012 Bluetooth 4.0 Combo Adapter	655795-005
Broadcom 4313GN 802.11b/g/n 1×1 WiFi and 20702 Bluetooth 4.0 Combo Adapter	657325-005
802.11 b/g/n HMC 1×1 WiFi adapter	675794-005
Atheros AR9565 802.11 b/g/n 1×1 WiFi Adapter	690019-005
Ralink 802.11 b/g/n 1×1 WiFi + Bluetooth 4.0 Combo Adapter	690020-005
Atheros HB125 802.11 b/g/n 1×1 WiFi + Bluetooth 4.0 Combo Adapter for use in Brazil	699834-201

 **CAUTION:** To prevent an unresponsive system, replace the wireless module only with a wireless module authorized for use in the computer by the governmental agency that regulates wireless devices in your country or region. If you replace the module and then receive a warning message, remove the module to restore device functionality, and then contact technical support.

Before removing the WLAN module, follow these steps:

1. Shut down the computer. If you are unsure whether the computer is off or in Hibernation, turn the computer on, and then shut it down through the operating system.
2. Disconnect all external devices connected to the computer.
3. Disconnect the power from the computer by first unplugging the power cord from the AC outlet and then unplugging the AC adapter from the computer.
4. Remove the display panel (see [Display panel on page 39](#)).
5. Remove the base enclosure (see [Base enclosure on page 42](#)).
6. Disconnect the battery cable (see [Battery on page 43](#)).

Remove the WLAN module:

1. Disconnect the #1 and #2 WLAN antenna cables from the WLAN module **(1)**.

 **NOTE:** The #1 WLAN antenna cable is connected to the WLAN module #1 main terminal. The #2 WLAN antenna cable is connected to the WLAN module #2 auxiliary terminal.

2. Remove the 1 Phillips PM 2.0×2.5 screw **(2)** that secures the WLAN module to the system board. (The WLAN module tilts up.)

3. Remove the WLAN module by pulling the module away from the slot at an angle (3).

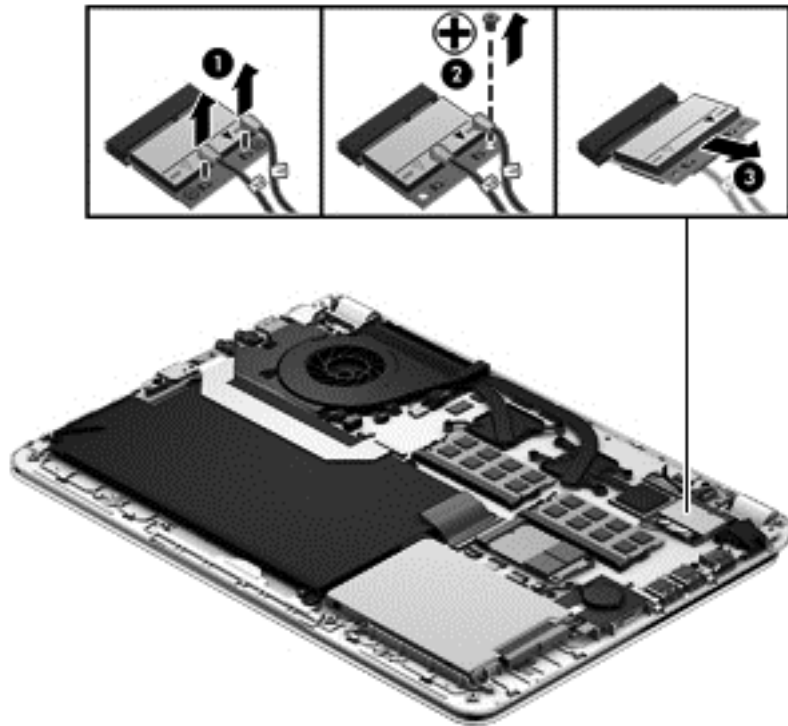

 **NOTE:** If the WLAN antennas are not connected to the terminals on the WLAN module, the protective sleeves must be installed on the antenna connectors.

## TouchPad module

Description	Spare part number
TouchPad button board (includes cable) in black finish	687997-001
TouchPad button board (includes cable) in silver finish	691640-001

Before removing the TouchPad button board, follow these steps:

1. Shut down the computer. If you are unsure whether the computer is off or in Hibernation, turn the computer on, and then shut it down through the operating system.
2. Disconnect all external devices connected to the computer.
3. Disconnect the power from the computer by first unplugging the power cord from the AC outlet and then unplugging the AC adapter from the computer.
4. Remove the display panel (see [Display panel on page 39](#)).
5. Remove the base enclosure (see [Base enclosure on page 42](#)).

Remove the TouchPad button board and cable:

1. Turn the top cover upside down, with the back edge toward you.
2. Disconnect the cable **(1)** that secures the TouchPad cable to the system board.
3. Remove the 4 Phillips PM 2.5×3.0 black screws **(2)** that secure the TouchPad button board to the top cover.
4. Remove the 2 Phillips PM 2.5×3.0 silver screws, and then remove the TouchPad bracket **(3)**.

5. Lift up on the rear edge, slide backwards, and then remove the TouchPad button board and cable (4).

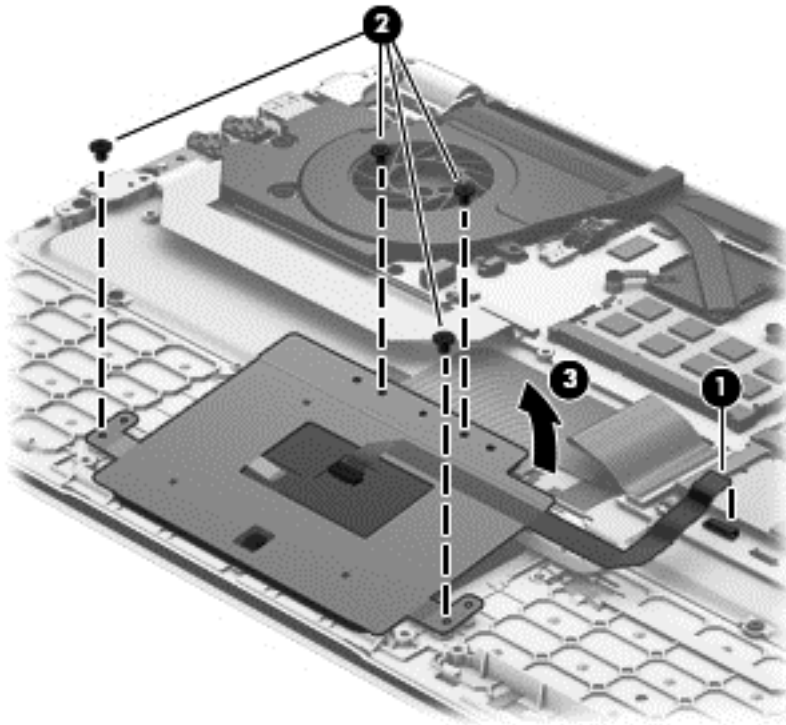

Reverse this procedure to install the TouchPad button board and cable.

## Fan

Description	Spare part number
Fan (with foil)	691641-001

Before removing the fan:

1. Shut down the computer. If you are unsure whether the computer is off or in Hibernation, turn the computer on, and then shut it down through the operating system.
2. Disconnect all external devices connected to the computer.
3. Disconnect the power from the computer by first unplugging the power cord from the AC outlet and then unplugging the AC adapter from the computer.
4. Remove the display panel (see [Display panel on page 39](#)).
5. Remove the base enclosure (see [Base enclosure on page 42](#)).
6. Remove the battery cable (see [Battery on page 43](#)).

Remove the fan:

1. Disconnect the fan cable (1).
2. Remove the 2 Phillips PM screws securing the fan to the unit (2), and then lift the fan upwards (3).
3. Remove the piece of tape on the underside of the heat sink that secures the fan to the unit (4).

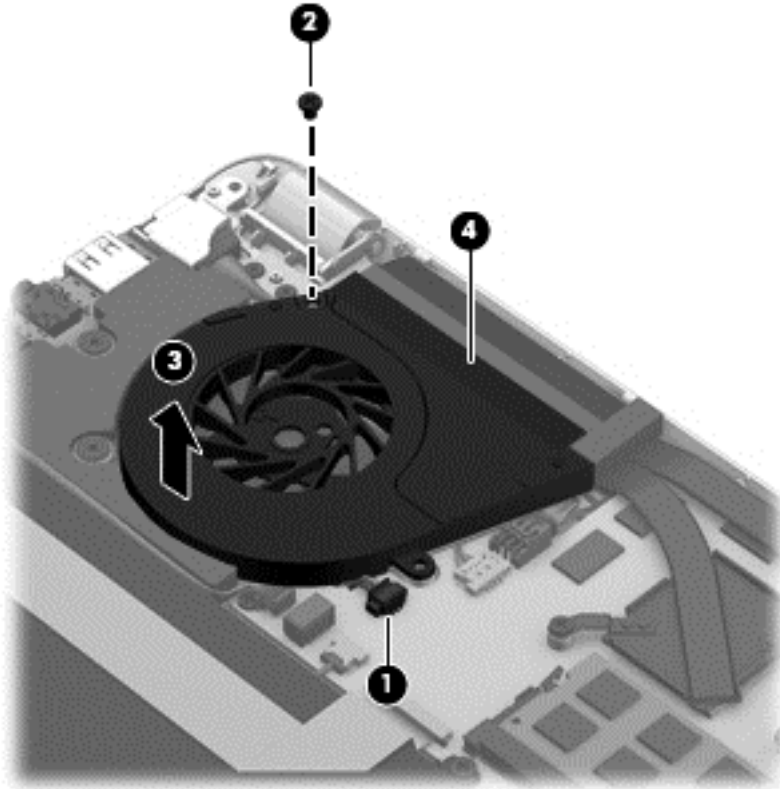

## System board

 **NOTE:** The system board spare part kit includes replacement thermal material.

Description	Spare part number
For non-touch models:	
For use only with computer models equipped with an Intel 1.8GHz processor but not WWAN capability (includes replacement thermal material)	686086-002
For use only with computer models equipped with an Intel 1.7GHz processor, but not WWAN capability (includes replacement thermal material)	686087-002 689844-002
For use only with computer models equipped with an Intel 1.5GHz processor, but not WWAN capability (includes replacement thermal material)	693655-001 693656-001
For use only with computer models equipped with an Intel 1.4GHz processor, but not WWAN capability (includes replacement thermal material)	686088-002 686090-001



<b>Description</b>	<b>Spare part number</b>
For use only with computer models equipped with an Intel 1.9 GHz processor (includes replacement thermal material)	713814-001
For use only with computer models equipped with an Intel 1.9 GHz processor and Windows 8 Standard (includes replacement thermal material)	713810-501 713814-501
For use only with computer models equipped with an Intel 1.9 GHz processor and Windows 8 Pro (includes replacement thermal material)	713809-601 713810-601 713814-601
or use only with computer models equipped with an Intel 1.8 GHz processor (includes replacement thermal material)	708961-001 713813-001 716306-001
For use only with computer models equipped with an Intel 1.8 GHz processor and Windows 8 Standard (includes replacement thermal material)	708961-501 708966-501 712355-501 713809-501 713813-501 713814-501 716306-501
For use only with computer models equipped with an Intel 1.8 GHz processor and Windows 8 Pro (includes replacement thermal material)	708961-601 708966-601 712355-601 713809-601 713813-601 716306-601
For use only with computer models equipped with an Intel 1.7 GHz processor (includes processor and replacement thermal material)	708963-001 716307-001
For use only with computer models equipped with an Intel 1.7 GHz processor and Windows 8 Standard (includes processor and replacement thermal material)	708962-501 708963-501 712354-501 716307-501
For use only with computer models equipped with an Intel 1.7 GHz processor and Windows 8 Pro (includes processor and replacement thermal material)	693657-001 708962-601 708963-601 712354-601 716307-601

Description	Spare part number
For use only with computer models equipped with an Intel 1.6 GHz processor (includes processor and replacement thermal material)	686089-002
	686091-002
For use only with computer models equipped with an Intel 1.5 GHz processor (includes processor and replacement thermal material)	712356-001
	716308-001
For use only with computer models equipped with an Intel 1.5 GHz processor and Windows 8 Standard (includes processor and replacement thermal material)	708964-501
	708965-501
	712356-501
	716308-501
For use only with computer models equipped with an Intel 1.5 GHz processor and Windows 8 Pro (includes processor and replacement thermal material)	708964-601
	708965-601
	712356-601
716308-601	
For use only with computer models equipped with an Intel 1.4 GHz processor (includes processor and replacement thermal material)	686090-002
For use with touch models only	
For use only with computer models equipped with an Intel 1.8 GHz processor and Windows 8 Standard (includes processor and replacement thermal material)	702925-001
For use only with computer models equipped with an Intel 1.8 GHz processor and Windows 8 Standard (includes processor and replacement thermal material)	702925-501
For use only with computer models equipped with an Intel 1.8 GHz processor and Windows 8 Pro (includes processor and replacement thermal material)	702925-601
For use only with computer models equipped with an Intel 1.7 GHz processor and Windows 8 Standard (includes processor and replacement thermal material)	702926-501
For use only with computer models equipped with an Intel 1.7 GHz processor and Windows 8 Pro (includes processor and replacement thermal material)	702926-601

Before removing the system board, follow these steps:

1. Shut down the computer. If you are unsure whether the computer is off or in Hibernation, turn the computer on, and then shut it down through the operating system.
2. Disconnect all external devices connected to the computer.
3. Disconnect the power from the computer by first unplugging the power cord from the AC outlet and then unplugging the AC adapter from the computer.
4. Remove the display panel (see [Display panel on page 39](#)).
5. Remove the base enclosure (see [Base enclosure on page 42](#)).
6. Remove the battery (see [Battery on page 43](#)).
7. Remove the WLAN module (see [WLAN module on page 52](#)).

8. Remove the hard drive (see [Hard drive on page 46](#)).
9. Disconnect the display panel cable from the system board (see [Display panel on page 39](#)).
10. Remove the speaker (see [Speakers on page 68](#)).
11. Remove the power connector and cable (see [Power connector cable on page 67](#)).
12. Remove the USB/Audio and cable (see [USB/Audio](#)).

When replacing the system board, be sure that the following components are removed from the defective system board and installed on the replacement system board:

- RTC battery (see [RTC battery on page 49](#))
- Memory module (see [Memory module on page 50](#))
- Power connector cable (see [Power connector cable on page 67](#))
- Fan (see [Heat sink on page 61](#))
- Heat sink (see [Heat sink on page 61](#))
- WLAN module see ([WLAN module on page 52](#)).
- Hard drive (see [Hard drive on page 46](#)).
- USB/Audio (see [USB/Audio](#))
- Display panel cable (see [Display panel on page 39](#)).

Remove the system board:

1. Remove the following cables:
  - Power connector cable **(1)**
  - Speaker cable **(2)**
  - Subwoofer cable **(3)**
  - USB/Audio board cable **(4)**
  - Keyboard cable **(5)**
  - Keyboard light cable **(6)**
  - TouchPad board cable **(7)**
  - Wireless cable **(8)**
  - Display panel cable **(9)**
  - Power button board cable **(10)**

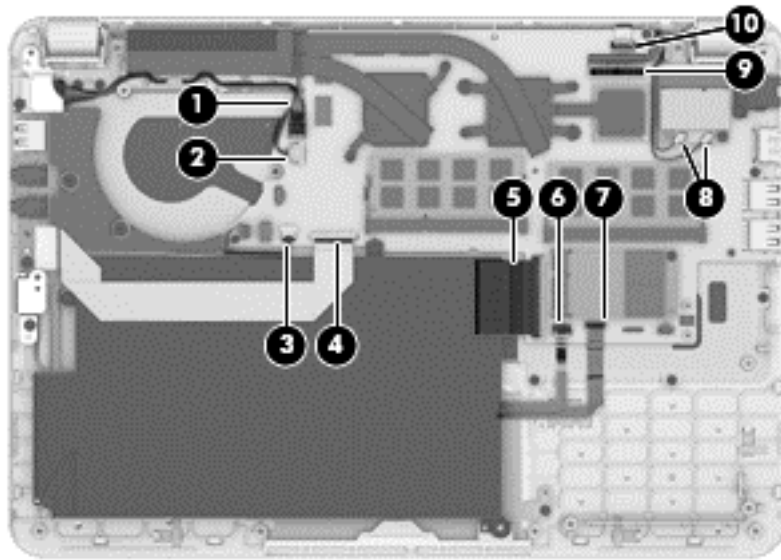

2. Remove the 4 Phillips PM 2.5x3 screws (1) until the system board rests at an angle.
3. Remove the system board (2) by sliding it up and to the right at an angle.

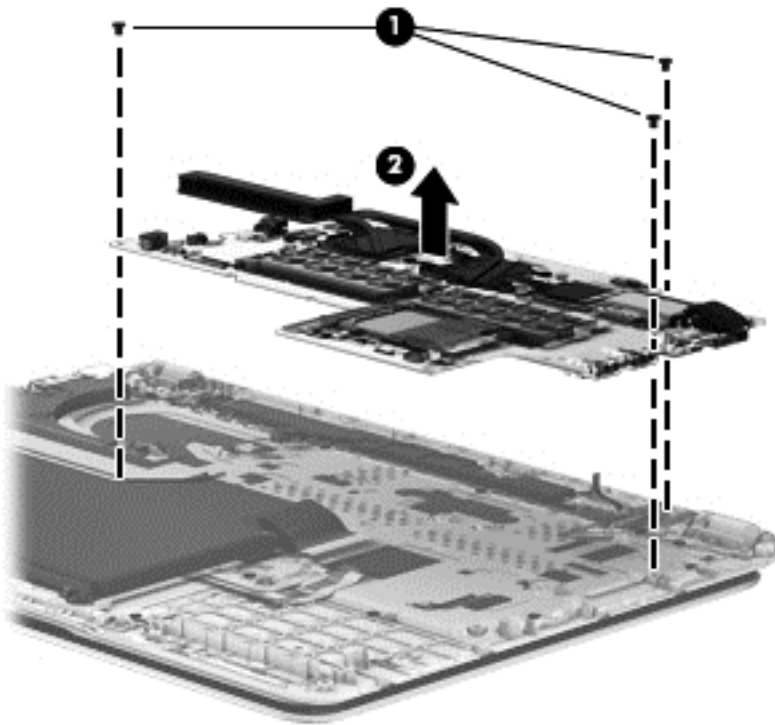

Reverse this procedure to install the system board.

## Heat sink

Description	Spare part number
Fan—Heat sink	686578-001
Fan—Heat sink	686579-001

 **NOTE:** To properly ventilate the computer, allow at least 7.6 cm (3 in) of clearance on the left side of the computer. The computer uses an electric fan for ventilation. The fan is controlled by a temperature sensor and is designed to turn on automatically when high temperature conditions exist. These conditions are affected by high external temperatures, system power consumption, power management/battery conservation configurations, battery fast charging, and software requirements. Exhaust air is displaced through the ventilation grill located on the left side of the computer.

Before removing the fan, follow these steps:

1. Shut down the computer. If you are unsure whether the computer is off or in Hibernation, turn the computer on, and then shut it down through the operating system.
2. Disconnect all external devices connected to the computer.
3. Disconnect the power from the computer by first unplugging the power cord from the AC outlet and then unplugging the AC adapter from the computer.
4. Remove the display panel (see [Display panel on page 39](#)).
5. Remove the base enclosure (see [Base enclosure on page 42](#)).
6. Disconnect the battery cable (see [Battery on page 43](#)).

Remove the fan:

1. Turn the computer, with the front toward you.
2. Disconnect the fan cable **(1)** from the system board.
3. Remove the 4 Phillips PM 2.0×3.0 screws securing the heat sink **(2)**, and the 2 Phillips PM 2.0×3.0 screws securing the fan **(3)**.

4. Remove the heat sink (4).

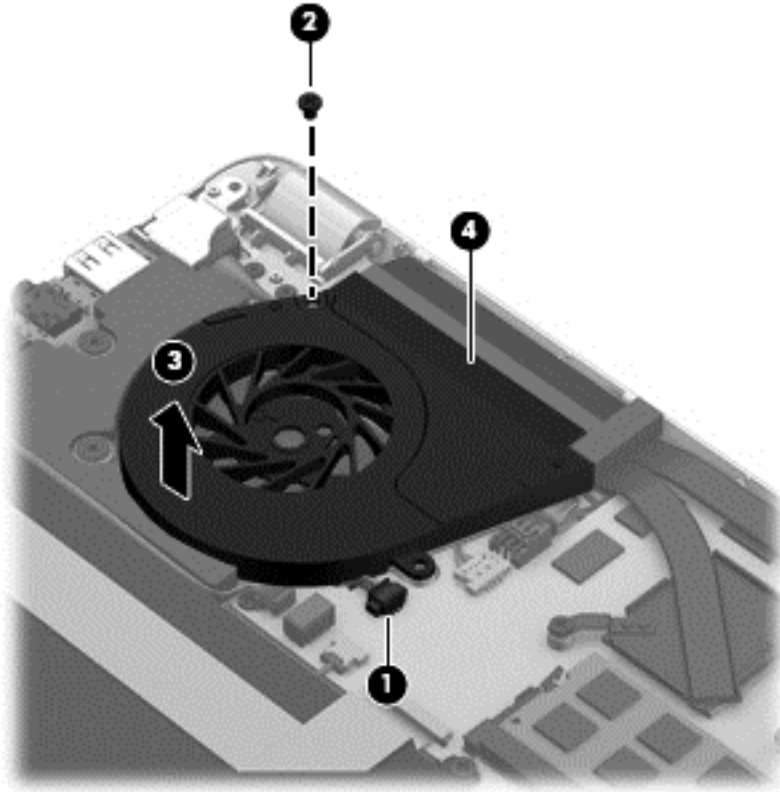

Reverse this procedure to install the fan and the heat sink.

## RJ-45 module cover

Description	Spare part number
RJ-45 module cover	686582-001

Before removing the RJ-45 module cover:

1. Shut down the computer. If you are unsure whether the computer is off or in Hibernation, turn the computer on, and then shut it down through the operating system.
2. Disconnect all external devices connected to the computer.
3. Disconnect the power from the computer by first unplugging the power cord from the AC outlet and then unplugging the AC adapter from the computer.
4. Remove the display panel (see [Display panel on page 39](#)).
5. Remove the base enclosure (see [Base enclosure on page 42](#)).
6. Disconnect the battery cable (see [Battery on page 43](#)).

Remove the RJ-45 module cover:

1. Remove the 2 Phillips PM screws securing the RJ-45 module cover (1).

2. Remove the cover (2).

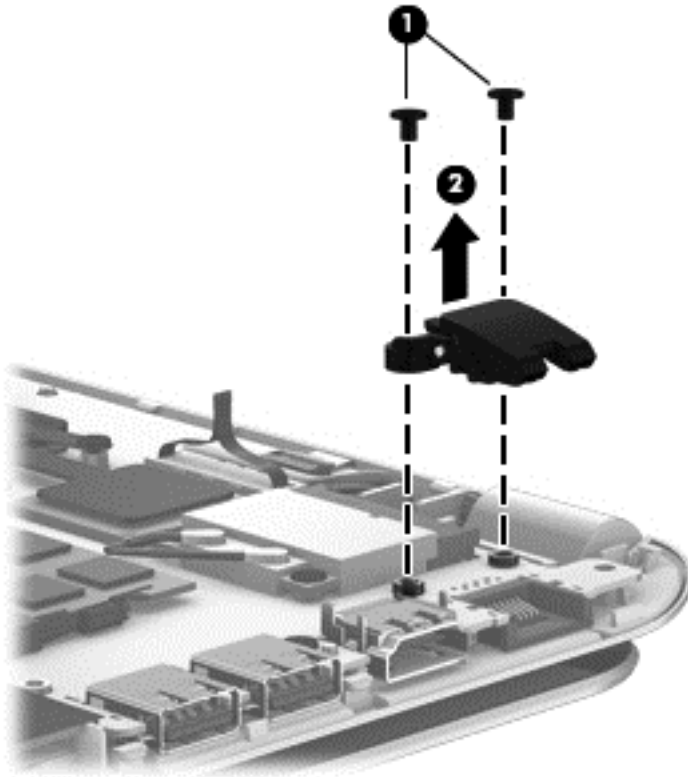

## Media card reader assembly (smart card reader)

Description	Spare part number
Media card reader assembly (smart card reader)	687097-001
Media card reader assembly (smart card reader) for touch models only	702928-001

Before removing the media reader assembly, follow these steps:

1. Shut down the computer. If you are unsure whether the computer is off or in Hibernation, turn the computer on, and then shut it down through the operating system.
2. Disconnect all external devices connected to the computer.
3. Disconnect the power from the computer by first unplugging the power cord from the AC outlet and then unplugging the AC adapter from the computer.
4. Remove the display panel (see [Display panel on page 39](#)).
5. Remove the base enclosure (see [Base enclosure on page 42](#)).
6. Disconnect the battery cable (see [Battery on page 43](#)).

Remove the media card reader assembly:

1. Remove the 2 screws (1), and then lift the media card reader assembly (2).

2. Disconnect the cable (3), and then remove the media card reader (4).

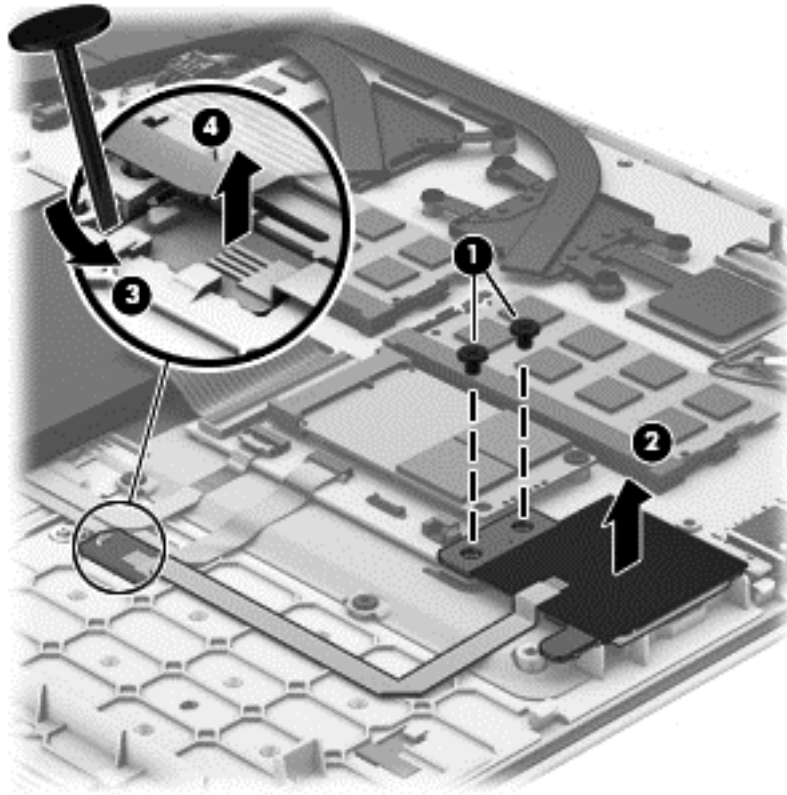

## Subwoofer

Description	Spare part number
Subwoofer	686586-001

Before removing the USB/Audio board, follow these steps:

1. Shut down the computer. If you are unsure whether the computer is off or in Hibernation, turn the computer on, and then shut it down through the operating system.
2. Disconnect all external devices connected to the computer.
3. Disconnect the power from the computer by first unplugging the power cord from the AC outlet and then unplugging the AC adapter from the computer.
4. Remove the display panel (see [Display panel on page 39](#)).
5. Remove the base enclosure (see [Base enclosure on page 42](#)).
6. Disconnect the battery cable (see [Battery on page 43](#)).

Remove the subwoofer:

1. Disconnect the subwoofer cable (1).
2. Remove the 2 broadhead screws (2).



3. Remove the subwoofer (3).

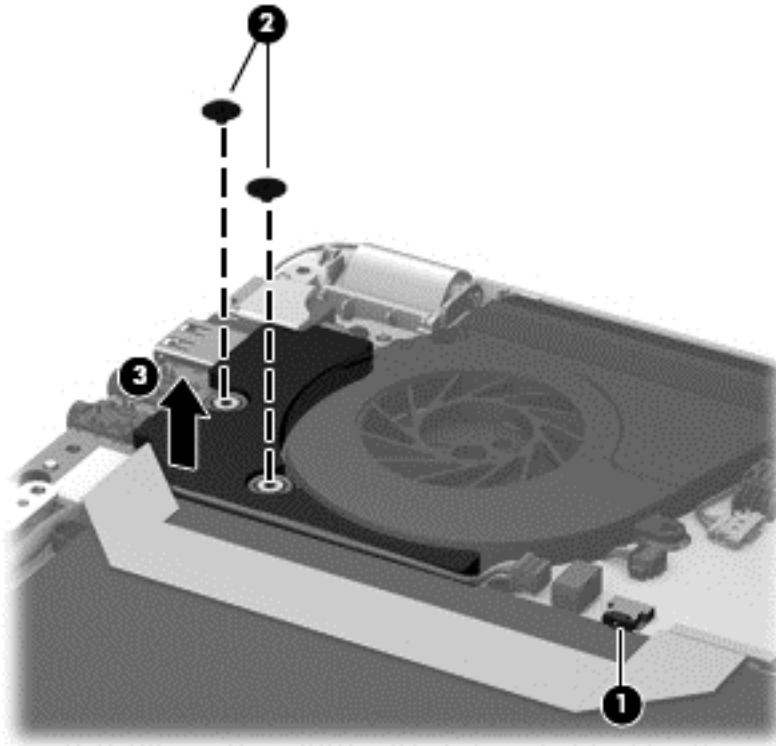

## Security bracket

Description	Spare part number
Security bracket (included in power connector kit)	686577-001

Before you remove the security bracket, follow these steps:

1. Shut down the computer. If you are unsure whether the computer is off or in Hibernation, turn the computer on, and then shut it down through the operating system.
2. Disconnect all external devices connected to the computer.
3. Disconnect the power from the computer by first unplugging the power cord from the AC outlet and then unplugging the AC adapter from the computer.
4. Remove the display panel (see [Display panel on page 39](#)).
5. Disconnect the battery cable (see [Battery on page 43](#)).
6. Remove the subwoofer (see

Remove the security bracket:

1. Remove the 2 Phillips PM screws (1).

2. Remove the security bracket (2).

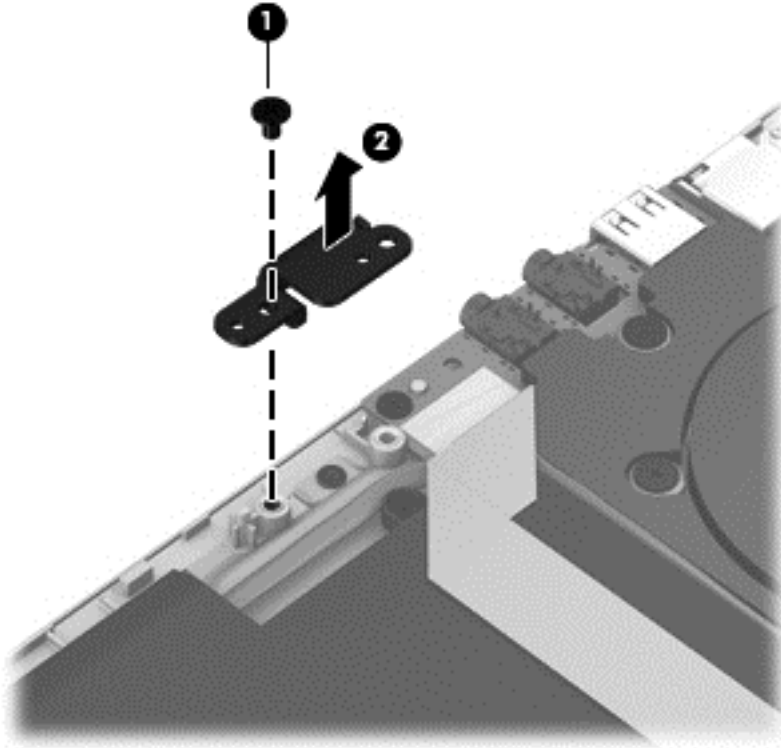

## USB/Audio board

Description	Spare part number
USB/Audio board	686584-001

Before removing the USB/Audio board, follow these steps:

1. Shut down the computer. If you are unsure whether the computer is off or in Hibernation, turn the computer on, and then shut it down through the operating system.
2. Disconnect all external devices connected to the computer.
3. Disconnect the power from the computer by first unplugging the power cord from the AC outlet and then unplugging the AC adapter from the computer.
4. Remove the display panel (see [Display panel on page 39](#)).
5. Remove the base enclosure (see [Base enclosure on page 42](#)).
6. Disconnect the battery cable (see [Battery on page 43](#)).
7. Remove the subwoofer (see [Subwoofer on page 64](#)).
8. Remove the security bracket (see [Security bracket on page 65](#)).

Remove the USB/Audio board:

1. Disconnect the USB/Audio board cable from the system board (1)
2. Disconnect the Phillips PM 2.0x2.0 screw securing the USB/Audio board (2).
3. Remove the USB/Audio board (3).

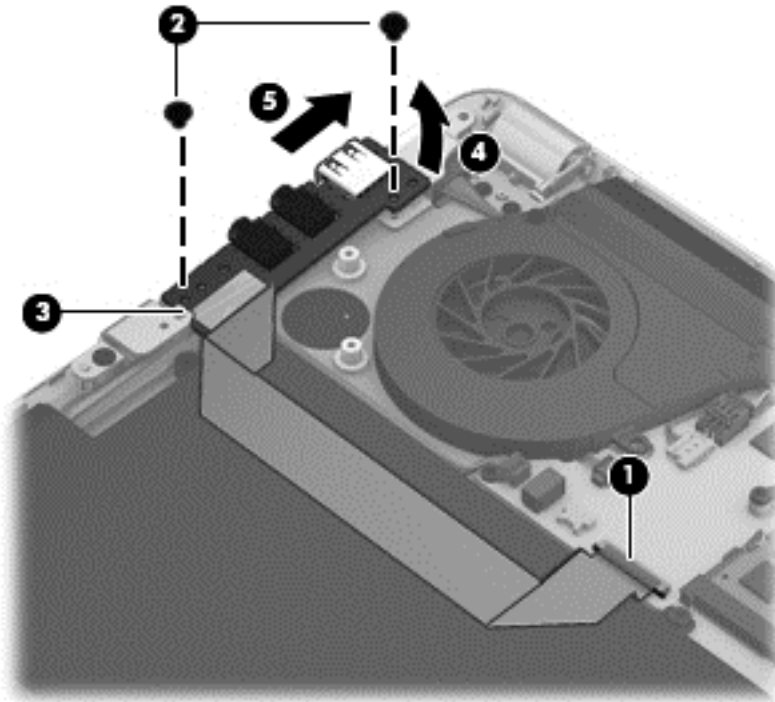

## Power connector cable

Description	Spare part number
Power connector cable (includes bracket)	686577-001

Before removing the power connector cable, follow these steps:

1. Shut down the computer. If you are unsure whether the computer is off or in Hibernation, turn the computer on, and then shut it down through the operating system.
2. Disconnect all external devices connected to the computer.
3. Disconnect the power from the computer by first unplugging the power cord from the AC outlet and then unplugging the AC adapter from the computer.
4. Remove the display panel (see [Display panel on page 39](#)).
5. Remove the base enclosure (see [Base enclosure on page 42](#)).
6. Disconnect the battery cable (see [Battery on page 43](#)).
7. Remove the subwoofer (see [Subwoofer on page 64](#)).

8. Remove the security bracket (see [Security bracket on page 65](#))
9. Remove the USB/Audio board (see [USB/Audio board on page 66](#)).

Remove the power connector cable:

1. Turn the computer, with the right side toward you.
2. Disconnect the power connector cable (1) from the system board.
3. Remove the double-sided tape (2) from the power connector.
4. Remove the power connector cable (3).

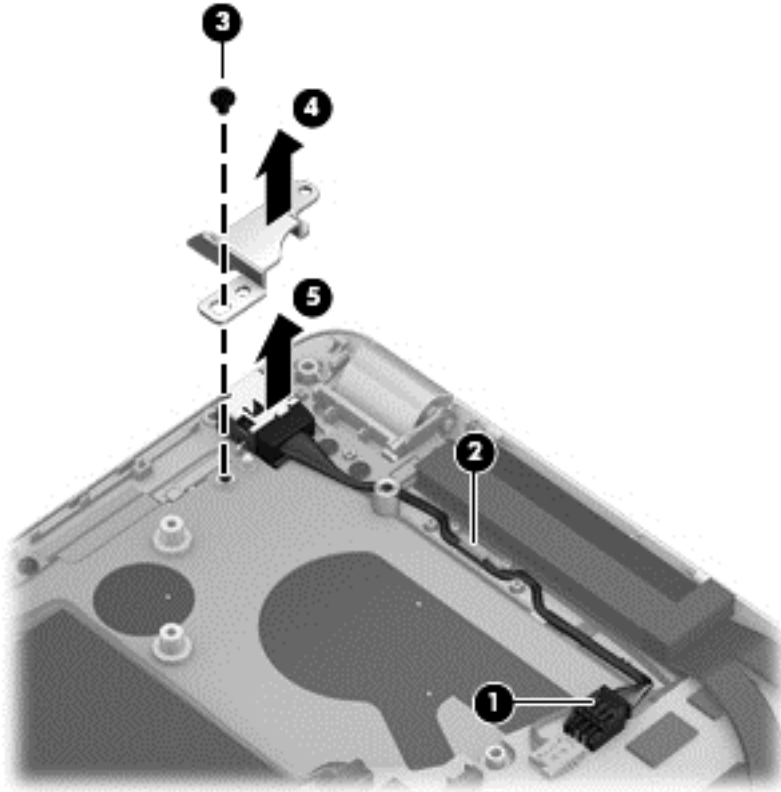

Reverse this procedure to install the power connector cable and bracket.

## Speakers

Description	Spare part number
Speaker Kit (includes left and right speakers and cable)	686585-001

Before removing the speakers, follow these steps:

1. Shut down the computer. If you are unsure whether the computer is off or in Hibernation, turn the computer on, and then shut it down through the operating system.
2. Disconnect all external devices connected to the computer.

3. Disconnect the power from the computer by first unplugging the power cord from the AC outlet and then unplugging the AC adapter from the computer.
4. Remove the display panel (see [Display panel on page 39](#)).
5. Remove the base enclosure (see [Base enclosure on page 42](#)).
6. Disconnect the battery cable (see [Battery on page 43](#)).

Remove the speakers:

1. Turn the computer, with the front edge toward you.
2. Release the 2 Phillips PM 2.0×3.0 screws securing each speaker. **(1)**
3. Remove the speakers and cables **(2)**.

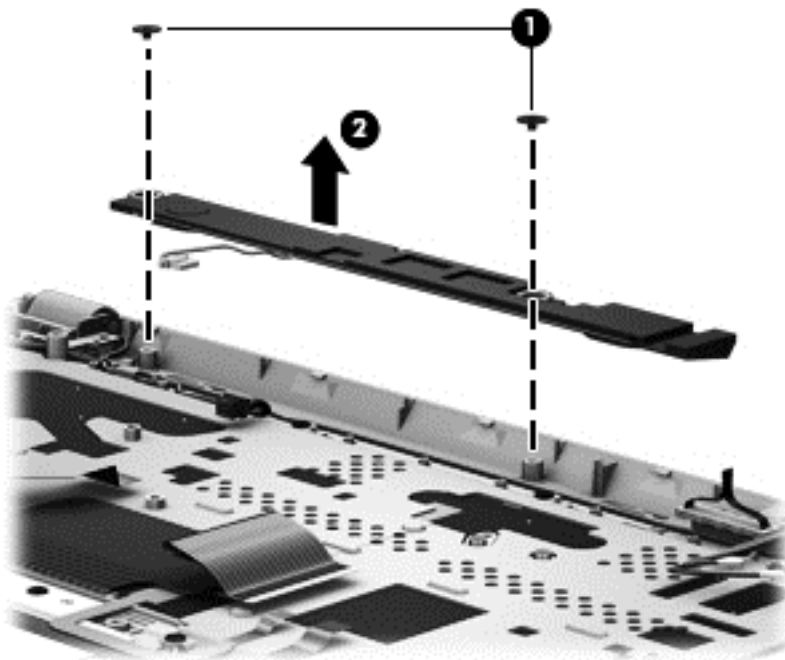

Reverse this procedure to install the speakers.

## Power button board

Description	Spare part number
Power button board (includes cable)	688000-001

Before removing the Power button board, follow these steps:

1. Shut down the computer. If you are unsure whether the computer is off or in Hibernation, turn the computer on, and then shut it down through the operating system.
2. Disconnect all external devices connected to the computer.

3. Disconnect the power from the computer by first unplugging the power cord from the AC outlet and then unplugging the AC adapter from the computer.
4. Remove the display panel (see [Display panel on page 39](#)).
5. Remove the base enclosure (see [Base enclosure on page 42](#)).
6. Disconnect the battery cable (see [Battery on page 43](#)).

Remove the Power button board and cable:

1. Turn the top cover upside down, with the back edge toward you.
2. Remove the 2 Phillips PM 2.0x3x0 screws securing the Power button board to the top cover (1).
3. Remove the Power button board (2).

---

 **NOTE:** The Power button board's cable is attached to the board.

---

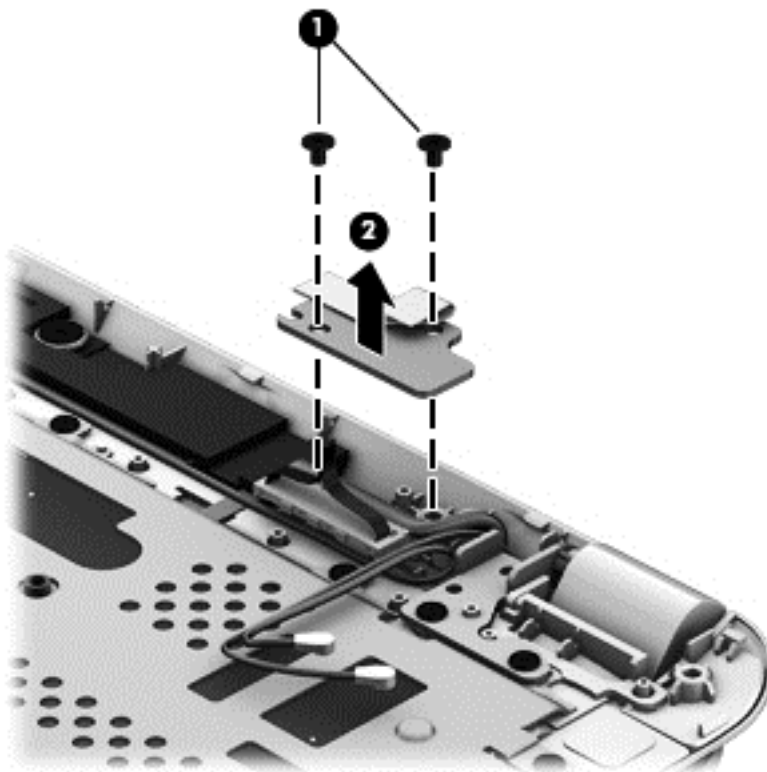

## Keyboard

---

 **NOTE:** The keyboard spare part kit includes a keyboard cable.

---

For use in country or region:	Spare part number:	For use in country or region:	Spare part number:
Keyboard in black finish:			
For use in Russia	686836-251		
Keyboard in black/silver finish			

---

<b>For use in country or region:</b>	<b>Spare part number:</b>	<b>For use in country or region:</b>	<b>Spare part number:</b>
For use in Russia	692758-251		
Keyboard in black finish for use with Windows 8:			
For use in the United States	698679-001	For use in the United Kingdom and Singapore	698679-031
For use in Germany	698679-041	For use in France	698679-051
For use in Italy	698679-061	For use in Latin America	698679-161
For use in Thailand	698679-281	For use in Japan	698679-291
For use in Taiwan	698679-AB1	For use in Korea	698679-AD1
For use in the Netherlands	698679-B31	For use in Slovenia	698679-BA1
For use in India	698679-D61	For use in the Czech Republic	698679-FL1
Backlit keyboard in black finish for use with Windows 8:			
For use in the United States	698680-001	For use in Spain	698680-071
For use in Turkey	698680-141	For use in Latin America	698680-161
For use in Saudi Arabia	698680-171	For use in Russia	698680-251
For use in Belgium	698680-A41	For use in the Netherlands	698680-B31
For use in Switzerland	698680-BG1	For use in Canada	698680-DB1
For use in Denmark, Finland, Norway	698680-DH1		
Keyboard in black/silver finish for use with Windows 8:			
For use in the United States	698681-001	For use in the United Kingdom and Singapore	698681-031
For use in Germany	698681-041	For use in France	698681-051
For use in Italy	698681-061	For use in Latin America	698681-161
For use in Thailand	698681-281	For use in Japan	698681-291
For use in Taiwan	698681-AB1	For use in Korea	698681-AD1
For use in the Netherlands	698681-B31	For use in Slovenia	698681-BA1
For use in India	698681-D61	For use in the Czech Republic	698681-FL1
Backlit keyboard in black/silver finish for use with Windows 8:			
For use in the United States	698682-001	For use in Spain	698682-071
For use in Turkey	698682-141	For use in Latin America	698682-161
For use in Saudi Arabia	698682-171	For use in Brazil	698682-201
For use in Russia	698682-251	For use in Belgium	698682-A41
For use in the Netherlands	698682-B31	For use in Switzerland	698681-BG1
For use in Canada	698682-DB1	For use in Denmark, Finland, Norway	698682-DH1

Before removing the keyboard, follow these steps:

1. Shut down the computer. If you are unsure whether the computer is off or in Hibernation, turn the computer on, and then shut it down through the operating system.
2. Disconnect all external devices connected to the computer.
3. Disconnect the power from the computer by first unplugging the power cord from the AC outlet and then unplugging the AC adapter from the computer.
4. Remove the display panel (see [Display panel on page 39](#)).
5. Remove the base enclosure (see [Base enclosure on page 42](#)).

Remove the keyboard:

1. Turn the computer right-side up with the front facing you.
2. Remove the 16 Phillips PM 2x3 screws.

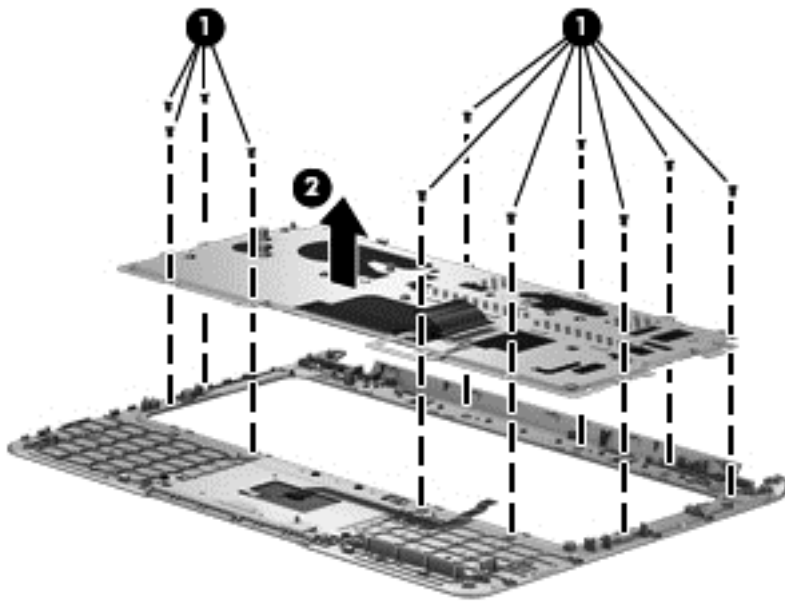



3. Remove the single screw (1), and then release the keyboard and keyboard bracket from the top cover (2).

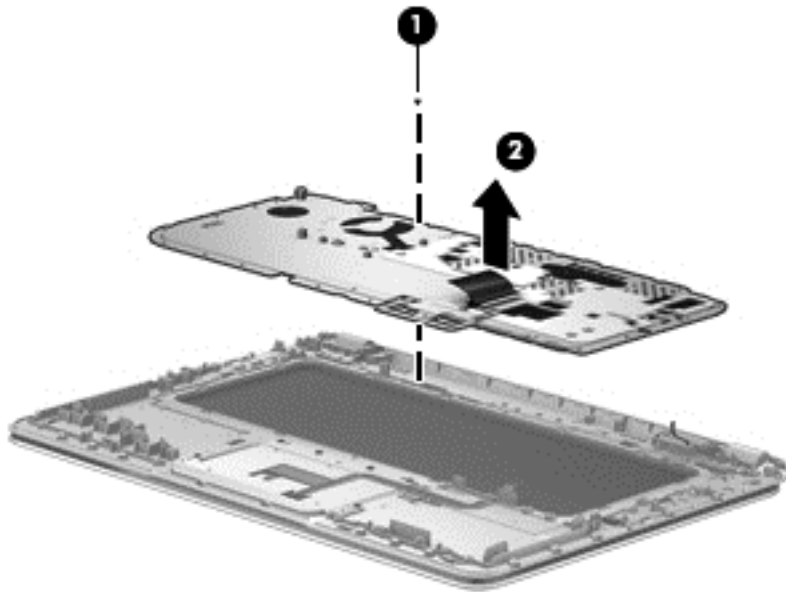

4. Remove the 1 Phillips PM 2.5x3 screw securing the keyboard to the bracket (1), disconnect the keyboard cable (2) (pushing it through the bracket), and then remove the keyboard from the bracket (3).

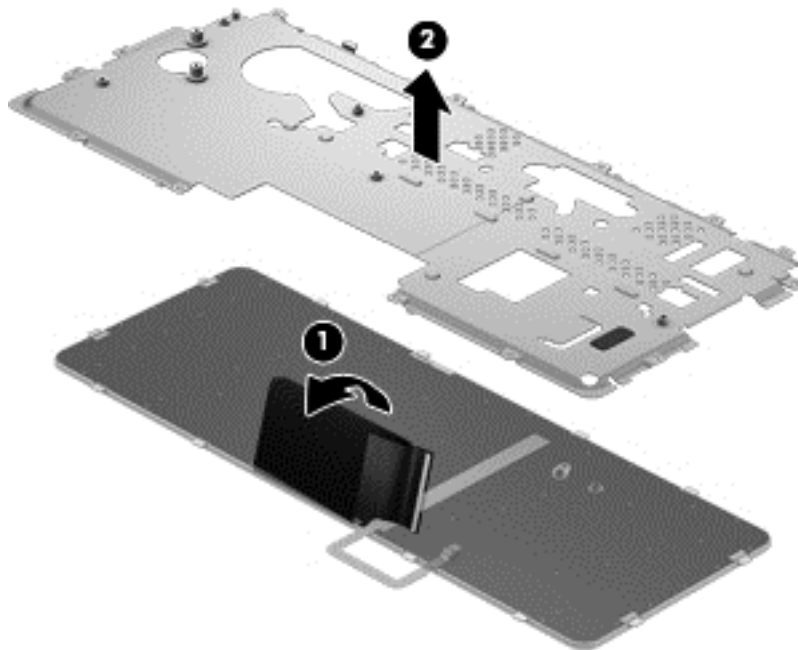

Reverse this procedure to install the keyboard.

## Top cover

Description	Spare part number
Top cover in black finish	686093-001
Top cover in silver finish	690194-001

Before removing the top cover, follow these steps:

1. Shut down the computer. If you are unsure whether the computer is off or in Hibernation, turn the computer on, and then shut it down through the operating system.
2. Disconnect all external devices connected to the computer.
3. Disconnect the power from the computer by first unplugging the power cord from the AC outlet and then unplugging the AC adapter from the computer.
4. Remove the display panel (see [Display panel on page 39](#)).
5. Remove the base enclosure (see [Base enclosure on page 42](#)).
6. Disconnect the battery cable (see [Battery on page 43](#)).

Remove the top cover:

1. Turn the computer right-side up, with the front toward you.
2. Open the computer.
3. Remove the 3 screws from each hinge on the top cover (1), and then remove the top cover (2).

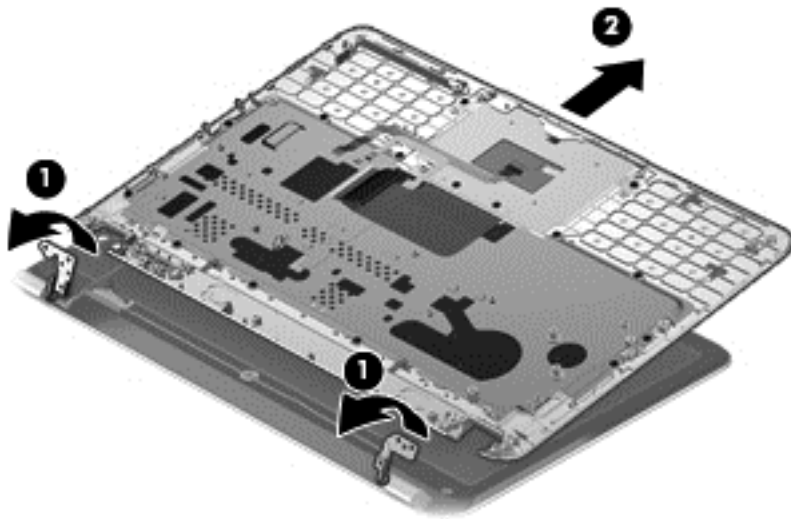

Reverse this procedure to install the top cover.

## WLAN antenna cables

Description	Spare part numbers
WLAN antennas	686573-001

Before removing the antenna cables:

1. Shut down the computer. If you are unsure whether the computer is off or in Hibernation, turn the computer on, and then shut it down through the operating system.
2. Disconnect all external devices connected to the computer.
3. Disconnect the power from the computer by first unplugging the power cord from the AC outlet and then unplugging the AC adapter from the computer.
4. Remove the display panel (see [Display panel on page 39](#)).
5. Remove the base enclosure (see [Base enclosure on page 42](#)).
6. Disconnect the battery cable (see [Battery on page 43](#)).

Remove the WLAN antenna cables:

- ▲ Remove the WLAN antenna transceivers (1), and then remove the cables (2) from the right and left sides of the hinge.

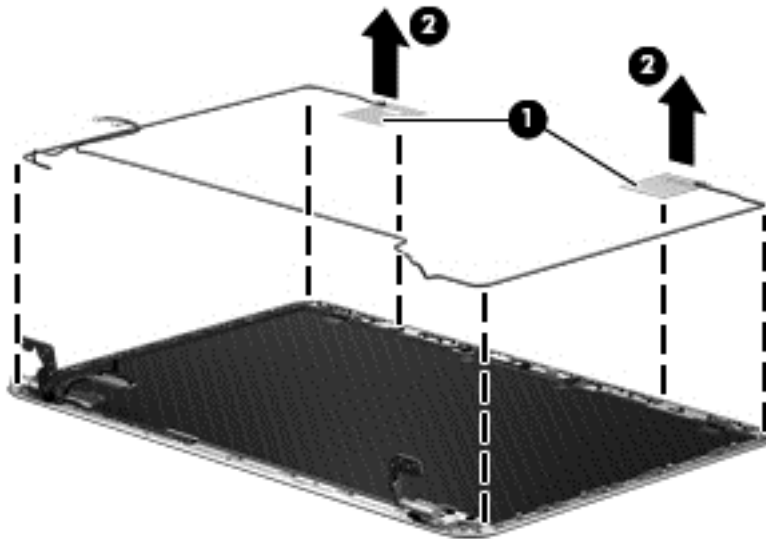

## Display panel cable assembly

Description	Spare part number
Display panel cable assembly	687718-001

Before removing the display panel cable assembly:

1. Shut down the computer. If you are unsure whether the computer is off or in Hibernation, turn the computer on, and then shut it down through the operating system.
2. Disconnect all external devices connected to the computer.
3. Disconnect the power from the computer by first unplugging the power cord from the AC outlet and then unplugging the AC adapter from the computer.
4. Remove the display panel (see [Display panel on page 39](#)).
5. Remove the base enclosure (see [Base enclosure on page 42](#)).
6. Disconnect the battery cable (see [Battery on page 43](#)).

Remove the display panel cable assembly:

- ▲ Disconnect the display panel cable from the webcam, and then remove the cable on the left side up to the left hinge.

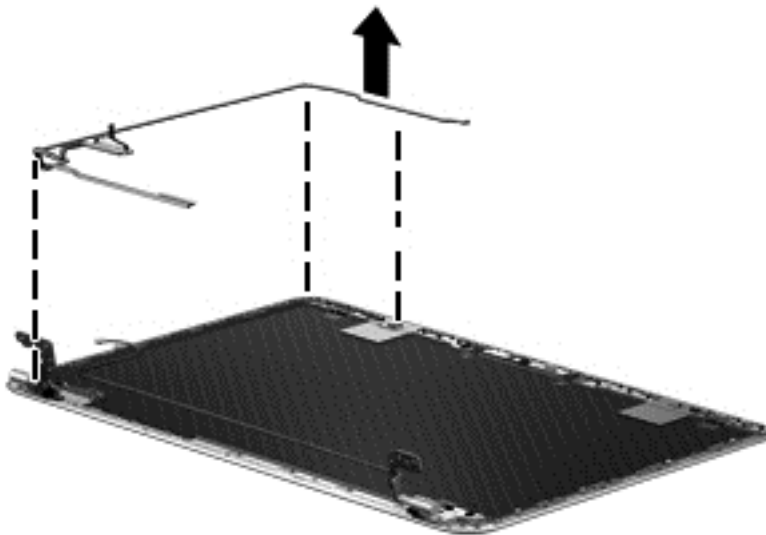

## Webcam assembly

Description	Spare part numbers
Webcam assembly	686587-001

Before removing the webcam assembly:

1. Shut down the computer. If you are unsure whether the computer is off or in Hibernation, turn the computer on, and then shut it down through the operating system.
2. Disconnect all external devices connected to the computer.
3. Disconnect the power from the computer by first unplugging the power cord from the AC outlet and then unplugging the AC adapter from the computer.
4. Remove the display panel (see [Display panel on page 39](#)).

5. Remove the base enclosure (see [Base enclosure on page 42](#)).
6. Disconnect the battery cable (see [Battery on page 43](#)).

Remove the webcam assembly:

- ▲ Disconnect the webcam cable (1), and then remove the cable (2).

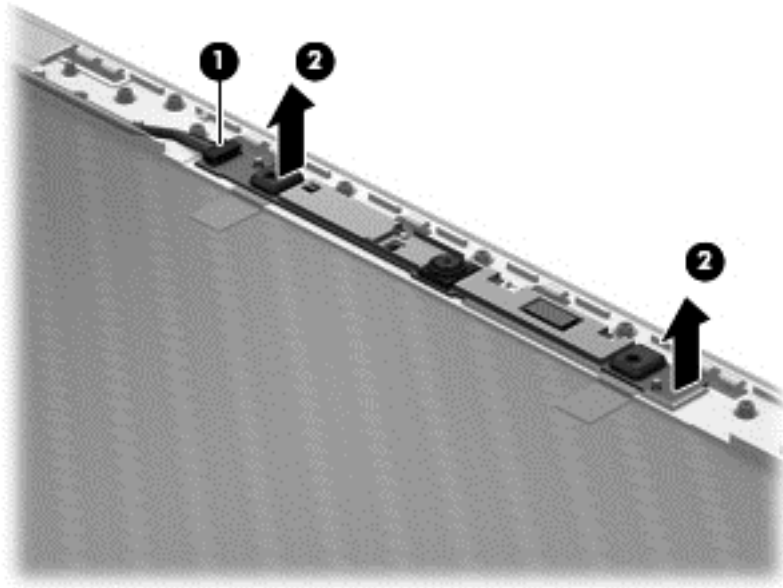

## Display hinges and hinge covers

Description	Spare part number
Display hinges	686583-001
Display hinge covers	691639-001

Before removing the webcam assembly:

1. Shut down the computer. If you are unsure whether the computer is off or in Hibernation, turn the computer on, and then shut it down through the operating system.
2. Disconnect all external devices connected to the computer.
3. Disconnect the power from the computer by first unplugging the power cord from the AC outlet and then unplugging the AC adapter from the computer.
4. Remove the display panel (see [Display panel on page 39](#)).
5. Remove the base enclosure (see [Base enclosure on page 42](#)).
6. Disconnect the battery cable (see [Battery on page 43](#)).

Remove the display hinge covers:

1. Remove the 1 Phillips PM screws that secures the display the left and right hinge covers (1), and then remove the hinge covers (2).

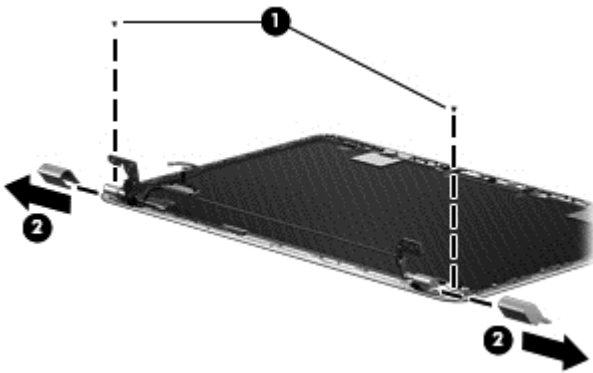

2. Remove the 4 Phillips PM screws (2 on each side) that secure the hinge to the display panel (1), and then remove the hinges (2).

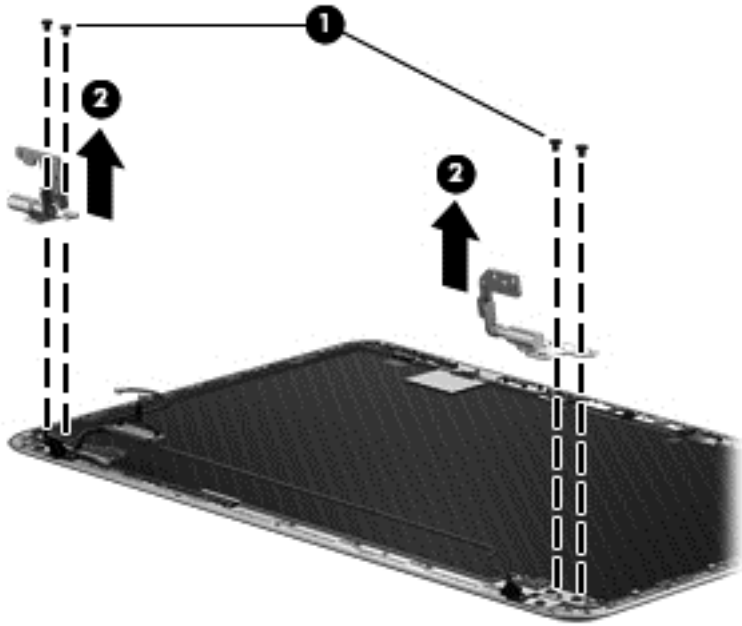

---

# 5 Setup Utility (BIOS) and System Diagnostics

## Windows 8 – Computer Setup (BIOS) and Advanced System Diagnostics

### Using Setup Utility

Setup Utility, or Basic Input/Output System (BIOS), controls communication between all the input and output devices on the system (such as disk drives, display, keyboard, mouse, and printer). Setup Utility (BIOS) includes settings for the types of devices installed, the startup sequence of the computer, and the amount of system and extended memory.

### Starting Setup Utility (BIOS)

To start Setup Utility (BIOS), turn on or restart the computer, quickly press **esc**, and then press **f10**.

Information about how to navigate in Setup Utility (BIOS) is located at the bottom of the screen.



**NOTE:** Use extreme care when making changes in Setup Utility (BIOS). Errors can prevent the computer from operating properly.

---

### Updating the BIOS

Updated versions of the BIOS may be available on the HP website.

Most BIOS updates on the HP website are packaged in compressed files called *SoftPaqs*.

Some download packages contain a file named *Readme.txt*, which contains information regarding installing and troubleshooting the file.

### Determining the BIOS version

To determine whether available BIOS updates contain later BIOS versions than those currently installed on the computer, you need to know the version of the system BIOS currently installed.

BIOS version information (also known as *ROM date* and *System BIOS*) can be revealed by pressing **fn+esc** (if you are already in Windows) or by using Setup Utility (BIOS).

1. Start Setup Utility (BIOS).
2. Use the arrow keys to select **Main**.
3. To exit Setup Utility (BIOS) without saving your changes, use the arrow keys to select **Exit**, select **Exit Discarding Changes**, and then press **enter**.

## Downloading a BIOS update

---

 **CAUTION:** To reduce the risk of damage to the computer or an unsuccessful installation, download and install a BIOS update only when the computer is connected to reliable external power using the AC adapter. Do not download or install a BIOS update while the computer is running on battery power, docked in an optional docking device, or connected to an optional power source. During the download and installation, follow these instructions:

Do not disconnect power from the computer by unplugging the power cord from the AC outlet.

Do not shut down the computer or initiate Sleep.

Do not insert, remove, connect, or disconnect any device, cable, or cord.

---

1. From the Start screen, select the **HP Support Assistant** app.
2. Click **Updates and tune-ups**, and then click **Check for HP updates now**.
3. Follow the on-screen instructions.
4. At the download area, follow these steps:
  - a. Identify the most recent BIOS update and compare it to the BIOS version currently installed on your computer. If the update is more recent than your BIOS, make a note of the date, name, or other identifier. You may need this information to locate the update later, after it has been downloaded to your hard drive.
  - b. Follow the on-screen instructions to download your selection to the hard drive.

If the update is more recent than your BIOS, make a note of the path to the location on your hard drive where the BIOS update is downloaded. You will need to access this path when you are ready to install the update.

---

 **NOTE:** If you connect your computer to a network, consult the network administrator before installing any software updates, especially system BIOS updates.

---

BIOS installation procedures vary. Follow any instructions that are revealed on the screen after the download is complete. If no instructions are revealed, follow these steps:

1. From the Start screen, type **e**, and then select **File Explorer**.
2. Click your hard drive designation. The hard drive designation is typically Local Disk (C:).
3. Using the hard drive path you recorded earlier, open the folder on your hard drive that contains the update.



4. Double-click the file that has an .exe extension (for example, *filename.exe*).

The BIOS installation begins.

5. Complete the installation by following the on-screen instructions.

---

 **NOTE:** After a message on the screen reports a successful installation, you can delete the downloaded file from your hard drive.

---

## Using System Diagnostics

System Diagnostics allows you to run diagnostic tests to determine if the computer hardware is functioning properly.

To start System Diagnostics:

1. Turn on or restart the computer, quickly press **esc**, and then press **f2**.
2. Click the diagnostic test you want to run, and then follow the on-screen instructions.

---

 **NOTE:** If you need to stop a diagnostic test while it is running, press **esc**.

---

# Ubuntu Linux – Setup Utility (BIOS) and AdvancedSystem Diagnostics

## Using Setup Utility

Setup Utility, or Basic Input/Output System (BIOS), controls communication between all the input and output devices on the system (such as disk drives, display, keyboard, mouse, and printer). Setup Utility includes settings for the types of peripherals installed, the startup sequence of the computer, and the amount of system and extended memory.

---

 **NOTE:** Use extreme care when making changes in Setup Utility. Errors can prevent the computer from operating properly.

---

## Starting Setup Utility

- ▲ Turn on or restart the computer. While the “Press the ESC key for Startup Menu” message is displayed in the lower-left corner of the screen, press **esc**. When the Startup Menu is displayed, press **f10**.

## Changing the language of Setup Utility

1. Start Setup Utility.
2. Use the arrow keys to select **System Configuration > Language**, and then press **enter**.
3. Use the arrow keys to select a language, and then press **enter**.
4. When a confirmation prompt with your language selected is displayed, press **enter**.
5. To save your change and exit Setup Utility, use the arrow keys to select **Exit > Exit Saving Changes**, and then press **enter**.

Your change takes effect immediately.

## Using Setup Utility

### Navigating and selecting in Setup Utility

Setup Utility does not support the TouchPad. Navigation and selection are by keystroke.

- To choose a menu or a menu item, use the arrow keys.
- To choose an item in a list or to toggle a field—for example an Enable/Disable field—use either the arrow keys or **f5** and **f6**.
- To select an item, press **enter**.
- To close a text box or return to the menu display, press **esc**.
- To display additional navigation and selection information while Setup Utility is open, press **f1**.

### Displaying system information

1. Start Setup Utility.
2. Select the **Main** menu. System information such as the system time and date, and identification information about the computer is displayed.
3. To exit Setup Utility without changing any settings, use the arrow keys to select **Exit > Exit Discarding Changes**, and then press **enter**.

### Restoring factory default settings in Setup Utility

1. Start Setup Utility.
2. Use the arrow keys to select **Exit > Load Setup Defaults**, and then press **enter**.
3. When the Setup Confirmation is displayed, press **enter**.
4. To save your change and exit Setup Utility, use the arrow keys to select **Exit > Exit Saving Changes**, and then press **enter**.

The Setup Utility factory settings take effect when the computer restarts.



---

**NOTE:** Your password, security, and language settings are not changed when you restore the factory settings.

---

### Exiting Setup Utility

- To exit Setup Utility and save your changes from the current session:  
If the Setup Utility menus are not visible, press **esc** to return to the menu display. Then use the arrow keys to select **Exit > Exit Saving Changes**, and then press **enter**.
- To exit Setup Utility without saving your changes from the current session:  
If the Setup Utility menus are not visible, press **esc** to return to the menu display. Then use the arrow keys to select **Exit > Exit Discarding Changes**, and then press **enter**.

### Updating the BIOS

Updated versions of the BIOS may be available on the HP website.

Most BIOS updates on the HP website are packaged in compressed files called *SoftPaqs*.

Some download packages contain a file named `Readme.txt`, which contains information regarding installing and troubleshooting the file.

### Determining the BIOS version

To determine whether available BIOS updates contain later BIOS versions than those currently installed on the computer, you need to know the version of the system BIOS currently installed.

BIOS version information (also known as *ROM date* and *System BIOS*) can be displayed by using Setup Utility.

1. Start Setup Utility.
2. If the system information is not displayed, use the arrow keys to select the **Main** menu.  
BIOS and other system information is displayed.
3. To exit Setup Utility, use the arrow keys to select **Exit > Exit Discarding Changes**, and then press `enter`.

### Downloading a BIOS update

 **CAUTION:** To reduce the risk of damage to the computer or an unsuccessful installation, download and install a BIOS update only when the computer is connected to reliable external power using the AC adapter. Do not download or install a BIOS update while the computer is running on battery power, or connected to an optional power source. During the download and installation, follow these instructions:

Do not disconnect power from the computer by unplugging the power cord from the AC outlet.

Do not shut down the computer or initiate Suspend or Hibernation.

Do not insert, remove, connect, or disconnect any device, cable, or cord.

1. Access the page on the HP website that provides software for your computer.
2. Follow the on-screen instructions to identify your computer and access the BIOS update you want to download.
3. At the download area, follow these steps:
  - a. Identify the BIOS update that is later than the BIOS version currently installed on your computer. Make a note of the date, name, or other identifier. You may need this information to locate the update later, after it has been downloaded to your hard drive.
  - b. Follow the on-screen instructions to download your selection to the hard drive.

Make a note of the path to the location on your hard drive where the BIOS update is downloaded. You will need to access this path when you are ready to install the update.

 **NOTE:** If you connect your computer to a network, consult the network administrator before installing any software updates, especially system BIOS updates.

BIOS installation procedures vary. Follow any instructions that are displayed on the screen after the download is complete.

 **NOTE:** After a message on the screen reports a successful installation, you can delete the downloaded file from your hard drive.

## Using System Diagnostics

System Diagnostics allows you to run diagnostic tests to determine if the computer hardware is functioning properly.

To start System Diagnostics:

1. Turn on or restart the computer. While the “Press the ESC key for Startup Menu” message is displayed in the lower-left corner of the screen, press **esc**. When the Startup Menu is displayed, press **f2**.
2. Click the diagnostic test you want to run, and then follow the on-screen instructions.



**NOTE:** If you need to stop a diagnostics test while it is running, press **esc**.

---

# 6 Specifications

## Computer specifications

	Metric	U.S.
<b>Dimensions</b>		
Width	29.16 cm	11.48 in
Depth	2.15 cm	8.46 in
Height (front to back)	2.11 to 3.19 cm	0.83 to 1.26 in
<b>Weight</b>		
With 6-cell battery	1.60 kg	3.53 lb
With 3-cell battery	1.46 kg	3.22 lb
<b>Input power</b>		
Operating voltage and current	18.5 V dc @ 3.5 A - 65 W – or – 19.5 V dc @ 3.33 A - 65 W	
<b>Temperature</b>		
Operating	5°C to 35°C	41°F to 95°F
Nonoperating	-20°C to 60°C	-4°F to 140°F
<b>Relative humidity (noncondensing)</b>		
Operating	10% to 90%	
Nonoperating	5% to 95%	
<b>Maximum altitude (unpressurized)</b>		
Operating	-15 m to 3,048 m	-50 ft to 10,000 ft
Nonoperating	-15 m to 12,192 m	-50 ft to 40,000 ft
<b>NOTE:</b> Applicable product safety standards specify thermal limits for plastic surfaces. The device operates well within this range of temperatures.		

## 14.0-inch display specifications

	Metric	U.S.
<b>Dimensions</b>		
Height	16.50 cm	6.50 in
Width	25.34 cm	11.60 in
Diagonal	33.66 cm	13.30 in
<b>Number of colors</b>	262,144	
<b>Contrast ratio</b>	200:1 (typical)	
<b>Brightness</b>	200 nits (typical)	
<b>Pixel resolution</b>		
Pitch	0.197 mm × 0.197 mm	
Format	1366 × 768	
Configuration	RGB vertical stripe	
<b>Backlight</b>	LED	
<b>Character display</b>	80 × 25	
<b>Total power consumption</b>	2.0 W	
<b>Viewing angle</b>	±65° horizontal, ±50° vertical (typical)	

---

# 7 Backing up, restoring, and recovering

## Windows 8 — Backing up, restoring, and recovering

Your computer includes tools provided by HP and the operating system to help you safeguard your information and retrieve it if you ever need to. These tools will help you return your computer to a proper working state or even back to the original factory state, all with simple steps.

This chapter provides information about the following processes:

- Creating recovery media and backups
- Restoring and recovering your system



**NOTE:** This guide describes an overview of backing up, restoring and recovering options. For more details about the tools provided, see Help and Support. From the Start screen, type **h**, and then select **Help and Support**.

### Creating recovery media and backups

Recovery after a system failure is only as good as your most recent backup.

1. After you successfully set up the computer, create HP Recovery media. This step creates a backup of the HP Recovery partition on the computer. The backup can be used to reinstall the original operating system in cases where the hard drive is corrupted or has been replaced.

HP Recovery media you create will provide the following recovery options:

- **System Recovery**—Reinstalls the original operating system and the programs that were installed at the factory.
- **Minimized Image Recovery**—Reinstalls the operating system and all hardware-related drivers and software, but not other software applications.
- **Factory Reset**—Restores the computer to its original factory state by deleting all information from the hard drive and re-creating the partitions. Then it reinstalls the operating system and the software that was installed at the factory.

See [Creating HP Recovery media on page 88](#).

2. As you add hardware and software programs, create system restore points. A system restore point is a snapshot of certain hard drive contents saved by Windows System Restore at a specific time. A system restore point contains information that Windows uses, such as registry settings. Windows creates a system restore point for you automatically during a Windows update and during other system maintenance (such as a software update, security scanning, or system diagnostics). You can also manually create a system restore point at any time. For more information and steps for creating specific system restore points, see Help and Support. From the Start screen, type **h**, and then select **Help and Support**.
3. As you add photos, video, music, and other personal files, create a backup of your personal information. Windows File History can be set to regularly and automatically back up files from libraries, desktop, contacts, and favorites. If files are accidentally deleted from the hard drive and they can no longer be restored from the Recycle Bin, or if files become corrupted, you can restore the files that you backed up using File History. Restoring files is also useful if you ever choose to reset the computer by reinstalling Windows or choose to recover using HP Recovery Manager.



---

**NOTE:** File History is not enabled by default, so you must turn it on.

---

For more information and steps for enabling Windows File History, see Help and Support. From the Start screen, type **h**, and then select **Help and Support**.

## Creating HP Recovery media

HP Recovery Manager is a software program that offers a way to create recovery media after you successfully set up the computer. HP Recovery media can be used to perform system recovery if the hard drive becomes corrupted. System recovery reinstalls the original operating system and the software programs installed at the factory, and then configures the settings for the programs. HP Recovery media can also be used to customize the system or aid in the replacement of a hard drive.

- Only one set of HP Recovery media can be created. Handle these recovery tools carefully, and keep them in a safe place.
- HP Recovery Manager examines the computer and determines the required storage capacity for the blank USB flash drive or the number of blank DVD discs that will be required.
- To create recovery discs, your computer must have an optical drive with DVD writer capability, and you must use only high-quality blank DVD-R, DVD+R, DVD-R DL, or DVD+R DL discs. Do not use rewritable discs such as CD±RW, DVD±RW, double-layer DVD±RW, or BD-RE (rewritable Blu-ray) discs; they are not compatible with HP Recovery Manager software. Or instead you can use a high-quality blank USB flash drive.
- If your computer does not include an integrated optical drive with DVD writer capability, but you would like to create DVD recovery media, you can use an external optical drive (purchased separately) to create recovery discs, or you can obtain recovery discs for your computer from the HP website. For U.S. support, go to <http://www.hp.com/go/contactHP>. For worldwide support, go to [http://welcome.hp.com/country/us/en/wwcontact\\_us.html](http://welcome.hp.com/country/us/en/wwcontact_us.html). If you use an external optical drive, it must be connected directly to a USB port on the computer; the drive cannot be connected to a USB port on an external device, such as a USB hub.
- Be sure that the computer is connected to AC power before you begin creating the recovery media.



- The creation process can take up to an hour or more. Do not interrupt the creation process.
- If necessary, you can exit the program before you have finished creating all of the recovery DVDs. HP Recovery Manager will finish burning the current DVD. The next time you start HP Recovery Manager, you will be prompted to continue, and the remaining discs will be burned.

To create HP Recovery media:

1. From the Start screen, type `recovery`, and then select **HP Recovery Manager**.
2. Select **Recovery Media Creation**, and then follow the on-screen instructions.

If you ever need to recover the system, see [Recovering using HP Recovery Manager on page 91](#).

## Restore and recovery

There are several options for recovering your system. Choose the method that best matches your situation and level of expertise:

- If you need to restore your personal files and data, you can use Windows File History to restore your information from the backups you created. For more information and steps for using File History, see Help and Support. From the Start screen, type `h`, and then select **Help and Support**.
- If you need to correct a problem with a preinstalled application or driver, use the Drivers and Applications Reinstall option of HP Recovery Manager to reinstall the individual application or driver.

From the Start screen, type `recovery`, select **HP Recovery Manager**, select **Drivers and Applications Reinstall**, and then follow the on-screen instructions.

- If you want to restore the system to a previous state without losing any personal information, Windows System Restore is an option. System Restore allows you to restore without the requirements of Windows Refresh or a reinstallation. Windows creates system restore points automatically during a Windows update and other system maintenance events. Even if you did not manually create a restore point, you can choose to restore to a previous point, automatically created. For more information and steps for using Windows System Restore, see Help and Support. From the Start screen, type `h`, and then select **Help and Support**.
- If you want a quick and easy way to recover the system without losing your personal information, settings, or apps that came preinstalled on your computer or were purchased from the Windows Store, consider using Windows Refresh. This option does not require backing up data to another drive. See [Using Windows Refresh for quick and easy recovery on page 90](#).
- If you want to reset your computer to its original state, Windows provides an easy way to remove all personal data, apps, and settings, and reinstall Windows.

For more information, see [Remove everything and reinstall Windows on page 90](#).

- If you want to reset your computer using a minimized image, you can choose the HP Minimized Image Recovery option from the HP Recovery partition (select models only) or HP Recovery media. Minimized Image Recovery installs only drivers and hardware-enabling applications. Other applications included in the image continue to be available for installation through the Drivers and Applications Reinstall option in HP Recovery Manager.

For more information, see [Recovering using HP Recovery Manager on page 91](#).

- If you want to recover the computer's original factory partitioning and content, you can choose the System Recovery option from the HP Recovery media. For more information, see [Recovering using HP Recovery Manager on page 91](#).
- If you have replaced the hard drive, you can use the Factory Reset option of HP Recovery media to restore the factory image to the replacement drive. For more information, see [Recovering using HP Recovery Manager on page 91](#).
- If you wish to remove the recovery partition to reclaim hard drive space, HP Recovery Manager offers the Remove Recovery Partition option.

For more information, see [Removing the HP Recovery partition on page 93](#).

## Using Windows Refresh for quick and easy recovery

When your computer is not working properly and you need to regain system stability, the Windows Refresh option allows you to start fresh and keep what is important to you.

---

 **IMPORTANT:** Refresh removes any traditional applications that were not originally installed on the system at the factory.

 **NOTE:** During Refresh, a list of removed traditional applications will be saved so that you have a quick way to see what you might need to reinstall. See Help and Support for instructions on reinstalling traditional applications. From the Start screen, type **h**, and then select **Help and Support**.

 **NOTE:** You may be prompted for your permission or password when using Refresh. See Help and Support for more information. From the Start screen, type **h**, and then select **Help and Support**.

---

To start Refresh:

1. From the Start screen, point to the upper-right or lower-right corner of the screen to reveal the charms.
2. Click **Settings**.
3. Click **Change PC settings** in the bottom-right corner of the screen, and then select **General** from the PC settings screen.
4. Under **Refresh your PC without affecting your files**, select **Get started**, and then follow the on-screen instructions.

## Remove everything and reinstall Windows

Sometimes you want to perform detailed reformatting of your computer, or you want to remove personal information before you give away or recycle your computer. The process described in this section provides a speedy, simple way to return the computer to its original state. This option removes all personal data, apps, and settings from your computer, and reinstalls Windows.

---

 **IMPORTANT:** This option does not provide backups of your information. Before using this option, back up any personal information you wish to retain.

---

You can initiate this option by using the **f11** key or from the Start screen.

To use the **f11** key:

1. Press **f11** while the computer boots.  
– or –  
Press and hold **f11** as you press the power button.
2. Select **Troubleshoot** from the boot options menu.
3. Select **Reset your PC**, and then follow the on-screen instructions.

To use the Start screen:

1. From the Start screen, point to the upper-right or lower-right corner of the screen to reveal the charms.
2. Click **Settings**.
3. Click **Change PC settings** in the bottom-right corner of the screen, and then select **General** from the PC settings screen.
4. Under **Remove everything and reinstall Windows**, select **Get started**, and follow the on-screen instructions.

## Recovering using HP Recovery Manager

HP Recovery Manager software allows you to recover the computer to its original factory state. Using the HP Recovery media you created, you can choose from one of the following recovery options:

- **System Recovery**—Reinstalls the original operating system, and then configures the settings for the programs that were installed at the factory.
- **Minimized Image Recovery**—Reinstalls the operating system and all hardware-related drivers and software, but not other software applications.
- **Factory Reset**—Restores the computer to its original factory state by deleting all information from the hard drive and re-creating the partitions. Then it reinstalls the operating system and the software that was installed at the factory.

The HP Recovery partition (select models only) allows Minimized Image Recovery.

### What you need to know

- HP Recovery Manager recovers only software that was installed at the factory. For software not provided with this computer, you must either download the software from the manufacturer's website or reinstall the software from the media provided by the manufacturer.
- Recovery through HP Recovery Manager should be used as a final attempt to correct computer issues.
- HP Recovery media must be used if the computer hard drive fails.
- To use the Factory Reset or System Recovery options, you must use HP Recovery media.
- If the HP Recovery media do not work, you can obtain recovery media for your system from the HP website. For U.S. support, go to <http://www.hp.com/go/contactHP>. For worldwide support, go to [http://welcome.hp.com/country/us/en/wwcontact\\_us.html](http://welcome.hp.com/country/us/en/wwcontact_us.html).



---

**IMPORTANT:** HP Recovery Manager does not automatically provide backups of your personal data. Before beginning recovery, back up any personal data you wish to retain.

---

### Using the HP Recovery partition to recover a minimized image (select models only)

The HP Recovery partition (select models only) allows you to perform a minimized image recovery without the need for recovery discs or a recovery USB flash drive. This type of recovery can only be used if the hard drive is still working.

To start HP Recovery Manager from the HP Recovery partition:

1. Press **f11** while the computer boots.  
– or –  
Press and hold **f11** as you press the power button.
2. Select **Troubleshoot** from the boot options menu.
3. Select **HP Recovery Manager**, and follow the on-screen instructions.

### Using HP Recovery media to recover

You can use HP Recovery media to recover the original system. This method can be used if your system does not have an HP Recovery partition or if the hard drive is not working properly.

1. If possible, back up all personal files.
2. Insert the first HP Recovery disc you created into the optical drive on your computer or into an optional external optical drive, and then restart the computer.

– or –

Insert the HP Recovery USB flash drive you created into a USB port on your computer, and then restart the computer.



---

**NOTE:** If the computer does not automatically restart in HP Recovery Manager, change the computer boot order. See [Changing the computer boot order on page 92](#).

---

3. Follow the on-screen instructions.

### Changing the computer boot order

If computer does not restart in HP Recovery Manager, you can change the computer boot order, which is the order of devices listed in BIOS where the computer looks for startup information. You can change the selection for an optical drive or a USB flash drive.

To change the boot order:

1. Insert the HP Recovery media you created.
2. Restart the computer.
3. Press and hold **esc** while the computer is restarting, and then press **f9** for boot options.
4. Select the optical drive or USB flash drive you want to boot from.
5. Follow the on-screen instructions.

## Removing the HP Recovery partition

HP Recovery Manager software allows you to remove the HP Recovery partition to free up hard drive space.

---

 **IMPORTANT:** Removing the HP Recovery partition means you can no longer use Windows Refresh, the Windows Remove everything and reinstall Windows option, or the HP Recovery Manager option for minimized image recovery. Create HP Recovery media before removing the Recovery partition to ensure you have recovery options; see [Creating HP Recovery media on page 88](#).

---

Follow these steps to remove the HP Recovery partition:

1. From the Start screen, type `recovery`, and then select **HP Recovery Manager**.
2. Select **Remove Recovery Partition**, and then follow the on-screen instructions.

## Ubuntu Linux — Backing up, restoring, and recovering

Recovery after a system failure is as good as your most recent backup. As you add new software and data files, you should continue to back up your system on a regular basis to maintain a reasonably current backup.

### Performing a system recovery

The Deja Dup Restore Tool allows you to repair or restore the computer to its original factory state. You can create an image restore DVD using a DVD±RW optical drive. You can also create a restore image on a USB storage device.

---

 **CAUTION:** Using Restore completely erases hard drive contents and reformats the hard drive. All files you have created and any software installed on the computer are permanently removed. The recovery tool reinstalls the original operating system and programs and drivers that were installed at the factory. Software, drivers, and updates not installed at the factory must be manually reinstalled. Personal files must be restored from a backup.

---

 **NOTE:** HP recommends that you create the image restore in the event of a system failure.

---

### Creating the restore DVDs

The restore creation software creates a set of system restore discs using blank, writable DVDs (DVD-R or DVD+R). HP recommends using blank DVD+R discs from a manufacturer you trust, because these recovery DVDs are so important. You need approximately 3 blank DVD+R discs. The program states how many discs are needed at the beginning of the process.

To create restore DVDs:

1. Click the **System menu** icon at the far right of the top panel, and then click **System Settings > Backup**.
2. Select **Storage** from the panel on the left side of the window, click the down-arrow next to **Backup Location**, and select the DVD from the drop-down list.
3. Select **Overview** from the panel on the left side of the window, and then click **Back Up Now**.
4. Follow the on-screen instructions.

## Creating a restore image on a USB device

---

 **NOTE:** Be sure AC power is connected to the computer you begin.

---

Verify the exact amount of free space on your storage device before you begin the creation process. For most models, you will need at least 8 GB of free space on the storage device. However, depending on the drivers and software installed on your computer, you may need slightly more than 8 GB of space. **HP recommends that you use a 16 GB device or above for best results.**

---

 **IMPORTANT:** Remember to insert your USB device into the USB port on the computer before starting this procedure.

---

To create the restore image:

1. Click the **System menu** icon at the far right of the top panel, and then click **System Settings > Backup**.
2. Select **Storage** from the panel on the left side of the window, click the down-arrow next to **Backup location**, and select the USB device from the drop-down list.

---

 **NOTE:** If the USB device is not listed in the drop-down list for Backup Location, select **Local Folder**, and then click the **Choose Folder** button. Select the USB device from the panel on the left side of the Choose Folder window, and click **OK**.

---

3. Select **Overview** from the panel on the left side of the window, and then click **Backup Now**.
4. Follow the on-screen instructions.

## Performing recovery using the restore DVD

---

 **NOTE:** The following procedure uses the F11 BIOS Recovery feature to perform the recovery.

---

1. If possible, back up all personal files.
2. Shut down the computer.
3. Be sure the restore DVD or USB device is connected to the computer.
4. Restart the computer.
5. Using the arrow keys, select **Recovery**, and then press [enter](#).
6. Follow the on-screen instructions.

---

 **NOTE:** If you are unable to boot (start up) your computer, and you did not create a system recovery disc, you must purchase an *Ubuntu Operating System* DVD to reinstall the operating system. For additional information, refer to the *Worldwide Telephone Numbers* booklet.

---

## Backing up your information

You should back up your computer files on a regular schedule to maintain a current backup. You can manually back up your information to an optional external drive, a network drive, discs, or the Ubuntu One website. Back up your system at the following times:

- At regularly scheduled times
- Before the computer is repaired or restored
- Before you add or modify hardware or software

To back up your home directory files to the Ubuntu One website using the Deja Dup Backup Tool:

---

 **NOTE:** Before you back up your information, be sure you have designated a location to save the backup files.

---

1. Click the **System menu** icon at the far right of the top panel, and then click **System Settings > Backup** icon.
2. Select **Folders** from the panel on the left side of the window, and beneath **Folders to back up**, select the folders to back up.
3. Select **Storage** from the panel on the left side of the window, click the down-arrow next to **Backup Location**, and select **Ubuntu One** from the drop-down list.
4. Select **Overview** from the panel on the left side of the window, and then click **Back Up Now**.

---

 **NOTE:** The first time you back up your files to Ubuntu One, you will need to create an account to sign into Ubuntu One. Enter your email address and password into the account sign-in boxes and follow the on-screen instructions to complete the sign-in process.

---

To restore backup files:

1. Click the **System menu** icon at the far right of the top panel, and then click **System Settings > Backup** icon.
2. Click **Restore**, select the location of the backup files and the folder name, and then click **Forward**.
3. Under **Restore from When?**, select the date of the files to be restored, and then click **Forward**.
4. Select the location and folder where the files are to be restored, and then click **Forward**.
5. Follow the instructions on the screen.
6. Click **Restore** to start restoring the files, or click **Cancel** to cancel the operation.

---

 **NOTE:** You may also back up to cloud storage services provided by various companies. For a small fee, they will keep your backup for you. A cloud service is recommended, since it is an easy way to keep your backups off-site and safe.

---





---

## 8 Power cord set requirements

The wide-range input feature of the computer permits it to operate from any line voltage from 100 to 120 volts AC, or from 220 to 240 volts AC.

The 3-conductor power cord set included with the computer meets the requirements for use in the country or region where the equipment is purchased.

Power cord sets for use in other countries and regions must meet the requirements of the country or region where the computer is used.

### Requirements for all countries

The following requirements are applicable to all countries and regions:

- The length of the power cord set must be at least **1.0 m** (3.3 ft) and no more than **2.0 m** (6.5 ft).
- All power cord sets must be approved by an acceptable accredited agency responsible for evaluation in the country or region where the power cord set will be used.
- The power cord sets must have a minimum current capacity of 10 A and a nominal voltage rating of 125 or 250 V ac, as required by the power system of each country or region.
- The appliance coupler must meet the mechanical configuration of an EN 60 320/IEC 320 Standard Sheet C13 connector for mating with the appliance inlet on the back of the computer.

## Requirements for specific countries and regions

Country/region	Accredited agency	Applicable note number
Argentina	IRAM	1
Australia	SAA	1
Austria	OVE	1
Belgium	CEBEC	1
Brazil	ABNT	1
Canada	CSA	2
Chile	IMQ	1
Denmark	DEMKO	1
Finland	FIMKO	1
France	UTE	1
Germany	VDE	1
India	ISI	1
Israel	SII	1
Italy	IMQ	1
Japan	JIS	3
The Netherlands	KEMA	1
New Zealand	SANZ	1
Norway	NEMKO	1
The People's Republic of China	CCC	4
Saudi Arabia	SASO	7
Singapore	PSB	1
South Africa	SABS	1
South Korea	KTL	5
Sweden	SEMKO	1
Switzerland	SEV	1
Taiwan	BSMI	6
Thailand	TISI	1
The United Kingdom	ASTA	1

Country/region	Accredited agency	Applicable note number
The United States	UL	2
<ol style="list-style-type: none"> <li>1. The flexible cord must be Type HO5VV-F, 3-conductor, 0.75-mm<sup>2</sup> conductor size. Power cord set fittings (appliance coupler and wall plug) must bear the certification mark of the agency responsible for evaluation in the country or region where it will be used.</li> <li>2. The flexible cord must be Type SVT/SJT or equivalent, No. 18 AWG, 3-conductor. The wall plug must be a two-pole grounding type with a NEMA 5-15P (15 A, 125 V) or NEMA 6-15P (15 A, 250 V ac) configuration. CSA or C-UL mark. UL file number must be on each element.</li> <li>3. The appliance coupler, flexible cord, and wall plug must bear a “T” mark and registration number in accordance with the Japanese Dentori Law. The flexible cord must be Type VCTF, 3-conductor, 0.75-mm<sup>2</sup> or 1.25-mm<sup>2</sup> conductor size. The wall plug must be a two-pole grounding type with a Japanese Industrial Standard C8303 (7 A, 125 V ac) configuration.</li> <li>4. The flexible cord must be Type RVV, 3-conductor, 0.75-mm<sup>2</sup> conductor size. Power cord set fittings (appliance coupler and wall plug) must bear the CCC certification mark.</li> <li>5. The flexible cord must be Type H05VV-F 3X0.75-mm<sup>2</sup> conductor size. KTL logo and individual approval number must be on each element. Corset approval number and logo must be printed on a flag label.</li> <li>6. The flexible cord must be Type HVCTF 3×1.25-mm<sup>2</sup> conductor size. Power cord set fittings (appliance coupler, cable, and wall plug) must bear the BSMI certification mark.</li> <li>7. For 127 V ac, the flexible cord must be Type SVT or SJT 3 x 18 AWG, with plug NEMA 5-15P (15 A, 125 V ac), with UL and CSA or C-UL marks. For 240 V ac, the flexible cord must be Type H05VV-F 3×0.75-1.00-mm<sup>2</sup> conductor size, with plug BS 1363/A with BSI or ASTA marks.</li> </ol>		



---

## 9 Recycling

When a non-rechargeable or rechargeable battery has reached the end of its useful life, do not dispose of the battery in general household waste. Follow the local laws and regulations in your area for battery disposal.

HP encourages customers to recycle used electronic hardware, HP original print cartridges, and rechargeable batteries. For more information about recycling programs, see the HP Web site at <http://www.hp.com/recycle>.



---

# Index

## A

- AC adapter 14
- AC adapter, spare part numbers 26, 29, 32
- action keys
  - identifying 8, 9
- audio, product description 2
- audio-in (microphone) jack 14
- audio-out (headphone) jacks 14

## B

- back up
  - personal files 88
- backups 87, 93
- base enclosure
  - removal 42
  - spare part numbers 42
- base enclosure, spare part number 28
- battery
  - removal 43
  - spare part numbers 24, 27, 43
- BIOS
  - determining version 79, 83
  - downloading an update 80, 83
  - updating 79, 82
- Blu-ray ROM DVD±R/RW Super Multi Double-Layer Drive
  - precautions 36
  - spare part number 25, 27
- boot order
  - changing HP Recovery Manager 92
- buttons
  - left TouchPad 11
  - power 7
  - right TouchPad 11
  - TouchPad on/off 11

## C

- cables, service considerations 35
  - caps lock light, identifying 10
  - chipset, product description 1
  - components
    - bottom 15
    - display 5
    - left side 12
    - right side 14
  - computer major components 19
  - computer reset 90
  - computer specifications 85
  - connector, power 14
  - connectors, service considerations 35
- ## D
- default settings, restoring 82
  - deleted files
    - restoring 89
  - Digital Media slot, identifying 12
  - display
    - specifications 86
  - display assembly
    - spare part numbers 39
  - display panel
    - removal 39
  - display panel, product description 1
  - drives, preventing damage 36
  - DVD±RW and CD-RW Super Multi Double-Layer Combo Drive
    - precautions 36
    - spare part number 25, 27

## E

- electrostatic discharge 36
- equipment guidelines 38
- esc key, identifying 8, 9

- Ethernet, product description 2
- external media cards, product description 3

## F

- factory settings, restoring 82
- fan
  - removal 61
  - spare part number 61
- fn key, identifying 8, 9

## G

- graphics, product description 1
- grounding guidelines 36
- guidelines
  - equipment 38
  - grounding 36
  - packaging 37
  - transporting 37
  - workstation 37

## H

- hard drive
  - precautions 36
  - product description 2
  - removal 46
  - spare part numbers 25, 46
- hard drive light 13
- hard drive, spare part numbers 24, 25, 27
- HDMI port, identifying 12
- HP Recovery Manager 91
  - correcting boot problems 92
  - starting 92
- HP Recovery media
  - creating 88
  - recovery 92

- HP Recovery partition 92
  - recovery 92
  - removing 93
- I**
- integrated webcam light,
  - identifying 6
- internal display switch,
  - identifying 5
- internal microphones, identifying 5
- J**
- jacks
  - audio-in (microphone) 14
  - audio-out (headphone) 14
  - network 12
  - RJ-45 (network) 12
- K**
- keyboard
  - product description 3
  - removal 70
  - spare part numbers 20, 70
- keys
  - action 8, 9
  - esc 8, 9
  - fn 8, 9
  - operating system 9
  - operating system applications 9
  - Windows applications 8
  - Windows logo 8
- L**
- lights
  - AC adapter 14
  - caps lock 10
  - hard drive 13
  - mute 10
  - power 10, 13
  - TouchPad 10, 11
  - webcam 6
  - wireless 10
- M**
- mass storage device
  - precautions 36
  - removal 46
  - spare part numbers 25, 46
- media card reader assembly
  - removal 63
  - spare part numbers 63
- memory module
  - product description 1
  - removal 50
  - spare part numbers 27, 50
- microphone
  - product description 2
- minimized image
  - creating 91
- minimized image recovery 92
- model name 1
- mute light, identifying 10
- N**
- network jack, identifying 12
- O**
- operating system applications key,
  - identifying 9
- operating system logo key,
  - identifying 9
- operating system, product description 3
- optical drive
  - precautions 36
  - product description 2
  - spare part numbers 25, 27
- original system recovery 91
- P**
- packaging guidelines 37
- PCID label 17
- plastic parts, service considerations 35
- pointing device, product description 3
- ports
  - HDMI 12
  - product description 3
  - USB 14
  - USB 3.0 12
- power button, identifying 7
- power connector cable
  - removal 67
  - spare part number 22
- power connector, identifying 14
- power cord
  - set requirements 97
  - spare part numbers 26, 27
- power lights, identifying 10, 13
- power requirements, product description 3
- processor, product description 1
- product description
  - audio 2
  - chipset 1
  - display panel 1
  - Ethernet 2
  - external media cards 3
  - graphics 1
  - hard drives 2
  - keyboard 3
  - memory module 1
  - microphone 2
  - operating system 3
  - optical drive 2
  - pointing device 3
  - ports 3
  - power requirements 3
  - processors 1
  - product name 1
  - serviceability 3
  - video 2
  - wireless 2
- product name 1
- R**
- recovery 89, 90
  - discs 88, 92
  - HP Recovery Manager 91
  - media 92
  - starting 92
  - supported discs 88
  - system 91
  - USB flash drive 92
  - using HP Recovery media 89
- recovery media
  - creating 88
  - creating using HP Recovery Manager 89
- recovery partition 92
- removing 93
- recycle
  - computer 89, 90
- refresh 90
  - computer 89
- removal/replacement preliminaries 35
- procedures 39



- remove everything and reinstall
  - Windows 90
- reset
  - computer 89, 90
  - steps 90
- restore
  - Windows File History 89
- RJ-45 (network) jack, identifying 12
- RTC battery
  - removal 49
  - spare part numbers 22, 28, 49
- S**
- Screw Kit, spare part number 26
- security cable slot, identifying 14
- service considerations
  - cables 35
  - connectors 35
  - plastic parts 35
- service tag 17
- serviceability, product
  - description 3
- Setup Utility
  - changing the language 81
  - displaying system information 82
  - exiting 82
  - navigating 82
  - restoring default settings 82
  - selecting 82
  - starting 81
- slots
  - security cable 14
- solid-state drive, spare part
  - number 28
- Speaker Kit, spare part number 68
- speakers
  - removal 68
  - spare part number 68
- speakers, identifying 7
- specifications
  - computer 85
  - display 86
- supported discs
  - recovery 88
- system board
  - removal 56
  - spare part numbers 22, 23, 24, 27, 28, 29, 56
- system information, displaying 82
- system recovery 91
- system restore point
  - creating 88
  - restoring 89
- T**
- tools required 35
- top cover
  - removal 74
  - spare part numbers 28, 74
- TouchPad
  - buttons 11
- TouchPad button board
  - removal 54
  - spare part number 21, 54
- TouchPad light 10, 11
- TouchPad on/off button 11
- TouchPad zone, identifying 11
- transporting guidelines 37
- U**
- USB 3.0 ports identifying 12
- USB ports, identifying 14
- USB/Audio board 24
- V**
- vents, identifying 15
- video, product description 2
- W**
- webcam light, identifying 5
- webcam, identifying 5
- Windows
  - backup 88
  - File History 88, 89
  - Refresh 89, 90
  - reinstall 89, 90
  - remove everything and reinstall
    - option 90
  - reset 90
  - restoring files 89
  - system restore point 88, 89
- Windows applications key,
  - identifying 8
- Windows logo key, identifying 8
- wireless light 10
- wireless, product description 2
- WLAN antennas, identifying 5
- WLAN module
  - removal 52
  - spare part numbers 2, 27, 28, 31, 52
- workstation guidelines 37





