



## Maintenance and Service Guide

HP Compaq Pro 6305 Microtower Business PC

HP Compaq Pro 6305 Small Form Factor Business  
PC

© Copyright 2012, 2013 Hewlett-Packard Development Company, L.P. The information contained herein is subject to change without notice.

Microsoft, Windows, and Windows Vista are either trademarks or registered trademarks of Microsoft Corporation in the United States and/or other countries.

The only warranties for HP products and services are set forth in the express warranty statements accompanying such products and services. Nothing herein should be construed as constituting an additional warranty. HP shall not be liable for technical or editorial errors or omissions contained herein.

This document contains proprietary information that is protected by copyright. No part of this document may be photocopied, reproduced, or translated to another language without the prior written consent of Hewlett-Packard Company.

Fourth Edition (August 2013)

First Edition (October 2012)

Document Part Number: 706894-004

## About This Book

---

 **WARNING!** Text set off in this manner indicates that failure to follow directions could result in bodily harm or loss of life.

 **CAUTION:** Text set off in this manner indicates that failure to follow directions could result in damage to equipment or loss of information.

 **NOTE:** Text set off in this manner provides important supplemental information.

---



---

# Table of contents

<b>1 Product Features .....</b>	<b>1</b>
Standard Configuration Features .....	1
Microtower (MT) Front Panel Components .....	2
Small Form Factor (SFF) Front Panel Components .....	3
Microtower (MT) Rear Panel Components .....	4
Small Form Factor (SFF) Rear Panel Components .....	5
Serial Number Location .....	6
<b>2 Activating and Customizing the Software .....</b>	<b>7</b>
Activating and customizing the software in Windows 7 .....	7
Activating the Windows operating system .....	7
Downloading Windows 7 updates .....	8
Installing or upgrading device drivers .....	8
Customizing the monitor display .....	8
Activating and customizing the software in Windows 8 .....	8
Activating the Windows Operating System .....	8
Downloading Windows 8 updates .....	9
Customizing the monitor display .....	9
<b>3 Computer Setup (F10) Utility .....</b>	<b>10</b>
Computer Setup (F10) Utilities .....	10
Using Computer Setup (F10) Utilities .....	11
Computer Setup—File .....	12
Computer Setup—Storage .....	13
Computer Setup—Security .....	16
Computer Setup—Power .....	21
Computer Setup—Advanced .....	22
Recovering the Configuration Settings .....	24
<b>4 Illustrated parts catalog .....</b>	<b>25</b>
Microtower (MT) chassis spare parts .....	25
Computer major components .....	25
Cables .....	27
Misc parts .....	28
Drives .....	30
Misc boards .....	30

Sequential part number listing .....	31
Small Form Factor (SFF) chassis spare parts .....	35
Computer major components .....	35
Cables .....	37
Misc parts .....	38
Drives .....	40
Misc boards .....	40
Sequential part number listing .....	41

## **5 Routine Care, SATA Drive Guidelines, and Disassembly Preparation ..... 45**

Electrostatic Discharge Information .....	45
Generating Static .....	45
Preventing Electrostatic Damage to Equipment .....	46
Personal Grounding Methods and Equipment .....	46
Grounding the Work Area .....	47
Recommended Materials and Equipment .....	47
Operating Guidelines .....	48
Routine Care .....	48
General Cleaning Safety Precautions .....	48
Cleaning the Computer Case .....	49
Cleaning the Keyboard .....	49
Cleaning the Monitor .....	49
Cleaning the Mouse .....	50
Service Considerations .....	50
Power Supply Fan .....	50
Tools and Software Requirements .....	50
Screws .....	50
Cables and Connectors .....	51
Hard Drives .....	51
Lithium Coin Cell Battery .....	51
SATA Hard Drives .....	52
SATA Hard Drive Cables .....	52
SATA Data Cable .....	52
SMART ATA Drives .....	52
Cable Management .....	52
Hard Drive Capacities .....	53

## **6 Removal and Replacement Procedures Microtower (MT) Chassis ..... 54**

Preparation for Disassembly .....	54
Computer Access Panel .....	55
Front Bezel .....	56

Front Bezel Security .....	57
Bezel Blanks .....	59
Memory .....	60
DIMMs .....	60
DDR3-SDRAM DIMMs .....	60
Populating DIMM Sockets .....	61
Installing DIMMs .....	62
Expansion Cards .....	64
WLAN module .....	67
System Board Connections .....	69
Drives .....	70
Drive Positions .....	72
Removing a 5.25-inch or 3.5-inch Drive from a Drive Bay .....	73
Installing a 5.25-inch or 3.5-inch Drive into a Drive Bay .....	75
Removing a Hard Drive from a Drive Bay .....	77
Installing a Hard Drive into an Internal Drive Bay .....	78
Removing and Replacing a Removable 3.5-inch SATA Hard Drive .....	80
Front Fan Assembly .....	85
Front I/O Assembly .....	86
Power Switch/LED Assembly .....	87
Heat sink .....	89
Processor .....	90
Speaker .....	91
Rear Chassis Fan .....	93
Power Supply .....	95
System Board .....	96

## **7 Removal and Replacement Procedures Small Form Factor (SFF) Chassis ..... 99**

Preparation for Disassembly .....	99
Access Panel .....	100
Front Bezel .....	101
Front Bezel Security .....	102
Bezel Blanks .....	104
Memory .....	105
DIMMs .....	105
DDR3-SDRAM DIMMs .....	105
Populating DIMM Sockets .....	106
Installing DIMMs .....	107
Expansion Card .....	109
WLAN module .....	113
System Board Connections .....	115

Drives .....	116
Drive Positions .....	117
Installing and Removing Drives .....	117
Removing a 5.25-inch Drive from a Drive Bay .....	119
Installing a 5.25-inch Drive into a Drive Bay .....	119
Removing a 3.5-inch Drive from a Drive Bay .....	121
Installing a 3.5-inch Drive into a Drive Bay .....	123
Removing and Replacing the Primary 3.5-inch Internal Hard Drive .....	125
Removing and Replacing a Removable 3.5-inch SATA Hard Drive .....	127
Fan duct .....	132
Front Fan Assembly .....	133
Hood Sensor .....	135
Front I/O, Power Switch Assembly .....	136
Speaker .....	138
Heat sink .....	139
Processor .....	141
Power Supply .....	142
System Board .....	143
Using the Small Form Factor Computer in a Tower Orientation .....	145

## **8 Troubleshooting Without Diagnostics ..... 146**

Safety and Comfort .....	146
Before You Call for Technical Support .....	146
Helpful Hints .....	147
Solving General Problems .....	148
Solving Power Problems .....	152
Solving Hard Drive Problems .....	154
Solving Media Card Reader Problems .....	156
Solving Display Problems .....	158
Solving Audio Problems .....	163
Solving Printer Problems .....	165
Solving Keyboard and Mouse Problems .....	166
Solving Hardware Installation Problems .....	169
Solving Network Problems .....	171
Solving Memory Problems .....	175
Solving Processor Problems .....	176
Solving CD-ROM and DVD Problems .....	177
Solving USB Flash Drive Problems .....	179
Solving Front Panel Component Problems .....	180
Solving Internet Access Problems .....	181
Solving Software Problems .....	182



Contacting Customer Support .....	184
<b>9 HP PC Hardware Diagnostics .....</b>	<b>185</b>
Why run HP PC Hardware Diagnostics – UEFI .....	185
How to access and run HP PC Hardware Diagnostics - UEFI .....	185
Downloading HP PC Hardware Diagnostics to a USB device .....	186
<b>10 POST Error Messages .....</b>	<b>187</b>
POST Numeric Codes and Text Messages .....	187
Interpreting POST Diagnostic Front Panel LEDs and Audible Codes .....	195
<b>11 Password Security and Resetting CMOS .....</b>	<b>199</b>
Resetting the Password Jumper .....	199
Clearing and Resetting the CMOS .....	200
<b>12 Backup and Recovery .....</b>	<b>203</b>
Restoring and recovering in Windows 7 .....	203
System Restore .....	203
System Recovery .....	203
System Recovery when Windows is responding .....	204
System Recovery when Windows is not responding .....	205
System recovery using recovery media .....	205
Creating recovery media .....	206
Using recovery media .....	207
Backup and recovery in Windows 8 .....	207
Backing up your information .....	208
Performing a system recovery .....	208
Using the Windows recovery tools .....	209
Using f11 recovery tools .....	209
Using Windows 8 operating system media (purchased separately) .....	210
<b>Appendix A Battery Replacement .....</b>	<b>211</b>
<b>Appendix B Power Cord Set Requirements .....</b>	<b>214</b>
General Requirements .....	214
Japanese Power Cord Requirements .....	214
Country-Specific Requirements .....	215
<b>Appendix C Specifications .....</b>	<b>216</b>
MT Specifications .....	216

SFF Specifications ..... 217

**Index ..... 218**

---

# 1 Product Features

## Standard Configuration Features

Features may vary depending on the model. For a complete listing of the hardware and software installed in the computer, run the diagnostic utility (included on some computer models only).

**Figure 1-1** Microtower Configuration



**Figure 1-2** Small Form Factor Configuration



---

 **NOTE:** The Small Form Factor computer can also be used in a tower orientation. For more information, see [Using the Small Form Factor Computer in a Tower Orientation on page 145](#) in this guide.

---

# Microtower (MT) Front Panel Components

Drive configuration may vary by model. Some models have a bezel blank covering one or more drive bays.

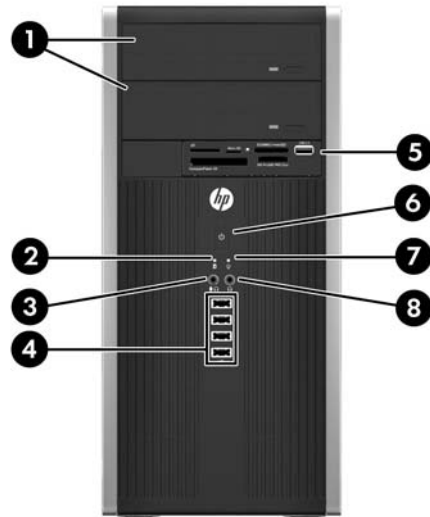

**Table 1-1 Front Panel Components**

1	5.25-inch Optical Drives	5	3.5-inch Media Card Reader (optional)
2	Hard Drive Activity Light	6	Dual-State Power Button
3	Microphone/Headphone Connector	7	Power On Light
4	USB (Universal Serial Bus) 2.0 Ports	8	Headphone Connector

**NOTE:** When a device is plugged into the Microphone/Headphone Connector, a dialog box will pop up asking if you want to use the connector for a microphone Line-In device or a headphone. You can reconfigure the connector at any time in the Realtek HD Audio Manager.

**NOTE:** The Power On Light is normally green when the power is on. If it is flashing red, there is a problem with the computer and it is displaying a diagnostic code.

# Small Form Factor (SFF) Front Panel Components

Drive configuration may vary by model. Some models have a bezel blank covering one or more drive bays.

**Figure 1-3** Front Panel Components

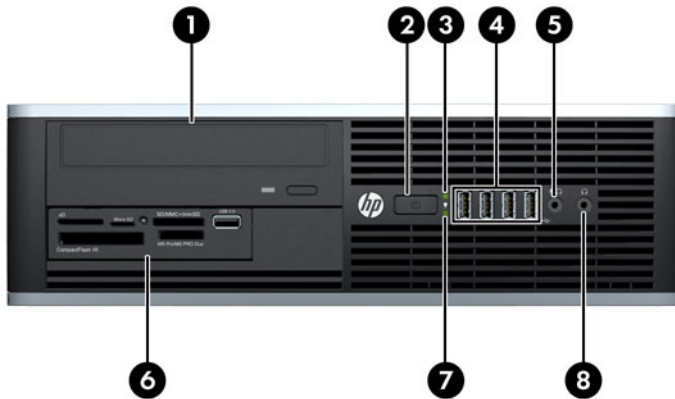

**Table 1-2** Front Panel Components

1	5.25-inch Optical Drive	5	Microphone/Headphone Connector
2	Dual-State Power Button	6	3.5-inch Media Card Reader (optional)
3	Power On Light	7	Hard Drive Activity Light
4	USB (Universal Serial Bus) Ports	8	Headphone Connector

**NOTE:** When a device is plugged into the Microphone/Headphone Connector, a dialog box will pop up asking if you want to use the connector for a microphone Line-In device or a headphone. You can reconfigure the connector at any time in the Realtek HD Audio Manager.

**NOTE:** The Power On Light is normally green when the power is on. If it is flashing red, there is a problem with the computer and it is displaying a diagnostic code.

# Microtower (MT) Rear Panel Components

Figure 1-4 Rear Panel Components

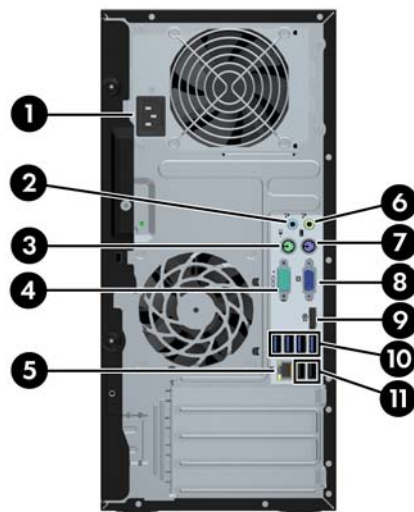











Table 1-3 Rear Panel Components

1	Power Cord Connector	6		Line-Out Connector for powered audio devices (green)
2	 Line-In Audio Connector (blue)	7		PS/2 Keyboard Connector (purple)
3	 PS/2 Mouse Connector (green)	8		VGA Monitor Connector
4	 Serial Connector	9		DisplayPort Monitor Connector
5	 RJ-45 Network Connector	10		USB 3.0 ports (blue)
		11		USB 2.0 ports (black)

**NOTE:** An optional second serial port and an optional parallel port are available from HP.

When a device is plugged into the blue Line-In Audio Connector, a dialog box will pop up asking if you want to use the connector for a line-in device or a microphone. You can reconfigure the connector at any time in the Realtek HD Audio Manager.

For AMD/ATI graphic cards installed in one of the system board slots, the video connectors on the graphics card and the integrated graphics on the system board may be used at the same time. However, for other non-AMD/ATI graphics cards, the video connectors will only be functional on the graphics card.

If inserting a wireless receiver, use a USB 2.0 port that is separated from USB 3.0 devices.

# Small Form Factor (SFF) Rear Panel Components

**Figure 1-5** Rear Panel Components

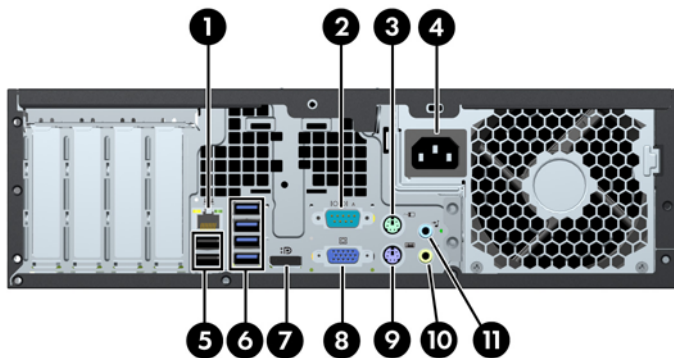

**Table 1-4** Rear Panel Components

1	RJ-45 Network Connector	7	DisplayPort Monitor Connector
2	Serial Connector	8	VGA Monitor Connector
3	PS/2 Mouse Connector (green)	9	PS/2 Keyboard Connector (purple)
4	Power Cord Connector	10	Line-Out Connector for powered audio devices (green)
5	USB 2.0 ports (black)	11	Line-In Audio Connector (blue)
6	USB 3.0 ports (blue)		

**NOTE:** An optional second serial port and an optional parallel port are available from HP.

When a device is plugged into the blue Line-In Audio Connector, a dialog box will pop up asking if you want to use the connector for a line-in device or a microphone. You can reconfigure the connector at any time in the Realtek HD Audio Manager.

For AMD/ATI graphic cards installed in one of the system board slots, the video connectors on the graphics card and the integrated graphics on the system board may be used at the same time. However, for other non-AMD/ATI graphics cards, the video connectors will only be functional on the graphics card.

If inserting a wireless receiver, use a USB 2.0 port that is separated from USB 3.0 devices.

## Serial Number Location

Each computer has a unique serial number and a product ID number that are located on the top cover of the computer. Keep these numbers available for use when contacting customer service for assistance.

**Figure 1-6** Microtower Serial Number and Product ID Location



**Figure 1-7** Small Form Factor Serial Number and Product ID Location





---

## 2 Activating and Customizing the Software

---

 **NOTE:** This chapter provides information for both Windows 7 and Windows 8.

---

### Activating and customizing the software in Windows 7

If your computer was not shipped with a Windows® operating system, some portions of this documentation do not apply. Additional information is available in online help after you activate the operating system.

 **CAUTION:** Do not add optional hardware or third-party devices to the computer until the operating system is successfully activated. Doing so may cause errors and prevent the operating system from installing properly.

 **NOTE:** Be sure there is a 10.2 cm (4 inch) clearance at the back of the unit and above the monitor to permit the required airflow.

---

### Activating the Windows operating system

The first time you turn on the computer, the operating system is set up and activated automatically. This process takes about 5 to 10 minutes. Carefully read and follow the instructions on the screen to complete the activation.

We recommend that you register your computer with HP during operating system setup so you can receive important software updates, facilitate support questions, and sign up for special offers.

 **CAUTION:** After the activation process has begun, **DO NOT TURN OFF THE COMPUTER UNTIL THE PROCESS IS COMPLETE.** Turning off the computer during the activation process may damage the software that runs the computer or prevent its proper installation.

 **NOTE:** If the computer shipped with more than one operating system language on the hard drive, the activation process could take up to 60 minutes.

---

## Downloading Windows 7 updates

Microsoft may release updates to the operating system. To help keep the computer running optimally, HP recommends checking for the latest updates during the initial installation and periodically throughout the life of the computer.

1. To set up your Internet connection, click **Start > Internet Explorer** and follow the instructions on the screen.
2. After an Internet connection has been established, click the **Start > All Programs > Windows Update**.
3. Run Windows Update monthly thereafter.

## Installing or upgrading device drivers

When installing optional hardware devices after the operating system installation is complete, you must also install the drivers for each of the devices.

In Windows 7, if prompted for the i386 directory, replace the path specification with `C:\i386`, or use the **Browse** button in the dialog box to locate the i386 folder. This action points the operating system to the appropriate drivers.

Obtain the latest support software, including support software for the operating system, from <http://www.hp.com/support>. Select your country and language, select **Download drivers and software (and firmware)**, enter the model number of the computer, and press **Enter**.

## Customizing the monitor display

If you wish, you can select or change the monitor refresh rates, screen resolution, color settings, font sizes, and power management settings.

For more information, refer to the online documentation provided with the graphics controller utility or the documentation that came with your monitor.

Right-click on the Windows desktop, then click **Personalize** to change display settings.

## Activating and customizing the software in Windows 8

Additional information is available in online help after you activate the operating system.



**NOTE:** Be sure there is a 10.2 cm (4 inch) clearance at the back of the unit and above the monitor to permit the required airflow.

---

## Activating the Windows Operating System

The first time you turn on the computer, the operating system is set up and activated automatically. This process takes about 5 to 10 minutes. Carefully read and follow the instructions on the screen to complete the activation.

We recommend that you register your computer with HP during operating system set up so you can receive important software updates, facilitate support questions, and sign up for special offers. You can also register your computer with HP using the **Register with HP** app on the Start screen.

 **CAUTION:** After the activation process has begun, **DO NOT TURN OFF THE COMPUTER UNTIL THE PROCESS IS COMPLETE**. Turning off the computer during the activation process may damage the software that runs the computer or prevent its proper installation.

---

## Downloading Windows 8 updates

Microsoft may release updates to the operating system. To help keep the computer running optimally, HP recommends checking for the latest updates during the initial installation and periodically throughout the life of the computer.

Run Windows Update as soon as possible after you set up your computer.

1. Point to the upper-right or lower-right corner of the Start screen to display the charms.
2. Click **Settings > Change PC Settings > Windows Update**.
3. Run Windows Update monthly thereafter.

## Customizing the monitor display

You can customize display settings for Windows 8 separately for the Start screen and the Desktop.

To customize the Start screen:

1. Point to the upper-right or lower-right corner of the Start screen to display the charms.
2. Click **Settings > Change PC Settings**.
3. Click **Personalize** to change the display settings.

To customize the Desktop:

1. Click the Desktop app on the Start screen.
2. Right-click on the desktop, and then click **Personalize** to change display settings.

---

# 3 Computer Setup (F10) Utility

## Computer Setup (F10) Utilities

Use Computer Setup (F10) Utility to do the following:

- Change factory default settings.
- Set the system date and time.
- Set, view, change, or verify the system configuration, including settings for processor, graphics, memory, audio, storage, communications, and input devices.
- Modify the boot order of bootable devices such as hard drives, optical drives, or USB flash media devices.
- Enable Quick Boot, which is faster than Full Boot but does not run all of the diagnostic tests run during a Full Boot. You can set the system to:
  - always Quick Boot (default);
  - periodically Full Boot (from every 1 to 30 days); or
  - always Full Boot.
- Select Post Messages Enabled or Disabled to change the display status of Power-On Self-Test (POST) messages. Post Messages Disabled suppresses most POST messages, such as memory count, product name, and other non-error text messages. If a POST error occurs, the error is displayed regardless of the mode selected. To manually switch to Post Messages Enabled during POST, press any key (except **F1** through **F12**).
- Establish an Ownership Tag, the text of which is displayed each time the system is turned on or restarted.
- Enter the Asset Tag or property identification number assigned by the company to this computer.
- Enable the power-on password prompt during system restarts (warm boots) as well as during power-on.
- Establish a setup password that controls access to the Computer Setup (F10) Utility and the settings described in this section.
- Secure integrated I/O functionality, including the serial, USB, or parallel ports, audio, or embedded NIC, so that they cannot be used until they are unsecured.
- Enable or disable removable media boot ability.
- Solve system configuration errors detected but not automatically fixed during the Power-On Self-Test (POST).
- Replicate the system setup by saving system configuration information on a USB device and restoring it on one or more computers.

- Execute self-tests on a specified ATA hard drive (when supported by drive).
- Enable or disable DriveLock security (when supported by drive).

## Using Computer Setup (F10) Utilities

Computer Setup can be accessed only by turning the computer on or restarting the system. To access the Computer Setup Utilities menu, complete the following steps:

1. Turn on or restart the computer.
2. Repeatedly press **F10** when the monitor light turns green to access the utility.

You can also press **Esc** to a menu that allows you to access different options available at startup, including the Computer Setup utility.

 **NOTE:** If you do not press **F10** at the appropriate time, you must restart the computer and again repeatedly press **F10** when the monitor light turns green to access the utility.

3. A choice of five headings appears in the Computer Setup Utilities menu: File, Storage, Security, Power, and Advanced.
4. Use the arrow (left and right) keys to select the appropriate heading. Use the arrow (up and down) keys to select the option you want, then press **Enter**. To return to the Computer Setup Utilities menu, press **Esc**.
5. To apply and save changes, select **File > Save Changes and Exit**.
  - If you have made changes that you do not want applied, select **Ignore Changes and Exit**.
  - To reset to factory settings or previously saved default settings (some models), select **Apply Defaults and Exit**. This option will restore the original factory system defaults.

 **NOTE:** Not all settings shown in the following sections are available for all models

 **CAUTION:** Do NOT turn the computer power OFF while the BIOS is saving the Computer Setup (F10) changes because the CMOS could become corrupted. It is safe to turn off the computer only after exiting the F10 Setup screen.

**Table 3-1 Computer Setup (F10) Utility**

Heading	Table
File	<a href="#">Computer Setup—File on page 12</a>
Storage	<a href="#">Computer Setup—Storage on page 13</a>
Security	<a href="#">Computer Setup—Security on page 16</a>
Power	<a href="#">Computer Setup—Power on page 21</a>
Advanced	<a href="#">Computer Setup—Advanced on page 22</a>

## Computer Setup—File

 **NOTE:** Support for specific Computer Setup options may vary depending on the hardware configuration.

**Table 3-2 Computer Setup—File**

Option	Description
<b>System Information</b>	Lists: <ul style="list-style-type: none"><li>• Product name</li><li>• SKU number</li><li>• Processor type/speed/stepping</li><li>• Cache size (L1/L2/L3) (dual core processors have this listed twice)</li><li>• Installed memory size/speed, number of channels (single or dual) (if applicable)</li><li>• Integrated MAC address for embedded, enabled NIC (if applicable)</li><li>• System BIOS (includes family name and version)</li><li>• Chassis serial number</li><li>• Asset tracking number</li><li>• ME firmware version</li><li>• ME Management mode</li></ul>
<b>About</b>	Displays copyright notice.
<b>Set Time and Date</b>	Allows you to set system time and date.
<b>Flash System ROM</b>	Allows you to update the system ROM with a BIOS image file located on removable media.
<b>Replicated Setup</b>	<b>Save to Removable Media</b> Saves system configuration to a formatted USB flash media device. <b>Restore from Removable Media</b> Restores system configuration from a USB flash media device.
<b>Default Setup</b>	<b>Save Current Settings as Default</b> Saves the current system configuration settings as the default. <b>Restore Factory Settings as Default</b> Restores the factory system configuration settings as the default.
<b>Apply Defaults and Exit</b>	Applies the currently selected default settings and clears any established passwords.
<b>Ignore Changes and Exit</b>	Exits Computer Setup without applying or saving any changes.
<b>Save Changes and Exit</b>	Saves changes to system configuration or default settings and exits Computer Setup.

## Computer Setup—Storage



**NOTE:** Support for specific Computer Setup options may vary depending on the hardware configuration.

**Table 3-3 Computer Setup—Storage**

Option	Description
<b>Device Configuration</b>	<p>Lists all installed BIOS-controlled storage devices.</p> <p>When a device is selected, detailed information and options are displayed. The following options may be presented:</p> <ul style="list-style-type: none"><li>• <b>Hard Disk:</b> Size, model, firmware version, serial number, connector color.</li></ul> <p><b>Translation mode</b> (ATA disks only)</p> <p>Lets you select the translation mode to be used for the device. This enables the BIOS to access disks partitioned and formatted on other systems and may be necessary for users of older versions of UNIX (e.g., SCO UNIX version 3.2). Options are Automatic, Bit-Shift, LBA Assisted, User, and Off.</p> <p>Available only when the drive translation mode is set to User, allows you to specify the parameters (logical cylinders, heads, and sectors per track) used by the BIOS to translate disk I/O requests (from the operating system or an application) into terms the hard drive can accept. Logical cylinders may not exceed 1024. The number of heads may not exceed 256. The number of sectors per track may not exceed 63.</p> <p><b>CAUTION:</b> Ordinarily, the translation mode selected automatically by the BIOS should not be changed. If the selected translation mode is not compatible with the translation mode that was active when the disk was partitioned and formatted, the data on the disk will be inaccessible.</p> <ul style="list-style-type: none"><li>• <b>CD-ROM:</b> Model, firmware version, serial number, connector color (not included for USB CD-ROM).</li><li>• <b>SSD Life Used</b> <b>NOTE:</b> Displays for solid-state drives.</li><li>• <b>SMART</b> (ATA disks only)</li><li>• <b>Diskette:</b> Model and firmware version.</li></ul> <p><b>NOTE:</b> Displays for USB diskette drives.</p> <ul style="list-style-type: none"><li>• <b>Default Values</b> (ATA disks only) See Translation Mode above for details.</li></ul> <p><b>SATA Defaults</b></p>

**Table 3-3 Computer Setup—Storage (continued)**

---

**Storage Options**

**eSATA Port**

Allows you to set a SATA port as an eSATA port for use with an external drive. Default is enabled.

This setting affects only the port with the black connector, labeled as eSATA on the system board. This port should have the eSATA back panel connector attached to use eSATA drives. For more information, see the eSATA white paper at [www.hp.com](http://www.hp.com).

**SATA Emulation**

Allows you to choose how the SATA controller and devices are accessed by the operating system. There are three supported options: IDE, RAID, and AHCI (default).

**CAUTION:** SATA emulation changes may prevent access to existing hard drive data and degrade or corrupt established volumes.

IDE - This is the most backwards-compatible setting of the three options. Operating systems usually do not require additional driver support in IDE mode.

RAID - Allows DOS and boot access to RAID volumes. Use this mode with the RAID device driver loaded in the operating system to take advantage of RAID features.

AHCI (default option) - Allows operating systems with AHCI device drivers loaded to take advantage of more advanced features of the SATA controller.

**NOTE:** The RAID/AHCI device driver must be installed prior to attempting to boot from a RAID/AHCI volume. If you attempt to boot from a RAID/AHCI volume without the required device driver installed, the system will crash (blue screen). RAID volumes may become corrupted if they are booted to after disabling RAID.

**Removable Media Boot**

Enables/disables ability to boot the system from removable media. Default is enabled.

**Max eSATA Speed**

Allows you to choose 1.5 Gbps or 3.0 Gbps as the maximum eSATA speed. By default, the speed is limited to 1.5 Gbps for maximum reliability.

**CAUTION:** Consult your eSATA drive and cable manufacturer before enabling 3.0 Gbps speed. Some drive and cable combinations may not run reliably at 3.0 Gbps.

---



**Table 3-3 Computer Setup—Storage (continued)**

---

<b>DPS Self-Test</b>	Allows you to execute self-tests on ATA hard drives capable of performing the Drive Protection System (DPS) self-tests.  <b>NOTE:</b> This selection will only appear when at least one drive capable of performing the DPS self-tests is attached to the system.
<b>Boot Order</b>	Allows you to: <ul style="list-style-type: none"><li>• <b>EFI Boot Sources:</b> Specify the order in which EFI boot sources (such as a internal hard drive, USB hard drive, USB optical drive, or internal optical drive) are checked for a bootable operating system image. Each device on the list may be individually excluded from or included for consideration as a bootable operating system source.  EFI boot sources always have precedence over legacy boot sources.</li><li>• <b>Legacy Boot Sources:</b> Specify the order in which legacy boot sources (such as a network interface card, internal hard drive, USB optical drive, or internal optical drive) are checked for a bootable operating system image. Each device on the list may be individually excluded from or included for consideration as a bootable operating system source.  Specify the order of attached hard drives. The first hard drive in the order will have priority in the boot sequence and will be recognized as drive C (if any devices are attached).  <b>NOTE:</b> To drag a device to a preferred place, press <b>Enter</b>. To remove the device from consideration as a bootable device, press <b>F5</b>.  You can use <b>F5</b> to disable individual boot items, as well as disable EFI boot and/or legacy boot.  <b>NOTE:</b> MS-DOS drive lettering assignments may not apply after a non-MS-DOS operating system has started.</li></ul> <b>Shortcut to Temporarily Override Boot Order</b>  To boot <b>one time</b> from a device other than the default device specified in Boot Order, restart the computer and press <b>Esc</b> (to access the boot menu) and then <b>F9</b> (Boot Order), or only <b>F9</b> (skipping the boot menu) when the monitor light turns green. After POST is completed, a list of bootable devices is displayed. Use the arrow keys to select the preferred bootable device and press <b>Enter</b> . The computer then boots from the selected non-default device for this one time.

---

## Computer Setup—Security



**NOTE:** Support for specific Computer Setup options may vary depending on the hardware configuration.

**Table 3-4 Computer Setup—Security**

Option	Description
<b>Setup Password</b>	<p>Allows you to set and enable a setup (administrator) password.</p> <p><b>NOTE:</b> If the setup password is set, it is required to change Computer Setup options, flash the ROM, and make changes to certain plug and play settings under Windows.</p>
<b>Power-On Password</b>	<p>Allows you to set and enable a power-on password. The power-on password prompt appears after a power cycle or reboot. If the user does not enter the correct power-on password, the unit will not boot.</p>
<b>Password Options</b>  (This selection appears only if a power-on password or setup password is set.)	<p>Allows you to enable/disable:</p> <ul style="list-style-type: none"><li>• Lock Legacy Resources (determines whether or not Windows Device Manager is allowed to change resource settings for serial and parallel ports).</li><li>• Stringent security (enabling the stringent password disables the ability to reset the password by moving the jumper on the system board). Default is disabled.</li></ul> <p><b>CAUTION:</b> If you enable the stringent security feature and you forget the setup password or the power-on password, the computer is inaccessible and can no longer be used.</p> <p>If you lose or forget the password, the system board must be replaced. This scenario is not covered under warranty.</p> <p>To prevent the computer from becoming permanently unusable, record your configured setup password or power-on password in a safe place away from your computer. Without these passwords, the computer cannot be unlocked.</p> <ul style="list-style-type: none"><li>• Setup Browse Mode (appears if a setup password is set) (allows viewing, but not changing, the F10 Setup Options without entering setup password). Default is enabled.</li><li>• Password prompt on F9 &amp; F12 (requires setup password to use these boot functions). Default is enabled.</li><li>• Network Server Mode. Default is disabled.</li></ul>
<b>Smart Cover</b>	<p>Allows you to:</p> <ul style="list-style-type: none"><li>• Lock/unlock the Cover Lock.</li><li>• Set the Cover Removal Sensor to Disable/Notify User/Setup Password.</li></ul> <p><b>NOTE:</b> <i>Notify User</i> alerts the user that the sensor has detected that the cover has been removed. <i>Setup Password</i> requires that the setup password be entered to boot the computer if the sensor detects that the cover has been removed.</p>

**Table 3-4 Computer Setup—Security (continued)**

<b>Device Security</b>	<p>Allows you to set Device Available/Device Hidden (default is Device Available) for:</p> <ul style="list-style-type: none"><li>• Embedded security device</li><li>• System audio</li><li>• USB controller (varies by model)</li><li>• Network controller</li></ul> <p><b>NOTE:</b> You must disable AMT before trying to hide the network controller.</p> <ul style="list-style-type: none"><li>• Serial port</li><li>• Parallel port</li><li>• SATA ports (varies by model)</li></ul>
<b>USB Security</b>	<p>Allows you to set Enabled/Disabled (default is Enabled) for:</p> <ul style="list-style-type: none"><li>• Front USB Ports</li><li>• Rear USB Ports</li><li>• Accessory USB Ports</li></ul>
<b>Slot Security</b>	<p>Allows you to disable any PCI or PCI Express slot. Default is enabled.</p>
<b>Network Boot</b>	<p>Enables/disables the computer's ability to boot from an operating system installed on a network server. (Feature available on NIC models only; the network controller must be either a PCI expansion card or embedded on the system board.) Default is enabled.</p>
<b>System IDs</b>	<p>Allows you to set:</p> <ul style="list-style-type: none"><li>• Asset tag (18-byte identifier), a property identification number assigned by the company to the computer.</li><li>• Ownership tag (80-byte identifier) displayed during POST.</li><li>• Universal Unique Identifier (UUID) number. The UUID can only be updated if the current chassis serial number is invalid. (These ID numbers are normally set in the factory and are used to uniquely identify the system.)</li><li>• Keyboard locale setting for System ID entry.</li></ul>

**Table 3-4 Computer Setup—Security (continued)**

---

<b>Master Boot Record Security</b>	<p>Enables/disables Master Boot Record (MBR) security.</p> <p>The MBR contains information needed to successfully boot from a disk and to access the data stored on the disk. Master Boot Record Security may prevent unintentional or malicious changes to the MBR, such as those caused by some viruses or by the incorrect use of certain disk utilities. It also allows you to recover the "last known good" MBR, should changes to the MBR be detected when the system is restarted.</p> <p>When MBR Security is enabled, the BIOS prevents any changes being made to the MBR of the current bootable disk while in MS-DOS or Windows Safe Mode.</p> <p><b>NOTE:</b> Most operating systems control access to the MBR of the current bootable disk; the BIOS cannot prevent changes that may occur while the operating system is running.</p> <p>Restores the backup Master Boot Record to the current bootable disk. Default is disabled.</p> <p>Only appears if all of the following conditions are true:</p> <ul style="list-style-type: none"><li>• MBR security is enabled</li><li>• A backup copy of the MBR has been previously saved</li><li>• The current bootable disk is the same disk from which the backup copy was saved</li></ul> <p><b>CAUTION:</b> Restoring a previously saved MBR after a disk utility or operating system has modified the MBR, may cause the data on the disk to become inaccessible. Only restore a previously saved MBR if you are confident that the current bootable disk's MBR has been corrupted or infected with a virus.</p>
------------------------------------	--

---

**Table 3-4 Computer Setup—Security (continued)**

<b>System Security</b> (these options are hardware dependent)	<p>Data Execution Prevention (enable/disable) - Helps prevent operating system security breaches. Default is enabled.</p> <p>SVM CPU Virtualization (enable/disable). Controls the virtualization features of the processor. Changing this setting requires turning the computer off and then back on. Default is disabled.</p> <p>Virtualization Technology (VTx) (enable/disable) - Controls the virtualization features of the processor. Changing this setting requires turning the computer off and then back on. Default is disabled.</p> <p>Virtualization Technology Directed I/O (VTd) (enable/disable) - Controls virtualization DMA remapping features of the chipset. Changing this setting requires turning the computer off and then back on. Default is disabled.</p> <p>Trusted Execution Technology (enable/disable) - Controls the underlying processor and chipset features needed to support a virtual appliance. Changing this setting requires turning the computer off and then back on. Default is disabled. To enable this feature you must enable the following features:</p> <ul style="list-style-type: none"><li>• Embedded Security Device Support</li><li>• Virtualization Technology</li><li>• Virtualization Technology Directed I/O</li></ul> <p>Embedded Security Device (enable/disable) - Permits activation and deactivation of the Embedded Security Device.</p> <p><b>NOTE:</b> To configure the Embedded Security Device, a Setup password must be set.</p> <ul style="list-style-type: none"><li>• Reset to Factory Settings (Do not reset/Reset) - Resetting to factory defaults will erase all security keys and leave the device in a disabled state. Changing this setting requires that you restart the computer. Default is Do not reset.</li></ul> <p><b>CAUTION:</b> The embedded security device is a critical component of many security schemes. Erasing the security keys will prevent access to data protected by the Embedded Security Device. Choosing Reset to Factory Settings may result in significant data loss.</p> <ul style="list-style-type: none"><li>• Measure boot variables/devices to PCR1 - Typically, the computer measures the boot path and saves collected metrics to PCR5 (a register in the Embedded Security Device). Bitlocker tracks changes to any of these metrics, and forces the user to re-authenticate if it detects any changes. Enabling this feature lets you set Bitlocker to ignore detected changes to boot path metrics, thereby avoiding re-authentication issues associated with USB keys inserted in a port. Default is enabled.</li></ul>
<b>System Security</b> (continued)	<p>OS management of Embedded Security Device (enable/disable) - This option allows the user to limit OS control of the Embedded Security Device. Default is enabled. This option is automatically disabled if Trusted Execution Technology is enabled.</p> <ul style="list-style-type: none"><li>• Reset of Embedded Security Device through OS (enable/disable) - This option allows the user to limit the operating system ability to request a Reset to Factory Settings of the Embedded Security Device. Default is disabled.</li></ul> <p><b>NOTE:</b> To enable this option, a Setup password must be set.</p> <ul style="list-style-type: none"><li>• No PPI provisioning (Windows 8 only) - This option lets you set Windows 8 to bypass the PPI (Physical Presence Interface) requirement and directly enable and take ownership of the TPM on first boot. You cannot change this setting after TPM is owned/initialized, unless the TPM is reset. Default is disabled for non-Windows 8 systems, and enabled for Windows 8.</li><li>• Allow PPI policy to be changed by OS. Enabling this option allows the operating system to execute TPM operations without Physical Presence Interface. Default is disabled.</li></ul> <p><b>NOTE:</b> To enable this option, a Setup password must be set.</p>

**Table 3-4 Computer Setup—Security (continued)**

---

<b>DriveLock Security</b>	Allows you to assign or modify a master or user password for hard drives. When this feature is enabled, the user is prompted to provide one of the DriveLock passwords during POST. If neither is successfully entered, the hard drive will remain inaccessible until one of the passwords is successfully provided during a subsequent cold-boot sequence.  <b>NOTE:</b> This selection will only appear when at least one drive that supports the DriveLock feature is attached to the system.
<b>Secure Boot Configuration</b>	This is a feature of Windows 8. <ul style="list-style-type: none"><li>• Legacy Support—Enable/Disable. Allows you to turn off all legacy support on the computer, including booting to DOS, running legacy graphics cards, booting to legacy devices, and so on. If set to disable, legacy boot options in <b>Storage &gt; Boot Order</b> are not displayed. Default is enabled.</li><li>• Secure Boot—Enable/Disable. Allows you to make sure an operating system is legitimate before booting to it, making Windows resistant to malicious modification from preboot to full OS booting, preventing firmware attacks. UEFI and Windows Secure Boot only allow code signed by pre-approved digital certificates to run during the firmware and OS boot process. Default is disabled, except for Windows 8 systems which have this setting enabled. Secure Boot enabled also sets <b>Legacy Support</b> to disabled.</li><li>• Key Management—This option lets you manage the custom key settings.<ul style="list-style-type: none"><li>◦ Clear Secure Boot Keys—Don't Clear/Clear. Allows you to delete any previously loaded custom boot keys. Default is Don't Clear.</li><li>◦ Key Ownership—HP Keys/Custom Keys. Selecting Custom Mode allows you to modify the contents of the secure boot signature databases and the platform key (PK) that verifies kernels during system start up, allowing you to use alternative operating systems. Selecting HP Keys causes the computer boot using the preloaded HP-specific boot keys. Default is HP Keys.</li></ul></li><li>• Fast Boot—Enable/Disable. Fast boot disables the ability to interrupt boot, such as pressing f keys to access items before the operating system loads. Default is disabled.</li></ul> <p><b>NOTE:</b> If Windows 8 detects a serious error, it will interrupt the boot process automatically and display advanced boot options.</p> <p>From Windows 8, you can press <b>Shift</b> and select <b>Restart</b> to access the screen that lets you boot to a device or troubleshoot your computer.</p>

---

# Computer Setup—Power

 **NOTE:** Support for specific Computer Setup options may vary depending on the hardware configuration.

**Table 3-5 Computer Setup—Power**

Option	Description
<b>OS Power Management</b>	<ul style="list-style-type: none"> <li>• Idle Power Savings—Extended/Normal. Allows certain operating systems to decrease the processors power consumption when the processor is idle. Default is extended.</li> <li>• Runtime Power Management— Enable/Disable. Allows certain operating systems to reduce processor voltage and frequency when the current software load does not require the full capabilities of the processor. Default is enabled.</li> <li>• Unique Sleep State Blink Rates—Enable/Disable. This feature is designed to provide a visual indication of what sleep state the system is in. Each sleep state has a unique blink pattern. Default is disabled.</li> </ul> <p><b>NOTE:</b> For Windows 8 systems with Fast Boot support, a normal shutdown goes to the S4 state, not the S5 state.</p> <ul style="list-style-type: none"> <li>◦ S0 (On) = Solid green LED.</li> <li>◦ S3 (Stand By)= 3 blinks at 1Hz (50% duty cycle) followed by a pause of 2 seconds (green LED) — repeated cycles of 3 blinks and a pause.</li> <li>◦ S4 (Hibernation)= 4 blinks at 1Hz (50% duty cycle) followed by a pause of 2 seconds (green LED) — repeated cycles of 4 blinks and a pause.</li> <li>◦ S5 (Soft Off) = LED is off.</li> </ul>
<b>Hardware Power Management</b>	<p>SATA Power Management – Enables or disables SATA bus and/or device power management. Default is enabled.</p> <p>S5 Maximum Power Savings – Turns off power to all nonessential hardware when system is off to meet EUP Lot 6 requirement of less than 0.5 Watt power usage. Default is disabled.</p> <p>PCI Express x16 Slot 1 – Sets Active State Power Management (ASPM) of the bus. ASPM lets you set lower power modes that activate when the bus is not being used. Options are Disabled, LOs, L1, LOs and L1. Default is ASPM Disabled.</p> <p>PCI Express x1 Slot 1 – Sets Active State Power Management (ASPM) of the bus. ASPM lets you set lower power modes that activate when the bus is not being used. Options are Disabled, LOs, L1, LOs and L1. Default is ASPM Disabled.</p> <p>Network Controller – Sets ASPM of the bus. ASPM lets you set lower power modes that activate when the bus is not being used. Options are Disabled, LOs, L1, LOs and L1. Default is ASPM Disabled.</p> <p>USB 3.0 Controller – Sets ASPM of the bus. ASPM lets you set lower power modes that activate when the bus is not being used. Options are Disabled, LOs, L1, LOs and L1. Default is ASPM Disabled.</p>
<b>Thermal</b>	<p>Fan idle mode—This bar graph controls the minimum permitted fan speed.</p> <p><b>NOTE:</b> This setting only changes the minimum fan speed. The fans are still automatically controlled.</p>

## Computer Setup—Advanced

 **NOTE:** Support for specific Computer Setup options may vary depending on the hardware configuration.

**Table 3-6 Computer Setup—Advanced (for advanced users)**

Option	Heading
<b>Power-On Options</b>	<p>Allows you to set:</p> <ul style="list-style-type: none"><li>• POST mode (QuickBoot, Clear Memory, FullBoot, or FullBoot Every x Days).<ul style="list-style-type: none"><li>◦ QuickBoot (default) = Do not clear memory or perform a memory test.</li><li>◦ FullBoot = Memory test (count) on cold boot. Clears memory on all boots.</li><li>◦ Clear Memory = No memory count on cold boot. Clears memory on all boots.</li><li>◦ FullBoot Every x Days = Memory count on 1st cold boot on or after the xth day. No more memory counts until 1st cold boot on or after x days. Clears memory on all boots.</li></ul></li><li>• POST messages (enable/disable). Enabling this feature will cause the system to display POST error messages, which are error messages displayed on the monitor during the Power On Self Test if the BIOS encounters some kind of problem while starting the PC. A POST error message will only display on screen if the computer is capable of booting this far. If the POST detects an error before this point, a beep code is generated instead. Default is disabled.</li><li>• Press the ESC key for Startup Menu (Enable/Disable). This feature controls the display of the text “Press the ESC key for Startup Menu” during POST. This text does not display on Windows 8 systems with Fast Boot support. Other text also will not display (for example, Ownership Tag). Default is enabled.</li><li>• Option ROM Prompt (enable/disable). Enabling this feature will cause the system to display a message before loading option ROMs. Default is enabled.</li><li>• After Power Loss (off/on/previous state). Default is Power off. Setting this option to:<ul style="list-style-type: none"><li>◦ Power off—causes the computer to remain powered off when power is restored.</li><li>◦ Power on—causes the computer to power on automatically as soon as power is restored.</li><li>◦ Previous state—causes the computer to power on automatically as soon as power is restored, if it was on when power was lost.</li></ul></li></ul> <p><b>NOTE:</b> If you turn off power to the computer using the switch on a power strip, you will not be able to use the suspend/sleep feature or the Remote Management features.</p> <ul style="list-style-type: none"><li>• POST Delay (in seconds). Enabling this feature will add a user-specified delay to the POST process. This delay is sometimes needed for hard disks on some PCI cards that spin up very slowly, so slowly that they are not ready to boot by the time POST is finished. The POST delay also gives you more time to select <b>F10</b> to enter Computer (F10) Setup. Default is None.</li><li>• Remote Wakeup Boot Source (remote server/local hard drive). Default is Local hard drive.</li><li>• Factory Recovery Boot Support (Enable/Disable). Provides the ability for the BIOS to redirect the boot to the recovery partition on the user hard drive, if present. Some versions of the recovery software honor the <b>F11</b> key press even when this feature is disabled by the BIOS. Default is disabled.</li><li>• Bypass F1 Prompt on Configuration Changes (Enable/Disable). Allows you to set the computer not to confirm when changes were made. Default is disabled.</li></ul>
<b>BIOS Power-On</b>	<p>Allows you to set the computer to turn on automatically at a time you specify.</p>



**Table 3-6 Computer Setup—Advanced (for advanced users) (continued)**

<b>Onboard Devices</b>	<p>Allows you to set resources for or disable Legacy devices.</p> <p>Select the Legacy device's IRQ, DMA, and I/O Range. The settings may not take effect for all operating systems. To hide a device from the operating system, see Security &gt; Device Security.</p>
<b>Bus Options</b>	<p>Allows you to enable or disable:</p> <ul style="list-style-type: none"><li>• PCI SERR# Generation. Default is enabled.</li><li>• PCI VGA Palette Snooping, which sets the VGA palette snooping bit in PCI configuration space; only needed when more than one graphics controller is installed. Default is disabled.</li></ul>
<b>Device Options</b>	<p>Allows you to set:</p> <ul style="list-style-type: none"><li>• Printer mode (Bi-Directional, EPP + ECP, Output Only). ECP = Enhanced Capabilities Port, EPP = Enhanced Parallel Port. Default is EPP+ECP.</li><li>• Num Lock State at Power-On (off/on). Default is off.</li><li>• Integrated Video (enable/disable). Use this option to disable the integrated video controller when another video controller is present in the system. Default is enabled.</li><li>• Integrated Graphics (Auto/Disable/Force) Use this option to manage integrated (UMA) graphics memory allocation. The value you choose is allocated permanently to graphics and is unavailable to the operating system. For example, if you set this value to 512M on a system with 2 GB of RAM, the system always allocates 512 MB for graphics and the other 1.5 GB for use by the BIOS and operating system. Default is Auto which sets memory allocation to 512 MB.  If you select Force, the UMA Frame Buffer Size option displays, which lets you set the UMA memory size allocation between 32 MB and 1 GB.</li><li>• Internal Speaker (does not affect external speakers). Default is enabled.</li><li>• NIC PXE Option ROM Download (PXE, iSCSI, disabled). The BIOS contains an embedded NIC option ROM to allow the unit to boot through the network to a PXE server. This is typically used to download a corporate image to a hard drive. The NIC option ROM takes up memory space below 1MB commonly referred to as DOS Compatibility Hole (DCH) space. This space is limited. This F10 option will allow users to disable the downloading of this embedded NIC option ROM thus giving more DCH space for additional PCI cards which may need option ROM space. The default will be to have the NIC option-ROM-enabled. Default is PXE.</li><li>• SATA RAID Option ROM Download (enable/disable). The BIOS contains an embedded SATA RAID option ROM for RAID support. This can be temporarily disabled to save DCH space. Note that with the option ROM disabled, users will be unable to boot to hard drives in the system while running in RAID mode. Default is disabled.</li><li>• Multi-Processor (enable/disable). Use this option to disable multi-processor support under the OS. Default is enabled.</li><li>• Hyper threading (enable/disable). Use this option to disable processor hyper-threading.</li><li>• Turbo Mode (enable/disable). Allows you to enable and disable the Intel Turbo Mode feature, which allows one core of the system to run at a higher than standard frequency and power if other cores are idle. Default is enabled.</li></ul>

**Table 3-6 Computer Setup—Advanced (for advanced users) (continued)**

<b>VGA Configuration</b>	Displayed only if there is an add-in video card in the system. Allows you to specify which VGA controller will be the “boot” or primary VGA controller.
<b>AMT Configuration</b>	Allows you to set: <ul style="list-style-type: none"><li>• AMT (enable/disable). Allows you to enable or disable functions of the embedded Management Engine (ME) such as Active Management Technology (AMT). If set to disable, the Management Engine is set to a temporarily disabled state and will not provide functions beyond necessary system configuration. Default is enabled.</li><li>• Unconfigure AMT/ME (enable/disable). Allows you to unconfigure any provisioned management settings for AMT. The AMT settings are restored to factory defaults. This feature should be used with caution as AMT will not be able to provide any set AMT management functions once unconfigured. Default is disabled.</li><li>• Hide Unconfigure ME Confirmation Prompt (enable/disable). Allows you to set the system to not display the confirmation to unconfigure ME.</li><li>• Watchdog Timer (enable/disable). Allows you to set amount of time for a operating system and BIOS watchdog alert to be sent if the timers are not deactivated. BIOS watchdog is deactivated by BIOS and would indicate that a halt occurred during execution if the alert is sent to the management console. An operating system alert is deactivated by the operating system image and would indicate that a hang occurred during its initialization. Default is enabled.</li></ul>

## Recovering the Configuration Settings

This method of recovery requires that you first perform the **Save to Removable Media** command with the Computer Setup (F10) Utility before **Restore** is needed. (See [Computer Setup—File on page 12](#) in the Computer Setup—File table.)



**NOTE:** It is recommended that you save any modified computer configuration settings to a USB flash media device and save the device for possible future use.

To restore the configuration, insert the USB flash media device with the saved configuration and perform the **Restore from Removable Media** command with the Computer Setup (F10) Utility. (See [Computer Setup—File on page 12](#) in the Computer Setup—File table.)

# 4 Illustrated parts catalog

## Microtower (MT) chassis spare parts

### Computer major components

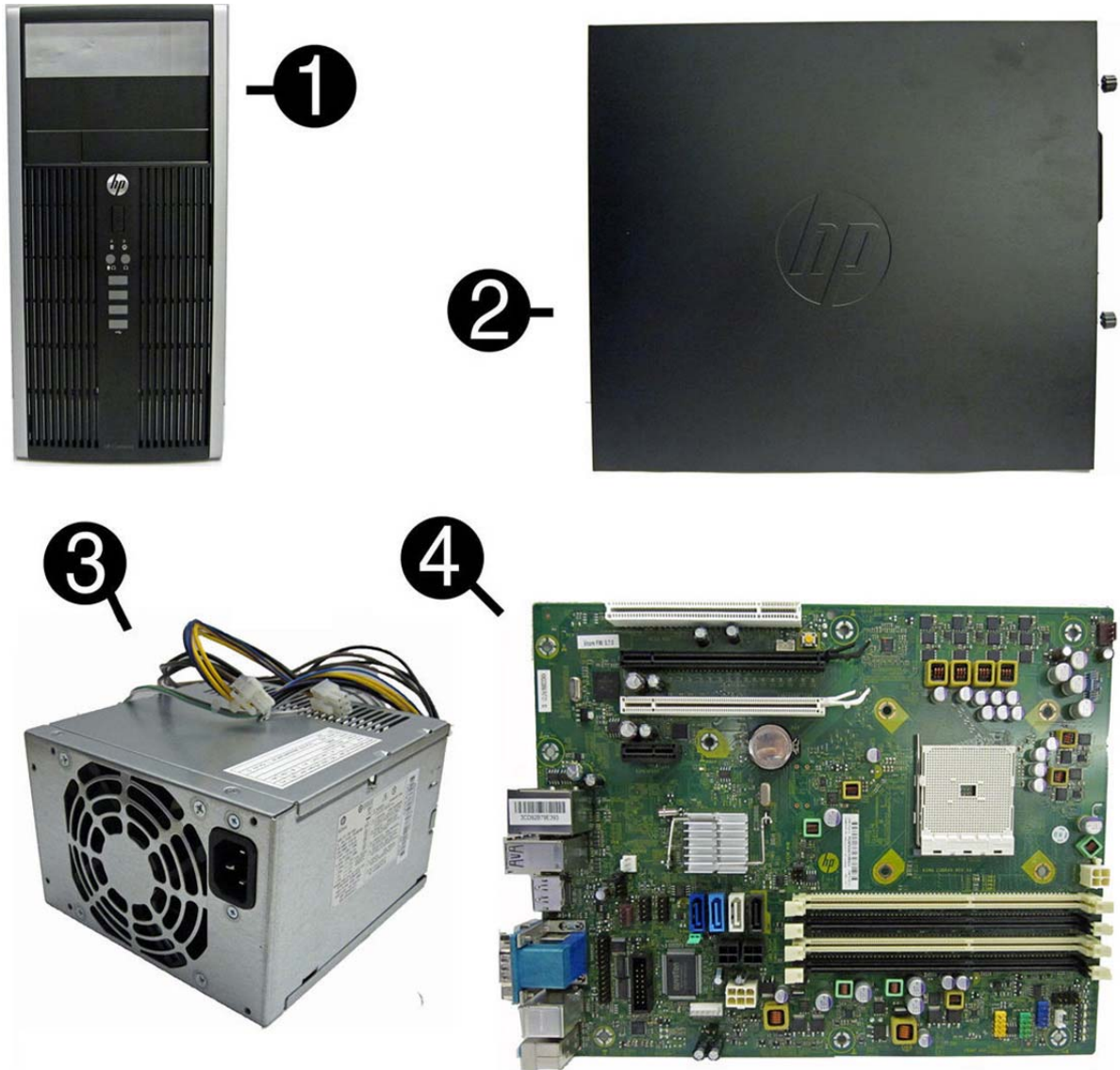

Item	Description	Spare part number
(1)	<b>Front bezel</b>	
	For use in all countries and regions except China	689377-001
	<b>5.25-inch bezel blank</b> (optical drive; not illustrated)	570838-001

<b>Item</b>	<b>Description</b>	<b>Spare part number</b>
	<b>3.5-inch bezel blank</b> (not illustrated)	583653-001
<b>(2)</b>	<b>Access panel</b>	646825-001
<b>(3)</b>	<b>Power supply</b>	
	320W, 90% efficient	613764-001
	320W, standard	613765-001
<b>(4)</b>	<b>System board</b> (includes replacement thermal material)	
	For use in Windows 7 models	703596-001
	For use in Windows 8 Standard models	703596-501
	For use in Windows 8 Professional models	703596-601
*	<b>Memory modules</b> (PC3-12800, 1600-MHz)	
	8-GB	689375-001
	4-GB	671613-001
	2-GB	671612-001
*	<b>Processors</b> (include replacement thermal material)	
	AMD A10-5800B, 3.8 GHz, 4-MB L2 cache (100-W), HD 7660D	703598-001
	AMD A8-5500B, 3.2 GHz, 4-MB L2 cache (65-W), HD 7560D	703601-001
	AMD A6-5400B, 3.6 GHz, 4-MB L2 cache (65-W), HD 7540D	703600-001
	AMD A4-5300B, 3.4 GHz, 4-MB L2 cache (65-W), HD 7480D	703599-001
	* not illustrated	

## Cables

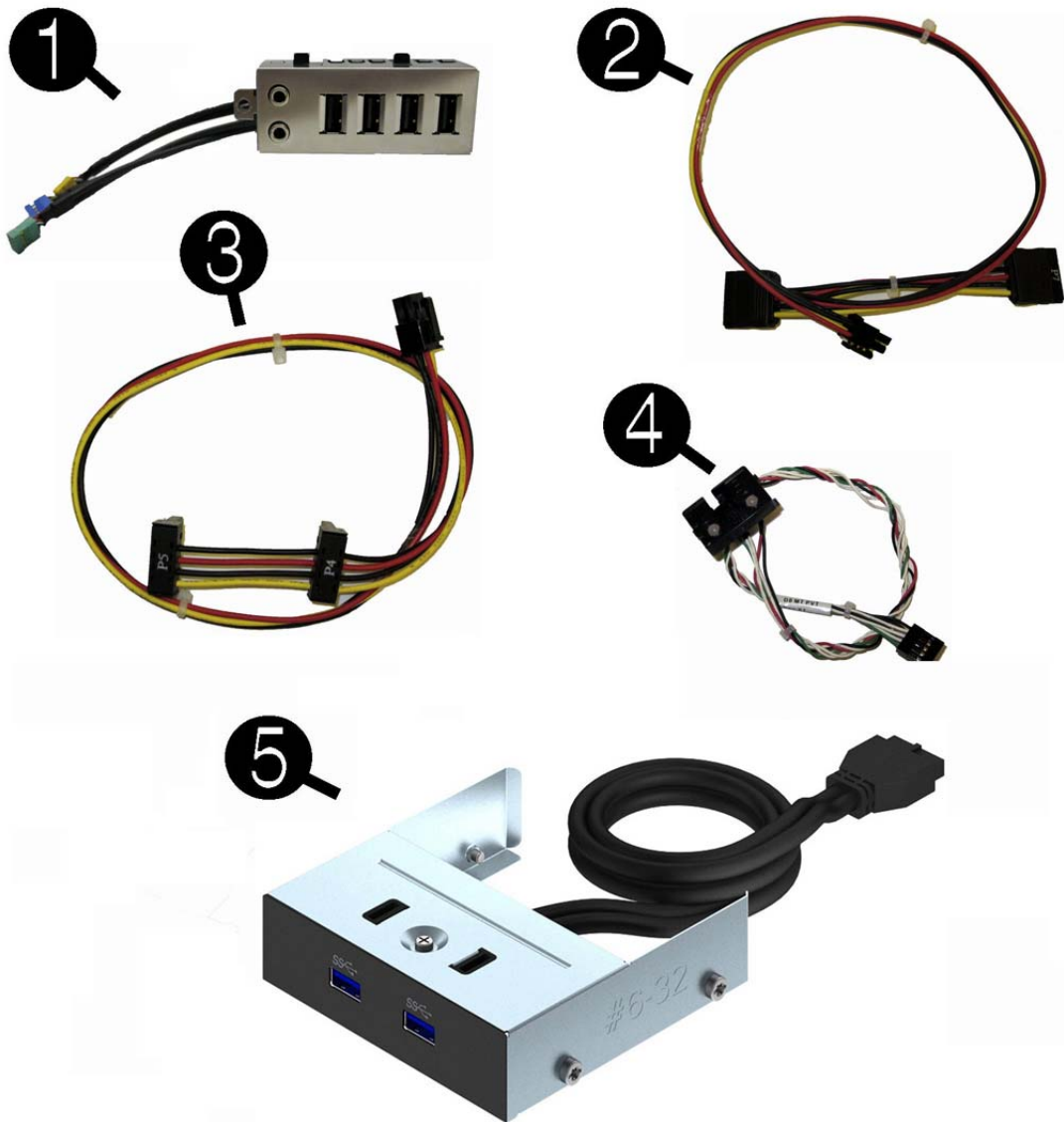

Item	Description	Spare part number
(1)	<b>Front I/O assembly</b>	646827-001
(2)	<b>SATA optical drive power cable</b>	646834-001
(3)	<b>SATA hard drive power cable</b>	646833-001
(4)	<b>Power switch/LED assembly</b>	646828-001
(5)	<b>HP USB 3.0 Front Port Adapter</b>	716391-001
	<b>SATA cable</b> , 18 inch, 1 straight end, 1 angled end (labeled; not illustrated)	646830-001
	<b>SATA cable</b> , 17.7 inch, 2 straight ends	639959-001
*	<b>DMS-59 to dual VGA cable</b>	463023-001
*	<b>Adapter, DisplayPort to VGA</b>	603250-001

Item	Description	Spare part number
*	<b>Adapter, DisplayPort to DVI</b>	662723-001
*	<b>Adapter, DVI-I to VGA</b>	202997-001
*	<b>Adapter, DVI-D to VGA</b>	657401-001
*	Adapter, USB 3.0 to USB 2.0	736835-001
*	<b>DMS-59 to dual DVI cable</b>	463024-001
*	<b>Adapter, DisplayPort to HDMI</b>	617450-001
*	<b>DisplayPort cable</b>	487562-001

\* not illustrated

## Misc parts

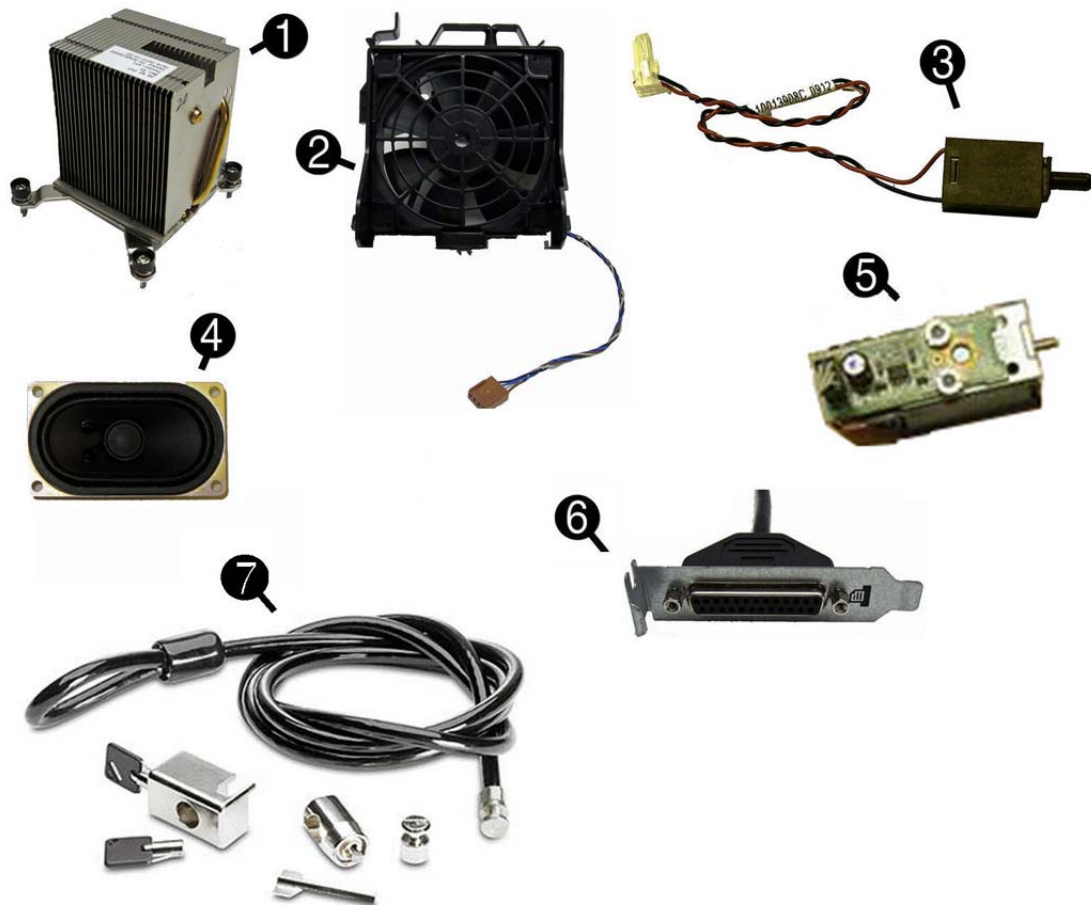

Item	Description	Spare part number
(1)	<b>Heat sink (includes replacement thermal material)</b>	645326-001
(2)	<b>Fan with guard</b>	585884-001

<b>Item</b>	<b>Description</b>	<b>Spare part number</b>
<b>(3)</b>	<b>Hood sensor</b>	638816-001
<b>(4)</b>	<b>Speaker</b>	645330-001
<b>(5)</b>	<b>Solenoid lock</b>	641498-001
<b>(6)</b>	<b>Printer port, PCI card</b>	638817-001
<b>(7)</b>	<b>Clamp lock</b> , includes universal cable (plate not included)	508987-001
*	<b>Rear chassis fan</b>	643908-001
*	<b>Fan duct assembly</b>	646824-001
*	<b>Serial port, PCI card</b>	638815-001
*	<b>2.5-in drive adapter</b>	586721-001
*	<b>Hard drive conversion bracket</b>	397117-001
*	<b>Grommet, hard drive isolation, blue</b>	450712-001
*	<b>Card reader, 22-in-1</b>	636166-001 698877-001
*	<b>Card reader, 14-in-1</b> , USB 2.0/3.0, 3.5-inch	716390-001
*	<b>USB powered speakers</b>	636917-001
*	<b>Mouse</b>	
	PS2, optical, jack black (non-ECO)	609250-001
	USB, optical, jack black	537749-001
	Washable	619580-001
	Wireless	674317-001
	Wireless (not for use in APJ region)	608150-001
	USB, laser (non-ECO)	570580-001
*	<b>eSATA port assembly, PCI card</b>	645558-001
*	<b>Antenna</b> for use with WLAN card	583345-001
*	<b>HP Business Digital Headset</b>	642738-001
*	<b>External USB Webcam</b>	609252-001
*	<b>Foot</b>	336445-001
*	<b>Keyboards</b>	
	PS/2	537745-xx1
	USB	537746-xx1
	Wireless	674314-xx1
	Washable	613125-xx1

Item	Description	Spare part number
	Smart card	631411-xx1
	Smartcard, CCID	701671-xx1
* not illustrated		

## Drives

Description	Spare part number
<b>Hard drives</b>	
1-TB hybrid hard drive (8-GB SSD)	724937-001
1-TB, 7200-rpm	636930-001
500-GB hybrid hard drive (8-GB SSD)	724938-001
500-GB, 7200-rpm	636929-001
500 GB, 7200 rpm, 2.5-inch, self-encrypting (SED)	696442-001
320-GB, 7200-rpm, 2.5-inch	634824-001
250-GB, 7200-rpm	636927-001
256-GB Solid-state Drive (SSD), self-encrypting (SED)	680020-001
160-GB Solid-state Drive (SSD)	646809-001
128-GB Solid-state Drive (SSD)	665961-001
120-GB Solid-state Drive (SSD)	661841-001
<b>Optical drives</b>	
Blu-ray BD-Writer XL Drive	682219-001
16X SATA DVD±RW drive	660408-001
	690418-001
16X SATA DVD-ROM drive	682550-001
<b>Grommet</b> , hard drive isolation, blue	450712-001

## Misc boards

Description	Spare part number
GeForce GT630 PCIe x16 graphics card, 2 GB (for use with Windows 8)	702084-001
nVidia Quadro NVS315 PCIe x16 graphics card, 1 GB (for use with Windows 8)	720837-001
nVidia Quadro NVS310 PCIe x16 graphics card, 512 MB (for use only with Windows 8)	707252-001
nVidia Quadro NVS300 PCIe x16 graphics card, 512 MB (for use with Windows 8)	700578-001



<b>Description</b>	<b>Spare part number</b>
AMD Radeon HD8490 PCIe x16 graphics card, 1 GB (for use with Windows 8)	717219-001
AMD Radeon HD8470 PCIe x16 graphics card, 2 GB (for use with Windows 8)	729085-001
AMD Radeon HD7450 PCIe x16 graphics card, 1 GB (for use with Windows 8)	702647-001
AMD Radeon HD7450 PCIe x16 graphics card, 1 GB (for use only in China)	702646-001
AMD Radeon HD7450 PCIe x16 graphics card, 1 GB (includes adapter; not for use with Windows 8)	682411-001
AMD Radeon HD6350 PCIe x16 graphics card, 512 MB (for use with Windows 8)	697246-001
AMD Radeon HD6350 PCIe x16 graphics card, 512 MB (not for use with Windows 8)	637995-001
HP WLAN 802.11 g/n 1x2 PCIe NIC	538048-001
Intel PRO/1000, single port, GbE, NIC	728562-001
Intel Centrino Advanced-N 6205, 802.11a/b/g/n WLAN module	695915-001
HP USB 3.0 SuperSpeed PCIe x1 card	663213-001
HP USB 3.0 SuperSpeed power extension cable (for use with 663213-001)	663214-001

## Sequential part number listing

<b>Spare part number</b>	<b>Description</b>
202997-001	Adapter, DVI-I to VGA
336445-001	Feet
397117-001	Hard drive conversion bracket
450712-001	Grommet, hard drive isolation, blue
463023-001	DMS-59 to dual VGA cable
463024-001	DMS-59 to dual VGA DVI
487562-001	DisplayPort cable
508987-001	Clamp lock, includes universal cable (plate not included)
537745-xx1	PS/2 basic keyboard
537746-xx1	USB basic keyboard
537749-001	Mouse, USB, optical, jack black
538048-001	HP WLAN 802.11b/g/n card
570580-001	Mouse, USB, laser (non-ECO)
570838-001	Bezel blank, optical drive, 5.25-inch
682550-001	16X SATA DVD-ROM drive

<b>Spare part number</b>	<b>Description</b>
583345-001	Antenna for use with 538048-001
583653-001	Bezel blank, 3.5-inch
585884-001	Chassis fan with guard
586721-001	2.5-in drive adapter
603250-001	Adapter, DisplayPort to VGA
608150-001	Mouse, wireless (not for use in APJ region)
609250-001	Mouse, PS2, optical, jack black (non-ECO)
609252-001	External USB webcam
613125-xx1	Washable keyboard
613764-001	320W, 90% efficient
613765-001	320W, standard
617450-001	Adapter, DisplayPort to HDMI
619580-001	Mouse, washable
631411-xx4	Smart card keyboard
634824-001	320-GB, 7200-rpm hard drive, 2.5 inch, SED
636166-001	Card reader, 22-in-1
636917-001	USB powered speakers
636927-001	250-GB, 7200-rpm hard drive
636929-001	500-GB, 7200-rpm hard drive
636930-001	1-TB, 7200-rpm hard drive
637995-001	AMD Radeon HD6350 PCIe x16 graphics card, 512 MB (not for use with Windows 8)
638815-001	Serial port PCI card
638816-001	Hood sensor
638817-001	Printer port, PCI card
639959-001	SATA cable, 17.7 inch, 2 straight ends
641498-001	Solenoid lock
642738-001	HP Business Digital Headset
643908-001	Chassis fan
645326-001	Heat sink (includes replacement thermal material)
645330-001	Speaker
645558-001	eSATA port assembly, PCI card
646809-001	160-GB Solid-state drive

<b>Spare part number</b>	<b>Description</b>
646824-001	Fan duct assembly
646825-001	Access panel
646827-001	Front I/O assembly
646828-001	Power switch/LED with holder
646830-001	SATA cable, 18 inch, 1 straight end, 1 angled end
646833-001	Hard drive power cable
646834-001	Optical drive power cable
657401-001	Adapter, DVI-D to VGA
660408-001	DVD±RW drive
661841-001	120-GB Solid-state drive, SATA 2.0
662723-001	Adapter, DisplayPort to DVI
663213-001	HP USB 3.0 SuperSpeed PCIe x1 card
663214-001	HP USB 3.0 SuperSpeed power extension cable (for use with 663213-001)
665961-001	128-GB Solid-state drive, SATA 2.0
671612-001	Memory module, 2-GB, PC3 12800, CL11)
671613-001	Memory module, 4-GB, PC3 10600, 1333-MH
674314-xx1	Keyboard, wireless
674317-001	Mouse, wireless
680020-001	256-GB Solid-state drive, self-encrypting (SED), SATA 6.0
682219-001	Blu-ray BD-Writer XL Drive
682411-001	AMD Radeon HD7450 PCIe x16 graphics card, 1 GB (includes adapter; not for use with Windows 8)
689375-001	Memory module, 8-GB, PC3 12800, CL11
689377-001	Front bezel
690418-001	16X SATA DVD±RW drive
695915-001	Intel Centrino Advanced-N 6205, 802.11a/b/g/n WLAN module
696442-001	500-GB hard drive, 7200-rpm, 2.5-inch, SED
697246-001	AMD Radeon HD6350 PCIe x16 graphics card, 512 MB (for use only with Windows 8)
698877-001	USB powered speakers
700578-001	nVidia Quadro NVS300 PCIe x16 graphics card, 512 MB (for use only with Windows 8)
701671-xx1	Keyboard, USB, Smartcard, CCID
702084-001	GeForce GT630 PCIe x16 graphics card, 2 GB (for use only with Windows 8)
702646-001	AMD Radeon HD7450 PCIe x16 graphics card, 1 GB (for use only in China)

<b>Spare part number</b>	<b>Description</b>
702647-001	AMD Radeon HD7450 PCIe x16 graphics card, 1 GB (for use only with Windows 8)
703596-001	System board for use in Windows 7 models (includes replacement thermal material)
703596-501	System board for use in Windows 8 Standard models (includes replacement thermal material)
703596-601	System board for use in Windows 8 Professional models (includes replacement thermal material)
703598-001	AMD A10-5800B, 3.8 GHz processor , 4-MB L2 cache (100-W), HD 7660D
703599-001	AMD A4-5300B processor, 3.4 GHz, 4-MB L2 cache (65-W), HD 7480D
703600-001	AMD A6-5400B, 3.6 GHz processor, 4-MB L2 cache (65-W), HD 7540D
703601-001	AMD A8-5500B, 3.2 GHz processor , 4-MB L2 cache (65-W), HD 7560D
707252-001	nVidia Quadro NVS310 PCIe x16 graphics card, 512 MB (for use only with Windows 8)
716390-001	Card reader, 14-in-1, USB2.0/3.0, 3.5-inch
716391-001	HP USB 3.0 Front Port Adapter
717219-001	AMD Radeon HD8490 PCIe x16 graphics card, 1 GB (for use with Windows 8)
720837-001	nVidia Quadro NVS315 PCIe x16 graphics card, 1 GB (for use with Windows 8)
724937-001	1 TB hybrid hard drive (8-GB SSD)
724938-001	500 GB hybrid hard drive (8-GB SSD)
728562-001	Intel PRO/1000, single port, GbE, NIC
729085-001	AMD Radeon HD8470 PCIe x16 graphics card, 2 GB (for use with Windows 8)
736835-001	Adapter, USB 3.0 to USB 2.0

# Small Form Factor (SFF) chassis spare parts

## Computer major components



1

2



4

3

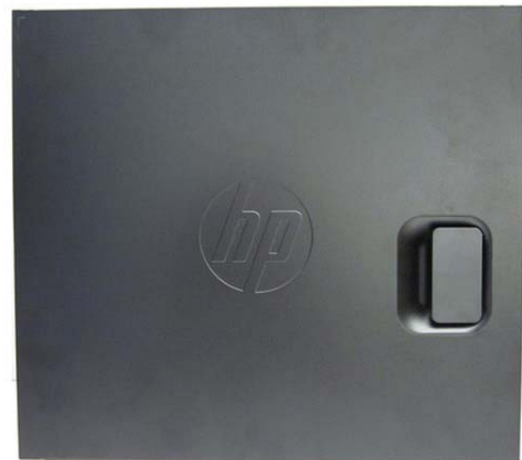

Item	Description	Spare part number
(1)	<b>Front bezel</b>	687950-001
	<b>Bezel blank</b> (optical drive; not illustrated)	570838-001
	<b>Bezel blank</b> (card reader; not illustrated)	583653-001
(2)	<b>Power supply</b>	
	240W, 90% efficient	613762-001
	240W, standard	613763-001
(3)	<b>System board</b> (includes replacement thermal material)	
	For use in Windows 7 models	703596-001
	For use in Windows 8 Standard models	703596-501
	For use in Windows 8 Professional models	703596-601
(4)	<b>Access panel</b>	646815-001

<b>Item</b>	<b>Description</b>	<b>Spare part number</b>
*	<b>Memory modules</b> (PC3-12800, 1600-MHz)	
	8-GB	689375-001
	4-GB	671613-001
	2-GB	671612-001
*	<b>Processors</b> (include replacement thermal material)	
	AMD A10-5800B, 3.8 GHz, 4-MB L2 cache (100-W), HD 7660D	703598-001
	AMD A8-5500B, 3.2 GHz, 4-MB L2 cache (65-W), HD 7560D	703601-001
	AMD A6-5400B, 3.6 GHz, 4-MB L2 cache (65-W), HD 7540D	703600-001
	AMD A4-5300B, 3.4 GHz, 4-MB L2 cache (65-W), HD 7480D	703599-001
* not illustrated		

## Cables



Item	Description	Spare part number
(1)	<b>Front I/O and power switch assembly</b>	636926-001
(2)	<b>HP USB 3.0 Front Port Adapter</b>	716391-001
(3)	<b>SATA drive power cable</b>	636923-001
*	<b>SATA cable</b> , 19.5 inch, 2 straight ends	638813-001
*	<b>SATA cable</b> , 25.2 inch, 1 straight end, 1 angled end (not illustrated)	638814-001
*	<b>DMS-59 to dual VGA cable</b>	463023-001
*	<b>DMS-59 to dual DVI cable</b>	463024-001
*	<b>Adapter, DisplayPort to VGA</b>	603250-001
*	<b>Adapter, DisplayPort to DVI</b>	662723-001
*	<b>Adapter, DVI-I to VGA</b>	202997-001
*	<b>Adapter, DVI-D to VGA</b>	657401-001
*	Adapter, USB 3.0 to USB 2.0	736835-001
*	<b>Adapter, DisplayPort to HDMI</b>	617450-001

Item	Description	Spare part number
*	<b>DisplayPort cable</b>	487562-001
* not illustrated		

## Misc parts

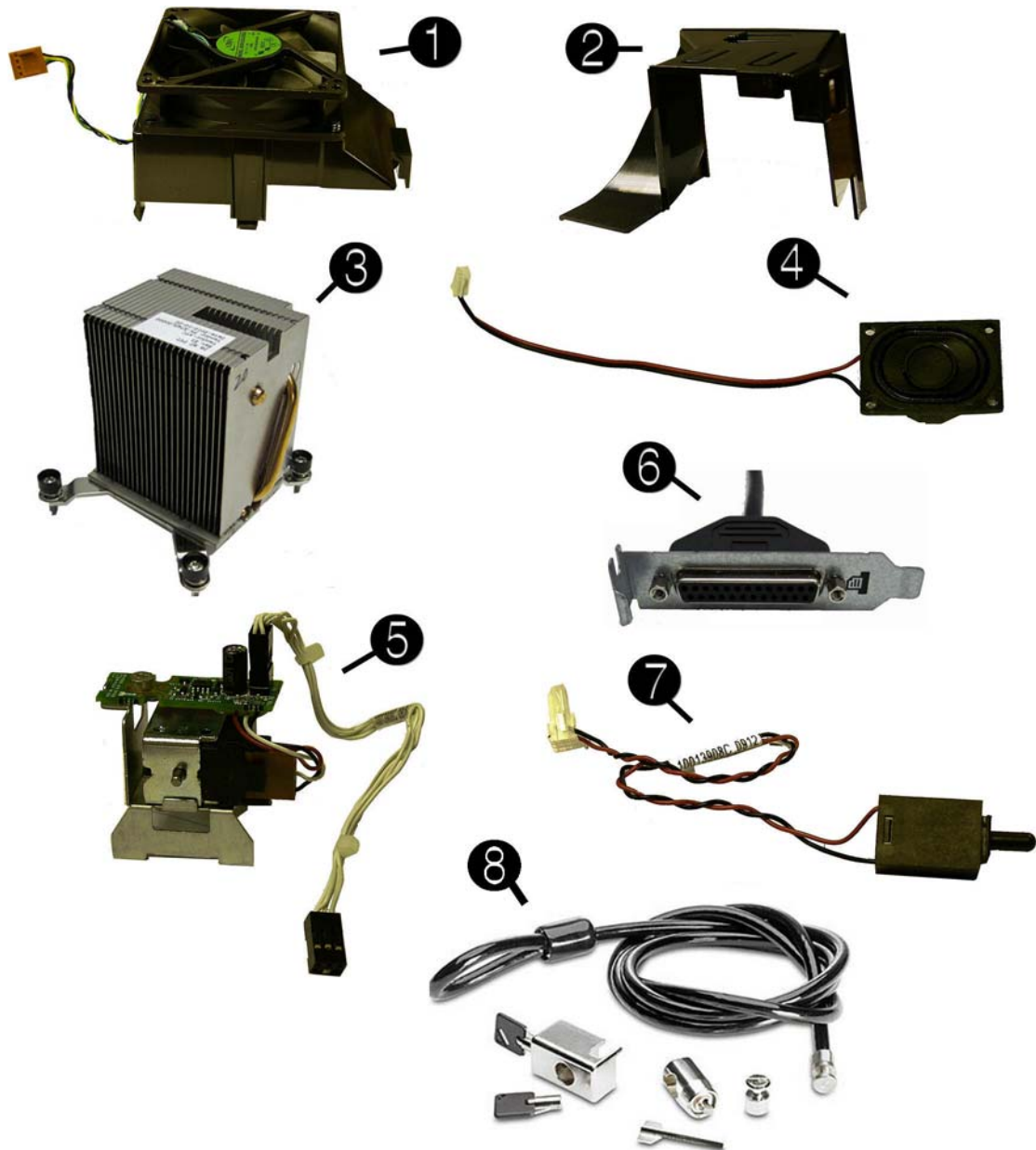

Item	Description	Spare part number
(1)	<b>Chassis fan</b>	645327-001
(2)	<b>Fan duct</b> (not illustrated)	636921-001



<b>Item</b>	<b>Description</b>	<b>Spare part number</b>
<b>(3)</b>	<b>Heat sink (includes replacement thermal material)</b>	645326-001
<b>(4)</b>	<b>Speaker</b>	636925-001
<b>(5)</b>	<b>Solenoid lock</b>	641471-001
<b>(6)</b>	<b>Printer port, PCI card</b>	638817-001
<b>(7)</b>	<b>Hood sensor</b>	638816-001
<b>(8)</b>	<b>Clamp lock</b> , includes universal cable (plate not included)	508987-001
*	<b>Rubber feet</b>	583654-001
*	<b>Chassis stand</b>	688952-001
*	<b>Serial port, PCI card</b> (not illustrated)	638815-001
*	<b>2.5-in drive adapter</b> (not illustrated)	586721-001
*	<b>Hard drive conversion bracket</b>	397117-001
*	<b>Grommet, hard drive isolation, blue</b> (not illustrated)	450712-001
*	<b>Card reader, 22-in-1</b> (not illustrated)	636166-001
*	Card reader, 14-in-1, USB 2.0/3.0, 3.5-inch	716390-001
*	<b>USB powered speakers</b> (not illustrated)	636917-001 698877-001
*	<b>Mouse</b> (not illustrated)	
	USB, optical, jack black	537749-001
	Washable	619580-001
	Wireless	674317-001
	Wireless (not for use in APJ region)	608150-001
	USB, laser (non-ECO)	570580-001
	PS2, optical, jack black (non-ECO)	609250-001
*	<b>eSATA port assembly, PCI card</b> (not illustrated)	645558-001
*	<b>Antenna</b> for use with 538048-001 (not illustrated)	583345-001
*	<b>HP Business Digital Headset</b> (not illustrated)	642738-001
*	<b>External USB webcam</b> (not illustrated)	609252-001
*	<b>Keyboard</b> (not illustrated)	
	PS/2	537745-xx1
	USB	537746-xx1
	USB, mini	674314-xx1
	Washable	613125-xx1

Item	Description	Spare part number
	Smart card	631411-xx1
	Smartcard, CCID	701671-xx1
* not illustrated		

## Drives

Description	Spare part number
<b>Hard drive</b>	
1-TB hybrid hard drive (8-GB SSD)	724937-001
1-TB, 7200-rpm	636930-001
500-GB hybrid hard drive (8-GB SSD)	724938-001
500-GB, 7200-rpm, 2.5-inch, SED	696442-001
500-GB, 7200-rpm	636929-001
320-GB, 7200-rpm, 2.5-inch	634824-001
250-GB, 7200-rpm	636927-001
256-GB Solid-state Drive (SSD), self-encrypting (SED)	680020-001
160-GB Solid-state Drive (SSD)	646809-001
128-GB Solid-state Drive (SSD)	665961-001
120-GB Solid-state Drive (SSD)	661841-001
<b>Optical drive</b>	
Blu-ray BD-Writer XL Drive	682219-001
16X SATA DVD±RW drive	660408-001
	690418-001
16X SATA DVD-ROM drive	682550-001
<b>Grommet</b> , hard drive isolation, blue	450712-001

## Misc boards

Description	Spare part number
GeForce GT630 PCIe x16 graphics card, 2 GB (for use with Windows 8)	702084-001
nVidia Quadro NVS315 PCIe x16 graphics card, 1 GB (for use with Windows 8)	720837-001
nVidia Quadro NVS310 PCIe x16 graphics card, 512 MB (for use only with Windows 8)	707252-001
nVidia Quadro NVS300 PCIe x16 graphics card, 512 MB (for use with Windows 8)	700578-001

<b>Description</b>	<b>Spare part number</b>
AMD Radeon HD8490 PCIe x16 graphics card, 1 GB (for use with Windows 8)	717219-001
AMD Radeon HD7450 PCIe x16 graphics card, 1 GB (for use only in China)	702646-001
AMD Radeon HD7450 PCIe x16 graphics card, 1 GB (for use with Windows 8)	705647-001
AMD Radeon HD7450 PCIe x16 graphics card, 1 GB (includes adapter; not for use with Windows 8)	682411-001
AMD Radeon HD6350 PCIe x16 graphics card, 512 MB (for use with Windows 8)	697246-001
AMD Radeon HD6350 PCIe x16 graphics card, 512 MB (not for use with Windows 8)	637995-001
Intel Centrino Advanced-N 6205, 802.11a/b/g/n WLAN module	695915-001
HP WLAN 802.11 g/n 1x2 PCIe NIC	538048-001
Intel PRO/1000, single port, GbE, NIC	728562-001
HP USB 3.0 SuperSpeed PCIe x1 card	663213-001
HP USB 3.0 SuperSpeed power extension cable (for use with 663213-001)	663214-001

## Sequential part number listing

<b>Spare part number</b>	<b>Description</b>
202997-001	Adapter, DVI-I to VGA
397117-001	Hard drive conversion bracket
450712-001	Grommet, hard drive isolation, blue
463023-001	DMS-59 to dual VGA cable
463024-001	DMS-59 to dual DVI cable
487562-001	DisplayPort cable
508987-001	Clamp lock, includes universal cable (plate not included)
537745-xx1	PS/2 basic keyboard
537746-xx1	USB basic keyboard
537749-001	Mouse, USB, optical, jack black
538048-001	HP WLAN 802.11b/g/n card
570580-001	Mouse, USB, laser (non-ECO)
570838-001	Bezel blank, optical drive, 5.25-inch
682550-001	DVD-ROM drive
583345-001	Antenna for use with 538048-001
583653-001	Bezel blank, 3.5-inch

<b>Spare part number</b>	<b>Description</b>
583654-001	Rubber foot
586721-001	Drive adapter, 2.5-inch
688952-001	Chassis stand
608150-001	Mouse, wireless (not for use in APJ region)
609250-001	Mouse, PS2, optical, jack black (non-ECO)
609252-001	External USB webcam
613125-xx1	Washable keyboard
613762-001	320W, 90% efficient
613763-001	320W, standard
617450-001	Adapter, DisplayPort to HDMI
619580-001	Mouse, washable
631411-xx4	Smart card keyboard
603250-001	Adapter, DisplayPort to VGA
634824-001	320-GB, 7200-rpm hard drive, 2.5 inch, SED
636166-001	Card reader, 22-in-1
636917-001	USB powered speakers
636921-001	Fan duct
636923-001	SATA power cable
636925-001	Speaker
636926-001	Front I/O cable and power switch assembly
636927-001	250-GB, 7200-rpm hard drive
636929-001	500-GB, 7200-rpm hard drive
636930-001	1-TB, 7200-rpm hard drive
637995-001	AMD Radeon HD6350 PCIe x16 graphics card, 512 MB (not for use with Windows 8)
638813-001	SATA cable, 19.5 inch, 2 straight ends
638814-001	SATA cable, 25.2 inch, 1 straight end, 1 angled end
638815-001	Serial port PCI card
638816-001	Hood sensor
638817-001	Printer port, PCI card
641471-001	Solenoid lock
642738-001	HP Business Digital Headset
645326-001	Heat sink

<b>Spare part number</b>	<b>Description</b>
645327-001	Chassis fan
645558-001	eSATA port assembly, PCI card
646809-001	160-GB Solid-state drive
646815-001	Access panel
657401-001	Adapter, DVI-D to VGA
660408-001	16X SATA DVD±RW drive
661841-001	120-GB Solid-state drive, SATA 2.0
662723-001	Adapter, DisplayPort to DVI
665961-001	128-GB Solid-state drive, SATA 2.0
671612-001	Memory module, 2-GB, PC3 12800, CL11)
671613-001	Memory module, 4-GB, PC3 10600, 1333-MH
674314-xx1	Keyboard, wireless
674317-001	Mouse, wireless
680020-001	256-GB Solid-state drive, self-encrypting (SED), SATA 6.0
682219-001	Blu-ray BD-Writer XL Drive
682411-001	AMD Radeon HD7450 PCIe x16 graphics card, 1 GB (includes adapter; not for use with Windows 8)
687950-001	Front bezel
689375-001	Memory module, 8-GB, PC3 12800, CL11
690418-001	16X SATA DVD±RW drive
695915-001	Intel Centrino Advanced-N 6205, 802.11a/b/g/n WLAN module
696422-001	500-GB hard drive, 7200-rpm, 2.5-inch, SED
697246-001	AMD Radeon HD6350 PCIe x16 graphics card, 512 MB (for use only with Windows 8)
698877-001	USB powered speakers
700578-001	nVidia Quadro NVS300 PCIe x16 graphics card, 512 MB (for use only with Windows 8)
701671-xx1	Keyboard, USB, Smartcard, CCID
702084-001	GeForce GT630 PCIe x16 graphics card, 2 GB (for use only with Windows 8)
702647-001	AMD Radeon HD7450 PCIe x16 graphics card, 1 GB (for use only with Windows 8)
703598-001	AMD A10-5800B processor, 3.8 GHz, 4-MB L2 cache (100-W), HD 7660D
703599-001	AMD A4-5300B processor, 3.4 GHz, 4-MB L2 cache (65-W), HD 7480D
703600-001	AMD A6-5400B processor, 3.6 GHz, 4-MB L2 cache (65-W), HD 7540D
703601-001	AMD A8-5500B processor, 3.2 GHz, 4-MB L2 cache (65-W), HD 7560D
707252-001	nVidia Quadro NVS310 PCIe x16 graphics card, 512 MB (for use only with Windows 8)

<b>Spare part number</b>	<b>Description</b>
703596-001	System board for use in Windows 7 models (includes replacement thermal material)
703596-501	System board for use in Windows 8 Standard models
703596-601	System board for use in Windows 8 Professional models
716390-001	Card reader, 14-in-1, USB 2.0/3.0, 3.5-inch
716391-001	HP USB 3.0 Front Port Adapter
717219-001	AMD Radeon HD8490 PCIe x16 graphics card, 1 GB (for use with Windows 8)
720837-001	nVidia Quadro NVS315 PCIe x16 graphics card, 1 GB (for use with Windows 8)
724937-001	1 TB hybrid hard drive (8-GB SSD)
724938-001	500 GB hybrid hard drive (8-GB SSD)
728562-001	Intel PRO/1000, single port, GbE, NIC
736835-001	Adapter, USB 3.0 to USB 2.0

---

# 5 Routine Care, SATA Drive Guidelines, and Disassembly Preparation

This chapter provides general service information for the computer. Adherence to the procedures and precautions described in this chapter is essential for proper service.

**⚠ CAUTION:** When the computer is plugged into an AC power source, voltage is always applied to the system board. You must disconnect the power cord from the power source before opening the computer to prevent system board or component damage.

---

## Electrostatic Discharge Information

A sudden discharge of static electricity from your finger or other conductor can destroy static-sensitive devices or microcircuitry. Often the spark is neither felt nor heard, but damage occurs. An electronic device exposed to electrostatic discharge (ESD) may not appear to be affected at all and can work perfectly throughout a normal cycle. The device may function normally for a while, but it has been degraded in the internal layers, reducing its life expectancy.

Networks built into many integrated circuits provide some protection, but in many cases, the discharge contains enough power to alter device parameters or melt silicon junctions.

## Generating Static

The following table shows that:

- Different activities generate different amounts of static electricity.
- Static electricity increases as humidity decreases.

Event	Relative Humidity		
	55%	40%	10%
Walking across carpet	7,500 V	15,000 V	35,000 V
Walking across vinyl floor	3,000 V	5,000 V	12,000 V
Motions of bench worker	400 V	800 V	6,000 V
Removing DIPs from plastic tube	400 V	700 V	2,000 V

Removing DIPs from vinyl tray	2,000 V	4,000 V	11,500 V
Removing DIPs from Styrofoam	3,500 V	5,000 V	14,500 V
Removing bubble pack from PCB	7,000 V	20,000 V	26,500 V
Packing PCBs in foam-lined box	5,000 V	11,000 V	21,000 V

These are then multi-packaged inside plastic tubes, trays, or Styrofoam.

 **NOTE:** 700 volts can degrade a product.

## Preventing Electrostatic Damage to Equipment

Many electronic components are sensitive to ESD. Circuitry design and structure determine the degree of sensitivity. The following packaging and grounding precautions are necessary to prevent damage to electric components and accessories.

- To avoid hand contact, transport products in static-safe containers such as tubes, bags, or boxes.
- Protect all electrostatic parts and assemblies with conductive or approved containers or packaging.
- Keep electrostatic sensitive parts in their containers until they arrive at static-free stations.
- Place items on a grounded surface before removing them from their container.
- Always be properly grounded when touching a sensitive component or assembly.
- Avoid contact with pins, leads, or circuitry.
- Place reusable electrostatic-sensitive parts from assemblies in protective packaging or conductive foam.

## Personal Grounding Methods and Equipment

Use the following equipment to prevent static electricity damage to equipment:

- **Wrist straps** are flexible straps with a maximum of one-megohm  $\pm$  10% resistance in the ground cords. To provide proper ground, a strap must be worn snug against bare skin. The ground cord must be connected and fit snugly into the banana plug connector on the grounding mat or workstation.
- **Heel straps/Toe straps/Boot straps** can be used at standing workstations and are compatible with most types of shoes or boots. On conductive floors or dissipative floor mats, use them on both feet with a maximum of one-megohm  $\pm$  10% resistance between the operator and ground.

---

### Static Shielding Protection Levels

---



<b>Method</b>	<b>Voltage</b>
Antistatic plastic	1,500
Carbon-loaded plastic	7,500
Metallized laminate	15,000

## Grounding the Work Area

To prevent static damage at the work area, use the following precautions:

- Cover the work surface with approved static-dissipative material. Provide a wrist strap connected to the work surface and properly grounded tools and equipment.
- Use static-dissipative mats, foot straps, or air ionizers to give added protection.
- Handle electrostatic sensitive components, parts, and assemblies by the case or PCB laminate. Handle them only at static-free work areas.
- Turn off power and input signals before inserting and removing connectors or test equipment.
- Use fixtures made of static-safe materials when fixtures must directly contact dissipative surfaces.
- Keep work area free of nonconductive materials such as ordinary plastic assembly aids and Styrofoam.
- Use field service tools, such as cutters, screwdrivers, and vacuums, that are conductive.

## Recommended Materials and Equipment

Materials and equipment that are recommended for use in preventing static electricity include:

- Antistatic tape
- Antistatic smocks, aprons, or sleeve protectors
- Conductive bins and other assembly or soldering aids
- Conductive foam
- Conductive tabletop workstations with ground cord of one-megohm +/- 10% resistance
- Static-dissipative table or floor mats with hard tie to ground
- Field service kits
- Static awareness labels
- Wrist straps and footwear straps providing one-megohm +/- 10% resistance
- Material handling packages
- Conductive plastic bags
- Conductive plastic tubes
- Conductive tote boxes
- Opaque shielding bags

- Transparent metallized shielding bags
- Transparent shielding tubes

## Operating Guidelines

To prevent overheating and to help prolong the life of the computer:

- Keep the computer away from excessive moisture, direct sunlight, and extremes of heat and cold.
- Operate the computer on a sturdy, level surface. Leave a 10.2-cm (4-inch) clearance on all vented sides of the computer and above the monitor to permit the required airflow.
- Never restrict the airflow into the computer by blocking any vents or air intakes. Do not place the keyboard, with the keyboard feet down, directly against the front of the desktop unit as this also restricts airflow.
- Occasionally clean the air vents on all vented sides of the computer. Lint, dust, and other foreign matter can block the vents and limit the airflow. Be sure to unplug the computer before cleaning the air vents.
- Never operate the computer with the cover or side panel removed.
- Do not stack computers on top of each other or place computers so near each other that they are subject to each other's re-circulated or preheated air.
- If the computer is to be operated within a separate enclosure, intake and exhaust ventilation must be provided on the enclosure, and the same operating guidelines listed above will still apply.
- Keep liquids away from the computer and keyboard.
- Never cover the ventilation slots on the monitor with any type of material.
- Install or enable power management functions of the operating system or other software, including sleep states.

## Routine Care

### General Cleaning Safety Precautions

1. Never use solvents or flammable solutions to clean the computer.
2. Never immerse any parts in water or cleaning solutions; apply any liquids to a clean cloth and then use the cloth on the component.
3. Always unplug the computer when cleaning with liquids or damp cloths.
4. Always unplug the computer before cleaning the keyboard, mouse, or air vents.
5. Disconnect the keyboard before cleaning it.
6. Wear safety glasses equipped with side shields when cleaning the keyboard.

## Cleaning the Computer Case

Follow all safety precautions in [General Cleaning Safety Precautions on page 48](#) before cleaning the computer.

To clean the computer case, follow the procedures described below:

- To remove light stains or dirt, use plain water with a clean, lint-free cloth or swab.
- For stronger stains, use a mild dishwashing liquid diluted with water. Rinse well by wiping it with a cloth or swab dampened with clear water.
- For stubborn stains, use isopropyl (rubbing) alcohol. No rinsing is needed as the alcohol will evaporate quickly and not leave a residue.
- After cleaning, always wipe the unit with a clean, lint-free cloth.
- Occasionally clean the air vents on the computer. Lint and other foreign matter can block the vents and limit the airflow.

## Cleaning the Keyboard

Follow all safety precautions in [General Cleaning Safety Precautions on page 48](#) before cleaning the keyboard.

To clean the tops of the keys or the keyboard body, follow the procedures described in [Cleaning the Computer Case on page 49](#).

When cleaning debris from under the keys, review all rules in [General Cleaning Safety Precautions on page 48](#) before following these procedures:

---

**⚠ CAUTION:** Use safety glasses equipped with side shields before attempting to clean debris from under the keys.

---

- Visible debris underneath or between the keys may be removed by vacuuming or shaking.
- Canned, pressurized air may be used to clean debris from under the keys. Caution should be used as too much air pressure can dislodge lubricants applied under the wide keys.
- If you remove a key, use a specially designed key puller to prevent damage to the keys. This tool is available through many electronic supply outlets.

---

**⚠ CAUTION:** Never remove a wide leveled key (like the space bar) from the keyboard. If these keys are improperly removed or installed, the keyboard may not function properly.

---

- Cleaning under a key may be done with a swab moistened with isopropyl alcohol and squeezed out. Be careful not to wipe away lubricants necessary for proper key functions. Use tweezers to remove any fibers or dirt in confined areas. Allow the parts to air dry before reassembly.

## Cleaning the Monitor

- Wipe the monitor screen with a clean cloth moistened with water or with a towelette designed for cleaning monitors. Do not use sprays or aerosols directly on the screen; the liquid may seep into the housing and damage a component. Never use solvents or flammable liquids on the monitor.
- To clean the monitor body follow the procedures in [Cleaning the Computer Case on page 49](#).

## Cleaning the Mouse

Before cleaning the mouse, ensure that the power to the computer is turned off.

- Clean the mouse ball by first removing the retaining plate and the ball from the housing. Pull out any debris from the ball socket and wipe the ball with a clean, dry cloth before reassembly.
- To clean the mouse body, follow the procedures in [Cleaning the Computer Case on page 49](#).

## Service Considerations

Listed below are some of the considerations that you should keep in mind during the disassembly and assembly of the computer.

### Power Supply Fan

The power supply fan is a variable-speed fan based on the temperature in the power supply.

---

**CAUTION:** The cooling fan is always on when the computer is in the “On” mode. The cooling fan is off when the computer is in “Standby,” “Suspend,” or “Off” modes.

You must disconnect the power cord from the power source before opening the computer to prevent system board or component damage.

---

### Tools and Software Requirements

To service the computer, you need the following:

- Torx T-15 screwdriver (HP screwdriver with bits, PN 161946-001)
- Torx T-15 screwdriver with small diameter shank (for certain front bezel removal)
- Flat-bladed screwdriver (may sometimes be used in place of the Torx screwdriver)
- Phillips #2 screwdriver
- Diagnostics software
- HP tamper-resistant T-15 wrench (Smart Cover FailSafe Key, PN 166527-001) or HP tamper-resistant bits (Smart Cover FailSafe Key, PN 166527-002)

### Screws

The screws used in the computer are not interchangeable. They may have standard or metric threads and may be of different lengths. If an incorrect screw is used during the reassembly process, it can damage the unit. HP strongly recommends that all screws removed during disassembly be kept with the part that was removed, then returned to their proper locations.

---

**CAUTION:** Metric screws have a black finish. U.S. screws have a silver finish and are used on hard drives only.

**CAUTION:** As each subassembly is removed from the computer, it should be placed away from the work area to prevent damage.

---

## Cables and Connectors

Most cables used throughout the unit are flat, flexible cables. These cables must be handled with care to avoid damage. Apply only the tension required to seat or unseat the cables during insertion or removal from the connector. Handle cables by the connector whenever possible. In all cases, avoid bending or twisting the cables, and ensure that the cables are routed in such a way that they cannot be caught or snagged by parts being removed or replaced.

---

 **CAUTION:** When servicing this computer, ensure that cables are placed in their proper location during the reassembly process. Improper cable placement can damage the computer.

---

## Hard Drives

Handle hard drives as delicate, precision components, avoiding all physical shock and vibration. This applies to failed drives as well as replacement spares.

- If a drive must be mailed, place the drive in a bubble-pack mailer or other suitable protective packaging and label the package "Fragile: Handle With Care."
- Do not remove hard drives from the shipping package for storage. Keep hard drives in their protective packaging until they are actually mounted in the CPU.
- Avoid dropping drives from any height onto any surface.
- If you are inserting or removing a hard drive, turn off the computer. Do not remove a hard drive while the computer is on or in standby mode.
- Before handling a drive, ensure that you are discharged of static electricity. While handling a drive, avoid touching the connector. For more information about preventing electrostatic damage, refer to [Electrostatic Discharge Information on page 45](#)
- Do not use excessive force when inserting a drive.
- Avoid exposing a hard drive to liquids, temperature extremes, or products that have magnetic fields such as monitors or speakers.

## Lithium Coin Cell Battery

The battery that comes with the computer provides power to the real-time clock and has a minimum lifetime of about three years.

See the appropriate removal and replacement chapter for the chassis you are working on in this guide for instructions on the replacement procedures.

---

 **WARNING!** This computer contains a lithium battery. There is a risk of fire and chemical burn if the battery is handled improperly. Do not disassemble, crush, puncture, short external contacts, dispose in water or fire, or expose it to temperatures higher than 140°F (60°C). Do not attempt to recharge the battery.

 **NOTE:** Batteries, battery packs, and accumulators should not be disposed of together with the general household waste. In order to forward them to recycling or proper disposal, please use the public collection system or return them to HP, their authorized partners, or their agents.

---

# SATA Hard Drives

Serial ATA Hard Drive Characteristics	
Number of pins/conductors in data cable	7/7
Number of pins in power cable	15
Maximum data cable length	39.37 in (100 cm)
Data interface voltage differential	400-700 mV
Drive voltages	3.3 V, 5 V, 12 V
Jumpers for configuring drive	N/A
Data transfer rate	3.0 Gb/s

## SATA Hard Drive Cables

### SATA Data Cable

Always use an HP approved SATA 3.0 Gb/s cable as it is fully backwards compatible with the SATA 1.5 Gb/s drives.

Current HP desktop products ship with SATA 3.0 Gb/s hard drives.

SATA data cables are susceptible to damage if overflexed. Never crease a SATA data cable and never bend it tighter than a 30 mm (1.18 in) radius.

The SATA data cable is a thin, 7-pin cable designed to transmit data for only a single drive.

## SMART ATA Drives

The Self Monitoring Analysis and Recording Technology (SMART) ATA drives for the HP Personal Computers have built-in drive failure prediction that warns the user or network administrator of an impending failure or crash of the hard drive. The SMART drive tracks fault prediction and failure indication parameters such as reallocated sector count, spin retry count, and calibration retry count. If the drive determines that a failure is imminent, it generates a fault alert.

## Cable Management

Always follow good cable management practices when working inside the computer.

- Keep cables away from major heat sources like the heat sink.
- Do not jam cables on top of expansion cards or memory modules. Printed circuit cards like these are not designed to take excessive pressure on them.
- Keep cables clear of sliding or moveable parts to prevent them from being cut or crimped when the parts are moved.

- When folding a flat ribbon cable, never fold to a sharp crease. Sharp creases may damage the wires.
- Some flat ribbon cables come prefolded. Never change the folds on these cables.
- Do not bend any cable sharply. A sharp bend can break the internal wires.
- Never bend a SATA data cable tighter than a 30 mm (1.18 in) radius.
- Never crease a SATA data cable.
- Do not rely on components like the drive cage, power supply, or computer cover to push cables down into the chassis. Always position the cables to lay properly by themselves.

## Hard Drive Capacities

The combination of the file system and the operating system used in the computer determines the maximum usable size of a drive partition. A drive partition is the largest segment of a drive that may be properly accessed by the operating system. A single hard drive may therefore be subdivided into a number of unique drive partitions in order to make use of all of its space.

Because of the differences in the way that drive sizes are calculated, the size reported by the operating system may differ from that marked on the hard drive or listed in the computer specification. Drive size calculations by drive manufacturers are bytes to the base 10 while calculations by Microsoft are bytes to the base 2.

Drive/Partition Capacity Limits				
File System	Controller Type	Operating System	Maximum Size	
			Partition	Drive
FAT 32	ATA	Windows 7	32 GB	2 TB
NTFS	ATA	Windows 7	2 TB	2 TB

---

# 6 Removal and Replacement Procedures Microtower (MT) Chassis

Adherence to the procedures and precautions described in this chapter is essential for proper service. After completing all necessary removal and replacement procedures, run the Diagnostics utility to verify that all components operate properly.

---

 **NOTE:** Not all features listed in this guide are available on all computers.

---

## Preparation for Disassembly

See [Routine Care, SATA Drive Guidelines, and Disassembly Preparation on page 45](#) for initial safety procedures.

1. Remove/disengage any security devices that prohibit opening the computer.
2. Close any open software applications.
3. Exit the operating system.
4. Remove any compact disc or media card from the computer.
5. Turn off the computer and any peripheral devices that are connected to it.

---

 **CAUTION:** Turn off the computer before disconnecting any cables.

Regardless of the power-on state, voltage is always present on the system board as long as the system is plugged into an active AC outlet. In some systems the cooling fan is on even when the computer is in the "Standby," or "Suspend" modes. The power cord should always be disconnected before servicing a unit.

- 
6. Disconnect the power cord from the electrical outlet and then from the computer.
  7. Disconnect all peripheral device cables from the computer.
  8. As applicable, lay the computer down on its side to achieve a safe working position.

---

 **NOTE:** During disassembly, label each cable as you remove it, noting its position and routing. Keep all screws with the units removed.

---

 **CAUTION:** The screws used in the computer are of different thread sizes and lengths; using the wrong screw in an application may damage the unit.

---



# Computer Access Panel

Description	Spare part number
Access panel	646825-001

To access internal components, you must remove the access panel:

1. Prepare the computer for disassembly ([Preparation for Disassembly on page 54](#))
2. Loosen the two captive thumbscrews **(1)** that secure the access panel to the computer chassis.
3. Use the handle located between the thumbscrews to lift the access panel off the unit **(2)**.

 **NOTE:** You may want to lay the computer on its side to install internal parts. Be sure the side with the access panel is facing up.

**Figure 6-1** Removing the Computer Access Panel

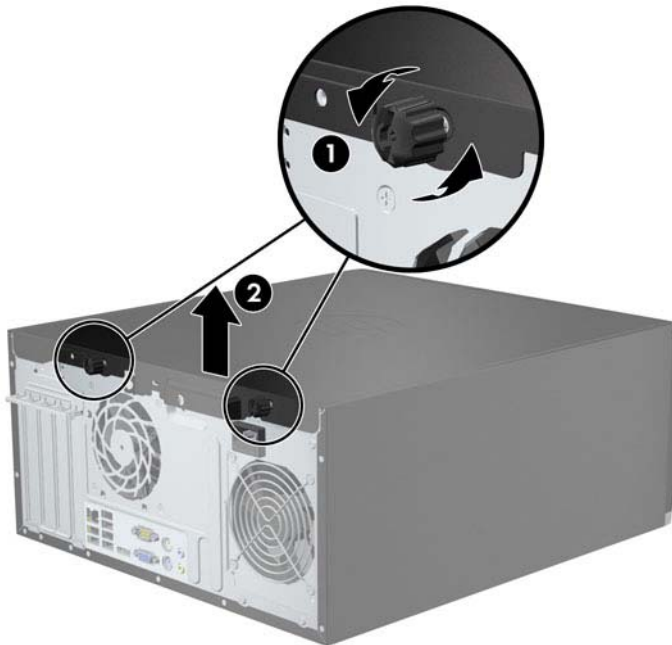

# Front Bezel

Description	Spare part number
Front bezel	689377-001

1. Prepare the computer for disassembly ([Preparation for Disassembly on page 54](#))
2. Remove the access panel ([Computer Access Panel on page 55](#))
3. Lift up the three tabs on the side of the bezel **(1)**, then rotate the bezel off the chassis **(2)**.

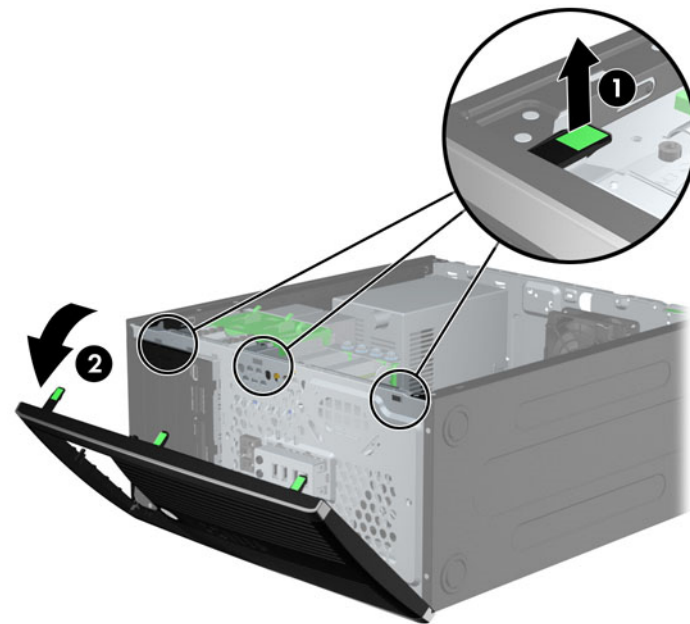

**Figure 6-2** Removing the Front Bezel

# Front Bezel Security

The front bezel can be locked in place by installing a security screw provided by HP. To install the security screw:

1. Remove/disengage any security devices that prohibit opening the computer.
2. Remove all removable media, such as compact discs or USB flash drives, from the computer.
3. Turn off the computer properly through the operating system, then turn off any external devices.
4. Disconnect the power cord from the power outlet and disconnect any external devices.

**⚠ CAUTION:** Regardless of the power-on state, voltage is always present on the system board as long as the system is plugged into an active AC outlet. You must disconnect the power cord to avoid damage to the internal components of the computer.

5. Remove the access panel and front bezel.
6. Remove the security screw from the inside of the front bezel.

**Figure 6-3** Retrieving the Front Bezel Security Screw

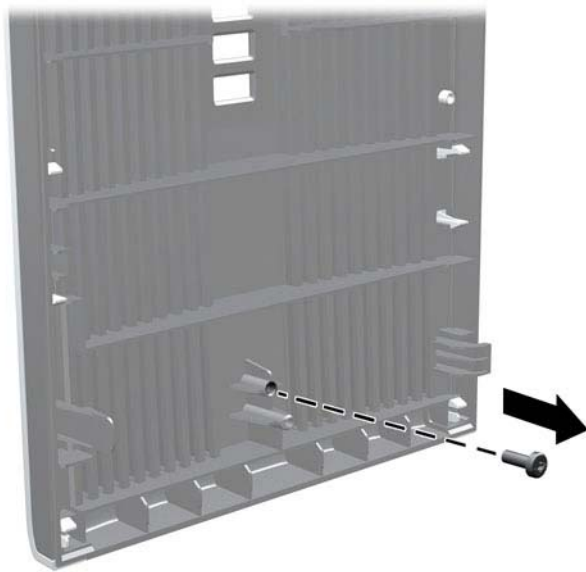

7. Replace the front bezel.

8. Install the screw through the interior of the front of the chassis into the front bezel. The screw hole is located toward the middle of the right edge of the chassis between the hard drive bay and speaker.

**Figure 6-4** Installing the Front Bezel Security Screw



9. Replace the access panel.
10. Reconnect the power cord and turn on the computer.
11. Lock any security devices that were disengaged when the access panel was removed.

# Bezel Blanks

Description	Spare part number
3.5-inch bezel blank	583653-001
5.25-inch bezel blank, optical drive	570838-001

On some models, there are bezel blanks covering the 3.5-inch and 5.25-inch drive bays that need to be removed before installing a drive. To remove a bezel blank:

1. Remove the access panel ([Computer Access Panel on page 55](#))
2. Remove the front bezel ([Front Bezel on page 56](#))
3. To remove a bezel blank, push the two retaining tabs that hold the bezel blank in place towards the outer right edge of the bezel **(1)** and slide the bezel blank back and to the right to remove it **(2)**.

**Figure 6-5** Removing a Bezel Blank

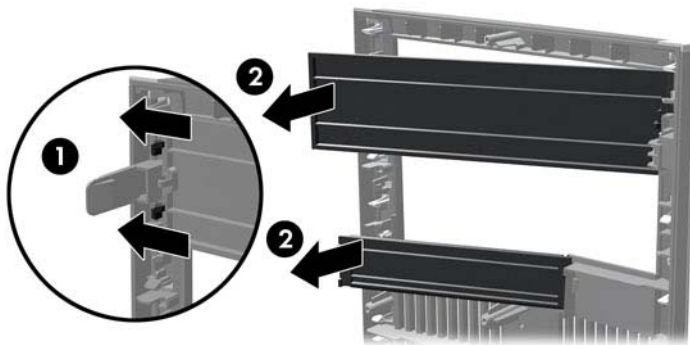

# Memory

Description	Spare part number
8-GB, PC3-12800	689375-001
4-GB, PC3-12800	671613-001
2-GB, PC3-12800	671612-001

The computer comes with double data rate 3 synchronous dynamic random access memory (DDR3-SDRAM) dual inline memory modules (DIMMs).

## DIMMs

The memory sockets on the system board can be populated with up to four industry-standard DIMMs. These memory sockets are populated with at least one preinstalled DIMM. To achieve the maximum memory support, you can populate the system board with up to 32-GB of memory configured in a high-performing dual channel mode.

## DDR3-SDRAM DIMMs

**CAUTION:** This product DOES NOT support DDR3 Ultra Low Voltage (DDR3U) memory. The processor is not compatible with DDR3U memory and if you plug DDR3U memory into the system board, it can cause the physical damage to the DIMM or invoke system malfunction.

For proper system operation, the DDR3-SDRAM DIMMs must be:

- industry-standard 240-pin
- unbuffered non-ECC PC3-PC12800 DDR3-1600 MHz-compliant
- 1.35 volt or 1.5 volt DDR3/DDR3L-SDRAM DIMMs

The DDR3-SDRAM DIMMs must also:

- support CAS latency 11 DDR3 1600 MHz (11-11-11 timing)
- contain the mandatory JEDEC SPD information

In addition, the computer supports:

- 512-Mbit, 1-Gbit, 2-Gbit, 4-Gbit, and 8-Gbit non-ECC memory technologies
- single-sided and double-sided DIMMs
- DIMMs constructed with x8 and x16 DDR devices; DIMMs constructed with x4 SDRAM are not supported

**NOTE:** The system will not operate properly if you install unsupported DIMMs.

## Populating DIMM Sockets

There are four DIMM sockets on the system board, with two sockets per channel. The sockets are labeled DIMM1, DIMM2, DIMM3, and DIMM4. Sockets DIMM1 and DIMM2 operate in memory channel B. Sockets DIMM3 and DIMM4 operate in memory channel A.

The system will automatically operate in single channel mode, dual channel mode, or flex mode, depending on how the DIMMs are installed.



---

**NOTE:** Single channel and unbalanced dual channel memory configurations will result in inferior graphics performance.

---

- The system will operate in single channel mode if the DIMM sockets are populated in one channel only.
- The system will operate in a higher-performing dual channel mode if the total memory capacity of the DIMMs in Channel A is equal to the total memory capacity of the DIMMs in Channel B. The technology and device width can vary between the channels. For example, if Channel A is populated with two 1-GB DIMMs and Channel B is populated with one 2-GB DIMM, the system will operate in dual channel mode.
- The system will operate in flex mode if the total memory capacity of the DIMMs in Channel A is not equal to the total memory capacity of the DIMMs in Channel B. In flex mode, the channel populated with the least amount of memory describes the total amount of memory assigned to dual channel and the remainder is assigned to single channel. For optimal speed, the channels should be balanced so that the largest amount of memory is spread between the two channels. If one channel will have more memory than the other, the larger amount should be assigned to Channel A. For example, if you are populating the sockets with one 2-GB DIMM, and three 1-GB DIMMs, Channel A should be populated with the 2-GB DIMM and one 1-GB DIMM, and Channel B should be populated with the other two 1-GB DIMMs. With this configuration, 4-GB will run as dual channel and 1-GB will run as single channel.
- In any mode, the maximum operational speed is determined by the slowest DIMM in the system.

## Installing DIMMs

**CAUTION:** You must disconnect the power cord and wait approximately 30 seconds for the power to drain before adding or removing memory modules. Regardless of the power-on state, voltage is always supplied to the memory modules as long as the computer is plugged into an active AC outlet. Adding or removing memory modules while voltage is present may cause irreparable damage to the memory modules or system board.

The memory module sockets have gold-plated metal contacts. When upgrading the memory, it is important to use memory modules with gold-plated metal contacts to prevent corrosion and/or oxidation resulting from having incompatible metals in contact with each other.

Static electricity can damage the electronic components of the computer or optional cards. Before beginning these procedures, ensure that you are discharged of static electricity by briefly touching a grounded metal object. For more information, refer to [Electrostatic Discharge Information on page 45](#).

When handling a memory module, be careful not to touch any of the contacts. Doing so may damage the module.

1. Prepare the computer for disassembly ([Preparation for Disassembly on page 54](#))
2. Remove the access panel ([Computer Access Panel on page 55](#))
3. Open both latches of the memory module socket (**1**), and insert the memory module into the socket (**2**).

**Figure 6-6** Installing a DIMM

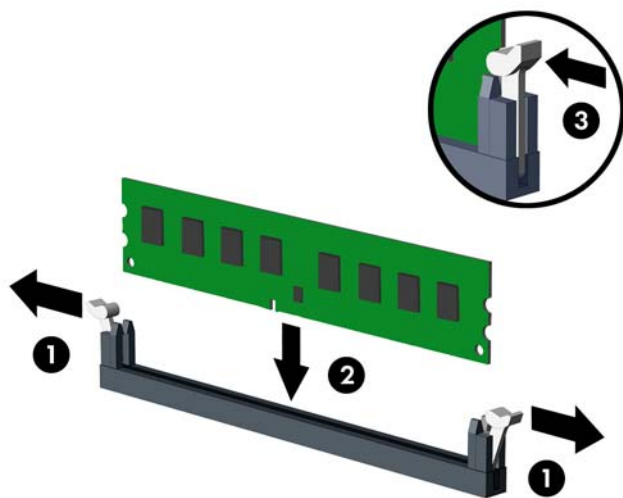

**NOTE:** A memory module can be installed in only one way. Match the notch on the module with the tab on the memory socket.

Populate the black DIMM sockets before the white DIMM sockets.

For maximum performance, populate the sockets so that the memory capacity is spread as equally as possible between Channel A and Channel B. Refer to [Populating DIMM Sockets on page 61](#) for more information.



4. Push the module down into the socket, ensuring that the module is fully inserted and properly seated. Make sure the latches are in the closed position **(3)**.
5. Repeat steps 3 and 4 to install any additional modules.
6. Replace the computer access panel.
7. Reconnect the power cord and turn on the computer.
8. Lock any security devices that were disengaged when the access panel was removed.

The computer should automatically recognize the additional memory the next time you turn on the computer.

## Expansion Cards

Description	Spare part number
GeForce GT630 PCIe x16 graphics card, 2 GB (for use only with Windows 8)	702084-001
nVidia Quadro NVS315 PCIe x16 graphics card, 1 GB (for use with Windows 8)	720837-001
nVidia Quadro NVS310 PCIe x16 graphics card, 512 MB (for use only with Windows 8)	707252-001
nVidia Quadro NVS300 PCIe x16 graphics card, 512 MB (for use only with Windows 8)	700578-001
AMD Radeon HD8490 PCIe x16 graphics card, 1 GB (for use with Windows 8)	717219-001
AMD Radeon HD8470 PCIe x16 graphics card, 2 GB (for use with Windows 8)	729085-001
AMD Radeon HD7450 PCIe x16 graphics card, 1 GB (for use only in China)	702646-001
AMD Radeon HD7450 PCIe x16 graphics card, 1 GB (includes adapter; for use only with Windows 8)	702647-001
AMD Radeon HD7450 PCIe x16 graphics card, 1 GB (includes adapter; not for use with Windows 8)	682411-001
AMD Radeon HD6350 PCIe x16 graphics card, 512 MB (for use only with Windows 8)	697246-001
AMD Radeon HD6350 PCIe x16 graphics card, 512 MB (not for use with Windows 8)	637995-001
HP WLAN 802.11 g/n 1x2 PCIe NIC	538048-001
Intel PRO/1000, single port, GbE, NIC	728562-001
HP USB 3.0 SuperSpeed PCIe x1 card	663213-001
HP USB 3.0 SuperSpeed power extension cable (for use with 663213-001)	663214-001

The computer has one PCI expansion slot, one PCI Express x1 expansion slot, one PCI Express x16 expansion slot, and one PCI Express x16 expansion slot that is downshifted to a x4 slot.



**NOTE:** You can install a PCI Express x1, x4, x8, or x16 expansion card in the PCI Express x16 slot.

To remove, replace, or add an expansion card:

1. Prepare the computer for disassembly ([Preparation for Disassembly on page 54](#))
2. Remove the access panel ([Computer Access Panel on page 55](#))
3. Locate the correct vacant expansion socket on the system board and the corresponding expansion slot on the back of the computer chassis.

4. Release the slot cover retention latch that secures the PCI slot covers by lifting the green tab on the latch and rotating the latch to the open position.

**Figure 6-7** Opening the Expansion Slot Retainer

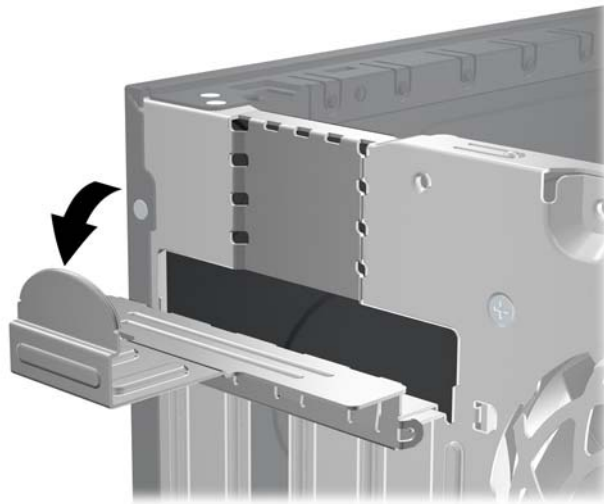

5. Before installing an expansion card, remove the expansion slot cover or the existing expansion card.

---

 **NOTE:** Before removing an installed expansion card, disconnect any cables that may be attached to the expansion card.

---

- a. If you are installing an expansion card in a vacant socket, remove the appropriate expansion slot cover on the back of the chassis. Pull the slot cover straight up then away from the inside of the chassis.

**Figure 6-8** Removing an Expansion Slot Cover

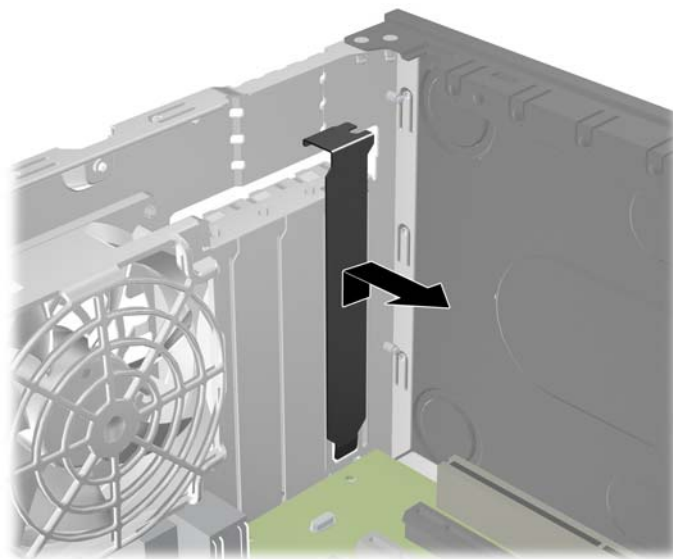

- b. If you are removing a standard PCI card or PCI Express x1 card, hold the card at each end, and carefully rock it back and forth until the connectors pull free from the socket. Pull the expansion card straight up from the socket then away from the inside of the chassis to release it from the chassis frame. Be sure not to scrape the card against the other components.

**Figure 6-9** Removing a Standard PCI Expansion Card

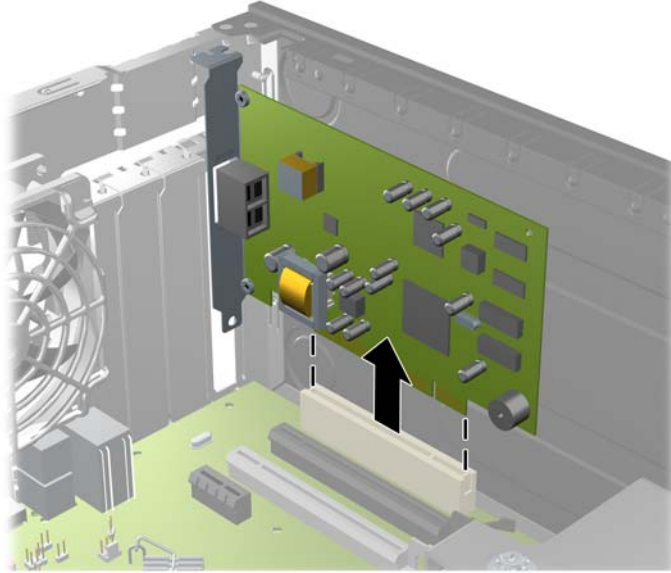

- c. If you are removing a PCI Express x16 card, pull the retention arm on the back of the expansion socket away from the card and carefully rock the card back and forth until the connectors pull free from the socket. Pull the expansion card straight up from the socket then away from the inside of the chassis to release it from the chassis frame. Be sure not to scrape the card against the other components.

**Figure 6-10** Removing a PCI Express x16 Expansion Card

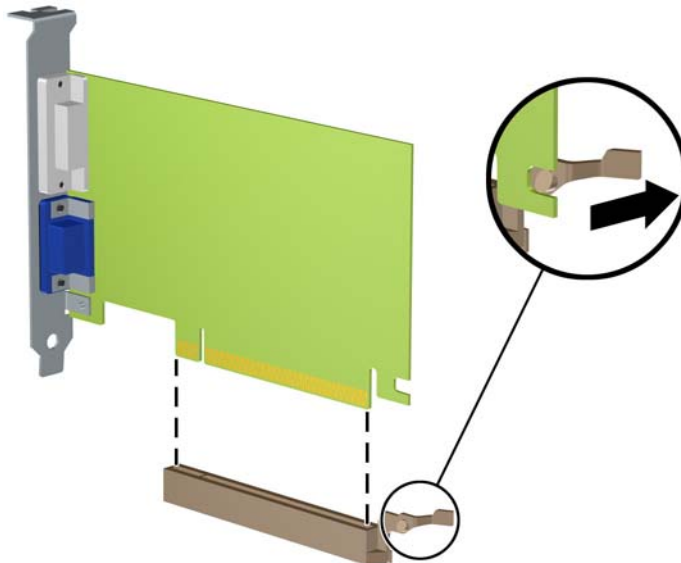

- 6. Store the removed card in anti-static packaging.

7. If you are not installing a new expansion card, install an expansion slot cover to close the open slot.

**CAUTION:** After removing an expansion card, you must replace it with a new card or expansion slot cover for proper cooling of internal components during operation.

8. To install a new expansion card, hold the card just above the expansion socket on the system board then move the card toward the rear of the chassis so that the bracket on the card is aligned with the open slot on the rear of the chassis. Press the card straight down into the expansion socket on the system board.

**Figure 6-11** Installing an Expansion Card

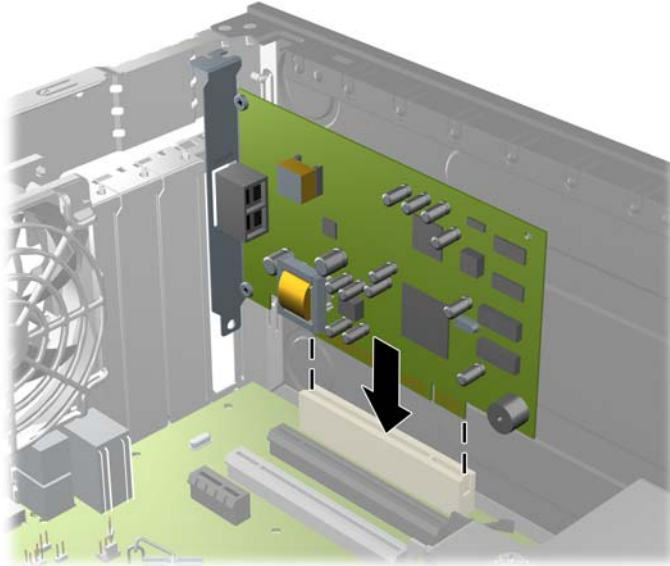

**NOTE:** When installing an expansion card, press firmly on the card so that the whole connector seats properly in the expansion card slot.

9. Rotate the slot cover retention latch back in place to secure the expansion card.
10. Connect external cables to the installed card, if needed. Connect internal cables to the system board, if needed.
11. Replace the computer access panel.
12. Reconnect the power cord and turn on the computer.
13. Lock any security devices that were disengaged when the access panel was removed.
14. Reconfigure the computer, if necessary.

## WLAN module

Description	Spare part number
Intel® Centrino™ Advanced-N 6205, 802.11a/b/g/n WLAN module	695915-001

**CAUTION:** To prevent an unresponsive system, replace the wireless module only with a wireless module authorized for use in the computer by the governmental agency that regulates wireless devices in your country or region. If you replace the module and then receive a warning message, remove the module to restore device functionality, and then contact technical support.

Before removing the WLAN module, follow these steps:

1. Prepare the computer for disassembly ([Preparation for Disassembly on page 54](#))
2. Remove the access panel ([Computer Access Panel on page 55](#))

Remove the WLAN module:

1. Disconnect the WLAN antenna cables (**1**) from the terminals on the WLAN module.

**NOTE:** The WLAN antenna cable labeled “1” connects to the WLAN module “Main” terminal labeled “1”. The WLAN antenna cable labeled “2” connects to the WLAN module “Aux” terminal labeled “2”. If the computer is equipped with an 802.11a/b/g/n WLAN module, the yellow WLAN antenna cable connects to the middle terminal on the WLAN module.

2. Remove the two Phillips PM2.0×3.0 screws (**2**) that secure the WLAN module to the system board. (The WLAN module tilts up.)
3. Remove the WLAN module (**3**) by pulling the module away from the slot at an angle.

**NOTE:** WLAN modules are designed with a notch to prevent incorrect insertion of the WLAN module into the WLAN module slot.

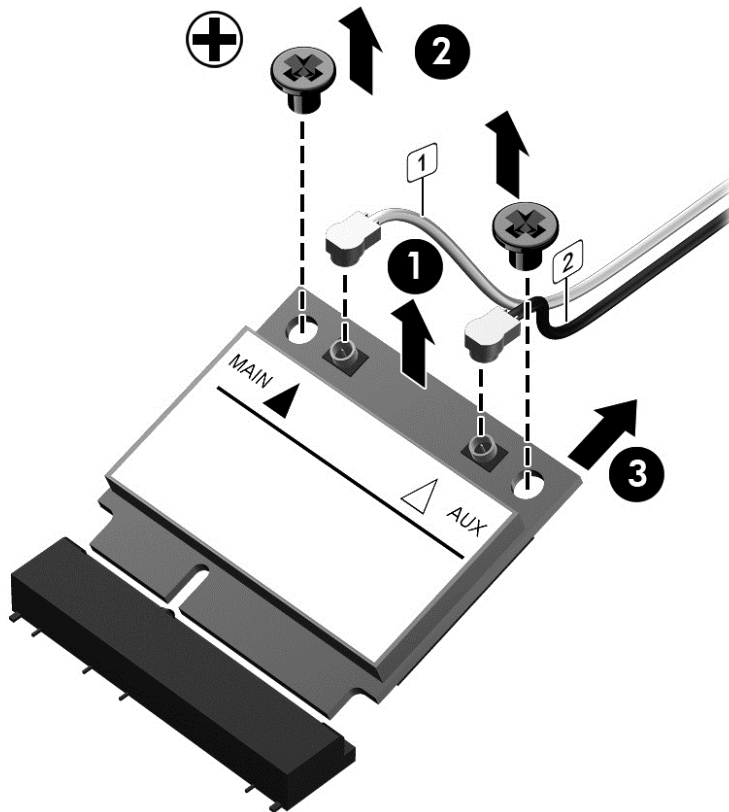

Reverse this procedure to install the WLAN module.

# System Board Connections

Refer to the following illustrations and tables to identify the system board connectors for your model.

**Figure 6-12** System Board Connections

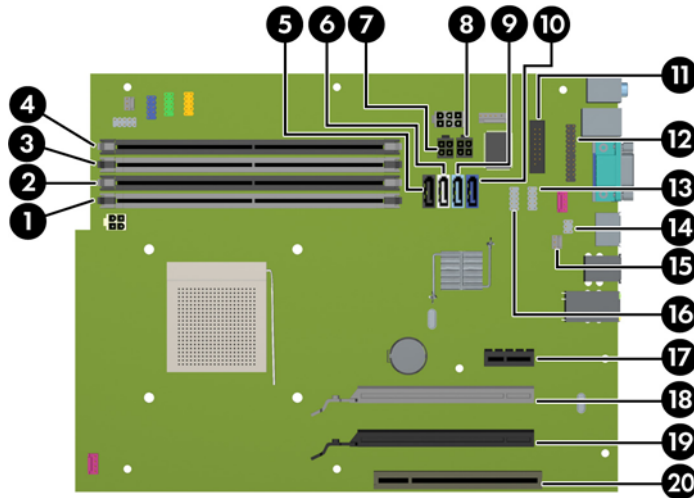

**Table 6-1** System Board Connections

No.	System Board Connector	System Board Label	Color	Component
1	DIMM4 (Channel A)	DIMM4	white	Memory Module
2	DIMM3 (Channel A)	DIMM3	black	Memory Module
3	DIMM2 (Channel B)	DIMM2	white	Memory Module
4	DIMM1 (Channel B)	DIMM1	black	Memory Module
5	eSATA	ESATA	black	eSATA Adapter Cable, or 2nd Optical Drive
6	SATA 2.0	SATA2	white	1st Optical Drive
7	Power	SATAS_PWR2	black	SATA Hard Drives
8	Power	SATAS_PWR1	black	SATA Optical Drives
9	SATA 3.0	SATA1	light blue	2nd Hard Drive, or 2nd Optical Drive if an ESATA Adapter Cable exists
10	SATA 3.0	SATA0	dark blue	1st Hard Drive
11	Serial Port	COMB	black	Serial Port
12	Parallel Port	PAR	black	Parallel Port
13	USB	MEDIA2	black	Second Media Card Reader
14	Hood Lock	HLCK	black	USB Device, such as a Media Card Reader
15	Hood Sensor	HSENSE	white	Hood Sensor

**Table 6-1 System Board Connections (continued)**

No.	System Board Connector	System Board Label	Color	Component
16	USB	MEDIA	black	USB Device, such as a Media Card Reader
17	PCI Express x1	X1PCIEXP1	black	Expansion Card
18	PCI Express x16 downshifted to a x4	X4PCIEXP	white	Expansion Card
19	PCI Express x16	X16PCIEXP	black	Expansion Card
20	PCI	PCI1	white	Expansion Card

## Drives

Description	Spare part number
DVD±RW drive	660408-001 690418-001
DVD-ROM drive	682550-001
Blu-ray BD-Writer XL Drive	682219-001
1 TB hybrid hard drive (8-GB SSD)	724937-001
1 TB, 7200 rpm SATA hard drive	636930-001
500 GB hybrid hard drive (8-GB SSD)	724938-001
500 GB, 7200 rpm, 2.5 inch, SED, SATA hard drive	696422-001
500 GB, 7200 rpm SATA hard drive	636929-001
320 GB, 7200 rpm SATA hard drive, 2.5-inch	634824-001
250 GB, 7200 rpm SATA hard drive	636927-001
256 GB Solid State Drive (SSD), self-encrypting (SED)	680020-001
160 GB Solid State Drive (SSD)	646809-001
128 GB Solid State Drive (SSD)	665961-001
120 GB Solid State Drive (SSD)	661841-001



When installing drives, follow these guidelines:

- The primary Serial ATA (SATA) hard drive must be connected to the dark blue primary SATA connector on the system board labeled SATA0. If you are adding a second hard drive, connect it to the light blue connector on the system board labeled SATA1.
- Connect the first SATA optical drive to the white SATA connector on the system board labeled SATA2. If you are adding a second optical drive connect it to the black SATA connector on the system board labeled ESATA. If the ESATA connector is already populated, connect the second optical drive to the light blue connector on the system board labeled SATA1.
- Connect an optional eSATA adapter cable to the black SATA connector on the system board labeled ESATA.
- Connect a media card reader USB cable to the USB connector on the system board labeled MEDIA.
- The power cable for the SATA optical drives is a two-headed cable this is plugged into the system board with the first connector routed to the top 5.25-inch bay and the second connector routed to the bottom 5.25-inch bay.
- The power cable for the SATA hard drives is a two-headed cable this is plugged into the system board with the first connector routed to the bottom 3.5-inch bay and the second connector routed to the top 3.5-inch bay.
- The system does not support Parallel ATA (PATA) optical drives or PATA hard drives.
- You must install guide screws to ensure the drive will line up correctly in the drive cage and lock in place. HP has provided extra guide screws for the drive bays (four 6-32 isolation mounting guide screws and eight M3 metric guide screws), installed on the side of the drive bays. The 6-32 isolation mounting screws are required for a secondary hard drive. All other drives (except the primary hard drive) use M3 metric screws. The HP-supplied metric screws are black and the HP-supplied isolation mounting screws are silver and blue. If you are replacing the primary hard drive, you must remove the four silver and blue 6-32 isolation mounting guide screws from the old hard drive and install them in the new hard drive.

**Figure 6-13** Extra Guide Screw Locations

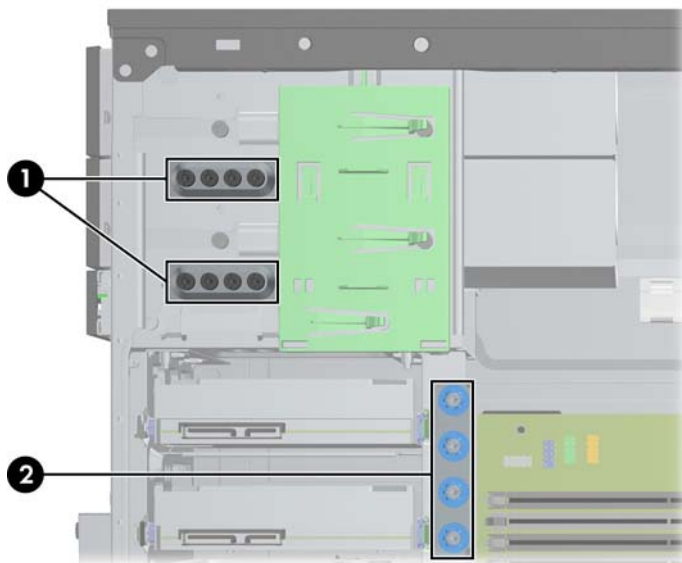

No.	Guide Screw	Device
1	Black M3 Metric Screws	All Drives (except hard drives)
2	Silver and Blue 6-32 Isolation Mounting Screws	Secondary Hard Drive

**CAUTION:** To prevent loss of work and damage to the computer or drive:

If you are inserting or removing a drive, shut down the operating system properly, turn off the computer, and unplug the power cord. Do not remove a drive while the computer is on or in standby mode.

Before handling a drive, ensure that you are discharged of static electricity. While handling a drive, avoid touching the connector.

Handle a drive carefully; do not drop it.

Do not use excessive force when inserting a drive.

Avoid exposing a hard drive to liquids, temperature extremes, or products that have magnetic fields such as monitors or speakers.

If a drive must be mailed, place the drive in a bubble-pack mailer or other protective packaging and label the package "Fragile: Handle With Care."

## Drive Positions

**Figure 6-14** Drive Positions

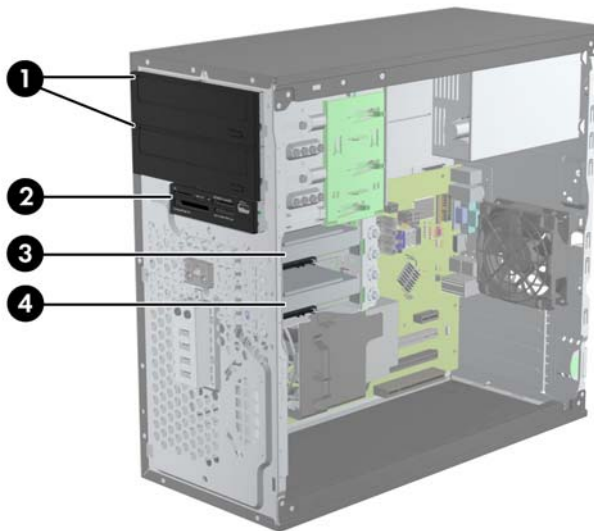

**Table 6-2** Drive Positions

1	Two 5.25-inch drive bays for optional drives (optical drives shown)
2	One 3.5-inch drive bay for optional drive (media card reader shown)

**Table 6-2 Drive Positions (continued)**

3	Secondary 3.5-inch internal hard drive bay for optional hard drive
4	Primary 3.5-inch internal hard drive bay

**NOTE:** The drive configuration on your computer may be different than the drive configuration shown above.

To verify the type and size of the storage devices installed in the computer, run Computer Setup.

## Removing a 5.25-inch or 3.5-inch Drive from a Drive Bay

**CAUTION:** All removable media should be taken out of a drive before removing the drive from the computer.

1. Prepare the computer for disassembly ([Preparation for Disassembly on page 54](#))
2. Remove the access panel ([Computer Access Panel on page 55](#))
3. Remove the front bezel ([Front Bezel on page 56](#))
4. Disconnect the drive cables, as indicated in the following illustrations.

**CAUTION:** When removing the cables, pull the tab or connector instead of the cable itself to avoid damaging the cable.

- a. If you are removing an optical drive, disconnect the power cable (**1**) and data cable (**2**) from the back of the drive.

**Figure 6-15** Disconnecting the Optical Drive Cables

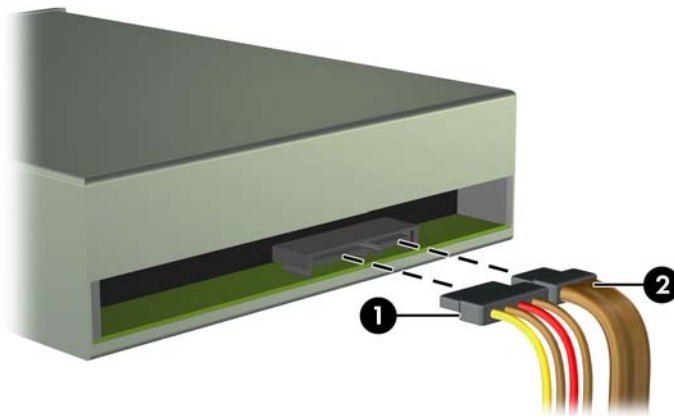

- b. If you are removing a media card reader, disconnect the USB cable from the system board.

**Figure 6-16** Disconnecting the Media Card Reader USB Cable

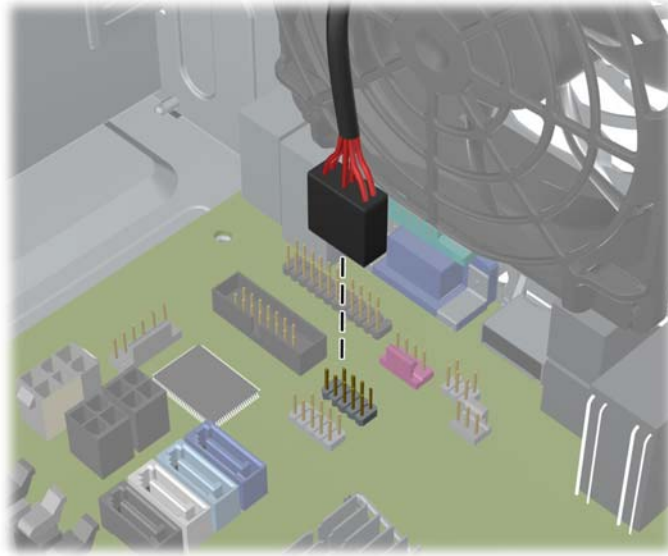

- 5. A latch drive bracket with release tabs secures the drives in the drive bay. Lift the release tab on the latch drive bracket **(1)** for the drive you want to remove, then slide the drive from its drive bay **(2)**.

**Figure 6-17** Removing the Drives

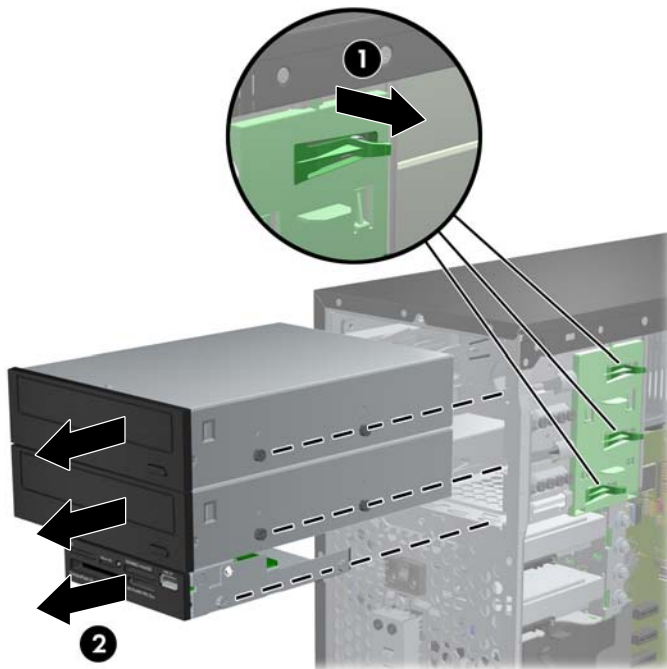

## Installing a 5.25-inch or 3.5-inch Drive into a Drive Bay

1. Prepare the computer for disassembly ([Preparation for Disassembly on page 54](#))
2. Remove the access panel ([Computer Access Panel on page 55](#))
3. Remove the front bezel ([Front Bezel on page 56](#))
4. If you are installing a drive in a bay covered by a bezel blank, remove the bezel blank. See [Bezel Blanks on page 59](#) for more information.
5. Install four M3 metric guide screws in the lower holes on each side of the drive. HP has provided eight extra M3 metric guide screws on the front of the chassis, under the front bezel. The M3 metric guide screws are black. Refer to [Drives on page 70](#) for an illustration of the extra M3 metric guide screws location.

 **NOTE:** When replacing the drive, transfer the four M3 metric guide screws from the old drive to the new one.

 **CAUTION:** Use only 5-mm long screws as guide screws. Longer screws can damage the internal components of the drive.

**Figure 6-18** Installing Guide Screws (Optical Drive Shown)



6. Slide the drive into the drive bay, making sure to align the guide screws with the guide slots, until the drive snaps into place.

**Figure 6-19** Sliding the Drives into the Drive Cage



7. Connect the power and data cables to the drive as indicated in the following illustrations.
  - a. If you are installing an optical drive, connect the power cable (1) and data cable (2) to the back of the drive.

 **NOTE:** The power cable for the optical drives is a two-headed cable that is routed from the system board to the rear of the optical drive bays.

**Figure 6-20** Connecting the Optical Drive Cables

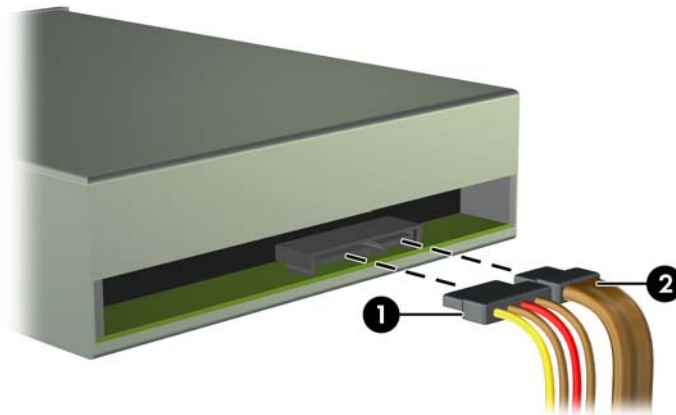

- b. If you are installing a media card reader, connect the USB cable to the USB system board connector labeled MEDIA.

**Figure 6-21** Connecting the Media Card Reader USB Cable

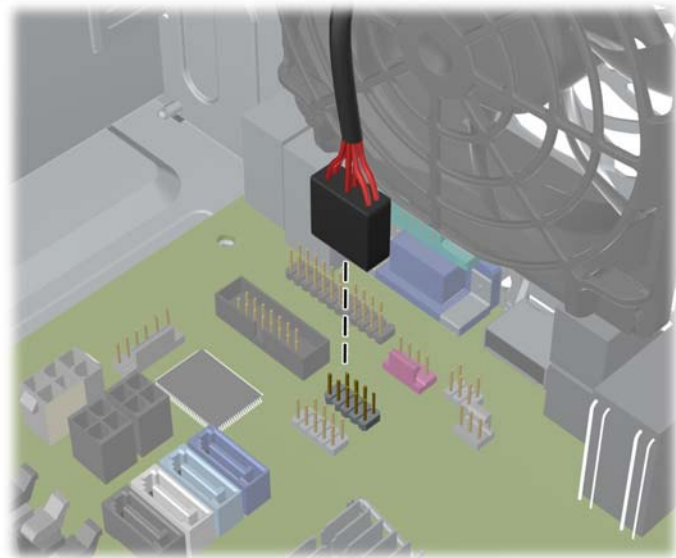

8. If installing a new drive, connect the opposite end of the data cable to the appropriate system board connector.

 **NOTE:** If you are installing a new SATA optical drive, connect the data cable for the first optical drive to the white SATA connector on the system board labeled SATA2. Connect the data cable for a second optical drive to the black SATA connector on the system board labeled ESATA. If the ESATA connector is already populated, connect the second optical drive to the light blue connector labeled SATA1.

Refer to [System Board Connections on page 69](#) for an illustration of the system board drive connectors.

9. Replace the front bezel and computer access panel.
10. Reconnect the power cord and any external devices, then turn on the computer.
11. Lock any security devices that were disengaged when the access panel was removed.

## Removing a Hard Drive from a Drive Bay

 **NOTE:** Before you remove the old hard drive, be sure to back up the data from the old hard drive so that you can transfer the data to the new hard drive.

1. Prepare the computer for disassembly ([Preparation for Disassembly on page 54](#))
2. Remove the access panel ([Computer Access Panel on page 55](#))
3. Disconnect the power cable and data cable from the back of the hard drive.
4. Release the drive by pulling the release tab away from the drive **(1)** and sliding the drive out of the bay **(2)**.

**Figure 6-22** Removing a Hard Drive



5. Remove the four guide screws (two on each side) from the old drive. You will need these screws to install a new drive.

## Installing a Hard Drive into an Internal Drive Bay

 **NOTE:** The system does not support Parallel ATA (PATA) hard drives.

1. Prepare the computer for disassembly ([Preparation for Disassembly on page 54](#))
2. Remove the access panel ([Computer Access Panel on page 55](#))
3. Install guide screws on the sides of the drive. If you are installing a 2.5-inch drive, you must install the drive in an adapter bracket.

 **NOTE:** The hard drive uses 6-32 isolation mounting guide screws. Four extra guide screws are installed on the exterior of the hard drive bays. The HP-supplied isolation mounting guide screws are silver and blue. Refer to [Drives on page 70](#) for an illustration of the extra 6-32 isolation mounting guide screws location.

If you are replacing a drive, transfer the guides screws from the old drive to the new one.

- If you are installing a 3.5-inch hard drive, install four isolation mounting guide screws (two on each side of the drive).

**Figure 6-23** Installing Isolation Mounting Guide Screws in a 3.5-inch Drive



- If you are installing a 2.5-inch hard drive:
  - Slide the drive into the bay adapter bracket, ensuring the connector on the drive is fully inserted into the connector on the adapter bracket.

**Figure 6-24** Sliding the 2.5-inch Drive in the Adapter Bracket

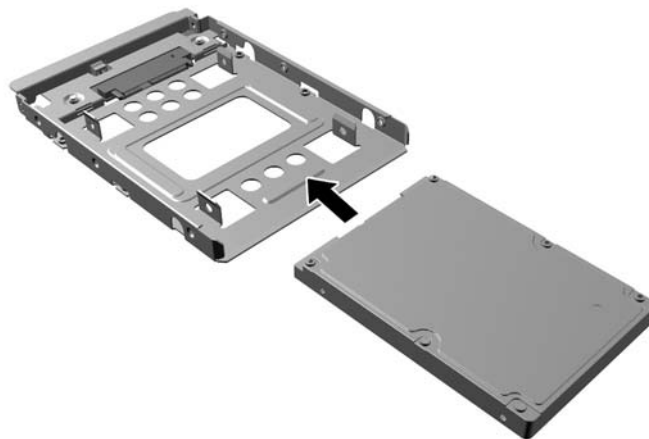



- Secure the drive to the bay adapter bracket by installing four black M3 adapter bracket screws through the sides of the bracket into the drive.

**Figure 6-25** Securing the Drive in the Adapter Bracket

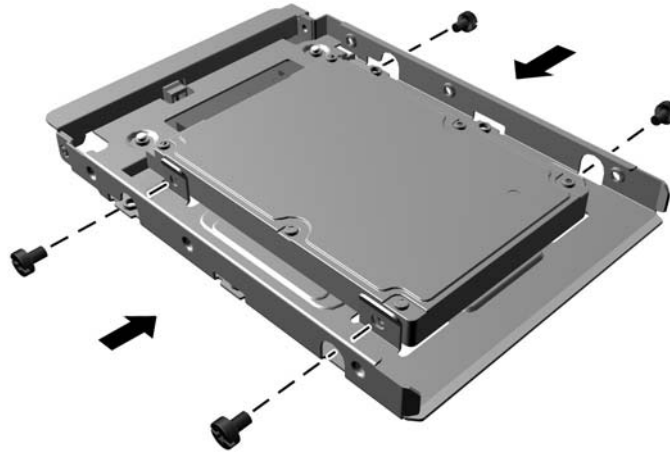

- Install four 6-32 silver and blue isolation mounting guide screws in the adapter bracket (two on each side of the bracket).

**Figure 6-26** Installing Isolation Mounting Guide Screws in the Adapter Bracket

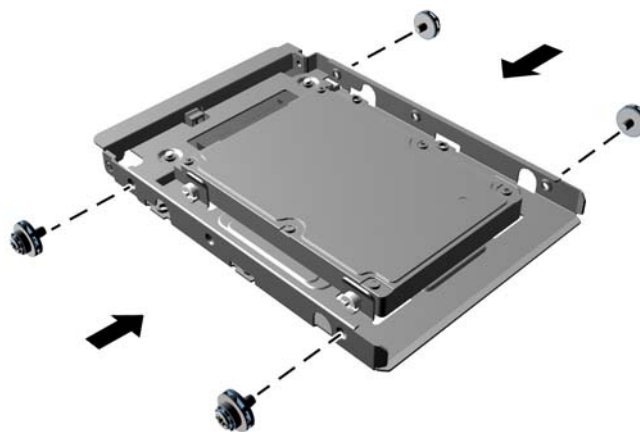

- Slide the drive into the drive bay, making sure to align the guide screws with the guide slots, until the drive snaps into place. The bottom bay is for the primary hard drive. The upper bay is for an optional secondary hard drive.

**Figure 6-27** Sliding a Hard Drive into the Drive Bay

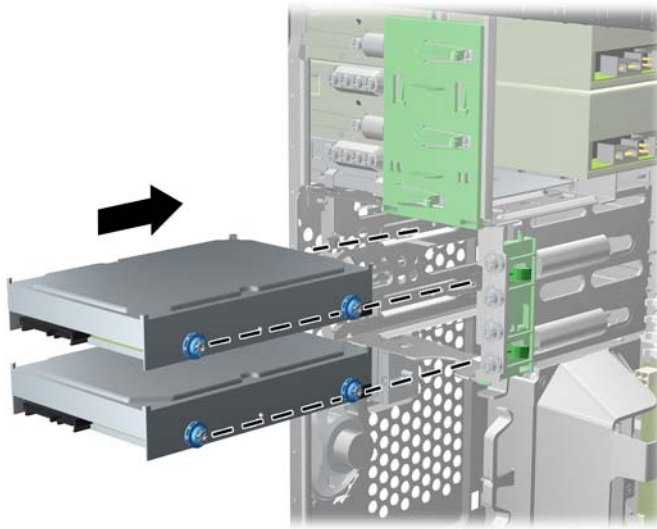

- Connect the power cable and data cable to the back of the hard drive.

 **NOTE:** The power cable for the hard drives is a two-headed cable that is routed from the system board to the rear of the hard drive bays.

- If installing a new drive, connect the opposite end of the data cable to the appropriate system board connector.

 **NOTE:** If your system has only one SATA hard drive, you must connect the hard drive data cable to the dark blue connector labeled SATA0 to avoid any hard drive performance problems. If you are adding a second hard drive, connect the data cable to the light blue connector labeled SATA1.

- Route the power and data cables in their cable retainers.
- Replace the computer access panel.
- Reconnect the power cord and any external devices, then turn on the computer.
- Lock any security devices that were disengaged when the access panel was removed.

## Removing and Replacing a Removable 3.5-inch SATA Hard Drive

Some models are equipped with a Removable SATA Hard Drive Enclosure in the 5.25-inch internal drive bay. The hard drive is housed in a carrier that can be quickly and easily removed from the drive bay. To remove and replace a drive in the carrier:

 **NOTE:** Before you remove the old hard drive, be sure to back up the data from the old hard drive so that you can transfer the data to the new hard drive.

- Unlock the hard drive carrier with the key provided and slide the carrier out of the enclosure.

2. Remove the screw from the rear of the carrier **(1)** and slide the top cover off the carrier **(2)**.

**Figure 6-28** Removing the Carrier Cover



3. Remove the adhesive strip that secures the thermal sensor to the top of the hard drive **(1)** and move the thermal sensor away from the carrier **(2)**.

**Figure 6-29** Removing the Thermal Sensor

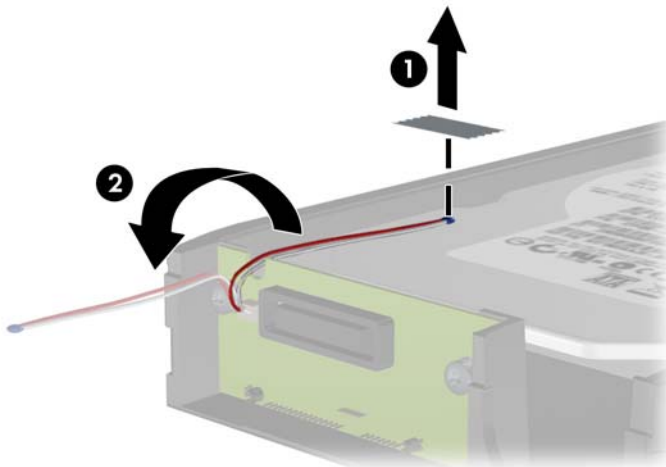

4. Remove the four screws from the bottom of the hard drive carrier.

**Figure 6-30** Removing the Security Screws

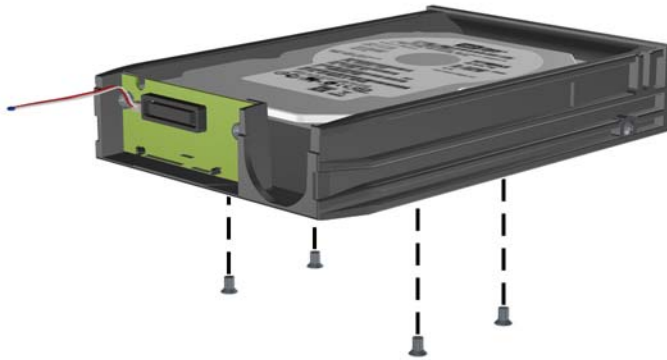

5. Slide the hard drive back to disconnect it from the carrier then lift it up and out of the carrier.

**Figure 6-31** Removing the Hard Drive

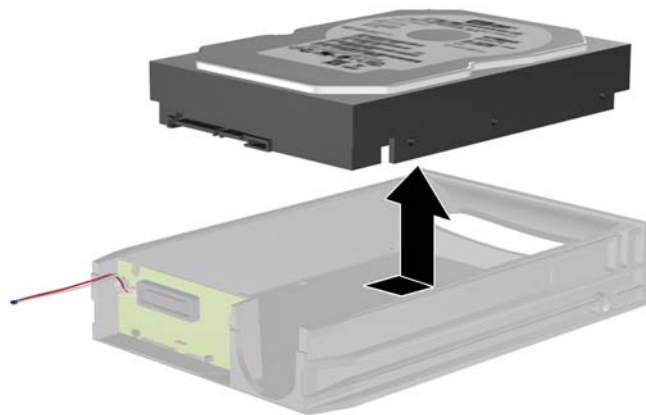

6. Place the new hard drive in the carrier then slide the hard drive back so that it seats in the SATA connector on the carrier's circuit board. Be sure the connector on the hard drive is pressed all the way into the connector on the carrier's circuit board.

**Figure 6-32** Replacing the Hard Drive

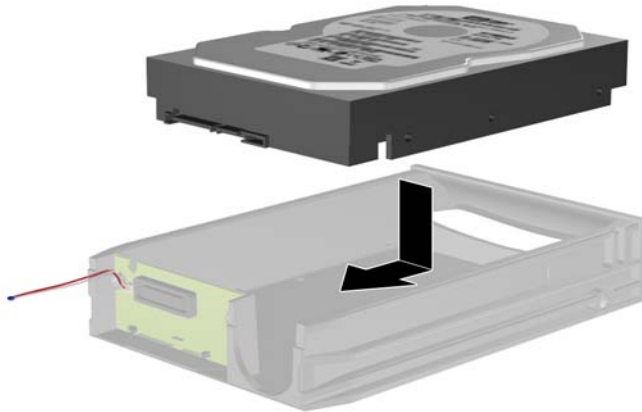

7. Replace the four screws in the bottom of the carrier to hold the drive securely in place.

**Figure 6-33** Replacing the Security Screws

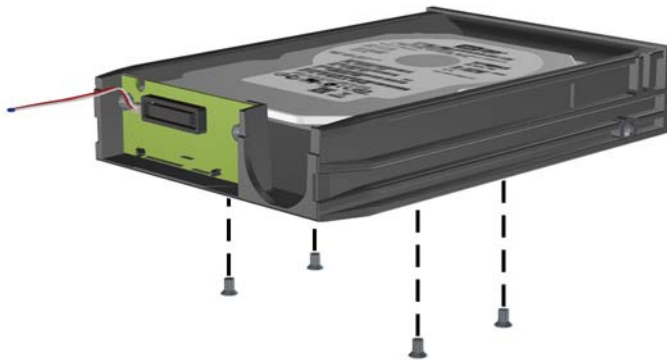

- Place the thermal sensor on top of the hard drive in a position that does not cover the label **(1)** and attach the thermal sensor to the top of the hard drive with the adhesive strip **(2)**.

**Figure 6-34** Replacing the Thermal Sensor

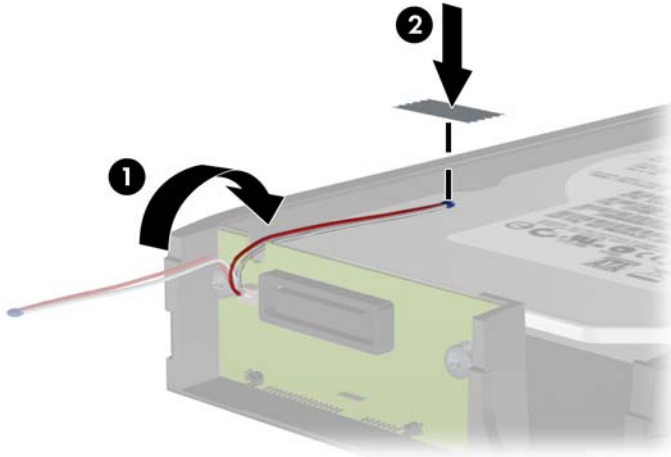

- Slide the cover on the carrier **(1)** and replace the screw on the rear of the carrier to secure the cover in place **(2)**.

**Figure 6-35** Replacing the Carrier Cover



- Slide the hard drive carrier into the enclosure on the computer and lock it with the key provided.

 **NOTE:** The carrier must be locked for power to be supplied to the hard drive.

# Front Fan Assembly

Description	Spare part number
Front fan assembly	585884-001

1. Prepare the computer for disassembly ([Preparation for Disassembly on page 54](#)).
2. Remove the access panel ([Computer Access Panel on page 55](#)).
3. Remove the cables from the clip on the top of the fan assembly.

**Figure 6-36** Removing the cables from atop the front fan assembly

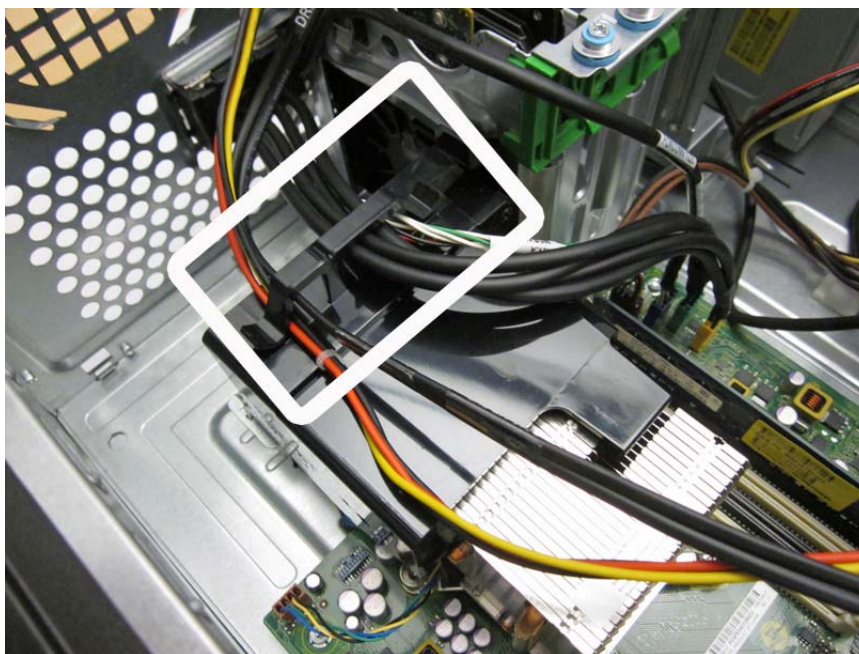

4. Unplug the fan cable from the system board connector labeled CHFAN.

5. Press the lever that secures the assembly to the chassis **(1)**, pivot the assembly forward toward the front of the computer **(2)**, and then lift the assembly straight up and out of the computer **(3)**.

**Figure 6-37** Removing the front fan assembly

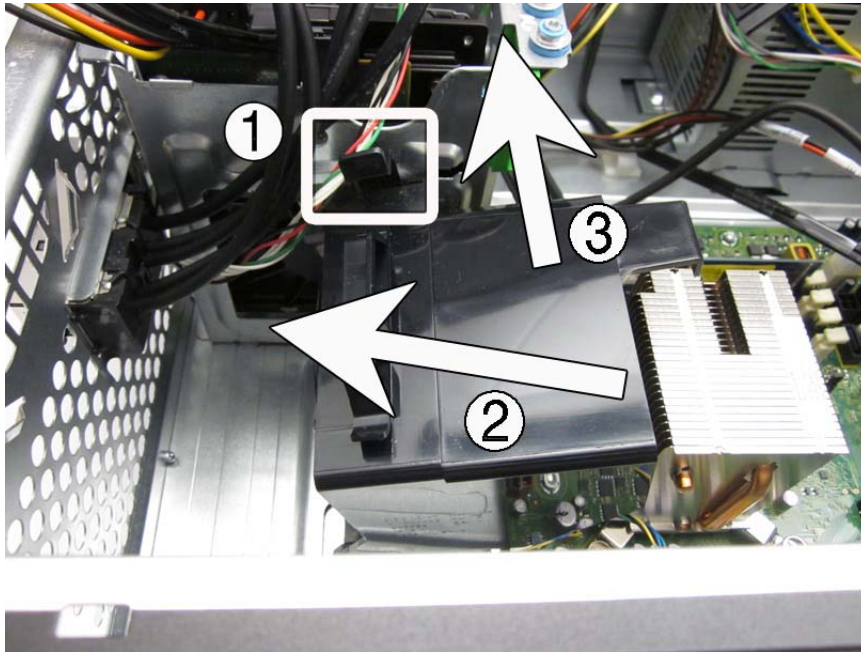

To reinstall the front fan, reverse the removal procedure.

## Front I/O Assembly

Description	Spare part number
Front I/O assembly	646827-001

1. Prepare the computer for disassembly ([Preparation for Disassembly on page 54](#)).
2. Remove the computer access panel ([Computer Access Panel on page 55](#)).
3. Remove the front bezel ([Front Bezel on page 56](#)).
4. Remove the front fan ([Front Fan Assembly on page 85](#)).
5. Disconnect the three front I/O cables (yellow, green, and blue) from the system board connectors (FRONT USB, FRONT USB2, and FRONT AUD).



6. Remove the Torx T15 screw that secures the assembly to the chassis.

**Figure 6-38** Removing the front I/O assembly screw



7. Rotate the left side of the assembly to the right .

**Figure 6-39** Removing the front I/O assembly



8. Pull the assembly away from the computer while threading the wires through the hole in the front of the chassis.

To reinstall the assembly, reverse the removal procedure.

## Power Switch/LED Assembly

Description	Spare part number
Power switch/LED assembly	646828-001

1. Prepare the computer for disassembly ([Preparation for Disassembly on page 54](#)).
2. Remove the access panel ([Computer Access Panel on page 55](#)).
3. Remove the front bezel ([Front Bezel on page 56](#)).
4. Remove the front fan ([Front Fan Assembly on page 85](#)).
5. Disconnect the cable from the system board connector labeled PB/LED.

6. With the computer on its side, press on the tabs on the bottom of the assembly **(1)** to disengage the assembly from the chassis, and then rotate the bottom of the assembly upward **(2)** to remove it from the chassis.

**Figure 6-40** Removing the power switch/LED

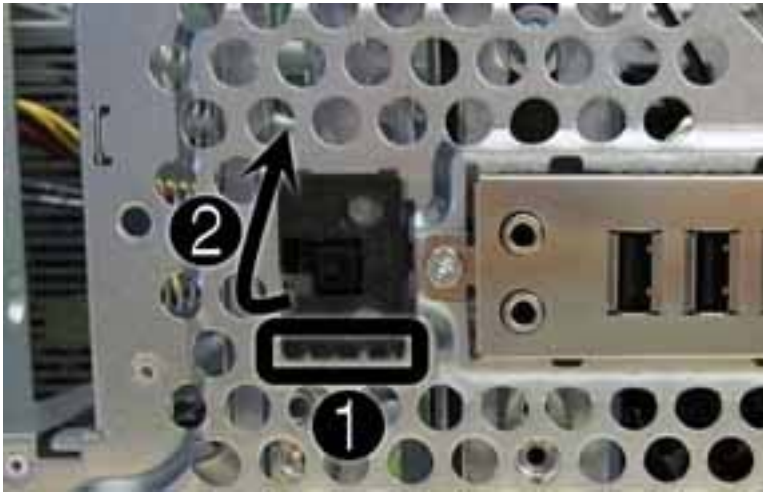

7. Pull the assembly away from the chassis while threading the cable through the hole in front of the chassis.

# Heat sink

Description	Spare part number
Heat sink	645326-001

**⚠ CAUTION:** The bond between the heat sink and the processor may be very tight.

If the computer will power on, before removing the heat sink, turn on the computer until it warms the heat sink. Warming the heat sink lessens the bond between the heat sink and the processor, thereby making separating them easier.

Make sure not to pull the processor out of the socket when you lift the heat sink, especially if you cannot warm the heat sink prior to removal. Inadvertently removing the processor can damage the pins.

1. Prepare the computer for disassembly ([Preparation for Disassembly on page 54](#)).
2. Remove the computer access panel ([Computer Access Panel on page 55](#)).
3. Remove the front fan ([Front Fan Assembly on page 85](#)).
4. Loosen the four silver captive Torx T15 screws that secure the heat sink to the system board.

**⚠ CAUTION:** Remove heat sink retaining screws in diagonally opposite pairs (as in an X) to even the downward forces on the processor. The pins on the socket are very fragile and any damage to them may require replacing the system board.

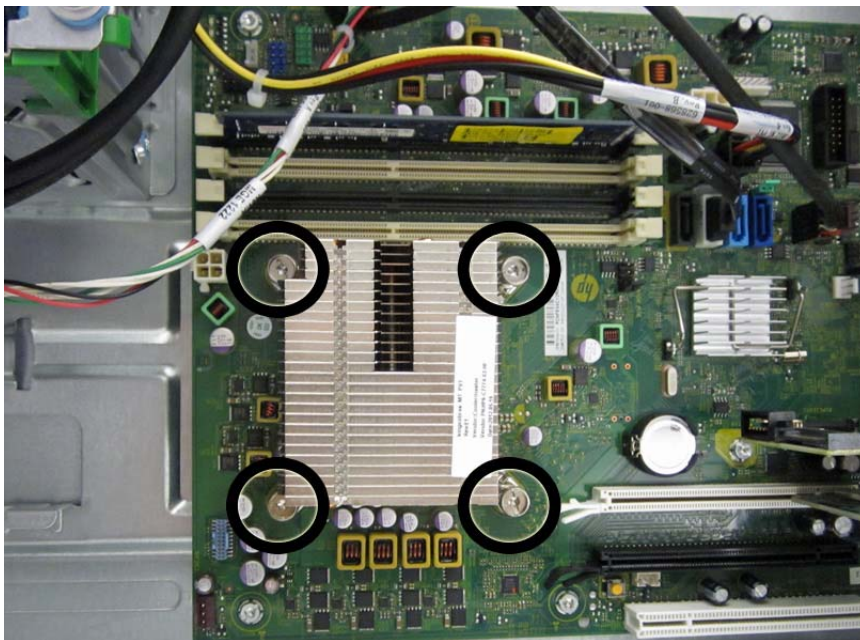

5. Lift the heat sink from atop the processor.

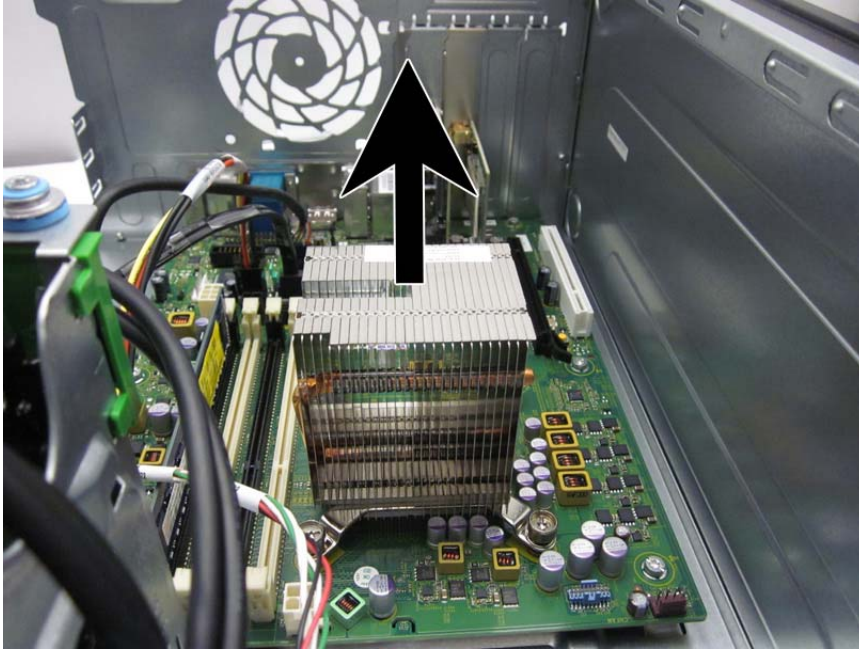

When reinstalling the heat sink, make sure that its bottom has been cleaned with an alcohol wipe and fresh thermal grease has been applied to the top of the processor.

**CAUTION:** Heat sink retaining screws should be tightened in diagonally opposite pairs (as in an X) to evenly seat the heat sink on the processor. This is especially important as the pins on the socket are very fragile and any damage to them may require replacing the system board.

## Processor

Description	Spare part number
AMD A10-5800B, 3.8 GHz, 4-MB L2 cache (100-W), HD 7660D	703598-001
AMD A8-5500B, 3.2 GHz, 4-MB L2 cache (65-W), HD 7560D	703601-001
AMD A6-5400B, 3.6 GHz, 4-MB L2 cache (65-W), HD 7540D	703600-001
AMD A4-5300B, 3.4 GHz, 4-MB L2 cache (65-W), HD 7480D	703599-001

1. Prepare the computer for disassembly ([Preparation for Disassembly on page 54](#)).
2. Remove the access panel ([Computer Access Panel on page 55](#)).
3. Remove the heat sink ([Heat sink on page 89](#)).
4. Rotate the locking lever to its full open position **(1)**.

- Carefully lift the processor from the socket **(2)**.

**CAUTION:** Do NOT handle the pins in the processor socket. These pins are very fragile and handling them could cause irreparable damage. Once pins are damaged it may be necessary to replace the system board.

The heat sink must be installed within 24 hours of installing the processor to prevent damage to the processor's solder connections.

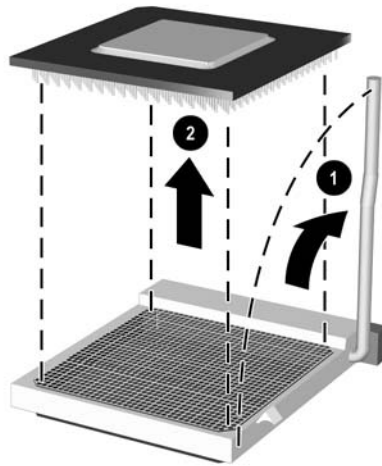

Reverse the removal procedure to install a new processor.

**NOTE:** After installing a new processor onto the system board, update the system ROM to ensure that the latest version of the BIOS is being used on the computer. The latest system BIOS can be found on the Web at: <http://h18000.www1.hp.com/support/files>.

## Speaker

Description	Spare part number
Speaker	645330-001

- Prepare the computer for disassembly ([Preparation for Disassembly on page 54](#)).
- Remove the access panel ([Computer Access Panel on page 55](#)).
- Remove the front fan assembly ([Front Fan Assembly on page 85](#)).
- Disconnect the speaker wire from the system board connector labeled SPKR.
- From the inside of the chassis, remove the two silver Torx T15 screws **(1)** that secure the speaker to the chassis.

6. Rotate the top of the speaker downward **(2)**, and then remove it from the chassis.

**Figure 6-41** Removing the speaker



To replace the speaker, reverse the removal procedures.

## Rear Chassis Fan

Description	Spare part number
Rear chassis fan	643908-001

1. Prepare the computer for disassembly ([Preparation for Disassembly on page 54](#)).
2. Remove the access panel ([Computer Access Panel on page 55](#)).
3. Remove the four silver Phillips screws that secure the fan to the chassis.

**Figure 6-42** Rear fan screws



4. Disconnect the fan control cable **(1)** from the system board connector labeled CHFAN2.

5. Lift the fan out of the chassis (2).

**Figure 6-43** Removing the rear fan

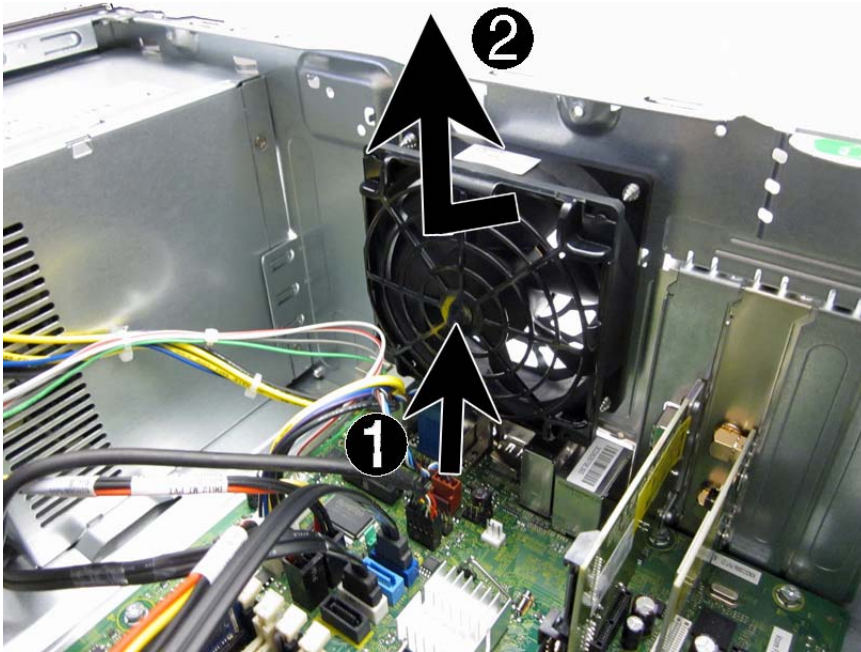

To install the fan assembly, reverse the removal procedure. Be sure to orient the air flow out of the unit.



# Power Supply

Description	Spare part number
Power supply, 320W, 90% efficient	613764-001
Power supply, 320W	613765-001

1. Prepare the computer for disassembly ([Preparation for Disassembly on page 54](#)).
2. Remove the access panel ([Computer Access Panel on page 55](#)).
3. Disconnect the power cables from the white system board connector labeled PWR and the white system board connector labeled PWRCMD.
4. Remove the power cables from the clip on the base pan.
5. Remove the four silver Torx T15 screws that connect the power supply to the chassis.

**Figure 6-44** Power supply screws



6. Press the tab **(1)** on the base pan in front of the power supply that holds it in place.

7. Slide the power supply toward the front of the computer **(2)**, rotate toward the fan so the power supply clears the lip on the top of the chassis, and then lift the power supply out of the chassis **(3)**.

**Figure 6-45** Removing the power supply

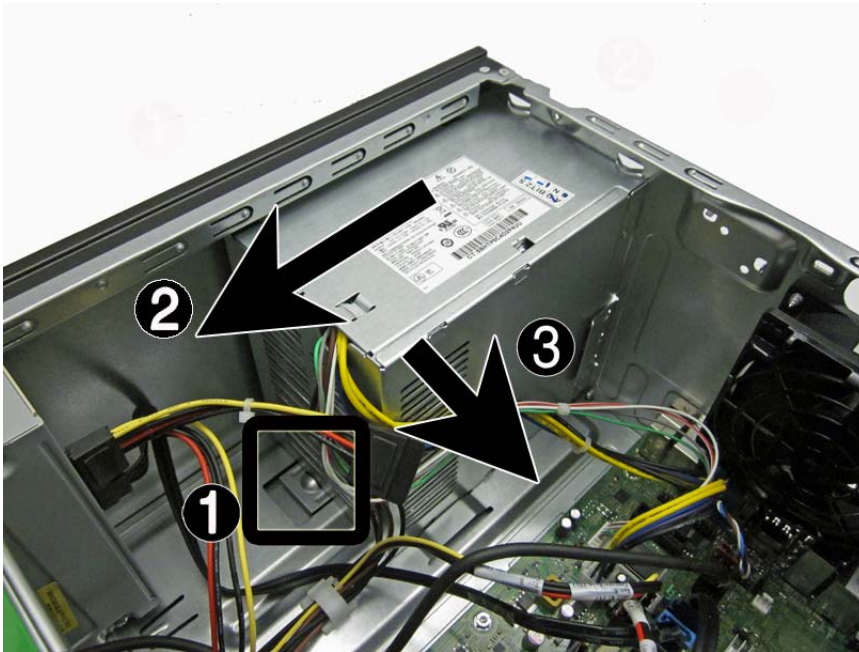

To install the power supply, reverse the removal procedure.

## System Board

Description	Spare part number
System board for use in Windows 7 models (includes thermal material)	703596-001
System board for use in Windows 8 Standard models	703596-501
System board for use in Windows 8 Professional models	703596-601

1. Prepare the computer for disassembly ([Preparation for Disassembly on page 54](#)).
2. Remove the access panel ([Computer Access Panel on page 55](#)).
3. Remove the front fan assembly ([Front Fan Assembly on page 85](#)).
4. When replacing the system board, make sure the following components are removed from the defective system board and installed on the replacement system board:
  - Memory modules ([Memory on page 60](#))
  - Expansion cards ([Expansion Cards on page 64](#))
  - Heat sink ([Heat sink on page 89](#)).

- Processor ([Processor on page 90](#))
  - WLAN module ([WLAN module on page 67](#))
5. Disconnect all cables connected to the system board, noting their location for reinstallation.
  6. Remove the eight Torx T15 screws that secure the system board to the chassis.

**Figure 6-46** System board screws

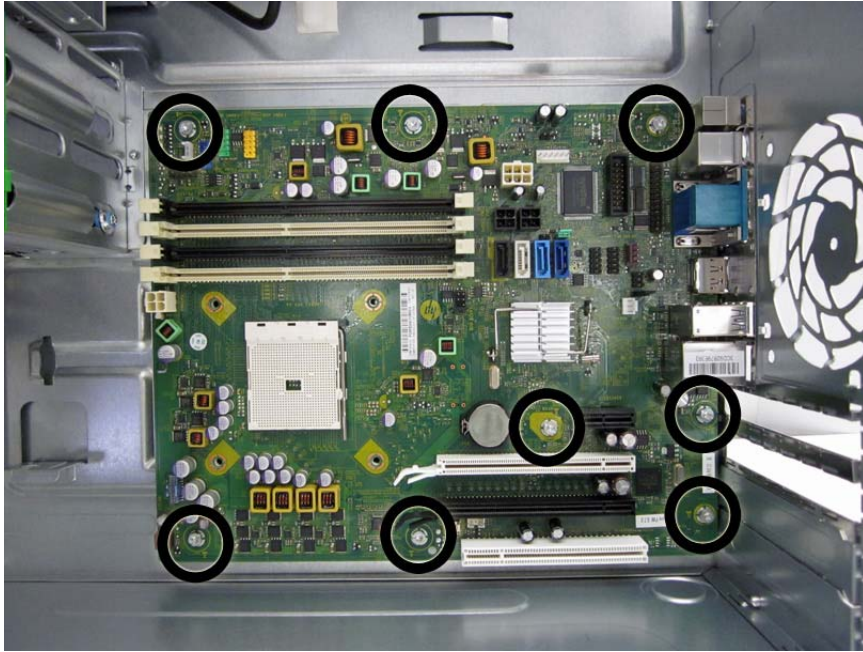

7. Slide the system board toward the front of the computer to disengage the I/O panel, lift the rear of the system board up at an angle, and then lift the system board out of the computer.

**Figure 6-47** Removing the system board

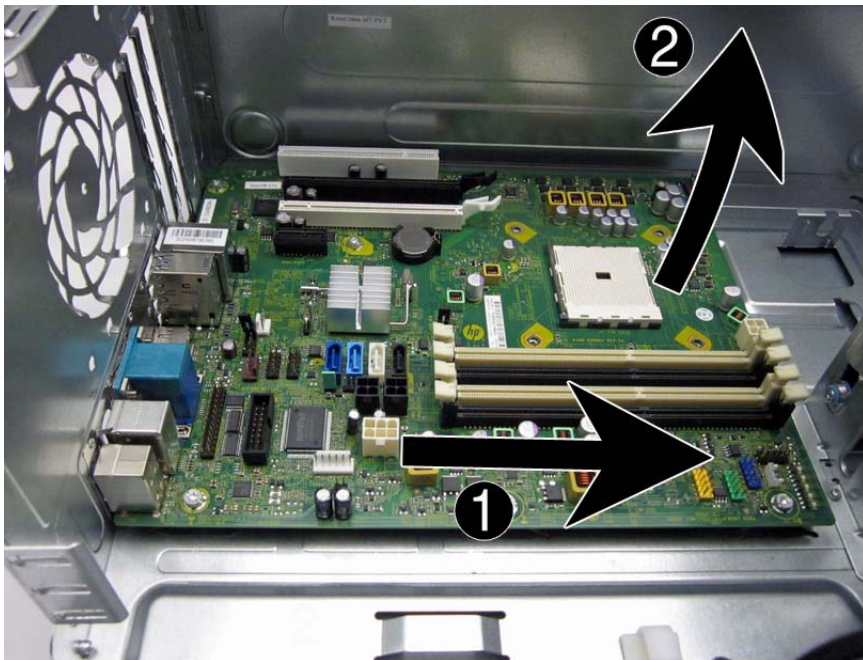

When reinstalling the system board, first insert the I/O panel back into the slots in the rear of the chassis, and then align the board with the chassis screw holes.



---

**NOTE:** When replacing the system board, you must change the chassis serial number in the BIOS.

---

---

# 7 Removal and Replacement Procedures Small Form Factor (SFF) Chassis

Adherence to the procedures and precautions described in this chapter is essential for proper service. After completing all necessary removal and replacement procedures, run the Diagnostics utility to verify that all components operate properly.

---

 **NOTE:** Not all features listed in this guide are available on all computers.

---

## Preparation for Disassembly

See [Routine Care, SATA Drive Guidelines, and Disassembly Preparation on page 45](#) for initial safety procedures.

1. Remove/disengage any security devices that prohibit opening the computer.
2. Close any open software applications.
3. Exit the operating system.
4. Remove any compact disc or media card from the computer.
5. Turn off the computer and any peripheral devices that are connected to it.

---

 **CAUTION:** Turn off the computer before disconnecting any cables.

Regardless of the power-on state, voltage is always present on the system board as long as the system is plugged into an active AC outlet. In some systems the cooling fan is on even when the computer is in the "Standby," or "Suspend" modes. The power cord should always be disconnected before servicing a unit.

---

6. Disconnect the power cord from the electrical outlet and then from the computer.
7. Disconnect all peripheral device cables from the computer.

---

 **NOTE:** During disassembly, label each cable as you remove it, noting its position and routing. Keep all screws with the units removed.

 **CAUTION:** The screws used in the computer are of different thread sizes and lengths; using the wrong screw in an application may damage the unit.

---

# Access Panel

Description	Spare part number
Access panel	646815-001

1. Prepare the computer for disassembly ([Preparation for Disassembly on page 99](#)).
2. If the computer is on a stand, remove the computer from the stand.
3. Lift up on the access panel handle **(1)** then lift the access panel off the computer **(2)**.

**Figure 7-1** Removing the access panel

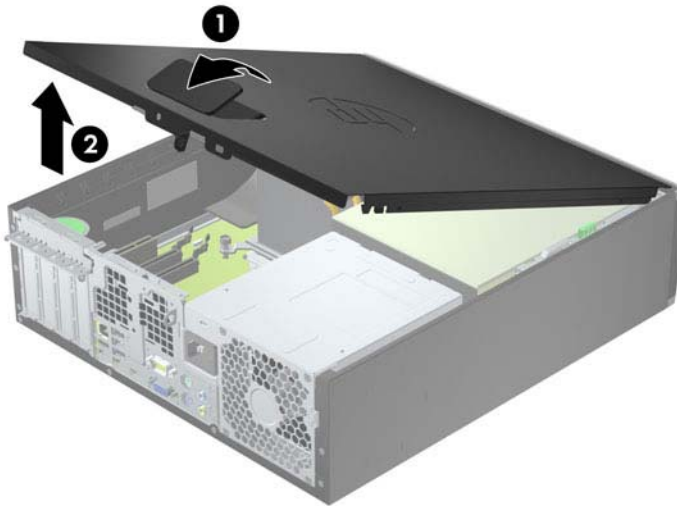

To install the access panel, reverse the removal procedure.

# Front Bezel

Description	Spare part number
Front bezel	687950-001

1. Prepare the computer for disassembly ([Preparation for Disassembly on page 99](#)).
2. Remove the access panel ([Access Panel on page 100](#)).
3. Lift up the three tabs on the side of the bezel **(1)**, then rotate the bezel off the chassis **(2)**.

**Figure 7-2** Removing the front bezel

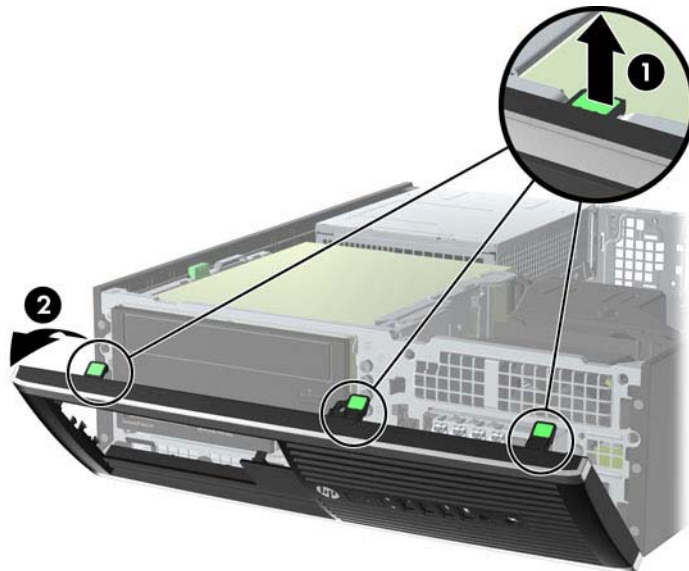

To install the front bezel, reverse the removal procedure.

# Front Bezel Security

The front bezel can be locked in place by installing a security screw provided by HP. To install the security screw:

1. Remove/disengage any security devices that prohibit opening the computer.
2. Remove all removable media, such as compact discs or USB flash drives, from the computer.
3. Turn off the computer properly through the operating system, then turn off any external devices.
4. Disconnect the power cord from the power outlet and disconnect any external devices.

**⚠ CAUTION:** Regardless of the power-on state, voltage is always present on the system board as long as the system is plugged into an active AC outlet. You must disconnect the power cord to avoid damage to the internal components of the computer.

5. If the computer is on a stand, remove the computer from the stand.
6. Remove the access panel and front bezel.
7. Remove one of the five silver 6-32 standard screws located on the front of the chassis behind the bezel.

**Figure 7-3** Retrieving the Front Bezel Security Screw



8. Replace the front bezel.



9. Install the security screw next to the middle front bezel release tab to secure the front bezel in place.

**Figure 7-4** Installing the Front Bezel Security Screw

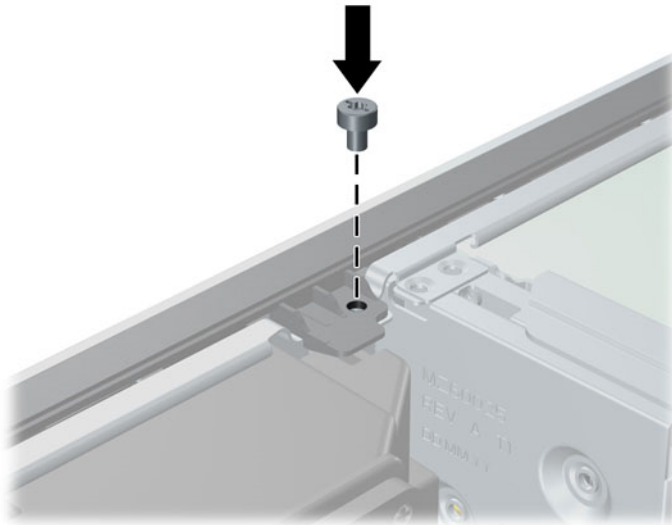

10. Replace the access panel.
11. If the computer was on a stand, replace the stand.
12. Reconnect the power cord and turn on the computer.
13. Lock any security devices that were disengaged when the access panel was removed.

## Bezel Blanks

Description	Spare part number
3.5-inch bezel blank	583653-001
5.25-inch bezel blank, optical drive	570838-001

On some models, there are bezel blanks covering the 3.5-inch and 5.25-inch external drive bays that need to be removed before installing a drive. To remove a bezel blank:

1. Remove the access panel ([Access Panel on page 100](#)).
2. Remove the front bezel ([Front Bezel on page 101](#)).
3. To remove a bezel blank, push the two retaining tabs that hold the bezel blank in place towards the outer right edge of the bezel **(1)** and slide the bezel blank back and to the right to remove it **(2)**.

**Figure 7-5** Removing a bezel blank

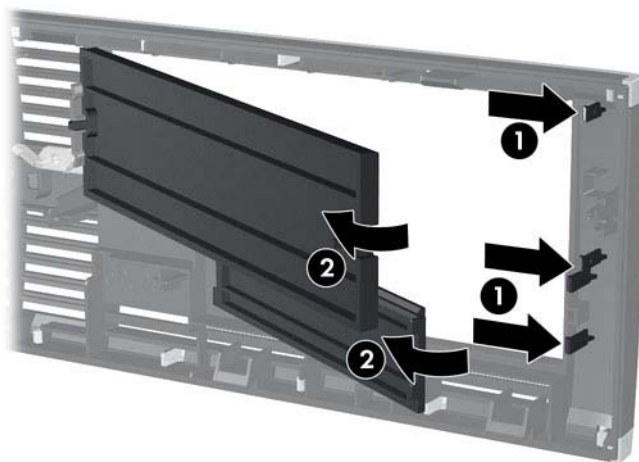

4. Replace the front bezel.

# Memory

Description	Spare part number
8-GB, PC3-12800	689375-001
4-GB, PC3-12800	671613-001
2-GB, PC3-12800	671612-001

The computer comes with double data rate 3 synchronous dynamic random access memory (DDR3-SDRAM) dual inline memory modules (DIMMs).

## DIMMs

The memory sockets on the system board can be populated with up to four industry-standard DIMMs. These memory sockets are populated with at least one preinstalled DIMM. To achieve the maximum memory support, you can populate the system board with up to 32-GB of memory configured in a high-performing dual channel mode.

## DDR3-SDRAM DIMMs

**⚠ CAUTION:** This product DOES NOT support DDR3 Ultra Low Voltage (DDR3U) memory. The processor is not compatible with DDR3U memory and if you plug DDR3U memory into the system board, it can cause the physical damage to the DIMM or invoke system malfunction.

For proper system operation, the DDR3-SDRAM DIMMs must be:

- industry-standard 240-pin
- unbuffered non-ECC PC3-PC12800 DDR3-1600 MHz-compliant
- 1.35 volt or 1.5 volt DDR3/DDR3L-SDRAM DIMMs

The DDR3-SDRAM DIMMs must also:

- support CAS latency 11 DDR3 1600 MHz (11-11-11 timing)
- contain the mandatory JEDEC SPD information

In addition, the computer supports:

- 512-Mbit, 1-Gbit, 2-Gbit, 4-Gbit, and 8-Gbit non-ECC memory technologies
- single-sided and double-sided DIMMs
- DIMMs constructed with x8 and x16 DDR devices; DIMMs constructed with x4 SDRAM are not supported

**📄 NOTE:** The system will not operate properly if you install unsupported DIMMs.

## Populating DIMM Sockets

There are four DIMM sockets on the system board, with two sockets per channel. The sockets are labeled DIMM1, DIMM2, DIMM3, and DIMM4. Sockets DIMM1 and DIMM2 operate in memory channel B. Sockets DIMM3 and DIMM4 operate in memory channel A.

The system will automatically operate in single channel mode, dual channel mode, or flex mode, depending on how the DIMMs are installed.

---

 **NOTE:** Single channel and unbalanced dual channel memory configurations will result in inferior graphics performance.

---

- The system will operate in single channel mode if the DIMM sockets are populated in one channel only.
- The system will operate in a higher-performing dual channel mode if the total memory capacity of the DIMMs in Channel A is equal to the total memory capacity of the DIMMs in Channel B. The technology and device width can vary between the channels. For example, if Channel A is populated with two 1-GB DIMMs and Channel B is populated with one 2-GB DIMM, the system will operate in dual channel mode.
- The system will operate in flex mode if the total memory capacity of the DIMMs in Channel A is not equal to the total memory capacity of the DIMMs in Channel B. In flex mode, the channel populated with the least amount of memory describes the total amount of memory assigned to dual channel and the remainder is assigned to single channel. For optimal speed, the channels should be balanced so that the largest amount of memory is spread between the two channels. If one channel will have more memory than the other, the larger amount should be assigned to Channel A. For example, if you are populating the sockets with one 2-GB DIMM, and three 1-GB DIMMs, Channel A should be populated with the 2-GB DIMM and one 1-GB DIMM, and Channel B should be populated with the other two 1-GB DIMMs. With this configuration, 4-GB will run as dual channel and 1-GB will run as single channel.
- In any mode, the maximum operational speed is determined by the slowest DIMM in the system.

## Installing DIMMs

---

**⚠ CAUTION:** You must disconnect the power cord and wait approximately 30 seconds for the power to drain before adding or removing memory modules. Regardless of the power-on state, voltage is always supplied to the memory modules as long as the computer is plugged into an active AC outlet. Adding or removing memory modules while voltage is present may cause irreparable damage to the memory modules or system board.

The memory module sockets have gold-plated metal contacts. When upgrading the memory, it is important to use memory modules with gold-plated metal contacts to prevent corrosion and/or oxidation resulting from having incompatible metals in contact with each other.

Static electricity can damage the electronic components of the computer or optional cards. Before beginning these procedures, ensure that you are discharged of static electricity by briefly touching a grounded metal object. For more information, refer to [Electrostatic Discharge Information on page 45](#).

When handling a memory module, be careful not to touch any of the contacts. Doing so may damage the module.

---

1. Prepare the computer for disassembly ([Preparation for Disassembly on page 99](#)).
2. Remove the access panel ([Access Panel on page 100](#)).
3. Rotate up the internal drive bay housing to access the memory module sockets on the system board.

4. Open both latches of the memory module socket **(1)**, and insert the memory module into the socket **(2)**.

**Figure 7-6** Installing a DIMM

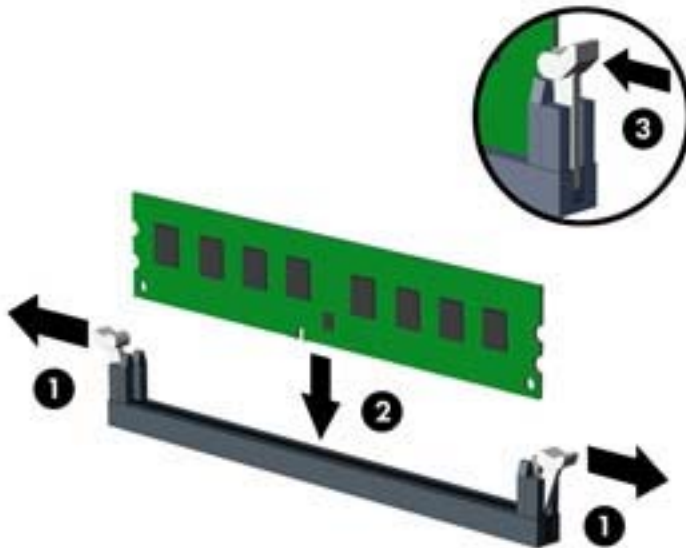

 **NOTE:** A memory module can be installed in only one way. Match the notch on the module with the tab on the memory socket.

Populate the black DIMM sockets before the white DIMM sockets.

For maximum performance, populate the sockets so that the memory capacity is spread as equally as possible between Channel A and Channel B. Refer to [Populating DIMM Sockets on page 106](#) for more information.

5. Push the module down into the socket, ensuring that the module is fully inserted and properly seated. Make sure the latches are in the closed position **(3)**.
6. Repeat steps 4 and 5 to install any additional modules.
7. Replace the access panel.
8. If the computer was on a stand, replace the stand.
9. Reconnect the power cord and turn on the computer.
10. Lock any security devices that were disengaged when the access panel was removed.

The computer should automatically recognize the additional memory the next time you turn on the computer.

# Expansion Card

Description	Spare part number
AMD HD8490 PCIe x16 graphics card, 1 GB (for use with Windows 8)	717219-001
nVidia Quadro NVS315 PCIe x16 graphics card, 1 GB (for use with Windows 8)	720837-001
GeForce GT630 PCIe x16 graphics card, 2 GB (for use only with Windows 8)	702084-001
nVidia Quadro NVS310 PCIe x16 graphics card, 512 MB (for use only with Windows 8)	707252-001
nVidia Quadro NVS300 PCIe x16 graphics card, 512 MB (for use only with Windows 8)	700578-001
AMD Radeon HD7450 PCIe x16 graphics card, 1 GB (for use only in China)	702646-001
AMD Radeon HD7450 PCIe x16 graphics card, 1 GB (for use only with Windows 8)	702647-001
AMD Radeon HD7450 PCIe x16 graphics card, 1 GB (includes adapter; not for use with Windows 8)	682411-001
AMD Radeon HD6350 PCIe x16 graphics card, 512 MB (for use only with Windows 8)	697246-001
AMD Radeon HD6350 PCIe x16 graphics card, 512 MB (not for use with Windows 8)	637995-001
HP WLAN 802.11 g/n 1x2 PCIe NIC	538048-001
Intel PRO/1000, single port, GbE, NIC	728562-001
HP USB 3.0 SuperSpeed PCIe x1 card	663213-001
HP USB 3.0 SuperSpeed power extension cable (for use with 663213-001)	663214-001

The computer has one PCI expansion slot, one PCI Express x1 expansion slot, one PCI Express x16 expansion slot, and one PCI Express x16 expansion slot that is downshifted to a x4 slot.

 **NOTE:** The PCI and PCI Express slots support only low profile cards.

You can install a PCI Express x1, x4, x8, or x16 expansion card in the PCI Express x16 slot.

For dual graphics card configurations, the first (primary) card must be installed in the PCI Express x16 slot that is NOT downshifted to a x4.

To remove, replace, or add an expansion card:

1. Prepare the computer for disassembly ([Preparation for Disassembly on page 99](#)).
2. Remove the access panel ([Access Panel on page 100](#)).
3. Locate the correct vacant expansion socket on the system board and the corresponding expansion slot on the back of the computer chassis.

4. Release the slot cover retention latch that secures the PCI slot covers by lifting the green tab on the latch and rotating the latch to the open position.

**Figure 7-7** Opening the Expansion Slot Retainer



5. Before installing an expansion card, remove the expansion slot cover or the existing expansion card.

---

 **NOTE:** Before removing an installed expansion card, disconnect any cables that may be attached to the expansion card.

---

- a. If you are installing an expansion card in a vacant socket, remove the appropriate expansion slot cover on the back of the chassis. Pull the slot cover straight up then away from the inside of the chassis.

**Figure 7-8** Removing an Expansion Slot Cover

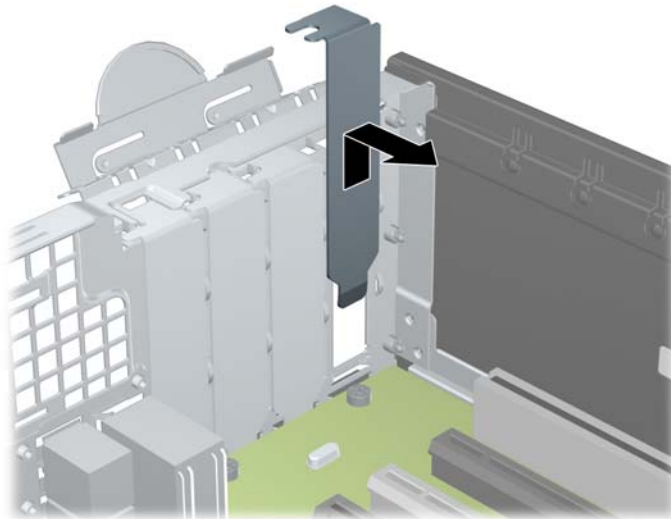



- b. If you are removing a standard PCI card or PCI Express x1 card, hold the card at each end, and carefully rock it back and forth until the connectors pull free from the socket. Pull the expansion card straight up from the socket **(1)** then away from the inside of the chassis to release it from the chassis frame **(2)**. Be sure not to scrape the card against the other components.

**Figure 7-9** Removing a Standard PCI Expansion Card

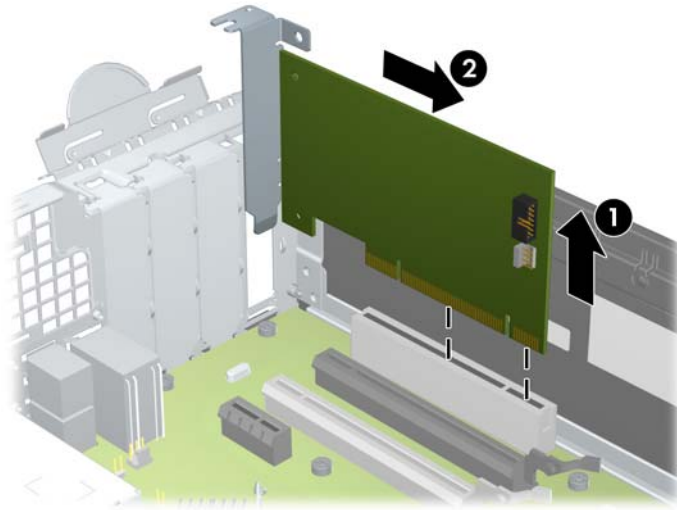

- c. If you are removing a PCI Express x16 card, pull the retention arm on the back of the expansion socket away from the card and carefully rock the card back and forth until the connectors pull free from the socket. Pull the expansion card straight up from the socket then away from the inside of the chassis to release it from the chassis frame. Be sure not to scrape the card against the other components.

**Figure 7-10** Removing a PCI Express x16 Expansion Card

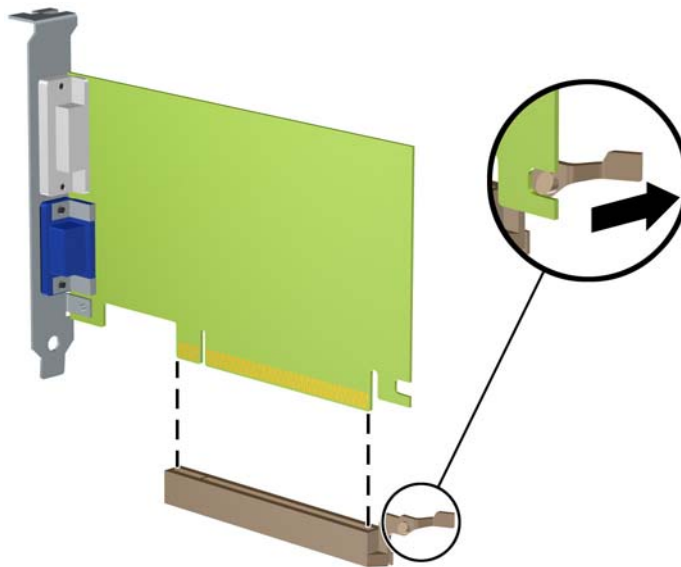

- 6. Store the removed card in anti-static packaging.

7. If you are not installing a new expansion card, install an expansion slot cover to close the open slot.

**⚠ CAUTION:** After removing an expansion card, you must replace it with a new card or expansion slot cover for proper cooling of internal components during operation.

8. To install a new expansion card, hold the card just above the expansion socket on the system board then move the card toward the rear of the chassis **(1)** so that the bracket on the card is aligned with the open slot on the rear of the chassis. Press the card straight down into the expansion socket on the system board **(2)**.

**Figure 7-11** Installing an Expansion Card

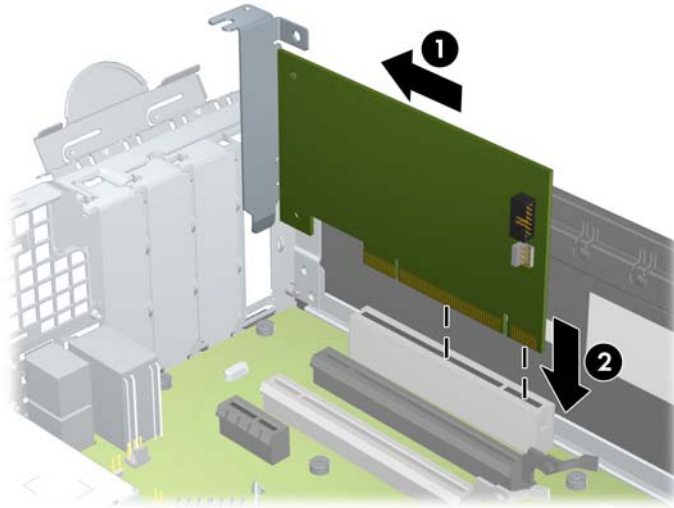

**📝 NOTE:** When installing an expansion card, press firmly on the card so that the whole connector seats properly in the expansion card slot.

9. Rotate the slot cover retention latch back in place to secure the expansion card.

**Figure 7-12** Closing the Expansion Slot Retainer

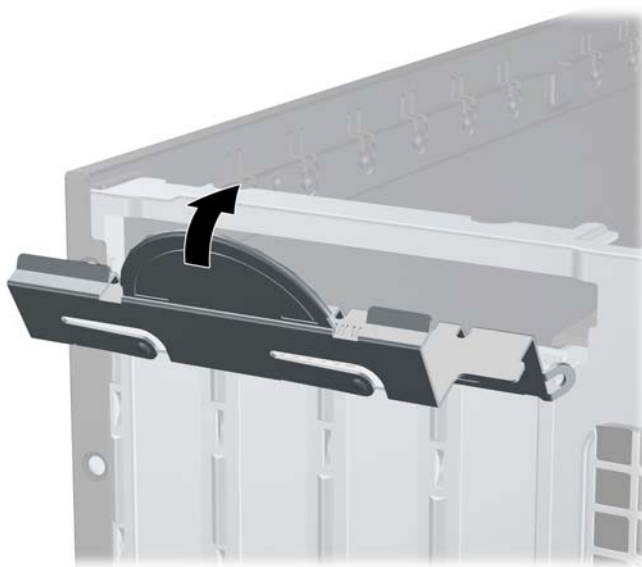

10. Connect external cables to the installed card, if needed. Connect internal cables to the system board, if needed.
11. Replace the computer access panel.
12. If the computer was on a stand, replace the stand.
13. Reconnect the power cord and turn on the computer.
14. Lock any security devices that were disengaged when the access panel was removed.
15. Reconfigure the computer, if necessary.

## WLAN module

Description	Spare part number
Intel® Centrino™ Advanced-N 6205, 802.11a/b/g/n WLAN module	695915-001

**CAUTION:** To prevent an unresponsive system, replace the wireless module only with a wireless module authorized for use in the computer by the governmental agency that regulates wireless devices in your country or region. If you replace the module and then receive a warning message, remove the module to restore device functionality, and then contact technical support.

Before removing the WLAN module, follow these steps:

1. Prepare the computer for disassembly ([Preparation for Disassembly on page 54](#))
2. Remove the access panel ([Access Panel on page 100](#))

Remove the WLAN module:

1. Disconnect the WLAN antenna cables **(1)** from the terminals on the WLAN module.

**NOTE:** The WLAN antenna cable labeled "1" connects to the WLAN module "Main" terminal labeled "1". The WLAN antenna cable labeled "2" connects to the WLAN module "Aux" terminal labeled "2". If the computer is equipped with an 802.11a/b/g/n WLAN module, the yellow WLAN antenna cable connects to the middle terminal on the WLAN module.

2. Remove the two Phillips PM2.0×3.0 screws **(2)** that secure the WLAN module to the system board. (The WLAN module tilts up.)

3. Remove the WLAN module (**3**) by pulling the module away from the slot at an angle.

 **NOTE:** WLAN modules are designed with a notch to prevent incorrect insertion of the WLAN module into the WLAN module slot.

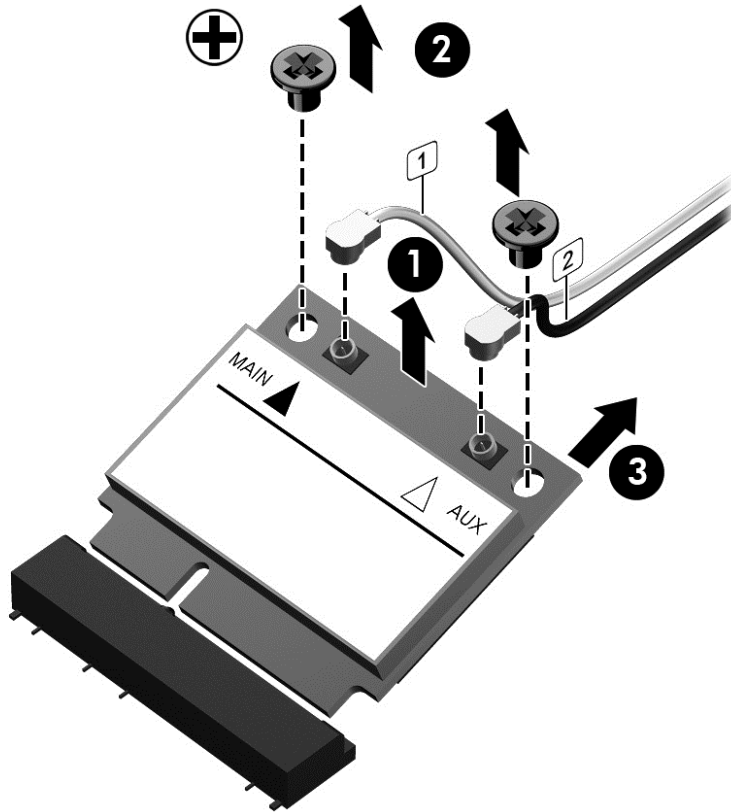

Reverse this procedure to install the WLAN module.

# System Board Connections

Refer to the following illustration and table to identify the system board connectors for your model.

**Figure 7-13** System Board Connections

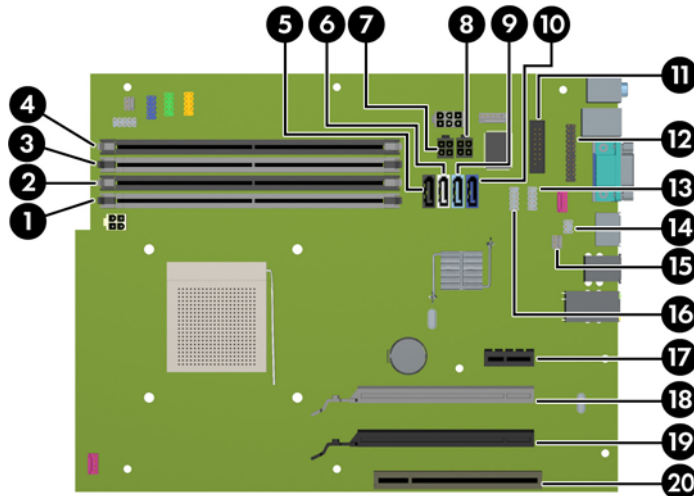

**Table 7-1** System Board Connections

No.	System Board Connector	System Board Label	Color	Component
1	DIMM4 (Channel A)	DIMM4	white	Memory Module
2	DIMM3 (Channel A)	DIMM3	black	Memory Module
3	DIMM2 (Channel B)	DIMM2	white	Memory Module
4	DIMM1 (Channel B)	DIMM1	black	Memory Module
5	eSATA	ESATA	black	eSATA Adapter Cable
6	SATA 2.0	SATA2	white	1st Optical Drive
7	Power	SATAS_PWR2	black	(unused)
8	Power	SATAS_PWR1	black	SATA Optical and Hard Drives
9	SATA 3.0	SATA1	light blue	2nd Hard Drive
10	SATA 3.0	SATA0	dark blue	1st Hard Drive
11	Serial Port	COMB	black	Serial Port
12	Parallel Port	PAR	black	Parallel Port
13	USB	MEDIA2	black	Second Media Card Reader
14	Hood Lock	HLCK	black	USB Device, such as a Media Card Reader
15	Hood Sensor	HSENSE	white	Hood Sensor
16	USB	MEDIA	black	USB Device, such as a Media Card Reader

**Table 7-1 System Board Connections (continued)**

No.	System Board Connector	System Board Label	Color	Component
17	PCI Express x1	X1PCIEXP1	black	Expansion Card
18	PCI Express x16 downshifted to a x4	X4PCIEXP	white	Expansion Card
19	PCI Express x16	X16PCIEXP	black	Expansion Card
20	PCI	PCI1	white	Expansion Card

## Drives

Description	Spare part number
DVD±RW drive	660408-001 690418-001
DVD-ROM drive	682550-001
Blu-ray BD-Writer XL Drive	682219-001
1 TB hybrid hard drive (8-GB SSD)	724937-001
1 TB, 7200 rpm SATA hard drive	636930-001
500 GB hybrid hard drive (8-GB SSD)	724938-001
500 GB, 7200 rpm, 2.5 inch, SED, SATA hard drive	696442-001
500 GB, 7200 rpm SATA hard drive	636929-001
320 GB, 7200 rpm SATA hard drive, 2.5-inch	634824-001
250 GB, 7200 rpm SATA hard drive	636927-001
256 GB Solid State Drive (SSD), self-encrypting (SED)	680020-001
160 GB Solid State Drive (SSD)	646809-001
128 GB Solid State Drive (SSD)	665961-001
120 GB Solid State Drive (SSD)	661841-001

## Drive Positions

**Figure 7-14** Drive Positions

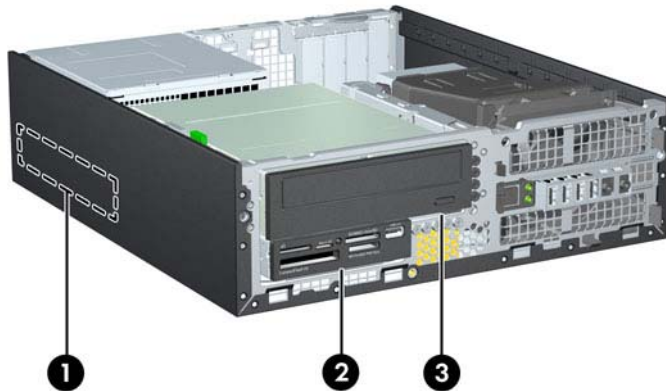

**Table 7-2** Drive Positions

1	3.5-inch internal hard drive bay
2	3.5-inch drive bay for optional drives (media card reader shown)
3	5.25-inch drive bay for optional drives (optical drive shown)

**NOTE:** The drive configuration on your computer may be different than the drive configuration shown above.

To verify the type and size of the storage devices installed in the computer, run Computer Setup.

## Installing and Removing Drives

When installing drives, follow these guidelines:

- The primary Serial ATA (SATA) hard drive must be connected to the dark blue primary SATA connector on the system board labeled SATA0. If you are adding a second hard drive, connect it to the light blue connector on the system board labeled SATA1.
- Connect a SATA optical drive to the white SATA connector on the system board labeled SATA2.
- Connect an optional eSATA adapter cable to the black SATA connector on the system board labeled ESATA.
- Connect a media card reader USB cable to the USB connector on the system board labeled MEDIA.
- The power cable for the SATA drives is a three-headed cable that is plugged into the system board with the first connector routed to the rear of the hard drive, the second connector routed to the rear of the 3.5" drive, and the third connector routed to the rear of the 5.25" optical drive.
- The system does not support Parallel ATA (PATA) optical drives or PATA hard drives.
- You must install guide screws to ensure the drive will line up correctly in the drive cage and lock in place. HP has provided extra guide screws for the drive bays (five 6-32 standard screws and four M3 metric screws), installed in the front of the chassis, under the front bezel. The 6-32 standard screws are required for a secondary hard drive. All other drives (except the primary hard drive)

use M3 metric screws. The HP-supplied metric screws are black and the HP-supplied standard screws are silver. If you are replacing the primary hard drive, you must remove the four silver and blue 6-32 isolation mounting guide screws from the old hard drive and install them in the new hard drive.

**Figure 7-15** Extra Guide Screw Locations

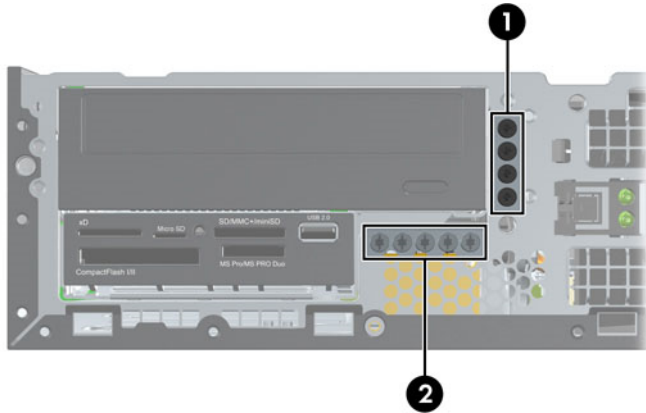

No.	Guide Screw	Device
1	Black M3 Metric Screws	All Drives (except primary and secondary hard drives)
2	Silver 6-32 Standard Screws	Secondary Hard Drive

There are a total of five extra silver 6-32 standard screws. Four are used as guide screws for a secondary hard drive. The fifth is used for bezel security (see [Front Bezel Security on page 102](#) for more information).

**CAUTION:** To prevent loss of work and damage to the computer or drive:

If you are inserting or removing a drive, shut down the operating system properly, turn off the computer, and unplug the power cord. Do not remove a drive while the computer is on or in standby mode.

Before handling a drive, ensure that you are discharged of static electricity. While handling a drive, avoid touching the connector.

Handle a drive carefully; do not drop it.

Do not use excessive force when inserting a drive.

Avoid exposing a hard drive to liquids, temperature extremes, or products that have magnetic fields such as monitors or speakers.

If a drive must be mailed, place the drive in a bubble-pack mailer or other protective packaging and label the package "Fragile: Handle With Care."



## Removing a 5.25-inch Drive from a Drive Bay

**⚠ CAUTION:** All removable media should be taken out of a drive before removing the drive from the computer.

1. Prepare the computer for disassembly ([Preparation for Disassembly on page 99](#)).
2. Remove the access panel ([Access Panel on page 100](#)).
3. Rotate the drive cage to its upright position.
4. If removing an optical drive, disconnect the power cable and data cable from the rear of the optical drive.

**⚠ CAUTION:** When removing the cables, pull the tab or connector instead of the cable itself to avoid damaging the cable.

5. Rotate the drive cage back down to its normal position.

**⚠ CAUTION:** Be careful not to pinch any cables or wires when rotating the drive cage down.

6. Press down on the green drive retainer button located on the left side of the drive to disengage the drive from the drive cage **(1)**. While pressing the drive retainer button, slide the drive back until it stops, then lift it up and out of the drive cage **(2)**.

**Figure 7-16** Removing the 5.25-inch Drive

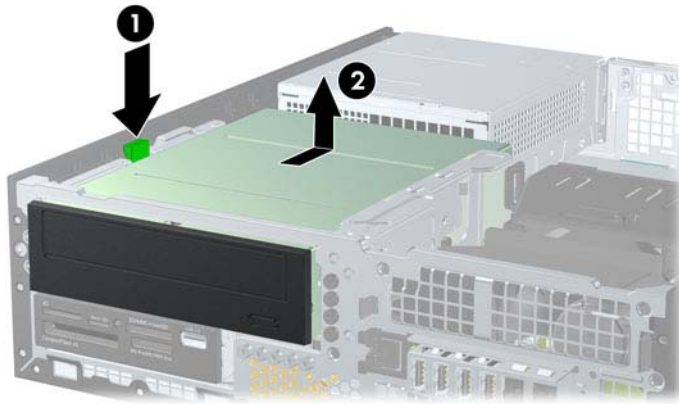

## Installing a 5.25-inch Drive into a Drive Bay

1. Prepare the computer for disassembly ([Preparation for Disassembly on page 99](#)).
2. Remove the access panel ([Access Panel on page 100](#)).
3. If you are installing a drive in a bay covered by a bezel blank, remove the front bezel then remove the bezel blank. See [Bezel Blanks on page 104](#) for more information.

4. Install four M3 metric guide screws in the lower holes on each side of the drive. HP has provided four extra M3 metric guide screws on the front of the chassis, under the front bezel. The M3 metric guide screws are black. Refer to [Installing and Removing Drives on page 117](#) for an illustration of the extra M3 metric guide screws location.

 **NOTE:** When replacing the drive, transfer the four M3 metric guide screws from the old drive to the new one.

 **CAUTION:** Use only 5-mm long screws as guide screws. Longer screws can damage the internal components of the drive.

**Figure 7-17** Installing Guide Screws in the Optical Drive



5. Position the guide screws on the drive into the J-slots in the drive bay. Then slide the drive toward the front of the computer until it locks into place.

**Figure 7-18** Installing the Optical Drive

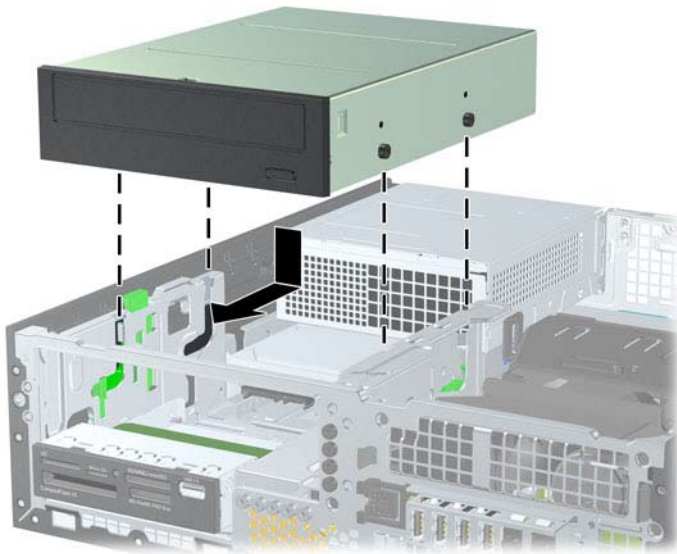

6. Rotate the drive cage to its upright position.
7. Connect the SATA data cable to the white SATA system board connector labeled SATA2.
8. Route the data cable through the cable guides.

 **CAUTION:** There are two cable guides that keep the data cable from being pinched by the drive cage when raising or lowering it. One is located on the bottom side of the drive cage. The other is located on the chassis frame under the drive cage. Ensure that the data cable is routed through these guides before connecting it to the optical drive.

9. Connect the power cable and data cable to the rear of the optical drive.

 **NOTE:** The power cable for the optical drive is a three-headed cable that is routed from the system board to the hard drive, then to the rear of the optical drive.

10. Rotate the drive cage back down to its normal position.

 **CAUTION:** Be careful not to pinch any cables or wires when rotating the drive cage down.

11. Replace the front bezel (if removed) and access panel.
12. If the computer was on a stand, replace the stand.
13. Reconnect the power cord and turn on the computer.
14. Lock any security devices that were disengaged when the access panel was removed.

## Removing a 3.5-inch Drive from a Drive Bay

 **CAUTION:** All removable media should be taken out of a drive before removing the drive from the computer.

The 3.5-inch drive is located underneath the 5.25-inch drive. You must remove the 5.25-inch drive before removing the 3.5-inch drive.

1. Follow the procedure in [Removing a 5.25-inch Drive from a Drive Bay on page 119](#) to remove the 5.25-inch drive and access the 3.5-inch drive.

 **CAUTION:** Ensure that the computer is turned off and that the power cord is disconnected from the electrical outlet before proceeding.

2. Disconnect the drive cables from the rear of the drive, or, if you are removing a media card reader, disconnect the USB cable from the system board as indicated in the following illustration.

**Figure 7-19** Disconnecting the Media Card Reader USB Cable

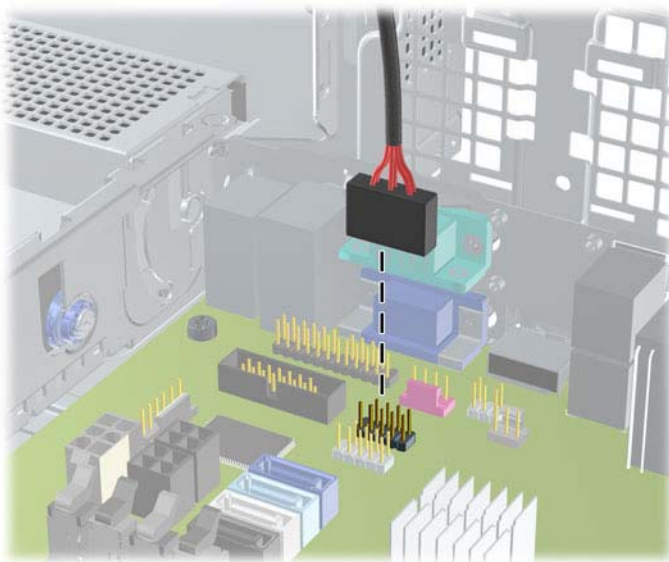

3. Press down on the green drive retainer button located on the left side of the drive to disengage the drive from the drive cage (1). While pressing the drive retainer button, slide the drive back until it stops, then lift it up and out of the drive cage (2).

**Figure 7-20** Removing a 3.5-inch Drive (Media Card Reader Shown)

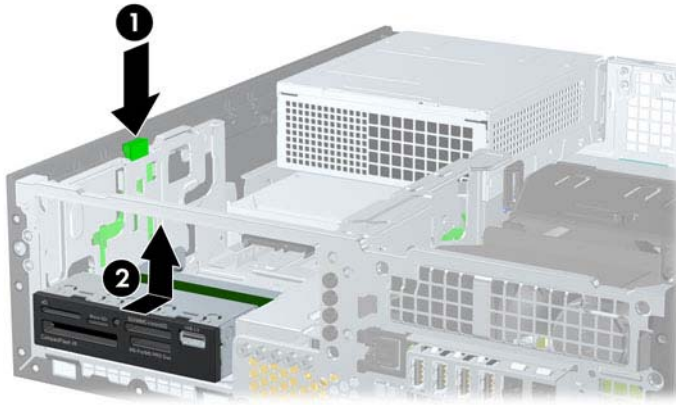

## Installing a 3.5-inch Drive into a Drive Bay

The 3.5-inch bay is located underneath the 5.25-inch drive. To install a drive into the 3.5-inch bay:

 **NOTE:** Install guide screws to ensure the drive will line up correctly in the drive cage and lock in place. HP has provided extra guide screws for the drive bays (four 6-32 standard screws and four M3 metric screws), installed in the front of the chassis, under the front bezel. A secondary hard drive uses 6-32 standard screws. All other drives (except the primary hard drive) use M3 metric screws. The HP-supplied M3 metric screws are black and the HP-supplied 6-32 standard screws are silver. Refer to [Installing and Removing Drives on page 117](#) for illustrations of the guide screw locations.

1. Follow the procedure in [Removing a 5.25-inch Drive from a Drive Bay on page 119](#) to remove the 5.25-inch drive and access the 3.5-inch drive bay.

 **CAUTION:** Ensure that the computer is turned off and that the power cord is disconnected from the electrical outlet before proceeding.

2. If you are installing a drive in a bay covered by a bezel blank, remove the front bezel then remove the bezel blank. See [Bezel Blanks on page 104](#) for more information.
3. Install guide screws in the holes on each side of the drive.

**Figure 7-21** Installing Guide Screws (Media Card Reader Shown)



4. Position the guide screws on the drive into the J-slots in the drive bay. Then slide the drive toward the front of the computer until it locks into place.

**Figure 7-22** Installing a Drive into the 3.5-inch Drive Bay (Media Card Reader Shown)

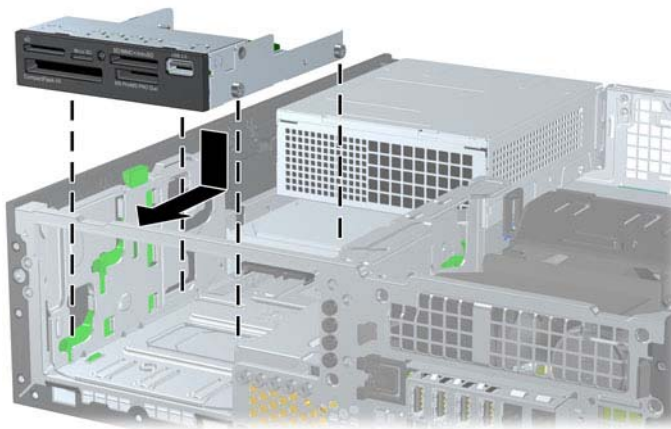

5. Connect the appropriate drive cables:
  - a. If installing a second hard drive, connect the power cable (1) and data cable (2) to the rear of the drive and connect the other end of the data cable to the light blue connector on the system board labeled SATA1.

**Figure 7-23** Connecting the Secondary Hard Drive Power Cable and Data Cable

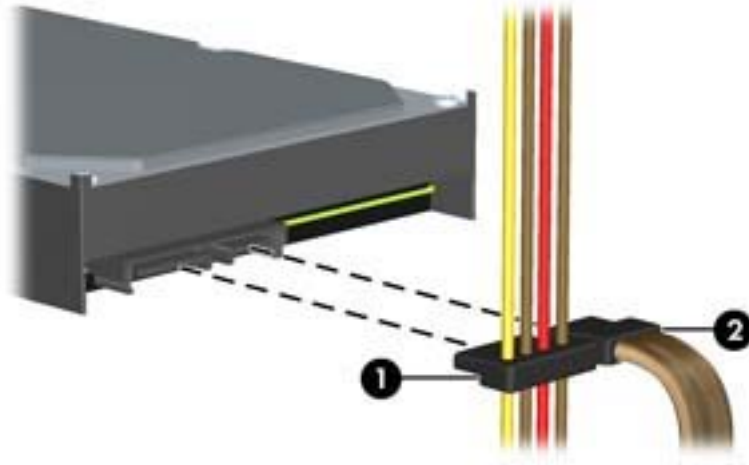

- b. If installing a media card reader, connect the USB cable from the media card reader to the USB connector on the system board labeled MEDIA.

**Figure 7-24** Connecting the Media Card Reader USB Cable

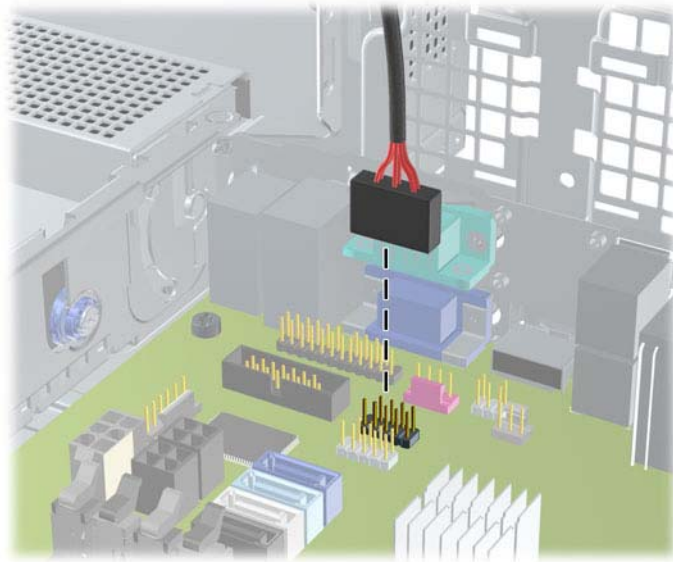

 **NOTE:** Refer to [System Board Connections on page 115](#) for an illustration of the system board drive connectors.

6. Replace the 5.25-inch drive.
7. Replace the front bezel (if removed) and access panel.
8. If the computer was on a stand, replace the stand.

9. Reconnect the power cord and turn on the computer.
10. Lock any security devices that were disengaged when the access panel was removed.

## Removing and Replacing the Primary 3.5-inch Internal Hard Drive

 **NOTE:** Before you remove the old hard drive, be sure to back up the data from the old hard drive so that you can transfer the data to the new hard drive.

The preinstalled 3.5-inch hard drive is located under the power supply. To remove and replace the hard drive:

1. Prepare the computer for disassembly ([Preparation for Disassembly on page 99](#)).
2. Remove the access panel ([Access Panel on page 100](#)).
3. Rotate the drive cage for internal drives to its upright position.
4. Rotate the power supply to its upright position. The hard drive is located beneath the power supply.

**Figure 7-25** Raising the Power Supply

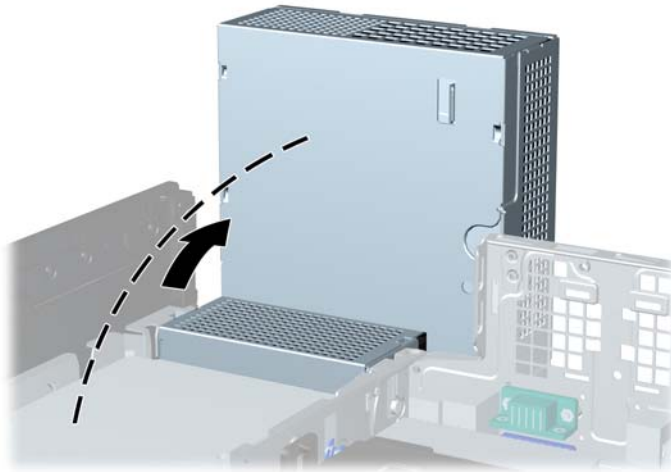

5. Disconnect the power cable and data cable from the back of the hard drive.

6. Press down on the green release latch next to the hard drive **(1)**. While holding the latch down, slide the drive forward until it stops, then lift the drive up and out of the bay **(2)**.

**Figure 7-26** Removing the Hard Drive

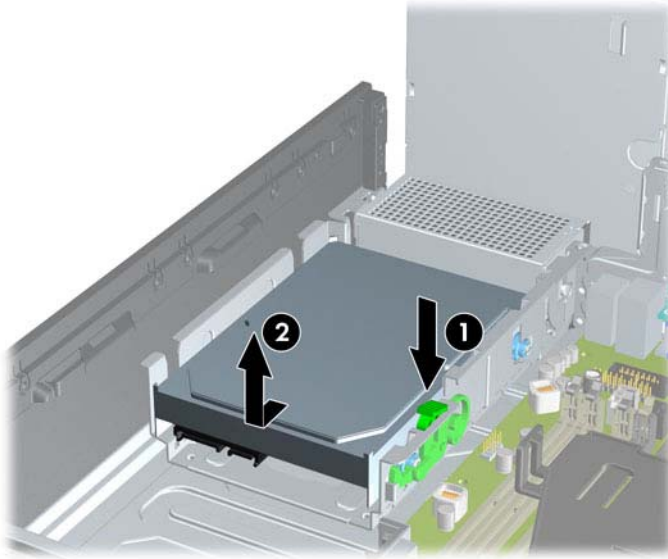

7. To install a hard drive, you must transfer the silver and blue isolation mounting guide screws from the old hard drive to the new hard drive.

**Figure 7-27** Installing Hard Drive Guide Screws

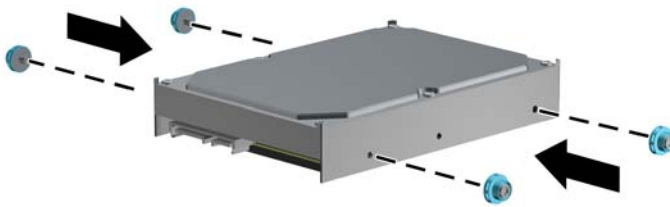



8. Align the guide screws with the slots on the chassis drive cage, press the hard drive down into the bay, then slide it back until it stops and locks in place.

**Figure 7-28** Installing the Hard Drive

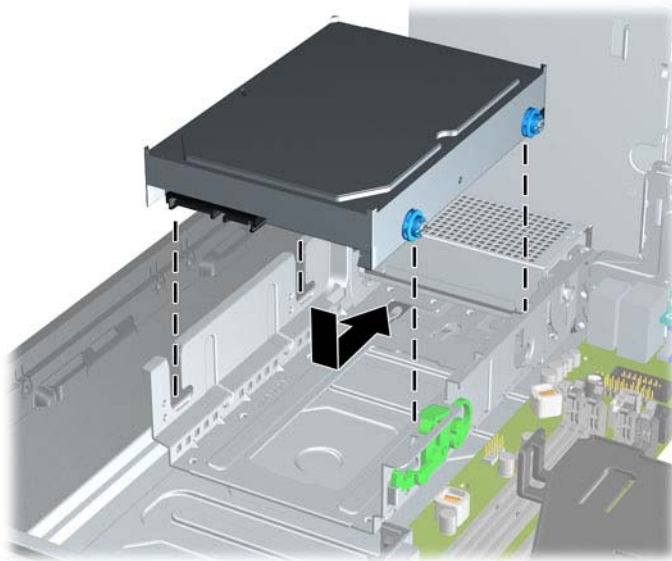

9. Connect the power cable and data cable to the back of the hard drive.

---

 **NOTE:** If the system has only one SATA hard drive, the data cable must be connected to the dark blue connector labeled SATA0 on the system board to avoid any hard drive performance problems.

---

10. Rotate the drive cage for internal drives and the power supply down to their normal positions.
11. Replace the access panel.
12. If the computer was on a stand, replace the stand.
13. Reconnect the power cord and turn on the computer.
14. Lock any security devices that were disengaged when the access panel was removed.

## Removing and Replacing a Removable 3.5-inch SATA Hard Drive

Some models are equipped with a Removable SATA Hard Drive Enclosure in the 5.25-inch internal drive bay. The hard drive is housed in a carrier that can be quickly and easily removed from the drive bay. To remove and replace a drive in the carrier:

---

 **NOTE:** Before you remove the old hard drive, be sure to back up the data from the old hard drive so that you can transfer the data to the new hard drive.

---

1. Unlock the hard drive carrier with the key provided and slide the carrier out of the enclosure.

2. Remove the screw from the rear of the carrier **(1)** and slide the top cover off the carrier **(2)**.

**Figure 7-29** Removing the Carrier Cover



3. Remove the adhesive strip that secures the thermal sensor to the top of the hard drive **(1)** and move the thermal sensor away from the carrier **(2)**.

**Figure 7-30** Removing the Thermal Sensor

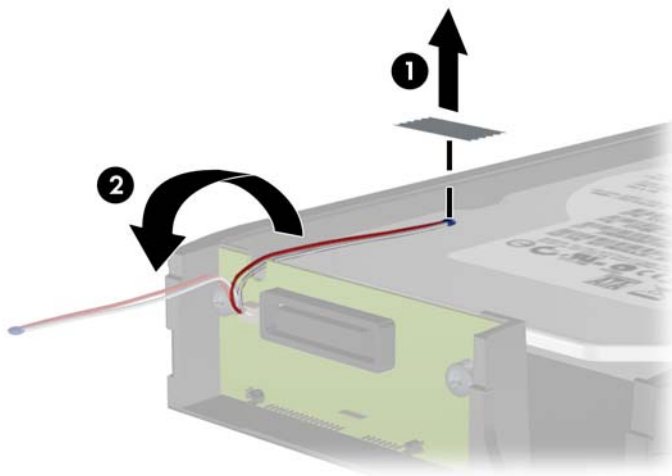

4. Remove the four screws from the bottom of the hard drive carrier.

**Figure 7-31** Removing the Security Screws

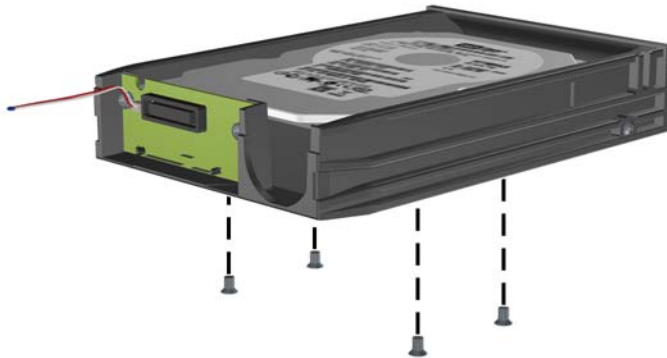

5. Slide the hard drive back to disconnect it from the carrier then lift it up and out of the carrier.

**Figure 7-32** Removing the Hard Drive

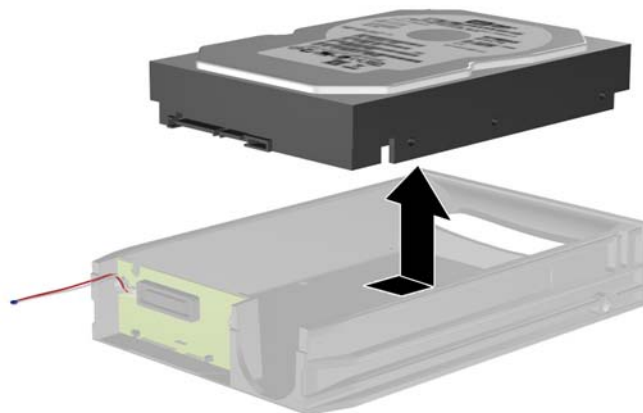

6. Place the new hard drive in the carrier then slide the hard drive back so that it seats in the SATA connector on the carrier's circuit board. Be sure the connector on the hard drive is pressed all the way into the connector on the carrier's circuit board.

**Figure 7-33** Replacing the Hard Drive

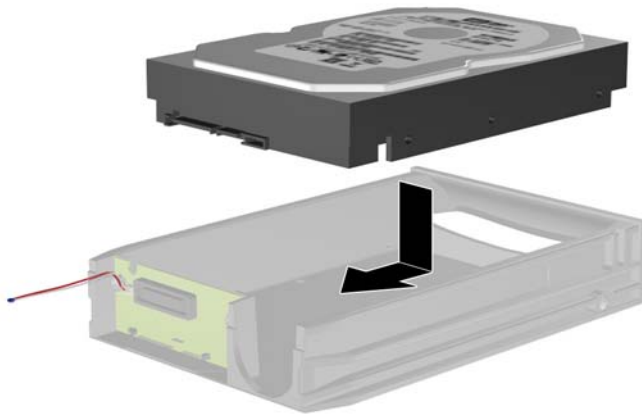

7. Replace the four screws in the bottom of the carrier to hold the drive securely in place.

**Figure 7-34** Replacing the Security Screws

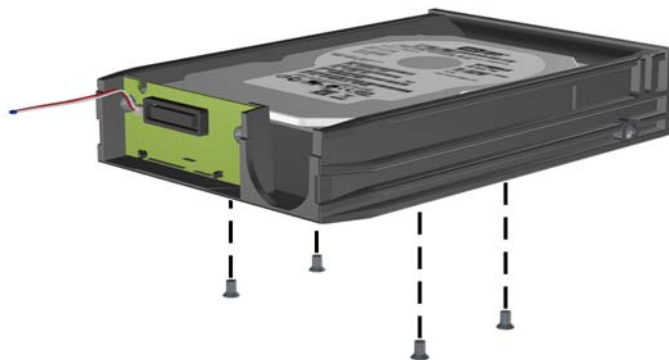

- Place the thermal sensor on top of the hard drive in a position that does not cover the label **(1)** and attach the thermal sensor to the top of the hard drive with the adhesive strip **(2)**.

**Figure 7-35** Replacing the Thermal Sensor

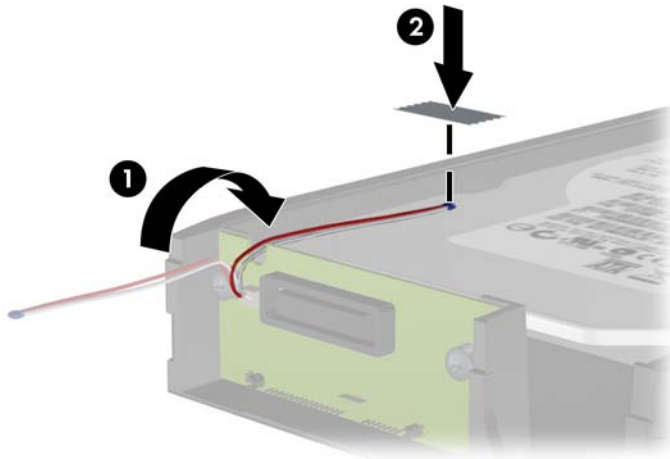

- Slide the cover on the carrier **(1)** and replace the screw on the rear of the carrier to secure the cover in place **(2)**.

**Figure 7-36** Replacing the Carrier Cover



- Slide the hard drive carrier into the enclosure on the computer and lock it with the key provided.

 **NOTE:** The carrier must be locked for power to be supplied to the hard drive.

# Fan duct

Description	Spare part number
Fan duct	636921-001

The fan duct sits between the front fan and the heat sink.

1. Prepare the computer for disassembly ([Preparation for Disassembly on page 99](#)).
2. Remove the access panel ([Access Panel on page 100](#)).
3. Remove the cables from the hook on the duct **(1)**.
4. Lift the fan duct straight up out of the chassis **(2)**.

**Figure 7-37** Removing the fan duct

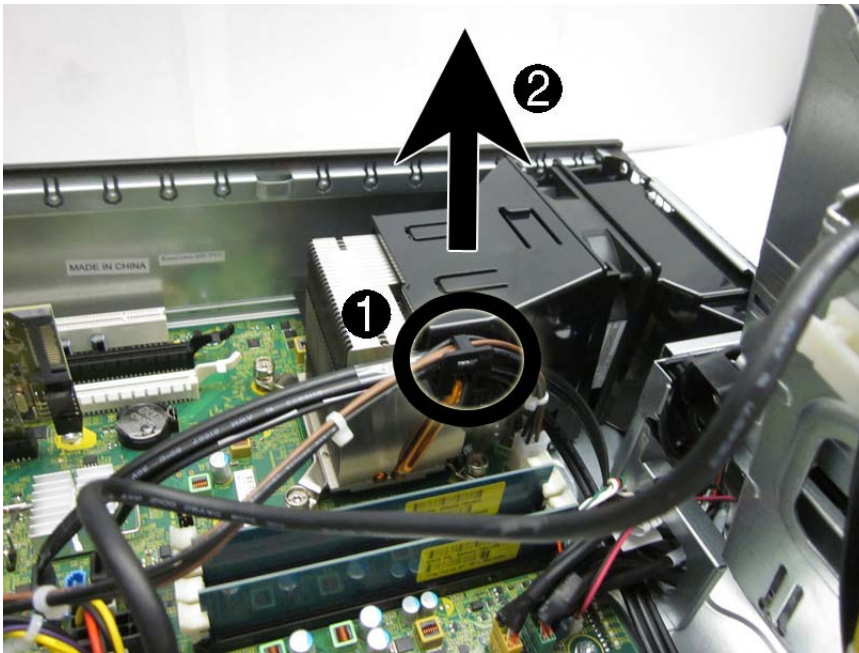

To install the fan duct, reverse the removal procedure.

# Front Fan Assembly

Description	Spare part number
Front fan	645327-001

The front fan assembly is attached to the front of the chassis.

1. Prepare the computer for disassembly ([Preparation for Disassembly on page 99](#)).
2. Remove the access panel ([Access Panel on page 100](#)).
3. Remove the front bezel ([Front Bezel on page 101](#)).
4. Remove the baffle ([Fan duct on page 132](#)).
5. Disconnect the fan cable from the red/brown system board connector labeled CHFAN.

**Figure 7-38** Disconnecting the front fan cable

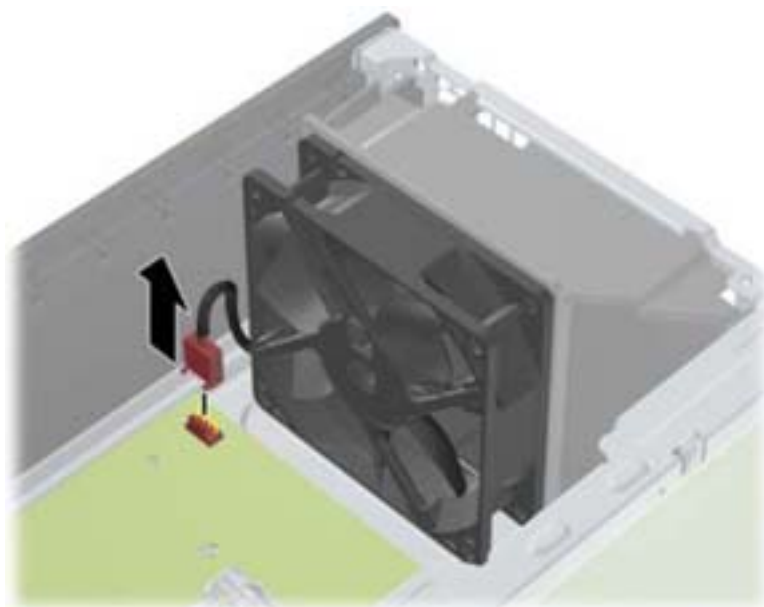

6. Press the tabs that secure the fan assembly to the front of the chassis **(1)**.

7. Pull the assembly toward the rear of the unit **(2)**, and then lift it out of the chassis.

**Figure 7-39** Removing the front fan

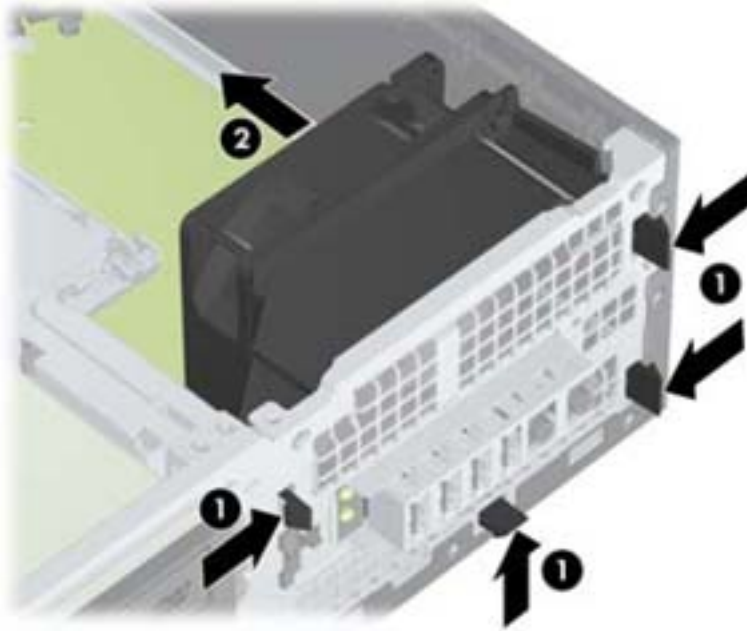

To install the front fan, reverse the removal procedure. Be sure to orient the air flow into the unit.



# Hood Sensor

Description	Spare part number
Hood sensor	638816-001

The hood sensor is attached in a slot in the rear of the chassis.

1. Prepare the computer for disassembly ([Preparation for Disassembly on page 99](#)).
2. Remove the access panel ([Access Panel on page 100](#)).
3. Unplug the sensor cable from the system board connector labeled HSENSE **(1)**.
4. Slide the hood sensor straight out of the notch in the chassis **(2)**.

 **NOTE:** A flat blade screwdriver can be used to push the hood sensor out of the slot.

**Figure 7-40** Removing the hood sensor from the chassis fan

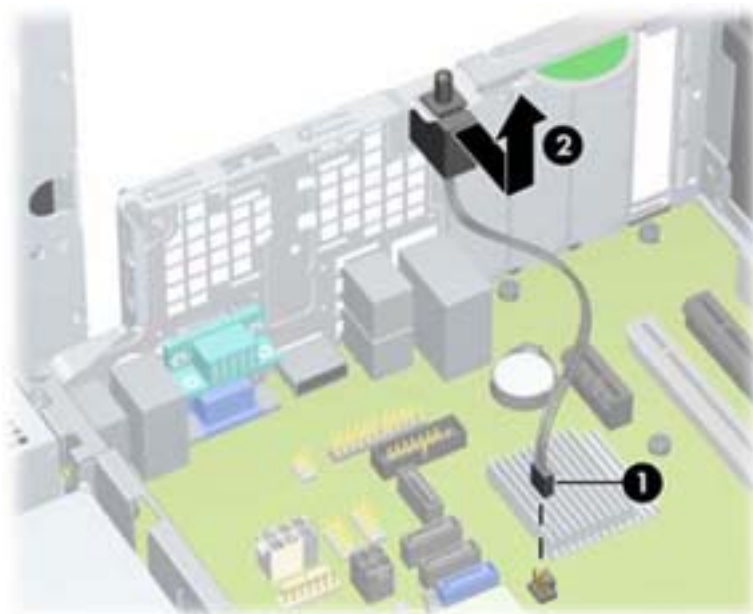

To install the hood sensor, reverse the removal procedure.

# Front I/O, Power Switch Assembly

Description	Spare part number
Front I/O and power switch assembly	636926-001

The front I/O and power switch/LEDs is one assembly, attached to the front of the chassis. Push the assembly into the chassis to remove.

1. Prepare the computer for disassembly ([Preparation for Disassembly on page 99](#)).
2. Remove the access panel ([Access Panel on page 100](#)).
3. Remove the front bezel ([Front Bezel on page 101](#)).
4. Remove the chassis fan ([Front Fan Assembly on page 133](#)).
5. Rotate the drive cage to its upright position.
6. Disconnect the four cables from the system board as follows:
  - Yellow connector labeled FRONT\_USB
  - Green connector labeled FRONT\_USB2
  - Blue connector labeled FRONT AUD
  - Black connector labeled PB/LED

**Figure 7-41** Disconnecting the front I/O, power switch/LED assembly cables

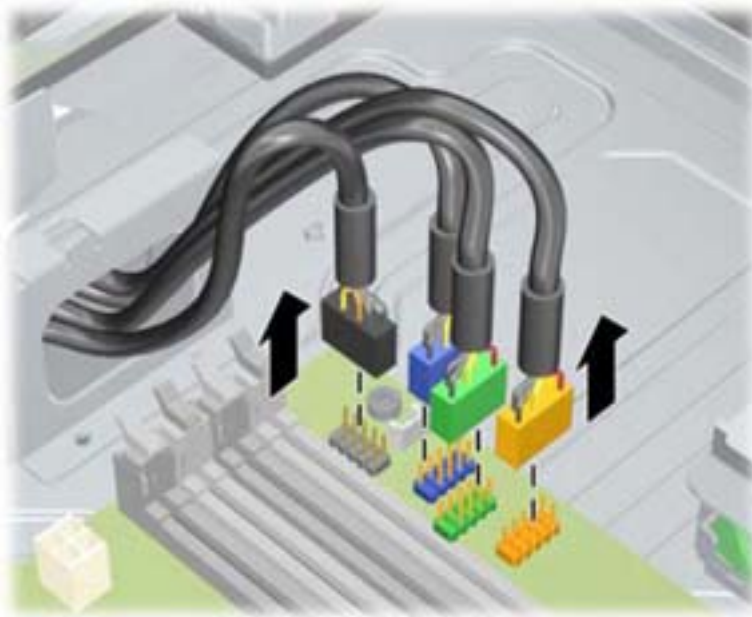

7. Remove the Torx T15 screw **(1)** that secures the assembly to the front of the chassis.

8. Route the cables through the slots beneath the drive cage, rotate the assembly into the chassis **(2)**, and then remove the assembly from the computer.

**Figure 7-42** Removing the front I/O, power switch/LED assembly screw

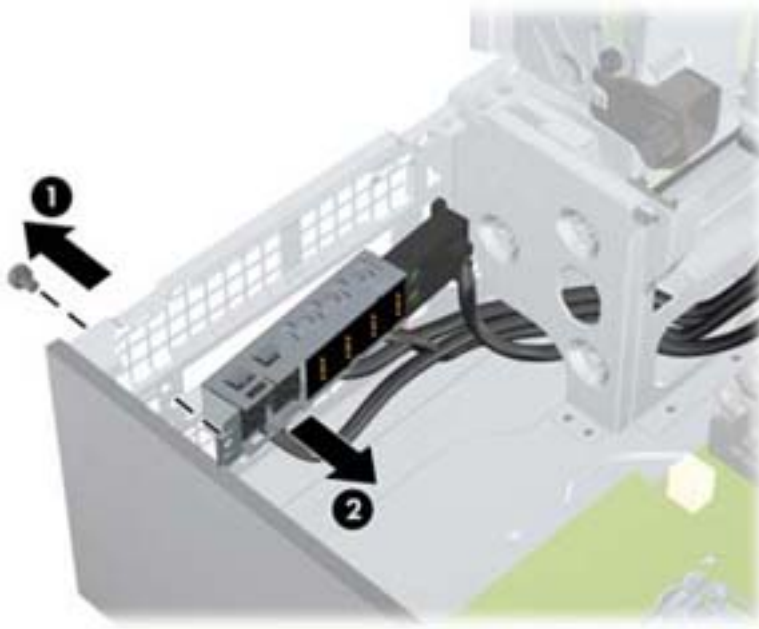

To install the front I/O and power switch assembly, reverse the removal procedure.

 **NOTE:** Be sure to correctly route the cables beneath the drive cage when reinstalling the assembly. Proper cable routing prevents damage to the cables and allows the drive cage to close properly.

# Speaker

Description	Spare part number
Speaker	636925-001

The speaker is attached to the front of the chassis under the rotating drive cage.

1. Prepare the computer for disassembly ([Preparation for Disassembly on page 99](#)).
2. Remove the access panel ([Access Panel on page 100](#)).
3. Remove the front bezel ([Front Bezel on page 101](#)).
4. Rotate the drive cage to its upright position.
5. Disconnect the speaker wire from the white system board labeled SPKR **(1)**.
6. Remove the Torx screw that secures the speaker to the chassis **(2)**.
7. Lift the speaker from the inside of the chassis to remove it **(3)**.

**Figure 7-43** Removing the speaker

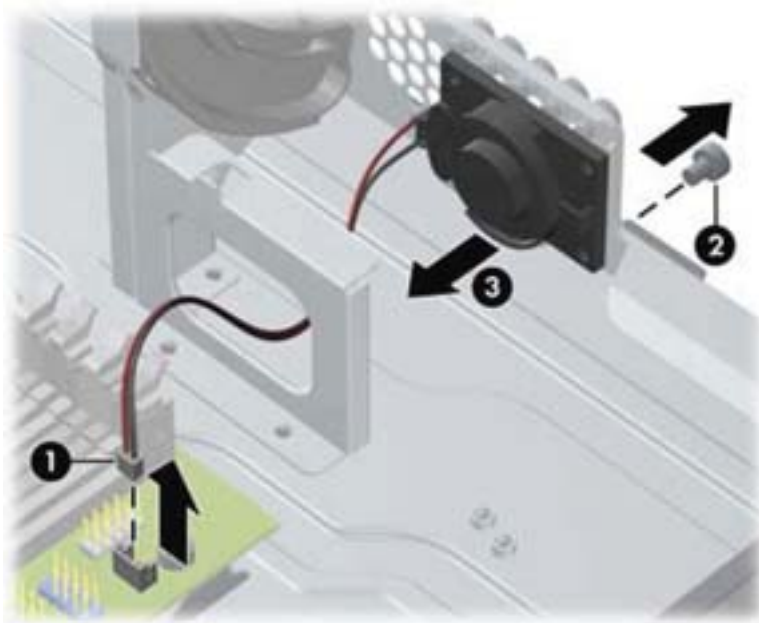

To install the speaker, reverse the removal procedures.

# Heat sink

Description	Spare part number
Heat sink	645326-001

**⚠ CAUTION:** The bond between the heat sink and the processor may be very tight.

If the computer will power on, before removing the heat sink, turn on the computer until it warms the heat sink. Warming the heat sink lessens the bond between the heat sink and the processor, thereby making separating them easier.

Make sure not to pull the processor out of the socket when you lift the heat sink, especially if you cannot warm the heat sink prior to removal. Inadvertently removing the processor can damage the pins.

The heat sink is secured atop the processor with four captive Torx screws. The heat sink does not include a fan.

1. Prepare the computer for disassembly ([Preparation for Disassembly on page 99](#)).
2. Remove the access panel ([Access Panel on page 100](#)).
3. Remove the fan duct ([Fan duct on page 132](#)).
4. Remove the front fan ([Front Fan Assembly on page 133](#)).
5. Loosen the four captive screws that secure the heat sink to the system board tray.

**⚠ CAUTION:** Heat sink retaining screws should be removed in diagonally opposite pairs (as in an X) to even the downward forces on the processor. This is especially important as the pins on the socket are very fragile and any damage to them may require replacing the system board.

**Figure 7-44** Loosening the heat sink screws

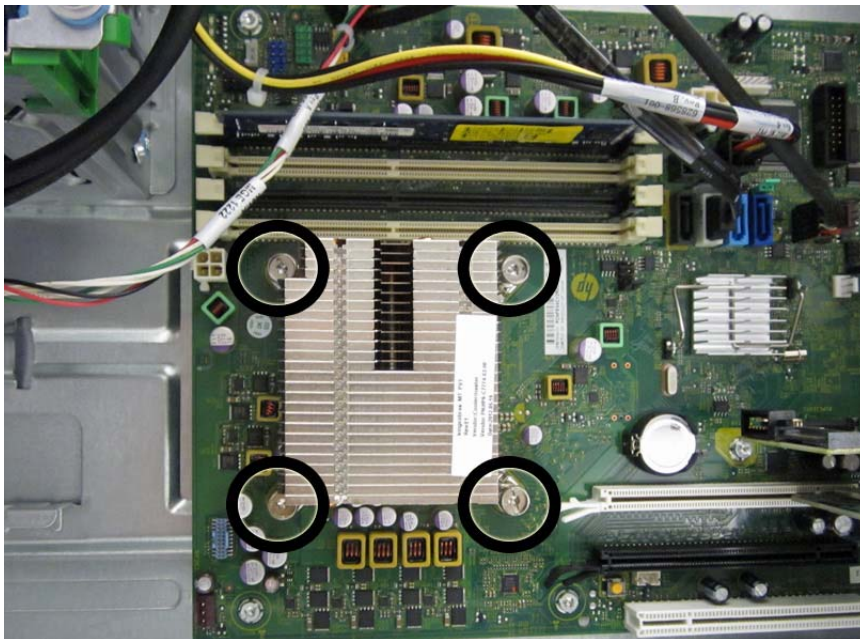

6. Lift the heat sink from atop the processor and set it on its side to keep from contaminating the work area with thermal grease.

**Figure 7-45** Removing the heat sink

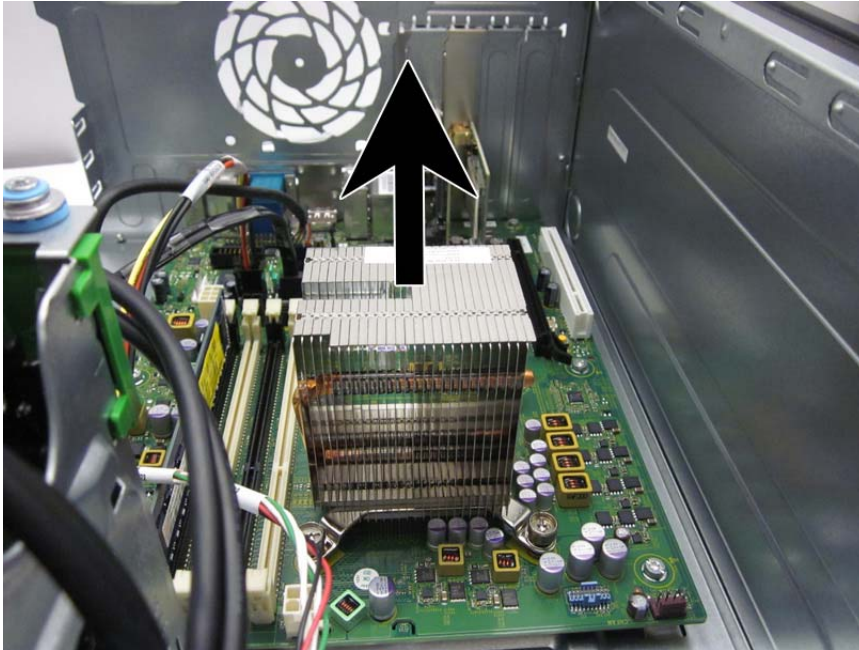

When reinstalling the heat sink, make sure that its bottom has been cleaned with an alcohol wipe and fresh thermal grease has been applied to the top of the processor.

**CAUTION:** Heat sink retaining screws should be tightened in diagonally opposite pairs (as in an X) to evenly seat the heat sink on the processor to avoid damage that could require replacing the system board.

Failure to install the fan duct may cause the computer to overheat.

# Processor

Description	Spare part number
AMD A10-5800B, 3.8 GHz, 4-MB L2 cache (100-W), HD 7660D	703598-001
AMD A8-5500B, 3.2 GHz, 4-MB L2 cache (65-W), HD 7560D	703601-001
AMD A6-5400B, 3.6 GHz, 4-MB L2 cache (65-W), HD 7540D	703600-001
AMD A4-5300B, 3.4 GHz, 4-MB L2 cache (65-W), HD 7480D	703599-001

1. Prepare the computer for disassembly ([Preparation for Disassembly on page 99](#)).
2. Remove the access panel ([Access Panel on page 100](#)).
3. Remove the fan duct ([Fan duct on page 132](#)).
4. Remove the front fan assembly ([Front Fan Assembly on page 133](#)).
5. Remove the heat sink ([Heat sink on page 139](#)).
6. Rotate the locking lever to its full open position **(1)**.
7. Carefully lift the processor from the socket **(2)**.

**⚠ CAUTION:** Do NOT handle the pins in the processor socket. These pins are very fragile and handling them could cause irreparable damage. Once pins are damaged it may be necessary to replace the system board.

The heat sink must be installed within 24 hours of installing the processor to prevent damage to the processor's solder connections.

**Figure 7-46** Removing the processor

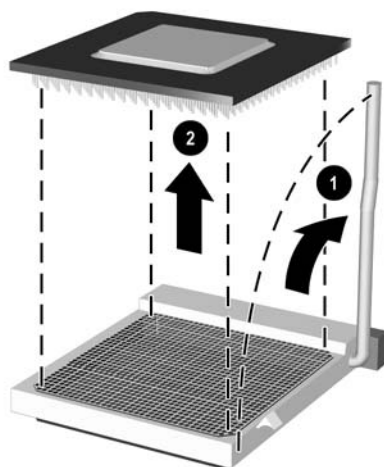

To replace the processor, reverse the removal procedures.



**NOTE:** After installing a new processor onto the system board, always update the system ROM to ensure that the latest version of the BIOS is being used on the computer. The latest system BIOS can be found on the Web at: <http://h18000.www1.hp.com/support/files>.

## Power Supply

Description	Spare part number
Power supply, 90% efficient	613762-001
Power supply, standard	613763-001



**WARNING!** To reduce potential safety issues, only the power supply provided with the computer, a replacement power supply provided by HP, or a power supply purchased as an accessory from HP should be used with the computer.

The rotating power supply is located at the rear of the chassis. It is held in place by a bracket – no screws are used.



**WARNING!** Voltage is always present on the system board when the computer is plugged into an active AC outlet. To avoid possible personal injury and damage to the equipment the power cord should be disconnected from the computer and/or the AC outlet before opening the computer.

1. Prepare the computer for disassembly ([Preparation for Disassembly on page 99](#)).
2. Remove the access panel ([Access Panel on page 100](#)).
3. Rotate the drive cage up and disconnect the power cables from all of the drives.
4. Disconnect all power cables from the system board as follows:
  - 4-pin PWRCPU
  - 6-pin PWR
  - 6-pin PWRCMD
5. Rotate the power supply to its full upright position.
6. Release the power supply cables from the cable retaining clip under the drive cage.



7. Pull the power supply forward until the posts on the power supply move forward in the power supply bracket, and then lift the power supply straight up and out of the chassis.

**Figure 7-47** Removing the power supply



To install the power supply, reverse the removal procedure.

**CAUTION:** When installing the power supply cables, make sure they are properly positioned so they are not cut by the drive cage and are not pinched by the rotating power supply.

## System Board

Description	Spare part number
System board for use in Windows 7 models (includes thermal material)	703596-001
System board for use in Windows 8 Standard models	703596-501
System board for use in Windows 8 Professional models	703596-601

1. Prepare the computer for disassembly ([Preparation for Disassembly on page 99](#)).
2. Remove the access panel ([Access Panel on page 100](#)).
3. When replacing the system board, make sure the following components are removed from the defective system board and installed on the replacement system board:
  - Memory modules ([Memory on page 105](#))
  - Expansion cards ([Expansion Card on page 109](#))

- Heat sink ([Heat sink on page 139](#))
  - Processor ([Processor on page 141](#))
  - WLAN module ([WLAN module on page 113](#))
4. Remove the baffle from the chassis ([Fan duct on page 132](#)).
  5. Remove the fan from the chassis ([Front Fan Assembly on page 133](#)).
  6. Rotate the drive cage to its upright position.
  7. Rotate the power supply to its full upright position.
  8. Disconnect all data and power cables from the system board.
  9. Disconnect the balance of the cables from the system board.
  10. Remove the eight Torx T15 screws **(1)** that secure the system board to the chassis.
  11. Lift up the front of the system board, and then pull the system board forward, up, and out of the chassis **(2)**.

**Figure 7-48** Removing the system board

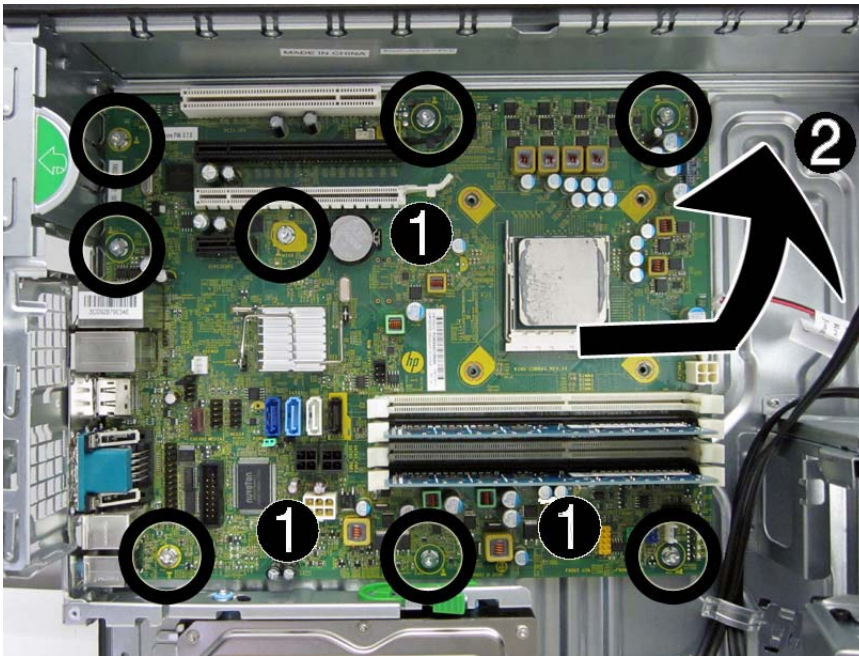

To install the system board, reverse the removal procedure.

**NOTE:** When replacing the system board, you must also change the chassis serial number in the BIOS.

**CAUTION:** Before reinstalling the heat sink you must clean the top of the processor and the bottom of the heat sink with an alcohol pad supplied in the spares kit. After the alcohol has evaporated, apply thermal grease to the top of the processor from the syringe supplied in the spares kit.

**CAUTION:** When reconnecting the cables it is important that they be positioned so they do not interfere with the rotation of the drive cage or power supply.

# Using the Small Form Factor Computer in a Tower Orientation

The Small Form Factor computer can be used in a tower orientation. The HP logo plate on the front bezel is adjustable for either desktop or tower orientation.

1. Prepare the computer for disassembly ([Preparation for Disassembly on page 99](#)).
2. Orient the computer so that its right side is facing down and place the computer in the optional stand.

**Figure 7-49** Changing from Desktop to Tower Orientation



---

 **NOTE:** To stabilize the computer in a tower orientation, HP recommends the use of the optional tower stand.

---

3. Lock any security devices that were disengaged when the access panel was removed.

 **NOTE:** Ensure at least 10.2 centimeters (4 inches) of space on all sides of the computer remains clear and free of obstructions.

---

---

# 8 Troubleshooting Without Diagnostics

This chapter provides information on how to identify and correct minor problems, such as USB devices, hard drive, optical drive, graphics, audio, memory, and software problems. If you encounter problems with the computer, refer to the tables in this chapter for probable causes and recommended solutions.

 **NOTE:** For information on specific error messages that may appear on the screen during Power-On Self-Test (POST) at startup, refer to Appendix A, [POST Error Messages on page 187](#).

---

## Safety and Comfort

 **WARNING!** Misuse of the computer or failure to establish a safe and comfortable work environment may result in discomfort or serious injury. Refer to the *Safety & Comfort Guide* at <http://www.hp.com/ergo> for more information on choosing a workspace and creating a safe and comfortable work environment. For more information, refer to the *Safety & Regulatory Information* guide.

---

## Before You Call for Technical Support

If you are having problems with the computer, try the appropriate solutions below to try to isolate the exact problem before calling for technical support.

- Run the HP diagnostic tool.
- Run the hard drive self-test in Computer Setup. Refer to [Computer Setup \(F10\) Utility on page 10](#) for more information.
- Check the Power LED on the front of the computer to see if it is flashing red. The flashing lights are error codes that will help you diagnose the problem. Refer to Appendix A, [POST Error Messages on page 187](#) for more information.
- If the screen is blank, plug the monitor into a different video port on the computer if one is available. Or, replace the monitor with a monitor that you know is functioning properly.
- If you are working on a network, plug another computer with a different cable into the network connection. There may be a problem with the network plug or cable.
- If you recently added new hardware, remove the hardware and see if the computer functions properly.
- If you recently installed new software, uninstall the software and see if the computer functions properly.
- Boot the computer to the Safe Mode to see if it will boot without all of the drivers loaded. When booting the operating system, use “Last Known Configuration.”

- Refer to the comprehensive online technical support at <http://www.hp.com/support>.
- Refer to [Helpful Hints on page 147](#) in this guide.

To assist you in resolving problems online, HP Instant Support Professional Edition provides you with self-solve diagnostics. If you need to contact HP support, use HP Instant Support Professional Edition's online chat feature. Access HP Instant Support Professional Edition at: <http://www.hp.com/go/ispe>.

Access the Business Support Center (BSC) at <http://www.hp.com/go/bizsupport> for the latest online support information, software and drivers, proactive notification, and worldwide community of peers and HP experts.

If it becomes necessary to call for technical assistance, be prepared to do the following to ensure that your service call is handled properly:

- Be in front of your computer when you call.
- Write down the computer serial number, product ID number, and monitor serial number before calling.
- Spend time troubleshooting the problem with the service technician.
- Remove any hardware that was recently added to your system.
- Remove any software that was recently installed.
- Restore the system from the Recovery Disc Set that you created or restore the system to its original factory condition in System Software Requirement Disks (SSRD).

---

 **CAUTION:** Restoring the system will erase all data on the hard drive. Be sure to back up all data files before running the restore process.

 **NOTE:** For sales information and warranty upgrades (Care Packs), call your local authorized service provider or dealer.

---

## Helpful Hints

If you encounter problems with the computer, monitor, or software, see the following list of general suggestions before taking further action:

- Check that the computer and monitor are plugged into a working electrical outlet.
- Check that the voltage select switch (some models) is set to the appropriate voltage for your region (115V or 230V).
- Check that the computer is turned on and the green power light is on.
- Check that the monitor is turned on and the green monitor light is on.
- Check the Power LED on the front of the computer to see if it is flashing red. The flashing lights are error codes that will help you diagnose the problem. Refer to Appendix A, [POST Error Messages on page 187](#) for more information.
- Turn up the brightness and contrast controls of the monitor if the monitor is dim.
- Press and hold any key. If the system beeps, then the keyboard should be operating correctly.
- Check all cable connections for loose connections or incorrect connections.

- Wake the computer by pressing any key on the keyboard or pressing the power button. If the system remains in suspend mode, shut down the computer by pressing and holding the power button for at least four seconds then press the power button again to restart the computer. If the system will not shut down, unplug the power cord, wait a few seconds, then plug it in again. The computer will restart if it is set to power on automatically as soon as power is restored in Computer Setup. If it does not restart, press the power button to start the computer.
- Reconfigure the computer after installing a non-plug and play expansion board or other option. See [Solving Hardware Installation Problems on page 169](#) for instructions.
- Be sure that all the needed device drivers have been installed. For example, if you are using a printer, you need a driver for that model printer.
- Remove all bootable media (CD/DVD or USB device) from the system before turning it on.
- If you have installed an operating system other than the factory-installed operating system, check to be sure that it is supported on the system.
- If the system has multiple video sources (embedded, PCI, or PCI-Express adapters) installed (embedded video on some models only) and a single monitor, the monitor must be plugged into the monitor connector on the source selected as the primary VGA adapter. During boot, the other monitor connectors are disabled and if the monitor is connected into these ports, the monitor will not function. You can select which source will be the default VGA source in Computer Setup.

---

**⚠ CAUTION:** When the computer is plugged into an AC power source, there is always voltage applied to the system board. You must disconnect the power cord from the power source before opening the computer to prevent system board or component damage.

---

## Solving General Problems

You may be able to easily resolve the general problems described in this section. If a problem persists and you are unable to resolve it yourself or if you feel uncomfortable about performing the operation, contact an authorized dealer or reseller.

---

**⚠ WARNING!** When the computer is plugged into an AC power source, voltage is always applied to the system board. To reduce the risk of personal injury from electrical shock and/or hot surfaces, be sure to disconnect the power cord from the wall outlet and allow the internal system components to cool before touching.

---

**Table 8-1 Solving General Problems**

**Computer appears locked up and will not turn off when the power button is pressed.**

Cause	Solution
Software control of the power switch is not functional.	<ol style="list-style-type: none"> <li>1. Press and hold the power button for at least four seconds until the computer turns off.</li> <li>2. Disconnect the power cord from the electrical outlet.</li> </ol>

---

### Computer will not respond to keyboard or mouse.

Cause	Solution
Computer is in Sleep state.	To resume from Sleep state, press the power button.  <b>CAUTION:</b> When attempting to resume from Sleep state, do not hold down the power button for more than four seconds. Otherwise, the computer will shut down and you will lose any unsaved data.
System has locked up.	Restart computer.

### Computer date and time display is incorrect.

Cause	Solution
RTC (real-time clock) battery may need to be replaced.  <b>NOTE:</b> Connecting the computer to a live AC outlet prolongs the life of the RTC battery.	Reset the date and time under <b>Control Panel</b> (Computer Setup can also be used to update the RTC date and time). If the problem persists, replace the RTC battery. See the Removal and Replacement section for instructions on installing a new battery, or contact an authorized dealer or reseller for RTC battery replacement.  To access Control Panel in Windows 7, select <b>Start</b> , and then select <b>Control Panel</b> .  To access Control Panel in Windows 8, from the Start screen, type <b>c</b> , and then select <b>Control Panel</b> from the list of applications.

### Cursor will not move using the arrow keys on the keypad.

Cause	Solution
The Num Lock key is turned on.	Press the Num Lock key. The Num Lock light must be off if you want to use the arrow keys on the keypad. You can also disable or enable the Num Lock key in Computer Setup at <b>Advanced &gt; Device Options</b> .

### There is no sound or sound volume is too low.

Cause	Solution
System volume may be set low or muted.	<ol style="list-style-type: none"><li>1. Check the Computer Setup settings to make sure the internal system speaker is not muted (this setting does not affect the external speakers).</li><li>2. Make sure the external speakers are properly connected and powered on and that the speakers' volume control is set correctly.</li><li>3. Use the system volume control available in the operating system to make sure the speakers are not muted or to increase the volume.</li></ol>

### Cannot remove computer cover or access panel.

Cause	Solution
Smart Cover Lock, featured on some computers, is locked.	Unlock the Smart Cover Lock using Computer Setup.  In case of forgotten password, power loss, or computer malfunction, you must manually disable the Smart Cover lock . A key to unlock the Smart Cover Lock is not available from HP. Keys are typically available from a hardware store.

### Poor performance.

Cause	Solution
Processor is too hot.	<ol style="list-style-type: none"><li>1. Make sure airflow to the computer is not blocked. Leave a 10.2-cm (4-inch) clearance on all vented sides of the computer and above the monitor to permit the required airflow.</li><li>2. Make sure fans are connected and working properly (some fans only operate when needed).</li><li>3. Make sure the processor heat sink is installed properly.</li></ol>
Hard drive is full.	Transfer data from the hard drive to create more space on the hard drive.
Low on memory.	Add more memory.
Hard drive fragmented.	Defragment hard drive.
Program previously accessed did not release reserved memory back to the system.	Restart the computer.
Virus resident on the hard drive.	Run virus protection program.
Too many applications running.	Windows 7: <ol style="list-style-type: none"><li>1. Close unnecessary applications to free up memory.</li><li>2. Add more memory.</li><li>3. Some applications run in the background and can be closed by right-clicking on their corresponding icons in the task tray. To prevent these applications from launching at startup:  In Windows 7:<ol style="list-style-type: none"><li>a. Go to <b>Start &gt; All Programs &gt; Accessories &gt; Run</b></li><li>b. Type <code>msconfig</code>, and then press <b>Enter</b>.</li><li>c. On the <b>Startup</b> tab of the System Configuration Utility, clear applications that you do not want to launch automatically, and then click <b>OK</b>.</li></ol></li></ol>



**Table 8-1 Solving General Problems (continued)****Poor performance.**

Cause	Solution
	<p>In Windows 8:</p> <ol style="list-style-type: none"> <li>a. On the Start screen, right-click, and then select the <b>All apps</b> icon.</li> <li>b. Under <b>Windows System</b>, click <b>Run</b>.</li> <li>c. Type <code>msconfig</code>, and then press <b>Enter</b>.</li> <li>d. On the <b>Startup</b> tab of the System Configuration Utility, clear applications that you do not want to launch automatically, and then click <b>OK</b>.</li> </ol>
<p>Some software applications, especially games, are stressful on the graphics subsystem.</p>	<ol style="list-style-type: none"> <li>1. Lower the display resolution for the current application or consult the documentation that came with the application for suggestions on how to improve performance by adjusting parameters in the application.</li> <li>2. Add more memory.</li> <li>3. Upgrade the graphics solution.</li> </ol>
<p>Cause unknown.</p>	<p>Restart the computer.</p>

**Computer powered off automatically and the Power LED flashes Red two times, once every second, followed by a two second pause, and the computer beeps two times. (Beeps stop after fifth iteration but LEDs continue flashing).**

Cause	Solution
<p>Processor thermal protection activated: A fan may be blocked or not turning. OR The heat sink is not properly attached to the processor.</p>	<ol style="list-style-type: none"> <li>1. Ensure that the computer air vents are not blocked and the processor cooling fan is running.</li> <li>2. Open the access panel, press the power button, and see if the processor fan (or other system fan) spins. If the fan does not spin, make sure the fan cable is plugged onto the system board header.</li> <li>3. If fan is plugged in and not spinning, replace it.</li> </ol>

**System does not power on and the LEDs on the front of the computer are not flashing.**

<b>Cause</b>	<b>Solution</b>
System unable to power on.	<p>Press and hold the power button for less than 4 seconds. If the hard drive LED turns green, then:</p> <ol style="list-style-type: none"><li>1. If equipped with a voltage selector, check that the voltage selector (located on the rear of the power supply) is set to the appropriate voltage. Proper voltage setting depends on your region.</li><li>2. Remove the expansion cards one at a time until the 5V_aux light on the system board turns on.</li><li>3. Replace the system board.</li></ol> <p>OR</p> <p>Press and hold the power button for less than 4 seconds. If the hard drive LED does not turn on green then:</p> <ol style="list-style-type: none"><li>1. Check that the unit is plugged into a working AC outlet.</li><li>2. Open the access panel and check that the power button cable is properly connected to the system board.</li><li>3. Check that the power supply cables are properly connected to the system board.</li><li>4. Check to see if the 5V_aux light on the system board is turned on. If it is turned on, then replace the power button assembly.</li><li>5. If the 5V_aux light on the system board is off, then replace the power supply.</li><li>6. Replace the system board.</li></ol>

## Solving Power Problems

Common causes and solutions for power problems are listed in the following table.

**Table 8-2 Solving Power Problems**

**Power supply shuts down intermittently.**

<b>Cause</b>	<b>Solution</b>
If equipped with a voltage selector, voltage selector switch on rear of computer chassis (some models) not switched to correct line voltage (115V or 230V).	Select the proper AC voltage using the selector switch.
Power supply will not turn on because of internal power supply fault.	Replace the power supply.

**Computer powered off automatically and the Power LED flashes Red two times, once every second, followed by a two second pause, and the computer beeps two times. (Beeps stop after fifth iteration but LEDs continue flashing.)**

Cause	Solution
Processor thermal protection activated: A fan may be blocked or not turning. OR The heat sink is not properly attached to the processor.	<ol style="list-style-type: none"><li>1. Ensure that the computer air vents are not blocked and the processor cooling fan is running.</li><li>2. Open the access panel, press the power button, and see if the processor fan (or other system fan) spins. If the fan does not spin, make sure the fan cable is plugged onto the system board header.</li><li>3. If fan a plugged in and not spinning, replace it.</li></ol>

**Power LED flashes Red four times, once every second, followed by a two second pause, and the computer beeps four times. (Beeps stop after fifth iteration but LEDs continue flashing.)**

Cause	Solution
Power failure (power supply is overloaded).	<ol style="list-style-type: none"><li>1. If equipped with a voltage selector, check that the voltage selector, located on the rear of the power supply (some models), is set to the appropriate voltage. Proper voltage setting depends on your region.</li><li>2. Open the access panel and ensure the power supply cable is seated into the connector on the system board.</li><li>3. Check if a device is causing the problem by removing ALL attached devices (such as hard drives or optical drives and expansion cards). Power on the system. If the system enters POST, then power off and replace one device at a time and repeat this procedure until failure occurs. Replace the device that is causing the failure. Continue adding devices one at a time to ensure all devices are functioning properly.</li><li>4. Replace the power supply.</li><li>5. Replace the system board.</li></ol>
The incorrect external power supply adapter is being used on the All-in One or USDT.	The power supply adapter must be at the correct power rating and use the Smart ID technology before the system will power up. Replace the power supply adapter with the HP-supplied power supply adapter.

# Solving Hard Drive Problems

**Table 8-3 Solving Hard Drive Problems**

**Hard drive error occurs.**

Cause	Solution
Hard disk has bad sectors or has failed.	<ol style="list-style-type: none"><li>1. In Windows 7, click <b>Start</b>, click <b>Computer</b>, and right-click on a drive. Select <b>Properties</b>, and then select the <b>Tools</b> tab. Under <b>Error-checking</b> click <b>Check Now</b>.  In Windows 8, on the Start screen type <b>e</b>, and then select <b>File Explorer</b> from the list of applications. In the left column, expand <b>Computer</b>, right-click on a drive, select <b>Properties</b>, and then select the <b>Tools</b> tab. Under <b>Error checking</b> click <b>Check</b>.</li><li>2. Use a utility to locate and block usage of bad sectors. If necessary, reformat the hard disk.</li></ol>

**Disk transaction problem.**

Cause	Solution
Either the directory structure is bad or there is a problem with a file.	<p>In Windows 7, click <b>Start</b>, expand <b>Computer</b>, and right-click on a drive. Select <b>Properties</b>, and then select the <b>Tools</b> tab. Under <b>Error-checking</b> click <b>Check Now</b>.</p> <p>In Windows 8, on the Start screen type <b>e</b>, and then click <b>File Explorer</b> from the list of applications. In the left column, expand <b>Computer</b>, right-click on a drive, select <b>Properties</b>, and then select the <b>Tools</b> tab. Under <b>Error checking</b> click <b>Check</b>.</p>

**Drive not found (identified).**

Cause	Solution
Cable could be loose.	Check cable connections.
The system may not have automatically recognized a newly installed device.	<p>See reconfiguration directions in the <a href="#">Solving Hardware Installation Problems on page 169</a> section. If the system still does not recognize the new device, check to see if the device is listed within Computer Setup. If it is listed, the probable cause is a driver problem. If it is not listed, the probable cause is a hardware problem.</p> <p>If this is a newly installed drive, run the Computer Setup utility and try adding a POST delay under <b>Advanced &gt; Power-On Options</b>.</p>

**Table 8-3 Solving Hard Drive Problems (continued)**

<b>Drive not found (identified).</b>	
<b>Cause</b>	<b>Solution</b>
The device is attached to a SATA port that has been hidden in Computer Setup.	Run the Computer Setup utility and ensure <b>Device Available</b> is selected for the device's SATA port in <b>Security &gt; Device Security</b> .
Drive responds slowly immediately after power-up.	Run Computer Setup and increase the POST Delay in <b>Advanced &gt; Power-On Options</b> .
<b>Nonsystem disk/NTLDR missing message.</b>	
<b>Cause</b>	<b>Solution</b>
The system is trying to start from the hard drive but the hard drive may have been damaged.	<ol style="list-style-type: none"> <li>1. Perform Drive Protection System (DPS) testing in system ROM.</li> </ol>
System files missing or not properly installed.	<ol style="list-style-type: none"> <li>1. Insert bootable media and restart the computer.</li> <li>2. Boot to the windows installation media and select the recovery option. If only a restore kit is available, then select the <b>File Backup Program</b> option, and then restore the system.</li> <li>3. Install system files for the appropriate operating system.</li> </ol>
Hard drive boot has been disabled in Computer Setup.	Run the Computer Setup utility and enable the hard drive entry in the <b>Storage &gt; Boot Order</b> list.
Bootable hard drive is not attached as first in a multi-hard drive configuration.	If attempting to boot from a hard drive, ensure it is attached to the system board dark blue SATA connector.
Bootable hard drive is not listed first in the Boot Order.	Run the Computer Setup utility and select <b>Storage &gt; Boot Order</b> and ensure the bootable hard drive is listed immediately under the <b>Hard Drive</b> entry.
<b>Computer will not boot from hard drive.</b>	
<b>Cause</b>	<b>Solution</b>
The device is attached to a SATA port that has been hidden in Computer Setup.	<ol style="list-style-type: none"> <li>1. Check SATA cable connections.</li> <li>2. Run the Computer Setup utility and ensure <b>Device Available</b> is selected for the device's SATA port in <b>Security &gt; Device Security</b>.</li> </ol>
Boot order is not correct.	Run the Computer Setup utility and change boot sequence in <b>Storage &gt; Boot Order</b> .

**Table 8-3 Solving Hard Drive Problems (continued)**

**Computer will not boot from hard drive.**

Cause	Solution
Hard Drive's "Emulation Type" is set to "None." (some models)	Run the Computer Setup utility and change the "Emulation Type" to "Hard Disk" in the device's details under <b>Storage &gt; Device Configuration</b> .
Hard drive is damaged.	Observe if the front panel Power LED is blinking RED and if any beeps are heard. See Appendix A, <a href="#">POST Error Messages on page 187</a> to determine possible causes for the blinking red and beep codes.  See the Worldwide Limited Warranty for terms and conditions.

**Computer seems to be locked up.**

Cause	Solution
Program in use has stopped responding to commands.	<ol style="list-style-type: none"><li>1. Use the task manager to close programs that do not respond.</li><li>2. Attempt the normal Windows "Shut Down" procedure. If this fails, press the power button for four or more seconds to turn off the power. To restart the computer, press the power button again.</li></ol>

## Solving Media Card Reader Problems

**Table 8-4 Solving Media Card Reader Problems**

**Media card will not work in a digital camera after formatting it in Windows.**

Cause	Solution
By default, Windows will format any media card with a capacity greater than 32MB with the FAT32 format. Some digital cameras use the FAT (FAT16 & FAT12) format and can not operate with a FAT32 formatted card.	Either format the media card in the digital camera or select FAT file system to format the media card in a computer with Windows.

**A write-protected or locked error occurs when attempting to write to the media card.**

Cause	Solution
Media card is locked. Locking the media card is a safety feature that prevents writing to and deleting from an SD/Memory Stick/PRO card.	If using an SD card, make sure that the lock tab located on the right of the SD card is not in the locked position. If using a Memory Stick/PRO card, make sure that the lock tab located on the bottom of the Memory Stick/PRO card is not in the locked position.

---

**Can not write to the media card.**

---

<b>Cause</b>	<b>Solution</b>
The media card is a read-only memory (ROM) card.	Check the manufacturer's documentation included with your card to see if it writable. Refer to the previous section for a list of compatible cards.
Media card is locked. Locking the media card is a safety feature that prevents writing to and deleting from an SD/Memory Stick/PRO card.	If using an SD card, make sure that the lock tab located on the right of the SD card is not in the locked position. If using a Memory Stick/PRO card, make sure that the lock tab located on the bottom of the Memory Stick/PRO card is not in the locked position.

---

**Unable to access data on the media card after inserting it into a slot.**

---

<b>Cause</b>	<b>Solution</b>
The media card is not inserted properly, is inserted in the wrong slot, or is not supported.	Ensure that the card is inserted properly with the gold contact on the correct side. The green LED will light if inserted properly.

---

**Do not know how to remove a media card correctly.**

---

<b>Cause</b>	<b>Solution</b>
The computer's software is used to safely eject the card.	<p>In Windows 7, click <b>Start</b>, select <b>Computer</b>, right-click on the corresponding drive icon, and then select <b>Eject</b>. Pull the card out of the slot.</p> <p>In Windows 8, on the Start screen, type <b>e</b>, and then click <b>File Explorer</b> from the list of applications. Expand <b>Computer</b>, right-click on the corresponding drive icon, and then select <b>Eject</b>. Pull the card out of the slot.</p> <p><b>NOTE:</b> Never remove the card when the green LED is flashing</p>

---

**After installing the media card reader and booting to Windows, the reader and the inserted cards are not recognized by the computer.**

---

<b>Cause</b>	<b>Solution</b>
The operating system needs time to recognize the device if the reader was just installed into the computer and you are turning the PC on for the first time.	Wait a few seconds so that the operating system can recognize the reader and the available ports, and then recognize the media inserted in the reader.

---

**After inserting a media card in the reader, the computer attempts to boot from the media card.**

<b>Cause</b>	<b>Solution</b>
The inserted media card has boot capability.	<ol style="list-style-type: none"><li>1. If you do not want to boot from the media card, remove it during boot or do not select the option to boot from the inserted media card during the boot process.</li><li>2. During POST (Power On Self-Test), press <b>F9</b> to modify the boot menu.</li><li>3. Change the boot sequence in F10 Computer Setup.</li></ol>

## Solving Display Problems

If you encounter display problems, see the documentation that came with the monitor and to the common causes and solutions listed in the following table.

**Table 8-5 Solving Display Problems**

**Blank screen (no video).**

<b>Cause</b>	<b>Solution</b>
Monitor is not turned on and the monitor light is not on.	Turn on the monitor and check that the monitor light is on.
Bad monitor.	Try a different monitor.
The cable connections are not correct.	Check the cable connection from the monitor to the computer and to the electrical outlet.
You may have a screen blanking utility installed or energy saver features are enabled.	Press any key or click the mouse button and type your password (if set).
System ROM is corrupted; system is running in Boot Block Emergency Recovery Mode (indicated by eight beeps).	Reflash the system ROM with the latest BIOS image.
You are using a fixed-sync monitor and it will not sync at the resolution chosen.	Be sure that the monitor can accept the same horizontal scan rate as the resolution chosen.
Computer is in Sleep state.	Press the power button to resume from Sleep state. <b>CAUTION:</b> When attempting to resume from Sleep state, do not hold down the power button for more than four seconds. Otherwise, the computer will shut down and you will lose any unsaved data.
Monitor cable is plugged into the wrong connector.	Systems may have a monitor connection on both the motherboard or an add-in card. Try moving the monitor connection to a different connector on the back of the computer



**Table 8-5 Solving Display Problems (continued)**

**Blank screen (no video).**

<b>Cause</b>	<b>Solution</b>
Monitor settings in the computer are not compatible with the monitor.	<ol style="list-style-type: none"><li>1. In Control Panel, select <b>Category</b> from the <b>View by</b> list, then under <b>Appearance and Personalization</b>, select <b>Adjust screen resolution</b>.  To access Control Panel in Windows 7, click <b>Start</b>, and then select <b>Control Panel</b>.  To access Control Panel in Windows 8, from the Start screen, type <b>c</b>, and then select <b>Control Panel</b> from the list of applications.</li><li>2. Expand the <b>Resolution</b> box, and then use the sliding control to reset the resolution.</li></ol>
Monitor is configured to use an input that is not active.	Use the monitor's on-screen menu controls to select the input that is being driven by the system. Refer to the monitor's user documentation for more information on the on-screen controls and settings.

**Blank screen and the power LED flashes Red five times, once every second, followed by a two second pause, and the computer beeps five times. (Beeps stop after fifth iteration but LEDs continue flashing.)**

<b>Cause</b>	<b>Solution</b>
Pre-video memory error.	<ol style="list-style-type: none"><li>1. Reseat DIMMs. Power on the system.</li><li>2. Replace DIMMs one at a time to isolate the faulty module.</li><li>3. Replace third-party memory with HP memory.</li><li>4. Replace the system board.</li></ol>

**Blank screen and the power LED flashes Red six times, once every second, followed by a two second pause, and the computer beeps six times. (Beeps stop after fifth iteration but LEDs continue flashing.)**

<b>Cause</b>	<b>Solution</b>
Pre-video graphics error.	<p>For systems with a graphics card:</p> <ol style="list-style-type: none"><li>1. Reseat the graphics card (if applicable). Power on the system.</li><li>2. Replace the graphics card (if applicable).</li><li>3. Replace the system board.</li></ol> <p>For systems with integrated graphics, replace the system board.</p>

**Blank screen and the power LED flashes Red seven times, once every second, followed by a two second pause, and the computer beeps seven times. (Beeps stop after fifth iteration but LEDs continue flashing.)**

<b>Cause</b>	<b>Solution</b>
System board failure (ROM detected failure prior to video).	Replace the system board.

**Monitor does not function properly when used with energy saver features.**

<b>Cause</b>	<b>Solution</b>
Monitor without energy saver capabilities is being used with energy saver features enabled.	Disable monitor energy saver feature.

**Dim characters.**

<b>Cause</b>	<b>Solution</b>
The brightness and contrast controls are not set properly.	Adjust the monitor brightness and contrast controls.
Cables are not properly connected.	Check that the graphics cable is securely connected to the graphics card (if applicable) or video connector and the monitor.

**Blurry video or requested resolution cannot be set.**

<b>Cause</b>	<b>Solution</b>
If the graphics controller was upgraded, the correct graphics drivers may not be loaded.	Install the video drivers included in the upgrade kit.
Monitor is not capable of displaying requested resolution.	Change requested resolution.
Graphics card is bad.	Replace the graphics card.

**The picture is broken up, rolls, jitters, or flashes.**

<b>Cause</b>	<b>Solution</b>
The monitor connections may be incomplete or the monitor may be incorrectly adjusted.	<ol style="list-style-type: none"><li>1. Be sure the monitor cable is securely connected to the computer.</li><li>2. In a two-monitor system or if another monitor is in close proximity, be sure the monitors are not interfering with each other's electromagnetic field by moving them apart.</li><li>3. Fluorescent lights or fans may be too close to the monitor.</li></ol>
Monitor needs to be degaussed.	Degauss the monitor. Refer to the documentation that came with the monitor for instructions.

**Image is not centered.**

---

<b>Cause</b>	<b>Solution</b>
Position may need adjustment.	Press the monitor's Menu button to access the OSD menu. Select <b>ImageControl/ Horizontal Position</b> or <b>Vertical Position</b> to adjust the horizontal or vertical position of the image.

---

**"No Connection, Check Signal Cable" displays on screen.**

---

<b>Cause</b>	<b>Solution</b>
Monitor video cable is disconnected.	Connect the video cable between the monitor and computer. <b>CAUTION:</b> Ensure that the computer power is off while connecting the video cable.

---

### “Out of Range” displays on screen.

Cause	Solution
Video resolution and refresh rate are set higher than what the monitor supports.	<p>Restart the computer and enter Safe Mode. Change the settings to a supported setting then restart the computer so that the new settings take effect.</p> <p>To enter Safe Mode in Windows 7:</p> <ol style="list-style-type: none"><li>1. Restart the computer.</li><li>2. Press and hold the <b>F8</b> key as your computer restarts, before the Windows logo appears. If the Windows logo appears, you must restart the computer and try again.</li><li>3. On the Advanced Boot Options screen, use the arrow keys to highlight the safe mode option you want, and then press <b>Enter</b>.</li><li>4. Log on to your computer with a user account that has administrator rights.</li></ol> <p>When your computer is in safe mode, <b>Safe Mode</b> displays in the corners of your monitor. To exit safe mode, restart your computer and let Windows start normally.</p> <p>To enter Safe Mode in Windows 8:</p> <ol style="list-style-type: none"><li>1. Press the <b>Windows logo + I</b> to open the Settings charm.</li><li>2. Select <b>Change PC Settings</b>, select <b>General</b>, and then under <b>Advanced startup</b>, click <b>Restart now</b>.</li><li>3. Select <b>Troubleshoot</b>, select <b>Advanced options</b>, select <b>Startup Settings</b>, and then click <b>Restart</b>.</li><li>4. Use the function keys or number keys to select the safe mode option you want.</li></ol> <p>When your computer is in safe mode, <b>Safe Mode</b> displays in the corners of your monitor. To exit safe mode, restart your computer and let Windows start normally.</p>

### High pitched noise coming from inside a flat panel monitor.

Cause	Solution
Brightness and/or contrast settings are too high.	Lower brightness and/or contrast settings.

**Fuzzy focus; streaking, ghosting, or shadowing effects; horizontal scrolling lines; faint vertical bars; or unable to center the picture on the screen (flat panel monitors using an analog VGA input connection only).**

Cause	Solution
Flat panel monitor's internal digital conversion circuits may be unable to correctly interpret the output synchronization of the graphics card.	<ol style="list-style-type: none"> <li>1. Select the monitor's Auto-Adjustment option in the monitor's on-screen display menu.</li> <li>2. Manually synchronize the Clock and Clock Phase on-screen display functions. To download a SoftPaq that will assist you with the synchronization, go to the following Web site, select the appropriate monitor, and download either SP32347 or SP32202: <a href="http://www.hp.com/support">http://www.hp.com/support</a></li> </ol>
Graphics card is not seated properly or is bad (some models).	<ol style="list-style-type: none"> <li>1. Reseat the graphics card.</li> <li>2. Replace the graphics card.</li> </ol>

**Certain typed symbols do not appear correct.**

Cause	Solution
The font you are using does not support that particular symbol.	<p>Use the Character Map to locate and select the appropriate symbol. You can copy the symbol from the Character Map into a document.</p> <p>In Windows 7, click <b>Start</b>, select <b>All Programs</b>, select <b>Accessories</b>, select <b>System Tools</b>, and then select <b>Character Map</b>.</p> <p>In Windows 8, on the Start screen, type <code>ch</code>, and then select <b>Character Map</b> from the list of applications.</p>

## Solving Audio Problems

If the computer has audio features and you encounter audio problems, see the common causes and solutions listed in the following table.

**Table 8-6 Solving Audio Problems**

**Sound cuts in and out.**

Cause	Solution
Processor resources are being used by other open applications.	Shut down all open processor-intensive applications.

## Sound does not come out of the speaker or headphones.

Cause	Solution
Software volume control is turned down or muted.	Double-click the <b>Speaker</b> icon on the taskbar, then make sure that <b>Mute</b> is not selected and use the volume slider to adjust the volume.  <b>NOTE:</b> In Windows 8, the taskbar is available at the bottom of the Desktop screen.
Audio is hidden in Computer Setup.	Enable the audio in Computer Setup: <b>Security &gt; Device Security &gt; System Audio</b> .
The external speakers are not turned on.	Turn on the external speakers.
The audio device may be connected to the wrong jack.	Ensure that the device is connected to the correct jack on the computer. The rear audio jack output is the green receptacle. The speakers should be plugged into the line-out jack and the headphones should be plugged into the headphone jack.
External speakers plugged into the wrong audio jack on a recently installed sound card.	See the sound card documentation for proper speaker connection. The rear audio jack output is the green receptacle.
Headphones or devices connected to the line-out connector mute the internal speaker.	Turn on and use headphones or external speakers, if connected, or disconnect headphones or external speakers.
Computer is in Sleep state.	Press the power button to resume from Sleep state.  <b>CAUTION:</b> When attempting to resume from Sleep state, do not hold down the power button for more than four seconds. Otherwise, the computer will shut down and you will lose any unsaved data.
Internal speaker is disabled in Computer Setup.	Enable the internal speaker in Computer Setup. Select <b>Advanced &gt; Device Options &gt; Internal Speaker</b> .
The application is set to use a different audio device than speakers.	Some graphics cards support audio over the DisplayPort connection (if applicable), so multiple audio devices may be listed in Device Manager. Make sure the correct device is being used.  To access Device Manager in Windows 7, click <b>Start</b> , select <b>Control Panel</b> , and then select <b>Device Manager</b> .  To access Device Manager in Windows 8, from the Start screen, type <b>c</b> , select <b>Control Panel</b> from the list of applications, and then select <b>Device Manager</b> .
Some applications can select which audio output device is used.	Make sure the application has selected the correct audio device.
The operating system controls may be set to use a different audio device as the default output device than what is expected.	Set the operating system to use the correct audio device.

### Sound from headphones is not clear or muffled.

Cause	Solution
Headphones are plugged into the rear audio output connector. The rear audio output connector is for powered audio devices and is not designed for headphone use.	Plug the headphones into the headphone connector on the front of the computer.

### Computer appears to be locked up while recording audio.

Cause	Solution
The hard disk may be full.	Before recording, make sure there is enough free space on the hard disk. You can also try recording the audio file in a compressed format.

### Line-in jack is not functioning properly.

Cause	Solution
Jack has been reconfigured in the audio driver or application software.	In the audio driver or application software, reconfigure the jack or set the jack to its default value.

### There is no sound or sound volume is too low.

Cause	Solution
The application is set to use a different audio device than speakers.	Some graphics cards support audio over the DisplayPort connection (if applicable), so multiple audio devices may be listed in Device Manager. Make sure the correct device is being used.  To access Device Manager in Windows 7, click <b>Start</b> , select <b>Control Panel</b> , and then select <b>Device Manager</b> .  To access Device Manager in Windows 8, from the Start screen, type <b>c</b> , select <b>Control Panel</b> from the list of applications, and then select <b>Device Manager</b> .
Some applications can select which audio output device is used.	Make sure the application has selected the correct audio device.
The operating system controls may be set to use a different audio device as the default output device than what is expected.	Set the operating system to use the correct audio device.

## Solving Printer Problems

If you encounter printer problems, see the documentation that came with the printer and to the common causes and solutions listed in the following table.

**Table 8-7 Solving Printer Problems****Printer will not print.**

<b>Cause</b>	<b>Solution</b>
Printer is not turned on and online.	Turn the printer on and make sure it is online.
The correct printer drivers for the application are not installed.	<ol style="list-style-type: none"> <li>1. Install the correct printer driver for the application.</li> <li>2. Try printing using the MS-DOS command:  <pre>DIR C:\ &gt; [printer port]</pre>           where [printer port] is the address of the printer being used. If the printer works, reload the printer driver.             To run MS-DOS commands, press the Windows key + <b>r</b>, type <code>cmd</code> in the <b>Open</b> box, and then click <b>OK</b>.         </li> </ol>
If you are on a network, you may not have made the connection to the printer.	Make the proper network connections to the printer.
Printer may have failed.	Run printer self-test.

**Printer will not turn on.**

<b>Cause</b>	<b>Solution</b>
The cables may not be connected properly.	Reconnect all cables and check the power cord and electrical outlet.

**Printer prints garbled information.**

<b>Cause</b>	<b>Solution</b>
The correct printer driver for the application is not installed.	Install the correct printer driver for the application.
The cables may not be connected properly.	Reconnect all cables.
Printer memory may be overloaded.	Reset the printer by turning it off for one minute, then turn it back on.

**Printer will not print.**

<b>Cause</b>	<b>Solution</b>
The printer may be out of paper.	Check the paper tray and refill it if it is empty.

## Solving Keyboard and Mouse Problems

If you encounter keyboard or mouse problems, see the documentation that came with the equipment and to the common causes and solutions listed in the following table.



## Table 8-8 Solving Keyboard Problems

**A wireless keyboard/mouse is not working correctly. Symptoms include lagging mouse movement, jumpy mouse/keyboard, or no function of mouse/keyboard and external drive.**

Cause	Solution
If your computer is equipped with USB 3.0 ports, connected USB 3.0 devices can interfere with the wireless keyboard USB receiver.	Connect the wireless keyboard USB receiver to a USB 2.0 port that is separated from ports with USB 3.0 devices. If you still experience interference, you may have to place the connectors farther apart using an external USB hub.

**Keyboard commands and typing are not recognized by the computer.**

Cause	Solution
Keyboard connector is not properly connected.	Shut down the computer, reconnect the keyboard to the back of the computer, and then restart the computer.
Program in use has stopped responding to commands.	Shut down your computer using the mouse and then restart the computer.
Keyboard needs repairs.	See the Worldwide Limited Warranty for terms and conditions.
Computer is in Sleep state.	Press the power button to resume from Sleep state.  <b>CAUTION:</b> When attempting to resume from Sleep state, do not hold down the power button for more than four seconds. Otherwise, the computer will shut down and you will lose any unsaved data.

**Cursor will not move using the arrow keys on the keypad.**

Cause	Solution
The Num Lock key is on.	Press the Num Lock key. The Num Lock light should be off if you want to use the arrow keys on the keypad. You can disable or enable the Num Lock key in Computer Setup at <b>Advanced &gt; Device Options</b> .

**Table 8-9 Solving Mouse Problems**

**Mouse does not respond to movement or is too slow.**

<b>Cause</b>	<b>Solution</b>
Mouse connector is not properly plugged into the back of the computer.	Shut down the computer using the keyboard.  Windows 7: <ol style="list-style-type: none"><li>1. Press the <b>Ctrl</b> and <b>Esc</b> keys at the same time (or press the <b>Windows logo</b> key) to display the <b>Start</b> menu.</li><li>2. Use the <b>arrow</b> keys to select <b>Shut Down</b> and then press <b>Enter</b>.</li><li>3. After the shutdown is complete, plug the mouse connector into the back of the computer (or the keyboard) and restart.</li></ol> Windows 8: <ol style="list-style-type: none"><li>1. Press the <b>Windows logo</b> + <b>I</b> to open the Settings charm.</li><li>2. Use the <b>arrow</b> keys to select <b>Power</b>, and then press <b>Enter</b>.</li><li>3. Use the <b>arrow</b> keys to select <b>Shut Down</b>, and then press <b>Enter</b>.</li><li>4. After the shutdown is complete, plug the mouse connector into the back of the computer (or the keyboard) and restart.</li></ol>
Program in use has stopped responding to commands.	Shut down the computer using the keyboard then restart the computer.
Mouse may need cleaning.	Remove the roller ball cover on the mouse and clean the internal components.
Mouse may need repair.	See the Worldwide Limited Warranty for terms and conditions.
Computer is in Sleep state.	Press the power button to resume from Sleep state.  <b>CAUTION:</b> When attempting to resume from Sleep state, do not hold down the power button for more than four seconds. Otherwise, the computer will shut down and you will lose any unsaved data.

**Mouse will only move vertically, horizontally, or movement is jerky.**

<b>Cause</b>	<b>Solution</b>
Mouse roller ball or the rotating encoder shafts that make contact with the ball are dirty.	Remove roller ball cover from the bottom of the mouse and clean the internal components with a mouse cleaning kit available from most computer stores.

# Solving Hardware Installation Problems

You may need to reconfigure the computer when you add or remove hardware, such as an additional drive or expansion card. If you install a plug and play device, Windows automatically recognizes the device and configures the computer. If you install a non-plug and play device, you must reconfigure the computer after completing installation of the new hardware. In Windows, use the **Add Hardware Wizard** and follow the instructions that appear on the screen.

To open the Add Hardware Wizard, open a Command Prompt and open hdwwiz.exe.

**WARNING!** When the computer is plugged into an AC power source, voltage is always applied to the system board. To reduce the risk of personal injury from electrical shock and/or hot surfaces, be sure to disconnect the power cord from the wall outlet and allow the internal system components to cool before touching.

**Table 8-10 Solving Hardware Installation Problems**

**A new device is not recognized as part of the system.**

Cause	Solution
Device is not seated or connected properly.	Ensure that the device is properly and securely connected and that pins in the connector are not bent down.
Cable(s) of new external device are loose or power cables are unplugged.	Ensure that all cables are properly and securely connected and that pins in the cable or connector are not bent down.
Power switch of new external device is not turned on.	Turn off the computer, turn on the external device, then turn on the computer to integrate the device with the computer system.
When the system advised you of changes to the configuration, you did not accept them.	Reboot the computer and follow the instructions for accepting the changes.
A plug and play board may not automatically configure when added if the default configuration conflicts with other devices.	Use Windows Device Manager to deselect the automatic settings for the board and choose a basic configuration that does not cause a resource conflict. You can also use Computer Setup to reconfigure or disable devices to resolve the resource conflict.  To access Device Manager in Windows 7, click <b>Start</b> , select <b>Control Panel</b> , and then select <b>Device Manager</b> .  To access Device Manager in Windows 8, from the Start screen, type <b>c</b> , select <b>Control Panel</b> from the list of applications, and then select <b>Device Manager</b> .
USB ports on the computer are disabled in Computer Setup.	Run the Computer Setup utility and ensure that <b>Device available</b> is selected for appropriate USB ports under <b>Security &gt; USB Security</b> .

## Computer will not start.

Cause	Solution
Wrong memory modules were used in the upgrade or memory modules were installed in the wrong location.	<ol style="list-style-type: none"><li>1. Review the documentation that came with the system to determine if you are using the correct memory modules and to verify the proper installation.  <b>NOTE:</b> DIMM1 or XMM1 must always be installed. On all computers except the USDT, DIMM1 must be installed before DIMM2, and DIMM3 must be installed before DIMM4.</li><li>2. Observe the beeps and LED lights on the front of the computer. Beeps and flashing LEDs are codes for specific problems.</li><li>3. If you still cannot resolve the issue, contact Customer Support.</li></ol>

## Power LED flashes Red five times, once every second, followed by a two second pause, and the computer beeps five times. (Beeps stop after fifth iteration but LEDs continue flashing.)

Cause	Solution
Memory is installed incorrectly or is bad.	<p><b>CAUTION:</b> To avoid damage to the DIMMs or the system board, you must unplug the computer power cord before attempting to reseat, install, or remove a DIMM module.</p> <ol style="list-style-type: none"><li>1. Reseat DIMMs. Power on the system.</li><li>2. Replace DIMMs one at a time to isolate the faulty module.  <b>NOTE:</b> DIMM1 or XMM1 must always be installed. On all computers except the USDT, DIMM1 must be installed before DIMM2, and DIMM3 must be installed before DIMM4</li><li>3. Replace third-party memory with HP memory.</li><li>4. Replace the system board.</li></ol>

## Power LED flashes Red six times, once every second, followed by a two second pause, and the computer beeps six times. (Beeps stop after fifth iteration but LEDs continue flashing.)

Cause	Solution
Graphics card (some models) is not seated properly or is bad, or system board is bad.	<p>For systems with a graphics card:</p> <ol style="list-style-type: none"><li>1. Reseat the graphics card. Power on the system.</li><li>2. Replace the graphics card.</li><li>3. Replace the system board.</li></ol> <p>For systems with integrated graphics, replace the system board.</p>

**Power LED flashes Red ten times, once every second, followed by a two second pause, and the computer beeps ten times. (Beeps stop after fifth iteration but LEDs continue flashing.)**

<b>Cause</b>	<b>Solution</b>
Bad option card.	<ol style="list-style-type: none"><li>1. Check each option card by removing the cards one at a time (if multiple cards), then power on the system to see if fault goes away.</li><li>2. Once bad card is identified, remove and replace bad option card.</li><li>3. Replace the system board.</li></ol>

## Solving Network Problems

Some common causes and solutions for network problems are listed in the following table. These guidelines do not discuss the process of debugging the network cabling.

**Table 8-11 Solving Network Problems**

**Wake-on-LAN feature is not functioning.**

<b>Cause</b>	<b>Solution</b>
S5 Maximum Power Saving feature is enabled.	Disable the S5 Maximum Power Saving option in Computer Setup. Select <b>Power &gt; Hardware Power Management &gt; S5 Maximum Power Savings</b> .

**Table 8-11 Solving Network Problems (continued)****Wake-on-LAN feature is not functioning.**

<b>Cause</b>	<b>Solution</b>
S5 Wake on LAN is disabled (some models).	Enable the S5 Wake on LAN option in Computer Setup. Select <b>Advanced &gt; Device Options &gt; S5 Wake on LAN</b> .
Wake-on-LAN is not enabled.	<p>To enable Wake-on-LAN in Windows 7:</p> <ol style="list-style-type: none"> <li>1. Select <b>Start &gt; Control Panel &gt; Network and Sharing Center</b>.</li> <li>2. Under <b>Tasks</b>, select <b>Manage network connections</b>.</li> <li>3. Click <b>Local Area Connection</b>.</li> <li>4. Click the <b>Properties</b> button.</li> <li>5. Click the <b>Configure</b> button.</li> <li>6. Click the <b>Power Management</b> tab, then select <b>Allow this device to wake the computer</b>.</li> </ol> <p>To enable Wake-on-LAN in Windows 8:</p> <ol style="list-style-type: none"> <li>1. From the Start screen, type <b>c</b>, and then select <b>Control Panel</b> from the list of applications.</li> <li>2. Select <b>Network and Sharing Center</b>, and then click the <b>Ethernet</b> link next to the connection.</li> <li>3. Click the <b>Properties</b> button.</li> <li>4. Click the <b>Configure</b> button.</li> <li>5. Click the <b>Power Management</b> tab, then enable the appropriate Wake-on LAN option.</li> </ol>

**Network driver does not detect network controller.**

<b>Cause</b>	<b>Solution</b>
Network controller is disabled.	<ol style="list-style-type: none"> <li>1. Run Computer Setup and enable network controller.</li> <li>2. Enable the network controller in the operating system using Device Manager. <p>To access Device Manager in Windows 7, click <b>Start</b>, select <b>Control Panel</b>, and then select <b>Device Manager</b>.</p> <p>To access Device Manager in Windows 8, from the Start screen, type <b>c</b>, select <b>Control Panel</b> from the list of applications, and then select <b>Device Manager</b>.</p> </li> </ol>
Incorrect network driver.	Check the network controller documentation for the correct driver or obtain the latest driver from the manufacturer's Web site.

## Network status link light never flashes.

**NOTE:** The network status light is supposed to flash when there is network activity.

Cause	Solution
No active network is detected.	Check cabling and network equipment for proper connection.
Network controller is not set up properly.	<p>Check for the device status within Windows, such as Device Manager for driver load and the Network Connections applet within Windows for link status.</p> <p>To access Device Manager in Windows 7, click <b>Start</b>, select <b>Control Panel</b>, and then select <b>Device Manager</b>.</p> <p>To access Device Manager in Windows 8, from the Start screen, type <b>c</b>, select <b>Control Panel</b> from the list of applications, and then select <b>Device Manager</b>.</p>
Network controller is disabled.	<ol style="list-style-type: none"><li>1. Run Computer Setup and enable network controller.</li><li>2. Enable the network controller in the operating system using Device Manager.</li></ol> <p>To access Device Manager in Windows 7, click <b>Start</b>, select <b>Control Panel</b>, and then select <b>Device Manager</b>.</p> <p>To access Device Manager in Windows 8, from the Start screen, type <b>c</b>, select <b>Control Panel</b> from the list of applications, and then select <b>Device Manager</b>.</p>
Network driver is not properly loaded.	Reinstall network drivers.
System cannot autosense the network.	Disable auto-sensing capabilities and force the system into the correct operating mode.

## Diagnostics reports a failure.

Cause	Solution
The cable is not securely connected.	Ensure that the cable is securely attached to the network connector and that the other end of the cable is securely attached to the correct device.
The cable is attached to the incorrect connector.	Ensure that the cable is attached to the correct connector.
There is a problem with the cable or a device at the other end of the cable.	Ensure that the cable and device at the other end are operating correctly.
Network controller interrupt is shared with an expansion board.	Under the Computer Setup <b>Advanced</b> menu, change the resource settings for the board.
The network controller is defective.	Contact an authorized service provider.

### **Diagnostics passes, but the computer does not communicate with the network.**

<b>Cause</b>	<b>Solution</b>
Network drivers are not loaded, or driver parameters do not match current configuration.	Make sure the network drivers are loaded and that the driver parameters match the configuration of the network controller.  Make sure the correct network client and protocol is installed.
The network controller is not configured for this computer.	Select the <b>Network and Sharing Center</b> icon in the <b>Control Panel</b> and configure the network controller.  To access Control Panel in Windows 7, click <b>Start</b> , and then select <b>Control Panel</b> .  To access Control Panel in Windows 8, from the Start screen, type <b>c</b> , and then select <b>Control Panel</b> .

### **Network controller stopped working when an expansion board was added to the computer.**

<b>Cause</b>	<b>Solution</b>
Network controller interrupt is shared with an expansion board.	Under the Computer Setup <b>Advanced</b> menu, change the resource settings for the board.
The network controller requires drivers.	Verify that the drivers were not accidentally deleted when the drivers for a new expansion board were installed.
The expansion board installed is a network card (NIC) and conflicts with the embedded NIC.	Under the Computer Setup <b>Advanced</b> menu, change the resource settings for the board.

### **Network controller stops working without apparent cause.**

<b>Cause</b>	<b>Solution</b>
The files containing the network drivers are corrupted.	Reinstall the network drivers using the Recovery Disc Set in Windows 7 or Windows recovery tools in Windows 8.  If necessary, download the softpaq from the web (from a different computer).
The cable is not securely connected.	Ensure that the cable is securely attached to the network connector and that the other end of the cable is securely attached to the correct device.
The network controller is defective.	Contact an authorized service provider.

### **New network card will not boot.**

<b>Cause</b>	<b>Solution</b>
New network card may be defective or may not meet industry-standard specifications.	Install a working, industry-standard NIC, or change the boot sequence to boot from another source.



**Cannot connect to network server when attempting Remote System Installation.**

Cause	Solution
The network controller is not configured properly.	Verify Network Connectivity, that a DHCP Server is present, and that the Remote System Installation Server contains the NIC drivers for your NIC.

**System setup utility reports unprogrammed EEPROM.**

Cause	Solution
Unprogrammed EEPROM.	Contact an authorized service provider.

## Solving Memory Problems

If you encounter memory problems, some common causes and solutions are listed in the following table.

 **CAUTION:** Power may still be supplied to the DIMMs when the computer is turned off (depending on the Management Engine (ME) settings). To avoid damage to the DIMMs or the system board, you must unplug the computer power cord before attempting to reseat, install, or remove a memory module.

For those systems that support ECC memory, HP does not support mixing ECC and non-ECC memory. Otherwise, the computer will not boot the operating system.

 **NOTE:** The memory count will be affected by configurations with the Management Engine (ME) enabled. The ME uses 8MB of system memory in single channel mode or 16MB of memory in dual-channel mode to download, decompress, and execute the ME firmware for Out-of-Band (OOB), third-party data storage, and other management functions.

### Table 8-12 Solving Memory Problems

**System will not boot or does not function properly after installing additional memory modules.**

Cause	Solution
A memory module is not installed in the DIMM1 or XMM1 socket.	Ensure that a memory module is installed in the DIMM1 or XMM1 socket on the system board. This socket must be populated with a memory module.
Memory module is not the correct type or speed grade for the system or the new memory module is not seated properly.	Replace module with the correct industry-standard device for the computer. On some models, ECC and non-ECC memory modules cannot be mixed.

**Out of memory error.**

Cause	Solution
You have run out of memory to run the application.	Check the application documentation to determine the memory requirements.

**Memory count during POST is wrong.**

Cause	Solution
The memory modules may not be installed correctly.	Check that the memory modules have been installed correctly and that proper modules are used.
Integrated graphics may use system memory.	No action required.

**Insufficient memory error during operation.**

Cause	Solution
Too many Terminate and Stay Resident programs (TSRs) are installed.	Delete any TSRs that you do not need.
You have run out of memory for the application.	Check the memory requirements for the application or add more memory to the computer.

**Power LED flashes Red five times, once every second, followed by a two second pause, and the computer beeps five times. (Beeps stop after fifth iteration but LEDs continue flashing.)**

Cause	Solution
Memory is installed incorrectly or is bad.	<ol style="list-style-type: none"><li>1. Reseat DIMMs. Power on the system.</li><li>2. Replace DIMMs one at a time to isolate the faulty module.</li><li>3. Replace third-party memory with HP memory.</li><li>4. Replace the system board.</li></ol>

## Solving Processor Problems

If you encounter processor problems, common causes and solutions are listed in the following table.

**Table 8-13 Solving Processor Problems****Poor performance is experienced.**

Cause	Solution
Processor is hot.	<ol style="list-style-type: none"><li>1. Make sure the airflow to the computer is not blocked.</li><li>2. Make sure the fans are connected and working properly (some fans only operate when needed).</li><li>3. Make sure the processor heat sink is installed properly.</li></ol>

**Power LED flashes Red three times, once every second, followed by a two second pause.**

Cause	Solution
Processor is not seated properly or not installed.	<ol style="list-style-type: none"><li>1. Check to see that the processor is present.</li><li>2. Reseat the processor.</li></ol>

**Power LED flashes Red eleven times, once every second, followed by a two second pause.**

Cause	Solution
The current processor does not support a feature previously enabled on this system.	<ol style="list-style-type: none"><li>1. Install a TXT (Trusted Execution Technology) capable processor.</li><li>2. Disable TXT in the Computer Setup (F10) utility.</li><li>3. Reinstall the original processor.</li></ol>

## Solving CD-ROM and DVD Problems

If you encounter CD-ROM or DVD problems, see the common causes and solutions listed in the following table or to the documentation that came with the optional device.

**Table 8-14 Solving CD-ROM and DVD Problems**

**System will not boot from CD-ROM or DVD drive.**

Cause	Solution
The device is attached to a SATA port that has been hidden in the Computer Setup utility.	Run the Computer Setup utility and ensure <b>Device Available</b> is selected for the device's SATA port in <b>Security &gt; Device Security</b> .
Removable Media Boot is disabled in the Computer Setup utility.	Run the Computer Setup utility and enable booting to removable media in <b>Storage &gt; Storage Options</b> . Ensure CD-ROM is enabled in <b>Storage &gt; Boot Order</b> .
Network Boot is enabled in Computer Setup.	Run the Computer Setup utility and disable Network Boot in <b>Security &gt; Network Boot</b> .
Non-bootable CD in drive.	Try a bootable CD in the drive.
Boot order not correct.	Run the Computer Setup utility and change boot sequence in <b>Storage &gt; Boot Order</b> .

**Drive not found (identified).**

Cause	Solution
Cable could be loose.	Check cable connections.

**Table 8-14 Solving CD-ROM and DVD Problems (continued)****Drive not found (identified).**

<b>Cause</b>	<b>Solution</b>
The system may not have automatically recognized a newly installed device.	See reconfiguration directions in the <a href="#">Solving Hardware Installation Problems on page 169</a> section. If the system still does not recognize the new device, check to see if the device is listed within Computer Setup. If it is listed, the probable cause is a driver problem. If it is not listed, the probable cause is a hardware problem.  If this is a newly installed drive, run the Computer Setup utility and try adding a POST delay under <b>Advanced &gt; Power-On Options</b> .
The device is attached to a SATA port that has been hidden in Computer Setup.	Run the Computer Setup utility and ensure <b>Device Available</b> is selected for the device's SATA port in <b>Security &gt; Device Security</b> .
Drive responds slowly immediately after power-up.	Run Computer Setup and increase the POST Delay in <b>Advanced &gt; Power-On Options</b> .

**CD-ROM or DVD devices are not detected or driver is not loaded.**

<b>Cause</b>	<b>Solution</b>
Drive is not connected properly or not properly configured.	See the documentation that came with the optional device.

**Movie will not play in the DVD drive.**

<b>Cause</b>	<b>Solution</b>
Movie may be regionalized for a different country.	See the documentation that came with the DVD drive.
Decoder software is not installed.	Install decoder software.
Damaged media.	Replace media.
Movie rating locked out by parental lock.	Use DVD software to remove parental lock.
Media installed upside down.	Reinstall media.

**Cannot eject compact disc (tray-load unit).**

<b>Cause</b>	<b>Solution</b>
Disc not properly seated in the drive.	Turn off the computer and insert a thin metal rod into the emergency eject hole and push firmly. Slowly pull the tray out from the drive until the tray is fully extended, then remove the disc.

**CD-ROM, CD-RW, DVD-ROM, or DVD-R/RW drive cannot read a disc or takes too long to start.**

<b>Cause</b>	<b>Solution</b>
Media is corrupt.	Try different media to confirm whether media is valid.
Media has been inserted upside down.	Re-insert the media with the label facing up.
The DVD-ROM drive takes longer to start because it has to determine the type of media played, such as audio or video.	Wait at least 30 seconds to let the DVD-ROM drive determine the type of media being played. If the disc still does not start, read the other solutions listed for this topic.
CD or DVD disc is dirty.	Clean CD or DVD with a CD cleaning kit, available from most computer stores.
Windows does not detect the CD-ROM or DVD-ROM drive.	<ol style="list-style-type: none"><li>1. Use Device Manager to remove or uninstall the device.  To access Device Manager in Windows 7, click <b>Start</b>, select <b>Control Panel</b>, and then select <b>Device Manager</b>.  To access Device Manager in Windows 8, from the Start screen, type <b>c</b>, select <b>Control Panel</b> from the list of applications, and then select <b>Device Manager</b>.</li><li>2. Restart the computer and let Windows detect the CD or DVD driver.</li></ol>

**Recording or copying CDs is difficult or impossible.**

<b>Cause</b>	<b>Solution</b>
Wrong or poor quality media type.	<ol style="list-style-type: none"><li>1. Try using a slower speed when recording.</li><li>2. Verify that you are using the correct media for the drive.</li><li>3. Try a different brand of media. Quality varies widely between manufacturers.</li></ol>

## Solving USB Flash Drive Problems

If you encounter USB flash drive problems, common causes and solutions are listed in the following table.

**Table 8-15 Solving USB Flash Drive Problems****USB flash drive is not seen as a drive letter in Windows.**

<b>Cause</b>	<b>Solution</b>
The drive letter after the last physical drive is not available.	Change the default drive letter for the flash drive in Windows.

### USB flash drive not found (identified).

Cause	Solution
The device is attached to a USB port that has been hidden in Computer Setup.	Run the Computer Setup utility and enable USB ports in <b>Security &gt; USB Security</b> .
The device was not properly seated before power-up.	Ensure the device is fully inserted into the USB port before applying power to the system

### System will not boot from USB flash drive.

Cause	Solution
Boot order is not correct.	Run the Computer Setup utility and change boot sequence in <b>Storage &gt; Boot Order</b> .
Removable Media Boot is disabled in the Computer Setup utility.	Run the Computer Setup utility and enable booting to removable media in <b>Storage &gt; Storage Options</b> . Ensure USB is enabled in <b>Storage &gt; Boot Order</b> .

### The computer boots to DOS after making a bootable flash drive.

Cause	Solution
Flash drive is bootable.	Install the flash drive only after the operating system boots.
Flash drive is defective.	Try a different flash drive.

## Solving Front Panel Component Problems

If you encounter problems with devices connected to the front panel, refer to the common causes and solutions listed in the following table.

### A USB device, headphone, or microphone is not recognized by the computer.

Cause	Solution
Device is not properly connected.	<ol style="list-style-type: none"><li>1. Turn off the computer.</li><li>2. Reconnect the device to the front of the computer and restart the computer.</li></ol>
The device does not have power.	If the USB device requires AC power, be sure one end is connected to the device and one end is connected to a live outlet.
The correct device driver is not installed.	<ol style="list-style-type: none"><li>1. Install the correct driver for the device.</li><li>2. You might need to reboot the computer.</li></ol>
The cable from the device to the computer does not work.	<ol style="list-style-type: none"><li>1. If possible, replace the cable.</li><li>2. Restart the computer.</li></ol>

### **A USB device, headphone, or microphone is not recognized by the computer.**

<b>Cause</b>	<b>Solution</b>
The device is not working.	<ol style="list-style-type: none"><li>1. Replace the device.</li><li>2. Restart the computer.</li></ol>
USB ports on the computer are disabled in Computer Setup.	Run the Computer Setup utility and ensure that the USB ports are set to <b>Enabled</b> in <b>Security &gt; USB Security</b> .

## **Solving Internet Access Problems**

If you encounter Internet access problems, consult your Internet Service Provider (ISP) or refer to the common causes and solutions listed in the following table.

### **Unable to connect to the Internet.**

<b>Cause</b>	<b>Solution</b>
Internet Service Provider (ISP) account is not set up properly.	Verify Internet settings or contact your ISP for assistance.
Web browser is not set up properly.	Verify that the Web browser is installed and set up to work with your ISP.
Cable/DSL modem is not plugged in.	Plug in cable/DSL modem. You should see a "power" LED light on the front of the cable/DSL modem.
Cable/DSL service is not available or has been interrupted due to bad weather.	Try connecting to the Internet at a later time or contact your ISP. (If the cable/DSL service is connected, the "cable" LED light on the front of the cable/DSL modem will be on.)
The CAT5 UTP cable is disconnected.	Connect the CAT5 UTP cable between the cable modem and the computer's RJ-45 connector. (If the connection is good, the "PC" LED light on the front of the cable/DSL modem will be on.)

### Unable to connect to the Internet.

Cause	Solution
IP address is not configured properly.	Contact your ISP for the correct IP address.
Cookies are corrupted. (A “cookie” is a small piece of information that a Web server can store temporarily with the Web browser. This is useful for having the browser remember some specific information that the Web server can later retrieve.)	Windows 7: <ol style="list-style-type: none"><li>1. Select <b>Start &gt; Control Panel</b>.</li><li>2. Click <b>Internet Options</b>.</li><li>3. In the <b>Browsing history</b> section on the <b>General</b> tab, click the <b>Delete</b> button.</li><li>4. Select the <b>Cookies</b> check box and click the <b>Delete</b> button.</li></ol> Windows 8: <ol style="list-style-type: none"><li>1. From the Start screen, type <b>c</b>, and then select <b>Control Panel</b> from the list of applications..</li><li>2. Click <b>Internet Options</b>.</li><li>3. In the <b>Browsing history</b> section on the <b>General</b> tab, click the <b>Delete</b> button.</li><li>4. Select the <b>Cookies</b> check box and click the <b>Delete</b> button.</li></ol>

### Cannot automatically launch Internet programs.

Cause	Solution
You must log on to your ISP before some programs will start.	Log on to your ISP and launch the desired program.

## Solving Software Problems

Most software problems occur as a result of the following:

- The application was not installed or configured correctly.
- There is insufficient memory available to run the application.
- There is a conflict between applications.
- Be sure that all the needed device drivers have been installed.
- If you have installed an operating system other than the factory-installed operating system, check to be sure it is supported on the system.

If you encounter software problems, see the applicable solutions listed in the following table.



---

**Computer will not continue and the HP logo does not display.**

---

<b>Cause</b>	<b>Solution</b>
ROM issue - POST error has occurred.	Observe the beeps and LED lights on the front of the computer. See Appendix A, <a href="#">POST Error Messages on page 187</a> to determine possible causes.  See the Worldwide Limited Warranty for terms and conditions.

---

---

**Computer will not continue after HP logo screen displays.**

---

<b>Cause</b>	<b>Solution</b>
System files may be damaged.	<p>In Windows 7, use recovery media to scan hard drive for errors, or use Windows Startup Repair to fix problems that might prevent Windows from starting correctly. Windows Startup Repair is one of the recovery tools in the System Recovery Options menu. You can also create a system repair disc that contains the System Recovery Options menu. If the problem is severe enough that Startup Repair doesn't start on its own and you can't access the System Recovery Options menu on your computer's hard disk, you can get to the menu and start Startup Repair by using the Windows installation disc or a system repair disc that you created earlier.</p> <p>In Windows 8, use Automatic Repair to fix problems that might prevent Windows from starting correctly.</p> <p>To access Automatic Repair:</p> <ol style="list-style-type: none"><li>1. Press the <b>Windows logo + I</b> to open the Settings charm.</li><li>2. Select <b>Change PC Settings</b>, select <b>General</b>, and then under <b>Advanced startup</b>, click <b>Restart now</b>.</li><li>3. Select <b>Troubleshoot</b>, select <b>Advanced options</b>, and then select <b>Automatic Repair</b>.  Windows starts Automatic Repair.</li><li>4. Select the account to use to begin Automatic Repair, and type the password for the account.  Windows diagnoses the computer and attempts the repair it.</li></ol>

---

---

**"Illegal Operation has Occurred" error message is displayed.**

---

<b>Cause</b>	<b>Solution</b>
Software being used is not Microsoft-certified for your version of Windows.	Verify that the software is certified by Microsoft for your version of Windows (see program packaging for this information).
Configuration files are corrupt.	If possible, save all data, close all programs, and restart the computer.

---

## Contacting Customer Support

For help and service, contact an authorized reseller or dealer. To locate a reseller or dealer near you, visit <http://www.hp.com>.

---

 **NOTE:** If you take the computer to an authorized reseller, dealer, or service provider for service, remember to provide the setup and power-on passwords if they are set.

Refer to the number listed in the warranty or in the *Support Telephone Numbers* guide for technical assistance.

---

# 9 HP PC Hardware Diagnostics

To help troubleshoot and diagnose failures, use the UEFI-based hardware diagnostic solution that HP includes on all products. This tool can even be used if the computer will not boot to the operating system.

## Why run HP PC Hardware Diagnostics – UEFI

The HP PC Hardware Diagnostic tools simplify the process of diagnosing hardware issues and expedite the support process when issues are found. The tools save time by pinpointing the component that needs to be replaced.

- **Isolate true hardware failures:** The diagnostics run outside of the operating system so they effectively isolate hardware failures from issues that may be caused by the operating system or other software components.
- **Failure ID:** When a failure is detected that requires hardware replacement, a 24-digit Failure ID is generated. This ID can then be provided to the call agent, who will either schedule support or provide replacement parts.

## How to access and run HP PC Hardware Diagnostics - UEFI

To access the UEFI diagnostics:

1. Restart or turn on the computer and press **Esc** repeatedly until the BIOS boot menu appears.
2. Press **F2** or select **Diagnostics (F2)**.

### How to access and run UEFI diagnostics

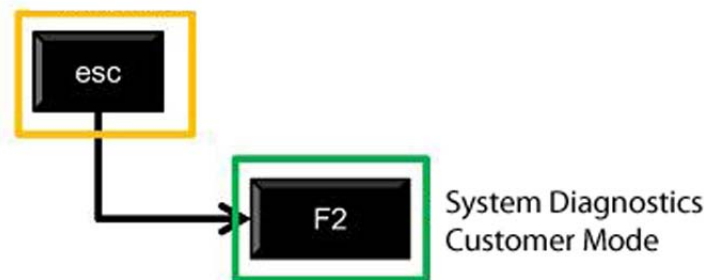

**Note:** The key (F2 or F10) depends on the product.



After pressing **F2**, the BIOS sequentially searches three places for the system diagnostics:

- a. **First** – a connected USB drive (to download the diagnostics tools to a USB drive, see the instructions in [Downloading HP PC Hardware Diagnostics to a USB device on page 186](#)).
- b. **Second** – the hard disk drive.
- c. **Third** – in the BIOS, a core set of diagnostics (for memory and hard disk drive) that are accessible only if the USB or hard disk drive versions are not detected.

## Downloading HP PC Hardware Diagnostics to a USB device

1. Go to <http://www.hp.com>.
2. Click the **Support & Drivers** link.
3. Select the **Drivers & Software** tab.
4. Enter the product name in the text box and click **Search**.
5. Select your specific computer model.
6. Select your operating system.
7. In the Diagnostic section, click the **HP UEFI Support Environment** link. This link provides additional information.

- or -

Click the **Download** button and select **Run**. The download includes instructions (in English) on how to install the tools on the USB device.



---

**NOTE:** HP diagnostic solutions are developed to test components typically included on HP products. They may not diagnose all third-party accessories that can be added to the system.

---

# 10 POST Error Messages

This appendix lists the error codes, error messages, and the various indicator light and audible sequences that you may encounter during Power-On Self-Test (POST) or computer restart, the probable source of the problem, and steps you can take to resolve the error condition.

POST Message Disabled suppresses most system messages during POST, such as memory count and non-error text messages. If a POST error occurs, the screen will display the error message. To manually switch to the POST Messages Enabled mode during POST, press any key (except [F10](#), [F11](#), or [F12](#)). The default mode is POST Message Disabled.

The speed at which the computer loads the operating system and the extent to which it is tested are determined by the POST mode selection.

Quick Boot is a fast startup process that does not run all of the system level tests, such as the memory test. Full Boot runs all of the ROM-based system tests and takes longer to complete.

Full Boot may also be enabled to run every 1 to 30 days on a regularly scheduled basis. To establish the schedule, reconfigure the computer to the Full Boot Every x Days mode, using Computer Setup.

 **NOTE:** For more information on Computer Setup, see [Computer Setup \(F10\) Utility on page 10](#).

## POST Numeric Codes and Text Messages

This section covers those POST errors that have numeric codes associated with them. The section also includes some text messages that may be encountered during POST.

 **NOTE:** The computer will beep once after a POST text message is displayed on the screen.

**Table 10-1 Numeric Codes and Text Messages**

Control panel message	Description	Recommended action
101-Option ROM Checksum Error	System ROM or expansion board option ROM checksum.	<ol style="list-style-type: none"><li>1. Verify the correct ROM.</li><li>2. Flash the ROM if needed.</li><li>3. If an expansion board was recently added, remove it to see if the problem remains.</li><li>4. Clear CMOS. (See Appendix B, <a href="#">Password Security and Resetting CMOS on page 199</a>.)</li><li>5. If the message disappears, there may be a problem with the expansion card.</li><li>6. Replace the system board.</li></ol>

**Table 10-1 Numeric Codes and Text Messages (continued)**

Control panel message	Description	Recommended action
103-System Board Failure	DMA or timers.	<ol style="list-style-type: none"> <li>1. Clear CMOS. (See Appendix B, <a href="#">Password Security and Resetting CMOS on page 199.</a>)</li> <li>2. Remove expansion boards.</li> <li>3. Replace the system board.</li> </ol>
110-Out of Memory Space for Option ROMs	Recently added PCI expansion card contains an option ROM too large to download during POST.	<ol style="list-style-type: none"> <li>1. If a PCI expansion card was recently added, remove it to see if the problem remains.</li> <li>2. In Computer Setup, set <b>Advanced &gt; Device Options &gt; NIC PXE Option ROM Download</b> to <b>DISABLE</b> to prevent PXE option ROM for the internal NIC from being downloaded during POST to free more memory for an expansion card's option ROM. Internal PXE option ROM is used for booting from the NIC to a PXE server.</li> </ol>
162-System Options Not Set	Configuration incorrect.  RTC (real-time clock) battery may need to be replaced.	<p>Run Computer Setup and check the configuration in <b>Advanced &gt; Onboard Devices</b>.</p> <p>Reset the date and time under <b>Control Panel</b>. If the problem persists, replace the RTC battery. See the Removal and Replacement section for instructions on installing a new battery, or contact an authorized dealer or reseller for RTC battery replacement.</p>
163-Time & Date Not Set	Invalid time or date in configuration memory.  RTC (real-time clock) battery may need to be replaced.	Reset the date and time under <b>Control Panel</b> (Computer Setup can also be used). If the problem persists, replace the RTC battery. See the Removal and Replacement section for instructions on installing a new battery, or contact an authorized dealer or reseller for RTC battery replacement.
163-Time & Date Not Set	CMOS jumper may not be properly installed.	Check for proper placement of the CMOS jumper if applicable.
164-MemorySize Error	Memory amount has changed since the last boot (memory added or removed).	Press the <b>F1</b> key to save the memory changes.
164-MemorySize Error	Memory configuration incorrect.	<ol style="list-style-type: none"> <li>1. Run Computer Setup or Windows utilities.</li> <li>2. Make sure the memory module(s) are installed properly.</li> <li>3. If third-party memory has been added, test using HP-only memory.</li> <li>4. Verify proper memory module type.</li> </ol>

**Table 10-1 Numeric Codes and Text Messages (continued)**

<b>Control panel message</b>	<b>Description</b>	<b>Recommended action</b>
201-Memory Error	RAM failure.	<ol style="list-style-type: none"><li>1. Ensure memory modules are correctly installed.</li><li>2. Verify proper memory module type.</li><li>3. Remove and replace the identified faulty memory module(s).</li><li>4. If the error persists after replacing memory modules, replace the system board.</li></ol>
213-Incompatible Memory Module in Memory Socket(s) X, X, ...	A memory module in memory socket identified in the error message is missing critical SPD information, or is incompatible with the chipset.	<ol style="list-style-type: none"><li>1. Verify proper memory module type.</li><li>2. Try another memory socket.</li><li>3. Replace DIMM with a module conforming to the SPD standard.</li></ol>
214-DIMM Configuration Warning	Populated DIMM Configuration is not optimized.	Rearrange the DIMMs so that each channel has the same amount of memory.
219-ECC Memory Module Detected ECC Modules not supported on this Platform	Recently added memory module(s) support ECC memory error correction.	<ol style="list-style-type: none"><li>1. If additional memory was recently added, remove it to see if the problem remains.</li><li>2. Check product documentation for memory support information.</li></ol>
301-Keyboard Error	Keyboard failure.	<ol style="list-style-type: none"><li>1. Reconnect keyboard with computer turned off.</li><li>2. Check connector for bent or missing pins.</li><li>3. Ensure that none of the keys are depressed.</li><li>4. Replace keyboard.</li></ol>
303-Keyboard Controller Error	I/O board keyboard controller.	<ol style="list-style-type: none"><li>1. Reconnect keyboard with computer turned off.</li><li>2. Replace the system board.</li></ol>
304-Keyboard or System Unit Error	Keyboard failure.	<ol style="list-style-type: none"><li>1. Reconnect the keyboard with computer turned off.</li><li>2. Ensure that none of the keys are depressed.</li><li>3. Replace the keyboard.</li><li>4. Replace the system board.</li></ol>

**Table 10-1 Numeric Codes and Text Messages (continued)**

Control panel message	Description	Recommended action
501-Display Adapter Failure	Graphics display controller.	<ol style="list-style-type: none"> <li>1. Reseat the graphics card (if applicable).</li> <li>2. Clear CMOS. (See Appendix B, <a href="#">Password Security and Resetting CMOS on page 199.</a>)</li> <li>3. Verify monitor is attached and turned on.</li> <li>4. Replace the graphics card (if possible).</li> </ol>
510-Flash Screen Image Corrupted	Flash Screen image has errors.	Reflash the system ROM with the latest BIOS image.
511-CPU, CPUA, or CPUB Fan not Detected	CPU fan is not connected or may have malfunctioned.	<ol style="list-style-type: none"> <li>1. Reseat CPU fan.</li> <li>2. Reseat fan cable.</li> <li>3. Replace CPU fan.</li> </ol>
512-Chassis, Rear Chassis, or Front Chassis Fan not Detected	Chassis, rear chassis, or front chassis fan is not connected or may have malfunctioned.	<ol style="list-style-type: none"> <li>1. Reseat chassis, rear chassis, or front chassis fan.</li> <li>2. Reseat fan cable.</li> <li>3. Replace chassis, rear chassis, or front chassis fan.</li> </ol>
513-Front Chassis fan not detected	Front chassis fan is not connected or may have malfunctioned.	<ol style="list-style-type: none"> <li>1. Reseat front chassis fan.</li> <li>2. Reseat fan cable.</li> <li>3. Replace front chassis fan.</li> </ol>
514-CPU or Chassis Fan not Detected	CPU or chassis fan is not connected or may have malfunctioned.	<ol style="list-style-type: none"> <li>1. Reseat CPU or chassis fan.</li> <li>2. Reseat fan cable.</li> <li>3. Replace CPU or chassis fan.</li> </ol>
515-Power Supply fan not detected	Power supply fan is not connected or may have malfunctioned.	<ol style="list-style-type: none"> <li>1. Reseat power supply fan.</li> <li>2. Reseat fan cable.</li> <li>3. Replace power supply fan.</li> </ol>
601-Diskette Controller Error	Diskette controller circuitry or floppy drive circuitry incorrect.	<ol style="list-style-type: none"> <li>1. Check and/or replace cables.</li> <li>2. Clear CMOS. (See Appendix B, <a href="#">Password Security and Resetting CMOS on page 199.</a>)</li> <li>3. Replace the system board.</li> </ol>
605-Diskette Drive Type Error	Mismatch in drive type.	<ol style="list-style-type: none"> <li>1. Disconnect any other diskette controller devices (tape drives).</li> <li>2. Clear CMOS. (See Appendix B, <a href="#">Password Security and Resetting CMOS on page 199.</a>)</li> </ol>
660-Display cache is detected unreliable	Integrated graphics controller display cache is not working properly and will be disabled.	Replace system board if minimal graphics degrading is an issue.



**Table 10-1 Numeric Codes and Text Messages (continued)**

Control panel message	Description	Recommended action
912-Computer Cover Has Been Removed Since Last System Startup	Computer cover was removed since last system startup.	No action required.
917-Front Audio Not Connected	Front audio harness has been detached or unseated from motherboard.	Reconnect or replace front audio harness.
918-Front USB Not Connected	Front USB harness has been detached or unseated from motherboard.	Reconnect or replace front USB harness.
921-Device in PCI Express slot failed to initialize	There is an incompatibility/problem with this device and the system or PCI Express Link could not be retrained to an x1.	Try rebooting the system. If the error reoccurs, the device may not work with this system
1151-Serial Port A Address Conflict Detected	Both external and internal serial ports are assigned to COM1.	<ol style="list-style-type: none"> <li>1. Remove any serial port expansion cards.</li> <li>2. Clear CMOS. (See Appendix B, <a href="#">Password Security and Resetting CMOS on page 199.</a>)</li> <li>3. Reconfigure card resources and/or run Computer Setup or Windows utilities.</li> </ol>
1152-Serial Port B Address Conflict Detected	Both external and internal serial ports are assigned to COM2.	<ol style="list-style-type: none"> <li>1. Remove any serial port expansion cards.</li> <li>2. Clear CMOS. (See Appendix B, <a href="#">Password Security and Resetting CMOS on page 199.</a>)</li> <li>3. Reconfigure card resources and/or run Computer Setup or Windows utilities.</li> </ol>
1155-Serial Port Address Conflict Detected	Both external and internal serial ports are assigned to same IRQ.	<ol style="list-style-type: none"> <li>1. Remove any serial port expansion cards.</li> <li>2. Clear CMOS. (See Appendix B, <a href="#">Password Security and Resetting CMOS on page 199.</a>)</li> <li>3. Reconfigure card resources and/or run Computer Setup or Windows utilities.</li> </ol>
1720-SMART Hard Drive Detects Imminent Failure	Hard drive is about to fail. (Some hard drives have a hard drive firmware patch that will fix an erroneous error message.)	<ol style="list-style-type: none"> <li>1. Determine if hard drive is giving correct error message. Enter Computer Setup and run the Drive Protection System test under <b>Storage &gt; DPS Self-test</b>.</li> <li>2. Apply hard drive firmware patch if applicable. (Available at <a href="http://www.hp.com/support">http://www.hp.com/support</a>.)</li> <li>3. Back up contents and replace hard drive.</li> </ol>
1796-SATA Cabling Error	One or more SATA devices are improperly attached. For optimal performance, the SATA 0 and SATA 1 connectors must be used before SATA 2 and SATA 3.	Ensure SATA connectors are used in ascending order. For one device, use SATA 0. For two devices, use SATA 0 and SATA 1. For three devices, use SATA 0, SATA 1, and SATA 2.

**Table 10-1 Numeric Codes and Text Messages (continued)**

Control panel message	Description	Recommended action
1797-SATA Drivelock is not supported in RAID mode.	Drivelock is enabled on one or more SATA hard drives, and they cannot be accessed while the system is configured for RAID mode.	Either remove the Drivelocked SATA device or disable the Drivelock feature. To disable the Drivelock feature, enter Computer Setup, change <b>Storage &gt; Storage Options &gt; SATA Emulation</b> to <b>IDE</b> , and select <b>File &gt; Save Changes and Exit</b> . Reenter Computer Setup and select <b>Security &gt; Drivelock Security</b> . For each listed Drivelock-capable SATA device, ensure Drivelock is <b>Disabled</b> . Lastly, change <b>Storage &gt; Storage Options &gt; SATA Emulation</b> back to <b>RAID</b> and select <b>File &gt; Save Changes and Exit</b> .
1801-Microcode Patch Error	Processor is not supported by ROM BIOS.	<ol style="list-style-type: none"><li>1. Upgrade BIOS to proper version.</li><li>2. Change the processor.</li></ol>
2200-PMM Allocation Error during MEBx Download	Memory error during POST execution of the Management Engine (ME) BIOS Extensions option ROM.	<ol style="list-style-type: none"><li>1. Reboot the computer.</li><li>2. Unplug the power cord, re-seat the memory modules, and reboot the computer.</li><li>3. If the memory configuration was recently changed, unplug the computer, restore the original memory configuration, and reboot the computer.</li><li>4. If the error persists, replace the system board.</li></ol>
2201-MEBx Module did not checksum correctly	Memory error during POST execution of the Management Engine (ME) BIOS Extensions option ROM.	<ol style="list-style-type: none"><li>1. Reboot the computer.</li><li>2. Unplug the power cord, re-seat the memory modules, and reboot the computer.</li><li>3. If the memory configuration was recently changed, unplug the power cord, restore the original memory configuration, and reboot the computer.</li><li>4. If the error persists, replace the system board.</li></ol>
2202-PMM Deallocation Error during MEBx cleanup	Memory error during POST execution of the Management Engine (ME) BIOS Extensions option ROM.	<ol style="list-style-type: none"><li>1. Reboot the computer.</li><li>2. Unplug the power cord, re-seat the memory modules, and reboot the computer.</li><li>3. If the memory configuration was recently changed, unplug the power cord, restore the original memory configuration, and reboot the computer.</li><li>4. If the error persists, replace the system board.</li></ol>

**Table 10-1 Numeric Codes and Text Messages (continued)**

<b>Control panel message</b>	<b>Description</b>	<b>Recommended action</b>
2203-Setup error during MEBx execution	MEBx selection or exit resulted in a setup failure.	<ol style="list-style-type: none"><li>1. Reboot the computer.</li><li>2. Unplug the power cord, re-seat the memory modules, and reboot the computer.</li><li>3. If the memory configuration was recently changed, unplug the power cord, restore the original memory configuration, and reboot the computer.</li><li>4. If the error persists, replace the system board.</li></ol>
2204-Inventory error during MEBx execution	BIOS information passed to the MEBx resulted in a failure.	<ol style="list-style-type: none"><li>1. Reboot the computer.</li><li>2. If the error persists, update to the latest BIOS version.</li><li>3. If the error still persists, replace the system board.</li></ol>
2205-Interface error during MEBx execution	MEBx operation experienced a hardware error during communication with ME.	<ol style="list-style-type: none"><li>1. Reboot the computer.</li><li>2. If the error persists, update to the latest BIOS version.</li><li>3. If the error still persists, replace the system board.</li></ol>
2211-Memory not configured correctly for proper MEBx execution.	DIMM1 or XMM1 is not installed.	Make sure there is a memory module in the black DIMM1 socket and that it is properly seated.
2212-USB Key Provisioning failure writing to device	USB device used for USB key provisioning will not allow BIOS to update provision file properly.	<ol style="list-style-type: none"><li>1. Try a different USB key device for provisioning.</li><li>2. If the error persists, update to the latest BIOS version and ME firmware version.</li><li>3. If the error still persists, replace the system board.</li></ol>
2217-ME Firmware Version request failure	ME firmware is not properly responding to BIOS query for version information.	<ol style="list-style-type: none"><li>1. Reboot the computer.</li><li>2. If the error persists, update to the latest BIOS version and ME firmware version.</li><li>3. If the error still persists, replace the system board.</li></ol>
2218-ME Firmware Version should be updated	ME firmware must be updated to match current functionality contained in the system BIOS.	<ol style="list-style-type: none"><li>1. Update to the latest ME firmware version.</li><li>2. If the error persists and system BIOS has been recently updated, restore previous system BIOS version.</li><li>3. If the error still persists, replace the system board.</li></ol>

**Table 10-1 Numeric Codes and Text Messages (continued)**

<b>Control panel message</b>	<b>Description</b>	<b>Recommended action</b>
2219-USB Key Provisioning file has invalid header identifier	Provisioning file contained on the USB key has been corrupted or is not a valid version for the current ME firmware.	<ol style="list-style-type: none"> <li>1. Recreate the provisioning file using third party management console software.</li> <li>2. If the error persists and system BIOS has been recently updated, restore previous system BIOS version. Otherwise, update the ME firmware version.</li> <li>3. If the error still persists, replace the system board.</li> </ol>
2220-USB Key Provisioning file has mismatch version	Provisioning file contained on the USB key is not a valid version for the current ME firmware.	<ol style="list-style-type: none"> <li>1. Reboot the computer.</li> <li>2. If the error persists and system BIOS has been recently updated, restore previous system BIOS version. Otherwise, update the ME firmware version.</li> <li>3. If the error still persists, replace the system board.</li> </ol>
2230-General error during MEBx execution	Error occurred during MEBx execution which fails into the "General" grouping. Status information displayed along with the error provides further clarity into the failure. MEBx handles transference of information between the system BIOS and ME firmware.	<ol style="list-style-type: none"> <li>1. Reboot the computer.</li> <li>2. If the error persists, update to the latest BIOS version and ME firmware version.</li> <li>3. If the error still persists, replace the system board.</li> </ol>
2231-ME error during MEBx execution	Error occurred during MEBx execution which fails into "ME" grouping.	<ol style="list-style-type: none"> <li>1. Reboot the computer.</li> <li>2. If the error persists, update to the latest BIOS version and ME firmware version.</li> <li>3. If the error still persists, replace the system board.</li> </ol>
2232-AMT error during MEBx execution	Error occurred during MEBx execution which fails into "AMT" grouping.	<ol style="list-style-type: none"> <li>1. Reboot the computer.</li> <li>2. If the error persists, update to the latest BIOS version and ME firmware version.</li> <li>3. If the error still persists, replace the system board.</li> </ol>
2233-HECI error during MEBx execution	Error occurred during MEBx execution which fails into "MEI or HECI" grouping.	<ol style="list-style-type: none"> <li>1. Reboot the computer.</li> <li>2. If the error persists, update to the latest BIOS version and ME firmware version.</li> <li>3. If the error still persists, replace the system board.</li> </ol>
2239-ME image lock failure	Special system configurations with reduced ME firmware image require BIOS control of ME firmware upgrading. A failure has occurred after the ME firmware update process in which the BIOS could not relock the ME firmware region.	<ol style="list-style-type: none"> <li>1. Reboot the computer.</li> <li>2. If the error persists, update to the latest BIOS version and ME firmware version.</li> <li>3. If the error still persists, replace the system board.</li> </ol>

**Table 10-1 Numeric Codes and Text Messages (continued)**

Control panel message	Description	Recommended action
2240-ME image unlock failure	Special system configurations with reduced ME firmware image require BIOS control of ME firmware upgrading. A failure has occurred prior to the ME firmware update process in which the BIOS could not unlock the ME firmware region.	<ol style="list-style-type: none"> <li>1. Reboot the computer.</li> <li>2. If the error persists, update to the latest BIOS version and ME firmware version.</li> <li>3. If the error still persists, replace the system board.</li> </ol>
Invalid Electronic Serial Number	Electronic serial number is missing.	Enter the correct serial number in Computer Setup.
Network Server Mode Active and No Keyboard Attached	Keyboard failure while Network Server Mode enabled.	<ol style="list-style-type: none"> <li>1. Reconnect keyboard with computer turned off.</li> <li>2. Check connector for bent or missing pins.</li> <li>3. Ensure that none of the keys are depressed.</li> <li>4. Replace keyboard.</li> </ol>
Parity Check 2	Parity RAM failure.	Run Computer Setup and Diagnostic utilities.

## Interpreting POST Diagnostic Front Panel LEDs and Audible Codes

This section covers the front panel LED codes as well as the audible codes that may occur before or during POST that do not necessarily have an error code or text message associated with them.

 **WARNING!** When the computer is plugged into an AC power source, voltage is always applied to the system board. To reduce the risk of personal injury from electrical shock and/or hot surfaces, be sure to disconnect the power cord from the wall outlet and allow the internal system components to cool before touching.

 **NOTE:** If you see flashing LEDs on a PS/2 keyboard, look for flashing LEDs on the front panel of the computer and refer to the following table to determine the front panel LED codes.

Recommended actions in the following table are listed in the order in which they should be performed.

Not all diagnostic lights and audible codes are available on all models.

**Table 10-2 Diagnostic Front Panel LEDs and Audible Codes**

Activity	Beeps	Possible Cause	Recommended Action
Green Power LED On.	None	Computer on.	None
Green Power LED flashes every two seconds.	None	Computer in Suspend to RAM mode (some models only) or normal Suspend mode.	None required. Press any key or move the mouse to wake the computer.

**Table 10-2 Diagnostic Front Panel LEDs and Audible Codes (continued)**

Activity	Beeps	Possible Cause	Recommended Action
Red Power LED flashes two times, once every second, followed by a two second pause. Beeps stop after fifth iteration but LEDs continue until problem is solved.	2	Processor thermal protection activated:  A fan may be blocked or not turning.  OR  The heat sink/fan assembly is not properly attached to the processor.	<ol style="list-style-type: none"><li>1. Ensure that the computer air vents are not blocked and the processor cooling fan is running.</li><li>2. Open hood, press power button, and see if the processor fan spins. If the processor fan is not spinning, make sure the fan's cable is plugged onto the system board header.</li><li>3. If fan is plugged in, but is not spinning, then replace heat sink/fan assembly.</li><li>4. Contact an authorized reseller or service provider.</li></ol>
Red Power LED flashes three times, once every second, followed by a two second pause. Beeps stop after fifth iteration but LEDs continue until problem is solved.	3	Processor not installed (not an indicator of bad processor).	<ol style="list-style-type: none"><li>1. Check to see that the processor is present.</li><li>2. Reseat the processor.</li></ol>
Red Power LED flashes four times, once every second, followed by a two second pause. Beeps stop after fifth iteration but LEDs continue until problem is solved.	4	Power failure (power supply is overloaded).	<ol style="list-style-type: none"><li>1. Open the hood and ensure the 4 or 6-wire power supply cable is seated into the connector on the system board.</li><li>2. Check if a device is causing the problem by removing ALL attached devices (such as hard or optical drives and expansion cards). Power on the system. If the system enters the POST, then power off and replace one device at a time and repeat this procedure until failure occurs. Replace the device that is causing the failure. Continue adding devices one at a time to ensure all devices are functioning properly.</li><li>3. Replace the power supply.</li><li>4. Replace the system board.</li></ol>
Red Power LED flashes five times, once every second, followed by a two second pause. Beeps stop after fifth iteration but LEDs continue until problem is solved.	5	Pre-video memory error.	<p><b>CAUTION:</b> To avoid damage to the DIMMs or the system board, you must unplug the computer power cord before attempting to reseat, install, or remove a DIMM module.</p> <ol style="list-style-type: none"><li>1. Reseat DIMMs.</li><li>2. Replace DIMMs one at a time to isolate the faulty module.</li><li>3. Replace third-party memory with HP memory.</li><li>4. Replace the system board.</li></ol>

**Table 10-2 Diagnostic Front Panel LEDs and Audible Codes (continued)**

Activity	Beeps	Possible Cause	Recommended Action
Red Power LED flashes six times, once every second, followed by a two second pause. Beeps stop after fifth iteration but LEDs continue until problem is solved.	6	Pre-video graphics error.	For systems with a graphics card: <ol style="list-style-type: none"><li>1. Reseat the graphics card.</li><li>2. Replace the graphics card.</li><li>3. Replace the system board.</li></ol> For systems with integrated graphics, replace the system board.
Red Power LED flashes seven times, once every second, followed by a two second pause. Beeps stop after fifth iteration but LEDs continue until problem is solved.	7	System board failure (ROM detected failure prior to video).	Replace the system board.
Red Power LED flashes eight times, once every second, followed by a two second pause. Beeps stop after fifth iteration but LEDs continue until problem is solved.	8	Invalid ROM based on bad checksum.	<ol style="list-style-type: none"><li>1. Reflash the system ROM with the latest BIOS image.</li><li>2. Replace the system board.</li></ol>
Red Power LED flashes nine times, once every second, followed by a two second pause. Beeps stop after fifth iteration but LEDs continue until problem is solved.	9	System powers on but is unable to boot.	<ol style="list-style-type: none"><li>1. Check that the voltage selector, located on the rear of the power supply (some models), is set to the appropriate voltage. Proper voltage setting depends on your region.</li><li>2. Unplug the AC power cord from the computer, wait 30 seconds, then plug the power cord back in to the computer.</li><li>3. Replace the system board.</li><li>4. Replace the processor.</li></ol>
Red Power LED flashes ten times, once every second, followed by a two second pause. Beeps stop after fifth iteration but LEDs continue until problem is solved.	10	Bad option card.	<ol style="list-style-type: none"><li>1. Check each option card by removing the card (one at a time if multiple cards), then power on the system to see if fault goes away.</li><li>2. Once a bad card is identified, remove and replace the bad option card.</li><li>3. Replace the system board.</li></ol>

**Table 10-2 Diagnostic Front Panel LEDs and Audible Codes (continued)**

Activity	Beeps	Possible Cause	Recommended Action
Red Power LED flashes eleven times, once every second, followed by a two second pause. Beeps stop after fifth iteration but LEDs continue until problem is solved.	1 1	The current processor does not support a feature previously enabled on this system.	<ol style="list-style-type: none"><li>1. Install a TXT capable processor.</li><li>2. Disable TXT in the Computer Setup (F10) utility.</li><li>3. Reinstall the original processor.</li></ol>
System does not power on and LEDs are not flashing.	None	System unable to power on.	<p>Press and hold the power button for less than 4 seconds. If the hard drive LED turns green, the power button is working correctly. Try the following:</p> <ol style="list-style-type: none"><li>1. Check that the voltage selector (some models), located on the rear of the power supply, is set to the appropriate voltage. Proper voltage setting depends on your region.</li><li>2. Replace the system board.</li></ol> <p>OR</p> <p>Press and hold the power button for less than 4 seconds. If the hard drive LED does not turn on green then:</p> <ol style="list-style-type: none"><li>1. Check that the unit is plugged into a working AC outlet.</li><li>2. Open hood and check that the power button harness is properly connected to the system board.</li><li>3. Check that both power supply cables are properly connected to the system board.</li><li>4. Check to see if the 5V_aux light on the system board is turned on. If it is turned on, then replace the power button harness. If the problem persists, replace the system board.</li><li>5. If the 5V_aux light on the system board is not turned on, remove the expansion cards one at a time until the 5V_aux light on the system board turns on. If the problem persists, replace the power supply.</li></ol>



---

# 11 Password Security and Resetting CMOS

This computer supports security password features, which can be established through the Computer Setup Utilities menu.

This computer supports two security password features that are established through the Computer Setup Utilities menu: setup password and power-on password. When you establish only a setup password, any user can access all the information on the computer except Computer Setup. When you establish only a power-on password, the power-on password is required to access Computer Setup and any other information on the computer. When you establish both passwords, only the setup password will give you access to Computer Setup.

When both passwords are set, the setup password can also be used in place of the power-on password as an override to log in to the computer. This is a useful feature for a network administrator.

If you forget the password for the computer, you can clear that password so you can gain access to the information on the computer by resetting the password jumper.

---

**⚠ CAUTION:** Pushing the CMOS button will reset CMOS values to factory defaults. It is important to back up the computer CMOS settings before resetting them in case they are needed later. Back up is easily done through Computer Setup. See [Computer Setup \(F10\) Utility on page 10](#) for information on backing up the CMOS settings.

---

## Resetting the Password Jumper

---

**⚠ CAUTION:** If you enable the stringent security feature in Computer Setup and you forget the setup password or the power-on password, the computer is inaccessible and can no longer be used.

Enabling the stringent password disables the ability to reset the password by moving the jumper on the system board.

If you lose or forget the password, the system board must be replaced. This scenario is not covered under warranty.

To prevent the computer from becoming permanently unusable, record your configured setup password or power-on password in a safe place away from your computer. Without these passwords, the computer cannot be unlocked.

---

To disable the power-on or setup password features, or to clear the power-on or setup passwords, complete the following steps:

1. Shut down the operating system properly, then turn off the computer and any external devices, and disconnect the power cord from the power outlet.
2. With the power cord disconnected, press the power button again to drain the system of any residual power.

---

 **WARNING!** To reduce the risk of personal injury from electrical shock and/or hot surfaces, be sure to disconnect the power cord from the wall outlet, and allow the internal system components to cool before touching.

 **CAUTION:** When the computer is plugged in, the power supply always has voltage applied to the system board even when the unit is turned off. Failure to disconnect the power cord can result in damage to the system.

Static electricity can damage the electronic components of the computer or optional equipment. Before beginning these procedures, ensure that you are discharged of static electricity by briefly touching a grounded metal object. See the *Safety & Regulatory Information* guide for more information.

---

3. Remove the access panel.
4. Locate the header and jumper.

---

 **NOTE:** The password jumper is green so that it can be easily identified. For assistance locating the password jumper and other system board components, see the Illustrated Parts & Service Map (IPSM). The IPSM can be downloaded from <http://www.hp.com/support>.

---

5. Remove the jumper from pins 1 and 2. Place the jumper on either pin 1 or 2, but not both, so that it does not get lost.
6. Replace the computer cover or access panel.
7. Reconnect the external equipment.
8. Plug in the computer and turn on power. Allow the operating system to start. This clears the current passwords and disables the password features.
9. To establish new passwords, repeat steps 1 through 4, replace the password jumper on pins 1 and 2, then repeat steps 6 through 8. Establish the new passwords in Computer Setup.

## Clearing and Resetting the CMOS

The computer's configuration memory (CMOS) stores information about the computer's configuration.

The CMOS button resets CMOS but does not clear the power-on and setup passwords.

Clearing CMOS will clear the Active Management Technology (AMT) settings in the Management Engine BIOS Extension (MEBx), including the password. The password will default to "admin" and will

need to be reset. The AMT settings will also need to be reset. To access the MEBx, press **Ctrl+P** during POST.

1. Turn off the computer and any external devices, and disconnect the power cord from the power outlet.
2. Disconnect the keyboard, monitor, and any other external equipment connected to the computer.

**⚠ WARNING!** To reduce the risk of personal injury from electrical shock and/or hot surfaces, be sure to disconnect the power cord from the wall outlet, and allow the internal system components to cool before touching.

**⚠ CAUTION:** When the computer is plugged in, the power supply always has voltage applied to the system board even when the unit is turned off. Failure to disconnect the power cord can result in damage to the system.

Static electricity can damage the electronic components of the computer or optional equipment. Before beginning these procedures, ensure that you are discharged of static electricity by briefly touching a grounded metal object. See the *Safety & Regulatory Information* guide for more information.

3. Remove the computer cover or access panel.

**⚠ CAUTION:** Pushing the CMOS button will reset CMOS values to factory defaults. It is important to back up the computer CMOS settings before resetting them in case they are needed later. Back up is easily done through Computer Setup. See [Computer Setup \(F10\) Utility on page 10](#) for information on backing up the CMOS settings.

4. Locate, press, and hold the CMOS button in for five seconds.

**📝 NOTE:** Make sure you have disconnected the AC power cord from the wall outlet. The CMOS button will not clear CMOS if the power cord is connected.

**Figure 11-1** CMOS button



**📝 NOTE:** For assistance locating the CMOS button and other system board components, see the *Illustrated Parts & Service Map (IPSM)*.

5. Replace the computer cover or access panel.
6. Reconnect the external devices.
7. Plug in the computer and turn on power.

---

 **NOTE:** You will receive POST error messages after clearing CMOS and rebooting advising you that configuration changes have occurred. Use Computer Setup to reset any special system setups along with the date and time.

---

For instructions on Computer Setup, see [Computer Setup \(F10\) Utility on page 10](#).

---

# 12 Backup and Recovery

## Restoring and recovering in Windows 7

To protect from loss or damage, back up your personal data files. Refer to the operating system or backup utility documentation for instructions on making backup copies of your data files.

To protect the software from loss or damage, keep a backup copy of all system software, applications, and related files stored on the hard drive.

If you cannot create system recovery CDs or DVDs, you can order a recovery disk set from support. To obtain the support telephone number for your region, see <http://www.hp.com/support/contactHP>.

### System Restore

If you have a problem that might be due to software that you installed on your computer, use System Restore to return the computer to a previous restore point. You can also set restore points manually.

---

 **NOTE:** Always use this System Restore procedure before you use the System Recovery feature.

 **NOTE:** Some features might not be available on systems that are shipped without a Windows operating system.

---

To start System Restore:

1. Close all open programs.
2. Click the **Start** button, right-click **Computer**, and then click **Properties**.
3. Click **System protection**, **System Restore**, click **Next**, and then follow the on-screen instructions.

To add restore points manually:

1. Close all open programs.
2. Click the **Start** button, right-click **Computer**, click **Properties**, and then click **System protection**.
3. Under **Protection Settings**, select the disk for which you want to create a restore point.
4. Click **Create**, and then follow the on-screen instructions.

### System Recovery

---

 **WARNING!** This procedure will delete all user information. To prevent loss of information, be sure to back up all user information so you can restore it after recovery.

---

System Recovery completely erases and reformats the hard disk drive, deleting all data files that you have created, and then reinstalls the operating system, programs, and drivers. However, you must reinstall any software that was not installed on the computer at the factory. This includes software that

came on media included in the computer accessory box, and any software programs you installed after purchase.

---

 **NOTE:** Always use the System Restore procedure before you use the System Recovery program. See [System Restore on page 203](#).

 **NOTE:** Some features might not be available on systems that are shipped without a Windows operating system.

---

You must choose one of the following methods to perform a System Recovery:

- Recovery image — Run System Recovery from a recovery image stored on your hard disk drive. The recovery image is a file that contains a copy of the original factory-shipped software. To perform a System Recovery from a recovery image, see [System Recovery when Windows is responding on page 204](#) or [System Recovery when Windows is not responding on page 205](#).
- Recovery media — Run System Recovery from recovery media that you have created from files stored on your hard disk drive or purchased separately. To create recovery media, see [System recovery using recovery media on page 205](#).

## System Recovery when Windows is responding

---

 **CAUTION:** System Recovery deletes all data and programs you created or installed. Before you begin, back up any important data to a CD or DVD or to a USB flash drive.

 **NOTE:** In some cases, you must use recovery media for this procedure. To create this media, follow the instructions in [Creating recovery media on page 206](#).

---

If the computer is working and Windows 7 is responding, use these steps to perform a System Recovery.

1. Turn off the computer.
2. Disconnect all peripheral devices from the computer except the monitor, keyboard, and mouse.
3. Turn on the computer.
4. When Windows has loaded, click the **Start** button, click **All Programs**, click **Security and Protection**, click **Recovery Manager**, and then click **Recovery Manager**. If prompted, click **Yes** to allow the program to continue.
5. Under **I need help immediately**, click **System Recovery**.
6. Select **Yes**, and then click **Next**. Your computer restarts.

---

 **NOTE:** If your system does not detect a recovery partition, it prompts you to insert recovery media that you have created. Insert the first disc or the USB flash drive, select **Yes**, and then click **Next** to restart the computer. If you are using discs, insert the next disc when prompted.

---

7. When the computer restarts, you will see the Recovery Manager welcome screen again. Under **I need help immediately**, click **System Recovery**. If you are prompted to back up your files, and you have not done so, select **Back up your files first (recommended)**, and then click **Next**. Otherwise, select **Recover without backing up your files**, and then click **Next**.
8. System Recovery begins. After System Recovery is complete, click **Finish** to restart the computer.
9. When Windows has loaded, shut down the computer, reconnect all peripheral devices, and then turn the computer back on.

## System Recovery when Windows is not responding

---

 **CAUTION:** System Recovery deletes all data and programs you created or installed.

---

If Windows is not responding, but the computer is working, follow these steps to perform a System Recovery.

1. Turn off the computer. If necessary, press and hold the power button until the computer turns off.
2. Disconnect all peripheral devices from the computer, except the monitor, keyboard, and mouse.
3. Press the power button to turn on the computer.
4. As soon as you see the HP logo screen, repeatedly press the **F11** key on your keyboard until the *Windows is Loading Files...* message appears on the screen.
5. Under **I need help immediately**, click **System Recovery**.
6. If you are prompted to back up your files, and you have not done so, select **Back up your files first (recommended)**, and then click **Next**. Otherwise, select **Recover without backing up your files**, and then click **Next**.
7. System Recovery begins. After System Recovery is complete, click **Finish** to restart the computer.
8. When Windows has loaded, shut down the computer, reconnect all peripheral devices, and then turn the computer back on.

## System recovery using recovery media

You should create a set of recovery media, either a set of DVDs or a USB flash drive, from the recovery image stored on your hard disk drive. This image contains the operating system and software program files that were originally installed on your computer at the factory. You can create only one set of recovery media for your computer, and the media can be used *only* with this computer. Store the recovery media in a safe place.

---

 **NOTE:** Some features might not be available on systems that are shipped without a Windows operating system.

---

- To create recovery discs, your computer must have a DVD writer, and you must use only high-quality blank DVD+R or DVD-R discs.

---

 **NOTE:** You *cannot* use DVD+RW, DVD-RW, DVD+RW DL, DVD-RW DL, DVD+R DL, or DVD-R DL discs to create recovery discs.

---

- You have the option of creating a recovery USB flash drive instead, using a high-quality USB drive.
- If you are creating recovery discs, be sure to use high-quality discs. It is normal for the system to reject defective discs. You will be prompted to insert a new blank disc to try again.
- The number of discs in the recovery-disc set depends on your computer model (typically 3 to 6 DVDs). The Recovery Media Creation program tells you the specific number of blank discs needed to make the set. If you are using a USB flash drive, the program will tell you the size of the drive required to store all the data (minimum of 8 GB).

---

 **NOTE:** The process of creating recovery media is lengthy. You can quit the process at any time. The next time you initiate the process, it resumes where it left off.

---

## Creating recovery media

To create recovery discs:

1. Close all open programs.
2. Click the **Start** button, click **All Programs**, click **Security and Protection**, and then click **HP Recovery Media Creation**. If prompted, click **Yes** to allow the program to continue.
3. Click **Create recovery media using blank DVD(s)**, and then click **Next**.
4. Follow the on-screen instructions. Label each disc as you make it (for example, Recovery 1, Recovery 2), and then store the discs in a secure place.

To create a recovery USB flash drive:

---

 **NOTE:** You must use a flash drive with a capacity of at least 8 GB.

---

1. Close all open programs.
2. Insert the USB flash drive into a USB port on the computer.
3. Click the **Start** button, click **All Programs**, click **Security and Protection**, and then click **Recovery Media Creation**.
4. Click **Create recovery media with a USB flash drive**, and then click **Next**.
5. Select the USB flash drive from the list of media. The program will let you know how much storage is required to create the recovery drive. If the USB flash drive does not have enough storage capacity, it will appear grayed out, and you must replace it with a larger USB flash drive. Click **Next**.

---

 **NOTE:** Recovery Media Creation formats the flash drive, deleting any files on it.

---

6. Follow the on-screen instructions. When the process is complete, label the USB flash drive and store it in a secure place.

---

 **NOTE:** Do not use media cards for creating recovery media. The system may not be able to boot up from a media card and you may not be able to run system recovery.

---



## Using recovery media

 **CAUTION:** System Recovery deletes all data and programs you have created or installed. Back up any important data to a CD or DVD or to a USB flash drive.

To create recovery media, see [System recovery using recovery media on page 205](#).

To perform a System Recovery using recovery media:

1. If using a set of DVDs, insert the first recovery disc into the DVD drive tray, and close the tray. If you are using a recovery USB flash drive, insert it into a USB port.
2. If the computer is not responding, press and hold the power button for approximately 5 seconds or until the computer turns off.  
  
or  
  
Click the **Start** button, and then click **Shut Down**.
3. Disconnect all peripheral devices from the computer except the monitor, keyboard, and mouse.
4. Press the power button to turn on the computer.
5. Press **Esc** as the computer is powering on to see the startup menu. Use the arrow keys to select the boot menu and press **Enter**. Use the arrow keys to select the location where the recovery media is inserted (USB or DVD). Press **Enter** to boot from that device.
6. If Recovery Manager asks if you want to run System Recovery from Media or Hard Drive, select **Media**. On the Welcome screen, under **I need help immediately**, click **Factory Reset**.
7. If you are prompted to back up your files, and you have not done so, select **Back up your files first (recommended)**, and then click **Next**. Otherwise, select **Recover without backing up your files**, and then click **Next**.
8. If you are prompted to insert the next recovery disc, do so.
9. When Recovery Manager is finished, remove the recovery disc or the recovery USB flash drive from the system.
10. Click **Finish** to restart the computer.

## Backup and recovery in Windows 8

To protect your information, use Windows Backup and Restore to back up individual files and folders, back up your entire hard drive, create system repair media, or create system restore points. In case of system failure, you can use the backup files to restore the contents of your computer.

From the Start screen, type `restore`, click **Settings**, and then select from the list of displayed options.

 **NOTE:** For detailed instructions on various backup and restore options, perform a search for these topics in Help and Support. From the Start screen, type `h`, and then select **Help and Support**.

In case of system instability, HP recommends that you print the recovery procedures and save them for later use.

 **NOTE:** Windows includes the User Account Control feature to improve the security of your computer. You may be prompted for your permission or password for tasks such as installing software, running utilities, or changing Windows settings. Refer to Help and Support for more information. From the Start screen, type `h`, and then select **Help and Support**.

---

## Backing up your information

Recovery after a system failure is as good as your most recent backup. You should create system repair media and your initial backup immediately after initial system setup. As you add new software and data files, you should continue to back up your system on a regular basis to maintain a reasonably current backup. The system repair media is used to start up (boot) the computer and repair the operating system in case of system instability or failure. Your initial and subsequent backups allow you to restore your data and settings if a failure occurs.

Type `backup` on the Start screen, click **Settings**, and then select **Save backup copies of your files with File History**.

You can back up your information to an optional external hard drive, or a network drive.

Note the following when backing up:

- Store personal files in the Documents library, and back it up regularly.
- Back up templates that are stored in their associated programs.
- Save customized settings that appear in a window, toolbar, or menu bar by taking a screen shot of your settings. The screen shot can be a time-saver if you have to reset your preferences.

To create a backup using Backup and Restore:

 **NOTE:** Be sure that the computer is connected to AC power before you start the backup process.

 **NOTE:** The backup process may take over an hour, depending on file size and the speed of the computer.

---

1. From the Start screen, type `backup`, click **Settings**, and then select from the list of displayed options.
2. Follow the on-screen instructions to set up your backup, create a system image, or create system repair media.

## Performing a system recovery

In case of system failure or instability, the computer provides the following tools to recover your files:

- Windows recovery tools: You can use Windows Backup and Restore to recover information you have previously backed up. You can also use Windows Automatic Repair to fix problems that might prevent Windows from starting correctly.
- `f11` recovery tools: You can use the `f11` recovery tools to recover your original hard drive image. The image includes the Windows operating system and software programs installed at the factory.

 **NOTE:** If you are unable to boot (start up) your computer and you cannot use the system repair media you previously created, you must purchase Windows 8 operating system media to reboot the computer and repair the operating system. For additional information, see [Using Windows 8 operating system media \(purchased separately\) on page 210](#).

---

## Using the Windows recovery tools

To recover information you previously backed up:

- ▲ From the Start screen, type **h**, and then select **Help and Support**.

To recover your information using Automatic Repair, follow these steps:

 **CAUTION:** Some Automatic Repair options will completely erase and reformat the hard drive. For additional information go to Help and Support. From the Start screen, type **h**, and then select **Help and Support**.

---

1. If possible, back up all personal files.
2. If possible, check for the presence of the HP Recovery partition and the Windows partition:

From the Start screen, type **e**, and then click **Windows Explorer**.

– or –

From the Start screen, type **c**, and then select **Computer**.

 **NOTE:** If the Windows partition and the HP Recovery partition are not listed, you must recover your operating system and programs using the Windows 8 operating system media and the *Driver Recovery* media (both purchased separately). For additional information, see [Using Windows 8 operating system media \(purchased separately\) on page 210](#).

---

3. If the Windows partition and the HP Recovery partition are listed, restart the computer after Windows has loaded, and then press and hold **Shift** while clicking **Restart**.

 **NOTE:** If the computer fails to boot to Windows after several attempts, the system will boot to the Windows Recovery Environment by default.

---

4. Select **Troubleshoot**, select **Advanced Options**, and then select **Automatic Repair**.
5. Follow the on-screen instructions.

 **NOTE:** For additional information on recovering information using the Windows tools, perform a search for these topics in Help and Support. From the Start screen, type **h**, and then select **Help and Support**.

---

## Using f11 recovery tools

 **CAUTION:** Using **f11** completely erases hard drive contents and reformats the hard drive. All files that you have created and any software that you have installed on the computer are permanently removed. The **f11** recovery tool reinstalls the operating system and HP programs and drivers that were installed at the factory. Software not installed at the factory must be reinstalled.

---

To recover the original hard drive image using **f11**:

1. If possible, back up all personal files.
2. If possible, check for the presence of the HP Recovery partition: From the Start screen, type **C**, and then select **Computer**.

---

 **NOTE:** If the HP Recovery partition is not listed, you must recover your operating system and programs using the Windows 8 operating system media, and the *Driver Recovery* media (both purchased separately). For additional information, see [Using Windows 8 operating system media \(purchased separately\) on page 210](#).

---

3. If the HP Recovery partition is listed, restart the computer, and then press **esc** while the company logo is displayed. The computer Startup Menu displays.
4. Press **f11** to select the System Recovery option.
5. Follow the on-screen instructions.

## Using Windows 8 operating system media (purchased separately)

To order Windows 8 operating system media, go to <http://www.hp.com/support>, select your country or region, and follow the on-screen instructions. You can also order the media by calling support.

 **CAUTION:** Using Windows 8 operating system media completely erases hard drive contents and reformats the hard drive. All files that you have created and any software that you have installed on the computer are permanently removed. When reformatting is complete, the recovery process helps you restore the operating system, as well as drivers, software, and utilities.

---

To initiate recovery using Windows 8 operating system media:

 **NOTE:** This process takes several minutes.

---

1. If possible, back up all personal files.
2. Restart the computer, and then follow the instructions provided with the Windows 8 operating system media to install the operating system.
3. When prompted, press any keyboard key.
4. Follow the on-screen instructions.

After the repair is completed:

1. Remove the Windows 8 operating system media, and then insert the *Driver Recovery* media.
2. Install the Hardware Enabling Drivers first, and then install Recommended Applications.

---

# A Battery Replacement

The battery that comes with the computer provides power to the real-time clock. When replacing the battery, use a battery equivalent to the battery originally installed in the computer. The computer comes with a 3-volt lithium coin cell battery.

---

 **WARNING!** The computer contains an internal lithium manganese dioxide battery. There is a risk of fire and burns if the battery is not handled properly. To reduce the risk of personal injury:

Do not attempt to recharge the battery.

Do not expose to temperatures higher than 60°C (140°F).

Do not disassemble, crush, puncture, short external contacts, or dispose of in fire or water.

Replace the battery only with the HP spare designated for this product.

 **CAUTION:** Before replacing the battery, it is important to back up the computer CMOS settings. When the battery is removed or replaced, the CMOS settings will be cleared.

Static electricity can damage the electronic components of the computer or optional equipment. Before beginning these procedures, ensure that you are discharged of static electricity by briefly touching a grounded metal object.

 **NOTE:** The lifetime of the lithium battery can be extended by plugging the computer into a live AC wall socket. The lithium battery is only used when the computer is NOT connected to AC power.

HP encourages customers to recycle used electronic hardware, HP original print cartridges, and rechargeable batteries. For more information about recycling programs, go to <http://www.hp.com/recycle>.

- 
1. Remove/disengage any security devices that prohibit opening the computer.
  2. Remove all removable media, such as compact discs or USB flash drives, from the computer.
  3. Turn off the computer properly through the operating system, then turn off any external devices.
  4. Disconnect the power cord from the power outlet and disconnect any external devices.

 **CAUTION:** Regardless of the power-on state, voltage is always present on the system board as long as the system is plugged into an active AC outlet. You must disconnect the power cord to avoid damage to the internal components of the computer.

- 
5. Remove the computer access panel.
  6. Locate the battery and battery holder on the system board.

 **NOTE:** On some computer models, it may be necessary to remove an internal component to gain access to the battery.

---

7. Depending on the type of battery holder on the system board, complete the following instructions to replace the battery.

**Type 1**

- a. Lift the battery out of its holder.

**Figure A-1** Removing a Coin Cell Battery (Type 1)

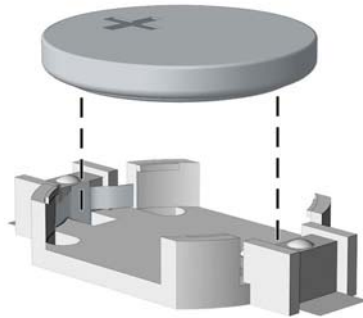

- b. Slide the replacement battery into position, positive side up. The battery holder automatically secures the battery in the proper position.

**Type 2**

- a. To release the battery from its holder, squeeze the metal clamp that extends above one edge of the battery. When the battery pops up, lift it out (1).
- b. To insert the new battery, slide one edge of the replacement battery under the holder's lip with the positive side up. Push the other edge down until the clamp snaps over the other edge of the battery (2).

**Figure A-2** Removing and Replacing a Coin Cell Battery (Type 2)

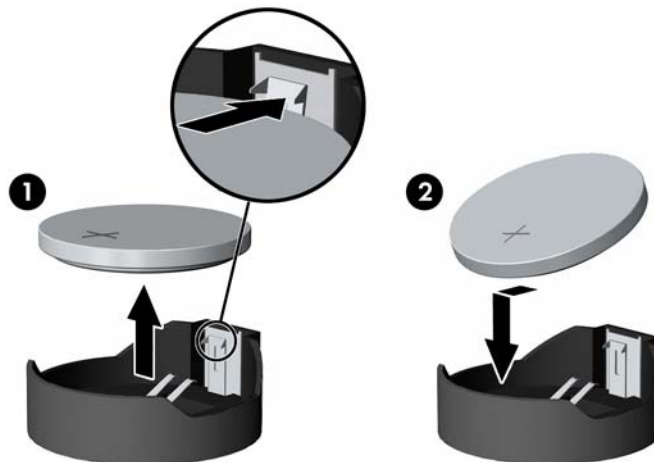

**Type 3**

- a. Pull back on the clip (1) that is holding the battery in place, and remove the battery (2).

- b. Insert the new battery and position the clip back into place.

**Figure A-3** Removing a Coin Cell Battery (Type 3)

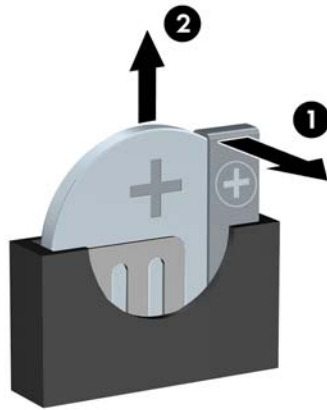

#### Type 4

- a. To release the battery from its holder, insert a pointed tool in the slot to loosen the battery (1). When the battery pops up, slide it out from under the holder, and lift it out (2).
- b. To insert the new battery, slide one edge of the replacement battery under the holder's lip with the positive side up. Push the other edge down until the clamp snaps over the other edge of the battery.

**Figure A-4** Removing and Replacing a Coin Cell Battery (Type 4)

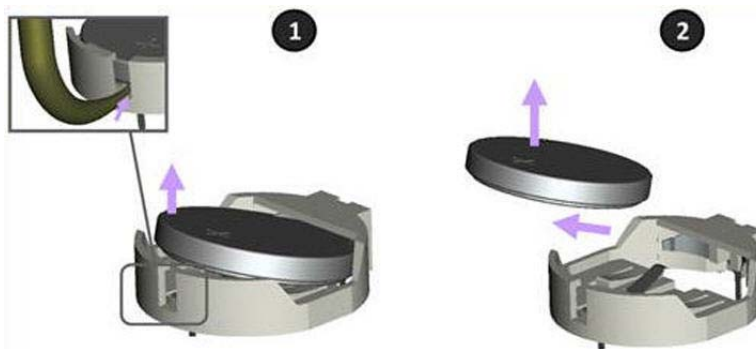

**NOTE:** After the battery has been replaced, use the following steps to complete this procedure.

- 8. Replace the computer access panel.
- 9. Plug in the computer and turn on power to the computer.
- 10. Reset the date and time, your passwords, and any special system setups using Computer Setup.
- 11. Lock any security devices that were disengaged when the computer access panel was removed.

---

## B Power Cord Set Requirements

The power supplies on some computers have external power switches. The voltage select switch feature on the computer permits it to operate from any line voltage between 100-120 or 220-240 volts AC. Power supplies on those computers that do not have external power switches are equipped with internal switches that sense the incoming voltage and automatically switch to the proper voltage.

The power cord set received with the computer meets the requirements for use in the country where you purchased the equipment.

Power cord sets for use in other countries must meet the requirements of the country where you use the computer.

### General Requirements

The requirements listed below are applicable to all countries:

1. The power cord must be approved by an acceptable accredited agency responsible for evaluation in the country where the power cord set will be installed.
2. The power cord set must have a minimum current capacity of 10A (7A Japan only) and a nominal voltage rating of 125 or 250 volts AC, as required by each country's power system.
3. The diameter of the wire must be a minimum of 0.75 mm<sup>2</sup> or 18AWG, and the length of the cord must be between 1.8 m (6 feet) and 3.6 m (12 feet).

The power cord should be routed so that it is not likely to be walked on or pinched by items placed upon it or against it. Particular attention should be paid to the plug, electrical outlet, and the point where the cord exits from the product.

---

**⚠ WARNING!** Do not operate this product with a damaged power cord set. If the power cord set is damaged in any manner, replace it immediately.

---

### Japanese Power Cord Requirements

For use in Japan, use only the power cord received with this product.

---

**⚠ CAUTION:** Do not use the power cord received with this product on any other products.

---



## Country-Specific Requirements

Additional requirements specific to a country are shown in parentheses and explained below.

Country	Accrediting Agency	Country	Accrediting Agency
Australia (1)	EANSW	Italy (1)	IMQ
Austria (1)	OVE	Japan (3)	METI
Belgium (1)	CEBC	Norway (1)	NEMKO
Canada (2)	CSA	Sweden (1)	SEMKO
Denmark (1)	DEMKO	Switzerland (1)	SEV
Finland (1)	SETI	United Kingdom (1)	BSI
France (1)	UTE	United States (2)	UL
Germany (1)	VDE		

1. The flexible cord must be Type HO5VV-F, 3-conductor, 0.75mm<sup>2</sup> conductor size. Power cord set fittings (appliance coupler and wall plug) must bear the certification mark of the agency responsible for evaluation in the country where it will be used.
2. The flexible cord must be Type SVT or equivalent, No. 18 AWG, 3-conductor. The wall plug must be a two-pole grounding type with a NEMA 5-15P (15A, 125V) or NEMA 6-15P (15A, 250V) configuration.
3. Appliance coupler, flexible cord, and wall plug must bear a "T" mark and registration number in accordance with the Japanese Dentori Law. Flexible cord must be Type VCT or VCTF, 3-conductor, 0.75 mm<sup>2</sup> conductor size. Wall plug must be a two-pole grounding type with a Japanese Industrial Standard C8303 (7A, 125V) configuration.

# C Specifications

## MT Specifications

**Table C-1 Specifications**

<b>Chassis</b>		
Height	14.9 in	37.7 cm
Width	7.0 in	17.7 cm
Depth	17.0 in	43.1 cm
<b>Approximate Weight</b>		
	20.5 lb	9.3 kg
<b>Temperature Range</b>		
Operating	50° to 95°F	10° to 35°C
Nonoperating	-22° to 140°F	-30° to 60°C
<p><b>NOTE:</b> Operating temperature is derated 1.0° C per 300 m (1000 ft) to 3000 m (10,000 ft) above sea level; no direct sustained sunlight. Maximum rate of change is 10° C/Hr. The upper limit may be limited by the type and number of options installed.</p>		
<b>Relative Humidity (noncondensing)</b>		
Operating	10-90%	10-90%
Nonoperating (38.7°C max wet bulb)	5-95%	5-95%
<b>Maximum Altitude (unpressurized)</b>		
Operating	10,000 ft	3048 m
Nonoperating	30,000 ft	9144 m
<b>Power Supply</b>		
Operating Voltage Range	90-264 VAC	
Rated Voltage Range <sup>1</sup>	100-240 VAC	
Rated Line Frequency	50-60 Hz	
Operating Line Frequency	47-63 Hz	
<b>Standard Efficiency</b>		
	320W	
<b>High Efficiency</b>		
	320W active PFC; 87/90/87% efficient at 20/50/100% load	
<b>Rated Input Current</b>		
	5.5A	

<sup>1</sup> This system utilizes an active power factor corrected power supply. This allows the system to pass the CE mark requirements for use in the countries of the European Union. The active power factor corrected power supply also has the added benefit of not requiring an input voltage range select switch.

# SFF Specifications

**Table C-2 Specifications**

<b>Chassis</b> (in the desktop position)		
Height	4.0 in	10.0 cm
Width	13.3 in	33.8 cm
Depth	14.9 in	37.9 cm
<b>Approximate Weight</b>		16.7 lb / 7.6 kg
<b>Weight Supported</b> (maximum distributed load in desktop position)		77 lb / 35 kg
<b>Temperature Range</b>		
Operating	50° to 95°F	10° to 35°C
Nonoperating	-22° to 140°F	-30° to 60°C
<p><b>NOTE:</b> Operating temperature is derated 1.0° C per 300 m (1000 ft) to 3000 m (10,000 ft) above sea level; no direct sustained sunlight. Maximum rate of change is 10° C/Hr. The upper limit may be limited by the type and number of options installed.</p>		
<b>Relative Humidity (noncondensing)</b>		
Operating	10-90%	10-90%
Nonoperating (38.7°C max wet bulb)	5-95%	5-95%
<b>Maximum Altitude (unpressurized)</b>		
Operating	10,000 ft	3048 m
Nonoperating	30,000 ft	9144 m
<b>Power Supply</b>		
Operating Voltage Range	90-264 VAC	
Rated Voltage Range <sup>1</sup>	100-240 VAC	
Rated Line Frequency	50-60 Hz	
Operating Line Frequency	47-63 Hz	
<b>Standard Efficiency</b>	240W active PFC	
<b>High Efficiency</b>	240W active PFC; 87/90/87% efficient at 20/50/100% load	
<b>Rated Input Current</b>	4A	

<sup>1</sup> This system utilizes an active power factor corrected power supply. This allows the system to pass the CE mark requirements for use in the countries of the European Union. The active power factor corrected power supply also has the added benefit of not requiring an input voltage range select switch.

# Index

## Symbols/Numerics

2.5-in drive adapter, spare part number 29, 39

## A

access panel  
  MT removal 55  
  MT spare part number 55  
  SFF removal and replacement 100  
  SFF spare part number 100  
access panel, locked 150  
access panel, MT  
  spare part number 26, 33  
access panel, SFF  
  spare part number 35, 43  
adapter, DisplayPort to DVI  
  spare part number 28, 33, 37, 43  
adapter, DisplayPort to HDMI  
  spare part number 28, 32, 37, 42  
adapter, DisplayPort to VGA  
  spare part number 27, 32, 37, 42  
antenna, spare part number 29, 39  
audible codes 195  
audio problems 163

## B

Backup and Restore 208  
battery  
  disposal 51  
battery replacement 211  
beep codes 195  
bezel blank  
  spare part number 59, 104  
booting options  
  Full Boot 187  
  Quick Boot 187

## C

cable management 52

cable pinouts  
  SATA data 52  
card reader, spare part number 29, 39  
cautions  
  AC power 45  
  cables 51  
  cooling fan 50  
  electrostatic discharge 45  
  keyboard cleaning 49  
  keyboard keys 49  
CD-ROM or DVD problems 177  
chassis types, illustrated 45  
chassis fan, MT  
  spare part number 32  
chassis fan, SFF  
  spare part number 43  
chassis stand  
  spare part number 39  
clamp lock, spare part number 29, 31, 39, 41  
cleaning  
  computer 49  
  mouse 50  
  safety precautions 48  
CMOS  
  backing up 199  
  clearing and resetting 200  
computer  
  specifications 217  
computer cleaning 49  
country power cord set requirements 215  
Customer Support 146, 184

## D

DIMMs. See memory  
disassembly preparation  
  MT 54  
  SFF 99  
DisplayPort cable  
  spare part number 28, 31, 38, 41  
DMS-59 to dual DVI cable  
  spare part number 28, 31, 41

DMS-59 to dual VGA cable  
  spare part number 27, 31, 37, 41

## drives

  MT cable connections 70  
  MT installation 70  
  MT locations 72  
  SFF cable connections 117  
  SFF installation 117  
  SFF locations 117

## E

electrostatic discharge (ESD) 45  
  preventing damage 46  
error  
  codes 187, 195  
  messages 187  
eSATA port (expansion), spare part number 32, 43  
eSATA port assembly, spare part number 29, 39  
expansion card  
  MT installation 64  
  MT removal 64  
  SFF installation 109  
  SFF removal 109  
expansion slot cover  
  MT removal 65  
  SFF removal 110  
external USB webcam, spare part number 29, 39

## F

f11 recovery 209  
fan  
  MT spare part number 93  
fan duct  
  SFF removal and replacement 132  
  SFF spare part number 132  
fan duct, SFF  
  spare part number 38, 42  
fan with guard, MT  
  spare part number 28

- fan, MT
  - spare part number 32
- fan, power supply 50
- fan, SFF
  - spare part number 38, 43
- fan/baffle assembly
  - MT removal and replacement 85
- flash drive problems 179
- flashing LEDs 195
- front bezel
  - MT blank removal 59
  - MT removal 56
  - MT security 57
  - MT spare part number 56
  - removing blanks 104
  - SFF removal and replacement 101
  - SFF security 102
  - SFF spare part number 101
- front bezel, MT
  - spare part number 25, 33
- front bezel, SFF
  - spare part number 35, 43
- front fan
  - SFF removal and replacement 133
  - SFF spare part number 133
- front fan assembly
  - MT spare part number 85
- front I/O and power switch assembly
  - SFF spare part number 136
- front I/O assembly
  - MT spare part number 86
- front I/O assembly, MT
  - spare part number 27, 33
- front I/O assembly, SFF
  - spare part number 37
- Front I/O cable and power switch assembly, SFF
  - spare part number 42
- front I/O, power switch assembly
  - SFF removal and replacement 136
- front panel components
  - MT 2
  - SFF 3
- front panel problems 180
- front USB panel
  - MT removal and replacement 86
- G**
  - general problems 148
  - grommet (hard drive isolation), spare part number 29, 39
  - grounding methods 46
  - guide screws
    - MT location 71
    - SFF location 118
- H**
  - hard drive
    - MT installation 78
    - MT removal 77
    - proper handling 51
    - SATA characteristics 52
    - SFF installation 125
    - SFF removal 125
    - spare part numbers 30, 40
  - hard drive problems 154
  - hard drive recovery 209
  - hardware installation problems 169
  - heat sink
    - MT removal and replacement 89
    - MT spare part number 89
    - SFF removal and replacement 139
    - SFF spare part number 139
  - heat sink, MT
    - spare part number 28, 32
  - heat sink, SFF
    - spare part number 39, 42
  - helpful hints 147
  - hood sensor
    - SFF removal and replacement 135
    - SFF spare part number 135
    - spare part number 29, 32, 39, 42
  - HP Business Digital Headset, spare part number 29, 39
- I**
  - installing
    - battery 211
    - MT drive cables 70
    - MT expansion card 64
    - MT hard drive 78
    - MT media card reader 75
    - MT memory 60
    - MT optical drive 75
    - SFF drive cables 117
    - SFF expansion card 109
    - SFF hard drive 125
    - SFF media card reader 123
    - SFF memory 105
    - SFF optical drive 119
  - Internet access problems 181
- K**
  - keyboard
    - cleaning 49
    - spare part numbers 29, 31, 32, 39, 41, 42
  - keyboard problems 166
- L**
  - LEDs
    - blinking power 195
    - blinking PS/2 keyboard 195
  - locks
    - MT front bezel 57
    - SFF front bezel 102
- M**
  - media card reader
    - MT installation 75
    - MT removal 73
    - SFF installation 123
    - SFF removal 121
  - Media Card Reader problems 156
  - memory
    - MT installation 60
    - MT socket population 61
    - MT specifications 60
    - SFF installation 105
    - SFF socket population 106
    - SFF specifications 105
  - memory module
    - spare part number 60, 105
  - memory modules
    - spare part number 26, 33, 36, 43
  - memory problems 175
  - monitor problems 158

- mouse
  - cleaning 50
- mouse problems 166
- mouse, spare part number 29, 39
- MT
  - access panel, spare part number 26, 33
  - disassembly preparation 54
  - fan with guard, spare part number 28
  - fan, spare part number 32
  - fan/baffle assembly removal and replacement 85
  - front bezel, spare part number 25, 33
  - front I/O assembly, spare part number 27, 33
  - front USB panel removal and replacement 86
  - heat sink removal and replacement 89
  - heat sink, spare part number 28, 32
  - power supply removal and replacement 95
  - power supply, spare part number 26, 32
  - power switch/LED assembly removal and replacement 87
  - power switch/LED assembly, spare part number 27, 33
  - preparation for disassembly 54
  - processor removal and replacement 90
  - rear chassis fan removal and replacement 93
  - SATA hard drive cable, spare part number 27, 33
  - SATA optical drive cable, spare part number 27, 33
  - speaker removal and replacement 91
  - speaker, spare part number 29, 32
  - system board removal and replacement 96
  - system board, spare part number 26, 34

**N**

- network problems 171
- numeric error codes 187

**O**

- operating guidelines 48
- optical drive
  - MT installation 75
  - MT removal 73
  - SFF installation 119
  - SFF removal 119
  - spare part numbers 30, 33, 40, 43
- optical drive problems 177
- overheating, prevention 48

**P**

- password
  - clearing 199
  - power-on 199
  - setup 199
- POST error messages 187
- power cord set requirements
  - country specific 215
- power problems 152
- power supply
  - fan 50
  - MT removal and replacement 95
  - MT spare part number 95
  - operating voltage range 216, 217
  - SFF removal and replacement 142
- power supply, MT
  - spare part number 26, 32
- power supply, SFF
  - spare part number 35, 42
- power switch/LED assembly
  - MT removal and replacement 87
  - MT spare part number 87
- power switch/LED assembly, MT
  - spare part number 27, 33
- power-on password 199
- printer port (expansion), spare part number 32, 42
- printer port, PCI card
  - spare part number 39

- printer port, spare part number 29
- printer problems 165
- problems
  - audio 163
  - CD-ROM or DVD 177
  - flash drive 179
  - front panel 180
  - general 148
  - hard drive 154
  - hardware installation 169
  - Internet access 181
  - keyboard 166
  - Media Card Reader 156
  - memory 175
  - monitor 158
  - mouse 166
  - network 171
  - power 152
  - printer 165
  - processor 176
  - software 182
- processor
  - MT removal and replacement 90
  - SFF removal and replacement 141
  - spare part number 26, 34, 36, 43
- processor problems 176
- product ID locations 6

**R**

- rear chassis fan
  - MT removal and replacement 93
  - MT spare part number 93
- rear panel components
  - MT 4
  - SFF 5
- recovery partition 209
- removal and replacement
  - MT fan/baffle assembly 85
  - MT front USB panel 86
  - MT heat sink 89
  - MT power supply 95
  - MT power switch/LED assembly 87
  - MT processor 90
  - MT rear chassis fan 93

- MT speaker 91
- MT system board 96
- SFF fan duct 132
- SFF front bezel 100, 101
- SFF front fan 133
- SFF front I/O, power switch assembly 136
- SFF heat sink 139
- SFF hood sensor 135
- SFF power supply 142
- SFF processor 141
- SFF speaker 138
- SFF system board 143
- removing
  - battery 211
  - bezel blanks 104
  - MT bezel blanks 59
  - MT computer access panel 55
  - MT expansion card 64
  - MT expansion slot cover 65
  - MT front bezel 56
  - MT hard drive 77
  - MT media card reader 73
  - MT optical drive 73
  - SFF expansion card 109
  - SFF expansion slot cover 110
  - SFF hard drive 125
  - SFF media card reader 121
  - SFF optical drive 119
- resetting
  - CMOS 199
  - password jumper 199
- restoring the hard drive 209
- rubber foot
  - spare part number 39
- S**
- safety and comfort 146
- safety precautions
  - cleaning 48
- SATA
  - connectors on system board 52
  - data cable pinouts 52
  - hard drive characteristics 52
- SATA cable, SFF
  - spare part number 37
- SATA drive cable, SFF
  - spare part number 37
- SATA hard drive cable, MT
  - spare part number 27, 33
- SATA optical drive cable, MT
  - spare part number 27, 33
- screws, correct size 50
- security
  - MT front bezel 57
  - SFF front bezel 102
- serial number locations 6
- serial port (expansion), spare part number 32, 42
- serial port, spare part number 29, 39
- service considerations 50
- setup password 199
- SFF
  - access panel, spare part number 35, 43
  - chassis fan, spare part number 43
  - disassembly preparation 99
  - fan duct removal and replacement 132
  - fan duct, spare part number 38, 42
  - fan, spare part number 38
  - front bezel removal and replacement 100, 101
  - front bezel, spare part number 35, 43
  - front fan removal and replacement 133
  - front I/O assembly, spare part number 37
  - Front I/O cable and power switch assembly, spare part number 42
  - front I/O, power switch assembly removal and replacement 136
  - heat sink removal and replacement 139
  - heat sink, spare part number 39, 42
  - hood sensor removal and replacement 135
  - power supply removal and replacement 142
  - power supply, spare part number 35, 42
  - preparation for disassembly 99
  - processor removal and replacement 141
  - SATA cable, spare part number 37
  - SATA drive cable, spare part number 37
  - solenoid lock, spare part number 39
  - speaker removal and replacement 138
  - speaker, spare part number 39, 42
  - system board removal and replacement 143
  - system board, spare part number 35, 44
- software
  - problems 182
  - servicing computer 50
- solenoid lock
  - spare part number 29, 32, 42
- solenoid lock, SFF
  - spare part number 39
- solid-state drive, spare part number 30, 40
- spare part number
  - tamper-resistant wrench 50
  - Torx T-15 screwdriver 50
- speaker
  - MT removal and replacement 91
  - MT spare part number 91
  - SFF removal and replacement 138
  - SFF spare part number 138
- speaker, MT
  - spare part number 29, 32
- speaker, SFF
  - spare part number 39, 42
- specifications
  - computer 216, 217
  - MT memory 60
  - SFF memory 105
- static electricity 45
- system board
  - MT removal and replacement 96
  - MT spare part number 96

- SATA connectors 52
- SFF removal and replacement 143
- SFF spare part number 143
- system board connections
  - MT 69
  - SFF 115
- system board, MT
  - spare part number 26, 34
- system board, SFF
  - spare part number 35, 44

## **T**

- tamper-proof screws
  - tool 50
- temperature control 48
- tools, servicing 50
- Torx T15 screwdriver 50
- tower orientation 145

## **U**

- USB powered speakers, spare part number 29, 32, 39, 42

## **V**

- ventilation, proper 48

## **W**

- Wake-on-LAN feature 171
- Windows 8 operating system
  - DVD 210
- WLAN module
  - removal 67, 113
  - spare part numbers 67, 113