



Hardware Reference Guide

HP t620 Flexible Series Thin Client

© Copyright 2013 Hewlett-Packard Development Company, L.P. The information contained herein is subject to change without notice.

Microsoft and Windows are U.S. registered trademarks of Microsoft Corporation.

The only warranties for HP products and services are set forth in the express warranty statements accompanying such products and services. Nothing herein should be construed as constituting an additional warranty. HP shall not be liable for technical or editorial errors or omissions contained herein.

This document contains proprietary information that is protected by copyright. No part of this document may be photocopied, reproduced, or translated to another language without the prior written consent of Hewlett-Packard Company.

Hardware Reference Guide

HP t620 Flexible Series Thin Client

Second Edition: November 2013

Document Part Number: 730525-002

About This Book

 **WARNING!** Text set off in this manner indicates that failure to follow directions could result in bodily harm or loss of life.

 **CAUTION:** Text set off in this manner indicates that failure to follow directions could result in damage to equipment or loss of information.

 **NOTE:** Text set off in this manner provides important supplemental information.

Table of contents

1 Product features	1
Standard features	1
Front panel components	2
Rear panel components	3
Using the keyboard	4
Windows Logo Key	5
Additional function keys	5
Special mouse functions	5
Serial number location	6
2 Hardware changes	7
Warnings and cautions	7
Connecting the power cord	8
Attaching the stand	9
Removing and replacing the access panel	10
Removing the access panel	10
Replacing the access panel	12
Installing internal USB flash drives	14
Installing additional memory	16
SODIMMs	16
DDR3L-SDRAM SODIMMs	16
Populating SODIMM sockets	17
Installing SODIMMs	17
Installing a half-height PCI-Express 2.0 card	23
Security	26
Hood sensor	26
Cable lock	27
Mounting the thin client	28
Supported mounting options	31
Appendix A Specifications	32

Appendix B Removing and replacing the battery	34
Appendix C Thin client operation	38
Routine thin client care	38
Supported orientations	39
Non-supported orientation	41
Appendix D Electrostatic discharge	42
Preventing electrostatic damage	42
Grounding methods	42
Appendix E Shipping information	43
Shipping preparation	43
Important service repair information	43
Removing the solid state drive (flash memory)	43
Index	46

1 Product features

Standard features



Thank you for purchasing an HP thin client. We hope you have years of use from our thin clients. Our goal is to provide you with award-winning clients that are easy to deploy and manage with the power and reliability you expect.

The next sections describe the features of the thin client. For a complete list of the hardware and software installed on a specific model, visit <http://www.hp.com> and search for your specific thin client model.

The following features are common to all HP thin clients:

- no hard drives or diskette drives
- 5 minutes or less hardware setup time
- central deployment and management using HP Management Solutions

Various options are available for your thin client. For more information about available options, visit the HP website at <http://www.hp.com> and search for your specific thin client model.

CAUTION: Ensure that the write filter is enabled after committing necessary configurations to the thin client flash drive. During normal operation of the thin client, the write filter must be enabled. Also ensure that Page File is not enabled on thin clients with flash memory storage. Failure to follow these required actions can void the warranty of the flash storage device. In the event of damage to the flash storage device due to operation with a disabled write filter or enabled Page File, the damage will not be covered by HP warranty.

For more information about write filter usage, see the operating system guide for your thin client available at <http://www.hp.com/support/manuals/thinclients>.

NOTE: Your computer model may look different than the model in the following illustrations.

Front panel components

For more information, go to <http://www.hp.com> and search for your specific thin client model to find the model-specific QuickSpecs.

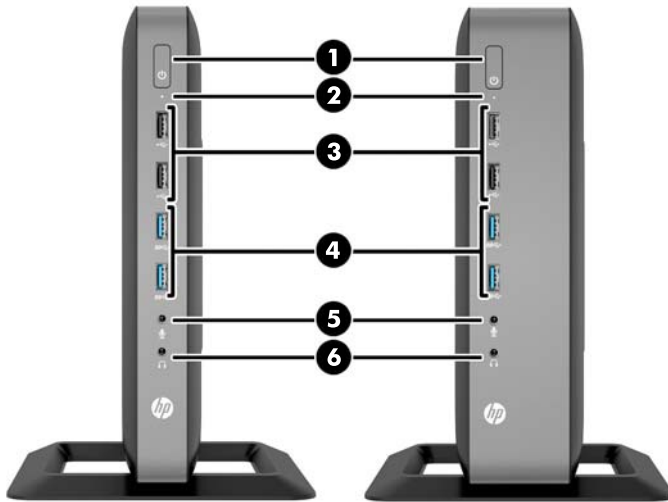

(1)	Power button	(4)	USB 3.0 ports (2)
(2)	Flash drive activity LED	(5)	Microphone port
(3)	USB 2.0 ports (2)	(6)	Headphone port

Rear panel components

For more information, go to <http://www.hp.com> and search for your specific thin client model to find the model-specific QuickSpecs.

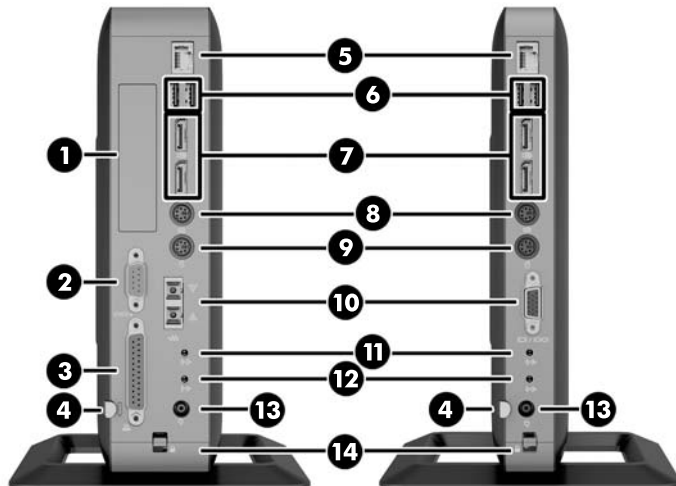

(1)	Half-height PCIe 2.0 expansion slot*	(8)	PS/2 keyboard port
(2)	Serial port*	(9)	PS/2 mouse port
(3)	Parallel port*	(10)	Serial port
			Optional: VGA port or fiber NIC port
(4)	Retractable power cord retention hook	(11)	Audio line-in port
(5)	Ethernet RJ-45 port	(12)	Audio line-out port
(6)	USB 2.0 ports (2)	(13)	Power
(7)	Dual-mode DisplayPort 1.2 ports (2)	(14)	Cable lock slot

*Available on some models. Refer to the model-specific QuickSpecs at www.hp.com for details.

The devices connected at boot up or subsequently disconnected determine which video ports are enabled and which is disabled.

- If a VGA device is connected at boot up, then only one DisplayPort port may be used. If the VGA device is subsequently disconnected, then both DisplayPort ports are enabled.
- If a VGA device and one DisplayPort device are connected at boot up, then the other DisplayPort port is disabled. If the VGA device is subsequently disconnected, then that DisplayPort port is enabled.
- If two DisplayPort devices are connected at boot up, then the VGA port is disabled. If one or both DisplayPort devices are subsequently disconnected, the VGA port is enabled.

Using the keyboard

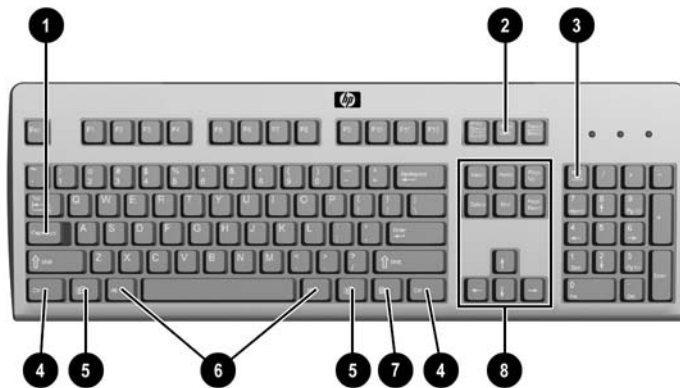

(1)	Caps Lock key	Activates/deactivates the Caps Lock feature.
(2)	Scroll Lock key	Activates/deactivates the Scroll Lock feature.
(3)	Num Lock key	Activates/deactivates the Num Lock feature.
(4)	Ctrl key	Use in combination with another key; its function depends on the application software you are using.
(5)	Windows Logo Key ^{1, 2}	Opens the Start menu in Windows®. Use in combination with other keys to perform other functions. For more information, see Windows Logo Key on page 5 .
(6)	Alt key	Use in combination with another key; its function depends on the application software you are using.
(7)	Application key ¹	Similar to the right mouse button, opens pop-up menus in a Microsoft® Office application. May perform other functions in other software applications.
(8)	Editing keys	Include the following: Insert , Home , Page Up , Delete , End , and Page Down . Hold Ctrl and Alt while pressing Delete to restart the thin client.

¹Available in select geographic regions.

²For local sessions, applies only to thin clients running Windows Embedded Standard. For full-screen remote Windows sessions, applies to all thin clients.

Windows Logo Key

Use the Windows Logo Key in combination with other keys to perform certain functions available in Windows operating systems.

Windows Logo Key + Tab	Switch between open items.
Windows Logo Key + e	Open My Computer.
Windows Logo Key + f	Search for a file or folder.
Windows Logo Key + Ctrl + f	Search for computers.
Windows Logo Key + m	Minimize all windows.
Windows Logo Key + Shift + m	Undo minimize all.
Windows Logo Key + Break	Display the System Properties dialog box.
Windows Logo Key + r	Open the Run dialog box.

Additional function keys

The following key combinations also work on all thin clients regardless of operating system:

Alt + Esc	Cycles through minimized applications.
Alt + Tab	Cycles through open applications.
Alt + Shift + Tab	Switches to the previous session.

Special mouse functions

Most software applications support the use of a mouse. The functions assigned to each mouse button depend on the software applications you are using.

Serial number location

Every thin client includes a unique serial number located as shown in the following illustration. Have this number available when contacting HP customer service for assistance.

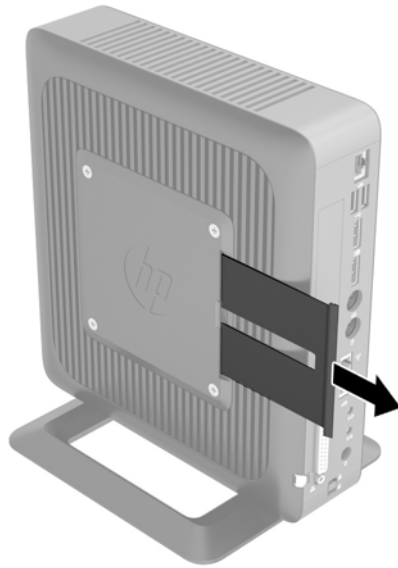

2 Hardware changes

Warnings and cautions

Before performing upgrades be sure to carefully read all of the applicable instructions, cautions, and warnings in this guide.

 **WARNING!** To reduce the risk of personal injury or equipment damage from electric shock, hot surfaces, or fire:

Disconnect the power cord from the power outlet and allow the internal system components to cool before you touch them.

Do not plug telecommunications or telephone connectors into the network interface controller (NIC) receptacles.

Do not disable the power cord grounding plug. The grounding plug is an important safety feature.

Plug the power cord into a grounded (earthed) outlet that is easily accessible at all times.

To reduce the risk of serious injury, read the *Safety & Comfort Guide*. It describes proper workstation, setup, posture, and health and work habits for computer users, and provides important electrical and mechanical safety information. The *Safety & Comfort Guide* is located on the HP website at <http://www.hp.com/ergo>.

 **WARNING!** Energized and moving parts inside.

Disconnect power to the equipment before removing the enclosure.

Replace and secure the enclosure before re-energizing the equipment.

 **CAUTION:** Static electricity can damage the electrical components of the computer or optional equipment. Before beginning the following procedures, be sure that you are discharged of static electricity by briefly touching a grounded metal object. See [Electrostatic discharge on page 42](#) for more information.

When the computer is plugged into an AC power source, voltage is always applied to the system board. To prevent damage to internal components, you must disconnect the power cord from the power source before opening the computer.

Connecting the power cord

1. Plug the female end of the power cord into the power supply brick (1).

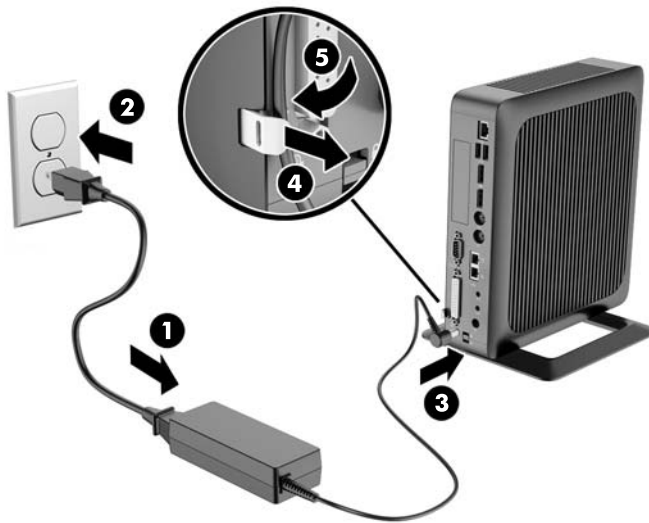

2. Connect the other end of the power cord to an electrical outlet (2).
3. Connect the round end of the power supply cord to the power supply connector on the rear of the computer (3).
4. Use the slot (4) on the side of the retractable power cord retention hook to pull the hook out.
5. Press the power cord into the retention hook (5) and bundle any excess power cord.

CAUTION: Failure to secure the power cable with the retention hook may result in the power cord becoming disconnected, causing loss of data.

Attaching the stand

⚠ CAUTION: The computer must be operated with the stand attached to ensure proper airflow around the computer.

The computer can be used in either a tower or horizontal orientation with the stand included with the computer.

1. Remove/disengage any security devices that prohibit opening the computer.
2. Remove all removable media, such as USB flash drives, from the computer.
3. Turn off the computer properly through the operating system, and then turn off any external devices.
4. Disconnect the power cord from the power outlet and disconnect any external devices.
5. Attach the stand to the computer.
 - Attach the stand to the bottom of the computer to use the computer in the tower orientation.
 - a. Turn the computer upside down and locate the two screw holes in the grid on the bottom of the computer.
 - b. Position the stand (1) over the bottom of the computer and line up the captive thumbscrews in the stand with the screw holes in the computer.
 - c. Tighten the captive thumbscrews (2) securely.

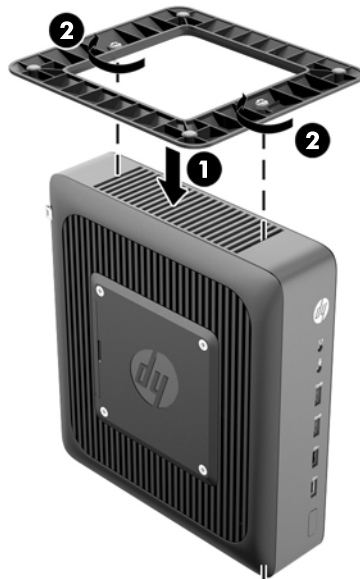

- Attach the stand to the right side of the computer to use it in the horizontal orientation.
 - a. Lay the computer down with the right side up and locate the two screw holes in the grid on the right side of the computer.
 - b. Position the stand (1) over the side of the computer and line up the captive thumbscrews in the stand with the screw holes in the computer.
 - c. Tighten the captive thumbscrews (2) securely.

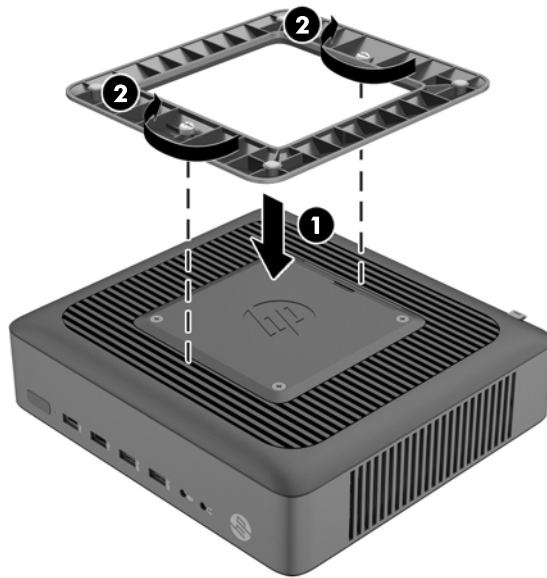

6. Reconnect the external equipment, plug the power cord into a power outlet, and then turn the computer on.

 **NOTE:** Be sure that at least 10.2 centimeters (4 inches) of space on all sides of the computer remain clear and free of obstructions.

 **NOTE:** An optional Quick Release mounting bracket is available from HP for mounting the computer to a wall, desk, or swing arm. When the mounting bracket is used, do not install the computer with the I/O ports oriented towards the ground.

Removing and replacing the access panel

Removing the access panel

 **WARNING!** To reduce the risk of personal injury or equipment damage from electric shock, hot surfaces, or fire, ALWAYS operate the computer with the access panel in place. In addition to enhancing safety, the access panel may provide important instructions and identification information, which may be lost if the access panel is not used. DO NOT use any access panel except the one that is provided by HP for use with this computer.

Before removing the side access panel, be sure that the thin client is turned off and the power cord is disconnected from the electrical outlet.

To remove the access panel:

1. Remove/disengage any security devices that prohibit opening the computer.
2. Remove all removable media, such as USB flash drives, from the computer.
3. Turn off the computer properly through the operating system, and then turn off any external devices.

4. Disconnect the power cord from the power outlet, and disconnect any external devices.

⚠ CAUTION: Regardless of the power-on state, voltage is always present on the system board as long as the system is plugged into an active AC outlet. You must disconnect the power cord to avoid damage to the internal components of the computer.

5. Remove the computer from the stand.
6. Lay the unit flat on a stable surface with the right side up.
7. Release the latch (1) on the left side of the rear I/O panel, rotate the I/O panel (2) to the right, and then lift it off the computer.

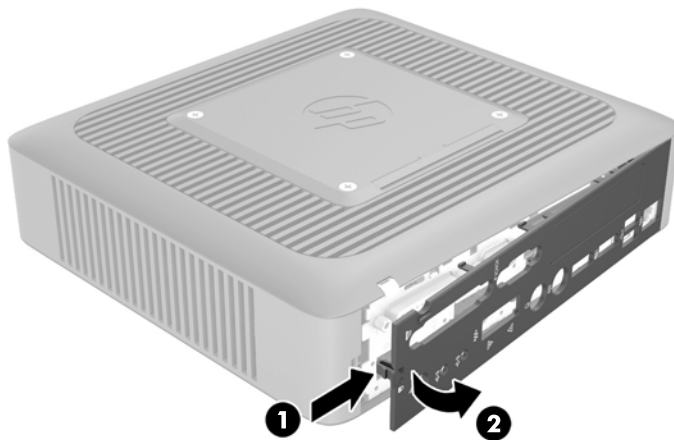

8. Move the access panel latch (1) to the left to release the access panel.
9. Slide the access panel (2) approximately 6 mm (.24 in) toward the back of the chassis, and then lift the panel off of the computer.



Replacing the access panel

To replace the access panel:

1. Position the access panel (1) on the chassis, approximately 6 mm (.24 in) inside the edge of the chassis. Be sure that the access panel covers the hood sensor, and then slide the panel toward the front of the chassis (2) until it locks into place.
2. Move the access panel latch (3) to the right to secure the access panel.

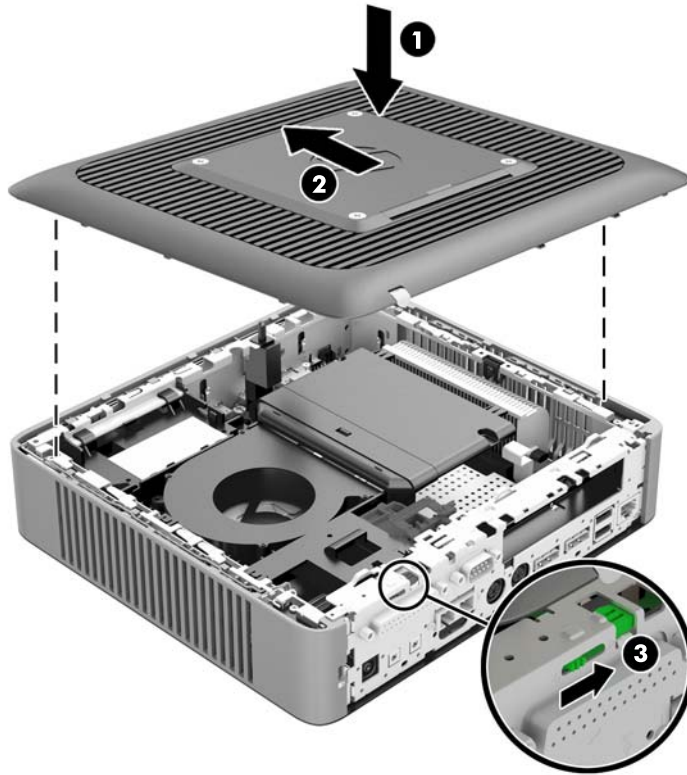

3. Insert the hooks on the right side of the I/O panel (1) into the right side of the back of the chassis, and then press the left side (2) to the chassis until it locks in place.

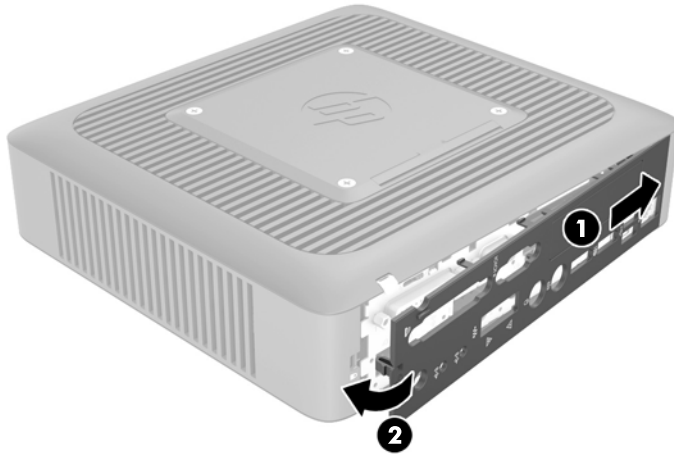

Installing internal USB flash drives

There are two USB flash drive ports on the system board.

To install a USB flash drive:

1. Remove/disengage any security devices that prohibit opening the computer.
2. Remove all removable media, such as USB flash drives, from the computer.
3. Turn off the computer properly through the operating system, and then turn off any external devices.
4. Disconnect the power cord from the power outlet, and disconnect any external devices.
5. Remove the computer from the stand and lay the computer down with the right side up.
6. Remove the computer access panel and back I/O panel. See [Removing and replacing the access panel on page 10](#).

⚠ WARNING! To reduce risk of personal injury from hot surfaces, allow the internal system components to cool before you touch them.

7. If the computer is an HP t620 PLUS Thin Client, push the fan assembly latch (1) toward the front of the computer and rotate the assembly (2) up and out of the way.

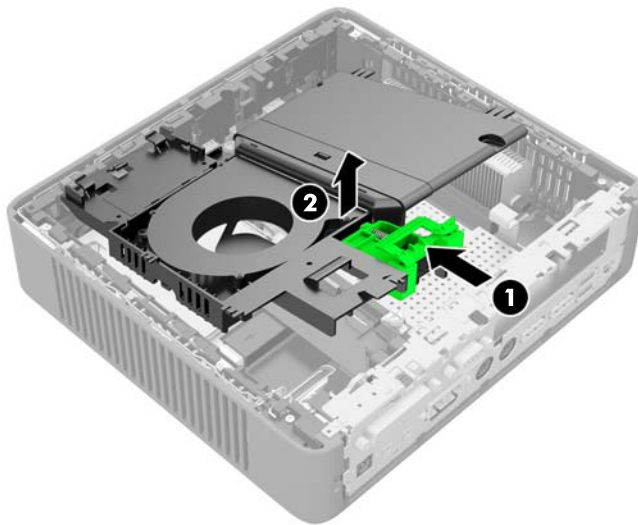

8. Locate the USB flash drive ports on the system board.

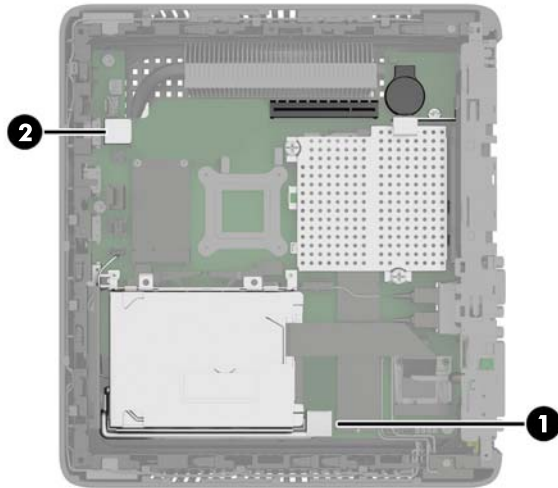

(1) USB-1 port

USB 2.0 flash drive: maximum dimensions 55 mm (L) x 16 mm (W) x 8 mm (H)

(2) USB-2 port

USB 2.0 flash drive: maximum dimensions 65 mm (L) x 25 mm (W) x 10 mm (H)

 **NOTE:** Be sure that the USB flash drive to be installed does not exceed the maximum size for that USB port.

9. Align the USB flash drive with the USB port and press the drive firmly into the port until it is securely seated.
10. If the computer is an HP t620 PLUS Thin Client, rotate the fan assembly down, push the fan assembly latch (1) toward the front of the computer, lower the assembly (2) until it stops, and then release the latch.

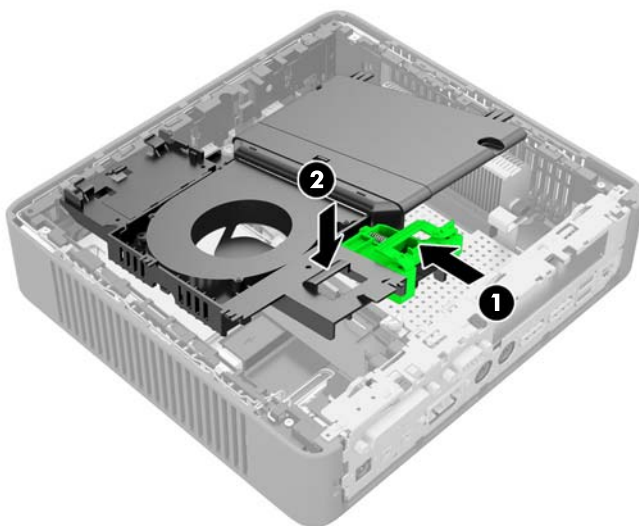

11. Replace and latch the access panel, and then reinstall the I/O panel.

12. Replace the computer stand.
13. Reconnect the power cord and turn on the computer.
14. Lock any security devices that were disengaged when the computer cover or access panel was removed.

Installing additional memory

The computer comes with double data rate 3 synchronous dynamic random access memory (DDR3L-SDRAM) small outline dual inline memory modules (SODIMMs).

SODIMMs

The memory sockets on the system board can be populated with up to two industry-standard SODIMMs. These memory sockets are populated with at least one preinstalled SODIMM. To achieve the maximum memory support, you can populate the system board with up to 16 GB of memory.

DDR3L-SDRAM SODIMMs

For proper system operation, the SODIMMs must adhere to the following specifications:

- industry-standard 204-pin
- unbuffered non-ECC PC3L-12800 DDR3L-1600 MHz-compliant
- 1.35 volt DDR3L-SDRAM SODIMMs
- support CAS latency 11 DDR3L 1600 MHz (11-11-11 timing)
- contain the mandatory Joint Electronic Device Engineering Council (JEDEC) specification

The computer supports the following:

- 2 Gb and 4 Gb non-ECC memory technologies
- single-sided and double-sided SODIMMS
- SODIMMs constructed with x8 and x16 devices; SODIMMs constructed with x4 SDRAM are not supported



NOTE: The system does not operate properly when unsupported SODIMMs are installed.

Populating SODIMM sockets

There are two SODIMM sockets on the system board. The sockets are labeled DIMM1 and DIMM2.

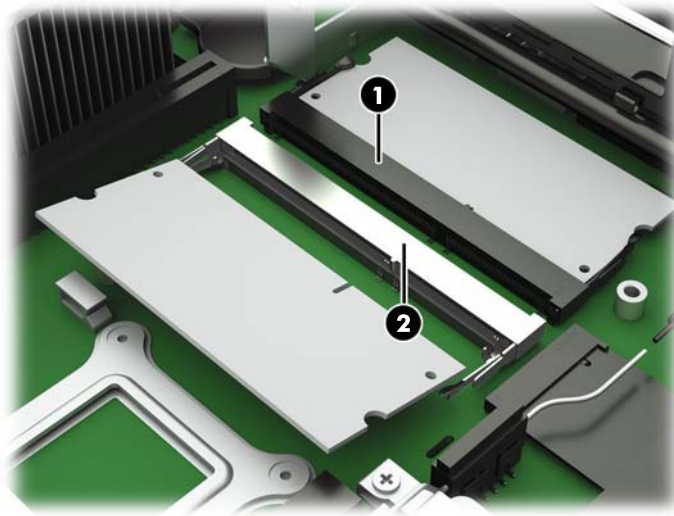

Item	Description	System Board Label	Socket Color
1	SODIMM1 socket	DIMM1	Black
2	SODIMM2 socket	DIMM2	White

The system operates in single-channel mode.

 **NOTE:** If both SODIMM sockets are populated with dual-sided SODIMMs, the system memory speed is reduced to 1333 MHz.

Installing SODIMMs

 **CAUTION:** You must disconnect the power cord and wait approximately 30 seconds for the power to drain before adding or removing memory modules. Regardless of the power-on state, voltage is always supplied to the memory modules as long as the computer is plugged into an active AC outlet. Adding or removing memory modules while voltage is present may cause irreparable damage to the memory modules or system board.

The memory module sockets have gold-plated metal contacts. When upgrading the memory, it is important to use memory modules with gold-plated metal contacts to prevent corrosion and/or oxidation resulting from having incompatible metals in contact with each other.

Static electricity can damage the electronic components of the computer or optional cards. Before beginning the following procedures, be sure that you are discharged of static electricity by briefly touching a grounded metal object. For more information, refer to [Electrostatic discharge on page 42](#).

When handling a memory module, be careful not to touch any of the contacts. Doing so may damage the module.

1. Remove/disengage any security devices that prohibit opening the computer.
2. Remove all removable media, such as USB flash drives, from the computer.

3. Turn off the computer properly through the operating system, and then turn off any external devices.
4. Disconnect the power cord from the power outlet, and disconnect any external devices.

⚠ CAUTION: You must disconnect the power cord and wait approximately 30 seconds for the power to drain before adding or removing memory modules. Regardless of the power-on state, voltage is always supplied to the memory modules as long as the computer is plugged into an active AC outlet. Adding or removing memory modules while voltage is present may cause irreparable damage to the memory modules or system board.

5. Remove the computer from the stand and lay the computer down with the right side up.
6. Remove the computer access panel and back I/O panel. See [Removing and replacing the access panel on page 10](#).

⚠ WARNING! To reduce risk of personal injury from hot surfaces, allow the internal system components to cool before you touch them.

7. If the computer is an HP t620 PLUS Thin Client, push the fan assembly latch (1) toward the front of the computer and rotate the assembly (2) up and out of the way.

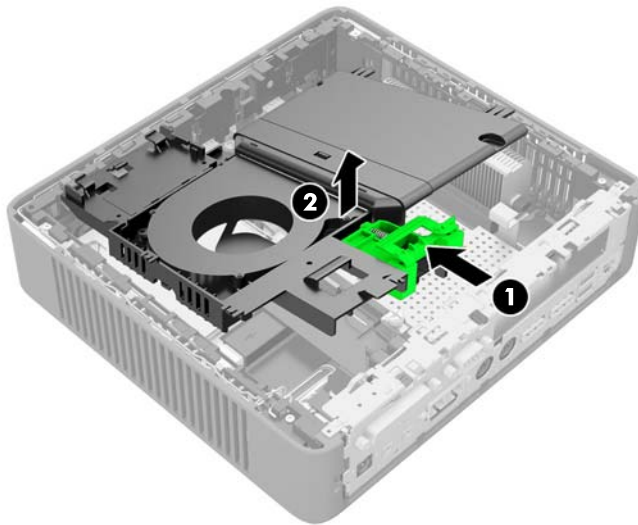

8. Locate the memory compartment on the system board.

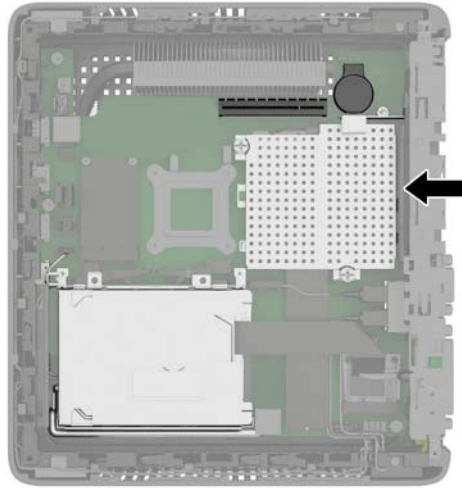

9. If a fiber NIC is installed, move the cable carefully out of the slot in the memory compartment cover.
10. Remove the two screws and springs (1) securing the memory compartment cover.

 **NOTE:** Be sure to retain the two screws and the springs beneath them.

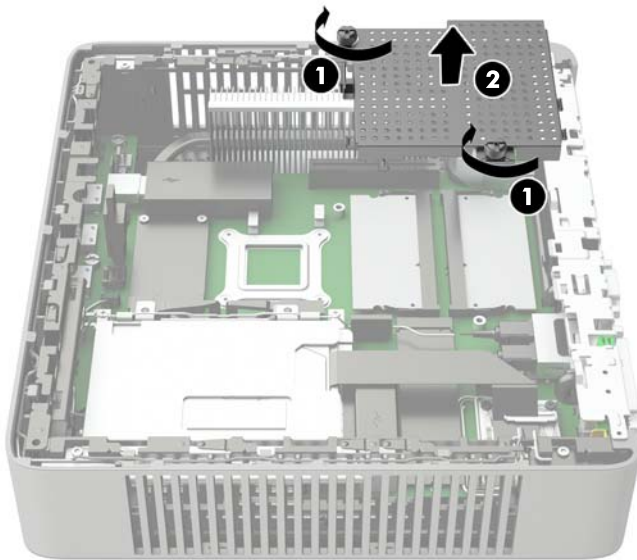

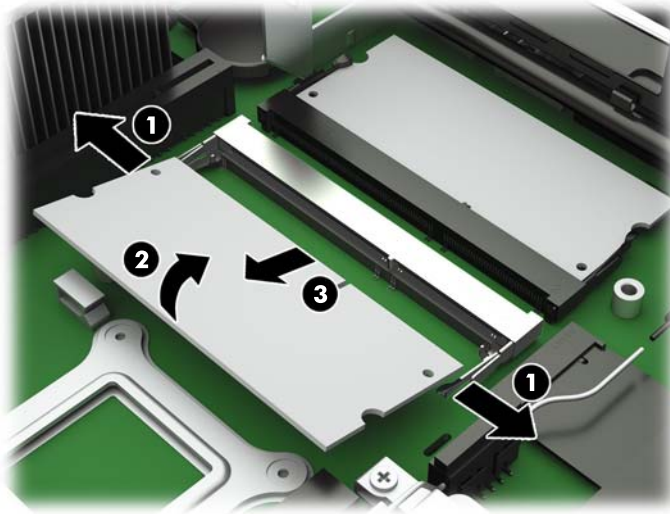

11. Slide the memory compartment cover (2) slightly toward the front of the computer to free it, and then lift it out of the chassis.

12. To remove a SODIMM, press outward on the two latches (1) on each side of the SODIMM, rotate the SODIMM up (2), and then pull the SODIMM out of the socket (3).

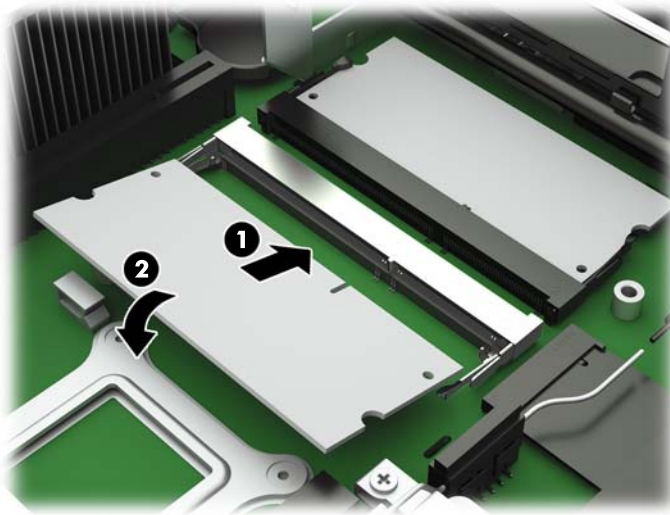

13. Slide the new SODIMM (1) into the socket at approximately a 30° angle, and then press the SODIMM into the socket (2) so that the latches lock it in place.



 **NOTE:** A memory module can be installed in only one way. Match the notch on the module with the tab on the memory socket.

14. Hold the memory compartment cover with the fiber NIC slot toward the front of the computer, and then set the memory compartment cover (1) over the SODIMMs.

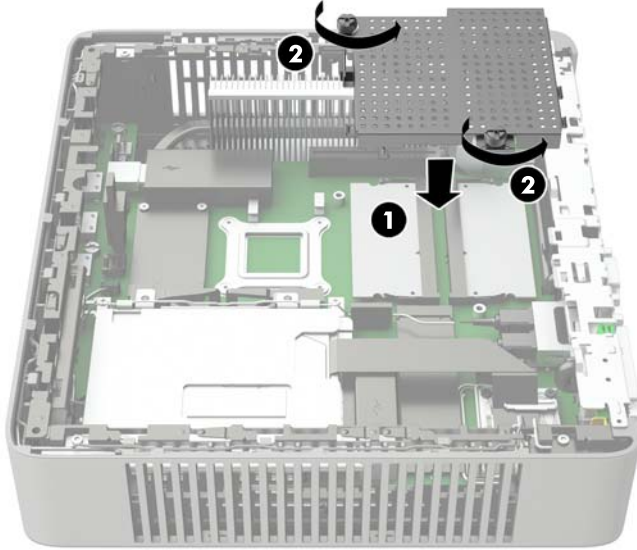

15. If a fiber NIC is installed, move the cable carefully into the slot in the memory compartment cover.
16. Line up the screw holes in the memory cover with the screw posts in the chassis, and then fasten the two screws (2) with the springs to secure the memory compartment cover.
17. If the computer is an HP t620 PLUS Thin Client, rotate the fan assembly down, push the fan assembly latch (1) toward the front of the computer, lower the assembly (2) until it stops, and then release the latch.

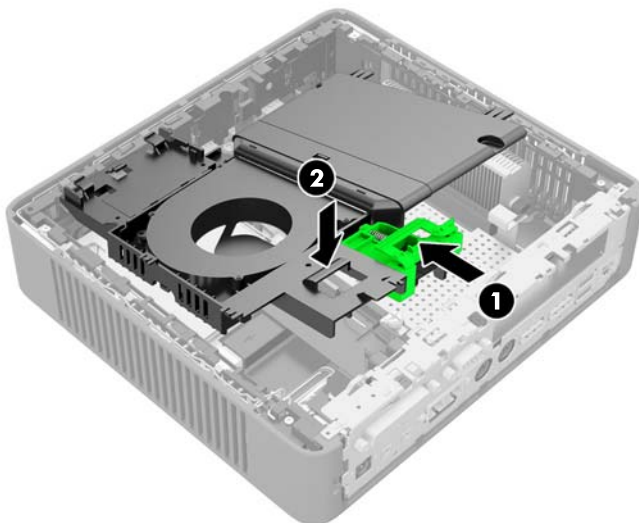

18. Replace and latch the access panel, and then reinstall the I/O panel.
19. Replace the computer stand.

20. Reconnect the power cord and turn on the computer.
21. Lock any security devices that were disengaged when the computer cover or access panel was removed.

The computer automatically recognizes the additional memory when you turn on the computer.

Installing a half-height PCI-Express 2.0 card

You may install an optional half-height PCI-Express (PCIe) card in the HP t620 PLUS Thin Client. A riser card is installed in this computer by default.

⚠ WARNING! To reduce the risk of personal injury or equipment damage from electric shock, hot surfaces, or fire, disconnect the power cord from the power outlet and allow the internal system components to cool before you touch them.

To install a PCIe card:

1. Remove/disengage any security devices that prohibit opening the computer.
2. Remove all removable media, such as USB flash drives, from the computer.
3. Turn off the computer properly through the operating system, and then turn off any external devices.
4. Disconnect the power cord from the power outlet, and disconnect any external devices.

⚠ CAUTION: Regardless of the power-on state, voltage is always present on the system board as long as the system is plugged into an active AC outlet. You must disconnect the power cord to avoid damage to the internal components of the computer.

5. Remove the computer from the stand and lay the computer down with the right side up.
6. Remove the computer access panel and back I/O panel. See [Removing and replacing the access panel on page 10](#).
7. Push the fan assembly latch (1) toward the front of the computer and rotate the assembly (2) up and out of the way.

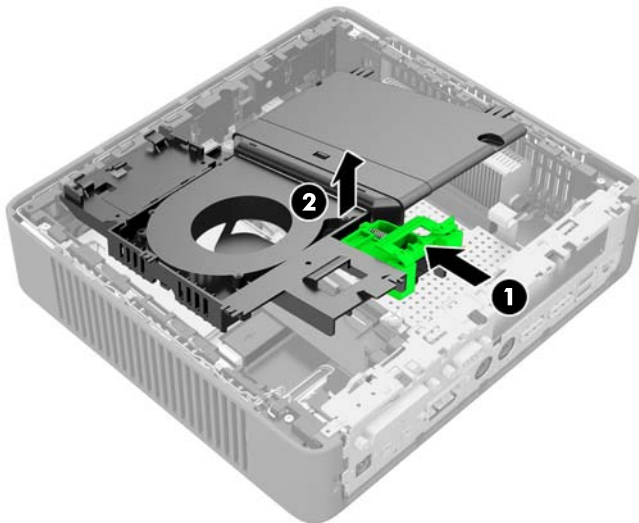

8. Locate the slot in the riser card.

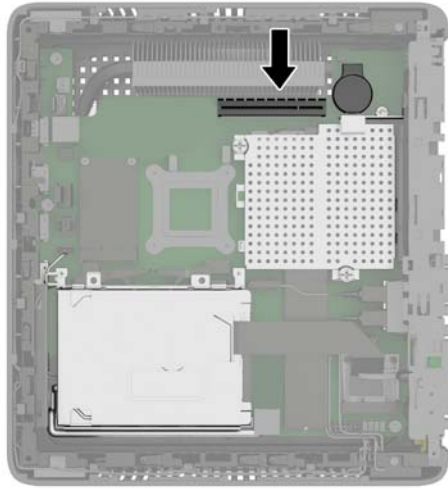

9. Slide the expansion slot cover left and remove it.

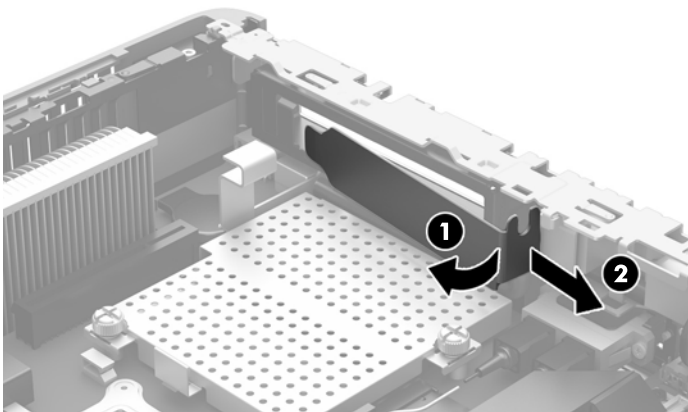

10. Align the PCIe card connectors with the slot in the riser card and the metal tab at the end of the card with the slot in the chassis. Press the PCIe card firmly into the slot in the riser card until it is securely seated and the tab is in the slot.

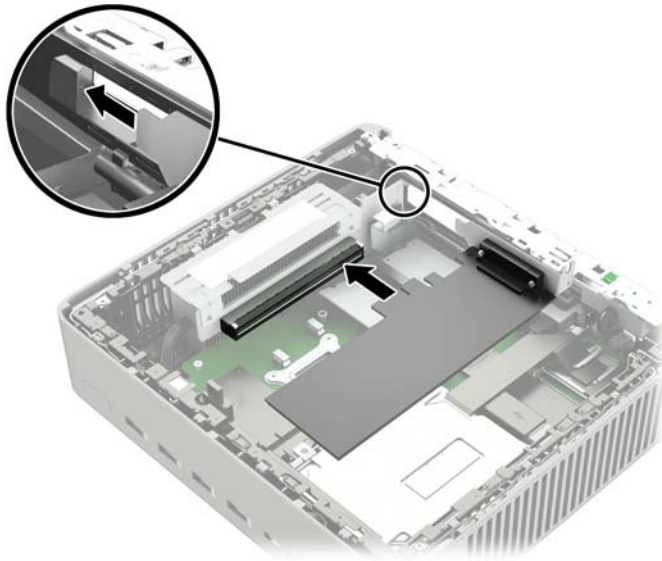

11. Rotate the fan assembly down, push the fan assembly latch (1) toward the front of the computer, lower the assembly (2) until it stops, and then release the latch.

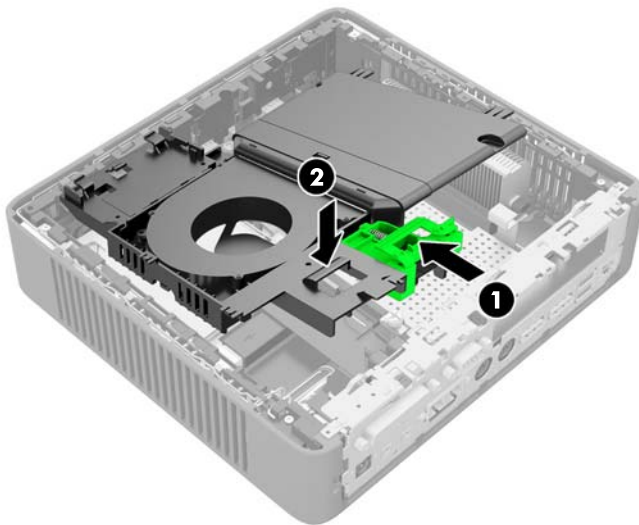

12. Replace and latch the access panel, and then reinstall the I/O panel.
13. Replace the computer stand.
14. Reconnect the power cord and turn on the computer.
15. Lock any security devices that were disengaged when the computer cover or access panel was removed.

Security

The thin client is equipped with a hood sensor. You may also use a cable lock to secure the computer.

For an additional layer of security, you may purchase a port cover to prevent unauthorized access to the rear ports.

Hood sensor

The hood sensor is a combination of hardware and software technology. If the access panel is removed, the hood sensor is released and the computer alerts local users to tampering or removal of the access panel.

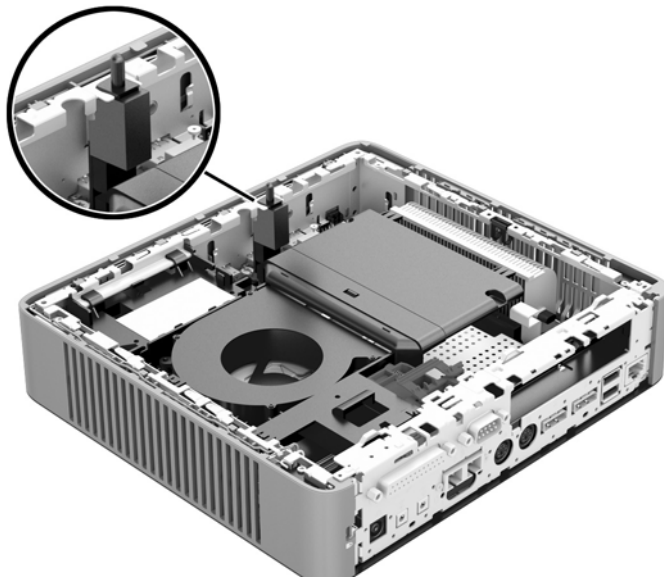

Cable lock

These thin clients are designed to accept a security cable lock. This cable lock prevents unauthorized removal of the thin client, as well as locking devices installed inside the case. To order this option, visit the HP website at <http://www.hp.com> and search for your specific thin client model.

1. Locate the cable lock slot on the back panel.
2. Insert the cable lock into the slot, and then use the key to lock it.



Mounting the thin client

HP t620 Thin Client: HP recommends mounting the thin client in the vertical (tower) orientation, with the HP logo right-side up. Mounting in other orientations may result in decreased performance under certain conditions; operating the computer with limited power to prevent overheating is one such condition. When the integrated fiber NIC is installed in the standard chassis and the chassis is mounted in the horizontal orientation, the maximum ambient temperature for device operation is reduced to 35°C (95°F).

HP t620 PLUS Thin Client: There is no orientation limitation for PLUS configurations. However, optimal performance will be obtained in the vertical (tower) orientation.

This thin client incorporates four mounting points on the right side of the unit. These mounting points follow the VESA (Video Electronics Standards Association) standard, which provides industry-standard mounting interfaces for Flat Displays (FDs), such as flat-panel monitors, flat displays, and flat TVs. The HP Quick Release connects to the VESA-standard mounting points, allowing you to mount the thin client in a variety of orientations.



NOTE: When mounting to a thin client, use the 15 mm screws supplied with the HP Quick Release.



To use the HP Quick Release:

1. Remove four screws from the right side of the computer.

- Using four 15 mm screws included in the mounting device kit, attach one side of the HP Quick Release to the thin client as shown in the following illustration.

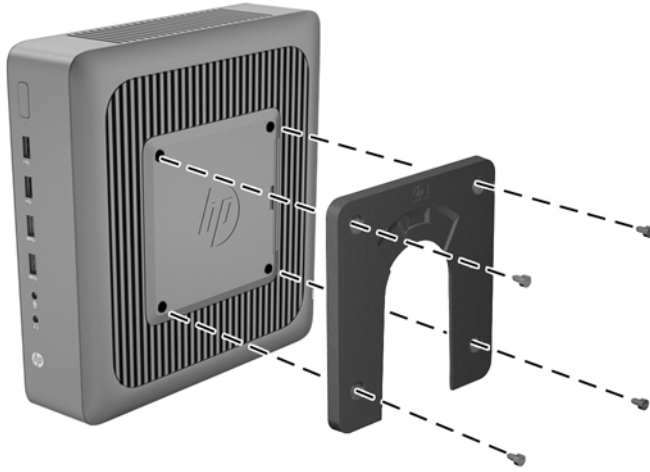

- Using four screws included in the mounting device kit, attach the other side of the HP Quick Release to the device to which you will mount the thin client. Make sure the release lever points upward.

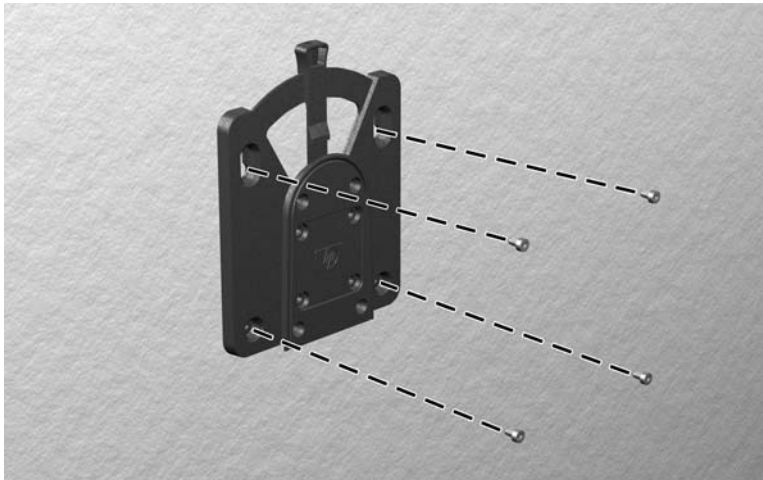

4. Slide the side of the mounting device attached to the thin client (1) over the other side of the mounting device (2) on the device on which you want to mount the thin client. An audible 'click' indicates a secure connection.

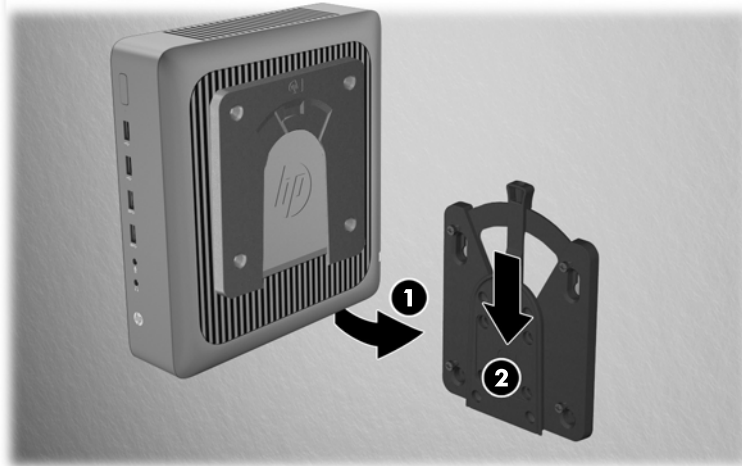

When attached, the HP Quick Release automatically locks in position. You only need to slide the lever to one side to remove the thin client.

CAUTION: For proper function of the HP Quick Release and a secure connection of all components, both the release lever on one side of the mounting device and the rounded opening on the other side must face upward.

Supported mounting options

The following illustrations demonstrate some of the supported mounting options for the mounting bracket.



A Specifications

For the latest specifications or additional specifications on the HP t620 Thin Client or the HP t620 PLUS Thin Client, go to <http://www.hp.com/go/quickspecs/> and search for your specific model to find the model-specific QuickSpecs.

Dimensions

Width: HP t620 Thin Client	40 mm	1.57 in.
Width: HP t620 PLUS Thin Client	65 mm	2.56 in.
Depth	240 mm	9.45 in.
Height (without stand)	219.70 mm	8.65 in.
Height (with stand)	220 mm	8.66 in.

Temperature Range (fanless design)*

Operating**	10°C to 40°C	50°F to 104°F
With the fiber NIC is installed	10°C to 35°C	50°F to 95°F
(max. rate of change is 10°C per hour or 18°F per hour)		
Nonoperating	-30°C to 60°C	-22°F to 140°F
(max. rate of change is 20°C per hour or 36°F per hour)		

*Specifications are at sea level with altitude derating of 1°C/300 m (1.8°F/1000 ft) to a maximum of 3 Km (10,000 ft), with no direct, sustained sunlight. Upper limit may be limited by the type and number of options installed.

** The operating temperature range when the thin client is attached to a flat panel using the HP Quick Release is 10°C to 35°C (50°F to 95°F).

Relative Humidity (non-condensing)

Operating	10% to 90%
(max. wet bulb temperature is 28°C or 84.2°F)	
Nonoperating	5% to 95%
(max. wet bulb temperature is 38.7°C or 101.6°F)	

Maximum Altitude (unpressurized)		
Operating	3048 m	10,000 ft
(max. allowed rate of change is 457m per minute or 1500 ft per minute)		
Nonoperating	9144 m	30,000 ft
(max. allowed rate of change is 457m per minute or 1500 ft per minute)		
Power Supply	HP t620 Thin Client	HP t620 PLUS Thin Client
Operating Voltage Range	100 VAC to 240 VAC	100 VAC to 240 VAC
Rated Line Frequency	50 Hz to 60 Hz	50 Hz to 60 Hz
Power Output (maximum)	65 W	85 W
Rated Output Current (maximum)	3.33 A	4.36 A
Output Voltage	+19.5 V dc	+19.5 V dc

B Removing and replacing the battery

 **WARNING!** Before removing the side access panel, be sure that the thin client is turned off and the power cord is disconnected from the electrical outlet.

To remove and replace the battery:

1. Remove/disengage any security devices that prohibit opening the computer.
2. Remove all removable media, such as USB flash drives, from the computer.
3. Turn off the computer properly through the operating system, and then turn off any external devices.
4. Disconnect the power cord from the power outlet, and disconnect any external devices.

 **CAUTION:** Regardless of the power-on state, voltage is always present on the system board as long as the system is plugged into an active AC outlet. You must disconnect the power cord to avoid damage to the internal components of the computer.

5. Remove the computer from the stand and lay the computer down with the right side up.
6. Remove the computer access panel and back I/O panel. See [Removing and replacing the access panel on page 10](#).

7. If the computer is an HP t620 PLUS Thin Client, perform the following steps:
 - a. Push the fan assembly latch (1) toward the front of the computer and rotate the assembly (2) up and out of the way.

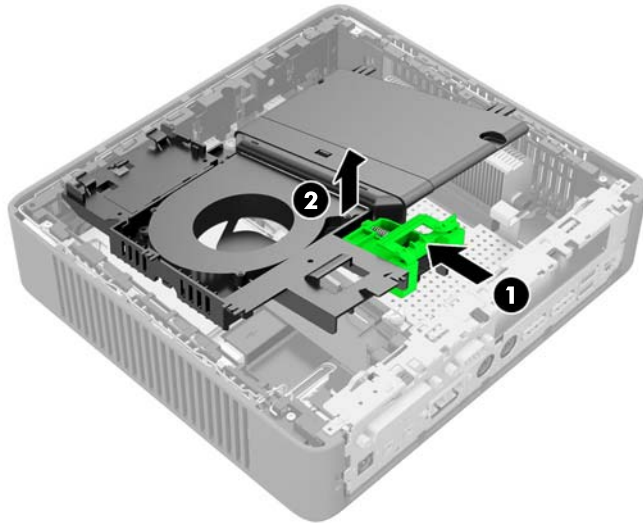

- b. If a PCIe card is installed, remove it carefully.
- c. Pull the riser card out of the socket and carefully move it to one side.
Disconnecting the cables from the PCIe riser card is not necessary.

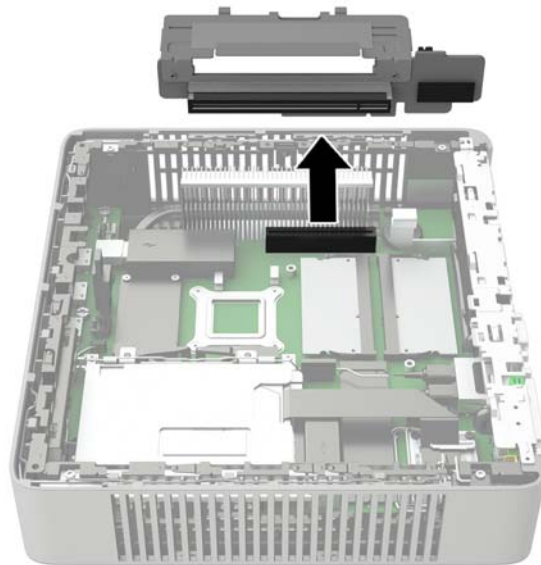

8. Locate the battery on the system board.

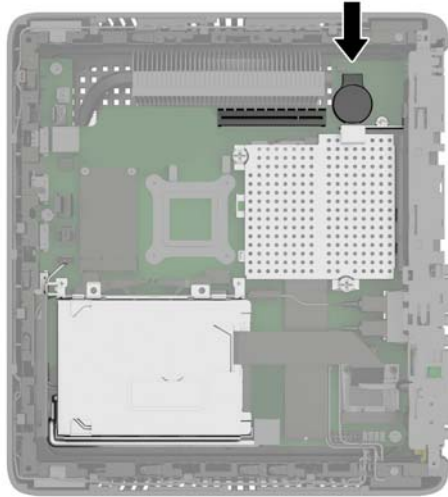

9. Carefully pry the battery up from the system board.
10. Unplug the battery cable connector from the system board.
11. Connect the cable connector from the new battery to the system board.
12. Carefully press the new battery down to adhere the battery securely to the system board.
13. If the computer is an HP t620 PLUS Thin Client, perform the following steps.
 - a. If the cables from the PCIe riser card were disconnected in step 7 c, reconnect them.
 - b. Align the riser card with the socket on the system board and press the riser card firm into the socket.

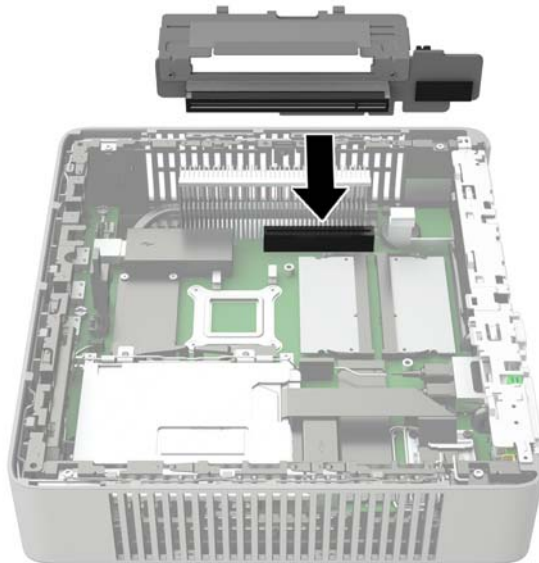

 **NOTE:** The riser card can be installed in only one way. Match the notch on the card with the tab on the socket.

- c. If a PCIe card was installed, reinstall it. For instructions, see [Installing a half-height PCI-Express 2.0 card on page 23](#).
- d. Rotate the fan assembly down, push the fan assembly latch (1) toward the front of the computer, lower the assembly (2) until it stops, and then release the latch.

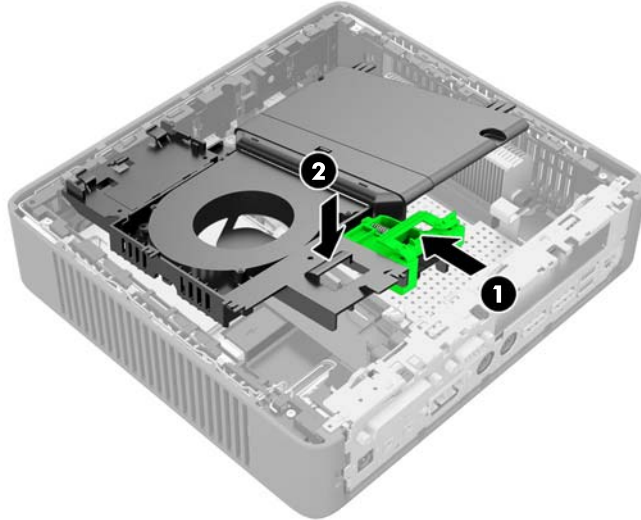

14. Replace and latch the access panel, and then reinstall the I/O panel.
15. Replace the computer stand.
16. Reconnect the power cord and turn on the computer.
17. Lock any security devices that were disengaged when the computer cover or access panel was removed.

HP encourages customers to recycle used electronic hardware, HP original print cartridges, and rechargeable batteries. For more information about recycling programs, go to <http://www.hp.com> and search for “recycle”.



Batteries, battery packs, and accumulators should not be disposed of together with the general household waste. In order to forward them to recycling or proper disposal, please use the public collection system or return them to HP, an authorized HP partner, or their agents.



廢電池請回收

The Taiwan EPA requires dry battery manufacturing or importing firms, in accordance with Article 15 or the Waste Disposal Act, to indicate the recovery marks on the batteries used in sales, giveaways, or promotions. Contact a qualified Taiwanese recycler for proper battery disposal.

C Thin client operation

⚠ CAUTION: Ensure that the write filter is enabled after committing necessary configurations to the thin client flash drive. During normal operation of the thin client, the write filter must be enabled. Also ensure that Page File is not enabled on thin clients with flash memory storage. Failure to follow these required actions can void the warranty of the flash storage device. In the event of damage to the flash storage device due to operation with a disabled write filter or enabled Page File, the damage will not be covered by HP warranty.

For more information about write filter usage, see the operating system guide for your thin client available at <http://www.hp.com/support/manuals/thinclients>.

Routine thin client care

Use the following information to properly care for your thin client:

- Never operate the thin client with the outside panel removed.
- Keep the thin client away from excessive moisture, direct sunlight, and extreme heat and cold. For information about the recommended temperature and humidity ranges for the thin client, see [Specifications on page 32](#).
- Keep liquids away from the thin client and keyboard.
- Turn off the thin client and wipe the exterior with a soft, damp cloth as needed. Using cleaning products may discolor or damage the finish.

Supported orientations

HP supports the following orientations for the thin client.

⚠ CAUTION: You must adhere to HP-supported orientations to be sure that your thin client functions properly.

📝 NOTE: HP t620 standard (slim) chassis: HP recommends mounting the thin client in the vertical (tower) orientation, with the HP logo right-side up. Mounting in other orientations may result in decreased performance under certain conditions; operating the computer with limited power to prevent overheating is one such condition.





Non-supported orientation

HP does not support the following orientations for the thin client.

⚠ CAUTION: Non-supported placement of thin clients could result in operation failure and/or damage to the devices.

CAUTION: Thin clients require proper ventilation to maintain operating temperature. Do not block the vents.

Do not put thin clients in drawers or other sealed enclosures. Do not place a monitor or other object on top of the thin client. Thin clients require proper ventilation to maintain operating temperatures.

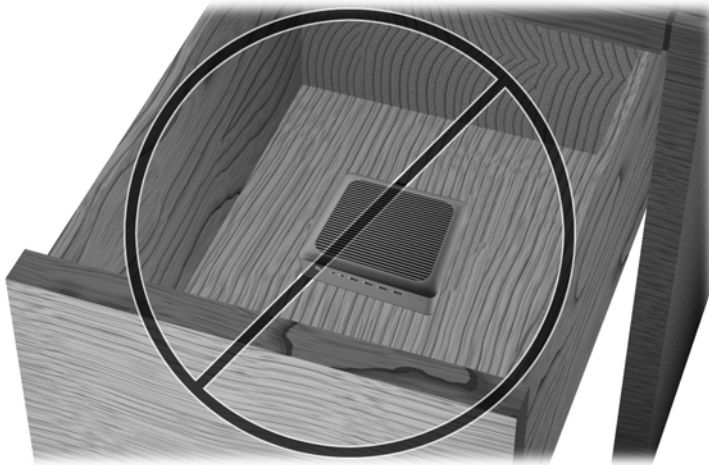

D Electrostatic discharge

A discharge of static electricity from a finger or other conductor may damage system boards or other static-sensitive devices. This type of damage may reduce the life expectancy of the device.

Preventing electrostatic damage

To prevent electrostatic damage, observe the following precautions:

- Avoid hand contact by transporting and storing products in static-safe containers.
- Keep electrostatic-sensitive parts in their containers until they arrive at static-free workstations.
- Place parts on a grounded surface before removing them from their containers.
- Avoid touching pins, leads, or circuitry.
- Always be properly grounded when touching a static-sensitive component or assembly.

Grounding methods

There are several methods for grounding. Use one or more of the following methods when handling or installing electrostatic-sensitive parts:

- Use a wrist strap connected by a ground cord to a grounded Thin Client chassis. Wrist straps are flexible straps of 1 megohm +/- 10 percent resistance in the ground cords. To provide proper grounding, wear the strap snug against the skin.
- Use heelstraps, toestraps, or bootstraps at standing workstations. Wear the straps on both feet when standing on conductive floors or dissipating floor mats.
- Use conductive field service tools.
- Use a portable field service kit with a folding static-dissipating work mat.

If you do not have any of the suggested equipment for proper grounding, contact an HP authorized dealer, reseller, or service provider.



NOTE: For more information about static electricity, contact an HP authorized dealer, reseller, or service provider.

E Shipping information

Shipping preparation

Follow these suggestions when preparing to ship the thin client:

1. Turn off the thin client and external devices.
2. Disconnect the power cord from the electrical outlet, and then from the thin client.
3. Disconnect the system components and external devices from their power sources, and then from the thin client.
4. Pack the system components and external devices in their original packing boxes or similar packaging with sufficient packing material to protect them.



NOTE: For environmental nonoperating ranges, see [Specifications on page 32](#)

Important service repair information

In all cases, remove and safeguard all external options before returning the thin client to HP for repair or exchange.

In countries that support customer mail-in repair by returning the same unit to the customer, HP makes every effort to return the repaired unit with the same internal memory and flash modules that were sent.

In countries that do not support customer mail-in repair by returning the same unit to the customer, all internal options should be removed and safeguarded in addition to the external options. The thin client should be restored to the **original configuration** before returning it to HP for repair.

To remove the solid state drive (SSD), perform the following steps:

Removing the solid state drive (flash memory)

1. Remove/disengage any security devices that prohibit opening the computer.
2. Remove all removable media, such as USB flash drives, from the computer.
3. Turn off the computer properly through the operating system, and then turn off any external devices.

4. Disconnect the power cord from the power outlet, and disconnect any external devices.

⚠ CAUTION: Regardless of the power-on state, voltage is always present on the system board as long as the system is plugged into an active AC outlet. You must disconnect the power cord to avoid damage to the internal components of the computer.

5. Remove the computer from the stand and lay the computer down with the right side up.
6. Remove the computer access panel and back I/O panel. See [Removing and replacing the access panel on page 10](#).
7. If the computer is an HP t620 PLUS Thin Client, push the fan assembly latch (1) toward the front of the computer and rotate the assembly (2) up and out of the way.

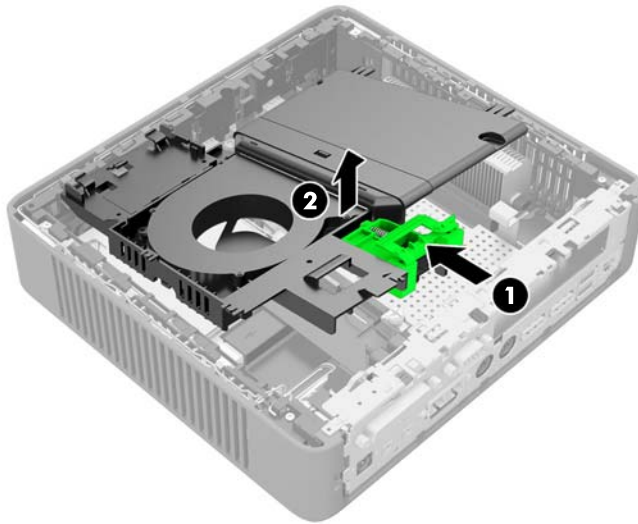

8. Remove the two screws securing the SSD to the system board.

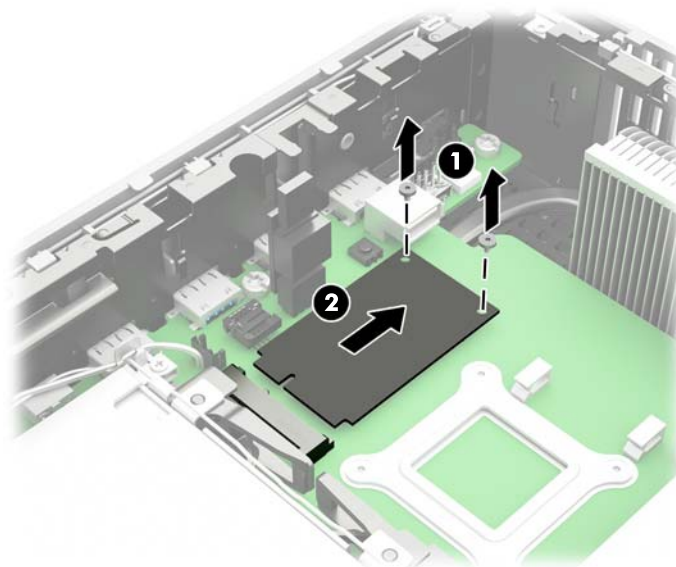

9. Carefully pull the SSD out of the socket.

Store the SSD carefully until it can be installed in the returned computer.

10. Rotate the fan assembly down, push the fan assembly latch (1) toward the front of the computer, lower the assembly (2) until it stops, and then release the latch.

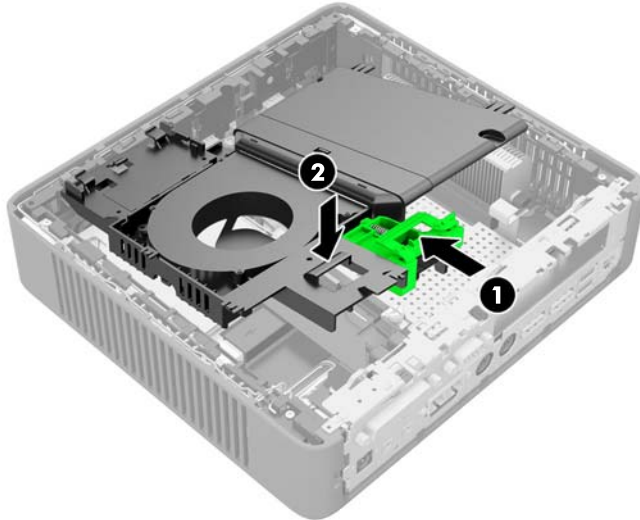

11. Replace and latch the access panel, and then reinstall the I/O panel.

Index

A

- access panel
 - removing 10
 - replacing 12
- altitude specifications 33

B

- battery, replacing 34

C

- cable lock 27
- cable lock slot 3
- cautions
 - attaching the stand 9
 - damage to flash storage device 2, 38
 - electric shock 7, 10, 17, 23
 - HP Quick Release 30
 - installing SODIMMs 17
 - removing the battery 34
 - securing the power cable 8
 - static electricity 7
 - thin client orientation 39, 41
 - ventilation 41
 - write filter 2, 38
- components
 - front panel 2
 - keyboard 4
 - mouse 5
 - rear panel 3

D

- dimensions 32
- dual-mode DisplayPort 1.2 ports location 3

E

- electrostatic discharge 42
- Ethernet connector location 3

F

- fiber NIC port location 3
- Flash drive activity LED location 2
- flash memory, removing 43
- front panel components 2
- function keys 5

G

- grounding methods 42

H

- half-height PCIe 2.0 card, installing 23
- half-height PCIe 2.0 expansion slot location 3
- hardware specifications 32
- headphone port location 2
- hood sensor 26
- horizontal orientation 39
- humidity specifications 32

I

- installation guidelines 7
- installing
 - half-height PCIe 2.0 card 23
 - memory 16
 - SODIMMs 16
 - USB devices 14

K

- keyboard
 - function keys 5
 - layout 4
 - Windows Logo Key 5

L

- line-in audio port location 3
- line-out audio port location 3

M

- memory
 - installation 16
 - socket population 17
 - specifications 16
- microphone port location 2
- mounting options
 - on back of monitor stand 31
 - on wall 31
 - under desk 31
- mounting thin client 28
- mouse functions 5

N

- non-supported orientations
 - in a drawer 41
 - under a monitor 41

O

- options 1, 27

P

- parallel port location 3
- PCIe 2.0 card, half-height, installing 23
- PCIe 2.0 expansion slot location 3
- power button location 2
- power cord connection 8
- power output specifications 33
- power port location 3
- power supply specifications 33
- preventing electrostatic damage 42
- PS/2 keyboard port location 3
- PS/2 mouse port location 3

R

- rated output current 33

- rear panel components 3
- recycling 37
- relative humidity specifications 32
- removing
 - access panel 10
 - battery 34
 - flash memory 43
 - solid state drive 43
 - SSD 43
- replacing
 - access panel 12
 - battery 34
- retention hook location 3
- RJ-45 connector location 3
- routine care 38
- S**
- security 26
 - cable lock 27
 - hood sensor 26
- serial number location 6
- serial port location 3
- service repair 43
- shipping preparation 43
- SODIMMs
 - installation 16
 - socket population 17
- solid state drive, removing 43
- specifications
 - altitude 33
 - dimensions 32
 - hardware 32
 - humidity 32
 - power output 33
 - power supply 33
 - rated output current 33
 - relative humidity 32
 - temperature 32
 - thin client 32
- specifications, memory 16
- SSD, removing 43
- stand, attaching 9
- supported mounting options 31
- supported orientations 39
 - horizontal 39
 - under monitor stand 39
 - vertical 39

- T**
- temperature specifications 32
- tower stand 9

- U**
- USB devices, installing 14
- USB ports
 - 2.0 2, 3, 14
 - 3.0 2
 - location 2, 3, 14
 - maximum size 14

- V**
- vertical orientation 39
- VGA port location 3

- W**
- warnings
 - burn 7, 14, 18, 23
 - electric shock 7, 10, 23, 34
 - grounding plug 7
 - NIC receptacles 7
- websites
 - HP 1
 - options 1
- Windows Logo Key 5