



Maintenance and Service Guide

SUMMARY

This guide provides information about spare parts, removal and replacement of parts, security, backing up, and more.

Legal information

© Copyright 2021 HP Development Company, L.P.

AMD and Radeon are trademarks of Advanced Micro Devices, Inc. Bluetooth is a trademark owned by its proprietor and used by HP Inc. under license. Intel, Core, Thunderbolt, vPro, Xeon, and XMM are trademarks of Intel Corporation or its subsidiaries in the U.S. and/or other countries. Linux is the registered trademark of Linus Torvalds in the U.S. and other countries. Microsoft and Windows are either registered trademarks or trademarks of Microsoft Corporation in the United States and/or other countries. NVIDIA and Quadro are trademarks and/or registered trademarks of NVIDIA Corporation in the U.S. and other countries. USB Type-C and USB-C are registered trademarks of USB Implementers Forum. DisplayPort™ and the DisplayPort™ logo are trademarks owned by the Video Electronics Standards Association (VESA®) in the United States and other countries.

The information contained herein is subject to change without notice. The only warranties for HP products and services are set forth in the express warranty statements accompanying such products and services. Nothing herein should be construed as constituting an additional warranty. HP shall not be liable for technical or editorial errors or omissions contained herein.

First Edition: July 2021

Document Part Number: M73307-001

Product notice

This guide describes features that are common to most models. Some features may not be available on your computer.

Not all features are available in all editions or versions of Windows. Systems may require upgraded and/or separately purchased hardware, drivers, software or BIOS update to take full advantage of Windows functionality. Windows 10 is automatically updated, which is always enabled. ISP fees may apply and additional requirements may apply over time for updates. Go to <http://www.microsoft.com> for details.

To access the latest user guides, go to <http://www.hp.com/support>, and follow the instructions to find your product. Then select **Manuals**.

Software terms

By installing, copying, downloading, or otherwise using any software product preinstalled on this computer, you agree to be bound by the terms of the HP End User License Agreement (EULA). If you do not accept these license terms, your sole remedy is to return the entire unused product (hardware and software) within 14 days for a full refund subject to the refund policy of your seller.

For any further information or to request a full refund of the price of the computer, please contact your seller.

Safety warning notice

Reduce the possibility of heat-related injuries or of overheating the computer by following the practices described.

⚠ WARNING! To reduce the possibility of heat-related injuries or of overheating the computer, do not place the computer directly on your lap or obstruct the computer air vents. Use the computer only on a hard, flat surface. Do not allow another hard surface, such as an adjoining optional printer, or a soft surface, such as pillows or rugs or clothing, to block airflow. Also, do not allow the AC adapter to come into contact with the skin or a soft surface, such as pillows or rugs or clothing, during operation. The computer and the AC adapter comply with the user-accessible surface temperature limits defined by applicable safety standards.

Important notice about Customer Self-Repair parts

Your computer includes Customer Self-Repair parts and parts that should be accessed by only an authorized service provider.



IMPORTANT: See "Removal and replacement procedures for Customer Self-Repair parts" for details.

Accessing parts described in "Removal and replacement procedures for authorized service provider parts" can damage the computer or void your warranty.

Table of contents

1 Product description	1
2 Components	5
Locating hardware	5
Locating software	5
Right.....	5
Left	6
Display.....	8
Keyboard area	9
Touchpad.....	9
Touchpad settings.....	9
Adjusting touchpad settings	9
Turning on the touchpad.....	9
Touchpad components	9
Lights.....	10
Button, speakers, and fingerprint reader	11
Special keys.....	13
Action keys	14
Hot keys	16
Bottom	16
Top cover	17
Rear	18
HP TamperLock	18
Labels.....	19
Using a SIM card (select products only).....	20
Determining the correct SIM card size for your computer	21
Inserting a SIM card in the service bay	21
3 Illustrated parts catalog	23
Computer major components.....	23
Mass storage devices.....	29
Cables.....	30
Miscellaneous parts	31
4 Removal and replacement procedures preliminary requirements	33
Tools required	33
Service considerations.....	33
Plastic parts	33
Cables and connectors.....	33

Drive handling	33
Electrostatic discharge information	34
Generating static electricity	34
Preventing electrostatic damage to equipment	35
Personal grounding methods and equipment	35
Grounding the work area	36
Recommended materials and equipment	36
Cleaning your computer	37
Enabling HP Easy Clean (select products only)	37
Removing dirt and debris from your computer	37
Cleaning your computer with a disinfectant	38
Caring for wood veneer (select products only)	39
Packaging and transporting guidelines	39
Accessing support information	39
5 Removal and replacement procedures for Customer Self-Repair parts.....	42
Component replacement procedures.....	42
Preparation for disassembly	42
Service cover	42
Battery	43
Solid-state drives 3 and 4.....	44
Hard drive.....	46
WLAN module.....	48
WWAN module	49
Solid-state drive 2	51
Memory modules 2 and 4	53
Keyboard	55
Memory modules 1 and 3	59
Solid-state drive 1	62
6 Removal and replacement procedures for authorized service provider parts.....	65
Component replacement procedures.....	65
Preparation for disassembly	65
Bottom case	65
SD card board cable	67
SD card board.....	68
Fingerprint reader module cable.....	69
Fingerprint reader board	70
Hard drive cable	71
Touchpad cable	73
Touchpad.....	74
NFC module cable	75
NFC module	76
Card reader board	77
Fan/heat sink assembly.....	78
Display assembly	81
Beam connector	85
Graphics card.....	87

System board	89
RTC battery	94
I/O board	95
Speakers.....	96
7 Troubleshooting guide.....	98
Resources.....	98
General troubleshooting steps.....	99
Identify the issue	99
1. Understand the issue.....	100
Boot up sequence.....	100
Failure classification	100
2. Examine the environment	102
3. Perform a visual inspection of hardware	102
4. Update BIOS and drivers	103
Manually updating BIOS and drivers.....	103
Remotely deploying the BIOS and drivers	103
Analyze the issue	103
5. Remove or uninstall recently added hardware, software	103
6. HP Hardware Diagnostics and Tools.....	103
HP PC Hardware Diagnostics (UEFI)	104
HP BIOS Configuration Utility (BCU)	105
HP Image Diagnostic Tool	106
HP Thermal Monitor	106
Non HP diagnostics tools.....	106
7. Status lights, blinking light codes, troubleshooting lights, and POST error messages	106
Status lights.....	106
Blinking light codes.....	107
POST error messages.....	108
Resolve the issue	109
8. Hard reset.....	109
9. Soft reset (Default Settings).....	110
10. Reseat cables and connections	110
11. Test with minimum configuration	111
Essential hardware configuration.....	111
Safe mode	112
12. Test with verified working configuration (hardware or operating system)	112
13. Replace the system board	112
Verify solution.....	113
Helpful Hints	113
At startup	114
During operation.....	114
Consulting with HP Service	115
Common issues and possible solutions	115
Power-on issues.....	115
No power	115
Intermittent power-on, shutdown, reboot.....	117
AC adapter issue.....	118

Battery not recognized, not charging	119
Battery discharges too fast	120
Burnt smell.....	121
POST	122
No video (with power)	122
Blinking lights	123
Diagnostic error messages	124
BIOS password	124
Performance (OS).....	125
Intermittent shutdown	125
Blue screen.....	126
Freeze at Windows Logo (hang or lockup).....	128
Electromagnetic Interference (EMI).....	129
No wake up.....	129
Unresponsive	130
Slow performance.....	131
HP Smart Adapter warning message.....	131
Incorrect time and date.....	132
Display.....	133
Display anomalies.....	133
Symptom.....	133
Quick check	134
HP PC Hardware Diagnostics (UEFI) for video test	134
Display assembly diagram.....	135
Dead pixel.....	135
No video (internal)	135
No video (external)	136
DisplayPort/VGA	136
HDMI	136
No or bad external video via docking	137
Incorrect or missing color/distorted image	138
Touch screen	138
I/O devices.....	139
Keyboard	139
Keyboard pointing stick (select products only)	140
Keyboard backlight	141
Touchpad.....	141
Network connectivity (RJ-45 jack)	142
Network connectivity wireless (WLAN)	142
WWAN.....	143
USB	143
Smart card reader	144
Speaker, headphone - audio issues	145
Thunderbolt (TB).....	146
Storage.....	147
Hard drive or solid-state drive not recognized.....	148
No boot to operating system (no read-write error)	149
Read-write error	149
Slow performance.....	150

Blue screen (BSOD) error	150
Noisy hard drive	150
Mechanical	151
Noise (sound)	151
Fan runs constantly	152
Thermal shutdown (hot)	153
Additional information	154
Acronyms	154
Blinking lights and boot error codes	155
Processor not executing code.....	155
BIOS recovery code unable to find valid BIOS recovery image.....	156
Memory module error	156
Graphics Controller Error (No Controller)	156
Failure System Board Error	156
Intel Trusted Execution Technology (TXT) Error	157
Sure Start unable to find valid BIOS Boot Block image	157
Sure Start has identified a problem (Manual Recovery Policy Set).....	157
POST error messages and user actions.....	157
Routine maintenance for performance improvement	159
Common blue screen error messages	160
Error message list.....	160
Bug check symbolic names.....	160
Microsoft general troubleshooting of Windows bug check codes	160
Use Windows Debugging Tool	161
Windows Software Development Kit (SDK)	161
Display issue: pixel anomalies.....	165
Cable management.....	166
Connector types.....	167
Flex cable	167
Horizontal cable insertion	168
Multiple-pin horizontal connector (LVDS cable to display panel)	168
Multiple-pin vertical connector (LVDS cable to system board)	169
8 Using Setup Utility (BIOS)	170
Starting Setup Utility (BIOS)	170
Updating Setup Utility (BIOS)	170
Determining the BIOS version	170
Preparing for a BIOS update	171
Downloading a BIOS update	171
Installing a BIOS update.....	171
9 Computer Setup (BIOS), TPM, and HP Sure Start.....	173
Using Computer Setup.....	173
Navigating and selecting in Computer Setup	173
Restoring factory settings in Computer Setup.....	173
Updating the BIOS.....	174
Determining the BIOS version.....	174
Preparing for a BIOS update	174

Downloading a BIOS update	175
Installing a BIOS update	175
Changing the boot order using the f9 prompt	175
TPM BIOS settings (select products only)	176
Using HP Sure Start (select products only)	176
10 Backing up, resetting, and recovering	177
Backing up.....	177
Resetting.....	177
Recovering	177
Installing the Chromebook Recovery Utility.....	178
Creating recovery media.....	178
Recovering the Chrome operating system	178
Setting up your computer after a reset or recovery	179
Erase and reformat the recovery media.....	179
11 Backing up, restoring, and recovering	180
Backing up information and creating recovery media	180
Using Windows tools for backing up	180
Using the HP Cloud Recovery Download Tool to create recovery media (select products only)	180
Restoring and recovering your system.....	180
Creating a system restore	181
Restoring and recovery methods	181
Recovering using HP Recovery media	181
Changing the computer boot order	182
Using HP Sure Recover (select products only).....	182
12 Using HP PC Hardware Diagnostics	183
Using HP PC Hardware Diagnostics Windows (select products only)	183
Using an HP PC Hardware Diagnostics Windows hardware failure ID code	183
Accessing HP PC Hardware Diagnostics Windows.....	183
Accessing HP PC Hardware Diagnostics Windows from HP Help and Support (select products only)	183
Accessing HP PC Hardware Diagnostics Windows from Support Assistant.....	184
Accessing HP PC Hardware Diagnostics Windows from the Start menu (select products only)	184
Downloading HP PC Hardware Diagnostics Windows	184
Downloading the latest HP PC Hardware Diagnostics Windows version from HP.....	184
Downloading the HP PC Hardware Diagnostics Windows from the Microsoft Store	184
Downloading HP Hardware Diagnostics Windows by product name or number (select products only).....	185
Installing HP PC Hardware Diagnostics Windows.....	185
Using HP PC Hardware Diagnostics UEFI	185
Using an HP PC Hardware Diagnostics UEFI hardware failure ID code.....	185
Starting HP PC Hardware Diagnostics UEFI	186
Downloading HP PC Hardware Diagnostics UEFI to a USB flash drive	186
Downloading the latest HP PC Hardware Diagnostics UEFI version	186
Downloading HP PC Hardware Diagnostics UEFI by product name or number (select products only)	186
Using Remote HP PC Hardware Diagnostics UEFI settings (select products only)	187

Downloading Remote HP PC Hardware Diagnostics UEFI	187
Downloading the latest Remote HP PC Hardware Diagnostics UEFI version.....	187
Downloading Remote HP PC Hardware Diagnostics UEFI by product name or number.....	187
Customizing Remote HP PC Hardware Diagnostics UEFI settings	187
13 Specifications.....	189
Computer specifications	189
39.6 cm (15.6 in) display specifications	190
Hard drive specifications	191
Solid-state drive specifications	191
Solid-state drive specifications (SATA-3)	192
14 Statement of memory volatility.....	193
Current BIOS steps	193
Nonvolatile memory usage	195
Questions and answers	197
Using HP Sure Start (select products only)	199
15 Power cord set requirements	200
Requirements for all countries	200
Requirements for specific countries and regions.....	200
16 Recycling.....	202
Index	203

1 Product description

This table provides detailed product information.

Table 1-1 Product components and their descriptions

Category	Description
Product Name	HP ZBook Fury 15 G8 Mobile Workstation
Processors	<p>10th Generation Intel® Core™ processors</p> <p>Intel® Xeon™ W-11955M 2.6 GHz (5.1 GHz max turbo frequency) processor (8 cores, 24 MB L3 cache, 45 W)</p> <p>Intel Core™ i9-11950H 2.6 GHz (5.1 GHz max turbo frequency) processor (8 cores, 24 MB L3 cache, 45 W)</p> <p>Intel Core i9-11900H 2.6 GHz (5.1 GHz max turbo frequency) processor (8 cores, 24 MB L3 cache, 45 W)</p> <p>Intel Core i7-11800H 2.7 GHz (5.1 GHz max turbo frequency) processor (8 cores, 24 MB L3 cache, 45 W)</p> <p>Intel Core i7-11850H 2.7 GHz (5.1 GHz max turbo frequency) processor (8 cores, 24 MB L3 cache, 45 W)</p> <p>Intel Core i5-11500H 2.9 GHz (4.6 GHz max turbo frequency) processor (6 cores, 12 MB L3 cache, 45 W)</p>
Graphics controller	<p>AMD® Radeon™ F21M-P70-50 graphics controller</p> <p>NVIDIA® Quadro® RTX A2000 graphics controller</p> <p>NVIDIA Quadro T1200 graphics controller</p> <p>NVIDIA Quadro N20-E1-Q-KD graphics controller</p> <p>NVIDIA Quadro N20E-E3 graphics controller</p> <p>NVIDIA Quadro N20E- graphics controller</p>
Graphics card	<p>AMD W 6600M graphics card with 8 GB integrated memory</p> <p>AMD Thermal Pad Kit</p> <p>NVIDIA RTX 3000 graphics card with 6 GB integrated memo</p> <p>NVIDIA RTX 4000 graphics card with 8 GB integrated memory</p> <p>NVIDIA RTX 5000 graphics card with 16 GB integrated memory</p> <p>NVIDIA T1000 graphics card with 4 GB integrated memory</p> <p>NVIDIA T2000 graphics card with 2 GB integrated memory</p>
Display	<p>39.6 cm (15.6 in), liquid crystal display (LCD), white light-emitting diode (WLED), ultrawide viewing angle (UWVA), flat bezel</p> <p>Ultra high definition (UHD) (3840 × 1980), touchscreen display assembly with Dream Vision, infrared sensor; typical brightness: 600 nits</p> <p>UHD (3840 × 1980), touchscreen display assembly; typical brightness: 600 nits, antiglare, Dream Vision, assembly with webcam and typical brightness: 400 nits</p> <p>UHD (3840 × 1980), touchscreen display assembly; typical brightness: 600 nits, antiglare, Dream Vision, assembly with webcam and typical brightness: 400 nits</p> <p>Full high definition (FHD) (1980 × 1080), antiglare, non-touchscreen display assembly with FHD webcam, and ambient light sensor; typical brightness: 1000 nits</p>

Table 1-1 Product components and their descriptions (continued)

Category	Description
	FHD (1980 × 1080), antiglare, non-touchscreen display assembly with FHD webcam, and ambient light sensor; typical brightness: 1000 nits
	FHD (1980 × 1080), antiglare, non-touchscreen display assembly with FHD webcam, infrared sensor, and ambient light sensor; typical brightness: 1000 nits
	FHD (1980 × 1080), antiglare, non-touchscreen display assembly with FHD webcam, infrared sensor, and ambient light sensor; typical brightness: 1000 nits
	FHD (1980 × 1080), antiglare, non-touchscreen display assembly with FHD webcam, and ambient light sensor; typical brightness: 400 nits
	FHD (1980 × 1080), antiglare, non-touchscreen display assembly with FHD webcam, and ambient light sensor; typical brightness: 400 nits
	FHD (1980 × 1080), antiglare, non-touchscreen display assembly with FHD webcam, infrared sensor, and ambient light sensor; typical brightness: 400 nits
	FHD (1980 × 1080), antiglare, non-touchscreen display assembly with FHD webcam, and ambient light sensor; typical brightness: 250 nits M75784-001\FHD (1980×1080), antiglare, non-touchscreen display assembly with FHD webcam, and ambient light sensor; typical brightness: 250 nits
Memory	Four customer-accessible memory module slots supporting up to 128 GB of RAM
	DDR4-3200 dual-channel support
	NOTE: For maximum memory performance, use the memory module part numbers specified in the following table, and insert the modules in the correct order.
	Supports the following configurations:
	<ul style="list-style-type: none"> • 128 GB (32 × 4 @ DDR4-3200 1.2 V SODIMM) • 64 GB (32 × 2 or 16 × 4 @ DDR4-3200 1.2 V SODIMM) • 64 GB (16 × 4 @ DDR4-3200 1.2 V SODIMM ECC) • 32 GB (32 × 1 or 16 × 2 or 8 × 4 @ DDR4-3200 1.2 V SODIMM) • 32 GB (32 × 1 or 16 × 2 or 8 × 4 @ DDR4-3200 1.2 V SODIMM) • 16 GB (16 × 1 or 8 × 2 @ DDR4-3200 1.2 V SODIMM) • 16 GB (16 × 1 or 8 × 2 @ DDR4-3200 1.2 V SODIMM ECC) • 8 GB (8 × 1 @ DDR4-3200 1.2 V SODIMM) • 8 GB (8 × 1 @ DDR4-3200 1.2 V SODIMM ECC)
Primary storage	PCIe, (Non-Volatile Memory Express) NVMe, M.2 2280 solid-state drives
	2 TB, M.2 2280, PCIe, NVMe-3×4, solid state (SS) with triple-layer cell (TLC)
	2 TB, M.2 2280, PCIe, NVMe, self-encrypting (SED) with TLC
	1 TB, M.2 2280, PCIe, NVMe-3×4, SS with TLC
	1 TB, M.2 2280, PCIe NVMe-3×4, SED with TLC
	512 GB, M.2 2280, PCIe-3×4, SS with TLC
	512 GB, M.2 2280, PCIe, NVMe, SED with TLC
	256 GB, M.2 2280, PCIe-3×4, SS with TLC
	256 GB, M.2 2280, PCIe, NVMe, SED with TLC

Table 1-1 Product components and their descriptions (continued)

Category	Description
	Hard drives, serial ATA (SATA), 6.35 cm (2.5 in), 7.0 mm (0.28 in)
	2 TB, 5400 RPM
	1 TB, 7200 RPM
	500 GB, 7200 RPM
	500 GB, 7200 RPM, Federal Information Processing Standard (FIPS), (SED), OPAL2
Optical drive	Blu-ray R/RE DVD±RW SuperMulti DL Drive
Audio and video	Integrated HD Camera: (on select models)
	Infrared (on select models)
	Dual-array, world-facing, digital microphone
RJ-45 (network) jack	Integrated 10/100/1000 NIC
Wireless	Wireless Local Area Network (WLAN)
	Intel Wi-Fi® 6 AX201 ax 2×2 + Bluetooth® 5.0 multiple user, multiple input, multiple output (MU-MIMO) M.2 2230 non-vPro® MIPI + BRI WW with 2 antennas
	Intel Wi-Fi 6 AX201 ax 2×2 + Bluetooth 5.0 MU-MIMO M.2 2230 vPro 160 MHz MIPI + BRI WW with 2 antennas
	Intel XMM™ 7360 LTE-Advanced (Cat 9) Wireless Wide Area Network (WWAN)
Media card reader	Supports microSD™, SDHC™, SDXC™
	Push-push insertion/removal
Near field communication (NFC)	NFC Mirage WNC XRAV-1
Keyboard/pointing devices	Dual-point keyboard with clickpad, backlit, spill-resistant, premium notebook keyboard
Power requirements	Battery
	8 cell, 94 WHr long life, PL Fast Charge
	HP Fast Charge Technology
	Smart AC adapters
	200 watt AC adapter HP Smart (PFC, ultraslim barrel, 4.5 mm, straight-to-right angle)
	150 watt AC adapter HP Smart (PFC, slim barrel, 4.5 mm)
	120 watt AC Adapter HP Smart (PFC, slim barrel, 4.5 mm, right angle)
	Power cord
	C13 premium, 1.0 m, with tag
	C5 premium, 1.0 m, with tag
Security	Integrated fingerprint reader
Operating system	Windows® 10 Home 64
	Windows 10 Home 64 Advanced
	Windows 10 Home 64 Advanced Single Language

Table 1-1 Product components and their descriptions (continued)

Category	Description
	Windows 10 Home 64 High-End Chinese Market PPP
	Windows 10 Home 64 Plus Single Language
	Windows 10 Home 64 Single Language
	Windows 10 Professional 64
	Windows 10 Professional 64 CBB 1909
	Windows 10 Professional 64 CBB 2004
	Windows 10 Professional 64 Chinese Market
	Win 10 Professional 64 for Workstations Plus
	Win 10 Professional 64 for Workstations Plus Chinese Market
	Win 10 Professional 64 High End
	Win 10 Professional 64 High End Chinese Market
	Win 10 Enterprise 64
	Win 10 Enterprise 64 LTSC 1809 (RS5)
	FreeDOS 3.0 Version
	Ubuntu Linux 20.04
Serviceability	End user replaceable parts
	AC adapter
	Memory module
	Service cover
	Battery
	Solid-state drive
	Hard drive
	WLAN module
	WWAN module
	Keyboard
	Solid-state drive

2 Components

Your computer features top-rated components. This chapter provides details about your components, where they are located, and how they work.

Locating hardware

Use these instructions to find out what hardware is installed on your computer.

- ▲ Type `device manager` in the taskbar search box, and then select the **Device Manager** app.

A list displays all the devices installed on your computer.

For information about system hardware components and the system BIOS version number, press `fn+esc` (select products only).

Locating software

Use these instructions to find out what software is installed on your computer:

- ▲ Right-click the **Start** button, and then select **Apps and Features**.

Right

Use the illustration and table to identify the components on the right side of the computer.

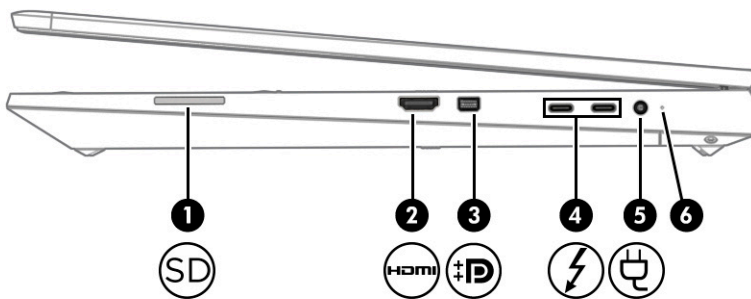





Table 2-1 Right-side components and their descriptions

Component	Description
(1) SD	Memory card reader Reads optional memory cards that store, manage, share, or access information. To insert a card: 1. Hold the card label-side up, with the connectors facing the computer.

Table 2-1 Right-side components and their descriptions (continued)

Component	Description
	<p>2. Insert the card into the memory card reader, and then press in on the card until it is firmly seated.</p> <p>To remove a card:</p> <ul style="list-style-type: none"> ▲ Press in on the card, and then remove it from the memory card reader.
(2)  HDMI port	Connects an optional video or audio device, such as a high-definition television, any compatible digital or audio component, or a high-speed High Definition Multimedia Interface (HDMI) device.
(3)  Dual-Mode DisplayPort™ connector	Connects an optional digital display device, such as a high-performance monitor or projector.
(4)  USB Type-C® Thunderbolt™ ports with HP Sleep and Charge (2)	<p>Connect USB devices, provide high-speed data transfer, and charge small devices, even when the computer is off.</p> <p>– and –</p> <p>Connect display devices that have a USB Type-C connector, providing DisplayPort output.</p> <p>NOTE: Your computer might also support a Thunderbolt docking station.</p> <p>NOTE: Cables, adapters, or both (purchased separately) might be required.</p>
(5)  Power connector	Connects an AC adapter.
(6) Battery light	<p>When AC power is connected:</p> <ul style="list-style-type: none"> • White: The battery charge is greater than 90 percent. • Amber: The battery charge is from 0 to 90 percent. • Off: The battery is not charging. <p>When AC power is disconnected (battery not charging):</p> <ul style="list-style-type: none"> • Blinking amber: The battery has reached a low battery level. When the battery has reached a critical battery level, the battery light begins blinking rapidly. • Off: The battery is not charging.

Left

Use the illustration and table to identify the components on the left side of the computer.



NOTE: Your computer might look slightly different from the following illustration.

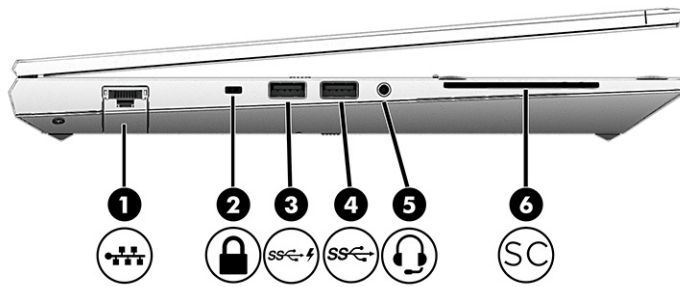







Table 2-2 Left-side components and their descriptions

Component	Description
(1) 	RJ-45 (network) jack/status lights Connects a network cable. <ul style="list-style-type: none"> Green (left): The network is connected. Amber (right): Activity is occurring on the network.
(2) 	Security cable lock slot Attaches an optional security cable lock to the computer. <p>NOTE: The security cable lock is designed to act as a deterrent, but it might not prevent the computer from being mishandled or stolen.</p>
(3) 	USB SuperSpeed port with HP Sleep and Charge Connects a USB device, provides high-speed data transfer, and charges small devices, even when the computer is off.
(4) 	USB SuperSpeed ports Connect USB devices, provide high-speed data transfer, and (for select products) charge small devices when the computer is on or in Sleep mode. <p>NOTE: Depending on your computer model, your computer might have one or two USB SuperSpeed ports.</p>
(5) 	Audio-out (headphone)/Audio-in (microphone) combo jack Connects optional powered stereo speakers, headphones, earbuds, a headset, or a television audio cable. Also connects an optional headset microphone. This jack does not support optional standalone microphones. <p>WARNING! To reduce the risk of personal injury, adjust the volume before putting on headphones, earbuds, or a headset. For additional safety information, see the <i>Regulatory, Safety, and Environmental Notices</i>.</p> <p>To access this guide:</p> <ul style="list-style-type: none"> ▲ Type <code>HP Documentation</code> in the taskbar search box, and then select HP Documentation. <p>NOTE: When a device is connected to the jack, the computer speakers are disabled.</p>
(6) 	Smart card reader Supports optional smart cards.

Display

Use the illustration and table to identify the display components.

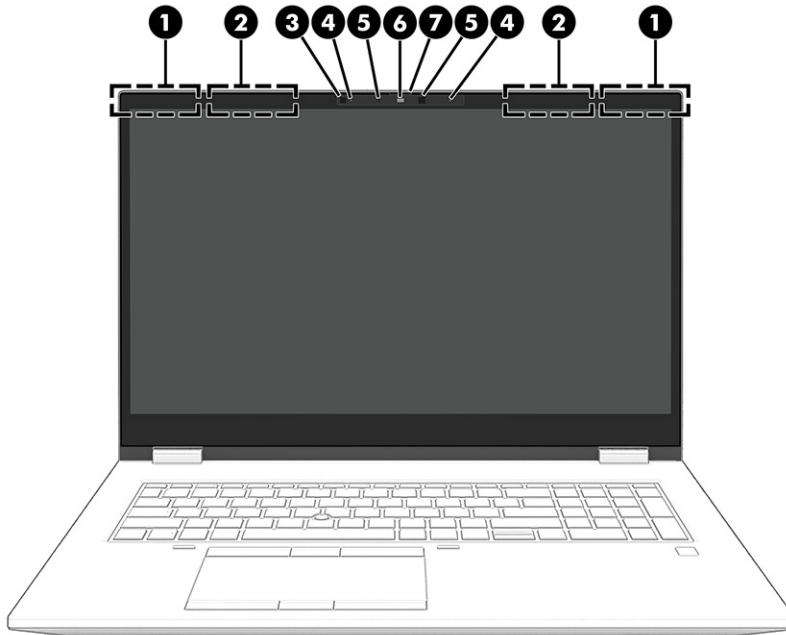

Table 2-3 Display components and their descriptions

Component	Description
(1) WLAN antennas (select products only)*	Send and receive wireless signals to communicate with wireless local area networks (WLANs).
(2) WWAN antennas (select products only)*	Send and receive wireless signals to communicate with wireless wide area networks (WWANs).
(3) Camera light(s) (select products only)	On: One or more cameras are in use.
(4) Ambient light sensor	Adjusts the brightness of the display, depending on the ambient light.
(5) Internal microphones (select products only)	Record sound.
(6) Camera privacy cover (select products only)	By default, the camera lens is uncovered, but you can slide the camera privacy cover to block the camera's view. To use the camera, slide the camera privacy cover in the opposite direction to reveal the lens. NOTE: If you have both front-facing and rear-facing cameras, when one camera lens is revealed and ready to use, the other is concealed.
(7) Camera(s) (select products only)	Allow(s) you to video chat, record video, and record still images. Some cameras also allow a facial recognition logon to Windows, instead of a password logon. NOTE: Camera functions vary depending on the camera hardware and software installed on your product.

*The antennas are not visible from the outside of the computer. For optimal transmission, keep the areas immediately around the antennas free from obstructions.

For wireless regulatory notices, see the section of the *Regulatory, Safety, and Environmental Notices* that applies to your country or region.

Table 2-3 Display components and their descriptions (continued)

Component	Description
To access this guide:	
▲ Type <code>HP Documentation</code> in the taskbar search box, and then select HP Documentation .	

Keyboard area

Keyboards can vary by language.

Touchpad

The touchpad settings and components are described here.

Touchpad settings

You learn how to adjust the touchpad settings and components here.

Adjusting touchpad settings

Use these steps to adjust touchpad settings and gestures.

1. Type `touchpad settings` in the taskbar search box, and then press `enter`.
2. Choose a setting.

Turning on the touchpad

Follow these steps to turn on the touchpad.

1. Type `touchpad settings` in the taskbar search box, and then press `enter`.
2. Using an external mouse, click the **Touchpad** button.

If you are not using an external mouse, press the `Tab` key repeatedly until the pointer rests on the **touchpad** button. Then press the `spacebar` to select the button.

Touchpad components

Use the illustration and table to identify the touchpad components.

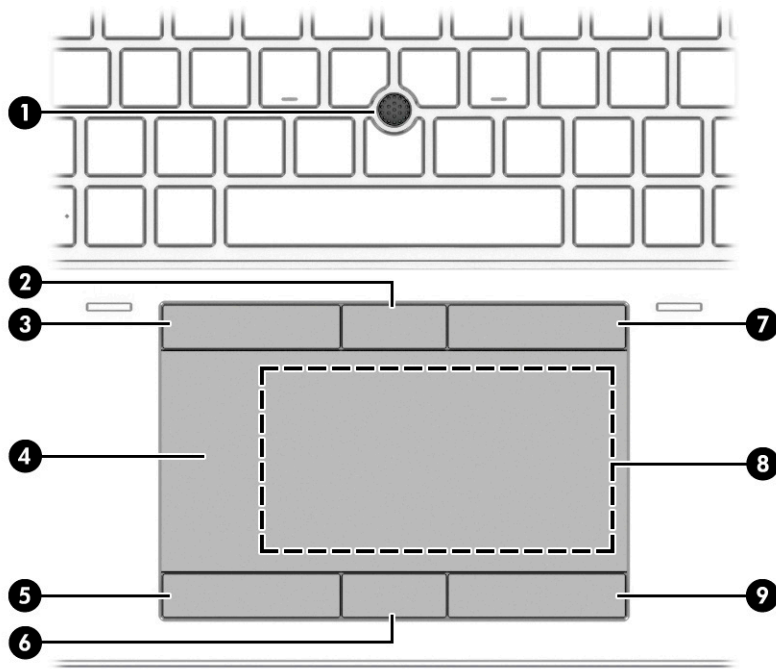

Table 2-4 Touchpad components and their descriptions

Component	Description
(1) Pointing stick	Moves the pointer on the screen.
(2) Center pointing stick button	Functions like the center button on an external mouse.
(3) Left pointstick button	Functions like the left button on an external mouse.
(4) Touchpad zone	Reads your finger gestures to move the pointer or activate items on the screen.
(5) Left touchpad button	Functions like the left button on an external mouse.
(6) Center touchpad button	Functions like the center button on an external mouse.
(7) Right pointstick button	Functions like the right button on an external mouse.
(8) Near Field Communications (NFC) tapping area and antenna (select products only)*	Allows you to wirelessly share information when you tap it with an NFC-enabled device.
(9) Right touchpad button	Functions like the right button on an external mouse.

*The antennas are not visible from the outside of the computer. For optimal transmission, keep the areas immediately around the antennas free from obstructions.

For wireless regulatory notices, see the section of the *Regulatory, Safety, and Environmental Notices* that applies to your country or region.

To access this guide:

▲ Type `HP Documentation` in the taskbar search box, and then select **HP Documentation**.

Lights

Use the illustration and table to identify the lights on the computer.

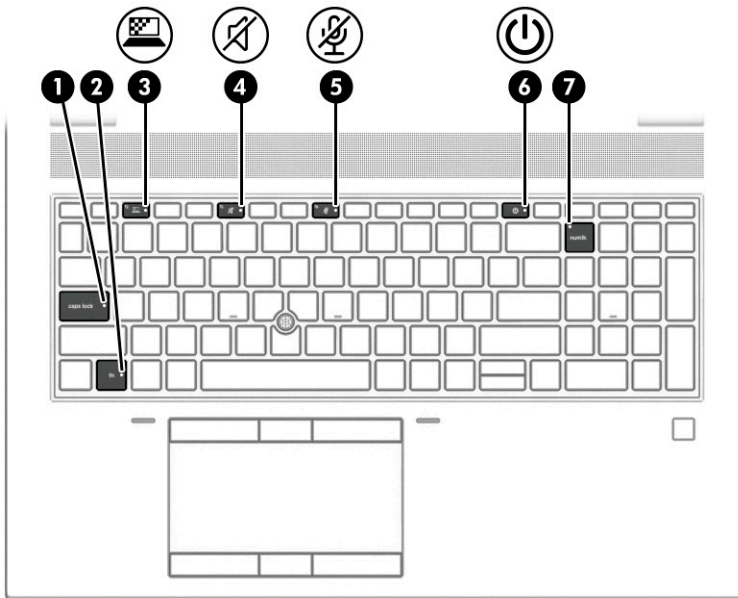





Table 2-5 Lights and their descriptions

Component	Description
(1) Caps lock light	On: Caps lock is on, which switches the key input to all capital letters.
(2) Fn lock light	On: The fn key is locked. For more information, see Hot keys on page 16 .
(3)  Privacy key light (select products only)	On: Privacy screen is on, which helps prevent side-angle viewing.
(4)  Mute light	<ul style="list-style-type: none"> On: Computer sound is off. Off: Computer sound is on.
(5)  Microphone mute light	<ul style="list-style-type: none"> On: Microphone is off. Off: Microphone is on.
(6)  Power light	<ul style="list-style-type: none"> On: The computer is on. Blinking (select products only): The computer is in the Sleep state, a power-saving state. The computer shuts off power to the display and other unnecessary components. Off: Depending on your computer model, the computer is off, in Hibernation, or in Sleep. Hibernation is the power-saving state that uses the least amount of power.
(7) Num lk light	On: Num lk is on.

Button, speakers, and fingerprint reader

Use the illustration and table to identify the button, speakers, and fingerprint reader on the computer.

 **IMPORTANT:** To verify that your computer supports fingerprint reader sign-in, type `Sign-in options` in the taskbar search box and follow the on-screen instructions. If **Fingerprint reader** is not listed as an option, then your notebook does not include a fingerprint reader.

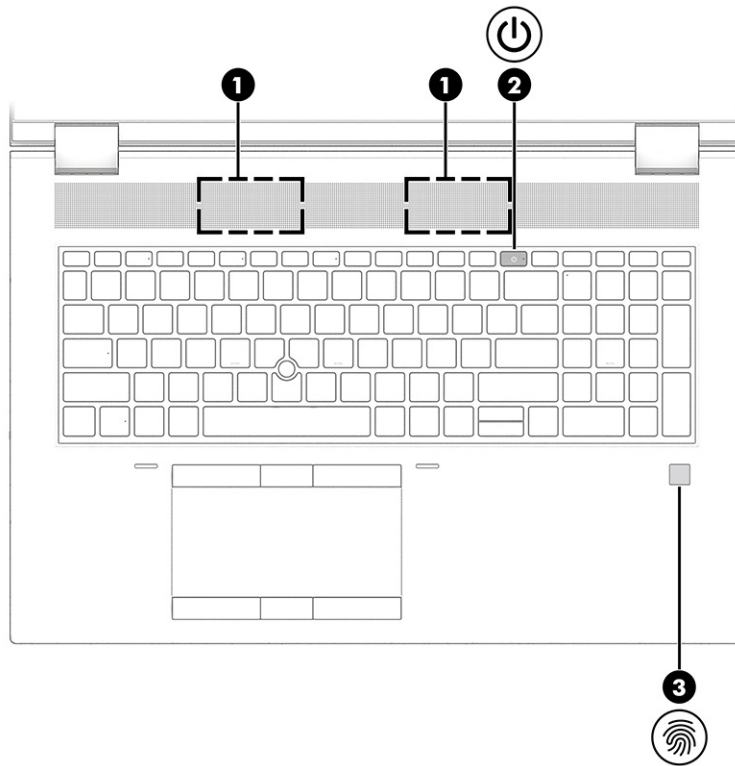

Table 2-6 Button, speakers, and fingerprint reader and their descriptions



Component	Description
(1) Speakers	Produce sound.
(2)  Power button	<ul style="list-style-type: none"> • When the computer is off, press the button briefly to turn on the computer. • When the computer is on, press the button briefly to initiate Sleep. • When the computer is in the Sleep state, press the button briefly to exit Sleep (select products only). • When the computer is in Hibernation, press the button briefly to exit Hibernation. <p>IMPORTANT: Pressing and holding down the power button results in the loss of unsaved information.</p> <p>If the computer has stopped responding and shutdown procedures are ineffective, press and hold the power button for at least 4 seconds to turn off the computer.</p> <p>To learn more about your power settings, see your power options.</p> <p>▲ Right-click the Power meter icon  and then select Power Options.</p>

Table 2-6 Button, speakers, and fingerprint reader and their descriptions (continued)

Component	Description
(3) Fingerprint reader (select products only)	<p>Allows a fingerprint logon to Windows, instead of a password logon.</p> <p>▲ Touch your finger to the fingerprint reader.</p> <p>IMPORTANT: To prevent fingerprint logon issues, be sure when you register your fingerprint that all sides of your finger are registered by the fingerprint reader.</p>

Special keys

Use the illustration and table to identify the special keys.

 **NOTE:** Your computer might look slightly different from the following illustration.

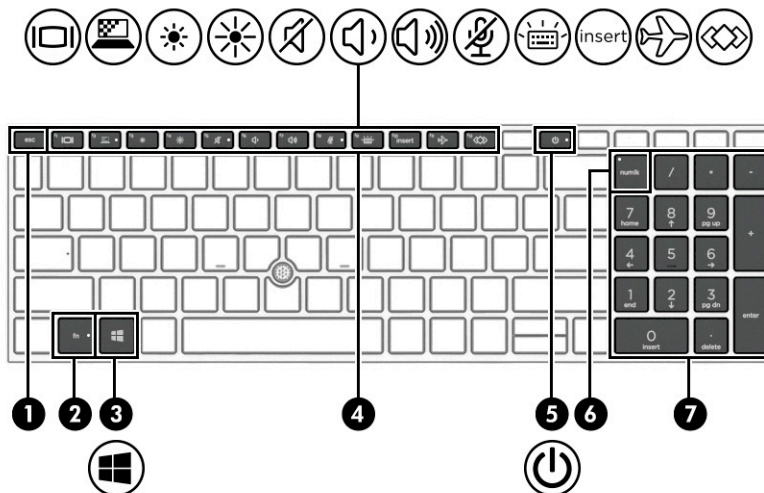

Table 2-7 Special keys and their descriptions



Component	Description
(1) <code>esc</code> key	Displays system information when pressed in combination with the <code>fn</code> key.
(2) <code>fn</code> key	<p>Executes frequently used system functions when pressed in combination with another key. Such key combinations are called <i>hot keys</i>.</p> <p>See Hot keys on page 16.</p>
(3)  Windows key	<p>Opens the Start menu.</p> <p>NOTE: Pressing the Windows key again will close the Start menu.</p>
(4) Action keys	<p>Execute frequently used system functions.</p> <p>See Action keys on page 14.</p>

Table 2-7 Special keys and their descriptions (continued)

Component	Description
(5)  Power button	<ul style="list-style-type: none"> • When the computer is off, press the button briefly to turn on the computer. • When the computer is on, press the button briefly to initiate Sleep. • When the computer is in the Sleep state, press the button briefly to exit Sleep (select products only). • When the computer is in Hibernation, press the button briefly to exit Hibernation. <p>IMPORTANT: Pressing and holding down the power button results in the loss of unsaved information.</p> <p>If the computer has stopped responding and shutdown procedures are ineffective, press and hold the power button for at least 4 seconds to turn off the computer.</p> <p>To learn more about your power settings, see your power options.</p> <p>▲ Right-click the Power meter icon  and then select Power Options.</p>
(6) <code>num lk</code> key	Turns the embedded numeric keypad on and off.
(7) Integrated numeric keypad	A separate keypad to the right of the alphabet keyboard. When <code>num lk</code> is pressed, the integrated keypad can be used like an external numeric keypad. <p>NOTE: If the keypad function is active when the computer is turned off, that function is reinstated when the computer is turned back on.</p>

Action keys

Action keys perform specific functions and vary by computer. To determine which keys are on your computer, look at the icons on your keyboard and match them to the descriptions in this table.

- ▲ To use an action key, press and hold the key.



NOTE: On some products, you must press the `fn` key in combination with the action key.

Table 2-8 Action keys and their descriptions

Icon	Description
	Switches the screen image among display devices connected to the system. For example, if a monitor is connected to the computer, repeatedly pressing the key alternates the screen image from computer display to monitor display to simultaneous display on both the computer and the monitor.

Table 2-8 Action keys and their descriptions (continued)









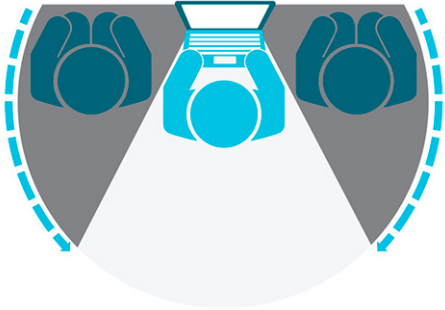

Icon	Description
	<p>On select products, helps prevent side-angle viewing from onlookers. If needed, decrease or increase brightness for well-lit or darker environments. Press the key again to turn off the privacy screen.</p> <p>NOTE: To quickly turn on the highest privacy setting, press fn+p.</p>
	
	Decreases the screen brightness incrementally as long as you hold down the key.
	Increases the screen brightness incrementally as long as you hold down the key.
	Mutes or restores speaker sound.
	Decreases speaker volume incrementally while you hold down the key.
	Increases speaker volume incrementally while you hold down the key.
	Mutes the microphone.
	<p>Turns the keyboard backlight off or on. On select products, you can adjust the brightness of the keyboard backlight. Press the key repeatedly to adjust the brightness from high (when you first start up the computer), to low, to off. After you adjust the keyboard backlight setting, the backlight will revert to your previous setting each time you turn on the computer. The keyboard backlight will turn off after 30 seconds of inactivity. To turn the keyboard backlight back on, press any key or tap the touchpad (select products only). To conserve battery power, turn off this feature.</p>
insert	Turns the insert function on or off.
	<p>Turns the wireless feature on or off.</p> <p>NOTE: A wireless network must be set up before a wireless connection is possible.</p>
	<p>Executes frequently used tasks. Some tasks might not be available on all products.</p> <ul style="list-style-type: none"> • Opens an application, file, or website • Enter frequently used text into a permanent clipboard • Ability to change system profiles

Table 2-8 Action keys and their descriptions (continued)

Icon	Description
	<ul style="list-style-type: none">• Ability to change system properties• Execute user-defined key sequences



NOTE: The action key feature is enabled at the factory. You can disable this feature by pressing and holding the **fn** key and the left **shift** key. The **fn** lock light will turn on. After you have disabled the action key feature, you can still perform each function by pressing the **fn** key in combination with the appropriate action key.

Hot keys

A hot key is the combination of the **fn** key and another key. Use the table to identify the hot keys.

To use a hot key:

- ▲ Press the **fn** key, and then press one of the keys listed in the following table.

Table 2-9 Hot keys and their descriptions

Key	Description
C	Turns on scroll lock.
R	Breaks the operation.
S	Sends a programming query.
W	Pauses the operation.

Bottom

Use the illustration and table to identify the bottom components.

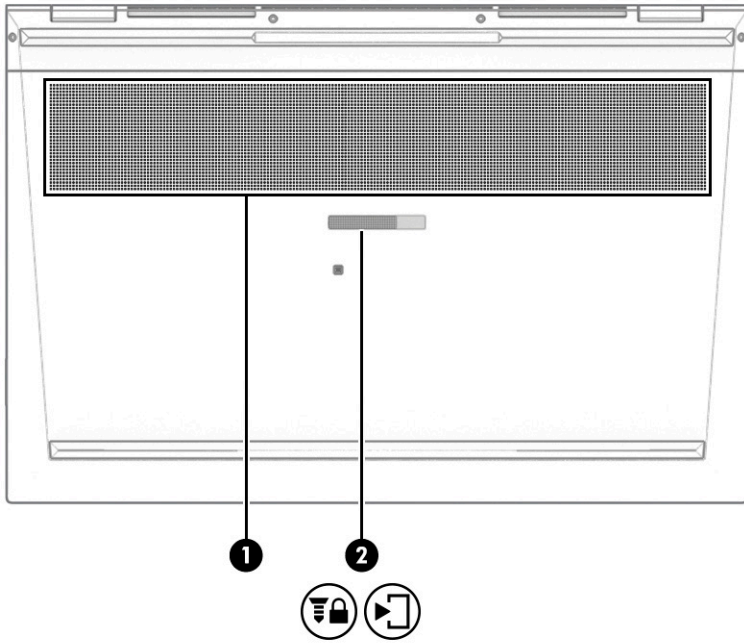



Table 2-10 Bottom components and their descriptions

Component	Description
(1) Vent	Enables airflow to cool internal components. NOTE: The computer fan starts up automatically to cool internal components and prevent overheating. It is normal for the internal fan to cycle on and off during routine operation.
(2)  Service door release latch and security screw 	Releases the service door after you remove the security screw.

Top cover

Use the illustration and table to identify the top cover components.

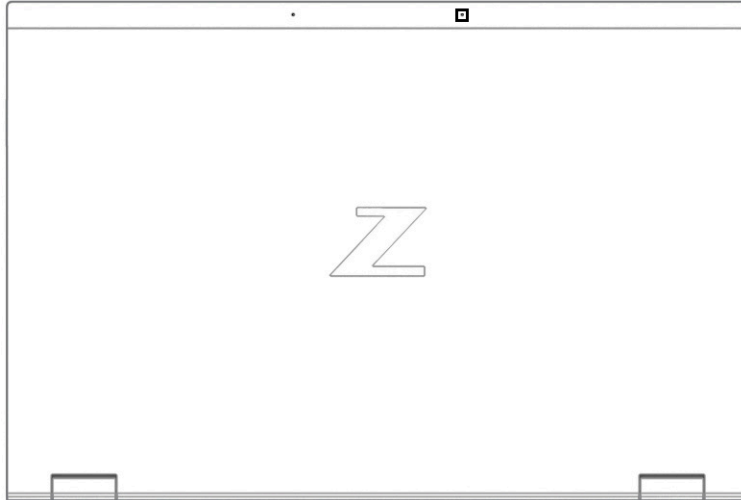

Table 2-11 Top cover component and its description

Component	Description
Internal microphone (select products only)	Records sound.

Rear

Use the illustration and table to identify the rear components.



Table 2-12 Rear component and its description

Component	Description
Vents	Enable airflow to cool internal components. NOTE: The computer fan starts up automatically to cool internal components and prevent overheating. It is normal for the internal fan to cycle on and off during routine operation.

HP TamperLock

Use this section to understand HP TamperLock.

This computer features a security application called HP TamperLock, which alerts customers if the service cover has been removed. The application is preset to **disabled**. The customer must enable this application in the BIOS, where it is called **Smart Cover**.

If the customer enables HP TamperLock and sends in the computer for repair, the repair center will not be able to repair it. The Call Center will receive the following message:

This product is equipped with **Smart Cover** (Tamper Detection password feature.) **Ensure that the customer has disabled the Tamper Detection password in the BIOS before sending it in for repair.** If this is not done, it will delay the repair and potentially result in a billable event. If the computer does not boot or the customer is not able to check in and disable the feature, continue with normal procedures to replace the system board.

Labels

The labels affixed to the computer provide information you might need when you troubleshoot system problems or travel internationally with the computer. Labels might be in paper form or imprinted on the product.

 **IMPORTANT:** Check the following locations for the labels described in this section: the bottom of the computer, inside the battery bay, under the service door, on the back of the display, or on the bottom of a tablet kickstand.

- Service label—Provides important information to identify your computer. When contacting support, you might be asked for the serial number, the product number, or the model number. Locate this information before you contact support.

Your service label will resemble one of these examples. Refer to the illustration that most closely matches the service label on your computer.

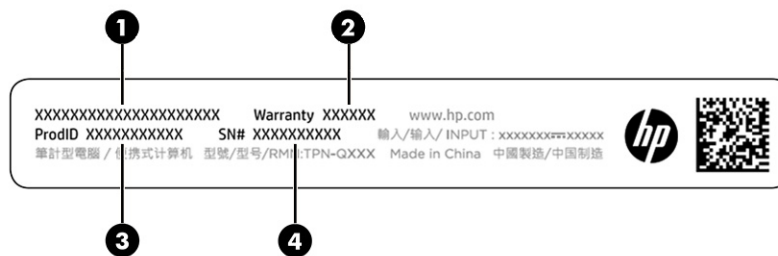

Table 2-13 Service label components

Component	
(1)	HP product name
(2)	Warranty period
(3)	Product ID
(4)	Serial number

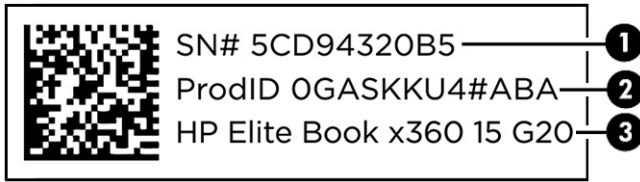

Table 2-14 Service label components

Component	
(1)	Serial number
(2)	Product ID
(3)	HP product name

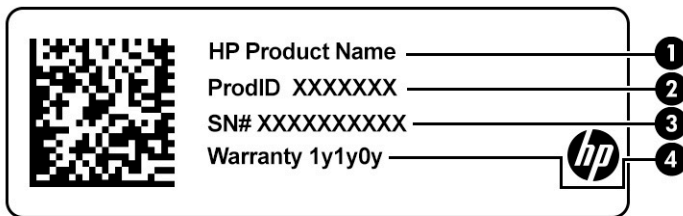

Table 2-15 Service label components

Component	
(1)	HP product name
(2)	Product ID
(3)	Serial number
(4)	Warranty period

- Regulatory label(s)—Provide regulatory information about the computer.
- Wireless certification label(s)—Provide information about optional wireless devices and the approval markings for the countries or regions in which the devices have been approved for use.

Using a SIM card (select products only)

Use these instructions to insert a SIM card.



IMPORTANT: You can damage the SIM card if you insert the wrong size card or insert it or the SIM card tray in the wrong direction. The card might also become stuck in the slot. Do not use SIM card adapters. To prevent damage to the SIM card or connectors, use minimal force when inserting or removing a SIM card.

Determining the correct SIM card size for your computer

Before purchasing a SIM card, follow these instructions to determine the correct SIM card size for your computer.



1. Go to <http://www.hp.com/support>, and then search for your computer by product name or number.
2. Select **Product Information**.
3. Refer to the listed options to determine which card to purchase.

Inserting a SIM card in the service bay

To insert a SIM card, follow these steps.

1. Turn off the computer by using the Shut down command.
2. Close the display.
3. Disconnect all external devices connected to the computer.
4. Unplug the power cord from the AC outlet.
5. Turn the computer upside down on a flat surface, with the service door toward you.
6. Remove the service door, and then remove the battery.
7. Slide the SIM tray cover to the right (1), open the cover (2), and then insert the SIM card into the SIM tray (3).

 **NOTE:** The SIM card in your computer might look slightly different from the illustration in this section.

 **NOTE:** To properly insert the SIM card, match the angled edge of the card with the triangle  on the tray.

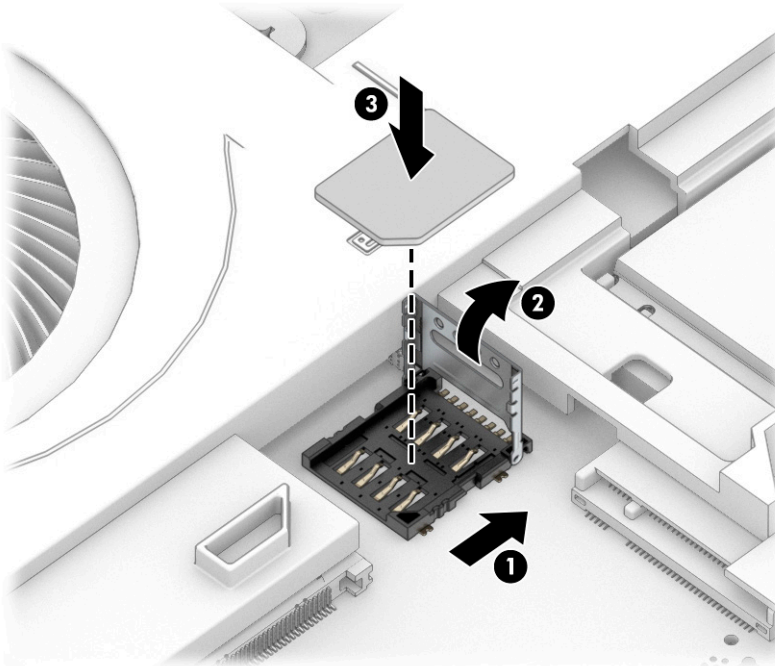

8. Close the SIM tray cover (1), and slide it to the left (2).

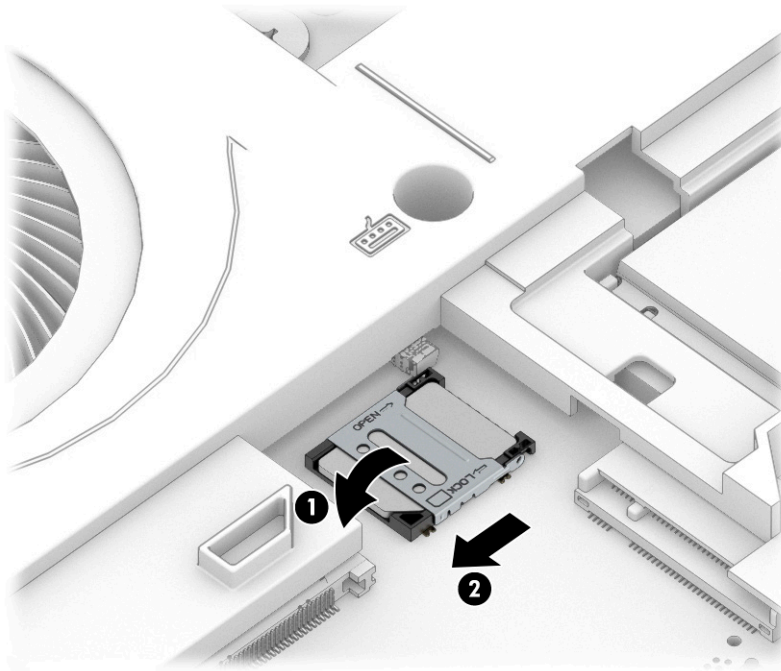



To remove the SIM card, reverse the procedures as described previously.

3 Illustrated parts catalog

Use this table to determine the spare parts that are available for the computer.

Computer major components

To identify the computer major components, use this illustration and table.

-
-  **NOTE:** HP continually improves and changes product parts. For complete and current information about supported parts for your computer, go to <http://partsurfer.hp.com>, select your country or region, and then follow the on-screen instructions.
 -  **NOTE:** Details about your computer, including model, serial number, product key, and length of warranty, are on the service tag at the bottom of your computer.
-

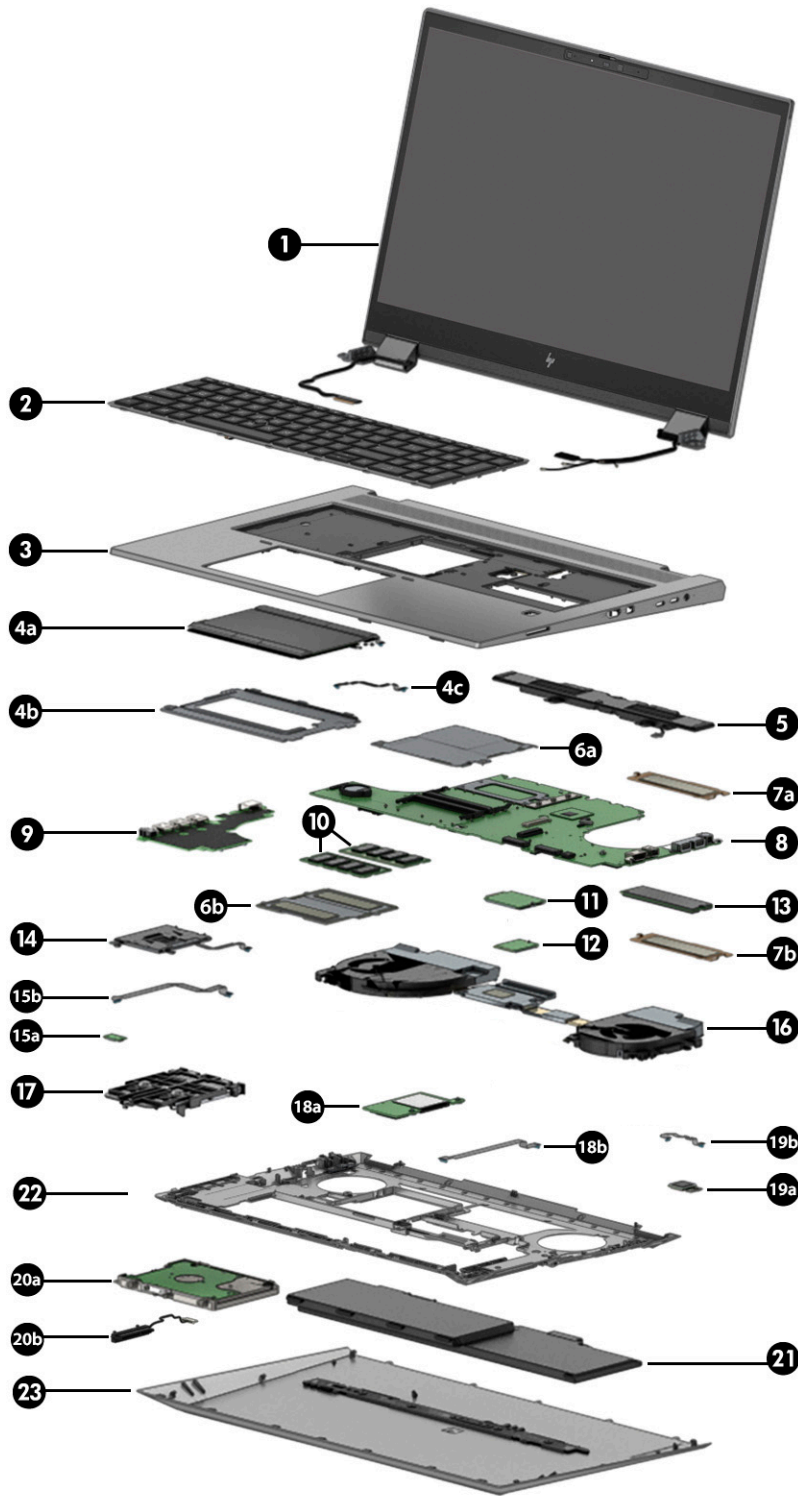

Table 3-1 Computer major component descriptions and part numbers

Item	Component	Spare part number
(1)	39.6 cm (15.6 in) display assembly:	

Table 3-1 Computer major component descriptions and part numbers (continued)

Item	Component	Spare part number
	Ultra high definition (UHD) (3840 × 1980), touchscreen display assembly with Dream Vision, infrared sensor; typical brightness: 600 nits	M75793-001
	UHD (3840 × 1980), touchscreen HDC display assembly; typical brightness: 600 nits, antiglare, Dream Vision, assembly with webcam	M75792-001
	UHD (3840 × 1980), touchscreen display assembly; UWVA, typical brightness: 600 nits, antiglare, Dream Vision, assembly with webcam	M82622-001
	UHD (3840 × 1980), touchscreen HDC display assembly; UWVA, Brightview, typical brightness: 400/600 nits, antiglare, Dream Vision, assembly with webcam	M75790-001
	UHD (3840 × 1980), touchscreen display assembly; UWVA, IR, typical brightness: 400/600 nits, antiglare, Dream Vision, assembly with webcam	M75791-001
	Full high definition (FHD) (1980 × 1080), antiglare, non-touchscreen display assembly with FHD webcam, and ambient light sensor; typical brightness: 1000 nits	M75787-001
	FHD (1980 × 1080), antiglare, non-touchscreen HDC display assembly with FHD webcam, and ambient light sensor; typical brightness: 1000 nits	M75788-001
	FHD (1980 × 1080), antiglare, non-touchscreen display assembly with FHD webcam, infrared sensor, and ambient light sensor; typical brightness: 250 nits	M75786-001
	FHD (1980 × 1080), antiglare, non-touchscreen display assembly with FHD webcam, infrared sensor, and ambient light sensor; typical brightness: 1000 nits	M75789-001
	FHD (1980 × 1080), antiglare, non-touchscreen display assembly with FHD webcam, and ambient light sensor; typical brightness: 400 nits	M75781-001
	FHD (1980 × 1080), antiglare, non-touchscreen HDC display assembly with FHD webcam, and ambient light sensor; typical brightness: 400 nits	M75782-001
	FHD (1980 × 1080), antiglare, non-touchscreen display assembly with FHD webcam, infrared sensor, and ambient light sensor; typical brightness: 400 nits	M75783-001
	FHD (1980 × 1080), antiglare, non-touchscreen HDC display assembly with FHD webcam, and ambient light sensor; typical brightness: 250 nits	M75785-001
	FHD (1980 × 1080), antiglare, non-touchscreen display assembly with FHD webcam, and ambient light sensor; typical brightness: 250 nits	M75784-001
(2)	Keyboard NOTE: For a detailed list of country codes, see Keyboard on page 55 .	
(3)	Top Cover	M17068-001
(4a)	Touchpad NOTE: The touchpad spare part kit does not include the touchpad bracket or touchpad cable. The touchpad bracket is not available as a spare part. The touchpad cable is available in the Cable Kit, spare part number M17062-001.	
	For use on computer models equipped with NFC capability (includes NFC antenna and double-sided adhesive)	M75772-001
	For use on computer models not equipped with NFC capability	M17066-001
(4b)	Touchpad bracket: The touchpad bracket is not available as a spare part.	
(4c)	Touchpad cable: The touchpad cable is available in the Cable Kit, spare part number M17062-001.	
(5)	Speakers (includes three rubber isolators)	M17067-001
	Memory module compartment covers (include thermal material, included in the Bracket Kit, spare part number M75763-001)	
(6a)	Memory module compartment cover under keyboard	

Table 3-1 Computer major component descriptions and part numbers (continued)

Item	Component	Spare part number
(6b)	Memory module compartment cover under service cover	
	Solid-state drive compartment covers (include thermal material):	
(7a)	Solid-state drive cover under keyboard (included in the Bracket Kit, spare part number M75763-001)	
(7b)	Solid-state drive cover under service cover (included in the Solid-state Drive Hardware Kit, spare part number M17040-001)	
(8)	System board (includes integrated processor)	
	NOTE: All system board spare part kits include replacement thermal material.	
	All system boards use the following part numbers:	
	xxxxxx-001: Non-Windows operating systems	
	xxxxxx-601: Windows operating system	
	Equipped with an Intel Core W-11955M processor and a non-Windows 10 operating system for use only on computers not equipped with WWAN capability	M87581-001
	Equipped with an Intel Core W-11955M processor and the Windows 10 operating system for use only on computers not equipped with WWAN capability	M87581-601
	Equipped with an Intel Core W-11955M processor and a non-Windows 10 operating system for use only on computers equipped with WWAN capability	M87580-001
	Equipped with an Intel Core W-11955M processor and the Windows 10 operating system for use only on computers equipped with WWAN capability	M87580-601
	Equipped with an i5-11500H processor and a non-Windows 10 operating system for use only on computers equipped with WWAN capability	M76123-001
	Equipped with an Intel Core i5-11500H processor and the Windows 10 operating system for use only on computers equipped with WWAN capability	M76123-601
	Equipped with an Intel Core i5-11500H processor and a non-Windows 10 operating system for use only on computers not equipped with WWAN capability	M87576-001
	Equipped with an Intel Core i5-11500H processor and the Windows 10 operating system for use only on computers not equipped with WWAN capability	M87576-601
	Equipped with an Intel Core i7-11800H processor and a non-Windows 10 operating system for use only on computers equipped with WWAN capability	M75777-001
	Equipped with an Intel Core i7-11800H processor and the Windows 10 operating system for use only on computers equipped with WWAN capability	M75777-601
	Equipped with an Intel Core i7-11850H processor and a non-Windows 10 operating system for use only on computers equipped with WWAN capability	M75778-001
	Equipped with an Intel Core i7-11850H processor and the Windows 10 operating system for use only on computers equipped with WWAN capability	M75778-601
	Equipped with an Intel Core i7-11800H processor and a non-Windows 10 operating system for use only on computers not equipped with WWAN capability	M87577-001
	Equipped with an Intel Core i7-11800H processor and a Windows 10 operating system for use only on computers not equipped with WWAN capability	M87577-601
	Equipped with an Intel Core i7-11850H processor and a non-Windows 10 operating system for use only on computers not equipped with WWAN capability	M87578-001
	Equipped with an Intel Core i7-11850H processor and the Windows 10 operating system for use only on computers not equipped with WWAN capability	M87578-601

Table 3-1 Computer major component descriptions and part numbers (continued)

Item	Component	Spare part number
	Equipped with an Intel Core i9-11900H processor and a non-Windows 10 operating system for use only on computers not equipped with WWAN capability	M87579-001
	Equipped with an Intel Core i9-11900H processor and the Windows 10 operating system for use only on computers not equipped with WWAN capability	M87579-601
	Equipped with an Intel Core i9-11950H processor and a non-Windows operating system for use only on computers not equipped with WWAN capability	M87580-001
	Equipped with an Intel Core i9-11950H processor and the Windows 10 operating system for use only on computers not equipped with WWAN capability	M87580-601
	Equipped with an Intel Core i9-11950H processor and a non-Windows operating system for use only on computers equipped with WWAN capability	M75779-001
	Equipped with an Intel Core i9-11950H processor and the Windows 10 operating system for use only on computers equipped with WWAN capability	M75779-601
	Equipped with an Intel Core i9-11900H processor and a non-Windows operating system for use only on computers equipped with WWAN capability	M76124-001
	Equipped with an Intel Core i9-11900H processor and the Windows 10 operating system for use only on computers equipped with WWAN capability	M76124-601
	Graphics card (not illustrated):	
	AMD W 6600M graphics card with 8 GB integrated memory	M76116-001
	AMD Thermal Pad Kit	M83913-001
	NVIDIA RTX 3000 graphics card with 6 GB integrated memo	M76119-001
	NVIDIA RTX 4000 graphics card with 8 GB integrated memory	M76120-001
	NVIDIA RTX 5000 graphics card with 16 GB integrated memory	M76121-001
	NVIDIA T1200 graphics card with 4 GB integrated memory	M76117-001
	NVIDIA A2000 graphics card with 2 GB integrated memory	M76118-001
	NVIDIA Thermal Pad Kit	M83915-001
(9)	I/O board (includes audio jack, 3 USB ports, and RJ45 network jack)	
	For use only on vPro computer models	M75767-001
	For use only on non-vPro computer models	M75768-001
(10)	Memory module:	
	32 GB (3200 MHz, 1.2 V, DDR4)	M09713-001
	16 GB (3200 MHz, 1.2 V, DDR4)	L67710-001
	8 GB (3200 MHz, 1.2 V, DDR4)	L46598-001
(11)	WWAN module (HP Intel XMM 7360 LTE M.2 with GPS)	L70670-001
	Shield Kit (not illustrated, includes WLAN module and WWAN module shields)	M23349-001
	Rubber Kit (not illustrated, includes WWAN module rubber)	M17076-001
(12)	WLAN module:	
	Intel Wi-Fi 6 AX201 ax 2x2 + Bluetooth 5.0 MU-MIMO M.2 2121 non-vPro MIPI+BRI WW with 2 antennas	L92724-001

Table 3-1 Computer major component descriptions and part numbers (continued)

Item	Component	Spare part number
	Intel Wi-Fi 6 AX201 ax 2×2 + Bluetooth 5.0 MU-MIMO M.2 1216 vPro 160MHz MIPI + BRI WW with 2 antennas	L92722-001
	Shield Kit (includes WLAN module and WWAN module shields)	M23349-001
	Rubber Kit (includes WLAN module rubber)	M17076-001
(13)	Solid-state drive	
	2 TB, M.2 2280, PCIe, NVMe-3×4, SS with TLC	L85358-001
	2 TB, M.2 2280, PCIe, NVMe, SED with TLC	L91394-001
	1 TB, M.2 2280, PCIe, NVMe-3×4, SS with TLC	L85348-001
	1 TB, M.2 2280, PCIe NVMe-3×4, SED with TLC	L66613-001
	512 GB, M.2 2280, PCIe-3×4, SS with TLC	L85360-001
	512 GB, M.2 2280, PCIe, NVMe, SED with TLC	L85368-002
	256 GB, M.2 2280, PCIe-3×4, SS with TLC	L85350-001
	256 GB, M.2 2280, PCIe, NVMe, SED with TLC	M07245-001
	Solid-state Drive Thermal Pad Kit (not illustrated, includes replacement thermal material)	M29534-001
	Solid-state Drive Hardware Kit (not illustrated, includes copper plate and support plate)	M17040-001
(14)	Card reader board (includes cable)	M17063-001
(15a)	NFC module (The NFC module spare part kit does not include the NFC module cable. The NFC module cable is available in the Cable Kit, spare part number M17062-001.)	M17065-001
(15b)	NFC module cable: The NFC module cable is available in the Cable Kit, spare part number M17062-001.	
(16)	Fan/heat sink assembly (3) (includes replacement thermal material):	
	For use on computer models equipped with an AMD graphics card	M75776-001
	For use on computer models equipped with a graphics subsystem with discrete memory	M82623-001
	For use on computer models equipped with a graphics subsystem with a vapor chamber	M75775-001
	For use on computer models equipped with a graphics subsystem with unified memory architecture (UMA) memory	M75773-001
(17)	Solid-state drive carriage	M17040-001
(18a)	SD card board (The SD card board spare part kit does not include the SD card board cable. The SD card board cable is available in the Cable Kit, spare part number M17062-001.)	M75769-001
(18b)	SD card board cable: The SD card board cable is available in the Cable Kit, spare part number M17062-001.	
(19a)	Fingerprint reader module (The fingerprint reader module spare part kit does not include the fingerprint reader module cable. The fingerprint reader module cable is available in the Cable Kit, spare part number M17062-001.)	M75762-001
(19b)	Fingerprint reader module cable: The fingerprint reader module cable is available in the Cable Kit, spare part number M17062-001.	
(20a)	Hard drive (The hard drive spare part kit does not include the hard drive cable. The hard drive cable is available in the Cable Kit, spare part number M17062-001.)	

Table 3-1 Computer major component descriptions and part numbers (continued)

Item	Component	Spare part number
	2 TB, 5400 RPM, 7.0 mm hard drive	912487-850
	2 TB, 5400 RPM, 7.0 mm hard drive	L89711-001
	1 TB, 7200 RPM, 7.0 mm hard drive	L89707-001
	500 GB, 7200 RPM, 7.0 mm Federal Information Processing Standards (FIPS) hard drive	L33356-001
	500 GB, 7200 RPM, 7.0 mm hard drive	703267-001
	500 GB, 7200 RPM, 7.0 mm, FIPS hard drive	820572-001
(20b)	Hard drive cable: The hard drive cable is available in the Cable Kit, spare part number M17062-001.	
(21)	Battery (8 cell, 94 Whr)	L86212-001
(22)	Bottom case	M82073-001
(23)	Service cover	M17068-001
	Beam connector (includes plastic installation tool and replacement thermal material) (not pictured)	M86387-001

Mass storage devices

To identify the mass storage devices, use this illustration and table.

Table 3-2 Mass storage device descriptions and part numbers

Item	Component	Spare part number
	Hard drive	
	2 TB, 5400 RPM, 7.0 mm hard drive	912487-850
	2 TB, 5400 RPM, 7.0 mm hard drive	L89711-001
	1 TB, 7200 RPM, 7.0 mm hard drive	L89707-001
	500 GB, 7200 RPM, 7.0 mm FIPS hard drive	L33356-001
	500 GB, 7200 RPM, 7.0 mm hard drive	703267-001
	500 GB, 7200 RPM, 7.0 mm, FIPS hard drive	820572-001
	Hard Drive Hardware Kit (includes hard drive bracket)	M17041-001
	Hard drive cable: The hard drive cable is available in the Cable Kit, spare part number M17062-001.	
	Solid-state drive	
	2 TB, M.2 2280, PCIe, NVMe-3x4, SS with TLC	L85358-001
	2 TB, M.2 2280, PCIe, NVMe, SED with TLC	L91394-001
	1 TB, M.2 2280, PCIe, NVMe-3x4, SS with TLC	L85348-001
	1 TB, M.2 2280, PCIe NVMe-3x4, SED with TLC	L66613-001
	512 GB, M.2 2280, PCIe-3x4, SS with TLC	L85360-001

Table 3-2 Mass storage device descriptions and part numbers (continued)

Item	Component	Spare part number
	512 GB, M.2 2280, PCIe, NVMe, SED with TLC	L85368-002
	256 GB, M.2 2280, PCIe-3x4, SS with TLC	L85350-001
	256 GB, M.2 2280, PCIe, NVMe, SED with TLC	M07245-001
	Solid-state Drive Hardware Kit (includes solid-state drive carrier)	M17040-001

Cables

To identify the cables, use this illustration and table.

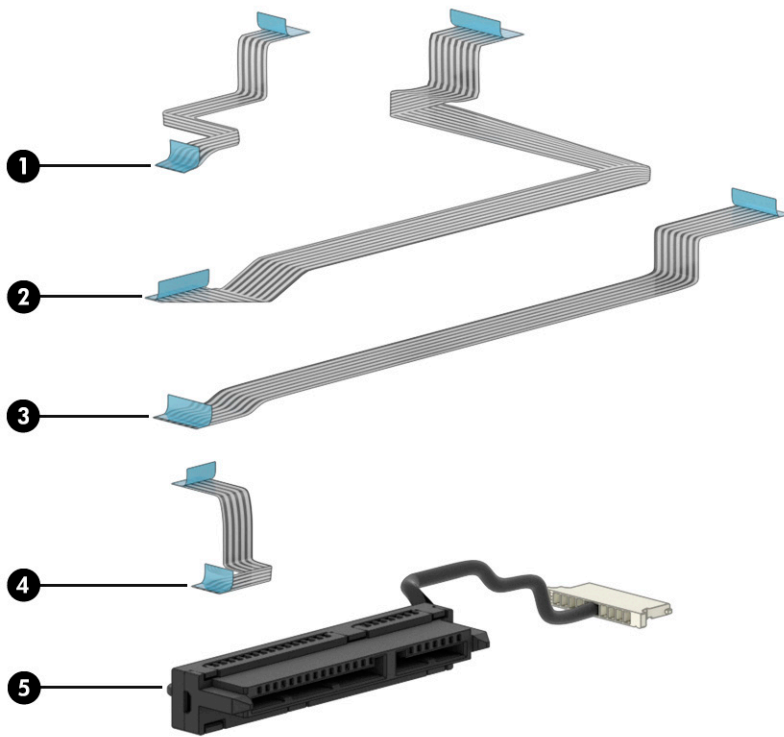

Table 3-3 Cable descriptions and part numbers

Item	Component	Spare part number
The following cables are available in the Cable Kit, spare part number M17062-001.		
(1)	Touchpad cable	
(2)	NFC module cable	
(3)	SD card board cable	
(4)	Fingerprint reader module cable	
(5)	Hard drive cable	

Miscellaneous parts

To identify the miscellaneous parts, use this table.

Table 3-4 Miscellaneous part descriptions and part numbers

Component	Spare part number
AC adapters	
200 W AC Smart adapter (PFC, RC, 3 pin, 4.5 mm)	L74881-001
150 W HP Smart adapter (PFC, slim, 4.5 mm)	L32661-001
120 W HP Smart adapter (PFC, RC, slim, 4.5 mm)	L41856-001
Adapters:	
USB-C® to USB 3.0 Adapter	814618-001
Adapter Conn HDMI to DVI-D	691227-001
HDMI to VGA Adapter	701943-001
HDMI to DVI Adapter	749038-001
USB-C to HDMI Adapter	831752-001
USB-C to DisplayPort Adapter	831753-001
Mouse/Trackball	
Mouse HP USB Laser	674318-001
Comfort Grip Wireless Mouse	691922-001
Bracket Kit (includes fingerprint bracket, memory module compartment covers, solid-state drive compartment cover, and security lock bracket)	M75763-001
Shield Kit (includes fingerprint reader shield, memory module shield, WLAN module shield, and WWAN shield)	M23349-001
Plastics Kit (includes fingerprint blank bezel, SD card slot bezel, and webcam blank bezel)	M75770-001
Webcam shutter kit	M75764-001
Screw Kit	M75771-001
Rubber Kit (includes display hinge rubber caps, microphone rubber cover, and WWAN module rubber cover)	M17076-001
Hinge Kit	M17072-001
Power cords (Power cord (C13, 1.0 m, premium with tag):	
For use in Australia	100661-021
For use in Denmark	130627-014
For use in Europe	100614-016
For use in India	403440-008
For use in Israel	398062-011
For use in Japan	653326-005
For use in North America	121565-023

Table 3-4 Miscellaneous part descriptions and part numbers (continued)

Component	Spare part number
For use in the People's Republic of China	286496-024
For use in South Africa	187487-012
For use in South Korea	231216-015
For use in Switzerland	150304-015
For use in Taiwan	393312-008
For use in Thailand	285052-013
For use in the United Kingdom	100613-021
Power cord (C5, 1.0 m, premium with tag):	920689-003
For use in Argentina	
For use in Australia	L30769-001
For use in Brazil	L30770-001
For use in Australia	L30771-001
For use in Europe	L30772-001
For use in India	920689-016
For use in Israel	L30773-001
For use in Italy	L30774-001
For use in Japan	L30775-001
For use in North America	920689-001
For use in the People's Republic of China	920689-014
For use in South Africa	L30777-001
For use in South Korea	L30776-001
For use in Switzerland	L30778-001
For use in Taiwan	L30780-001
For use in Thailand	L30779-001
For use in the United Kingdom	L30781-001
RJ-45 (network) door	M75765-001

4 Removal and replacement procedures preliminary requirements

Use this information to properly prepare to disassemble and reassemble the computer.

Tools required

You need the following tools to complete the removal and replacement procedures:

- Tweezers
- Nonconductive, nonmarking pry tool
- Magnetic Phillips P1 screwdriver

Service considerations

The following sections include some of the considerations that you must keep in mind during disassembly and assembly procedures.

 **NOTE:** As you remove each subassembly from the computer, place the subassembly (and all accompanying screws) away from the work area to prevent damage.

Plastic parts

Using excessive force during disassembly and reassembly can damage plastic parts.

Cables and connectors

Handle cables with extreme care to avoid damage.

 **IMPORTANT:** When servicing the computer, be sure that cables are placed in their proper locations during the reassembly process. Improper cable placement can damage the computer.

Apply only the tension required to unseat or seat the cables during removal and insertion. Handle cables by the connector whenever possible. In all cases, avoid bending, twisting, or tearing cables. Be sure that cables are routed so that they cannot be caught or snagged as you remove or replace parts. Handle flex cables with extreme care; these cables tear easily.

Drive handling

Note the following guidelines when handling drives.

 **IMPORTANT:** Drives are fragile components. Handle them with care. To prevent damage to the computer, damage to a drive, or loss of information, observe these precautions:

Before removing or inserting a hard drive, shut down the computer. If you are unsure whether the computer is off or in Hibernation, turn the computer on, and then shut it down through the operating system.

Before handling a drive, be sure that you are discharged of static electricity. While handling a drive, avoid touching the connector.

Before removing an optical drive, be sure that a disc is not in the drive, and be sure that the optical drive tray is closed.

Handle drives on surfaces covered with at least 2.54 cm (1 inch) of shock-proof foam.

Avoid dropping drives from any height onto any surface.

After removing a hard drive or an optical drive, place it in a static-proof bag.

Avoid exposing an internal hard drive to products that have magnetic fields, such as monitors or speakers.

Avoid exposing a drive to temperature extremes or liquids.

If a drive must be mailed, place the drive in a bubble pack mailer or other suitable form of protective packaging, and label the package "FRAGILE."

Electrostatic discharge information

A sudden discharge of static electricity from your finger or other conductor can destroy static-sensitive devices or microcircuitry. Often the spark is neither felt nor heard, but damage occurs. An electronic device exposed to electrostatic discharge (ESD) might not appear to be affected at all and can work perfectly throughout a normal cycle. The device might function normally for a while, but it has been degraded in the internal layers, reducing its life expectancy.

Networks built into many integrated circuits provide some protection, but in many cases, the discharge contains enough power to alter device parameters or melt silicon junctions.

 **IMPORTANT:** To prevent damage to the device when you remove or install internal components, observe these precautions:

Keep components in their electrostatic-safe containers until you are ready to install them.

Before touching an electronic component, discharge static electricity by using the guidelines described [Personal grounding methods and equipment on page 35](#).

Avoid touching pins, leads, and circuitry. Handle electronic components as little as possible.

If you remove a component, place it in an electrostatic-safe container.

Generating static electricity

Follow these static electricity guidelines.

- Different activities generate different amounts of static electricity.
- Static electricity increases as humidity decreases.

Table 4-1 Static electricity occurrence based on activity and humidity

Event	Relative humidity		
	55%	40%	10%
Walking across carpet	7,500 V	15,000 V	35,000 V
Walking across vinyl floor	3,000 V	5,000 V	12,000 V

Table 4-1 Static electricity occurrence based on activity and humidity (continued)

Event	Relative humidity		
	55%	40%	10%
Motions of bench worker	400 V	800 V	6,000 V
Removing DIPs (dual in-line packages) from plastic tube	400 V	700 V	2,000 V
Removing DIPs from vinyl tray	2,000 V	4,000 V	11,500 V
Removing DIPs from polystyrene foam	3,500 V	5,000 V	14,500 V
Removing bubble pack from PCB (printed circuit board)	7,000 V	20,000 V	26,500 V
Packing PCBs in foam-lined box	5,000 V	11,000 V	21,000 V

Multiple electric components can be packaged together in plastic tubes, trays, or polystyrene foam.

 **NOTE:** As little as 700 V can degrade a product.

Preventing electrostatic damage to equipment

Many electronic components are sensitive to ESD. Circuitry design and structure determine the degree of sensitivity. The following packaging and grounding precautions are necessary to prevent static electricity damage to electronic components.

- To avoid hand contact, transport products in static-safe containers such as tubes, bags, or boxes.
- Protect all electrostatic parts and assemblies with conductive or approved containers or packaging.
- Keep electrostatic-sensitive parts in their containers until they arrive at static-free stations.
- Place items on a grounded surface before removing them from their container.
- Always be properly grounded when touching a sensitive component or assembly.
- Avoid contact with pins, leads, or circuitry.
- Place reusable electrostatic-sensitive parts from assemblies in protective packaging or conductive foam.

Personal grounding methods and equipment

Using certain equipment can prevent static electricity damage to electronic components.

- **Wrist straps** are flexible straps with a maximum of $1\text{ M}\Omega \pm 10\%$ resistance in the ground cords. To provide proper ground, a strap must be worn snug against bare skin. The ground cord must be connected and fit snugly into the banana plug connector on the grounding mat or workstation.
- **Heel straps/Toe straps/Boot straps** can be used at standing workstations and are compatible with most types of shoes or boots. On conductive floors or dissipative floor mats, use them on both feet with a maximum of $1\text{ M}\Omega \pm 10\%$ resistance between the operator and ground.

Table 4-2 Static shielding protection levels

Static shielding protection levels	
Method	Voltage
Antistatic plastic	1,500

Table 4-2 Static shielding protection levels (continued)

Static shielding protection levels	
Carbon-loaded plastic	7,500
Metallized laminate	15,000

Grounding the work area

To prevent static damage at the work area, follow these precautions.

- Cover the work surface with approved static-dissipative material.
- Use a wrist strap connected to a properly grounded work surface and use properly grounded tools and equipment.
- Use static-dissipative mats, foot straps, or air ionizers to give added protection.
- Handle electrostatic sensitive components, parts, and assemblies by the case or PCB laminate. Handle them only at static-free work areas.
- Turn off power and input signals before inserting and removing connectors or test equipment.
- Use fixtures made of static-safe materials when fixtures must directly contact dissipative surfaces.
- Keep the work area free of nonconductive materials, such as ordinary plastic assembly aids and polystyrene foam.
- Use conductive field service tools, such as cutters, screwdrivers, and vacuums.
- Avoid contact with pins, leads, or circuitry.

Recommended materials and equipment

HP recommends certain materials and equipment to prevent static electricity.

- Antistatic tape
- Antistatic smocks, aprons, or sleeve protectors
- Conductive bins and other assembly or soldering aids
- Conductive foam
- Conductive tabletop workstations with ground cord of $1\text{ M}\Omega \pm 10\%$ resistance
- Static-dissipative table or floor mats with hard tie to ground
- Field service kits
- Static awareness labels
- Wrist straps and footwear straps providing $1\text{ M}\Omega \pm 10\%$ resistance
- Material handling packages
- Conductive plastic bags

- Conductive plastic tubes
- Conductive tote boxes
- Opaque shielding bags
- Transparent metallized shielding bags
- Transparent shielding tubes

Cleaning your computer

Cleaning your computer regularly removes dirt and debris so that your device continues to operate at its best. Use the following information to safely clean the external surfaces of your computer.

Enabling HP Easy Clean (select products only)

HP Easy Clean helps you to avoid accidental input while you clean the computer surfaces. This software disables devices such as the keyboard, touch screen, and touchpad for a preset amount of time so that you can clean all computer surfaces.

1. Start HP Easy Clean in one of the following ways:
 - Select the **Start** menu, and then select **HP Easy Clean**.
– or –
 - Select the **HP Easy Clean** icon in the taskbar.
– or –
 - Select **Start**, and then select the **HP Easy Clean** tile.
2. Now that your device is disabled for a short period, see [Removing dirt and debris from your computer on page 37](#) for the recommended steps to clean the high-touch, external surfaces on your computer. After you remove the dirt and debris, you can also clean the surfaces with a disinfectant. See [Cleaning your computer with a disinfectant on page 38](#) for guidelines to help prevent the spread of harmful bacteria and viruses.

Removing dirt and debris from your computer

Here are the recommended steps to clean dirt and debris from your computer.

For computers with wood veneer, see [Caring for wood veneer \(select products only\) on page 39](#).

1. Wear disposable gloves made of latex (or nitrile gloves, if you are latex-sensitive) when cleaning the surfaces.
2. Turn off your device and unplug the power cord and other connected external devices. Remove any installed batteries from items such as wireless keyboards.

 **CAUTION:** To prevent electric shock or damage to components, never clean a product while it is turned on or plugged in.

3. Moisten a microfiber cloth with water. The cloth should be moist, but not dripping wet.

 **IMPORTANT:** To avoid damaging the surface, avoid abrasive cloths, towels, and paper towels.

4. Wipe the exterior of the product gently with the moistened cloth.

 **IMPORTANT:** Keep liquids away from the product. Avoid getting moisture in any openings. If liquid makes its way inside your HP product, it can cause damage to the product. Do not spray liquids directly on the product. Do not use aerosol sprays, solvents, abrasives, or cleaners containing hydrogen peroxide or bleach that might damage the finish.

5. Start with the display (if applicable). Wipe carefully in one direction, and move from the top of the display to the bottom. Finish with any flexible cables, like power cord, keyboard cable, and USB cables.
6. Be sure that surfaces have completely air-dried before turning the device on after cleaning.
7. Discard the gloves after each cleaning. Clean your hands immediately after you remove the gloves.

See [Cleaning your computer with a disinfectant on page 38](#) for recommended steps to clean the high-touch, external surfaces on your computer to help prevent the spread of harmful bacteria and viruses.

Cleaning your computer with a disinfectant

The World Health Organization (WHO) recommends cleaning surfaces, followed by disinfection, as a best practice for preventing the spread of viral respiratory illnesses and harmful bacteria.

After cleaning the external surfaces of your computer using the steps in [Removing dirt and debris from your computer on page 37](#), [Caring for wood veneer \(select products only\) on page 39](#), or both, you might also choose to clean the surfaces with a disinfectant. A disinfectant that is within HP's cleaning guidelines is an alcohol solution consisting of 70% isopropyl alcohol and 30% water. This solution is also known as rubbing alcohol and is sold in most stores.

Follow these steps when disinfecting high-touch, external surfaces on your computer:

1. Wear disposable gloves made of latex (or nitrile gloves, if you are latex-sensitive) when cleaning the surfaces.
2. Turn off your device and unplug the power cord and other connected external devices. Remove any installed batteries from items such as wireless keyboards.

 **CAUTION:** To prevent electric shock or damage to components, never clean a product while it is turned on or plugged in.

3. Moisten a microfiber cloth with a mixture of 70% isopropyl alcohol and 30% water. The cloth should be moist, but not dripping wet.

 **CAUTION:** Do not use any of the following chemicals or any solutions that contain them, including spray-based surface cleaners: bleach, peroxides (including hydrogen peroxide), acetone, ammonia, ethyl alcohol, methylene chloride, or any petroleum-based materials, such as gasoline, paint thinner, benzene, or toluene.

 **IMPORTANT:** To avoid damaging the surface, avoid abrasive cloths, towels, and paper towels.

4. Wipe the exterior of the product gently with the moistened cloth.

 **IMPORTANT:** Keep liquids away from the product. Avoid getting moisture in any openings. If liquid makes its way inside your HP product, it can cause damage to the product. Do not spray liquids directly on the product. Do not use aerosol sprays, solvents, abrasives, or cleaners containing hydrogen peroxide or bleach that might damage the finish.

5. Start with the display (if applicable). Wipe carefully in one direction, and move from the top of the display to the bottom. Finish with any flexible cables, like power cord, keyboard cable, and USB cables.
6. Be sure that surfaces have completely air-dried before turning the device on after cleaning.
7. Discard the gloves after each cleaning. Clean your hands immediately after you remove the gloves.

Caring for wood veneer (select products only)

Your product might feature high-quality wood veneer. As with all natural wood products, proper care is important for best results over the life of the product. Because of the nature of natural wood, you might see unique variations in the grain pattern or subtle variations in color, which are normal.

- Clean the wood with a dry, static-free microfiber cloth or chamois.
- Avoid cleaning products containing substances such as ammonia, methylene chloride, acetone, turpentine, or other petroleum-based solvents.
- Do not expose the wood to sun or moisture for long periods of time.
- If the wood becomes wet, dry it by dabbing with an absorbent, lint-free cloth.
- Avoid contact with any substance that might dye or discolor the wood.
- Avoid contact with sharp objects or rough surfaces that might scratch the wood.

See [Removing dirt and debris from your computer on page 37](#) for the recommended steps to clean the high-touch, external surfaces on your computer. After you remove the dirt and debris, you can also clean the surfaces with a disinfectant. See [Cleaning your computer with a disinfectant on page 38](#) for sanitizing guidelines to help prevent the spread of harmful bacteria and viruses.

Packaging and transporting guidelines

Follow these grounding guidelines when packaging and transporting equipment.

- To avoid hand contact, transport products in static-safe tubes, bags, or boxes.
- Protect ESD-sensitive parts and assemblies with conductive or approved containers or packaging.
- Keep ESD-sensitive parts in their containers until the parts arrive at static-free workstations.
- Place items on a grounded surface before removing items from their containers.
- Always be properly grounded when touching a component or assembly.
- Store reusable ESD-sensitive parts from assemblies in protective packaging or nonconductive foam.
- Use transporters and conveyors made of antistatic belts and roller bushings. Be sure that mechanized equipment used for moving materials is wired to ground and that proper materials are selected to avoid static charging. When grounding is not possible, use an ionizer to dissipate electric charges.

Accessing support information

Use this information to find the HP support that you need.

Table 4-3 Support information locations



Service consideration	Path to access information
Records of reported failure incidents stored on the computer	<p>Windows:</p> <p>Pre-operating system failures are logged in the BIOS Event Log. To view the BIOS Event Log:</p> <ol style="list-style-type: none"> 1. Press the power button. 2. Immediately and repeatedly press esc when the power button light turns white. <p>NOTE: If you do not press esc at the appropriate time, you must restart the computer and again repeatedly press esc when the power button light turns white to access the utility.</p> <ol style="list-style-type: none"> 3. Press f10 to enter the BIOS setup. 4. (On commercial products) Under the Main tab, select BIOS event log, and then select View BIOS Event Log. <p>- or -</p> <p>(On consumer products) Under the Main tab, select System Log.</p> <p>Post operating system failures are logged in the Event Viewer.</p> <ol style="list-style-type: none"> 1. Turn on the computer and allow the operating system to open. 2. Click the search icon  in the taskbar. 3. Type <code>Event Viewer</code>, and then press enter. 4. Select the log from the left panel. Details display in the right panel. <p>Chrome:</p> <ol style="list-style-type: none"> 1. Go to support.google.com/chrome. 2. Search <code>collect Chrome device logs</code>.
Technical bulletins	<p>To locate technical bulletins:</p> <ol style="list-style-type: none"> 1. Go to www.hp.com. 2. Place the cursor over Problem solving to display more options. 3. Select Support & Troubleshooting. 4. Type the serial number, product number, or product name to go to the product support page. 5. Select Advisories to view technical bulletins.
Repair professionals	<p>To locate repair professionals:</p> <ol style="list-style-type: none"> 1. Go to www.hp.com. 2. Place the cursor over Support resources to display more options. 3. Select Authorized service providers.
Component and diagnosis information, failure detection, and required action	<p>To locate diagnosis information and actions:</p> <ol style="list-style-type: none"> 1. Go to http://www.hp.com/go/techcenter/pcdiags. 2. Select Get Support.

Table 4-3 Support information locations (continued)

Service consideration	Path to access information
	3. Near the bottom of the window, select Notebook PCs , and then select your location.

5 Removal and replacement procedures for Customer Self-Repair parts

This chapter provides removal and replacement procedures for Customer Self-Repair parts.

 **NOTE:** The Customer Self-Repair program is not available in all locations. Installing a part that is not supported by the Customer Self-Repair program can void your warranty. Check your warranty to determine whether Customer Self-Repair is supported in your location.

Component replacement procedures

To remove and replace computer components, use these procedures.

 **NOTE:** Details about your computer, including model, serial number, product key, and length of warranty, are on the service tag at the bottom of your computer.

 **NOTE:** HP continually improves and changes product parts. For complete and current information about supported parts for your computer, go to <http://partsurfer.hp.com>, select your country or region, and then follow the on-screen instructions.

You must remove, replace, or loosen as many as xx screws when you service Customer Self-Repair parts. Make special note of each screw size and location during removal and replacement.

Preparation for disassembly

To prepare to disassemble the computer, use these steps.

See [Removal and replacement procedures preliminary requirements on page 33](#) for initial safety procedures.

1. Turn off the computer. If you are unsure whether the computer is off or in Hibernation, turn the computer on, and then shut it down through the operating system.
2. Disconnect the power from the computer by unplugging the power cord from the computer.
3. Disconnect all external devices from the computer.

Service cover

To remove the service cover, use this procedure and illustration.

Table 5-1 Bottom cover description and part number

Description	Spare part number
Service cover	M82073-001

Before removing the service cover, prepare the computer for disassembly (see [Preparation for disassembly on page 42](#)).

Remove the service cover:

1. Close the computer and rest it upside down on a flat work surface with the front toward you.
2. Slide the service cover release latch (1) to the right far enough to access the security screw.
3. If present, remove the Phillips M2.0 × 6.0 security screw (2) that secures the service cover release latch in place.
4. Slide the service cover release latch (3) all the way to the right to release the service cover.
5. Slide the service cover (4) toward the front of the computer, and then remove the service cover.

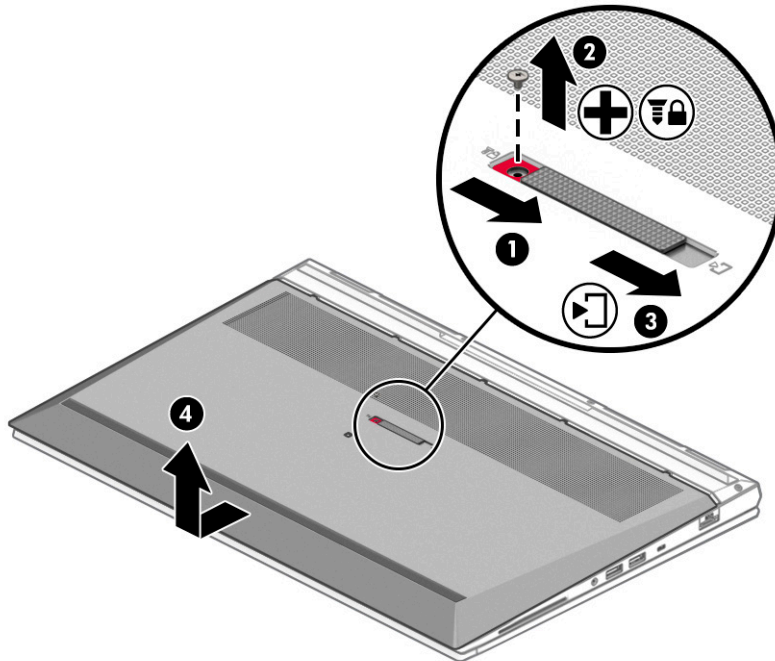

To replace the service cover, reverse the removal procedures.

Battery

To remove the battery, use this procedure and illustration.

Table 5-2 Battery description and part number

Description	Spare part number
8 cell, 94 Whr battery	L86212-001

⚠ WARNING! To avoid personal injury and damage to the product:

- Do *not* puncture, twist, or crack the battery.
- Do *not* cause an external puncture or rupture to the battery. They can cause a short inside the battery, which can result in battery thermal runaway.
- Do *not* handle or touch the battery enclosure with sharp objects such as tweezers or pliers, which might puncture the battery.

- Do *not* compress or squeeze the battery case with tools or heavy objects stacked on top of the case. These actions can apply undue force on the battery.
- Do *not* touch the connectors with any metallic surface or object, such as metal tools, screws, or coins, which can cause shorting across the connectors.

Before removing the battery, follow these steps:

1. Prepare the computer for disassembly (see [Preparation for disassembly on page 42](#)).
2. Remove the service cover (see [Service cover on page 42](#)).

⚠ WARNING! To reduce potential safety issues, use only the user-replaceable battery provided with the computer, a replacement battery provided by HP, or a compatible battery purchased from HP.

📌 IMPORTANT: Removing a battery that is the sole power source for the computer can cause loss of information. To prevent loss of information, save your work or shut down the computer through Windows before you remove the battery.

Remove the battery:

1. Slide the battery latches (1) to the left to unlock the battery.
2. Use the tab (2) to swing the battery rear edge (3) up and forward until it rests at an angle.
3. Remove the battery (4) from the computer.

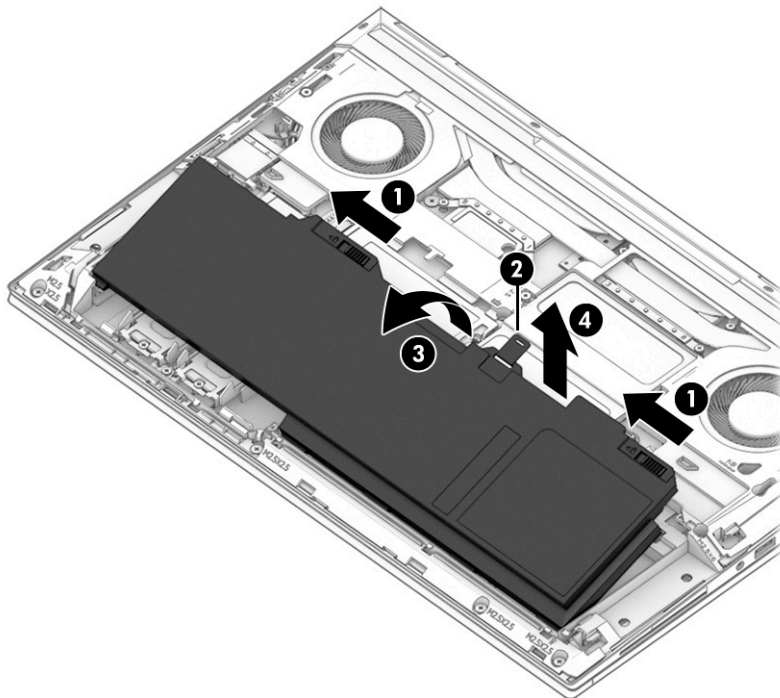

To insert the battery, reverse the removal procedures.

Solid-state drives 3 and 4

To remove solid-state drives 3 and 4, use this procedure and illustration.

Table 5-3 Solid-state drive descriptions and part numbers

Description	Spare part number
2 TB, M.2 2280, PCIe, NVMe-3x4, SS with TLC	L85358-001
2 TB, M.2 2280, PCIe, NVMe, SED with TLC	L91394-001
1 TB, M.2 2280, PCIe, NVMe-3x4, SS with TLC	L85348-001
1 TB, M.2 2280, PCIe NVMe-3x4, SED with TLC	L66613-001
512 GB, M.2 2280, PCIe-3x4, SS with TLC	L85360-001
512 GB, M.2 2280, PCIe, NVMe, SED with TLC	L85368-002
256 GB, M.2 2280, PCIe-3x4, SS with TLC	L85350-001
256 GB, M.2 2280, PCIe, NVMe, SED with TLC	M07245-001

Before removing solid-state drive 3 and 4, follow these steps:

1. Prepare the computer for disassembly (see [Preparation for disassembly on page 42](#)).
2. Remove the service cover (see [Service cover on page 42](#)).
3. Remove the battery (see [Battery on page 43](#)).

Remove solid-state drives 3 and 4:

1. Remove the slotted 2.0 × 6.0 screw (1) that secures the solid-state drive to the solid-state drive carrier.
2. Spread the retention tabs (2) that secure the solid-state drive carrier gate.
3. Swing the solid-state drive carrier gate (3) up and back.
4. Slide the solid-state drives away from the slots (4) on the system board.

Solid-state drives are designed with a notch (5) to prevent incorrect installation.

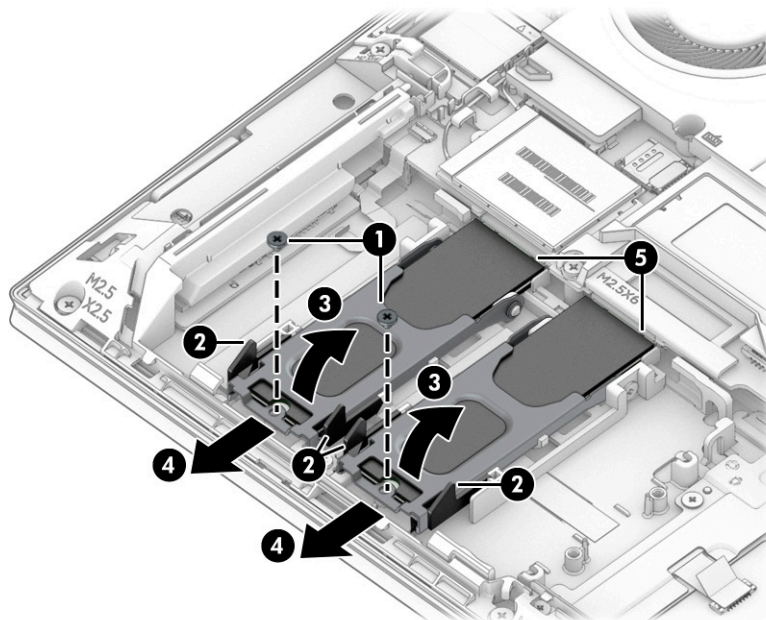

5. If it is necessary to remove the solid-state drive carrier, loosen the captive Phillips screw (1) that secures the carrier to the computer.
6. Lift the front edge of the carrier (2) until it rests at an angle.
7. Remove the carrier (3).

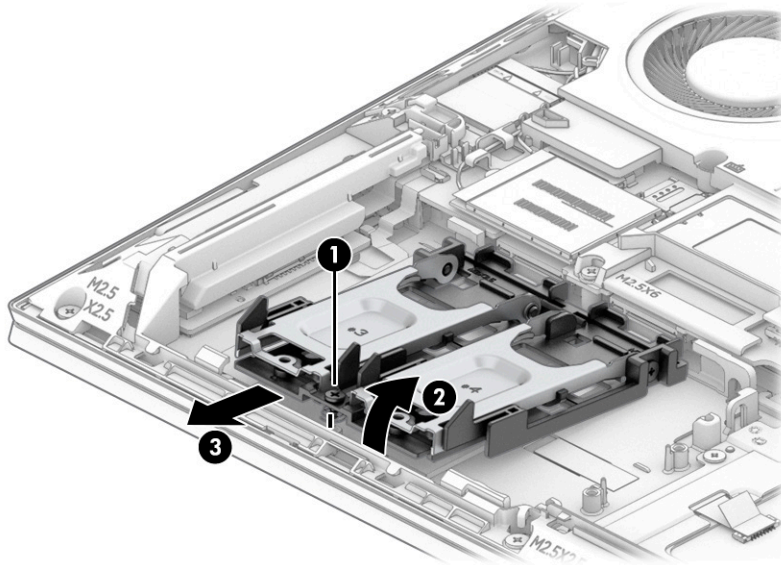

To install the solid-state drive, reverse the removal procedures.



NOTE: Solid-state drives are designed with a notch to prevent incorrect insertion.

Hard drive

To remove the hard drive, use these procedures and illustrations.

Table 5-4 Hard drive, hard drive bracket, and hard drive cable descriptions and part numbers

Description	Spare part number
The hard drive spare part kit does not include the hard drive cable. The hard drive cable is available in the Cable Kit, spare part number M17062-001.	
2 TB, 5400 RPM, 7.0 mm hard drive	912487-850
2 TB, 5400 RPM, 7.0 mm hard drive	L89711-001
1 TB, 7200 RPM, 7.0 mm hard drive	L89707-001
1 TB, 7200 RPM, 9.5 mm hard drive	766644-001
500 GB, 7200 RPM, 7.0 mm FIPS hard drive	L33356-001
500 GB, 7200 RPM, 7.0 mm hard drive	703267-001
500 GB, 7200 RPM, 7.0 mm, FIPS hard drive	820572-001
Hard Drive Hardware Kit (includes hard drive bracket)	M17041-001

Before removing the hard drive, follow these steps:

1. Prepare the computer for disassembly (see [Preparation for disassembly on page 42](#)).
2. Remove the service cover (see [Service cover on page 42](#)).
3. Remove the battery (see [Battery on page 43](#)).
4. Remove the solid-state drive carrier (see [Solid-state drives 3 and 4 on page 44](#)).

Remove the hard drive:

1. Loosen the three Phillips screws (1) that secure the hard drive to the computer.
2. Swing the carrier bar (2) up and to the left to release the hard drive.
3. Slide the hard drive (3) to the left, and then remove the hard drive from the computer

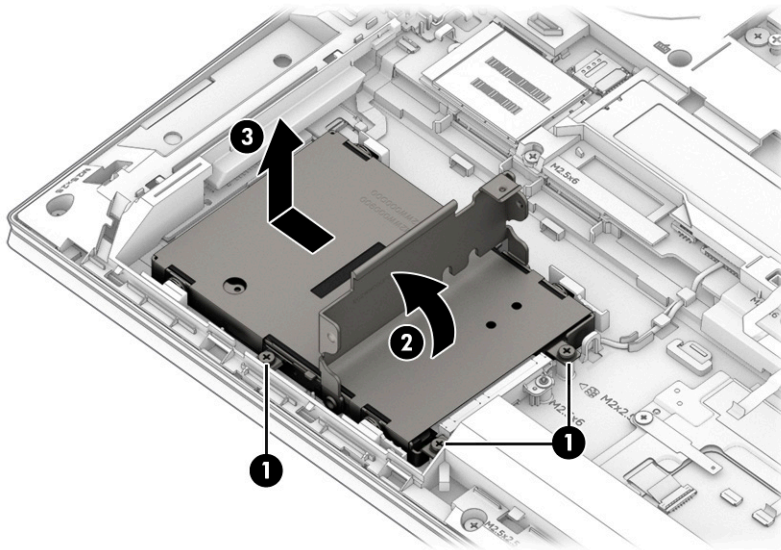

Reverse this procedure to install the hard drive.

If you must disassemble the hard drive, follow these steps:

1. Remove the four Phillips M3.0 × 3.0 screws (1) that secure the hard drive cover to the hard drive.

2. Remove the cover from the hard drive (2).

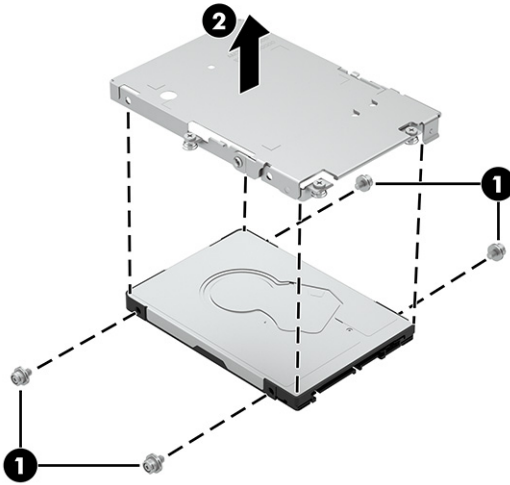

Reverse this procedure to reassemble the hard drive.

WLAN module

To remove the WLAN module, use this procedure and illustration.

Table 5-5 WLAN module descriptions and part numbers

Description	Spare part number
Intel Wi-Fi 6 AX201 ax 2x2 + Bluetooth 5.0 MU-MIMO M.2 2121 non-vPro MIPI+BRI WW with 2 antennas	L92724-001
Intel Wi-Fi 6 AX201 ax 2x2 + Bluetooth 5.0 MU-MIMO M.2 1216 vPro 160MHz MIPI + BRI WW with 2 antennas	L92722-001
Shield Kit (includes WLAN module and WWAN module shields)	M23349-001
Rubber Kit (includes WLAN module rubber)	M17076-001

 **IMPORTANT:** To prevent an unresponsive system, replace the wireless module only with a wireless module authorized for use in the computer by the governmental agency that regulates wireless devices in your country or region. If you replace the module and then receive a warning message, remove the module to restore device functionality, and then contact technical support.

Before removing the WLAN module, follow these steps:

1. Prepare the computer for disassembly (see [Preparation for disassembly on page 42](#)).
2. Remove the service cover (see [Service cover on page 42](#)).
3. Remove the battery (see [Battery on page 43](#)).

Remove the WLAN module:

1. Carefully disconnect the two antenna cables from the module (1).

2. Remove the Phillips M2.0 × 2.5 screw (2), and then remove the WLAN module (3).

 **NOTE:** Models have either one or two WLAN antennas. On models with two antennas, the #1 white WLAN antenna cable connects to the WLAN module #1 Main terminal. The #2 black WLAN antenna cable connects to the WLAN module #1 Aux terminal.

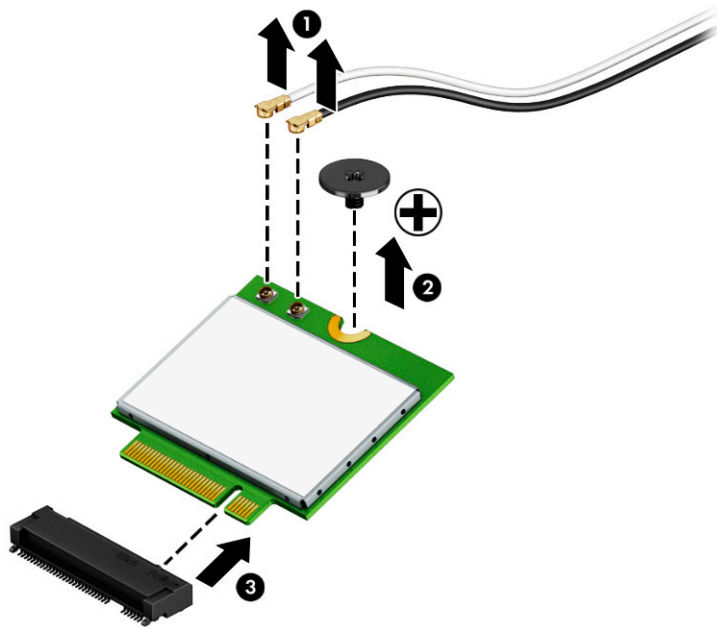

3. If the WLAN antenna is not connected to the terminal on the WLAN module, install a protective sleeve on the antenna connector, as shown in the following illustration.

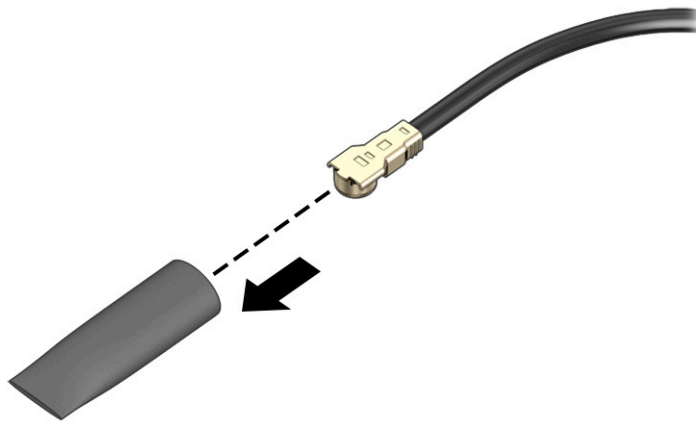

Reverse this procedure to install the WLAN module.

WWAN module

To remove the WWAN module, use this procedure and illustration.

Table 5-6 WWAN module descriptions and part numbers

Description	Spare part number
HP Intel XMM 7360 LTE M.2 WWAN module with GPS	L70670-001
Shield Kit (includes WLAN module and WWAN module Mylar shields)	M23349-001
Rubber Kit (includes WWAN module rubber)	M17076-001

 **IMPORTANT:** To prevent an unresponsive system, replace the wireless module only with a wireless module authorized for use in the computer by the governmental agency that regulates wireless devices in your country or region. If you replace the module and then receive a warning message, remove the module to restore device functionality, and then contact technical support.

Before removing the WWAN module, follow these steps:

1. Prepare the computer for disassembly (see [Preparation for disassembly on page 42](#)).
2. Remove the service cover (see [Service cover on page 42](#)).
3. Remove the battery (see [Battery on page 43](#)).

Remove the WWAN module:

1. Disconnect the WWAN antenna cables **(1)** from the terminals on the WWAN module.
2. Remove the Phillips M2.0 × 2.0 screw **(2)** that secures the WWAN module to the bottom cover. (The WWAN module tilts up.)
3. Remove the WWAN module **(3)** by pulling the module away from the slot at an angle.

 **NOTE:** Models have either one or two WLAN antennas. On models with two antennas, the #1 white WLAN antenna cable connects to the WLAN module #1 Main terminal. The #2 black WLAN antenna cable connects to the WLAN module #1 Aux terminal.

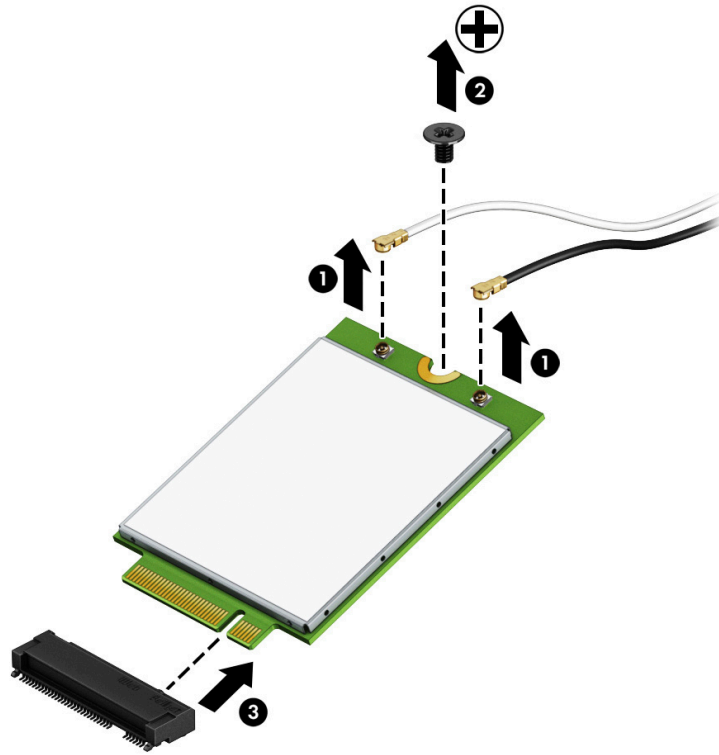

4. If the WWAN antenna is not connected to the terminal on the WWAN module, a protective sleeve must be installed on the antenna connector, as shown in the following illustration.

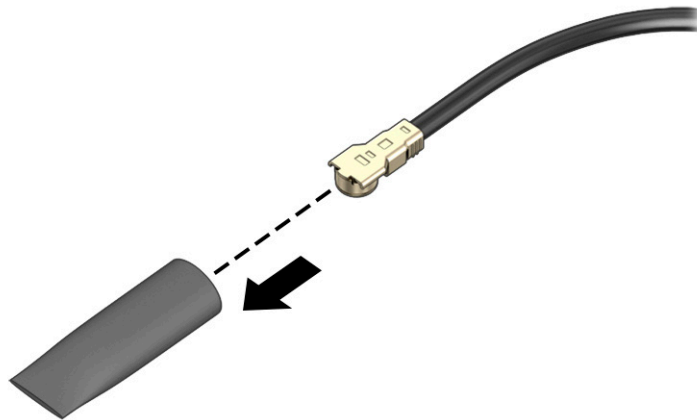

Reverse this procedure to install the WWAN module.

Solid-state drive 2

To remove solid-state drive 2, use this procedure and illustration.

Table 5-7 Solid-state drive descriptions and part numbers

Description	Spare part number
Only NVMe solid-state drives can be used in solid-state drive compartment 2	
2 TB, M.2 2280, PCIe, NVMe-3×4, SS with TLC	L85358-001
2 TB, M.2 2280, PCIe, NVMe, SED with TLC	L91394-001
1 TB, M.2 2280, PCIe, NVMe-3×4, SS with TLC	L85348-001
1 TB, M.2 2280, PCIe NVMe-3x4, SED with TLC	L66613-001
512 GB, M.2 2280, PCIe, NVMe, SED with TLC	L85368-002
256 GB, M.2 2280, PCIe, NVMe, SED with TLC	M07245-001

Before removing the solid-state drive, follow these steps:

1. Prepare the computer for disassembly (see [Preparation for disassembly on page 42](#)).
2. Remove the service cover (see [Service cover on page 42](#)).
3. Remove the battery (see [Battery on page 43](#)).

Remove solid-state drive 2:

1. Remove the Phillips M2.0 × 2.5 screw (1) that secures the solid-state drive cover to the computer.
2. Lift the right side of the cover (2) until it rests at an angle.
3. Remove the cover (3) by sliding it to the left at an angle.

The solid-state drive cover is included in the Solid-state Drive Hardware Kit, spare part number M17040-001.

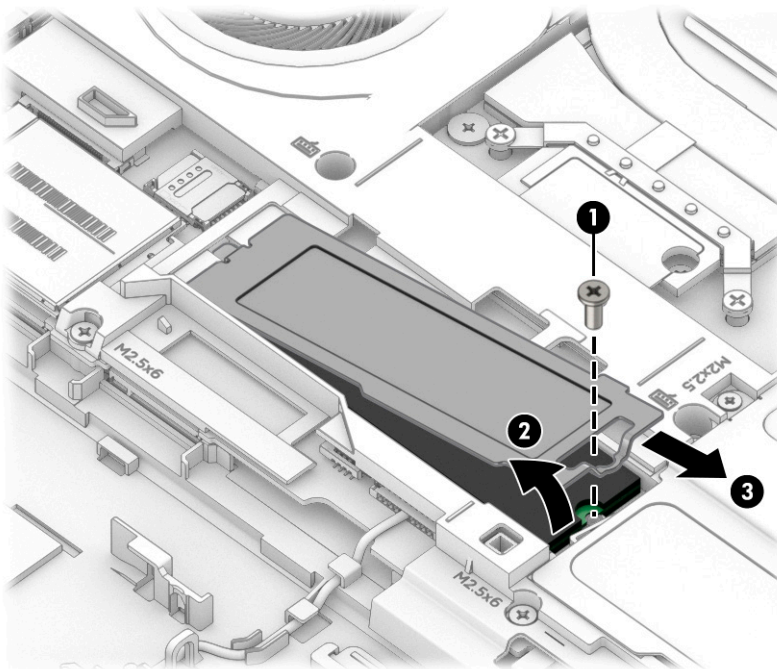

4. Pull the drive away from the socket to remove it (1).

 **NOTE:** Solid-state drives are designed with a notch (2) to prevent incorrect installation.

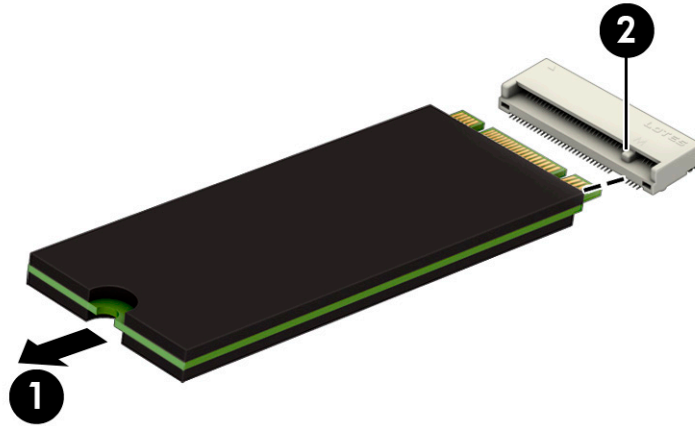

A thermal pad services solid-state drive 2 and is located on the solid-state drive compartment cover. This pad should be inspected each time that the cover is removed. This pad is intended to be reused if it is not damaged. If this pad is damaged and any residue remains on the solid-state drive (1) or the cover (2), remove it thoroughly and replace it. If protective releasing paper is attached to the thermal pad,

remove it before replacement.

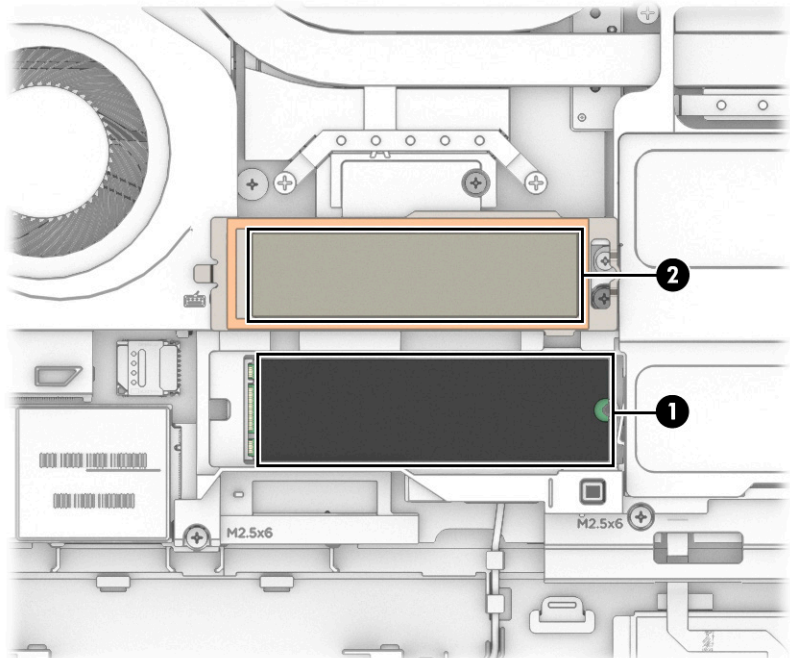

To install the solid-state drive, reverse the removal procedures.

 **NOTE:** Solid-state drives are designed with a notch to prevent incorrect insertion.

Memory modules 2 and 4

To remove memory modules 2 and 4, use this procedure and illustration.



NOTE: For proper functionality, the memory modules must be populated in the following order: module 1, module 3, module 2, module 4.

Table 5-8 Memory module descriptions and part numbers

Description	Spare part number
32 GB (3200 MHz, 1.2 V, DDR4)	M09713-001
16 GB (3200 MHz, 1.2 V, DDR4)	L67710-001
8 GB (3200 MHz, 1.2 V, DDR4)	L46598-001

Before removing memory modules 2 and 4, follow these steps:

1. Prepare the computer for disassembly (see [Preparation for disassembly on page 42](#)).
2. Remove the service cover (see [Service cover on page 42](#)).
3. Remove the battery (see [Battery on page 43](#)).

If you are replacing memory modules 2 and 4, remove the existing memory module:

1. Remove the Phillips M2.0 × 2.5 screw (1) that secures the memory module compartment cover to the computer.
2. Lift the left edge of the cover (2) and swing it up and to the right until it rests at an angle.
3. Remove the cover (3) by sliding it to the left at an angle.

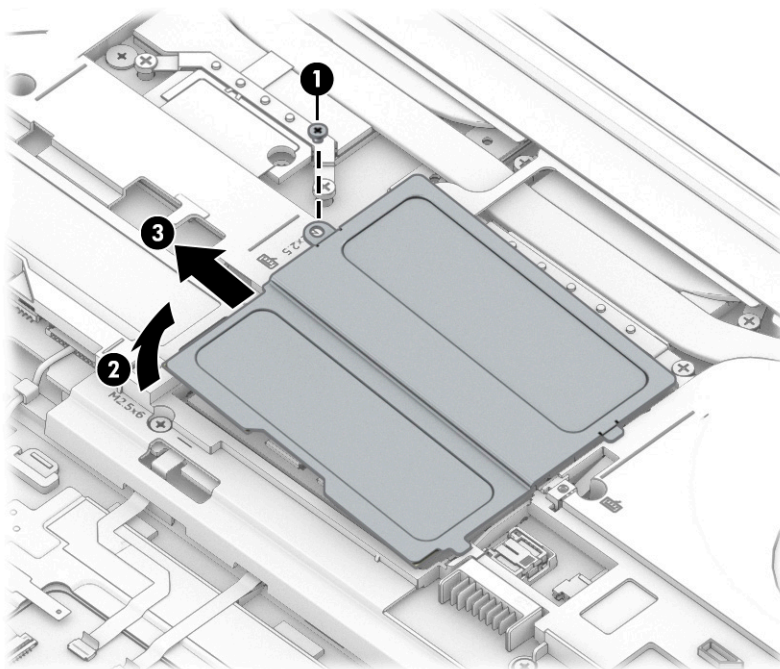

4. Spread the two retention clips outward (1) until the memory module tilts up at a 45° angle, and then remove the module (2). Use the same procedure to remove all memory modules.



IMPORTANT: To prevent damage to the memory module, hold the memory module by the edges only. Do not touch the components on the memory module.

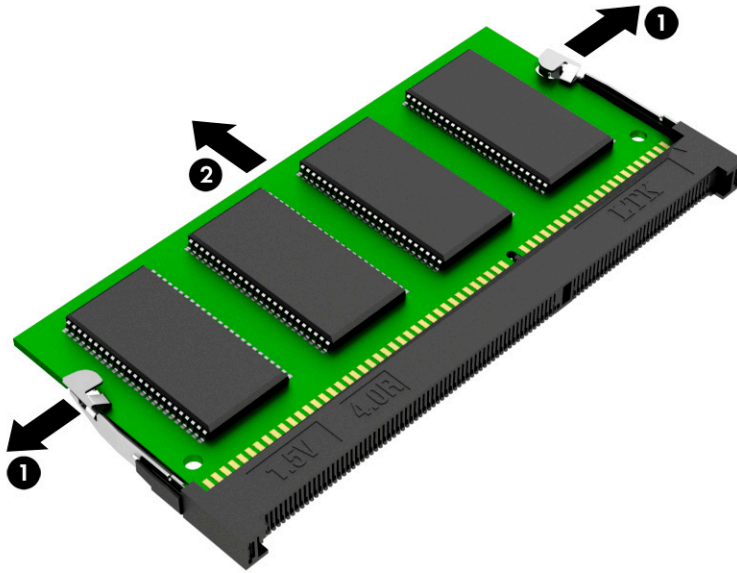

To protect a memory module after removal, place it in an electrostatic-safe container.

To install a memory module:

1. Align the notched edge of the module with the tab in the slot (1), and then press the module into the slot at an angle until it is seated (2).
2. Press down on the module until the side retention clips snap into place (3).

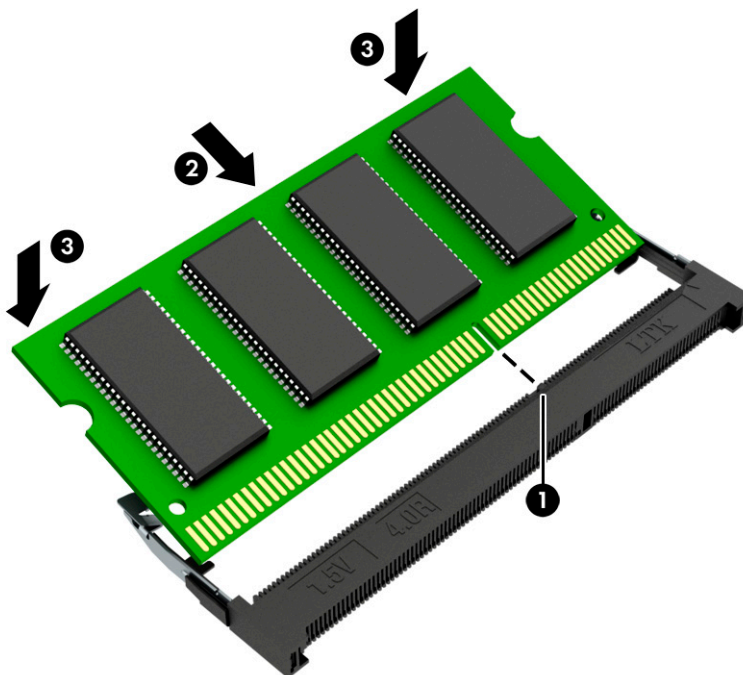

Keyboard

To remove the keyboard, use this procedure and illustration.

Table 5-9 Keyboard description and part number

Description	Spare part number
Keyboard with backlight, clickpad, pointing stick, and privacy screen (includes backlight cable, clickpad cable, keyboard cable, and pointing stick cable):	M17095-001
Keyboard with backlight, clickpad, pointing stick (includes backlight cable, clickpad cable, keyboard cable, and pointing stick cable):	M17094-001

Table 5-10 Spare part country codes

For use in country or region	Spare part number	For use in country or region	Spare part number	For use in country or region	Spare part number
Belgium	-A41	Iceland	-DD1	Saudi Arabia	-171
Brazil	-201	India	-D61	Slovenia	-BA1
Bulgaria	-261	Israel	-BB1	South Korea	-AD1
Chile	-161	Italy	-061	Spain	-071
Czech Republic/Slovakia	-FL1	Japan	-291	Switzerland	-BG1
Denmark, Finland, and Norway	-DH1	Kazakhstan	-DF1	Taiwan	-AB1
French Canada	-DB1	The Netherlands	-B31	Thailand	-281
France	-051	Northern Africa	-FP1	Turkey	-141
Germany	-041	Portugal	-131	Ukraine	-BD1
Greece	-151	Romania	-271	United Kingdom	-031
Hungary	-211	Russia	-251	United States	-001

Before removing the keyboard, follow these steps:

1. Prepare the computer for disassembly (see [Preparation for disassembly on page 42](#)).
2. Remove the service cover (see [Service cover on page 42](#)).
3. Remove the battery (see [Battery on page 43](#)).

Remove the keyboard:

1. Remove the three Phillips M2.5 × 6.0 screws **(1)**, identified by the keyboard icon **(2)**, that secure the keyboard to the computer.
2. Release the zero insertion force (ZIF) connector **(3)** to which the pointing stick cable is connected, and then disconnect the cable from the connector.

3. Detach the pointing stick cable (4) from the top cover. (The pointing stick cable is attached to the top cover with double-sided adhesive.)

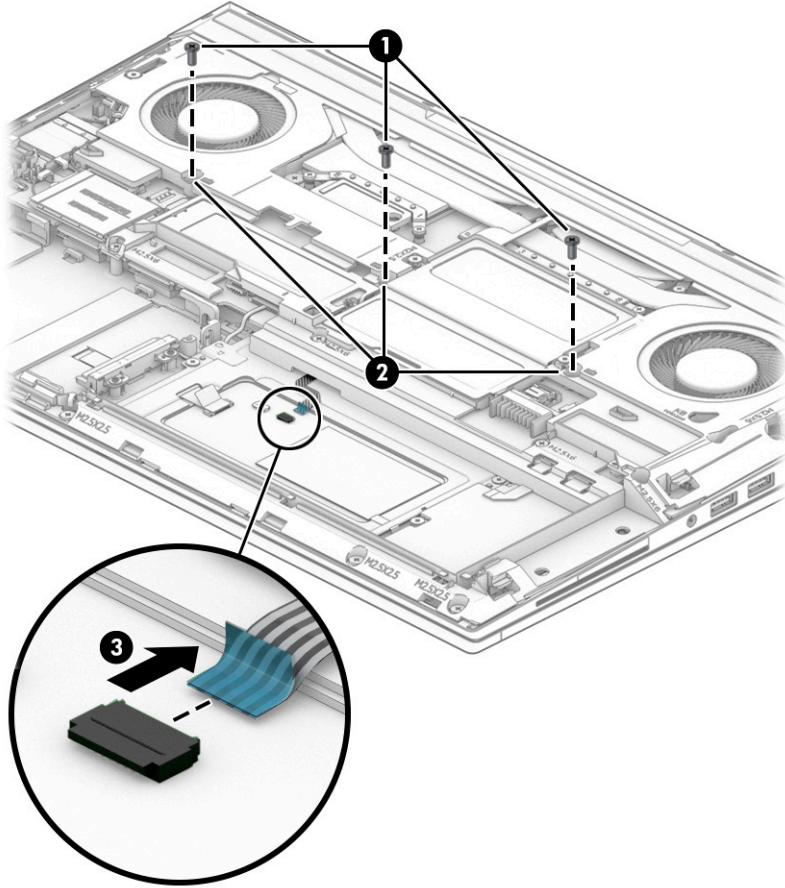

4. Open the computer.
5. Rest the open computer on its left side.

6. Insert a keyboard release tool or other thin, plastic tool through the KB release opening near the fan, and release the keyboard by pressing on its back **(1)**. Be sure the open computer is right side up with the front toward you.

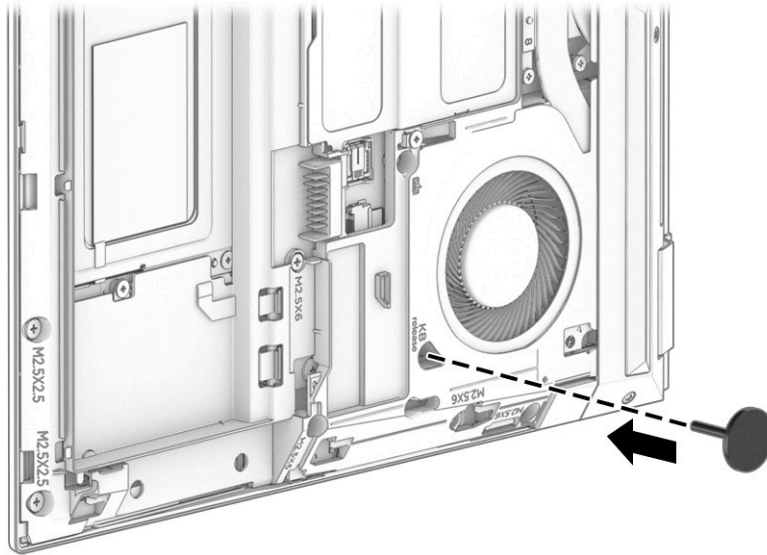

7. Swing the top edge of the keyboard **(2)** up and forward until it rests upside down on the top cover.
8. Detach the backlight cable **(3)** from the top cover. (The backlight cable is attached to the top cover with double-side adhesive.)
9. Release the ZIF connector **(4)** to which the backlight cable is connected, and then disconnect the cable from the connector.
10. Release the ZIF connector **(5)** to which the keyboard cable is connected, and then disconnect the cable from the connector.
11. Release the pointing stick cable **(6)** through the opening in the top cover and remove the keyboard.

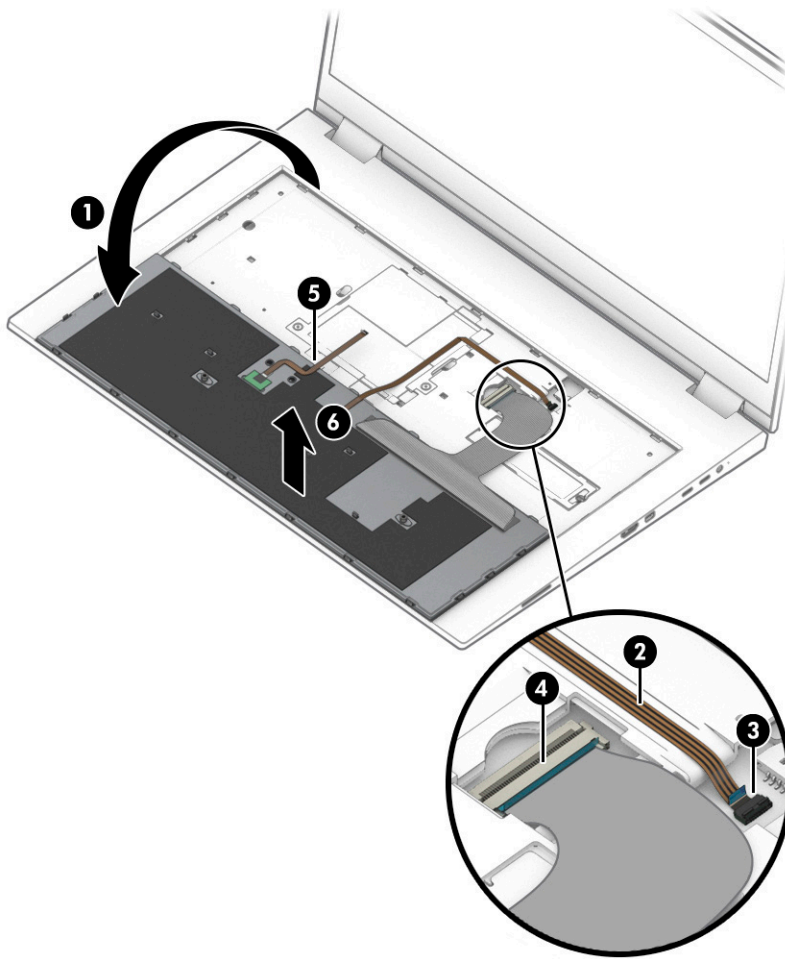

To install the keyboard, reverse the removal procedures.

Memory modules 1 and 3

To remove memory modules 1 and 3, use this procedure and illustration.

 **NOTE:** For proper functionality, the memory modules must be populated in the following order: module 1, module 3, module 2, module 4.

Table 5-11 Memory module descriptions and part numbers

Description	Spare part number
32 GB (3200 MHz, 1.2 V, DDR4)	M09713-001
16 GB (3200 MHz, 1.2 V, DDR4)	L67710-001
8 GB (3200 MHz, 1.2 V, DDR4)	L46598-001

Before removing memory modules 1 and 3, follow these steps:

1. Prepare the computer for disassembly (see [Preparation for disassembly on page 42](#)).
2. Remove the service cover (see [Service cover on page 42](#)).

3. Remove the battery (see [Battery on page 43](#)).
4. Remove the keyboard (see [Keyboard on page 55](#))

If you are replacing memory modules 1 and 3, remove the existing memory module:

1. Remove the two Phillips M2.0 × 2.5 screws (1) that secure the memory module compartment cover to the computer.
2. Lift the front edge of the cover (2) and swing it up and back until it rests at an angle.
3. Remove the cover (3) by sliding it forward and then lifting it up. The memory module compartment cover is included in the Bracket Kit, spare part number M17044-001.

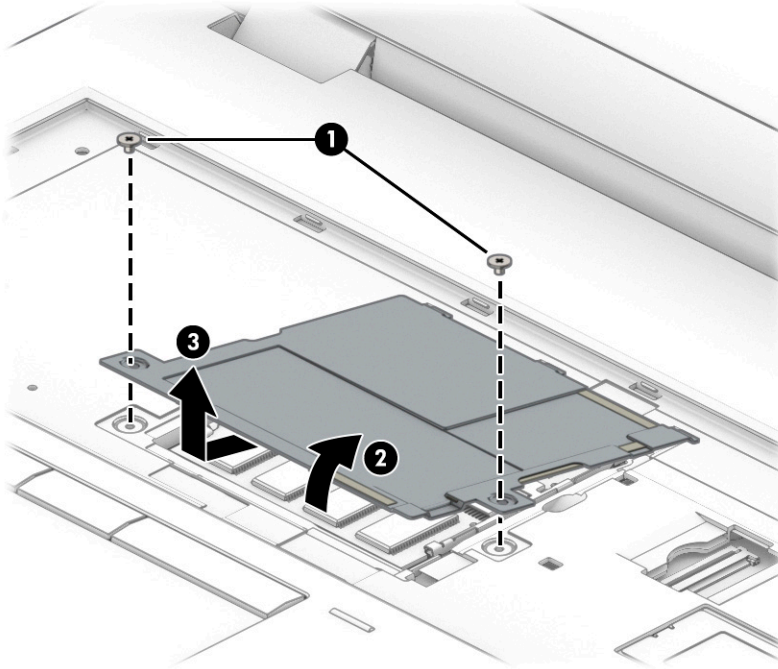

4. Spread the two retention clips outward (1) until the memory module tilts up at a 45° angle, and then remove the module (2). Use the same procedure to remove all memory modules.

 **IMPORTANT:** To prevent damage to the memory module, hold the memory module by the edges only. Do not touch the components on the memory module.

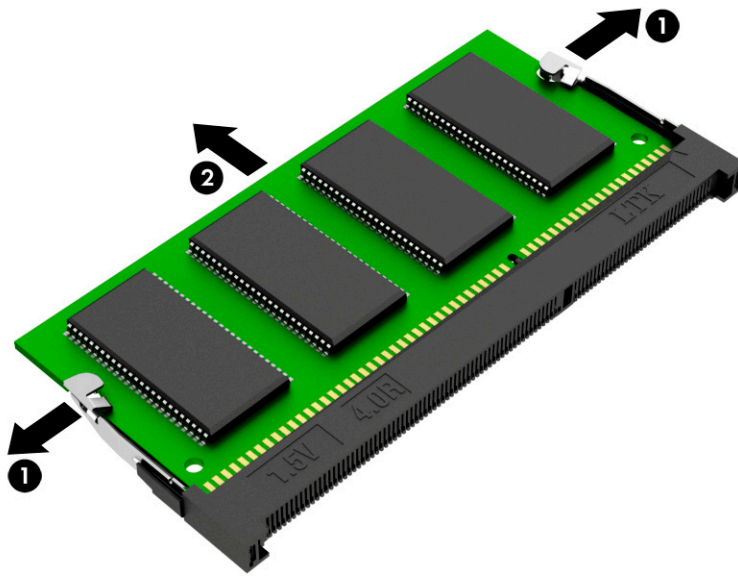

To protect a memory module after removal, place it in an electrostatic-safe container.

To install a memory module:

1. Align the notched edge of the module with the tab in the slot (1), and then press the module into the slot at an angle until it is seated (2).
2. Press down on the module until the side retention clips snap into place (3).

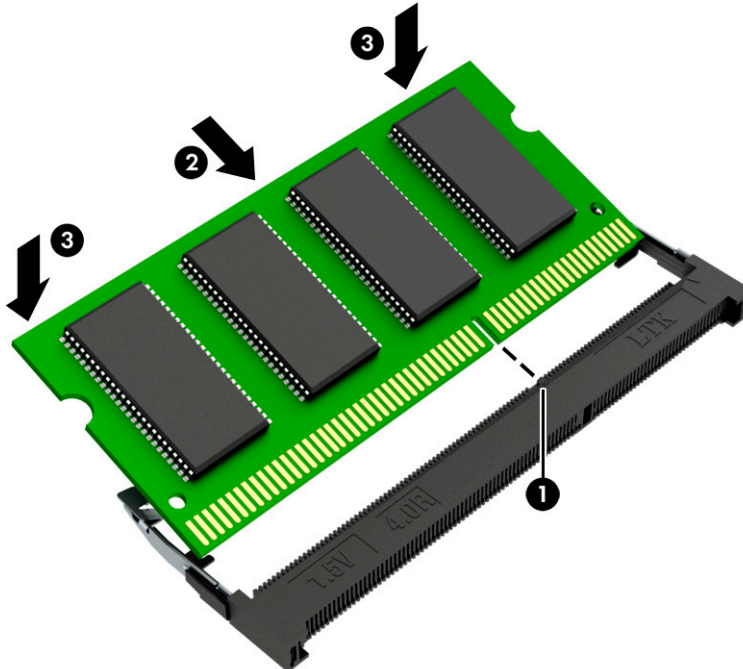

 **NOTE:** Thermal pads service the memory modules and are located on the memory module compartment cover. These pads should be inspected each time that the cover is removed. These pads are intended to be reused if they are not damaged. If these pads are damaged and any residue remains

on the memory modules (1) or the cover (2), it should be thoroughly removed and replaced. If protective releasing paper is attached to the thermal pads, remove it before replacement.

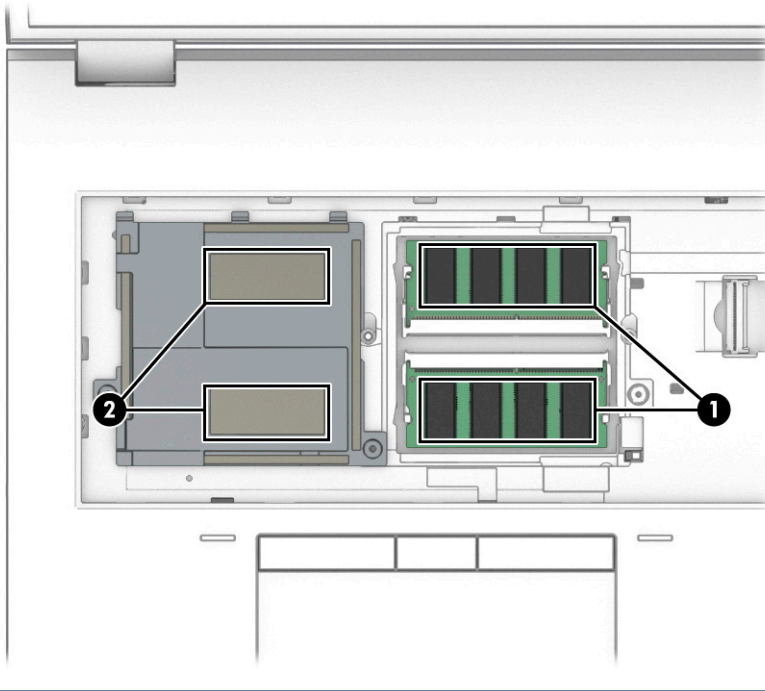

Solid-state drive 1

To remove solid-state drive 1, use this procedure and illustration.

Table 5-12 Solid-state drive descriptions and part numbers

Description	Spare part number
2 TB, M.2 2280, PCIe, NVMe-3x4, SS with TLC	L85358-001
2 TB, M.2 2280, PCIe, NVMe, SED with TLC	L91394-001
1 TB, M.2 2280, PCIe, NVMe-3x4, SS with TLC	L85348-001
1 TB, M.2 2280, PCIe NVMe-3x4, SED with TLC	L66613-001
512 GB, M.2 2280, PCIe-3x4, SS with TLC	L85360-001
512 GB, M.2 2280, PCIe, NVMe, SED with TLC	L85368-002
256 GB, M.2 2280, PCIe-3x4, SS with TLC	L85350-001

Before removing the solid-state drive, follow these steps:

1. Prepare the computer for disassembly (see [Preparation for disassembly on page 42](#)).
2. Remove the service cover (see [Service cover on page 42](#)).
3. Remove the battery (see [Battery on page 43](#)).
4. Remove the keyboard (see [Keyboard on page 55](#)).

Remove solid-state drive 1:

1. Remove the Phillips M2.0 × 2.9 screw (1) that secures the solid-state drive cover to the computer.
2. Lift the right side of the cover (2) until it rests at an angle.
3. Remove the cover (3) by sliding it to the left at an angle.

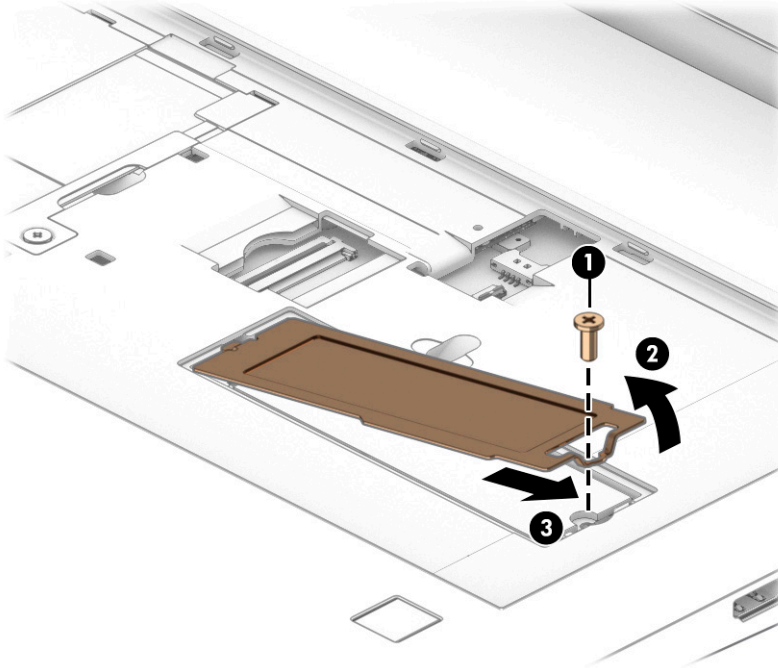

A thermal pad services solid-state drive 1 and is located on the solid-state drive cover. Inspect the pad each time that the cover is removed. This pad is intended to be reused if it is not damaged. If this pad is damaged and any residue remains on the solid-state drive (1) or the cover (2), it should be thoroughly removed and replaced. If protective releasing paper is attached to the thermal pad, remove and replace it.

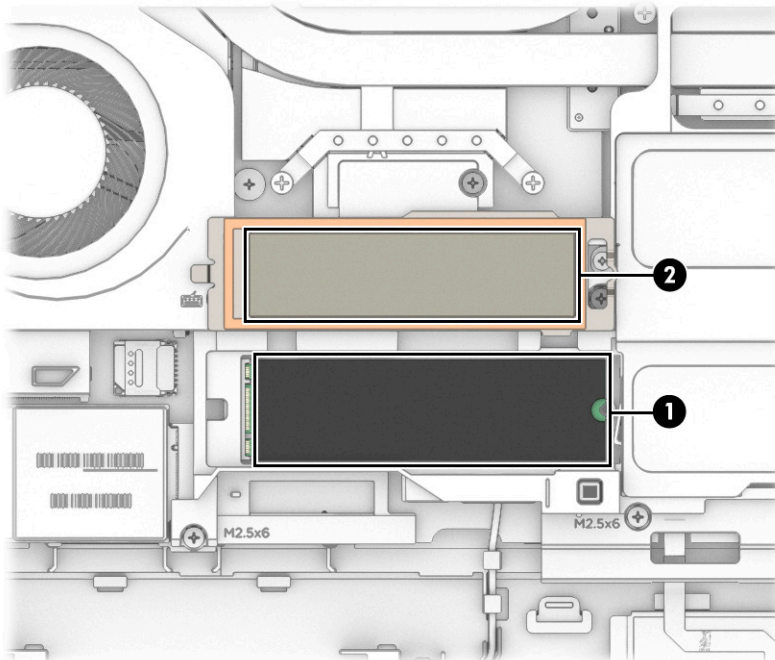

4. Pull the drive away from the socket to remove it (1).



NOTE: Solid-state drives are designed with a notch (2) to prevent incorrect installation.

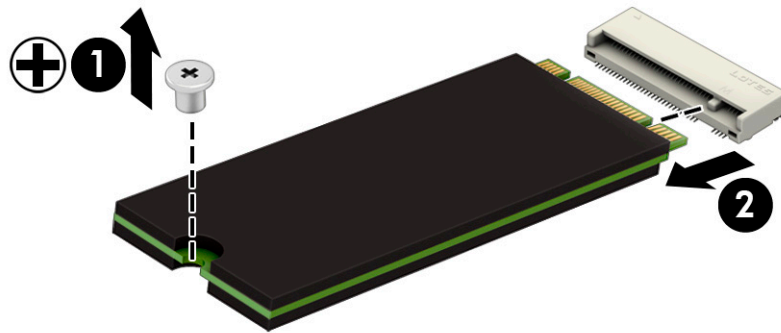

To install the solid-state drive, reverse the removal procedures.



NOTE: Solid-state drives are designed with a notch to prevent incorrect insertion.

6 Removal and replacement procedures for authorized service provider parts

This chapter provides removal and replacement procedures for authorized service provider parts.

 **IMPORTANT:** Components described in this chapter should be accessed only by an authorized service provider. Accessing these parts can damage the computer or void the warranty.

 **NOTE:** Details about your computer, including model, serial number, product key, and length of warranty, are on the service tag at the bottom of your computer.

Component replacement procedures

To remove and replace computer components, use these procedures.

 **NOTE:** HP continually improves and changes product parts. For complete and current information about supported parts for your computer, go to <http://partsurfer.hp.com>, select your country or region, and then follow the on-screen instructions.

You must remove, replace, or loosen as many as 99 screws when you service the parts described in this chapter. Make special note of each screw size and location during removal and replacement.

Preparation for disassembly

To remove and replace computer components, use these procedures.

See [Removal and replacement procedures preliminary requirements on page 33](#) for initial safety procedures.

1. Turn off the computer. If you are unsure whether the computer is off or in Hibernation, turn the computer on, and then shut it down through the operating system.
2. Disconnect the power from the computer by unplugging the power cord from the computer.
3. Disconnect all external devices from the computer.

Bottom case

To remove the bottom case, use this procedure and illustration.

Table 6-1 Bottom case description and part number

Description	Spare part number
Bottom case	M82073-001

Before removing the bottom case, follow these steps:

1. Prepare the computer for disassembly (see [Preparation for disassembly on page 42](#)).

2. Remove the service cover (see [Service cover on page 42](#)).
3. Remove the battery (see [Battery on page 43](#)).
4. Remove solid-state drive 3 and 4 (see [Solid-state drives 3 and 4 on page 44](#)).
5. Remove the solid-state drive carrier (see [Solid-state drives 3 and 4 on page 44](#)).
6. Remove the hard drive (see [Hard drive on page 46](#)).
7. Remove the keyboard (see [Keyboard on page 55](#)).

Remove the bottom case:

1. Close the computer.
2. Turn the computer upside down with the front toward you.
3. Remove the four Phillips M2.5 × 3.0 (1) screws that secure the bottom case to the computer.
4. Remove the nine Phillips M2.5 × 6.0 (2) screws that secure the bottom case to the computer.
5. Remove the four Torx8 M2.5 × 3.0 (3) screws that secure the bottom case to the computer.

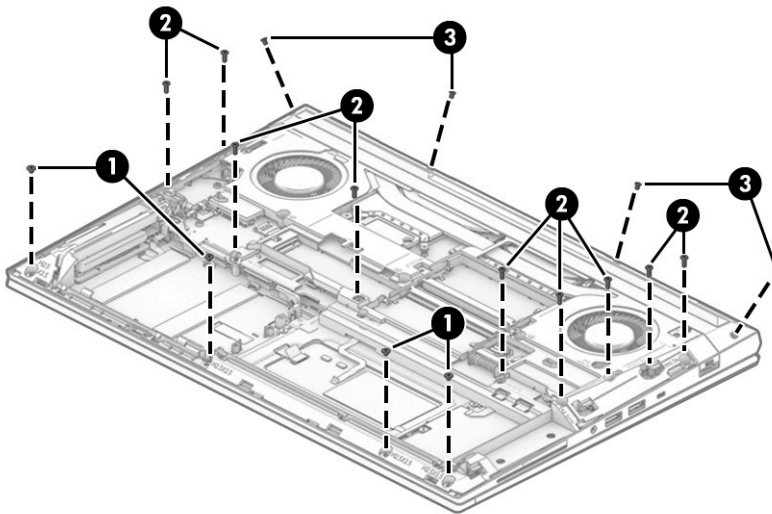

6. Insert a case utility tool (1) or similar thin plastic tool in the display hinge area and separate the bottom case from the top cover.
7. Swing the rear edge of the bottom case (2) up and forward until it rests at an angle.
8. Remove the bottom case (3). When removing the bottom case, take care not to damage the front edge (4) and the area around the solid-state drive compartment. These areas of the bottom case have thin material and are susceptible to breakage if precautions are not taken.

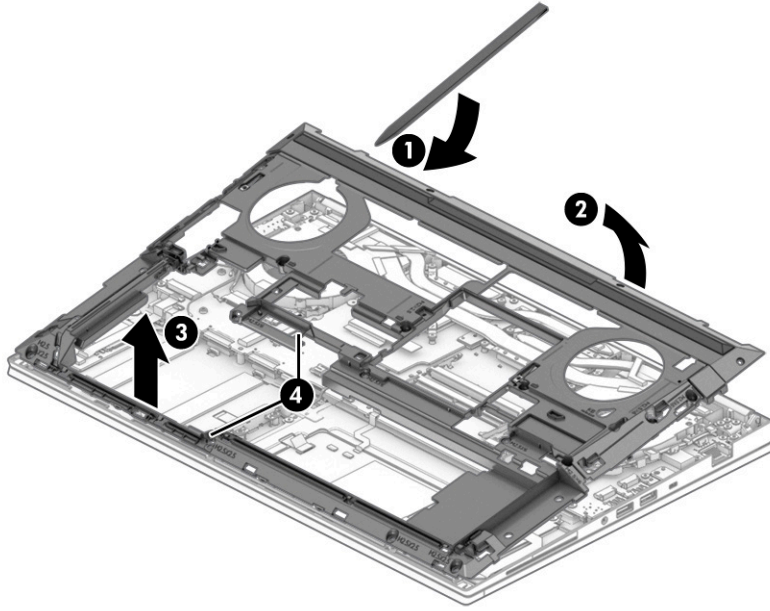

Reverse this procedure to install the bottom case.

SD card board cable

To remove the SD card board cable, use this procedure and illustration.

Table 6-2 SD card board cable description and part number

Description	Spare part number
SD card board cable (part of the kit that includes the SD card board)	M17063-001

Before removing the SD card board cable, follow these steps:

1. Prepare the computer for disassembly (see [Preparation for disassembly on page 42](#)).
2. Remove the service cover (see [Service cover on page 42](#)).
3. Remove the battery (see [Battery on page 43](#)).
4. Remove solid-state drives 3 and 4 (see [Solid-state drives 3 and 4 on page 44](#)).
5. Remove the solid-state drive carrier (see [Solid-state drives 3 and 4 on page 44](#)).
6. Remove the hard drive (see [Hard drive on page 46](#)).
7. Remove the keyboard (see [Keyboard on page 55](#)).
8. Remove the bottom case (see [Bottom case on page 65](#)).

Remove the SD card board cable:

1. Detach the SD card board cable (1) from the top cover. (The SD card board cable is attached to the top cover with double-sided adhesive.)

2. Release the ZIF connector (2) to which the SD card board cable is connected, and then disconnect the SD card board cable from the system board.
3. Release the ZIF connector (3) to which the SD card board cable is connected, and then remove the SD card board cable from the SD card board.

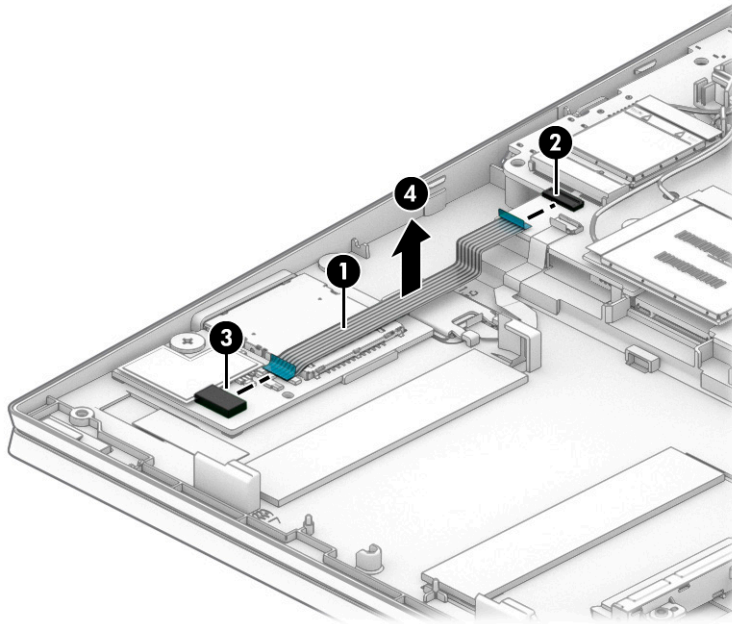

Reverse this procedure to install the SD card cable.

SD card board

To remove the SD card board, use this procedure and illustration.

Table 6-3 SD card board description and part number

Description	Spare part number
SD card board (part of the kit that includes the SD card board cable)	M17063-001

Before removing the SD card board, follow these steps:

1. Prepare the computer for disassembly ([Preparation for disassembly on page 42](#)).
2. Remove the service cover ([Service cover on page 42](#)).
3. Remove the battery (see [Battery on page 43](#)).
4. Remove solid-state drives 3 and 4 (see [Solid-state drives 3 and 4 on page 44](#)).
5. Remove the solid-state drive carrier (see [Solid-state drives 3 and 4 on page 44](#)).
6. Remove the hard drive (see [Hard drive on page 46](#)).
7. Remove the keyboard (see [Keyboard on page 55](#)).

8. Remove the bottom case (see [Bottom case on page 65](#)).

Remove the SD card board:

1. Remove the SD card slot bezel (1).
2. Detach the SD card board cable (2) from the top cover. (The SD card board cable is attached to the top cover with double-sided adhesive.)
3. Release the ZIF connector (3) to which the SD card board cable is connected, and then disconnect the SD card board cable from the system board.
4. Remove the two Phillips M2.0 × 1.7 broadhead screws (4) that secure the SD card board to the top cover.
5. Remove the SD card board (5) and cable.

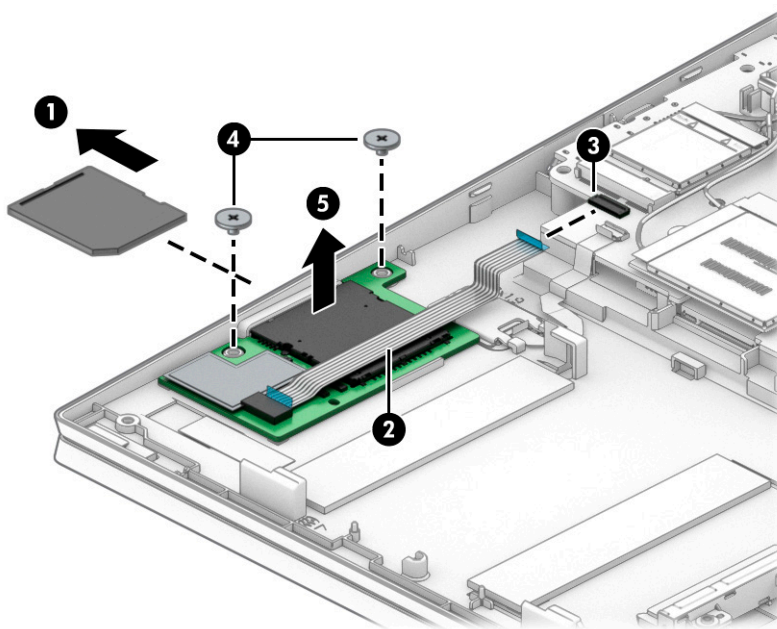

Reverse this procedure to install the SD cable board.

Fingerprint reader module cable

To remove the fingerprint reader module, use this procedure and illustration.

 **NOTE:** The fingerprint reader module cable is available in the Cable Kit, spare part number M17062-001.

Table 6-4 Fingerprint module cable description and part number

Description	Spare part number
Fingerprint reader module cable	M17062-001

Before removing the fingerprint reader module cable, follow these steps:

1. Prepare the computer for disassembly ([Preparation for disassembly on page 42](#)).

2. Remove the service cover (see [Service cover on page 42](#)).
3. Remove the battery (see [Battery on page 43](#)).
4. Remove solid-state drives 3 and 4 (see [Solid-state drives 3 and 4 on page 44](#)).
5. Remove the solid-state drive carrier (see [Solid-state drives 3 and 4 on page 44](#)).
6. Remove the hard drive (see [Hard drive on page 46](#)).
7. Remove the keyboard (see [Keyboard on page 55](#)).
8. Remove the bottom case (see [Bottom case on page 65](#)).

Before removing the fingerprint reader module, follow these steps:

1. Release the ZIF connector (1) to which the fingerprint reader module cable is attached, and then disconnect the fingerprint reader module cable from the system board.
2. Remove the Phillips M2.0 × 2.5 broadhead screw (2) that secures the fingerprint reader module and bracket to the computer.
3. Remove the fingerprint module cable (3).

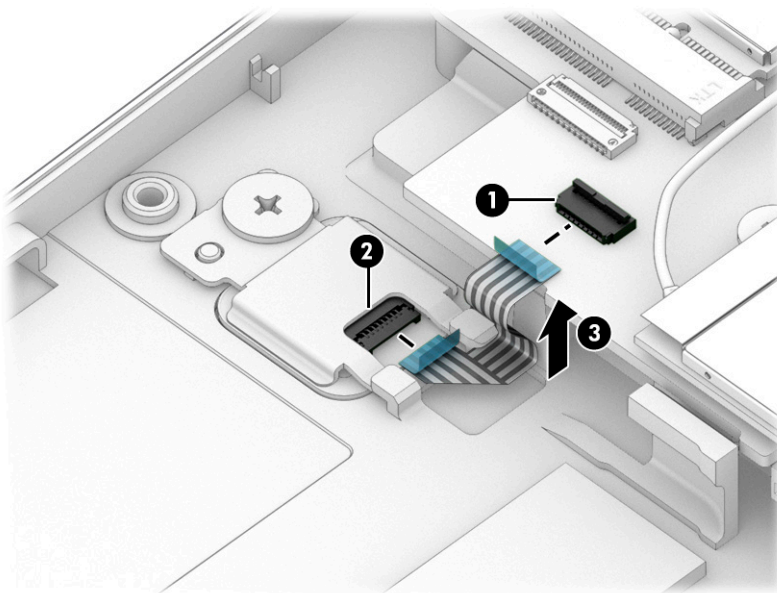

Reverse this procedure to install the fingerprint reader module cable.

Fingerprint reader board

To remove the fingerprint reader board, use this procedure and illustration.

Table 6-5 Fingerprint reader board description and part number

Description	Spare part number
Fingerprint reader board	M75762-001
Fingerprint reader board cable	M17062-001

Before removing the fingerprint reader board, follow these steps:

1. Prepare the computer for disassembly (see [Preparation for disassembly on page 42](#)).
2. Remove the service cover (see [Service cover on page 42](#)).
3. Remove the battery (see [Battery on page 43](#)).
4. Remove solid-state drives 3 and 4 ([Solid-state drives 3 and 4 on page 44](#)).
5. Remove the solid-state drive carrier (see [Solid-state drives 3 and 4 on page 44](#)).
6. Remove the hard drive (see [Hard drive on page 46](#)).
7. Remove the keyboard (see [Keyboard on page 55](#)).
8. Remove the bottom case (see [Bottom case on page 65](#)).

Remove the fingerprint reader board:

1. Release the ZIF connector (1) to which the fingerprint reader module cable is attached, and then disconnect the fingerprint reader module cable from the system board.
2. Remove the Phillips M2.0 × 1.9 broad head screw (2) that secures the fingerprint reader module and bracket to the computer.
3. Remove the fingerprint reader module bracket (3). The fingerprint reader module bracket is included in the Bracket Kit, spare part number M17044-001.
4. Remove the fingerprint reader module (4).

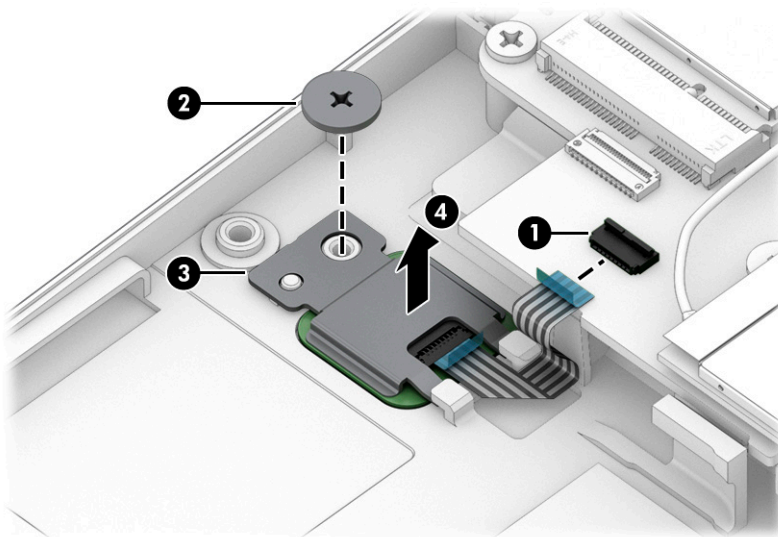

Reverse this procedure to install the fingerprint reader board.

Hard drive cable

To remove the hard drive cable, use this procedure and illustration.

Table 6-6 Hard drive cable description and part number

Description	Spare part number
Hard drive cable	M17062-001

Before removing the hard drive cable, follow these steps:

1. Prepare the computer for disassembly (see [Preparation for disassembly on page 42](#)).
2. Remove the service cover (see [Service cover on page 42](#)).
3. Remove the battery (see [Battery on page 43](#)).
4. Remove the solid-state drives 3 and 4 (see [Solid-state drives 3 and 4 on page 44](#)).
5. Remove the solid-state drive carrier (see [Solid-state drives 3 and 4 on page 44](#)).
6. Remove the hard drive (see [Hard drive on page 46](#)).
7. Remove the keyboard (see [Keyboard on page 55](#)).
8. Remove the bottom case (see [Bottom case on page 65](#)).

Remove the hard drive cable:

1. Disconnect the hard drive cable **(1)** from the system board.
2. Release the hard drive cable from the retention clips **(2)** built into the top cover.
3. Remove the two Phillips M2.5 × 6.0 screws **(3)** that secure the hard drive cable to the top cover.
4. Remove the hard drive cable **(4)**.

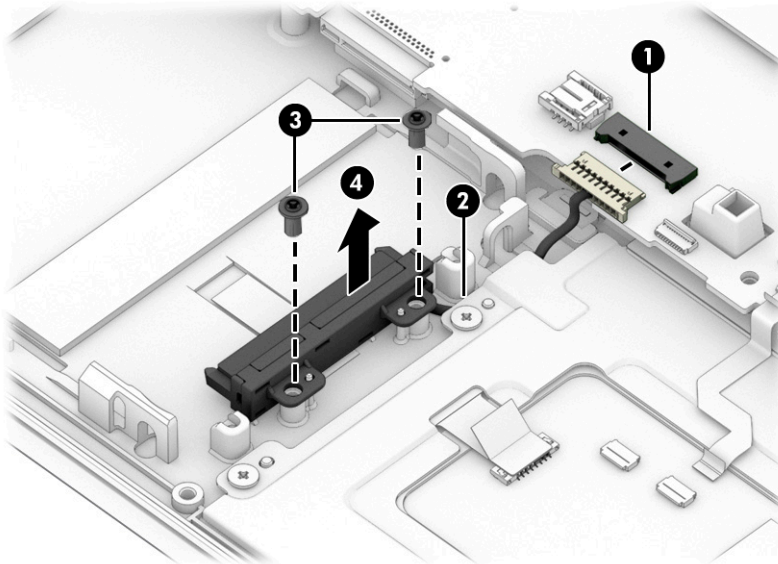

Reverse this procedure to install the hard drive cable.

Touchpad cable

To remove the touchpad cable, use this procedure and illustration.

Table 6-7 Touchpad cable description and part number

Description	Spare part number
Touchpad cable	M17062-001

Before removing the touchpad cable, follow these steps:

1. Prepare the computer for disassembly (see [Preparation for disassembly on page 42](#)).
2. Remove the service cover (see [Service cover on page 42](#)).
3. Remove the battery (see [Battery on page 43](#)).
4. Remove solid-state drives 3 and 4 (see [Solid-state drives 3 and 4 on page 44](#)).
5. Remove the solid-state drive carrier (see [Solid-state drives 3 and 4 on page 44](#)).
6. Remove the hard drive (see [Hard drive on page 46](#)).
7. Remove the keyboard (see [Keyboard on page 55](#)).
8. Remove the bottom case (see [Bottom case on page 65](#)).

Remove the touchpad cable:

1. Detach the touchpad cable **(1)** from the top cover. (The touchpad cable is attached to the top cover with double-sided adhesive.)
2. Release the ZIF connector **(2)** to which the touchpad cable is connected, and then disconnect the touchpad cable from the system board.

3. Release the ZIF connector (3) to which the touchpad cable is connected, and then disconnect and remove the touchpad cable from the touchpad.

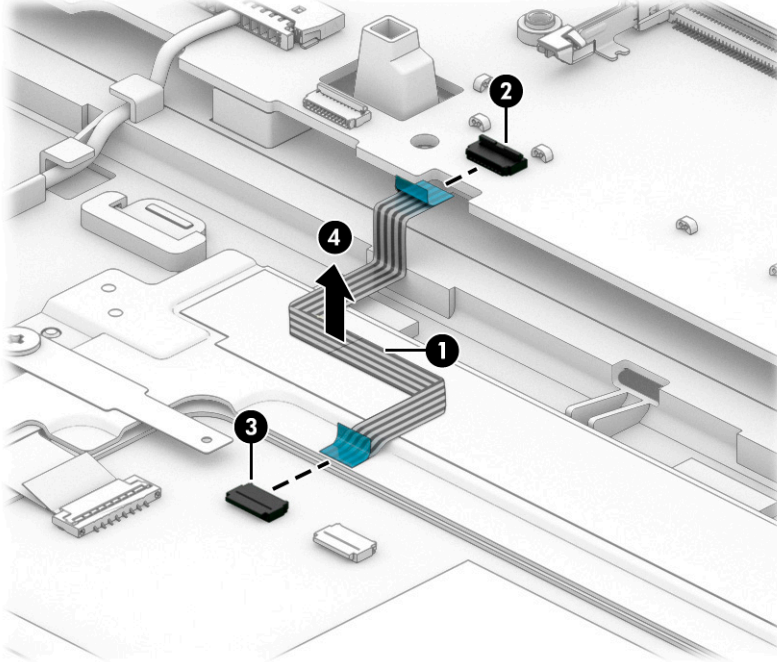

Reverse this procedure to install the touchpad cable.

Touchpad

To remove the touchpad, use this procedure and illustration.

Table 6-8 Touchpad description and part number

Description	Spare part number
Touchpad	M17066-001

Before removing the touchpad, follow these steps:

1. Prepare the computer for disassembly (see [Preparation for disassembly on page 42](#)).
2. Remove the service cover (see [Service cover on page 42](#)).
3. Remove the battery (see [Service cover on page 42](#)).
4. Remove solid-state drives 3 and 4 (see [Solid-state drives 3 and 4 on page 44](#)).
5. Remove the solid-state drive carrier (see [Solid-state drives 3 and 4 on page 44](#)).
6. Remove the hard drive (see [Hard drive on page 46](#)).
7. Remove the keyboard (see [Keyboard on page 55](#)).
8. Remove the bottom case (see [Bottom case on page 65](#)).

Remove the touchpad:

1. Detach the touchpad cable (1) from the top cover. (The touchpad cable is attached to the top cover with double-sided adhesive.)
2. Release the ZIF connector (2) to which the touchpad cable is connected, and then disconnect the touchpad cable from the system board.
3. Remove the four Phillips M2.0 × 2.5 screws (3) that secure the touchpad to the top cover.
4. Remove the touchpad (4).

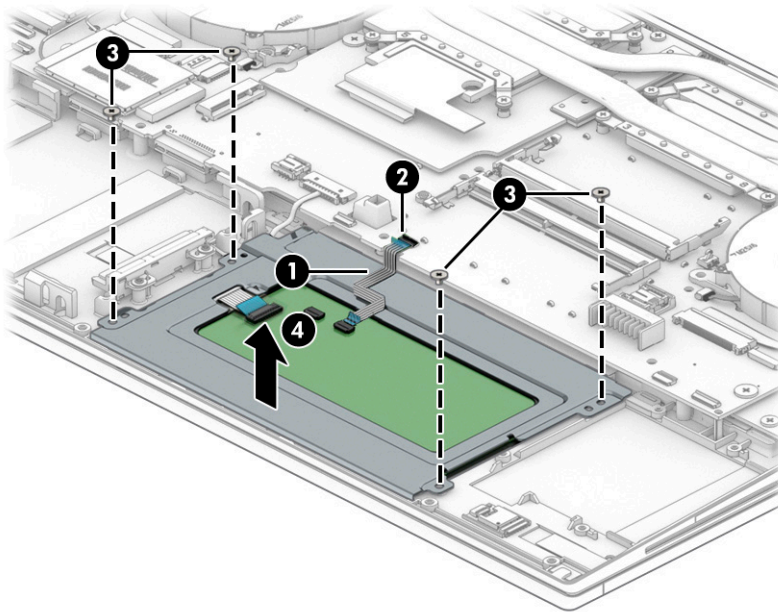

Reverse this procedure to install the touchpad.

NFC module cable

To remove the NFC module cable, use this procedure and illustration.

Table 6-9 NFC module cable description and part number

Description	Spare part number
NFC module cable	M17062-001

Before removing the NFC module cable, follow these steps:

1. Prepare the computer for disassembly (see [Preparation for disassembly on page 42](#)).
2. Remove the service cover (see [Service cover on page 42](#)).
3. Remove the battery (see [Battery on page 43](#)).
4. Remove solid-state drives 3 and 4 (see [Solid-state drives 3 and 4 on page 44](#)).
5. Remove the solid-state drive carriers (see [Solid-state drives 3 and 4 on page 44](#)).
6. Remove the hard drive (see [Hard drive on page 46](#)).

7. Remove the keyboard (see [Keyboard on page 55](#)).
8. Remove the bottom case (see [Bottom case on page 65](#)).

Remove the NFC module cable:

1. Release the ZIF connector (1) to which the NFC module cable is connected, and then disconnect the NFC module cable from the system board.
2. Release the ZIF connector (2) to which the NFC module cable is connected, and then disconnect the NFC module cable from the SD card board.
3. Detach the NFC module cable (3) from the top cover and remove it. (The NFC module cable is attached to the top cover with double-sided adhesive.)

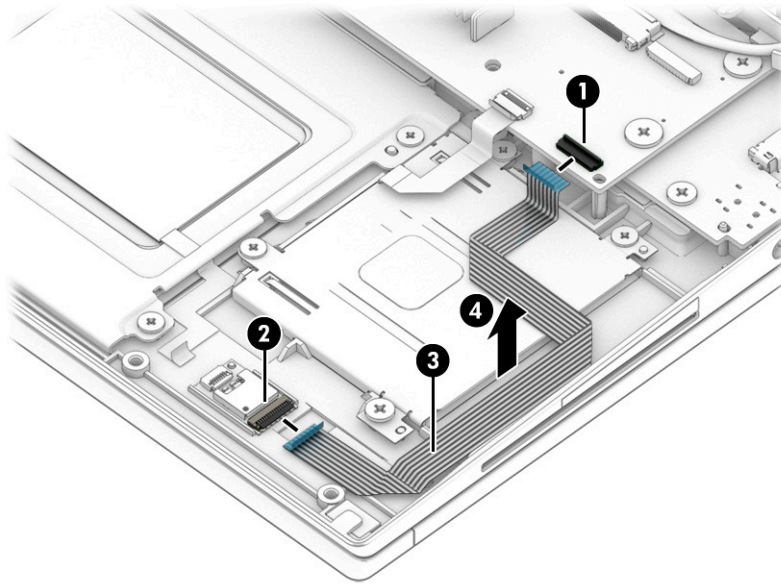

Reverse this procedure to install the NFC module cable.

NFC module

To remove the NFC module, use this procedure and illustration.

Table 6-10 NFC module description and part number

Description	Spare part number
NFC module	M17065-001

Before removing the NFC module, follow these steps:

1. Prepare the computer for disassembly (see [Preparation for disassembly on page 42](#)).
2. Remove the service cover (see [Service cover on page 42](#)).
3. Remove the battery (see [Battery on page 43](#)).

4. Remove solid-state drives 3 and 4 (see [Solid-state drives 3 and 4 on page 44](#)).
5. Remove the solid-state drive carrier (see [Solid-state drives 3 and 4 on page 44](#)).
6. Remove the hard drive (see [Hard drive on page 46](#)).
7. Remove the keyboard (see [Keyboard on page 55](#)).
8. Remove the bottom case (see [Bottom case on page 65](#)).

Remove the NFC module:

1. Release the ZIF connector (1) to which the NFC module cable is connected, and then disconnect the NFC module cable from the system board.
2. Release the ZIF connector (2) to which the NFC module cable is connected, and then disconnect the NFC module cable from the SD card board.
3. Detach and remove the NFC module cable (3) from the top cover. (The NFC module cable is attached to the top cover with double-sided adhesive.)
4. Remove the NFC module (4).

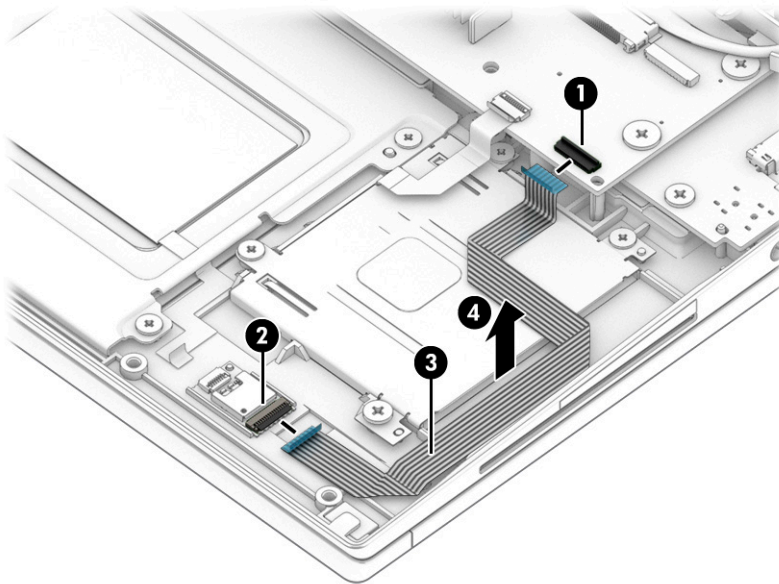

Reverse this procedure to install the NFC module.

Card reader board

To remove the card reader board, use this procedure and illustration.

Table 6-11 USB board description and part number

Description	Spare part number
Card reader board (includes cable)	M17063-001

Before removing the card reader board, follow these steps:

1. Prepare the computer for disassembly (see [Preparation for disassembly on page 42](#)).
2. Remove the service cover (see [Service cover on page 42](#)).
3. Remove the battery (see [Battery on page 43](#))
4. Remove solid-state drives 3 and 4 (see [Solid-state drives 3 and 4 on page 44](#)).
5. Remove the solid-state drive carriers (see [Solid-state drives 3 and 4 on page 44](#)).
6. Remove the hard drive (see [Hard drive on page 46](#)).
7. Remove the keyboard (see [Keyboard on page 55](#)).
8. Remove the bottom case (see [Bottom case on page 65](#)).

Remove the card reader board:

1. Release the ZIF connector (1) to which the card reader board cable is connected, and then disconnect the card reader board cable from the system board.
2. Detach the card reader board cable (2) from the top cover. (The card reader board cable is attached to the top cover with double-sided adhesive.)
3. Remove the four Phillips M2.0 × 2.5 broadhead screws (3) that secure the card reader board to the top cover.
4. Remove the card reader board (4) and cable.

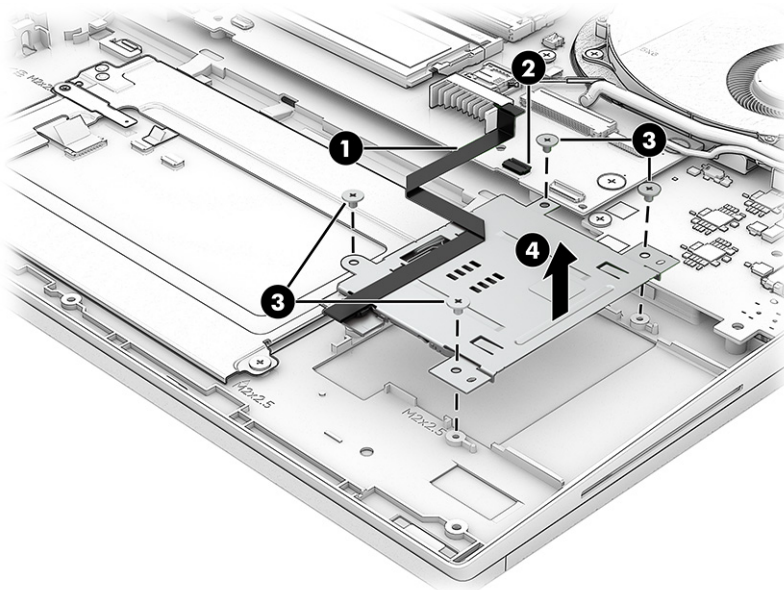

Reverse this procedure to install the card reader board.

Fan/heat sink assembly

To remove the heat sink, use these procedures and illustrations.

Table 6-12 Fan/heat sink assembly descriptions and part numbers

Description	Spare part number
All fan/heat sink assembly spare part kits include replacement thermal material	
For use on computer models equipped with an AMD graphics card	M75776-001
For use on computer models equipped with a graphics subsystem with discrete memory	M82623-001
For use on computer models equipped with a graphics subsystem with a vapor chamber	M75775-001
For use on computer models equipped with a graphics subsystem with UMA memory	M75773-001

Before removing the fan/heat sink assembly, follow these steps:

1. Prepare the computer for disassembly (see [Preparation for disassembly on page 42](#)).
2. Remove the bottom cover (see [Service cover on page 42](#)).
3. Remove the battery (see [Battery on page 43](#)).
4. Remove solid-state drives 3 and 4 (see [Solid-state drives 3 and 4 on page 44](#)).
5. Remove the solid-state drive carrier (see [Solid-state drives 3 and 4 on page 44](#)).
6. Remove the hard drive (see [Hard drive on page 46](#)).
7. Remove the keyboard (see [Keyboard on page 55](#)).
8. Remove the bottom case (see [Bottom case on page 65](#)).

Remove the heat sink:

1. Disconnect the fan cables **(1)** from the system board.
2. Release the webcam cable **(2)** and the wireless antenna cables from the retention clips **(3)** built into the right fan.
3. Release the display panel cable from the retention clips **(4)** built into the left fan.
4. Remove the four Phillips M2.5 × 6.0 screws **(5)** that secure the fan/heat sink assembly to the computer.
5. In the order indicated on the fan/heat sink assembly, loosen the eight captive Phillips screws **(6)** that secure the fan/heat sink assembly to the computer.

Computer models equipped with a graphics subsystem with UMA memory have only four captive screws securing the fan/heat sink assembly to the computer.

6. Lift the front edge of the fan/heat sink assembly **(7)** until it rests at an angle.

7. Remove the fan/heat sink assembly (8) by sliding it up and forward at an angle.

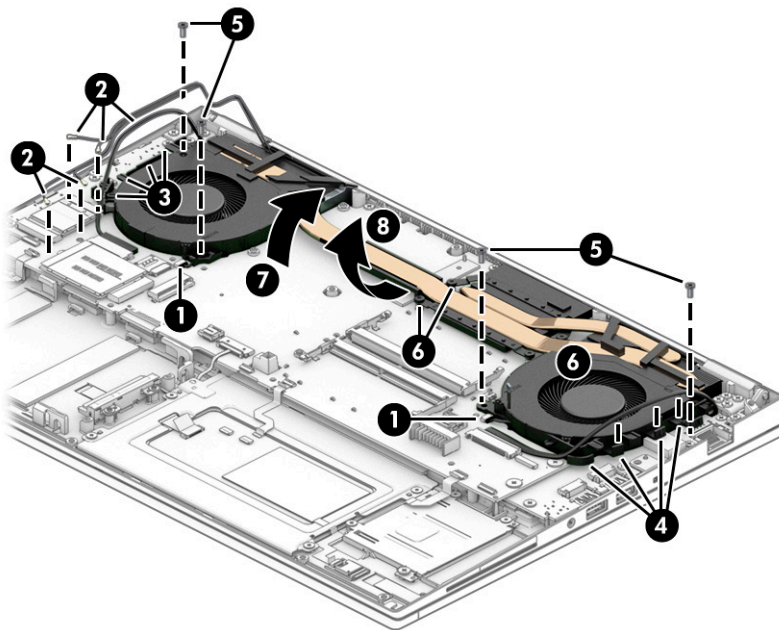
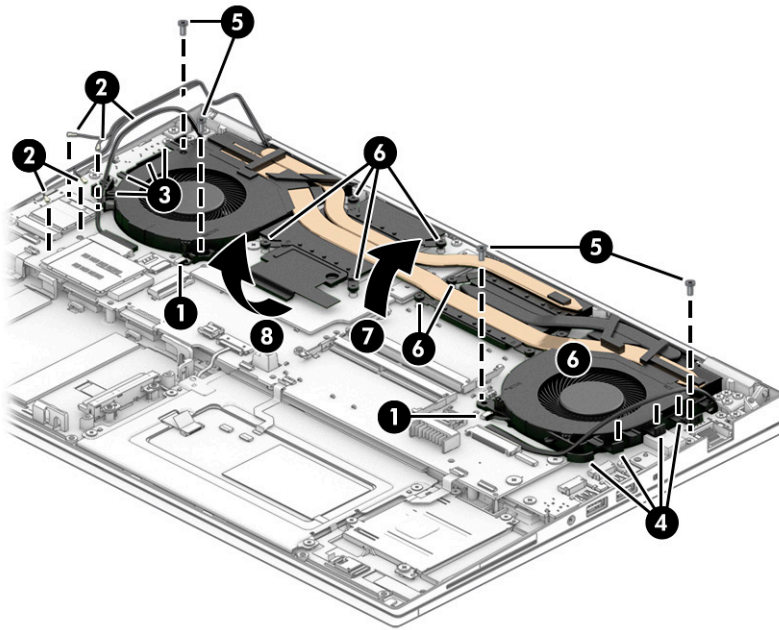

8. Thoroughly clean the thermal material from the surfaces of the heat sink and the system board components each time the heat sink is removed. Replacement thermal material is included with the heat sink and system board spare part kits. The following illustration shows the replacement thermal material locations.

Thermal paste is used on the processor (1) and on the fan/heat sink assembly area (2) that services the processor. Thermal pads are used on other system board components (3) and the fan/heat sink assembly areas (4) that service them.

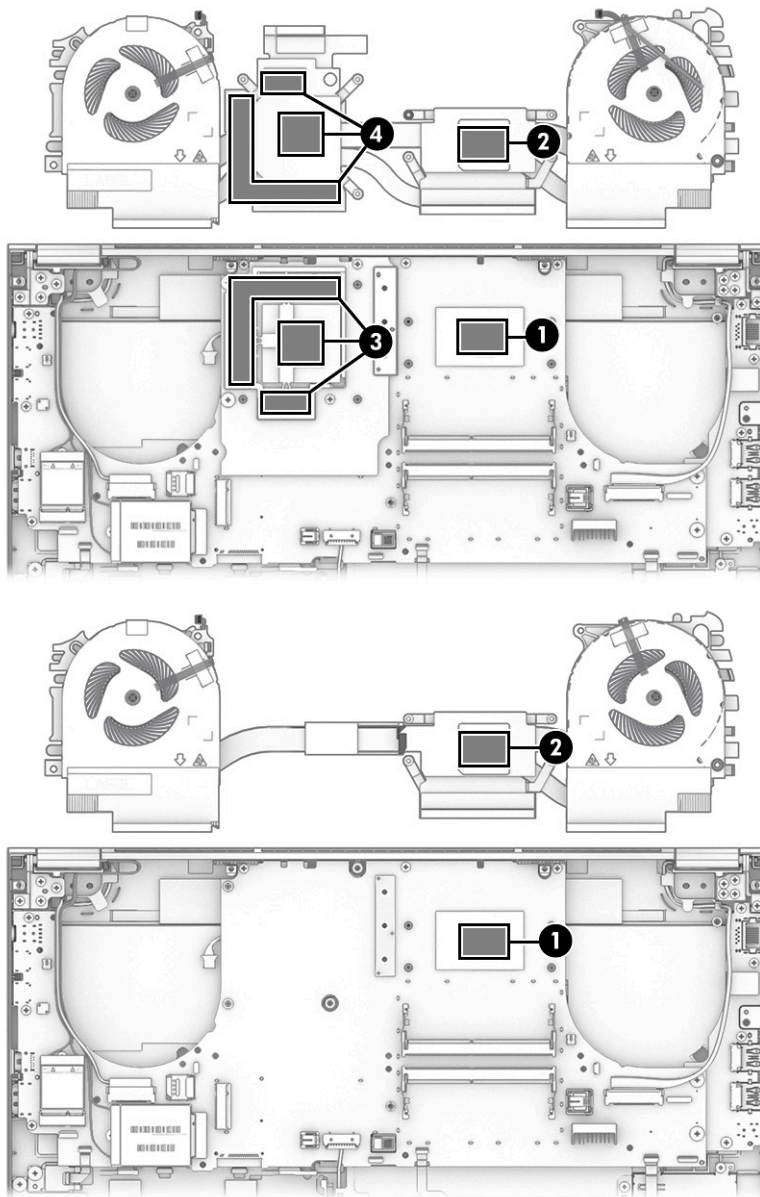

Reverse this procedure to install the fan/heat sink assembly.

Display assembly

To remove and disassemble the display assembly, use these procedures and illustrations.

The display assembly is available as a full hinge-up assembly. Full hinge-up assembly spare part information is presented in the following table.

Before removing the display panel, follow these steps:

1. Prepare the computer for disassembly (see [Preparation for disassembly on page 42](#)).
2. Remove the service cover (see [Service cover on page 42](#)).
3. Remove the battery (see [Battery on page 43](#)).

4. Remove solid-state drives 3 and 4 (see [Solid-state drives 3 and 4 on page 44](#)).
5. Remove the solid-state drive carriers (see [Solid-state drives 3 and 4 on page 44](#)).
6. Remove the hard drive (see [Hard drive on page 46](#)).
7. Remove the keyboard (see [Keyboard on page 55](#)).
8. Remove the bottom case (see [Bottom case on page 65](#)).
9. Remove the fan/heat sink assembly (see [Fan/heat sink assembly on page 78](#)).

Table 6-13 39.6 cm (15.6 in) display assembly description and part numbers

Description	Spare part number
Ultra high definition (UHD) (3840 × 1980), touchscreen display assembly with Dream Vision, infrared sensor; typical brightness: 600 nits	M75793-001
UHD (3840 × 1980), touchscreen display assembly; typical brightness: 600 nits, antiglare, Dream Vision, assembly with webcam and typical brightness: 400 nits	M75792-001
UHD (3840 × 1980), touchscreen display assembly; typical brightness: 600 nits, antiglare, Dream Vision, assembly with webcam and typical brightness: 400 nits	M75792-001
Full high definition (FHD) (1980 × 1080), antiglare, non-touchscreen display assembly with FHD webcam, and ambient light sensor; typical brightness: 1000 nits	M75787-001
FHD (1980 × 1080), antiglare, non-touchscreen display assembly with FHD webcam, and ambient light sensor; typical brightness: 1000 nits	M75788-001
FHD (1980 × 1080), antiglare, non-touchscreen display assembly with FHD webcam, infrared sensor, and ambient light sensor; typical brightness: 1000 nits	M75786-001
FHD (1980 × 1080), antiglare, non-touchscreen display assembly with FHD webcam, infrared sensor, and ambient light sensor; typical brightness: 1000 nits	M75789-001
FHD (1980 × 1080), antiglare, non-touchscreen display assembly with FHD webcam, and ambient light sensor; typical brightness: 400 nits	M75781-001
FHD (1980 × 1080), antiglare, non-touchscreen display assembly with FHD webcam, and ambient light sensor; typical brightness: 400 nits	M75782-001
FHD (1980 × 1080), antiglare, non-touchscreen display assembly with FHD webcam, infrared sensor, and ambient light sensor; typical brightness: 400 nits	M75783-001
FHD (1980 × 1080), antiglare, non-touchscreen display assembly with FHD webcam, and ambient light sensor; typical brightness: 250 nits	M757845-001
FHD (1980 × 1080), antiglare, non-touchscreen display assembly with FHD webcam, and ambient light sensor; typical brightness: 250 nits	M75784-001

Remove the display assembly:

1. Remove the WLAN module shield (1) and the WWAN module shield. The WLAN/WWAN module shields are included in the Shield Kit, spare part number M23349-001.
2. Disconnect the wireless antenna cables (2) from the WLAN module and the WWAN module.

The #1/Main WLAN antenna cable connects to the WLAN module #1/Main terminal. The #2/Aux WLAN antenna cable connects to the WLAN module #2/Aux terminal. The #5/Main WWAN antenna cable connects to the WWAN module #5/Main terminal. The #6/Aux WWAN antenna cable connects to the WWAN module #6/Aux terminal.

3. Disconnect the webcam module cable (3) from the system board.
4. Release the webcam module cable and the wireless antenna cables from the retention clips (4) built into the top cover.
5. Disconnect the display panel cable (5) from the system board.
6. Release the display panel cable from the retention clips (6) built into the top cover.

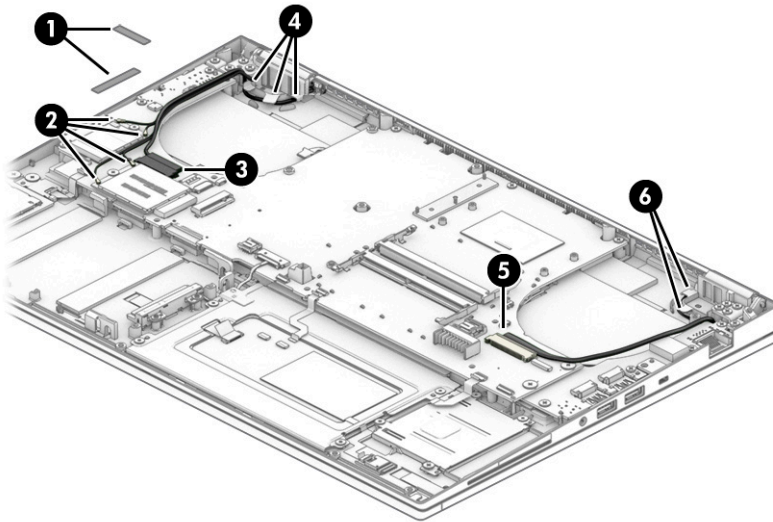

7. Remove the nine Phillips M2.5 × 6.0 screws (1) that secure the display assembly to the computer.

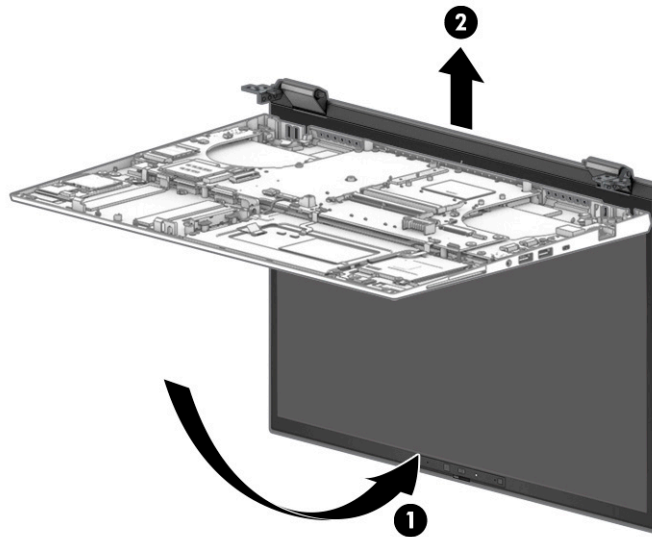

Reverse this procedure to replace the display assembly.

8. If you need to replace display assembly subcomponents:
 - a. Flex the top (1) and the inside edges of the left and right sides of the bezel (2) to release it.
 - b. Slide a flat tool across the inside of the bottom of the bezel to release it (3), and then remove the bezel from the display (4).

The bezel is available as spare part numbers M75759-001, M75760-001, and M75761-001.

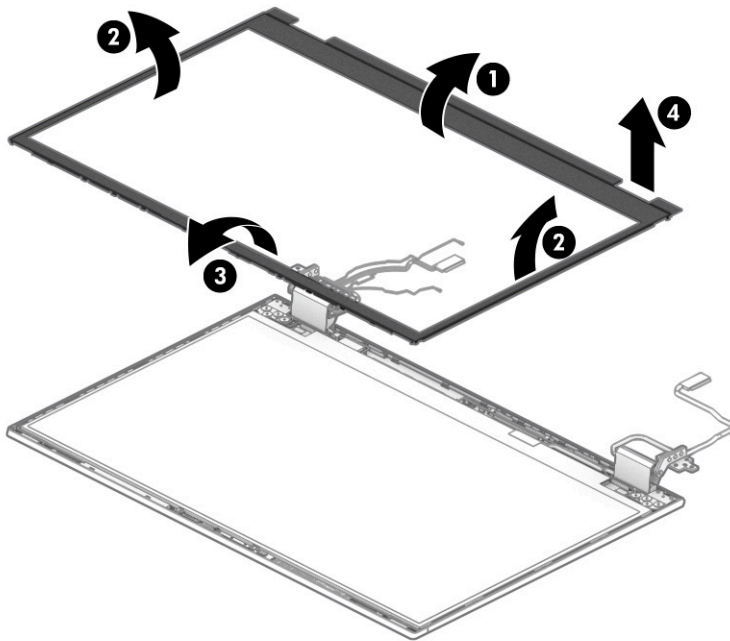

9. If you need to remove the hinges from the display enclosure:

- a. Release the latches (1), and remove the hinge cables from the left side (2) and then the right side (3).

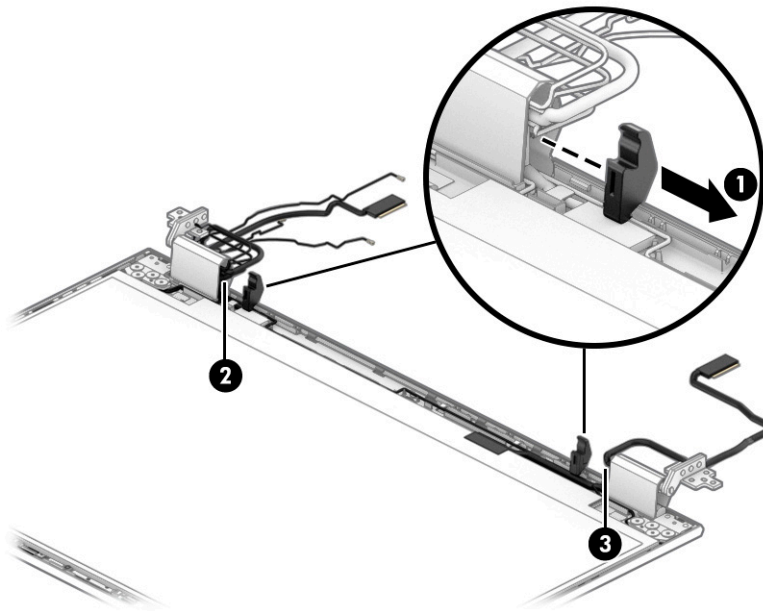

- b. Remove the four Phillips broadhead M2.0 × 2.0 screws (1) from each hinge.
- c. Remove the hinges from the display (2).

The display hinges are available as spare part number M17072-001.

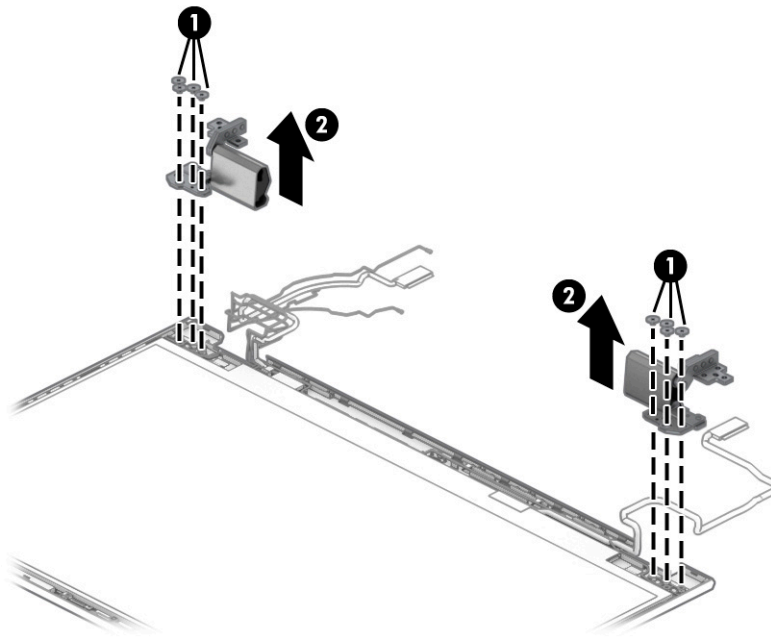

Reverse this procedure to reassemble and replace the display assembly.

Beam connector

To remove the beam connector, use this procedure and illustration.

Table 6-14 Beam connector description and part number

Description	Spare part number
Beam connector ((includes plastic installation tool and replacement thermal material)	M86387-001

The beam connector ships attached to a plastic installation tool that is packaged inside a sealed plastic container. Extra precautions have been taken to prevent any unnecessary contact with the pins on the beam connector, which are delicate. Take every precaution not to directly touch the beam connector when installing the beam connector.

Before removing the beam connector, follow these steps:

1. Prepare the computer for disassembly (see [Preparation for disassembly on page 42](#)).
2. Remove the service cover (see [Service cover on page 42](#)).
3. Remove the battery (see [Battery on page 43](#)).
4. Remove solid-state drives 3 and 4 (see [Solid-state drives 3 and 4 on page 44](#)).
5. Remove the solid-state drive carrier (see [Solid-state drives 3 and 4 on page 44](#)).
6. Remove the hard drive (see [Hard drive on page 46](#)).
7. Remove the keyboard (see [Keyboard on page 55](#)).
8. Remove the bottom case (see [Bottom case on page 65](#)).
9. Remove the fan/heat sink assembly (see [Fan/heat sink assembly on page 78](#)).

Remove the beam connector:

1. Remove the three Phillips M2.0 × 6.5 broadhead screws (1) that secure the beam connector and bracket to the computer.
2. Remove the beam connector bracket (2).

The beam connector bracket will be reused when installing the new beam connector.

3. Remove the beam connector (3).

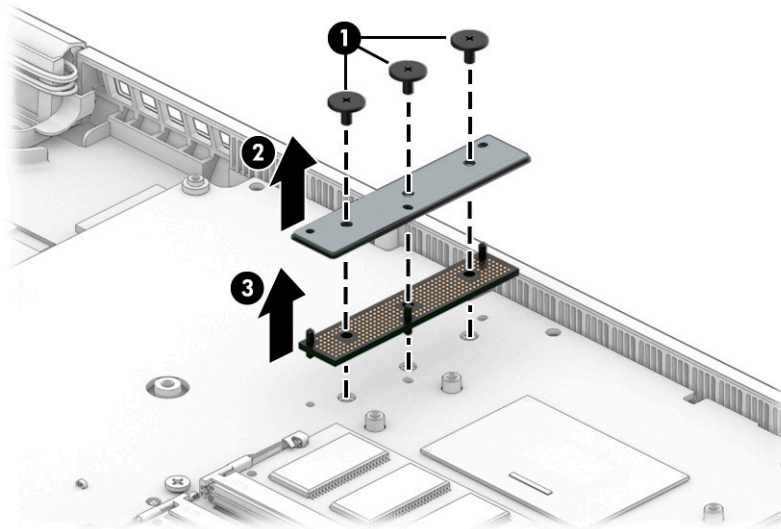

NOTE: The replacement beam connector is packaged in a plastic tray with an installation tool to avoid damage and contamination. Special care should be taken during replacement.

4. Align the pins on the replacement beam connector with the holes in the system board, and then carefully install the beam connector (1) onto the socket on the system board.
5. Without moving the beam connector, press the installation tool release tabs (2) together to release the beam connector.

6. Remove the installation tool

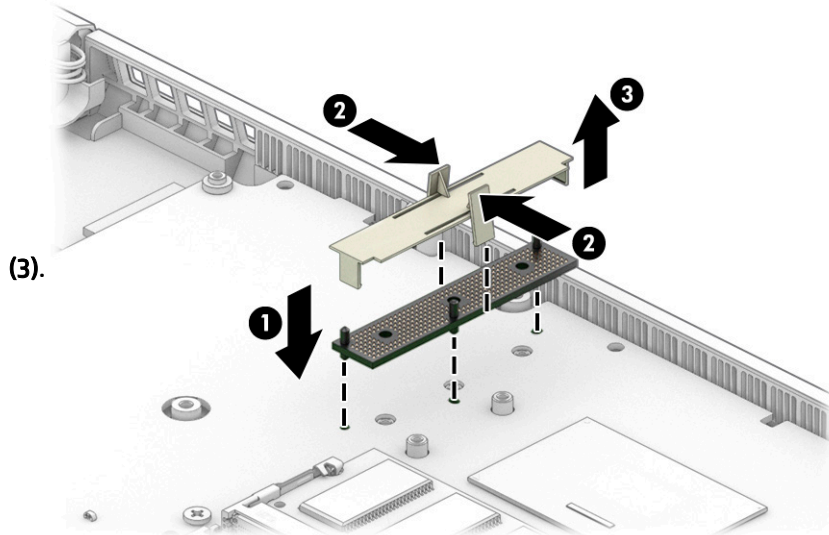

7. Align the holes on the beam connector bracket with the pins on the beam connector, and then install the beam connector bracket (1).

8. Install the three Phillips M2.0 × 2.9 broadhead screws (2) to secure the beam connector and bracket to the computer.

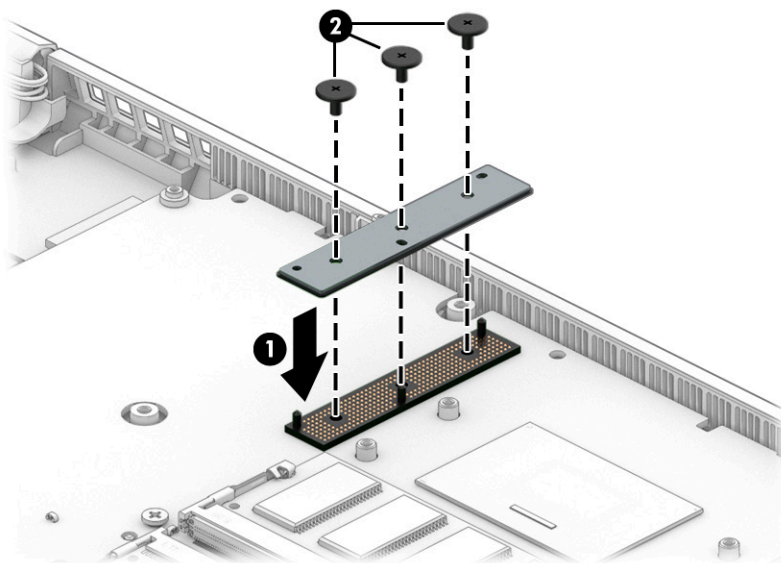

Graphics card

To remove the graphics card, use this procedure and illustration.

Table 6-15 Graphics card description and part number

Description	Spare part number
AMD W 6600M graphics card with 8 GB integrated memory	M76116-001
AMD Thermal Pad Kit	M83913-001
NVIDIA RTX 3000 graphics card with 6 GB integrated memo	M76119-001

Table 6-15 Graphics card description and part number (continued)

Description	Spare part number
NVIDIA RTX 4000 graphics card with 8 GB integrated memory	M76120-001
NVIDIA RTX 5000 graphics card with 16 GB integrated memory	M76121-001
NVIDIA T1000 graphics card with 4 GB integrated memory	M76117-001
NVIDIA T2000 graphics card with 2 GB integrated memory	M76118-001
NVIDIA Thermal Pad Kit	M83915-001

Before removing the graphics card, follow these steps:

1. Prepare the computer for disassembly (see [Preparation for disassembly on page 42](#)).
2. Remove the service cover (see [Service cover on page 42](#)).
3. Remove the battery (see [Battery on page 43](#)).
4. Remove solid-state drives 3 and 4 (see [Solid-state drives 3 and 4 on page 44](#)).
5. Remove the solid-state drive carrier (see [Solid-state drives 3 and 4 on page 44](#)).
6. Remove the hard drive (see [Hard drive on page 46](#)).
7. Remove the keyboard (see [Keyboard on page 55](#)).
8. Remove the bottom case (see [Bottom case on page 65](#)).
9. Remove the fan/heat sink assembly (see [Fan/heat sink assembly on page 78](#)).
10. Remove the beam connector (see [Beam connector on page 85](#)).

Remove the graphics card:

1. Remove the two Phillips M2.0 × 6.0 and Phillips M2.0 × 1.7 screws (1) that secure the graphics card to the system board.

- Slide the graphics card (2) away from the system board slot, and remove it.

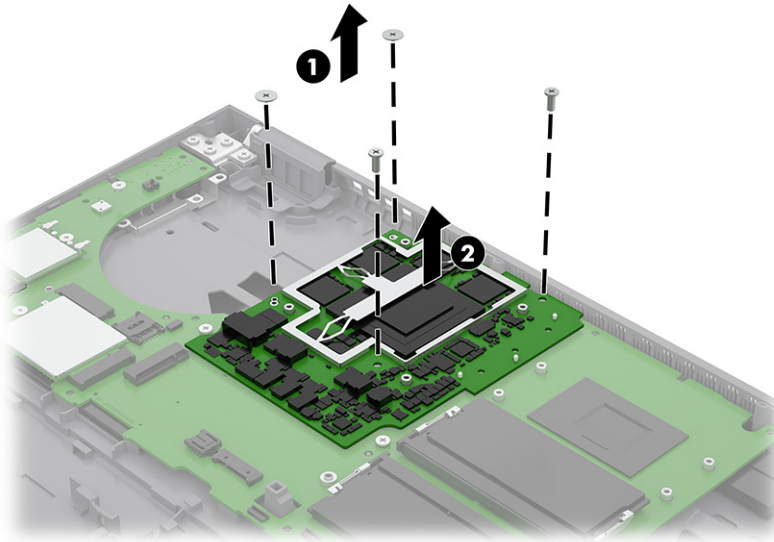

Reverse this procedure to install the graphics card.

System board

To remove the system board, use these procedures and illustrations.

Table 6-16 System board descriptions and part numbers

Description	Spare part number
System board (includes processor):	
Equipped with an Intel Core W-11955M processor and a non-Windows 10 operating system for use only on computers not equipped with WWAN capability	M87581-001
Equipped with an Intel Core W-11955M processor and the Windows 10 operating system for use only on computers not equipped with WWAN capability	M87581-601
Equipped with an Intel Core W-11955M processor and a non-Windows 10 operating system for use only on computers equipped with WWAN capability	M87581-001
Equipped with an Intel Core W-11955M processor and the Windows 10 operating system for use only on computers equipped with WWAN capability	M87581-601
Equipped with an i5-11500H processor and a non-Windows 10 operating system for use only on computers equipped with WWAN capability	M76123-001
Equipped with an Intel Core i5-11500H processor and the Windows 10 operating system for use only on computers equipped with WWAN capability	M76123-601
Equipped with an Intel Core i5-11500H processor and a non-Windows 10 operating system for use only on computers equipped with WWAN capability	M87576-001
Equipped with an Intel Core i5-11500H processor and the Windows 10 operating system for use only on computers equipped with WWAN capability	M87576-601
Equipped with an Intel Core i7-11800H processor and a non-Windows 10 operating system for use only on computers equipped with WWAN capability	M75777-001

Table 6-16 System board descriptions and part numbers (continued)

Description	Spare part number
Equipped with an Intel Core i7-11800H processor and the Windows 10 operating system for use only on computers equipped with WWAN capability	M75777-601
Equipped with an Intel Core i7-11850H processor and a non-Windows 10 operating system for use only on computers equipped with WWAN capability	M75778-001
Equipped with an Intel Core i7-11850H processor and the Windows 10 operating system for use only on computers equipped with WWAN capability	M75778-601
Equipped with an Intel Core i7-11800H processor and a non-Windows 10 operating system for use only on computers not equipped with WWAN capability	M87577-001
Equipped with an Intel Core i7-11850H processor and a non-Windows 10 operating system for use only on computers not equipped with WWAN capability	M87578-001
Equipped with an Intel Core i7-11850H processor and the Windows 10 operating system for use only on computers not equipped with WWAN capability	M87578-601
Equipped with an Intel Core i9-11900H processor and a non-Windows 10 operating system for use only on computers not equipped with WWAN capability	M87579-001
Equipped with an Intel Core i9--11900H processor and the Windows 10 operating system for use only on computers not equipped with WWAN capability	M87579-601
Equipped with an Intel Core i9-11950H processor and a non-Windows operating system for use only on computers not equipped with WWAN capability	M87580-001
Equipped with an Intel Core i9-11950H processor and the Windows 10 operating system for use only on computers not equipped with WWAN capability	M87580-601
Equipped with an Intel Core i9-11950H processor and a non-Windows operating system for use only on computers equipped with WWAN capability	M75779-001
Equipped with an Intel Core i9-11950H processor and the Windows 10 operating system for use only on computers equipped with WWAN capability	M75779-601
Equipped with an Intel Core i9-11900H processor and a non-Windows operating system for use only on computers equipped with WWAN capability	M76124-001
Equipped with an Intel Core i9-11900H processor and the Windows 10 operating system for use only on computers equipped with WWAN capability	M76124-601

Before removing the system board, follow these steps:

1. Prepare the computer for disassembly (see [Preparation for disassembly on page 42](#)).
2. Remove the service cover (see [Service cover on page 42](#)).
3. Remove the battery (see [Battery on page 43](#)).
4. Remove solid-state drives 3 and 4 (see [Solid-state drives 3 and 4 on page 44](#)).
5. Remove the solid-state drive carrier (see [Solid-state drives 3 and 4 on page 44](#)).
6. Remove the hard drive (see [Hard drive on page 46](#)).
7. Remove the keyboard (see [Keyboard on page 55](#)).
8. Remove the memory module compartment cover for modules 1 and 3 (see [Memory modules 1 and 3 on page 59](#)).

9. Remove solid-state drive 1 (see [Solid-state drive 1 on page 62](#)).
10. Remove the bottom case (see [Bottom case on page 65](#)).

When you replace the system board, be sure to remove the following components (as applicable) from the defective system board and install them on the replacement system board:

- Memory modules (see [Memory modules 2 and 4 on page 53](#) and [Memory modules 1 and 3 on page 59](#)).
- WWAN module (see [WWAN module on page 49](#)).
- WLAN module (see [WLAN module on page 48](#)).
- Fan/heat sink assembly (see [Fan/heat sink assembly on page 78](#)).
- RTC battery (see [RTC battery on page 94](#)).

Remove the system board:

1. Turn the computer right side up with the front toward you.
2. Open the computer.
3. Disconnect the speaker cable from the system board.

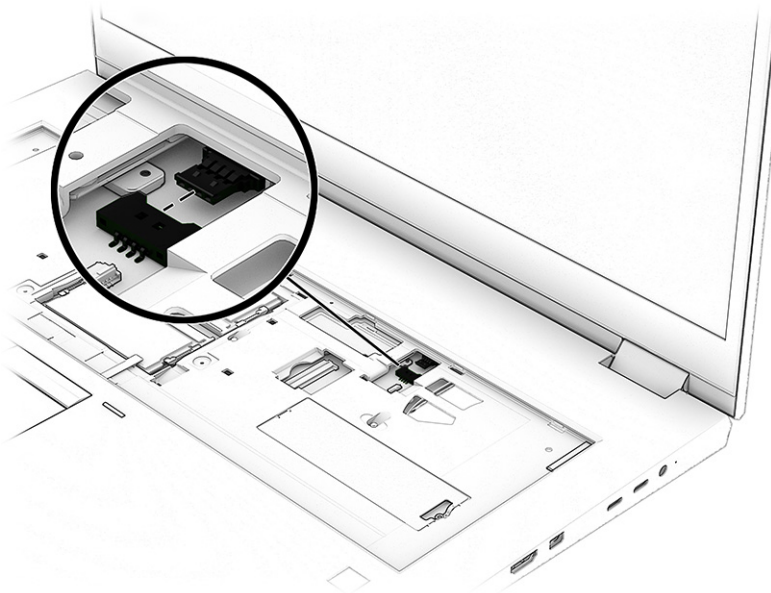

4. Close the computer.
5. Turn the computer upside down with the front toward you.
6. Remove the WLAN module shield **(1)**.

The WLAN module shield is included in the Shield Kit, spare part number M23344-001.

7. Disconnect the wireless antenna cables **(2)** from the WWAN module.

The #5/blue WWAN antenna cable connects to the WWAN module #5/Main terminal. The #6/red WWAN antenna cable connects to the WWAN module #6/Aux terminal.

8. Release the webcam cable and the wireless antenna cables from the retention clips **(3)** built into the right fan.
9. Disconnect the webcam cable **(4)** and the display panel cable **(5)** from the system board.
10. Release the display panel cable from the retention clips **(6)** built into the left fan.
11. Disconnect the following cables from the system board:
 - NFC module cable (ZIF) **(7)**
 - Card reader board cable (NFC) **(8)**
 - Touchpad cable (ZIF) **(9)**
 - Hard drive cable **(10)**
12. Remove the WWAN module shield **(11)**.
The WWAN module shield is included in the Shield Kit, spare part number M23344-001.
13. Disconnect the wireless antenna cables (12) from the WWAN module.
The #5/blue WWAN antenna cable connects to the WWAN module #5/Main terminal. The #6/red WWAN antenna cable connects to the WWAN module #6/Aux terminal.
14. Disconnect the following cables from the system board:
 - Fingerprint reader module cable (ZIF) (13)
 - SD card board cable (ZIF) (14)

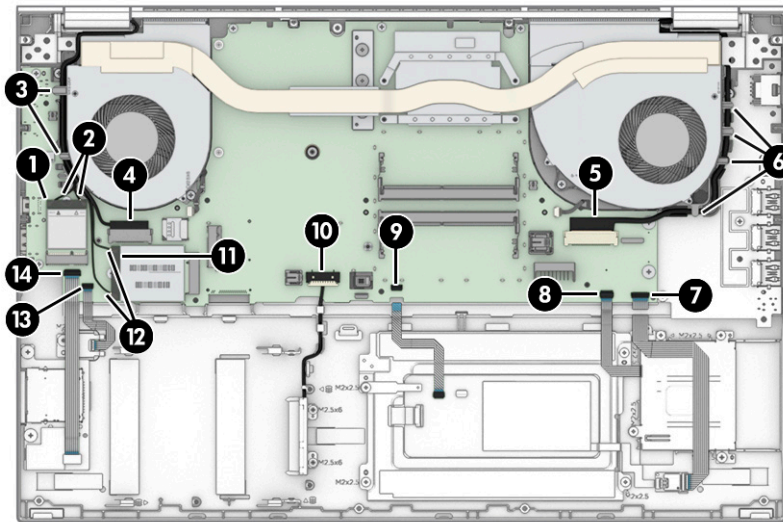

15. Remove the following screws:
 - a. Five Phillips M2.5 × 6.0 screws that secure the system board to the computer **(1)**
 - b. Four Phillips M2.5 × 6.0 screws that secure the fans to the computer **(2)**
 - c. Two Phillips M2.0 × 2.0 screws that secure the system board to the computer **(3)**

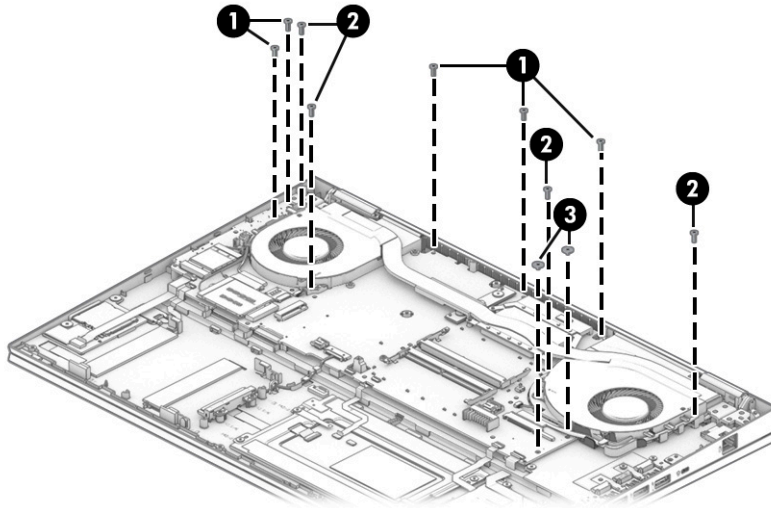

16. Lift the front right edge of the system board (1) until it rests at an angle. When the system board is released, it is disconnected from the I/O board (2).
17. Remove the system board (3).

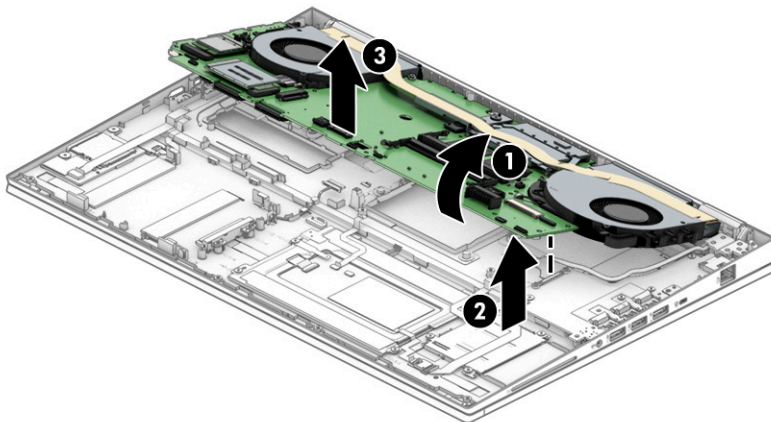

 **NOTE:** A thermal pad services the chip (2) on the top of the system board and is located on the heat sink (1) built into the top cover. Inspect this pad each time that the cover is removed. This pad is intended to be reused if it is not damaged. If this pad is damaged and any residue remains on the system board chip or top cover, thoroughly remove and replace it. If protective releasing paper is attached to the thermal pad, remove it before replacement.

18. Identify the thermal material locations.

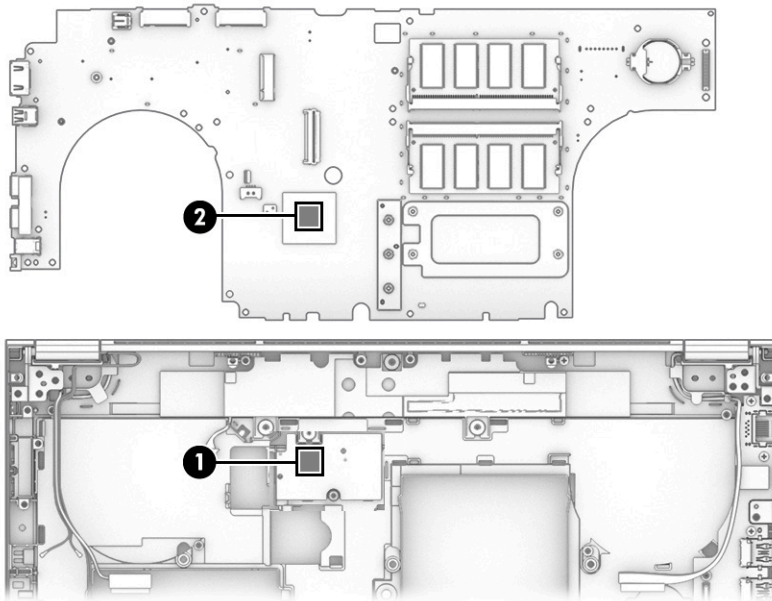

Reverse this procedure to install the system board.

RTC battery

To remove the RTC battery, use this procedure and illustration.

Before removing the RTC battery, follow these steps:

1. Prepare the computer for disassembly (see [Preparation for disassembly on page 42](#)).
2. Remove the service cover (see [Service cover on page 42](#)).
3. Remove the battery (see [Battery on page 43](#)).
4. Remove solid-state drives 3 and 4 (see [Solid-state drives 3 and 4 on page 44](#)).
5. Remove solid-state drive carrier (see [Solid-state drives 3 and 4 on page 44](#)).
6. Remove the hard drive (see [Hard drive on page 46](#)).
7. Remove the keyboard (see [Keyboard on page 55](#)).
8. Remove the memory module compartment cover for memory modules 1 and 3 (see [Memory modules 1 and 3 on page 59](#)).
9. Remove solid-state drive 1 (see [Solid-state drive 1 on page 62](#)).
10. Remove the bottom case (see [Bottom case on page 65](#)).
11. Remove the system board (see [System board on page 89](#)).

Remove the RTC battery:

1. Turn the removed system board upside down with the front toward you.

2. Insert a case utility tool (1) or similar thin plastic tool into the slot on the RTC battery socket and remove the RTC battery (2) from the socket.

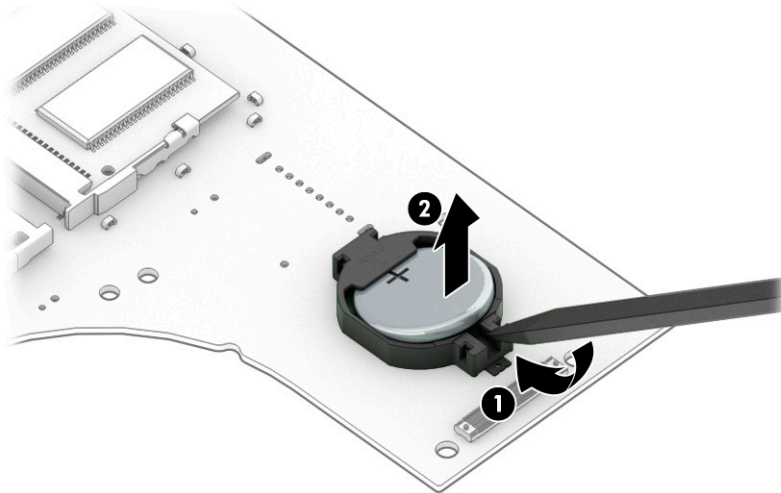

Reverse this procedure to install the RTC battery.

I/O board

To remove the I/O board, use this procedure and illustration.

Table 6-17 I/O board description and part number

Description	Spare part number
I/O board (For use only on vPro computer models)	M75767-001
I/O board (For use only on non-vPro computer models)	M75768-001

Before removing the I/O board, follow these steps:

1. Prepare the computer for disassembly ([Preparation for disassembly on page 42](#)).
2. Remove the service cover (see [Service cover on page 42](#)).
3. Remove the battery (see [Battery on page 43](#)).
4. Remove solid-state drives 3 and 4 (see [Solid-state drives 3 and 4 on page 44](#)).
5. Remove the solid-state drive carrier (see [Solid-state drives 3 and 4 on page 44](#)).
6. Remove the hard drive (see [Hard drive on page 46](#)).
7. Remove the keyboard (see [Keyboard on page 55](#)).
8. Remove the memory module compartment cover for memory modules 1 and 3 (see [Memory modules 1 and 3 on page 59](#)).
9. Remove solid-state drive 1 (see [Solid-state drive 1 on page 62](#)).
10. Remove the bottom case (see [Bottom case on page 65](#)).

11. Remove the system board (see [System board on page 89](#)).

Remove the I/O board:

1. Remove the two Phillips M2.5 × 6.0 screws (1) that secure the I/O board to the computer.
2. Remove the I/O board (2).

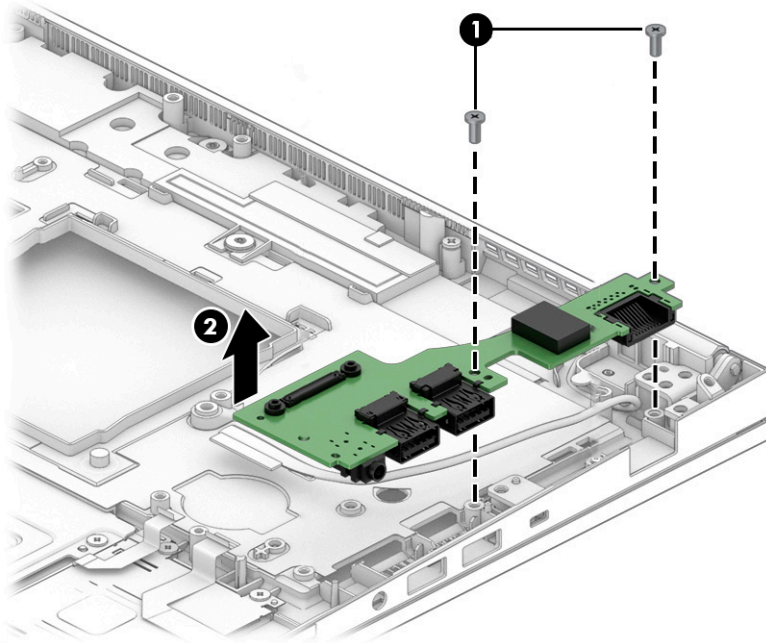

Reverse this procedure to install the I/O board.

Speakers

To remove the speakers, use this procedure and illustration.

Table 6-18 Speaker description and part number

Description	Spare part number
Speaker Kit	M17067-001

Before removing the speakers, follow these steps:

1. Prepare the computer for disassembly (see [Preparation for disassembly on page 42](#)).
2. Remove the service cover (see [Service cover on page 42](#)).
3. Remove the battery (see [Battery on page 43](#)).
4. Remove solid-state drives 3 and 4 (see [Solid-state drives 3 and 4 on page 44](#)).
5. Remove the solid-state drive carrier (see [Solid-state drives 3 and 4 on page 44](#)).
6. Remove the hard drive (see [Hard drive on page 46](#)).
7. Remove the keyboard (see [Keyboard on page 55](#)).

8. Remove the memory module compartment cover for memory modules 1 and 3 (see [Memory modules 1 and 3 on page 59](#))
9. Remove solid-state drive 1 (see [Solid-state drive 1 on page 62](#)).
10. Remove the bottom case (see [Bottom case on page 65](#)).
11. Remove the system board (see [System board on page 89](#)).

Remove the speakers:

1. Remove the three Phillips M2.0 × 1.7 broadhead screws (1) that secure the speakers to the top cover.
2. Remove the speakers from the computer (2).

When removing the speakers, make note of the location of the rubber isolator locations (3). The absence of these or damage to these isolators can result in degraded speaker performance.

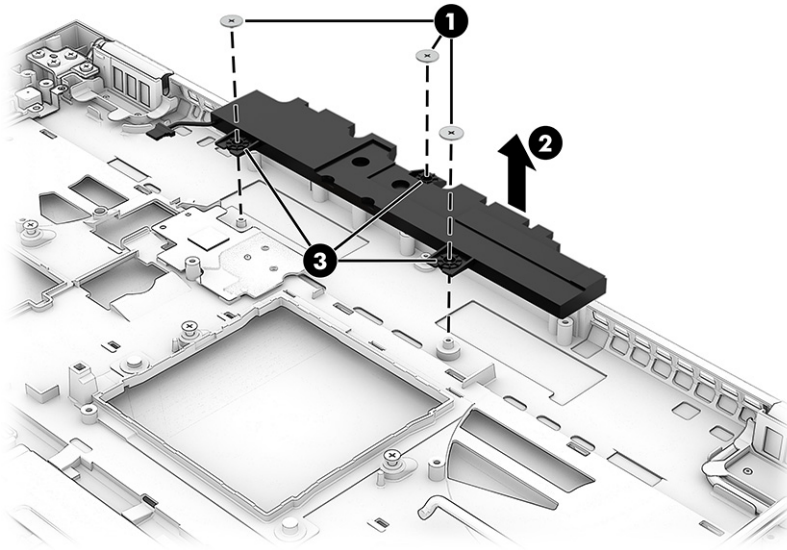

Reverse this procedure to install the speakers.

7 Troubleshooting guide

This chapter primarily focuses on troubleshooting HP Mobile Workstations. The information is provided so that you can solve problems yourself or at least narrow down the number of possible causes.

Based on some of the most common symptoms, this chapter identifies logical steps and available resources or tools for resolving an issue. HP recommends that you follow the instructions carefully, observe safety precautions, and note any observations or results. Capturing this information can help identify and resolve the problem more quickly.

 **WARNING!** To reduce the risk of electric shock or damage to the equipment:

- Do not disable the power cord grounding plug. The grounding plug is an important safety feature.
- Plug the power cord into a grounded (earthed) outlet that is easily accessible at all times.
- Disconnect power from the equipment by unplugging the power cord from the AC outlet.
- Before disassembling notebooks, always disconnect power and remove the battery.

 **IMPORTANT:** Static electricity can damage the electronic components of the computer. To prevent damage to the computer, carefully observe the electrostatic discharge precautions.

- Discharge static electricity by briefly touching a grounded metal object before you begin.
- Work on a static-free mat.
- Wear a static strap to ensure that any accumulated electrostatic charge is discharged from your body to the ground.
- Create a common ground for the equipment that you are working on by connecting the static-free mat, static strap, and peripheral units to that piece of equipment.
- For more information, see [Electrostatic discharge information on page 34](#).

 **IMPORTANT:** The computer includes customer self-repair parts and parts that should be accessed only by an authorized service provider. Accessing parts described in the chapter titled "Removal and replacement procedures for authorized service provider only parts" can damage the computer or void the computer warranty.

Resources

Use this table to locate troubleshooting resources.

Table 7-1 Troubleshooting resources and their descriptions

HP Resource Tool	Description	Link
HP Elite Support	Provides live HP Premium support (available 24/7) to Elite computers.	http://www8.hp.com/us/en/ads/elite-products/overview.html
HP Customer Support	Provides important support, such as warranty, support cases, drivers, Customer Advisories, Customer and Security Bulletins, and Product Change Notices.	https://support.hp.com/us-en/contact-hp

Table 7-1 Troubleshooting resources and their descriptions (continued)

HP Resource Tool	Description	Link
Subscribers Choice	Allows you to sign up for HP product updates.	http://www8.hp.com/us/en/subscribe/
HP Support Forums	Provide discussions about HP products and issues.	http://h30434.www3.hp.com/psq/
Service Access Workbench (SAW) (available for technicians and Business Partners only)	Provides navigable content intended for use by internal and outsourced call center staff and can be a resource for support and product division professionals.	http://sawpro.atlanta.hp.com/km/saw/home.do
Vendors' web sites	Provide additional information for associated components such as Intel (processor, WLAN), Microsoft (Windows 7, 8, 10), AMD®/NVIDIA® (GPU), and so on.	http://www.intel.com/content/www/us/en/homepage.html http://www.amd.com http://www.nvidia.com

General troubleshooting steps

This section helps you become familiar with troubleshooting methodology and efficiently resolve problems.

Proceed through the steps in the following table until the issue is resolved, and then move on to the next step that is relevant to the issue. For example, if you resolve a memory issue using the HP PC Diagnostics (UEFI) tool in step 6, you can then move on to step 10 to reseal the memory into its memory slot.



NOTE: You can ignore troubleshooting steps that do not apply to your issue.

Table 7-2 Troubleshooting methodology and general troubleshooting steps

Identify issue	Analyze issue	Resolve issue	Verify solution
1. Understand the issue on page 100	5. Remove or uninstall recently added hardware, software on page 103	8. Hard reset on page 109	Verify solution on page 113
2. Examine the environment on page 102	6. HP Hardware Diagnostics and Tools on page 103	9. Soft reset (Default Settings) on page 110	
3. Perform a visual inspection of hardware on page 102	Status lights on page 106	10. Reseat cables and connections on page 110	
4. Update BIOS and drivers on page 103		11. Test with minimum configuration on page 111	
		12. Test with verified working configuration (hardware or operating system) on page 112	
		13. Replace the system board on page 112	

Identify the issue

Use these guidelines to correctly determine the problem.

1. Understand the issue

It is important to understand the issue that occurred, including related symptoms. It helps to understand the basic computer boot-up sequence as well as the failure itself.

Boot up sequence

The computer performs several steps after you press the power button or restart the computer.

It is important to understand where in the boot-up sequence the symptoms occur. The following table lists the phases of the boot-up sequence and explains the symptoms that may occur in each phase. For example, a blue screen error (BSOD) often occurs during the performance phase.

Table 7-3 Boot-up sequence and associated failures

Item	Procedure
Startup	<p>After you press the power button, the computer boots after all internal power rails (such as 5 V, 3.3 V) are stable.</p> <p>Confirm that power lights are on and fan is spinning.</p> <p>Common issues: all lights are off; troubleshooting lights are on; computer does not boot; video is absent.</p>
POST (UEFI/BIOS)	<p>Power-On Self-Test (POST) verifies that hardware components (such as processor, hard drive, memory) are functional. When POST is complete, the HP logo appears briefly and then disappears.</p> <p>If there are errors, the computer may exhibit blinking lights and POST error messages, and so on.</p> <p>Common issues: lights blink; error message appears; system hangs (lock up or freezes)</p>
Performance (operating system)	<p>System boots to operating system, and Windows logo screen appears.</p> <p>Common issues: hangs, blue screen, distorted video, driver conflict, slow performance, display issue (dead pixel), I/O issue (no speaker sound), wireless/audio unavailable, noise.</p> <p>See Analyze the issue on page 103 table for detailed troubleshooting information.</p>

Failure classification

Failure classification is a breakdown of different types of failures and symptoms that could occur during the boot-up sequence.

[Failure classification by boot-up sequence on page 101](#) and [Table 7-5 Failure classification by hardware devices on page 101](#) represent the failure classification for common notebook failures.

[Failure classification by boot-up sequence on page 101](#) categorizes failures by the boot-up sequence.

1. Power-on: Common issues are no power, recycle, or reboot.
2. POST: Common issues are no boot (despite power), light flash, or diagnostics error.
3. Performance: Common issues are Intermittent Loss of Power, Blue Screen, Hang. In many cases, issues can be identified and associated with particular hardware (for example, display or storage).

[Table 7-5 Failure classification by hardware devices on page 101](#) categorizes failures by hardware:

- Display
- I/O (input/output) devices

- Storage
- Mechanical

A single symptom can be listed under different groups. For example, No Video can belong to (1) power-on or (4) display; but flickering when turned on should be listed in (4) display. Or, in another example, a blue screen can be caused by a driver conflict in performance (4), but it can also be caused by a defective hard drive under (6) storage. Therefore, failures that share similar symptoms are noted.

If possible, make a record of the failure symptom, the phase of the boot-up sequence where the failure occurs, and the most likely location in the failure tree ([Failure classification by boot-up sequence on page 101](#) and [Table 7-5 Failure classification by hardware devices on page 101](#)). This record helps isolate the issue and indicate the next steps. For example, when the computer is running the operating system, it can experience an issue with (4) display, (5) I/O devices (keyboard, wireless, and so on), (6) storage, or (7) mechanical components (stuck buttons, thermal shutdown, and so on).



NOTE: *Uncategorized* is used if an issue found is not listed. For example, Bluetooth is offered on certain hardware configurations; therefore, you can classify a Bluetooth issue under I/O Device if needed.

Failure classification by boot-up sequence

Use this table to locate failure classification information.

Table 7-4 Failure classification by boot-up sequence

1. Power-on	2. POST	3. Performance
1. No power on page 115	1. No video (with power) on page 122	1. Intermittent shutdown on page 125^a
2. Intermittent power-on, shutdown, reboot on page 117^a	2. Blinking lights on page 123	2. Blue screen on page 126^b
3. AC adapter issue on page 118	3. Diagnostic error messages on page 124	3. Freeze at Windows Logo (hang or lockup) on page 128
4. Battery not recognized, not charging on page 119	4. BIOS password on page 124	4. Electromagnetic Interference (EMI) on page 129
5. Battery discharges too fast on page 120		5. No wake up on page 129
6. Burnt smell on page 121		6. Unresponsive on page 130
		7. Slow performance on page 131^c
		8. HP Smart Adapter warning message on page 131
		9. Incorrect time and date on page 132

^{a,b,c} similar symptoms

Failure classification by hardware devices

To determine failure by device, use this table.

Table 7-5 Failure classification by hardware devices

4. Display	5. I/O devices	6. Storage	7. Mechanical
1. Display anomalies on page 133	1. Keyboard on page 139	1. Hard drive or solid-state drive not recognized on page 148	1. Noise (sound) on page 151

Table 7-5 Failure classification by hardware devices (continued)

4. Display	5. I/O devices	6. Storage	7. Mechanical
2. Dead pixel on page 135	2. Keyboard pointing stick (select products only) on page 140	2. No boot to operating system (no read-write error) on page 149	2. Fan runs constantly on page 152
3. No video (internal) on page 135^d	3. Keyboard backlight on page 141	3. Read-write error on page 149	3. Thermal shutdown (hot) on page 153
4. No video (external) on page 136^d	4. Touchpad on page 141	4. Slow performance on page 150^c	
5. DisplayPort/VGA on page 136	5. Network connectivity (RJ-45 jack) on page 142	5. Blue screen (BSOD) error on page 150^b	
6. HDMI on page 136	6. Network connectivity wireless (WLAN) on page 142	6. Noisy hard drive on page 150	
7. No or bad external video via docking on page 137	7. WWAN on page 143		
8. Incorrect or missing color/ distorted image on page 138	8. USB on page 143		
9. Touch screen on page 138	9. Smart card reader on page 144		
	10. Speaker, headphone - audio issues on page 145		
	11. Thunderbolt (TB) on page 146		

^{b,c,d} similar symptoms

2. Examine the environment

It is important to examine the computer's environment. If you can quickly identify the cause of the issue, fewer resolution steps might be needed. Perform the following environment inspections:

- Check all cables and connections to be sure that no connections are loose.
- Confirm that power sources are good, such as AC outlet or adapter (110 V/220 V ac), power strip. Test with a verified working AC outlet.
- Check for compatibility issues between the computer and third-party devices, peripherals, uncertified devices, incompatible hardware (for instance, Mac OS device). Incompatibility can result in blue screen errors, improper operation, and so on.
- Isolate the computer from sources of electromagnetic interference (EMI), such as cell phones, two-way radios, floor mats, fans (and other electronic motors). EMI may contribute to a display freeze issue or lock-up.

3. Perform a visual inspection of hardware

Perform a physical inspection of the computer.

- Look for abnormalities such as a cracked display, dented battery, broken latches for battery bay, keyboard key caps popped out, dust over connectors, liquid spill over keyboard.
- Look for signs of drop, movement, or vibration that may cause internal and external loose connections.

4. Update BIOS and drivers

Whenever possible, update to the latest BIOS, firmware, and drivers before troubleshooting.

 **IMPORTANT:** Note that some customer company policies prohibit updates. Check your company policy before taking action.

The updates may include fixes for your computer issues, and they may also enhance system performance. HP continually improves the update process to make it easier. You can update the BIOS locally through a manual process, through an automatic installation, or through a remote installation on multiple units.

Manually updating BIOS and drivers

Use this information to update the BIOS.

- To manually update the BIOS and drivers, see the Setup Utility (BIOS) chapter.
- See the specific BIOS update installation instructions that accompany the download.

Remotely deploying the BIOS and drivers

Instead of manually searching for and downloading each SoftPaq, users and IT personnel can use two tools to identify and download all appropriate SoftPaqs for the selected HP models.

- HP SoftPaq Download Manager (SDM) is a software tool that streamlines the download, extraction, and installation process of SoftPaqs, including BIOS and drivers.
- HP System Software Manager (SSM) is a software tool that simplifies the deployment of SoftPaqs to HP computers.

Analyze the issue

Use these steps to evaluate and interpret the problem.

5. Remove or uninstall recently added hardware, software

HP has designed this computer and validated it using a full-range hardware and software qualification matrix. If an issue appears to have started recently, it may be related to the recent addition of hardware or software.

A good method to determine the root cause is to remove recently added components or uninstall applications one at a time and restart the computer when necessary.

 **IMPORTANT:** After you have completed the process of uninstalling hardware or software and are ready to reinstall, be sure that the new device is seated properly and all cables are correctly connected. After installing the device, restart the computer, and be sure that the new device is turned on. In addition, if the new device is a root cause of a problem, it could cause a conflict in drivers or incompatibility issues with other installed programs. For any new hardware you have added, be sure to install the latest drivers available from the device vendor website.

6. HP Hardware Diagnostics and Tools

HP offers diagnostics and tools to diagnose hardware failure. This section describes how to use some of these tools. Make sure to check for the latest versions before use.

HP PC Hardware Diagnostics (UEFI)

HP PC Hardware Diagnostics is a Unified Extensible Firmware Interface (UEFI) that allows you to run diagnostic tests to determine whether the computer hardware is functioning properly.

The HP PC Hardware Diagnostics (UEFI) tool is built within BIOS (basic memory and hard drive diagnostics only), or within new hard drives themselves. These drives contain more advanced versions of the diagnostic tool than the BIOS-based version.

In addition, for HP authorized service partners and IT professionals who need to support a mixed environment of older and newer HP/Compaq PCs, the HP PC Hardware Diagnostics Tool

(
http://www8.hp.com/us/en/campaigns/hpsupportassistant/pc-diags.html?jumpid=va_r602_us/en/any/pps/pl_ot_ob_ds_p
) supports a wide range of HP computers.

The tool runs outside the operating system so that it can isolate hardware failures from software issues, whether caused by the operating system or applications. In reality, you can determine many problems using this tool if the issue is a defective part or a loose connection (for example, reseating the keyboard cable after the tool reports a keyboard error).

The tool has three major functions:

- System Tests check the computer's hardware to verify that everything is functioning properly. If your system won't boot into Windows, try the Quick System Test. For more comprehensive testing, use the Extensive System Test option. If the System Test did not detect a hardware problem, continue with the Component Tests.
 - Component Tests focus on selected hardware components in your computer.
 - Firmware Management update your computer's BIOS to the latest version (available separately) or rolls back to a previous version.
1. Turn on or restart the computer, quickly press the **esc** key on the computer, and then press **f2**. The BIOS searches three places for the diagnostic tools, in the following order:
 - a. Connected USB drive
 - b. Hard drive
 - c. BIOS
 2. When the diagnostic tool opens, use the keyboard arrow keys to select the type of diagnostic test you want to run, and then follow the on-screen instructions.

Screen capture appearance may vary.

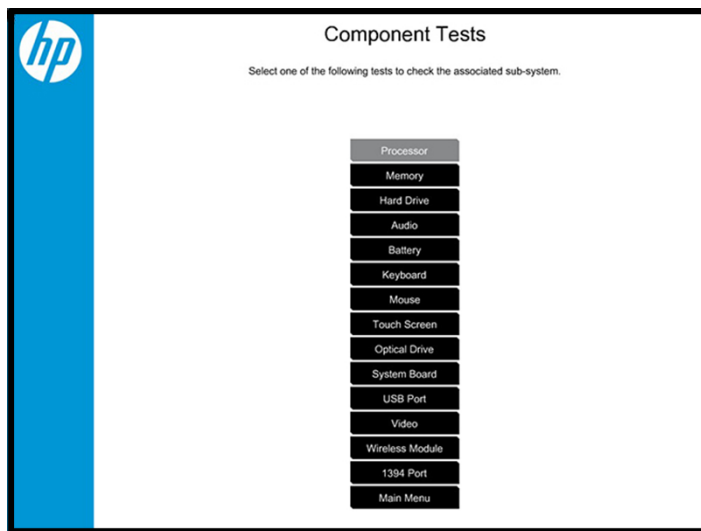
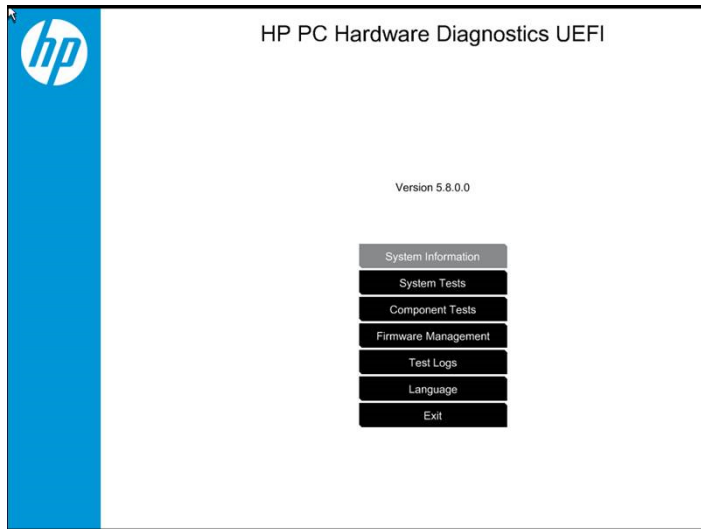

 **NOTE:** Use this tool, especially when the computer cannot boot to Windows.

 **NOTE:** If a component fails a test, write down the information so that it is available when you contact support. The information is also available in **Test Logs** on the Main Menu.

For more information, see [Using HP PC Hardware Diagnostics on page 183](#)

HP BIOS Configuration Utility (BCU)

HP BCU is a free utility that captures the BIOS settings and their values. This tool provides a text file of the computer's BIOS configuration. This file can help identify any settings that may be contributing to an issue.

In some cases, it may help to compare this BIOS text file to the default settings of the computer.

For more information, see the

http://ftp.hp.com/pub/caps-softpaq/cmit/whitepapers/BIOS_Configuration_UTILITY_User_Guide.pdf.

 **NOTE:** HP recommends that you reset BIOS before trying BCU. Resetting the BIOS is always available and relatively quick to try, whereas BCU takes extra time and effort.

HP Image Diagnostic Tool

Available to HP Authorized Support Partners (ASPs) and users, this tool collects information about the current state of the computer, including product serial number, platform and BIOS information, and information about user-installed software and hardware components.

Access this tool at <ftp://ftp.hp.com/pub/idr/ImageDiags/>. HP encourages you to review the report before sending it to support. The report may assist you with diagnostics and solutions to problems you encounter.

HP Thermal Monitor

You can use HP Thermal Monitor to stress the processor and GPU and monitor the temperature values of various components in the system.



NOTE: Available only to authorized service providers and technicians.

The components that are currently monitored include the processor, GPU, ACPI thermal zones, hard drive, and battery. The tool reads the temperatures of the components, logs the data, and helps to determine whether the computer would overheat in the event of thermal shutdown, fan spinning loud, and so on.

Non HP diagnostics tools

Refer to the following diagnostic tools for troubleshooting help.

Windows-to-Go USB

Windows-To-Go USB is a Microsoft-based tool for Enterprise editions of Windows that can help in troubleshooting. You can find a process online about how to create a live Windows USB drive. For more information, see <https://technet.microsoft.com/en-us/library/hh831833.aspx>.

Intel Processor Diagnostic Tool

Determine what processor is in your computer and verify the processor operating frequency. The tool also tests specific processor features and performs a stress test on the processor. For more information, see http://www.intel.com/support/processors/sb/CS-031726.htm?iid=subhdr+tools_procdiagtool.

7. Status lights, blinking light codes, troubleshooting lights, and POST error messages

Carefully observe any behavior that the computer may be exhibiting: status lights, blinking lights, and POST error messages during boot. It is important to understand what these indicators mean.

Status lights

The following table describes basic lights on the computer.

Table 7-6 Power button functions and lights and their descriptions

Component	Description
Power button	When the computer is off, press the button to turn on the computer. When the computer is on, press the button briefly to initiate Sleep (Windows) or Suspend (Linux®). When the computer is in the Sleep state, press the button briefly to exit Sleep (Windows) or Suspend (Linux).

Table 7-6 Power button functions and lights and their descriptions (continued)

Component	Description
	When the computer is in Hibernation, press the button briefly to exit Hibernation. IMPORTANT: Pressing and holding down the power button results in the loss of unsaved information. If the computer stops responding and operating system shutdown procedures are ineffective, press and hold the power button.
Front power light	On: The computer is on. Blinking: The computer is in the Sleep state. Off: The computer is off.
Front AC adapter and battery light	White: The computer is connected to external power, and the battery is charged from 90% to 99%. Amber: The computer is connected to external power, and the battery is charged from 0 to 90%. Blinking amber: A battery that is the only available power source has reached a low battery level. When the battery reaches a critical battery level, the battery light blinks rapidly. By default, the critical battery level is defined in Power Options as 5%. Off: The battery is fully charged.
Front hard drive light	Blinking white: The hard drive is being accessed. Amber: HP 3D DriveGuard has temporarily parked the hard drive.
Rear AC adapter light	White: The computer is connected to external power. Off: The computer is not connected to external power.



NOTE: The power light is part of the power button. The power light behavior is the same as the Front AC adapter and battery light listed in the table.

Blinking light codes

During startup, the computer may not boot properly. If this occurs, blinking light codes can help identify the cause.

The computer uses the following blinking lights to identify a hardware component that reports an error during startup. For more information, see [Blinking lights and boot error codes on page 155](#).

Table 7-7 Blinking light codes and what they mean

Blink codes	Error
Amber battery light: blinks 1 Hz continuously	Embedded controller unable to load firmware
Caps and num lk lights = 1 blink	Processor not executing code
Caps and num lk lights = 2 blinks	BIOS recovery code unable to find valid BIOS recovery image
Caps and num lk lights = 3 blinks	Memory module error
Caps and num lk lights = 4 blinks	Graphics controller error
Caps and num lk lights = 5 blinks	System board error
Caps and num lk lights = 6 blinks	Intel Trusted Execution Technology (TXT) Error

Table 7-7 Blinking light codes and what they mean (continued)

Blink codes	Error
Caps and num lk lights = 7 blinks	Sure Start unable to find valid BIOS Boot Block image
Caps and num lk lights = 8 blinks	Sure Start has identified a problem (Manual Recovery Policy Set)

POST error messages

The Power-On Self-Test (POST) is a series of diagnostic tests that runs automatically when the computer is turned on. If the POST encounters a problem, visual error messages are displayed before the operating system starts.

POST checks the following items to ensure that the computer system is functioning properly:

- Memory
- Processors
- BIOS
- Mass storage devices
- Fans

The following table describes errors encountered during HP PC Hardware Diagnostics (UEFI).

Table 7-8 System diagnostics failure codes and actions to address the failure

Test description	Failure description	Error code	Suggested user actions
Startup Test	Memory module	200	Attempt to reseat the memory module, and then repeat the test. For details on troubleshooting issues related to the memory module, search for support documentation at http://www.hp.com/support .
Startup Test	Hard Disk 1 SMART	301	Attempt to reseat the hard drive, and repeat the test. The hard drive may have failed.
Boot Device Manager	Boot device not found	3F0	Reset BIOS. Then reseat the hard drive, and repeat the test.
BIOS Recovery	BIOS Recovery Occurred	500	This message indicates that BIOS recovery was completed successfully. No further action is required.
BIOS Application	BIOS Application Error	501	The BIOS installation may have become corrupted. Download the latest version of the BIOS and install it. If reinstalling the BIOS fails, contact support for further assistance.
CMOS Recovery	CMOS Recovery Occurred	502	This message indicates that CMOS recovery was completed successfully. No further action is required.
Battery Check	Primary Battery Replace	601	This message indicates that the primary battery has very low capacity. Search for support documentation at http://www.hp.com/support for details on using the HP Support Assistant to verify the battery capacity and, if necessary, order a replacement.
Wireless Modules	Not installed or responding	701	Reseat the wireless LAN adapter module and antennas.

Table 7-8 System diagnostics failure codes and actions to address the failure (continued)

Test description	Failure description	Error code	Suggested user actions
			Because seating or reseating a wireless LAN adapter is unique to each computer model, see the WLAN module removal section in the removal and replacement chapter for further details. Contact support if third-party wireless adapters are installed in the computer.
Fan	Fan not operating correctly	90B	The system fan may be malfunctioning. Replace the fan.

Resolve the issue

The following sections help you fix the issue.

8. Hard reset

A hard reset (or forced reset) erases all information in the computer's memory and may restore functionality. Resetting the computer forces the system to clear and reestablish the connections between the BIOS and the hardware.

For more information, see <http://support.hp.com/us-en/document/c01684768>.

Performing a hard reset might fix the following common conditions:

- Windows stops responding.
- Computer stops before Windows loads, indicated by incomplete startup, blinking cursor on a black background, and errors relating to operating system not found or a missing drive.
- Display suddenly goes blank and stays blank.
- Software freezes.
- Keyboard stops responding.
- The computer does not exit Sleep or Suspend state.
- An external device stops responding. Turn off the power to that device in addition to performing the steps in this document.

Before performing a hard reset, you must disconnect or remove all peripheral devices. Start and test the computer by itself, and if the problem is not resolved, reconnect one peripheral device at a time. To resolve the startup or operational problem, run HP Support Assistant, or manually install all updated drivers from Microsoft and HP.

Before beginning, turn the computer over and look for a battery compartment door (service door). On some platforms, the battery is considered removable but not accessible.

1. Turn off the computer.
2. Remove the computer from any port replicator or docking station.
3. Disconnect all external connected peripheral devices such as USB storage devices, external displays, and printers.

4. Unplug the AC adapter from the computer.
5. Disconnect the battery.
6. Press and hold the power button for at least 15 seconds to drain residual power.
7. Reconnect the battery and plug the AC adapter back into the computer, but do not connect any of the peripheral devices.
8. Press the power button to turn on the computer.
9. If a startup menu appears, use the arrow keys to select **Start Windows Normally**, and then press the **enter** key.
10. After reconnecting each of the peripheral devices, run Windows Update and HP Support Assistant to update all device drivers.

CMOS refers to the battery-powered semiconductor chip located on computer's system board. Notebooks store low-level settings like the system time and hardware settings in CMOS. Sometimes you must clear CMOS, which requires removing and reinserting the 3 V RTC battery for a short time (a few minutes before reinserting), in addition to removing the AC adapter and battery.

 **NOTE:** Clearing the CMOS should only be performed for troubleshooting purposes. There is no reason to clear CMOS if the computer is working properly.

You must remove the notebook service door to access the CMOS battery. If the computer has a replaceable RTC battery, see the RTC battery replacement section for the battery removal or replacement.

9. Soft reset (Default Settings)

If your computer has issues booting, has errors during boot, has issues after you add hardware, or has other abnormal system behaviors that you cannot resolve through any other methods (for example, hard reset), it may be necessary to reset the system BIOS to default settings.

 **NOTE:** Some company policies prohibit updates or changes. Check whether the computer has custom BIOS settings before taking action.

To load BIOS to default settings: Reboot the computer, and then press **f10 > Main > Restore defaults**. For more information, see <http://support.hp.com>, and the search for **BIOS Setup Utility Information and Menu Options**.

10. Reseat cables and connections

Many problems are caused by improper connections or loose connections because of abnormal movement and vibration.

 **NOTE:** Before disassembling the computer to reseat cables and connections, always disconnect power and remove the battery, or disconnect a nonremovable battery.

See [Cable management on page 166](#) and [Connector types on page 167](#) for suggested cable management practices when you remove and install components.

You can access and reseat connections for Customer Self-Repair (CSR) parts. Examples of reseating hardware include:

- Reseating the battery into the battery bay can resolve no-battery found and no-charging issues.
- Reseating memory modules can resolve memory error, no-boot, and blue screen issues.

- Reseating the hard drive can resolve a POST error 3F0 (no boot device) issue (see [POST error messages and user actions on page 157](#)).
- Reseating the keyboard cable can resolve an unrecognized keys error.
- Reseating the wireless module and antenna cable can resolve a wireless connection issue.

For field replaceable units (FRUs), authorized service providers can try the following steps. For more information, see [Removal and replacement procedures for authorized service provider parts on page 65](#).

- Reseating the fan cable can fix POST error 90B (no fan detected) issue (see [POST error messages and user actions on page 157](#)).
- Reseating the power cable can fix a no-boot issue.
- Reseating the daughterboards can resolve their functional issues. Some models may have items such as a power button board, VGA board, and others.
- Reseating graphics cables and panel connectors can fix distorted or flickering video.
- Replacing thermal pads may resolve thermal power-down issue.

11. Test with minimum configuration

The factory-shipped computer (hardware configuration and preinstalled operating system image) is well tested and ready for use. Therefore, using the original factory hardware configuration or booting to operating system safe mode often resolves issues quickly.

- Disconnect any external USB storage, remove any discs in optical drives, remove the computer from a docking station, remove external video, and others.
- In addition to removing recently added components, you can narrow the issue down further with a minimum configuration. For example, if HP PC Diagnostics reports a memory error, test one memory module at a time to isolate the defective module.
- If the computer does not successfully boot the operating system, booting to safe mode may help identify the following possible causes of the issue.

Essential hardware configuration

If none of the previous steps resolve the issue, start the computer with essential hardware only. The purpose is to remove as much as hardware as possible while still maintaining the computer's ability to turn on.



NOTE: This step is to be used by authorized service providers only. HP will not honor the warranty for a system tested with the system board removed without the heat sink or fan.

This essential configuration is often used to troubleshoot power-on related issues, such as no-boot, reboot, and freezing issues.

The essential hardware consists of the following components:

- System board
- AC adapter (unplug nonremovable battery or remove battery)
- Processor (and heat sink or fan). (Processor may be integrated into the system board.)
- Memory (one verified working memory DIMM)

- Graphics card (if no VGA port is available on the system board). Platform may have both Intel integrated graphics and discrete graphics. Therefore, you might not need a discrete graphics card.
- External VGA monitor
- External USB keyboard
- External mouse



NOTE: After you remove the service door, disconnect all connections (internal keyboard, display, discrete GPU, hard drive or solid-state drive, daughterboards, and so on) to achieve the essential hardware configuration. **Do not** disassemble the system board from its enclosure at this time.

Reverse the previous procedure by reinstalling each piece of hardware removed, one piece at a time, and testing your computer after each installation. Because your computer works with only the essential hardware installed, those parts must be working properly. This means that one of the hardware components removed is causing the computer to fail. By installing each device back into the computer and testing each time, you eventually identify the failing hardware.

Safe mode

A driver conflict often results in a blue screen error message. Booting in safe mode can resolve many issues in Windows because safe mode forces the computer to load a limited version of Windows which contains only essential files.

Safe mode is useful for troubleshooting problems with programs and drivers that might not start correctly or that might prevent Windows from starting correctly. If a problem does not reappear when you start in safe mode, eliminate the default settings and basic device drivers as possible causes. Refer to the following links for how to start your computer in safe mode:

- <http://support.hp.com/us-en/document/c01835750>
- <http://support.hp.com/us-en/document/c03439317>

12. Test with verified working configuration (hardware or operating system)

One troubleshooting technique that can quickly isolate an issue is using a verified working part while testing. A good example is to use an external keyboard, mouse, or VGA monitor when you have issues with an internal keyboard, touchpad, or display.

Testing with a verified working AC adapter can identify an error caused by a faulty one. Similarly, testing with a verified working operating system can determine bad behaviors of the current operating system. See [Non HP diagnostics tools on page 106](#) for instructions about obtaining and using a Windows-To-Go USB.



NOTE: In some situations, more than one item may contribute to a problem.

13. Replace the system board

Only authorized service providers may replace the system board. This should not be considered an initial step taken to resolve an issue.

Review and perform all steps discussed previously before replacing the system board. [4. Update BIOS and drivers on page 103](#), [Status lights on page 106](#), [8. Hard reset on page 109](#), and [9. Soft reset \(Default Settings\) on page 110](#), or [10. Reseat cables and connections on page 110](#) can resolve many system board issues without requiring the effort of replacing unnecessary hardware.

Review [General troubleshooting steps on page 99](#) for appropriate troubleshooting steps.

 **IMPORTANT:** System board failure is not common. Do not replace the system board until you have tried all other troubleshooting options.

 **NOTE:** Determine whether a previous service case might be related to the current problem. For example, a fan detection issue could be caused by a loose connection resulting from previous service.

 **TIP:** Without an RTC battery (3 V coin-cell battery), the computer automatically reboots. This feature is useful when the power connector cable (between external AC adapter and system board) is defective.

 **NOTE:** Most of the time, effective troubleshooting can prevent a system board replacement.

Situations that can prevent resolution of the issue:

- The information provided about the issue omits key details, including any actions taken before the issue occurred.
- BIOS, software, and drivers have not been updated.
- Cables or connections are loose.
- Technician is unaware of information available from the HP Support website (CA - Customer Advisory).
- The issue is related to existing or known issues that might be identified in existing support articles.
- Technician might have omitted steps in the provided repair instructions (for example, Spare Part Replacement Instructions).
- Skipping one of steps from Troubleshooting Methodology table results in No Defect Found (NDF)/No Fault Found (NFF)/No Issue Detected (NID) messages.

Verify solution

Confirm that the implemented solution works.

- Reboot the system or device, and try to complete the task that produced the issue.
- If a part has been replaced, verify other basic functions. For example, GPU replacement requires keyboard removal. Therefore, it is good practice to verify all basic components to be sure that the solution is complete.
- Explain to the customer why the issue occurred and what was done to resolve it. If the solution you used was in an HP public document, provide the document information to the customer, letting them know they can locate it on <http://www.hp.com>. Also, tell them that there are other solutions available on the website. Advise the customer to check the website first when they have an issue. It might save them time calling in.
- Document the correct issue. Update the case with as many details as possible for other agents and engineers to analyze and study for lessons learned.

Helpful Hints

After you become familiar with the troubleshooting steps, use the helpful hints before running diagnostics and troubleshooting.

At startup

These steps provide simple, useful checks that you can perform when troubleshooting.



TIP: If you have installed an operating system other than the factory-installed operating system, go to <http://www.hp.com/go/quickspecs> and verify that it is supported on your system.

1. Be sure that the computer is plugged into a working AC outlet.
2. Be sure that power is connected to the docking station if you use a dock.
3. Be sure that the AC adapter light is on.
4. Be sure that the AC adapter is connected when you update BIOS to avoid BIOS corruption.
5. Be sure that the computer is turned on, the rear power light is solid white (connected to an external power source), and the front power light is solid white (normal operation).
6. Remove all optical and flash drives from your system before turning it on.
7. Be sure that the boot option is set to a working operating system drive.
8. Be sure that externally connected monitors are turned on and their power lights are on. Not all monitors are equipped with lights to indicate their functionality.
9. Turn up the brightness and contrast controls of a display or external display device if the screen is dim.

During operation

The following steps provide simple, useful checks that you can perform when troubleshooting.

1. To wake the computer:
 - a. Press the power button or any key on the keyboard.
 - b. If the system remains in the Sleep (Windows), Suspend (Linux), or Hibernate state, shut down the system by pressing and holding the power button for at least 4 seconds.
 - c. If the system does not shut down, unplug the power cord, wait a few seconds, and then plug it in again. Then press the power button again to restart the system.
2. Look for blinking lights on the computer. The blinking lights could be error codes that help diagnose the problem.
3. Check all cables for loose or incorrect connections (external devices, power cords, dock, and so on).
4. After installing a non-Plug and Play expansion board or other option, reconfigure the computer. For example, if you upgrade to a solid-state drive, you might have to reconfigure the boot order.
5. Be sure that all required device drivers have been installed. For example, if you have connected a printer, you must install a printer driver.
6. If there is a network connection issue, plug another computer with a different cable into the network connection. There might be a problem with the network plug or cable.
7. If hardware has recently been installed, remove it and determine whether the computer functions properly.
8. If software has recently been installed, uninstall it and determine whether the computer functions properly.

9. If the screen is blank, confirm the display choice by pressing **Windows logo**  + **p** and set to screen only. Or plug an external monitor into a different video port on the computer, if one is available, and close the computer lid.
10. Verify that the latest version of BIOS, drivers, and software are installed. A new release might support new features or fix the problem.
11. Press the **caps lock** or **num lk** key. If the **caps lock** or **num lk** light toggles on or off, the keyboard is likely operating correctly.
12. Press the touchpad On/Off button light. If the light toggles on or off, the touchpad is likely operating correctly.

Consulting with HP Service

If further HP support is required, this information may be requested when you call. So it may be helpful to take notes.

- Technical support registration number (if applicable)
- Product serial number
- Product model name and number
- Product identification number
- Applicable error messages
- Add-on boards or hardware
- Third-party hardware or software
- Operating system type and revision level
- Description of symptom or failure

Common issues and possible solutions

This section contains common issues, symptoms, and a series of tables that describe possible solutions to issues from Failure Classification tables. The following sections identify the issue with symptoms and solutions to resolve an issue.

Power-on issues

Use the following sections to troubleshooting power issues.

No power

When a unit experiences no power, there are several contributing factors to consider. Be sure to consider all symptoms related to this behavior when troubleshooting.

Table 7-9 Issues, possible causes, and fixes

Items	Procedures
<i>Symptoms</i>	<i>Possible causes</i>

Table 7-9 Issues, possible causes, and fixes (continued)

Items	Procedures
<ul style="list-style-type: none">• Computer does not start• Display is black or blank• No fan noise• No hard drive spinning• Lights do not glow	Failed power input to the computer (external power source, AC adapter, faulty battery). Bad connection to the computer (bad power button, power connector). Defective parts (memory, hard drive, graphics) or failed system board.
<i>Troubleshooting steps</i>	
Perform quick check	
Remove all external devices, including docking station.	
Verify external power source (2. Examine the environment on page 102).	
Perform a hard reset (8. Hard reset on page 109).	
Verify AC adapter	
Verify the battery before verifying the AC adapter. However, you can verify the AC adapter first, before opening the service door for a battery check.	
<ul style="list-style-type: none">• Verify AC adapter is compatible with product. Verify that the part number is for this computer if possible.• Verify AC adapter and power cord are good (no physical damage, bent middle ID pin).• Verify AC adapter works on a verified working computer.• Plug in AC adapter and power on computer without battery.• Inspect power port on computer side for any damage, dust, or debris.• Check power light (Status lights on page 106). Rear power light indicates external power to the computer is good.	
Verify battery condition and status	
<ol style="list-style-type: none">1. Check battery condition (overall result, cycle life, voltage) using HP PC Hardware Diagnostics (UEFI) tool.2. Verify that battery is installed properly in battery bay without a gap and that latch locks are tight (for models with removable batteries).3. Check battery status light (Status lights on page 106). Be sure that battery is not fully discharged, preventing system from booting.4. Determine whether the computer can turn on with battery only.5. Remove service door and test with a verified working battery. If the computer boots, inspect original battery before replacement.6. Test battery with a verified working computer to verify that it works.7. If the computer still does not boot, remove battery and boot on AC power only.	
The following steps are for authorized providers or technicians.	
Verify AC adapter voltage	
<ol style="list-style-type: none">1. Measure DC voltage output, which should be approximately 19.5 V dc. Acceptable voltage range is from 18.5 to 20.5 V dc.	

Table 7-9 Issues, possible causes, and fixes (continued)

Items	Procedures
	<ol style="list-style-type: none"> If the DC voltage is out of range, replace the AC adapter. <p>NOTE: This action requires a digital voltmeter.</p>
<p>NOTE: Select models include a power cable between the system board and chassis power connector.</p> 	<p>Verify power button, power connector</p> <ol style="list-style-type: none"> Be sure that power button is not stuck. Reseat power connector cable (if applicable). Replace new power connector cable (if the cable exists and is defective) To isolate faulty power connector cable and power button, technicians can short power-on pads or pins to turn on the computer. Contact HP Engineering for this information.
	<p>Verify blinking lights (Status lights on page 106)</p> <p>At this point, there should be sufficient power from the AC adapter to the system board. Expect to hear the fan spinning and see blinking lights or error messages (for example, faulty memory, HDD).</p>
	<p>Verify system board</p> <ol style="list-style-type: none"> Test essential hardware configuration (11. Test with minimum configuration on page 111, 12. Test with verified working configuration (hardware or operating system) on page 112, 13. Replace the system board on page 112) by removing nonessential parts. If the computer still does not boot, replace system board.
Tips	<p>Computer automatically boots without pressing power button when the RTC 3 V battery is removed. Therefore, after the service door and RTC 3 V battery are removed, you do not have to press power button from top side.</p> <p>In essential hardware configuration, mWS G1 and G2 may require discrete graphics processing unit (GPU) to boot. However, mWS G3 can boot with integrated graphics.</p>

Intermittent power-on, shutdown, reboot

Use this information to troubleshoot power-on, shutdown, and reboot issues.

Table 7-10 Issues, possible causes, and fixes

Items	Procedures
<i>Symptoms</i>	<i>Possible causes</i>
<ul style="list-style-type: none"> Does not always turn on Intermittently hangs Intermittently shuts down Spontaneously reboots 	<p>Electrical short, fluctuating power source, unstable power rails, loose connections, bent pins, stray wires, dust, obvious damage, nearly faulty parts (bulging or leaking capacitor).</p> <p>Potentially turn into a no-power issue (No power on page 115).</p>
	<i>Troubleshooting steps</i>
	<ol style="list-style-type: none"> Visually check power ports on both AC adapter and computer sides. Inspect power sources:

Table 7-10 Issues, possible causes, and fixes (continued)

Items	Procedures
	<ol style="list-style-type: none"> a. Verify that the AC adapter is working correctly. Use a confirmed working adapter to test. b. Verify that battery is not depleted while system is in the Sleep state. Test with a confirmed working battery.
The following steps are for authorized providers or technicians.	
	<ol style="list-style-type: none"> 1. Follow actions in No power on page 115. <ol style="list-style-type: none"> a. Be sure that AC adapter has correct DC voltage. b. Verify battery: test with a confirmed working battery. c. Verify that power button is not stuck. d. Verify that power connector is not loose. e. Remedy loose connections and reseat major components (processor, memory, GPU, hard drive, solid-state drive, and others). 2. Perform visual check for loose connections, bent pins, stray wires, dust, nearly faulty parts (bulging or leaking capacitor). 3. Test essential hardware configuration (11. Test with minimum configuration on page 111) <ol style="list-style-type: none"> a. If system boots, reinstall nonessential hardware one component at a time to isolate issue. b. If system does not boot, replace essential hardware with verified working parts, one component at a time. If system still does not boot, replace system board.

AC adapter issue

Use this information to troubleshoot AC adapter issues.

Table 7-11 Issues, possible causes, and fixes

Symptoms	Solution
<ul style="list-style-type: none"> • No sign of power 	AC adapter and others (for example, external power source).
<ul style="list-style-type: none"> • No boot 	<i>Troubleshooting steps</i>
<ul style="list-style-type: none"> • No rear power light 	Quick check
<ul style="list-style-type: none"> • No front power light 	<ol style="list-style-type: none"> 1. Verify external power source (2. Examine the environment on page 102). 2. Remove all external devices, including docking station. 3. Perform a hard reset for the computer (8. Hard reset on page 109). 4. Disconnect and reassemble the power cord and adapter in case the adapter experienced short circuit, over current, over temperature events. 5. Use a verified working adapter. If the computer operates normally, there is a problem with the original adapter.
<ul style="list-style-type: none"> • Battery does not charge when AC adapter is connected 	

Table 7-11 Issues, possible causes, and fixes (continued)

Solution	
<p>6. Verify that the AC adapter works on a verified working computer. If the computer operates normally, there is no problem with the adapter. See HP Smart Adapter warning message on page 131 for further information.</p>	
Verify AC adapter	
<ol style="list-style-type: none"> 1. Remove working battery. 2. Verify that AC adapter is compatible with product. Verify that part number is for this computer if possible. 3. Inspect AC adapter and power cord for physical damage, bent middle ID pin. 4. Plug in AC adapter and power the computer without battery. 5. Inspect the power port on computer side for any damage, dust, debris. 6. Check power light (Status lights on page 106). Rear power light indicates that external power to the computer is good. 7. If there is still no rear power light or no boot, replace the AC adapter. 	
Tips	<p>The HP Smart AC adapter has a special pin in the middle, called the ID pin, for power rating and throttling. If this pin is broken, the rear power light turns on, but the power button and front power lights blink continuously, and the computer does not turn on. Third-party AC adapters do not work with the computer.</p> <p>Use the AC adapter that came with the computer for better performance.</p>

Battery not recognized, not charging

Use this information to troubleshoot battery issues.

Table 7-12 Issues, possible causes, and fixes

Items	Procedures
<i>Symptoms</i>	<i>Possible causes</i>
<ul style="list-style-type: none"> • No battery status light • Blinking amber (critically low battery level) • No boot without AC adapter 	<p>Defective AC adapter , battery, or both.</p> <p>NOTE: Before proceeding, verify that the computer can boot to BIOS or Windows with a good AC adapter.</p>
	<i>Troubleshooting steps</i>
	Visual inspections
	<ol style="list-style-type: none"> 1. Inspect battery connectors for any signs of damage. 2. Verify that battery is installed properly in battery bay without gap or obstructions and latch locks are tight. Reseat battery (for models with removable batteries). 3. Determine whether battery gets hot (batteries heat up when charging, but not too hot to touch).
	<p>Check battery warranty to see whether the battery is new or its warranty is expired. Battery capacity degrades over time.</p>
	Verify front battery status light

Table 7-12 Issues, possible causes, and fixes (continued)

Items	Procedures
	<ol style="list-style-type: none"> 1. Battery status light is off: battery not recognized. 2. Battery status light is blinking amber: critically low battery level. <p>Reset</p> <ol style="list-style-type: none"> 1. Hard reset (8. Hard reset on page 109) 2. Soft reset (9. Soft reset (Default Settings) on page 110) <p>Verify AC adapter</p> <ol style="list-style-type: none"> 1. Determine whether the computer needs the AC adapter to boot and operate. Sometimes, an intermittently bad AC adapter and loose connection between adapter and computer results in inability to charge battery, which causes short run time. 2. Inspect AC adapter to verify that it is functioning. 3. Test with a working AC adapter and confirm whether battery is charging. 4. Be sure that battery is fully charged (AC adapter plugged in at least 2.5 hours). <p>Diagnostics: HP tools report results such as passed, calibrate, weak, replace, no battery, and unknown, and they suggest corresponding actions.</p> <p>Use HP Hardware Diagnostics (UEFI) (6. HP Hardware Diagnostics and Tools on page 103)</p> <p>HP PC Hardware Diagnostics (UEFI) is a good tool to use to isolate and determine faulty battery, especially for quickly discharging (short life) battery.</p> <ol style="list-style-type: none"> 1. Verify that battery is recognized and charging. 2. Verify battery condition if battery cycle life is past its life expectancy (that is, past 1000-cycle life and 3-year warranty). Battery might need to be replaced. 3. If issue remains, test with a verified working battery and verify battery status lights and battery conditions. 4. If issue remains, replace system board. 5. Verify the new replacement.
Tips	See the computer user guide for instructions regarding battery maintenance and increasing battery life. Also see http://support.hp.com/us-en/document/c01297640?jumpid=hpr_r1002_usen_link3 .

Battery discharges too fast

Use this information to troubleshoot battery issues.

Table 7-13 Issues, possible causes, and fixes

Items	Procedures
<i>Symptoms</i>	<i>Possible causes</i>
Battery has good status light but discharges too fast	AC adapter, battery, or both.
	<i>Troubleshooting steps</i>
	Verify AC adapter

Table 7-13 Issues, possible causes, and fixes (continued)

Items	Procedures
	<p>Determine whether the computer needs the AC adapter to boot and operate. Sometimes an intermittently bad AC adapter and loose connection between adapter and computer results in the inability to charge the battery and causes short runtime.</p> <ol style="list-style-type: none"> Inspect AC adapter to verify that it is working. Test with AC adapter alone and with a verified working AC adapter.
	<p>Verify battery: Because battery capacity can degrade over time, check the warranty coverage. Run a battery test to confirm whether issue is hardware related.</p> <ol style="list-style-type: none"> Review battery power plans in Control Panel > Power Options that may consume more energy and discharge battery faster. Resetting default to Power Saver option can conserve battery power. Determine whether any graphics are processing. Verify battery maintenance and operations. Leaving the battery at a high level of charge in a high-temperature environment for extended periods accelerates the loss of capacity. Test and calibrate battery using HP PC Hardware Diagnostics (UEFI). Verify battery life cycle using HP Support Assistant tool. <p>If battery cycle life is past its life expectancy (past the 1000-cycle life and 3-year warranty), the battery might need to be replaced.</p> <ol style="list-style-type: none"> Compare discharge time with a verified working battery (remove AC adapter) using Hardware Diagnostics (UEFI)>Hard Drive Tests>Extensive Test>Loop until error.
Tips	<p>To conserve battery power, turn off Wireless On-Off button and other peripherals and USB devices, applications, processes (in Task Manager) when not in use; also, reduce screen brightness.</p> <p>Follow HP instructions about how to maintain battery and increase battery life. Also reference http://support.hp.com/us-en/document/c01297640?jumpid=hpr_r1002_usen_link3.</p>

Burnt smell

Use this information to troubleshoot burnt-odor issues.

Table 7-14 Issues, possible causes, and fixes

Items	Procedures
<i>Symptoms</i>	<i>Possible causes</i>
Emits smoke, burnt smell	Defective on-board components.
	<p><i>Troubleshooting steps</i></p> <p>General visual inspection</p> <ol style="list-style-type: none"> Disconnect the computer from power source (AC adapter and battery). Inspect for visual damage on AC adapter and battery. Test on a known working computer to isolate issue. If issue follows AC adapter or battery, replace it. Inspect any sign of liquid spill on the computer (back of keyboard).

Table 7-14 Issues, possible causes, and fixes (continued)

Items	Procedures
The following steps are for authorized providers or technicians.	
	Further inspection on components
	<ol style="list-style-type: none"> 1. Inspect further sources internally after disassembling chassis, such as burnt or damaged components. 2. If the issue persists, replace boards, AC adapter, and battery for safety concern, and report issues to HP.

POST

Use the following sections to troubleshoot Power-on Self Test issues.

No video (with power)

Use this information to troubleshoot video issues.

Table 7-15 Issues, possible causes, and fixes

Items	Procedures
<i>Symptoms</i>	<i>Possible causes</i>
<ul style="list-style-type: none"> • No video (black or blank image) but have power • Light activity • No error messages • Fan noise • Hard drive light blinking and hard drive noise 	<ul style="list-style-type: none"> Failed display Failed critical components (memory, hard drive, system board) Loose connection Recently added hardware <p>NOTE: These suggestions assume that the computer has not previously been set up for multiple displays.</p>
	<i>Troubleshooting steps</i>
	Quick check
	<ol style="list-style-type: none"> 1. Verify that system light activity is OK. 2. Remove all external devices, including docking station. Recently added hardware or applications may cause graphics driver conflict and result in loss of video. 3. Perform hardware reset (8. Hard reset on page 109) and verify that HP Logo is presented correctly on display screen when pressing f10. 4. Test with external monitor via VGA port (or DisplayPort, HDMI, or other). Press power button and close the computer lid to force video output to external video. If unsuccessful, contact HP service. 5. If external video is OK, update BIOS, software, and drivers (4. Update BIOS and drivers on page 103), and perform soft reset (9. Soft reset (Default Settings) on page 110) if needed. Go to next step to verify display.
	Verify display

Table 7-15 Issues, possible causes, and fixes (continued)

Items	Procedures
	<ul style="list-style-type: none"> When booting to Windows, determine whether image appears on display screen (via Windows Screen Solutions or Windows logo  + p for display switcher). If there is video on the display, disconnect external display device, open the computer lid, and restart.
The following steps are for authorized providers or technicians.	
	<ol style="list-style-type: none"> Reseat display cable connection on system board. Reseat display cable connection on display panel side. Examine and reseat major components, such as hard drive and memory. Test with minimum configuration (11. Test with minimum configuration on page 111) by removing hard drive to isolate operating system issues and testing video in F10 Setup. If video is present, restart and retest the computer. If video is present but bad, go to Display on page 133 section. If issue persists (no video), test with external video. If issue persists, test or replace a confirmed working display. If issue persists, replace discrete graphics card. If issue persists, replace system board because of defective video function.
Tips	Swipe a metal piece (screwdriver) over wireless or mute buttons to act as if closing lid to force video output to external display device.

Blinking lights

Use this information to interpret blinking lights on the computer.

Table 7-16 Issues, possible causes, and fixes

Items	Procedures
<i>Symptoms</i>	<i>Possible causes</i>
Lights blink on keyboard caps lock/num lock keys	Blinking lights on startup usually indicate a problem with basic functionality of a critical component (processor, BIOS, graphics cards, memory, and so on) because of a loose connection, defective parts, or recently added parts.
	<i>Troubleshooting steps</i>
	<ol style="list-style-type: none"> Check for any blink patterns. Count the number of blinks in a sequence, followed by a pause for a few seconds. See status, blinking lights, and error message (Status lights on page 106) for corrective actions. If internal hardware components (such as memory, hard drive) have been recently added, a component may not be connected properly. Remove and reseat new components (10. Reseat cables and connections on page 110) one at a time.
Note	Because the display might not be functional, lights are used to indicate an error.

Diagnostic error messages

Use the information in the table to help you understand diagnostic error messages.

Table 7-17 Issues, possible causes, and fixes

Items	Procedures
<i>Symptoms</i>	<i>Possible causes</i>
<ul style="list-style-type: none">• Computer has power• POST error message displays (Windows logo has not yet appeared)	Diagnostic error messages indicate a problem. There may be a problem with the instruction being sent from the BIOS to a hardware component (for example, keyboard failures), or incompatible hardware. Can usually be resolved by installing updated firmware for the component.
	<i>Troubleshooting steps</i>
	<ol style="list-style-type: none">1. See Status lights on page 106 for corrective actions. An example of a POST error message might be "Boot Device Not Found."2. If there is power, you might be able to access BIOS. Reset BIOS to its default condition. (9. Soft reset (Default Settings) on page 110)3. Restore hardware to its original condition (for example, bootable solid-state drive instead of hard drive).4. Reseat suspected components and verify connection.5. Test suspected components using HP PC Hardware Diagnostics (UEFI) tool.
Note	An Error Message means that the system has finished BIOS hardware validation and is ready to launch the Startup Menu . To access the Startup Menu for further options, press the esc key while restarting the computer.

BIOS password

Use the information in the table to troubleshoot BIOS password issues.

Table 7-18 Issues, possible causes, and fixes

Items	Procedures
<i>Symptoms</i>	<i>Possible causes</i>
Some sections are unavailable (grayed out)	You must use an administrator password.
	<i>Troubleshooting steps</i>
	<ol style="list-style-type: none">1. Review F10 BIOS Setup Overview to determine which features must be enabled.2. Your BIOS settings may be managed by a BIOS administrator password setup.3. If you lost or forgot the user password, contact your IT personnel.
Reference	HP F10 Setup Overview http://h10032.www1.hp.com/ctg/Manual/c04460979 http://h10032.www1.hp.com/ctg/Manual/c04685655 2015 Business PC models: see the HP PC BIOS F10 Setup Guide at http://support.hp.com .

Performance (OS)

Most software problems occur as a result of certain situations.

- The application was not installed or configured correctly.
- There is insufficient memory available to run the application.
- There is a conflict between applications.

Make sure that all the necessary device drivers are installed.

If an operating system other than the factory operating system is installed, check whether the operating system is supported and the application is certified for the version of the operating system.

Intermittent shutdown

Use this information to troubleshoot shutdown issues.

Table 7-19 Issues, possible causes, and fixes

Items	Procedures
<i>Symptoms</i>	<i>Possible causes</i>
<ul style="list-style-type: none">• Shutdown during startup• Shutdown during operation	<p>It is often difficult to troubleshoot an intermittent issue. Possible causes include:</p> <p>Power-related issue: defective or insufficient power sources, poor connection.</p> <p>OS Custom Setting: Energy Saver (Power Management).</p> <p>Thermal-related issue: thermal sensors reach limits.</p> <p>Hardware related issue, voltage, out-of-range current, electrical short.</p>
	<i>Troubleshooting steps</i>
	<ol style="list-style-type: none">1. Update BIOS and drivers. (4. Update BIOS and drivers on page 103)2. Perform hard reset (8. Hard reset on page 109)3. Perform soft reset (9. Soft reset (Default Settings) on page 110)
	Power-related issue
	<ol style="list-style-type: none">1. Verify functionality of AC adapter alone. If it does not work, test with a verified working adapter.2. Verify battery alone. Verify that battery is not depleted. Test battery using HP PC Hardware Diagnostics (UEFI) tool.3. Verify connection of power button and cable.
	OS custom settings
	<ol style="list-style-type: none">1. Advise users to reset power options and close all applications that are not in use, including applications in the background.2. Test with a confirmed working operating system to isolate custom settings by users or any conflicting applications that cause shutdown.
The following steps are for authorized providers or technicians.	
	Thermal-related issue
	<ol style="list-style-type: none">1. Verify thermal condition:

Table 7-19 Issues, possible causes, and fixes (continued)

Items	Procedures
	<ol style="list-style-type: none"> a. Test fan using HP PC Hardware Diagnostics (UEFI) tool (6. HP Hardware Diagnostics and Tools on page 103) b. Check fan and connection. Reseat fan cable. c. Be sure that no obstructions or dust are in heat sink fan, fin, or vent. d. Test with a verified working fan. e. Remove old thermal compound and pads and replace with new compound and pads. <ol style="list-style-type: none"> 2. Verify thermal solution: <ul style="list-style-type: none"> ○ Use Thermal Monitor tool (available only to authorized service providers/ technicians) to perform stress test (processor and GPU) (6. HP Hardware Diagnostics and Tools on page 103), and verify that thermal sensors are within limits after thermal condition is serviced.
	<p>Hardware-related issue</p> <ol style="list-style-type: none"> 1. Check for any signs of loose connections, bent pins, stray wires, dust, nearly faulty parts (bulging/leaking capacitor). 2. Verify that lights are solid. 3. If shutdown is reproducible, test essential hardware configuration: <ol style="list-style-type: none"> a. If no issue with hardware configuration, reinstall one nonessential component at a time to determine faulty hardware. b. If issue persists, replace essential hardware with a confirmed working part, one at a time. If the computer does not boot, replace system board.
Tips	Intermittent issues are difficult to reproduce and troubleshoot. It is important to record details about shutdown frequencies, system configuration (3D video application), and operating conditions.

Blue screen

Use this information to troubleshoot blue screen issues.

Table 7-20 Issues, possible causes, and fixes

Items	Procedures
<p><i>Symptoms</i></p> <ul style="list-style-type: none"> ● Have power, light activity, fan spinning ● HP Logo displays briefly ● Fails to boot into Windows operating system, displays blue screen, and then crashes, restarts, or stops responding 	<p><i>Possible causes</i></p> <p>Recent changes: conflict of instructions from multiple programs or just added hardware.</p> <p>Incompatible hardware and driver.</p> <p>Poor connection (hard drive, memory).</p> <p>Hardware malfunctioning due to overheating (GPU, processor).</p> <p>Defective hardware (memory, hard drive).</p>
Important Notes & Resources	<i>Troubleshooting steps</i>

Table 7-20 Issues, possible causes, and fixes (continued)

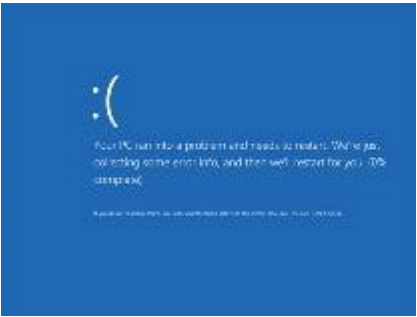
Items	Procedures
	<p>There are many different ways to troubleshoot a blue screen error. Therefore, you need to identify working configuration and specific symptoms of the failure to narrow down the issue. See Blue screen (BSOD) error on page 150.</p> <p>Recommended resources</p> <p>Microsoft knowledge base: http://windows.microsoft.com/en-us/windows-8/resolve-windows-blue-screen-errors</p> <p>For more information, search for HP Troubleshooting Error Messages on a blue screen at http://www.hp.com.</p>

Overview of general troubleshooting steps for a blue screen error

1. Note the blue screen error message and what activity was performed at the time.
2. Perform a hard reset ([8. Hard reset on page 109](#)) after disconnecting all external peripherals.
3. Reset BIOS to default ([9. Soft reset \(Default Settings\) on page 110](#)) to prevent booting to another device.
4. Run HP Hardware Diagnostics ([6. HP Hardware Diagnostics and Tools on page 103](#)) to isolate major faulty hardware issues.
 - HP PC Hardware Diagnostics (UEFI) tool to test hard drive, memory, and system.
 - Thermal Monitor (available only to authorized service providers and technicians) tool to monitor temperature limits of processor and GPU. See “HP Thermal Monitor” in [6. HP Hardware Diagnostics and Tools on page 103](#).
5. Remove or undo recently added hardware ([5. Remove or uninstall recently added hardware, software on page 103](#)). For example, incompatible memory or new solid-state drive storage.
6. Reseat cables and connections ([10. Reseat cables and connections on page 110](#)). Pay attention to proper installation of memory and hard drive.
7. Verify that a minimum of at least 100 MB of free space is available on your Windows partition.
8. If you can start Windows:
 - a. Update BIOS and drivers ([4. Update BIOS and drivers on page 103](#)) to support updates for incompatibilities.
 - b. Get all the latest updates, using Windows Update.
 - c. Undo recent changes:
 - Startup using Last Known Good Configuration.
 - Use System Restore.
 - Roll back device driver in Device Manager.

- d. Check for specific Error Message. See [Common blue screen error messages on page 160](#).
 - e. Boot to safe mode ([11. Test with minimum configuration on page 111](#)) to troubleshoot issues.
9. If you cannot start Windows:
- a. Boot to safe mode. ([11. Test with minimum configuration on page 111](#))
 - b. Use Startup Repair to fix Windows startup files.
 - c. Undo recent changes using System Restore to revert to a previous working state.
 - d. Check for specific STOP error by analyzing Crash Dump (retrieved via a bootable USB). See [Use Windows Debugging Tool on page 161](#).
 - e. Restore computer using System Recovery or image backup to factory settings.
10. Test with essential hardware configuration ([11. Test with minimum configuration on page 111](#)) with a verified working operating system (for instance, USB Windows-To-Go), if available, to isolate the software issue.

Freeze at Windows Logo (hang or lockup)

Use the following information to troubleshoot hang or lockup issues.

Table 7-21 Issues, possible causes, and fixes

Items	Procedures
<p><i>Symptoms</i></p> <ul style="list-style-type: none"> • Has power, light activity, fan spinning • HP Logo displays briefly • Attempt to boot to operating system and freeze/hang at Windows logo • No response to pressing num lk or caps lock key 	<p><i>Possible causes</i></p> <p>Conflict of instructions from multiple programs or drivers; installing a new hardware or program that is not compatible (may also cause a blue screen error—see blue screen issue).</p>
	<p><i>Troubleshooting steps</i></p> <p>Perform the following steps one at a time to verify normal boot process:</p> <ol style="list-style-type: none"> 1. Disconnect all external peripherals, and perform a hard reset (8. Hard reset on page 109). 2. Perform soft reset (9. Soft reset (Default Settings) on page 110). 3. Update BIOS and drivers (4. Update BIOS and drivers on page 103). <ol style="list-style-type: none"> a. Roll back to previous version may be necessary.

Table 7-21 Issues, possible causes, and fixes (continued)

Items	Procedures
	<ul style="list-style-type: none"> b. Go to safe mode to install drivers.
	<ol style="list-style-type: none"> 4. Run Hardware Diagnostics (6. HP Hardware Diagnostics and Tools on page 103) to isolate hardware issue. 5. Undo recent changes in Windows (5. Remove or uninstall recently added hardware, software on page 103). 6. Reseat cables and connections (10. Reseat cables and connections on page 110). 7. Start Windows in safe mode (11. Test with minimum configuration on page 111). 8. Use Startup Repair Windows to fix Windows damaged files. 9. Test with essential hardware configuration (11. Test with minimum configuration on page 111) with a verified working operating system (for instance, USB Windows-To-Go), if available, to isolate the software issue.
Tips	For more information, see http://support.hp.com/us-en/document/c03671001 .

Electromagnetic Interference (EMI)

Use this information to troubleshoot EMI issues.

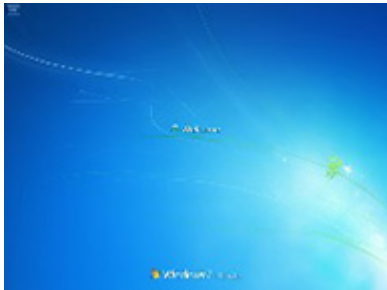
Table 7-22 Issues, possible causes, and fixes

Items	Procedures
<i>Symptoms</i>	<i>Possible causes</i>
System locks up, freezes in certain physical area or location	Electromagnetic interference (EMI).
	<i>Troubleshooting steps</i>
	<ol style="list-style-type: none"> 1. See (2. Examine the environment on page 102). Pay attention to external power source, high-frequency signals such as cell phones, microwave ovens. 2. Move the computer to different locations nearby to determine where it fails and where it does not fail. 3. Test with a verified working computer in original factory configuration. 4. Consult with support.

No wake up

Use this information to troubleshoot wake-up issues.

Table 7-23 Issues, possible causes, and fixes

Items	Procedures
<i>Symptoms</i>	<i>Possible causes</i>
	Power-saving mode; multiple-display setting.

Table 7-23 Issues, possible causes, and fixes (continued)

Items	Procedures
When resuming from a power management state the computer may display:	<i>Troubleshooting steps</i>
<ul style="list-style-type: none"> • Blank screen • Some light activity 	<ol style="list-style-type: none"> 1. Verify that front power light (Status lights on page 106) is blinking (indicating Sleep state). Press power button to exit Sleep. 2. Reset BIOS to default (associated with OS Power Management in Power Menu) (4. Update BIOS and drivers on page 103) 3. Check power management settings in Windows Power Options. Disable Sleep options if the issue is resolved.

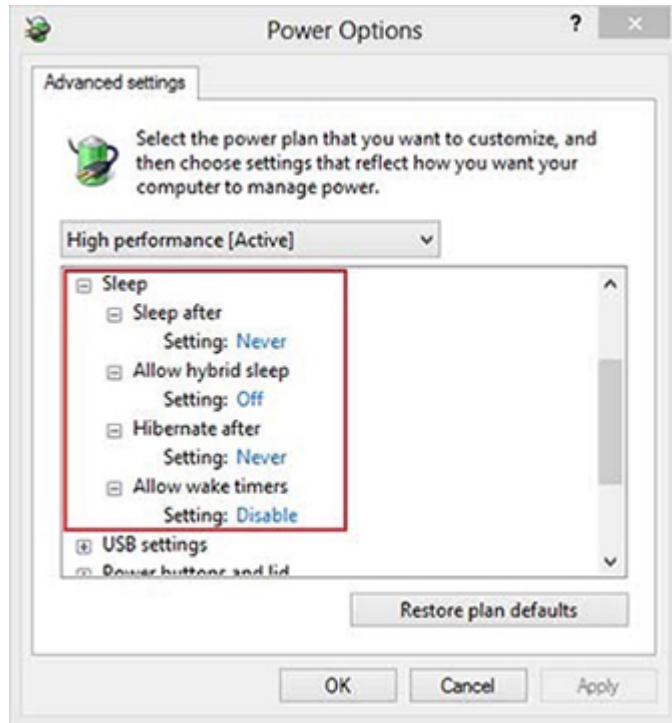

4. Screen saver is set. Press any key or touch touchpad to resume.
5. Verify that Display Choice is set to external video only. Toggle screen control key combination **fn + f4** or **Windows logo + P**.

Tips

If you are using a docking station, set your notebook display as a primary display. When the computer is undocked, you may think it is in a power-saving state, but the screen image may actually appear on an external display device in the docking configuration.

Unresponsive

Use this information to troubleshoot issues with responsiveness.

Table 7-24 Issues, possible causes, and fixes

Items	Procedures
<i>Symptom</i>	<i>Possible causes</i>

Table 7-24 Issues, possible causes, and fixes (continued)

Items	Procedures
Unresponsive	Program in use has stopped responding to commands.
	<i>Troubleshooting steps</i>
	<ol style="list-style-type: none"> 1. If possible, use the Windows Task Manager to isolate and terminate the offending process. 2. Attempt the normal Windows shutdown procedure. 3. Restart the computer using the power button.

Slow performance

Use this information to troubleshoot performance issues.

Table 7-25 Issues, possible causes, and fixes

Items	Procedures
<i>Symptom</i>	<i>Possible causes</i>
Slow performance when performing small tasks, or even in idle mode	Processor is hot or hard drive is full.
	<i>Troubleshooting steps</i>
	Processor is hot
	<ol style="list-style-type: none"> 1. Verify that airflow to the computer is not blocked. 2. Verify that chassis fans are connected and working properly. Some fans operate only when needed. 3. Verify that the processor heat sink is installed properly.
	Hard drive is full
	<ol style="list-style-type: none"> 1. Transfer data from the hard drive to create more space on the hard drive. Microsoft recommends at least 200 MB to sync system files. 2. Perform disk defragmentation to consolidate fragmented data on the hard drive so it works more efficiently.
Tips	<p>See Routine maintenance for performance improvement on page 159).</p> <p>See http://windows.microsoft.com/en-us/windows-8/free-up-disk-space.</p> <p>See http://windows.microsoft.com/en-us/windows/optimize-windows-better-performance#optimize-windows-better-performance=windows-vista.</p>

HP Smart Adapter warning message

Use this information to troubleshoot power adapter warning messages.

Table 7-26 Issues, possible causes, and fixes

Items	Procedures
<i>Symptom</i>	<i>Possible causes</i>
Warning message appears in window	Less powerful AC adapter, BIOS out of date.
	
	<i>Troubleshooting steps</i>
	<ol style="list-style-type: none">1. Update BIOS, which may contain information that assigns an appropriate adapter for the configuration.2. Update the latest HP Hotkey Support software from Drivers website.3. Be sure that the power source is sufficient (where adapter is connected).4. Use appropriate AC adapter (often supplied with system) for optimum system performance.5. Test with a verified working AC adapter.6. Test the adapter on a verified working computer.7. Contact HP for configuration details.
Note	<p>HP Smart AC adapter warning message: informs you that as power demands increase, the notebook may not perform at full capacity, which may result in longer battery-charging time. In cases of extreme power demands, the system may also throttle back the processor, or with systems that have a discrete video subsystem, a video balance mode may occur to further balance the power needs of the system.</p> <p>Because system processor functions always have priority over battery charging, charging delays occur first.</p>

Incorrect time and date

Use the following information to troubleshoot time and date issues.

Table 7-27 Issues, possible causes, and fixes

Item	Procedure
<i>Symptom</i>	<i>Possible cause</i>
Incorrect date and time	Real-time clock (RTC) battery might need replacement.
	<i>Troubleshooting steps</i>
	<ol style="list-style-type: none">1. Reset the date and time in the operating system Control Panel.2. Replace the RTC battery.3. Verify that date and time are correct.

Display

Use these sections to troubleshoot display issues.

Display anomalies

The display panel is a field-replaceable unit (FRU) and must be replaced by only authorized technicians. However, HP highly recommends that users and technicians observe symptoms and use the HP PC Hardware Diagnostics (UEFI) tool before any replacement.

Symptom

This section includes common display issues with symptoms:

- Blank or black video
- Incorrect color, missing color, distorted image
- Flickering image
- Vertical lines (because of LDVS, decreased signal integrity, and data loss)
- Dead pixel (because of display liquid, internal transistor, and others)
- Horizontal lines (because of video memory)
- Distorted when hot (because of thermal issue)
- Cracked screen/image (physical damage)
Contact support for assistance.
- Humming noise (due to frequency settings)
Contact support for assistance.

Table 7-28 Display anomaly illustrations

Display anomalies		
		
Cracked screen	Cracked image	Blurred image

Table 7-28 Display anomaly illustrations (continued)

Display anomalies		
		
Dead pixel	Vertical lines	Horizontal lines

Quick check

Use these steps to check the display.

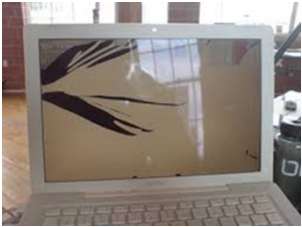
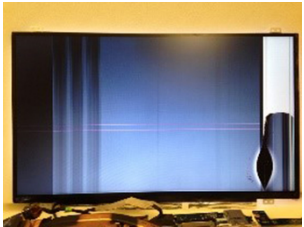
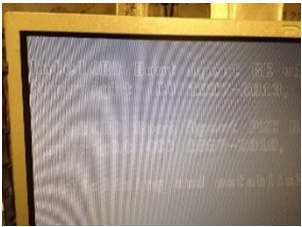
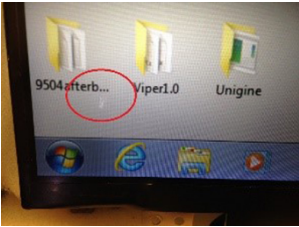
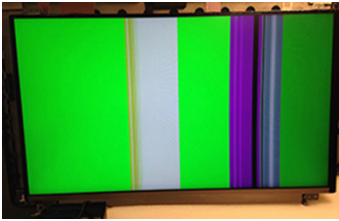
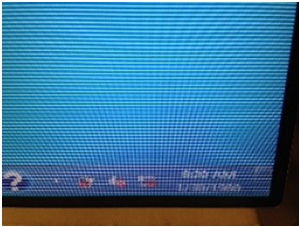
- Visually examine the display for cracked screen, liquid crystal leak, dirty spots on glass, and other issues.
- Reset and update BIOS and docking firmware.
- Update operating system (OS), graphics or video drivers (Intel, AMD, NVIDIA, and others).

For custom images, HP highly recommends upgrading or installing Windows in UEFI mode (or Legacy disabled) to fully support hybrid graphics and avoid unexpected behaviors (for example, blue screen error, graphics or video issues) in the BIOS Legacy setting.

- Configure Windows settings (Power options, Screen brightness, Personalization, Screen resolution, and so on).
- Test with a verified working external display.
- Boot to Windows in safe mode.
- Test with a verified working operating system (for instance, shipping image).

HP PC Hardware Diagnostics (UEFI) for video test

Use this tool to quickly determine if the display issue is related to a real hardware issue.

To start HP PC Hardware Diagnostics (UEFI) ([6. HP Hardware Diagnostics and Tools on page 103](#)), when the computer is at boot, press the **f2** key, select **Component Tests**, and then select **Video**.

There are three options:

- **Video Memory Check:** to test video memory
- **Palette Check:** to test the three video color components (red, green, blue)
- **Dead Pixel Check:** to check dead pixels in eight different colors (Dead Pixel Check is available with the HP PC Diagnostics 3-in-1 USB Key tool)

Review the video troubleshooting in the following Display section for specific issues and possible solutions. For additional information about display problems, see documentation provided by the product manufacturer.

Display assembly diagram

The display assembly diagram shows basic video components: system board, graphics cards, display cables, display connectors, operating system (OS), graphics driver, and LCD display panel. Any component or a combination of these components can contribute to a video issue.

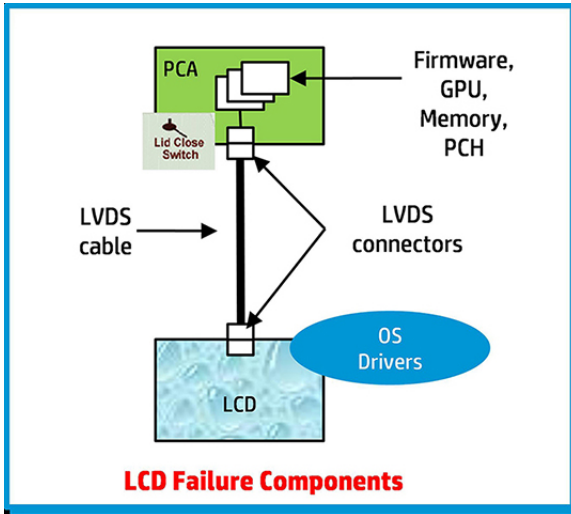

NOTE: The lid close switch is a Hall-effect sensor located in the top cover. When the display is closed, the sensor acts like a switch is closed. A notebook can force a video output to an external monitor, or go to hibernation or standby mode through power management. If the display screen does not light up when the display is open, the lid close switch (Hall-effect sensor) could be faulty.

Dead pixel

Display panel may show one or more pixels that are not properly lit when displaying a single color over the screen area. Use HP PC Hardware Diagnostics (UEFI) tool to determine those defective pixels.

There is no solution for dead pixels. See [Display issue: pixel anomalies on page 165](#) for the HP dead pixel policy.

No video (internal)

Use this information to troubleshoot video issues.

Table 7-29 Issues, possible causes, and fixes

Items	Procedures
<i>Symptoms</i>	<i>Possible causes</i>
No internal video with certain programs (for example, video-intensive games)	Display resolution, brightness, faulty lid switch, running a program requiring a higher resolution than the display screen can support. Faulty lid switch may put the system into Sleep or Hibernation mode.
	<i>Troubleshooting steps</i>
	Use an external monitor with higher resolution. Test with external monitor using HDMI or HP port. Press the power button and close the computer lid to force video output to external video. If there is still no video, contact support.
References	See section No video (with power) on page 122 for display information.

No video (external)

Use this information to troubleshoot external video issues.

Table 7-30 Issues, possible causes, and fixes

Items	Procedures
<i>Symptom</i>	<i>Possible causes</i>
No image on external monitor	External monitor, resolution, display configuration, drivers.
	<i>Troubleshooting steps</i>
	<ol style="list-style-type: none">1. Be sure external monitor is compatible with the computer.2. Be sure that external monitor is turned on.3. Press any key to exit the power-saving mode.4. Adjust the brightness of the monitor.5. Test with a verified working monitor.6. Test the monitor via internal ports (VGA, DP ports).7. Install latest video driver.8. Reset the screen resolution as described in the documentation.9. Configure display choice, and then force output to external video by closing the notebook lid or pressing fn + f4 to switch screen output.

DisplayPort/VGA

Use this information to troubleshoot DisplayPort and VGA issues.

See [No video \(external\) on page 136](#).

HDMI

Use this information to troubleshoot HDMI issues.

Table 7-31 Issues, possible causes, and fixes

Items	Procedures
<i>Symptoms</i>	<i>Possible causes</i>
<ul style="list-style-type: none">• Display issue• Sound issue	Cable, connection, settings.
	<i>Troubleshooting steps</i>
	Quick Check
	<ol style="list-style-type: none">1. Verify that the HDMI device input source is set correctly (for example, HDMI1).2. Be sure you are using the correct HDMI cable.

Table 7-31 Issues, possible causes, and fixes (continued)

Items	Procedures
	<ol style="list-style-type: none"> 3. Check connection and reconnect the HDMI cable. 4. Verify whether sound output is configured correctly in Control Panel > Sound Manager.
	<ol style="list-style-type: none"> 1. Perform hard reset (4. Update BIOS and drivers on page 103). 2. Update BIOS and drivers (4. Update BIOS and drivers on page 103) when you hear sound but do not see video on HDTV.
References	http://support.hp.com/us-en/document/c01186408

No or bad external video via docking

Use this information to troubleshoot video issues while docking.

Table 7-32 Issues, possible causes, and fixes

Items	Procedures
<i>Symptoms</i>	<i>Possible causes</i>
No or bad image on external monitor via ports of docking station (such as VGA, DP, TB, display port, and others)	Rooted from system board, software or drivers, dock connectors, docking station hardware or firmware, dock video ports (DP, VGA, and others).
	<i>Troubleshooting steps</i>
	<ol style="list-style-type: none"> 1. Be sure that external monitor is turned on. 2. Be sure that external monitor is compatible with the computer. 3. If applicable, plug the dock in different Type-C ports. For more information, see the technical white paper titled "HP Elite Dock with Thunderbolt 3 & HP ZBook Dock with Thunderbolt 3." Go to http://www.hp.com/ and search for HP ZBook Thunderbolt 3 Dock User Guide. 4. If the screen image is distorted, try a DP-to-VGA adapter. Connect the adapter to each DisplayPort and VGA port of the dock. 5. Test the monitor via internal ports (such as VGA, DP, HDMI, and others). 6. Verify that dock connectors of the notebook and the dock are clean, without dust, debris (for example, using air duster). 7. Ideally, use a verified working operating system or system connected to the dock to isolate the issue of the current operating system. 8. Ideally, use a verified working docking station to isolate the faulty dock. 9. Update latest dock firmware. Follow the installation instructions carefully. You may want to try a DP-to-VGA adapter if you have a distorted screen image. Connect the adapter to each DisplayPort of the dock. If you still cannot update the dock, attempt to update it on a confirmed working notebook before having the dock replaced.
Note	See the technical white paper titled "Multiple displays on HP ZBook Mobile Workstations" from HP platform support website. Go to http://h20195.www2.hp.com/v2/getpdf.aspx/4aa5-2657enw .

Incorrect or missing color/distorted image

Use this information to troubleshoot image issues.

Table 7-33 Issues, possible causes, and fixes

Items	Procedures
<i>Symptoms</i>	<i>Possible causes</i>
System works normally but the display shows:	Loose connection, display cable, display, graphics card.
<ul style="list-style-type: none">Missing or strange colorImage distortion	<i>Troubleshooting steps</i> Verify with external monitor <ol style="list-style-type: none">Use combination fn + f4 to enable output to external monitor.Close the lid. <p>If the external monitor also shows incorrect color, it is graphics card issue. Test with a verified working graphics card.</p> <hr/> Verify monitor cable and cable connection (Monitor disassembly is required.) <p>Be sure the monitor cables are not pinched or damaged.</p> <p>Be sure the monitor cables have good connection at both ends (system board and display panel).</p> <ul style="list-style-type: none">If moving cables affects the image, the monitor cable is the cause of the issue. Test with a confirmed working cable.If moving cables does not affect the image, the monitor has an issue. Test with a confirmed working monitor.

Touch screen

Use this information to troubleshoot touch screen issues.

Table 7-34 Issues, possible causes, and fixes

Items	Procedures
<i>Symptoms</i>	<i>Possible causes</i>
Unresponsive	Dirt and smudge, driver, touch display configuration, power management.
Inaccurate	<i>Troubleshooting steps</i> Quick check <p>Turn off the computer, spray glass cleaner onto a soft, damp cloth, and gently wipe the screen to remove dirt and smudge.</p> <p>NOTE: Do not spray cleaner directly onto the screen.</p> <hr/> <p>Configure the touch display in Control Panel > Tablet PC Settings</p> <ol style="list-style-type: none">Restart the computer.Verify touch screen and graphics drivers.Configure the touch display to identify the screen as a touch screen as shown in the image at left.

Table 7-34 Issues, possible causes, and fixes (continued)

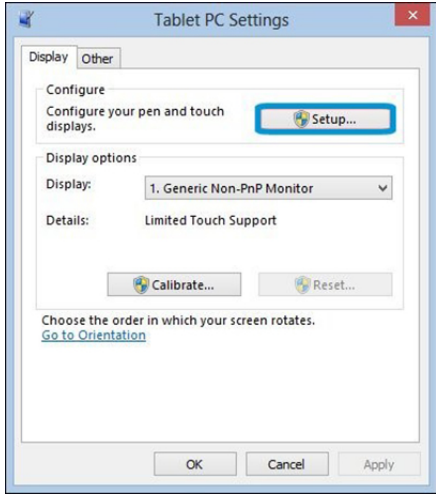
Items	Procedures
	<ol style="list-style-type: none"> 4. Calibrate the screen and reset if touch functionality is still not working correctly. 5. Perform diagnostic test in HP Hardware Diagnostics under Component Tests > Touch Screen. If the diagnostics tests pass but the touch screen still does not respond, continue following the steps. 6. Adjust the power management settings for your touch screen. If the touch screen stops working after waking from sleep, adjust the power management settings so that the touch screen device stays active while the computer is in Sleep mode. 7. Perform Microsoft System Restore, and restore to a time when the system was working. 8. Perform HP System Recovery if none of the previous actions resolve the issue.
References	https://support.hp.com/us-en/document/c03488148

I/O devices

Use this information to troubleshoot I/O device issues.

 **NOTE:**

- Be sure that external devices are supported and compliant (for example, USB Type-C®, Thunderbolt 3, PCI Express).
- If you have problems with external devices not provided by HP, contact device manufacturers for compatibility and latest drivers before troubleshooting (for example, USB devices, Thunderbolt devices, PCI express card reader, VGA, display, HDMI monitors, speakers).
- Be sure I/O devices are properly inserted into the I/O ports, and then be sure that Windows Device Manager recognizes the I/O devices.

Keyboard

Use this information to troubleshoot keyboard issues.

Table 7-35 Issues, possible causes, and fixes

Items	Procedures
<i>Symptoms</i>	<i>Possible causes</i>
Keystrokes not recognized	Dust trapped under keycap, loose keycap, loose keyboard connection, defective keyboard.
Characters not matched	<i>Troubleshooting steps</i>
	<ol style="list-style-type: none"> 1. Inspect the keyboard for any signs of dust, liquid, or debris trapped under sticky keys that might prevent keystroke recognition.

Table 7-35 Issues, possible causes, and fixes (continued)

Items	Procedures
	<ol style="list-style-type: none"> Check for incomplete connection between keyboard and system board by verifying that caps lock or num lk light turns on when you press the key. Verify whether the keyboard is recognized in Windows Device Manager, and verify whether the keyboard driver is installed properly. Test with a working external keyboard (such as a USB keyboard). Also test in Windows for special keys (caps lock, shift, ctrl, fn, Windows, alt) if necessary. Test with HP PC Hardware Diagnostics (UEFI) to isolate a hardware issue from a software issue. Verify that BIOS is up to date. If so, resetting BIOS to default may help. Test with a verified working operating system, or restore the operating system to be sure that the issue is not caused by items such as different language settings, sticky keys feature, and so on. Verify that keyboard flex cables are fully inserted and in good condition.
The following steps are for authorized providers and technicians.	
	<ol style="list-style-type: none"> Verify whether keyboard flex cable is in good condition (no delamination or torn cable end, no missing or cracked tracks, pads). Verify that keyboard flex cable ends are fully inserted and aligned with connectors on system board, and those connector tabs are properly closed. Reseat cables. Replace new internal keyboard and retest.
Tips	If a key works only when pressed with force, inspect and remove debris trapped under keycap.

Keyboard pointing stick (select products only)

Use this information to troubleshoot pointing stick issues.

Table 7-36 Issues, possible causes, and fixes

Items	Procedures
<i>Symptom</i>	<i>Possible causes</i>
Point stick not working properly	Dust trapped under point stick, loose point stick cap.
	<i>Troubleshooting steps</i>
	<ol style="list-style-type: none"> Inspect for any signs of dust or liquid spill that prevents point stick from working. Check whether point stick cap is loose, and reseat it if necessary.
The following steps are for authorized providers and technicians.	

Table 7-36 Issues, possible causes, and fixes (continued)

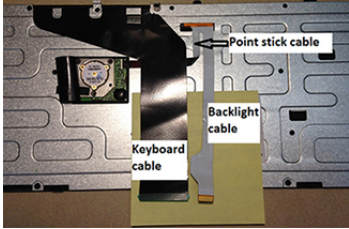
Items	Procedures
 <p>Example of back of keyboard, including keyboard, point stick, and backlight cables.</p>	<ol style="list-style-type: none"> 1. Verify whether keyboard flex cables are in good condition (no delamination or torn cable end, no missing or cracked tracks, pads). 2. Verify that keyboard flex cable ends are fully inserted and aligned with connectors on system board and back of keyboard, and that connector tabs are properly closed. 3. Reseat point stick cables.

Keyboard backlight

Use this information to troubleshoot keyboard backlight issues.

Table 7-37 Issues, possible causes, and fixes

Items	Procedures
<i>Symptom</i>	<i>Possible causes</i>
Backlight function not working properly	Backlight disabled, loose connection.
	<i>Troubleshooting steps</i>
	<p>NOTE: Not all notebook computers have backlit keyboards.</p> <p>A keyboard function key lets you turn the light on and off. Verify whether backlit feature is not disabled by pressing a combination of fn + backlit key.</p>
The following steps are for authorized providers or technicians.	
	<ol style="list-style-type: none"> 1. Verify whether backlight flex cables are in good condition (no delamination or torn cable end, no missing or cracked tracks or pads). 2. Verify that backlight flex cable ends are fully inserted and aligned with connectors on system board and that connector tabs are properly closed. 3. Reseat backlight cable.

Touchpad

Use this information to troubleshoot touchpad issues.

Table 7-38 Issues, possible causes, and fixes

Items	Procedures
<i>Symptoms</i>	<i>Possible causes</i>
Not working properly	Touchpad turned off, driver, settings.
(1) Touchpad on/off button	<i>Troubleshooting steps</i>

Table 7-38 Issues, possible causes, and fixes (continued)

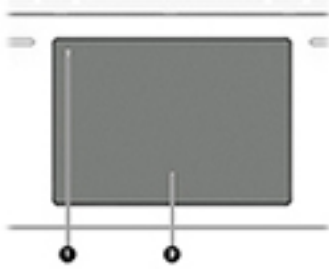
Items	Procedures
(2) Touchpad	<ol style="list-style-type: none"> 1. Ensure touchpad on/off light is not amber (disabled). Double tap to enable. 2. Verify whether touchpad device is listed in Device Manager > Mice and other pointing devices. 3. Install the latest touchpad driver. 4. Adjust touchpad settings (Control Panel > Mouse). 5. Test touchpad controller using the HP PC Hardware Diagnostics (UEFI) tool (f2 > Component Tests > Mouse Test > Pointer Test & Drag and Drop Test).
	
<p>The following steps are for authorized service providers/technicians.</p> <ol style="list-style-type: none"> 1. Check the touchpad cable for damage or a loose connection, and then reseal the touchpad cable. 2. If issue persists, replace the touchpad and verify the change. 	

Network connectivity (RJ-45 jack)

Use this information to troubleshoot network issues.

Table 7-39 Issues, possible causes, and fixes

Items	Procedures
<i>Symptoms</i>	<i>Possible causes</i>
<ul style="list-style-type: none"> • Unable to find networks (yellow bang) • Connection dropouts • Slow performance 	Network source, cable, connection, RJ-45 (network) jack, driver, settings.
	<i>Troubleshooting steps</i>
	Quick Check: verify the network status lights that supposed to flash when there is network activity.

Network connectivity wireless (WLAN)

Use this information to troubleshoot wireless connectivity issues.

Table 7-40 Issues, possible causes, and fixes

Items	Procedures
<i>Symptoms</i>	<i>Possible causes</i>
<ul style="list-style-type: none"> • Unable to find networks (yellow bang) • Connection dropouts • Slow performance 	Network source, cable, connection, wireless module, driver, settings.

Table 7-40 Issues, possible causes, and fixes (continued)

Items	Procedures
The following steps are for authorized providers or technicians.	
	<ol style="list-style-type: none"> 1. Verify that the wireless module and its antenna cables are fully inserted and in good condition (see WLAN module removal and replacement section). Reseat wireless module and antenna connection. 2. Verify the module antenna cable connection is not loose. 3. Verify that antenna cables are properly connected to the MAIN and AUX terminals (see WLAN module removal and replacement section).

WWAN

Use this information to troubleshoot WWAN issues.

Table 7-41 Issues, possible causes, and fixes

Items	Procedures
<i>Symptom</i>	<i>Possible causes</i>
Unable to find networks or service	Network source, cable, connection, driver, settings.
	<i>Troubleshooting steps</i>
	<ol style="list-style-type: none"> 1. Update to the latest driver and utility. 2. Check with network service provider for signal coverage. 3. Be sure signal strength is good. 4. Be sure that your service is active.

The following steps are for authorized providers or technicians.

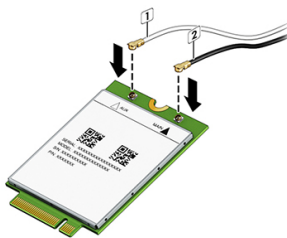

- Verify module and antenna cable connections are not loose.
- Verify antenna cables are properly connected to the correct terminals. For example, the antenna cable labeled 1 connects to the Main terminal labeled 1. The antenna cable labeled 2 connects to the Aux terminal labeled 2.

USB

Use this information to troubleshoot USB port issues.

Table 7-42 Issues, possible causes, and fixes

Items	Procedures
<i>Symptoms</i>	<i>Possible causes</i>
<ul style="list-style-type: none"> • USB devices are not recognized 	

Table 7-42 Issues, possible causes, and fixes (continued)

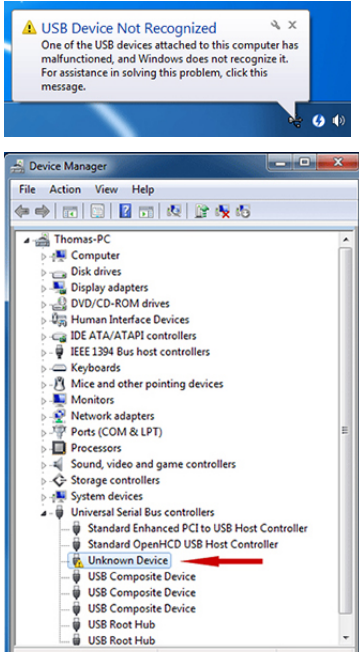
Items	Procedures
<ul style="list-style-type: none"> USB devices are not charging 	<p>USB devices do not have the latest software drivers or port insufficient power, or the devices are not compliant.</p> <p>NOTE: USB Type-C uses a different connector entirely.</p>
<p>Examples of USB device Not Recognized</p>  <p>The image shows a Windows error message box titled 'USB Device Not Recognized' with a yellow warning icon. The text inside says: 'One of the USB devices attached to this computer has malfunctioned, and Windows does not recognize it. For assistance in solving this problem, click this message.' Below the error message is a screenshot of the Windows Device Manager window. The 'Universal Serial Bus controllers' category is expanded, and an 'Unknown Device' is highlighted with a red arrow. Other devices listed include Standard Enhanced PCI to USB Host Controller, Standard OpenHCD USB Host Controller, and several USB Composite Devices and USB Root Hubs.</p>	<p><i>Troubleshooting steps</i></p> <ol style="list-style-type: none"> 1. Unplug the USB device. Restart the computer (wait for 2–5 minutes) to reset the USB port or hub in case of a power surge. 2. Perform a soft reset (9. Soft reset (Default Settings) on page 110), and verify if the USB device is recognized. 3. Verify whether the USB device is recognized in Device Manager > Universal Serial Bus Controller, or the USB is recognized without a yellow warning symbol, or bang. 4. Verify whether the latest USB driver, USB chipset driver, or both are installed. You can remove or reinstall the USB driver. 5. Be sure the USB device is supported, for example, USB 3.0 device requires more power draw (0.9 A) from a USB port than a USB 2.0 device (0.5 A). As a result, identify the USB charging port to be used for charging a USB device, or an external AC power adapter might be required for an external USB storage device to work properly. 6. Test with verified working USB devices (keyboard, mouse, USB key) to be sure USB ports are functional. 7. Test the USB device on a verified working computer to be sure the USB device is not malfunctioning.

Smart card reader

Use this information to troubleshoot smart card reader issues.

Table 7-43 Issues, possible causes, and fixes

Items	Procedures
<p><i>Symptoms</i></p> <ul style="list-style-type: none"> Not recognized Unable to write 	<p><i>Possible causes</i></p> <p>Physical damage, incorrect insertion, dirt, driver, malfunctioning card reader.</p> <p>NOTE: Some cards have a read-write security switch on the card. Be sure that switch is set to Write Enabled before attempting to write data to it.</p>
<p>Card Reader Removal Policy</p>	<p><i>Troubleshooting steps</i></p> <ol style="list-style-type: none"> 1. Verify card reader removal policy. 2. Make sure there is no physical damage to the card. 3. Inspect the ends of the memory cards for dirt or material closing a hole or spoiling a metal contact. Clean the contacts with a lint-free cloth and small amounts of isopropyl alcohol. Replace the memory card if necessary. 4. Reinstall and update the drivers for the card reader. 5. Make sure the smart card reader is compliant with ISO 7816 Class A, B, and C.

Table 7-43 Issues, possible causes, and fixes (continued)

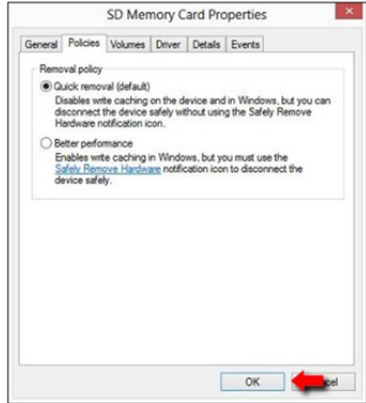
Items	Procedures
	<ol style="list-style-type: none"> 6. Reinsert the card reader with correct face as described in its documentation. 7. Check reader function with a verified working card.

IMPORTANT: If the card reader has an in-use indicator light, do not insert or remove memory cards while the light is flashing. Doing so might cause loss of data on the card or might permanently damage the card reader.

Speaker, headphone - audio issues

Use this information to troubleshoot audio issues.

Table 7-44 Issues, possible causes, and fixes

Items	Procedures
<i>Symptoms</i>	<i>Possible causes</i>
<ul style="list-style-type: none"> • No sound from external or internal speakers • Distorted sound, too soft, too loud, intermittent 	<p>Volume turned down, sound card not recognized, malfunctioning hardware, electronic interference.</p>
	<i>Troubleshooting steps</i>
	<ol style="list-style-type: none"> 1. Remove any device connected to the audio jack to enable the internal speaker. 2. Close all open programs. 3. Adjust volume by pressing fn + f6 or f7. Be sure that volume button light is not amber (mute). - or - Adjust Windows volume control by clicking the speaker icon on the Windows taskbar. Be sure that the sound is not muted. 4. Verify that the sound card is detected in Windows Device Manager. 5. Reinstall the latest audio driver. 6. Test audio device using HP PC Hardware Diagnostics (UEFI) tool (f2 > Component Tests > Audio). 7. Test with a verified working operating system. If issue is resolved, restore full operating system.

Table 7-44 Issues, possible causes, and fixes (continued)

Items	Procedures
	<ol style="list-style-type: none"> 8. Test with verified working external speakers or headset. 9. Reseat internal speaker connections. 10. Test with verified working internal speakers. 11. Replace internal speakers.
No sound from headphones	<ol style="list-style-type: none"> 1. Adjust volume by pressing fn + f6 or f7. Be sure that volume button light is not amber (mute). Or adjust Windows volume control by clicking the speaker icon on the Windows taskbar. Be sure that the sound it not muted. 2. Check headphone cable connection. 3. Test with a verified working audio board. 4. Replace audio board and verify the change.
No sound from external speakers	<ol style="list-style-type: none"> 1. Verify that external speakers are turned on. 2. Disconnect headphones from headphone jack. 3. Adjust volume by pressing fn + f6 or f7. Be sure that volume button light is not amber (mute). <p style="text-align: center;">- or -</p> Adjust Windows volume control by clicking the speaker icon on the Windows taskbar. Be sure that the sound is not muted. 4. Check for possible interference devices nearby that might affect the audio (cell phone or portable communications handset.)

Thunderbolt (TB)

Use this information to troubleshoot Thunderbolt issues.

Table 7-45 Issues, possible causes, and fixes

Items	Procedures
<i>Symptom</i>	<i>Possible causes</i>
Thunderbolt device not working	BIOS, drivers, and user settings.
	<i>Troubleshooting steps</i>
	<ol style="list-style-type: none"> 1. Update to the latest BIOS and choose appropriate TB Port settings. 2. Reset User Account Settings to default. 3. Update Intel Thunderbolt software that includes firmware version (for TB controller), driver version (operating system driver), and application version.

Table 7-45 Issues, possible causes, and fixes (continued)

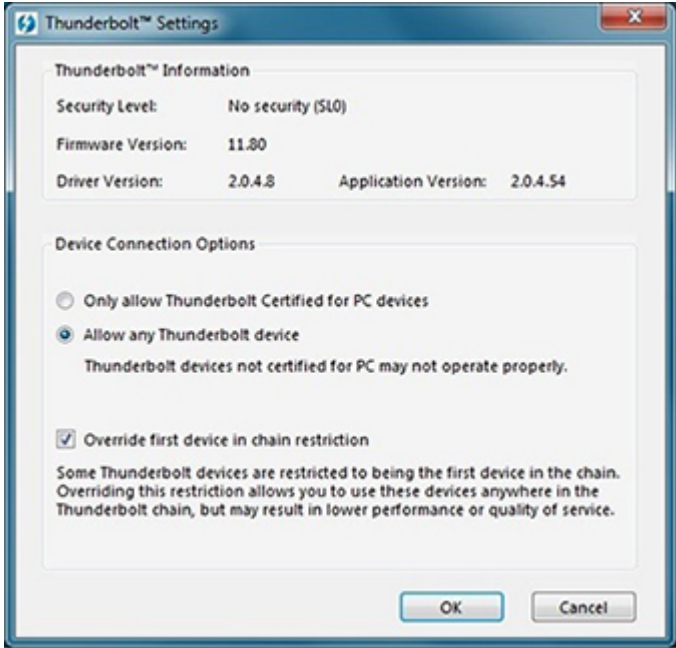
Items	Procedures
	<ol style="list-style-type: none">4. Verify that Windows Device Manager detects the TB device.5. Verify cable connection to TB port.6. Test with a verified working TB board, if possible.

NOTE: Thunderbolt is new technology. Thunderbolt cable and Thunderbolt device must be compatible with Windows. To determine whether your device is Thunderbolt Certified for Windows, see <https://thunderbolttechnology.net/products>.

Storage

Use this information to troubleshoot storage issues.



NOTE:

- Back up all critical data before troubleshooting the drive.
- Before contacting support, HP recommends that you run a drive (HDD, SSD, M.2 drive) test using the HP PC Hardware Diagnostics (UEFI) tool on the suspected failed drive.
- Diagnose the hard drive using BIOS, Diagnostics built in the shipping image, or an external USB (http://www8.hp.com/us/en/campaigns/hpsupportassistant/pc-diags.html?jumpid=va_r602_us/en/any/pps/pl_ot_of).
- HP recommends the drive quick test to quickly (less than 10 minutes) identify the malfunctioning drive. If the issue still exists, run Extensive Test (more than 2 hours, or loop mode, which runs until an error occurs).

- If any test fails, record failure code and contact support for instructions about how to order a replacement hard drive.
- If all of the tests pass, the hard drive is not damaged. As a rule, HP will not replace a hard drive under warranty that does not fail the HP Hard Drive Self-Test.
- If there is no physical problem with the hard drive (or memory), then try reinstalling the Windows operating system to troubleshoot the problem.

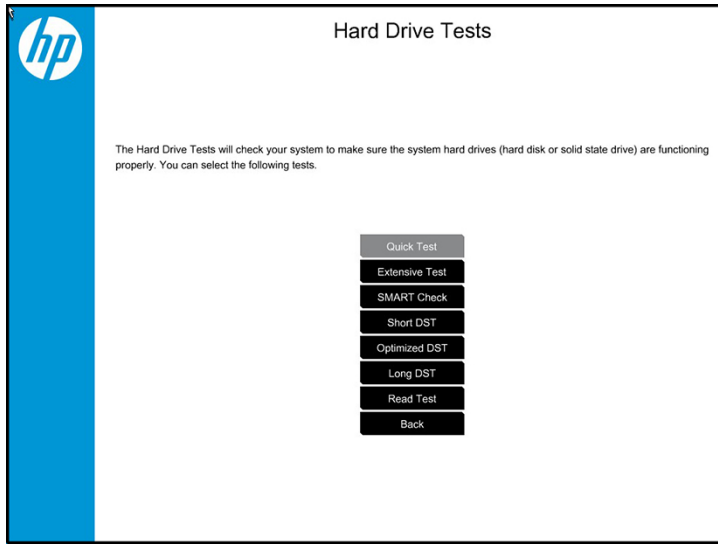

Hard drive or solid-state drive not recognized

Use this information to troubleshoot storage device issues.

Table 7-46 Issues, possible causes, and fixes

Items	Procedures
<i>Symptom</i>	<i>Possible causes</i>
Hard drive is not recognized during POST	Loose connection, faulty hard drive, faulty drive configuration/BIOS setting.
	<i>Troubleshooting steps</i>
	<ol style="list-style-type: none"> 1. Perform a hard reset (8. Hard reset on page 109). 2. Reset BIOS to default. 3. Verify hard drive connection and flex cable. Reseat hard drive and cable connection. For multiple storage devices, keep the primary drive with the operating system and remove other devices. 4. Use the HP Hardware Diagnostics tool to verify that the drive is recognized and test it. 5. If the hard drive fails diagnostics, record failure and have the drive replaced. 6. Identify when the issue is related to software. If the hard drive passes diagnostics, test the drive on a verified working computer. If the failure follows the drive, reinstall the operating system to be sure that software is not an issue.

Table 7-46 Issues, possible causes, and fixes (continued)

Items	Procedures
	<ol style="list-style-type: none"> Test with a verified working hard drive. If it is still not recognized, the system board is faulty. <p>NOTE: If the drive is seen in BIOS and Diagnostics, try a secure erase before replacing a drive as this might resolve related issues.</p>

No boot to operating system (no read-write error)

Use this information to troubleshoot issues with booting to the operating system.

Table 7-47 Issues, possible causes, and fixes

Items	Procedures
<i>Symptoms</i>	<i>Possible causes</i>
<ul style="list-style-type: none"> POST error message: Boot Device not found (3F0) 	Operating system, loose connection, faulty hard drive, BIOS configuration, Secure Boot.
<ul style="list-style-type: none"> Hang when booting to operating system 	<p><i>Troubleshooting steps</i></p> <ol style="list-style-type: none"> Verify whether Secure Boot is enabled in BIOS. Secure Boot prevents legacy boot devices from starting the computer, including bootable CDs and DVDs. For more information, see http://support.hp.com/us-en/document/c03653226. Reset BIOS to default. Be sure that BIOS Boot Mode in Boot Option is set up properly for bootable device and its operating system (for example, UEFI Native for Windows 8). Another example, choosing Legacy Boot Order for an UEFI device causes "Boot Device not found (3F0)" error. Verify hard drive connection and flex cable. Reseat connection. For multiple storage devices, keep the primary drive with the operating system and remove other devices. Use PC Hardware Diagnostics tool to test. Record failure code and have the hard drive replaced. If there is no error, reinstall the operating system using HP Restore. Test with a verified working operating system hard drive, if available.
Note	If there is a hard drive POST error message, see POST error messages and user actions on page 157 .

Read-write error

Use this information to troubleshoot read and write errors.

Table 7-48 Issues, possible causes, and fixes

Items	Procedures
<i>Symptoms</i>	<i>Possible causes</i>
<ul style="list-style-type: none"> POST error message (for example, error code 301) 	Loose connection, faulty hardware.
<ul style="list-style-type: none"> Hang when working on data, files, documents 	<p><i>Troubleshooting steps</i></p> <ol style="list-style-type: none"> Perform a hard reset (8. Hard reset on page 109).

Table 7-48 Issues, possible causes, and fixes (continued)

Items	Procedures
	<ol style="list-style-type: none"> Reset BIOS to default (9. Soft reset (Default Settings) on page 110). Verify the drive connection and flex cable. Reseat connection (10. Reseat cables and connections on page 110). Use the HP Hardware Diagnostics tool to test. If failed, record failure code and have the hard drive replaced. If no error with HP PC Hardware Diagnostics (UEFI) tool, try to repair the hard drive and its files in Windows (using command "<code>CHKDSK /f /r /x</code>"). Use HP Restore to reinstall the operating system, if needed. Test with a verified working hard drive. If it is not recognized, the system board is faulty.
Note	If there is a hard drive POST error message, see POST error messages and user actions on page 157 .

Slow performance

Use this information to troubleshoot performance issues.

Table 7-49 Issues, possible causes, and fixes

Items	Procedures
<i>Symptoms</i>	<i>Possible causes</i>
Slow performance even when performing small read-write operations	Operating system files, hard drive is full.
	<i>Troubleshooting steps</i>
	<ol style="list-style-type: none"> Transfer data from the hard drive to create more space. Microsoft recommends at least 200 MB to sync system files. Perform disk defragmentation to consolidate fragmented data on the hard drive so that it works more efficiently. <p>NOTE: Do not defragment an SSD.</p>
Tips & tricks	For optimal system performance, place your operating system and all of your most commonly used applications and files on the fastest hard drive (solid-state drive) and fastest areas on the drive (primary partition of 200 GB max).
	See Routine maintenance for performance improvement on page 159 .

Blue screen (BSOD) error

A faulty hard drive can cause a blue screen error. Perform the drive tests using the HP Diagnostics Tool to be sure that the drive is functional.

If all of the tests are successful, see [Common blue screen error messages on page 160](#) for detailed troubleshooting steps.

Noisy hard drive

Use this information to troubleshoot a noisy hard drive.

 **IMPORTANT:** Because an SSD has no moving parts, it does not make loud or clicking noises.

Depending on type and rotational speed, some hard drives make more noise than others.

Not all noises are related to the fan or hard drive.

Table 7-50 Issues, possible causes, and fixes

Items	Procedures
<i>Symptoms</i>	<i>Possible causes</i>
<ul style="list-style-type: none">Loud noise from hard drive	BIOS, hard drive firmware, driver, faulty drive, power supply (AC adapter).
<ul style="list-style-type: none">Clicking noise from hard drive	<i>Troubleshooting steps</i>
<ul style="list-style-type: none">Still boots to operating system and operates normally	<ol style="list-style-type: none">Update BIOS and hard drive firmware.Examine AC adapter to be sure that it is not faulty or overloaded. Disconnect all peripherals (USB storages, dock, and others).Remove hard drive to isolate the noise.Test the hard drive on a verified working computer if the noise continues. If the hard drive makes the same noise or clicking sounds, the sounds are either normal sounds for the hard drive or a fault with the hard drive.Verify original hard drive connection and flex cable. Reseat hard drive and connection.Run HP PC Hardware Diagnostics (UEFI). If failed, record failure code and replace hard drive replace.If you find no error with HP PC Hardware Diagnostics (UEFI), perform disk defragmentation. Some hard drives make a clicking noise when highly fragmented.
Tips	For optimal system performance, place your operating system and all of your most commonly used applications and files on the fastest hard drive or solid-state drive and on the fastest areas on the drive (primary partition of 200 GB max). See Routine maintenance for performance improvement on page 159 .

Mechanical

Use this information to troubleshoot mechanical issues.

Noise (sound)

Use this information to troubleshoot abnormal noise issues.

Table 7-51 Issues, possible causes, and fixes

Items	Procedures
<i>Symptoms</i>	<i>Possible causes</i>
Computer emits abnormal noise	Aside from basic components (power adapter, supply, fan, speaker, hard drive, optical drive, display panel, external devices), it is also common for electronic components to produce noise.
	<i>Troubleshooting steps</i>
	<ol style="list-style-type: none">Inspect external power source and change to verified working one.

Table 7-51 Issues, possible causes, and fixes (continued)

Items	Procedures
	<ol style="list-style-type: none"> Determine whether the noise comes from AC power adapter. Test with a verified working AC adapter.
	Disconnect external devices and all cables connected to the computer to isolate issue to computer only.
Noisy fan	Determine whether the noise comes from the fan. Disconnect the fan briefly to isolate whether noise originates from fan. If noise is absent with fan disconnected, see Fan runs constantly on page 152 .
Noisy hard drive	Determine whether the noise comes from the hard drive. See Noisy hard drive on page 150 .
Noisy optical drive	<ol style="list-style-type: none"> Determine whether the noise comes from an optical drive. Remove CD/DVD from the optical drive.
Noisy speaker	<ol style="list-style-type: none"> Determine whether the noise comes from speaker. Test with a verified working external headset/speaker.
Noisy display	Determine whether the noise comes from display panel (humming noise). Change display frequency settings. See Display on page 133 .
The section below is intended for authorized service providers and technicians.	
	<ol style="list-style-type: none"> After disassembling the chassis, inspect components of the interior for excessive wear or damage. If noise issues persist, proceed with process of elimination for battery, AC adapter, or boards.

Fan runs constantly

Use this information to troubleshoot a constantly running fan.

Table 7-52 Issues, possible causes, and fixes

Items	Procedures
<i>Symptoms</i>	<i>Possible causes</i>
<ul style="list-style-type: none"> Fan never stops running Generates heat Decreased computer performance 	<ul style="list-style-type: none"> BIOS not up to date. Thermal condition (fan, air flow)—fan might not be defective but must run constantly to remove excess heat generated by electrical components. Inappropriate configuration.
	<i>Troubleshooting steps</i>
	General actions
	<ol style="list-style-type: none"> Verify whether BIOS is set to Fan Always on while on AC Power F10 Setup. When booting the computer, press f10 to open Setup, and then select Advanced > Built-In Device Options Menu. Update BIOS and drivers (4. Update BIOS and drivers on page 103) and reset BIOS to default. BIOS can implement new fan characteristics and updates for other components.

Table 7-52 Issues, possible causes, and fixes (continued)

Items	Procedures
	<p>3. Perform a hard reset (8. Hard reset on page 109). Performing a hard reset can reset recorded thermal values in memory.</p>
	<p>Thermal-related issue</p> <p>1. Verify that fan is spinning. Reseat fan cable before moving to next step.</p> <ol style="list-style-type: none"> Check fan and connection. Reseat fan cable. Be sure that no obstructions or dust are in heat sink fan, heat sink fin, or vent. Test fan using HP PC Hardware Diagnostics (UEFI) tool (6. HP Hardware Diagnostics and Tools on page 103). Be sure that the fan is not producing loud noise and that fan blades spin correctly. Test with a verified working fan. Replace the fan. <p>2. Verify thermal solution</p> <p>Use Thermal Monitor tool (available only to authorized service providers and technicians)(HP Thermal Monitor on page 106) to run stress test (processor and GPU) and verify that thermal sensors are within limits after thermal condition is serviced.</p>
	<p>User configuration</p> <p>Change Power Options in Windows (for example, choosing Balanced mode instead of High performance). High performance and extensive graphics might cause the fan run constantly to release the heat.</p>
Notes	<p>BIOS currently omits fan presence detection to shorten boot time delay less than four seconds. Therefore, the fan error is generated based on previous boot to operating system that found system fan error.</p> <p>Fan often is part of thermal solution, including heat sink, heat sink fin/muffler, and thermal grease. Fan replacement requires reboot and fan function verification using HP PC Hardware Diagnostics (UEFI) tool.</p> <p>For more information, see the following links:</p> <ul style="list-style-type: none"> http://support.hp.com/us-en/document/c01007591. https://support.hp.com/us-en/document/c01657439.

Thermal shutdown (hot)

Use this information to troubleshoot a thermal shutdown.

Table 7-53 Issues, possible causes, and fixes

Items	Procedures
<i>Symptoms</i>	<i>Possible causes</i>
Similar to fan runs constantly issue (Fan runs constantly on page 152)	BIOS not up to date, thermal condition (fan, air flow)
	<i>Troubleshooting steps</i>
<ul style="list-style-type: none"> System shutdown Abnormal heat 	<p>1. Update BIOS and drivers (4. Update BIOS and drivers on page 103) and reset BIOS to default. BIOS can implement new fan characteristics and updates for other component.</p>

Table 7-53 Issues, possible causes, and fixes (continued)

Items	Procedures
<ul style="list-style-type: none">Continually running fanDecreased computer performance	<ol style="list-style-type: none">Perform a hard reset (8. Hard reset on page 109). Performing a hard reset can reset recorded thermal values in memory.Determine whether you are using a correct AC adapter.Be sure to turn power off completely when putting a notebook in a travel bag.
	<p>Thermal-related issue</p> <ol style="list-style-type: none">Verify thermal condition:<ol style="list-style-type: none">Check fan and connection. Check if fan is spinning when computer is on. Reseat fan cable.Be sure that no obstructions or dust are in heat sink fan, fin, or vent.Be sure that the notebook is not sitting on a hot surface that blocks vent intakes.Test fan using HP PC Hardware Diagnostics (UEFI) tool (6. HP Hardware Diagnostics and Tools on page 103). Be sure that the fan is not producing a loud noise and that fan blades spin correctly.Test with a verified working fan.Remove old thermal compound and pads, and replace properly with new pads.Verify thermal solution:<ul style="list-style-type: none">Use Thermal Monitor tool (available only to authorized service providers and technicians) to run stress test (processor and GPU), and verify that thermal sensors are within limits after thermal condition is serviced.
Note	See https://support.hp.com/us-en/document/c01657439 .

Additional information

The following sections provide additional information that you can use during the troubleshooting process.

Acronyms

These acronyms are used in this chapter.

Blue screen (BSOD)—A Windows error screen that can occur if a problem causes your computer to shut down or restart unexpectedly. When you experience this type of error, you cannot see items such as the Start menu or the taskbar when your computer is turned on. Instead you might see a blue screen with a message that your computer ran into a problem and needs to restart.

CPU—Central processing unit

DIMM—Dual in-line memory module

Daughterboard—Type of circuit board that plugs into or is attached to the system board or similar expansion card to extend its features and services.

GPU—Graphics processor unit

GTS—General Troubleshooting Step

HDD–Hard drive

KB–Keyboard

LVDS–Low-Voltage Differential Signaling

MSG–Maintenance and Service Guide

mWS–Mobile Workstations

WS–Workstations

OS–Operating system

PC–Personal computer

POST–Power-On Self-Test

SSD–Solid-state drive

TSG–Troubleshooting Guide

UEFI–Unified Extensible Firmware Interface

WLAN–Wireless local area network

WWAN–Wireless wide area network

Blinking lights and boot error codes

In some cases, when the host processor is not executing code or does not have the necessary code to drive the display, light blink codes inform you of a problem.

The following information is from the white paper <http://h10032.www1.hp.com/ctg/Manual/c04685655>.

Table 7-54 Blinking lights and boot error codes

Blink codes	Error
Amber battery light: blinks 1 Hz continuously	Embedded Controller unable to load firmware
Caps and num lk lights = 1 blink	Processor not executing code
Caps and num lk lights = 2 blinks	BIOS recovery code unable to find valid BIOS recovery image
Caps and num lk lights = 3 blinks	Memory module error
Caps and num lk lights = 4 blinks	Graphics controller error
Caps and num lk lights = 5 blinks	System board error
Caps and num lk lights = 6 blinks	Intel Trusted Execution Technology (TXT) Error
Caps and num lk lights = 7 blinks	Sure Start unable to find valid BIOS Boot Block image
Caps and num lk lights = 8 blinks	Sure Start has identified a problem (Manual Recovery Policy Set)

Processor not executing code

This computer experienced a problem due to the failure of certain code to execute, resulting in a failed startup of the processor.

The issue could be related to the processor or the system board in the computer. If the processor is socketed, be sure that the processor is seated correctly in the socket. If this error reoccurs, see [General troubleshooting steps on page 99](#).



NOTE: The computer attempts to notify you of this problem through a series of blinking lights. When you attempt to turn on the computer from an Off or Hibernated state, lights associated with the **caps lock** and **num lk** keys both **blink once**, followed by a pause, and then continue in a repeating pattern.

BIOS recovery code unable to find valid BIOS recovery image

This computer has experienced a problem in locating a valid BIOS image, resulting in a failed startup.

You can resolve this problem by placing a clean copy of the system BIOS on a USB key or in the appropriate hard drive directory and performing a reboot. If this error reoccurs, see [General troubleshooting steps on page 99](#).



NOTE: The computer attempts to notify you of this problem through a series of blinking lights. When you attempt to turn on the computer from an Off or Hibernated state, lights associated with the **caps lock** and **num lock** keys both **blink twice**, followed by a pause, and then continue in a repeating pattern.

Memory module error

This computer has experienced a memory initialization problem resulting in a failed startup. This issue might be related to the memory modules in the computer. You can resolve this problem by ensuring that memory modules are correctly inserted and seated.

If this error reoccurs, you must use a service event to determine the source of the error (memory modules or system board) and take the appropriate corrective action.



NOTE: The computer attempts to notify you of this problem through a series of blinking lights. When you attempt to turn on the computer from an Off or Hibernated state, lights associated with the **caps lock** and **num lock** keys both **blink three times**, followed by a pause, and then continue in a repeating pattern.

Graphics Controller Error (No Controller)

This computer has experienced a graphics controller initialization problem resulting in a failed startup. This issue might be related to the graphics controller in your machine.

You can resolve this problem by ensuring that the graphics controller module is seated correctly in machines with modular graphics. If this error reoccurs, you must use a service event to identify the source of the error and take the appropriate corrective action.



NOTE: The computer attempts to notify you of this problem through a series of blinking lights. When you attempt to turn on the computer from an Off or Hibernated state, lights associated with the **caps lock** and **num lock** keys both **blink four times**, followed by a pause, and then continue in a repeating pattern.

Failure System Board Error

This computer has experienced a system board initialization problem resulting in a failed startup. This issue might be related to the system board in the computer. You must use a service event to identify the source of the error and take the appropriate corrective action.



NOTE: The computer attempts to notify you of this problem through a series of blinking lights. When you attempt to turn on the computer from an Off or Hibernated state, lights associated with the **caps lock** and **num lock** keys both **blink five times**, followed by a pause, and then continue in a repeating pattern.

Intel Trusted Execution Technology (TXT) Error

This computer has experienced a problem related to the Intel Trusted Execution Technology resulting in a failed startup. The error occurs when three situations are true:

- The Intel Trusted Execution Technology (TXT) has been enabled on the computer.
- Policies have been set to prevent startup if the BIOS measurement has changed.
- The BIOS measurement has changed.

For more information about Intel TXT, go to

<http://www.intel.com/content/dam/www/public/us/en/documents/white-papers/trusted-execution-technology-security>

You must use a service event to resolve this issue.

 **NOTE:** The computer attempts to notify you of this problem through a series of blinking lights. When you attempt to turn on the computer from an Off or Hibernated state, lights associated with the **caps lock** and **num lock** keys both **blink six times**, followed by a pause, and then continue in a repeating pattern.

Sure Start unable to find valid BIOS Boot Block image

This computer has experienced a problem in locating a valid BIOS image, resulting in a failed startup. You must use a service event to identify the source of the error and take appropriate corrective action.

 **NOTE:** The computer attempts to notify you of this problem through a series of blinking lights. When you attempt to turn on the computer from an Off or Hibernated state, lights associated with the **caps lock** and **num lock** keys both **blink seven times**, followed by a pause, and then continue in a repeating pattern.

Sure Start has identified a problem (Manual Recovery Policy Set)

This computer has experienced a problem in locating a valid BIOS image, resulting in a failed startup. HP Sure Start normally repairs this type of issue; however, on this computer HP Sure Start has been configured to operate in manual mode key sequence.

To proceed with the repair, press and hold the following keys: **esc + up arrow + down arrow**. To avoid the need for this manual recovery step, set the HP Sure Start recovery policy to automatic. If this error reoccurs, you must use a service event to identify the source of the error and take appropriate corrective action.

 **NOTE:** The computer attempts to notify you of this problem through a series of blinking lights. When you attempt to turn on the computer from an Off or Hibernated state, lights associated with the **caps lock** and **num lk** keys both **blink eight times**, followed by a pause, and then continue in a repeating pattern.

POST error messages and user actions

Use this information to determine the meaning of POST error messages.

Table 7-55 POST error messages and user actions to address the error

Test description	Failure descriptions	Error code	Possible user actions
Product information	Invalid value	00A	Contact support for assistance.
Startup test	Memory module	200	Attempt to reseat the memory module and then repeat the test. Search http://www.hp.com/support for details about troubleshooting issues related to the memory module.

Table 7-55 POST error messages and user actions to address the error (continued)

Test description	Failure descriptions	Error code	Possible user actions
			If the memory module still fails, contact support.
Startup test	Hard Disk 1 SMART	301	Attempt to reseal the hard drive and repeat the test. The hard disk drive might have failed. Contact support for assistance.
Startup test	Hard Disk 2 SMART	302	The hard drive might have failed. Contact support for assistance.
Startup test	Hard Disk 1 Quick	303	The hard drive might have failed. Contact support for assistance.
Startup test	Hard Disk 2 Quick	304	The hard drive might have failed. Contact support for assistance.
Run-in test	Memory module	200	Attempt to reseal the memory module and then repeat the test. Search http://www.hp.com/support for details about troubleshooting issues related to the memory module. If the memory module still fails, contact support.
Run-in test	Hard Disk 1 SMART	301	Attempt to reseal the hard drive and repeat the test. The hard drive might have failed. Contact support for assistance.
Run-in test	Hard Disk 2 SMART	302	The hard drive might have failed. Contact support for assistance.
Run-in test	Hard Disk 1 Quick	303	The hard drive might have failed. Contact support for assistance.
Run-in test	Hard Disk 2 Quick	304	The hard drive might have failed. Contact support for assistance.
Hard Disk Test	Hard Disk 1 SMART	301	Attempt to reseal the hard drive and repeat the test. The hard drive might have failed. Contact support for assistance.
Hard Disk Test	Hard Disk 2 SMART	302	The hard drive might have failed. Contact support for assistance.
Hard Disk Test	Hard Disk 1 Quick	303	The hard drive might have failed. Contact support for assistance.
Hard Disk Test	Hard Disk 2 Quick	304	The hard drive might have failed. Contact support for assistance.
Hard Disk Test	Hard Disk 1 Full	305	The hard drive might have failed. Contact support for assistance.
Hard Disk Test	Hard Disk 2 Full	306	The hard drive might have failed. Contact support for assistance.
Boot Device Manager	Boot device not found	3F0	This code indicates a potential problem with the hard drive. Run the hard drive test. See https://support.hp.com/emea_africa-en/document/c01443371 for more information.
Boot Device Manager	Hard Disk 1 Error	3F1	Indicates a potential problem with the hard drive. Run the hard drive test. See https://support.hp.com/emea_africa-en/document/c01443371 for more information.
Boot Device Manager	Hard Disk 2 Error	3F2	This code indicates a potential problem with the hard drive. Run the hard drive test. See https://support.hp.com/emea_africa-en/document/c01443371 for more information.
Boot Device Manager	Hard Disk 1 SMART	301	This code indicates a potential problem with the hard drive. Run the hard drive test. See https://support.hp.com/emea_africa-en/document/c01443371 for more information.

Table 7-55 POST error messages and user actions to address the error (continued)

Test description	Failure descriptions	Error code	Possible user actions
Boot Device Manager	Hard Disk 2 SMART	302	This code indicates a potential problem with the hard drive. Run the hard drive test. See https://support.hp.com/emea_africa-en/document/c01443371 for more information.
BIOS Recovery	BIOS Recovery Occurred	500	This message indicates that BIOS recovery was completed successfully. No further action is required.
BIOS Application	BIOS Application Error	501	The BIOS installation might have become corrupted. Download the latest version of the BIOS and install it. See 4. Update BIOS and drivers on page 103 for more information. If reinstalling the BIOS fails, contact support for further assistance.
CMOS Recovery	CMOS Recovery Occurred	502	This message indicates that CMOS recovery was completed successfully. No further action is required.
Battery Check	Primary Battery Replace	601	This code indicates that the primary battery has very low capacity. Search http://www.hp.com/support for details about using the HP Support Assistant to verify the battery capacity and, if necessary, order a replacement.
Battery Check	Secondary Battery Replace	602	This indicates that the secondary battery has very low capacity. Search http://www.hp.com/support for details about using the HP Support Assistant to verify the battery capacity and, if necessary, order a replacement.
Wireless Module	Not installed or responding	701	Reseat the wireless LAN adapter module, if your notebook supports it. Because seating or reseating a wireless LAN adapter is unique to each computer model.
Fan	Fan not operating correctly	90B	The system fan might be malfunctioning. For information about troubleshooting heat-related issues, see http://support.hp.com/us-en/document/c01007591 . A hard reset can sometimes restore the system fan to working order. See https://support.hp.com/us-en/document/c01684768 for details. If the system fan continues to malfunction, contact support.

Routine maintenance for performance improvement

The table presents a summary of the suggested times for performing the routine maintenance tasks that are described in this document.

Table 7-56 Routine maintenance tasks to improve performance

Tasks	Weekly	Monthly	Occasionally
Perform a system tune up.	X		
Run Windows Update.	X		
Scan for and remove viruses.	X		
Scan for and remove spyware and adware.	X		

Table 7-56 Routine maintenance tasks to improve performance (continued)

Tasks	Weekly	Monthly	Occasionally
Empty the Recycle Bin.	X		
Delete temporary Internet files.	X		
Back up user files.		X	
Create a restore point.		X	
Defragment the hard drive.		X	
Run Scan Disk.		X	
Clean the exterior of the computer.			X
Close programs that are not being used.			X
Prevent programs from loading at startup.			X
Remove rear cover and clean fan blades and vents with compressed air.			X

Common blue screen error messages

The following sections define blue screen error messages.

Error message list

For an example of a Bug Check Code Reference, use this image.

For more information, see

[https://msdn.microsoft.com/en-us/library/windows/hardware/hh994433\(v=vs.85\).aspx](https://msdn.microsoft.com/en-us/library/windows/hardware/hh994433(v=vs.85).aspx).



```
STOP: 0x00000079 (0x00000002, 0x00000001, 0x00000002,
0x00000000)

Mismatched kernel and hal image.

Beginning dump of physical memory
Physical memory dump complete. Contact your system
administrator or technical support group.
```

Note that the hexadecimal number following the word "STOP" is called the bug check code or Stop code.

Bug check symbolic names

Each bug check code also has an associated symbolic name.

In the example, the screen shows

[https://msdn.microsoft.com/en-us/library/windows/hardware/ff559209\(v=vs.85\).aspx](https://msdn.microsoft.com/en-us/library/windows/hardware/ff559209(v=vs.85).aspx)

Microsoft general troubleshooting of Windows bug check codes

Use this information to troubleshoot Windows bug codes.

- If you recently added hardware to the system, try removing or replacing it. Or check with the manufacturer to see if any patches are available.
- Try running HP PC Hardware Diagnostics (UEFI).

- Check with the manufacturer to see if an updated system BIOS or firmware is available.
- Be sure that any expansion board is properly seated and all cables are completely connected.
- Confirm that any new hardware that is installed is compatible with the installed version of Windows.
- If new device drivers or system services have been added recently, try removing or updating them.



NOTE: Use safe mode when removing or disabling components. Safe mode loads only the minimum required drivers and system services during the Windows startup. To enter safe mode, restart your computer and press **F8** at the menu that displays the operating system choices. At the resulting **Windows Advanced Options** menu, choose **Safe Mode**.

- Run a virus detection program. Viruses can infect all types of hard drives formatted for Windows, and resulting drive corruption can generate system bug check codes. Be sure that the virus detection program checks the Master Boot Record for infections.
- Verify that the system has the latest service pack installed. To detect which service pack, if any, is installed on your system, click **Start**, click **Run**, type `winver`, and then press **enter**. The **About Windows** dialog box displays the Windows version number and the version number of the service pack, if one has been installed.
- Disable BIOS memory options such as caching or shadowing.
- Check the System Log and Application Log in Event Viewer to see if any additional error messages have been logged recently. These might pinpoint the cause of the error.

Use Windows Debugging Tool

Debugging Tools for Windows are the primary tools used by Microsoft software developers to analyze and resolve errors that result in memory dumps.

Use the tool ([https://msdn.microsoft.com/library/windows/hardware/ff551063%20\(v=vs.85\).aspx](https://msdn.microsoft.com/library/windows/hardware/ff551063%20(v=vs.85).aspx)) to determine the cause of the error. Follow general steps for downloading, setting up, and using the Windows 10 debugging tool. A similar process is used for Windows 7 or Windows 8.



NOTE: The following screen shots provide only an example of the tool. Specifics shown are not representative of all applications of the debugging tool. This is a Microsoft tool supported by Microsoft.

Windows Software Development Kit (SDK)

Use these steps to download and use the Windows SDK.

1. Download the SDK from the following link:

<https://dev.windows.com/en-US/downloads/windows-10-sdk>

2. Set up the SDK in the configuration window (Windows 10 shown).

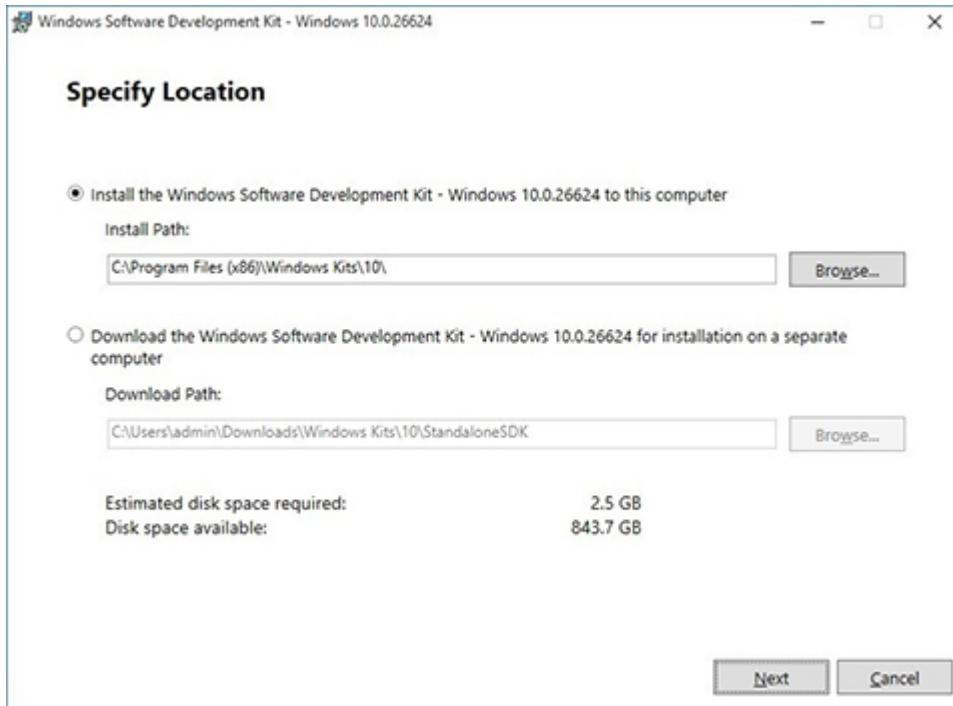

3. Select features to install.

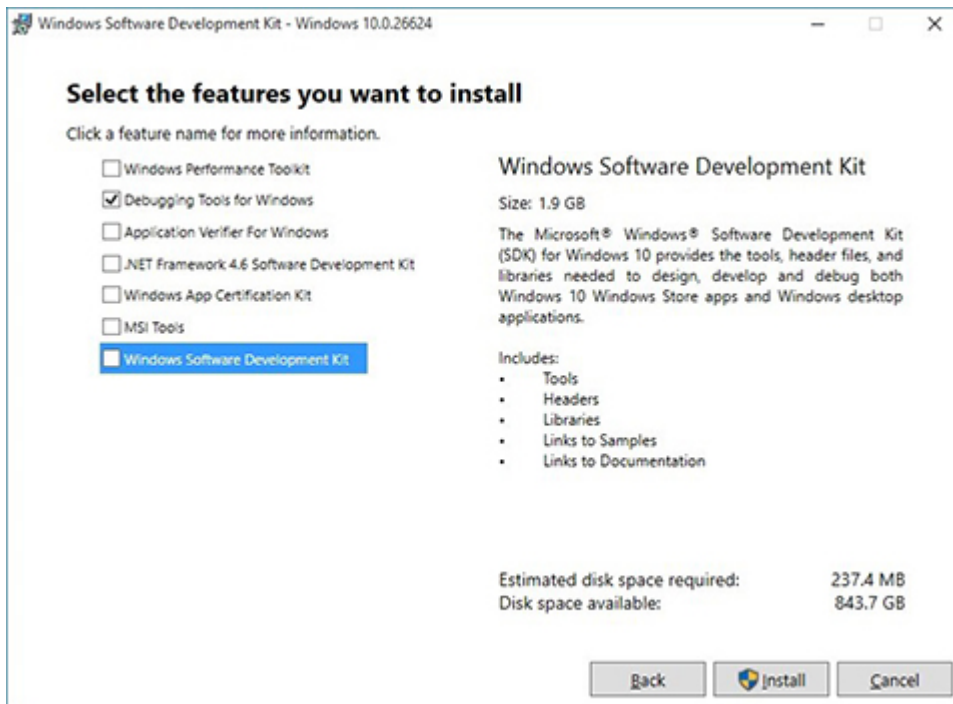

4. Run the SDK as an administrator.

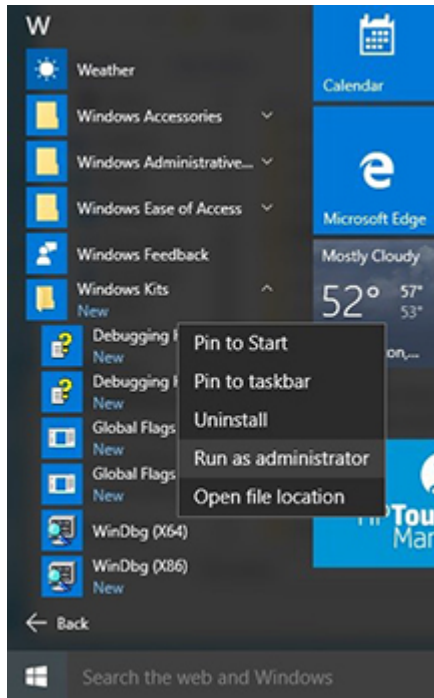

5. Set the symbol path. Select **File > Symbol File Path**.

- In the **Symbol path** box, type `SRV*C:\Windows\symbol_cache*http://msdl.microsoft.com/download/symbols`.
- Save the workspace.

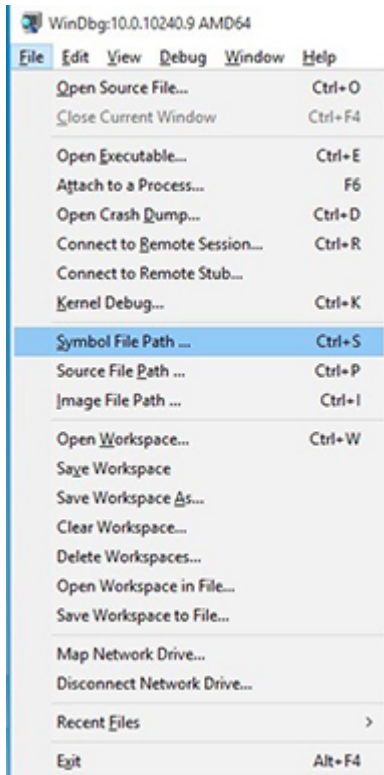

6. Open the crash dump file.

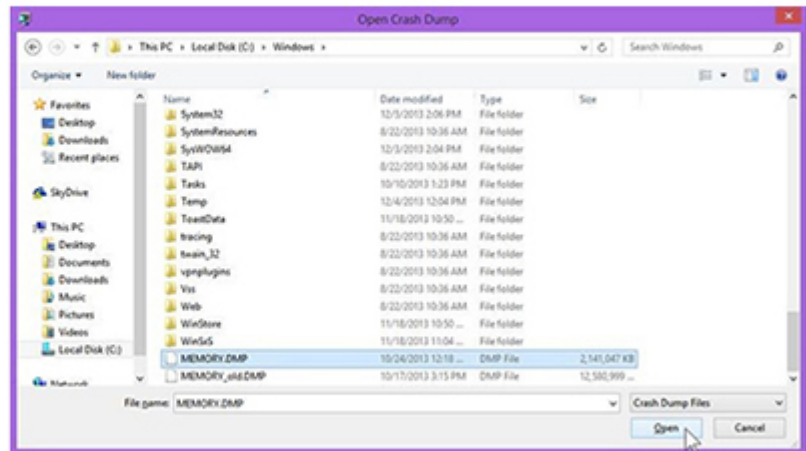
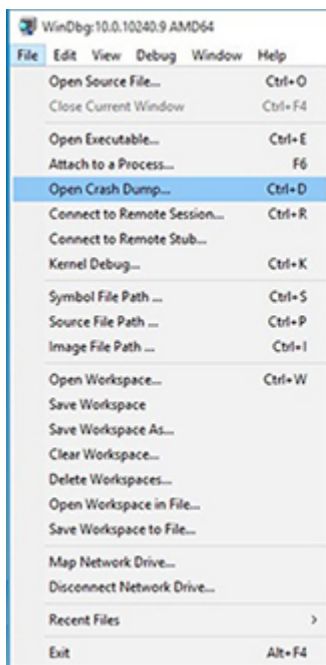

7. Analyze the file. In the following memory dump sample, look for Bug Check 0x3B. The ATIKMAG driver needs to be investigated for further root cause.

Lookup for Bug Check 0xC2.

- Type 1: Bright dot on a dark background = Always On
- Type 2: Dark dot on a bright background = Always Off
- Combination = in any combination and any color that are always on or off

Use the HP PC Hardware Diagnostics (UEFI) tool to determine numbers of pixels and their distance. HP uses the following set of criteria when damaged displays are submitted for warranty coverage.

Source: <http://support.hp.com/us-en/document/c00035844>

Table 7-57 Electrical defect criteria

Panel resolution	Accept	Reject
Subpixel faults		
VGA, SVGA, SD, WSVGA, XGA, 720p, SD+, WXGA, HD	N ≤ 2 Type 1 N ≤ 2 Type 2	N ≥ 3 Type 1
WXGA+, SXGA+, HD+, SXGA+	N ≤ 3 Type 1 N ≤ 3 Type 2	N ≥ 4 Type 1
WSXGA+, UXGA, FHD, WUXGA	N ≤ 4 Type 1 N ≤ 4 Type 2	N ≥ 5 Type 1
QHD, QHD+, WQXGA, UD	N ≤ 5 Type 1 N ≤ 5 Type 2	N ≥ 6 Type 1
Electrical defect clusters (defects within a 5x5 pixel block)		
Minimum distance between ANY allowable defects (unless otherwise specified)	S ≥ 25 mm	S < 25 mm
Cluster with 2 or more subpixels with subpixel faults		Not allowed
Dim lines		Not allowed
Cross lines on/off		Not allowed
Horizontal lines on/off		Not allowed
Vertical lines on/off		Not allowed



NOTE: Examine all LCD panel defects at the highest possible resolution using both the brightest and darkest possible backgrounds, because some subpixel failures might not be readily visible under certain conditions.



NOTE: Contact support for assistance if issues are not listed.

Cable management

Proper routing of the internal cables is critical to the operation of the computer. Follow good cable management practices when you have to remove and install components.

- Handle cables with care to avoid damage.
- Apply only the tension required to seat or unseat cables during insertion or removal from the connector.

- When possible, handle cables by the connector or pull-strap.
- Route cables in such a way that they cannot be caught or snagged by parts being removed or replaced.
- Keep cables away from direct contact with major heat sources, such as the heat sink. (Some air flow guides have a cable guide that lets you route cables safely around the heat sink.)
- Do not jam cables on top of daughterboards or memory modules (DIMMs). Circuit cards and DIMMs are not designed to take excessive pressure.
- Keep cables clear of any movable or rotating parts (such as a fan) to prevent them from being cut or crimped when the component is lowered into its normal position.
- In all cases, avoid bending or twisting the cables. Do not bend any cable sharply. A sharp bend can break the internal wires.
- Do not rely on components like the keyboard or service door to push cables down internally. Always position the cables to lie properly by themselves or in the cable guides and chassis areas designed for cable routing.

 **IMPORTANT:** Always release connector latch before removing the cable. Otherwise, pulling the cable could damage the cable pins and result in a failed device.

Connector types

There are several types of connectors on the system board with different requirements for cable removal or insertion.

 **IMPORTANT:** Do not touch connector pins and connector gold fingers directly with bare hands.

Flex cable

Use this information to properly use flex cables.

When connecting flex cables to a ZIF connector, rotate the latch to 90°, push the cable completely, evenly into the connector, and then close the latch.

When removing flex cables from a ZIF connector on the system board, you must release the latch before removing the cable. Always follow these steps:

1. Flip the connector latch 90° to release the cable.
2. Grasp the cable end of the connector and pull it straight out.

 **IMPORTANT:** Always release connector latch before removing the cable. Otherwise, pulling the cable could damage the cable pins and result in a failed device.

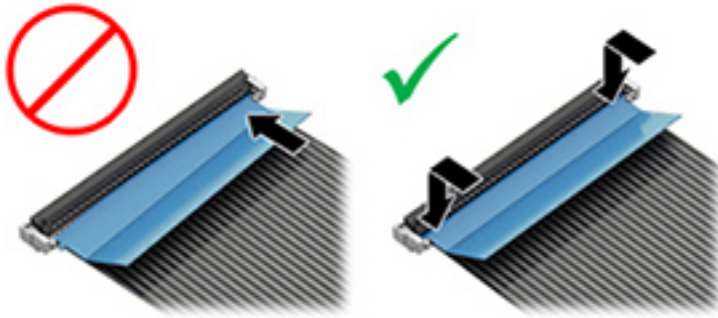

Horizontal cable insertion

Use flat tool to pull connector evenly. Do not pull on cable to remove.

Slide connector into receptacle on same horizontal plane as board and use a flat tool to push evenly into receptacle.

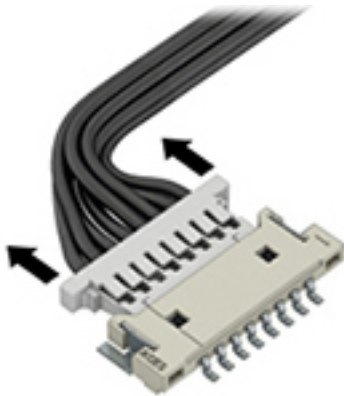

Multiple-pin horizontal connector (LVDS cable to display panel)

Use these procedures to properly insert and remove a multiple-pin horizontal connector.

Insert procedure:

1. Slide connector evenly into receptacle on same horizontal plane as PCB connector.
2. Pull lock bar to insert and push both side connector horizontally to firmly lock.
3. Tape down lock bar over the panel to hold in position.

Reverse the previous procedure to remove the connector:

1. Remove tape.
2. Pull up bar (pull tape) and release the lock with the PCB connector.
3. Pull to the direction in parallel with PCB to withdraw the connector.

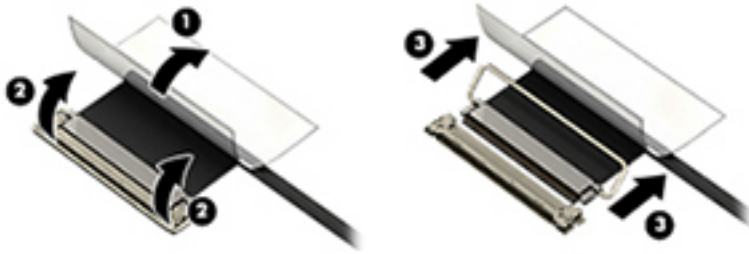

Multiple-pin vertical connector (LVDS cable to system board)

Use this procedure to properly insert and remove a multiple-pin vertical connector.

- Remove the connector gasket before removing the connector.
- If the connector has a plastic pull tab, pull the tab to disconnect. Otherwise, use flat tool under the connector to remove evenly. Do not pull on the cable to remove.
- Press evenly when reseating, reconnecting, or installing the connector.

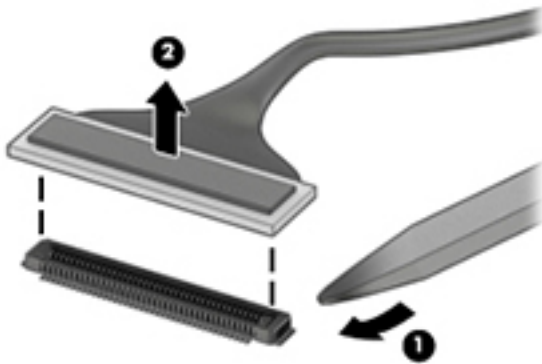

For more information about cable management, see [Cable management on page 166](#).

8 Using Setup Utility (BIOS)

Setup Utility, or Basic Input/Output System (BIOS), controls communication between all the input and output devices on the system (such as disk drives, display, keyboard, mouse, and printer). Setup Utility (BIOS) includes settings for the types of devices installed, the startup sequence of the computer, and the amount of system and extended memory.

 **NOTE:** To start Setup Utility on convertible computers, your computer must be in notebook mode and you must use the keyboard attached to your notebook.

Starting Setup Utility (BIOS)

You have several ways to access the Setup Utility (BIOS).

 **IMPORTANT:** Use extreme care when making changes in Setup Utility (BIOS). Errors can prevent the computer from operating properly.

▲ Turn on or restart the computer and quickly press **f10**.

– or –

Turn on or restart the computer, quickly press **esc**, and then press **f10** when the Start menu is displayed.

Updating Setup Utility (BIOS)

Updated versions of Setup Utility (BIOS) might be available on the HP website. Most BIOS updates on the HP website are packaged in compressed files called *SoftPaqs*. Some download packages contain a file named *Readme.txt*, which contains information regarding installing and troubleshooting the file.

Determining the BIOS version

To decide whether you need to update Setup Utility (BIOS), first determine the BIOS version on your computer.

To reveal the BIOS version information (also known as *ROM date* and *System BIOS*), use one of these options.

- HP Support Assistant
 1. Type `support` in the taskbar search box, and then select the **HP Support Assistant** app.
– or –
Select the question mark icon in the taskbar.
 2. Select **My notebook**, and then select **Specifications**.
- Setup Utility (BIOS)
 1. Start Setup Utility (BIOS) (see [Starting Setup Utility \(BIOS\) on page 170](#)).
 2. Select **Main**, and then make note of the BIOS version.

3. Select **Exit**, select one of the options, and then follow the on-screen instructions.
- In Windows, press **ctrl+alt+s**.

To check for later BIOS versions, see [Preparing for a BIOS update on page 171](#).

Preparing for a BIOS update

Be sure to follow all prerequisites before downloading and installing a BIOS update.

 **IMPORTANT:** To reduce the risk of damage to the computer or an unsuccessful installation, download and install a BIOS update only when the computer is connected to reliable external power using the AC adapter. Do not download or install a BIOS update while the computer is running on battery power, docked in an optional docking device, or connected to an optional power source. During the download and installation, follow these instructions:

- Do not disconnect power from the computer by unplugging the power cord from the AC outlet.
- Do not shut down the computer or initiate Sleep.
- Do not insert, remove, connect, or disconnect any device, cable, or cord.

 **NOTE:** If your computer is connected to a network, consult the network administrator before installing any software updates, especially system BIOS updates.

Downloading a BIOS update

After you review the prerequisites, you can check for and download BIOS updates.

1. Type `support` in the taskbar search box, and then select the **HP Support Assistant** app.
– or –
Select the question mark icon in the taskbar.
2. Select **Updates**, and then select **Check for updates and messages**.
3. Follow the on-screen instructions.
4. At the download area, follow these steps:
 - a. Identify the most recent BIOS update and compare it to the BIOS version currently installed on your computer. If the update is more recent than your BIOS version, make a note of the date, name, or other identifier. You might need this information to locate the update later, after it has been downloaded to your hard drive.
 - b. Follow the on-screen instructions to download your selection to the hard drive.

Make a note of the path to the location on your hard drive where the BIOS update is downloaded. You will need to access this path when you are ready to install the update.

Installing a BIOS update

BIOS installation procedures vary. Follow any instructions that appear on the screen after the download is complete. If no instructions appear, follow these steps.

1. Type `file` in the taskbar search box, and then select **File Explorer**.
2. Select your hard drive designation. The hard drive designation is typically Local Disk (C:).

3. Using the hard drive path you recorded earlier, open the folder that contains the update.
4. Double-click the file that has an .exe extension (for example, *filename.exe*).
The BIOS installation begins.
5. Complete the installation by following the on-screen instructions.



NOTE: After a message on the screen reports a successful installation, you can delete the downloaded file from your hard drive.

9 Computer Setup (BIOS), TPM, and HP Sure Start

HP provides several tools to help set up and protect your computer.

Using Computer Setup

Computer Setup, or Basic Input/Output System (BIOS), controls communication between all the input and output devices on the system (such as hard drives, display, keyboard, mouse, and printer). Computer Setup includes settings for types of devices installed, the startup sequence of the computer, and amount of system and extended memory.

 **NOTE:** Use extreme care when making changes in Computer Setup. Errors can prevent the computer from operating properly.

To start Computer Setup, turn on or restart the computer, and when the HP logo appears, press **f10** to enter Computer Setup.

Navigating and selecting in Computer Setup

You can navigate and select in Computer Setup using one or more methods.

- To select a menu or a menu item, use the **tab** key and the keyboard arrow keys and then press **enter**, or use a pointing device to select the item.
- To scroll up and down, select the up arrow or the down arrow in the upper-right corner of the screen, or use the up arrow key or the down arrow key on the keyboard.
- To close open dialog boxes and return to the main Computer Setup screen, press **esc**, and then follow the on-screen instructions.

To exit Computer Setup, choose one of the following methods:

- To exit Computer Setup menus without saving your changes, select **Main**, select **Ignore Changes and Exit**, and then select **Yes**.

 **NOTE:** If you are using arrow keys to highlight your choice, you must then press **enter**.

- To save your changes and exit Computer Setup menus, select **Main**, select **Save Changes and Exit**, and then select **Yes**.

 **NOTE:** If you are using arrow keys to highlight your choice, you must then press **enter**.

Your changes go into effect when the computer restarts.

Restoring factory settings in Computer Setup

To return all settings in Computer Setup to the values that were set at the factory, follow these steps.

 **NOTE:** Restoring defaults will not change the hard drive mode.

1. Start Computer Setup. See [Using Computer Setup on page 173](#).
2. Select **Main**, select **Apply Factory Defaults and Exit**, and then select **Yes**.

 **NOTE:** If you are using arrow keys to highlight your choice, you must then press **enter**.

 **NOTE:** On select products, the selections might display **Restore Defaults** instead of **Apply Factory Defaults and Exit**.

Your changes go into effect when the computer restarts.

 **NOTE:** Your password settings and security settings are not changed when you restore the factory settings.

Updating the BIOS

Updated versions of the BIOS might be available on the HP website. Most BIOS updates on the HP website are packaged in compressed files called *SoftPaqs*.

Some download packages contain a file named *Readme.txt*, which contains information regarding installing and troubleshooting the file.

Determining the BIOS version

To decide whether you need to update Computer Setup (BIOS), first determine the BIOS version on your computer.

You can access BIOS version information (also known as *ROM date* and *System BIOS*) by pressing **fn+esc** (if you are already in Windows) or by using Computer Setup.

1. Start Computer Setup. See [Using Computer Setup on page 173](#).
2. Select **Main**, and then select **System Information**.
3. To exit Computer Setup menus without saving your changes, select **Main**, select **Ignore Changes and Exit**, and then select **Yes**.

 **NOTE:** If you are using arrow keys to highlight your choice, you must then press **enter**.

To check for later BIOS versions, see [Preparing for a BIOS update on page 174](#).

Preparing for a BIOS update

Be sure to follow all prerequisites before downloading and installing a BIOS update.

 **IMPORTANT:** To reduce the risk of damage to the computer or an unsuccessful installation, download and install a BIOS update only when the computer is connected to reliable external power using the AC adapter. Do not download or install a BIOS update while the computer is running on battery power, docked in an optional docking device, or connected to an optional power source. During the download and installation, follow these instructions:

Do not disconnect power on the computer by unplugging the power cord from the AC outlet.

Do not shut down the computer or initiate Sleep.

Do not insert, remove, connect, or disconnect any device, cable, or cord.

Downloading a BIOS update

After you review the prerequisites, you can check for and download BIOS updates.

1. Type `support` in the taskbar search box, and then select the HP Support Assistant app.
– or –
Select the question mark icon in the taskbar.
2. Select **Updates**, and then select **Check for updates and messages**.
3. Follow the on-screen instructions.
4. At the download area, follow these steps:
 - a. Identify the most recent BIOS update and compare it to the BIOS version currently installed on your computer. Make a note of the date, name, or other identifier. You might need this information to locate the update later, after it has been downloaded to your hard drive.
 - b. Follow the on-screen instructions to download your selection to the hard drive.

Make a note of the path to the location on your hard drive where the BIOS update is downloaded. You will need to access this path when you are ready to install the update.



NOTE: If you connect your computer to a network, consult the network administrator before installing any software updates, especially system BIOS updates.

Installing a BIOS update

BIOS installation procedures vary. Follow any instructions that are displayed on the screen after the download is complete. If no instructions are displayed, follow these steps.

1. Type `file` in the taskbar search box, and then select **File Explorer**.
2. Select your hard drive designation. The hard drive designation is typically Local Disk (C:).
3. Using the hard drive path you recorded earlier, open the folder that contains the update.
4. Double-click the file that has an `.exe` extension (for example, `filename.exe`).

The BIOS installation begins.
5. Complete the installation by following the on-screen instructions.



NOTE: After a message on the screen reports a successful installation, you can delete the downloaded file from your hard drive.

Changing the boot order using the f9 prompt

To dynamically choose a boot device for the current startup sequence, follow these steps.

1. Access the Boot Device Options menu:
 - Turn on or restart the computer, and when the HP logo appears, press **f9** to enter the Boot Device Options menu.
2. Select a boot device, press `enter`, and then follow the on-screen instructions.

TPM BIOS settings (select products only)

TPM provides additional security for your computer. You can modify the TPM settings in Computer Setup (BIOS).

 **IMPORTANT:** Before enabling Trusted Platform Module (TPM) functionality on this system, you must ensure that your intended use of TPM complies with relevant local laws, regulations and policies, and approvals or licenses must be obtained if applicable. For any compliance issues arising from your operation or usage of TPM that violates the previously mentioned requirement, you shall bear all the liabilities wholly and solely. HP will not be responsible for any related liabilities.

 **NOTE:** If you change the TPM setting to Hidden, TPM is not visible in the operating system.

To access TPM settings in Computer Setup:

1. Start Computer Setup. See [Using Computer Setup on page 173](#).
2. Select **Security**, select **TPM Embedded Security**, and then follow the on-screen instructions.

Using HP Sure Start (select products only)

Select computer models are configured with HP Sure Start, a technology that monitors the computer's BIOS for attacks or corruption. If the BIOS becomes corrupted or is attacked, HP Sure Start automatically restores the BIOS to its previously safe state, without user intervention.

HP Sure Start is configured and already enabled so that most users can use the HP Sure Start default configuration. Advanced users can customize the default configuration.

To access the latest documentation on HP Sure Start, go to <http://www.hp.com/support>. Select **Find your product**, and then follow the on-screen instructions.

10 Backing up, resetting, and recovering

This chapter provides information about processes that are standard procedure for most products.

Backing up

You can back up your data to an optional USB flash drive or SD memory card or through Google Drive.

For detailed information about creating a backup, go to <http://www.support.google.com>.

Resetting

A factory reset erases all the information on your computer hard drive, including all the files in the Downloads folder. Before you reset, make sure to back up your files to an optional USB flash drive, SD memory card, or through Google Drive. The factory reset will not delete any of your files on Google Drive or an external storage device.

 **IMPORTANT:** Resetting permanently erases everything on your computer hard drive, including your downloaded files. If possible, back up your files before you reset your computer.

You might want to reset your computer in the following circumstances:

- You see the message "Reset this Chrome device."
- You are having problems with your user profile or settings.
- You have tried restarting your computer, and it is still not working properly.
- You want to change the owner of your computer.

To reset your computer:

1. Under the **Settings** menu, click **Advanced**.
2. In the **Powerwash** section, click **Powerwash**.
3. Click **Restart**, and then sign in with your Google Account.

 **NOTE:** The account you sign in with after you reset your computer will be recognized as the owner account.

4. Follow the on-screen instructions to reset your computer.
5. Once you complete the reset, you can set up your computer and check to see whether the problem is fixed.

Recovering

When your Chrome OS™ operating system is not working properly, you can perform a recovery. A recovery reinstalls the operating system and software programs and restores the original factory settings. Locally

saved files and saved networks are deleted for all accounts. Your Google Accounts and any data synced to your Google Drive™ storage are not affected by a system recovery.



NOTE: For more information about performing a system recovery on your computer, go to <http://www.support.google.com>

Before beginning the recovery process, you need the following:

- A USB flash drive or SD memory card with a capacity of 4 GB or greater. All data is erased from this storage device when the recovery media is created, so back up any files from the device before you begin.
- A computer with internet access. You must also have administrative rights to the computer.
- Computer AC adapter. The computer must be plugged into AC power during recovery.
- The “Chrome OS is missing or damaged” screen displaying on your computer. If this message is not already displayed:
 - Turn on the computer, press and hold the **esc + f3** keys, and then press the power button. The computer restarts, and the screen shows the “Chrome OS is missing or damaged” screen.

Installing the Chromebook Recovery Utility

The Chromebook™ Recovery Utility is an app used to recover the original operating system and software programs that were installed at the factory. This utility can be installed from the Chrome Web Store on any computer.

To install the Chromebook Recovery Utility:

- ▲ Open the Chrome Web Store, search for , click **Chromebook Recovery Utility** from the Apps list, and follow the on-screen instructions.

Creating recovery media

Recovery media is used to recover the original operating system and software programs that were installed at the factory.

To create recovery media:

1. Turn on a computer with Internet access.



NOTE: You must have administrative rights to the computer.

2. Click the **Launcher** icon, and then click **All Apps**.
3. In the Apps window, click **Recovery**, and then click **Get started**.
4. Follow the on-screen instructions to create the recovery media.



NOTE: All data and partitions on your recovery media will be deleted. Do not remove the USB flash drive or SD memory card until the process is complete.

Recovering the Chrome operating system

To recover the Chrome operating system on your computer using the recovery media you created:

1. Disconnect any external devices connected to your computer, plug in the power cord, and then turn on the computer.

2. To enter recovery mode, press and hold **esc + f3**, and then press the power button. When the “Chrome OS is missing or damaged” screen displays, insert the recovery media into your computer. The recovery process begins immediately.
3. Wait while Chrome verifies the integrity of the recovery media.



NOTE: If you need to cancel the recovery during the verification process, press and hold the power button until the computer turns off. Do not disrupt the system recovery process after the verification step is complete.



NOTE: If an error message displays, you might need to run the Chrome Recovery Utility again, or use a different USB flash drive or SD memory card.

4. When the “System Recovery is complete” message displays, remove the recovery media.

The computer restarts with Chrome OS reinstalled.

Setting up your computer after a reset or recovery

After a reset or recovery is complete, perform the initial setup process.

For details on setting up the computer, go to <http://www.support.google.com>.

Erase and reformat the recovery media

During the process of creating recovery media, the USB flash drive or SD memory card is formatted for use as a recovery tool. After you recover your computer, you will need to erase the recovery media if you want to reuse your USB flash drive or SD memory card to store other files. Use the steps in this section to erase the recovery media using the Chromebook Recovery Utility.

1. Click the **Launcher** icon, and then click **All Apps**.
2. In the apps window, click **Recovery**.
3. Click the **Settings** icon, and then click **Erase recovery media**.
4. Select the USB flash drive or SD memory card you inserted, click **Continue**, and then click **Erase now**.
5. After the recovery media is erased, click **Done** to close the Chromebook Recovery Utility, and then remove the USB flash drive or SD memory card.

The media is ready to be formatted using a formatting tool provided by your operating system.

11 Backing up, restoring, and recovering

You can use Windows tools or HP software to back up your information, create a restore point, reset your computer, create recovery media, or restore your computer to its factory state. Performing these standard procedures can return your computer to a working state faster.

 **IMPORTANT:** If you will be performing recovery procedures on a tablet, the tablet battery must be at least 70% charged before you start the recovery process.

 **IMPORTANT:** For a tablet with a detachable keyboard, connect the tablet to the keyboard base before beginning any recovery process.

Backing up information and creating recovery media

These methods of creating recovery media and backups are available on select products only.

Using Windows tools for backing up

HP recommends that you back up your information immediately after initial setup. You can do this task either using Windows Backup locally with an external USB drive or using online tools.

 **IMPORTANT:** Windows is the only option that allows you to back up your personal information. Schedule regular backups to avoid information loss.

 **NOTE:** If computer storage is 32 GB or less, Microsoft® System Restore is disabled by default.

Using the HP Cloud Recovery Download Tool to create recovery media (select products only)

You can use the HP Cloud Recovery Download Tool to create HP Recovery media on a bootable USB flash drive.

For details:

▲ Go to <http://www.hp.com/support>, search for HP Cloud Recovery, and then select the result that matches the type of computer that you have.

 **NOTE:** If you cannot create recovery media yourself, contact support to obtain recovery discs. Go to <http://www.hp.com/support>, select your country or region, and then follow the on-screen instructions.

 **IMPORTANT:** HP recommends that you follow the [Restoring and recovery methods on page 181](#) to restore your computer before you obtain and use the HP recovery discs. Using a recent backup can return your machine to a working state sooner than using the HP recovery discs. After the system is restored, reinstalling all the operating system software released since your initial purchase can be a lengthy process.

Restoring and recovering your system

You have several tools available to recover your system both within and outside of Windows if the desktop cannot load.

HP recommends that you attempt to restore your system using the [Restoring and recovery methods on page 181](#).

Creating a system restore

System Restore is available in Windows. The System Restore software can automatically or manually create restore points, or snapshots, of the system files and settings on the computer at a particular point.

When you use System Restore, it returns your computer to its state at the time you made the restore point. Your personal files and documents should not be affected.

Restoring and recovery methods

After you run the first method, test to see whether the issue still exists before you proceed to the next method, which might now be unnecessary.

1. Run a Microsoft System Restore.
2. Run Reset this PC.



NOTE: The options **Remove everything** and then **Fully clean the drive** can take several hours to complete and leave no information on your computer. It is the safest way to reset your computer before you recycle it.

3. Recover using HP Recovery media. For more information, see [Recovering using HP Recovery media on page 181](#).

For more information about the first two methods, see the Get Help app:

Select the **Start** button, select the **Get Help** app, and then enter the task you want to perform.



NOTE: You must be connected to the internet to access the Get Help app.

Recovering using HP Recovery media

You can use HP Recovery media to recover the original operating system and software programs that were installed at the factory. On select products, it can be created on a bootable USB flash drive using the HP Cloud Recovery Download Tool.

For details, see [Using the HP Cloud Recovery Download Tool to create recovery media \(select products only\) on page 180](#).



NOTE: If you cannot create recovery media yourself, contact support to obtain recovery discs. Go to <http://www.hp.com/support>, select your country or region, and then follow the on-screen instructions.

To recover your system:

- ▲ Insert the HP Recovery media, and then restart the computer.



NOTE: HP recommends that you follow the [Restoring and recovery methods on page 181](#) to restore your computer before you obtain and use the HP recovery discs. Using a recent backup can return your machine to a working state sooner than using the HP recovery discs. After the system is restored, reinstalling all the operating system software released since your initial purchase can be a lengthy process.

Changing the computer boot order

If your computer does not restart using the HP Recovery media, you can change the computer boot order, the order of devices listed in BIOS for startup information. You can select an optical drive or a USB flash drive, depending on the location of your HP Recovery media.



IMPORTANT: For a tablet with a detachable keyboard, connect the tablet to the keyboard base before beginning these steps.

To change the boot order:

1. Insert the HP Recovery media.
2. Access the system **Startup** menu.
 - For computers or tablets with keyboards attached, turn on or restart the computer or tablet, quickly press **esc**, and then press **f9** for boot options.
 - For tablets without keyboards, turn on or restart the tablet, quickly press and hold the volume up button, and then select **f9**.

– or –

Turn on or restart the tablet, quickly press and hold the volume down button, and then select **f9**.
3. Select the optical drive or USB flash drive from which you want to boot, and then follow the on-screen instructions.

Using HP Sure Recover (select products only)

Select computer models are configured with HP Sure Recover, a PC operating system (OS) recovery solution built into the hardware and software. HP Sure Recover can fully restore the HP OS image without installed recovery software.

Using HP Sure Recover, an administrator or user can restore the system and install:

- Latest version of the operating system
- Platform-specific device drivers
- Software applications, in the case of a custom image

To access the latest documentation for HP Sure Recover, go to <http://www.hp.com/support>. Follow the on-screen instructions to find your product and locate your documentation.

12 Using HP PC Hardware Diagnostics

You can use the HP PC Hardware Diagnostics utility to determine whether your computer hardware is running properly. The three versions are HP PC Hardware Diagnostics Windows, HP PC Hardware Diagnostics UEFI (Unified Extensible Firmware Interface), and (for select products only) Remote HP PC Hardware Diagnostics UEFI, a firmware feature.

Using HP PC Hardware Diagnostics Windows (select products only)

HP PC Hardware Diagnostics Windows is a Windows-based utility that allows you to run diagnostic tests to determine whether the computer hardware is functioning properly. The tool runs within the Windows operating system to diagnose hardware failures.

If HP PC Hardware Diagnostics Windows is not installed on your computer, first you must download and install it. To download HP PC Hardware Diagnostics Windows, see [Downloading HP PC Hardware Diagnostics Windows on page 184](#).

Using an HP PC Hardware Diagnostics Windows hardware failure ID code

When HP PC Hardware Diagnostics Windows detects a failure that requires hardware replacement, a 24-digit failure ID code is generated for select component tests. For interactive tests, such as keyboard, mouse, or audio and video palette, you must perform troubleshooting steps before you can receive a failure ID.

- ▲ You have several options after you receive a failure ID:
 - Select **Next** to open the Event Automation Service (EAS) page, where you can log the case.
– or –
 - Scan the QR code with your mobile device, which takes you to the EAS page, where you can log the case.
– or –
 - Select the box next to the 24-digit failure ID to copy your failure code and send it to support.

Accessing HP PC Hardware Diagnostics Windows

After HP PC Hardware Diagnostics Windows is installed, you can access it from HP Help and Support, HP Support Assistant, or the Start menu.

Accessing HP PC Hardware Diagnostics Windows from HP Help and Support (select products only)

After HP PC Hardware Diagnostics Windows is installed, follow these steps to access it from HP Help and Support.

1. Select the **Start** button, and then select **HP Help and Support**.
2. Select **HP PC Hardware Diagnostics Windows**.
3. When the tool opens, select the type of diagnostic test that you want to run, and then follow the on-screen instructions.



NOTE: To stop a diagnostic test, select **Cancel**.

Accessing HP PC Hardware Diagnostics Windows from Support Assistant

After HP PC Hardware Diagnostics Windows is installed, follow these steps to access it from HP Support Assistant.

1. Type `support` in the taskbar search box, and then select the **HP Support Assistant** app.
– or –
Select the question mark icon in the taskbar.
2. Select **Troubleshooting and fixes**.
3. Select **Diagnostics**, and then select **HP PC Hardware Diagnostics Windows**.
4. When the tool opens, select the type of diagnostic test that you want to run, and then follow the on-screen instructions.



NOTE: To stop a diagnostic test, select **Cancel**.

Accessing HP PC Hardware Diagnostics Windows from the Start menu (select products only)

After HP PC Hardware Diagnostics Windows is installed, follow these steps to access it from the Start menu.

1. Select the **Start** button.
2. Right-click **HP PC Hardware Diagnostics for Windows**, select **More**, and then select **Run as administrator**.
3. When the tool opens, select the type of diagnostic test that you want to run, and then follow the on-screen instructions.



NOTE: To stop a diagnostic test, select **Cancel**.

Downloading HP PC Hardware Diagnostics Windows

The HP PC Hardware Diagnostics Windows downloading instructions are provided in English only. You must use a Windows computer to download this tool because only .exe files are provided.

Downloading the latest HP PC Hardware Diagnostics Windows version from HP

To download HP PC Hardware Diagnostics Windows from HP, follow these steps.

1. Go to <http://www.hp.com/go/techcenter/pcdiags>. The HP PC Diagnostics home page is displayed.
2. Select **Download HP Diagnostics Windows**, and then select the specific Windows diagnostics version to download to your computer or a USB flash drive.

The tool downloads to the selected location.

Downloading the HP PC Hardware Diagnostics Windows from the Microsoft Store

You can download the HP PC Hardware Diagnostics Windows from the Microsoft Store.

1. Select the Microsoft Store app on your desktop or enter `Microsoft Store` in the taskbar search box.

2. Enter `HP PC Hardware Diagnostics Windows` in the **Microsoft Store** search box.
3. Follow the on-screen directions.

The tool downloads to the selected location.

Downloading HP Hardware Diagnostics Windows by product name or number (select products only)

You can download HP PC Hardware Diagnostics Windows by product name or number.

 **NOTE:** For some products, you might have to download the software to a USB flash drive by using the product name or number.

1. Go to <http://www.hp.com/support>.
2. Select **Software and Drivers**, select your type of product, and then enter the product name or number in the search box that is displayed.
3. In the **Diagnostics** section, select **Download**, and then follow the on-screen instructions to select the specific Windows diagnostics version to be downloaded to your computer or USB flash drive.

The tool downloads to the selected location.

Installing HP PC Hardware Diagnostics Windows

To install HP PC Hardware Diagnostics Windows, navigate to the folder on your computer or the USB flash drive where the .exe file downloaded, double-click the .exe file, and then follow the on-screen instructions.

Using HP PC Hardware Diagnostics UEFI

HP PC Hardware Diagnostics UEFI (Unified Extensible Firmware Interface) allows you to run diagnostic tests to determine whether the computer hardware is functioning properly. The tool runs outside the operating system so that it can isolate hardware failures from issues that are caused by the operating system or other software components.

 **NOTE:** For Windows 10 S computers, you must use a Windows computer and a USB flash drive to download and create the HP UEFI support environment because only .exe files are provided. For more information, see [Downloading HP PC Hardware Diagnostics UEFI to a USB flash drive on page 186](#).

If your PC does not start in Windows, you can use HP PC Hardware Diagnostics UEFI to diagnose hardware issues.

Using an HP PC Hardware Diagnostics UEFI hardware failure ID code

When HP PC Hardware Diagnostics UEFI detects a failure that requires hardware replacement, a 24-digit failure ID code is generated.

For assistance in solving the problem:

- ▲ Select **Contact HP**, accept the HP privacy disclaimer, and then use a mobile device to scan the failure ID code that appears on the next screen. The HP Customer Support - Service Center page appears with your failure ID and product number automatically filled in. Follow the on-screen instructions.

– or –

Contact support, and provide the failure ID code.

 **NOTE:** To start diagnostics on a convertible computer, your computer must be in notebook mode, and you must use the attached keyboard.

 **NOTE:** If you need to stop a diagnostic test, press `esc`.

Starting HP PC Hardware Diagnostics UEFI

To start HP PC Hardware Diagnostics UEFI, follow this procedure.

1. Turn on or restart the computer, and quickly press `esc`.
2. Press `f2`.

The BIOS searches three places for the diagnostic tools, in the following order:

- a. Connected USB flash drive

 **NOTE:** To download the HP PC Hardware Diagnostics UEFI tool to a USB flash drive, see [Downloading the latest HP PC Hardware Diagnostics UEFI version on page 186](#).

- b. Hard drive

- c. BIOS

3. When the diagnostic tool opens, select a language, select the type of diagnostic test you want to run, and then follow the on-screen instructions.

Downloading HP PC Hardware Diagnostics UEFI to a USB flash drive

Downloading HP PC Hardware Diagnostics UEFI to a USB flash drive can be useful in some situations.

- HP PC Hardware Diagnostics UEFI is not included in the preinstallation image.
- HP PC Hardware Diagnostics UEFI is not included in the HP Tool partition.
- The hard drive is damaged.

 **NOTE:** The HP PC Hardware Diagnostics UEFI downloading instructions are provided in English only, and you must use a Windows computer to download and create the HP UEFI support environment because only `.exe` files are provided.

Downloading the latest HP PC Hardware Diagnostics UEFI version

To download the latest HP PC Hardware Diagnostics UEFI version to a USB flash drive, follow this procedure.

1. Go to <http://www.hp.com/go/techcenter/pcdiags>. The HP PC Diagnostics home page is displayed.
2. Select **Download HP Diagnostics UEFI**, and then select **Run**.

Downloading HP PC Hardware Diagnostics UEFI by product name or number (select products only)

You can download HP PC Hardware Diagnostics UEFI by product name or number (select products only) to a USB flash drive.

 **NOTE:** For some products, you might have to download the software to a USB flash drive by using the product name or number.

1. Go to <http://www.hp.com/support>.

2. Enter the product name or number, select your computer, and then select your operating system.
3. In the **Diagnostics** section, follow the on-screen instructions to select and download the specific UEFI Diagnostics version for your computer.

Using Remote HP PC Hardware Diagnostics UEFI settings (select products only)

Remote HP PC Hardware Diagnostics UEFI is a firmware (BIOS) feature that downloads HP PC Hardware Diagnostics UEFI to your computer. It can then execute the diagnostics on your computer, and it might upload results to a preconfigured server.

For more information about Remote HP PC Hardware Diagnostics UEFI, go to <http://www.hp.com/go/techcenter/pcdiags>, and then select **Find out more**.

Downloading Remote HP PC Hardware Diagnostics UEFI

HP Remote PC Hardware Diagnostics UEFI is also available as a SoftPaq that you can download to a server.

Downloading the latest Remote HP PC Hardware Diagnostics UEFI version

You can download the latest HP PC Hardware Diagnostics UEFI version to a USB flash drive.

1. Go to <http://www.hp.com/go/techcenter/pcdiags>. The HP PC Diagnostics home page is displayed.
2. Select **Download Remote Diagnostics**, and then select **Run**.

Downloading Remote HP PC Hardware Diagnostics UEFI by product name or number

You can download HP Remote PC Hardware Diagnostics UEFI by product name or number.



NOTE: For some products, you might have to download the software by using the product name or number.

1. Go to <http://www.hp.com/support>.
2. Select **Software and Drivers**, select your type of product, enter the product name or number in the search box that is displayed, select your computer, and then select your operating system.
3. In the **Diagnostics** section, follow the on-screen instructions to select and download the **Remote UEFI** version for the product.

Customizing Remote HP PC Hardware Diagnostics UEFI settings

Using the Remote HP PC Hardware Diagnostics setting in Computer Setup (BIOS), you can perform several customizations.

- Set a schedule for running diagnostics unattended. You can also start diagnostics immediately in interactive mode by selecting **Execute Remote HP PC Hardware Diagnostics**.
- Set the location for downloading the diagnostic tools. This feature provides access to the tools from the HP website or from a server that has been preconfigured for use. Your computer does not require the traditional local storage (such as a hard drive or USB flash drive) to run remote diagnostics.
- Set a location for storing the test results. You can also set the user name and password that you use for uploads.

- Display status information about the diagnostics run previously.

To customize Remote HP PC Hardware Diagnostics UEFI settings, follow these steps:

1. Turn on or restart the computer, and when the HP logo appears, press **f10** to enter Computer Setup.
2. Select **Advanced**, and then select **Settings**.
3. Make your customization selections.
4. Select **Main**, and then **Save Changes and Exit** to save your settings.

Your changes take effect when the computer restarts.

13 Specifications

This chapter provides specifications for your computer.

Computer specifications

This section provides specifications for your computer. When you travel with your computer, the computer dimensions and weights, as well as input power ratings and operating specifications, provide helpful information.

Table 13-1 Computer specifications

	Metric	U.S.
Dimensions		
Width	35.7 cm	14.06 in
Depth	24.25 cm	9.55 in
Height (front to back)	2.59 cm	1.02 in
Weight		
Input power		
Operating voltage and current	5 V dc @ 2 A / 12 V dc @ 3 A / 15 V dc @ 3 A – 45 W USB-C	
	5 V dc @ 3 A / 9 V dc @ 3 A / 12 V dc @ 3.75 A / 15 V dc @ 3 A – 45 W USB-C	
	5 V dc @ 3 A / 9 V dc @ 3 A / 10 V dc @ 3.75 A / 12 V dc @ 3.75 A / 15 V dc @ 3 A / 20 V dc @ 2.25 A – 45 W USB-C	
	5 V dc @ 3 A / 9 V dc @ 3 A / 12 V dc @ 5 A / 15 V dc @ 4.33 A / 20 V dc @ 3.25 A – 65 W USB-C	
	5 V dc @ 3 A / 9 V dc @ 3 A / 10 V dc @ 5 A / 12 V dc @ 5 A / 15 V dc @ 4.33 A / 20 V dc @ 3.25 A – 65 W USB-C	
	5 V dc @ 3 A / 9 V dc @ 3 A / 10 V dc @ 5 A / 12 V dc @ 5 A / 15 V dc @ 5 A / 20 V dc @ 4.5 A – 90 W USB-C	
	19.5 V dc @ 2.31 A – 45 W	
	19.5 V dc @ 3.33 A – 65 W	
	19.5 V dc @ 4.62 A – 90 W	
	19.5 V dc @ 6.15 A – 120 W	
	19.5 V dc @ 6.9 A – 135 W	
	19.5 V dc @ 7.70 A – 150 W	
	19.5 V dc @ 10.3 A – 200 W	
	19.5 V dc @ 11.8 A – 230 W	
	19.5 V dc @ 16.92 A – 330 W	

Table 13-1 Computer specifications (continued)

	Metric	U.S.
	19.5 V dc @ 3.33 A – 65 W	
	19.5 V dc @ 4.62 A – 90 W	
	19.5 V dc @ 7.70 A – 150 W	
	19.5 V dc @ 10.3 A – 200 W	
Temperature		
Operating	5°C to 35°C	41°F to 95°F
Nonoperating	–20°C to 60°C	–4°F to 140°F
Relative humidity (noncondensing)		
Operating	10% to 90%	
Nonoperating	5% to 95%	
Maximum altitude (unpressurized)		
Operating	–15 m to 3,048 m	–50 ft to 10,000 ft
Nonoperating	–15 m to 12,192 m	–50 ft to 40,000 ft
NOTE: Applicable product safety standards specify thermal limits for plastic surfaces. The device operates well within this range of temperatures.		

39.6 cm (15.6 in) display specifications

This section provides specifications for your display.

Table 13-2 Display specifications

	Metric	U.S.
Active diagonal size	39.6 cm	15.6 in
Resolution	1920 × 1080 (FHD) 3840 × 2160 (UHD)	
Surface treatment	Antiglare (FHD, UHD panels) BrightView (OLED panel)	
Brightness	1000 nits (FHD panels) 600 nits (UHD panels) 250 nits (FHD panels)	
Viewing angle	UWVA	
Backlight	WLED	
Display panel interface	eDP	

Hard drive specifications

This section provides specifications for your hard drives.

Table 13-3 Hard drive specifications

	2T	1T	500 GB*
Dimensions			
Height	7.0 mm	7.0 mm	7.0 mm
Width	70 mm	70 mm	70 mm
Weight	107 g max	107 g max	107 g max
Interface type	SATA	SATA	SATA
Transfer rate	300 MB/s	300 MB/s	300 MB/s
Security	ATA security	ATA security	ATA security
Seek times (typical read, including setting)			
Single track	1.5 ms	1.1 ms	1.1 ms
Average	12.0 ms	12.0 ms	12.0 ms
Maximum	22.0 ms	21.0 ms	21.0 ms
Logical blocks	976,752,240	976,752,240	976,752,240
Disk rotational speed	5400 rpm	7200 rpm	7200 rpm
Operating temperature	0°C to 60°C (0°F to 140°F)	0°C to 60°C (0°F to 140°F)	0°C to 60°C (0°F to 140°F)
*Size refers to hard drive storage capacity. Actual accessible capacity is less. Actual drive specifications can differ slightly.			
NOTE: Certain restrictions and exclusions apply. Contact support for details.			

Solid-state drive specifications

This section provides specifications for your solid-state drives.

Table 13-4 Solid-state drive specifications

	256 GB*	512 GB*	1 TB*
Dimensions			
Height	1.0 mm	1.0 mm	1.0 mm
Length	50.8 mm	50.8 mm	50.8 mm
Width	28.9 mm	28.9 mm	28.9 mm
Weight	< 10 g	< 10 g	< 10 g
Interface type	PCIe	PCIe	PCIe
Ready time, maximum (to not busy)	1.0 ms	< 1.0 ms	1.0 ms
Access times, logical	0.1 ms	0.1 ms	0.1 ms

Table 13-4 Solid-state drive specifications (continued)

	256 GB*	512 GB*	1 TB*
Transfer rate			
Sequential read	up to 2150 MB/s	up to 2150 MB/s	up to 2150 MB/s
Random read	Up to 300,000 IOPs	Up to 300,000 IOPs	Up to 300,000 IOPs
Sequential write	up to 1550 MB/s	up to 1550 MB/s	up to 1550 MB/s
Random write	Up to 100,000 IOPs	Up to 100,000 IOPs	Up to 100,000 IOPs
Total logical sectors	468,883,296	1,000,215,216	1,500,336,388
Operating temperature	0°C to 70°C (32°F to 158°F)		
*1 GB = 1 billion bytes when referring to hard drive storage capacity. Actual accessible capacity is less. Actual drive specifications may differ slightly.			
NOTE: Certain restrictions and exclusions apply. Contact support for details.			

Solid-state drive specifications (SATA-3)

This section provides specifications for your solid-state drive.

Table 13-5 Solid-state drive specifications

	128 GB*
Dimensions	
Height	1.35 mm
Weight	< 10 g
Interface type	
Ready time, maximum (to not busy)	1.0 ms
Access times, logical	0.1 ms
Transfer rate	up to 540 MB/s
Total logical sectors	234,441,648
Operating temperature	0°C to 70°C (32°F to 158°F)
*1 GB = 1 billion bytes when referring to hard drive storage capacity. Actual accessible capacity is less. Actual drive specifications can differ slightly.	
NOTE: Certain restrictions and exclusions apply. Contact support for details.	

14 Statement of memory volatility

For general information regarding nonvolatile memory in HP business computers, and to restore nonvolatile memory that can contain personal data after the system has been turned off and the hard drive has been removed, use these instructions.

HP business computer products that use Intel®-based or AMD®-based system boards contain volatile DDR memory. The amount of nonvolatile memory present in the system depends upon the system configuration. Intel-based and AMD-based system boards contain nonvolatile memory subcomponents as originally shipped from HP, with the following assumptions:

- No subsequent modifications were made to the system.
- No applications, features, or functionality were added to or installed on the system.

Following system shutdown and removal of all power sources from an HP business computer system, personal data can remain on volatile system memory (DIMMs) for a finite period of time and also remains in nonvolatile memory. Use the following steps to remove personal data from the computer, including the nonvolatile memory found in Intel-based and AMD-based system boards.

 **NOTE:** If your tablet has a keyboard base, connect to the keyboard base before beginning steps in this chapter.

Current BIOS steps

Use these instructions to restore nonvolatile memory.

1. Follow these steps to restore the nonvolatile memory that can contain personal data. Restoring or reprogramming nonvolatile memory that does not store personal data is neither necessary nor recommended.
 - a. Turn on or restart the computer, and then quickly press **esc**.

 **NOTE:** If the system has a BIOS administrator password, enter the password at the prompt.

 - b. Select **Main**, select **Apply Factory Defaults and Exit**, and then select **Yes** to load defaults. The computer restarts.
 - c. During the restart, press **esc** while the "Press the ESC key for Startup Menu" message is displayed at the bottom of the screen.

 **NOTE:** If the system has a BIOS administrator password, enter the password at the prompt.

 - d. Select the **Security** menu, select **Restore Security Settings to Factory Defaults**, and then select **Yes** to restore security level defaults. The computer reboots.
 - e. During the reboot, press **esc** while the "Press the ESC key for Startup Menu" message is displayed at the bottom of the screen.

 **NOTE:** If the system has a BIOS administrator password, enter the password at the prompt.

- f. If an asset or ownership tag is set, select the **Security** menu and scroll down to the **Utilities** menu. Select **System IDs**, and then select **Asset Tracking Number**. Clear the tag, and then make the selection to return to the prior menu.
- g. If a DriveLock password is set, select the **Security** menu, and scroll down to **Hard Drive Utilities** under the **Utilities** menu. Select **Hard Drive Utilities**, select **DriveLock**, and then clear the check box for **DriveLock password on restart**. Select **OK** to proceed.
- h. Select the **Main** menu, and then select **Reset BIOS Security to factory default**. Select **Yes** at the warning message. The computer reboots.
- i. During the reboot, press **esc** while the "Press the ESC key for Startup Menu" message is displayed at the bottom of the screen.



NOTE: If the system has a BIOS administrator password, enter the password at the prompt.

- j. Select the **Main** menu, select **Apply Factory Defaults and Exit**, select **Yes** to save changes and exit, and then select **Shutdown**.
 - k. Reboot the system. If the system has a Trusted Platform Module (TPM), fingerprint reader, or both, one or two prompts will appear—one to clear the TPM and the other to Reset Fingerprint Sensor. Press or tap **f1** to accept or **f2** to reject.
 - l. Remove all power and system batteries for at least 24 hours.
2. Complete one of the following:
- Remove and retain the storage drive.
– or –
 - Clear the drive contents by using a third-party utility designed to erase data from an SSD.
– or –
 - Clear the contents of the drive by using the following BIOS Setup Secure Erase command option steps:



NOTE: If you clear data using Secure Erase, you cannot recover it.

- a. Turn on or restart the computer, and then quickly press **esc**.
- b. Select the **Security** menu and scroll down to the **esc** menu.
- c. Select **Hard Drive Utilities**.
- d. Under **Utilities**, select **Secure Erase**, select the hard drive storing the data you want to clear, and then follow the on-screen instructions to continue.

– or –

Clear the contents of the drive using the following Disk Sanitizer commands steps:

- i. Turn on or restart the computer, and then quickly press **esc**.
- ii. Select the **Security** menu and scroll down to the **Utilities** menu.
- iii. Select **Hard Drive Utilities**.

- iv. Under **Utilities**, select **Disk Sanitizer**, select the hard drive with the data that you want to clear, and then follow the on-screen instructions to continue.

 **NOTE:** The amount of time it takes for Disk Sanitizer to run can take several hours. Plug the computer into an AC outlet before starting.

Nonvolatile memory usage

Use this table to troubleshooting nonvolatile memory usage.

Table 14-1 Troubleshooting steps for nonvolatile memory usage

Nonvolatile memory type	Amount (Size)	Does this memory store customer data?	Does this memory retain data when power is removed?	What is the purpose of this memory?	How is data entered into this memory?	How is this memory write-protected?
HP Sure Start flash (select models only)	8 MB	No	Yes	Provides protected backup of critical System BIOS code, EC firmware, and critical computer configuration data for select platforms that support HP Sure Start. For more information, see Using HP Sure Start (select products only) on page 199 .	Data cannot be written to this device via the host processor. The content is managed solely by the HP Sure Start Embedded Controller.	This memory is protected by the HP Sure Start Embedded Controller.
Real Time Clock (RTC) battery backed-up CMOS configuration memory	256 bytes	No	Yes	Stores system date and time and noncritical data.	RTC battery backed-up CMOS is programmed using Computer Setup (BIOS), or by changing the Windows date & time.	This memory is not write-protected.
Controller (NIC) EEPROM	64 KB (not customer accessible)	No	Yes	Stores NIC configuration and NIC firmware.	NIC EEPROM is programmed using a utility from the NIC vendor that can be run from DOS.	A utility must be used to write data to this memory and is available from the NIC vendor. Writing data to this ROM in an inappropriate manner will render the NIC nonfunctional.
DIMM Serial Presence Detect (SPD) configuration data	256 bytes per memory module, 128 bytes programmabl	No	Yes	Stores memory module information.	DIMM SPD is programmed by the memory vendor.	Data cannot be written to this memory when the module is installed in a computer. The specific

Table 14-1 Troubleshooting steps for nonvolatile memory usage (continued)

Nonvolatile memory type	Amount (Size)	Does this memory store customer data?	Does this memory retain data when power is removed?	What is the purpose of this memory?	How is data entered into this memory?	How is this memory write-protected?
						write-protection method varies by memory vendor.
System BIOS	9 MB	Yes	Yes	Stores system BIOS code and computer configuration data.	System BIOS code is programmed at the factory. Code is updated when the system BIOS is updated. Configuration data and settings are entered using the Computer Setup (BIOS) or a custom utility.	<p>NOTE: Writing data to this ROM in an inappropriate manner can render the computer nonfunctional.</p> <p>A utility must be used for writing data to this memory and is available on the HP website; go to http://www.hp.com/support. Select Find your product, and then follow the on-screen instructions.</p>
Intel Management Engine Firmware (present only in select Elite or Z models. For more information, go to http://www.hp.com/support . Select Identify your product for manuals and specific product information , and then follow the on-screen instructions.)	1.5 MB or 7 MB	Yes	Yes	Stores Management Engine Code, Settings, Provisioning Data and iAMT third-party data store.	Management Engine Code is programmed at the factory. Code is updated via Intel secure firmware update utility. Unique Provisioning Data can be entered at the factory or by an administrator using the Management Engine (MEBx) setup utility. The third-party data store contents can be populated by a remote management console or local applications that have been registered by an administrator to have access to the space.	The Intel chipset is configured to enforce hardware protection to block all direct read-write access to this area. An Intel utility must be used for updating the firmware. Only firmware updates digitally signed by Intel can be applied using this utility.
Bluetooth flash (select products only)	2 megabits	No	Yes	Stores Bluetooth configuration and firmware.	Bluetooth flash is programmed at the factory. Tools for writing data to this memory are not publicly available but can be obtained from the silicon vendor.	A utility must be used for writing data to this memory and is made available through newer versions of the driver whenever the flash requires an upgrade.
802.11 WLAN EEPROM	4 kilobits to 8 kilobits	No	Yes	Stores configuration and calibration data.	802.11 WLAN EEPROM is programmed at the factory. Tools for writing data to this memory are not made public.	A utility must be used for writing data to this memory and is typically not made available to the public unless a firmware upgrade is necessary to address a unique issue.

Table 14-1 Troubleshooting steps for nonvolatile memory usage (continued)

Nonvolatile memory type	Amount (Size)	Does this memory store customer data?	Does this memory retain data when power is removed?	What is the purpose of this memory?	How is data entered into this memory?	How is this memory write-protected?
Camera (select products only)	64 kilobits	No	Yes	Stores camera configuration and firmware.	Camera memory is programmed using a utility from the device manufacturer that can be run from Windows.	A utility must be used for writing data to this memory and is typically not made available to the public unless a firmware upgrade is necessary to address a unique issue.
Fingerprint reader (select products only)	512 KB flash	Yes	Yes	Stores fingerprint templates.	Fingerprint reader memory is programmed by user enrollment in HP ProtectTools Security Manager.	Only a digitally signed application can make the call to write to the flash.

Questions and answers

Use this section to answer your questions about nonvolatile memory.

1. How can the BIOS settings be restored (returned to factory settings)?

 **IMPORTANT:** The restore defaults feature does not securely erase any information on your hard drive. See question and answer 6 for steps to securely erase information.

The restore defaults feature does not reset the Custom Secure Boot keys. See question and answer 7 for information about resetting the keys.

- Turn on or restart the computer, and then quickly press *esc*.
- Select **Main**, and then select **Apply Factory Defaults and Exit**.
- Follow the on-screen instructions.
- Select **Main**, select **Save Changes and Exit**, and then follow the on-screen instructions.

2. What is a UEFI BIOS, and how is it different from a legacy BIOS?

The Unified Extensible Firmware Interface (UEFI) BIOS is an industry-standard software interface between the platform firmware and an operating system (OS). It replaces the older BIOS architecture but supports much of the legacy BIOS functionality.

Like the legacy BIOS, the UEFI BIOS provides an interface to display the system information and configuration settings and to change the configuration of your computer before an OS is loaded. BIOS provides a secure runtime environment that supports a Graphic User Interface (GUI). In this environment, you can use either a pointing device (touch screen, touchpad, pointing stick, or USB mouse) or the keyboard to navigate and make menu and configuration selections. The UEFI BIOS also contains basic system diagnostics.

The UEFI BIOS provides functionality beyond that of the legacy BIOS. In addition, the UEFI BIOS works to initialize the computer's hardware before loading and executing the OS; the runtime environment allows the loading and execution of software programs from storage devices to provide more functionality, such as advanced hardware diagnostics (with the ability to display more detailed system information) and advanced firmware management and recovery software.

HP has provided options in Computer Setup (BIOS) to allow you to run in legacy BIOS, if required by the operating system. Examples of this requirement would be if you upgrade or downgrade the OS.

3. Where is the UEFI BIOS located?

The UEFI BIOS is located on a flash memory chip. You must use a utility to write to the chip.

4. What kind of configuration data is stored on the DIMM Serial Presence Detect (SPD) memory module? How would this data be written?

The DIMM SPD memory contains information about the memory module, such as size, serial number, data width, speed and timing, voltage, and thermal information. This information is written by the module manufacturer and stored on an EEPROM. You cannot write to this EEPROM when the memory module is installed in a computer. Third-party tools do exist that can write to the EEPROM when the memory module is not installed in a computer. Various third-party tools are available to read SPD memory.

5. What is meant by “Restore the nonvolatile memory found in Intel-based system boards”?

This message relates to clearing the Real Time Clock (RTC) CMOS memory that contains computer configuration data.

6. How can the BIOS security be reset to factory defaults and erase the data?

 **IMPORTANT:** Resetting results in the loss of information.

These steps do not reset Custom Secure Boot Keys. See question and answer 7 for information about resetting the keys.

- a. Turn on or restart the computer, and then quickly press **esc**.
- b. Select **Main**, and then select **Reset Security to Factory Defaults**.
- c. Follow the on-screen instructions.
- d. Select **Main**, select **Save Changes and Exit**, and then follow the on-screen instructions.

7. How can the Custom Secure Boot Keys be reset?

Secure Boot is a feature to ensure that only authenticated code can start on a platform. If you enabled Secure Boot and created Custom Secure Boot Keys, disabling Secure Boot does not clear the keys. You must also select to clear the Custom Secure Boot Keys. Use the same Secure Boot access procedure that you used to create the Custom Secure Boot Keys, but select to clear or delete all Secure Boot Keys.

- a. Turn on or restart the computer, and then quickly press **esc**.
- b. Select the **Security** menu, select **Secure Boot Configuration**, and then follow the on-screen instructions.
- c. At the **Secure Boot Configuration** window, select **Secure Boot**, select **Clear Secure Boot Keys**, and then follow the on-screen instructions to continue.

Using HP Sure Start (select products only)

Select computer models are configured with HP Sure Start, a technology that continuously monitors your computer's BIOS for attacks or corruption.

If the BIOS becomes corrupted or is attacked, HP Sure Start restores the BIOS to its previously safe state, without user intervention. Those select computer models ship with HP Sure Start configured and enabled. HP Sure Start is configured and already enabled so that most users can use the HP Sure Start default configuration. Advanced users can customize the default configuration.

To access the latest documentation on HP Sure Start, go to <http://www.hp.com/support>.

15 Power cord set requirements

This chapter provides power cord requirements for countries and regions.

The wide-range input feature of the computer permits it to operate from any line voltage from 100 V ac to 120 V ac, or from 220 V ac to 240 V ac.

The three-conductor power cord set included with the computer meets the requirements for use in the country or region where the equipment is purchased.

Power cord sets for use in other countries or regions must meet the requirements of the country and region where the computer is used.

Requirements for all countries

These power cord requirements are applicable to all countries and regions.

- The length of the power cord set must be at least **1.0 m** (3.3 ft) and no more than **2.0 m** (6.5 ft).
- All power cord sets must be approved by an acceptable accredited agency responsible for evaluation in the country or region where the power cord set will be used.
- The power cord sets must have a minimum current capacity of 10 A and a nominal voltage rating of 125 V ac or 250 V ac, as required by the power system of each country or region.
- The appliance coupler must meet the mechanical configuration of an EN 60 320/IEC 320 Standard Sheet C13 connector for mating with the appliance inlet on the back of the computer.

Requirements for specific countries and regions

To determine power cord requirements for specific countries and regions, use this table.

Table 15-1 Power cord requirements for specific countries and regions

Country/region	Accredited agency	Applicable note number
Argentina	IRAM	1
Australia	SAA	1
Austria	OVE	1
Belgium	CEBEC	1
Brazil	ABNT	1
Canada	CSA	2
Chile	IMQ	1
Denmark	DEMKO	1
Finland	FIMKO	1
France	UTE	1
Germany	VDE	1

Table 15-1 Power cord requirements for specific countries and regions (continued)

Country/region	Accredited agency	Applicable note number
India	BIS	1
Israel	SII	1
Italy	IMQ	1
Japan	JIS	3
Netherlands	KEMA	1
New Zealand	SANZ	1
Norway	NEMKO	1
People's Republic of China	CCC	4
Saudi Arabia	SASO	7
Singapore	PSB	1
South Africa	SABS	1
South Korea	KTL	5
Sweden	SEMKO	1
Switzerland	SEV	1
Taiwan	BSMI	6
Thailand	TISI	1
United Kingdom	ASTA	1
United States	UL	2

1. The flexible cord must be Type H05VV-F, three-conductor, 0.75 mm² conductor size. Power cord set fittings (appliance coupler and wall plug) must bear the certification mark of the agency responsible for evaluation in the country or region where it will be used.
2. The flexible cord must be Type SVT/SJT or equivalent, No. 18 AWG, three-conductor. The wall plug must be a two-pole grounding type with a NEMA 5-15P (15 A, 125 V ac) or NEMA 6-15P (15 A, 250 V ac) configuration. CSA or C-UL mark. UL file number must be on each element.
3. The appliance coupler, flexible cord, and wall plug must bear a T mark and registration number in accordance with the Japanese Dentori Law. The flexible cord must be Type VCTF, three-conductor, 0.75 mm² or 1.25 mm² conductor size. The wall plug must be a two-pole grounding type with a Japanese Industrial Standard C8303 (7 A, 125 V ac) configuration.
4. The flexible cord must be Type RVV, three-conductor, 0.75 mm² conductor size. Power cord set fittings (appliance coupler and wall plug) must bear the CCC certification mark.
5. The flexible cord must be Type H05VV-F three-conductor, 0.75 mm² conductor size. KTL logo and individual approval number must be on each element. Approval number and logo must be printed on a flag label.
6. The flexible cord must be Type HVCTF three-conductor, 1.25 mm² conductor size. Power cord set fittings (appliance coupler, cable, and wall plug) must bear the BSMI certification mark.
7. For 127 V ac, the flexible cord must be Type SVT or SJT 3-conductor, 18 AWG, with plug NEMA 5-15P (15 A, 125 V ac), with UL and CSA or C-UL marks. For 240 V ac, the flexible cord must be Type H05VV-F three-conductor, 0.75 mm² or 1.00 mm² conductor size, with plug BS 1363/A with BSI or ASTA marks.

16 Recycling

When a nonrechargeable or rechargeable battery has reached the end of its useful life, do not dispose of the battery in general household waste. Follow the local laws and regulations in your area for battery disposal.

HP encourages customers to recycle used electronic hardware, HP original print cartridges, and rechargeable batteries. For more information about recycling programs, see the HP website at <http://www.hp.com/recycle>.

Index

A

- AC adapters, spare part numbers 31
- action keys 14
 - identifying 14
 - insert 14
 - keyboard backlight 14
 - mute 14
 - privacy screen 14
 - programmable key 14
 - screen brightness 14
 - speaker volume 14
 - switch screen image 14
 - touchpad 13
 - using 14
 - wireless 14
- ambient light sensor, identifying 8
- audio
 - adjusting volume 14
- audio-out (headphone)/audio-in (microphone) combo jack, identifying 5, 6
- audio, product description 3

B

- backup, creating 180
- backups 180
- battery light 5
- beam connector
 - removal 85
 - spare part numbers 85
- BIOS
 - determining version 170, 174
 - downloading an update 171, 174, 175
 - starting the Setup Utility 170
 - updating 170, 174
- Bluetooth label 19
- boot order
 - changing using the f9 prompt 175
- boot order, changing 182
- bottom 19
- bottom case
 - removal 65
 - spare part number 65

buttons

- center pointing stick 9
- center touchpad 9
- left pointing stick 9
- left touchpad 9
- power 11
- right pointing stick 9
- right touchpad 9

C

- cables
 - spare part numbers 30
- camera
 - identifying 8
- camera light, identifying 8
- camera privacy cover, identifying 8
- caps lock light, identifying 10
- card reader board
 - removal 77
 - spare part number 77
- caring for your computer 37
- cautions
 - electrostatic discharge 33, 34
- cleaning your computer 37
 - caring for wood veneer 39
 - disinfecting 38
 - HP Easy Clean 37
 - removing dirt and debris 37
- components
 - bottom 16
 - display 8
 - keyboard area 9
 - left side 6
 - rear 18
 - right side 5
 - top cover 17
- computer major components 23
- Computer Setup
 - navigating and selecting 173
 - restoring factory settings 173
 - starting 173
- computer specifications 189
- connector, power 5
- connectors
 - Dual-Mode DisplayPort 5
- creating recovery media 178

D

- display
 - specifications 189, 190
- display components 8
- display panel
 - product description 1
- Dual-Mode DisplayPort, identifying 5

E

- electrostatic discharge (ESD) 33, 34
 - preventing damage 33-35
- erase and reformat recovery media removal 179
- esc key, identifying 13

F

- factory reset 177
- fan/heat sink assembly
 - removal 78
 - spare part numbers 78
- fingerprint reader board
 - removal 70
 - spare part numbers 70
- fingerprint reader module
 - illustrated 28
 - spare part number 28
- fingerprint reader module cable
 - removal 69
 - spare part numbers 69
- fingerprint reader, identifying 11
- fn key, identifying 13
- fn lock light, identifying 10

G

- graphics card
 - removal 87
 - spare part numbers 87
- graphics controller, product description 1
- graphics, product description 1
- grounding methods 33-35
- guidelines
 - packaging 33, 39
 - transporting 33, 39
 - workstation 33

H

- hard drive
 - illustrated 29
 - product description 2
 - removal 46
 - spare part number 29
 - spare part numbers 46
 - specifications 189, 191
 - hard drive cable
 - removal 71
 - spare part numbers 71
 - hardware, locating 5
 - HDMI port, identifying 5
 - hot keys
 - break 16
 - microphone mute 14
 - pause 16
 - programming query 16
 - scroll lock 16
 - using 16
 - HP PC Hardware Diagnostics UEFI
 - downloading 186
 - failure ID code 185
 - starting 186
 - using 185
 - HP PC Hardware Diagnostics Windows
 - accessing 183, 184
 - downloading 184
 - failure ID code 183
 - installing 185
 - using 183
 - HP Recovery media
 - recovery 181
 - HP Sure Recover 182
 - HP Sure Start 193, 199
- ## I
- I/O board
 - removal 95
 - spare part numbers 95
 - illustrated parts catalog 23
 - insert action key 14
 - install
 - Chromebook Recovery Utility 178
 - Recovery Utility 178
 - integrated numeric keypad, identifying 13
 - internal microphone, identifying 17
 - internal microphones, identifying 8

J

- jacks
 - audio-out (headphone)/audio-in (microphone) combo 5
 - network 6
 - RJ-45 (network) 6

K

- keyboard backlight
 - action key 14
- keypad
 - integrated numeric 13
- keys
 - action 14
 - esc 13
 - fn 13
 - num lk 13
 - Windows 13

L

- labels
 - Bluetooth 19
 - regulatory 19
 - serial number 19
 - service 19
 - wireless certification 19
 - WLAN 19
- latches
 - service door release 16
- left side components 6
- lights
 - AC adapter and battery 5
 - battery 5
 - camera 8
 - caps lock 10
 - fn lock 10
 - microphone mute 10
 - num lk 10
 - power 10
 - privacy key 10
 - RJ-45 (network) 6

M

- media card reader, product description 3
- memory
 - nonvolatile 193
 - volatile 193
- memory card reader, identifying 5
- memory module
 - product description 2
- memory modules
 - spare part numbers 53, 59

- memory modules 1 and 3
 - removal 59
- memory modules 2 and 4
 - removal 53
- microphone
 - product description 3
- microphone mute key, identifying 14
- microphone mute light, identifying 10
- model name 1
- mute volume action key 14

N

- Near Field Communications (NFC) 9
- network jack, identifying 6
- NFC module
 - removal 76
 - spare part numbers 76
- NFC module cable
 - removal 75
 - spare part numbers 75
- nonvolatile memory 193
- num lk light 10

O

- operating system, product description 3
- optical drive
 - product description 3

P

- packaging guidelines 33, 39
- pointing stick buttons
 - identifying 9
- pointing stick, identifying 9
- ports
 - Dual-Mode DisplayPort 5
 - HDMI 5
 - USB SuperSpeed 6
 - USB SuperSpeed port with HP Sleep and Charge 6
 - USB Type-C Thunderbolt port with HP Sleep and Charge 5
- power button, identifying 11
- power connector
 - identifying 5
- power connector cable
 - illustrated 28
 - spare part number 28

- power cord
 - requirements for all countries 200
 - requirements for specific countries and regions 200
 - set requirements 200
 - power cords, spare part numbers 31
 - power lights 10
 - power requirements, product description 3
 - primary storage
 - product description 2
 - privacy key light 10
 - privacy screen action key, identifying 14
 - processor
 - product description 1
 - product description
 - audio 3
 - display panel 1
 - graphics 1
 - graphics controller 1
 - hard drive 2
 - media card reader 3
 - memory module 2
 - microphone 3
 - operating system 3
 - optical drive 3
 - power requirements 3
 - primary storage 2
 - processors 1
 - product name 1
 - RJ-45 (network) jack 3
 - security 3
 - serviceability 4
 - solid-state drive 2
 - video 3
 - wireless 3
 - product name 1
 - product name and number, computer 19
 - programable action key 14
- R**
- recovering 177
 - recovering Chrome operating system 178
 - recovery 180
 - discs 181
 - media 181
 - USB flash drive 181
 - recovery media 180
 - creating using HP Cloud Recovery Download Tool 180
 - creating using Windows tools 180
 - Recovery Utility 178
 - regulatory information
 - regulatory label 19
 - wireless certification labels 19
 - Remote HP PC Hardware Diagnostics
 - UEFI settings
 - customizing 187
 - using 187
 - removal and replacement
 - procedures 42, 65
 - solid-state drive 44, 62
 - solid-state drive 2 51
 - removing personal data from volatile system memory 193
 - resetting 177
 - restoring 180
 - restoring and recovery
 - methods 181
 - right side components 5
 - RJ-45 (network) jack, identifying 6
 - RJ-45 (network) jack, product description 3
 - RJ-45 (network) lights, identifying 6
 - RTC battery
 - removal 94
 - spare part numbers 94
- S**
- screen brightness action keys 14
 - Screw Kit, spare part number 31
 - SD card board
 - removal 68
 - spare part numbers 68
 - SD card board cable
 - removal 67
 - spare part numbers 67
 - security cable slot, identifying 6
 - security, product description 3
 - serial number, computer 19
 - service cover
 - removal 42
 - spare part number 42
 - service door release latch 16
 - service door security screw 16
 - service labels, locating 19
 - serviceability, product description 4
 - setting up computer after reset or recovery 179
 - setup utility
 - navigating and selecting 173
 - restoring factory settings 173
 - SIM card, correct size 21
 - SIM card, inserting 20, 21
 - slots
 - security cable 6
 - smart card 6
 - smart card slot, identifying 6
 - software installed, locating 5
 - solid-state drive
 - illustrated 28
 - product description 2
 - removal and replacement 44
 - spare part number 28
 - spare part numbers 29
 - specifications 191, 192
 - solid-state drive 1
 - removal and replacement 62
 - solid-state drive 2
 - removal and replacement 51
 - speaker
 - removal 96
 - spare part number 96
 - speaker volume action keys 14
 - speakers, identifying 11
 - special keys, using 13
 - specifications
 - computer 189
 - display 189, 190
 - hard drive 189, 191
 - solid-state drive 191, 192
 - static electricity 33, 34
 - support information 39
 - Sure Start
 - using 176
 - switch screen image action key 14
 - system board
 - illustrated 26
 - removal 89
 - spare part number 26
 - spare part numbers 89
 - system memory, removing personal data from volatile 193
 - system restore 181
 - system restore point, creating 180
- T**
- top cover/keyboard
 - illustrated 25
 - spare part number 25
 - touchpad
 - illustrated 25
 - removal 74

- settings 9
- spare part number 25
- spare part numbers 74
- touchpad buttons
 - identifying 9
- touchpad cable
 - removal 73
 - spare part number 30
 - spare part numbers 73
- touchpad zone, identifying 9
- TPM settings 176
- transporting guidelines 33, 39
- traveling with the computer 19

- WWAN module
 - removal 49
 - spare part numbers 49

U

- USB board cable
 - spare part number 30
- USB SuperSpeed port with HP Sleep and Charge, identifying 6
- USB SuperSpeed port, identifying 6
- USB Type-C Thunderbolt port with HP Sleep and Charge, identifying 5

V

- vent, identifying 18
- vents, identifying 16
- video
 - Dual-Mode DisplayPort 5
- video, product description 3
- volume
 - adjusting 14
 - mute 14

W

- Windows
 - backup 180
 - recovery media 180
 - system restore point 180
- Windows key, identifying 13
- Windows tools, using 180
- wireless action key 14
- wireless antennas, identifying 8
- wireless certification label 19
- wireless, product description 3
- WLAN antennas, identifying 8
- WLAN device 19
- WLAN label 19
- WLAN module
 - removal 48
 - spare part numbers 48
- workstation guidelines 33
- WWAN antennas, identifying 8