

# Adopt-A-Pond Notebook



**Read it. Use it. Share it!**

*Because healthy ponds don't just happen.*



*Revised June, 2012*

# **Table of Contents**

Introduction

Program & Group Goals

Management Guidelines

Maintenance Calendar

Pond Inspection Checklist

## **Section 1**

Visible Pollution Control

## **Section 2**

Wildlife Habitat

## **Section 3**

Native/FL Yards & Neighborhoods

Landscapes and Techniques

## **Section 4**

Pond Vegetation Coverage

## **Section 5**

Nuisance Vegetation

## **Section 6**

Duckweed Control

## **Section 7**

Algae Control

## **Section 8**

Storm Drains Marked

## **Introduction**

This notebook is designed to help your pond group develop a management plan that can be used to maintain your pond as a healthy, functioning ecosystem and stormwater facility.

Have a pond question? Look in your notebook for the answer! Also, ask your Adopt-A-Pond Coordinator for further assistance.

Start by reviewing and completing the first few pages of this notebook. Establish goals for the pond group, familiarize yourself with the Adopt-A-Pond Management Guidelines, and use the Maintenance Calendar to help direct your efforts based on the season. Finally, complete the Pond Inspection Checklist for your pond at the current moment. Use this notebook to help your group develop ideas for improving your score over the next three years. The notebook is divided into sections based on the Pond Inspection Checklist.

## Adopt-A-Pond Program Goals

- Stormwater Pollution Prevention
- Cleaner Water
- Beautiful Ponds
- Increased Wildlife Habitat
- Fewer Nuisance Plants

## Adopt-A-Pond Group Goals

List the things your group wants to accomplish through the Adopt-A-Pond program:

- \_\_\_\_\_
- \_\_\_\_\_
- \_\_\_\_\_
- \_\_\_\_\_
- \_\_\_\_\_

## Adopt-A-Pond Group Activities

- Complete Pond Inspection Checklist
- Neighborhood Education Meeting
- Develop Pond Management Plan
- Storm Drain Marking
- Pond Planting
- Pond Maintenance Work Days & Reports



## Adopt-A-Pond Management Guidelines

- ❶ It is important to remember that your pond is a stormwater pond, designed to collect runoff from streets, yards, and gutters. That fact must affect what you expect your pond to be. Also, it affects who you'll invite to be part of your “pond group”. All together your neighborhood contributes pollution to your stormwater pond, and all together you can improve the water quality and beauty of it.
- ❷ Your pond is also a product of geology. This will affect what grows in your pond. If it was dug next to a wetland it's probably sitting in rich soils, and might grow algae and duck weed. If it was dug in a pine area, it probably has sandy, nutrient-poor soils, and cypress trees may have trouble.
- ❸ Your goal is to *manage* your pond environment so that nuisance plants don't dominate, a healthy balance of plant diversity is achieved, and water quality is improved. You probably will not “eliminate” nuisance plants, duck weed, or algae from your pond.
- ❹ Although there are many plants that can become a nuisance in ponds, your pond probably has only 2 or 3 that you have to worry about. Concentrate on keeping those under control, especially during the summer months.
- ❺ When it comes to plants growing in your pond, "If you don't know what it is, don't pull it out!" We have many native plants that will naturally occur in healthy pond systems, so get it identified before you pull it out.
- ❻ Please remember that Adopt-A-Pond is a pollution prevention program first and foremost. Therefore, use herbicides, fertilizers and other chemicals strategically and sparingly. With proper management you can leave behind use of chemicals after the first year.
- ❼ The first year of your new pond maintenance program requires the most work and has the most problems, so plan to make monthly inspections and organize work days at least on a quarterly basis.
- ❽ Pulling up, cutting, and raking out nuisance plants will be easier in the winter and spring when water levels are low and the weather is pleasant for a day at the pond, so plan those activities accordingly.

**The Adopt-A-Pond Notebook:** Use it to learn more about your pond environment.

# **Adopt-A-Pond Maintenance Calendar**

## **Spring (March – May)**

Review winter damage. Clean up old leaves and growth from last year. Uncover and make way for the new spring growth. This is a good time to transplant from established clumps of old aquatics to start new planting areas. Everyone will think about fertilizing! So, spread the word... SLOW IS BEST! Be sure to keep fertilizer free zones around the pond and storm drains. Brush up on plant identification so that you and your group don't pull up good plants as they emerge from winter's rest. Plan at least one work day per season.

## **Summer (June - August)**

Pond weeds can easily get out of hand during the summer months, so don't turn your back on your pond this summer! Your pond is especially vulnerable if you are in the first two years of adopting your pond. You may have to schedule several short work days because of the heat. DON'T risk heat stroke or sunburn trying to do it all in one day. Concentrate on the "high-profile" weeds like cattails, torpedo grass and primrose willow.

## **Fall (September – November)**

It's starting to cool off, so tackle the last few patches of trouble before the holidays take over your life. If you just planted in the last 6 to 8 months, make sure you are able to identify all of the new aquatics you planted. Don't mistake them for weeds! They'll be laying in roots to grow like crazy in the spring. Take this time to schedule a pond walk. Show off all of your group's hard work.

## **Winter (December – February)**

You don't have to worry too much about new weedy growth (unless you did not maintain your pond during the summer and fall months). Now is a good time to "fine tune" your pond plantings. Prune trees and shrubs, plan new planting areas, plan new recreation areas, and install bird houses and feeders. Talk to your neighbors and your homeowner association about stormwater pollution prevention.

**Remember to send in your workday reports each season!**

## Pond Inspection Checklist

Date: \_\_\_\_\_ Pond ID/Group Name: \_\_\_\_\_

**For each category, circle the ranking/percentage most appropriate for your pond at this moment. Complete and bring to the Pond Group Kick-Off Meeting.**

<i>Point Values:</i>	<i>0</i>	<i>1</i>	<i>2</i>	<i>3</i>	<i>4</i>
<b>Visible Pollution Control:</b> (e.g. trash, pet waste, lawn clippings, etc.)	Poor	Fair	Good	Excellent	Exemplary
<b>Wildlife Habitat:</b> (e.g. habitat boxes, wildlife corridors, natural spaces, etc.)	Poor	Fair	Good	Excellent	Exemplary
<b>Florida Yards &amp; Neighborhoods Landscapes and Techniques used around the pond and neighborhood:</b> (see Section 3 for more details)	Poor	Fair	Good	Excellent	Exemplary
<b>Pond Surface Covered in Vegetation:</b> (including plants floating, underwater, and along the shoreline of the pond):	<15%	15-25%	26-40%	41-55%	>55%
<b>Presence of Nuisance Vegetation:</b> (best estimate of the amount of invasive, problem plants)	>50%	26-50%	16-25%	5-15%	<5%
<b>Duckweed Coverage:</b> (small floating-leaved plant on the surface of the water)	>50%	31-50%	11-30%	5-10%	<5%
<b>Algae Coverage:</b> (Algae can cause the water to look murky green or brown or it can look foamy/stringy on the surface of the water)	>50%	31-50%	11-30%	5-10%	<5%
<b>Storm Drains Marked with Adopt-A-Pond “No Trash in Drains” Tags:</b>	None/ No Storm Drains	1-30%	31-60%	61-90%	All Drains Marked
<b>General Appearance:</b> (overall look including plants, habitat, water clarity, etc.)	Poor	Fair	Good	Excellent	Exemplary



**Total Score:** \_\_\_\_\_ / 36 points possible  
(32 points possible if no storm drains)

**The Adopt-A-Pond Notebook:** Use it to learn more about your pond environment.

## **Section 1**

### **Visible Pollution Control**

Visible pollution is anything harmful to the waterbody that can physically be seen. This includes any trash, pet waste, lawn clippings in the water or on the pavement, etc. This section includes articles about sources of water pollution and ways each person can prevent water pollution.

#### **Featured Articles:**

- **Protect Florida's Water – Stop Non-point Source Pollution!**
- **Trash Catcher**
- **Muscovy Ducks - Love 'Em or Leave 'Em?**
- **Put Pet Waste in the Trash!**

# Protect Florida's Water

## Stop Non-Point Source Pollution!

### What is Non-Point Source Pollution?

**Non-point source pollution** is pollution that can't be traced back to a particular point or pipe. It comes from many diffuse sources. It travels over land with rain or irrigation runoff. It's then carried to ponds, lakes, rivers, and eventually Tampa Bay.

#### Examples of Non-Point Source Pollution:

- ☹ Fertilizers, pesticides, and weed killers
- ☹ Yard clippings and leaves
- ☹ Oil and grease from vehicles
- ☹ Sand and dirt from erosion
- ☹ Bacteria and excessive nutrients leaking from septic tanks and animal wastes
- ☹ Litter



#### Effects of Non-Point Source Pollution on a Waterbody:

- ☹ Nutrients from fertilizers, pet wastes, yard clippings, leaves, and septic systems can cause algae blooms and excessive growth of aquatic weeds.
- ☹ Oil and grease from vehicles and pesticides can kill aquatic organisms and contaminate ground water.
- ☹ Sand and dirt from soil erosion can block sunlight to underwater plants and clog fish gills, cutting off their oxygen supply.
- ☹ Bacteria from animal waste and septic systems can contaminate water and lead to beach closings.

#### What You Can Do:

##### At Home and in Your Garden

- ☹ Apply fertilizer per label instructions and follow all local ordinances.
- ☹ Sweep any fertilizer, leaves, grass clippings, and soil off driveways, walkways, and streets.
- ☹ Plant more Florida-Friendly landscaping that doesn't require fertilization.
- ☹ Minimize your use of pesticides and herbicides and always follow label instructions.
- ☹ Dispose of pet waste in the trash.
- ☹ Properly maintain septic systems.
- ☹ Bring hazardous materials to a hazardous waste collection center. Contact your local Solid Waste Department for more information.

##### With Your Vehicle

- ☹ Regularly service your vehicle to prevent leaks of motor oil, antifreeze, and other fluids.
- ☹ Put used motor oil in a sturdy container and bring to service stations for recycling.
- ☹ Pick up litter off the ground.
- ☹ Throw all trash into appropriate garbage cans, including cigarette butts.
- ☹ Recycle as much as possible.

The Adopt-A-Pond Notebook: *Use it to learn more about your pond environment.*

# Trash Catcher

Trash entering ponds through storm drains is a problem many neighborhoods face. In addition to marking your storm drains (see Section 8), a trash catcher in the pond can help keep trash contained in one area for easier clean-up. Trash catcher designs vary. Below are directions for making the type of trash catcher shown to the right. This design was developed by program participants just like you. If you come up with improvements to this design, let us know!

## Supplies

- 4" wide Corrugated Drain Pipe
- Light weight bird netting - 1" mesh (6' wide and cut to length)
- Polypropylene Rope
- Split lead weights (or similar) that fit the rope
- Several small empty plastic drink bottles with caps
- Zip-ties
- Wood/metal posts for securing device to the shore.

## Directions for Assembly

1. Measure the distance from shore-to-shore at least 6 feet from the storm pipe.
2. Cut the corrugated drain pipe and the netting about a meter longer than the length measured from shore-to-shore.
3. Wrap the top of the netting (length-wise) around the top of the corrugated pipe and secure along the way with zip-ties.
4. Weave the polypropylene rope through the bottom of the net and leave several feet of rope on either side of the netting as lead lines for securing to posts in the pond.
5. Clamp the split lead weights approximately every 2' along the bottom rope to weigh down the bottom of the device in the water.
6. Completely fill the drain pipe with the closed plastic bottles to help the device float in the water.
7. Cut 2 strips of rope the same length as the lead lines you left on the bottom rope.
8. Cut a hole all the way through the drain pipe on each end and attach each piece of rope through the pipe so the bottles can't come out the ends.



## Installation and Use

Once the device is assembled, loosely attach the top and bottom ropes to the posts on both sides of the shoreline at least 6 feet in front of the storm pipe. The device should be able to move freely up and down the posts as the water level changes. Trash will be contained by the device and will need to be regularly scooped out.



# Muscovy Ducks - Love 'Em or Leave 'Em?

By: Jennifer Aragon

Environmental Scientist II

Hillsborough County Public Works - Environmental Services

reprinted from the Winter 2012 edition of the On Our Pond newsletter

Muscovy ducks are commonly seen waddling through neighborhoods or waiting for the next hand-out at the park. They can be found in most urban areas throughout Florida and are easily recognizable by their large size and red, fleshy growth on their face. Did you know they aren't native to Florida and can actually be harmful to the environment?

Originally from Central and South America, Mexico, and the very southern tip of Texas, muscovy ducks were released in other parts of the United States with the belief they would improve the look of urban parks and lakes. However, they tend to gather in large numbers and can become a nuisance since they are often fed by people.

Female muscovy ducks can lay between eight and 16 eggs at a time and their populations can increase quickly if left uncontrolled. Whenever there are a lot of birds in an area, you'll generally find a lot of droppings. Not only are these droppings smelly, slippery, and just plain nasty, they are also harmful to the water. Muscovy ducks can also be harmful to native ducks by spreading serious diseases to them.

**So how can you help?** Discourage feeding them to help reduce the amount gathering in one spot. There is plenty of food naturally available including aquatic vegetation, seeds, acorns, and invertebrates. It's not recommended to move the muscovy ducks to the wild because of their potential to spread diseases to native ducks. The University of Florida IFAS Extension instead says their populations can be controlled by vigorously shaking their eggs to make them unviable and placing them back in their nest to prevent re-laying.



Muscovy ducks are recognizable by their red, fleshy growth on their faces.

# Put Pet Waste in the Trash!

**Don't leave pet waste on the ground.** Not only do you not want to step in it, dog poop doesn't just disappear when it rains. Rain and irrigation water wash dog poop into ponds, lakes, rivers, and eventually Tampa Bay. Dog poop has harmful bacteria and nutrients that can make people sick, cause beach closings, and lead to algae blooms. Algae blooms lower oxygen levels in the water and can be harmful to fish and other aquatic life.

## How You Can Be a Responsible Pet Owner:

- 🐾 **Pick up pet waste every time.**
- 🐾 **Put pet waste in the trash or flush it down the toilet to be treated at a sewage treatment plant.**
- 🐾 **Never put pet waste in the storm drain. They lead to ponds, lakes, rivers, and Tampa Bay.**
- 🐾 **Tell your friends and neighbors to do their part and pick up after their pets!**



The Adopt-A-Pond Notebook: *Use it to learn more about your pond environment.*



## **Section 2**

# Wildlife Habitat

Wildlife habitat, or areas for animals to live, is an important factor in creating a healthy pond environment. The articles in this section will help your group identify animals already living around your pond as well as attract more wildlife to the area.

### **Featured Articles:**

- Wildlife Commonly Seen Around Ponds
- Native Plants that Attract Wildlife: Central FL
- Helping Cavity-nesters in Florida
- Butterfly Gardening in Florida
- Hummingbirds of Florida
- Bats: Information for the Florida Homeowner
- Impact of Free-ranging Pets on Wildlife
- Dealing with Snakes in Florida's Residential Areas – ID Commonly Encountered Snakes

# Wildlife Commonly Seen Around Ponds

## Birds:

---

- |   |  |
|---|--|
| <input type="checkbox"/> Anhinga          | <input type="checkbox"/> Osprey            |
| <input type="checkbox"/> Common Moorhen   | <input type="checkbox"/> Pied-billed Grebe |
| <input type="checkbox"/> Great Blue Heron | <input type="checkbox"/> Sandhill Crane    |
| <input type="checkbox"/> Limpkin          | <input type="checkbox"/> White Ibis        |
| <input type="checkbox"/> Mallard Duck     | <input type="checkbox"/> Wood Duck         |
| <input type="checkbox"/> Muscovy Duck     | <input type="checkbox"/> Wood Stork        |

\*Use your field guides and visit [www.audubonbirds.org](http://www.audubonbirds.org) for identification.

## Insects:

---

- |  |  |
|--|--|
| <input type="checkbox"/> American Bumble Bee | <input type="checkbox"/> Southeastern Lubber Grasshopper |
| <input type="checkbox"/> Dragonfly_____      | <input type="checkbox"/> Water strider                   |
| <input type="checkbox"/> Praying Mantis      | <input type="checkbox"/> Whirlygig Beetle                |
| <input type="checkbox"/> Butterfly_____      |  |

\*Use your field guides and visit <http://entnemdept.ufl.edu/InsectID/index.html> for identification.

## Reptiles/ Amphibians:

---

- |   |  |
|---|--|
| <input type="checkbox"/> Alligator            | <input type="checkbox"/> Pond Slider           |
| <input type="checkbox"/> Banded Water Snake   | <input type="checkbox"/> Cuban Tree Frog       |
| <input type="checkbox"/> Green Anole          | <input type="checkbox"/> Southern Leopard Frog |
| <input type="checkbox"/> Eastern Glass Lizard | <input type="checkbox"/> Soft-shelled Turtle   |

\*Use your field guides and visit [www.flmnh.ufl.edu/herpetology/reptiles.htm](http://www.flmnh.ufl.edu/herpetology/reptiles.htm) and [www.hillsborough.wateratlas.usf.edu/FLN/](http://www.hillsborough.wateratlas.usf.edu/FLN/) for identification.

## Mammals:

---

- |  |  |
|--|--|
| <input type="checkbox"/> Bobcat        | <input type="checkbox"/> Opossum           |
| <input type="checkbox"/> Cotton Mouse  | <input type="checkbox"/> Raccoon           |
| <input type="checkbox"/> Gray Squirrel | <input type="checkbox"/> River Otter       |
| <input type="checkbox"/> Marsh Rabbit  | <input type="checkbox"/> White-tailed deer |

\*Use your field guides and visit [www.wildflorida.com/florida\\_mammals.php](http://www.wildflorida.com/florida_mammals.php) for identification.

## Fish:

---

- |   |  |
|---|--|
| <input type="checkbox"/> Large-mouthed Bass | <input type="checkbox"/> Nile Perch    |
| <input type="checkbox"/> Bream              | <input type="checkbox"/> Mosquito Fish |

\*Use your field guides and visit <http://myfwc.com/wildlifehabitats/profiles/> for identification.

**Other Species Observed:** \_\_\_\_\_

---



Florida Cooperative Extension Service

## Native Plants that Attract Wildlife: Central Florida<sup>1</sup>

Craig N. Huegel<sup>2</sup>

Gardening for wildlife is rapidly increasing in popularity. Home landscapes can help offset the habitat loss that occurs in urban areas. This allows a greater variety of wildlife to live near us.

Plants are the key to attracting wildlife to your property. Your plant choices and your landscape design both will determine what animals you will attract. A yard landscaped with wildlife in mind need not appear "wild." A more traditional landscape design also can have great benefits.

There are several considerations to make in gardening for wildlife. A very important one is your choice of plants. In most cases, wildlife do best in landscapes with plants native to the region in which they live. These plants often are better at providing the food and cover that is required. When used in the proper location, native plants also require less attention and water.

There are a great many native trees and shrubs to choose from in Florida. Every plant has some value to wildlife, but some are better than others. Tables 1, 2 and 3 list native Florida trees and shrubs that provide both food and cover. Not all of these are native to central Florida, but all of them can be grown here. Also, many of these are not available from a wide variety of commercial sources at this time.

This list is intended to be as thorough as possible, but it is not complete. Information for wildlife with specific requirements such as hummingbirds (*Florida's Hummingbirds*, SS-WIS-21) and butterflies (*Butterfly Gardening in Florida*, SS-WIS-22) is available from a variety of other sources.

Plants listed as "tall trees" (greater than 30 feet at maturity) often are used best as a canopy (Table 1). These trees also produce shade. The "small trees" (30 feet or less) can be used below the canopy when they are shade-tolerant or as a low canopy in areas where large trees are not desired or appropriate (Table 2). Shrubs are used best near trees. Shrubs (Table 3) here are defined as woody plants that have a bushy form. Shade-tolerant shrubs can be planted directly beneath the canopy. Others can be planted at the edge of the shade zone so that they receive ample sunlight.

Some plants produce either male or female flowers. These are known as dioecious. Other plants produce both male and female flowers. These are called monoecious. Monoecious plants can set fruit by themselves. For dioecious plants, you need to have both sexes nearby and only the female plants produce fruit. Because fruit production is important to a wildlife landscape, be aware of this when you make your plant choices. Consider the size of the fruit because large fruit may be difficult for small wildlife to use. Also be aware of the season when the

1. This document, SS-WIS-09, is part of a series published by the Cooperative Wildlife Program, a cooperative effort of the Florida Cooperative Extension Service, Institute of Food and Agricultural Sciences, University of Florida and the Florida Game and Fresh Water Fish Commission's Nongame Wildlife Program.
2. Craig N. Huegel, urban wildlife extension scientist, Wildlife and Range Sciences Department; Cooperative Extension Service, Institute of Food and Agricultural Sciences, University of Florida, Gainesville FL 32611-0304.

The Institute of Food and Agricultural Sciences is an equal opportunity/affirmative action employer authorized to provide research, educational information and other services only to individuals and institutions that function without regard to race, color, sex, age, handicap, or national origin. For information on obtaining other extension publications, contact your county Cooperative Extension Service office.  
Florida Cooperative Extension Service / Institute of Food and Agricultural Sciences / University of Florida / Christine Taylor Stephens, Dean

fruit ripens and try to have food available throughout the year.

The best wildlife landscapes require a minimum amount of care. Frequent watering, fertilizing, spraying and pruning disturbs animals and limits their use of the area. Use plants that are adapted to existing growing conditions.

It also is important that your landscape be attractive to you. The column for aesthetics lists some characteristics of the plants that may be of interest to people. Balance your desires with the needs of the wildlife you wish to attract.

For more information on wildlife gardening contact the Florida Game and Fresh Water Fish Commission (620 S. Meridian St., Tallahassee, FL 32399-1600) for a copy of *Planting a Refuge for Wildlife* or your local County Cooperative Extension Service office.

The following is a key to the headings used in the tables:

1. **Common name:** The name most commonly used; others used in parentheses
2. **Scientific name:** The botanical name most commonly used; others used in parentheses
3. **Hgt:** Average height in feet of mature plant; plants may grow taller after many years under ideal conditions

4. **Leaf type:** (D) Deciduous, (S) Semi-deciduous, (E) Evergreen
5. **Sex:** (D) Dioecious - male and female flowers on separate trees, (M) Monoecious - male and female flowers on same tree
6. **Moisture:** Preferred soil moisture for best growth
7. **Light:** (S) Full sun, (P) Partial sun, (Sh) Shade
8. **pH:** Soil pH preferred: (Av) Wide pH tolerance, (Ac) Acid, (Al) Alkaline
9. **Salt:** Degree of salt tolerance: (H) High, (M) Medium, (N) Low to none, (U) Unknown
10. **Wildlife use:** Major uses for wildlife
11. **Aesthetics:** Aesthetic considerations

The following is a key to the footnotes used in the tables:

1. \* Indicates plants that will suffer damage from severe or prolonged freezing temperatures.
2. \*\* Oaks are classified as either black (B) or white (W). White oak acorns often are sweeter and more preferred by wildlife than black oak acorns.

**Table 1.** Native Tall Trees for Central Florida

Common Name	Scientific Name	Hgt	Leaf Type	Moisture	pH	Salt
Florida maple	<i>Acer saccharum floridanum</i> ( <i>Acer barbatum</i> )	50	D	Moist	Av	N
<b>Wildlife Use of Native Plants:</b> Seeds used mostly by squirrels						
<b>Native Plant Aesthetics:</b> Good fall color, stately shade tree						
Boxelder	<i>Acer negundo</i>	60	D	Moist	Av	N
<b>Wildlife Use of Native Plants:</b> Seeds used mostly by squirrels						
<b>Native Plant Aesthetics:</b> Fairly short-lived, weak wood						
Red maple	<i>Acer rubrum</i>	80	D	Moist	Av	N
<b>Wildlife Use of Native Plants:</b> Seeds used mostly by squirrels						
<b>Native Plant Aesthetics:</b> Very good fall color, red flowers and fruits in spring						
Water hickory	<i>Carya aquatics</i>	90	D	Moist	Av	N
<b>Wildlife Use of Native Plants:</b> Nuts are important wildlife food						
<b>Native Plant Aesthetics:</b> Nuts bitter, narrow leaves and crown						
Scrub hickory	<i>Carya floridana</i>	30	D	Dry	Av	N

**Table 1.** Native Tall Trees for Central Florida

Common Name	Scientific Name	Hgt	Leaf Type	Moisture	pH	Salt
<b>Wildlife Use of Native Plants:</b> Nuts are important wildlife food						
<b>Native Plant Aesthetics:</b> Nuts edible, tree often multi-trunked and crooked						
Pignut hickory	<i>Carya glabra</i>	70	D	Avg	Av	N
<b>Wildlife Use of Native Plants:</b> Nuts are important wildlife food						
<b>Native Plant Aesthetics:</b> Good fall color, nuts bitter, good shade tree						
Mockernut hickory	<i>Carya tomentosa</i>	60	D	Avg	Av	N
<b>Wildlife Use of Native Plants:</b> Nuts are important wildlife food						
<b>Native Plant Aesthetics:</b> Nuts edible, good shade tree						
Sugarberry	<i>Celtis laevigata</i>	80	D	Moist	Av	N
<b>Wildlife Use of Native Plants:</b> Fruits used by many birds						
<b>Native Plant Aesthetics:</b> Excellent shade tree						
Flowering dogwood	<i>Cornus florida</i>	40	D	Moist-Avg	Ac-Av	N
<b>Wildlife Use of Native Plants:</b> Fruits used by many birds						
<b>Native Plant Aesthetics:</b> Very showy white flower bracts						
Persimmon	<i>Diospyros virginiana</i>	60	D	Avg	Av	N
<b>Wildlife Use of Native Plants:</b> Fruit attractive to opossums and other mammals						
<b>Native Plant Aesthetics:</b> Edible fruit, attractive flowers						
Willow bastic*	<i>Dipholis salicifolia</i>	40	E	Avg	Av	U
<b>Wildlife Use of Native Plants:</b> Small purple fruits used by some birds						
<b>Native Plant Aesthetics:</b> Young branches rusty hairy						
White ash	<i>Fraxinus americana</i>	80	D	Moist	Av	N
<b>Wildlife Use of Native Plants:</b> Seeds used by many birds, good seed set only every 2-3 years						
<b>Native Plant Aesthetics:</b> Important timber and shade tree						
Green ash	<i>Fraxinus pennsylvanica</i>	65	D	Moist	Av	N
<b>Wildlife Use of Native Plants:</b> Seeds used by many birds, good seed set annually						
<b>Native Plant Aesthetics:</b> Important limber and shade tree						
Pumpkin ash	<i>Fraxinus profunda</i>	90	D	Wet	Av	N
<b>Wildlife Use of Native Plants:</b> Seeds used by many birds						
<b>Native Plant Aesthetics:</b> Good shade tree for low moist areas						
Water locust	<i>Gleditsia aquatica</i>	60	D	Wet	Av	N
<b>Wildlife Use of Native Plants:</b> Seeds eaten by mammals and quail, excellent nesting cover						
<b>Native Plant Aesthetics:</b> Very thorny, "beans" can be messy after they fall						
Dahoon holly	<i>Ilex cassine</i>	40	E	Moist	Av	M
<b>Wildlife Use of Native Plants:</b> Berries excellent food for many wildlife						
<b>Native Plant Aesthetics:</b> Masses of red berries on female trees						
American holly	<i>Ilex opaca</i>	40	E	Avg	Av	M
<b>Wildlife Use of Native Plants:</b> Berries excellent food for many wildlife						
<b>Native Plant Aesthetics:</b> Bright red berries and shiny foliage, many cultivars offered						
Southern red cedar	<i>Juniperus silicicola</i>	50	E	Avg	Av-Al	H
<b>Wildlife Use of Native Plants:</b> Small fruits used by birds, excellent nesting cover						
<b>Native Plant Aesthetics:</b> Very adaptable long-lived tree						
Sweet gum	<i>Liquidambar styraciflua</i>	50	D	Avg	Av	N
<b>Wildlife Use of Native Plants:</b> Seeds of limited use to some birds and mammals						
<b>Native Plant Aesthetics:</b> Good fall color, spiny seed balls						
Southern magnolia	<i>Magnolia grandiflora</i>	80	E	Avg	Av	M
<b>Wildlife Use of Native Plants:</b> Red seeds used by variety of wildlife						
<b>Native Plant Aesthetics:</b> Large aromatic white flowers						

**Table 1.** Native Tall Trees for Central Florida

Common Name	Scientific Name	Hgt	Leaf Type	Moisture	pH	Salt
Sweet bay	<i>Magnolia virginiana</i>	60	E	Moist	Ac-Av	N
<b>Wildlife Use of Native Plants:</b> Small red seeds used by variety of wildlife						
<b>Native Plant Aesthetics:</b> Small aromatic white flowers, tree less stately than above						
Red mulberry	<i>Morus rubra</i>	50	D	Avg	Av	N
<b>Wildlife Use of Native Plants:</b> Fruits highly prized by variety of wildlife						
<b>Native Plant Aesthetics:</b> Fruits edible, very "messy" tree as fruits stain property						
Water tupelo	<i>Nyssa aquatica</i>	80	D	Wet	Av	N
<b>Wildlife Use of Native Plants:</b> Dark purple fruit used by many birds and mammals, bee tree						
<b>Native Plant Aesthetics:</b> Good fall color						
Ogeechee lime	<i>Nyssa ogeche</i>	30	D	Wet	Av	N
<b>Wildlife Use of Native Plants:</b> 1.5" bright red fruit used by large birds and mammals						
<b>Native Plant Aesthetics:</b> Best grown in permanently wet sites						
Black gum (Tupelo)	<i>Nyssa sylvatica biflora</i>	70	D	Moist	Av	N
<b>Wildlife Use of Native Plants:</b> Blue fruit eaten by many birds and mammals, bee tree						
<b>Native Plant Aesthetics:</b> Brilliant fall color						
Wild olive	<i>Osmanthus americana</i>	45	E	Avg	Ac-Av	M
<b>Wildlife Use of Native Plants:</b> Fruits of limited use by birds/mammals						
<b>Native Plant Aesthetics:</b> Very fragrant small flowers						
Red bay	<i>Persea borbonia</i>	65	E	Moist	Av	M
<b>Wildlife Use of Native Plants:</b> Purple fruit eaten by birds and squirrels						
<b>Native Plant Aesthetics:</b> Aromatic leaves can be used to season food						
Silk bay	<i>Persea humilis</i>	30	E	Dry	Av	M
<b>Wildlife Use of Native Plants:</b> Purple fruit eaten by birds and squirrels						
<b>Native Plant Aesthetics:</b> Lower surface of aromatic leaves with copper colored hairs						
Swamp bay	<i>Persea palustris</i>	40	E	Moist	Av	M
<b>Wildlife Use of Native Plants:</b> Purple fruit eaten by birds and squirrels						
<b>Native Plant Aesthetics:</b> Aromatic leaves and leaf stalks hairy						
Sand pine	<i>Pinus clausa</i>	70	E	Dry	Av	M
<b>Wildlife Use of Native Plants:</b> Seeds eaten by variety of wildlife						
<b>Native Plant Aesthetics:</b> Short-needed pine easily damaged by overwatering, often used as Christmas tree						
Slash pine	<i>Pinus elliotii</i>	90	E	Moist	Av	M
<b>Wildlife Use of Native Plants:</b> Seeds eaten by variety of wildlife						
<b>Native Plant Aesthetics:</b> Use south Florida variety (P. e. densa) for best results						
Spruce pine	<i>Pinus glabra</i>	90	E	Moist	Av	N
<b>Wildlife Use of Native Plants:</b> Seeds used by variety of wildlife						
<b>Native Plant Aesthetics:</b> A "soft" needled pine for moist areas						
Longleaf pine	<i>Pinus palustris</i>	90	E	Avg	Ac-Av	M
<b>Wildlife Use of Native Plants:</b> Seeds eaten by variety of wildlife						
<b>Native Plant Aesthetics:</b> Stately, long-lived tree, with good disease resistance						
Pond pine	<i>Pinus serotina</i>	60	E	Wet	Av	N
<b>Wildlife Use of Native Plants:</b> Seeds used by variety of wildlife						
<b>Native Plant Aesthetics:</b> Adapted to high and fluctuating water tables, irregular canopy						
Loblolly pine	<i>Pinus taeda</i>	90	E	Avg	Av	M
<b>Wildlife Use of Native Plants:</b> Large seed crops used by variety of wildlife						
<b>Native Plant Aesthetics:</b> Fast-growing, long-needed pine but susceptible to insect and disease damage						

**Table 1.** Native Tall Trees for Central Florida

Common Name	Scientific Name	Hgt	Leaf Type	Moisture	pH	Salt
Planer elm <b>Wildlife Use of Native Plants:</b> Seeds used by many wildlife <b>Native Plant Aesthetics:</b> Excellent tree for areas that frequently flood	<i>Planera aquatica</i>	40	D	Wet	Av	N
Cherry laurel <b>Wildlife Use of Native Plants:</b> Fruit used by many wildlife species <b>Native Plant Aesthetics:</b> Attractive flowers, may be pruned and used as a hedge	<i>Prunus caroliniana</i>	40	D	Avg	Av	N
Black cherry <b>Wildlife Use of Native Plants:</b> Very important food source, foliage poisonous to livestock <b>Native Plant Aesthetics:</b> Attractive flowers and good fall color	<i>Prunus serotina</i>	80	D	Avg	Av	N
Bluff oak (W)** <b>Wildlife Use of Native Plants:</b> Acorns .5" <b>Native Plant Aesthetics:</b> Southern version of the white oak, leaves with elongate rounded lobes	<i>Quercus austrina</i>	80	D	Avg	Av	N
Southern red oak (B) <b>Wildlife Use of Native Plants:</b> Acorns .5" <b>Native Plant Aesthetics:</b> Broad crowned, leaves with pointed lobes	<i>Quercus faicata</i>	50	D	Avg	Av	N
Cherrybark oak (B) <b>Wildlife Use of Native Plants:</b> Acorns .5" <b>Native Plant Aesthetics:</b> A large attractive oak that survives periodic flooding	<i>Quercus faicata pagodifolia</i>	80	D	Moist	Av	N
Turkey oak (B) <b>Wildlife Use of Native Plants:</b> Acorns 1" <b>Native Plant Aesthetics:</b> Thrives in very poor soils, leaves with deep pointed lobes	<i>Quercus laevis</i>	50	D	Dry	Av	N
Laurel oak (B) <b>Wildlife Use of Native Plants:</b> Acorns .5", abundant <b>Native Plant Aesthetics:</b> Commonly used landscape tree, straight trunk with rounded crown	<i>Quercus laurifolia</i>	80	s	Avg	Av	N
Overcup oak (W) <b>Wildlife Use of Native Plants:</b> Large acorns (1"), heavy production only every 3-4 years <b>Native Plant Aesthetics:</b> Broad crowned tree, leaves long and narrow with irregular rounded lobes	<i>Quercus lyrata</i>	80	D	Wet	Av	N
Swamp chestnut oak (W) <b>Wildlife Use of Native Plants:</b> Acorns 1-1.5" <b>Native Plant Aesthetics:</b> Leaves with numerous shallow rounded lobes	<i>Quercus michauxii</i>	90	D	Moist	Av	N
Water oak (B) <b>Wildlife Use of Native Plants:</b> Acorns .5" <b>Native Plant Aesthetics:</b> Attractive light bark, leaves spatula shaped	<i>Quercus nigra</i>	80	D	Moist	Av	N
Shumard oak (B) <b>Wildlife Use of Native Plants:</b> Acorns .5-1" <b>Native Plant Aesthetics:</b> Broad, rounded crown, leaves with many deeply pointed lobes	<i>Quercus shumardii</i>	70	D	Avg	Av	N
Post oak (W) <b>Wildlife Use of Native Plants:</b> Acorns .5-1", good production only every 2-4 years <b>Native Plant Aesthetics:</b> Leaves 5-lobed, crucifix shaped	<i>Quercus stellata</i>	65	D	Avg	Av	N
Live oak (W) <b>Wildlife Use of Native Plants:</b> Abundant acorns 1" <b>Native Plant Aesthetics:</b> Very broad crowned, long-lived shade tree	<i>Quercus virginiana</i>	45	E	Avg	Av	M
Cabbage palm <b>Wildlife Use of Native Plants:</b> Fruits important to many wildlife <b>Native Plant Aesthetics:</b> Florida state tree, very adaptable	<i>Sabal palmetto</i>	70	E	Avg	Av	H

**Table 1.** Native Tall Trees for Central Florida

Common Name	Scientific Name	Hgt	Leaf Type	Moisture	pH	Salt
Pond cypress	<i>Taxodium ascendens</i>	100	D	Wet	Av	N
<b>Wildlife Use of Native Plants:</b> Small seeds used by some birds and squirrels <b>Native Plant Aesthetics:</b> Small leaves closely pressed against stems						
Bald cypress	<i>Taxodium distichum</i>	100	D	Wet	Ac-Av	N
<b>Wildlife Use of Native Plants:</b> Small seeds used by some birds and squirrels <b>Native Plant Aesthetics:</b> Leaves spread away from stems, giving "leathery" appearance						
Florida trema	<i>Trema micrantha</i>	60	E	Avg	Al	u
<b>Wildlife Use of Native Plants:</b> Small fruit used by some birds <b>Native Plant Aesthetics:</b> Short-lived "weedy" tree						
Winged elm	<i>Ulmus alata</i>	50	D	Avg	Av	N
<b>Wildlife Use of Native Plants:</b> Seeds of minor use <b>Native Plant Aesthetics:</b> Corky "wings" on branches, open rounded crown						
Florida elm	<i>Ulmus americana floridana</i>	70	D	Avg	Av	N
<b>Wildlife Use of Native Plants:</b> Seeds of minor use <b>Native Plant Aesthetics:</b> Excellent shade tree, graceful spreading form						
Cedar elm	<i>Ulmus crassifolia</i>	50	D	Moist	Av-Al	N
<b>Wildlife Use of Native Plants:</b> Seeds of minor use <b>Native Plant Aesthetics:</b> Branches often with corky "wings"						
* Indicates plants that will suffer damage from severe or prolonged freezing temperatures.						
** Oaks are classified as either black (B) or white (W). White oak acorns often are sweeter and more preferred by wildlife than black oak acorns.						

**Table 2.** Native Small Trees for Central Florida

Common Name	Scientific Name	Hgt	Leaf Type	Sex	Moisture	pH	Salt
Sweet acacia	<i>Acacia farnesiana</i>	20	S	M	Avg	Av	M
<b>Wildlife Use of Native Plants:</b> Seeds inside "beans" used by large birds, nesting cover <b>Native Plant Aesthetics:</b> Bright yellow fragrant flower heads, used in perfume							
Red buckeye	<i>Aesculus pavia</i>	20	D	M	Avg	Av	N
<b>Wildlife Use of Native Plants:</b> Buckeyes eaten by squirrels, flowers attract hummingbirds <b>Native Plant Aesthetics:</b> Red tubular flowers in spring, needs some shade							
Downy serviceberry	<i>Amelanchier arborea</i> ( <i>Amelanchier canadensis</i> )	30	D	M	Avg	Av	N
<b>Wildlife Use of Native Plants:</b> Berries highly prized by most wildlife <b>Native Plant Aesthetics:</b> Berries edible, bell-like white flowers in spring							
Pond apple*	<i>Annona glabra</i>	30	E	M	Wet	Av	M
<b>Wildlife Use of Native Plants:</b> Large yellow "apples" mostly used by mammals <b>Native Plant Aesthetics:</b> 1" cream white to pale yellow flowers, leaves aromatic							
Devil's walking stick	<i>Aralia spinosa</i>	15	D	M	Moist	Av	N
<b>Wildlife Use of Native Plants:</b> Many purplish berries widely used by wildlife <b>Native Plant Aesthetics:</b> Leaf stems with spines, fast grower, may spread by suckers							
Saffron plum*	<i>Bumelia celastrina</i>	15	E	M	Avg-Dry	Av	H
<b>Wildlife Use of Native Plants:</b> Sweet black fruits used by birds, good nesting tree <b>Native Plant Aesthetics:</b> Thorny, fruits edible							
Gum bumelia	<i>Bumelia lanuginosa</i>	20	D	M	Avg	Av	N
<b>Wildlife Use of Native Plants:</b> Small black fruits used by some birds, good nesting tree <b>Native Plant Aesthetics:</b> Leaf undersides dense wooly							



**Table 2.** Native Small Trees for Central Florida

Common Name	Scientific Name	Hgt	Leaf Type	Sex	Moisture	pH	Salt
Buckthorn bumelia	<i>Bumelia lycioides</i>	20	D	M	Moist	Av	N
<b>Wildlife Use of Native Plants:</b> Small black fruits used by some birds							
<b>Native Plant Aesthetics:</b> Leaves without hairs, no thorns							
Tough bumelia	<i>Bumelia tenax</i>	20	E	M	Dry	Av	M
<b>Wildlife Use of Native Plants:</b> Small black fruits used by some birds, tree forms are good nesting cover							
<b>Native Plant Aesthetics:</b> Thorny branches, often shrubby, leaf undersides with dense copper hairs							
Blue hornbeam (ironwood)	<i>Carpinus caroliniana</i>	30	D	M	Ave	Av	N
<b>Wildlife Use of Native Plants:</b> Seeds and catkins used by birds and squirrels							
<b>Native Plant Aesthetics:</b> Excellent understory tree, trunk "muscled" in appearance							
Ashe chinkapin	<i>Castanea pumila</i>	20	D	M	Avg	Av	N
<b>Wildlife Use of Native Plants:</b> Small chestnuts eaten by wide variety of wildlife							
<b>Native Plant Aesthetics:</b> Sweet nuts similar to American chestnut							
Redbud	<i>Cercis canadensis</i>	30	D	M	Avg	Av	N
<b>Wildlife Use of Native Plants:</b> Beans provide seeds for some birds							
<b>Native Plant Aesthetics:</b> Very showy pink-red flowers in spring							
Pygmy fringe tree	<i>Chionanthus pygmaeus</i>	6	D	D	Dry	Av	N
<b>Wildlife Use of Native Plants:</b> Purple fruits used by birds							
<b>Native Plant Aesthetics:</b> Profuse clusters of fragrant white flowers in spring, small and multitrunked							
Fringe tree	<i>Chionanthus virginicus</i>	30	D	D	Avg	Av	N
<b>Wildlife Use of Native Plants:</b> Purple fruits used by birds							
<b>Native Plant Aesthetics:</b> Profuse clusters of fragrant white flowers in spring, multitrunked							
Swamp dogwood	<i>Cornus foemina</i>	20	D	M	Wet	Av	N
<b>Wildlife Use of Native Plants:</b> Blue berries used by wide variety of birds							
<b>Native Plant Aesthetics:</b> Flat-topped clusters of small white flowers in spring							
May haw	<i>Crataegus aestivalis</i>	20	D	M	Moist-Avg	Av	N
<b>Wildlife Use of Native Plants:</b> Medium-sized pale-orange "haws" eaten by variety of wildlife, good nesting cover							
<b>Native Plant Aesthetics:</b> Small apple-like flowers in clusters, fruit makes fine-flavored jelly							
Cockspur haw	<i>Crataegus crus-galli</i> ( <i>Crataegus pyracanthoides</i> )	25	D	M	Avg	Av	N
<b>Wildlife Use of Native Plants:</b> Small green-dull red fruit eaten by variety of wildlife, good nesting cover							
<b>Native Plant Aesthetics:</b> Long thorns, small white flowers in clusters							
Summer haw	<i>Crataegus flava</i>	25	D	M	Dry	Av	N
<b>Wildlife Use of Native Plants:</b> Orange-red "haws" eaten by variety of birds and mammals, good nesting cover							
<b>Native Plant Aesthetics:</b> Thorns, twisted weeping branches, medium-sized flowers in small clusters							
Parsley haw	<i>Crataegus marshallii</i>	20	D	M	Moist	Av	N
<b>Wildlife Use of Native Plants:</b> Small scarlet "haws" eaten by variety of wildlife, good nesting cover							
<b>Native Plant Aesthetics:</b> Finely cut leaves (similar to parsley) very attractive, small flowers in large clusters							
Littlehip haw	<i>Crataegus spathulata</i>	25	D	M	Avg	Av	N
<b>Wildlife Use of Native Plants:</b> Small red "haws" eaten by variety of wildlife, good nesting cover							
<b>Native Plant Aesthetics:</b> Long thorns, small flowers in clusters							
One-flowered haw	<i>Crataegus uniflora</i>	12	D	M	Avg	Av	N
<b>Wildlife Use of Native Plants:</b> Small yellowish-green "haws", good nesting cover							
<b>Native Plant Aesthetics:</b> Numerous long thorns, small flowers usually not in clusters							
Green haw	<i>Crataegus viridis</i>	30	D	M	Moist	Av	N
<b>Wildlife Use of Native Plants:</b> Small orange-red "haws" eaten by variety of wildlife, good nesting cover							
<b>Native Plant Aesthetics:</b> Largest of native hawthorns, branches largely spineless, small flowers in clusters							

**Table 2.** Native Small Trees for Central Florida

Common Name	Scientific Name	Hgt	Leaf Type	Sex	Moisture	pH	Salt
Inkwood*	<i>Exothea paniculata</i>	30	E	D	Avg	Av	M
<b>Wildlife Use of Native Plants:</b> Small purple fruits used by birds							
<b>Native Plant Aesthetics:</b> Reddish flaky bark							
Pop ash	<i>Fraxinus caroliniana</i>	30	D	D	Wet	Av	N
<b>Wildlife Use of Native Plants:</b> Seeds eaten by some birds and mammals							
<b>Native Plant Aesthetics:</b> Will tolerate shallow water for months							
Carolina silverbell	<i>Halesia caroliniana</i>	30	D	M	Avg	Av	N
<b>Wildlife Use of Native Plants:</b> Winged seeds used by some wildlife							
<b>Native Plant Aesthetics:</b> Very showy white bell-shaped flowers in spring							
Two-winged silverbell	<i>Halesia diptera</i>	25	D	M	Avg	Av	N
<b>Wildlife Use of Native Plants:</b> Winged seeds used by some wildlife							
<b>Native Plant Aesthetics:</b> Very showy white bell-shaped flowers in spring							
Little silverbell	<i>Halesia parviflora</i>	20	D	M	Avg	Av	N
<b>Wildlife Use of Native Plants:</b> Winged seeds used by some wildlife							
<b>Native Plant Aesthetics:</b> Very showy white bell-shaped flowers in spring							
Carolina holly	<i>Ilex ambigua</i>	20	D	D	Avg-Dry	Av	N
<b>Wildlife Use of Native Plants:</b> Abundant red fruit in early fall widely used by wildlife							
<b>Native Plant Aesthetics:</b> Abundant red fruit very colorful in landscape							
Large gallberry	<i>Ilex coriacea</i>	20	E	D	Wet	Ac-Av	N
<b>Wildlife Use of Native Plants:</b> Nonpersistent purple fruit used late fall and early winter							
<b>Native Plant Aesthetics:</b> Dark fruit & shrubby appearance less eye-catching than most							
Possumhaw holly	<i>Ilex decidua</i>	30	D	D	moist	Ac-Av	N
<b>Wildlife Use of Native Plants:</b> Orange-red fruit widely used late fall and winter							
<b>Native Plant Aesthetics:</b> Persistent fruit adds winter color on leafless branches							
Gallberry	<i>Ilex glabra</i>	6	E	D	Moist	Ac-Av	N
<b>Wildlife Use of Native Plants:</b> Nonpersistent black fruit used in late fall and winter							
<b>Native Plant Aesthetics:</b> An open "bushy" tree, may produce runners							
Tawnyberry*	<i>Ilex krugiana</i>	30	E	D	Avg	Av	U
<b>Wildlife Use of Native Plants:</b> Black fruit mature in summer							
<b>Native Plant Aesthetics:</b> Unique long-pointed leaf tips and fruit color							
Myrtle holly	<i>Ilex myrtifolia</i>	25	E	D	Moist	Ac-Av	N
<b>Wildlife Use of Native Plants:</b> Red fruit widely used in late fall							
<b>Native Plant Aesthetics:</b> Similar to dahoon, but smaller leaves, winter color							
Scrub holly	<i>Ilex opaca arenicola</i>	15	E	D	Dry	Av	M
<b>Wildlife Use of Native Plants:</b> Red fruit, but good fruit production variable							
<b>Native Plant Aesthetics:</b> Very similar to American holly with spiny leaves, attractive, but slow grower, very susceptible to root rot in all but well-drained soils							
Winterberry	<i>Ilex verticillata</i>	25	D	D	Wet	Ac	N
<b>Wildlife Use of Native Plants:</b> Very persistent red fruit widely used in winter							
<b>Native Plant Aesthetics:</b> Fruit color and foliage nice, used in holiday decorations							
Yaupon	<i>Ilex vomitoria</i>	25	E	D	Avg	Av	M
<b>Wildlife Use of Native Plants:</b> Red fruit widely used late fall and winter							
<b>Native Plant Aesthetics:</b> Very adaptable, tolerant of pruning, good color							
Simpson stopper	<i>Myrcianthes fragrans</i>	25	E	M	Avg	Av	M
<b>Wildlife Use of Native Plants:</b> Red berries used by many birds							
<b>Native Plant Aesthetics:</b> Small white fragrant flowers in spring, reddish flaky bark							

**Table 2.** Native Small Trees for Central Florida

Common Name	Scientific Name	Hgt	Leaf Type	Sex	Moisture	pH	Salt
Lancewood	<i>Nectandra conacea</i>	30	E	M	Avg	Av	M
<b>Wildlife Use of Native Plants:</b> Dark blue fruit used by some wildlife							
<b>Native Plant Aesthetics:</b> Small fragrant flower clusters in late spring							
Scrub olive	<i>Osmanthus megacarpa</i>	15	E	D	Dry	Av	M
<b>Wildlife Use of Native Plants:</b> Large "olives" marginally used by some birds and mammals							
<b>Native Plant Aesthetics:</b> Small fragrant flowers, large evergreen leaves							
Eastern hophornbeam	<i>Ostrya virginiana</i>	25	D	M	Avg	Av	N
<b>Wildlife Use of Native Plants:</b> Nutlets used by some birds and mammals							
<b>Native Plant Aesthetics:</b> Fruiting structure looks similar to hops, light flaky bark							
American plum	<i>Prunus americana</i>	30	D	M	Avg	Av	N
<b>Wildlife Use of Native Plants:</b> Medium-sized plums mostly used by mammals							
<b>Native Plant Aesthetics:</b> Showy white flowers in spring, plums used for jelly							
Chickasaw plum	<i>Prunus angustifolia</i>	20	D	M	Avg	Av	N
<b>Wildlife Use of Native Plants:</b> Reddish plums (.5" diameter) widely used by wildlife							
<b>Native Plant Aesthetics:</b> Showy white flowers in spring, red sour plums used in cooking							
Flatwoods plum	<i>Prunus umbellata</i>	20	D	M	Avg	Av	N
<b>Wildlife Use of Native Plants:</b> Purple plums (.5") widely used by wildlife							
<b>Native Plant Aesthetics:</b> Showy small white flowers in spring, purple plums edible, used in jelly							
Chapman oak (W)	<i>Quercus chapmanii</i>	20	S	M	Dry	Av	M
<b>Wildlife Use of Native Plants:</b> Acorns (.5-1")							
<b>Native Plant Aesthetics:</b> Broad crown, lobed leaves							
Sand live oak (W)	<i>Quercus geminata</i>	30	E	M	Dry	Av	H
<b>Wildlife Use of Native Plants:</b> Acorns (.5-1")							
<b>Native Plant Aesthetics:</b> Smaller than live oak with very narrow leaves							
Bluejack oak (B)	<i>Quercus incana</i>	30	D	M	Dry	Av	N
<b>Wildlife Use of Native Plants:</b> Acorns (.5")							
<b>Native Plant Aesthetics:</b> Rounded crown, leaves with bluish cast							
Inopina oak (B)	<i>Quercus inopina</i>	8	E	M	Dry	Av	U
<b>Wildlife Use of Native Plants:</b> Acorns (.5")							
<b>Native Plant Aesthetics:</b> Shrubby tree with round leaves often held vertical to ground							
Myrtle oak (B)	<i>Quercus myrtifolia</i>	25	E	M	Dry	Av	M
<b>Wildlife Use of Native Plants:</b> Acorns (.3")							
<b>Native Plant Aesthetics:</b> A bushy tree with round leaves and dense foliage							
Sand post oak (W)	<i>Quercus stellata margaretta</i>	30	D	M	Dry	Av	N
<b>Wildlife Use of Native Plants:</b> Acorns (.5")							
<b>Native Plant Aesthetics:</b> Nearly identical to post oak, with leaves less lobed							
Carolina buckthorn	<i>Rhamnus caroliniana</i>	30	D	M	Moist-Avg	Av-AI	N
<b>Wildlife Use of Native Plants:</b> Numerous black berries used by many birds							
<b>Native Plant Aesthetics:</b> Berries once used as source of yellow dye, flower clusters attractive							
Sassafras	<i>Sassafras albidum</i>	30	D	D	Avg	Av	N
<b>Wildlife Use of Native Plants:</b> Fruit (sets poorly in south 1/2 of FL) used by birds							
<b>Native Plant Aesthetics:</b> Small fragrant flowers, aromatic leaves and bark used in tea							
Sparkleberry	<i>Vaccinium arboreum</i>	20	E	M	Avg	Ac	N
<b>Wildlife Use of Native Plants:</b> Blueberries eaten by wide variety of birds							
<b>Native Plant Aesthetics:</b> Berries very bitter, attractive bell-like flowers in spring							

**Table 2.** Native Small Trees for Central Florida

Common Name	Scientific Name	Hgt	Leaf Type	Sex	Moisture	pH	Salt
Hercules club	<i>Zanthoxylum clava-herculis</i>	30	D	D	Avg	Av	M
<b>Wildlife Use of Native Plants:</b> Seeds used by some birds, good nesting cover for some birds <b>Native Plant Aesthetics:</b> Trunk and main branches thorny, leaves very aromatic							
*Indicates plants that will suffer damage from severe or prolonged freezing temperatures.							
**Oaks are classified as either black (B) or white (W). White oak acorns often are sweeter and more preferred by wildlife than black oak acorns.							

**Table 3.** Native Shrubs for Central Florida

Common Name	Scientific Name	Hgt	Leaf Type	Sex	Moisture	Light	pH	Salt
Marlberry (Marbleberry)*	<i>Ardisia escallonioides</i>	8	E	M	Avg	S-Sh	Av	M
<b>Wildlife Use of Native Plants:</b> Round purple fruits produced mostly fall-winter, widely used by wildlife <b>Native Plant Aesthetics:</b> Large clusters of fragrant white flowers, white trunk								
Slender buckthorn	<i>Bumelia reclinata</i>	25	E	M	Dry	S	Av	H
<b>Wildlife Use of Native Plants:</b> Small black fruits used by some birds <b>Native Plant Aesthetics:</b> Thorns								
Beautyberry	<i>Callicarpa americana</i>	6	D	M	Avg	P	Av	N
<b>Wildlife Use of Native Plants:</b> Small purplish fruits used by some birds in late winter <b>Native Plant Aesthetics:</b> Clusters of berries around stems very attractive								
Iguana hackberry*	<i>Celtis iguanaea</i>	8	E	M	Avg	S	Av-AI	H
<b>Wildlife Use of Native Plants:</b> Medium-sized orange fruits used by many wildlife species <b>Native Plant Aesthetics:</b> Spiny twisted branches, edible fruit								
Spiny hackberry*	<i>Celtis pallida</i>	8	E	M	Avg	S	Av-AI	H
<b>Wildlife Use of Native Plants:</b> Medium-sized orange fruits used by many wildlife species <b>Native Plant Aesthetics:</b> Spiny twisted branches, edible fruit								
Snowberry	<i>Chiococca alba</i>	10	E	M	Avg	P	Av	M
<b>Wildlife Use of Native Plants:</b> White berries produced year-round, used by many wildlife <b>Native Plant Aesthetics:</b> Flowers green-white to yellow, white stems with dark leaves								
Cocoplum*	<i>Chrysobalanus icaco</i>	6	E	M	Avg	S	Av	H
<b>Wildlife Use of Native Plants:</b> Purple "plums" used by mammals and large birds <b>Native Plant Aesthetics:</b> Two color forms (green and red lipped), edible fruit								
Seagrape*	<i>Coccoloba uvifera</i>	10	E	M	Avg	S	Av	H
<b>Wildlife Use of Native Plants:</b> Purple "grapes" used by mammals and large birds <b>Native Plant Aesthetics:</b> Large attractive leaves, edible fruit								
Scrub haw	<i>Crataegus lepida</i>	8	D	M	Dry	S	Av	N
<b>Wildlife Use of Native Plants:</b> Red "haws" eaten by variety of wildlife, nesting cover <b>Native Plant Aesthetics:</b> White flowers, weeping thorny branches								
White stopper*	<i>Eugenia axillaris</i>	25	E	M	Avg	S-P	Av	M
<b>Wildlife Use of Native Plants:</b> Blue-black fruits in winter used by many birds <b>Native Plant Aesthetics:</b> Fruits edible, leaves emit unpleasant odor when crushed								
Spanish (Boxleaf) stopper*	<i>Eugenia foetida</i>	15	E	M	Avg	S-P	AI	M
<b>Wildlife Use of Native Plants:</b> Small black fruits used by many birds <b>Native Plant Aesthetics:</b> Reddish scaly bark, leaves emit unpleasant odor								
Hearts a bustin'	<i>Euonymus americanus</i>	6	E	M	Avg	P	Av	N
<b>Wildlife Use of Native Plants:</b> Red seeds used by some wildlife, foliage often browsed <b>Native Plant Aesthetics:</b> Orange-red seed capsules with bright red seeds in fall								

**Table 3.** Native Shrubs for Central Florida

Common Name	Scientific Name	Hgt	Leaf Type	Sex	Moisture	Light	pH	Salt
Swamp privet	<i>Forestiera acuminata</i>	30	D	D	Moist	S-P	Av	U
<b>Wildlife Use of Native Plants:</b> Lavender wrinkled fruit used by some wildlife								
<b>Native Plant Aesthetics:</b> Weak leaning shrub, may sprout where branches contact soil								
Flatwoods privet	<i>Forestiera ligustrina</i>	10	D	D	Avg	S-P	Av	N
<b>Wildlife Use of Native Plants:</b> Small purple fruit used by many birds								
<b>Native Plant Aesthetics:</b> Similar to Florida privet, but deciduous								
Pineland privet*	<i>Forestiera pinetorium</i>	10	E	D	Avg	S	Av	M
<b>Wildlife Use of Native Plants:</b> Abundant small purple fruits used by many birds								
<b>Native Plant Aesthetics:</b> Low-growing relative of Florida privet								
Florida privet	<i>Forestiera segregate</i>	10	s	D	Avg	S-P	Av-AI	M
<b>Wildlife Use of Native Plants:</b> Abundant small purple fruits used by many birds, good nesting cover								
<b>Native Plant Aesthetics:</b> Very dense dark-green foliage								
Blolly*	<i>Guapira discolor</i>	25	E	M	Avg	S-P	AI	M
<b>Wildlife Use of Native Plants:</b> Red fruit used by birds								
<b>Native Plant Aesthetics:</b> Shiny green foliage, bright red fruit								
Sarvis holly	<i>Ilex amelanchar</i>	15	D	D	Avg	S-P	Ac-Av	N
<b>Wildlife Use of Native Plants:</b> Dull-red berries used by many birds in late fall and winter								
<b>Native Plant Aesthetics:</b> Large shrub with open rounded crown								
Pond spice	<i>Litsea aestivalis</i>	9	D	M	Wet	S-P	Av	N
<b>Wildlife Use of Native Plants:</b> Bright red fruits used by many wildlife species								
<b>Native Plant Aesthetics:</b> Attractive yellow spring flowers, colorful fruit								
Christmas berry	<i>Lycium carolinianum</i>	6	E	M	Avg	S	Av	H
<b>Wildlife Use of Native Plants:</b> Red egg-shaped berries produced year-round, widely used by wildlife								
<b>Native Plant Aesthetics:</b> Bluish flowers, succulent leaves on thorny stems								
Wax myrtle	<i>Myrica cerifera</i>	20	E	D	Avg	S-P	Av	H
<b>Wildlife Use of Native Plants:</b> Small waxy berries used by many birds, good nesting cover								
<b>Native Plant Aesthetics:</b> Extremely adaptable, may be used as a hedge, aromatic leaves								
Evergreen bayberry	<i>Myrica heterophylla</i>	15	E	D	Wet	S-P	Av	M
<b>Wildlife Use of Native Plants:</b> Small waxy berries used by many birds, good nesting cover								
<b>Native Plant Aesthetics:</b> Branches nearly black, leathery aromatic evergreen leaves								
Odorless bayberry	<i>Myrica inodora</i>	20	E	D	Wet	S-P	Av	M
<b>Wildlife Use of Native Plants:</b> Small waxy berries used by many birds, good nesting cover								
<b>Native Plant Aesthetics:</b> Bark almost white, leaves odorless								
Dwarf wax myrtle	<i>Myrica pumila</i>	3	E	D	Avg	S-P	Av	H
<b>Wildlife Use of Native Plants:</b> Small waxy berries used by many birds								
<b>Native Plant Aesthetics:</b> A small version of common wax myrtle								
Scrub plum	<i>Prunus geniculata</i>	6	D	M	Dry	S	Av	N
<b>Wildlife Use of Native Plants:</b> Small sweet plums prized by wildlife								
<b>Native Plant Aesthetics:</b> White flowers, thorny zigzag branches								
Wild coffee*	<i>Psychotria nervosa</i>	2	E	M	Avg	P-Sh	Av	N
<b>Wildlife Use of Native Plants:</b> Red fruits used by many wildlife species								
<b>Native Plant Aesthetics:</b> Dark shiny leaves and bright red fruit								
Dwarf oak (B)**	<i>Quercus minima</i>	2	D	M	Avg	S-P	Av	N
<b>Wildlife Use of Native Plants:</b> Acorns widely used by wildlife								
<b>Native Plant Aesthetics:</b> Good groundcover for sunny areas								

**Table 3.** Native Shrubs for Central Florida

Common Name	Scientific Name	Hgt	Leaf Type	Sex	Moisture	Light	pH	Salt
Running oak (B)	<i>Quercus pumila</i>	3	D	M	Avg	S-P	Av	N
<b>Wildlife Use of Native Plants:</b> Acorns widely used by wildlife								
<b>Native Plant Aesthetics:</b> Good groundcover for sunny areas								
White indigo berry*	<i>Randia aculeata</i>	6	E	M	Avg	S	Av	M
<b>Wildlife Use of Native Plants:</b> White-skinned fruits used by some birds								
<b>Native Plant Aesthetics:</b> Spines, attractive form but messy fruit								
Myrsine	<i>Rapanea punctata</i>	10	E	D	Avg	P-Sh	Av	M
<b>Wildlife Use of Native Plants:</b> Small black fruits along stem in winter used by some birds								
<b>Native Plant Aesthetics:</b> Bright green leathery leaves								
Needle palm	<i>Rhaphidophyllum hystrix</i>	6	E	M	Avg	P-Sh	Av	N
<b>Wildlife Use of Native Plants:</b> Yellowish fruits used by mammals and,large birds								
<b>Native Plant Aesthetics:</b> Trunks covered with needle-like spines								
Winged sumac	<i>Rhus copallina</i>	10	D	M	Avg	S	Av	N
<b>Wildlife Use of Native Plants:</b> Red fruits used by some birds during winter								
<b>Native Plant Aesthetics:</b> Good red fall color								
Sand blackberry	<i>Rubus cuneifolius</i>	4	E	M	Avg	S	Av	N
<b>Wildlife Use of Native Plants:</b> Berries greatly prized by wildlife, excellent cover								
<b>Native Plant Aesthetics:</b> Berries edible, white flowers in spring, very thorny and sprawling								
Scrub palmetto	<i>Sabal etonia</i>	3	E	M	Dry	S	Av	M
<b>Wildlife Use of Native Plants:</b> Round black fruits used by many mammals and large birds								
<b>Native Plant Aesthetics:</b> Leaf stems without teeth, trunks mostly underground								
Dwarf palmetto	<i>Sabal minor</i>	6	E	M	Moist	P	Av	H
<b>Wildlife Use of Native Plants:</b> Round black fruits used by mammals and large birds								
<b>Native Plant Aesthetics:</b> Leaves bluish and without teeth, trunks often underground								
Elderberry	<i>Sambucus canadensis</i>	12	D	M	Moist	S-P	Av	N
<b>Wildlife Use of Native Plants:</b> Purple fruit used by many birds, good nectar source								
<b>Native Plant Aesthetics:</b> Fruits used in jellies and wine, fragrant white flowers								
Saw palmetto	<i>Serenoa repens</i>	8	E	M	Avg	S-P	Av	H
<b>Wildlife Use of Native Plants:</b> Round black fruits used by many mammals and large birds								
<b>Native Plant Aesthetics:</b> Leaf stems with teeth, excellent groundcover beneath trees								
Mullein nightshade	<i>Solanum erianthum</i>	15	E	M	Avg	S	Av	M
<b>Wildlife Use of Native Plants:</b> Clusters of yellow berries used by some birds								
<b>Native Plant Aesthetics:</b> Open clusters of white flowers produced year-round								
Bay cedar*	<i>Suriana maritima</i>	8	E	M	Avg	S	Av	H
<b>Wildlife Use of Native Plants:</b> Seeds used by some birds, good nesting cover								
<b>Native Plant Aesthetics:</b> Small yellow flowers year-round, dense, succulent foliage								
Highbush blueberry	<i>Vaccinium corymbosum</i>	12	E	M	Avg	P	Ac	N
<b>Wildlife Use of Native Plants:</b> Berries greatly prized by wildlife								
<b>Native Plant Aesthetics:</b> Sweet edible berries, bell-shaped flowers in spring								
Little blueberry	<i>Vaccinium darrowii</i>	2	E	M	Avg-Dry	S-P	Ac	N
<b>Wildlife Use of Native Plants:</b> Berries greatly prized by wildlife								
<b>Native Plant Aesthetics:</b> Sweet edible berries, foliage with bluish cast								
Shiny blueberry	<i>Vaccinium myrsinites</i>	2	E	M	Avg-Dry	S-P	Ac	N
<b>Wildlife Use of Native Plants:</b> Berries greatly prized by wildlife								
<b>Native Plant Aesthetics:</b> Sweet edible berries, shiny green foliage								

**Table 3.** Native Shrubs for Central Florida

Common Name	Scientific Name	Hgt	Leaf Type	Sex	Moisture	Light	pH	Salt
Deerberry	<i>Vaccinium stamineum</i>	8	D	M	Avg	S-P	Ac	N
<p><b>Wildlife Use of Native Plants:</b> Berries used by many wildlife species</p> <p><b>Native Plant Aesthetics:</b> Berries bitter, bell-shaped flowers in spring</p>								
Possumhaw viburnum	<i>Viburnum nudum</i>	15	D	M	Moist	P-Sh	Av	N
<p><b>Wildlife Use of Native Plants:</b> Small blue-black fruit used by many birds</p> <p><b>Native Plant Aesthetics:</b> Large clusters of small white flowers in spring, sprawling</p>								
Walter's viburnum	<i>Viburnum obovatum</i>	15	E	M	Moist	S-Sh	Av	N
<p><b>Wildlife Use of Native Plants:</b> Small black fruit used by many birds, good nesting cover</p> <p><b>Native Plant Aesthetics:</b> Clusters of small white flowers in spring, easily pruned, versatile</p>								
Rusty viburnum	<i>Viburnum rufidulum</i>	20	O	M	Avg	S-Sh	Av	N
<p><b>Wildlife Use of Native Plants:</b> Small black fruit used by many birds</p> <p><b>Native Plant Aesthetics:</b> Large clusters of small white flowers in spring</p>								
Hog plum	<i>Ximenia americana</i>	10	E	M	Dry	S	Av	M
<p><b>Wildlife Use of Native Plants:</b> Yellow "plums" used by some wildlife</p> <p><b>Native Plant Aesthetics:</b> "Plums" tart, but edible, very thorny</p>								
<p>*Indicates plants that will suffer damage from severe or prolonged freezing temperatures.</p> <p>**Oaks are classified as either black (B) or white (W). White oak acorns often are sweeter and more preferred by wildlife than black oak acorns.</p>								

Florida Cooperative Extension Service

## Helping Cavity-nesters in Florida<sup>1</sup>

Joe Schaefer<sup>2</sup>

Cavities or holes in trees are required nesting sites for 25 bird species in Florida. Some cavity-nesters have very specific preferences for their homes. For example, the red-cockaded woodpecker excavates its nesting cavity only in older living pine trees that are infected with red heart rot, and in areas with little or no hardwood understory. On the other hand, Carolina wrens are quite adaptable and even have been known to set up house-keeping in pockets of accessible clothing articles, mailboxes, and old hornet nests.

Some cavity-nesters such as woodpeckers, Carolina chickadees, and brown-headed nuthatches prefer to excavate their own nest cavities in dead or decaying wood. Others select old woodpecker holes or cavities formed by lightning, disease, decay, or insects.

Turkey vultures are the largest cavity-nesters with wing-spans of about 6 feet (2 meters). Their nest site often is at or near ground level in hollow trees or logs. When these structures are not available, they will nest in caves or in dense shrubbery.

The smallest hole-nester in Florida is the brown-headed nuthatch which is only 3 1/2 inches (9 centimeters) long. These birds often nest in small cracks and crevices that do not have noticeable rounded openings like woodpecker holes.

Of the 25 species of cavity-nesters in Florida, two are legally classified as species in jeopardy of extinction. The southeastern American kestrel is a state-listed threatened species and the red-cockaded woodpecker is a federally-listed endangered species. The ivory-billed woodpecker also is doubly listed as endangered but probably is already extirpated from the state. The Florida Committee on Rare and Endangered Plants and Animals has recommended listing the hairy woodpecker and the white-breasted nuthatch.

### NEST SITES

Nest sites for cavity-nesters usually are in shorter supply than food and water. Dead trees (snags) often are removed from forests, parks, and yards. Whenever possible, snags should be left for birds; however, if you are concerned that a dead tree may fall, it can be shortened and supported with cables.

Properly built bird houses or nest boxes can mimic natural cavities and help to increase the availability of this limiting habitat component. Some cavity-nesters in Florida, such as black and turkey vultures, chimney swifts, and pileated and red-cockaded woodpeckers will not readily use bird houses. However, there can be exceptions to this general rule. Preferred habitats, house dimensions, entrance specifications, and other special requirements are fairly specific for each species. Refer to Table 1: Bird House Specifications.

1. This document, SS-WIS-901, is part of a series published by the Cooperative Wildlife Program, a cooperative effort of the Florida Cooperative Extension Service, Institute of Food and Agricultural Sciences, University of Florida and the Florida Game and Fresh Water Fish Commission's Nongame Wildlife Program. Publication date: December 1990.
2. Joe Schaefer, urban wildlife extension specialist, Wildlife and Range Sciences Department, Cooperative Extension Service, Institute of Food and Agricultural Sciences, University of Florida, Gainesville FL 32611-0304.

The Institute of Food and Agricultural Sciences is an equal opportunity/affirmative action employer authorized to provide research, educational information and other services only to individuals and institutions that function without regard to race, color, sex, age, handicap, or national origin. For information on obtaining other extension publications, contact your county Cooperative Extension Service office.  
Florida Cooperative Extension Service / Institute of Food and Agricultural Sciences / University of Florida / Christine Taylor Stephens, Dean



Bird houses can be set out at any time of the year. However, making them available just before the major nesting season (March-June) will enhance their use.

The following general considerations apply to all bird houses.

- Cleaning - Include a hinged door or other means for easily checking and cleaning out the house. Birds will do their own cleaning as they do in natural cavities, but your help will increase use.
- Drainage - The bottom should contain 3 or 4 1/4-inch holes to allow drainage of rain water that may enter.
- Attachment - Houses built for wrens can be suspended under an eave or a tree limb. All other houses should be firmly attached to a post, tree, or building.
- Perches - Natural cavities do not have perches, so do not attach perches on any built houses. Perches will only encourage use by exotic English sparrows and European starlings. A nail or knife can be used to scratch the outside surface below the entrance if smooth boards are used. Cavity-nesters perch on vertical roughened surfaces such as bark.
- Roof - The front edge of the roof should overhang about 1-2 inches (2.5-5 centimeters) to help protect the entrance from wind-driven rain.
- Ventilation - Ventilation holes or slits should be located at the top of both sides just beneath the roof.
- Nails - Use galvanized nails.
- Floor - The floor should be situated between and about 1/4 inch above the bottom edges of the front, back, and sides. This will help prevent the rain from seeping into the bottom of the nest.
- Wood - 1" x 4", 1" x 6", or 1" x 12", untreated boards are the best materials to use.

- Paint - Newly painted or oiled houses are less attractive to birds until they have weathered. However, it is desirable to paint the top surfaces of purple martin houses white to reflect the sun's heat.
- Style - The shape and style of the house are not as important as the dimensions.
- Size - House dimensions should be close to those given in this pamphlet, but they do not have to be exact.

Providing houses for cavity nesting birds is not only recommended to help reverse declining trends for some populations, but it is also a rewarding activity for many Floridians. What have you done for wildlife lately?

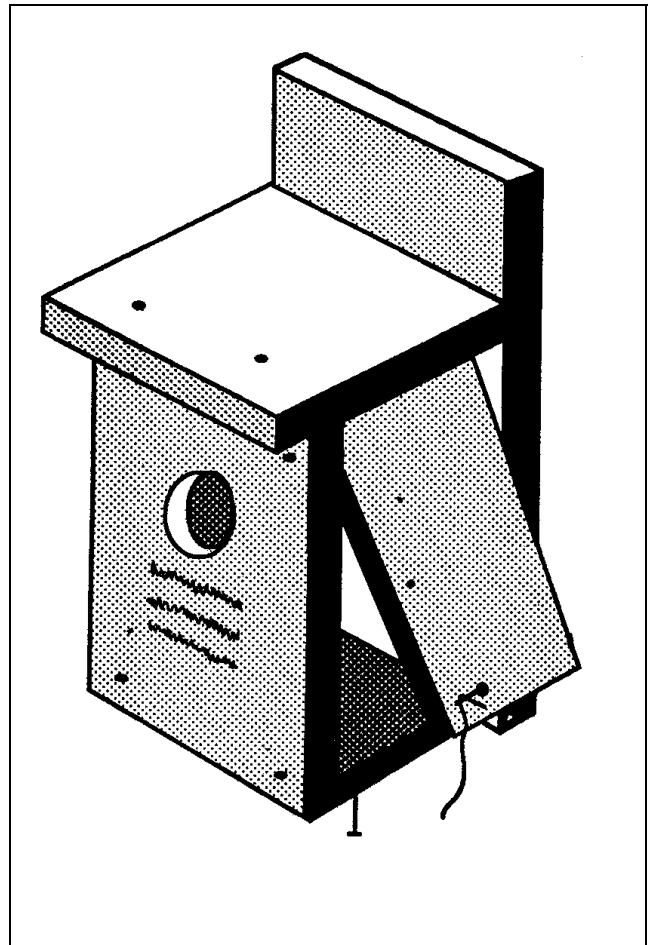

Figure 1. Basic birdhouse design.

**Table 1.** Bird House Specifications.

Width (in)	Height (in)	Entrance		Height of house (ft)
		Size (in)	Height above floor (in)	
<b>Barn-owl</b>				
22	18	10 square	centered at the top	in open building near roof
Preferred habitat: open canopy wood-lands or edges of thick woodlots				
Special tips: 2" of woodchips on bottom				
<b>Barred owl</b>				
12	24	7	12	20-30
Preferred habitat: old growth, wetland forests				
Special tips: 3" of woodchips on bottom, a perch should be close but not block entrance				
<b>Brown-headed nuthatch</b>				
4	10	1 1/4	7	10-25
Preferred habitat: pine woodlands				
Special tips: outer material should be <u>pine</u> bark				
<b>White-breasted nuthatch</b>				
4	10	1 1/4	7	6-25
Preferred habitat: deciduous woodlands				
Special tips: outer material should be bark				
<b>Carolina wren</b>				
4	8	1 1/2	1-6	6-10
Preferred habitat: woodlands with thick underbrush				
Special tips: bird house can be hung from limb or human house eave				
<b>Carolina chickadee</b>				
4	8	1 1/8	6	4-10
Preferred habitat: all woodlands				
Special tips: place house in area with about 1/2 sunlight				
<b>Common flicker</b>				
7	24	2 1/2	18	8-20
Preferred habitat: all woodlands				
Special tips: outer material should be bark				
<b>Downy woodpecker</b>				
4	10	1 1/4	7	8-25
Preferred habitat: all woodlands				
Special tips: fill house tightly with sawdust, outer material should be bark				
<b>Eastern bluebird</b>				
5	9	1 1/2	5	4-8
Preferred habitat: open fields, yards, golf courses				
Special tips: place house in open area facing and about 10 feet away from a bush or along a wire fence on which young can perch				
<b>Eastern screech-owl</b>				
8	16	3	10	15-30
Preferred habitat: woodland edges				
Special tips: 3" of woodchips on bottom				
<b>Great-crested flycatcher</b>				
6	10	2	6	8-20
Preferred habitat: all woodlands				
Special tips: place house in shade				

**Table 1.** Bird House Specifications.

Width (in)	Height (in)	Entrance		Height of house (ft)
		Size (in)	Height above floor (in)	
<b>Hairy woodpecker</b>				
6	15	1 1/2	10	12-25
Preferred habitat: all woodlands				
Special tips: fill house tightly with sawdust, outer material should be bark				
<b>Pileated woodpecker</b>				
11	24	4	18	20-30
Preferred habitat: old growth woodlands				
Special tips: 2" thick boards, fill house tightly with sawdust, outer material should be bark				
<b>Prothonotary warbler</b>				
4	8	1 1/4	6	2-12
Preferred habitat: swamps and along rivers				
Special tips: place house "next to" or "over" water				
<b>Purple martin</b>				
6	6	2 1/2	1	10-20
Preferred habitat: open fields, yards, and golf courses				
Special tips: must have several compartments, place house on pole at least 25' from trees and other tall structures				
<b>Red-bellied woodpecker</b>				
7	15	2	10	20-40
Preferred habitat: old growth woodlands				
Special tips: fill house tightly with sawdust, outer material should be bark				
<b>Red-headed woodpecker</b>				
6	15	2	10	20-40
Preferred habitat: open canopy woodlands and edges				
Special tips: fill house tightly with sawdust, outer material should be bark				
<b>Southeastern kestrel</b>				
9	16	3	11	13-16
Preferred habitat: open areas and edges of woodlands				
Special tips: 2" of woodchips on bottom				
<b>Tufted titmouse</b>				
4	10	1 1/4	7	4-15
Preferred habitat: old growth woodlands				
Special tips: place house in shade				
<b>Wood duck</b>				
10	24	4x3 horizontal oval	20	4-6 over water; 15-25 over land
Preferred habitat: bottomland hardwoods and wetlands				
Special tips: 4" of woodchips on bottom, 18"x3" strip of 1/4" hardware cloth on inside below entrance				
<b>Hooded merganser</b>				
10	24	4x3 horizontal oval	20	4-6 over water; 20-30 over land
Preferred habitat: bottomland hardwoods and wetlands				
Special tips: 4" of woodchips on bottom, 18"x3" strip of 1/4" hardware cloth on inside below entrance				



Cooperative Extension Service  
Institute of Food and Agricultural Sciences

## Butterfly Gardening in Florida<sup>1</sup>

Joe Schaefer, Craig N. Huegel, and Frank J. Mazzotti<sup>2</sup>

### Background

Few outdoor activities are more rewarding and easily available than attracting butterflies to a well-designed butterfly garden. Creating a butterfly garden can be as simple as planting a windowsill box or as complex as landscaping many acres. To be successful in any situation, however, requires the correct choice of plants.

The total butterfly garden takes into account the food preferences of both adult butterflies and their caterpillars. Many butterfly species will drink nectar from a variety of flowering plants, but their caterpillars often are greatly limited in the number of plants on which they can feed. It is not necessary to plant larval food plants to attract butterflies, but adults tend to stay fairly close to the areas where their larval food plants can be found.

All of this requires planning. There are a few basic rules to follow. You can be as creative as you wish, but you must start with a plan that considers the requirements of the butterflies you wish to attract and the plants you will use to lure them.

Butterfly gardening is an exacting (not difficult) pursuit and must be based on butterfly preferences-not human ones. Luckily, butterfly and human favorites are mostly compatible.

### Butterfly Facts and Biology

Of the 760 butterfly species that occur in North America, about 100 can be found in Florida. These do not include the skippers (of which Florida is home to an additional 70 species). Skippers, which are not listed in this publication, have relatively stout bodies and shorter wings than true butterflies. Moths are different from butterflies and skippers by having fluffy antenna instead of a club at the end. Other differences are that moths are active at night, and tend to hold their wings open while feeding or resting.

There are four stages in the amazing butterfly life cycle: egg, larva, chrysalis (resting), and adult. Butterfly eggs are laid on the larval food plant and caterpillars emerge within a few days. Some species overwinter in this stage. These larva have enormous appetites and do nothing but eat. When their skin is stretched as far as possible, they molt or shed that skin. After a few molts, they seek a sheltered place. Some spin a safety belt that holds them upside down on a twig or similar object, while others hang on with special hooks on their abdomen. At this time, the final molt takes place and the larva skin is replaced with a stiff butterfly chrysalis (pupa). During this stage, the once worm-like caterpillar transforms into a beautiful, flying adult.

1. This document is WEC-21, one of a series of the Wildlife Ecology and Conservation department, Florida Cooperative Extension Service, Institute of Food and Agricultural Sciences, University of Florida. Publication: December, 1990, as SS-WIS-26. Reviewed: January, 1999. Please visit the EDIS Web site at <http://edis.ifas.ufl.edu>
2. Joe Schaefer, Ph.D., associate professor, Craig N. Huegel, former assistant extension scientist, Pinellas County, and Frank J. Mazzotti, Ph.D., assistant professor, Wildlife Ecology and Conservation department, University of Florida, Everglades REC, Belle Glade, FL 33430, Florida Cooperative Extension Service, Institute of Food and Agricultural Sciences, University of Florida, Gainesville, 32611.

The Institute of Food and Agricultural Sciences is an equal opportunity/affirmative action employer authorized to provide research, educational information and other services only to individuals and institutions that function without regard to race, color, sex, age, handicap, or national origin. For information on obtaining other extension publications, contact your county Cooperative Extension Service office. Florida Cooperative Extension Service / Institute of Food and Agricultural Sciences / University of Florida / Christine Taylor Waddill, Dean

## Butterflies

Most adult butterflies found in Florida feed on flower nectar. Some visit a variety of flowers and others seem to prefer a more specialized menu. Butterflies generally are attracted to brightly colored simple flowers that are not too deep and that are wide enough for good perching platforms. Universal nectar favorites include: phlox, zinnias, asters, marigolds, daisies, coneflowers, black-eyed Susan, milkweeds, thistles, and butterflybush. Flowers in the composite family (e.g. daisies and asters) and flowers in clusters (e.g. milkweed and viburnum) also are good. Double-flowered varieties of cultivated flowers are never as good as the single ones.

White varieties are inferior to other colors as far as butterflies are concerned. A wide assortment of flowers is preferable to having just a few different kinds or a variety of similar flower types. As a rule, small butterflies nectar from small flowers and large butterflies nectar from larger ones. Flowers that produce the most scent generally furnish the most nectar. Nectar also should be available for the greatest number of months possible. Therefore, it is best to choose your flowers so that at least some of them are always blooming. Remember that many flowers are not designed to be pollinated by butterflies and are seldom, if ever, visited by them.

Adults of some butterfly species rarely visit flowers but instead are attracted to aphids, manure, rotting fruit, mud, or tree sap.

## Caterpillars

Larval (caterpillar) food plants must be tailored to specific butterflies. Some plants are hosts to several different butterflies (e.g., passion vine), but often each species requires its own plant. So, unless you have acres of land at your disposal, you will have to be selective in your plantings for specific butterflies. You also must remember that these plants ultimately will be chewed on if you are successful.

Birds and other predators are quick to eat these larva so few reach adulthood or get large enough to do extensive damage. In fact, very few butterfly species (unlike moths) cause significant problems to vegetable gardens. Most feed singly or in small groups, as their eggs are laid. Most butterfly gardeners are quite pleased to share their carrots and dill for the pleasure of the company of black swallowtails; they simply plant some extra for the caterpillars. If you must use insecticides, use them sparingly as they are just as deadly to butterflies as they are to other insects.

## Planning Your Garden

### Butterfly Basics

You can't attract butterfly species that are not present naturally in your region, nor can you grow plants that aren't adapted to the soils and climate in your region of the state. Butterfly gardening should not try to improve nature but complement it as the best horticultural practices have always done. Follow these easy steps to plan your garden.

### Your Butterfly Region Map

Look at the map provided (Figure 1) and determine the region in which you live.

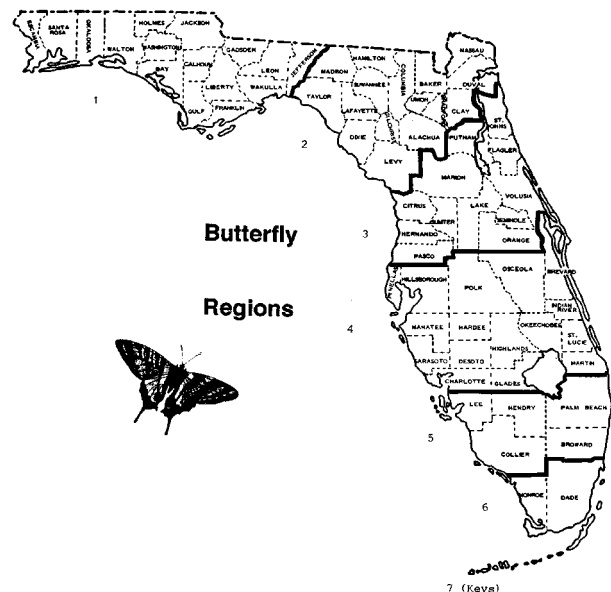

Figure 1. Florida's seven butterfly regions.

### Your Butterfly Region Table(s)

Then, look for your region in the Florida butterflies tables (Tables 1-9), highlight the species that occur in your area, and use habitats that can be found within 1/4 mile of the site you are considering for your butterfly garden.

**Butterfly nectar plants by region.** Table 10 lists butterfly nectar plants for north and central Florida (regions 1-4). Table 11 lists butterfly nectar plants for south Florida regions 5-7).

### *Keys to using the tables*

**Determine the larval and adult foods for each species from the tables.** Butterflies tend to stay fairly close to the areas where their natural larval food plants can be found.

**The "flight season"** indicates the months when the adults are active.

*Note: If you are not interested in trying to attract the greatest variety of butterflies, you can select plants from the butterfly nectar sources listed at the end of this publication. This approach also will help you to create a beautiful garden that also is appealing to some butterfly species.*

### *Keys to the tables*

Table 1. Swallowtails

Table 2. Sulfurs, Whites, and Orange-tip Butterflies

Table 3. Hairstreaks, Coppers, and Blue Butterflies

Table 4. Metalmark Butterflies

Table 5. Snout Butterflies

Table 6. Brushfooted Butterflies

Table 7. Goatweed Butterflies

Table 8. Nymphs and Satyrs

Table 9. Milkweed Butterflies

Table 10. Butterfly Nectar Plants. North and Central Florida: Regions 1 - 4.

Table 11. Butterfly Nectar Plants. South Florida: Regions 5 - 7.

### **Selected References**

- Gerberg, E. J., and R. H. Arnett, Jr. 1989. Florida butterflies. Natural Science Publications, Inc., Baltimore. 90 pp.
- Howe, W. H. 1975. The butterflies of North America. Doubleday & Company, Inc., Garden City. 633 pp.

**Table 1.** Swallowtails

Key for Larval and Adult Foods: \* = non-native species; \*\* = non-native species, **not** recommended for planting because of its tendency to spread and adversely affect natural communities.

Species of Butterfly	Regions	Habitats	Flight Season
Pipevine Swallow	1-4	Fields, gardens, wetlands, orchards	Feb.-Nov.
<b>Larval Foods:</b> Herbaceous plants--Dutchman's pipe ( <i>Aristolochia</i> spp.)			
<b>Adult Foods:</b> Other Adult Foods-Flowers, nonspecific			
Gold Rim Swallowtail	1-5	disturbed areas, gardens, fields	All year
<b>Larval Foods:</b> Herbaceous plants-Dutchman's pipe ( <i>Aristolochia</i> spp.)			
<b>Adult Foods:</b> Shrubs and Vines-Lantana ( <i>Lantana camara</i> )			
Zebra swallowtail	1-7	wetlands	March-Dec.
<b>Larval Foods:</b> Shrubs and Vines-Pawpaw ( <i>Asimina</i> spp.)			
<b>Adult Foods:</b> Other Adult Foods-Flowers, nonspecific			
American swallowtail	1-7	open areas	All year
<b>Larval Foods:</b> Herbaceous plants-Parsley ( <i>Umbelliferae</i> )* and Wild carrot ( <i>Daucus carota</i> )			
<b>Adult Foods:</b> Other Adult Foods-Flowers, nonspecific			
Giant swallowtail	1-7	open areas, forest edges, citrus groves	All year
<b>Larval Foods:</b> Trees-Citrus trees ( <i>Citrus</i> spp.)* and Common hoptree ( <i>Ptelea trifoliata</i> ); Shrubs and Vines-Torchwood ( <i>Amyris elemifera</i> )			
<b>Adult Foods:</b> Other Adult Foods-Flowers, nonspecific and manure			
Schaus' swallowtail	7	tropical hammocks	May-July
<b>Larval Foods:</b> Trees-Bay, red ( <i>Persea borbonia</i> ); Shrubs and Vines-Torchwood ( <i>Amyris elemifera</i> )			
<b>Adult Foods:</b> Unknown			
Eastern tiger swallowtail	1-6	open areas, orchards, gardens	March-Nov.
<b>Larval Foods:</b> Trees-Ash ( <i>Fraxinus</i> spp.), Plums ( <i>Prunus</i> spp.), Yellow poplar ( <i>Liriodendron tulipifera</i> )			
<b>Adult Foods:</b> Other adult foods-Carrion, flowers-nonspecific, and mud			
Spicebush swallowtail (Figure 2)	1-7	forest edges, wetlands, fields, gardens	March-Dec.
<b>Larval Foods:</b> Trees-Bays ( <i>Persea</i> spp.), Camphor tree ( <i>Cinnamomum camphora</i> **), Pines ( <i>Pinus</i> spp.), Prickly ash ( <i>Zanthoxylum coriaceum</i> ), Sassafras ( <i>Sassafras albidum</i> ); Shrubs and Vines-Spicebush ( <i>Lindera benzoin</i> )			
<b>Adult Foods:</b> Flowers, nonspecific and Mud			
Laurel swallowtail	1-6	swamps	March-Dec.
<b>Larval Foods:</b> Trees-Avocado ( <i>Persea americana</i> )*, Bay, red ( <i>Persea borbonia</i> ), Bays ( <i>Persea</i> spp.), Sweet bay ( <i>Magnolia virginiana</i> )			
<b>Adult Foods:</b> Flowers, nonspecific and Mud			

**Table 2.** Sulfurs, Whites, and Orange-tip Butterflies

Key for Larval and Adult Foods: \* = non-native species; \*\* = non-native species, **not** recommended for planting because of its tendency to spread and adversely affect natural communities

Species of Butterfly	Regions	Habitats	Flight Season
Florida white <b>Larval Foods:</b> Shrubs and Vines--Capers ( <i>Capparis</i> spp.), Guiana plum ( <i>Drypetes lateriflora</i> ) <b>Adult Foods:</b> Unknown	5-7	hardwood hammocks, wetlands	All year
Checkered white <b>Larval Foods:</b> Herbaceous Plants--Mustards (Cruciferae), Peppergrass ( <i>Lepidium virginicum</i> ), Spider flower ( <i>Cleome spinosa</i> )* <b>Adult Foods:</b> Herbaceous Plants--Mustards (Cruciferae), Peppergrass ( <i>Lepidium virginicum</i> )	1-7	disturbed areas, fields	March-Nov.
European cabbage butterfly <b>Larval Foods:</b> Herbaceous Plants--Mustards (Cruciferae), Nasturtiums (Tropaeolaceae)*, and Watercress ( <i>Nasturtium officinale</i> )* <b>Adult Foods:</b> Unknown	1-7	gardens, fields	March-Nov.
Great southern white <b>Larval Foods:</b> Herbaceous Plants--Mustards (Cruciferae), Peppergrass ( <i>Lepidium virginicum</i> ), Saltwort ( <i>Batis maritima</i> ), Spider flower ( <i>Cleome spinosa</i> )* <b>Adult Foods:</b> Other Adult Foods--Flowers, nonspecific	2-7	beaches, salt marshes, coastal strand	All year
Falcate orange tip <b>Larval Foods:</b> Herbaceous Plants--Avocado ( <i>Persea americana</i> ), Bittercress ( <i>Cardamine</i> spp.), Mustards (Cruciferae) <b>Adult Foods:</b> Herbaceous Plants--Peppergrass ( <i>Lepidium virginicum</i> )	Liberty County	deciduous forests, oak-pine forests	March-April
Orange sulfur butterfly <b>Larval Foods:</b> Herbaceous Plants--Beans (Fabaceae), Clover, sweet ( <i>Melilotus</i> spp.), Vetch ( <i>vicea</i> spp.) <b>Adult Foods:</b> Other Adult Foods--Flowers, nonspecific and Mud	1-7	open areas, alfalfa fields	March-Dec.
Common sulfur <b>Larval Foods:</b> Herbaceous Plants--Clover, white ( <i>Trifolium</i> spp.) <b>Adult Foods:</b> Unknown	1-2	open areas, pastures	March-Dec.
Eastern dogface <b>Larval Foods:</b> Shrubs and Vines--Dalea ( <i>Dalea</i> spp.); Herbaceous Plants--Alfalfa ( <i>Medicago sativa</i> )*, Clover, sweet ( <i>Melilotus</i> spp.), Lead plant ( <i>Amorpha</i> spp.), Soybean ( <i>Glycine max</i> )* <b>Adult Foods:</b> Shrubs and Vines--Dalea ( <i>Dalea</i> spp.); Herbaceous Plants--Alfalfa ( <i>Medicago sativa</i> )*, Clover, sweet ( <i>Melilotus</i> spp.), Lead plant ( <i>Amorpha</i> spp.), Soybean ( <i>Glycine max</i> )*	1-6	sandhills, scrub, flatwoods	All year
Large orange sulfur <b>Larval Foods:</b> Shrubs and Vines--Blackbeard ( <i>Pithecellobium keyense</i> ), Cat claw ( <i>Pithecellobium unguis-cati</i> ); Herbaceous Plants--Senna ( <i>cassia</i> spp.) <b>Adult Foods:</b> Shrubs and Vines--Lantana ( <i>Lantana camara</i> ); Herbaceous Plants--Hibiscus ( <i>Hibiscus</i> spp.)	4-7	scrub	March-Dec.
Cloudless sulfur <b>Larval Foods:</b> Herbaceous Plants--Clovers ( <i>Trifolium</i> spp.), Partridge pea ( <i>Cassia fasciculata</i> ), Senna ( <i>cassia</i> spp.) <b>Adult Foods:</b> Trees--Geiger tree ( <i>Cordia sebestena</i> ); Shrubs and Vines--Lantana ( <i>Lantana</i> spp.); Herbaceous Plants--Hibiscus ( <i>Hibiscus</i> spp.)	1-7	open areas, gardens, beaches, wetlands	All year
Orange barred sulfur <b>Larval Foods:</b> Herbaceous Plants--Poinsettia ( <i>Poinsettia pulcherrima</i> ), Senna ( <i>cassia</i> spp.) <b>Adult Foods:</b> Other Adult Foods--Flowers, nonspecific and mud	4-7	gardens, scrub	All year
Migrant sulfur <b>Larval Foods:</b> Trees--Lignum vitae ( <i>Guaicum sanctum</i> ); Shrubs and Vines--False violet ( <i>Dalbergia ecastophyllum</i> ) <b>Adult Foods:</b> Unknown	4-7	coastal strand, keys, beaches	Feb.-Nov.



**Table 2.** Sulfurs, Whites, and Orange-tip Butterflies

Key for Larval and Adult Foods: \* = non-native species; \*\* = non-native species, **not** recommended for planting because of its tendency to spread and adversely affect natural communities

Species of Butterfly	Regions	Habitats	Flight Season
Guayacan sulfur <b>Larval Foods:</b> Trees--Lignum vitae ( <i>Guaiacum sanctum</i> ) <b>Adult Foods:</b> Trees--Mangrove, black ( <i>Avicennia germinans</i> ); Herbaceous plants--Marigold, bur or Spanish needle ( <i>Bidens pilosa</i> )*	5-7	open areas	May-August
Barred sulfur <b>Larval Foods:</b> Herbaceous plants--Beans (Fabaceae), Pencil flower ( <i>Stylosanthes biflora</i> ), Shy leaves ( <i>Aeschynome viscidula</i> )* <b>Adult Foods:</b> Herbaceous plants--Beans (Fabaceae)*, Pencil flower ( <i>Stylosanthes biflora</i> ), Shy leaves ( <i>Aeschynome viscidula</i> )*	1-7	beaches, scrub, disturbed areas	All year
Little sulfur <b>Larval Foods:</b> Trees--Legumes (Fabaceae); Herbaceous plants--Clovers ( <i>Trifolium</i> spp.), Senna ( <i>Cassia</i> spp.) <b>Adult Foods:</b> Other Adult Foods--Flowers, nonspecific	1-7	disturbed areas, open areas, fields	All year
Bush sulfur <b>Larval Foods:</b> Shrubs and Vines--Mexican alvaradoa ( <i>Alvaradoa amorphoides</i> ) <b>Adult Foods:</b> Herbaceous Plants--Composites (Compositae)	5-7	flatwoods, fields	All year
Blacktip sulfur <b>Larval Foods:</b> Herbaceous Plants--Sensitive plant ( <i>Mimosa pudica</i> ) <b>Adult Foods:</b> Herbaceous Plants--Composites (Compositae)	6-7	forest edges	May-Dec.
Rambling orange <b>Larval Foods:</b> Herbaceous Plants--Clovers ( <i>Trifolium</i> spp.), Partridge pea ( <i>Cassia fasciculata</i> ), Senna ( <i>Cassia</i> spp.) <b>Adult Foods:</b> Herbaceous Plants--Marigold, bur or Spanish needle ( <i>Bidens pilosa</i> )*; Other Adult Foods--Flowers, nonspecific	1-7	fields, forest edges, scrub, sandhills	All year
Dainty sulfur <b>Larval Foods:</b> Herbaceous Plants--Asters, smooth-leaved (Asteraceae), Common chickweed ( <i>Stellaria media</i> ), Marigold, bur ( <i>Bidens pilosa</i> ), Marigold, garden varieties ( <i>Tagetes</i> spp.)*, Sneezeweed ( <i>Helenium autumnale</i> ) <b>Adult Foods:</b> Herbaceous Plants--Asters, smooth-leaved (Asteraceae), Common chickweed ( <i>Stellaria media</i> ), Marigold, bur or Spanish needle ( <i>Bidens pilosa</i> )*, Marigold, garden varieties ( <i>Tagetes</i> spp.)*, Sneezeweed ( <i>Helenium autumnale</i> )	2-7	disturbed areas, pastures	All year

**Table 3.** Hairstreaks, Coppers, and Blue Butterflies

Key for Larval and Adult Foods: \* = non-native species; \*\* = non-native species, **not** recommended for planting because of its tendency to spread and adversely affect natural communities

Species of Butterfly	Regions	Habitats	Flight Season
The harvester <b>Larval Foods:</b> Animals--Aphids on alders, witch hazel, wild currants, hawthorn, beech, ash and other plants <b>Adult Foods:</b> Other Adult Foods--Aphid honeydew and Manure	Local distribution in panhandle, Jacksonville, Tampa and Orlando areas	Wetlands, swamps	Feb.-Dec.
Coontie hairstreak <b>Larval Foods:</b> Shrubs and Vines--Coontie ( <i>Zamia floridana</i> ) <b>Adult Foods:</b> Shrubs and Vines--Saw palmetto ( <i>Serenoa repens</i> ), scrub palmetto ( <i>Sabal etonia</i> )	5-7	Forest edges, Hammocks	All year
Great blue hairstreak <b>Larval Foods:</b> Herbaceous Plants--Mistletoe ( <i>Phoradendron serotinum</i> )	1-3	Hammocks	All year

**Table 3.** Hairstreaks, Coppers, and Blue Butterflies

Key for Larval and Adult Foods: \* = non-native species; \*\* = non-native species, **not** recommended for planting because of its tendency to spread and adversely affect natural communities

Species of Butterfly	Regions	Habitats	Flight Season
<b>Adult Foods:</b> Trees--Plums ( <i>Prunus</i> spp.), Hercules-club ( <i>Zanthoxylum clava-herculis</i> ); Shrubs and Vines--Frog fruit ( <i>Lippia nodiflora</i> ); Herbaceous Plants--Marigold, bur or Spanish needle ( <i>Bidens pilosa</i> )*			
Verde azul hairstreak	7	Hammocks	All year
<b>Larval Foods:</b> Trees--Lead tree ( <i>Albizia lebecki</i> )*			
<b>Adult Foods:</b> Trees--Brazilian peppertree ( <i>Schinus terebinthifolius</i> **); Shrubs and Vines--Sweet pepper bush ( <i>Clethra alnifolia</i> ); Herbaceous plants--Marigold, bur or Spanish needle ( <i>Bidens pilosa</i> )*			
Silver banded hairstreak			
<b>Larval Foods:</b> Shrubs and Vines--Heart seed ( <i>Cardiospermum halicacabum</i> )			
<b>Adult Foods:</b> Other Adult Foods--Flowers, nonspecific			
Coral hairstreak	Tallahassee	Deciduous forest edges	May-July
<b>Larval Foods:</b> Trees--Cherries ( <i>Prunus</i> spp.)			
<b>Adult Foods:</b> Herbaceous plants--Butterfly weed ( <i>Asclepias tuberosa</i> )			
Banded hairstreak	1-3	Deciduous forests	April-June
<b>Larval Foods:</b> Trees--Hickories ( <i>Carya</i> spp.), Oaks ( <i>Quercus</i> spp.), Walnuts ( <i>Juglans</i> sp.)			
<b>Adult Foods:</b> Herbaceous plants--Indian hemp ( <i>Apocynum cannabinum</i> ), Milkweeds ( <i>Asclepias</i> spp.); Other Adult Foods--Flowers, nonspecific			
Sweetleaf hairstreak	1	Coastal strand, hammocks, swamps	May-June
<b>Larval Foods:</b> Trees--Sweetleaf ( <i>Symplocos tinctoria</i> ); Shrubs--Azaleas ( <i>Rhododendron</i> spp.)			
<b>Adult Foods:</b> Trees--Oaks ( <i>Quercus</i> spp.)			
Striped hairstreak	1-3	Deciduous forests, fields, disturbed areas	May-June
<b>Larval Foods:</b> Trees--Hawthorns ( <i>Crataegus</i> spp.); Shrubs and Vines--Blueberry ( <i>Vaccinium</i> spp.)			
<b>Adult Foods:</b> Herbaceous plants--Clover, white sweet ( <i>Melilotus</i> spp.), Indian hemp ( <i>Apocynum cannabinum</i> ), Milkweeds ( <i>Asclepias</i> spp.)			
Tiny hairstreak	6-7	fields	April-Dec.
<b>Larval Foods:</b> Trees--Lead tree ( <i>Albizia lebecki</i> )*, wild tamarind ( <i>Lysiloma latisiliqua</i> )			
<b>Adult Foods:</b> Shrubs and Vines--Scrub palmetto ( <i>Sabal etonia</i> ); Herbaceous plants--Marigold, bur or Spanish needle ( <i>Bidens pilosa</i> )*			
Red banded hairstreak	1-7	open areas, forest edges	All year
<b>Larval Foods:</b> Trees--Oaks ( <i>Quercus</i> spp.); Shrubs and Vines--Croton ( <i>Croton</i> spp.), Sumac, winged ( <i>Rhus copallina</i> ), Wax myrtle ( <i>Myrica cerifera</i> )			
<b>Adult Foods:</b> Trees--Cherry ( <i>Prunus</i> spp.); Shrubs and Vines--Sweet pepperbush ( <i>Clethra alnifolia</i> ); Herbaceous Plants--Indian hemp ( <i>Apocynum cannabinum</i> ), Milkweeds ( <i>Asclepias</i> spp.)			
Cedar hairstreak	1-3	fields, coastal hammocks, dunes	Feb.-Sept.
<b>Larval Foods:</b> Trees--Cedar, southern red ( <i>Juniperus silicicola</i> ), Cedar, eastern red ( <i>Juniperus, virginiana</i> )*			
<b>Adult Foods:</b> Trees--Plum, wild ( <i>Prunus americana</i> ); Herbaceous Plants--Marigold, bur or Spanish needle ( <i>Bidens pilosa</i> )*			
White cedar hairstreak	Liberty and Santa Rosa counties	bogs and swamps	April-July
<b>Larval Foods:</b> Trees--Cedar, Atlantic white ( <i>Chamaecyparis thyoides</i> )			
<b>Adult Foods:</b> Other Adult Foods--Flowers, nonspecific and Mud			
Woodland elfin	1-3	coastal strand, sandhills, oak-pine forests	Feb.-April
<b>Larval Foods:</b> Trees--Dahoon ( <i>Ilex cassine</i> ), Redbud ( <i>Cercis canadensis</i> ); Shrubs and Vines--Blueberry ( <i>Vaccinium</i> spp.), Persimmon ( <i>Diospyros virginiana</i> )			
<b>Adult Foods:</b> Other Adult Foods--Flowers, nonspecific and Mud			
Eastern pine elfin	2	sandhills, oak-pine forests	March-April

**Table 3.** Hairstreaks, Coppers, and Blue Butterflies

Key for Larval and Adult Foods: \* = non-native species; \*\* = non-native species, **not** recommended for planting because of its tendency to spread and adversely affect natural communities

Species of Butterfly	Regions	Habitats	Flight Season
<b>Larval Foods:</b> Trees--Pines ( <i>Pinus</i> spp.) <b>Adult Foods:</b> Other Adult Foods--Flowers, nonspecific and Mud			
Southern oak hairstreak	1-7	hammocks	March-May
<b>Larval Foods:</b> Trees--Oaks ( <i>Quercus</i> spp.) <b>Adult Foods:</b> Trees--Oak, chinquapin ( <i>Quercus muhlenbergii</i> ); Shrubs and Vines--Viburnum ( <i>Viburnum</i> spp.); Herbaceous Plants--Clover, sweet ( <i>Melilotus</i> spp.)			
White M hairstreak	1-7	hammocks, sandhills, scrub	March-Dec.
<b>Larval Foods:</b> Trees--Oaks ( <i>Quercus</i> spp.) <b>Adult Foods:</b> Shrubs and Vines--Lantana ( <i>Lantana camara</i> ), Sweet pepperbush ( <i>Clethra alnifolia</i> ), Viburnum ( <i>Viburnum</i> spp.); Herbaceous Plants--Milkweeds ( <i>Asclepias</i> spp.)			
Gray hairstreak	1-7	sandhills, disturbed areas, flatwoods	April-Oct.
<b>Larval Foods:</b> Trees--Hawthorns ( <i>Crataegus</i> spp.); Herbaceous Plants -Beans (Fabaceae), Mallows ( Malvaceae), Mints (Lamiaceae) <b>Adult Foods:</b> Other Adult Foods--Flowers, nonspecific			
Blue and gray hairstreak	5-7	open fields along the coast	All year
<b>Larval Foods:</b> Trees--Trema, florida ( <i>Trema micrantha</i> ); Shrubs and Vines--Bay cedar ( <i>Suriana maritima</i> ) <b>Adult Foods:</b> Trees--Brazilian peppertree ( <i>Schinus terbinthifolius</i> )**; Shrubs and Vines--Bay cedar ( <i>Suriana maritima</i> ), Lantana ( <i>Lantana camara</i> ); Herbaceous Plants--Marigold, bur or Spanish needle ( <i>Bidens pilosa</i> )*			
Bartram's hairstreak	5-7	hammocks	All year
<b>Larval Foods:</b> Shrubs and Vines--Croton, narrow leafed ( <i>Croton linearis</i> ) <b>Adult Foods:</b> Shrubs and Vines--Croton, narrow leafed ( <i>Croton linearis</i> ); Herbaceous Plants--Marigold, bur or Spanish needle ( <i>Bidens pilosa</i> )*			
Dotted hairstreak	5-7	fields	All year
<b>Larval Foods:</b> Shrubs and Vines--Avocado ( <i>Persea americana</i> ); Herbaceous Plants--Mallows (Malvaceae), Mints (Lamiaceae) <b>Adult Foods:</b> Other Adult Foods--Flowers, nonspecific			
Fulvous hairstreak	6-7	coastal strand, hammocks, wetlands	All year
<b>Larval Foods:</b> Trees--Brazilian peppertree ( <i>Schinus terbinthifolius</i> )**; other unknown <b>Adult Foods:</b> Trees--Brazilian peppertree ( <i>Schinus terbinthifolius</i> )**; Shrubs and Vines--Sea grape ( <i>Coccoloba uvifera</i> ); Herbaceous Plants--Marigold, bur or Spanish needle ( <i>Bidens pilosa</i> )*			
Eastern pigmy blue	East 2-3; West 1-7	salt marshes and tidal flats	All year
<b>Larval Foods:</b> Herbaceous Plants--Glasswort, annual ( <i>Salicornia bigelovii</i> ) <b>Adult Foods:</b> Shrubs and Vines--Saw palmetto ( <i>Serenoa repens</i> ); Herbaceous Plants--Saltwort ( <i>Batis maritima</i> )			
Tropical striped blue	3-7	gardens, forest edges	All year
<b>Larval Foods:</b> Herbaceous Plants--Leadwort, ornamental ( <i>Plumbago capensis</i> ) <b>Adult Foods:</b> Herbaceous Plants--Beans (Fabaceae)*, Clover, sweet ( <i>Melilotus</i> spp.)			
Miami blue	6-7	fields	All year
<b>Larval Foods:</b> Shrubs and Vines--Ballon vine ( <i>Cardiospermum</i> spp.)* <b>Adult Foods:</b> Herbaceous Plants--Marigold, bur or Spanish needle ( <i>Bidens pilosa</i> )*			

**Table 3.** Hairstreaks, Coppers, and Blue Butterflies

Key for Larval and Adult Foods: \* = non-native species; \*\* = non-native species, **not** recommended for planting because of its tendency to spread and adversely affect natural communities

Species of Butterfly	Regions	Habitats	Flight Season
Southern blue <b>Larval Foods:</b> Trees--Legumes (Fabaceae); Herbaceous Plants--Beans (Fabaceae); Partridge pea ( <i>Cassia fasciculata</i> ) <b>Adult Foods:</b> Herbaceous Plants--Marigold, bur or Spanish needle ( <i>Bidens pilosa</i> )* ; Other Adult Foods--Flowers, nonspecific	1	sandhills, beach	All year
Eastern tailed blue <b>Larval Foods:</b> Trees--Legumes (Fabaceae); Herbaceous Plants--Beans (Fabaceae); Clovers ( <i>Trifolium</i> spp.) <b>Adult Foods:</b> Other Adult Foods--Flowers, nonspecific, Mud	1-2	fields	Feb.-Nov.
Spring azure <b>Larval Foods:</b> Trees--Legumes (Fabaceae), Plums ( <i>Prunus</i> spp.); Shrubs and Vines--Blueberry ( <i>Vaccinium</i> spp.), Sumac, winged ( <i>Rhus copallina</i> ), Viburnum ( <i>Viburnum</i> spp.) <b>Adult Foods:</b> Herbaceous Plants--Milkweeds ( <i>Asclepias</i> spp.); Other Adult Foods--Flowers, nonspecific	1-2	hammocks, swamps	January-Oct.

**Table 4.** Metalmark Butterflies

Key for Larval and Adult Foods: \* = non-native species; \*\* = non-native species, **not** recommended for planting because of its tendency to spread and adversely affect natural communities

Species	Regions	Habitats	Flight Season
Little metalmark <b>Larval Foods:</b> Herbaceous Plants--Thistle, yellow ( <i>Cirsium horridulum</i> ) <b>Adult Foods:</b> Herbaceous Plants--Composites (Compositae)	1-7	sandhills, salt marsh, southern flatwoods	All year

**Table 5.** Snout Butterflies

Key for Larval and Adult Foods: \* = non-native species; \*\* = non-native species, **not** recommended for planting because of its tendency to spread and adversely affect natural communities

Species	Regions	Habitats	Flight Season
Snout butterfly <b>Larval Foods:</b> Trees--Hackberry ( <i>Celtis</i> spp.) <b>Adult Foods:</b> Herbaceous Plants--Asters (Asteraceae); Other Adult Foods--Flowers, nonspecific	1-7	wetlands, deciduous forests	January-August

**Table 6.** Brushfooted Butterflies

Key for Larval and Adult Foods: \* = non-native species; \*\* = non-native species, **not** recommended for planting because of its tendency to spread and adversely affect natural communities

Species	Region	Habitats	Flight Season
Gulf fritillary (Figure 3)	1-7	gardens, fields	All year
<b>Larval Foods:</b> Shrubs and Vines--Passion flower ( <i>Passiflora incarnata</i> )			
<b>Adult Foods:</b> Shrubs and Vines--Lantana ( <i>Lantana camara</i> ); Herbaceous Plants--Marigold, bur or Spanish needle ( <i>Bidens pilosa</i> )*			
Orange long wing	5-7	hammocks, fields, gardens	All year
<b>Larval Foods:</b> Shrubs and Vines--Maypops ( <i>Passiflora</i> spp.), Passion flower ( <i>Passiflora incarnata</i> )			
<b>Adult Foods:</b> Shrubs and Vines--Lantana ( <i>Lantana camara</i> ); Herbaceous Plants--Marigold, bur or Spanish needle ( <i>Bidens pilosa</i> )*			
Zebra long wing	1-7	hammocks, fields, gardens	All year
<b>Larval Foods:</b> Shrubs and Vines--Maypops ( <i>Passiflora</i> spp.), Passion flower ( <i>Passiflora incarnata</i> )			
<b>Adult Foods:</b> Shrubs and Vines--Lantana ( <i>Lantana camara</i> ); Herbaceous Plants--Marigold, bur or Spanish needle ( <i>Bidens pilosa</i> )*			
Variagated fritillary	1-7	open areas	March-Dec.
<b>Larval Foods:</b> Shrubs and Vines--Passion flower ( <i>Passiflora incarnata</i> ); Herbaceous Plants--Beggar's tick ( <i>Desmodium</i> spp.), Plantain ( <i>Plantago lanceolata</i> ), Spurge (Euphorbiaceae), Stonecrop ( <i>Sedum</i> spp.)			
<b>Adult Foods:</b> Other Adult Foods--Flowers, nonspecific			
Streamside checkerspot	Marianna	deciduous forests	March-Sept.
<b>Larval Foods:</b> Herbaceous Plants--Composites (Asteraceae)			
<b>Adult Foods:</b> Herbaceous Plants--Clover, red ( <i>Trifolium pratense</i> )*, Composites (Asteraceae), Milkweeds ( <i>Asclepias</i> spp.)			
Seminole crescent	1-3	wetlands	March-Nov.
<b>Larval Foods:</b> Herbaceous Plants--Alder, hazel ( <i>Alnus serrulata</i> ), Water willow ( <i>Justicia</i> spp.)			
<b>Adult Foods:</b> Unknown			
Black crescent	5-7	fields	All year
<b>Larval Foods:</b> Herbaceous Plants--Shrimp plant ( <i>Justicia brandegeana</i> )*			
<b>Adult Foods:</b> Unknown			
Mat plant crescent	1-7	swamps, bogs, marshes	March-Dec.
<b>Larval Foods:</b> Herbaceous Plants--Frog fruit ( <i>Lippia nodiflora</i> )			
<b>Adult Foods:</b> Herbaceous Plants--Composites (Compositae), Frog fruit ( <i>Lippia nodiflora</i> )			
Pearl crescent	1-6	swamps, fields, wetlands	All year
<b>Larval Foods:</b> Herbaceous Plants--Asters, smooth leaved (Asteraceae)			
<b>Adult Foods:</b> Herbaceous Plants--Composites (Compositae), Milkweeds ( <i>Asclepias</i> spp.)			
Question mark	1-4	deciduous forests, wetlands, orchards	All year
<b>Larval Foods:</b> Trees--Elms ( <i>Ulmus</i> spp.), Hackberry ( <i>Celtis</i> spp.), Mulberries ( <i>Morus</i> spp.); Herbaceous Plants--Parsley (Umbelliferae)*			
<b>Adult Foods:</b> Other Adult Foods--Carrion, Manure, Mud, Rotting fruit, Sap			
Comma angelwing	1-2	deciduous forests, wetlands, fields	May -Sept.
<b>Larval Foods:</b> Trees--Elms ( <i>Ulmus</i> spp.); Herbaceous Plants--Nettles (Urticaceae)			
<b>Adult Foods:</b> Other Adult Foods--Carrion, Mud, Rotting fruit, Sap			
Mourning cloak	Jacksonville, Tampa	deciduous forests, wetlands, gardens	Feb.-March
<b>Larval Foods:</b> Trees--Beech ( <i>Fagus</i> spp.), Elms ( <i>Ulmus</i> spp.), Hackberry ( <i>Celtis</i> spp.), Hollies ( <i>Ilex</i> spp.); Shrubs and Vines -Alder, hazel ( <i>Alnus serrulata</i> )			
<b>Adult Foods:</b> Other Adult Foods--Decaying plants, Flowers, non specific, Mud, Sap			
American painted lady (Figure 4)	1-7	open areas, gardens, wetlands, fields	All year

**Table 6.** Brushfooted Butterflies

Key for Larval and Adult Foods: \* = non-native species; \*\* = non-native species, **not** recommended for planting because of its tendency to spread and adversely affect natural communities

Species	Region	Habitats	Flight Season
<b>Larval Foods:</b> Herbaceous Plants--Asters, smooth leaved (Asteraceae), Mallows (Malvaceae), Thistle, yellow ( <i>Cirsium horridulum</i> ) <b>Adult Foods:</b> Other Adult Foods--Flowers, non specific, Mud			
Red admiral	1-7	deciduous forests, fields, gardens, riparian	All year
<b>Larval Foods:</b> Trees--Mulberries ( <i>Morus</i> spp.); Herbaceous Plants--False nettle ( <i>Boehmeria cylindrica</i> ), Nettles (Urticaceae) <b>Adult Foods:</b> Other Adult Foods--Bird droppings, Rotting fruit, Sap			
The buckeye	1-7	wetlands, fields, open areas	All year
<b>Larval Foods:</b> Herbaceous Plants--Acanthus (Acanthaceae), Plantain ( <i>Plantago lanceolata</i> ), Stonecrop ( <i>Sedum</i> spp.), Vervains (Verbenaceae) <b>Adult Foods:</b> Herbaceous Plants--Composites (Compositae)			
Black mangrove	5-7	mangrove swamps, tidal flats, fields	All year
<b>Larval Foods:</b> Trees--Mangrove, black ( <i>Avicennia germinans</i> ); Shrubs and Vines--Blue porterweed ( <i>Stachytarpheta</i> spp.); Herbaceous plants--Vervains (Verbenaceae) <b>Adult Foods:</b> Other Adult Foods--Flowers, nonspecific			
White peacock	2-7	swamps, wetlands	All year
<b>Larval Foods:</b> Herbaceous Plants--Figworts (Scrophulariaceae) <b>Adult Foods:</b> Herbaceous Plants--Marigold, bur or Spanish needle ( <i>Bidens pilosa</i> )*			
Malachite	5-7	Citrus groves, scrub	All year
<b>Larval Foods:</b> Herbaceous Plants--Cajetin ( <i>Blechnum brownei</i> ), Ruellia ( <i>Ruellia</i> spp.) <b>Adult Foods:</b> Other Adult Foods--Flowers, nonspecific, Manure, Rotting fruit			
Red spotted purple	1-3	sandhills, flatwoods, forest edges, hammocks	March-Oct.
<b>Larval Foods:</b> Trees--Apples ( <i>Malus</i> spp.), Cherries ( <i>Prunus</i> spp.), Leadwort, ornamental ( <i>Plumbago capensis</i> ), Willows ( <i>Salix</i> spp.) <b>Adult Foods:</b> Herbaceous Plants--Composites (Compositae); Other Adult Foods--Carrion, Manure, Rotting fruit, sap			
Viceroy	1-6	wetlands, marshes	April-Sept.
<b>Larval Foods:</b> Trees--Apples ( <i>Malus</i> spp.), Cherries ( <i>Prunus</i> spp.), Willows ( <i>Salix</i> spp.) <b>Adult Foods:</b> Other Adult Foods--Carrion, Manure			
Large purplewing	5-7	coastal hammocks	July-May
<b>Larval Foods:</b> Trees--Crabwood ( <i>Gymnanthes lucida</i> ) <b>Adult Foods:</b> Other Adult Foods--Manure, Mud, Rotting fruit, sap			
Dingy purplewing	5-7	hammocks	May-Dec.
<b>Larval Foods:</b> Trees--Gumbo limbo ( <i>Bursera simaruba</i> ) <b>Adult Foods:</b> Other Adult Foods--Manure, Mud, Rotting fruit, sap			
Red dagger wing	3-7	hammocks, swamps	All year
<b>Larval Foods:</b> Trees--Fig ( <i>Ficus</i> spp.), Short-leaf fig ( <i>Ficus citrifolia</i> ); Shrubs and Vines--Cashews ( <i>Anacardium occidentale</i> )* <b>Adult Foods:</b> Herbaceous Plants--Milkweeds ( <i>Asclepias</i> spp.); Other Adult Foods--Mud, Rotting fruit			

**Table 7. Goatweed Butterflies**

Key for Larval and Adult Foods: \* = non-native species; \*\* = non-native species, **not** recommended for planting because of its tendency to spread and adversely affect natural communities

Species	Regions	Habitats	Flight Season
Goatweed butterfly	1-3	swamps, forest edges, fields	April-August
<b>Larval Foods:</b> Shrubs and Vines--Croton ( <i>Croton</i> spp.), Croton, narrow leaved ( <i>Croton linearis</i> )			
<b>Adult Foods:</b> Other Adult Foods--Bird droppings, Manure, Rotting fruit, Sap			
Florida leafwing	6-7	forest edges, scrub	All year
<b>Larval Foods:</b> Shrubs and Vines--Croton, narrow leaved ( <i>Croton linearis</i> )			
<b>Adult Foods:</b> Other Adult Foods--Manure, Rotting fruit			
Hackberry butterfly	1-7	deciduous forests, riparian	March-Nov.
<b>Larval Foods:</b> Trees -Elms ( <i>Ulmus</i> spp.), Hackberry ( <i>Celtis</i> spp.)			
<b>Adult Foods:</b> Other Adult Foods--Carrion, Manure, Persimmons, Sap			
Tawny emperor	1-4	deciduous forests, riparian	March-Nov.
<b>Larval Foods:</b> Trees--Hackberry ( <i>Celtis</i> spp.)			
<b>Adult Foods:</b> Trees--Hackberry ( <i>Celtis</i> spp.); Other Adult Foods--Carrion, Manure, Rotting fruit, Sap			

**Table 8. Nymphs and Satyrs**

Key for Larval and Adult Foods: \* = non-native species; \*\* = non-native species, **not** recommended for planting because of its tendency to spread and adversely affect natural communities

Species	Regions	Habitats	Flight Season
Southern pearly eye	1-3	hammocks, wetlands	April-Nov.
<b>Larval Foods:</b> Grasses--Switch cane ( <i>Arundinaria gigantea</i> ), Grasses (Poaceae), Maidencane ( <i>Panicum hemitomom</i> )			
<b>Adult Foods:</b> Other Adult Foods--Carrion, Manure, Rotting fruit, Sap			
Woods eyed brown	1	swamps, bogs, wetlands	June-Oct.
<b>Larval Foods:</b> Grasses--Inundated beak-rush ( <i>Rhynchospora inundata</i> )*			
<b>Adult Foods:</b> Other Adult Foods--Mud, Sap			
Jeweled satyr	1-3	tall grass fields, wetlands	Feb.-Nov.
<b>Larval Foods:</b> Grasses--Bermuda grass ( <i>Cynodon dactylon</i> )*			
<b>Adult Foods:</b> Unknown			
Southern satyr	1-6	fields, hammocks, wetlands	All year
<b>Larval Foods:</b> Grasses--Grasses (Poaceae)			
<b>Adult Foods:</b> Other Adult Foods--Rotting fruit, Sap			
Orange oval satyr	1-7	fields, sandhills, flatwoods	All year
<b>Larval Foods:</b> Grasses--Grasses (Poaceae)			
<b>Adult Foods:</b> Unknown			
Little wood satyr	1-2	fields, hammocks, wetlands	March-June
<b>Larval Foods:</b> Grasses--Grasses (Poaceae), Sedges (Cyperaceae)			
<b>Adult Foods:</b> Other Adult Foods--Aphid honeydew, Sap			
Viola's wood satyr	1-3	grassy wooded areas	April
<b>Larval Foods:</b> Grasses--Grasses (Poaceae)			
<b>Adult Foods:</b> Unknown			
Common wood nymph	1-3	sandhills, fields, marshes, wetlands	June-July
<b>Larval Foods:</b> Grasses--Grasses (Poaceae)			
<b>Adult Foods:</b> Other Adult Foods--Rotting fruit			

**Table 9.** Milkweed Butterflies

Key for Larval and Adult Foods: \* = non-native species; \*\* = non-native species, **not** recommended for planting because of its tendency to spread and adversely affect natural communities

Species	Regions	Habitats	Flight Season
Monarch	1-7	fields, gardens	All year
<b>Larval Foods:</b> Herbaceous Plants--Indian hemp ( <i>Apocynum cannabinum</i> ), Milkweed, scarlet ( <i>Asclepias curassavica</i> )* <b>Adult Foods:</b> Herbaceous Plants--Composites (Compositae), Milkweeds ( <i>Asclepias</i> spp.)			
Queen	1-7	fields, sandhills, flatwoods	All year
<b>Larval Foods:</b> Shrubs and Vines--Oleander ( <i>Nerium oleander</i> ), White vine ( <i>Sarcostemma clausum</i> )*; Herbaceous Plants--Milkweeds ( <i>Asclepias</i> spp.) <b>Adult Foods:</b> Herbaceous Plants--Frog fruit ( <i>Lippia nodiflora</i> ); Milkweeds ( <i>Asclepias</i> spp.)			
Soldier	5-7	sandhills, flatwoods, fields, gardens	Feb.-Oct.
<b>Larval Foods:</b> Shrubs and Vines--White vine ( <i>Sarcostemma clausum</i> )*; Herbaceous Plants--Milkweeds ( <i>Asclepias</i> spp.), West Indian pinkroot ( <i>Spigelia anthelmia</i> ) <b>Adult Foods:</b> Other Adult Foods--Flowers, nonspecific			

**Table 10.** Butterfly Nectar Plants. North and Central Florida: Regions 1-4.

\* indicates non-native species

Common Name	Scientific Name	Flowering Season
<b>SHRUBS</b>		
False indigo bush*	<i>Amorpha fruticosa</i>	Summer-Fall
Tarflower	<i>Befaria racemosa</i>	Summer
Butterfly bush*	<i>Buddleia officianalis</i>	Spring-Fall
New Jersey tea	<i>Ceanothus americanus</i>	Spring
False heather	<i>Cuphea hyssopifolia</i>	Spring-Winter
Garberia	<i>Garberia fruticosa</i>	Fall
Hibiscus	<i>Hibiscus</i> spp.	Spring-Winter
Lantana	<i>Lantana</i> spp.	Spring-Winter
Plumbago*	<i>Plumbago capensis</i>	Spring-Fall
Azalea	<i>Rhododendron</i> spp.	Spring
Viburnum	<i>Viburnum</i> spp.	Spring
<b>PERENNIALS</b>		
Butterfly milkweed	<i>Asclepias tuberosa</i>	Summer-Fall
Aster	<i>Aster</i> spp.	Summer-Fall
Paint brush	<i>Carphephorus corymbosus</i>	Fall
Vanilla plant	<i>Carphephorus odoratissimus</i>	Fall
Golden aster	<i>Chrysopsis</i> spp.	Fall
Dalea	<i>Dalea</i> spp.	Fall
Purple coneflower	<i>Echinacea purpurea</i>	Summer
Mistflower	<i>Eupatorium coelestinum</i>	Summer-Fall
Sunflower	<i>Helianthus</i> spp.	Summer-Fall
Blazing star	<i>Liatris</i> spp.	Summer-Fall
Cardinal flower	<i>Lobelia cardinalis</i>	Summer-Fall
Purple lobelia	<i>Lobelia puberula</i>	Summer-Fall
Mint*	<i>Mentha, Nepeta</i> , others	Spring-Fall
Pentas*	<i>Pentas lanceolata</i>	Spring-Fall
Phlox	<i>Phlox</i> spp.	Spring-Summer
Pennyroyal	<i>Piloblephis rigida</i>	Spring
Yellow coneflower	<i>Ratibida pinnata</i>	Summer



**Table 10.** Butterfly Nectar Plants. North and Central Florida: Regions 1-4.

\* indicates non-native species

Common Name	Scientific Name	Flowering Season
Wild petunia	<i>Ruellia caroliniensis</i>	Spring-Fall
Salvia (Sage)	<i>Salvia</i> spp.	Summer-Fall
Sedum	<i>Sedum spectabile</i>	Fall-Winter
Rosinweed	<i>Silphium asteriscus</i>	Summer-Fall
Goldenrod	<i>Solidago</i> spp.	Summer-Fall
Stoke's aster	<i>Stokesia laevis</i>	Summer
Thyme*	<i>Thymus</i> spp.	Spring-Fall
Verbena	<i>Verbena</i> spp.	Spring-Fall
Ironweed	<i>Vernonia</i> spp.	Summer
<b>ANNUALS</b>		
Ageratum*	<i>Ageratum</i> spp.	Spring-Summer
Spanish needle	<i>Bidens pilosa</i>	Spring-Fall
Borage*	<i>Borage officinalis</i>	Summer-Fall
Shasta daisy*	<i>Chrysanthemum</i> spp.	Spring-Summer
Sweet William*	<i>Dianthus</i> spp.	Spring-Summer
Gaillardia	<i>Gaillardia pulchella</i>	Spring-Summer
Strawflower*	<i>Helichrysum</i> spp.	Spring-Summer
Phlox	<i>Phlox drummondii</i>	Summer
Black-eyed Susan	<i>Rudbeckia hirta</i>	Summer-Fall
Marigold (Marietta)*	<i>Tagetes</i> spp.	Summer-Fall
Clover	<i>Trifolium</i> spp.	Summer-Fall
Zinnia*	<i>Zinnia</i> spp.	Summer-Fall

**Table 11.** Butterfly Nectar Plants. South Florida: Regions 5-7.

\* indicates non-native species

Common Name	Scientific Name	Flowering Season
<b>TREES</b>		
Bottlebrush*	<i>Callistemon</i> spp.	Summer-Fall
Citrus*	<i>Citrus</i> spp.	Spring
<b>SHRUBS</b>		
Buttonbush	<i>Cephalanthus occidentalis</i>	Summer
Geiger tree	<i>Cordia</i> spp.	Summer-Winter
Firebush	<i>Hamelia patens</i>	Summer-Winter
Lantana	<i>Lantana</i> spp.	Spring-Winter
<b>PERENNIALS</b>		
Scarlet milkweed*	<i>Asclepias curassavica</i>	Summer-Fall
Florida or Blue sage	<i>Eranthemum nervosum</i>	Summer-Fall
Mistflower	<i>Eupatorium coelestinum</i>	Summer-Fall
Blazing star	<i>Liatris</i> spp.	Summer-Fall
Pentas*	<i>Pentas lanceolata</i>	Summer-Fall
Pennyroyal	<i>Piloblephis rigida</i>	Spring
<b>ANNUALS</b>		
Beggar-ticks	<i>Bidens alba</i>	Summer-Fall
Red root	<i>Lachnanthes caroliniana</i>	Summer
Frog fruit	<i>Lippia nodiflora</i>	Spring-Fall



## Hummingbirds of Florida<sup>1</sup>

Joe Schaefer and Craig N. Huegel<sup>2</sup>

Centuries ago their plumage was used to adorn Indian ceremonial costumes. Even today, some people believe that the hummingbird's glittering plumage contains mythical powers. However, most of us merely enjoy watching these sparkling gems of the bird world.

### DESCRIPTION

Hummingbirds live only in the Americas. Of the 338 species known, 16 are found in the United States and 3 occur in Florida. Black-chinned and rufous hummingbirds occasionally can be seen in Florida during the winter. The ruby-throated hummingbird is by far the most common hummer in the state. This feathered jewel is about 3 inches (7.5 centimeters) long and weighs as little as a penny ( 1/4 ounce). Its name describes the most brilliant part of the mature male's plumage. The throat feathers contain air bubbles that give off an iridescent red tone in full light. Both sexes, young and mature birds, have metallic green backs and white-tipped tail feathers.

### RANGE

The ruby-throat's breeding range extends from central Kansas to the east coast and from Saskatchewan to central Florida. Although, some



**ruby-throated hummingbird.**

birds may stay in south Florida year-round, most winter in Mexico and South America. Males arrive in Florida in March. Females follow them about a week later.

### NESTING

Nesting in Florida begins in April. The nest is a walnut-size structure of plant down, adorned with lichens, moss, and bound with spider webs or fine plant fibers. Nests frequently are built over water. The female lays 2 eggs less than 1/2 inch (1.2 centimeters) long. After 20 days of incubation and 4 weeks of growing, young hummingbirds leave the nest.

1. This document is Fact Sheet SS-WIS-21, one of a series of the Department of Wildlife Ecology & Conservation, Florida Cooperative Extension Service, Institute of Food and Agricultural Sciences, University of Florida. Originally published in cooperation with the Florida Fish and Wildlife Conservation Commission's Nongame Wildlife Program. Published December, 1990 as "Florida's Hummingbirds". Reviewed: February, 2001. Minor Revisions: July, 2001. Please visit the Edis Web site at <http://edis.ifas.ufl.edu>

2. Joe Schaefer, urban wildlife extension specialist; Craig N. Huegel, former urban wildlife extension specialist, Wildlife and Range Sciences Department, Cooperative Extension Service, Institute of Food and Agricultural Sciences, University of Florida, Gainesville FL 32611-0304.

## FLYING FEATS

One of the most fascinating things about hummingbirds is their helicopter-like flying stunts. Not only can hummers suspend their bodies in midair as shown in Figure 1, they also can fly backward, upward, even upside down. These maneuvers are possible because of a unique design that allows the wing to move very freely and in almost any direction at the shoulder. Soaring is the only maneuver they can not perform. Contrary to popular belief, hummingbirds do not hum. The sound is made by their rapid wing movements (50-200 beats per second).

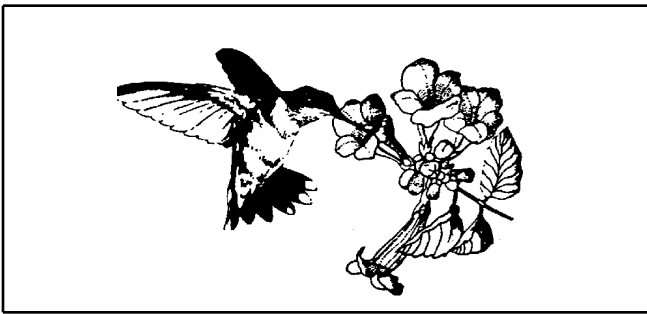

Figure 1.

## FEEDING

To acquire enough strength to support all of this high speed activity, hummingbirds need to consume large amounts of high energy food. Adult hummingbirds feed primarily on nectar. Young are fed insects by their parents, but are switched to a mostly nectar diet by the time they leave the nest. Nectar is an energy-rich food that is used rapidly. One hummingbird may need nectar from hundreds of blossoms every day to maintain its body weight.

Hummingbirds are well adapted to a liquid diet. Long needlelike bills and specially adapted tongues allow them to reach nectar in deep tubular flowers (Figure 1). The last half-inch of the long tongue is divided into equal halves, each grooved on the outside edge to form two tube-like structures. Nectar is drawn into the tongue much the same way liquid travels up a straw. Hummingbirds can lick at a rate of 13 times per second, and their stomach is capable of holding about 0.18 ounces (5 grams) of nectar at one time. They also feed to a lesser extent on insects.

For their size, hummingbirds have among the largest appetites in the bird world. They feed every 10 or 15 minutes from dawn until dusk. During this period, they eat more than half their weight in food and 8 times their weight in water. Hummingbirds have developed 2 adaptations to help them survive the hours of darkness when they cannot feed. First, they eat as much as they can just before dark. During the night, their heart rate and body temperature drop to conserve energy. If they did not go into this sort of daily hibernation stage, they likely would starve.

## ARTIFICIAL FEEDERS

Artificial feeders will attract hummingbirds. Because feeders can be placed almost anywhere, they increase your opportunities to view hummers from inside your house. However, feeders should not be the sole source of food provided. The sugar solution may appeal to the hummingbirds' sweet tooth, but it provides little nourishment. Nectar is much more than just water and sugar.

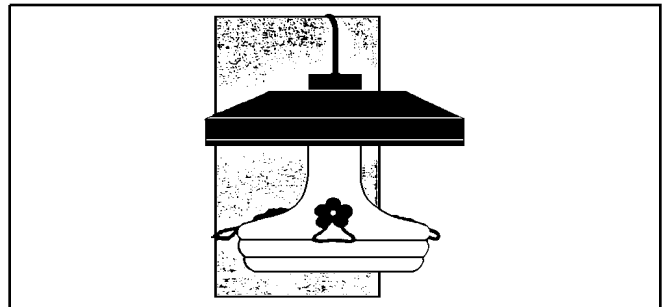

Artificial feeders.

Packages of instant nectar may be found at many lawn and garden stores. You also can prepare your own solution with 1 part white, granulated, cane sugar to 4 parts water. Boil the sugar solution to help dissolve the sugar. Then allow it to cool before filling a feeder. This concentration is about the same as that in wildflower nectar. Using a sweeter solution, sugar substitutes or honey could be lethal to hummers. It also is not necessary to add red food coloring. The birds will be attracted to the red feeders.

Several different feeder styles are available. The ones with perches are not necessary, but they do provide an unusual view of this bird without its wings beating rapidly. The upside-down jar-and-tube feeders have a tendency to leak.

Most feeders come with bee guards (Figure 2). Although hummingbirds will feed right next to bees, clusters of these insects will keep them away. If ants are attracted, moisten the hanging wire with cooking oil.

Hummingbirds are very possessive of feeders and usually will not tolerate another bird feeding from the same feeder at the same time. The less dominant ones just wait their turn. Juveniles are a bit more sociable than adults. If you are using more than 1 feeder, arrange them at least 10 feet apart so that all can feed peacefully at once.

Place the feeder where rain will not dilute nectar in the end of the tube. Also avoid direct sunlight as heat stimulates bacterial growth.

Sugar solutions must be kept fresh. Florida's hot weather can cause rapid bacterial growth in these feeders and birds that drink contaminated water could die. To avoid this, change the solution every 3-5 days. Clean the feeders with hot water and white vinegar. Do not use soap or chlorine bleach (Clorox™).

## GARDENING FOR HUMMINGBIRDS

To be successful in keeping hummingbirds around your house, you must garden for them. The ideal flower color is red, orange, or pink. Hummingbirds are not born with an attraction to certain colors but learn by trial and error which flowers give the best results. Because most nectar-bearing flowers within the range of the ruby-throat are red and orange, they quickly come to favor those colors. Hummingbirds also have been known to show an interest in red-colored lipstick, fingernails, and clothing.

Tubular flowers that are either large and solitary or in loose drooping clusters are best. Generally, tubular flowers hold large amounts of nectar at their base.

Blooming season is another important gardening consideration. Nesting hummingbirds will need nectar from March to September. Therefore, your garden should have numerous nectar plants available throughout this time. It is best to plant a variety of

species and to arrange these flowers in several groupings. Nesting hummingbirds are very aggressive and territorial around their food source. Having more than one flower garden will allow several hummers to feed at the same time without conflict.

## HUMMINGBIRD PLANTS

Certain plants are among the favorites used by hummingbirds in north and central Florida:

Table 1. Hummingbird Plants - Trees

Table 2. Hummingbird Plants - Shrubs

Table 3. Hummingbird Plants - Vines

Table 4. Hummingbird Plants - Perennials

Table 5. Hummingbird Plants - Annuals

While red flowers dominate the list, others have been added to allow for a varied planting. Plants native to Florida often are preferable when given the proper growing conditions for the species.

**Table 1.**

<b>Table 1. Hummingbird Plants - Trees.</b>			
Common Name	Adaptability to area	Scientific Name	Blooming Season
Red Buckeye	Native species; not recommended for S. Florida	<i>Aesculus pavia</i>	Spring
Mimosa	---	<i>Albizia julibrissin</i>	Spring
Bottlebrush	---	<i>Callistemon</i> spp.	Spring-Fall

**Table 2.**

<b>Table 2. Hummingbird Plants - Shrubs.</b>			
Common Name	Adaptability to area	Scientific Name	Blooming Season
Butterfly Bush	Used as annual and perennial in Florida	<i>Buddleia alternifolia</i>	Summer
Coral Bean	Native Species	<i>Erythrina herbacea</i>	Spring
Firebush	Native Species; will return from roots in cold areas	<i>Hamelia patens</i>	Spring-Winter
Red Star Hibiscus	Native Species	<i>Hibiscus coccineus</i>	Summer-Fall
Lantana	Native Species	<i>Lantana camara</i>	Spring-Winter
Firespike	Frost sensitive but will return in the spring	<i>Odontonema stricta</i>	Summer-Fall
Cardinal's Guard	Not recommended for N. Florida	<i>Pachystachys coccinea</i>	Summer-Fall
Wild Azalea	Native species	<i>Rhododendron</i> spp.	Spring-Summer

**Table 3.**

<b>Table 3. Hummingbird Plants - Vines.</b>			
Common Name	Adaptability to Region	Scientific Name	Blooming Season

**Table 3.**

<b>Table 3. Hummingbird Plants - Vines.</b>			
Cross Vine	Native species	<i>Bignonia capreolata</i>	Spring
Trumpet Vine	Native Species	<i>Campsis radicans</i>	Spring-Summer
Coral Honeysuckle	Native species	<i>Lonicera sempervirens</i>	Spring-Summer

**Table 4.**

<b>Table 4. Hummingbird Plants - Perennials.</b>			
Common Name	Adaptability to Region	Scientific Name	Blooming Season
Butterfly Milkweed	Native Species	<i>Asclepius tuberosa</i>	Spring-Fall
Red Basil	Native Species	<i>Calamintha coccinea</i>	Spring
Shrimp Plant	Used as an annual in Florida	<i>Justicia brandegeana</i>	Spring-Summer
Cardinal Flower	Native Species	<i>Lobelia cardinalis</i>	Summer-Fall
Obedient Plant	Native Species	<i>Physostegia</i> spp.	Summer-Fall

**Table 5.**

<b>Table 5. Hummingbird Plants - Annuals.</b>			
Common Name	Adaptability to Region	Scientific Name	Blooming Season
Scarlet Morning Glory	Native Species	<i>Ipomea coccinea</i>	Summer-Fall
Cypress Vine	Native Species	<i>Ipomea quamoclit</i>	Summer-Fall
Standing Cypress	Native Species	<i>Ipomopsis rubra</i>	Summer
Four O'Clock	Not recommended for S. Florida	<i>Mirabilis jalapa</i>	Fall



## Bats: Information for the Florida Homeowner<sup>1</sup>

Amy K. Taylor, Frank J. Mazzotti, and Craig N. Huegel<sup>2</sup>

### Background

Bats are an essential link in the balance of nature. In Florida, bats provide a valuable service by consuming mosquitoes and other night-flying insects--while posing little threat to human health. Curiously, bats have been feared and maligned by man since the Dark Ages. Some of this fear comes from the misconception that most bats carry rabies when, in fact, less than 1/2 of 1 percent carry the disease. There is no evidence that widespread destruction of bats or their roosts has reduced the already low health hazard. Bat control should be done by excluding entry into buildings, not by killing bats.

### About Bats

Some people wrongly believe bats are flying mice. In fact, bats form a separate and distinguishable group of mammals more closely related to moles, shrews, and even monkeys than to rodents. Bats are the only flying mammals, and, except for certain unique features, their anatomy is similar to that of most other mammals.

Bat's wings are very different from those of birds, and built upon the same general pattern as the limbs of other mammals. The wing is composed of an upper arm, forearm, wrist, and hand with thumb and four fingers. The hand and fingers are greatly elongated in order to spread and control the wing. The hind limbs of the bat are attached at the hip in reverse, pointing the knees backward. This arrangement is thought to facilitate the bat's ability to alight upside down and hang by its toes.

Bats occur worldwide. Of the approximately 850 species of bats only 39 occur in the United States and of those, 17 occur in Florida. (For details on specific species see "A Checklist of Florida's Mammals", Florida Game and Fresh Water Fish Commission (GFC).)

Florida bats are highly beneficial because they consume tremendous numbers of night-flying insects, including mosquitoes. Bats locate insects at night using a very sophisticated sonar system (echolocation), emitting supersonic sounds and listening for echoes. Bats are most frequently seen on warm nights feeding over bodies of water, around buildings or forest edges, or around lights. During the day, bats find shelter in a variety of secluded places, preferring small, dark, poorly ventilated spaces that heat up during the day. Tree cavities, snags, and especially unpruned cabbage palms are important roost sites. Due to increasing urbanization, the number of these natural roosting sites has been reduced and window shutters, drain pipes, billboards, roof tiles, and attics have become popular roosting site substitutes.

### Bats in the home

The presence of a bat in the home may be a sign that the house is not weather-tight. If so, take appropriate measures to locate openings and seal them. The best way to remove a single bat from the home is not to panic, but simply open a window in the room. The bat usually will circle the room, using its sonar, until it detects the open window and flies out on its own. If possible, stay in the room with the lights on and make sure the bat leaves.

1. This document is WEC-32, one of a series of the Wildlife Ecology and Conservation department, Florida Cooperative Extension Service, Institute of Food and Agricultural Sciences, University of Florida. Published: June, 1991. Reviewed: January, 1999. Please visit the EDIS Web site at <http://edis.ifas.ufl.edu>
2. Amy K. Taylor, former undergraduate assistant; Frank J. Mazzotti, Ph.D., associate professor, Wildlife Ecology and Conservation department, University of Florida, Everglades REC, Belle Glade, FL 33430, and Craig N. Huegel, former assistant extension scientist, Pinellas County, Cooperative Extension Service, Institute of Food and Agricultural Sciences, University of Florida, Gainesville, 32611.

The Institute of Food and Agricultural Sciences is an equal opportunity/affirmative action employer authorized to provide research, educational information and other services only to individuals and institutions that function without regard to race, color, sex, age, handicap, or national origin. For information on obtaining other extension publications, contact your county Cooperative Extension Service office. Florida Cooperative Extension Service / Institute of Food and Agricultural Sciences / University of Florida / Christine Taylor Waddill, Dean

This should only take a few minutes. Another method is to use leather gloves and simply pick up the bat. *Never handle a bat with bare hands because it may try to bite to protect itself.*

If the bat “disappears” in the room, it probably has landed behind a curtain or in some hidden nook. In this case: open a window, turn off the lights, close the door

behind you, and isolate the bat by blocking the space under the door with a towel. The bat should find its way out within an hour after dark as long as the weather is not too cold. One or two bats in the home may mean only that they came in through an open window. However, their presence could be a sign that a colony of bats has established a roost in a crawl space or attic. An

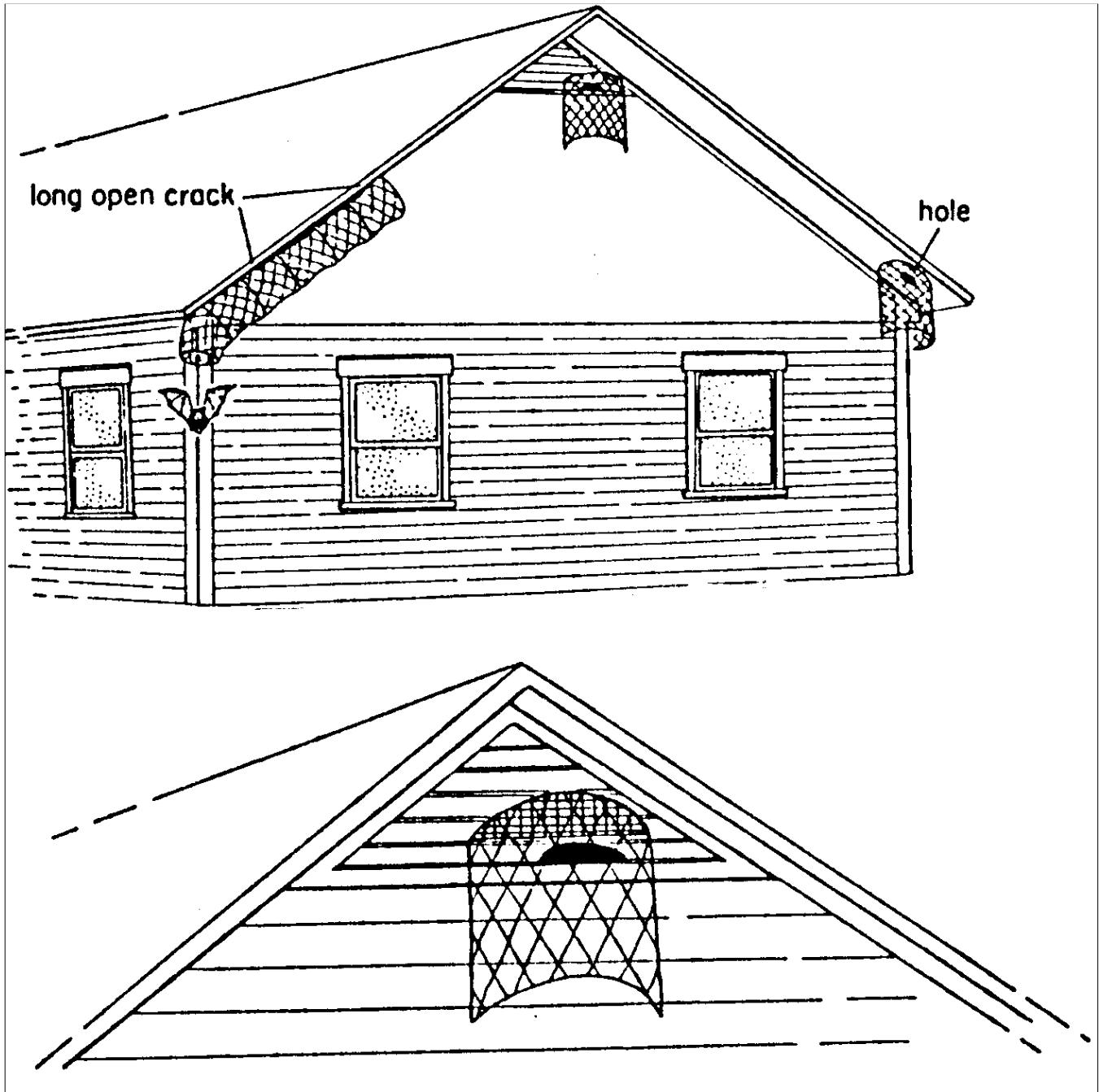

**Figure 1.** Enclose top and sides of entrances with nylon netting or wire screening, with an opening 2' below the entrance.



obvious sign that a bat colony has taken up residence is when bats are observed flying in and out of a hole in the house. If they become a nuisance, the only long-term solution is to bat proof the building (Figure 1).

## Bat Control Methods

In light of bats' beneficial feeding habits, give careful consideration before implementing any control measures. Pesticides, pollution, people, and habitat loss have reduced bat populations significantly. That is why non-lethal control measures are recommended.

### Exclusion Method

The only permanent way to get rid of a bat colony is to exclude them from the building by plugging their entrance holes (bat proofing). Figure 1 shows a bat-proofed building. Locating the entrance way(s) to a bat colony is the most important step before implementing an eviction plan. Time of year is an important factor. Spring, fall and winter are the best times to exclude bats in Florida. Bats will hibernate during winter in cold weather climates. If you live in the northern one-third of the state, wait till after early January to exclude bats and seal openings. The worst time? From the first of April to approximately the third week in July, bats form nursing colonies. Exclusionary measures taken at this time would create major problems. There is a high probability that lactating mothers and their young are present. Young bats, not yet able to fly, remain in the roost. Sealing entrance ways would trap many of the bats, separating mothers from their young and leaving the young bats to die. The odor from dead bats is extremely offensive. It also may attract other bats in the area, increasing bat activity even more. Any adults trapped inside would try to locate other exits increasing the possibility of contact with humans.

To remove a bat colony, locate where the bats are entering or exiting. Since bats leave their roost shortly after sunset, watch the outside of the house from 30 minutes before sunset until 30 minutes after. Bats may enter and exit through an unscreened attic vent, a chimney, and cracks or openings along eaves, window sills, and siding. *Note: Bats do not need an opening they can fly through. A crack only 3/8" wide will admit bats.*

Once all entrances have been located, seal all but the primary entrance. Next install a one-way door over the entrance as shown in Figure 1. Wait three or four nights, and if bats are no longer seen leaving the building, seal the remaining hole. If all the holes have been sealed, there will be no further problems.

Cracks, separations, or other openings should be repaired as soon as they are noticed. Keeping the house weather-tight and energy efficient is the best way to prevent bat problems from recurring.

### Methods of habitat manipulation

#### *Artificial Light*

Since bats prefer dark spaces, artificial light can be used quite successfully, but only if the light is kept on continuously and moved regularly. Otherwise, the bats will soon find dark corners to avoid the light. This method also may cause bats to move deeper into the house as they avoid the light, making them more likely to enter living areas and come into contact with people.

#### *Repellents*

Although a number of methods have been devised to repel bats, this approach is only a temporary solution. Naphthalene (mothball) flakes can be applied to the area of infestation. As long as a strong odor remains, bats may not return. The effects will not last long and repeated applications are required to deter bat re-entry. Ammonia can be used to clean areas infested by bats. Pans of the solution then can be placed in a former roost to act as a repellent. Neither of these methods will be successful as long as bats can reenter the habitat once the odor has begun to fade. The strong odor is also offensive to humans and repeated applications may not be a tolerable long-term solution. Repellents are not as effective as simply waiting for the bat's normal departure at dusk and taking appropriate exclusionary measures.

#### *Fumigants*

There are serious disadvantages to the use of fumigants against bats. The results are not permanent, and the building may be recolonized at a later time. Also, poisons used in the extermination of bats may cause an increase in human or pet contact with bats as sickened bats fall to the ground and slowly die. Even if fumigation quickly killed all bats present, it would provide only a very temporary solution at best. Other bats could safely move in within just 2 days unless entry holes are plugged—a solution that would negate the need for fumigation. If fumigation killed a significant number of bats within the walls of a home, a serious odor problem would result. Simple exclusion after the bats' nightly departure is a far preferable solution.

A fumigant can be considered for bat control only in a real public health emergency under the authority of a special permit issued by the Florida Game and Fresh Water Fish Commission and only after all other feasible methods of exclusion and removal have failed.

### Ultrasonics

Ultrasonic repellents are ineffective as a deterrent against an animal that uses ultrasound waves in many aspects of its life. They may actually attract bats.

## Bat Conservation

Bat populations are on the decline throughout the United States. Loss of habitat due to the disturbance of natural and man-made roosting sites in buildings, old trees, and caves is a major factor in this decline. Another factor is active and persistent persecution by people not aware of the bat's gentle nature and beneficial activities.

Once bats have been excluded from one habitat it is often possible to provide alternative habitats. Uncut woodlots, snags, and viable wetlands with open water are important bat habitats. In particular, cabbage palm left unpruned is tremendously valuable as a home for bats. Also, you can build a bat house (Figure 2).

### How to Build a Bat House

This bat house designed by Bat Conservation International (Figure 2) combines relative ease of construction with the varied crevice sizes most often used by American bats, and temperature buffering features. Western red cedar is recommended for its ability to withstand outdoor exposure, though many other woods are suitable. Six feet of 1x12in board and 10ft of 1x10in board are sufficient for construction. (Actual board sizes normally are about 3/4x9-1/4in.)

Dimensions may be varied to allow for slight differences in board widths or personal preferences, but spacing between partitions should remain approximately the same. Use rough lumber and turn all rough sides inward. The rough side of the ceiling should face down. Cut 1/16in horizontal grooves at 1/2in intervals on the smooth sides of all partitions. This enables bat climbing and roosting. Apply a bead of silicon caulk along each exterior joint to prevent heat loss. The estimated cost of materials is less than \$20, and a single house may be occupied by 100 or more bats.

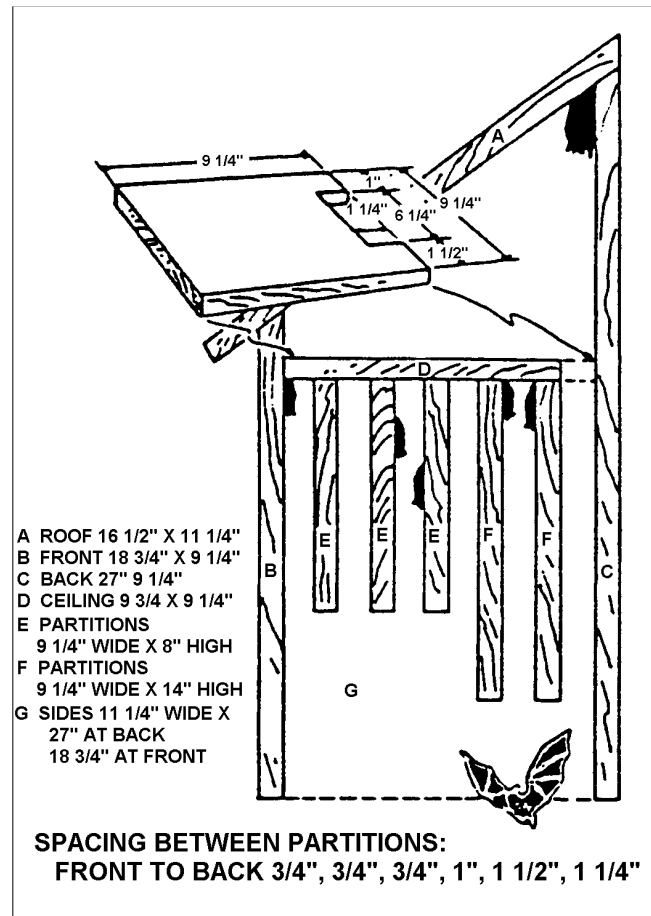

Figure 2. Bat house designed by Bat Conservation Intern'l.

Notes: Do not let the space between inner partitions exceed 1in.

When house is completed, hang it 12-15ft above the ground on a tree trunk or side of a building facing south or southeast so it catches the morning sun, but is in the shade during mid-day.

Provide a watering station or locate your bat house near a natural water source to increase your chance of attracting bats.

## Suggested Reading

### For Bat Problems:

Timm, R.M. (ed.). 1983. Prevention and Control of Wildlife Damage. Nebraska Coop. Exten. Serv., Univ. Nebraska-Lincoln, NE.

French, T.W., J.E. Cardoza, and G.S. Jones. 1986. A Homeowner's Guide to Massachusetts Bats and Bat Problems. Div. Fisheries & Wildlife, Commonw. of Massachusetts, Boston, MA.

### For Natural History:

Barbour, R.W. and W.H. Davis. 1969. *Bats of America*. Univ. Press of Kentucky, Lexington, KY.



Cooperative Extension Service  
Institute of Food and Agricultural Sciences

## Impacts of Free-ranging Pets on Wildlife<sup>1</sup>

Joe Schaefer<sup>2</sup>

### Overview

Cats and dogs are domesticated predators. They have natural prey-chasing, capturing, and killing instincts. As a result of this and the large numbers of them in Florida, cats and dogs have the potential to severely impact local wildlife populations. In addition to reducing populations of species and limiting the number of prey items for native predators, free-ranging pets can cause other problems. For example, they serve as important reservoirs for human and wildlife diseases like ringworm, *toxoplasmosis*, *leptospirosis*, distemper, and rabies. They may be an important factor in introducing these diseases into susceptible wildlife populations.

Dogs kill turtles and other wildlife. My own Australian silky terrier killed a young blue jay, and several frogs and lizards in my backyard. Exotic snakes and other pet predators can also have local impacts if released into the wild. But the pet that is by far the most devastating on wildlife populations is the furry feline. While a few species such as great horned owls and coyotes may think of cats as delicacies, many wildlife populations are threatened by "outside" cats that are allowed to range freely.

The instinctive hunting and killing behavior of cats is extensively documented. Unlike wild predators that kill to eat, cats kill impulsively even when they are not hungry. Animals that nest or feed on or close to the ground such as cardinals, bobwhites, towhees, wrens, rabbits, and lizards are most susceptible. At least part of the population declines experienced by Florida's endangered beach mice are due to domestic cat

predation. A Michigan study provided some insight into the impact of a single cat on local prey. During an 18-month period, one well-fed, domestic farm cat killed at least 60 birds and 1,600 small mammals. A study in England estimated that over a million birds are killed each year there by free-ranging cats.

Although it is impossible to determine the extent of this problem in Florida, estimates are astounding. Several thousand stray cats are picked up by county animal control departments in Florida each month (for example, Orange County averages almost 670/month). If each cat killed only one animal each month, tens-of-thousands of animals would be killed each year here. This is a conservative estimate, because studies have shown that cats kill more than one animal per month (almost 100 were killed each month by the cat in the Michigan study), and we really do not know what percentage of all free-ranging cats are picked up by animal control departments.

### Solutions

Dr. H.W. Kale, II and David Maehr recommend actions in their book, *Florida's Birds*, that you can take to reduce the chances of cats' sneaking up undetected on wildlife on your property:

- Do not place a bird feeder or bath immediately next to dense shrubbery or other cat hiding places.
- If you own an outside cat, place two bells on its collar--some cats can learn to adjust their moves to silence a single bell.

1. This document is WEC-136, one of a series of the Department of Wildlife Ecology and Conservation], Florida Cooperative Extension Service, Institute of Food and Agricultural Sciences, University of Florida. Publication: December 1991, as SS-WIS-52. Reviewed, and renumbered, August 1999. Please visit the EDIS Web site at <http://edis.ifas.ufl.edu>.

2. Joe Schaefer, Ph.D., professor, Director, Center for Natural Resources, Florida Cooperative Extension Service, Institute of Food and Agricultural Sciences, University of Florida, Gainesville, 32611. Agricultural Sciences, University of Florida, Gainesville, 32611.

The Institute of Food and Agricultural Sciences is an equal opportunity/affirmative action employer authorized to provide research, educational information and other services only to individuals and institutions that function without regard to race, color, sex, age, handicap, or national origin. For information on obtaining other extension publications, contact your county Cooperative Extension Service office. Florida Cooperative Extension Service / Institute of Food and Agricultural Sciences / University of Florida / Christine Taylor Waddill, Dean

- Do not let your cat roam at night when they can be much more effective predators on sleeping prey.
- If you are having problems with a neighbor's cat, speak to the neighbor about the problem and see what can be worked out.
- Cats hate water, so you may be able to discourage a cat from entering your yard by spraying it several times with a garden hose.
- If the cat is an untagged stray or feral, trap it with a live trap (the raccoon-type trap) then turn it over to the local animal control office or Humane Society.

The best solution to the problem of predatory cats and dogs is responsible pet ownership including: spaying and neutering, as well as confining. Responsible pet owners are also concerned about the potential dangers that their free-ranging pets may encounter: death by vehicles; diseases transmitted by wildlife and other pets; death by wildlife predators; injury from fights with other dogs and cats; and the various animal control practices used by unhappy neighbors.

### **Suggested Reading**

Kale, II, H.W. and D.S. Maehr. 1990. *Florida's Birds*. P. 250. Pineapple Press, Inc. City, FL 288 pp.

## Dealing with Snakes in Florida's Residential Areas - Identifying Commonly Encountered Snakes<sup>1</sup>

---

Steve A. Johnson and Monica E. McGarrity<sup>2</sup>

Florida's native snake species play important roles in the environment, serving as prey for many native birds and helping to regulate amphibian and rodent populations. Considering the fact that rodents worldwide help to spread 35 known human diseases, we would be well-advised to learn to respect and appreciate snakes for the role they play in our environment. Unfortunately, many snakes are now threatened by habitat loss caused by development of natural habitats to meet the needs of Florida's growing human population. Additionally, large numbers of snakes are killed each year as a result of road mortality and persecution by humans. In the U.S., humans kill thousands of snakes each year, yet only 5-6 people die each year of venomous snakebites. In order for snakes and people to safely coexist, it is important that Floridians learn to identify, understand, and respect snakes.

In residential areas where human-snake encounters are likely to occur, we recommend a three-part proactive approach for coexisting safely with snakes. This document provides information on the first step of this proactive approach – learning to

identify Florida's commonly encountered non-venomous and venomous snakes. Please note that, in keeping with the “leave it be” attitude that we advocate, we recommend that you avoid handling snakes if at all possible and NEVER attempt to handle a snake with your bare hands or attempt to handle ANY venomous snake – that is a task best left to professionals.

### NON-VENOMOUS SNAKES

Florida is home to 44 species of native snakes, only six of which are venomous. The 13 species described here are commonly encountered snakes that may be found in yards, golf courses, parks, retention ponds, or even in garages and houses. There are certainly other species of snakes that are found in residential areas, but those listed here are the ones most frequently encountered. For each species, we provide information about how to identify it, what it eats, and where it is commonly found in residential settings, as well as insights on behavior and how to deal with each species safely.

- 
1. This document is WEC 220, the second in a 4-part series entitled "Dealing with Snakes in Florida's Residential Areas", of the Department of Wildlife Ecology and Conservation, University of Florida / IFAS. First published July 2007. Accompanying documents by Dr. Johnson related to dealing with snakes in a variety of settings are available through the University of Florida/EDIS at [http://edis.ifas.ufl.edu/TOPIA\\_A23708620](http://edis.ifas.ufl.edu/TOPIA_A23708620). A free PowerPoint presentation (with speaking notes) on the topic of venomous snake safety is available upon request from Steve A. Johnson by email - [tadpole@ufl.edu](mailto:tadpole@ufl.edu).
  2. Steve A. Johnson - Department of Wildlife Ecology and Conservation and Gulf Coast Research and Education Center, University of Florida IFAS/Plant City Campus, 1200 North Park Road, Plant City, FL 33563  
Monica E. McGarrity - Gulf Coast Research and Education Center, University of Florida IFAS/Plant City Campus, Plant City, FL

The Institute of Food and Agricultural Sciences (IFAS) is an Equal Opportunity Institution authorized to provide research, educational information and other services only to individuals and institutions that function with non-discrimination with respect to race, creed, color, religion, age, disability, sex, sexual orientation, marital status, national origin, political opinions or affiliations. U.S. Department of Agriculture, Cooperative Extension Service, University of Florida, IFAS, Florida A. & M. University Cooperative Extension Program, and Boards of County Commissioners Cooperating. Larry Arrington, Dean

## Southern Black Racer

The Southern Black Racer (*Coluber constrictor*), also known as the Eastern Racer, is the “black snake” most commonly found in urban and natural areas throughout all of Florida (Figure 1). These long, slender snakes can grow to 4-5 feet in length, and have smooth gray/black scales on their backs and bellies and white chins and throats.



**Figure 1.** Southern Black Racer (Adult). Credits: Steve A. Johnson, University of Florida

Adult Black Racers are commonly found sunning themselves on lawns, shrubbery, walkways and fences, and are occasionally found in houses (particularly after rains). Racers are harmless to people and are swift and agile (as their name implies), fleeing rapidly when approached. However, if they are cornered and feel threatened, they may vigorously shake their tail (making a rattling sound on the floor or dry leaves) and may release a foul smelling 'musk' on their captor or even strike if handled. Black Racers use their speed to catch a variety of prey, including frogs, lizards, small snakes, birds, and rodents.

Due to their dark coloration, harmless Black Racers are sometimes incorrectly identified as venomous Cottonmouth Water Moccasins (Figure 16), which have rather thick, heavy bodies with rough-looking keeled scales (with longitudinal ridges) and blocky heads. Young Black Racers (Figure 2) are also long and slender, but bear little resemblance to adults. They have a series of reddish-brown blotches down the middle of their

backs on a gray background and abundant small, dark specks on their sides and bellies.



**Figure 2.** Southern Black Racer (Juvenile) - note the slender body and reddish colored blotches. Credits: Steve A. Johnson, University of Florida

There are several other “Black Snakes” found throughout the southeastern U.S. that are often difficult to identify. Of these, only the Black Racer and Southern Ring-necked Snake (also described here) are commonly found in residential areas. Additional information about “Black Snakes” and tips on identification can be found in the document “Black Snakes”: Identification and Ecology, available online through the University of Florida's Electronic Data Information Source (EDIS) at <http://edis.ifas.ufl.edu/UW251>.

## "Flower Pot Snake" - Brahminy Blind Snake

Brahminy Blind Snakes (*Ramphotyphlops braminus*) are tiny (2-6 inches), brownish-black, earthworm-like snakes with nearly invisible eyes and no distinct head or tail (Figure 3).

Unlike earthworms, these non-native snakes are smooth and are not segmented. They were introduced to Florida through the ornamental plant trade (hence the name “Flower Pot Snake”) and are one of the most commonly found snakes in urban areas throughout peninsular Florida. Notably, the prevalence of this non-native species can be attributed in part to the fact that all Brahminy Blind Snakes are female, meaning that a single individual can reproduce asexually by a process called 'parthenogenesis'. These tiny snakes burrow in potted plants or flower beds, feeding on larval ants and





**Figure 3.** "Flower Pot Snake" or Brahminy Blind Snake, shown next to a dime for size comparison (Adult). Credits: Jason Butler, 2007

termites, and are occasionally found in houses, as their small size allows them to slip in under doors. These snakes are completely harmless to humans, and may be removed from the house by sweeping them into a bucket or small garbage can.

### Southern Ring-necked Snake

Southern Ring-necked Snakes (*Diadophis punctatus*) are one of the most commonly found snake species in urban areas throughout all of Florida, where they are found in leaf litter or mulch, on walkways, and sometimes in houses. They occasionally fall into pools and end up in the skimmer basket. These small, grayish-black snakes rarely grow longer than 12 inches, and can be easily identified by the obvious ring of orange or yellow around the neck and a matching brightly colored belly with a row of black spots down the center (Figures 4 & 5). When alarmed or threatened, Ring-necked Snakes coil their tail like a corkscrew and may emit a foul scent, although they rarely attempt to bite.

These shy snakes are harmless, preferring to spend their time under logs and rocks, where they eat earthworms, slugs, salamanders, lizards, and small snakes. Due to their small size, these snakes may be unable to climb out of pools and may inadvertently slip into a house under doors. They can easily be removed from the pool using a leaf skimmer or from the house by sweeping them into a bucket or small garbage can. Release them in nearby shrubs, so that



**Figure 4.** A Southern Ring-necked Snake (Adult) showing typical defensive posture—note the coiled tail. Credits: Steve A. Johnson, University of Florida



**Figure 5.** Southern Ring-necked Snake (Adult) showing yellow belly coloration. Credits: Kenneth Krysko, FLMNH, University of Florida, 1996

these harmless snakes can continue to eat your garden slugs!

### Rat Snakes

Red Rat Snakes, also known as Corn Snakes (*Elaphe guttata*, Figure 6) are frequently found in urban areas throughout Florida. These beautiful snakes have reddish-orange blotches (outlined in black) on their backs and sides on a highly variable background of tan, gray, or yellow-orange, and a distinctive black and white "checkerboard" pattern on their bellies.

Due to their reddish coloration, these snakes are occasionally confused with coral snakes (Figure 17). However, non-venomous Red Rat Snakes are generally larger (3-5 feet), and lack the distinct black nose and red, yellow and black bands of coral snakes.

Yellow Rat Snakes (*Elaphe obsoleta*, Figure 7) are closely related to Red Rat Snakes, and are frequently found in urban areas throughout peninsular Florida (not found in the Panhandle). This is a large



**Figure 6.** Red Rat Snake (Adult), demonstrating its superior climbing skills. Credits: Steve A. Johnson, University of Florida

(4-6 feet), distinctive golden yellow snake with four dark longitudinal lines running down its back.



**Figure 7.** Yellow Rat Snake (Adult). Credits: Steve A. Johnson, University of Florida, 2004

Juvenile Red Rat and Yellow Rat Snakes look similar and resemble Red Rat Snake adults, albeit a dull, brownish version. As Yellow Rat Snakes grow, the blotches will fuse to form the longitudinal lines seen in adults, and the gray-brown background coloration turns to yellow-orange. Typical juvenile rat snake markings are shown in Figure 8 below.

Both Yellow and Red Rat Snakes are excellent climbers and are frequently found in residential areas on shrubs or fences. They are also found on occasion



**Figure 8.** Juvenile Yellow Rat Snake - Markings are typical of juvenile rat snakes. Credits: Kenneth Krysko, FLMNH, University of Florida

in garages and even in bathrooms inside the home, where they gain entrance by way of holes in walls or uncovered roof vent-pipes. These are harmless non-venomous snakes, but can be quite defensive and may emit a foul smelling musk and strike when cornered. If found in the house, you may be able to remove these snakes by using a broom to gently guide them into a large outdoor garbage can, which can then be covered and used to relocate the snake outdoors. In the garage, you may be able to gently guide the snake through an open door using a broom. If this is not possible, remember that Rat Snakes feed primarily on rodents – after they rid you of your rodent pests, they will likely move on in search of food and water. In addition, there are many preventative methods, detailed in the next document of this series, which will greatly reduce your chances of an indoor encounter with a snake.

### Garter Snakes

Eastern Garter Snakes (*Thamnophis sirtalis*, Figure 9) are frequently encountered in urban areas throughout Florida. Eastern Garter Snakes are small-medium sized snakes (2-3 feet long) with keeled scales marked with three light-colored longitudinal lines, one down the middle of the back and one along each side of the body. There is also a “checkerboard” pattern of black splotches down the back between the stripes.

Due to this splotched pattern, Eastern Garter Snakes are occasionally misidentified as Pygmy Rattlesnakes (Figure 15), which have large, irregular blotches, much thicker bodies, blocky heads, vertical





**Figure 9.** Eastern Garter Snake (Adult). Credits: Steve A. Johnson, University of Florida

pupils, and a dark stripe through the eye to the corner of the jaw.

Eastern Garter Snakes feed primarily on small prey such as earthworms, frogs, and salamanders. In urban areas, they are often found among shrubbery near houses, along the edges of ditches or ponds, and may even get into bathrooms inside a home, gaining entrance by way of holes in walls. These snakes are generally docile, but when cornered may release a foul smelling musk and flatten their heads and bodies to appear more imposing. These harmless snakes may be removed from the house by sweeping them into a bucket or small garbage can. Preventive methods, detailed in the next document in this series, can help to eliminate unwanted indoor encounters with snakes.

### Rough Green Snake

The Rough Green Snake (*Opheodrys aestivus*) was once among the most commonly encountered snakes in Florida, and may still be encountered in urban settings. This small, slender snake grows to only 2-3 feet in length, and can be easily recognized by its bright green, keeled scales, which give it a rough appearance (Figure 10). The belly is generally a cream or pale yellow color.

This snake is often seen sunning itself on bushes or in trees but is seldom (if ever) encountered in houses. These snakes are docile, and will generally attempt to stay still, relying on their green camouflage to keep them hidden when approached by people. If camouflage does not work they will quickly flee through the branches of shrubs and small trees. Rough Green Snakes specialize in eating insects they



**Figure 10.** Rough Green Snake (Adult). Credits: Steve A. Johnson, University of Florida

find on bushes or trees, and should be left in place to play their role in the environment.

### Southern "Banded" Water Snakes

Southern Water Snakes (*Nerodia fasciata*), are perhaps the most commonly misidentified non-venomous snake species—people often confuse them with the venomous Cottonmouth. Southern Water Snakes have rough-looking, keeled scales, and can reach up to 5 feet in length (typical size ranges from 2-4 feet). The Banded Water Snake (*N. f. fasciata*) has dark crossbands on a lighter colored background (Figure 11).

The crossbands are quite variable in color, and may be black, brown, or even red. The background color of these snakes may be brown, gray, dull yellow, or reddish brown.

The closely related Florida Banded Water Snake (*N. f. pictiventris*) has similar crossband markings, and a distinctly marked belly. The Latin name “pictiventris” means “painted belly” and refers to the conspicuous dark markings on the belly of these snakes (Figure 12).

In both subspecies the crossbands tend to darken as the snakes age, and large snakes may be a nearly uniform dark-color (Figure 13).

These large, dark-colored snakes also have dark “eye stripes” through the eye to the corner of the jaw, and large individuals are easily (and frequently)



**Figure 11.** Banded Water Snake (Adult) showing typical banded pattern. This snake feels threatened and has flattened its head and puffed up its body to look more intimidating. Credits: Kenneth Krysko, FLMNH, University of Florida



**Figure 12.** Florida Banded Water Snake (Adult), showing markings on belly scales. Credits: Photo courtesy of USGS

confused with the venomous Cottonmouth Water Moccasin (Figure 16). When threatened, water snakes will flatten their heads and bodies in an attempt to look larger and more intimidating. These snakes prey upon salamanders, frogs, fish and crayfish, and are often encountered along the edges of ditches and ponds, in the same habitats where Cottonmouths are found. If you encounter a large, dark snake that you cannot confidently identify, particularly near water, "leave it be!" Even the non-venomous water snakes should not be handled unless absolutely necessary, as they release an especially foul-smelling musk and sometimes bite



**Figure 13.** Banded Water Snake (not a Cottonmouth), showing nearly uniform dark coloration. This snake feels threatened and has flattened its head and puffed up its body to look more intimidating. Credits: Photo courtesy of USGS

when they feel threatened. If necessary, these snakes can be relocated using a broom to guide them into a large garbage can – although they will likely attempt to escape to the safety of any nearby water.

## FLORIDA'S VENOMOUS SNAKES

Of the approximately twenty species of venomous snakes found in the United States, only six are found in Florida, and only four are found in central and southern Florida. Florida's venomous snakes belong to two families – the Viperidae or "Pit Vipers" (5 species) and the Elapidae, represented in Florida by the Coral Snake. The four species described here are the most commonly encountered venomous snakes in Florida. More information on identifying all six of Florida's venomous snake species can be found in "Recognizing Florida's Venomous Snakes", an educational document available online through the University of Florida's Electronic Data Information Source (EDIS) at <http://edis.ifas.ufl.edu/UW229>.

Learning to identify Florida's most commonly encountered venomous snakes is essential, not only for safety reasons but also to alleviate the fears that lead to needless persecution of snakes. As you learn more about snakes and begin to understand them, you will see that all snakes – even venomous species – are beneficial and play important roles in our environment. Negative encounters with venomous



snakes are rare and several precautions, described in the next document in this series, will help prevent such unwanted encounters in residential areas.

### PIT VIPERS - VIPERIDAE

The pit vipers found in Florida all share certain characteristics that can help you to learn to identify them. They all have bodies that are rather thick and heavy for their length, heat sensing pits on the side of the face, vertical pupils, and they usually have a dark stripe through the eye to the corner of the jaw (as do some non-venomous water snakes). Pit vipers also have rough-looking, keeled scales (with longitudinal ridges) and wide, somewhat triangular heads with obvious thin necks. However, many non-venomous species also have keeled scales and triangular heads, and should not be mistaken for venomous snakes. If you aren't sure, be safe – give the snake its space!

#### Eastern Diamondback Rattlesnake

The Eastern Diamondback Rattlesnake (*Crotalus adamanteus*, Figure 14) is Florida's largest venomous snake, typically ranging in size from 3-6 feet (record length 8 feet!), and is found throughout the state of Florida. This snake can easily be identified by the large black diamonds with beige borders, which are repeated down the back.



**Figure 14.** Eastern Diamondback Rattlesnake (Adult). Credits: Steve A. Johnson, University of Florida

These snakes have large, blocky heads with a distinctive dark band from the eye to the corner of the jaw, rough-looking keeled scales, and may have large rattles at the tip of the tail that *usually* make a loud buzzing sound when the snake feels threatened. Juvenile Eastern Diamondback Rattlesnakes are similar in appearance to adults, and can also be easily identified.

The Eastern Diamondback Rattlesnake is rarely found in urban areas, preferring more natural scrub or wooded areas, where it preys on mice, rats, and rabbits. However, they occasionally wander onto golf courses and into suburban neighborhoods that are near pine forests. Eastern Diamondback Rattlesnakes have declined severely in numbers due to habitat loss, road mortality, and indiscriminate killing by people. The Eastern Diamondback Rattlesnake should be respected and admired from a safe distance. It can strike up to two-thirds its body length and possesses the largest quantity of the most toxic venom (at least to mice) of any species in the United States. If you encounter this snake, "leave it be" -- DO NOT attempt to approach, handle or kill it!

#### Pygmy Rattlesnake

The Pygmy Rattlesnake (*Sistrurus miliarius*, Figure 15) is the smallest venomous snake in Florida, averaging one foot in length, and feeds primarily on frogs, toads, and mice. Found throughout the state, this is the most commonly encountered venomous snake in Florida, and can be found in a variety of urban settings.



**Figure 15.** Pygmy Rattlesnake (Adult). Credits: Steve A. Johnson, University of Florida

Although small, the Pygmy Rattlesnake has a stout body and blocky head. The body is gray with irregular dark blotches down the back and sides and a broken reddish-brown line down the center of the back between blotches. There is also a distinctive dark line through the eye to the corner of the jaw. Juveniles are similar in appearance, but the tip of the tail is a bright yellowish color.

Although Pygmy Rattlesnakes do have a rattle, it is so small it is barely audible and makes an insect-like buzzing noise. These small rattlesnakes are quite defensive – if approached, they may hold their ground and strike at their perceived attacker. It is a good idea to wear leather gloves at all times while gardening, as these venomous snakes are often encountered in flower beds and gardens.

### Cottonmouth

The Cottonmouth (*Agkistrodon piscivorus*, Figure 16), also known as the Water Moccasin, is the most aquatic venomous snake in Florida. It is occasionally seen in urban areas throughout Florida near the edges of ditches, ponds, lakes, and wetlands, where it feeds on fishes, frogs, mice, and rats.



**Figure 16.** Cottonmouth (Adult), showing banded markings and the namesake defensive posture. Credits: Steve A. Johnson, University of Florida

These heavy-bodied snakes can grow to 6 feet in length (typical size ranges from 2-4 feet), and have rough-looking, keeled scales. Young Cottonmouths resemble the closely related Copperhead, and have bright reddish-brown, splotched crossbands, a dark stripe through the eye to the corner of the jaw, and a

bright yellow-tipped tail. The crossbands darken with age, and older snakes may be nearly uniformly dark-colored.

As mentioned in the previous section, several species of non-venomous water snakes are often misidentified as Cottonmouths. In order to avoid being bitten, it is best to never attempt to handle any aquatic snake. Cottonmouths do not have rattles, but may vigorously shake their tail when threatened (like many non-venomous snakes), making a rattling sound in dry leaves. As a defensive behavior, Cottonmouths may coil their body and open their mouth widely, showing the namesake cotton-white interior. These behaviors are defensive, rather than aggressive, and, despite their infamous reputation as being aggressive, Cottonmouths will generally flee from threat unless harassed.

## CORALSNAKES - ELAPIDAE

### Harlequin Coral Snake

The Harlequin Coral Snake (*Micrurus fulvius*, Figure 17), is a small (1 - 2.5 feet in length), slender, secretive snake that spends most of its life underground. This snake feeds on lizards and other snakes. Coral Snakes occur in residential areas, where they may be encountered under brush piles, firewood, or other objects under which they hide. You may also encounter a Coral Snake while you are digging in your yard to plant shrubs or a garden. Coral Snakes stay in hiding most of the time, and if you see one in the open it will likely be moving rapidly across your lawn to a new hiding place.

Coral Snakes have smooth, glossy scales and are brightly colored with red, yellow, and black rings. Their snout is blunt and black, followed by a band of yellow, and their body is marked with wide red and black rings separated by narrow yellow rings (the colored rings go all the way around the snake), and the tail is black and yellow.

There are two non-venomous Coral Snake "look-alikes" (Scarlet Kingsnake and Scarlet Snake) that can be confused with the Coral Snake at first glance, but they can easily be identified as non-venomous by the order of their colored bands (red touching black). Remember the "stoplight





**Figure 17.** Harlequin Coralsnake (Adult) - Note the black nose and the touching red and yellow bands. Credits: Steve A. Johnson, University of Florida

phrase" -- when you see a snake with bright red, yellow & black bands, remember "yellow, red, STOP!" In the venomous Coral Snake, the yellow and red bands touch. In the two non-venomous species the black and red bands touch—these snakes also have red, rather than black, snouts.

Interestingly, all of the pit vipers give birth to live young, and the Harlequin Coral Snake is the only venomous egg-laying species in Florida. Therefore, when snake eggs are encountered, they almost certainly belong to a non-venomous species and can be left in place unharmed without fear for your safety.

## ADDITIONAL RESOURCES

This document is the second in a series of four documents by Dr. Steve Johnson and Monica McGarrity that provide information to Florida's residents on how to identify snakes that are commonly encountered in residential settings, how to prevent encounters from occurring in the first place, and how to respond in the unlikely event that someone is bitten by a snake. Anyone living in Florida, especially people new to the state, will find these documents useful. These documents are available online through UF/IFAS Extension Electronic Data Information Source.

1. Dealing With Snakes in Florida's Residential Areas – Introduction (<http://edis.ifas.ufl.edu/UW257>)

2. Dealing With Snakes in Florida's Residential Areas - Identifying Commonly Encountered Snakes (<http://edis.ifas.ufl.edu/UW258>)

3. Dealing With Snakes in Florida's Residential Areas – Preventing Encounters (<http://edis.ifas.ufl.edu/UW260> )

4. Dealing With Snakes in Florida's Residential Areas – Emergency Planning (<http://edis.ifas.ufl.edu/UW261>)

### Hotline Numbers:

Poison Control Hotline: 1-800-222-1222

American Society for the Prevention of Cruelty to Animals (ASPCA) Poisoning Hotline: 1-888-426-4435 (charges may apply)

### Good Books on Florida Snakes:

Conant, R., and J. Collins. 1998. Peterson Field Guide to Reptiles and Amphibians of Eastern and Central North America, 3rd edition. Boston: Houghton Mifflin Company.

Carmichael, P., and W. Williams. 2004. Florida's Fabulous Reptiles and Amphibians. Tampa: World Publications.

Tennant, A. 2003. Snakes of North America: Eastern and Central Regions. revised edition. Houston: Lone Star Books.

### Snake Resources on the World Wide Web:

Johnson, S.A. 2005. **Dealing with Venomous Snakes in Florida Schoolyards Series.** WEC199-202. Gainesville: Institute of Food and Agricultural Services. [http://edis.ifas.ufl.edu/TOPIC\\_SERIES\\_Dealing\\_with\\_Venomous\\_Snakes\\_in\\_Florida\\_School\\_Yards](http://edis.ifas.ufl.edu/TOPIC_SERIES_Dealing_with_Venomous_Snakes_in_Florida_School_Yards)

Johnson, S.A., and M.E. McGarrity. **“Black Snakes”:** Identification and Ecology. WEC214. Gainesville: Institute of Food and Agricultural Services. 2006. <http://edis.ifas.ufl.edu/UW251>

**Florida Museum of Natural History—Online guide to Florida snakes:**

<http://www.flmnh.ufl.edu/herpetology/FLGUIDE/onlineguide.htm>

**Florida Fish and Wildlife Conservation Commission snake**

**page:**<http://www.myfwc.com/critters/snakes.asp>

**Partners in Amphibians and Reptile Conservation (PARC) site:**

<http://www.parcplace.org/index.html>

**Snake Handling Equipment:**

Midwest Tongs - <http://www.tongs.com> (we recommend their Gentle Giant tongs)

Tomahawk Live Trap - <http://www.tomahawklivetraps.com> (we recommend their 60" Super Tube tongs with rubber cushions)

## **Section 3**

# Native/FL Yards & Neighborhoods Landscapes and Techniques in the Neighborhood

Much of what happens in your pond is due to the landscape practices in the surrounding yards. When it rains, stormwater can carry pollutants from streets and yards into the pond. You often can't see these pollutants entering the water, but they can have major impacts to the pond. Florida-Friendly Landscaping™ involves using the 9 techniques described in this section to reduce your impact and help create a healthier environment. The Adopt-A-Pond program also has an incentive program to encourage more homeowners to practice these techniques in their yards. Visit the Florida-Friendly Landscaping website at [www.floridayards.org](http://www.floridayards.org) for more information.

### **Featured Articles:**

- Incentive for Florida-Friendly Yards
- FL-Friendly Landscaping Principles:

1. Right Plant, Right Place
2. Water Efficiently
3. Fertilize Appropriately
4. Mulch
5. Attract Wildlife
6. Manage Yard Pests Responsibly
7. Recycle
8. Reduce Stormwater Runoff
9. Protect the Waterfront

# **A Florida-Friendly Yard gets you more stuff!**

Adopt-A-Pond and the Florida Yards & Neighborhoods Program go hand in hand. We encourage all pond groups to use Florida-Friendly techniques in their landscapes.

Now we're going a step further. We're offering rewards for actually using the techniques. The more your group uses them, the more you get.

## **Here's how it works!**

### **Level 1**

1 to 2 Florida Yards, or 1 common area = \$200.00 of equipment/hardware for the pond.

Stormwater isn't just about ponds and pipes, everything we do in our yards can have an effect on our water quality.

There are currently 125 waterbodies in Hillsborough County impaired for nutrients or dissolved oxygen as determined by the Florida Department of Environmental Protection. Landscape practices can be a significant contribution to these impairments.

The major complaint from pond residents is about material coming through the pipes.

Florida Yards have been found to increase the perceived value and decrease days to sale of homes.

Properly maintained, established Florida Yards can use 30% less water and fertilizer than traditional landscapes. That means less runoff and less pollution.



### **Level 2**

3 to 5 Florida Yards = 1 free herbicide application and \$500.00 of equipment or hardware

**OR**

\$500.00 of equipment/hardware and \$200.00 of plants.

### **Level 3**

more than 5 Florida Yards = 2 free herbicide applications, \$500.00 of equipment or hardware, and \$200.00 of native plants.

**OR**

\$500.00 of equipment/hardware and \$500.00 of plants.

**For details on the rewards program see the attached policy sheet.**



**To learn more about Florida Yards, refer to the publication *A Guide to Florida-Friendly Landscaping* or visit [http://hillsborough\\_fyn.ifas.ufl.edu](http://hillsborough_fyn.ifas.ufl.edu)**



## Incentives for Florida Friendly Yards in Adopt-A-Pond Drainage Areas

### Intent

In the current climate of stormwater regulations in the NPDES and TMDL programs, the Stormwater Management Section Environmental Team recognizes that we must take cooperative steps with other programs and with citizens to accomplish our goals of safe and healthy stormwater resources. To that end, the Hillsborough County Adopt-A-Pond Program will initiate an incentive program to encourage citizens to adopt Florida-friendly landscape practices. The program recognizes that typical landscape practices result in significant contributions to stormwater pollution. The Florida-friendly landscape concept is designed to produce low cost, low water use, low fertilizer use landscapes that also provide habitat for wildlife and reduce the spread of invasive plants. The Hillsborough County Extension Service coordinates the Florida Yards & Neighborhoods Program (FY&N) to teach this concept, and evaluate and recognize yards that comply with the program criteria.

### Incentives

These incentives are available for currently active Adopt-A-Pond groups who meet the criteria.

**Level 1:** Pond Groups that have 1 to 2 properties with Florida-friendly Yards recognized by the Adopt-A-Pond Program within the area that drains to the pond either over land or through the storm sewer system are eligible to receive \$200.00 worth of equipment/hardware<sup>1</sup> for their pond group.

**Level 2:** Pond Groups that have 3 to 5 of the properties in the drainage area recognized as Florida-friendly Yards by the Adopt-A-Pond Program are eligible to receive one free herbicide treatment<sup>2</sup> in the pond and \$500.00 of equipment/hardware<sup>1</sup> for the pond group, **OR** \$500.00 of equipment/hardware<sup>1</sup> and \$200.00 of native plants<sup>3</sup>.

**Level 3:** Pond Groups that have 6 or more of the properties in the drainage area recognized as Florida-friendly Yards by the Adopt-A-Pond Program are eligible to receive two free herbicide treatments<sup>2</sup> in the pond, \$500.00 of equipment/hardware<sup>1</sup> and \$200.00 worth of native plants<sup>3</sup>, **OR** \$500.00 of equipment/hardware and \$500.00 of native plants.

**Bonus Incentive:** Pond Groups that have a common area of their community recognized as a Florida-friendly area by the Adopt-A-Pond Program are eligible to receive \$200.00 worth of equipment/hardware<sup>1</sup> for their pond group.

---

<sup>1</sup> Equipment may include waders, shovels/rakes, pump sprayers, habitat boxes, bird feeders, benches, or other similar items as approved by the Adopt-A-Pond Program Coordinator.

<sup>2</sup> Herbicide treatment is subject to the Program Coordinator's determination that there is a need for the application. Treatment shall not exceed \$3500 in total value.

<sup>3</sup> Native plants are subject to availability. Plants may be used in the pond or other community areas.

## **Conditions**

Qualifying yards must be adjacent to the pond, or drain directly to a storm sewer system that discharges to the pond and must be officially recognized by the Hillsborough County Adopt-A-Pond Program.

To claim an incentive, Pond Group Representatives should contact the Adopt-A-Pond Program to request verification. The Program will verify the level of incentive available to the pond group.

Incentives must be used within six months of official notification of eligibility. Six months from the date of notification, all unused portions of the incentive will be void.

Incentives will be distributed at the discretion of the Adopt-A-Pond Program Coordinator.

The Group Representative is responsible for communicating with the Pond Group and arriving at a decision about which option to select (in the case of Levels 2 & 3), and what items will be selected. The Group Representative must then coordinate with the Program Coordinator to receive the incentives for the group.

A Pond Group shall be eligible for a particular level of incentive only once. The Group will be eligible to receive higher level incentives as they qualify. A Group that qualifies for a higher level incentive at the time of verification will not be eligible to receive a lower level incentive.

# **Florida-Friendly Landscaping Principles**

1. Right Plant, Right Place
2. Water Efficiently
3. Fertilize Appropriately
4. Mulch
5. Attract Wildlife
6. Manage Yard Pests Responsibly
7. Recycle
8. Reduce Stormwater Runoff
9. Protect the Waterfront

# #1: Right Plant, Right Place

## ENJOY HEALTHIER PLANTS AND REDUCE WORK BY USING PLANTS SUITED TO YOUR LANDSCAPE CONDITIONS

Achieving a natural, healthy balance in your landscape starts with putting the right plant in the right place. This encompasses far more than simply putting sun-loving plants in your yard's sunny spots—you also need to consider things like maintenance and water needs. Matching plants to conditions in your landscape can help them thrive, once established, with little or no irrigation and few or no fertilizers and pesticides.

The secret to successful landscape design is thorough planning. Remember that once you have a plan, you don't have to do all the work at once—you can implement it one area at a time. Read this chapter to get an idea of the factors you should take into account when planning your new landscape or renovating an existing one, and use the worksheet at the end of the chapter to design a customized landscape plan that is sure to work for you.

### LANDSCAPE DESIGN

Florida-Friendly Landscape design combines art and science to create functional, attractive, and ecologically sound surroundings that complement a home or other structure. The main idea when placing plants in your landscape is not to waste time, energy, and money caring for a plant that is not adapted to the spot where it's planted. But Florida-Friendly Landscaping™ guidelines need not restrict your choices of color, texture, and style.

### FORM FOLLOWS FUNCTION

In a landscape, plants fulfill multiple roles. For example, landscape designers often recommend grouping plants into masses to unify the design of plant beds. Groups of plants are visually pleasing, but this design technique provides environmental benefits as well. Trees planted in groups provide more atmospheric cooling than the same number of evenly spaced, isolated trees and are much better protected in high winds. In addition, trees planted in combination with appropriate shrubs and groundcovers form effective windbreaks and wildlife habitat.

### PLANT MATCHMAKING

Turf and landscape plants have different water, fertilizer, and maintenance needs. All it takes is one misplaced shrub to disrupt mowing and irrigation patterns. To conserve water and make maintenance easier, group plants in beds according to water requirements.

### COLOR IN THE LANDSCAPE

One way to design your landscape is by choosing two or three colors that complement each other, and repeating the color combination throughout the landscaped area. You'll create a scene that's visually attractive, and the repetition of color will draw the eye through the planting.



Two or three complementary colors create an inviting landscape.

However you design your landscape, don't forget to take into consideration what times of year different plants bloom.

### WET VS. DRY

Many drought-tolerant plants thrive on elevated dry spots or in windy areas, but can quickly succumb to root diseases and pest problems if planted in areas that tend to stay wet. Drought-tolerant plants do well in exposed areas and along the unshaded southern or western walls of buildings, but you should place plants adapted to wet soils in low spots, along waterways, and in areas with poor drainage.

### WIND-WISE PLANTINGS

Florida winter winds tend to blow from the north or northwest. A solid fence or a row of evergreens situated on the north side of a house forms a barrier against cold winter winds, which can dry and damage plants. In the summer, winds typically originate in the south, so to allow breezes to cool outdoor living spaces in the warm months, keep tall barriers away from the southern edge of your landscape. Since Florida is frequently in the path of hurricanes, choose trees that are known for their sturdiness in high winds.

### MADE IN THE SHADE

Position trees and shrubs strategically to naturally cool or heat your home. Plant deciduous shade trees on the south, east, and west sides of a house to cast shade in summer and allow warming in winter.

Tree shade can reduce air conditioning costs significantly. An air-conditioning system's outdoor compressor/condenser unit uses less energy when it is shaded from direct sun

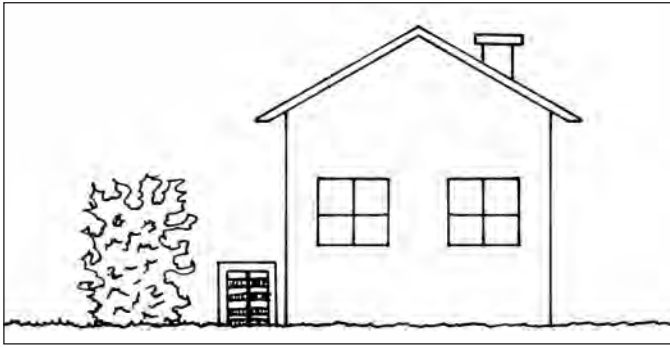

Shade your A/C unit from direct sun, but do not block the airflow.

during the day—but be careful not to block the unit’s airflow. If the warm discharge air cannot escape, the intake air temperature rises, causing the unit to operate less efficiently.

### THE LOWDOWN ON GRASS

Healthy lawns clean and cool the air by absorbing carbon dioxide, releasing oxygen, and collecting dust and dirt. They filter stormwater runoff and reduce erosion, glare, and noise. But the many benefits of grass are only realized when it’s cared for and used properly. Turfgrass thrives in sunny areas, but most types do not grow well in dense shade. In shady spots, plant shade-tolerant groundcovers instead of turf.

For a more thorough overview of the artistic elements of landscape design, visit <http://gardeningolutions.ifas.ufl.edu> or consult a reputable landscape designer or professional landscape architect.

### SOIL KNOW-HOW

In much of Florida, “soil” and “sand” are synonymous. Where sandy soils predominate, water and nutrients move downward quickly. As a result, Florida soils usually dry out rapidly and are not compatible with plants having high water and nutritional needs. Sandy soils are also more likely to allow pollutants to leach into groundwater and waterways.

In certain parts of the state, the sandy soil has a hardpan (a dense layer of largely impervious soil) under it, causing water to stand for long periods instead of draining away. Other exceptions to the quick-draining sandy soils situation occur in three main locations:

- In parts of Miami-Dade County drainage is slow, because the soil has a high clay content.
- In the Keys there is really no soil at all—it is rock.
- In parts of the panhandle the soil is reddish clay.

### IMPROVING SOIL

For best results growing flowers or vegetables, you may need to amend the planting bed frequently by adding



Soil amendments keep garden soil robust and healthy.

organic matter, such as compost, composted animal manure, or sphagnum peat moss. Organic matter retains moisture, provides nutrients, and attracts beneficial organisms like earthworms. When selecting organic matter, choose materials that are decomposed to the point of containing few or no recognizable source materials – in yard waste, that would mean you wouldn’t see any leaves or sticks.

The easiest way to add organic matter to an empty planting bed is to put down a layer 2–3 inches thick, then mix it into the soil using a tiller, shovel, or digging fork. In established planting areas, such as a rose bed, add organic matter as mulch around plantings each spring, before the rainy season.

### SOIL PH

Soil pH is the measure of acidity or alkalinity and can have a big effect on the health of your plants—essential plant nutrients like iron and manganese become more or less available depending on the pH of the soil. Soil testing will help you determine the pH of your site. In general, coastal areas are usually alkaline (high pH), while inland areas are usually acidic (low pH).

Although many plants tolerate a wide pH range, they do best when planted in the right soil. Plant reference guides often provide pH information along with other plant requirements. Raising soil pH is easy, but lowering it is harder to do and is only a temporary condition.



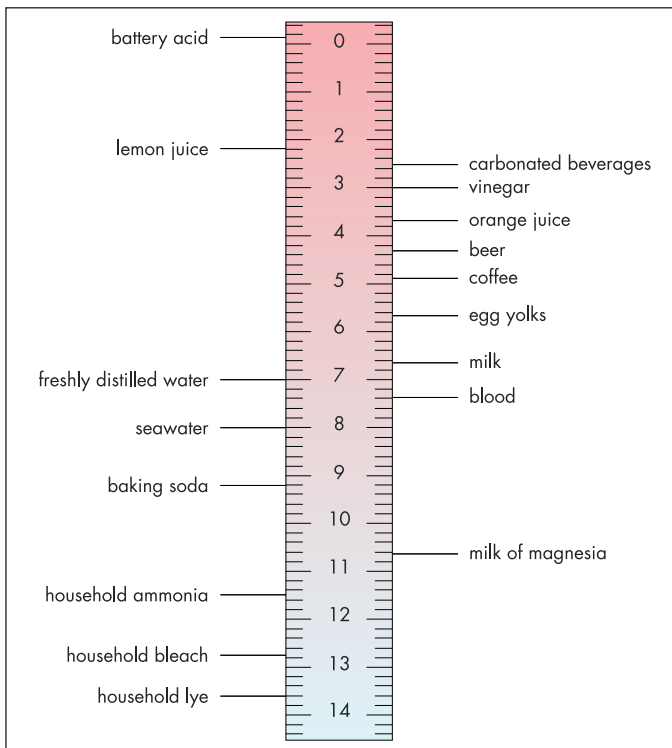

The pH scale measures acidity and alkalinity of substances.

Concrete, stucco, brick, mortar, plaster, and other building materials are strongly alkaline. These materials dissolve into surrounding soil, drastically changing the pH over time. For this reason, azaleas (*Rhododendron*), flowering dogwoods (*Cornus*), ixora (*Ixora coccinea*), and other acid-loving plants should not be planted near the concrete foundation of a home or along sidewalks.



Plant alkaline-loving plants by concrete, brick, or other building materials.

### COMPACTED SOIL

Many new homes are built on a raised platform of compacted “fill dirt” imported during the construction process. Such compacted soils don’t absorb water readily and restrict the healthy root growth of plants. If you have a landscape that has compacted soil, loosen and amend the soil with organic matter as you add planting beds.

### HARDPAN

Some soils have a sub-layer of hardpan, limestone, rock, or shell, which limits root penetration, essentially establishing a barrier to plant roots. Where possible, examine your soil to a depth of about 18 inches before making final plant selections.

## SOIL TESTING

Whether you’re deciding what to plant or just doing some troubleshooting, you should get your soil tested. A soil test can tell you some of the nutrients your soil contains or the pH of your soil. For a specific area, like a planting bed, you can take just one sample; for a large area (like a lawn), you should take samples from multiple locations to get an average reading. County Extension offices can test your soil for a small fee or provide you with a kit to send a soil sample to the University of Florida/IFAS Extension Soil Testing Laboratory. Detailed directions come with the kit. You’ll get the results within a few weeks, helping you make smart plant and fertilizer choices.

UF/IFAS County Extension Offices:  
<http://SolutionsForYourLife.com/map>

UF/IFAS Soil Testing Laboratory:  
<http://soilslab.ifas.ufl.edu>

### PLANT SELECTION

The plants you choose determine how much maintenance your landscape will require and also how long it will last. There are countless varieties of plants that can work in a Florida-Friendly Landscape. Select plants from the UF/IFAS Florida-Friendly Plant List (see <http://fyn.ifas.ufl.edu>), or consult your county Extension office.

Use these steps as a guide to selecting the right plants for the right places in your Florida-Friendly yard:

- **Choose low-maintenance plants** suited to your site. Once these plants are established in the right location, most require little, if any, supplemental water, fertilizer, or pesticides.
- **Welcome wildlife.** Provide flowering and fruiting plants to bring birds and butterflies into your yard. Florida is a stopover or second home for many migrating and wintering butterflies and birds, so cater to these colorful, winged creatures.
- **Plant for impact.** If you do choose high-maintenance plants, group them together for greater visual impact and easier care.

- **Eliminate invasive plants.** Invasive exotics can aggressively out-compete native plants, contributing to habitat loss. Learn to identify problematic plants and dispose of them carefully. And never plant them!
- **Buy quality plants.** Choose the healthiest plants you can find. Slip plants out of pots to inspect roots. Diseased roots are brown to black and often have a sour or rotting odor. Roots growing in a circle inside the pot indicate a rootbound plant—a plant that has been left in the pot too long. Purchase a different plant, if possible.



Healthy roots are white and earthy-smelling.



Unhealthy roots may have a sour odor or dark color.

- **Consider size.** Most plants are not full-grown when purchased (smaller plants will often establish faster and grow as quickly as larger plants). Make sure you know how large a plant will grow before purchasing it, and consider buying dwarf species for smaller spaces to reduce pruning needs and overcrowding. Always give plants enough room to grow to full size. Think ahead—don't plant trees that grow large beneath power lines, close to your house, or in other potentially hazardous sites. If your home features solar panels, be sure any trees you plant will not block them.



Always consider a plant's mature size when you purchase it.



Mature plants need more room than immature plantings.

- **Aim for diversity.** Create a mosaic of trees, shrubs, groundcovers, native grasses, and wildflowers. Monocultures—large expanses of the same plant species—are prone to disease and insect infestation and aren't as sustainable as a diverse plant community.
- **Keep grass useful.** Plan turf areas to be functional and design them for easy maintenance. Define planting bed edges and shapes to make mowing easy.
- **Cope with a slope.** Use groundcovers on slopes where grass is difficult to maintain.
- **Don't use quick fixes.** Don't be fooled by the quick-fix appeal of fast-growing plants. Such plants require frequent pruning and more water. Also, fast growth yields lots of lush, green shoots, which can attract certain pests. Slow-growing plants may take longer to fill in your landscape, but they'll ultimately last longer and create less work.
- **Consider wind tolerance.** Certain tree species are less wind-tolerant than others, meaning they are more likely to be damaged or blow over in a hurricane or other severe weather. Look for sturdy trees to place in your landscape. Check <http://treesandhurricanes.ifas.ufl.edu> for information about specific species.
- **Think of upkeep.** Do not overlook maintenance needs when designing your landscape. Maintenance includes



proper watering, fertilizing, composting, pruning, mowing, mulching, and pest management. The more carefully you plan your landscape, the less you will have to worry about maintenance. Newly installed plants need frequent water, but it's possible to maintain an established landscape with minimal amounts of pesticide, fertilizers, and supplemental water.

For more information about choosing plants, use the plant list that is available on the FYN Web site <http://fyn.ifas.ufl.edu>, contact your county Extension office, or visit <http://floridayards.org> and <http://gardeningolutions.ifas.ufl.edu>.

## INVASIVE PLANTS

Below is a list of some of the most problematic invasive exotic plants. The State of Florida prohibits their planting. If you have any of these plants in your landscape, remove them to prevent their further spread.



Air potato  
(*Dioscorea bulbifera*)

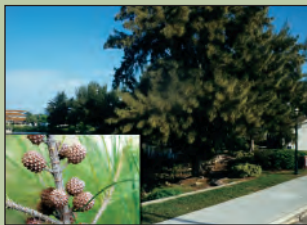

Australian pine  
(*Casuarina equisetifolia*)



Brazilian pepper  
(*Schinus terebinthifolius*)



Chinese tallow  
(*Sapium sebiferum*)

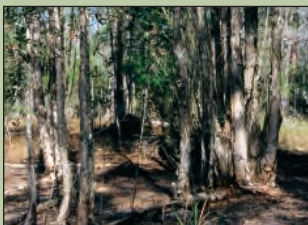

Melaleuca  
(*Melaleuca quinquenervia*)

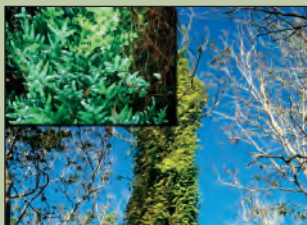

Old World climbing fern  
(*Lygodium microphyllum*)

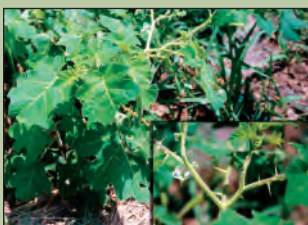

Tropical soda apple  
(*Solanum viarum*)

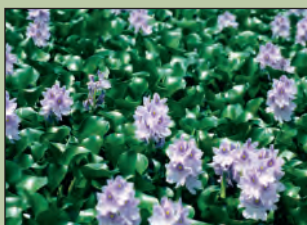

Water hyacinth  
(*Eichhornia crassipes*)

For information about invasive plants, contact your county's UF/IFAS Extension office or visit the Florida Yards & Neighborhoods Web site: <http://fyn.ifas.ufl.edu>.

## DO YOU NEED SALT-TOLERANT PLANTS?

Many Floridians live near the coast, where the air, ground-water, and soil can be salty and capable of severely damaging, deforming, or killing plants. But there are many plants with varying degrees of salt tolerance. Choose salt-tolerant plants if you live on or near an estuary or a salt marsh, or within one-eighth of a mile of the ocean. Use the UF/IFAS Florida-Friendly Plant List, available on the FYN Web site, to help you choose salt-tolerant plants for your landscape.

## KNOW YOUR ZONE!

How well your plants perform depends in large part on choosing the right plants for your climate. The U.S. Department of Agriculture has designated eleven hardiness zones to guide gardeners; each zone indicates the average lowest temperatures of an area. Figure out your USDA plant hardiness zone for guidance in what will survive your winters.

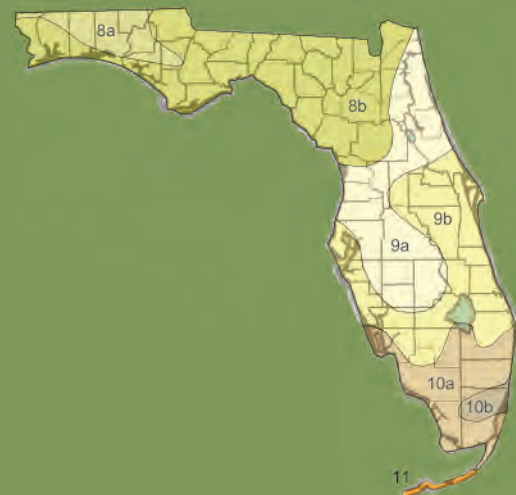

## IS IT SAFE TO DIG?

Before you dig in your yard, it's important that you get your underground utilities marked. Hitting utilities while digging can cause tremendous damage, interrupting your electric, telephone, cable television, water, sewer, and gas service—it can even cause injury or loss of life.

All you have to do is dial 811 at least two business days before you want to dig. Your utility companies will locate any underground utilities in your landscape for free. If you don't follow this procedure and underground lines are damaged, you could be fined.

For more information, visit <http://callsunshine.com>.



## Plant Sorting: To Keep or Not to Keep

If you're renovating your landscape, it's wise to keep some of the plants you already have. In an established landscape, retaining trees, shrubs, perennials, and other plants will save you money—and it also preserves established wildlife habitat. If you are dealing with new home construction, leaving plants in place will help reduce erosion. The trick is knowing which plants to keep.

Follow these simple guidelines to sift through your botanical choices:

- **Keep healthy plants** that show good form and are growing in appropriate locations. Consider just pruning healthy, overgrown shrubs.
- **Discard tightly spaced plants.** Over time, tight spacing fosters insect and disease problems and stresses plants. Overcrowding can also cause leggy growth from plants competing for sunlight and nutrients. It's best to get rid of plants that are grouped too closely together.
- **Retain trees with long lifespans.** Some examples are live oak (*Quercus virginiana*), mahogany (*Sweetenia mahogany*), and sabal palm (*Sabal palmetto*). Remove trees that are short-lived, like cherry laurel (*Prunus caroliniana*); prone to decay, such as mature laurel oak (*Quercus laurifolia*); or weak-wooded, such as pine (*Pinus*).
- **Save clusters of trees and the plants growing beneath them.** Trees growing in groups or shady forests often grow very tall and narrow. If the site is cleared, an isolated tree becomes vulnerable to wind damage and could snap or fall over during a windstorm or hurricane. For this reason, it is best to leave trees in clusters. The cluster should include the trees along with any groundcovers or native shrubs growing beneath them. This trio of trees, shrubs, and groundcovers buffers wind and maintains habitat for wildlife.



Plant trees in clusters to protect from wind damage.

- **Remove unsuitable plants.** These include unhealthy plants, invasive plants, and plants that require constant

care to survive. Plants with these characteristics are usually more trouble than they're worth.

- **Move plants located too close to walls.** They block air currents and prevent access for home maintenance.



Move plants that block air currents or interfere with home maintenance.

- **Relocate plantings out from under eaves.** They often prove problematic, as they may not receive adequate rainfall or may be damaged by the force of rainwater dropping from the roof.

Once you know which plants you intend to keep, ensure that roots are not damaged through construction activities or soil compaction, which can damage or kill a plant. Avoid driving over the roots of plants, especially trees, with heavy vehicles; digging into the root zone area; and mounding soil against the base of plants. To protect trees during construction, construct barricades at the edge of the canopy drip line. Even though this does not protect the entire root system, it will improve your trees' odds of survival.

Trees particularly sensitive to soil compaction include sweetgum (*Liquidambar*), dogwood (*Cornus* spp.), sassafras (*Sassafras* spp.), tupelo (*Nyssa* spp.), pine (*Pinus* spp.), white oak (*Quercus alba*), laurel oak (*Quercus laurifolia*) and most nut trees, such as black walnut (*Juglans nigra*), hickory (*Carya* spp.), and pecan (*Carya illinoensis*).

## Planting Trees

Begin your landscape renovation by putting walkways, irrigation systems, or patios into place first; then plant trees. Because trees are a more permanent addition to the landscape, careful site selection and proper planting techniques are essential.



## TREES CAN HELP

Not sure where to start with a new landscape? Plant trees. Establishing a tree canopy is a great way to begin your Florida-Friendly yard. Trees not only provide shade and wildlife habitat, they also help to reduce stormwater runoff. Trees significantly increase the value of a home and lot. According to the American Forestry Association, trees have other significant monetary benefits. Each year, a single tree provides \$73 worth of air conditioning savings, \$75 worth of erosion control, \$75 worth of wildlife shelter, and \$50 worth of air pollution reduction. Compounding this annual total of \$273 for 50 years at 5 percent interest results in a tree value of \$57,151. The overall benefits far outweigh the initial cost and maintenance of each tree.

1. **Look up.** Find a new planting site if there is a wire, security light, or building nearby that could interfere with the tree as it grows.
2. **Dig a wide, shallow hole.** Dig a hole that is one and one-half to three times the width of the root ball (the roots and soil attached to the plant when you remove it from its pot).



Loosen the root ball.

3. **Find the point where the topmost root emerges from the trunk.** This point is called the trunk flare, root flare, or root crown and should be 2 inches above the soil surface.

## WHERE ARE TREE ROOTS?

A tree resembles a wine glass placed on a dinner plate. Consider the base of the wine glass as the lowest part of the trunk where major roots flare outward. The dinner plate represents the rest of the root system, which extends far beyond the drip line—up to three times the canopy's diameter, depending on the species. Vertically speaking, most tree roots are located in the top two feet of soil, where oxygen is most available.

4. **Slide the tree into the planting hole and position it carefully.** Place the trunk flare slightly above the surface of the landscape soil and begin to fill the hole with the excavated soil, making sure the tree is straight as you go. As you add the soil, slice a shovel down into it twenty to thirty times, all around the tree. Compress the soil to stabilize the tree.



The trunk flare should be two inches above the soil surface.

5. **Add plenty of water to the root ball and planting hole.** Make sure the root ball and surrounding soil are thoroughly moistened. Add more soil around the root ball if needed.
6. **Cover the backfill soil with mulch.** Apply mulch to a minimum 8-foot diameter circle around the tree, with a gap of 12 inches between the trunk and the mulch.



Cover the backfill soil with mulch.

7. **Stake the tree, if necessary.** Staking holds the root ball firmly in the soil. Top-heavy trees might require staking, especially if they're located in a windy location.
8. **Water trees frequently so roots fully establish.** Light, frequent irrigation fosters the quickest establishment for trees (see "Establishing Trees" on page XX for more information). Following the initial few months of frequent irrigation, water weekly until plants are fully established.

For more information about planting trees, visit <http://gardeningolutions.ifas.ufl.edu>.



## CHOOSING A TURFGRASS

Grass is a good choice for areas with high recreational use, for erosion control, or for use in a swale (an open channel with gently sloping sides that collects and slows the flow of rainwater). When planning a grass area, carefully consider which type of turfgrass is best for your site conditions and your desired maintenance level. (For example, bermudagrass and seashore paspalum are not usually recommended for home lawns because of their high maintenance requirements. For more information about them, visit <http://yourfloridalawn.ifas.ufl.edu>.) Groundcovers may be more successful and practical in low-traffic areas, heavily shaded spots (such as under trees), or on steep slopes where grass is difficult to maintain. Keep these factors in mind when choosing a turfgrass:

- **Drought tolerance.** St. Augustinegrass will not thrive in some sites without supplemental irrigation in dry times. Bahiagrass will survive without supplemental irrigation by going into drought-induced dormancy, but may not form a lawn as dense as other grasses. Centipedegrass and zoysiagrass need slightly less water than St. Augustinegrass but do require supplemental irrigation to remain green and healthy during dry periods.
- **Shade tolerance.** Most turfgrasses grown in Florida are sun-loving, but some will grow in areas with partial shade. Dwarf St. Augustinegrass cultivars such as 'Captiva', 'Delmar', and 'Seville' are best for shaded areas and can tolerate as few as five to six hours of sunlight daily. 'Floritam' has the lowest shade tolerance and does best where it will receive seven to eight hours of sunlight per day.



Sun-loving turf cultivars will not thrive in shady conditions.



Shade-loving shrubs are a better choice for underneath trees.

- **Wear tolerance.** This term describes how well a turf species will stand up to repeated traffic, either human or vehicular. Most zoysiagrasses have relatively high wear tolerance.
- **Salt tolerance.** This is mainly a concern for lawns in coastal areas, where salt spray from the ocean or use of reclaimed/recycled water may expose the grass to higher concentrations of salt. St. Augustinegrass and zoysiagrasses are the better choices for these areas, although they may sustain injury with high levels of salinity. Bahiagrass and centipedegrass have relatively poor salt tolerance.
- **Fertility requirements.** A lawn that needs more fertilizer costs a homeowner more time, money, and effort. Centipedegrass and bahiagrass have relatively low fertility requirements, while zoysiagrass and some cultivars of St. Augustinegrass need more fertilizer and consequently more water and pest control. When choosing a grass type, consider the time and money you are willing to spend on maintenance.
- **Climatic conditions.** Florida's climate varies greatly from north to south. It's important to research which species and cultivars are best suited to your region of the state and your soil type. Consulting your county Extension office is always a good idea.
- **Leaf texture.** Leaf texture describes the width and coarseness of the grass blades. Although often preferred, the fine-textured leaf blades have higher maintenance requirements.
- **Pest & disease problems.** Each species and cultivar of turfgrass is prone to certain insect pests and fungal or bacterial pathogens. St. Augustinegrass often suffers from chinch bugs, while zoysiagrass is prone to hunting billbugs and brown patch disease. Know which pests and diseases your chosen grass is most prone to, and be aware of what your control options are.

For more information about selecting a turfgrass for your landscape, visit <http://gardeningolutions.ifas.ufl.edu>.

## TURFGRASS SELECTOR

CHARACTERISTICS	SPECIES			
	Bahiagrass 	Centipedegrass 	St. Augustinegrass 	Zoysiagrass 
Area Adapted To	Statewide	N. Fla. and Panhandle (except for 'Hammock')	Statewide	Statewide
Mowing Height (inches)	3–4	1.5–2.5	3.5–4 (2–2.5 for dwarf cultivars)	1.5–2.5
Soil	Acid, sandy	Acid, sandy, or clay	Wide range	Wide range
Leaf Texture	Coarse–Medium	Medium	Coarse–Medium	Fine–Medium
Drought Tolerance	Excellent	Medium	Fair	Medium
Salt Tolerance	Poor	Poor	Good	Good
Shade Tolerance	Poor	Fair	Good (cultivar-dependent)	Good (cultivar-dependent)
Wear Tolerance	Poor	Poor	Poor	Good–Excellent
Nematode Tolerance	Very good	Poor	Good	Depends on cultivar
Maintenance Levels	Low	Low	Medium	Medium

### CHOOSING A LANDSCAPE MAINTENANCE SERVICE

If you lack the time, desire, or ability to tackle your own landscape work, you may decide to hire a professional landscape maintenance company. Look for companies whose employees have obtained a certificate of completion in the Florida-Friendly Best Management Practices for Protection of Water Resources by the Green Industries (GI-BMPs), a joint program of the Florida Department of Environmental Protection and UF/IFAS. In many areas, this training is already mandatory, and by January 1, 2014, all commercial fertilizer applicators must have a license from the Department of Agriculture and Consumer Services (FDACS) (482.1562, F.S.)

Ask potential hires if they follow these Florida-Friendly practices:

### PEST CONTROL

- Monitor for pests instead of routinely treating
- Use the least toxic methods of managing pests
- Apply pesticides only with your approval

### FERTILIZER

- Apply fertilizer only if plants show signs of nutrient deficiencies, and follow UF/IFAS recommendations and BMPs
- Use slow-release fertilizers
- Avoid fertilizers containing weed killer or insecticide
- Sweep fertilizer from sidewalks and driveways

## LAWN CARE

- Mow turf areas only as needed, according to seasonal growth
- Mow no more than one-third the height of the grass blades per mowing, using a reel, rotary, or mulching mower
- Mow turf to University of Florida-recommended height for your species and cultivar (see chart on page 13)
- Maintain sharp mower blades at all times
- Leave grass clippings on the lawn and use yard waste as mulch or compost

## IRRIGATION

By law, automatic irrigation systems must have a functioning rain sensor or other device to bypass irrigation if adequate moisture is present. Licensed contractors are required by law to install, repair, or replace these control devices if they are not installed and working properly before doing any other work on an irrigation system.

- Inspect and test rain shut-off devices and other components and zones in the irrigation system regularly
- Make regular minor adjustments and repairs to irrigation systems such as head cleaning and replacement, filter cleaning, small leak repair, and minor timer adjustments

## YARD WASTE

- Don't sweep or blow yard waste into storm drains
- Replenish all mulched areas regularly to maintain 2- to 3-inch layer using pine bark, pine needles, melaleuca, eucalyptus, or other Florida-Friendly materials

For more information on selecting a landscape maintenance service, please visit <http://fyn.ifas.ufl.edu>.

## QUALIFICATIONS TO LOOK FOR

Landscape maintenance professionals can take many kinds of trainings and display many different certifications—but there are only a few that UF/IFAS recommends. Ask if any of a landscape maintenance company's employees have any of the following licenses or certifications:

- Florida-Friendly Best Management Practices (Florida Department of Environmental Protection and UF/IFAS)



Professionals can use different techniques and products than a homeowner.

- International Society of Arboriculture (ISA) certification
- Florida Irrigation Society (FIS) or Irrigation Association (IA) certification
- Florida Certified Horticulture Professional (FCHP) certification from the Florida Nursery, Growers, and Landscape Association
- Limited Commercial Landscape Maintenance Certification (Florida Department of Agriculture and Consumer Services)
- Pesticide Applicator License (FDACS)

## WE WANT TO KNOW ABOUT YOUR SUCCESS!

Photograph the evolution of your Florida-Friendly yard, and share pictures with the horticulture agent or FYN program coordinator at your county's UF/IFAS Extension office. Let us learn from your experience and share your knowledge with others. "Before" and "after" shots with captions are particularly useful to illustrate your success. In some counties, FYN offers official yard recognition for landscapes that meet the Florida-Friendly criteria. Contact your county Extension office for more information (<http://SolutionsForYourLife.com/map>).



## #2: Water Efficiently

### REDUCE WATER BILLS, PEST PROBLEMS, AND MAINTENANCE NEEDS

We all know water is a limited resource and should be used wisely, but we often overwater our landscapes unintentionally. Overwatering does more than deplete the water supply; it also makes plants more prone to disease and pests. By choosing and operating a watering system correctly, you can reduce water bills, decrease plant problems, and lower maintenance requirements. For example, the more you water your lawn, the faster it grows and the more it needs to be mowed. It's also more likely to develop fungal problems that require treatment with pesticides.

Overwatering can also cause water pollution via a process called leaching. Leaching happens when more fertilizer is applied to a landscape than the plants can absorb, or when heavy rains and overwatering cause nutrients to travel quickly through Florida's sandy soils, past plant roots, and into the aquifer. Eventually these nutrients can reach nearby water bodies, disrupting natural systems.

#### WATER RESTRICTIONS

Florida's five water management districts (WMDs) are state agencies that manage and protect our water resources on a regional basis. The water restrictions issued by your WMD or local government—in many areas, they're in effect year-round—should be followed exactly, as they exist to ensure that there's enough water for everyone.

Restrictions usually limit watering with a sprinkler or irrigation system to certain times on certain days of the week. These times and days may be different depending on your house number, neighborhood, or side of the street. Water restrictions in your area may also be called "irrigation schedules." Water restrictions apply to everyone and every water source in a WMD. (Water use requirements may be different with reclaimed/recycled water.)

Even if it is your assigned day to irrigate, that doesn't mean you should irrigate. Scheduled watering can waste money and water. Don't let the calendar tell you when to water—look to your plants for telltale signs of thirst and turn on your irrigation system manually instead of allowing the automatic controller to run on a set schedule. For information about setting your irrigation controller, visit <http://fyn.ifas.ufl.edu>.

#### WATER-WISE ADVICE

##### 1. Choose the right plant for the right place

All plants must get the right amount of sun, water, and nutrients to thrive—even natives.

- Select plants suited to your area.

#### WATER MANAGEMENT DISTRICTS

Figure out what water management district you live in, and follow the water restrictions for your area.

Northwest Florida Water Management District:  
<http://nwfwmd.state.fl.us>  
(850) 539-5999

St. Johns River Water Management District:  
<http://floridaswater.com>  
(386) 329-4500 or (800) 232-0904

Southwest Florida Water Management District:  
<http://swfwmd.state.fl.us>  
(352) 796-7211 or (800) 423-1476

South Florida Water Management District:  
<http://savewaterfl.com>  
(561) 686-8800 or (800) 432-2045

Suwannee River Water Management District:  
<http://www.srwmd.state.fl.us>  
(386) 362-1001 or (800) 226-1066

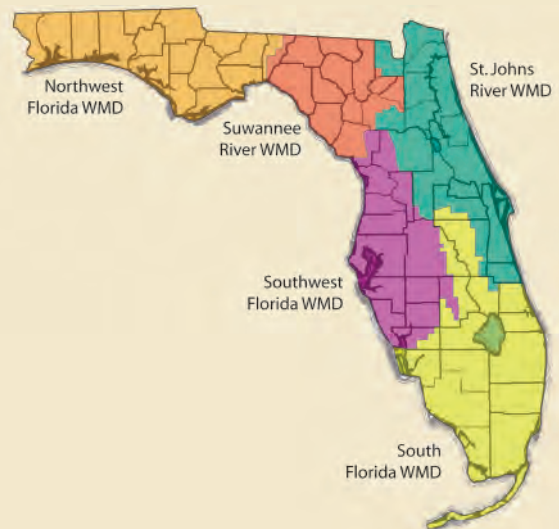

Florida is divided into five water management districts.

- Place plants in the landscape where site conditions match their needs.
  - Group plants with similar water needs together.
2. Water thoughtfully  
A drop here and a drop there can add up to a lot of water.

- Always follow any water restrictions in your area.
- Water early in the morning.
- Irrigate plants and grass only when they start to wilt, as allowed by water restrictions.

### 3. Handwater when possible

Handwatering is usually allowed during water restrictions, because it uses less water than an automatic irrigation system.

- Use a watering can, pail, or hose with an automatic shutoff nozzle.
- Handwater potted plants, shrubs, trees, vegetables, and flower beds.
- Check if your water management district limits handwatering.



Handwater whenever possible.

### 4. Perform regular irrigation system maintenance

An irrigation system is only as efficient as it's maintained to be.



Perform regular irrigation system maintenance.

- Check for and repair leaks.
- Unclog and replace broken heads.
- Point heads at plants, not driveways and sidewalks.
- Prune plants that interfere with irrigation systems.

### 5. Calibrate irrigation system

Even an efficient irrigation system can waste water if it's left on for too long. The ideal amount of water to apply to a lawn is  $\frac{1}{2}$  -  $\frac{3}{4}$  inch. See page 19 for information on how to calibrate your system.



A rain barrel can save excess rainwater for dry times.

### 6. Make a rain barrel

Rain barrels capture rainwater that flows off your roof. They're easy and inexpensive to make. Instead of watering your plants with water you're paying for, you're using free water!

### 7. Use microirrigation

Drip or micro-spray irrigation systems apply water directly to the roots of plants, where it's needed, and lose minimal water to evaporation or wind drift.

### 8. Mulch plants

Mulch helps keep moisture in the soil around your plants. Choose from many different kinds of mulch and apply two to three inches around trees, shrubs, flowers, and vegetables.

### 9. Mow correctly

How you mow your lawn can have a big impact on how much water it needs. Raise your mowing deck to promote a healthy root system, which will make your grass more drought tolerant.

### 10. Be a weather watcher

Rain is irrigation, too. Use it to your advantage—it's free!



- Don't water your landscape if it's rained in the past twenty-four hours or if rain is forecast in the next twenty-four hours.
- Purchase a rain gauge to track how much rain your plants are getting.
- Install a rain shut-off device or soil moisture sensor to override your irrigation system when it's raining.

## CALIBRATING IRRIGATION SYSTEMS

Follow these steps to determine how much water your irrigation system is applying:

- Set out five to ten flat-bottomed, straight-sided cans (all of equal size). Containers that are three to six inches in diameter, such as cat food or tuna cans, work best for this.
- If you have an in-ground system, place the containers in one zone at a time, scattering the cans randomly throughout the zone. You'll need to repeat this procedure in each zone.
- If you use a hose-end sprinkler to water your turf, place the containers in a straight line from the sprinkler to the edge of the watering pattern. Space the containers evenly.
- If you have a drip irrigation system, place the cans under emitters.
- Turn on sprinklers for fifteen minutes.
- Use a ruler to measure the depth of water in each container. The more precise your measurement, the better your calibration will be. Measurement to the nearest  $\frac{1}{8}$  inch should be adequate.
- Find the average depth of water collected in the containers by adding up the depths and dividing by the number of containers.
- To determine the irrigation rate in inches per hour, multiply the average depth of water times four (since you ran the water for fifteen minutes).
- Check your system yearly to make sure it's working properly.



Drip tubing.



Bubbler.

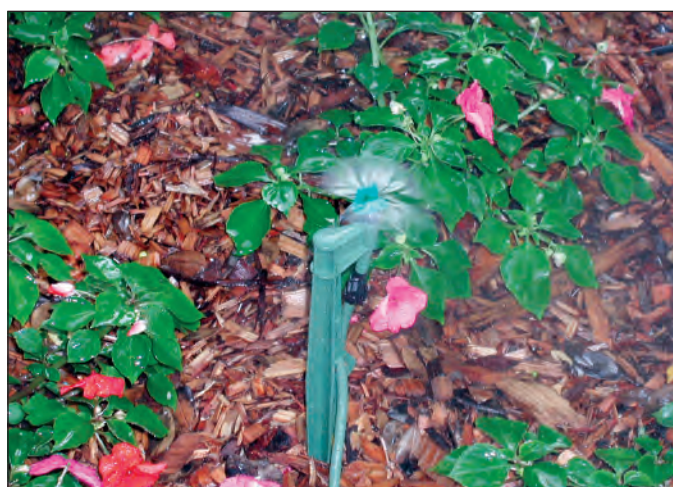

Micro-spray.

## MICROIRRIGATION

Microirrigation systems deliver small volumes of water directly to the root zone through low-flow emitters, such as micro-spray jets, bubblers, or drip tubes.

Microirrigation can be a great way to water your plants more efficiently. It can be installed under shrubs and trees, in planting beds, and in containers, but should be avoided in lawns.



- Drip or micro-spray fittings can clog; you may need to filter the water source. Inspect fittings regularly and clean them when necessary. Insects, rodents, and enthusiastic hoeing can damage drip tape or tubing.
- If you already have an irrigation system, your options for converting to microirrigation may be limited. But sometimes low-pressure emitters, such as bubblers, can be adapted to existing sprinkler heads. This may require a pressure regulator at the source to reduce water pressure.
- Although microirrigation equipment releases small amounts of water, overwatering is still possible if the system is left on for too long.

## SOAKER HOSES

While plants are becoming established in your yard, you may want a temporary watering system—it's convenient and usually worth the effort. Temporary watering systems could be a soaker hose or just a garden hose attached to a sprinkler.

Unlike regular garden hoses, soaker hoses seep or leak water along their entire length, delivering it to the soil around the plants. Lay the hose on top of the soil, or bury it slightly in the soil or mulch. Landscape staple pins work great for holding the hose in place. If you decide to use a soaker hose or other temporary watering system, purchase a battery-powered timer to hook up to the spigot. The timer will help you make sure you don't leave the water running longer than it needs to.

Use the soaker hose until your plants are established, and then install or use a more permanent irrigation system if needed. Soaker hoses aren't recommended for long-term use because they distribute water inefficiently.

## RAIN & SOIL MOISTURE SENSORS

Rain and soil moisture sensors are shut-off devices that provide a great way to save water in your landscape. These devices detect when a certain amount of rain has fallen or when a certain level of moisture is present in the soil. They will then shut off your irrigation system, making sure it doesn't run when it's not needed.

Any person who purchases and installs an automatic landscape irrigation system must properly install, maintain, and operate technology that inhibits or interrupts operation of the system during periods of sufficient moisture.

A licensed contractor who installs or performs work on an automatic landscape irrigation system must test for the



Soil moisture sensor.

correct operation of each inhibiting or interrupting device or switch on that system. If such devices or switches are not installed in the system or are not in proper operating condition, the contractor must install new ones or repair the existing ones and confirm that each device or switch is in proper operating condition before completing other work on the system.

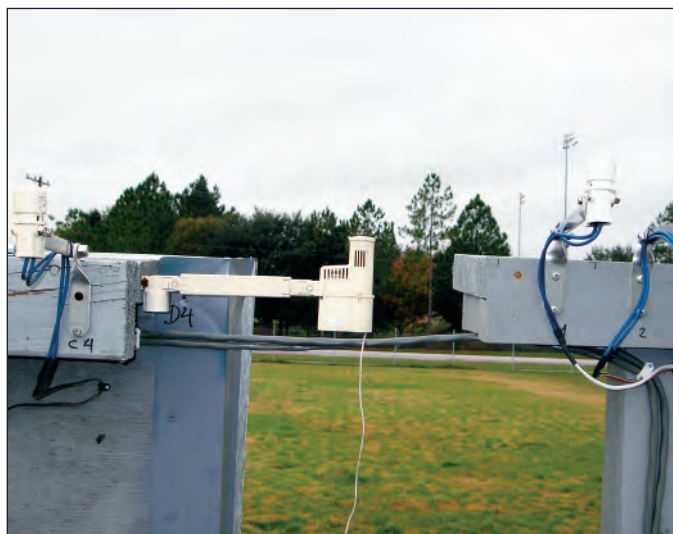

Rain sensors.

These devices, and others like “smart” control systems such as soil moisture sensing or evapotranspiration-based controllers, conserve water, save you money, and reduce wear on your irrigation system. They can also help prevent turf disease and other problems caused by excess moisture. Make sure yours is working properly, or replace or repair it if needed.

## ESTABLISHING PLANTS

Remember to water your new plants thoroughly when establishing them. In North and Central Florida, you'll

need to irrigate 3-gallon plants two to three times per week. In South Florida, irrigate three to four times per week. For each watering, apply 3 liters (about .8 gallons) of water. Irrigate your new plants until they're established, which usually takes fifteen to twenty weeks. You may need to handwater plants to comply with local water restrictions. Once your plants are established, water on an as-needed basis, continuing to comply with the irrigation schedule mandated by your water management district.

### ESTABLISHING TREES

Newly planted trees need regular irrigation to rapidly grow the roots necessary for proper establishment. For trees planted in spring or summer, water two to three times per week. After the first few months, provide weekly irrigation until plants are fully established. Irrigations should be 2 to 3 gallons of water per inch trunk diameter. For example, a 2-inch tree should be watered 4 to 6 gallons each irrigation. Again, handwatering may be the only way you can follow this schedule and still comply with water restrictions.

### DROUGHT-TOLERANT LAWNS

All turfgrasses need water to remain green, whether it comes from rainfall or supplemental irrigation. Drought-tolerant grasses will go into dormancy during dry periods, growing more slowly or turning brown until conditions are favorable for growth. When enough soil moisture returns, these grasses can usually recover from drought-induced dormancy, rather than dying. Bahiagrass and centipedegrass are more drought tolerant than zoysiagrass and St. Augustinegrass, but for all grass types, proper watering and mowing practices will encourage the grass to develop deep roots that aid recovery from drought stress. In other words, you can make your lawn more drought tolerant no matter what kind of grass you have.

When rainfall is inadequate, grasses will require supplemental irrigation to remain green. But you can train your lawn to use less water by following these easy steps:

- **Mow your lawn at the highest recommended setting** for your grass type (see page 13) and don't remove more than one-third of the grass blade at each mowing. Mowing high results in deeper roots, which is important in developing drought tolerance and minimizing irrigation requirements.

- **Keep your mower blades sharp.** Leaves cut by a dull blade will need more water.



Keep mower blades sharp and clean.

- **Adjust irrigation frequencies** by season, weather conditions, and your region of the state. Don't irrigate until you see signs of wilt, making sure to comply with water restrictions.



Let your lawn tell you when to water.

- **Water infrequently and deeply.** This will train the grass roots to grow deep. Make sure you don't overwater—just fill the root zone with  $\frac{1}{2}$  -  $\frac{3}{4}$  inch per application.
- **Spot-treat pest problems only as needed.** Chemicals can cause damage and stress to the grass, which can increase its need for water.

For more information on caring for your lawn, see <http://gardeningolutions.ifas.ufl.edu>.

## LANDSCAPE PLANNING WORKSHEET

This worksheet can be used for both new and established landscapes. By following these steps, you're almost guaranteed a thriving, low-maintenance landscape suitable to your climate and needs.

### 1. Decide why you want to landscape.

Most homeowners think of landscaping as a way to add beauty to their home or to improve the resale value. Other reasons to landscape are more specific, such as enhancing or screening a view, creating a microclimate, or attracting wildlife to a yard. You may need a play area for your children, or perhaps you'd like to entertain family and friends outdoors. Your passion may be raising vegetables or simply savoring a lovely view.

How will you use your landscape? (A typical landscape has multiple uses.)

---

---

---

---

---

### 2. Obtain a soil analysis.

Soil plays a big part in any landscape project, influencing what plants will thrive in your yard. Determine the soil's texture (sandy to clay), and have it tested to determine the pH—the level of acidity or alkalinity. This information will help you decide which plants are best suited to the conditions of your yard. Read more about soil starting on page 6.

Type of soil in your landscape: \_\_\_\_\_

pH: \_\_\_\_\_

Any exceptions? (For example, maybe the place where you want to put a planting bed has more acidic soil than other areas in the landscape.)

---

---

---

---

### 3. Inventory your landscape.

Walk around your property, noting conditions that make your yard unique. Does your site call for plants that are tolerant of cold, wind, full sun, shade, drought, occasional flooding, or salt spray? Also take note of the locations of more permanent features, including utilities, hardscapes like the driveway, and water sources such as hoses.

What kinds of conditions does your landscape have? \_\_\_\_\_

---

---

---

---



# #3: Fertilize Appropriately

## PREVENT POLLUTION AND MAXIMIZE PLANT HEALTH

All plants need nutrients for growth. They must obtain these nutrients from the soil or other medium in which they're growing. Gardeners can also provide supplemental nutrients to plants by applying fertilizers in the form of composted organic material, packaged fertilizer, or a specific mineral such as iron.

Plants have varying nutrient needs, depending on the species, the age of the plant, and its location. It's not always necessary to fertilize your plants or lawn, but if you choose to fertilize, it's important that you do so properly. This section will help you correctly choose and apply the right type of fertilizer.

Too much fertilizer can weaken a plant, promote disease, and invite pests, in addition to wasting money and harming the environment. It also means more pruning and mowing. So consider your plants' needs carefully before applying any fertilizer, and always follow label directions when using fertilizer.

### FERTILIZER COMPONENTS

Most fertilizers available for use in the home landscape or garden are blends of several elements mixed together to achieve a specific formulation of plant nutrients.

### MACRONUTRIENTS

Macronutrients are nutrients required by plants in relatively large amounts for optimum plant growth. The three main nutrients contained in fertilizers are nitrogen (N), phosphorus (P), and potassium (K), represented by three numbers that appear on the bag. A complete fertilizer will contain all three of the major plant nutrients. Other macronutrients include calcium (Ca), magnesium (Mg), and sulfur (S).

### MICRONUTRIENTS

Micronutrients are nutrients most plants need in small quantities and are sometimes referred to as trace elements or minor elements. These nutrients—which include boron (B), chlorine (Cl), copper (Cu), iron (Fe), manganese (Mn), molybdenum (Mo), and zinc (Zn)—are often available in sufficient quantities in the soil, but are also present in many fertilizers. Micronutrients are also sold as individual nutrients.

### ARE FERTILIZERS NEEDED?

Before you use fertilizer, you should always determine if it's really needed. Keep in mind that certain plants are more prone to specific kinds of nutrient deficiencies (for example, ixora and palms tend to run low on manganese).

### VISUAL SIGNS

Your plants will indicate when they lack certain nutrients—you just have to know what to look for. Plant nutrient deficiency symptoms are often symmetrical (for

example, yellowing areas that appear to be mirror images on a plant leaf), whereas pathogenic (e.g., fungal or bacterial) problems tend to appear more randomly on the plant. Remember that many nutrient deficiencies look similar. Any time you're not certain of what ails a plant, take a sample into your county Extension office for help.

### SOIL TESTING

A soil test can help you understand what nutrients are present in your soil. This is important for deciding what nutrients, if any, you should add. Your county Extension office can help you with this. For more information about testing your soil, see page 7.

### PREVENTING POLLUTION

Fertilizer is a powerful tool that can help plants thrive—if used appropriately. If applied incorrectly, it can not only harm plants, but also the environment. To prevent water pollution from nutrient leaching and runoff, always follow these steps when fertilizing your lawn or landscape.

#### IN GENERAL

- **Follow UF/IFAS** recommendations. Ideal rates, application timings, and formulas are different for different plants.
- **Choose slow-release products.** Look for fertilizers with slow-release nutrients. They should include potassium and little or no phosphorus.
- **Keep fertilizer off hard surfaces.** If fertilizer gets spilled on a hard surface (like a driveway), sweep it up and dispose of it. Fertilizers can wash into storm drains and from there into a nearby water body.



Do not rinse fertilizer into storm drains.

- **If you spill fertilizer on the lawn, collect whatever you can.** It might be tempting to just water extra fertilizer into the lawn, but the excess nutrients will leach (seep downwards) through the soil and into the groundwater.



Sweep up fertilizer spills on the lawn.

- **Never fertilize within 10 feet of any water body.** Designate a 10-foot maintenance-free zone between your landscape and the riparian zone.



Never apply fertilizer within 10 feet of any water body.

- **Don't fertilize before a heavy rain.** If rain is forecast in the next twenty-four hours, hold off on applying fertilizer. Rain can wash fertilizer off lawns or cause it to leach into groundwater, contributing to pollution.
- **Know your water source.** If you use reclaimed/recycled water for irrigation, keep in mind that it can contain

nutrients, including nitrogen, and adjust the amount you fertilize accordingly.

#### FOR LAWNS

- **Apply fertilizer only when grass is actively growing.** Many Florida turfgrasses go dormant or slow their growth in cooler seasons. Water it in with  $\frac{1}{4}$  inch of water or less.
- **Use a broadcast spreader with a deflector shield.** Don't use a drop spreader, which can damage the coatings on slow-release fertilizers, rendering them quick-release.



A deflector shield directs fertilizer away from your maintenance-free zone.

- **Avoid using "weed and feed" products.** These contain herbicides and fertilizer together.
  - These products can injure some trees and shrubs. Tree and shrub root systems can extend far beyond the canopy drip line, intermingling with turf.
  - Pesticides should be applied only to affected areas, rather than broadcast over the entire yard as occurs with a weed and feed product.
  - The appropriate timing is often different, with pre-emergent herbicides applied far earlier than fertilizer. This almost ensures that one or the other is ineffective, if not harmful.
- **Apply an iron source instead of a nitrogen fertilizer.** To green the lawn without increasing growth in the summer, use chelated iron or iron sulfate.

## SELECTING A FERTILIZER

A wide range of fertilizers is available for gardeners. You can select from different combinations of nutrients that come in a variety of forms. The key to selecting a fertilizer is understanding what nutrients your plants need.

## INORGANIC FERTILIZERS

Inorganic fertilizers are materials that are mined or synthesized from non-living materials. Many inorganic fertilizers contain nutrients that are immediately available to plants. Others are formulated to allow nutrients to be released



over a period of time. If you use an inorganic fertilizer in your landscape, choose one with some or all of the nutrients in slow- or controlled-release form, so that the plants will be able to take up the fertilizer as it is gradually released.

### ORGANIC FERTILIZERS

Organic fertilizers are materials that are derived from plants and animals; one of the most common forms is manure. Animal manure can come from chickens, cows, pigs, sheep, horses, or rabbits and should always be composted before use in vegetable gardens to reduce risk to food safety. (Keep in mind that these products often contain high levels of phosphorus, which has been shown to cause water pollution, and should be applied carefully.) Never use cat or dog manure or human waste—there is a greater risk of these sources transmitting disease. Homemade compost (typically made of kitchen scraps and/or yard waste) is another excellent source of organic matter for garden soils. It usually contains small amounts of nitrogen and potassium, but very little phosphorus. Both composted manure and compost also contain micronutrients.

Most of the nutrients in composted manure and compost are available more slowly than those in most inorganic fertilizers. The quick availability of nutrients, especially nitrogen, in inorganic fertilizers is very important in vegetable growing. If you're growing vegetables, you may want to supplement any organic fertilizer you apply with some inorganic fertilizer for quick feeding.

### READING THE LABEL

When selecting a fertilizer, look at the three numbers on the bag. They will read something like 15-0-15 or

GUARANTEED ANALYSIS	
Total Nitrogen (N).....	35.0%
35% Urea Nitrogen*	
Soluble Potash (K <sub>2</sub> O).....	5.00%
Boron (B).....	0.03%
Copper (Cu).....	0.05%
Iron (Fe).....	5.00%
0.10% Water Soluble Iron (Fe)	
Manganese (Mn).....	0.05%
Molybdenum (Mo).....	0.0006%
Zinc (Zn).....	0.05%
<b>Derived from:</b> Polymer-coated Urea, Urea, Muriate of Potash, Sodium Borate, Copper Oxide, Ferric Oxide, Ferrous Sulfate, Manganese Oxide, Molybdic Oxide and Zinc Oxide.	
* Contains 15% slowly available Nitrogen from coated Urea.	
F1074	

Always check the N-P-K ratio and quantity of slow-release nitrogen.

16-2-8. The first number represents the percentage of nitrogen in the bag, the second refers to phosphorus, and the third number is the amount of potassium. For example, a 50-pound bag of 16-2-8 is 16 percent nitrogen (8 pounds total); 2 percent phosphorus (1 pound total); and 8 percent potassium (4 pounds total). The remaining weight is usually comprised of inert ingredients. Nitrogen and phosphorus cause the most problems with regard to water pollution.

## SLOW- & CONTROLLED-RELEASE FERTILIZERS

Slow- and controlled-release fertilizers provide nutrients to plant roots over an extended period of time. This allows you to fertilize less frequently—and to prevent nutrients from leaving your landscape and entering waterways, contributing to harmful algal blooms and other water quality problems.

In Florida, any fertilizer that is labeled “slow-release” or “controlled-release” must contain 15 percent or more slow- or controlled-release nitrogen. The label will indicate the percentage of slow- or controlled-release nutrients in the fertilizer, and it’s a good idea to look for a fertilizer with higher amounts of slow-release nitrogen.

Slow- or controlled-release fertilizers can be applied to your lawn, bedding plants, trees, and any other plants that need nutrients.

### FERTILIZING LANDSCAPE PLANTS

If you're happy with the color and appearance of your landscape plants (shrubs, flowers, trees, etc.), you don't need to fertilize them. Many established plants don't need fertilizer, and many trees will thrive without it. Remember that fertilizer applied to turf will reach the roots of plants nearby, so if you fertilize your lawn, your plants may already be getting all the nutrients they need.

Even when plants show signs of nutrient deficiencies, keep in mind that fertilizer might not help—these plants may not be suited for their location or their roots may be damaged in some way. Consider removing high-maintenance plants from your landscape and substituting lower-maintenance choices.

### PALMS & CYCADS

Palms and cycads have more complex nutritional requirements than other landscape plants. The ideal fertilizer for palms and cycads has an analysis of 8-2-12-4 Mg; all of its



Palms have special nutritional needs.

N, K, and Mg should be in slow- or controlled-release form. Since palms are prone to several potentially fatal micronutrient deficiencies, this fertilizer should also contain 1–2 percent iron (Fe) and manganese (Mn), plus trace amounts of zinc (Zn), copper (Cu), and boron (B). Using fertilizers with ratios other than the one given may cause or intensify nutrient deficiencies.

### FERTILIZING THE LAWN

A properly maintained lawn filters stormwater runoff, reduces air temperatures, and helps prevent pollution and stabilize soil. Grass that receives appropriate levels of fertilizer—not too little and not too much—might also require fewer cultural or chemical controls for weeds, insects, and diseases, since it grows more vigorously and is strong and healthy.

On the other hand, fertilizing incorrectly can aggravate pest problems, stimulate excessive growth, and require

frequent watering. In addition, when too much nitrogen fertilizer is used on lawns, it can leach through the ground, past the root zones of grass, plants, and trees, and into the aquifer, where almost all of the freshwater used in Florida comes from. It can also be washed off by rainfall directly into surface water or stormwater systems.

### *How much fertilizer should I apply to a lawn?*

No matter what kind of grass you have or where in the state you live, you should not apply more fertilizer than the rate listed on the label. If using a quick release product, apply only up to 0.5 pound of nitrogen per 1,000 square feet.

How much fertilizer that translates to depends on the percentage of nitrogen in your fertilizer and the size of your landscape. To calculate how much fertilizer to apply to your lawn, use the following table.

**TABLE 1A.**

Recommended application rates for turfgrass fertilizers to Florida lawns: 30% or more slow-release nitrogen.

In the table below, match the size of your lawn to the percentage of nitrogen (N) in your fertilizer to find the amount of fertilizer you need to apply. If you have a bahiagrass lawn, apply this amount of fertilizer about twice a year no matter where you live in the state. For centipedegrass, apply about once a year in North Florida and once or twice a year in Central and South Florida. For St. Augustinegrass or zoysiagrass, apply about two or three times a year in North and Central Florida and three or four times a year in South Florida. UF/IFAS recommends soil testing for phosphorus content before any P fertilizer is applied.

	6% N	10% N	12% N	15% N	16% N	23% N	27% N
1,000 ft <sup>2</sup>	16.5 lbs	10 lbs	8.5 lbs	6.5 lbs	6 lbs	4.5 lbs	4 lbs
1,100 ft <sup>2</sup>	18.5 lbs	11 lbs	9.5 lbs	7 lbs	7 lbs	5 lbs	4 lbs
1,200 ft <sup>2</sup>	20 lbs	12 lbs	10.5 lbs	8 lbs	7.5 lbs	5 lbs	4.5 lbs
1,300 ft <sup>2</sup>	22 lbs	13 lbs	11.5 lbs	8.5 lbs	8 lbs	5.5 lbs	5 lbs
1,400 ft <sup>2</sup>	23.5 lbs	14 lbs	12.5 lbs	9 lbs	9 lbs	6 lbs	5 lbs
1,500 ft <sup>2</sup>	25 lbs	15 lbs	13.5 lbs	10 lbs	9.5 lbs	6.5 lbs	5.5 lbs
2,000 ft <sup>2</sup>	33.5 lbs	20 lbs	17 lbs	13 lbs	12 lbs	9 lbs	8 lbs
2,500 ft <sup>2</sup>	41.5 lbs	25 lbs	21 lbs	16.5 lbs	15.5 lbs	11 lbs	9.5 lbs
3,000 ft <sup>2</sup>	50 lbs	30 lbs	25.5 lbs	19.5 lbs	18 lbs	13 lbs	12 lbs
3,500 ft <sup>2</sup>	58 lbs	35 lbs	30 lbs	23 lbs	21.5 lbs	15.5 lbs	13.5 lbs
4,000 ft <sup>2</sup>	66 lbs	40 lbs	34 lbs	26 lbs	24 lbs	18 lbs	16 lbs
4,500 ft <sup>2</sup>	74 lbs	45 lbs	38 lbs	29.5 lbs	27.5 lbs	20 lbs	17.5 lbs
5,000 ft <sup>2</sup>	82 lbs	50 lbs	42.5 lbs	33 lbs	31 lbs	22 lbs	19 lbs

\*These recommendations assume use of a properly calibrated spreader. See [www.yourfloridalawn.ifas.ufl.edu](http://www.yourfloridalawn.ifas.ufl.edu) for instructions on calibrating your spreader.

# #4: Mulch

## KEEP MOISTURE IN THE SOIL, HELP CONTROL WEEDS, AND REDUCE STORMWATER RUNOFF

A mulch layer around trees, shrubs, and planted beds provides many benefits. In areas that are difficult to mow, irrigate, or otherwise maintain, use mulch to replace turf or groundcovers. Also consider placing mulch in shady areas where many plants don't grow well.

### THE DIRT ON MULCH

Mulch is a wonderful addition to any landscape, because it:

- **Buffers soil temperature.** Mulch keeps soils and plant roots warmer in winter and cooler in summer.
- **Helps maintain soil moisture.** Mulch slows evaporation and reduces the water needs of plants.



Properly applied mulch encourages moisture retention and accents the landscape.

- **Inhibits weed germination and growth.**
- **Adds beauty.** Mulch gives planting beds a neat and uniform appearance, and its color and texture can complement plantings.
- **Helps reduce soil erosion.**
- **Can improve soil.** As they decompose, organic materials like wood chips, pine needles, leaves, and grass clippings make soil more fertile and improve soil aeration, structure, and drainage.
- **Can protect plants.** Mulch can help prevent certain plant diseases, and when placed around shrubs and trees (at least 12 inches from the trunk), it reduces the likelihood of damage from trimmers and mowers.

### CHOOSING A MULCH

There are many factors to consider when selecting mulch for your landscape. Depending on your priorities, you could make a decision based on any or all of them:

- Cost
- Color
- Origins of the mulch
- Durability
- Nutrient content
- Texture/Appearance

All of the different kinds of mulch available in Florida have benefits and drawbacks. Cypress, melaleuca, and pine bark are the longest lasting types of mulch but don't offer plants many nutrients when they break down. Soil pH may be reduced by pine bark and pine straw, which would be excellent for acid-loving plants like azaleas, but not plants that require high-pH soil. Here's an overview of the most popular mulches:

**Pine bark** is a byproduct of the forest industry. It comes in ground and nugget forms, and has a rich brown color.

**Pine straw** (pine needles) comes from pine plantations, which produce paper and wood products, and is sold in bales. Unlike some mulches, pine needles are not likely to wash away, because they knit together.

**Fallen leaves** (including grass clippings) can be raked up for free in your landscape. This type of mulch is high in nutrients, but decomposes quickly.

**Melaleuca mulch** is made from the invasive exotic trees. The product is cured at a high temperature to kill seeds.

**Mixed hardwood mulch** is produced from scrap lumber, recycled pallets, or tree stems that are too small to be used for paper or wood production.

**Eucalyptus mulch** typically comes from plantations in South and Central Florida where the trees are grown specifically for mulch. They grow quickly, so this mulch is considered renewable.

**Utility mulch** is sold or given away for free by many utility companies. This mulch comes from trimming trees and



other plants that get in the way of power lines, but it can come with weed seeds.

**Cypress mulch** is composed of both wood and bark. Cypress trees, which grow in Florida's forested wetlands, are often harvested for lumber used in fencing, flooring, furniture and other wood products. Cypress mulch is often made from the waste wood generated in the manufacture of these products, but it may also be produced from whole trees cut from wetlands. The Florida-Friendly Landscaping™ Program does not recommend the use of cypress mulch, as its origins may be difficult to determine.

**Gravel or pebbles** can be used as mulch, but they won't contribute to the soil's nutrient and organic content or water-holding capacity. If you choose to use these products, make sure to first install a woven ground cloth to keep them from sinking in sandy soils. These mulches last a long time, but will need to be cleared of debris to look their best.

### **GUIDELINES FOR USING MULCH**

Follow these tips when using mulch in your landscape:

- **Maintain a 2- to 3-inch layer** around established trees, shrubs, and bedding plants. Coarse materials, such as pine nuggets, may be applied to a depth of 4 inches, but don't allow mulch to accumulate to a greater depth. Adding more mulch can harm plants because

mulch intercepts rain and irrigation meant for plants' root systems.

- **Avoid "volcano mulching."** When mulch is piled against the base of a tree, it holds moisture, encouraging rot in the trunk. Mulch piled against the trunks of young trees may also create habitat for rodents that chew the tender bark and can ultimately kill the trees.
- **Mulch to the drip line or beyond.** The mulched area around the tree should be at least 8 feet in diameter. Remember that in a forest environment, a tree's entire root system (which usually extends well beyond the drip line) would be naturally mulched.
- **Rake old mulch.** Some mulches can become matted, preventing water and air from seeping through. Rake it to benefit plantings and refresh the mulch's appearance.

### **HOW MUCH MULCH?**

Purchasing mulch by the bag is convenient, but it can be costly. Buying mulch in bulk quantities can save you money. Bulk mulch is sold by the cubic yard; each cubic yard contains 27 cubic feet. Remember to apply 3 to 4 inches of mulch for a layer that will be 2 to 3 inches when settled.

## #5: Attract Wildlife

BRING YOUR YARD TO LIFE BY PROVIDING WATER, FOOD, AND SHELTER FOR BIRDS, BUTTERFLIES, AND OTHER CREATURES



Remember to plant for pollinators.



Firebush supplies food for birds and butterflies.

Florida is a state renowned for its diverse and unique ecosystems. But rapid development, particularly in coastal areas, is continuing to destroy wildlife habitat. As our communities expand, we rightly lament the loss of native birds and other animals. But did you know there is much you can do at home to create a safe haven for these displaced Floridians?

By following the simple tips in this chapter, your Florida-Friendly lawn and garden can become a sanctuary for wildlife, as well as part of a migratory passage between one wild space and another. Animals need to move from place to place, just like people. They have trouble traveling in heavily urban and suburban landscapes, but you can help them by joining your Florida-Friendly yard with others in the neighborhood to create a “natural corridor”—a safe, traversable route between woodlands, wetlands, or other wild areas.

Use a variety of plants in your yard’s design to attract many different species of animals, from birds and butterflies to snakes and squirrels. Your home landscape will become a refuge for critters in need of shade, rest, food, and water. In return, your landscape will become a living, lovely part of Florida. Talk with your neighbors and community organizations about Florida-Friendly Landscaping™, and encourage others to make their yards as hospitable as yours.

### TIPS

Try a few of these ideas to lure wildlife to your yard:

- **Provide food.** Select plants with seeds, fruit, foliage, or flowers that butterflies, birds, and other wildlife like to eat. Berries, fleshy fruits, nuts, and acorns are all treats for many animals.

- **Supply water.** Any water you provide will attract wildlife. You could have running water in the form of a natural feature, such as a pond, creek, or other body of fresh water, but a fountain or birdbath will also beckon wildlife. Empty and clean your birdbath every few days. Do not clean it with soap or bleach—just physically scrub all surfaces with a brush or scouring-type sponge. Change the water regularly to prevent mosquito breeding and bacterial contamination.
- **Leave snags.** Leave snags, which are the trunks of dead trees, in place if they do not create a hazard. Many birds use snags for perching, nesting, and feeding.



Snags have great appeal for various woodpeckers.

- **Manage pets.** If you permit pets to harass or kill wildlife, you will only hinder any efforts you make toward attracting wildlife. This is especially true for cats allowed outdoors, so keep your cats inside.

- **Reduce insecticide use.** Each time you apply an insecticide to your landscape, you reduce insect populations, which form an important food source for birds. Some chemicals can also poison birds and other animals that feed on affected insects.
- **Reduce the amount of mowed lawn area.** Unmowed areas can contain more plant species than mowed areas, providing more potential food sources and habitat for wildlife. Reduce the mowed area around your house, especially in low-traffic areas, such as corners of the yard.
- **Increase vertical layering.** Plant a variety of plants in different sizes and heights to provide more cover and feeding opportunities for diverse species of wildlife.



Layers of vegetation entice wildlife and add visual interest.

## CREATURE COMFORTS

To attract specific types of animals or insects to your yard, think about their needs.

### BATS

A small bat house in your yard can provide a roost for bats. An individual bat can eat thousands of insects in a night, and



A bat house provides a roost for these nocturnal pollinators.

bats also serve as important pollinators for many flowering plants, including fruit trees. Bat houses aren't complex structures, and designs are easy to find in books and on the Internet. Your bat house should be tall, shallow, and hung at least twelve to fifteen feet above the ground on the south or southeast side of a tree, pole, or building. The site should be fairly open and easy for bats to see.

### BIRDS

Design planted areas that include a tree canopy, smaller understory trees and shrubs, grasses, and flowers. Allow grasses and flowers to go to seed on occasion—this is a real draw for birds.

### BUTTERFLIES

A combination of both larval (caterpillar) and nectar plants will attract a variety of butterflies to your yard. Nectar plants provide food for adult butterflies, while larval plants are food sources for the caterpillar stage. If you want to attract butterflies to your yard, expect a certain level of damage to certain plants from hungry caterpillars. See the plant list online at <http://fyn.ifas.ufl.edu> for help with choosing species that attract butterflies.



# #6: Manage Yard Pests Responsibly

## CREATE AN EFFECTIVE DEFENSE AGAINST PESTS WHILE MINIMIZING YOUR IMPACT ON THE ENVIRONMENT

Pest management in the home landscape once relied heavily on the use of chemicals. Today that is changing because of concerns for human health and environmental safety. Scientists now recommend using Integrated Pest Management (IPM), a strategy that helps gardeners prevent and manage pest problems with as few chemicals as possible. IPM emphasizes smart planning, proper maintenance, and natural or low-toxicity controls in ensuring plants stay healthy and resist insect and disease infestation.

### AVOIDING PEST PROBLEMS

The way that you plant and maintain your yard either discourages pests or throws out the welcome mat for them. Follow these tips to prevent pests:

- **Think before you plant.** Plants in locations not suited to them may be stressed and thus more susceptible to pests.
- **Start early.** IPM begins at planting time, with the selection of plants that are pest-free and pest-resistant.
- **Keep your plants healthy.** Using appropriate amounts of water and fertilizer is the best defense against pests.
- **Conduct regular scouting.** Keep an eye on your yard's plants to detect pest problems early, before significant damage occurs.
- **Go easy on water and fertilizer.** Too much of either can cause excessive growth, making plants vulnerable to some insects and diseases. Encourage healthy growth by applying fertilizer and water only when they're needed and in moderate amounts.
- **Mow to the proper height and prune selectively.** Mowing grass too short and severely pruning trees and shrubs weakens them, potentially inviting problems.
- **Encourage beneficial insects.** Learn to recognize the insects in your garden that help manage pests and let them continue their good work! The pictures below are beneficial insects.



Assassin bug.



Green lynx spider.



Ladybug.



Big-eyed bug.

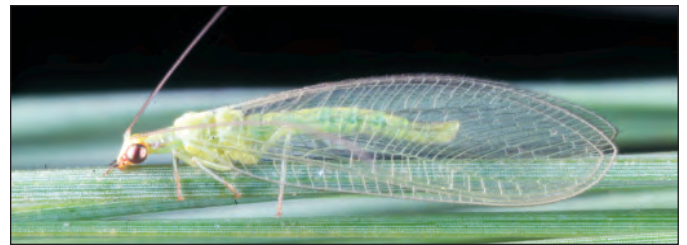

Green lacewing.

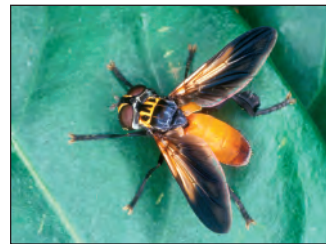

Parasitic fly.



Parasitic wasp.

### DETECTING PEST PROBLEMS

Inspecting plants frequently helps detect pest problems early. You can give plants the once-over anytime you water by hand, mow, or do other outdoor chores. Set aside a time twice or more each week to walk through your yard and look at plants. Some small insects complete their life cycles in one week, so a weekly wander through the yard may not be frequent enough.

Common plant pests in Florida include aphids, mealybugs, scales, whiteflies, thrips, plant-feeding mites, caterpillars, and chinch bugs. Often you will spot evidence of a pest's activity before you see the insect itself. If you see chewed or deformed leaves, sooty mold, many ants scurrying up and down plant stems, or discolored "trails" on leaves, you are likely to find a pest lurking somewhere.

Detecting small insects and mites can be difficult. One method that works well is to flick the leaves of small branches against a sheet of white paper. Use a ten-power (10X) magnifying glass to search for movement or

evidence of pests. Chinch bugs can be collected from lawn thatch using a shop vacuum.

Look on the branches and on both the upper- and under-sides of leaves for pests that attach to the plant, such as scales and whitefly nymphs. Sooty mold on leaves is a tell-tale clue to an infestation by what are known as piercing-sucking insects (aphids are one example). These pests pierce the plant with sharp mouthparts and suck the sap. Some piercing-sucking insects secrete a sugary substance called honeydew, on which the black-colored sooty mold fungus grows. Sooty mold doesn't injure a plant directly, but it does block sunlight from leaves, reducing photosynthesis. Ants also signal the potential presence of pests, since they feed on honeydew and often protect the insects that produce it.

If you see plant damage but few pests, beneficial insects may already be working on your behalf. These may include lady beetles (commonly called ladybugs) and their larvae, lacewings and their larvae, assassin bugs, spiders, parasitic wasps, and parasitic flies (syrphid or hoverfly larvae and tachinid flies).



Removing by hand and tolerating minor insect damage are responsible ways to manage pests.

Tolerate some insect damage and leaf disease on plants. No one can maintain an insect- and disease-free landscape, and a little damage will not hurt your plants. Remember, in order to have the “good guys,” such as ladybugs, there must be some “bad guys,” or pests, for them to feed on. If a pest problem persists, take a sample of the damaged plant and pest to your county Extension office for identification and suggestions on how to use IPM techniques.

## TREATING PEST PROBLEMS

IPM is the best strategy for dealing with pest management, and it relies on the use of chemicals only as a last resort. Check out these IPM techniques.

- **Remove affected leaves or plant parts.** When pests are heavily concentrated on a plant, you can often reduce or eliminate the problem by simply removing the affected leaves or stems.
- **Pick insects off by hand.** This easy step can often defeat infestations of large, slow-moving pests. Dispose of any captured insects so they do not return to feed again. Try one of these methods:
  - Drop pests into soapy water or isopropyl alcohol.
  - Place them in the freezer overnight (in a baggy or plastic container).
  - Crush them and put them in your household trash.
- **Look for beneficials.** If you see a pest outbreak, determine if it's being managed by natural enemies already present. Many beneficial insects prey on pests, and harming them will just help the pests.
- **Don't treat by default.** Plants with aesthetic damage don't necessarily need to be treated. Consider the amount of damage you're willing to accept. Remember that there will always be insects in any healthy landscape, and don't worry about minor damage.
- **Start with low-impact techniques.** Always try the safest alternatives first, such as handpicking insects or pruning affected parts of a plant. If pesticide use does become necessary, choose products that are the least harmful to people, pets, and wildlife. These products include insecticidal soap, horticultural oil, botanicals (e.g., pyrethrum, neem, and rotenone), microbials (e.g., spinosad, abamectin, and *Bacillus thuringiensis* 'Kurstaki'), and entomopathogenic nematodes (small worms that kill insects).
- **Avoid using broad-spectrum insecticides.** They're not selective, meaning they also kill beneficials. Instead, choose targeted products, which are designed to harm only specific pests. For example, products that contain an extract of the bacterium *Bacillus thuringiensis* 'Kurstaki' are used to manage caterpillars without affecting other organisms.
- **Spot-treat only.** Use pesticides to treat only the affected areas of a plant or lawn. Never use blanket applications to treat problems.
- **Read and follow all label instructions.** Be careful and remember that the label is the law!



- **Apply pesticides during the cooler part of the day.** Heat combined with soaps, horticultural oils, and other pesticides can injure plants.
- **Use products only on recommended plants.** Always read the label to find out which plants a product can be applied on and which plants are sensitive to the product. If you're unsure about applying a product to a plant, test it on a small area of the plant first. Check for leaf burn in the tested area after one to two days. Phytotoxicity, or chemical injury, often looks like a burn on the edge of leaves.

For more information about specific yard pests, diagnosing pest problems, and controlling pests, visit <http://ipm.ifas.ufl.edu>.

## COMMON LANDSCAPE PESTS AND THEIR MANAGEMENT

Certain pests are considered “key,” in that they cause the vast majority of landscape problems. Here is a list of ten common causes of lawn and garden damage.

### 1. APHIDS

Winged or wingless pear-shaped bodies may be green, yellow, black, red, or multi-colored. Typically found on new growth. Damaged leaves appear yellow, twisted, or distorted; ants (which nurture aphids) or sooty mold may also be present.



Green peach aphids.

#### Natural Enemies

Lady beetle (ladybug) adults and larvae, lacewing larvae, syrphid fly larvae, parasitic wasps.

#### Other Controls

Prune infested plant parts or forcefully spray them with water to dislodge the insects. Apply insecticidal soaps or horticultural oils.

### 2. CATERPILLARS

These are the larvae of butterflies and moths. They chew on foliage, creating skeletonized, notched, or ragged leaves. Watch for greenish fecal pellets on leaves or below plants.



Caterpillar.

#### Natural Enemies

Wasps, predatory stink bugs, big-eyed bugs, birds, lizards.

#### Other Controls

Remove by hand (use pliers to remove stinging caterpillars), apply *Bacillus thuringiensis* ‘Kurstaki’ (most effective when caterpillars are small).

Note: Most caterpillars only feed on specific host plants. Remember that if you want butterflies you will need to tolerate caterpillar feeding activity.

### 3. CHINCH BUGS

Chinch bugs only feed on St. Augustinegrass, often in stressed areas in full sun or near pavement. Adults are 1/5-inch long, black with white patches on wings. Young nymphs are smaller, reddish, and have a white stripe across their backs. Injured turf yellows and dies.



Chinch bug.

#### Natural Enemies

Big-eyed bugs, earwigs, and a species of parasitic wasp.

#### Other Controls

Fertilize correctly. Maintain St. Augustinegrass at height of 3 inches in sun and 4 inches in shade. Spot-treat infestations with insecticides labeled for chinch bugs.

#### 4. MEALYBUGS

White, soft-bodied insects  $\frac{1}{16}$ - to  $\frac{1}{8}$ -inch long. Bodies and egg masses covered by powdery white wax. Attack leaves, twigs, and roots. Sooty mold or ants may also be present.



Mealybug.

#### Natural Enemies

Lady beetles, lacewing larvae.

#### Other Controls

Spray with horticultural oil or insecticidal soap. If that fails, apply a systemic insecticide (i.e., imidacloprid) to the root system. Soil systemics may take several weeks to work.

#### 5. MOLE CRICKETS

Velvety brown,  $\frac{1}{2}$  inch long, feed on turfgrass and vegetable roots. Flattened front legs adapted for burrowing. Mole crickets affect all grasses, but prefer bahiagrass and bermudagrass. Injured turf may be spongy and thinning, with  $\frac{3}{4}$  inch, round holes that are signs of tunneling. Infestation usually occurs in the same area each year. Test for infestation by flushing area with soapy water (1–2 tablespoons soap in a gallon of water). Crickets will surface within 3–5 minutes if present.



Mole crickets.

#### Natural Enemies

Parasitic wasp (*Larra bicolor*), red-eyed fly (*Ormia depleta*), insect-parasitic nematodes (*Steinernema scapterisci*), and birds.

#### Other Controls

For chronic infestation, consider replacing turf with trees, shrubs, or groundcovers. If necessary, spot-treat infestations in May or June with insecticides labeled for mole cricket control.

#### 6. PLANT-FEEDING MITES

Tiny ( $\frac{1}{32}$ -inch) red, yellow, or green with oval bodies. Some spin loose webs on foliage. Mites reproduce rapidly in hot weather. Injuries to plants look like light-colored dots, giving leaves a dull, gray-green, speckled appearance.



Texas citrus mite.

#### Natural Enemies

Lady beetles, predatory mites.

#### Other Controls

Spray undersides of foliage with water, then alternate with soap and oils if necessary.

#### 7. SCALES

Vary in size, shape, and color. Soft scales and armored scales are the most common. Soft scales produce honeydew (sugary secretion), which promotes sooty mold and attracts ants. The armored scale body is hidden under a waxy covering. Mature scales are stationary and feed on leaves, twigs, stems, and fruit. “Crawlers” (the immature, mobile stage) are the most vulnerable life stage and, therefore, easiest to control.



Green scales.



### Natural Enemies

Lady beetles, parasitic wasps.

### Other Controls

Scrape scales off plant tissue. See other controls for mealybugs.

### 8. SOD WEBWORMS

Gray-green caterpillars with brown spots on each segment. These lawn-damaging pests chew on grass blades, causing short, ragged patches in the lawn. They feed at night and hide by day. A soap flush may verify their presence.

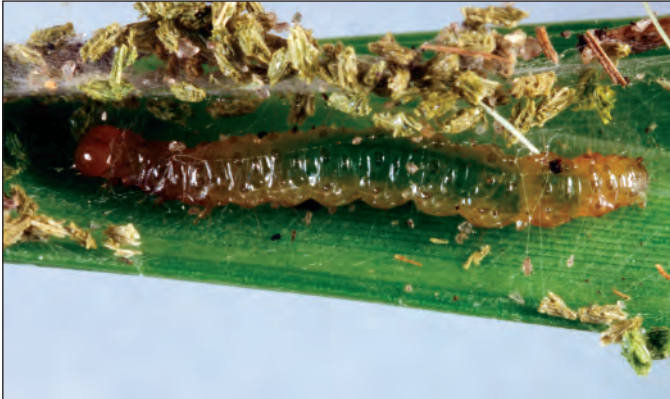

Sod webworms.

### Natural Enemies

Spiders and numerous other beneficials that live in lawns.

### Control

Apply products containing *Bacillus thuringiensis*.

### 9. THRIPS

Tiny ( $\frac{1}{32}$ -inch) winged insects that scar leaves, buds, and flower petals to drink sap from wounds. Injured plant may be dull gray with curling, distorted leaves or browning flowers.



Thrips.

### Natural Enemies

Predaceous thrips, predatory mites.

### Other Controls

Apply horticultural oils and/or insecticidal soaps.

### 10. WHITEFLIES

Adults look like tiny white moths on plants. They take flight when leaves are disturbed. Eggs are on leaf undersides. Nymphs (the stage of whitefly that feeds on plants) are oval, flat, transparent-to-greenish in color, and may look like scales. They are stationary and are located on undersides of leaves. Ants or sooty mold may be present.



Citrus whitefly.

### Natural Enemies

Fungi (most effective in humid weather), parasitic wasps, lady beetles.

### Other Controls

Spray with insecticidal soap. Follow with horticultural oils, if necessary. Be aware that several species are resistant to insecticides.

### PLANT DISEASES

Many organisms, including viruses, fungi, and bacteria, can cause diseases in plants. Diseases can be specific to certain plants, but identifying them can still be extremely difficult. Often, home gardeners mistake environmental or maintenance problems for diseases. For example, Spanish moss, lichens, and ball moss are not parasites that should be killed or removed; they are merely harmless plants themselves. Another common misdiagnosis in coastal areas is mistaking saltwater damage for disease. Irrigating plants with salty well water can cause yellowing around the edges of leaves and leaf-drop starting from the bottom part of the plant's canopy.

When a plant does have a disease, the problem may be merely cosmetic rather than truly damaging to the plant. Examples are minor leaf spots or other damage to select leaves. Such minor aesthetic concerns are no cause for alarm or treatment. There are serious diseases, however, that can damage or kill plants they affect. Examples are mushroom root rot on landscape plants,

bacterial wilt on vegetables, and take-all root rot on turf. Such diseases can seriously damage the plant's appearance or growth.

Because diseases are difficult to identify, do not assume a disease is in the works just because of a plant's appearance. Use a magnifying glass to look for insect pests that may be causing the damage. Also analyze maintenance practices for causes related to visible symptoms. If you still suspect a disease, contact your county Extension office for advice on how to collect and submit plant samples for disease diagnosis and recommendations on the least toxic methods of treatment.



Bacterial wilt.

# #7: Recycle

## RE-USE YOUR YARD WASTE TO SAVE MONEY AND ENRICH YOUR SOIL

Landscape maintenance activities like mowing, pruning, and raking generate yard waste that you can compost or mulch, recycling valuable nutrients. It's easy to recycle yard waste.

### MOWING

Leave clippings on the lawn—they'll decompose, returning nutrients to the turf. Use a mulching mower blade to cut grass into smaller pieces, speeding decomposition. You can also use clippings as mulch or compost.

### PRUNING

Pruning is selectively removing parts of a plant to improve plant health, control growth, or enhance fruiting, flowering, or appearance. Prune shrubs and other small plants using one of three techniques: thinning, heading back, or hedging. Follow the steps below, and then shred the resulting cuttings to add to the compost pile or use as mulch. You can also toss the cuttings behind a shrub to decompose.

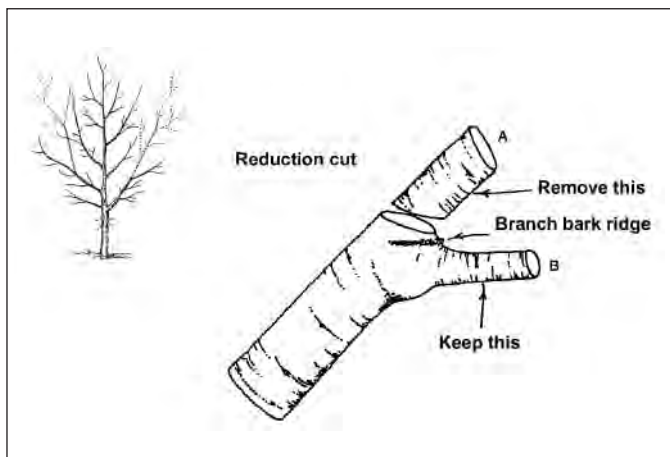

Proper pruning enhances plant health.

- **Keep it healthy.** Remove all dead, diseased, or injured branches.
- **Keep it clean.** If pruning a diseased plant, dip pruning shears and saws in alcohol to keep from spreading the problem.
- **Keep it uniform.** Remove branches that cross or touch each other and any that look out of place.
- **Keep it minor.** Hire an arborist certified by the International Society of Arboriculture to prune trees taller than about 15 feet. Correct pruning makes trees more resistant to hurricane damage.

### CALLING THE PROFESSIONALS

If you are unsure about proper tree pruning techniques, consider hiring an arborist—a specialist in the care of trees—to prune your trees. Look for someone who is certified by the International Society of Arboriculture. Certification indicates that the arborist has been trained through continuing education administered by the ISA.

To find an ISA-certified arborist in your area, check out the International Society of Arboriculture Florida Chapter's Web site, <http://floridaisa.org>, and search by ZIP code.

Pruning trees can be a technical, detailed, and dangerous process. Learn more about it online at <http://gardeningolutions.ifas.ufl.edu>.



Hire a certified arborist if you are unsure about proper pruning techniques.

### BASIC PRUNING STEPS

Use these simple steps as a guideline for every pruning job you tackle:

- Remove all dead, diseased, or injured branches.
- Dip pruning shears and saws in alcohol to prevent spreading diseases between plants.
- Remove branches that cross or touch each other and any that look out of place.
- If a shrub is too tall, heading and thinning may both be necessary. Don't use hedge shears, but cut each branch individually to different lengths with hand pruners. This maintains a neat informal shrub with a natural shape.



## REDUCE YOUR PRUNING LOAD

Keep pruning chores to a minimum:

- Select slow-growing plants
- Place plants far enough from walkways, driveways, or buildings to allow them to reach maturity without encountering obstructions that require hauling out the pruners.
- Forget the clipped, formal look. Soft, flowing, natural lines are attractive and easy to maintain.

## RAKING

Many new Floridians avoid having deciduous trees in their yards because they believe that fallen leaves require raking. But deciduous trees reduce energy costs by shading a house in summer and, after leaves fall, by allowing sunshine to heat a house in winter.

Rake up leaves and pine needles and use them as mulch or add them to the compost pile. Or permit leaves to remain under trees to form a self-mulching area. Leaves add nutrients to soil as they decompose. If aesthetics are an issue, plant shrubs under trees to avoid raking. The shrubs will benefit from decomposing plant litter and help to hold leaves in place so they won't clutter the landscape.

## COMPOSTING

A common misconception about plant care is that all plants require fertilizer. Plants do need nutrients, but they might not need added fertilizer. That is because as organic matter decomposes, nutrients are released into the soil in a form that plants can utilize.

A great way to supply some of these key nutrients to plants while recycling yard waste is by adding compost, which you can make from yard or kitchen waste. As compost decomposes in soil, it releases essential nutrients. Add generous amounts of composted material frequently to soil to help create the perfect medium for sustained plant health.

Adding compost to soil can:

- Improve soil structure, texture, and aeration.
- Increase the water-holding capacity of soil.
- Help loosen compacted soils.
- Promote soil fertility and stimulate root development.

- Create a favorable environment for microorganisms, earthworms, and insects that are nature's "soil builders."

Composting can be as simple as placing leaves, grass clippings, and small cuttings behind shrubs or in a hidden corner of the yard and letting nature take its course. Homemade or manufactured compost bins allow you to easily incorporate kitchen waste, such as vegetable and fruit scraps, eggshells, and coffee grounds. Numerous types of compost bins are commercially available, and many are attractive. Gardening magazines, catalogs, and garden centers are good sources for composting products. For more information about composting, visit <http://gardeningolutions.ifas.ufl.edu>.



Place your compost bin in a convenient location.

Follow these tips for successful composting:

- **Try using a bin.** They're not necessary, but they help keep piles neat, retain heat and moisture, and prevent complaints from neighbors. The minimum recommended size is 1 cubic yard (3 feet square by 3 feet high).
- **Decide when you want it.** Composting can take as little as four to six weeks or as long as one to two years, depending on the size and type of material in the pile and the amount of attention you give it.
- **Add water as you build the pile.** Proper moisture is necessary for microorganisms to decompose the material. Covering the pile retains moisture and prevents the decomposing material from getting too soggy when it rains. You should not be able to squeeze water from the material produced at the bottom of the pile.
- **Combine different materials in the pile,** such as grass clippings and leaves, to achieve the right proportions of carbon and nitrogen for effective composting.
- **Always bury kitchen waste** inside the pile to discourage pests and to prevent odor from rotting fruit and

vegetables. Never place meat, animal fat, or dairy products in a compost pile.

- **Turn or stir the pile with a pitchfork or shovel** on a weekly basis for faster composting. Stabbing the pile

with a length of pipe or rake handle will also help aerate and mix the material.

## WHAT TO COMPOST

Compost is both an easy way to reduce the amount of waste you send to the landfill and a cheap way to get nutrients for your garden. The key is balancing “green,” or nitrogen-rich, materials with “brown,” or carbon-rich, materials (plus some air and moisture). Here are some items you can compost. All of them will decompose faster when chopped up.

### GREEN

Grass clippings  
Weeds  
Fruit and vegetable scraps  
Eggshells  
Plant trimmings  
Farm animal manure

### BROWN

Fallen leaves  
Twigs and fallen branches  
Wood chips and sawdust  
Tea bags  
Coffee grounds and filters  
Paper towels  
Pine needles  
Dryer lint  
Cornstalks and corn cobs  
Shredded newspaper and cardboard

Never compost pet waste or animal fats like meat, grease, and cheese. They can create odor problems and attract pests.

# #8: Reduce Stormwater Runoff

## FILTER RAIN THROUGH YOUR LANDSCAPE TO PROTECT WATERWAYS AND REPLENISH THE AQUIFER

A rainstorm can wash exposed soil, landscape debris, oil, fertilizers, and pesticides off your landscape—all of which then become a part of stormwater runoff. Ultimately, every yard and neighborhood is connected to water resources. This connection may be immediate and obvious, like in a waterfront community, or gradual and unnoticed, through the flow of storm drains, ditches, streams, rivers, and groundwater. Either way, the decisions you make in your lawn and garden actually directly influence the health of Florida's waters.

### HOW WATER WORKS

No matter where you are in Florida, chances are there's a body of water nearby—a river, lake, creek, or canal. These surface waters are actually connected to Florida's groundwater supplies through sinkholes, springs, drainage basins, and other pathways. Groundwater comes from the aquifer, an underground cave system made of porous limestone called karst. It is the source of almost all of the water we use in our daily lives, both in our homes and in our yards.

Because Florida's groundwater is so close to the surface, the health of our groundwater is directly linked to the health of our visible water bodies, and the ways we maintain our landscapes can have a powerful impact on both groundwater and surface waters. Pollutants can enter water bodies through stormwater runoff, which is rain that flows off roads, roofs, gutters, and yards into stormwater drains, retention ponds, and surface water bodies. As it travels to the nearest body of water, stormwater runoff can pick up contaminants from landscapes such as excess fertilizer and pesticides.

The nitrogen and phosphorus found in fertilizers fuel the excessive growth of algae, which smother natural vegetation, deplete oxygen, and kill fish. Nitrogen and phosphorus can also cause invasive weeds to flourish, changing Florida's natural plant communities. Common household pesticides and fertilizers can also run off into our water supply, potentially damaging aquatic life and harming people.

A healthy, properly maintained lawn and landscape can absorb and/or filter stormwater runoff, helping to protect Florida's waters. Following Florida-Friendly Landscaping™ guidelines will reduce pollution coming from the landscape.

### KEEP IT IN THE GROUND

One of the basic concepts of a Florida-Friendly yard is that the rain that falls in your yard should soak into your yard. After all, rainfall is an excellent water source for your landscape, and reducing runoff reduces impacts to waterways. But retaining rainfall long enough for it to percolate through soil is challenging in neighborhoods built on

compacted fill soils. Consider these ways to reduce the amount of rainfall that runs off your yard. Keep in mind that you may need to get permission from your homeowners' association before adding any of these features.

### RAIN GARDENS

Rain gardens are an easy and attractive way to reduce the amount of stormwater runoff that leaves your landscape. These shallow areas are planted with grasses and other plants to filter water before letting it flow naturally into the ground. Water kept within a landscape this way returns to the aquifer, helping to replenish Florida's water supplies.

Rain gardens work best when they're placed at the bottom of downspouts or in places where water tends to puddle. They're especially good for diverting runoff from paved surfaces but can also be placed in turf areas. They can be any size or shape, and can attract wildlife.



Rain gardens filter stormwater runoff before it soaks into the ground.

The plants you choose for your rain garden should thrive in wet conditions, but also be drought tolerant for the times between rains.

### DOWNSPOUTS

If your roof has rain gutters, aim the downspouts at a porous surface so water can soak into soil. If the soil is compacted, you can improve drainage by periodically aerating it. To prevent water from pooling



Direct downspouts to porous areas, including rain gardens.



next to your home's foundation, extend downspouts further out into the yard and create a depressed area to collect storm-water for infiltration. See the "Rain Gardens" section of this chapter for more information about helping stormwater drain into your landscape.

### POROUS SURFACES

Whenever possible, use bricks, gravel, turf block, mulch, pervious (permeable) concrete, or other porous materials for walkways, driveways, and patios. These materials allow rainwater to seep into the ground, helping to recharge



Consider using mulch or other porous materials for walkways.

groundwater and filter pollutants and reducing the amount of runoff from your yard. In some cases these porous materials may even cost less to install than concrete or asphalt.

### EARTH SHAPING

Swales (small dips in the ground) and berms (raised earthen areas) located perpendicular to the slope can help capture or slow runoff that would otherwise rush from your yard,



Swales encourage stormwater to soak into the ground.

giving it time to soak into the ground. In a waterfront yard, use a berm-and-swale combination, placed above the high water line and parallel to the shoreline, to reduce stormwater runoff. Add a maintenance-free zone of native wetland plants to the swale to make your yard more waterfront-friendly.



Berms also help slow runoff.

Minor alterations to the lay of the land won't require permits or engineers, but any major earthwork should have a professional touch and will require regulatory review. Always check with your local Florida Department of Environmental Protection office and other local governmental agencies before making any changes to shorelines.

### RAIN BARRELS & CISTERNS

When it rains in Florida, it often pours. Wouldn't it be great if you could save some of that rain and use it on a dry day to water your plants? Rain barrels are a great way to lessen your impact on our natural resources.

Rain barrels can capture a significant amount of water and can have a tangible effect on your water bill—especially when two or more rain barrels are connected together. Best of all, they're fairly easy to find in stores and to make!

Installing a spigot on a rain barrel makes it easy to fill a watering can for handwatering plants. A rain barrel can also be hooked up to seep irrigation systems. Your rain barrel can (and should) be made mosquito-proof with a tight-fitting lid and mesh screen, and can be painted or hidden by foliage or a trellis to make it more attractive.

Contact your county Extension office to see if they offer workshops on how to make a rain barrel. The Internet also has a lot of information about buying or making rain barrels.

Cisterns also catch rain, but can hold hundreds or thousands of gallons and require more engineering than rain barrels. Keep in mind that your community or county may require a permit for cisterns.

Cisterns can be located above or below ground.





# #9: Protect the Waterfront

## HELP PRESERVE FLORIDA'S WATERWAYS, PLANTS, AND WILDLIFE

Florida is covered with water. The state boasts over 10,000 miles of rivers and streams, about 7,800 lakes, more than 700 freshwater springs, and the second-longest coastline in the United States. Even if you do not reside on a waterfront, the land you live on is directly connected to a nearby water body. That's because no matter where you live, surface water that leaves your landscape as runoff (either due to rain or over-watering), together with any fertilizers and pesticides in that runoff, will eventually drain into a water body. The contributing drainage area is called a watershed.

All watersheds are ultimately connected to each other and to the underground aquifer that supplies most of Florida's drinking water. So what you do in your yard has further-reaching consequences than you might imagine. If you live on the waterfront, the information in this chapter can help you create a landscape that is beautiful, functional, and environmentally sound. But you should consider the waterfront wherever you live.

### MAINTAINING YOUR WATERFRONT PROPERTY

Waterfront property owners have firsthand knowledge of the special value that lakes, ponds, rivers, streams, and lagoons contribute to Florida's quality of life. Florida-Friendly waterfront living also involves unique challenges and responsibilities, some of which are outlined here.

### SHORELINE VEGETATION

The land along the water's edge is called the riparian zone and is often a wetland. Some cities and counties require homeowners to establish a buffer zone to protect this area.



A 10-foot-wide maintenance-free zone protects a water body from fertilizer and pesticide runoff.

If there is no buffer zone along your waterfront, add Florida-Friendly, low-maintenance plantings to help filter out pesticide and fertilizer runoff from adjacent lawns and

landscaped areas. Shoreline vegetation attracts native wildlife and reduces erosion. It can also help beautify your property, dissipate noise from passing boats and other watercraft, and protect your privacy.

For your freshwater shoreline, select native aquatic plants such as softstem bullrush, giant bullrush, common arrowhead, pickerelweed, and maidencane. Remove invasive exotic species like water hyacinth, purple loosestrife, hydrilla, and water chestnut.

### SEAWALLS AND RIP RAP

While shoreline vegetation has benefits, many waterfront homes have man-made structures bordering the water instead of a riparian zone with plants. These structures can also help minimize shoreline erosion. They include seawalls (sea-facing walls on a steeply sloped shoreline exposed to high wind and waves), rip rap (loose, large stones), and gabions (rectangular metal baskets filled with rock).



Seawalls can help minimize shoreline erosion but may cause other problems.



Natural edges with native aquatic plants can help filter runoff before it enters the water body.

But these structures can cause other problems. Seawalls, for example, can cause erosion on adjoining properties. Consider inquiring into your city and county ordinances



to determine whether removal of these structures is an option. When such structures are necessary, look for ways to encourage native vegetation in and along them, especially rip rap and gabions.

### YOUR MAINTENANCE-FREE ZONE

Whether you live on a natural or man-made water body, it's important to designate a "maintenance-free zone" of at least 10 feet between your landscape and the riparian zone. This area helps to protect the water from runoff. Don't mow, fertilize, or apply pesticides in the maintenance-free zone. Select plants that will do well without fertilization or irrigation after establishment. If your landscape already features a buffer zone that's larger than 10 feet, you don't need to create an additional maintenance-free zone.

### OTHER MAINTENANCE CONSIDERATIONS

Don't let grass clippings get washed into the water body; their high nutrient content can cause pollution. Also, pick up all pet wastes deposited in your landscape. Pet wastes contain not only lots of nutrients, but also many harmful bacteria.

### CLEARING AND CONSTRUCTION

Waterfront property is often protected by local or state regulations. A permit may be required for activities as diverse

as removing vegetation; extending a fence; building any structure; or developing walking, cycling, or vehicular paths. Before building anything on or clearing anything from your property, make sure you contact the Department of Environmental Protection or your local city or county offices or departments related to land development, building, and planning.

## WETLANDS

Wetlands are transition ecosystems between land and water. Bogs, cypress domes, mangroves, swamps, wet prairies, and marshes are all types of wetlands. Some of these wetlands are enormous, like the Florida Everglades. Others may be small and contained entirely on one property.

Wetlands play a critical role in reducing flood damage by storing stormwater when it surges and releasing it slowly over time. Wetlands are invaluable in keeping water clean by acting as filters for pollutants, silt, and sediment. Fish, birds, and wildlife depend upon wetlands for food, nesting grounds, migratory stops, and shelter. Wetlands are also valuable to the Florida economy, as they support commercial fisheries and tourist-based wildlife watching.

## SPRINGS

Florida has the largest concentration of freshwater springs in the world. Floridians and visitors enjoy the recreational opportunities afforded by many springs, including diving, snorkeling, tubing, and canoeing. Springs also serve as important habitats for many fragile plant and wildlife species, and are considered "windows into the aquifer," because the water they pump out comes from the underground source of most of Florida's drinking water. But like other water bodies, Florida springs are threatened by population growth, urban sprawl, groundwater withdrawals, and the use of fertilizers, pesticides, and other potential pollutants.



Excess nutrients cause algae and vegetation blooms in Florida springs.



Unpolluted springs offer wildlife habitat and recreational opportunity.

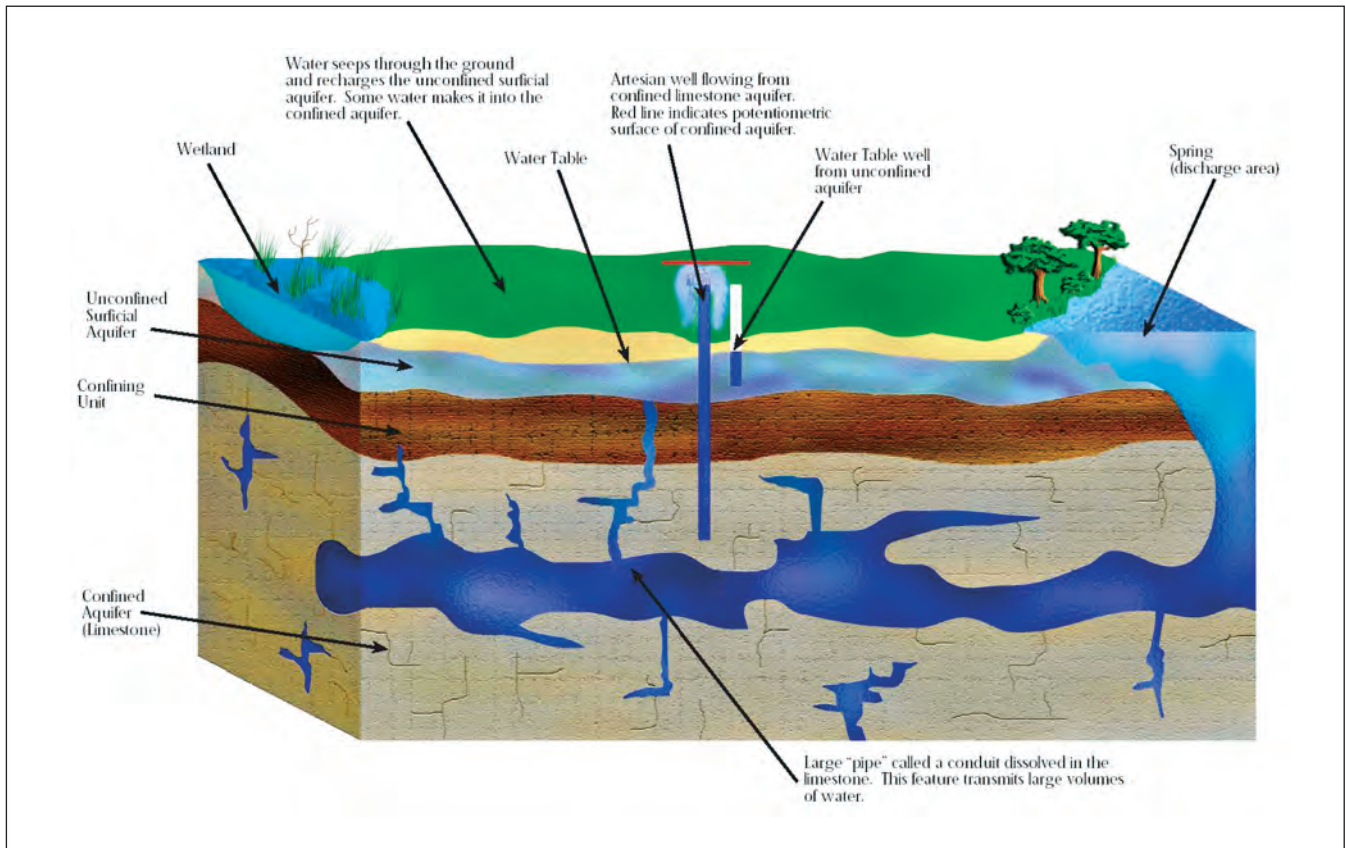

Keeping stormwater onsite allows it to soak into the ground and recharge aquifers.

## STORMWATER PONDS AND CANALS

Many Floridians live near man-made water bodies called stormwater ponds and canals. These structures are created to prevent flooding, manage stormwater, and improve water quality in urbanized areas. Stormwater ponds and canals are just as important to protect as our natural water bodies because all of Florida's waterways are connected,



Stormwater management ponds can be beautiful and educational amenities.

and anything that enters a man-made water body could eventually enter our natural water system.

Stormwater ponds and canals can be more than functional. With a little help from you, they can serve as a home for birds, fish, plants, and frogs and become a neighborhood amenity. Work with your neighborhood association or your neighbors to create an area that not only improves the environment, but also contributes to your quality of life. Just make sure you talk to your water management district before making any modifications, because you'll probably need to get a permit change. Consider these strategies to enhance stormwater ponds and canals:

- Plant flood-tolerant species that are known to help reduce contaminants in water.
- Plant a wide variety of plants to increase biodiversity and attract a wider range of wildlife and insects.
- Add landscaping to make it look like a natural wetland.
- Build boardwalks and trails so neighbors can enjoy plants and wildlife.
- Add varied water depths to an existing pond to create diverse habitats.

## WATER AT THE NEIGHBORHOOD LEVEL

Whether you want to improve water quality in your neighborhood or just make the waterways in your area more attractive, if you're interested in doing more with waterfronts in your community, ask your neighborhood association about some of these things.

- Are Florida-Friendly Landscaping™ practices being used in neighborhood common areas?
- Have neighborhood canals, stormwater ponds, or other artificial water bodies been enhanced with aquatic plants? Are the plants appropriate for the site?
- Are swales and berms being used to help clean and filter runoff before it reaches water bodies?
- Are there dry basins in our neighborhood? If so, how are they being maintained? Can Florida-Friendly Landscaping™ practices be implemented?
- Can stormwater ponds be improved to provide wildlife habitat and recreational opportunities?

## Section 4

# Pond Vegetation Coverage

Plants are important in any healthy pond environment. They help clean the water by filtering pollutants, slow the flow of water to the pond, and create an area for wildlife to live. For many ponds, **30% plant coverage** over the entire pond area is a good balance. Some ponds may need more than this depending on the conditions.

It's important to encourage native plants (those naturally from Florida) to grow in the pond. The Adopt-A-Pond program provides native plants to each pond group to help boost the native plant community in their pond. Keep in mind, there are also many native plants that naturally grow in ponds. Just because it wasn't planted by the group, doesn't mean it shouldn't be in the pond.

This section contains a list with descriptions of the native plants Adopt-A-Pond can provide to pond groups. There is a Quick Reference List of all the plants and further details of many of them under the Planted and Transitional Species Description pages. The Floating Islands article describes how you can build an island of native vegetation to provide more plant coverage in the pond.

### Featured Articles:

- Adopt-A-Pond Native Plant Quick Reference List
- Planted Species Descriptions
- Transitional Species Descriptions
- Floating Island Project



# Adopt-A-Pond Native Plant Quick Reference List

<u>Common Name</u>	<u>Scientific Name</u>
<b><u>Submerged Plants</u></b>	
Lemon bacopa	<i>Bacopa caroliniana</i>
Red ludwigia	<i>Ludwigia repens</i>
<b><u>Emergent Plants</u></b>	
Blue flag iris	<i>Iris virginica</i>
Duck potato	<i>Sagittaria lancifolia</i>
Fire flag/Alligator flag	<i>Thalia geniculata</i>
Golden canna	<i>Canna flaccida</i>
Lizard's tail	<i>Saururus cernuus</i>
Pickereelweed	<i>Pontederia cordata</i>
Soft rush	<i>Juncus effusus</i>
Soft-stem bulrush	<i>Scirpus validus</i>
Swamp lily	<i>Crinum americanum</i>
<b><u>Transitional Plants</u></b>	
American beautyberry	<i>Callicarpa americana</i>
Beach sunflower	<i>Helianthus debilis</i>
Buttonbush	<i>Cephalanthus occidentalis</i>
Gulf muhly grass	<i>Muhlenbergia capillaris</i>
Sand cordgrass	<i>Spartina bakeri</i>
Sunshine mimosa	<i>Mimosa strigillosa</i>
Wax myrtle	<i>Myrica cerifera</i>
<b><u>Trees</u></b>	
Bald cypress	<i>Taxodium distichum</i>
Florida elm	<i>Ulmus floridana</i>
Laurel oak	<i>Quercus laurifolia</i>
Pop ash	<i>Fraxinus caroliniana</i>
Red maple	<i>Acer rubrum</i>
Sugarberry	<i>Celtis laevigata</i>
Sweetgum	<i>Liquidambar styraciflua</i>

The Adopt-A-Pond Notebook: Use it to learn more about your pond environment.



Red ludwigia  
*Ludwigia repens*



Lemon bacopa  
*Bacopa caroliniana*



Blue flag iris  
*Iris virginica*



Duck potato  
*Sagittaria lancifolia*



Fire flag/Alligator flag  
*Thalia geniculata*



Golden canna  
*Canna flaccida*



Lizard's tail  
*Saururus cernuus*



Pickerelweed  
*Pontederia cordata*



Soft rush  
*Juncus effusus*

The Adopt-A-Pond Notebook: *Use it to learn more about your pond environment.*





Soft-stem bulrush  
*Scirpus validus*

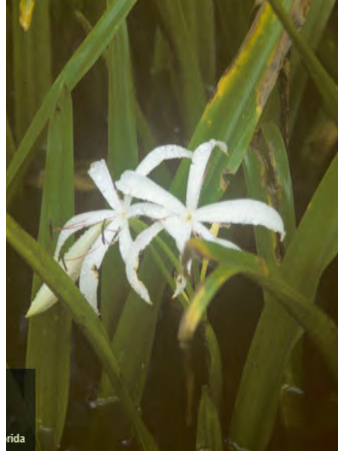

Swamp lily  
*Crinum americanum*



American beautyberry  
*Callicarpa americana*



Beach sunflower  
*Helianthus debilis*



Buttonbush  
*Cephalanthus occidentalis*



Gulf Muhly Grass  
*Muhlenbergia capillaris*



Sand cordgrass  
*Spartina bakeri*



Sunshine mimosa  
*Mimosa strigillosa*



Wax myrtle  
*Myrica cerifera*

The Adopt-A-Pond Notebook: *Use it to learn more about your pond environment.*





Bald Cypress  
*Taxodium distichum*



Florida Elm  
*Ulmus floridana*



Laurel Oak  
*Quercus laurifolia*



Pop Ash  
*Fraxinus caroliniana*



Red Maple  
*Acer rubrum*

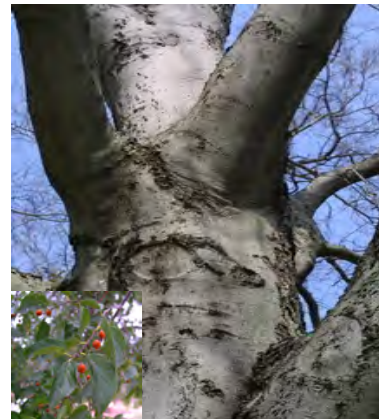

Sugarberry  
*Celtis laevigata*



Sweetgum  
*Liquidambar styraciflua*



# Planted Species

These pages contain pictures and information on several of the planted species available through Adopt-A-Pond.

Remember that there are plants that will come into your pond naturally and that is good. Just because it isn't planted doesn't mean you need to remove it.

The Adopt-A-Pond Notebook: Use it to learn more about your pond environment.

## Lemon Bacopa or Water hyssop

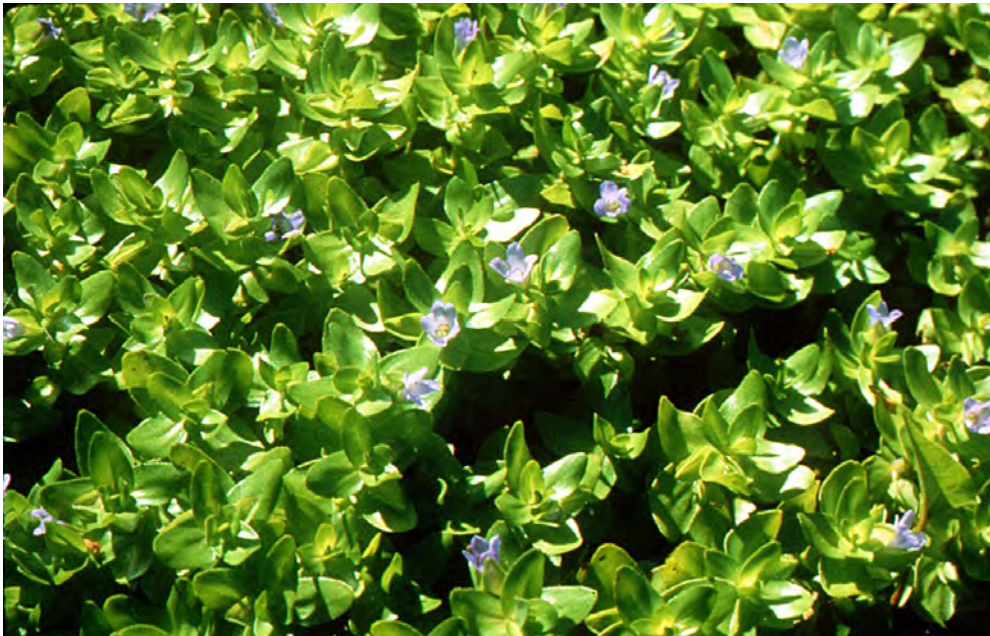

### *Lemon Bacopa*

- small, sprawling, emerged herb
- leaves are small, round and relatively thick
- small blue or white flowers
- with 4-5 pedicels
- plant in shallow water

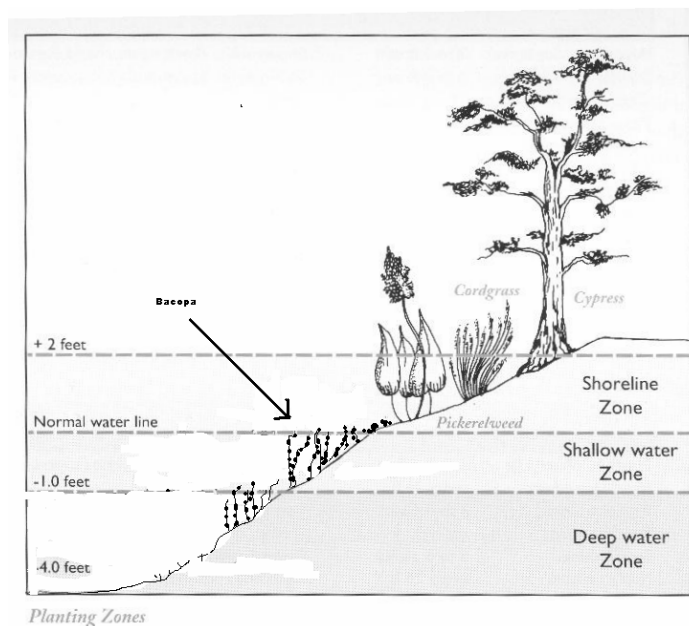

The Adopt-A-Pond Notebook: Use it to learn more about your pond environment.

## Blue Flag Iris



### *Iris virginica*

- narrow and sword-like leaves
- unique large, light purple to blue flowers
- plant above normal water level

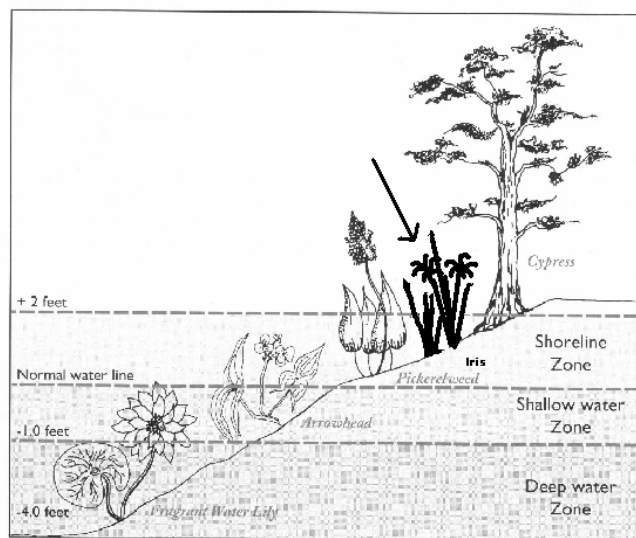

Planting Zones

The Adopt-A-Pond Notebook: Use it to learn more about your pond environment.



## Duck Potato



### *Sagittaria lancifolia*

- shallow water plant
- large lance-shaped leaves
- leaf bases taper to the stem
- produces large, white, 3 pedal flowers
- plant duck potato at and below the normal water level

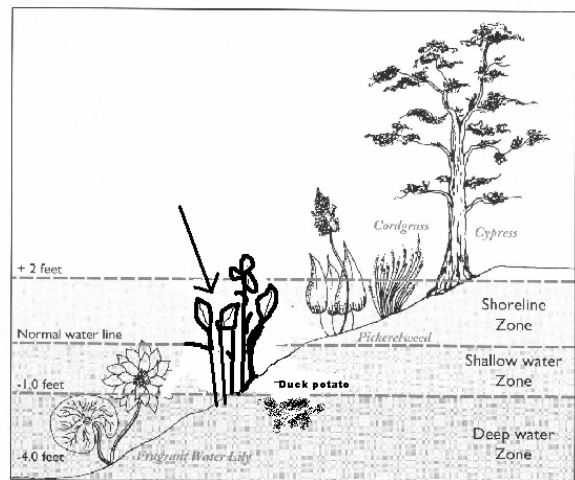

The Adopt-A-Pond Notebook: Use it to learn more about your pond environment.



## Yellow or Golden Canna



### ***Canna flaccida***

- shallow water plants
- can grow to four feet
- leaf shape is oblong or elliptic, with tapered bases and pointed tips
- leaves can be six inches wide and 2 feet long
- three part capsule fruit, rough to touch
- bright yellow-golden blooms in summer

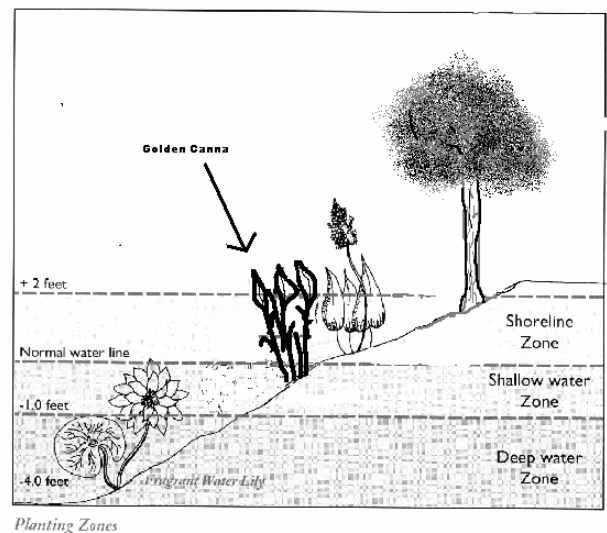

The Adopt-A-Pond Notebook: *Use it to learn more about your pond environment.*

## Lizard's-tail



### ***Saururus cernuus***

- shallow water shoreline plant
- grows into small colonies
- one to two feet tall
- has a brush-like arrangement of flowers that arch above the leaves
- leaves can be arrow or heart shaped
- plant in a slightly shaded area

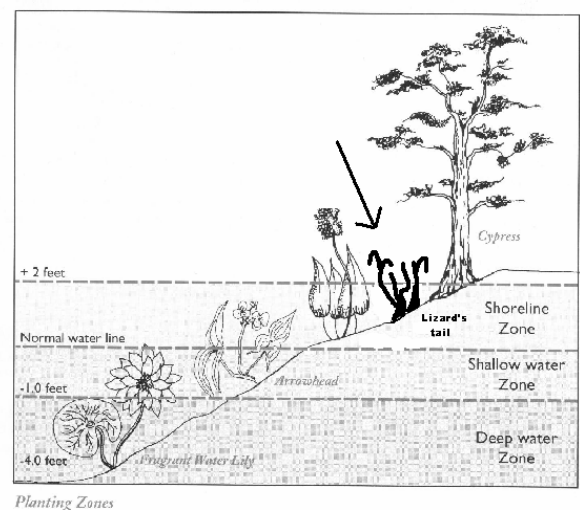

The Adopt-A-Pond Notebook: *Use it to learn more about your pond environment.*

## Pickerelweed



### ***Pontederia cordata***

- common shallow water plant
- purple flower spikes most of the year
- covers shoreline areas and grows quickly
- large lance-shaped leaves
- plant at and slightly below the normal water level

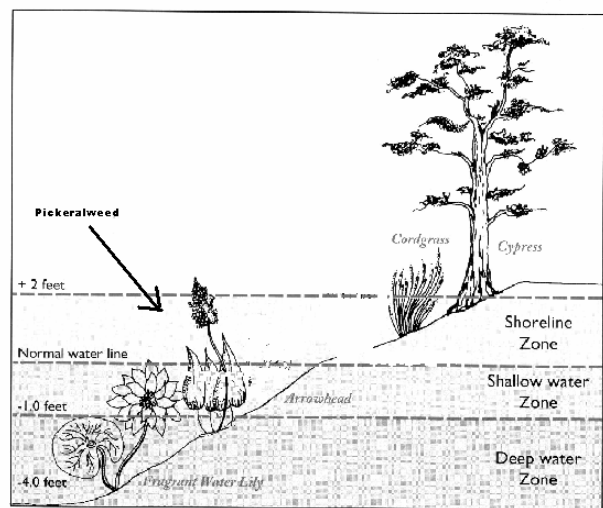

The Adopt-A-Pond Notebook: *Use it to learn more about your pond environment.*



## Soft Rush



## *Juncus effuses*

- most common species of rush
- provides food and nesting to birds and other wildlife
- round stems, pale green, hollow
- grows to 4 feet tall
- flowers and seeds at tops of pointed stems

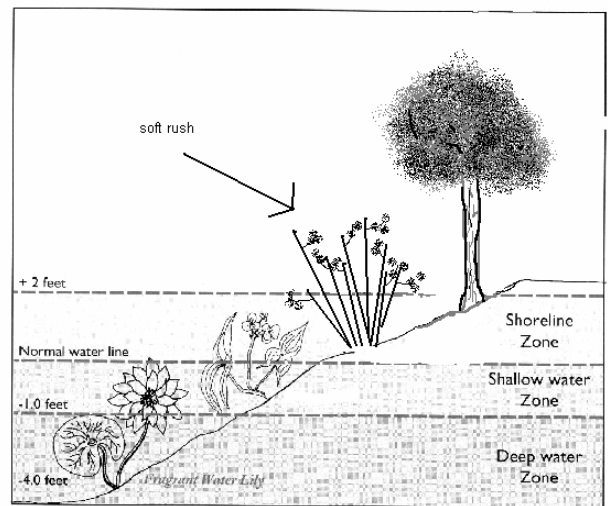

The Adopt-A-Pond Notebook: Use it to learn more about your pond environment.



## Soft-stem Bulrush



## *Scirpus validus*

- birds feed on the tall seed heads
- grows along underground runners
- can grow in several feet of water
- stems are larger at the base and taper off at the top
- good game fish habitat

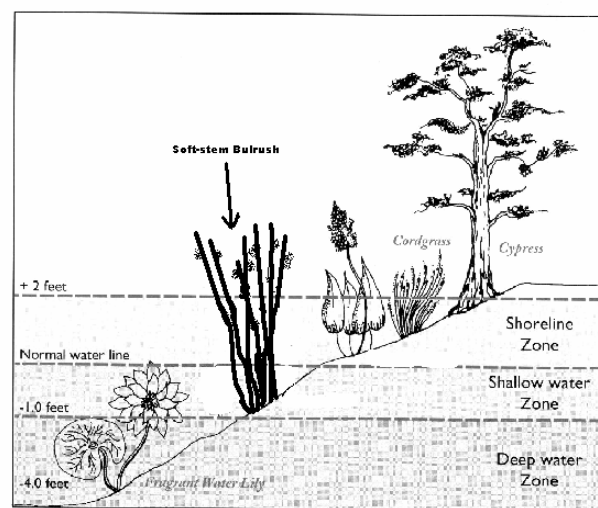

Planting Zones

The Adopt-A-Pond Notebook: Use it to learn more about your pond environment.

# Transitional Species

These pages contain pictures and information on transitional species available through Adopt-A-Pond. These plants may be planted or may occur naturally around the upper banks of the pond. They are also useful in situations where ponds go dry through portions of the year.

These plants can be great for creating a vegetated buffer area around the pond to form a natural transition from yard to pond. Note: Some of the plants may be hard to establish in certain situations.

Adopt-A-Pond will help you determine which plants are most appropriate for your area.

## American Beautyberry



### *Callicarpa americana*

- Shrub, 8ft tall
- Small pink flowers
- Pink to purple berry clusters in late summer
- Grows in pinelands and clearings

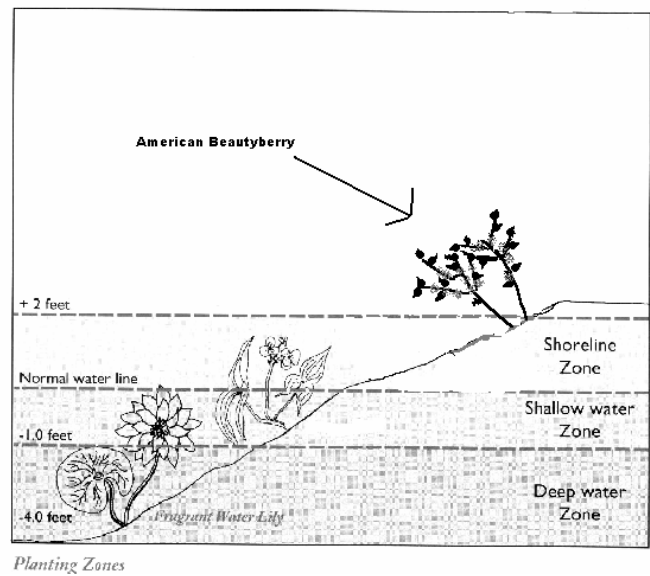

The Adopt-A-Pond Notebook: *Use it to learn more about your pond environment.*

## Beach Sunflower



### *Helianthus debilis*

- Annual, spreading
- Yellow flowers in spring summer and fall
- Grows in disturbed soils and dunes.

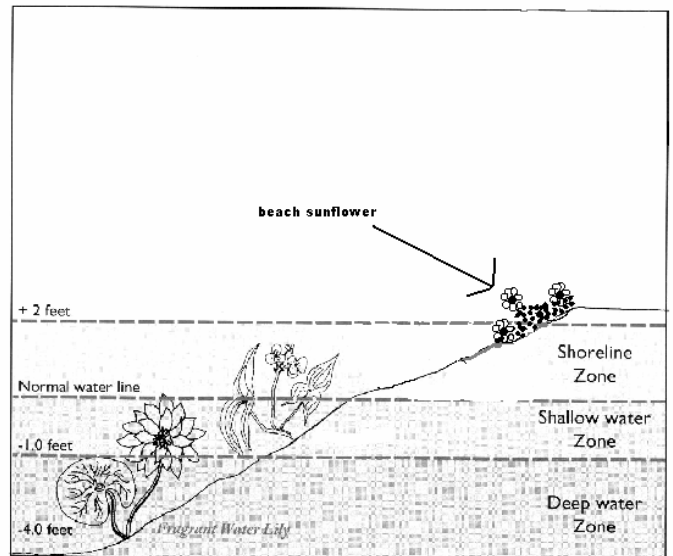

Planting Zones

The Adopt-A-Pond Notebook: *Use it to learn more about your pond environment.*



## Buttonbush



### *Cephalanthus occidentalis*

- wetland shrub or small tree
- opposite leaves
- small white flowers form a dense ball
- brownish ball-shaped fruits
- plant just above the normal water level
- good butterfly bush

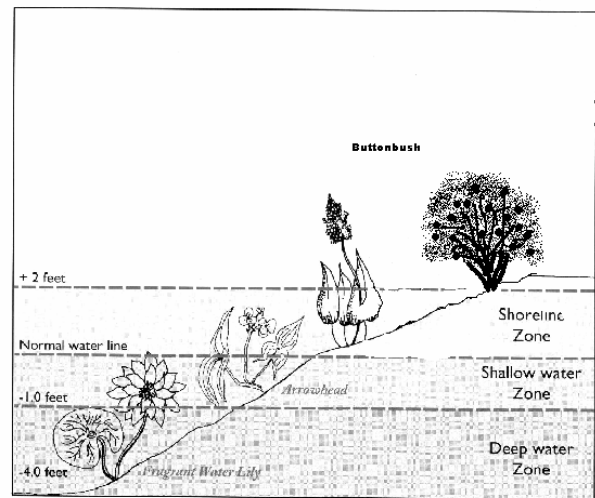

The Adopt-A-Pond Notebook: Use it to learn more about your pond environment.

## Gulf Muhly Grass



### *Muhlenbergia capillaris*

- Perennial, 4 ½ ft tall
- Grass grows in clumps
- Feathery purple plumes in fall and winter
- Similar to cordgrass

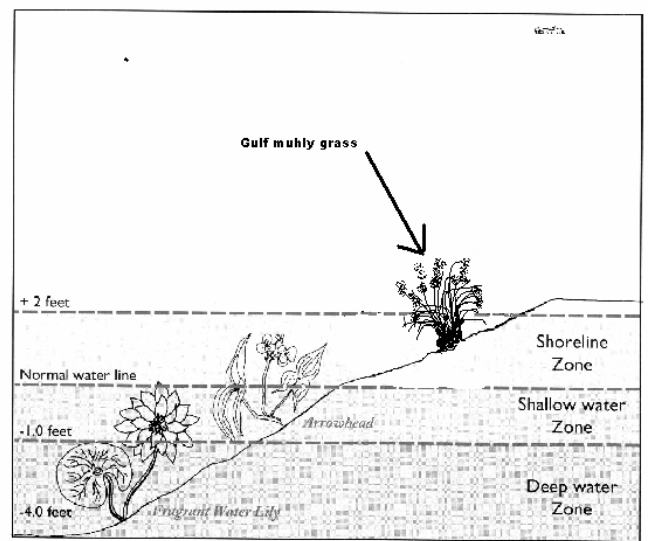

Planting Zones

The Adopt-A-Pond Notebook: Use it to learn more about your pond environment.



## Sand Cordgrass



### ***Spartina bakeri***

- shoreline plant
- grows in thick clumps (does not spread by runners)
- helps reduce erosion
- cylindrical, pointed leaves
- gray-green or silver color
- plant along shoreline

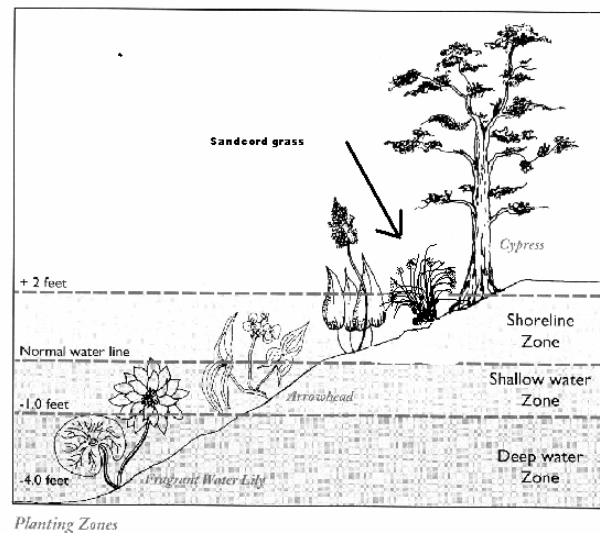

The Adopt-A-Pond Notebook: Use it to learn more about your pond environment.

## Wax myrtle



### ***Myrica cerifera***

- shrub or small wetland tree
- waxy-gray fruits that are hard and fleshy, clustered on branches
- thin alternating leaves
- leaves have a characteristic odor when crushed
- plant at the top of the bank

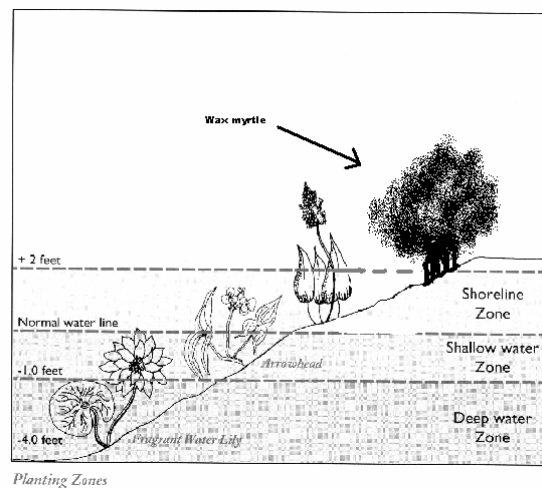

The Adopt-A-Pond Notebook: Use it to learn more about your pond environment.



## Bald Cypress



### ***Taxodium distichum.***

- deciduous wetland tree
- grows tall and narrow
- needle-like leaves
- might grow “knees”, especially in areas with a sprinkler system
- plant at or above normal water level

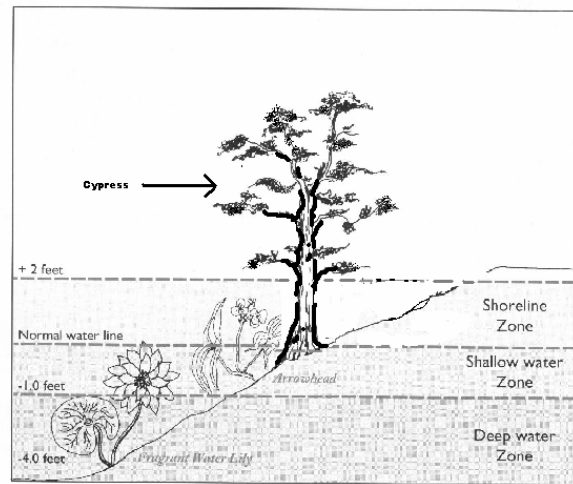

The Adopt-A-Pond Notebook: Use it to learn more about your pond environment.

## Florida Elm



### *Ulmus floridana*

- large deciduous wetland tree
- dark green leaves that turn in fall
- reproduces by seed
- plant above normal water level

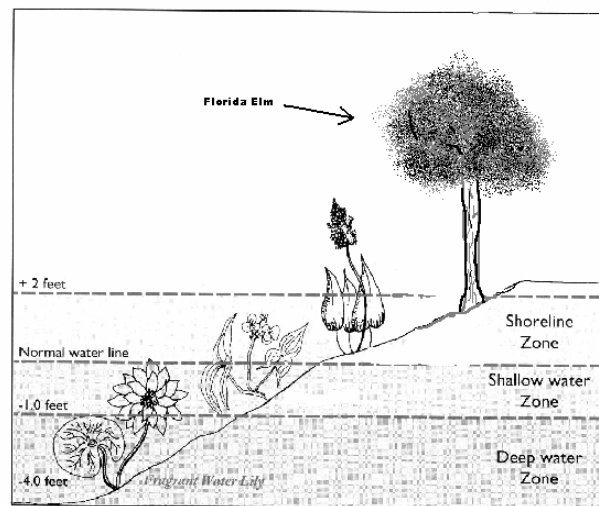

Planting Zones

The Adopt-A-Pond Notebook: Use it to learn more about your pond environment.

## Laurel Oak



### ***Quercus laurifolia***

- large semi-deciduous wetland tree
- leaves dark green above, lighter green below
- produces nearly round acorns, covered  $\frac{1}{3}$  to  $\frac{1}{2}$  by the cap.
- plant at top of bank

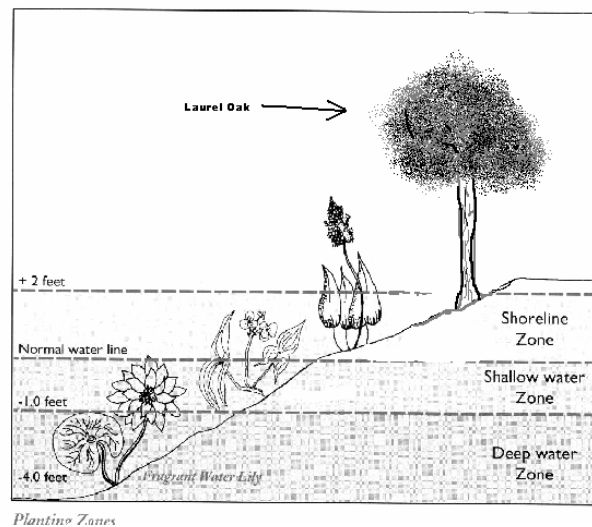

The Adopt-A-Pond Notebook: Use it to learn more about your pond environment.



## Popash



### *Fraxinus caroliniana*

- small tree to 30 ft-light green leaves-
- white to pinkish flowers in spring
- grows in similar location to cypress
- plant at or above normal water level

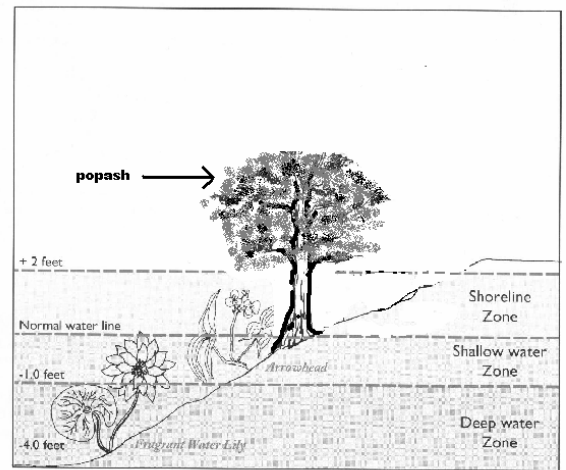

The Adopt-A-Pond Notebook: *Use it to learn more about your pond environment.*



## Red Maple



### *Acer rubrum*

- fast-growing wetland tree
- leaf stems are often reddish
- bright red fruit in spring
- plant at or above the normal water level

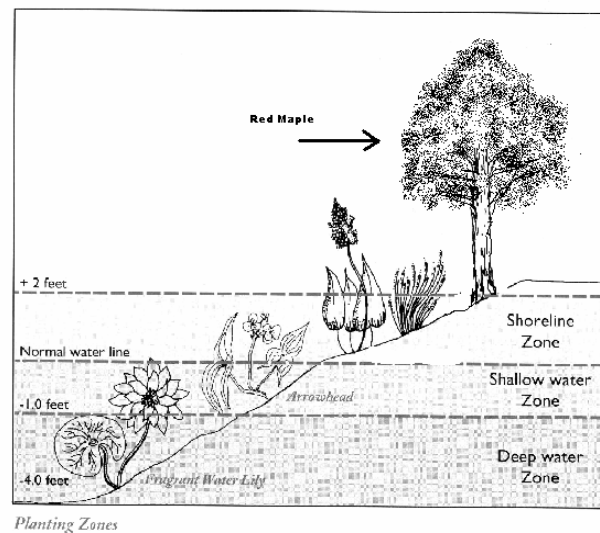

The Adopt-A-Pond Notebook: Use it to learn more about your pond environment.

## Sugarberry or Hackberry



### *Celtis laevigata*

- medium-sized tree with slender branches
- gray, smooth bark usually becoming “warty”
- red fleshy fruits
- plant above the normal water level

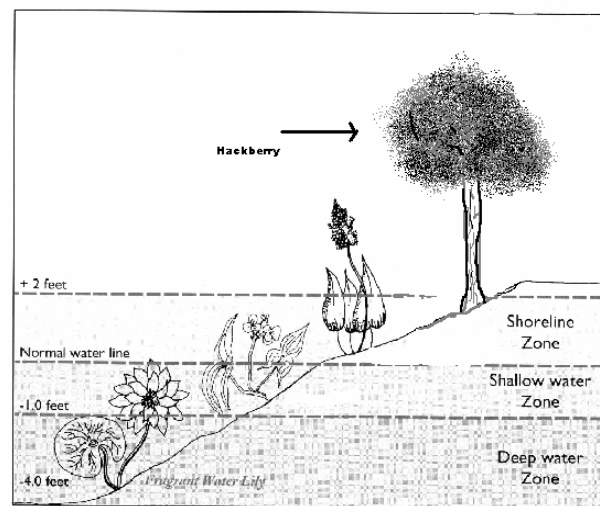

Planting Zones

The Adopt-A-Pond Notebook: Use it to learn more about your pond environment.



## Sweetgum



### *Liquidambar styraciflua*

- large wetland tree
- brilliant green foliage turns purple shade in fall
- produces seedpods
- plant above normal water level

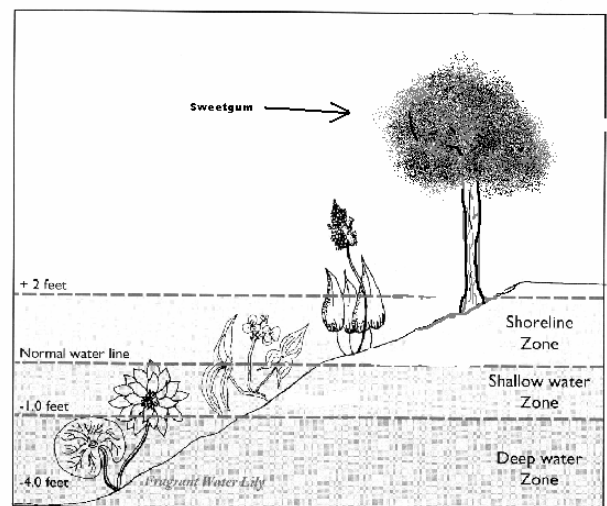

Planting Zones

The Adopt-A-Pond Notebook: Use it to learn more about your pond environment.

## Goldenrod



### ***Solidago fistulosa***

- Perennial, 6ft. tall
- Grows in individual stalks
- Yellow Flower spikes in fall
- Grows in dry to moist open areas

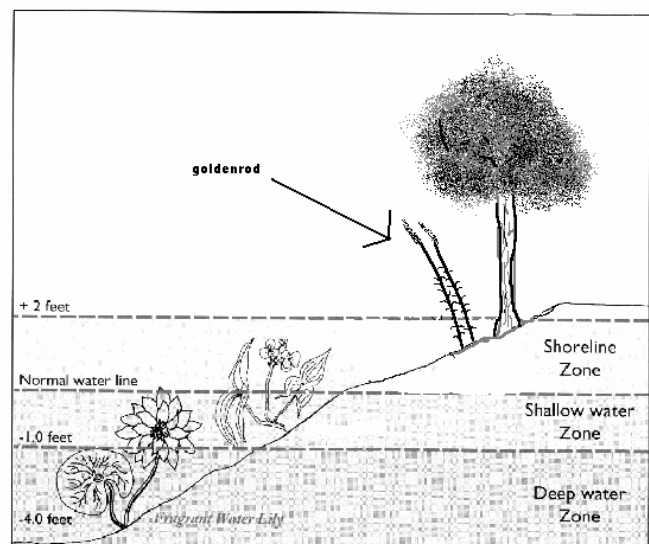

Planting Zones

The Adopt-A-Pond Notebook: *Use it to learn more about your pond environment.*



## St John's Wort



### *Hypericum hypericoides*

- Evergreen shrub, 4ft tall
- Yellow flowers in spring
- Grows in depressions, bogs, and pond edges

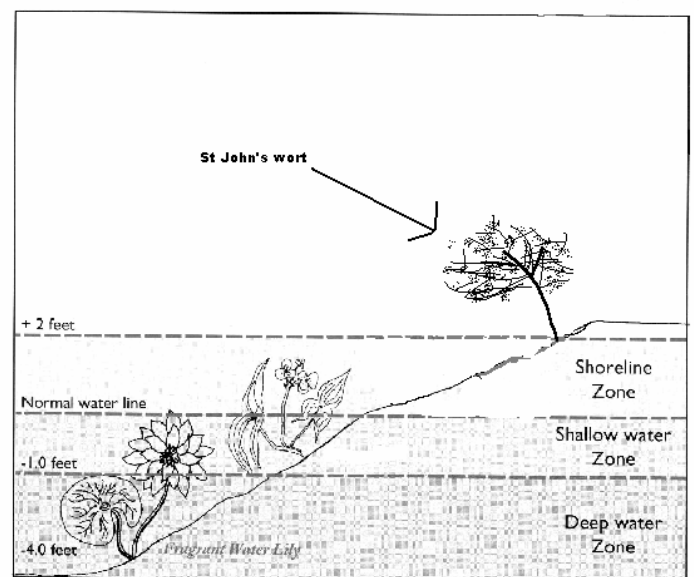

Planting Zones

The Adopt-A-Pond Notebook: *Use it to learn more about your pond environment.*

## Star Anise



### *Illicium parviflorum*

- Evergreen shrub, grows to 25ft.
- Yellow star-shaped flowers in spring
- Grows in wet marginal and low areas

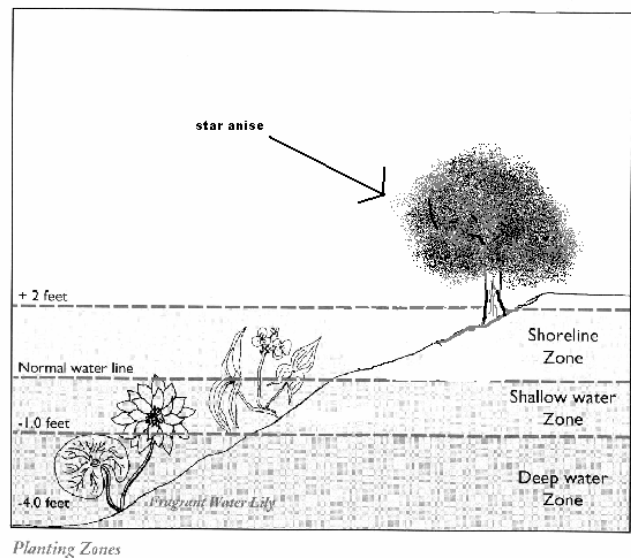

The Adopt-A-Pond Notebook: *Use it to learn more about your pond environment.*

## Star-Rush



### *Rhynchospora colorata*

- Perennial, low growing
- White flower-like leaves
- Spiky, sedge-like
- Flowers year-round
- Grows in wet sandy areas

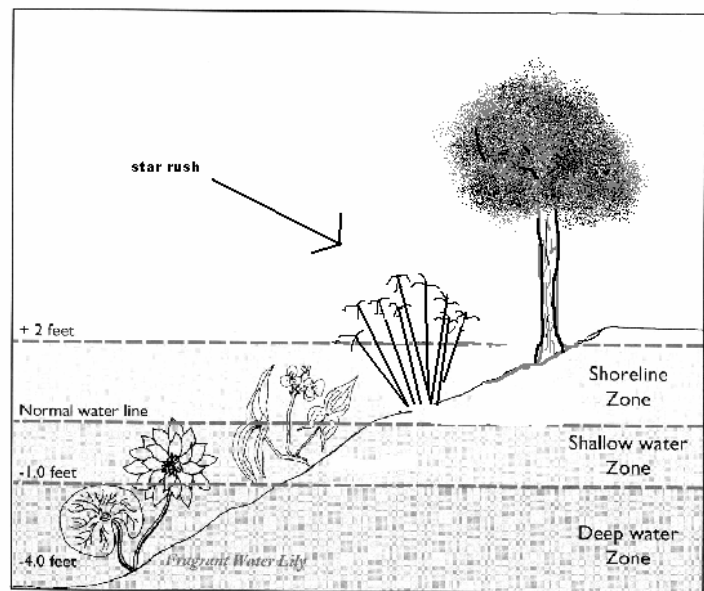

Planting Zones

The Adopt-A-Pond Notebook: Use it to learn more about your pond environment.



## Tickseed



### *Coreopsis leavenworthii*

- Perennial, 40in. tall
- Yellow flowers with brown centers
- Grows in moist open areas

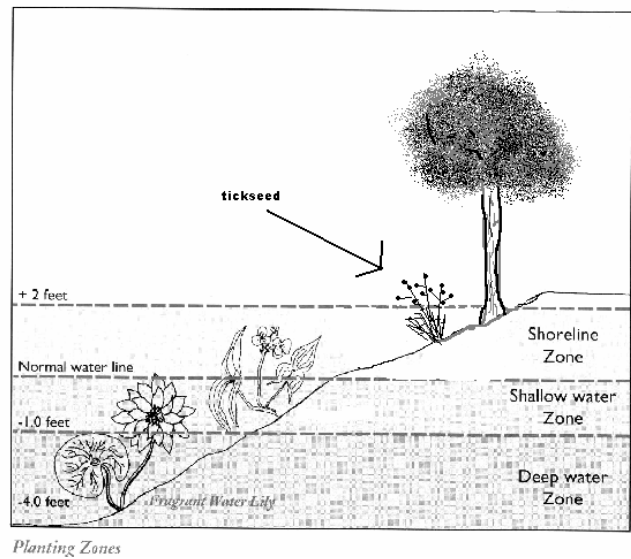

The Adopt-A-Pond Notebook: *Use it to learn more about your pond environment.*



## Yellow-eyed Grasses



### *Xyris* spp.

- Perennial, 40in. tall
- Grows in tufts or solitary
- Yellow flowers in cone-like clusters all year
- Grows in moist sandy ditches and pond shores

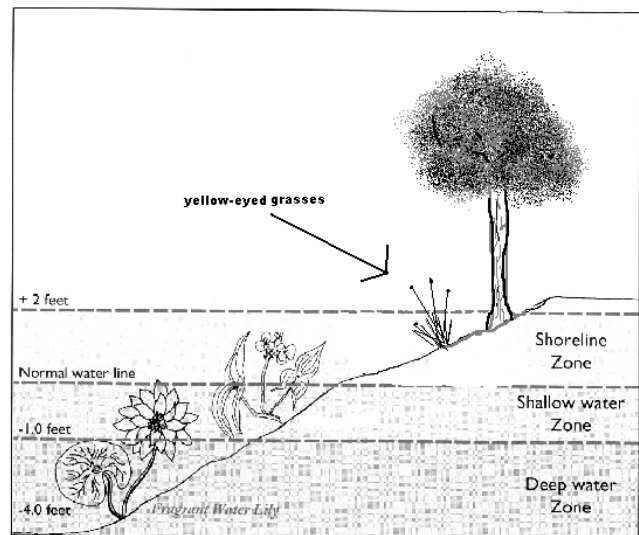

Planting Zones

The Adopt-A-Pond Notebook: *Use it to learn more about your pond environment.*

# Floating Island Project



LOGAN GATE VILLAGE SPECIAL DEPENDENT TAX DISTRICT

Volume 1, Issue 1

October 2006



**Salvinia:** This plant features larger leaf elements than the others and has leaf hair .



**Duckweed:** These plants have smaller leaf structure with smooth surfaces. Several may be



**Azolla:** This is a small branched fern looking water



**Water Meal:** This is a bright green plant that looks like green colored grits.

## Trucious Pond Annual Duckweed Infestation



Trucious Pond Photograph September 2006. On the bank is a pile of hand extracted duckweed.

In a word, DUCKWEED! Duckweed is a general term used to describe several varieties of plant life that grows abundantly and so rapidly that it can cover a pond in a matter of a few weeks. The components of this green soup covering the pond are listed on the left.

Why do we not see these plants in such abundance the rest of the year? The reason for their rapid growth in a word is nutrients. With the rains comes the infusion of super-nutrients.

A pond system is a delicate balance of constantly competing factors. When sufficient levels of nutrients

are available duckweed can cover a pond in a matter of 2 weeks. When sufficient nutrients are not available, they die off as other plants compete.

So goes the annual cycle that has gone on now for three years. Prior to the Buckley-Shuler development of the Porter Tract which now houses the Super Wal-Mart and all of the other commercial outlets, Trucious pond did not suffer the duckweed events. We believe that the stormwater drains on Normandie Road are collecting super-nutrients from the commercial development and flooding into Trucious Pond. Other properties in the Logan Gate Village watershed are also contributing.



# Floating Island Project

## Duckweed Options

If you can stand it, duckweed is beneficial for your pond. Aesthetically it may have a less than desirable visual plus for your pond but underneath the surface these plants are sucking up the excess nutrients that come in the form of nitrogen and phosphates.

Some people over react and have the plants surface sprayed to terminate their existence. The result of such a drastic action is a quick kill, followed by a brown decomposition of the plant life which if not removed from the pond will decompose and return in the form of more unwanted nutrients.

The tiny root systems of these plants actually suck up the nutrients helping with water clarity and conditioning.

The textbook answer to defeating duckweed is to stop the infusion of the nutrients and to plant more beneficial aquatic plants to consume the nutrients that are present. We have been unable to stop the infusion of nutrients so taking on the planting task was the next logical approach.

Trucious pond has two very distinct attributes that makes the tasks of adding plants difficult. First the

banks are very steep. Secondly, the pond depth ranges widely. In the rainy part of the summer, the water rises about 4 feet. In the dry portions of the year it drops 4 feet. Because of these two factors, planting marginal plants has proven to be very unsuccessful. During the summer "high-tide" season the plants are deep underwater and in the winter dry season they wither and die several feet from the water's edge.

What we needed was a planter that could move up and down with the height of the pond water. This fostered the idea of a floating plant island.

## Building the Island

From our experience with growing marginal plants, we knew they liked to have their roots in water but they did not like to be submerged. To satisfy those conditions we designed the island out of thin-walled PVC pipe components. Once the pipe frame was assembled we stitched a UV resistant sun shade material the formed a trampoline cover to which we could mount planting baskets.

Open mesh planter baskets were mounted to the trampoline using nylon wire ties. Inside the planter baskets we stuffed in coco-fiber inserts. The coco-fiber inserts were used to help hold the potting soil in place while the plants grow and mature. Plants were installed and bedded down with potting soil. The weight of the planters filled with soil and plants stretched the trampoline. This stretching allowed the planters to be partially submerged in pond water.

The objective is to have the plants root system penetrate the coco-fiber and open mesh planters, down through the tram-

poline mesh and into the pond water itself.

In the first month we lost 4 of the plants. We also noted the growth of algae on the top and bottom of the trampoline surface that was submerged in water. We also noted wildlife activity in the form of ducks chewing on the plant leaf material.

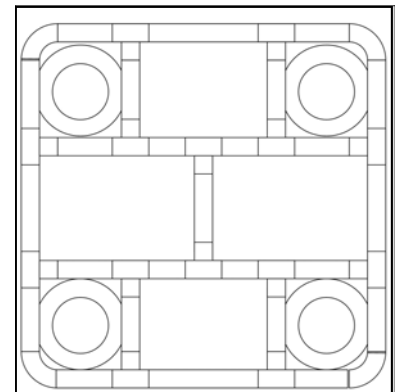

Island components, circles are tire tubes



Elbows and tees laid out for the assembly



Jim Smith cleans the pipe in preparation for assembly



Don Hardy gluing pipe components together



Plant baskets with coco fiber inserts and potting soil



Island skeleton is assembled



Plants in place in the planting baskets



Bottom view of baskets wire tied to trampoline



Don Hardy launches the island for a float test



Top view of trampoline with planter baskets



Island anchored at the shore



## Serving the Community

### LOGAN GATE VILLAGE SPECIAL DEPENDENT TAX DISTRICT

Logan Gate Village SDTD  
PO Box 272911  
Tampa, FL 33688

E-mail:  
president@logangatevillage.org

*The Logan Gate Village Special Tax District remains committed to helping homeowner's manage their pond properties. The board of trustee's recognize that these ponds are on private property but many of the problems that ponds have are the direct results of the homes and streets that comprise the watershed of Logan Gate Village. The project is an attempt to find a solution to a problem that faces many communities. Floating plant islands can be found in nature and have been man-made before. This island project is designed to have plants roots grow directly into the water, thereby absorbing nutrients as done in hydroponic farms. Observations will be recorded on the progress of the island and its impact on wildlife and water plants.*

*Don B. Hardy, President, LGV SDTD*

**We're on the Web!**  
**example.microsoft**  
**.com**

### Island Parts List—Approximate cost \$550

61021	10" Square Plant Basket	24 Ea
61024	12" Plant Basket	24 Ea
63648	12" Coconut Liner	48 Ea
22736	3" Santee pvc	14 Ea
22735	3" Elbow PVC	4 Ea
24164	3" S&D Pipe 10'	7 Ea
19549	Lacing Cord	2 Ea
17304	6' Med Forest Sun Screen	30 Ft
23778	4 oz NSF primer	1 Ea
23777	8 oz CPVC Cement	1 Ea
31884	36" Flex Duct Ties	1 Pkg
	Cable Ties	2 Pkg
86633	1CF Plant Mix	4 Ea
1000-20	Tire Tube	4 Ea

This is the materials list needed to construct the 10-foot by 10-foot island. As seen in

the pictures the pipe components were laid out on a deck then measurements taken and the pipe sections were cut to fit. Having an electric chop saw as shown in the picture helps you make quick, clean and square cuts.

The sunscreen fabric is wrapped over the pipe (hemmed) and using the lacing cord, stitched into place on one side. Then it is stretched tight and stitched on the opposite side.

Planter baskets are then wire tied into place. Coconut fiber liners are then wire tied inside the baskets.

Tire tubes are loosely tied to the four corners to provide floatation support. Initially they are not needed. When the plants grow heavy, they will need to be partially inflated to balance the island.

A rope and a cement block anchor is all you should need to anchor it in place.

## **Section 5**

# Nuisance Vegetation

Invasive vegetation, described here as nuisance vegetation, are plants that rapidly grow and can shade-out and/or crowd-out desirable plants.

It's important to do regular inspections of the pond to identify and control nuisance vegetation before they become a problem. This section provides information to help you identify some of the common nuisance plants found around ponds and provides information on ways to control some of these plants.

The goal is to use an integrated approach and to reduce or eliminate the use of chemicals to control nuisance vegetation. Consult with your Adopt-A-Pond coordinator for any questions about plant identification and for recommendations on control measures.

Remember, some presence of nuisance or exotic plants is normal and okay. We just want to control them from taking over.

### Featured Articles:

- Nuisance Vegetation ID & Descriptions
- Control of Non-native Plants in Natural Areas of FL
- Triploid Grass Carp
- The Lake Rake

# Nuisance Plants

The following pages contain pictures and information about plants that may be a nuisance in your pond. The list is not exhaustive, but it has all the main problem plants. Use it to help you identify things you need to control or manage.

Take care to identify plants properly, because there are many look-alikes that may not be bad.

Remember as well, that some presence of nuisance or exotic plants is normal and okay. We just want to control them from taking over.

## Alligator Weed



### *Alternanthera philoxeroides*

- small sprawling plant
- forms dense mats
- green with white flowers
- reproduces by propagation
- target of successful biological control (release of insects that eat it)
- grows fast
- difficult to control

**The Adopt-A-Pond Notebook:** Use it to learn more about your pond environment.



## Australian Pine



### *Casuarina equisetifolia*

- evergreen tree similar to pine trees
- leaves are drooping and needle-like with segments
- very invasive
- leaves drop to form dense mats on the ground that choke out other growth
- will take over wetland or coastal areas forming stands of only Australian pine
- reproduces by seeds in small cones
- fairly easy to control

**The Adopt-A-Pond Notebook:** Use it to learn more about your pond environment.

## Brazilian Pepper-tree



### *Schinus terebinthifolius*

- medium-sized shrubby tree
- bright green leaves with serrated edges
- produces bright red berries in season
- can be identified by distinct spicy smell when leaves are crushed
- extremely invasive
- reproduces by seeds & propagation
- dropped berries will sprout as will twigs, branches, and roots

**The Adopt-A-Pond Notebook:** Use it to learn more about your pond environment.



## Cattails



### *Typha spp.*

- actually a native, but often invasive in ponds
- can reach nine feet tall
- flowers in long brown cylinders that bloom into soft, fine hair-like seeds
- leaves twist half-way up length
- reproduces mainly by rhizome
- very invasive
- hard to control
- can be confused with iris when small, distinguished by round base (iris is flat and curved)

**The Adopt-A-Pond Notebook:** Use it to learn more about your pond environment.

## Dog Fennel



### *Eupatorium capillifolium*

- native plant, invasive in ponds
- green, early on then brown to white with wispy seeds
- can reach six feet tall
- very common in fields and disturbed areas
- reproduces by seeds and propagation
- fairly easy to control

**The Adopt-A-Pond Notebook:** Use it to learn more about your pond environment.



## Eurasian Watermilfoil

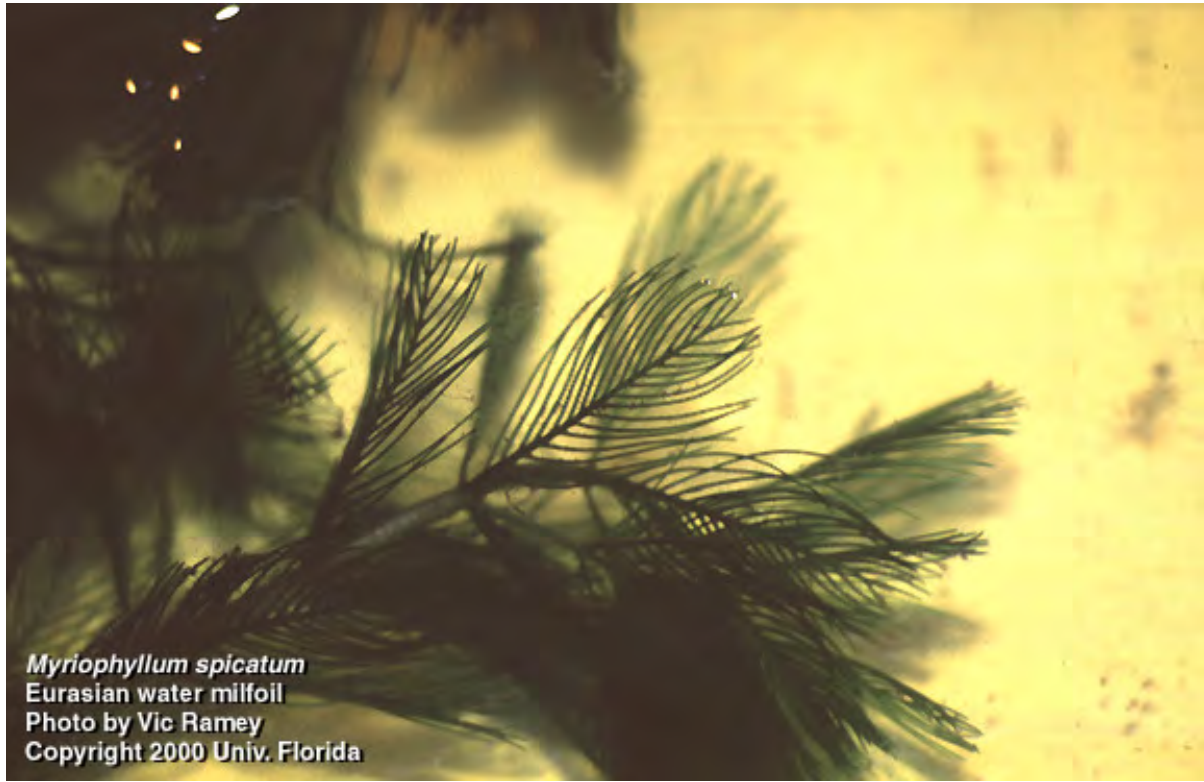

### *Myriophyllum spicatum*

- submerged aquatic plant that can reach 10 feet long
- leaves form thin whorls around the stem giving it a wispy appearance
- grows into mats that can block waterways and shade out vegetation
- reproduces by propagation mainly
- not a serious problem in most cases

**The Adopt-A-Pond Notebook:** Use it to learn more about your pond environment.

## Hydrilla



### *Hydrilla verticillata*

- submersed plant
- grows in long stalks from bottom of water but can form floating mats
- numerous small serrated leaves ringing the stalk
- tiny flowers grow at water surface on very long, thin stalks
- can block waterways
- very invasive
- can be confused with Brazilian elodea, another exotic, distinguished by smaller flowers than elodea

**The Adopt-A-Pond Notebook:** Use it to learn more about your pond environment.

## Hygrophila



### *Hygrophila polysperma*

- mostly submerged creeping plant
- brownish green in color
- small bluish white flowers at uppermost leaves
- clogs canals and waterways
- competes with hydrilla
- fast growing
- very invasive

The Adopt-A-Pond Notebook: Use it to learn more about your pond environment.



## Melaleuca



### *Melaleuca quinquenervia*

- large evergreen tree
- flowers look like bottlebrush
- bark is spongy and peels off in layers
- reproduces by propagation
- extremely invasive
- moves into wet areas and out-competes other vegetation
- can have drying effect on land
- also called 'punk tree', 'bottlebrush tree'

**The Adopt-A-Pond Notebook:** Use it to learn more about your pond environment.



## Mikania



### *Mikania scandens*

- climbing vine with nearly heart-shaped leaves
- small white flowers in clusters
- forms tangled mats over other plants
- reproduces by propagation and by seeds
- very invasive
- difficult to control

The Adopt-A-Pond Notebook: Use it to learn more about your pond environment.

## Primrose



### *Ludwigia peruviana*

- actually a native, but nonetheless a nuisance
- many species varying in size
- range from 1 foot to 6 feet in height
- woody stalks and yellow to white four-petal flowers
- reproduce by propagation or seeds
- extremely invasive
- trunks, roots, or branches will sprout if wet

**The Adopt-A-Pond Notebook:** Use it to learn more about your pond environment.



## Torpedo Grass



### *Panicum repens*

- grass that forms thick mats on ground and over water
- alternating light green blades with hairs on top
- thin spikelet seed heads
- reproduces by rhizomes and seeds
- extremely invasive
- long rhizomes may sprout several feet from main mat
- easily confused with maidencane, a native, distinguished by the leaf hairs

**The Adopt-A-Pond Notebook:** Use it to learn more about your pond environment.

## Water Hyacinth



### *Eichhornia spp.*

- shiny green floating plant
- forms white to purple flowers in clusters on top of short stalk
- flesh is hollow with air-filled cells that keep it afloat
- reproduces by propagation mainly, and by seeds
- grows fast and can block waterways and pond surfaces
- very invasive
- fairly easy to control

**The Adopt-A-Pond Notebook:** Use it to learn more about your pond environment.



## Water Lettuce



### *Pistia stratiotes*

- light green floating plant that grows in large colonies
- resembles lettuce head
- reproduces by budding
- can block waterways and cover large surface area
- very invasive
- fairly easy to control

**The Adopt-A-Pond Notebook:** Use it to learn more about your pond environment.

## Water Spinach



### *Ipomoea aquatica*

- bright green or red-purple vine with arrowhead shaped leaves
- stems hollow
- white to pink-lilac flowers are funnel shaped, similar to morning glory
- forms tangled mats that float over shallows
- very invasive
- hard to control

**The Adopt-A-Pond Notebook:** Use it to learn more about your pond environment.



## Control of Non-native Plants in Natural Areas of Florida<sup>1</sup>

K.A. Langeland and R.K. Stocker<sup>2</sup>

### Introduction

Forty-three percent of Florida's land area is currently in agricultural or urban land uses and over one third of its native habitats have been lost (1987 census). While continued urbanization is an inevitable consequence of increasing population, and food production by agriculture is essential, it is also important to preserve and protect Florida's native habitats for historical significance and to protect species, water quality, and water quantity. Setting aside certain lands to be managed for conservation is a method to protect them. According to the Florida Natural Areas Inventory, 6.3 million acres of state and federal public lands are currently managed for conservation. Natural areas are conservation lands that have been set aside for the purpose of preserving (or restoring) native plant and animal communities. Natural areas are also maintained by counties and cities in Florida and by private land owners.

Non-native plants, carried here by humans since Florida's discovery by Columbus, now threaten the state's remaining natural areas. Of the 4,012 plant species now growing on their own without cultivation in Florida, 29% are non-native (Atlas of Florida Flora, R. P Wunderlin). Many of these

non-native plants were originally introduced as garden ornamentals or agricultural crops. Other non-native plants were accidentally introduced. Regardless of how they arrived, these 1,200 or so non-native plants grew so well in Florida that they naturalized, that is, spread on their own without cultivation into managed and natural areas. While some of these naturalized non-native plants are not a problem, many became weeds, or undesirable plants, in agricultural, forestry, yards, and roadways. When these naturalized non-native plants spread extensively into natural areas and dominate by displacing native plants and disrupting natural processes such as fire or water flow, they are called invasive. Invasive non-native plants can be thought of as weeds in natural areas.

Familiar examples of invasive non-native plants that have already replaced native Florida plant communities and drastically changed the landscape both visually and ecologically include Brazilian pepper (*Schinus terebinthifolius*), and melaleuca (*Melaleuca quinquenervia*) in south Florida, and cogongrass (*Imperata cylindrica*) and Chinese tallow (*Sapium sebiferum*) in north Florida.

1. This document is SP 242, one of a series of the Department of Agronomy, Florida Cooperative Extension Service, Institute of Food and Agricultural Sciences, University of Florida. First printed: 1997. Revised: April, 2001. Please visit the EDIS website at <http://edis.ifas.ufl.edu>. This document was prepared in cooperation with the Metropolitan Dade County Park and Recreation Department, Natural Areas Management, and the Florida Exotic Pest Plant Council.

2. Kenneth Langeland, Professor, Department of Agronomy; Randall Stocker, Professor and Center Director, Center for Aquatic Plants, Department of Agronomy, Cooperative Extension Service, Institute of Food and Agricultural Sciences, University of Florida, Gainesville, FL, 32611.

Currently there is no information source that describes all invasive species for each particular part of Florida, and most invasive species are weed problems in some areas, but not in others. Until more information is developed, the best strategy for land managers is to become familiar with the most invasive species, and be watchful for their appearance. Listing of a species in this publication does not necessarily suggest that it should be regulated. It does indicate that it has warranted control measures in at least one natural area in the state and should be viewed as potentially invasive in other natural areas if it appears. Several invasive plants in Florida are regulated by statutory authority of the Florida Department of Agriculture and Consumer Services (DACS) and the Florida Department of Environmental Protection (DEP). The list of plants regulated by DACS, the Florida Noxious Weed List, includes plants that are federally regulated by the Federal Noxious Weed Act of 1974. The Florida Exotic Pest Plant Council (EPPC) maintains a current list of plants that are considered to be invasive or have invasive potential. While the EPPC list contains some plants that are also regulated by DACS and DEP, the list does not have statutory authority. These lists can be obtained from the University of Florida, Institute of Food and Agricultural Sciences Center for Aquatic Plants at 352/392-9613.

Management of invasive vegetation in natural areas requires methods that will minimize damage to nontarget vegetation and soil. Often this need for caution necessitates more time and effort than weed management in agricultural, industrial, or right-of-way settings. Some particular types of vegetation, for instance woody or sprawling vegetation, may require removal of standing plant material even after it has been killed if its presence increases fire hazard, reduces aesthetic appeal, or could cause harm as it decays and falls. Control methods include manual removal, mechanical removal, physical controls, herbicides, and biological control alone or in combination.

The purpose of this publication is to provide land managers in Florida with current methods being used to manage non-native plants by other land managers in the state.

## Regulatory Agencies

Removal of vegetation in certain areas such as public waters and wetlands is regulated by state and local agencies and a permit may be required. For questions regarding permits to control vegetation in public waters, contact one of the following Department of Environmental Protection regional offices:

Bartow (941) 534-7143  
 Floral City (352) 726-8622  
 Lake City (904) 758-0464  
 Orlando (407) 275-4004  
 Upland Weed Office (904) 487-2600  
 Tampa (813) 744-6163  
 West Palm Beach (561) 791-4720

For regulatory questions regarding vegetation control in wetlands contact the Water Management District (WMD) in which you are located:

Northwest Florida WMD (850) 482-9522  
 Suwannee River WMD (904) 362-1001  
 St. Johns River WMD (904) 329-4500  
 Southwest Florida WMD (813) 796-7211  
 South Florida WMD (561) 682-6201

## Control Methods

### Prevention

The importation and spread of invasive vegetation can be significantly reduced by public education. **It is the responsibility of those who are aware of the problems caused by invasive non-native plants to educate others about their identity, impacts, and control so that further ecological degradation of native ecosystems can be reduced.**

### Biological Control

In Florida, classical biological control (introduction of reproducing populations of foreign insects or diseases) of invasive non-native plants in non-agricultural areas has focused on aquatic weeds. The first biocontrol agent introduced was the alligatorweed flea beetle (*Agasicles hygrophila*) in 1964 for control of alligatorweed (*Alternanthera philoxeroides*). Subsequently, the alligatorweed



thrips (*Aminothrips andersoni*) was released in 1967 and the alligatorweed stem borer (*Vogtia malloi*) in 1971. The flea beetle and stem borer proved to be fairly effective for suppressing growth of alligatorweed, although harsh winters can reduce their populations. Less effective have been introductions of the waterhyacinth weevils (*Neochotina eichhorniae* and *N. bruchi*), released in 1972 and 1974, and the waterhyacinth borer, released in 1977 (*Sameodes albigutalis*) for waterhyacinth (*Eichhornia crassipes*) control. Likewise, effectiveness of a weevil (*Neohydronomous affinis*) and a moth (*Namangama pectinicornis*) released for control of water lettuce (*Pistia stratiotes*) has been unpredictable. Waterhyacinth and water lettuce continue to be problems that require management by other methods. Current biological control research is focused on hydrilla (*Hydrilla verticillata*), waterhyacinth (*Eichhornia crassipes*), melaleuca, and Brazilian pepper.

While classical biological controls are currently under study and will be implemented in the future, their development takes years and they cannot be expected to solve all invasive plant problems. Biological control programs are typically implemented by state and federal agencies, and the potential role of individual resource managers and the public will depend on the particular action being implemented.

Introduction of animals such as cattle, sheep, goats, or weed-eating fish may also be used to control certain invasive plants. However, environmental impacts of using such nonselective herbivores in natural areas should be carefully considered before implementation.

### Manual Removal

Manual removal is very time-consuming but often a major component of effective invasive plant control. Seedlings and small saplings can sometimes be pulled from the ground, but even small seedlings of some plants have tenacious roots that will prevent extraction or cause them to break at the root collar. Plants that break off at the ground will often resprout, and even small root fragments left in the ground may sprout. Therefore, repeated hand-pulling or

follow-up with herbicide applications is often necessary.

Removal of uprooted plant material is important. Stems and branches of certain species (e.g. ligustrum and melaleuca) that are laid on the ground can sprout roots, and attached seeds can germinate. If material cannot be destroyed by methods such as burning, it should be piled in a secure area that can be monitored and new plants killed as they appear.

Pulling plants from the ground may cause unwanted soil disturbance in some natural areas, especially pine rockland habitat. This soil disturbance may result in further invasion by invasive non-native plant species, again requiring follow-up control measures.

### Mechanical Removal

Mechanical removal involves the use of bulldozers, or specialized logging equipment to remove woody plants. Intense follow-up with other control methods is essential after the use of heavy equipment because disturbance of the soil creates favorable conditions for regrowth from seeds and root fragments, and recolonization by invasive non-native plants. Plans for management or replanting of sites with native vegetation following mechanical removal should be carefully developed prior to implementation of mechanical removal. Mechanical removal may not be appropriate in natural areas because of disturbance to soils and nontarget vegetation caused by heavy equipment.

### Cultural Practices

Prescribed burning and water level manipulation are cultural practices that are used in management of pastures, rangeland, and commercial forests and may be appropriate for vegetation management in natural areas in some situations. One important consideration is the degree of degradation for the area in question. Cultural practices may have impacts to all parts of the habitat, native species included. If the habitat is so badly degraded that the need to reduce invasives strongly outweighs consideration of remaining native species, more aggressive control strategies can be considered. In

less degraded areas, more careful use of integrated methods may be appropriate.

Land use history is critical in understanding the effects of fire and flooding on the resulting plant species composition. Past practices affect soil structure, organic content, seed bank (both native and invasive non-native species), and species composition. While there is evidence that past farming and timber management practices will greatly influence the outcome of cultural management, very little is known about effects of specific historical practices. Similar management practices conducted in areas with dissimilar histories may achieve very different results. Even less is known about the effects of invasives entering these communities, and the subsequent management effects of fire on the altered communities.

Understanding the reproductive biology of the target and nontarget plant species is critical to effective use of any control methods, but particularly so with methods, such as fire management, that often require significant preparation time. Important opportunities exist when management tools can be applied to habitats when non-native invasive species flower or set seed at different times than the native species.

### **Prescribed Burning**

Fire is a very normal part of most of Florida's many ecosystems, and native species have evolved varying degrees of fire tolerance. Throughout much of Florida, suppression of fire during this century has altered historical plant communities, such as flatwood and oak scrub communities, enhancing fire-intolerant species, and reducing the coverage of species that possess fire adaptations. Within these communities, the fire-tolerant woody species have lingered in smaller numbers, and less fire-tolerant species have replaced ephemeral herbs. Little is known about the amount, frequency, timing, and intensity of fire that would best enhance the historically fire-tolerant plant species, and less is known about how such a fire management regime could be best used to suppress invasive species. Single fires in areas with many years of fire suppression are unlikely to restore historical species

composition. Periodic fires in frequently burned areas do little to alter native species composition.

In a special case, invasion of tree stands by exotic vines and other climbing plants has greatly increased the danger of canopy (crown) fires and the resulting death to mature trees.

Added biomass by invasive plants can result in hotter fires, and can greatly increase the risk of fires spreading to inhabited areas. In these situations, use of fire to reduce standing biomass of invasive species may better protect the remaining plant populations than doing nothing, even though impacts to non-target native species will occur. Under these conditions, the expense of reducing standing biomass of invasive plant species might be justified by the savings on subsequent fire suppression.

In general, fire can be used to suppress plant growth, and even kill certain plants that are not fire tolerant. Most often, woody species are reduced while effects are less noticeable on herbaceous species. Some information has been published on responses of individual Florida plant species, but very little is known about the vast majority of native plant species, and less about invasive exotic species. Tolerance to fire can sometimes be predicted in species with thick bark, seeds, either in the soil or held in the canopy, that are adapted to fire (either tolerant of high temperature, or requiring fire for seed release or germination), and seeds that are dispersed over a wide area.

Effects of a single burn are hard to predict, but under some conditions a single fire effect can persist for several growing seasons. The length of effect is due to intensity of fire, time of year of fire (fire during the growing season can be more destructive than during dormant seasons), and the plant species involved. Smoke is now recognized as a germination triggering mechanism for fire-dependent as well as non-fire-dependent species, so plant species composition following a burn is due, in part, to the type of fire and the distribution of the smoke from that fire. A single burn may or may not start a replacement sequence (succession) with its own effects on species composition.

Whether fire can play a logical role in suppression or elimination of invasive exotic plant species depends on many factors. In addition to the principal factors described above, the resource manager must consider potential fire effects on soil loss and water quality, historical and economic impacts to buildings, possible harm to human life, and the potential for escape of a fire to nontarget areas.

Fire has been very successfully used to manage plant species in grasslands, to maintain open savannahs (scattered trees in herbaceous species dominated habitats), and to promote seral (fire-induced or fire-tolerant) stages of forest succession. Very little is known about the use of fire to enhance natives while reducing invasive exotic plant species. As a final caution in the use of fire to manage invasive plant species, too frequent burning has been shown to reduce plant diversity under many conditions, and it appears possible that increased fire frequency could provide opportunities for invasive plants to enter new areas.

### **Water Level Manipulation**

Some success has been achieved regulating water levels to reduce invasive plant species in aquatic and wetland habitats. Dewatering aquatic sites reduces standing biomass, but little else is usually achieved unless the site is rendered less susceptible to repeated invasion when rewatered. Planting native species may reduce the susceptibility of aquatic and wetland sites in some cases.

In most situations, water level manipulation in reservoirs has not provided the level of invasive plant control that was once thought achievable. Ponds and reservoirs can be constructed with steep sides to reduce invadable habitat, and levels can be avoided that promote invasive species, but rarely are these management options adaptable to natural areas.

Carefully timed water level increases following mechanical removal or fire management of invasive species can provide effective control of subsequent germination, and, with some species, resprouting. Specific methods applicable to natural areas have not been described.

### **Re-establishment of Native Plant Species**

Planting native species can be an effective, though expensive, way to reduce the likelihood of exotic species reinvasion following removal of non-native species. Commercial plant nurseries currently provide seed and plants of several wetland and upland species. Since some species cover a wide range of habitats and latitudes, care should be taken to obtain plant material suitable to the habitat under consideration. Seed collected from plants growing in more northern latitudes may do very poorly in Florida. Introduction of seeds, plant parts, or whole plants should include thorough screening for any unwanted pests, plant or animal.

It often takes several years for plantings to become thoroughly established, and extra care (water, nutrients) and protection (from fire and pests) may be necessary for a while. Also during this establishment phase, past management practices may have to be altered to avoid injury to the plantings. If periodic burning or flooding, for example, is part of the current management practice, it may be necessary to reduce the intensity or duration until the plantings are able to exhibit their typical resistance to injury, whatever that may be. Unfortunately, little is known about requirements for successful establishment of many native species, and less is known about their tolerances to cultural invasive plant management techniques. Even when tolerances are better known, responses may be affected by historical site effects, traits of particular genetic strains, site specific nutrition and light conditions, and interactions of soil type, hydroperiod, and microclimate.

### **Herbicides**

#### **Training and Certification**

Anyone who applies herbicides in natural areas should have basic training in herbicide application technology. Only topics specifically important to herbicide use in natural areas are emphasized in this circular and the reader is expected to have prior knowledge of basic herbicide application technology.

A pesticide, or some of its uses, is classified as restricted if it could cause harm to humans or to the environment unless it is applied by certified applicators who have the knowledge to use these pesticides safely and effectively. Although none of the herbicides or uses listed in this publication, or commonly used for invasive plant control in natural areas, are classified as restricted-use, the basic knowledge of herbicide technology and application techniques that is needed for safe handling and effective use of any herbicides can be obtained from restricted-use pesticide certification training. This training can be obtained through the University of Florida Institute of Food and Agricultural Sciences. Certification requirements are met by successfully completing testing to ensure that the individual is knowledgeable in the use and supervision of restricted use pesticide application. Once certified, applicators may obtain a license from the Florida Department of Agriculture and Consumer Services as either public applicators or commercial applicators. The fees for a four-year license are \$35 for a public applicator and \$90 for a commercial applicator. Workshops on use of herbicides for invasive plant control in natural areas can also be arranged. For additional information regarding pesticide applicator training contact the Cooperative Extension Service in your county or the IFAS Pesticide Information Office (352) 392-4721. The EPPC can provide information on training opportunities and assist with organization of workshops for natural area managers through its education committee.

### Active Ingredients and Formulations

A herbicide formulation, or product, consists of the herbicide active ingredient dissolved in a solvent (e.g., oil, water, or alcohol), or adsorbed to a solid such as clay. Formulations often include an adjuvant that facilitates spreading, sticking, wetting, and other modifying characteristics of the spray solution. Special ingredients may also improve the safety, handling, measuring, and application of the herbicide. Products mentioned in this publication contain the active ingredients 2,4-D, fluzifop, glyphosate, imazapyr, triclopyr (amine or ester), and hexazinone in varying concentrations (Table 1).

The active ingredients 2,4-D amine, triclopyr amine, imazapyr, and hexazinone are formulated as water-soluble liquids (L). They are not compatible with oil-based diluents and are diluted in water for foliar applications and diluted in water or applied in their concentrated form for cut stump applications. They are not normally used for basal bark applications.

Triclopyr ester, imazapyr, and fluzifop are formulated as emulsifiable concentrates (EC). Emulsifiable concentrates are compatible with oil-based diluents and also contain emulsifiers that allow the formulation to mix with water. Agitation is used to mix the EC in water. They may be diluted in water for foliar applications or mixed with oil based diluents for low volume applications (e.g., basal bark).

Hexazinone is also formulated as an ultra-low-weight soluble granule (ULW) formulation. This formulation is broadcast with specialized ground or aerial equipment.

### Where Herbicides Can Be Used

No pesticide may be sold in the United States until the U.S. Environmental Protection Agency (EPA) has reviewed the manufacturer's application for registration and determined that the use of the product will not present unreasonable risk to humans or the environment. **Pesticide users are required by law to comply with all the instructions and directions for use in pesticide labeling.**

EPA approves use of pesticides on specific sites, i.e., for use on individual crops, terrestrial non-crop or aquatic areas. Only those herbicides registered by EPA specifically for use in aquatic sites can be applied to plants growing in lakes, rivers, canals, etc. For terrestrial uses, EPA requires herbicide labels to have the statement: "Do not apply directly to water, to areas where surface water is present, or to intertidal areas below the mean highmark." Rodeo® is the only product mentioned in this publication that is registered for aquatic use and can be applied directly to water (Table 1). Certain but not all products that contain 2,4-D can also be applied directly to water. The state supplemental special local need label for the imazapyr-containing product,



Arsenal® (EPA SLN NO. FL-940004) allows government agencies and their contractors to use it for injection, frill/girdle or cut stump applications to control melaleuca and Brazilian pepper (addition of Chinese tallow to label applied for) growing in water. Other products mentioned can be used in noncropland areas and variously described low lying areas, including wetlands, but cannot be applied directly to water (Table 1).

### Absorption Characteristics

Herbicides recommended in this publication for invasive plant control are systemic. They move within the plant to the site where they are active after being absorbed by foliage, roots, or bark. Triclopyr, 2,4-D imazapyr, and glyphosate can be absorbed by plant leaves and are effective for foliar applications. Addition of an appropriate surfactant, as recommended on the herbicide label, is essential. Triclopyr, 2,4-D and glyphosate are absorbed by soils or broken down quickly in soil and are not absorbed effectively by plant roots, whereas imazapyr and hexazinone are readily absorbed by plant roots (Table 2). Only oil-soluble herbicide formulations, i.e. emulsifiable concentrates, are absorbed readily through tree bark.

### Behavior in Soils

Herbicides used for invasive plant control vary in their persistence and sorption to soils (Table 2). The most important factor is the ability of various soil types to chemically bind herbicides. Soil-applied herbicides, such as hexazinone, have label recommendations that vary the application rate for different types of soils. In general, soils with more organic matter and/or clay have greater capacities for binding herbicides than coarse, sandy soils and require higher application rates. Because woody plants are a problem on a range of Florida soils including highly organic muck, sand, and very thin soil layers over limestone, a broad range of herbicide behavior in different soils can be expected.

### Selectivity

The ability to selectively control target vegetation with herbicides without harming nontarget plants is related to the relative sensitivities

of target and nontarget plants, absorption and chemical characteristics of the herbicides, and placement.

Herbicides vary in their potential to damage nontarget vegetation, and unwanted results can be prevented or minimized by making the best choice of herbicides in conjunction with careful application. Fluazifop, which kills many grasses, can be used to selectively manage invasive grass species among nontarget broadplant species. Formulations that contain the active ingredients 2,4-D or triclopyr can often be used selectively because many broadleaf species are more sensitive to them than to perennial grasses.

Because 2,4-D, triclopyr and glyphosate have negligible root activity and break down quickly (Table 2), they have little potential for causing nontarget damage, due to root absorption, when carefully applied to target vegetation. In contrast, caution must be used with root active herbicides (i.e. hexazinone and imazapyr) to minimize damage to nontarget vegetation by root absorption.

Care must be taken to avoid unwanted contact of herbicide spray (drift) to foliage of nontarget plants when broadcast applications of the foliar active herbicides, 2,4-D, triclopyr, glyphosate, or imazapyr are made. Particulate drift can be minimized by avoiding windy conditions when spraying and using low pressures and large nozzle orifices. Volatile compounds such as ester formulations may cause nontarget damage due to vapor drift when applied on very hot days. This damage, which may be observed as wilting or curling leaves, has been minimal and has not caused permanent harm to woody nontarget plants.

### Wildlife Toxicity

Invasive plant management is often conducted in natural areas with the purpose of maintaining or restoring wildlife habitat. Therefore, it is essential that the herbicides themselves are not toxic to wildlife. Risk assessment to wildlife is conducted as part of the registration procedure for herbicides and is determined as the product of hazard and exposure. Hazard is measured as the toxicity of the herbicide to test animals and exposure depends on the use and

persistence of the compound. Herbicides recommended in this publication have shown very low toxicity to wildlife that they have been tested on, with the exception of the relatively low  $LC_{50}$  (0.87 ppm) of triclopyr ester and fluzifop (0.57 ppm) for fish, neither of which can be applied directly to water (Table 3). Ester formulations are toxic to fish because of irritation to fishes' gill surfaces. However, because triclopyr ester and fluzifop are not applied directly to water, are absorbed by soil particles, and have low persistence, exposure is low, which results in low risk when properly used.

### Herbicide Application Methods

**Foliar applications.** Herbicide is diluted in water and applied to the leaves with aerial or ground equipment. Dilution is usually about 20 parts water to 1 part herbicide concentrate for aerial applications, and 50 to 400 parts water to 1 part herbicide concentrate when making ground applications for woody plant control. Adjuvants, such as surfactants, drift control agents or other spray modifiers, are often added to the spray mix, as specified on the herbicide label. Ground equipment ranges from handspray bottles for applications to small individual plants, to large high pressure vehicle or boat-mounted sprayers for larger areas. Foliar applications can either be directed, to minimize damage to nontarget vegetation, or broadcast. Broadcast applications are used where damage to nontarget vegetation is not a concern or where a selective herbicide is used.

For directed spray, selective applications, backpack sprayers such as the Solo Model 475 with diaphragm pump or Swissmex SPI are effective and commonly used. A spray tip such as a TP 2503 or TP 2504 produces large spray droplets to reduce spray drift. The 2503 spray tips may be installed in the spray wand that comes with the backpack sprayer, or a Model 30 Gunjet with the 2503 or 2504 spray tip may be attached to any backpack spray unit. If an adjustable tip is used, a Tee-Jet 5500-X8 or equivalent is recommended. All backpack sprayers and spray guns should have chemical-resistant seals for the herbicides being used.

Power-driven ground equipment is commonly used to spray large/tall plants or large areas. Properly adjusted equipment should deliver a uniform spray with nozzle pressures of about 30 to 80 psi and should generate large spray droplets to reduce potential for spray drift. Higher spray pressures produce many small spray particles, which may drift onto sensitive desirable plants adjacent to the treated area. Application is made by directing the spray on the target foliage, being sure to spray the growing tips and terminal leader. Techniques must be employed to prevent the spray from contacting foliage of desirable plants.

Commonly used power equipment consists of portable power driven spray units mounted on a truck or all-terrain vehicle. A wide variety of pumps, tanks, and accessories are used. The most common and maintenance-free pump is a diaphragm pump driven by a gasoline engine, or a self-contained 12-volt pump unit. Routinely used spray guns are Spraying Systems Model 2 and 2A Gunjets. These are adjustable spray guns which produce patterns ranging from a solid stream to a wide cone spray. These spray guns may produce small spray particles at the cone spray setting, resulting in spray drift. Also, a Model 30 Gunjet with a Tee-Jet 5500-X10 adjustable tip is very effective for power sprayers. Dual spray Gunjets that accommodate two flat spray tips with different volumes and patterns are available. The spray gun can immediately be switched from one spray tip to the other by rotating the spray head. The two most commonly used spray tips for the spray gun are TP 0512, TP 4010 or TP 4020. These tips produce few fine spray particles so spray drift potential is reduced.

**Basal bark applications.** Herbicide is applied, commonly with a backpack sprayer, directly to the bark around the circumference of each stem/tree up to 15 inches above the ground. The herbicide must be in an oil-soluble formulation (EC) and if not in a ready-to-use form it may be mixed with a specially formulated penetrating oil. The spray tip should be a narrow angle (15-25 degrees) flat fan-tip nozzle such as a TP 1502 or TP 1503 or TP 2502/TP 2503, a solid cone nozzle, or an adjustable conejet such as a Tee-Jet 5500-X4 or 5500-X5 or equivalent. Any of these tips may be installed in the spray wand that

comes with the spray unit. A good alternative is a brass tip shut-off wand such as a Spraying Systems Model 31 with brass extension and tip shut-off or a Spraying Systems Model 30 Gunjet. A TP-0001/TP-0002 tip or DE-1/DE-2 disc should be used with the Model 30 Gunjet. The Gunjet may be attached to most backpack spray units that produce pressures between 20 and 50 psi. All backpack sprayers and spray guns should have chemical resistant seals for the herbicides and carriers being used.

**Frill or girdle (sometimes called hack-and-squirt) applications.** Cuts into the cambium are made completely around the circumference of the tree with no more than 3-inch intervals between cut edges. Continuous cuts (girdle) are sometimes used for difficult-to-control species and large trees. Do not make multiple cuts directly above or below each other because this will inhibit movement of the herbicide. Incisions should be angled downward to hold herbicide and must be deep enough to penetrate the bark and cambium layer. Herbicide (concentrated or diluted) is applied to each cut until the exposed area is thoroughly wet. Frill or girdle treatments are slow and labor intensive but sometimes necessary in mixed communities to kill target vegetation and minimize impact to desirable vegetation. To further minimize potential impact to desirable vegetation, cuts can be wrapped with tape to prevent rainfall from washing herbicide to the soil. Water- or oil-soluble formulations can be used for frill or girdle applications.

Backpack sprayers such as described above or 1- to 2-gallon pump-up sprayers can be suitable for frill or girdle herbicide mixtures as long as they contain chemically resistant seals such as Viton. Hand-held, chemical resistant spray bottles, such as the 1-quart Delta Industries "Spraymaster" are commonly used for applying herbicide for frill and girdle applications.

**Stump treatments.** After cutting and removing large trees or brush, herbicide (concentrated or diluted) is sprayed or painted on to the cut surface. The cut surface should be as level as possible so that herbicide solution does not run off. Sweep off dirt and sawdust that may prevent the herbicide solution

from being taken up by the stump. The herbicide is usually concentrated on the cambium layer on large stumps, especially when using concentrated herbicide solutions. The cambium is next to the bark around the entire circumference of the stump. When using dilute solutions the entire stump is sometimes flooded (depending on label instructions) with herbicide solution. Water- or oil-soluble formulations can be used. Spray equipment previously described can be used as long as they contain chemical resistant seals for the herbicides and carriers being used. Best results are obtained if the herbicide is applied immediately after cutting and with no more than one hour between cutting and applying herbicide, especially when using a water-soluble formulation (seconds can count with less susceptible species). Oil-soluble formulations can be effective when applied after some time has passed and should then be applied to the bark as well. The procedure must ensure that cut stems, branches, or seeds do not take root and produce additional plants.

**Soil applications.** Granular herbicide formulations can be applied by hand held spreaders, by specially designed blowers, or aerially. Soil-applied water-soluble or water-dispersible formulations can be applied with the same type of application equipment described for foliar applications or spotguns that can accurately deliver a measured amount of herbicide.

**Marker Dyes.** Marker dyes are very useful for keeping track of what vegetation has been treated when making applications to large numbers of individual trees or stumps. Dyes are also a useful indicator of the applicator's efficiency of limiting herbicide contact with nontarget vegetation and personal contact.

### **Methods Currently Used by Land Managers in Florida**

Control methods being used for invasive non-native plants by land managers in Florida are listed in Table 4. All methods listed have been found effective under certain circumstances. However, many factors can affect the performance of a herbicide application and results can vary. Choice of application method, herbicide, and rate for individual

species depend on environmental conditions and personal experience. Experience has shown that treatment success may vary from site to site and on the same site.

Pesticide product labeling is the primary method of communication between a herbicide manufacturer and the herbicide users and provides instructions on how to use the product safely and correctly. Changes in herbicide label directions may occur that are not concurrently updated in this publication. Because pesticide users are required by law to comply with all the instructions and directions for use contained in the pesticide label, no herbicide applications should be made based solely on information presented in this publication. **Pesticide users must review and comply with all conditions set forth in the pesticide label.**



**Table 1.** Herbicides commonly used in natural areas of Florida. (Alphabetical by active ingredient. All concentrations are a.i.)

PRODUCT	FORMULATION	COMMENTS
Several	2,4-D various	Some products can be applied directly to water.
Fusilade	Fluazifop 24.5% EC	Post emergence, grass specific. Cannot be applied directly to water.
Rodeo, Aquamaster, Aquaneat, Eagre, AquaPro, GlyPro, Accord	Glyphosate 53.8% L	Can be applied directly to water.
Roundup Pro, Roundup Super Concentrate, Credit, Glyphos, GloPro Plus, Rattler, Honcho, Touchdown Pro, Dupont Glyphosate, Roundup Pro Dry, Gly Gran	Glyphosate 41.0% L	May be applied to ditch banks, dry ditches, dry canals. May not be applied directly to water.
Velpar L	Hexazinone 25% L	May cause ground-water contamination if applied to areas where soils are permeable, especially where the water table is shallow. Nontarget plants can be damaged by root absorption.
Velpar ULW	Hexazinone 75% ULW	Same comments as Velpar L.
Arsenal	Imazapyr 28.7% L	May be applied to non-irrigation ditches and low lying areas when water has drained but may be isolated in pockets due to uneven or unlevel conditions. Otherwise, may not be applied directly to water. May be applied by government agencies or their contractors in Florida, under SLN, by injection, frill and girdle, or cut stump to melaleuca and Brazilian pepper when growing in water. Nontarget plants can be damaged by root absorption.
Stalker	Imazapyr 28.7% L	Can be applied to non-irrigation ditch banks. Nontarget plants can be damaged by root absorption.
Brush-B-Gon	Triclopyr amine 8.0% L	Homeowner packaging readily available in retail stores. Lower concentration than Garlon 3A may require follow-up applications.
Brush Killer	Triclopyr amine 8.8% L	Homeowner packaging readily available in retail stores. Lower concentration than Garlon 3A may require follow-up applications.
Garlon 3A	Triclopyr amine 44.4% L	May be applied to non-irrigation ditch banks, seasonally dry wetlands, flood plains, deltas, marshes, swamps, bogs, and transitional areas between upland and lowland sites. May not be applied directly to water.

**Table 1.** Herbicides commonly used in natural areas of Florida. (Alphabetical by active ingredient. All concentrations are a.i.)

PRODUCT	FORMULATION	COMMENTS
Garlon 4	Triclopyr ester 61.6% L	Same comments as Garlon 3A.
Pathfinder II	Triclopyr ester 13.6% L	Same comments as Garlon 3A. Ready to use.

**Table 2.** Soil behavior of herbicides commonly used in natural areas of Florida.

	HALF-LIFE (DAYS)	MOBILITY IN SOIL	ABSORPTION BY PLANT ROOTS
Glyphosate	~47	Little	Negligible
Fluazifop	15	Little	Negligible
Triclopyr	10-46	Moderate	Slight
2,4-D amine	10	Moderate	Slight
Imazapyr	25-142	Mobile	Strong
Hexazinone	~90	Mobile	Strong

**Table 3.** Toxicity of herbicides commonly used in natural areas of Florida.

	BOBWHITE QUAIL 8-DAY DIETARY LC <sub>50</sub> *	LABORATORY RAT 96-HR ORAL LD <sub>50</sub> **	BLUEGILL SUNFISH 96-HR LC <sub>50</sub> *
2,4-D amine	>5,620	>1000	524
Fluazifop	>4659 (5-day)	2721 (Female)	0.53
Triclopyr amine	>10,000	2574	891
Triclopyr ester	9,026	1581	0.87
Imazapyr	> 5,000	>5000	>100
Glyphosate	> 4,640	>5000	120
Hexazinone	>10,000	1690	420

\*LC<sub>50</sub> is the concentration in food (mg/kg) or water (mg/l) required to kill 50% of the population of test animals.

\*\*LD<sub>50</sub> is the quantity of herbicide in food that is lethal to 50% of test animals expressed as mg of herbicide per kg body wt.

**Table 4.** Control methods for non-native plants in use by land managers in Florida.

<p>The development and testing of many of these techniques was made possible through the Post-Hurricane Natural Areas Recovery Program supported by the Knight Foundation and a Florida state legislative appropriation to the Metro-Dade Park and Recreation Department. The following individuals contributed to recommendations listed in this table: Rodell Collins, Laura Flynn, Roger Hammer, Dallas Hazelton, Linda McDonald, Laurie McHargue, Jose Prieto, Robert Stewart, Sandra Vardaman Wells - Metro-Dade Park and Recreation Department; Jim Duquesnel, Mark Ludlow, Greg Jubinsky - Florida Department of Environmental Protection; Doria Gordon - The Nature Conservancy; Brian Nelson - Southwest Florida Water Management District; Wayne Corbin, Johnny Drew, Shawn Moore, Jerry Glance - St. Johns River Water Management District; Ross Hakes, Monsanto; Joe Visaggio, American Cyanamid; Bill Kline, DowElanco; Doug DeVries - National Park Service; Alison Fox, Ken Langeland, Jeff Mullahey, Donn Shilling, Brian Smith - University of Florida Institute of Food and Agricultural Sciences. Deborah Shelley, Jim Burney</p> <p><b>NOTE!</b> All dilutions of Garlon 4 applications (except foliar) are made with oil. All dilutions of Arsenal, Garlon 3A, Rodeo, Roundup Pro, or Roundup Super Concentrate are made with water.</p>	
<b>AGAVACEAE</b>	
<b><i>Sansevieria hyacinthoides</i></b>	<p>Bowstring hemp, Mother-in-law's tongue</p> <p>Treatment: Foliar apply 5%-10% Garlon 4 in oil or water. Addition of 3% stalker may increase consistency where non-target vegetation will not be endangered. In sandy soils where a greater potential exists for non-target damage plants can be cut and 15%-25% Roundup applied to the cut surfaces.</p> <p>Comments: Plants often take six to twelve months to die and follow-up applications are necessary.</p>
<b>ANACARDIACEAE (Cashew Family)</b>	
<b><i>Schinus terebinthifolius</i></b>	<p>Brazilian pepper; Florida holly</p> <p>Treatment: Cut-stump treatment with 50% Garlon 3A, 10% Garlon 4 or a basal bark application of 10% Garlon 4. Foliar application of Garlon 4, Garlon 3A, Roundup Pro, Roundup Super Concentrate, or Rodeo, according label directions may be used where appropriate. Glyphosate products are less effective when used alone in spring and early summer. Use Rodeo or cut stump application of 50% Arsenal where plants are growing in aquatic sites.</p> <p>Comments: Dioecious; female trees produce enormous quantities of bird-dispersed fruit; seed germinate readily; some people experience allergic reactions to the sap; target only female trees if time, funds or herbicide limitations are a factor.</p>
<b>APOCYNACEAE (Oleander Family)</b>	
<b><i>Alstonia macrophylla</i></b>	Devil tree
<b><i>Alstonia scholaris</i></b>	Scholar tree
	<p>Treatment: Basal bark application of 10% Garlon 4 or cut stump application of 50% Garlon 3A.</p> <p>Comments: Both species Invade hammocks, pinelands and disturbed sites; leaves are reportedly toxic to eat; <i>A. macrophylla</i> is becoming widespread in Dade county.</p>
<b><i>Ochrosia elliptica</i></b>	Ochrosia; Kopsia
	<p>Treatment: Cut-stump treatment with 50% Garlon 3A.</p> <p>Comments: Fruits are bright red, paired and reportedly poisonous to eat; often used in coastal landscaping.</p>

**Table 4.** Control methods for non-native plants in use by land managers in Florida.

<b>ARACEAE</b> (Arum Family)	
<b><i>Colocasia esculenta</i></b>	Wild Taro
	Treatment: Foliar application of 1% Weedar 64 (3lb a.e./gal 2,4-D amine) + 1% Rodeo + 0.5% 1% Kammo (D-limonene) + silicone surfactant.
	Comments: Usually found in aquatic habitats so only herbicides labeled for aquatic sites can be used. Large corms make control very difficult and repeat applications will be necessary.
<b><i>Syngonium podophyllum</i></b>	Nepthytis
	Treatment: Hand pull vegetation, remove from site, spray resprouts with 3% Roundup or apply 10% Garlon 4 to stems. Foliar application of 3% Garlon 4 in water with surfactant has also achieved reasonable success. Multiple treatments are required.
	Comments: Breaks readily when pulled; roots from nodes; difficult to control; sap is a skin, mouth, and eye irritant; only spreads vegetatively; many populations are the result of discarded landscape material.
<b><i>Epipremnum pinnatum</i></b> cv. 'aureum'	
	Treatment: Hand pull vegetation, remove from site or place in plastic in plastic bags and leave on-site until decomposed. After it has resprouted from broken stems, treat with 3% Roundup and surfactant. If non-target damage is not a concern, 3% roundup is very effective on large intact patches. Repeated cuttings of climbing vines 4-6' above ground and removal of the lower portion.
	Comment: Roots at nodes; sap is skin, mouth, and eye irritant; may form extensive groundcover; leaves enlarge considerably when plants climb trees or other support; spreads vegetatively, apparently does not set seed in Florida.
<b>ARALIACEAE</b> (Aralia Family)	
<b><i>Schefflera actinophylla</i></b>	Queensland umbrella; Umbrella tree
	Treatment: Large individuals (>10 inches dbh) have proven extremely difficult to eradicate. A cut-stump treatment with 50% Garlon 3A or 10% Garlon 4 is recommended. If a cut-stump treatment is not possible, application of a wide band of 10% Garlon 4 may be used on smaller individuals and 20% Garlon 4 may be used on larger individuals. It may take up to 9 months to kill large trees.
	Comments: Grows terrestrially or as an epiphyte; invasive in hammocks, particularly wet, rocky sites; bird-dispersed fruits.
<b>ARECACEAE</b> (Palm Family)	
<b><i>Caryota mitis</i></b>	Fishtail palm (clumping species)
<b><i>Caryota urens</i></b>	Fishtail palm (solitary-trunked species)
	Treatment: Cut palm below growing point and treat with 50% Garlon 3A or 10% Garlon 4. Alternatively, Garlon 4 can be applied to the apical bud.
	Comments: Unlike any other palm genus, the leaves are twice compound; on multiple-trunked (clumping) species, when one trunk is cut the plant will resprout; fruits abundantly and is a common invasive plant in hammocks; fruit and sap are a skin, mouth, and eye irritant.
<b><i>Chamaedorea seifrizii</i></b>	Bamboo palm
	Treatment: Treat as fishtail palm, above.
	Comments: Pinnate-leaved, narrow-trunked, clustering species; invades hammocks.



**Table 4.** Control methods for non-native plants in use by land managers in Florida.

<b><i>Livistona chinensis</i></b>	Chinese fan palm
	Treatment: Hand pull seedlings; cut young specimens at ground level or spray Garlon 4 into the apical bud.
	Comments: Costapalmate leaves; green, curved, sharp spines along petiole; can be mistaken for <i>Sabal</i> and <i>Thrinax</i> species, but neither of the latter have spines on the petioles; differs from <i>Washingtonia</i> by having green, not brown, spines and lacking threadlike fiber on the leaves.
<b><i>Phoenix reclinata</i></b>	Senegal date palm
	Treatment: Cut stems near ground level and treat with 50% Garlon 3A or 10% Garlon 4 or apply 10% Garlon 4 to meristem.
	Comments: Common non-native palm in hammocks, especially near coast; pinnate leaves with straight, sharp spines on petiole.
<b><i>Ptychosperma elegans</i></b>	Solitaire palm
	Treatment: Hand pull seedlings; cut mature trees down at ground level; remove fruiting stems from site.
	Comments: Pinnate leaves, solitary trunk; commonly invades hammocks; high seed germination; fruit dispersed by birds, raccoons and opossums; very common in the landscape.
<b><i>Roystonea regia</i></b>	Royal palm
	Treatment: Hand pull seedlings; chainsaw mature trees down near the base.
	Comments: Commonly escapes into hammocks from landscape trees; best controlled in the seedling stage; Florida royal palm, <i>Roystonea elata</i> is similar and some taxonomists lump these two species together as synonyms; royal palms should only be treated as exotics if it is known that they are invading areas outside of their native Florida range; Florida royal palm still occurs as a wild plant in Everglades National park (Royal Palm Hammock), Fakahatchee Strand State Preserve, and Royal Palm Hammock in Collier Seminole State Park in Collier County.
<b><i>Syagrus romanzoffianum</i></b> (= <i>Arecastrum romanzoffianum</i> )	Queen palm
	Treatment: Treat the same as Royal palm, above.
	Comments: Pinnate leaves, single trunk; common in the landscape; invasive in hammocks.
<b><i>Washingtonia robusta</i></b>	Mexican fan palm, Washingtonia palm
	Treatment: Hand pull seedlings; cut young specimens at ground level or spray Garlon 4 into apical bud. Large, mature trees in natural areas will need to be cut down.
	Comments: Palmate leaves with brown, curved, sharp spines along the petioles; mature trees may retain dead leaves along the trunk; leaves characteristically have brown, threadlike fibers attached; can be mistaken for Chinese fan palm, <i>Livistona chinensis</i> , but the latter has green petiole spines and costapalmate leaves; invades pinelands and disturbed sites.
<b>ASTERACEAE (Aster Family)</b>	
<b><i>Wedelia trilobata</i></b>	Wedelia; Dune sunflower
	Treatment: Treat small patches with 2% Roundup; large, dense populations may be treated by broadcast-spraying 5% Roundup (with follow-up treatments as needed). Or 1/4-1.0% Garlon 4 in water.

**Table 4.** Control methods for non-native plants in use by land managers in Florida.

<p>Comments: Trailing species, forming dense groundcover; yellow, daisy-like flowers produced all year; invades a variety of open, sunny habitats, including beaches; often becomes established from discarded landscape material.</p>	
<p><b>BERBERIDACEAE</b> (Barberry family)</p>	
<p><b><i>Nandina domestica</i></b></p>	<p>Nandina, Heavenly bamboo</p> <p>Treatment: Basal bark application of 15% Garlon 4 in mineral oil. Collect and destroy attached fruits.</p> <p>Comments: Naturalized in Gadsden, Jackson, Leon, Wakulla, and perhaps other Counties.</p>
<p><b>CACTACEAE</b> (Cactus Family)</p>	
<p><b><i>Hylocereus undatus</i> (=Cereus undatus)</b></p>	<p>Night-blooming cereus</p> <p>Treatment: Hand pull and remove from site if possible; if removal is not feasible, lay the plants out on a plastic tarp and spray them with 10% Garlon 4; 15% Roundup has been successful but it takes much longer for the plants to die.</p> <p>Comments: Vining cactus that climbs and roots to tree trunks; sometimes epiphytic; very showy, fragrant flowers open at night in summertime.</p>
<p><b>CAPRIFOLIACEAE</b></p>	
<p><b><i>Lonicera japonica</i></b></p>	<p>Japanese honeysuckle</p> <p>Treatment: Foliar application of 3%-5% Garlon 3A or 1%-3% Roundup Pro or equivalent concentration of other glyphosate containing product.</p> <p>Comments: Twining or trailing woody vine with young stems pubescent. Interrupts succession in once-forested areas by overtopping and smothering young trees, preventing their recruitment to the overstory and can disrupt understory structure in mature forests. May be confused with native honeysuckle, <i>Lonicera sempervirens</i>, leaves and stems of which are not hairy and flowers red with yellow within.</p>
<p><b>CASUARINACEAE</b> (Beefwood Family)</p>	
<p><b><i>Casuarina equisetifolia</i></b> <b><i>Casuarina glauca</i></b></p>	<p>Australian pine Beefwood, Brazilian oak</p> <p>Treatment: Basal bark treatment with 10% Garlon 4 is very effective, as is a cut-stump treatment with 50% Garlon 3A or 10% Garlon 4. When basal bark treatment is used on trees greater than 1 foot in diameter it may be necessary to slough off loose bark in the application area to prevent the bark from trapping the herbicide. Addition of 3% Stalker will increase consistency on older trees. Broadcut of 4-6 lb Velpar ULW may be used when appropriate.</p> <p>Comments: <i>C. equisetifolia</i> has a single trunk and produces viable seeds which are wind- and bird-dispersed; <i>C. glauca</i> produces suckers at the base of the trunk, rarely sets seed in Florida, and has a weeping growth habit.</p>
<p><b>CLUSIACEAE</b> (Pitch-apple Family)</p>	
<p><b><i>Calophyllum antillanum</i></b> (= <i>C. Calaba</i>; <i>C. brasiliense</i> var. <i>antillanum</i>)</p>	<p>Brazilian beauty-leaf</p> <p>Treatment: Basal bark treatment with 10% Garlon 4. Follow-up herbicide applications may be necessary.</p> <p>Comments: Medium-sized tree with glossy, leathery leaves; has been found principally invading coastal areas, including mangrove fringe.</p>

**Table 4.** Control methods for non-native plants in use by land managers in Florida.

<b>COMBRETACEAE</b> (Combretum Family)	
<i>Terminalia arjuna</i>	Arjun tree
<i>Terminalia catappa</i>	Indian almond
<i>Terminalia muelleri</i>	Mueller's almond
	Treatment: Basal bark application of 10% Garlon 4 or cut-stump treatment with 50% Garlon 3A.
	Comments: The Indian almond is deciduous and invades coastal habitats, hammocks, and disturbed sites; Arjun tree and Mueller's almond invade hammock interiors and margins.
<b>COMMELINACEAE</b> (Spiderwort Family)	
<i>Tradescantia spathacea</i> (= <i>Rhoeo spathacea</i> )	Oyster plant
	Treatment: Hand pull and remove from site.
	Comments: Succulent with sword-shaped rosettes of leaves, green on upper surface, bright purple on lower surface; highly invasive, forming extensive colonies.
<b>CONVOLVULACEAE</b> (Morning-glory Family)	
<i>Merremia tuberosa</i>	Wood rose
	Treatment: Cut stem at ground level and treat with 50% Garlon 3A or 10% Garlon 4. A basal bark treatment with 10% Garlon 4 also works. The cut-stem treatment is preferred because it is evident within one week which stems were treated and which were missed.
	Comments: Individual plants can cover extensive areas; rarely roots at nodes; bright yellow morning-glory-like flowers produced in late fall, fruits profusely in early winter; later December and early January die backs occur; seeds germinate readily.
<b>CRASSULACEAE</b> (Orpine Family)	
<i>Kalanchoe pinnata</i>	Life plant, Live leaf
	Treatment: Hand pull or treat with direct application of 3% Roundup and surfactant. Roundup is an effective treatment because it kills individual leaves that otherwise may produce new plants along leaf margins. Follow-up hand removal of leaves is necessary to prevent leaves from producing new plants. Basal stem treatments with 10% Garlon 4 is <b>NOT</b> recommended. This causes the leaves to drop, resulting in hundreds of new plantlets.
	Comments: Often found along edges of natural areas, generally as a result of discarded landscape material.
<b>DIOSCOREACEAE</b> (Yam Family)	
<i>Dioscorea alata</i>	Water yam
<i>Dioscorea bulbifera</i>	Air-potato; Air yam
<i>Dioscorea sansibarensis</i>	West African yam
	Treatment: Cut and remove as much of the vines as possible and collect bulbils and remove from site. Apply foliar application of 1.25%-2.0% Garlon 3A or 0.5%-2.0% Garlon 4 to remaining vegetation. Several follow-up applications will be necessary through the growing season and perhaps successive years to control growth.

**Table 4.** Control methods for non-native plants in use by land managers in Florida.

Comments: Monocot with heart-shaped leaves; dies back to tubers in winter in response to shortened day length, resprouts in spring from tubers; all three species produce aerial bulbils in late summer, early fall.	
<b>EBENACEAE</b> (Ebony Family)	
<i>Diospyros digyna</i> (= <i>D. ebenaster</i> )	Black sapote
Treatment: Large individuals are difficult to kill. Applying 50% Garlon 3A to a freshly cut stump is recommended. Basal bark treatments with Garlon 4 does not work.	
Comments: Black bark, shiny alternate leaves; scattered throughout a few hammocks in South Florida; fruits large, edible; green when ripe.	
<b>ELAEAGNACEAE</b> (Oleaster family)	
<i>Elaeagnus pungens</i>	Silverthorn
Treatment: Basal bark application of 15% Garlon 4 in mineral oil.	
Comments: Naturalized and targeted for removal in Florida Caverns State Park (Jackson County).	
<b>EUPHORBIACEAE</b> (Spurge Family)	
<i>Aleurites fordii</i>	Tungoil tree
Treatment: Basal bark applications with 20% Garlon 4.	
Comments: Found mainly in northern counties to Citrus County.	
<i>Bischofia javanica</i>	Bishopwood; toog
Treatment: Basal bark treatment with 10% Garlon 4 is effective. Large trees require applying a wider band of herbicide on the trunk, or increasing the concentration of Garlon 4 to 20%.	
Comments: Dioecious; compound leaves with three large leaflets; herbicide treatment may cause adventitious roots to form along trunk; female trees produce massive numbers of bird-dispersed fruits that hang in grape-like clusters; target only female trees if time, funds, or herbicide limitations are a factor.	
<i>Ricinus communis</i>	Castor bean
Treatment: Basal bark or cut-stump treatment with 10% Garlon 4. Site must be revisited several times to pull up seedlings.	
Comments: High seed germination: seeds extremely poisonous to eat.	
<i>Sapium sebiferum</i>	Chinese tallow, popcorn tree
Treatment: Cut stump treatment of 20% Garlon 4; or basal bark application of 15% Garlon 4 to trees <10 in dbh or 20% Garlon 4 to trees >10 in dbh (non-aquatic sites only). Addition of 3% Stalker will reduce resprouting on older trees. Experimental cut stump and frill applications of 2-3% Arsenal have proven effective in aquatic sites and an application has been made to add to the label. Low volume foliar application with 0.5%-0.75% Arsenal can be used where appropriate.	
Comments: Use basal bark method when seeds are present on tree to reduce seed spread, apply to run-off. Seedlings up to 10 in tall can be hand pulled.	
<b>FABACEAE</b> (Pea Family)	
<i>Abrus precatorius</i>	Rosary pea
Treatment: Treat base of vine with 10% Garlon 4. Site must be revisited several times to pull seedlings.	



**Table 4.** Control methods for non-native plants in use by land managers in Florida.

	Comments: Seeds black and red, highly poisonous.
<b><i>Acacia auriculiformis</i></b>	Earleaf acacia Treatment: Basal bark application of 10% Garlon 4 or cut-stump treatment with 50% Garlon 3A. Addition of 3% Stalker will increase consistency.
	Comments: A frequent invader of pinelands and disturbed sites.
<b><i>Adenanthera pavonina</i></b>	Red sandalwood Treatment: Basal bark treatment with 10% Garlon 4. Cut-stump treatments are also effective with 50% Garlon 3A or 10% Garlon 4. Small seedlings can be hand-pulled.
	Comments: Can be easily confused with <i>Albizia lebbbeck</i> , which has larger leaflets; bark of red sandalwood is typically reddish; produces hard red seeds which seem to persist in soil.
<b><i>Albizia lebbbeck</i></b>	Woman's tongue; Rattle pod Treatment: Basal bark treatment with 10% Garlon 4. Cut stump treatments are also effective with 50% Garlon 3A or 10% Garlon 4. Small seedlings can be hand-pulled.
	Comments: Large, dry, brown pods with few large seeds, mature principally in winter; common in pinelands and hammocks.
<b><i>Albizia julibrissin</i></b>	Mimosa Treatment: Basal bark application of 15% Garlon 4. Comments: Apply to 1-2 ft of trunk on larger trees. Trees >3 in dbh may require retreatment.
<b><i>Bauhinia forficata</i></b>	Spiny orchid tree
<b><i>Bauhinia purpurea</i></b>	Orchid tree
<b><i>Bauhinia variegata</i></b>	Orchid tree Treatment: Basal bark application of 10% Garlon 4 or application of 50% Garlon 3A to cut stump. Comments: All three species invade disturbed sites and the edges of natural areas in Dade County.
<b><i>Dalbergia sissoo</i></b>	Indian rosewood Treatment: Basal bark treatment with 10% Garlon 4. Comments: Medium to large tree with compound leaves bearing 3 to 5 leaflets; papery seed pods wind-dispersed; invasive along hammock margin, canopy gaps and disturbed sites.
<b><i>Delonix regia</i></b>	Royal poinciana Treatment: Cut stump application of 50% Garlon 3A. Comments: Large spreading tree with bi-pinnately compound leaves; very popular flowering tree in the landscape; invades hammock margin, canopy gaps and disturbed sites; seeds commonly sprout beneath parent trees.
<b><i>Leucaena leucocephala</i></b>	Lead tree, jumble bean Treatment: Difficult to control and variable results have been reported. Basal bark or cut-stem treatment with 10%-20% Garlon 4 has been reported to be effective while others report only partial success with 40% Garlon 4. 25% has been effective on trees <3" DBH, while larger trees were not killed. Large trees must be completely girdled for frill/girdle applications.

**Table 4.** Control methods for non-native plants in use by land managers in Florida.

<p><b><i>Mimosa pigra</i></b> (=M. <i>pelita</i>) Catclaw mimosa</p>	<p>Comments: Usually found on edges of natural areas; can be mistaken for native wild tamarind, <i>Lysiloma latisiliquum</i>. A larger band of Garlon 4 is applied to larger trees or those growing in sandy soils.</p>
<p><b><i>Mucuna pruriens</i></b> Cow itch</p>	<p>Treatment: Basal bark or cut stump application of Pathfinder or 30%-50% Garlon 4 and oil. Repeat foliar applications of 1.5% Rodeo or 2%-3% Garlon 3A.</p> <p>Comments: Repeated site visits are necessary to control seedlings and prevent further seed production. An estimated ten years are estimated to be needed for seed bank eradication.</p>
<p><b><i>Pueraria montana</i></b> (=P. <i>lobata</i>) Kudzu</p>	<p>Treatment: Basal bark application of 10% Garlon 4, or hand pull mature vines and seedlings; does not resprout from roots. It is important to continue pulling seedlings until seed bank is exhausted.</p> <p>Comments: Hairs on seed pods cause intense itching.</p> <p>When actively growing at or beyond bloom stage of growth apply 2% Roundup Pro (or equivalent) diluted in water with hand held equipment. During early to mid growing season apply 2% Garlon 3A. Use sufficient spray volume to thoroughly wet foliage.</p> <p>Comments: Follow up treatments are necessary as resprouting occurs from root crowns and tubers.</p>
<p><b><i>Wisteria sinensis</i></b> Chinese wisteria</p>	<p>Treatment: Cut vine and treat stump with 20%-30% Garlon 4 or 100% Garlon 3A.</p> <p>Comments: High climbing woody vine with showy lavender flowers in spring. Can top and kill mature trees. Legume densely, velvety pubescent compared to the native <i>Wisteria frutescens</i> with glabrous fruits.</p>
<p><b>GOODENIACEAE</b> (Goodenia Family)</p>	
<p><b><i>Scaevola sericea</i></b> (=S. <i>frutescens</i>; S. <i>taccada</i>) Beach naupaka; Half-flower; Scaevola</p>	<p>Treatment: Hand pull and remove, at least fruit, from site whenever possible; basal treatment with 10% Garlon 4 or treat cut stump with 50% Garlon 3A or 10% garlon 4 if removal is not feasible. Monocultures can be treated foliarly with 4% Garlon 4 in water, using care not to allow drift to non-target vegetation.</p> <p>Comments: Semi-woody shrub with either glabrous or pubescent, somewhat succulent leaves; flowers fan-shaped, white or blushed with purple; fruit are white, which helps distinguish it from the black-fruited, native Inkberry, <i>Scaevola plumieri</i>; seeds of the exotic scaevola are carried by ocean currents where they sprout and colonize beaches and other shoreline habitats. Branches in contact with ground may root.</p>
<p><b>LYGODIACEAE</b> (Climbing fern family)</p>	
<p><b><i>Lygodium microphyllum</i></b> Old World climbing fern</p>	<p>Treatment: Thoroughly spray foliage to wet with 1.25% Garlon 4 (4 pt per acre), 0.6% Roundup Pro (maximum 5 pt/acre), 1.0%-3.0% Rodeo (maximum 7 pt per acre). Only Rodeo can be used if plants are growing in aquatic site. Plants growing high into trees cut vines and treat lower portions. Do not apply when plants are under environmental stress.</p>

**Table 4.** Control methods for non-native plants in use by land managers in Florida.

	<p>Comments: Fern with twining, climbing fronds, leaflets unlobed. The most serious natural area weed in Florida. Land managers should be on constant lookout for it and take immediate steps to control it when encountered.</p>
<b><i>Lygodium japonicum</i></b>	<p>Japanese climbing fern</p> <p>Treatment: Foliar application of 1.5% Rodeo or equivalent glyphosate containing product at proportional glyphosate concentration.</p> <p>Comments: Fern with twining, climbing fronds, leaflets lobed. Occurs throughout west and north Florida into central Florida. Smothers seedlings of overstory tree species.</p>
<b>MALVACEAE</b> (Mallow Family)	
<b><i>Hibiscus tiliaceus</i></b>	<p>Sea hibiscus; Mahoe</p> <p>Treatment: Hand pull seedlings; basal bark treatment with 10% Garlon 4 or cut stump treatment with 50% Garlon 3A.</p> <p>Comments: Multi-trunked, large, spreading tree with long-petioled, rounded cordate leaves, hibiscus-like yellow flowers turn pink or red with age; seeds float and drift to new coastal habitats; erroneously considered native by some people.</p>
<b><i>Thespesia populnea</i></b>	<p>Seaside mahoe; Portia tree</p> <p>Treatment: Seedlings can be hand pulled. 50% Garlon 3A for cut stump applicaitons. Basal bark applications of 10% Garlon 4 have killed trees &lt;2" DBH after 8 weeks. Larger trees with thick corky bark require up to 25% Garlon 4.</p> <p>Comments: Multi-trunked, large, spreading tree; heart-shaped leaves with a pronounced drip-tip; hibiscus-like yellow flowers turn pink or red with age; seeds float and drift to new coastal habitats; erroneously considered native by some people.</p>
<b>MELIACEAE</b> (Mahogany family)	
<b><i>Melia azedarach</i></b>	<p>Chinaberry, Pride of India</p> <p>Treatment: Basal bark application of 15% to 30% Garlon 4. Treat 1-2 ft of trunk for larger trees. Trees &gt; 3" dbh may require retreatment. Fell trees over 6" DBH and treat stumps with up to 30% Garlon 4. Addition of 3% Stalker may increase consistency. Apply low volume foliar application of 1% Arsenal covering 50% of the foliage.</p> <p>Comments: Often shrubby and root-suckering, forming thickets. Fruits poisonous to humans and some other mammals. Most abundantly found in north and west Florida but often escaping cultivation in peninsular counties, south to the Keys.</p>
<b>MORACEAE</b> (Mulberry Family)	
<b><i>Broussonetia papyrifera</i></b>	<p>Paper mulberry</p> <p>Treatment: Basal bark application of 10%-30% Garlon 4. Addition of 3% Stalker will increase consistency.</p> <p>Comments: Large tree with scabrous leaves and reddish-orange balls of flowers. Invades hammocks and disturbed sites; young trees can be mistaken for the native red mulberry, <i>Morus rubra</i>.</p>
<b><i>Ficus altissima</i></b>	Lofty fig
<b><i>Ficus benghalensis</i></b>	Banyan fig
<b><i>Ficus microcarpa</i></b>	Laurel fig

**Table 4.** Control methods for non-native plants in use by land managers in Florida.

		<p>Treatment: Basal bark application of 10% Garlon 4 is effective.</p> <p>Comments: All three species invade the interior and edges of hammocks; often found growing as epiphytes (on trees) or epiliths (on rocks or stone structures); exercise care when treating epiphytic figs to ensure that herbicide does not come in contact with the host tree; members of this genus are very sensitive to Garlon 4; extreme care must be taken when treating any vegetation near the native strangler fig and shortleaf fig; spray that contacts surface roots can kill a large tree.</p>
<b>MYRSINACEAE</b> (Myrsine Family)		
<b><i>Ardisia elliptica</i></b> (= <i>Ardisia solanacea</i> )	Shoe-button Ardisia	<p>Treatment: Basal bark treatment with 10% Garlon 4 or cut stump application of 50% Garlon 3A. Hand pull seedlings.</p> <p>Comments: Often found in wetter areas; prolific reproduction; closely resembles the native <i>Ardisia escallonioides</i> (Marlberry) but differs in that new growth, petioles, and stem tips are pink to red, and fruit are produced in axillary, not terminal, clusters.</p>
<b><i>Ardisia crenata</i></b>	Coral ardisia	<p>Treatment: Foliar application of 5% Garlon 4 or basal bark application of 10% Garlon 4. Thorough coverage is essential for foliar application.</p> <p>Comments: Small shrub, easily recognized by bright shiny leaves, with crenate (scalloped) margins and calluses in the margin notches and persistent bright red (sometimes white) fruits.</p>
<b>MYRTACEAE</b> (Myrtle Family)		
<b><i>Eugenia uniflora</i></b>	Surinam cherry	<p>Treatment: For seedlings and small plants up to 1/2 inch diameter, use a basal bark treatment with 10% Garlon 4. This species takes a long time to die, and may require a subsequent herbicide application. For larger stems, use a cut-stump treatment with either 50% Garlon 3A or 10% Garlon 4. Seedlings should be hand pulled.</p> <p>Comments: Looks quite similar to native species of <i>Eugenia</i>; leaves have a distinct odor when crushed.</p>
<b><i>Melaleuca quinquenervia</i></b>	Cajeput; Punk tree; Melaleuca	<p>Treatment: For seedlings and saplings: (1) hand pull, being sure not to break plant off of root system and remove or place in piles to help reduce the chance that they will reroot or; (2) Treat with foliar, low volume spot application of 5% Rodeo. For mature trees: (1) Fell large trees with chain saw leaving a level surface, or fell small trees with machete and treat with 20% to 40% Arsenal according to directions on SLN; (2) if trees are to be left standing, make girdle application of 20% to 50% Arsenal or mixture of 25% Arsenal and 25% Rodeo according to frill and girdle directions on Arsenal SLN. Monitor for resprouting and retreat as necessary. (3) Mature trees are very difficult to control with foliar applications. Experimental aerial applications of 3 qt Rodeo + 3 qt Arsenal + 4 qt methylated seed oil surfactant have been somewhat successful. Contact manufacturer representatives when planning such large-scale treatments.</p> <p>Comments: Tall, highly invasive tree in freshwater wetlands; thick, papery bark; extremely high seed production; seeds dispersed by wind following natural or mechanical disturbance.</p>



**Table 4.** Control methods for non-native plants in use by land managers in Florida.

<b><i>Psidium guajava</i></b>	Guava
	Treatment: Basal bark application of 10% Garlon 4.
	Comments: Yellow, edible fruits; common invader in disturbed areas, hammock margins and wetlands.
<b><i>Rhodomyrtus tomentosa</i></b>	Downy rosemyrtle
	Treatment: Basal bark application of 10%-20% Garlon 4.
	Comments: A very aggressive evergreen shrub to 6 ft tall found as far north as Pasco County on the West Coast. Action should be taken immediately to remove it when found in natural areas. Identified by opposite, simple entire leaves, which are glossy green above, densely soft-hairy below, with three main veins form blade base; round, dark purple fruit with sweet aromatic flesh.
<b><i>Syzygium cumini</i></b>	Jambolan plum; Java plum
<b><i>Syzygium jambos</i></b>	Rose apple
	Treatment: Cut-stump treatment with 50% Garlon 3A or 10% Garlon 4, or use a basal bark treatment with 10% Garlon 4.
	Comments: Large trees, bird- and mammal-dispersed fruits. - Mature trees may take up to 9 months to die.
<b>OLEACEAE (Olive Family)</b>	
<b><i>Jasminum dichotomum</i></b>	Gold coast jasmine
<b><i>Jasminum fluminense</i></b>	Brazilian jasmine
	Treatment: Individual vines of any size can receive a cut-stump treatment with 50% Garlon 3A or 10% Garlon 4, or a basal bark application of 10% Garlon 4. Because basally-applied Garlon 4 does not translocate beyond a few rooted nodes it is often necessary to pull runners back to the main stem, cut and apply Garlon 3A or Garlon 4 to the cut stem. Re-treatment of areas is usually necessary. Newly emerged seedlings can be hand pulled.
	Comments: Jasmines produce a large number of bird- and mammal-dispersed seeds with very high germination; highly invasive.
<b><i>Ligustrum lucidum</i></b>	Glossy privet
<b><i>Ligustrum sinense</i></b>	Chinese privet
	Treatment: Basal Bark application of 15% Garlon 4. Apply to 1-2 ft of trunk on larger trees.
	<i>L. sinense</i> widespread in northern Florida mesic woods, road shoulders, and farmlands. Invades logged areas, dispersed by mammals, birds, and floodwaters.
<b>PASSIFLORACEAE (Passion-flower Family)</b>	
<b><i>Passiflora edulis</i></b>	Passion-flower
	Treatment: Treat stems with a basal application of 10% Garlon 4 or use 10% Garlon 4 in a cut-stem application.
	Comments: Large attractive flower; fruit purple, edible; invasive in hammocks.
<b>PIPERACEAE (Pepper Family)</b>	
<b><i>Lepianthes peltata</i></b>	Lepianthes
<b><i>Piper aduncum</i></b>	Bamboo piper
<b><i>Piper auritum</i></b>	Makulan

**Table 4.** Control methods for non-native plants in use by land managers in Florida.

	<p>Treatment: Hand pull when possible (broken roots may resprout); remove entire plant from site; if hand pulling is not possible or feasible, use basal bark application of 20% Garlon 4, or cut stems off at ground level and treat stumps with 50% Garlon 3A; remove cut stems from the site to avoid resprouting from nodes.</p> <p>Comments: All three of the above species invade hardwood hammocks, especially margins and canopy gaps.</p>
<b>POACEAE (Grass Family)</b>	
<b><i>Imperata cylindrica</i></b>	<p>Cogongrass</p> <p>Treatment: 3-4 qt. Roundup Pro, 2-3 qt. Arsenal, or 0.5 qt Fusulade per acre. For high volume, spot treatment use 3%-5% Roundup Pro or 0.25%-0.5% Arsenal. Herbicides should be used in combination with burning or tillage for optimum control. See IFAS Publication SS-AGR-52 for additional information.</p> <p>Comments: If not controlled, cogongrass will spread along roadways and into pastures, mining areas, forest land, parks, and other recreation areas. Extensive rhizomes must be eliminated for long term control.</p>
<b><i>Neyraudia reynaudiana</i></b>	<p>Burma reed</p> <p>Treatment: Where non-target damage is not a concern, the entire culm can be sprayed with 1-3% Roundup Pro. In areas with surrounding desirable vegetation, the culms can be cut to ground level and sprayed with 5% Roundup Pro when the plant reaches a height of approximately 12 to 18 inches (cut stems should be removed from the site). Removing seedheads before treatment will reduce need for follow-up. Responds quickly after fire and should be targeted as soon as new growth reaches 12 to 18 inches. Most native plants will not have resprouted from the fire by the time Burma reed has reached this height, and it can be easily treated with little concern about non-target damage.</p> <p>Comments: Tall cane grass; extremely invasive in pine rockland habitat and open dry habitats, as well as roadsides, vacant lots and other disturbed sites; fire tolerant.</p>
<b><i>Panicum repens</i></b>	<p>Torpedograss</p> <p>Treatment: Foliar application of 0.75 - 1.5% Rodeo and surfactant solution. Re-apply as necessary when plants regrow to with 4 - 6 inches in height; or foliar application of 0.5% spot treatment or 4 pints per acre broadcast treatment of Arsenal.</p> <p>Comments: Numerous dormant buds associated with extensive rhizomes make this plant extremely difficult to control. Several years of re-application may be necessary to completely eliminate a population.</p>
<b><i>Pennisetum purpureum</i></b>	<p>Napier grass</p> <p>Treatment: Foliar application of 1%-3% Roundup Pro. If non-target damage is a concern, cut stems to ground level and allow sprouts to reach 8-12 inches and treat the same as <i>Neyraudia</i> above. Broadcast 3-5 quart/acre Roundup Pro, 2 quart/acre Arsenal, or 1 quart Arsenal and 2 quart Roundup Pro.</p> <p>Comments: Tall cane grass with white stripe down the center of the leaf blade and a foxtail-like inflorescence; prefers wetter substrates.</p>
<b><i>Phyllostachys aurea</i></b>	<p>Golden Bamboo</p>

**Table 4.** Control methods for non-native plants in use by land managers in Florida.

	<p>Treatment: Foliar application of 3% Roundup Pro (equivalent formulations should be effective). Application of 5% Roundup Pro to cut culms will reduce resprouting but results are inconsistent.</p> <p>Comments: Not a common problem but once established can spread extensively. Populations should be controlled immediately. Can become established by dumping of yard waste.</p>
<b>RHAMNACEAE</b> (Buckthorn Family)	
<b><i>Colubrina asiatica</i></b>	Latherleaf; Asian colubrina
	<p>Treatment: Basal bark application of 20% Garlon 4, cut-stump treatment with 50% Garlon 3A, or foliar application with 3% Garlon 3A or Garlon 4 in water with surfactant. Follow up for 3 to 4 weeks Hand pull seedlings.</p> <p>Comments: Sprawling shrub commonly invading coastal habitats; has become a serious pest plant in mangrove/buttonwood habitat and in coastal hardwood forests. Capsules spread by tides and currents. Seeds resemble small pebbles and may be used as crop stones by seed eating birds, such as doves, and dispersed.</p>
<b>ROSACEAE</b> (Rose Family)	
<b><i>Rubus albescens</i></b>	Mysore raspberry
	<p>Treatment: Cut stem near ground and spray with 50% Garlon 3A or 10% Garlon 4. This species has not been observed resprouting from cut stem segments lying on the ground.</p> <p>Comments: Sharp thorns on stems and leaves; arching stems and branches of intact plants root where they touch the ground; seeds bird and mammal dispersed.</p>
<b><i>Eriobotrya japonica</i></b>	Loquat
	<p>Treatment: Tree can be cut-stump treated with 50% Garlon 3A or Garlon 4 or with a basal bark application of 10% Garlon 4.</p> <p>Comments: Invasive in hammocks; commonly cultivated for its yellow, fuzzy, edible fruit; seeds spread into natural areas by mammals; exotic, free-flying parrots are known to feed on the fruit as well, and may also be vectors of seeds.</p>
<b>RUBIACEAE</b> (Madder Family)	
<b><i>Paederia cruddasiana</i></b>	Sewer vine; skunk vine; Chinese fever vine
	<p>Treatment: Low volume foliar applications of 3% RoundupPro where non-target damage is not a concern. Where there are desirable plants, basal bark applications of 10% Garlon 4. Within 2-4 weeks retreat the area with basal applications of 10% Garlon 4. This second treatment can be time-consuming because many underground runners sprout. The area should continue to be monitored for follow-up treatments.</p> <p>Comments: Climbing vine; related to <i>Paederia foetida</i>, which is established in central Florida; flowers profusely; produces viable seeds.</p>
<b><i>Paederia foetida</i></b>	Skunk vine
	<p>Treatment: Apply 0.5% Garlon 3A to thoroughly wet foliage (4-8 pt.acre) or 10% to 6-inch band chest high to foliage of vertically climbing vines. Or apply 0.2%-0.6% Garlon 4 to thoroughly wet foliage or 1.0%-10% to 6 to 20-inch band chest high. Or thoroughly wet foliage with 1.0%-1.5% Plateau. Homeowners can use Brush-B-Gon at maximum label rates.</p>

**Table 4.** Control methods for non-native plants in use by land managers in Florida.

	<p>Comments: Perennial twining vine from woody rootstock having leaves and stems with disagreeable odor, especially when crushed. Most common in west central Florida, documented northward to Gadsen County and southward to Broward County.</p>
<b><i>Paederia foetida</i></b>	<p>Skunk vine</p> <p>Treatment: Limited information available. Foliar application of 3% (4 oz/gal) Brush-B-Gone or 1-2% Roundup has been effective. Preliminary data suggests successful control with fire when invading a pyric community.</p> <p>Comments: Extremely aggressive, draping, foul smelling vine. Common in West Central Florida and expanding its range.</p>
<b>RUTACEAE (Rue Family)</b>	
<b><i>Murraya paniculata</i></b>	<p>Orange jessamine</p> <p>Treatment: Hand pull seedlings; basal bark treatment with 10% Garlon 4.</p> <p>Comments: Shrub or small tree with small, glossy, compound leaves that are fragrant when crushed; white, citrus-like, heavily perfumed flowers produced in summertime; small orange fruit are bird-dispersed; invasive in hammocks, especially when bordered by residential areas that use this plant in the landscape.</p>
<b>SAPINDACEAE (Soapberry Family)</b>	
<b><i>Cupaniopsis anacardioides</i></b>	<p>Carrotwood</p> <p>Treatment: Basal bark application of 100% Pathfinder II, or 10%-20% Garlon 4 diluted with oil; or cut stump application of 10% Garlon 3A, 100% Brush-B-Gon, 100% Roundup Pro, 100% Rodeo, or equivalent glyphosate containing product, or 100% Pathfinder II.</p> <p>Comments: Invades interior of hammocks; added to Florida Noxious List in 1999; bird dispersed. Note label restrictions with respect to high tide mark and use extra caution near mangroves.</p>
<b>SAPOTACEAE (Sapodilla Family)</b>	
<b><i>Manilkara zapota</i></b>	<p>Sapodilla</p> <p>Treatment: Hand pull seedlings; basal bark application of 10% Garlon 4, larger trees may require several applications or increasing the Garlon 4 to 20%; or cut stump application with 50% Garlon 3A.</p> <p>Comments: Large, spreading tree; edible fruit; seeds dispersed by raccoons and opossums; invades hammock interiors.</p>
<b><i>Pouteria campechiana</i></b>	<p>Egg fruit; Canistel</p> <p>Treatment: Hand pull seedlings; basal bark application of 10% Garlon 4.</p> <p>Comments: Small to medium tree; yellow, edible fruit; prolific invader of hammocks but local in distribution; fruit eaten by raccoons and opossums.</p>
<b>SOLANACEAE (Nightshade Family)</b>	
<b><i>Cestrum diurnum</i></b>	<p>Day jessamine</p> <p>Treatment: Hand pull when possible (if soil disturbance is not an issue); cut stump treatment with 50% Garlon 3A is effective.</p> <p>Comments: Shrub or small tree with small, tubular, very fragrant flowers (in daytime) small purple fruit dispersed by birds.</p>
<b><i>Solanum tampicense</i></b>	<p>Wetland nightshade, misleadingly called aquatic soda apple</p>



**Table 4.** Control methods for non-native plants in use by land managers in Florida.

	<p>Treatment: Preliminary research results suggest foliar applications of 1.5% Garlon 3A is most effective while similar application rates of Rodeo or Weedar 64 may be somewhat less effective. Aggressive follow-up treatments will probably be necessary to control seedlings.</p> <p>Comments: An aggressive invader of wetlands and floodplains. Should be eliminated whenever located.</p>
<b><i>Solanum viarum</i></b>	<p>Tropical soda apple</p> <p>Treatment: Foliar application of 1% Garlon 4, 3% Roundup or 0.5% Arsenal solution in water with surfactant.</p> <p>Comments: Destroy fruit and treat plants immediately after detection. Spreads extremely fast. Livestock and wild animals eat fruits and readily disperse seed. For additional information see IFAS publication SS-AGR-58.</p>
<b>VERBENACEAE</b> (Verbena Family)	
<b><i>Lantana camara</i></b>	<p>Shrub verbena; Lantana</p> <p>Treatment: Basal application with 10% Garlon 4 or cut stump treatment with 50% Garlon 3A or 10% Garlon 4.</p> <p>Comments: Shrub with prickly stems and branches; multi-colored flower heads; ripe fruit blue; green unripe fruit highly toxic if eaten; this exotic species should be controlled to help avoid hybridization with the endemic <i>Lantana depressa</i>; typically a plant of roadsides and other disturbed sites but also invades pineland as well as hammock margins; numerous cultivars exist in the nursery trade.</p>

**Index of Common Names.**

<b>COMMON NAME</b>	<b>REFER TO PLANT FAMILY</b>
Air-potato	Dioscoreaceae
Air yam	Dioscoreaceae
Ardisia	Myrsinaceae
Arjun tree	Combretaceae
Asian colubrina	Rhamnaceae
Australian pine	Casuarinaceae
Bamboo palm	Arecaceae
Bamboo piper	Piperaceae
Banyan fig	Moraceae
Beach naupaka	Goodeniaceae
Beefwood	Casuarinaceae
Bishopwood	Euphorbiaceae
Black sapote	Ebenaceae

**Index of Common Names.**

<b>COMMON NAME</b>	<b>REFER TO PLANT FAMILY</b>
Bowstring hemp	Agavaceae
Brazilian beauty-leaf	Clusiaceae
Brazilian jasmine	Oleaceae
Brazilian oak	Casuarinaceae
Brazilian pepper	Anacardiaceae
Burma reed	Poaceae
Cajeput	Myrtaceae
Canistel	Sapotaceae
Carrotwood	Sapindaceae
Castor bean	Euphorbiaceae
Catclaw mimosa	Fabaceae
Chinaberry	Meliaceae
Chinese fan palm	Arecaceae
Chinese privet	Oleaceae
Chinese tallow	Euphorbiaceae
Chinese wisteria	Fabaceae
Cogongrass	Poaceae
Coral ardisia	Myrsinaceae
Cow itch	Fabaceae
Day jessamine	Solanaceae
Devil tree	Apocynaceae
Downy rosemyrtle	Myrtaceae
Dune sunflower	Asteraceae
Earleaf acacia	Fabaceae
Egg fruit	Sapotaceae
Ficus	Moraceae
Fishtail palm	Arecaceae
Florida holly	Anacardiaceae
Glossy privet	Oleaceae

**Index of Common Names.**

<b>COMMON NAME</b>	<b>REFER TO PLANT FAMILY</b>
Gold coast jasmine	Oleaceae
Golden bamboo	Poaceae
Guava	Myrtaceae
Half-flower	Goodeniaceae
Heavenly bamboo	Berberidaceae
Hunter's robe	Araceae
Indian almond	Combretaceae
Indian rosewood	Fabaceae
Jambolan plum	Myrtaceae
Japanese climbing fern	Lygodiaceae
Japanese honeysuckle	Caprifoliaceae
Jasmine	Oleaceae
Java plum	Myrtaceae
Kopsia	Apocynaceae
Lantana	Verbenaceae
Latherleaf	Rhamnaceae
Laurel fig	Moraceae
Lead-tree	Fabaceae
Lepianthes	Piperaceae
Life plant	Crassulaceae
Live leaf	Crassulaceae
Lofty fig	Moraceae
Loquat	Rosaceae
Mahoe	Malvaceae
Makulan	Piperaceae
Melaleuca	Myrtaceae
Mexican fan palm	Arecaceae
Mimosa	Fabaceae
Mother-in-law's tongue	Agavaceae

**Index of Common Names.**

<b>COMMON NAME</b>	<b>REFER TO PLANT FAMILY</b>
Mueller's almond	Combretaceae
Mysore raspberry	Rosaceae
Nandina	Berberidaceae
Napier grass	Poaceae
Nephthytis	Araceae
Night-blooming cereus	Cactaceae
Ochrosia	Apocynaceae
Old World climbing fern	Lygodiaceae
Orange jessamine	Rutaceae
Orchid tree	Fabaceae
Oyster plant	Commelinaceae
Palms	Arecaceae
Paper mulberry	Moraceae
Passion-flower	Passifloraceae
Piper	Piperaceae
Popcorn tree	Euphorbiaceae
Portia tree	Malvaceae
Possum grape	Vitaceae
Pothos	Araceae
Punk tree	Myrtaceae
Queen palm	Arecaceae
Queensland umbrella	Araliaceae
Raspberry	Rosaceae
Red sandalwood	Fabaceae
Rosary pea	Fabaceae
Rose apple	Myrtaceae
Rosewood	Fabaceae
Royal poinciana	Fabaceae
Royal palm	Arecaceae



**Index of Common Names.**

<b>COMMON NAME</b>	<b>REFER TO PLANT FAMILY</b>
Sapodilla	Sapotaceae
Scaevola	Goodeniaceae
Schefflera	Araliaceae
Scholar tree	Apocynaceae
Sea hibiscus	Malvaceae
Seaside mahoe	Malvaceae
Senegal date palm	Arecaceae
Sewer vine	Rubiaceae
Shoebuttton ardisia	Myrsinaceae
Silverthorn	Elaeagnaceae
Skunk vine	Rubiaceae
Solitaire palm	Arecaceae
Surinam cherry	Myrtaceae
Toog	Euphorbiaceae
Torpedoglass	Poaceae
Tropical soda apple	Solanaceae
Tungoil tree	Euphorbiaceae
Umbrella tree	Araliaceae
Washingtonia palm	Arecaceae
Water yam	Dioscoreaceae
Wedelia	Asteraceae
West African yam	Dioscoreaceae
Wild taro	Araceae
Woman's tongue	Fabaceae
Wood rose	Convolvulaceae

**Index of Botanical Names.**

<b>GENUS NAME</b>	<b>REFER TO PLANT FAMILY</b>
Abrus	Fabaceae

**Index of Botanical Names.**

<b>GENUS NAME</b>	<b>REFER TO PLANT FAMILY</b>
Acacia	Fabaceae
Adenanthera	Fabaceae
Albizia	Fabaceae
Aleurites	Euphorbiaceae
Alstonia	Apocynaceae
Ardisia	Mysinaceae
Bauhinia	Fabaceae
Bischofia	Euphorbiaceae
Broussonetia	Moraceae
Calophyllum	Clusiaceae
Caryota	Arecaceae
Casuarina	Casuarinaceae
Cereus	Cactaceae
Cestrum	Solanaceae
Chamaedorea	Arecaceae
Colocasia	Araceae
Colubrina	Rhamnaceae
Cupaniopsis	Sapindaceae
Dalbergia	Fabaceae
Delonix	Fabaceae
Dioscorea	Dioscoreaceae
Diospyros	Ebenaceae
Elaeagnus	Elaeagnaceae
Epipremnum	Araceae
Eriobotrya	Rosaceae
Eugenia	Myrtaceae
Ficus	Moraceae
Hibiscus	Malvaceae
Hylocereus	Cactaceae

**Index of Botanical Names.**

<b>GENUS NAME</b>	<b>REFER TO PLANT FAMILY</b>
Imperata	Poaceae
Jasminum	Oleaceae
Kalanchoe	Crassulaceae
Lantana	Verbenaceae
Lepianthes	Piperaceae
Leucaena	Fabaceae
Ligustrum	Oleaceae
Livistona	Arecaceae
Lonicera	Caprifoliaceae
Lygodium	Lygodiaceae
Manilkara	Sapotaceae
Melaleuca	Myrtaceae
Melia	Meliaceae
Merremia	Convolvulaceae
Mimosa	Fabaceae
Mucuna	Fabaceae
Murraya	Rutaceae
Nandina	Berberidaceae
Ochosia	Apocynaceae
Neyraudia	Poaceae
Paederia	Rubiaceae
Panicum	Poaceae
Passiflora	Passifloraceae
Pennisetum	Poaceae
Phoenix	Arecaceae
Phylostachis	Poaceae
Piper	Piperaceae
Pouteria	Sapotaceae
Ptychosperma	Arecaceae

**Index of Botanical Names.**

<b>GENUS NAME</b>	<b>REFER TO PLANT FAMILY</b>
Psidium	Myrtaceae
Rhaphidophora	Araceae
Rhodomyrtus	Myrtaceae
Rhoeo	Commelinaceae
Ricinus	Euphorbiaceae
Roystonea	Arecaceae
Rubus	Rosaceae
Sansevieria	Agavaceae
Sapium	Euphorbiaceae
Scaevola	Goodeniaceae
Schefflera	Araliaceae
Schinus	Anacardiaceae
Solanum	Solanaceae
Sphagneticola	Asteraceae
Syagrus	Arecaceae
Syngonium	Araceae
Syzygium	Myrtaceae
Terminalia	Combretaceae
Thespesia	Malvaceae
Tradescantia	Commelinaceae
Washingtonia	Arecaceae
Wedelia	Asteraceae
Wisteria	Fabaceae



# TRIPLIOD GRASS CARP



*Pond owners must be careful to choose a method to selectively manage, rather than eliminate, aquatic vegetation.*

For more information  
contact Aquatic Plant  
Management  
Biologists:

Eustis  
(352) 742-6438

Lakeland  
(941) 648-3202

**M**ANY FLORIDA pond owners face problems with nuisance aquatic plants. One of the more publicized solutions is the triploid grass carp, a fish imported from Asia and genetically altered at hatcheries so it will not spawn. One of the few fish species that eats aquatic vegetation, grass carp are effective in controlling

some species of aquatic plants, particularly in small water bodies. However, this fish is not a magic solution for every pond owner.

This brochure is designed to help you evaluate whether grass carp are the appropriate solution to your problems, and how to properly acquire and stock this fish.

---

---

**Thirty percent plant coverage is a healthy balance.**

---

---

## Do You Really Have a Plant Problem?

Plants are a natural part of most Florida lakes. Aquatic vegetation provides cover for small fish along with the creatures they eat. Weedy areas are

such cases, pond owners must be careful to choose a method to selectively manage, rather than eliminate, aquatic vegetation.

Although vegetation is not critical for good fishing in small ponds, fisheries biologists recommend up to 30 percent plant coverage as a healthy balance. If your pond or lake falls within these guidelines, you may want to consider whether the cost of treatment is worthwhile.

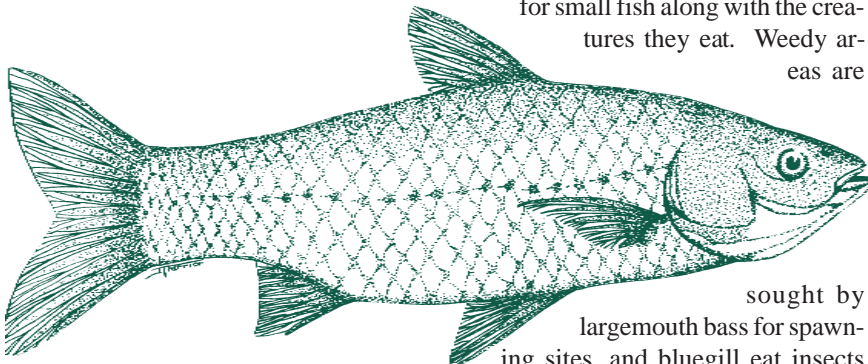

sought by largemouth bass for spawning sites, and bluegill eat insects associated with water plants. Wading birds are common in shoreline vegetation.

Many ponds with weed problems also have desirable aquatic plant species. A pond with dense hydrilla in the middle may have a band of water lilies that the owner would like to maintain. In

## Are Triploid Grass Carp The Answer to Your Problems?

Grass carp are not the only way to control nuisance aquatic plants. Chemicals (herbicides) and mechanical harvesting are also used. Although grass carp are very effective in controlling some species such as hydrilla and naiad, they are not recommended for many common plants, including water lilies, bacopa and water hyacinths. See back cover for a description of which aquatic plants are controlled by grass carp.

## The Triploid Grass Carp

The grass carp, also known as white amur, is the largest member of the minnow family and is native to eastern Asia. Grass carp were first introduced into the United States in 1963 to test their effectiveness for controlling aquatic plants.

Grass carp were brought to Florida in 1972. Early research found grass carp were effective in controlling hydrilla, a rapidly growing exotic aquatic plant. However, at high stocking rates, virtually all other aquatic plants were eliminated as well.

Because so many of Florida's fish and wildlife species depend on aquatic vegetation at some stage of their lives, controlling distribution of grass carp is a major concern. Spawning requirements are similar to those of striped bass, a species that spawns in a few north Florida river systems. Uncontrolled reproduction could have a long-term impact on desirable aquatic plants, ultimately resulting in degradation of fish and wildlife habitat.

In 1984, a method for producing sterile grass carp was developed. During artificial spawning, hatcheries use a process that results in three sets of chromosomes (triploid) instead of the normal two sets (diploid). This results in a functionally sterile triploid grass carp, greatly reducing the possibility of habitat destruction by escaped fish.

## Pros and Cons of Using Triploid Grass Carp

If grass carp will control your problem plant, there are several advantages in using this fish instead of chemical or mechanical methods. Triploid grass carp typically cost \$20 to \$250 per acre, avoid excess chemical use, and provide long-term control, often 2 to 6 years before restocking is necessary. Chemical treatments range from \$200 to \$600 per acre, while cost for mechanical control can exceed twice that amount. In addition, chemicals or harvesting may be required twice a year or more.

There are disadvantages in using triploid grass carp. At low stocking rates (generally two to five fish per acre), it often takes six months to a year before plants decrease. Higher rates are more expensive and often lead to elimination of all plants, including desirable species that provide cover for fish and other animals. When plants are removed, fish such as shad and crappie may increase, while bass and bream may become more difficult to locate and catch. Also fewer bird species use the water body if nesting and feeding sites are removed.

If you overstock and later change your mind about aquatic plants, it is difficult to remove grass carp. Triploid grass carp can live more than 10 years, and once vegetation has been eliminated, very few fish can keep a pond plant-free. Triploid grass carp can be caught on hook-and-line using bread, dough balls, dog food and live worms, but the bottom line is that once triploid grass carp have removed all the plants from your pond, it is likely to stay that way for awhile.



*To ensure that only triploid grass carp are sold in Florida, each grass carp is tested using scientific equipment that measures red blood cells nuclei. Because of their extra set of chromosomes, triploids have larger blood cells than diploids.*

Along with declines in some types of fish and wildlife, pond owners may notice green water, resulting from an increase in microscopic algae. As the problem plants are removed, algae multiplies rapidly. These algae "blooms" can turn the water green, and, in severe cases, the appearance of a "paint scum" may form on the surface. At their worst, blooms lead to fish kills, as algae die and decompose.

In water bodies over five acres, we recommend using triploid grass carp together with chemical or mechanical control. An initial herbicide treatment followed by a low triploid grass carp stocking rate generally results in more effective aquatic plant management at lower long-term cost.



*Triploid grass carp grow rapidly, reaching 20 inches and about three pounds in one year from a stocking size of 10-12 inches and one-half pound.*

## Triploid Grass Carp Checklist

### *Identify your problem plant.*

Triploid grass carp efficiently control some types of plants, such as hydrilla and naiad. Other species are better controlled with other methods. Refer to back cover for common Florida aquatic plants. Applicants may take plant samples to local offices of the Agricultural Extension Service, the Commission, or Department of Environmental Protection for identification.

### *Do you want to eliminate or selectively manage aquatic plants?*

Canals, golf courses, and small ponds may not need vegetation; some aquatic plants are beneficial in larger ponds and lakes where fishing is important. Determine what degree of control is appropriate for your water body.

### *Contact the Fish and Wildlife Conservation Commission for a permit application.*

The triploid grass carp is a restricted fish in Florida and can only be possessed by permit issued through the Commission. Your application details the size of the water body, a map showing its location, and its principal use (agriculture, fishing, etc.); what the suspected problem plant is; if your lake or pond has any connection to any other water body; and if you are the sole owner of the pond or lake, or a member of a waterfront property owners' association.

### *Obtain a permit.*

A Commission biologist will evaluate your aquatic plant situation, and check for possible escape routes that may impact other waters. If the permit is approved, the biologist will recommend the number of triploid grass carp to deal with your problem. Generally, two to ten fish per acre are used. Each permit is issued for a specific site and a specified number of fish. If your site has escape routes, you will be required to install an approved barrier before your permit is issued. Consent of all private waterfront property owners or the homeowners association is required prior to permitting.

### *Find a certified supplier.*

The Commission provides a list of suppliers approved to sell triploid grass carp in Florida with each permit. In 1999 there were 34 approved suppliers, 28 of which are in Florida. The cost of triploid grass carp varies depending on the number and size of the fish ordered. As of 1999, for large orders (several hundred) the cost is generally around \$5 per fish. The average homeowner with a small pond will probably pay \$7 to \$10 per fish. **You must use only triploid grass carp obtained from an approved supplier.**

## Grass Carp Barrier Designs

Triploid grass carp are attracted to flowing water and will escape through open connecting streams, marshes, ditches, culverts and drainage structures, particularly if aquatic plants are scarce. Grass carp have been known to leap several feet to leave a water body. In most cases, a fish barrier can be installed at potential escape routes. Such barriers are required to be installed and maintained by the applicant for a permit to be issued by the Commission.

Barrier designs often consist of corrosion-resistant screening placed over a culvert pipe or drain structure. If an area is subject to high flow, a more advanced barrier with a parallel bar design may be necessary to minimize debris build-up which may cause flooding. Barrier requirements must be acceptable to local storm water management agencies. **The permit applicant is responsible for obtaining approval.**

A maximum gap size of one and a half inches will block passage of 10-inch triploid grass carp. If smaller fish are stocked the gap size must be narrower. A leaflet titled "Barriers to Restrict the Movement of Grass Carp for Management of Aquatic Weeds" is available at no cost from Commission offices.

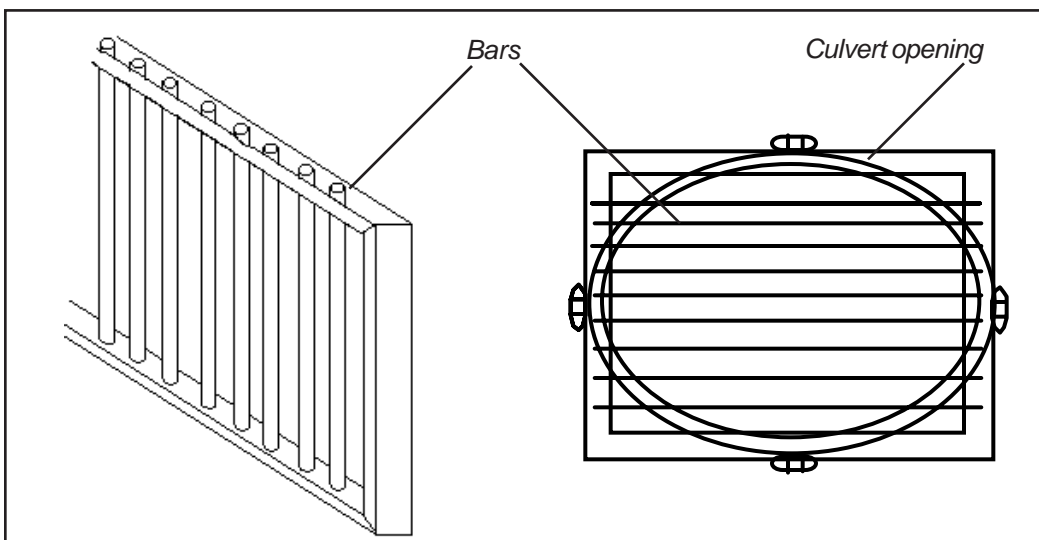

Basic Barrier Designs - A maximum gap of 1.5 inches between bars is allowed.

# PLANT IDENTIFICATION

Triploid grass carp will control these commonly found plants.

Grass carp also will consume other plants not shown here.

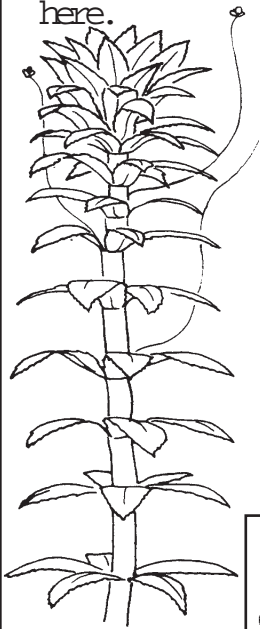

*Hydrilla*



*Coontail*

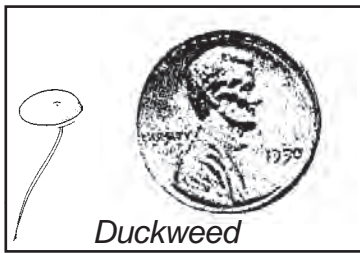

*Duckweed*



*Muskgrass or Chara*

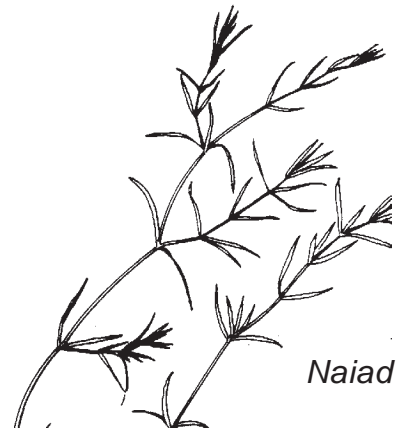

*Naiad*

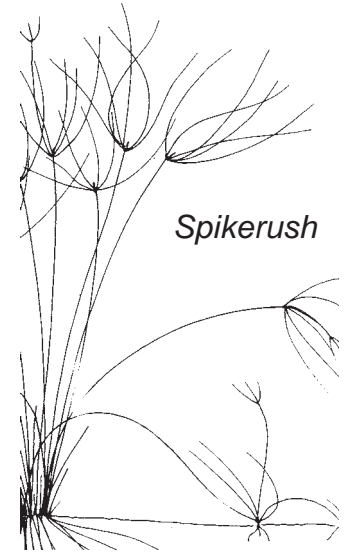

*Spikerush*

Triploid grass carp will not control these plants.



*Water hyacinth*

*Water lettuce*

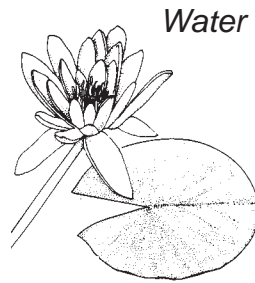
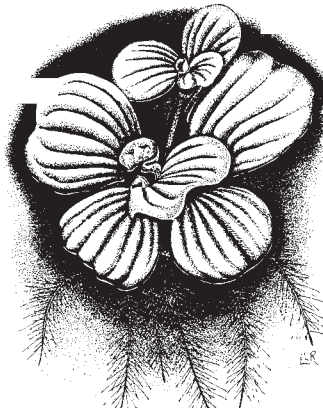

*Water lily*

*Torpedo grass*

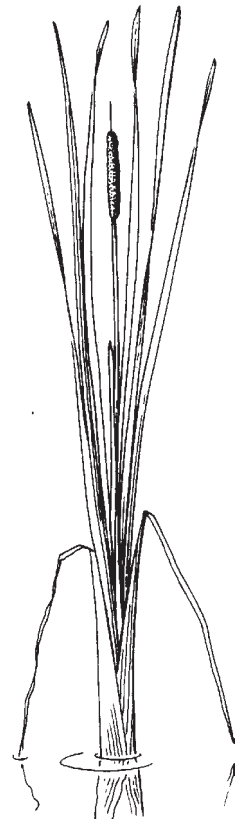

*Cattail*



# The Lake Rake

We often get questions from pond and lake residents about what tools can be used to manage invasive aquatic plants without using chemicals. The Lake Rake is an easy to make tool that can be used to rake invasive plants out of the water. It can be used on both submerged vegetation and floating plants. Here's how to make one of your own!

## Supplies

- 1¼" Schedule 40 PVC pipe (3½ ft length)
- 11, 5" Bolts
- 11 Nuts to fit on bolts
- Polypropylene Rope (cut 2 pieces, 1 shorter than the other)

## Directions for Assembly

1. Drill 11 holes for your bolts, spaced 3" apart, all the way through the PVC pipe leaving 4½" of space at each end of the pipe.
2. Insert bolts into holes (facing every other bolt in the opposite direction) and spin nuts on bolts to prevent from slipping.
3. Drill 1 rope-sized hole through the pipe 2" from each end with the holes facing at right angles from the bolt holes. Take the shorter rope (about 5½ ft long) and tie each end through the holes.
4. Tie one end of the longer rope to the loop of rope attached to the PVC pipe. This is your drag line.

## How to Use

Cast the rake into the water while holding the end of the drag line. Drag the rake back through the weeds. The weeds will tangle on the bolts as you pull the rake back to shore. Pull the weeds off the rake and you are ready for another throw.

Note: The rake will sink, but it can be modified to suit your purposes (e.g. by adding floats to the pipe for raking out floating plants).



## **Section 6**

### **Duckweed Control**

Duckweed is a very small, light green, floating plant. It is native to Florida and is often found in waters with little to no wave action. They are also commonly found with other small floating plants, including water fern, mosquito fern, and water meal. Because of this, we generally refer to all these plants as “duckweed.”

When nutrients are readily available in a waterbody, these plants can spread quickly and cover the entire surface of a pond. When this happens, they shade light from getting to submerged vegetation below. These plants also can affect the appearance of a pond.

This section includes information on techniques for controlling this vegetation.

#### **Featured Articles:**

- Duckweed Control-Hitchcock Pond Technique
- Duckweed Pumping



# Duckweed Control

## The Hitchcock Pond Technique

Is your pond covered end-to-end in a bunch of very small, floating plants? Well not to panic. We see this all the time. Most likely it is one of several species of plants such as these:

- Giant duckweed - *Spirodela polyrrhiza*
- Small duckweed - *Lemna valdiviana*
- Water meal - *Wolffia columbiana*
- Mud-midget - *Wolffiella floridana*

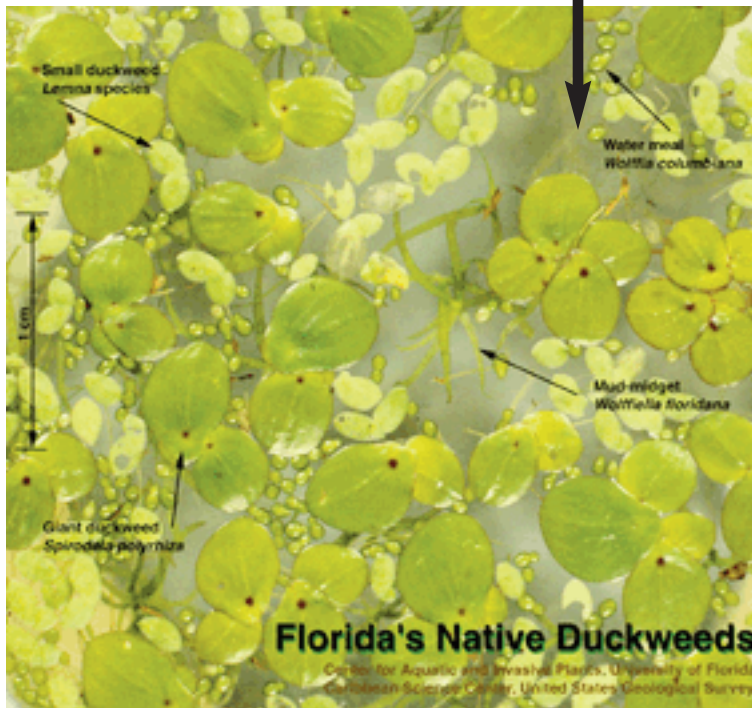

But you've probably got a lot of this too:

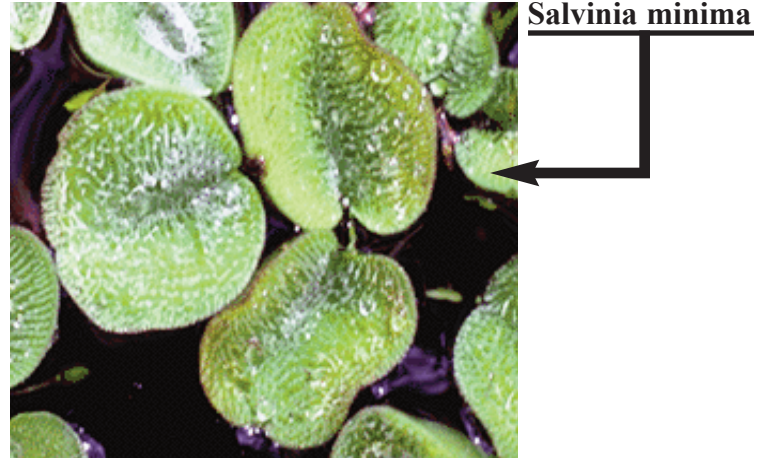

And if you're lucky, maybe some of this:

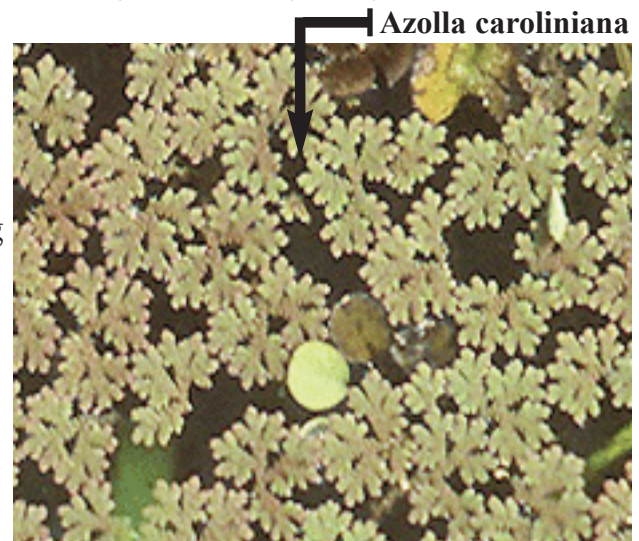

For convenience we generally refer to all these plants as “duckweed”, even though they are distinct species. These little guys may look like trouble, but the fact is, they won't hurt your pond. If anything, they're going to help by taking up the excess nutrients that are in your pond! They won't kill fish, in fact some fish eat them. The only problem with them, is the way they look.

If you can't stand 'em, you can contract someone to herbicide them, or you can gather your neighbors and rake them out. Removal is the best option because it removes the seed source, and the nutrient load stored in the plant. For best results, try the **Hitchcock Pond Technique**, described below.

Without complex, site-specific studies, it is impossible to determine exactly why these plants have multiplied in your pond. It is important to remember that a pond is a living system made up of many different interactions and processes. Many are driven by organisms trying to survive and reproduce. They compete for resources with other organisms doing the same thing. Since resources are limited, they get used up. Naturally, the one in shortest supply runs out first and limits the growth in your pond. But various organisms are limited by different things. So if one organism, in this case those little plants, can get a little more of that one resource they need... BOOM! They grow like crazy until it's all used up, or something else runs out.

This concept is called "limiting factors" and it's a fundamental principle of Environmental Science. You could call it a natural law -- that an organism will continue to grow until some factor limits that growth. Again, we can't be specific about what the limiting factor is without detailed studies, but we've noticed that duckweed becomes a problem in the spring and after it rains for awhile. This means that temperature probably checks the growth, as well as nutrients in the runoff that enters the pond. We can't control the temperature, but we can do something about the nutrients.

## The Hitchcock Pond Technique

This technique was invented by one of our pond groups in response to this very problem. Their 2-acre pond was completely covered, and they got rid of nearly all of it. Here's how it works.

**Step 1.** Plant native wetland vegetation. These plants look nice in the pond, but more importantly they take up nutrients that are otherwise fair game for the duckweed. Don't worry about it, plant right in among the duckweed. **Without this step, the duckweed will grow right back.**

**Step 2.** Buy a role of silt fence from a local hardware store -- you know, that black fabric-type stuff around construction sites.

**Step 3.** Anchor one end of the fence on the bank and drag a loop out into the pond using a boat or by walking it (you may need some milk-jug floats to keep it upright). Take advantage of the shape of the pond. The idea here is to block off a section of the pond, so if you have narrow spots, use'em.

**Step 4.** Get some hands to start raking the duckweed out from the bank. Use broad soft-tined rakes and nets. Take advantage of the wind. If no wind, use another section of silt fence as a seine to drag the plants to you. If you want, you can even use a solids pump to suck it off the surface like a vacuum (you can rent one from a machinery rental store). Let the plants dry and place them in your garden as mulch and compost.

Once you get one section completed, block off another one and repeat. Leave the old section of fence in place to prevent the duckweed from floating back over there. Modify the technique to fit your situation. If you come up with something good, we might name a technique after your pond!

**NOTE:** This technique will help you control the problem *in* the pond, but remember, the source of the nutrients is *outside* your pond, in people's yards. See Section 3 of this notebook to learn more about Florida-Friendly Landscape techniques to help limit the amount of nutrients washing off your yard.



# Hitchcock Pond



Look how thick the duckweed is. We planted the pickerelweed right in it.



Same pond after restoration. Beautiful. The 2001 Best Maintained Pond.

# Deepbrook Pond



This group used the technique as well. It really does work!



Lastly, remember we're dealing with natural cycles here. One year is only one of those cycles. So be patient and don't be surprised if it takes a year or more to get your pond in shape. Even then, it's always changing, so just have fun with it and don't stress. After all, it's just a pond!



# Duckweed Pumping

This technique was developed to be used in conjunction with the Hitchcock Pond duckweed removal technique. If used appropriately, this technique will accomplish the same result using less people. Like the Hitchcock Pond technique, Duckweed Pumping was developed by program participants in response to challenges they faced.

Location selection is crucial to the operation. We chose a site where the duckweed would blow toward us with the wind. We've also used current in the waterbody to draw material toward us. Once the pumping site is determined, the discharge site is equally as crucial. It is important to find a stabilized area for the water to return to the pond without creating erosion. We used an existing flow way that was heavily vegetated, but plastic sheeting could be used to create a temporary spillway. Turbidity in the water should also be monitored throughout. We don't want to create more problems.



Containment of the duckweed is the next consideration. Anything that keeps the duckweed in but lets the water flow back to the pond will work. We constructed a metal box frame about 5'x5'x3' and lined it with screen for a screened porch. This screen comes in rolls of varying widths. We used cable ties (zip ties) to secure the screen to the top of the frame, overlapping rows of screen until the box was fully lined. The overlaps were secured with cable ties to prevent gapping.

The discharge hose for the pump was secured into the box so that it spilled into the screen.

We used a 2" trash pump. A 3" pump would have drawn more water without becoming too unwieldy. A 2" or 3" diaphragm pump would also be effective. The pump was operated from the back of the truck.



The intake hose was placed in the water just below the surface so that the pump would draw duckweed down without sucking too much air and losing prime. It took several adjustments to get the hose into position. We found that passing the hose through the hole in a concrete block worked well. An easier variation is to create a skimmer basket for the intake hose from a plastic trash can. A description of the skimmer basket can be found at the end of this document.



**The Adopt-A-Pond Notebook:** *Use it to learn more about your pond environment.*

Throughout pumping, the operator remained by the intake to rake duckweed toward the suction with a broad soft-tined rake.

When the box became significantly full (1/4- 1/3 full) the duckweed was scooped out into trash bags for disposal. This way the bags never got too heavy. The duckweed could also be used as a soil amendment or mulch.

Operation is very slow, but effective. It is extremely important to make use of the natural conditions to keep the duckweed moving toward the pump. If this is not possible, the Hitchcock Pond technique should be used to corral the duckweed near the pump.

It should also be noted that removal of duckweed is never 100%, and that this technique is only effective as part of an overall waterbody management scheme.

### **Skimmer Basket Intake**

This modification makes it much easier to set the intake hose without losing prime. Thanks to Don Hardy from Truscious Pond for this design. (He also created the floating island design in this notebook.)



1. Office type plastic waste basket. Cut 3 inch hole and attach male or female hose coupler to match hose connections using threaded portion to attach to basket. Will need 3 inch nut on inside of basket.
2. Connect hose to pump and basket.
3. Sink basket below water surface, start pump and allow flow to start.
4. Raise the basket to the surface of the water allowing water and duckweed to flow in. Allow enough water to keep prime. The pump should handle solids. Works like pool skimmer.



## **Section 7**

### Algae Control

Algae are microscopic plants naturally found in all waterbodies. They usually don't occur in amounts high enough to be harmful to the environment. When there are excessive amounts of nutrients (particularly nitrogen and phosphorus) available in the water, they grow rapidly. This is called an "algae bloom."

Algae blooms are harmful to the pond environment. They shade out light from getting to submerged vegetation below and they can cause reductions in dissolved oxygen, potentially causing a fish kill.

This section includes articles on sources of nutrient pollution and identifies ways to prevent excess nutrients from getting into waterbodies.

#### Featured Articles:

- Algae Blooms
- Understanding Fish Kills in Florida  
Freshwater Systems



# Algae Blooms



Algae can cause the waterbody to turn a green color.

**Algae** are microscopic plants found in all waterbodies. They are an important food source for many aquatic organisms. When they grow too rapidly, called an “algae bloom,” they can cause major problems to the waterbody.

Algae blooms can make the water murky and block sunlight from getting to underwater plants. They can also reduce the amount of oxygen dissolved in the water. When less oxygen is available in the water, fish and other aquatic life can be stressed and may die. Algae blooms can also lower the pH of the water and some release toxins that can be harmful for wildlife and potentially people.

## Causes

Nutrients, particularly nitrogen and phosphorus, are absorbed by algae to allow them to grow. In natural waterbodies not impacted by pollution, nutrient levels are low and algae have to compete for available nutrients. This keeps the amount of algae in balance with other elements of the system.

When additional nutrients are added to the waterbody from outside sources, algae grow more rapidly than they can be consumed by aquatic organisms.

**Nutrient pollution** comes from many human activities.

Sources of nutrient pollution can come from fertilizers, pet waste, faulty septic systems, and lawn clippings and leaf litter blown onto streets and/or directly into a waterbody.



Algae can have a stringy, scummy appearance.

## How You Can Help Prevent Algae Blooms

- Apply fertilizer, pesticides, and herbicides sparingly, if at all.
- Follow all label directions.
- Follow local ordinances on fertilizer application.
- Choose slow-release fertilizers.
- Sweep yard waste and clippings off driveways, sidewalks, and streets.
- Pick-up and put pet waste in the trash.
- Properly maintain septic systems and have them inspected at least every three to five years.

The Adopt-A-Pond Notebook: *Use it to learn more about your pond environment.*

# Understanding Fish Kills in Florida Freshwater Systems

**A** fish kill is an event in which dead or dying fish are observed in a lake or waterbody. Some fish kill events involve small numbers of fish and others may involve hundreds, or even thousands of fish.

There are many factors that can contribute to a fish kill. This pamphlet was created to explain the most common factors and how they affect Florida's freshwater systems. It includes discussion of both natural and human-induced causes, as well the effects that stress can have on fish — a component of virtually every fish kill situation.

We hope this information will provide a greater understanding of the processes that commonly occur during a fish kill event, and perhaps alleviate some of the concerns you may have.

Should a fish kill occur in your area, the last section of this pamphlet (pages 14-16) provides steps you can take to help determine the cause. While this task can be challenging, the chances for success are greatly increased if both fish samples and water samples can be collected from the waterbody and analyzed in a timely manner. A listing of fish health diagnostic laboratories is provided on page 16.\* If too much time has already passed or if you don't have time to submit samples, the observations you collect can still provide important clues about what may have happened. Be sure to gather this information as soon as possible and contact the appropriate agency, listed on page 14.

*\* There are usually fees associated with having samples tested in a laboratory; it is recommended that you call ahead and discuss the cost before going to the trouble of collecting and submitting samples.*

## Included in this pamphlet:

Introduction	2
<b>Naturally Occurring Fish Kills</b>	<b>3</b>
Low Dissolved Oxygen Levels	3
Spawning Fatalities	7
Mortality Due to Cold Temperatures	7
<b>Sidebar: Stress in Fish</b>	<b>8</b>
Diseases and Parasites	10
Toxic Algae Blooms	11
<b>Human Induced Fish Kills</b>	<b>12</b>
<b>What You Can Do If You Observe a Fish Kill</b>	<b>14</b>
<b>Sidebar: Collecting Fish and Water Samples</b>	<b>15</b>
<b>Fish Health Diagnostic Facilities in Florida</b>	<b>16</b>

**F**

loridians are proud of the diversity and abundance of fish life found throughout the state, and for good reason. More than 225 different species of fish can be found in freshwater systems, including about 150 native species and approximately 75 non-natives. Of course, this doesn't even include the abundance of saltwater species!

With such a variety to choose from, it's easy to see why Florida is considered the Fishing Capital of the World — a place where virtually every day, thousands of anglers take to the water to land a trophy bass, catch a delicious fish dinner or enjoy the therapeutic qualities that fishing has to offer. In fact, freshwater anglers contribute nearly two billion dollars to the state's annual economy.<sup>1</sup>

However, anglers aren't the only people who care about fish. There are just as many individuals who enjoy feeding or watching them school under a dock. Some lake residents have even "adopted" or named individual fish that are seen on a regular basis. Still others feel good simply knowing that there are fish living in their neighborhood lake, pond, or canal, serving as indicators of the ecosystem's health.

Such strong connections to the aquatic environment may help explain the concern that surfaces when reports of a fish kill appear in the local media — especially if large numbers of fish are involved. Often the first assumption is that something is terribly wrong with the lake or waterbody. Suspicions are raised as to whether human activity, such as a chemical spill, may have caused the fish to die. Sometimes these suspicions are warranted but often they are not. What many people don't realize is that the vast majority of fish kills in Florida are due to natural

<sup>1</sup> According to the National Survey of Fishing, Hunting and Wildlife-Related Recreation. U.S. Census Bureau. 2001.

## The Bad News

- Fish kills occur frequently in Florida and most of them are natural.
- It is difficult to predict when a fish kill will occur.
- Even if a fish kill is predicted, there is not much that can be done to prevent it, especially in larger waterbodies.

## The Good News

- In the event of a fish kill, you may see a lot of dead fish but there are usually a lot more that are still alive.
- If water quality should change for the worse, there are often many refuges for fish to escape to.
- Because fish are known to lay many eggs, their reproductive potential is usually strong. As a result, they are generally able to rebound from a fish kill within a couple of years.



Photos by Joe Richard



# Naturally Occurring Fish Kills

**N**aturally occurring fish kills can be related to physical processes (e.g., rapid fluctuations in temperature), water chemistry changes (e.g., lack of oxygen or changes in the pH), or they can be biological in nature (e.g., stress from spawning activity, viruses, bacterial infection, parasites, etc.). Such processes are common to every lake in Florida and generally become lethal only after a fish is weakened by stress. As described on page 8, stress is usually caused by a number of factors — in addition to the daily challenge of living in an aquatic environment and continuously having to hide from predators.

In Florida, the vast majority of fish kills are caused by one or more natural causes. The most common are low dissolved oxygen levels, spawning fatalities, mortality due to cold temperature, and fish parasites or diseases. On occasion, toxic algae blooms may be suspect. The following segments provide basic descriptions of these factors and how they can adversely affect fish health.

## Low Dissolved Oxygen Levels

Fish need oxygen just as you and I do, even if they breathe a little differently. (Fish absorb oxygen from the water as it passes over their gills, whereas you and I use our lungs to absorb oxygen from the air.) For optimum health, warm water fish generally require dissolved oxygen (DO) concentrations of at least 5 parts per million, also expressed as 5 milligrams per liter or 5 mg/L.

Just like humans, fish can endure brief periods of reduced oxygen. However, if DO levels drop below 2 mg/L, they aren't always able to recover.<sup>2</sup> When concentrations fall below 1 mg/L fish begin to die.<sup>3</sup>

The periodic depletion of dissolved oxygen in a lake or waterbody is by far the most common cause of fish kills in Florida. These events are easy to recognize because they usually affect many different sizes and species of fish, whereas cold temperature-related or spawning-related fish kills tend to affect only one or two species. If it is a DO-related fish kill, large fish tend to be affected first and more severely than other fish. Another clue: small fish can be seen gulping or gasping for air at the surface just before a fish kill occurs.

When it comes to understanding the dynamics of oxygen and water, the most important thing to remember is that the amount of dissolved oxygen found in an aquatic system changes constantly, day and night. It is affected by weather, temperature, the amount of sunlight available, and the amount of plants and animals living in the water. Each of these factors can influence the amount of oxygen released or removed from the water at any given time. See pages 4 -6 for more about these processes.

<sup>2</sup> Dissolved oxygen refers to oxygen gas that is dissolved in water.

<sup>3</sup> Fish kill data reported to the South Florida Water Management District documents that 87% of the fish killed in South Florida (i.e., from 1991 to 2001) occurred when surface DO was 3 mg/L or less. Measurements were taken during or shortly after each fish kill event.



Joe Richard



Chuck Cichra

**The periodic depletion of dissolved oxygen in a lake or waterbody is by far the most common cause of fish kills in Florida.**



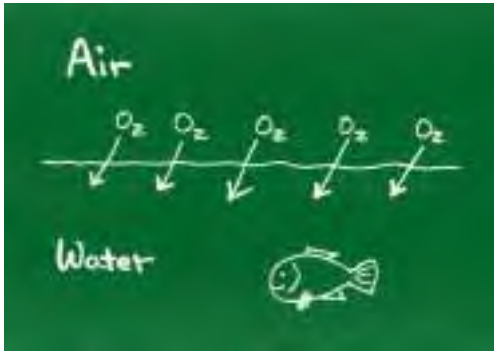

## Oxygen enters water from two main sources:

**The atmosphere:** The same oxygen that we breathe from the atmosphere is also slowly and continuously being dissolved into our oceans, lakes, rivers, streams, and ponds through a process known as **diffusion**. Wind and wave action can accelerate this process.

**Photosynthesis:** Photosynthesis is a process whereby algae and aquatic plants use carbon dioxide, water, and sunlight to make their own food. Oxygen is a by-product of this activity. Therefore, as long as photosynthesis is taking place, oxygen is continuously being released into the water.

## At the same time that oxygen enters the aquatic environment, it is also being removed by the following natural processes:

**Biological activity in the water column** – refers to the regular day-to-day functions carried on by various aquatic organisms in a lake including algae, aquatic plants, bacteria, fish, insects, zooplankton, etc. Just as you and I use oxygen from the air, these organisms are constantly using or removing oxygen from the water. This is usually not a problem during daylight hours because the algae and submersed aquatic plants generally produce a surplus of oxygen via photosynthesis. However, once the sun goes down, algae and plants are no longer able to photosynthesize and they become oxygen *consumers*, instead of oxygen *producers*. After a long night of limited oxygen production, the organisms in a lake are ready for some fresh DO.

**Water temperature** – affects how much oxygen water can hold at a given time. As a general rule, warm water holds less oxygen than cool water.<sup>4</sup> In fact, not only does warmer water hold less oxygen, it also speeds up a fish's metabolism. Of course, this dynamic puts fish in double jeopardy; as the water becomes warmer, fish need more oxygen for respiration,<sup>5</sup> but are getting less because warm water holds less oxygen.

**Decomposing aquatic plants and/or algae** – can result in the loss of oxygen in a waterbody and it works like this: once the plants or algae die, a feeding frenzy is often triggered within the detrital aquatic community,<sup>6</sup> as bacteria begin to break down or "decompose" the dead vegetation. The increased activity can result in a loss of oxygen because these organisms are working harder and therefore using more oxygen. If there is a large amount

<sup>4</sup> There are times when cooler water may not necessarily hold more dissolved oxygen than warm water. See **Lake Turnover** section described on page 5.

<sup>5</sup> (i.e., the act of breathing)

<sup>6</sup> (i.e., microbes and/or insects that feed on rotting vegetation and debris)



**Just as you and I use oxygen from the air, aquatic organisms and plants are constantly using or removing oxygen from the water.**

of dead vegetation or algae, such activity can result in a severe loss of dissolved oxygen and, consequently, a fish kill. Lakes or ponds with heavy populations of aquatic plants or algae are more susceptible to this type of event and can result in large numbers of dead fish. That is why, when using chemicals (i.e., algicides or herbicides) to remove algae or aquatic weeds from a lake, it's recommended that treatments be staggered in order to avoid large amounts of algae or plants dying all at once.<sup>7</sup>

**Lake turnovers** – generally occur in the fall but can sometimes occur in the summer. During hot weather, the surface water of a lake warms much faster than deeper water. This results in a temporary layering effect, with warm water on top and cool water underneath. Scientists refer to this as stratification. Because the top layer has constant access to the atmosphere, it tends to have more oxygen than the bottom layer — even though it's warmer.<sup>8</sup> If a heavy wind or cold rain should occur during these conditions, the stratification may be broken, causing the two layers to mix. Once this happens, oxygen-rich surface waters are suddenly mixed with the low-oxygen bottom waters.

If the volume of low oxygen water (i.e., from the bottom of the lake) is much greater than the oxygen-rich surface layer, this mixing action can result in low DO levels throughout the water column, and potentially result in a fish kill.

**To summarize:** Although oxygen depletions can happen at any time, they are most likely to occur during warm summer months due to the factors described above. A combination of hot weather and cloudy skies can be particularly deadly for fish, as the decrease in sunlight (i.e., from cloud cover) makes it difficult for algae and plants to photosynthesize. The reduction in photosynthesis results in a decrease in oxygen being released into the water column. When overcast skies persist for several days, oxygen levels can become severely depleted.

Heavy thunderstorms can also have an adverse effect on oxygen levels, especially after extended periods of dry weather or during hot weather. If conditions have been dry for a long time, heavy rains tend to wash large amounts of organic matter such as dried leaves, grasses, etc. into nearby canals, lakes, and ponds. As bacterial organisms begin to decompose the new material, oxygen is used at a faster rate than normal. This can be a problem during hot weather as there is less oxygen in the water.

See Figure 1 on page 6 for more on the relationship between fish kill events and rainfall in Florida.

---

<sup>7</sup> *A Beginner's Guide to Water Management - The ABCs (Information Circular 101)*. 1999. Florida LAKEWATCH. University of Florida/Department of Fisheries and Aquatic Sciences. Page 12.

<sup>8</sup> While cooler water has the potential to hold more oxygen, there are times when dissolved oxygen levels are lower in cool water — especially at greater depths where there is no access to atmospheric oxygen and photosynthesis is limited due to a lack of sunlight.



Amy Richard

**Lakes with large amounts of aquatic plants or algae are more susceptible to oxygen-related problems, especially if the plants happen to die all at once.**



Chuck Cichra

The graph below provides strong evidence that many of the fish kills in Florida are related to rain events, particularly during the summer months. It's also a good example of how useful long-term data can be for making such comparisons. Data for the graph was supplied by the South Florida Water Management District.

Figure 1

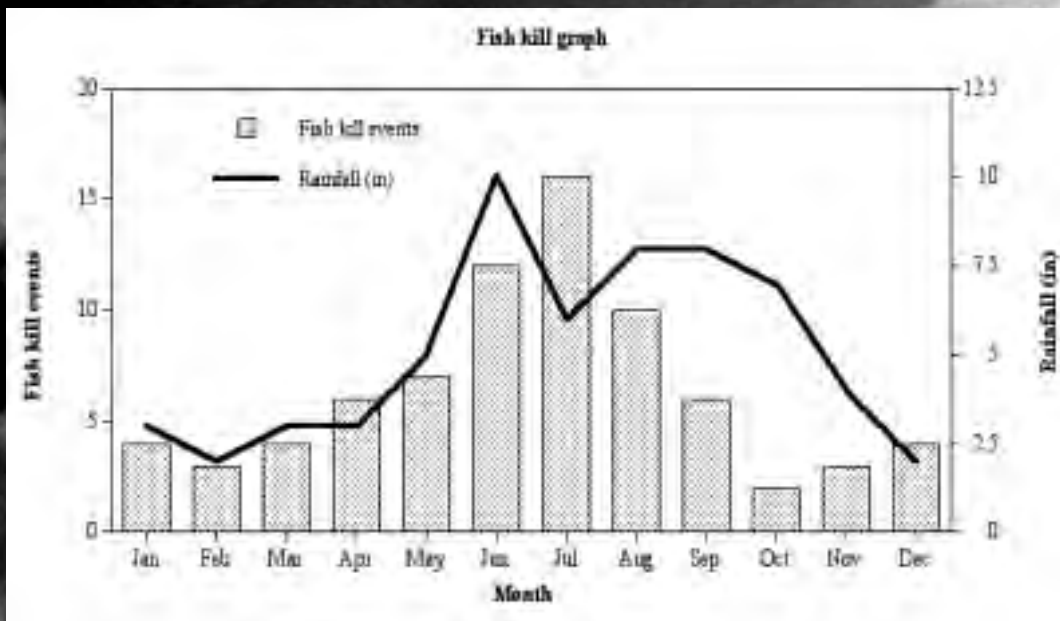

Figure 1 illustrates the relationship between the total number of fish kill events and average monthly rainfall in South Florida, from 1991 to 2001. Notice the strong correlation between the number of fish kill events and the amount of rainfall during the same time. Also notice that a large majority (64%) of the fish kill events occurred between May and September — traditionally known as Florida's rainy season. Average rainfall for this time period accounted for 61% of the annual average, whereas rainfall for the preceding four months accounted for only 18% of the annual average.



## Spawning Fatalities

Another type of fish kill event that is both natural and common in Florida waterbodies occurs after fish spawning activities. This is usually due to exhaustion from courtship behavior, nest building, and the release of eggs or milt. Fish have also been known to suffer fatal injury from defending their young. During and after spawning, fish are often quite weak and any change in the environment can stress them significantly and lead to death.

These type of events are most common in the springtime and early summer when the majority of the fish are spawning.<sup>9</sup> They are generally identified by the deaths of adult fish (only), belonging to one or two different species.



## Mortality Due to Cold Temperatures

Fish kills can also be the result of a dramatic drop in air, and consequently, water temperature. This type of event is easily identified because it generally happens after extended periods of cold weather and almost all of the dead fish will be cold intolerant species. In almost every instance, these cold intolerant species are “exotic” fish that have accidentally been introduced to Florida waters. One example is the blue tilapia (*Tilapia aurea*) from Africa’s Nile River. This fish was inadvertently introduced into Florida waterbodies in 1961 and is now successfully reproducing in 18 counties. Because they are from a tropical region of the world, blue tilapia don’t fare well in cold temperatures; they stop feeding when water temperatures drop to about 60 degrees Fahrenheit and die when it reaches approximately 45 degrees.

Those who worry about the further spread of exotic tropical fish species can take some comfort in knowing that their distribution is often naturally limited by their sensitivity to low temperatures. This natural control mechanism was recently demonstrated at Lake Alice, a small waterbody on the University of Florida campus in Gainesville in North Central Florida. For several years, the lake supported a population of blue tilapia estimated to be around 12,000. However, in early January 2001, a severe cold front passed through Gainesville bringing temperatures that were considerably colder than the tilapia’s native African habitat. Within a week, dead tilapia began to float to the surface. By the middle of the month, thousands of these fish had died, while native species survived the cold snap just fine. Several more cold fronts have effectively reduced the tilapia population to almost nothing.



Photos by Joe Richard

**Cold temperature related fish kills are easily identified because they generally occur after extended periods of cold weather and almost all of the dead fish will be cold intolerant species, such as the blue tilapia pictured above.**

<sup>9</sup> Some fish spawn year round in Florida, but the peak season is generally from January through April.





**A**s you've learned from reading this pamphlet, there are many factors that can contribute to a fish kill. However, stress seems to be a common element linked with virtually every one of these events.

The term "stress" is used to describe the physical changes that fish experience as they adjust to a changing environment. While it may not be the actual cause of disease or death, it is always a predisposing factor.

As with humans, there are numerous degrees of stress and a fish can recover from many of them, especially if it can remove itself from the negative events it is experiencing. However, if it cannot escape, or the events increase in severity or duration, the fish may be pushed beyond a level from which its system can recover.

The typical stresses that a fish may experience on a daily basis, such as the predator/prey example described on page 9, are natural situations that fish are designed to deal with. However, continuous stress tends to break down a fish's immune system and can lead to disease or death. Examples of continual stressors include poor nutrition, poor water chemistry, and overcrowding. Multiple stresses occurring at the same time, can have a magnified effect and often represent the fatal blow to a fish's health.

### **The Mechanics of Stress**

When fish experience stress, various physical and chemical processes occur. To be more

specific, stress triggers a series of events known as the **General Adaptation Syndrome**. This syndrome affects a fish's metabolism and immune system and occurs in three phases:

**Phase 1 Alarm Reaction** - This first phase involves the release of certain stress hormones, resulting in an immediate reaction from the fish. Also known as the "flee or fight" response, the release of stress hormones acts as a signal to the fish to swim away as quickly as possible or stay and fight.

**Phase 2 Resistance Stage** - The second phase involves the use of a fish's energy stores to compensate for the challenge it has detected (i.e., to flee or fight). If the "stressor" does not decline, the fish will continue to use its energy reserves until they are depleted, leading to the third phase.

**Phase 3 Exhaustion Phase** - During the Exhaustion Phase there is minimal ability to adapt or resist death.

Anglers are familiar with the fish behavior just described as it is (hopefully) played out many times during a fishing trip. Sometimes the angler wins, sometimes the fish wins. However, the General Adaptation Syndrome is most often associated with a fish's ability to survive in its normal aquatic environment full of hungry finned predators.



Photos by Joe Richard

## The following is a description of a typical predator/prey encounter:

*A largemouth bass spots a bluegill and begins to chase it. The bluegill senses the approaching bass and attempts to escape. Stress hormones are released, triggering an increase in blood flow to the bluegill's skeletal muscles and gills, and a decrease in blood flow to the digestive system (a low priority at this point). The increased blood flow to the gills and muscle tissue allows for a burst of fast swimming.*

*If the bluegill makes it to cover before the bass swallows it, the stress stops almost immediately — for the bluegill, anyway. Once the bluegill is safe in its new hiding place, it can rest and slowly replenish its depleted energy stores. However, if it is too far from cover or makes a mistake and bolts for open water, then the stressor (i.e., the bass) will continue the chase, "burning up" the bluegill's energy stores as it flees. Eventually the bluegill will exhaust its supply of quick energy and will begin to tire and slow until the bass captures it with one big gulp!*

This synopsis is a good example of an "all or nothing" situation where the outcome is very distinct (i.e., recovery or death). However, there is also a more complex form of the General Adaptation Syndrome that exists when stress occurs at lower levels, but for prolonged periods of time. When this happens, stress slowly catches up to the fish, resulting in disease and sometimes, death.

Such chronic low-level stress stimulates the production of a second type of hormone-induced process that affects the fish's metabolism and osmoregulation (water-ion salt balance).

The results are a prolonged reaction within the fish's body chemistry — a contrast to the more immediate "flee or fight" response described earlier. Though the release of low-level hormones is more gradual, it is similar in that it also occurs in three phases:

**Step 1** When a fish begins to experience a stressor, substances known as "releasers" are produced by the hypothalamus in the brain.

**Step 2** These releasers travel through the bloodstream to the pituitary gland, where they trigger the release of hormones to the kidney.

**Step 3** The hormones themselves produce a chemical that suppresses the immune system, resulting in an increased susceptibility to disease.

In addition to these steps, there is another physical process that occurs that can be beneficial to fish for the short term, but detrimental over the long term. When hormones are released, extra blood is shunted to the fish's gills, providing a quick source of oxygen and energy. However, if the stress continues, the gill tissue remains engorged with blood, and water flowing over the gills will remove too many salts and ions from the fish's bloodstream. This can be corrected on a short-term basis (i.e., predator/prey chase scenario). However if the stress continues over a prolonged period of time, there is no recovery phase and the fish will most likely become ill and experience a fatal outcome.

## Diseases and Parasites

Fish diseases (i.e., from viruses, bacteria, and fungi) and parasites (i.e., protozoans, crustaceans, flukes, and worms) occur naturally in Florida lakes and under certain circumstances, fish can contract one or more of these afflictions. Of course, a healthy fish is usually able to fend off such problems, but if a fish is weak from spawning or from extreme water quality conditions, it has a much greater chance of getting sick or possibly dying.

See sidebar: [Stress in Fish on pages 8 & 9.](#)

Fish infected with parasites or diseases may have physical clues on their bodies or they may display abnormal behavior. Some physical clues can be obvious, such as open sores on the body, missing scales, lack of slime, or strange growths on the body, head, or fins. If a fish is large enough (e.g., a largemouth bass), the careful observer may even notice parasites crawling on its skin or gills. Abnormal behavior may include swimming weakly, lazily, erratically, or in spirals; scratching or rubbing against objects in the water; twitching, darting, or convulsing; failure to flee when exposed to fright stimuli; gasping at the water surface or floating head, tail, or belly up.

These types of fish health problems are perhaps a little more difficult to spot in the natural environment whereas fish farmers are all too familiar with it. In channel catfish aquaculture ponds, for example, a protozoan known as *Aurantiactinomyxon ictaluri* is known for causing the dreaded Hamburger Gill Disease. In some instances, it has killed up to 100% of the fish in an infected pond. Fish with this particular problem may exhibit a reduction in feeding habits and can be seen swimming lethargically. They may also be gasping for air at the surface and frequently will congregate around aeration equipment. Their gills will be swollen and mottled with red and white colored streaks, closely resembling ground hamburger meat, hence the name.

If a fish disease problem is suspected in a lake or pond, it is helpful and informative if one is able to collect water samples and also capture several live fish samples for examination — especially fish that are near death.

*Note: Once dead fish are observed floating at the surface of a lake or waterbody, decomposition is usually advanced and the fish are not suitable for diagnostic evaluation.*

For more on the correct procedures for sampling, see [Collecting Fish and Water Samples on page 15.](#)



Joe Richard

**Fish infected with diseases or parasites may have physical clues on their bodies such as sores, or they may display abnormal behavior.**



Chuck Cichra

**Fish diseases such as the dreaded “Hamburger Gill Disease” can be devastating — particularly in ponds.**



## Toxic Algae Blooms

The appearance of large amounts of algae or scum floating on the surface of the water is often referred to as an “algae bloom” or “algal bloom.” Such occurrences can be smelly, unsightly, and — depending on the species of algae — the color of the water may even change. In some instances, a number of dead fish may be seen floating on the surface or washed up on the shoreline. As alarming as these events may seem, there are several factors to consider before assuming that an algal bloom is toxic:

- In Florida’s freshwater systems, there are relatively few species of algae that are known to produce toxins.<sup>10</sup> The most common species found here are the blue-green algae *Microcystis*, *Cylindrospermopsis*, *Anabaena* and *Aphanizomenon*, as well as the microflagellate *Prymnesiam*.<sup>11</sup> It’s important to note that not all of the species within these algal groups produce toxins; those that do, produce toxins in varying amounts, depending on prevailing conditions.
- While toxins produced by these algae have the potential for killing fish, there are very few cases that have been definitively linked to toxins. (This will most likely remain an important focus of research for years to come.)
- Algae blooms are a natural component of nutrient-rich lakes and rivers, particularly those with high levels of nitrogen and phosphorus.
- Algae blooms are fairly common in Florida either because of natural geologic conditions (nutrient-rich soils) or human induced increases in nutrients.
- It’s thought that most algae-related fish kills are the result of oxygen depletion, as opposed to toxicity problems.

See the Dissolved Oxygen segment on pages 3 - 6 for more on this.

<sup>10</sup> Coastal residents are perhaps familiar with toxic-algae related fish kills that occur periodically in coastal waters (i.e., in the form of red tides).

<sup>11</sup> A class of single-cell organisms such as a flagellate protozoan or alga.



Amy Richard

In Florida’s freshwater systems, there are relatively few species of algae that are known to produce toxins. The algae pictured below represent a few of the most common “toxic” blue-green algae found in Florida freshwaters.

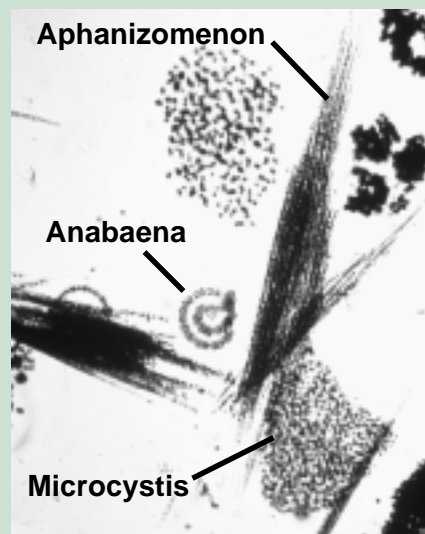

University of Florida



# Human Induced Fish Kills



Michael Connert — <http://www.fluoridealert.org>



Amy Richard



Michael Connert — <http://www.fluoridealert.org>

**T**here is no doubt that human impacts can lead to fish kills. However, in the United States, it is also true that point source pollution problems have been reduced dramatically since the turn of the 20th century, or even as recently as the 1960s, when raw sewage and industrial waste were routinely dumped into rivers, lakes, and oceans. (Remember the Hudson River fires?)

In recent decades such practices have been virtually eliminated. Nowadays, if a human-induced fish kill does occur, it's usually the result of contaminants unintentionally being spilled or leaked into a nearby waterbody. Obviously, the goal should be to prevent these occurrences in the first place. But accidents happen and they can happen in any number of ways: Highway accidents involving tanker trucks full of fertilizers or other toxic substances have resulted in chemicals spilling into nearby waterbodies. Barges have been known to run into things, rupturing storage tanks and releasing oil or other contaminants. Gas pipelines have also been known to crack and leak oil into various aquatic environments.

In some instances, a spilled substance may not even be toxic, but if enough of it is introduced into a system, it can be detrimental in another way such as causing a shift in water temperature or a change in pH.

As far as toxic spills are concerned, the effects of such an event often depend on the toxicity of the spilled substance and the surface area and volume of the waterbody. In other words, if a lake is large enough, it may be able to dilute the substance enough so that aquatic organisms, including fish, are able to avoid any detrimental effects. Of course, this isn't always the case.

One example of a catastrophic human-induced fish kill involved a phosphate plant in Mulberry, Florida in December 1997. Nearly 60 million gallons of acidic process water from the plant was accidentally dumped into Skinned Sapling Creek, a tributary to the Alafia River. In five days, the spill traveled 36 miles down river and changed the pH of the water from around eight to less than four.<sup>12</sup> A fish kill occurred along that entire stretch of river, killing an estimated 1,300,000 fish. Fortunately, such occurrences are rare.

---

<sup>12</sup> In addition to their sensitivity to changes in temperature and dissolved oxygen, fish can also be detrimentally affected by rapid changes in the pH of the water.

Sometimes, human-induced fish kills can occur from the sheer amount of foreign substances entering a waterbody. When this happens, fish die mostly from low oxygen levels that have resulted from an increase in biological activity in the water.

See [Low Dissolved Oxygen Levels / Biological Activity in the Water Column](#) on pages 3 & 4.

A related example of this involved an explosion at the Wild Turkey whiskey factory located along the banks of the Kentucky River, near Lawrenceburg, Kentucky. The explosion resulted in many thousands of gallons of bourbon flowing into the river. Officials were unsure whether it was the bourbon that killed the fish or a lack of oxygen from the millions of aquatic microbes that rapidly began to devour the liquor, essentially sucking all the dissolved oxygen from the water. Hundreds of thousands of fish died in that event.

If a human-induced spill or fish kill event should occur, there are often clues that will help bring attention to the problem: A “film” or “slick” can sometimes be seen on the surface of the water, or the color or clarity of the water may change.<sup>13</sup> Strange odors might also be noticeable or there may even be more obvious evidence such as large containers of the substance sitting near the shoreline. A thorough investigation of the local area, along with written observations of changes in water quality, can direct investigators to the possible contaminating source. Observers should look for evidence of other wildlife species being affected such as birds, frogs, snakes, turtles, etc.

If you see an oil spill or unknown substance in a lake or waterbody, the best bet is to call Florida’s 24-hour Hazardous Substance Hotline at (800) 320-0519 or (850) 413-9911.

If a fish kill has occurred as a result of the spill or substance, you may also want to call the Fish Kill Hotline at (800) 636-0511.

---

<sup>13</sup> An oily sheen on the water is not always an indication of a human-induced spill. There is a naturally occurring algae, known as *Botryococcus*, that produces an oily substance that can be seen on the surface of the water. In Florida, *Botryococcus* algae blooms are fairly common, especially during the summer months. Its presence has caused some alarm among lakefront citizens, as the algal cells are red or burnt orange in color and, in large enough concentrations, they have been known to temporarily change the color of a lake from green to orange. Also, in some instances, it will look very much like a gasoline spill or oil slick.

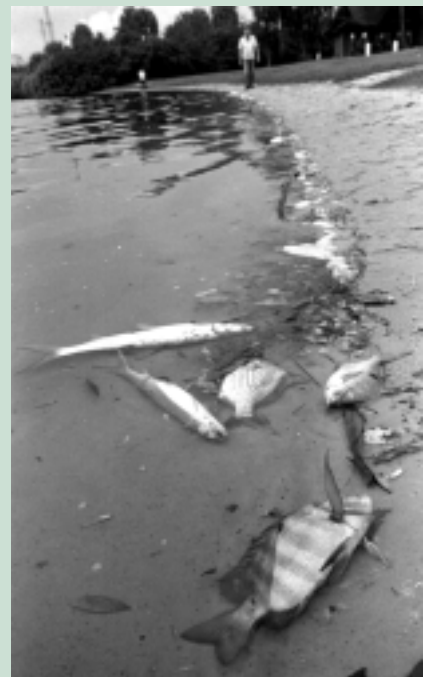

Tampa Tribune

**One example of a catastrophic human-induced fish kill involved a phosphate plant in Mulberry, Florida In 1997. Nearly 60 million gallons of acidic process water from the plant accidentally spilled into Skinned Sapling Creek, a tributary to the Alafia River. In five days, the spill traveled 36 miles down river and changed the pH of the water from around eight to less than four. A fish kill occurred along that entire stretch of river, killing an estimated 1,300,000 fish. Fortunately, such occurrences are rare.**

# What You Can Do If You Observe a Fish Kill

If you are especially concerned or interested in finding out what caused a fish kill, you should start off by collecting fish and water samples as quickly as possible. The proper procedures for collecting are discussed on page 15. Samples must be collected within hours of the fish kill. If too much time has already passed or if you don't have time to collect and submit samples, the following observations can still provide important clues as to what might have happened. Once you've gathered this information, call your local wildlife agency (listed below) to report it.

- Record the date and approximate time you first noticed dead fish.
- Observe and record the weather conditions from the past three or four days (e.g., temperature, amount of rainfall, cloud cover, wind strength and direction).
- Record any changes in the color of the lake water (e.g., did the water change from green to brown or black?).
- Record the type of dead fish, by species name, if possible.

*Note: If you cannot identify a species of fish, place one or more in a plastic bag and freeze it for identification purposes only. However, DO NOT FREEZE fish that you are submitting for diagnostic evaluation (i.e., for determining the cause of the fish kill). For more information on collecting and submitting fish and/or water samples for diagnostic evaluation, see page 15.*

- Record the number of dead fish and, if possible, categorize them by species.

*Note: If the dead fish are too numerous to count, try to estimate the number by first counting the number of dead fish in a 10-foot X 10-foot area. Then estimate the total distance along the shoreline and out into the water in which dead fish are present. These numbers can be used to estimate the extent of the kill.*

- If possible, take a few minutes to study the appearance of the dead fish and record the following observations:

- Size, to the nearest inch;
- The condition of the bodies (e.g., thin, bloated);
- Are one or both eyes normal, sunken in, or popped out ?
- Are the fins clamped down, bloody, or frayed?
- Are the gills discolored, bloody, or frayed?
- Are there lesions or growths on the fish?
- What else looks abnormal on the fish?

- Talk to your neighbors. Ask them if they've noticed anything unusual about the lake in the past few days. Were fish gulping air at the water's surface? Were there unfamiliar containers near the shore? Was there a "film" or "slick" present on the surface of the water? Any strange odors coming from the lake?

- Call the Florida Fish and Wildlife Conservation Commission (FWC) Fish Kill Hotline to report the event and they will pass it along to the appropriate regional biologist or enforcement officer.

**FWC Fish Kill Hotline  
(800) 636-0511**

**Florida's 24-hour Hazardous  
Substance Hotline  
(800) 320-0519 or (850) 413-9911**

---

# Collecting Fish and Water Samples

---

If you are trying to determine the cause of a fish kill, one way to improve your chances of an accurate “diagnosis” is to obtain both fish samples and water samples from the area where the fish kill occurred. The sooner the samples are collected, the more accurate the diagnosis will be. Also, keep in mind that it’s best to collect fish that are near death or showing signs of distress, such as gasping for air at the surface, etc. Careful sampling techniques and packaging procedures will also play a role in your success. The agency or fish health specialist that you report the fish kill to may provide you with specific sampling or packaging procedures but the following techniques may also be used. Also, be aware that there are usually fees associated with laboratory diagnostic services. If you are unable to pay for these services, you could just try to answer the questions on page 14 and report your observations to the nearest wildlife agency.

*Note: Some commercial carriers (UPS and Fed-Ex) will ship samples, but only if they are packaged correctly.*

## Fish Samples

### Live Fish

If the fish are alive and appear to be able to make the trip to the laboratory, place them into well-

aerated water in a heavy ply plastic bag (fish shipping bag or commercial freezer bag) in a Styrofoam® cooler to regulate temperature. It’s best to collect between three and five fish of each species involved. This ensures an accurate diagnosis of the population as a whole.

### Dead Fish

Even though the usefulness of dead fish is severely restricted for determining the cause of death, if they are in good condition (i.e., eyes are clear and the gills red), they may still be of value. Collect between three and five fish of each species and keep them moist with wet paper towels in a heavy-ply plastic bag. Pack the samples with ice in a Styrofoam® cooler and then place in a shipping carton. If the fish are obviously decomposed or malodorous, do not submit them.

*Hint: If there is a very strong noxious odor associated with the dead fish, they are rarely suitable for diagnostic evaluation.*

**IMPORTANT: DO NOT FREEZE SAMPLES.**



## Water Samples

If you are submitting fish samples from a fish kill event, you should also submit a water sample. When collecting a water sample for analysis, a few

simple yet important procedures must be followed.

*Note: No matter how “clean” you think the water is, it is important to submit a water sample for analysis.*

- Water samples should be collected and submitted in separate containers from fish samples. This is important, as the chemistry of a water sample will change significantly if it contains a live or dead fish.
- Use a clean (approximately) 1 quart-sized container. Thoroughly rinse any foreign matter or soap residue from the container before collecting your sample.
- Submerge the empty container 6 - 12 inches under water and hold it there until full. Place the cap back on the container while it is still beneath the surface. This removes air bubbles, which can interfere with the dissolved oxygen measurements. Check the sample to ensure no visible air bubbles are present.
- Label sample with the following information: sample location, water depth, date, time of collection.
- Keep water sample in cold storage once collected (on ice or ice packs in a cooler). If shipping samples to a lab, package them in a Styrofoam® cooler and then inside a shipping box. **DO NOT FREEZE.**



# Fish Health Diagnostic Facilities in Florida

## UF/IFAS Facilities

Department of Fisheries and Aquatic Sciences  
7922 NW 71st Street  
Gainesville, FL 32653  
Phone: (352) 392-9617 ext. 230  
Email: rffloyd@ufl.edu

Zoological Medicine Service, College of Veterinary Medicine  
P.O. Box 100125  
Gainesville, FL 32610  
Phone: (352) 392-4700 ext. 5686  
Email: riggsa@mail.vetmed.ufl.edu

## Florida Department of Agriculture & Consumer Services (DACS)

*Note: DACS facilities require referral by a licensed veterinarian*

Kissimmee Diagnostic Laboratory  
2700 N. Bermuda Avenue  
Kissimmee, FL 34741  
Phone: (407) 846-5200

Live Oak Diagnostic Laboratory  
P.O. Drawer 0  
Live Oak, FL 32064  
Phone: (386) 362-1216

*Note: There are fees associated with any diagnostic procedure performed by state agencies or by private consultants. Typically, state agencies are open Monday - Friday from 8:00 am to 5:00 pm. Some private consultants may have after-hours services at an additional cost. All laboratories must be notified prior to sample submission.*

## Acknowledgments

Many thanks to UF/IFAS fish veterinarians, Dr. Ruth Francis-Floyd and Dr. Allen Riggs, for their editorial contributions and review of this material. Also, many thanks to Dr. Ed Philips for his contributions on toxic algae.



## A Beginner's Guide to Water Management – Fish Kills (Information Circular 107)

This document is the seventh in a series of educational publications produced by Florida LAKEWATCH © 2003. For more information or to obtain copies, call 1-800-LAKEWATCH (525-3928) or (352) 392-4817.

Free copies are also available for download from our website:  
<http://lakewatch.ifas.ufl.edu/>

## **Section 8**

### Storm Drain Marking

Not only can the houses directly around a pond contribute stormwater pollution, but all the yards that drain to the pond through the storm pipe system can as well. That's why it's important to notify your neighbors that storm drains are only meant for rain.

Storm drain marking is a great way to get this message out to everyone in your neighborhood.

#### Featured Article:

➤ [Storm Drain Marking Kit Request](#)

# ADOPT-A-POND

## Your Storm Drain Marking Kit

*Use our colorful markers to add a pollution prevention message to your neighborhood storm drains. The message is "No Trash in Drains, Keep Your Water Clean." Kit includes door hangers.*

We're glad you're doing your part to teach your neighbors about stormwater pollution prevention. Stormwater pollution - water pollution that is carried from our yards & streets by rain runoff - is easy to prevent! Make sure everyone in your neighborhood knows that storm drains are only for rain - not oil, not grass clippings, not leaves, not fertilizers, not litter.

Follow these easy guidelines for a successful storm drain marking event:

1. Kids love this event – it's easy, it's in your neighborhood, and it's educational.
2. Be safe - at least one person on your storm drain marking team should be the "safety look-out" for traffic.
3. Bring a broom to sweep loose dirt from the storm drain - the glue will hold better if the surface is swept first.
4. Mark all storm drains around your pond, as well as those across the street, because those lead to your pond, too.
5. Distribute the door hangers in your kit to your neighbors.
6. Fill out the tracking form so that we can keep an accurate record of your storm drain marking event.



**Request your Storm Drain Marking Kit at**  
[www.hillsborough.wateratlas.usf.edu/forms/stormdrain.aspx](http://www.hillsborough.wateratlas.usf.edu/forms/stormdrain.aspx)