

# HP Archive

This vintage Hewlett Packard document was preserved  
and distributed by

**[www. hparchive.com](http://www.hparchive.com)**

Please visit us on the web !

On-line curator: Glenn Robb

This document is for FREE distribution only!



**OPERATING AND SERVICE MANUAL**

**MODEL 202D**

**SERIAL 81,053 & ABOVE**

**WITH CHANGES FOR SERIAL AND TYPE NUMBERS BELOW**

**AUDIO OSCILLATOR**

HEWLETT-PACKARD COMPANY  
1501 PAGE MILL ROAD, PALO ALTO, CALIFORNIA, U.S.A.



# hp MANUAL CHANGES

## MODEL 202D AUDIO OSCILLATOR

Manual Serial 81053 & above

To adapt this manual to instruments with other serial and type numbers, make the changes shown in tables.

Instrument Serial Number	Make Manual Changes	*Instrument Type Number	Make Manual Changes
81027 & below	1	All	2

\*Early instruments had type numbers which represented the month, day, and year, respectively, in which the instrument was built.

CHANGE 1 R19: Change to 39K ohms.

CHANGE 2 Refer to the following schematic diagram.

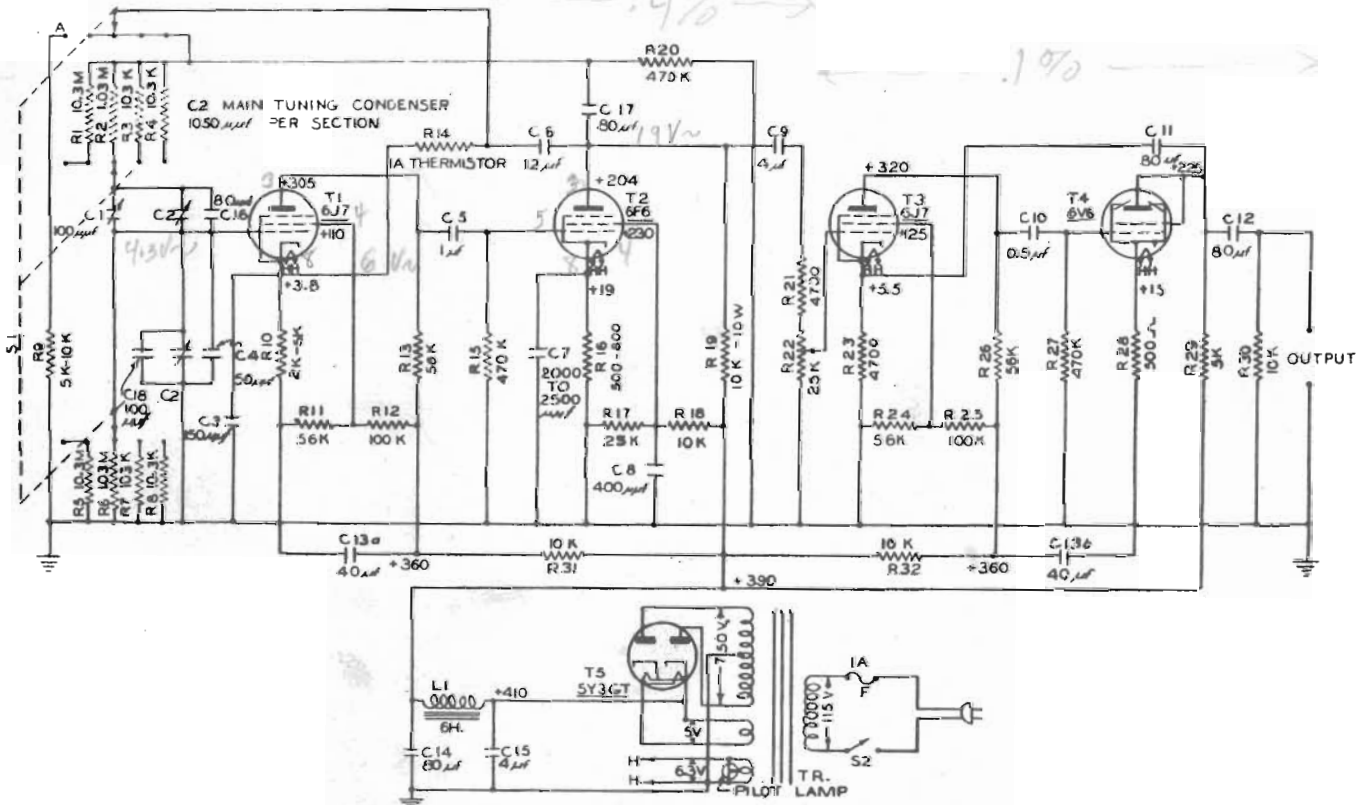

SCHEMATIC DIAGRAM OF -hp-MODEL 202D AUDIO OSCILLATOR

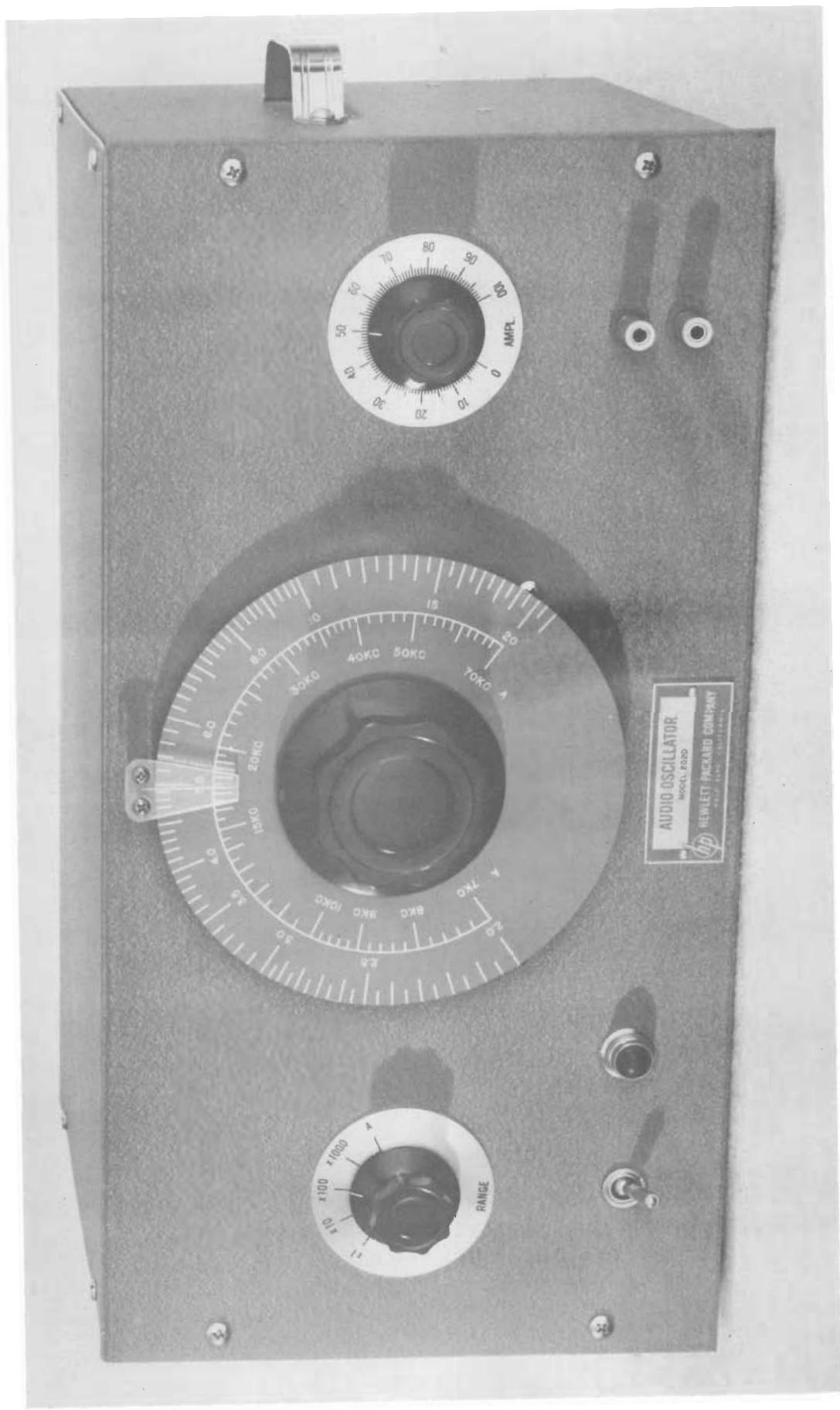

Fig. 1. Model 202D Audio Oscillator

### General Description

The Model 202D Audio Oscillator is a general purpose oscillator which uses the resistance-tuned circuit to generate alternating current voltages from 2 to 70,000 cycles/sec.

This audio oscillator provides a source of voltage for amplifier testing, audio response of transmitters, loud speaker resonance tests, and a voltage source for bridge measurements.

It is particularly useful where low frequencies are involved, as in mechanical vibration problems.

### Parts Substitutions

Difficulties in procuring some of the parts used in this instrument may cause the electrical or physical values to deviate from those shown in this instruction manual. These substitutions have been made so as not to impair the performance of this instrument. Whenever replacement of any of these parts is necessary, either the substitute value or the original value may be used.

202D 2/24/50 Serial 80025 to

70 000

# INSTRUCTIONS

## MODEL 202D

### AUDIO OSCILLATOR

#### Specifications

#### Frequency Rating --

Frequency Range - 2 - 70,000 cycles/sec.

Frequency Dial Calibration - X range 2 - 20

A range 7 Kc - 70 Kc

Range -

x1	2 - 20 cycles/sec.
x10	20 - 200 cycles/sec.
x100	200 - 2000 cycles/sec.
x1000	2000 - 20,000 cycles/sec.
A	7000 - 70,000 cycles/sec.

~~Calibration Accuracy -  $\pm 2\%$~~

~~Frequency Response -  $\pm 1$  db 2 to 70,000 cycles/sec. Reference: 1000 cycles/sec., 10 volts across 1000 ohms resistive load~~

Frequency Stability -  $\pm 2\%$  under normal temperature conditions, including initial warm-up.  $\pm 10$  volt line variations change frequency less than  $\pm .2\%$  at 1000 cycles/sec.

#### Power Output Rating --

~~Power Output - 100 milliwatts into rated load (10 volts across 1000 ohms resistive load)~~

~~Distortion - Less than 1% of rated output from 2 to 70,000 cycles/sec.~~

Hum - Less than .1% of rated output

Load Impedance - 1000 ohms (resistive)

Approximate Internal Impedance - 25 ohms from 50 to 70,000 cycles/sec.

#### Power Supply Rating --

Voltage - 115 volts

Frequency - 50 to 60 cycles

Wattage - 80 watts

#### Overall Dimensions --

Cabinet Model - 17" long x 8-3/4" high x 11-7/8" deep

Rack Model - 19" long x 8-3/4" high x 12" deep  
Panel 19" long x 8-3/4"  
Depth behind panel - 10-1/2"

Weight --

Cabinet Model - 25 pounds  
Rack Model - 25 pounds

Operating Instructions

Inspection --

This instrument has been thoroughly tested and inspected before being shipped and is ready for use when received.

After the instrument is unpacked, the instrument should be carefully inspected for damage received in transit. If any shipping damage is found, follow the procedure outlined in the "Claim for Damage in Shipment" page at the back of this instruction book.

Controls and Terminals --

AC Power - This toggle switch, which is located in the lower left corner of the control panel, controls the power supplied to the instrument from the power line. When the switch is in the ON position, the red indicator will glow.

FUSE - The fuseholder, located on the back of the chassis, contains a 1.5 ampere cartridge fuse. The fuse may be replaced by unscrewing the fuseholder cap and inserting a new fuse.

RANGE - This rotary switch inserts various range resistors in the frequency determining circuit of the oscillator. The position of this switch indicates the multiplying factor for the frequency dial calibration and which frequency dial scale should be used.

Frequency Dial - The frequency dial is calibrated directly in cycles per second for the lowest "X" range (outer scale) and in kilocycles per second for the "A" range (inner scale).

AMPL. - This variable resistor controls the amplitude of the oscillator voltage admitted to the amplifier and therefore the output voltage of the instrument.

Power Cable - The power cable consists of three conductors. Two of these conductors carry power to the instrument while the third conductor (green wire) is connected to the instrument chassis. The third wire projects from the

cable near the plug end of the cable and may be connected to a ground when it is desirable to have a grounded instrument chassis.

### Operation --

Plug the power cable to the Model 202D into a nominal 115 volts, 50/60 cycles power source and turn on the AC power switch. The instrument will begin to operate as soon as the tubes have heated, but for maximum accuracy a warm-up period of about 30 minutes is necessary.

Set the frequency dial (outer scale) and RANGE switch so that their indications, when multiplied together, equals the desired frequency. For example, if it is desired to select an output frequency of 800 cycles per second, set the frequency dial to "80" (outer scale) and the RANGE switch to "X10".

When the RANGE switch is set to A, the inner scale is read directly in kilocycles per second.

Connect the oscillator output binding posts to the equipment being driven and adjust the AMPL. control for the desired output voltage.

Although the rated load for the Model 202D is 1000 ohms (resistive), higher or lower impedance loads may be used without damage to the instrument. A higher impedance load will result in less power output and a lower impedance load will increase the percentage of distortion in the output voltage.

When the instrument is turned on there is a direct current voltage of several volts across the output terminals. This voltage surge is of short duration. After the instrument has settled down to normal operation, the direct current voltage across the output terminals is usually less than one volt.

As the output voltage of the audio oscillator is reduced, the percentage of hum voltage will increase. At the lower levels this hum voltage becomes quite large, relative to the sine wave output voltage. This undesirable condition can be remedied by operating the audio oscillator at or slightly below rated output and inserting a suitable attenuator between the oscillator and the equipment being driven by the oscillator. The voltage divider circuit shown below is satisfactory for most applications.

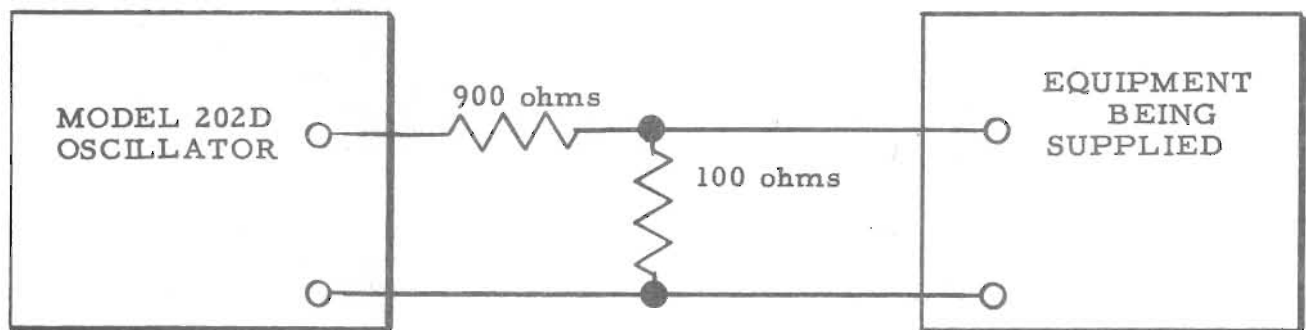



Other values of resistance may be used to obtain different voltage divisions. In all cases, the sum of the divider resistors should equal the rated load of 1000 ohms.

### Circuit Description

The Model 202D Audio Oscillator consists of an oscillator section, an amplifier section and a power supply.

The oscillator section (tubes V1 and V2) is a resistance-tuned type circuit. Basically, this oscillator is a two-stage resistance-coupled amplifier which is caused to oscillate by the use of a positive feedback network. This network is a frequency-selective resistance-capacity combination which controls the frequency of oscillation. By using a variable tuning condenser for the capacity of the network, it is possible to tune the oscillator over a wide 10:1 range; and by using a switching arrangement to select different values of resistance for the network, several ranges are given to the oscillator.

Negative feedback is used in the oscillator section in order to minimize distortion and to obtain a very high order of stability. The amount of negative feedback is determined by a resistance network, one element of which is non-linear (the 10-watt lamp in the cathode of V1). This element controls the amount of feedback in accordance with the amplitude of oscillation and consequently maintains the amplitude of oscillation substantially constant over a wide frequency range. The negative feedback also keeps the operation of the system on the linear portion of the tube characteristics. It is notable that the lamp has sufficient thermal inertia so that it operates well even at low frequencies.

Following the oscillator is the output amplifier section which includes tubes V3 and V4. Negative feedback is used in this amplifier in order to minimize distortion and to provide a good frequency response.

The power supply section includes a conventional full-wave rectifier with a low-pass pi filter for removing the ac components from the rectified wave.

### Maintenance

#### Cover and Bottom Plate Removal

The cover is removed by unscrewing the eight screws which fasten the cover to the back and top of the instrument.

The bottom plate is removed by unscrewing the four screws, one in each corner of the bottom plate, which fasten the plate to the chassis.

### Tube Replacement --

When replacing any of the tubes except the power rectifier, it is desirable to measure the distortion in the output if maximum performance from the instrument is desired because a poor tube can cause excessive distortion without seemingly affecting the operation. The distortion should be less than 1% of the rated output with rated load. Distortion may also be caused by leaking coupling capacitors and open by-pass capacitors.

### Replacement of Lamp R13 --

The 10-watt lamp R13 is operated at a very low level and should have an almost infinite life. Therefore, the lamp should not be changed indiscriminately. However, should the lamp require changing, it is necessary to check the ac voltage from the junction of R24 and C14 to ground with the new lamp in the circuit. As measured with a high-impedance ac vacuum tube voltmeter, this voltage should be within the range of approximately 27.5 - 28.5 volts when the Model 202D is tuned to 1000 cps. If the voltage is not within this range, it may be corrected by adjusting R11.

If the voltage cannot be brought within the range from 27.5 - 28.5 volts by means of R11, the new lamp should be rejected in favor of another.

### Intermittent Output --

"Jumpy" or intermittent output accompanied by flashing of the 10-watt oscillator lamp (R13) is a reliable indication of a short in trimmer capacitor C1 or in the four front (nearest the panel) sections of the main tuning capacitor. If these symptoms occur, search out and clear the short with a weak air jet or other means. Do not bend the capacitor plates because bending capacitor plates will destroy the frequency calibration.

A short in the four rear sections of the main tuning capacitor or in trimmer C4 will prevent the circuit from oscillating. Any such short should be cleared as explained above.

### Distortion --

Distortion may be caused by defective tubes, electrical leakage in the coupling capacitors, defective electrolytic capacitors, low DC supply voltage, or excessive output voltage from the oscillator section.

### Frequency Calibration --

If a change occurs in the frequency calibration, the instrument should be returned to the Hewlett-Packard Co. for re-calibration.

## Trimmer Capacitors --

Two trimmer capacitors are provided for the main tuning capacitor. One capacitor is located on the front of the tuning capacitor assembly and the other capacitor is mounted next to the main tuning capacitor at the rear edge of the chassis. These trimmers are adjusted at the factory and do not require further adjustment for the life of the equipment. If the trimmers are inadvertently misadjusted, directions for resetting should be requested of the Hewlett-Packard Company.

## Trouble Shooting --

The following is a listing of possible symptoms, causes and remedies.

<u>Symptoms</u>	<u>Causes</u>	<u>Remedies</u>
Instrument inoperative (Indicator lamp won't light, no audio output)	Blown fuse	Clear short circuit and re- place fuse.
Instrument inoperative (Indicator lamp lights no audio output)	Defective tube Check the 5Y3GT	Replace tube (see "Tube Replacement" in Mainte- nance section.)
	Short circuit in DC power circuit capa- citor.	Replace capacitor
	Short circuit in C2 (four rear sections) or C4	Clear the short circuit as outlined in the "Intermittent Output" paragraph in the Maintenance section.
Intermittent Output	Short circuit in C2 (four front sections) or C1	Clear the short circuit as outlined in the "Intermittent Output" paragraph in the Maintenance section.
	Capacitor C11, C14 or C15 intermittently open.	Replace capacitor

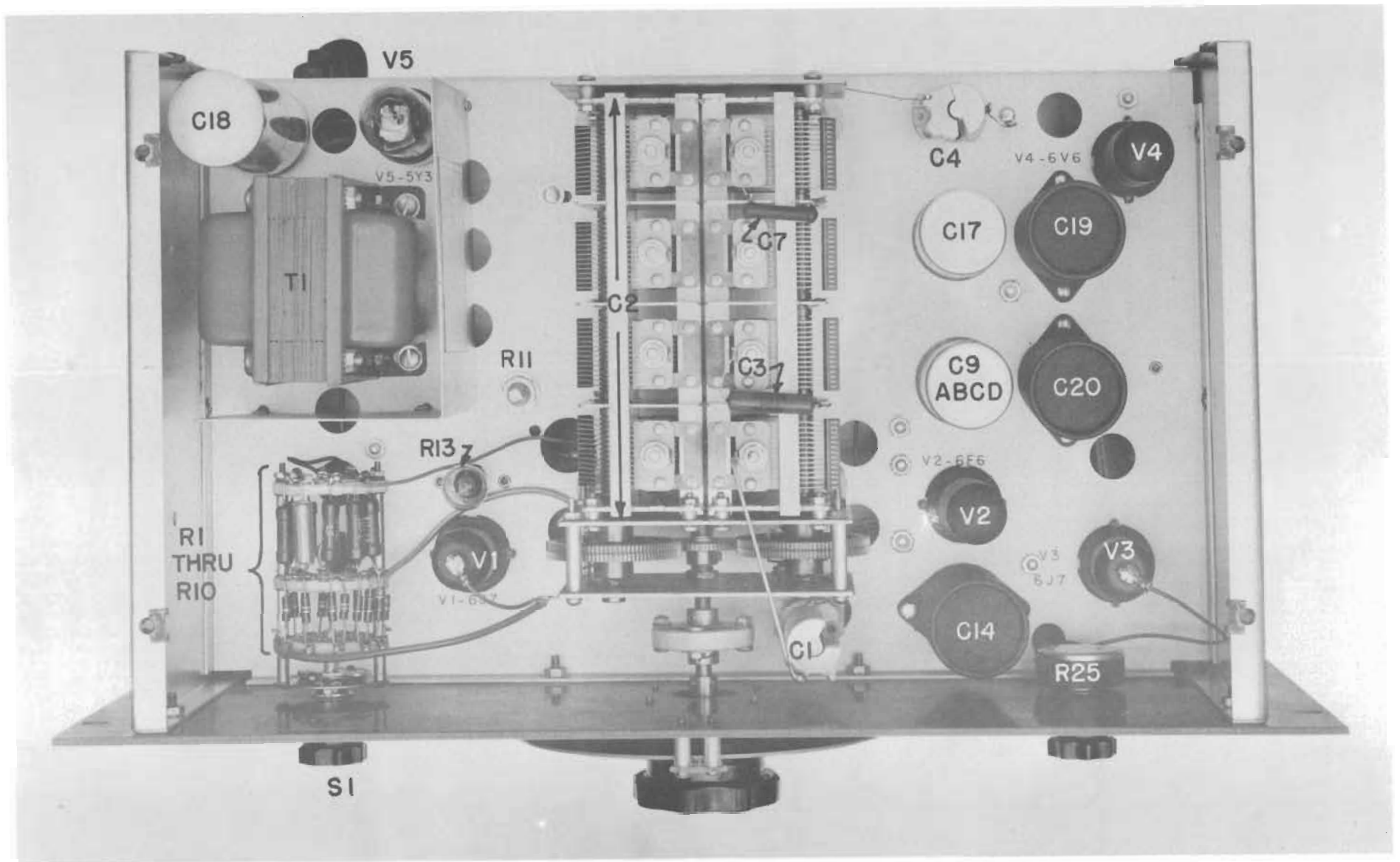

Fig. 2. Model 202D Cover Removed

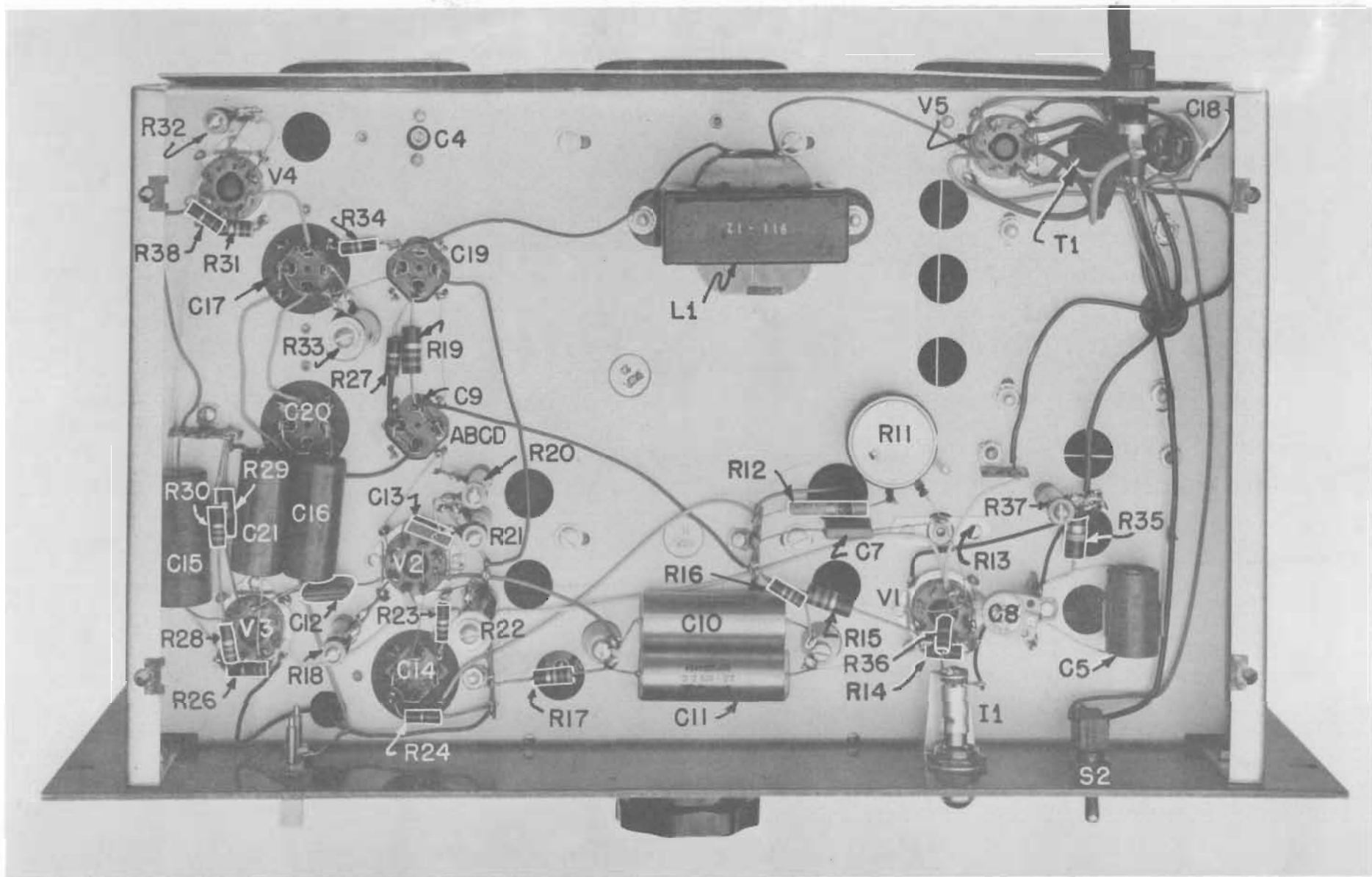
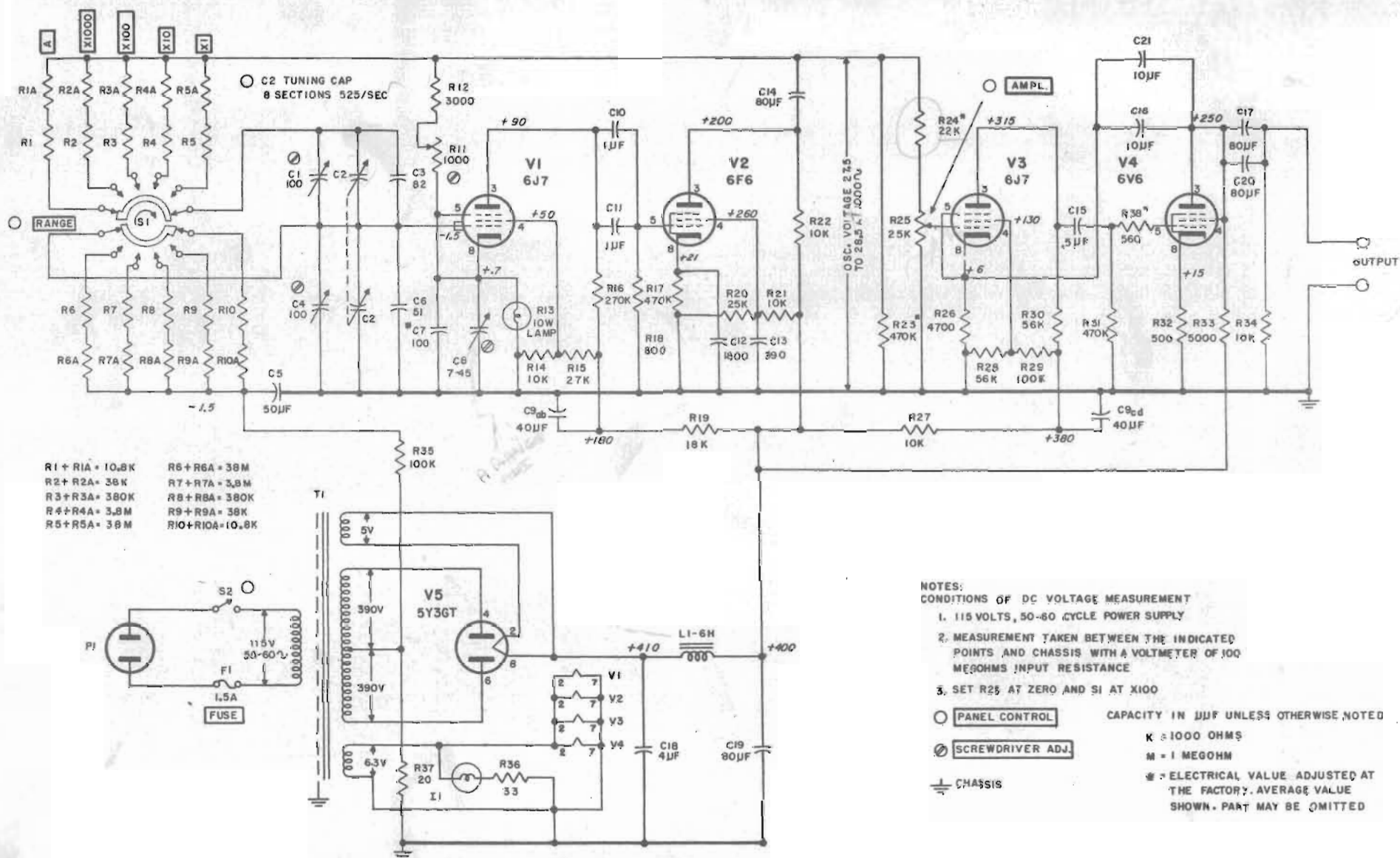

Fig. 3. Model 202D Bottom Plate Removed



**SCHEMATIC DIAGRAM OF MODEL 202D**  
**SERIAL 81053 & ABOVE**

**TABLE OF REPLACEABLE PARTS**

Circuit Ref.	Description	-hp- Stock No.	Mfr. * & Mfrs. Designation
C1	Capacitor: variable, air, 100 $\mu$ f	12-11	AA, A-103L
C2	Tuning Capacitor Assembly:	D-7	HP
C3	Capacitor: fixed, ceramic, 82 $\mu$ f, 500 vdcw	15-7	K CI-3
C4	Capacitor: variable, air, 100 $\mu$ f	12-11	AA, A-103L
C5	Capacitor: fixed, electrolytic, 50 $\mu$ f, 50 vdcw	18-50	X TC-39
C6	Capacitor: fixed, ceramic, 51 $\mu$ f, 500 vdcw	15-6	K CI-3
C7	Capacitor: fixed, mica, 100 $\mu$ f, 500 vdcw Electrical values adjusted at factory	14-100	V Type OXM
C8	Capacitor: variable ceramic, 7-45 $\mu$ f, 500 vdcw	13-1	L TS2AN500
C9 abcd	Capacitor: fixed, electrolytic, 20, 20, 20, 20 $\mu$ f, 450 vdcw	18-42	X FPQ 444
C10	Capacitor: fixed, paper, 1 $\mu$ f, 400 vdcw	16-44	CC 88P10504
C11	Capacitor: fixed, paper, 1 $\mu$ f, 400 vdcw	16-44	CC 88P10504
C12	Capacitor: fixed, mica, 1800 $\mu$ f, 500 vdcw	14-47	V Type W
C13	Capacitor: fixed, mica, 390 $\mu$ f, 500 vdcw	14-65	V Type OXM
C14	Capacitor: fixed, electrolytic, 20, 20, 20, 20 $\mu$ f, 450 vdcw	18-42	X FPQ 444
C15	Capacitor: fixed, paper, .5 $\mu$ f, 600 vdcw	16-58	Z 300405
C16, C21	Capacitor: fixed, electrolytic, 10 $\mu$ f, 450 vdcw	18-10	X WB 72
C17	Capacitor: fixed, electrolytic, 20, 20, 20, 20 $\mu$ f, 450 vdcw	18-42	X FPQ 444
C18	Capacitor: fixed, paper, 4 $\mu$ f, 600 vdcw	17-10	J TLA6040
C19, C20	Capacitor: fixed, electrolytic, 20, 20, 20, 20 $\mu$ f, 450 vdcw	18-42	X FPQ 444

\*See "List of Manufacturers Code Letters For Replaceable Parts Table."

202D 4/2/54 Serial 81, 053 and above.

TABLE OF REPLACEABLE PARTS

Circuit Ref.	Description	-hp- Stock No.	Mfr. * & Mfrs. Designation
R1 - R10	Part of Range Switch Assembly		
R11	Resistor, variable, wirewound, 1000 ohms, linear taper	210-5	I 43-1000
R12	Resistor fixed, wirewound, 3000 ohms, ±10%, 1 W	26-3000	R Type BW
R13	Lamp: 10 W	211-29	N, 10S6/10
R14	Resistor: fixed, composition, 10,000 ohms, ±10%, 1 W	24-10K	B GB 1031
R15	Resistor: fixed, composition, 27,000 ohms, ±10%, 2 W	25-27K	B HB 2731
R16	Resistor: fixed, composition, 270,000 ohms, ±10%, 1 W	24-270K	B GB 2741
R17	Resistor: fixed, composition, 470,000 ohms, ±10%, 1 W	24-470K	B GB 4741
R18	Resistor: fixed, wirewound, 800 ohms, ±10%, 10 W	26-6	S Type 1-3/4E
R19	Resistor: fixed, composition, 18,000 ohms, ±10%, 2 W	25-18K	B HB 1831
R20	Resistor: fixed, wirewound, 25,000 ohms, ±10%, 10 W	26-11	S Type 1-3/4E
R21	Resistor: fixed, wirewound, 10,000 ohms, ±10%, 10 W	26-10	S Type 1-3/4E
R22	Resistor: fixed, wirewound, 10,000 ohms, ±10%, 20 W	27-4	S Type 2R
R23	Resistor: fixed, composition, 470,000 ohms, ±10%, 1 W	24-470K	B GB 4741
R24	Resistor: fixed, composition, 22,000 ohms, ±10%, 1 W	24-22K	B GB 2231
R25	Resistor: variable, composition, 25,000 ohms, linear taper	210-54	B JU 2531
R26	Resistor: fixed, composition, 4700 ohms, ±10%, 1 W	24-4700	B GB 4721
R27	Resistor: fixed, composition, 10,000 ohms, ±10%, 1 W	24-10K	B GB 1031
R28	Resistor: fixed, composition, 56,000 ohms, ±10%, 1 W	24-56K	B GB 5631

\*See "List of Manufacturers Code Letters For Replaceable Parts Table."

202D 4/2/54 Serial 81, 053 and above



TABLE OF REPLACEABLE PARTS

Circuit Ref.	Description	-hp- Stock No.	Mfr. * & Mfrs. Designation
R29	Resistor: fixed, composition, 100,000 ohms, ±10%, 2 W	25-100K	B HB 1041
R30	Resistor: fixed, composition, 56,000 ohms, ±10%, 1 W	24-56K	B GB 5631
R31	Resistor: fixed, composition, 470,000 ohms, ±10%, 1 W	24-470K	B GB 4741
R32	Resistor: fixed, wirewound, 500 ohms, ±10%, 10 W	26-5	S Type 1-3/4E
R33	Resistor: fixed, wirewound, 5000 ohms, ±10%, 20 W	27-3	S Type 2R
R34	Resistor: fixed, composition, 10,000 ohms, ±10%, 1 W	24-10K	B GB 1031
R35	Resistor: fixed, composition, 100,000 ohms, ±10%, 2 W	25-100K	B HB 1041
R36	Resistor: fixed, composition, 33 ohms, ±10%, 1 W	24-33	B GB 3301
R37	Resistor: fixed, wirewound, 20 ohms, ±10%, 10 W	26-16	S Type 1-3/4E
R38	Resistor: fixed, composition, 560 ohms, ±10%, 1 W	24-560	B GB 5611
	Binding Post: Body	149-4	HP
	Binding Post: Nut	149-5	HP
F1	Fuse: 1, 5A, 3AG	211-8	T, 312002
	Fuseholder:	140-18	T, 342001
I1	Lamp:	211-47	O, #47
	Knob: 1-1/2" diam.	37-11	HP
	Knob: 3" diam.	37-14	HP
L1	Reactor: 6 H @ 125 MA; 240 ohms	911-12	HP
S1	Range Switch Assembly:	2D-19WA	HP
S2	Toggle Switch:	310-11	D, 20994-HW
T1	Power Transformer:	910-3	HP
P1	Power Transformer:	812-56	HP

\*See "List of Manufacturers Code Letters For Replaceable Parts Table."

202D 4/2/54 Serial 81,053 and above

TABLE OF REPLACEABLE PARTS

Circuit Ref.	Description	-hp- Stock No.	Mfr. * & Mfrs. Designation
V1	Tube: 6J7	212-6J7	ZZ
V2	Tube: 6F6	212-6F6	ZZ
V3	Tube: 6J7	212-6J7	ZZ
V4	Tube: 6V6	212-6V6	ZZ
V5	Tube: 5Y3GT	212-5Y3GT	ZZ

20210 4/2/54 Serial 81, 053 and above

\*See "List of Manufacturers Code Letters For Replaceable Parts Table."

LIST OF MANUFACTURERS CODE LETTERS  
FOR REPLACEABLE PARTS TABLE

<u>Code Letter</u>	<u>Manufacturer</u>
A	Aerovox Corp.
B	Allen-Bradley Co.
C	Amperite Co.
D	Arrow, Hart and Hegeman
E	Bussman Manufacturing Co.
F	Carborundum Co.
G	Centralab
H	Cinch Manufacturing Co.
I	Clarostat Manufacturing Co.
J	Cornell Dubilier Electric Co.
K	Electrical Reactance Co.
L	Erie Resistor Corp.
M	Federal Telephone and Radio Corp.
N	General Electric Co.
O	General Electric Supply Corp.
P	Girard-Hopkins
HP	Hewlett-Packard
Q	Industrial Products Co.
R	International Resistance Co.
S	Lectrohm, Inc.
T	Littelfuse, Inc.
U	Maguire Industries, Inc.
V	Micamold Radio Corp.
W	Oak Mfg. Co.
X	P. R. Mallory Co., Inc.
Y	Radio Corp. of America
Z	Sangamo Electric Co.
AA	Sarkes Tarzian
BB	Signal Indicator Co.
CC	Sprague Electric Co.
DD	Stackpole Carbon Co.
EE	Sylvania Electric Products, Inc.
FF	Western Electric Co.
GG	Wilkor Products, Inc.
HH	Amphenol
II	Dial Light Co. of America
JJ	Leecraft Manufacturing Co.
ZZ	Any tube having RMA standard characteristics



## WARRANTY

*All our products are warranted against defects in materials and workmanship for one year from the date of shipment. Our obligation is limited to repairing or replacing products (except tubes) which prove to be defective during the warranty period. We are not liable for consequential damages.*

For assistance of any kind, including help with instruments under warranty, contact your authorized  Sales Representative for instructions. Give full details of the difficulty and include the instrument model and serial numbers. Service data or shipping instructions will be promptly sent to you. There will be no charge for repair of instruments under warranty, *except transportation charges*. Estimates of charges for non-warranty or other service work will always be supplied, if requested, before work begins.

## CLAIM FOR DAMAGE IN SHIPMENT

Your instrument should be inspected and tested as soon as it is received. The instrument is insured for safe delivery. If the instrument is damaged in any way or fails to operate properly, file a claim with the carrier or, if insured separately, with the insurance company.

## SHIPPING

On receipt of shipping instructions, forward the instrument prepaid to the destination indicated. You may use the original shipping carton or any strong container. Wrap the instrument in heavy paper or a plastic bag and surround it with three or four inches of shock-absorbing material to cushion it firmly and prevent movement inside the container.

## GENERAL

Your authorized  Sales Representative is ready to assist you in any situation, and you are always welcome to get directly in touch with Hewlett-Packard service departments:

### CUSTOMER SERVICE

Hewlett-Packard Company  
395 Page Mill Road  
Palo Alto, California, U.S.A.  
Telephone: (415) 326-1755  
TWX No. PAL AL 117-U  
Cable: "HEWPACK"

### OR (In Western Europe)

Hewlett-Packard S.A.  
54-54bis Route Des Acacias  
Geneva, Switzerland  
Telephone: (022) 42. 81. 50  
Cable: "HEWPACKSA"

