









SMITHSONIAN INSTITUTION  
UNITED STATES NATIONAL MUSEUM

---

# PROCEEDINGS

OF THE

UNITED STATES NATIONAL MUSEUM

---

VOLUME XXXV

---



206513

WASHINGTON  
GOVERNMENT PRINTING OFFICE  
1909





## ADVERTISEMENT.

---

The scientific publications of the National Museum consists of two series—Proceedings and Bulletins.

The Proceedings, the first volume of which was issued in 1878, are intended primarily as a medium for the publication of original papers based on the collections of the National Museum, setting forth newly acquired facts in biology, anthropology, and geology derived therefrom, or containing descriptions of new forms and revisions of limited groups. A volume is issued annually or oftener for distribution to libraries and scientific establishments, and, in view of the importance of the more prompt dissemination of new facts, a limited edition of each paper is printed in pamphlet form in advance. The dates at which these separate papers are published are recorded in the table of contents of the volume.

The present volume is the thirty-fifth of this series.

The Bulletin, publication of which was begun in 1875, is a series of more elaborate papers, issued separately, and, like the Proceedings, based chiefly on the collections of the National Museum.

A quarto form of the Bulletin, known as the "Special Bulletin," has been adopted in a few instances in which a larger page was deemed indispensable.

Since 1902 the volumes of the series known as "Contributions from the National Herbarium," and containing papers relating to the botanical collections of the Museum, have been published as Bulletins.

RICHARD RATHBUN,

*Assistant Secretary, Smithsonian Institution,*

*In charge of the United States National Museum.*

FEBRUARY 20, 1909.



## TABLE OF CONTENTS.

	Page.
BASSLER, RAY S. The Formation of Geodes with Remarks on the Silicification of Fossils.—No. 1637. November 7, 1908 <sup>a</sup> .....	133-154
———. See under Ulrich, E. O. ....	277-340
BUSCK, AUGUST. A Generic Revision of American Moths of the Family Cecophoridae, with Descriptions of New Species.—No. 1644. October 31, 1908 <sup>a</sup> .....	187-207
New genera: <i>Gerdana</i> , <i>Darrantia</i> , <i>Inga</i> , <i>Decantha</i> , <i>Fabiola</i> .	
New species: <i>Gerdana caritella</i> , <i>Cryptolechia canariella</i> , <i>C. huachucella</i> , <i>C. ciliella</i> , <i>Agonopteryx plummerella</i> .	
CLARK, AUSTIN HOBART. The Axial Canals of the Recent Pentacrinitidae.—No. 1634. October 30, 1908 <sup>a</sup> .....	87-91
———. The Homologies of the Arm Joints and Arm Divisions in the Recent Crinoids of the Families of the Comatulida and the Pentacrinitidae.—No. 1636. October 30, 1908 <sup>a</sup> .....	113-131
New genera: <i>Hypalocrinus</i> , <i>Endorocrinus</i> .	
DALL, WILLIAM HEALEY. Descriptions and Figures of some Land and Fresh-water Shells from Mexico, believed to be New.—No. 1642. November 10, 1908 <sup>a</sup> .....	177-182
New section: <i>Crossostephanus</i> .	
New species: <i>Carlocentrum</i> ( <i>Crossostephanus</i> ) <i>palmeri</i> , <i>Streptostyla bartschii</i> , <i>S. toyuca</i> , <i>S. jililana</i> , <i>Englandina livida</i> , <i>Lampsis</i> ( <i>Propetra</i> ) <i>salinasensis</i> .	
DYAR, HARRISON G., and FREDERICK KNAB. Descriptions of some New Mosquitoes from Tropical America.—No. 1632. October 30, 1908 <sup>a</sup> .....	53-70
New species: <i>Aedes epactius</i> , <i>A. cuneatus</i> , <i>A. argentescens</i> , <i>A. harspicus</i> , <i>A. horridus</i> , <i>A. aldrichi</i> , <i>Culex chrysonotum</i> , <i>C. daumastocampa</i> , <i>C. pinarocampa</i> , <i>C. consternator</i> , <i>C. stenolepis</i> , <i>C. aikenii</i> , <i>C. euminctes</i> , <i>Sabethis tarsopus</i> , <i>S. schausi</i> , <i>Lesticocampa schedocyclia</i> , <i>Prosopelepis jocosa</i> , <i>Phonomyia simonsi</i> , <i>Wyeomyia abscauta</i> , <i>W. gynacopus</i> , <i>W. ablechra</i> , <i>W. ablabis</i> , <i>W. abebela</i> , <i>W. abia</i> , <i>W. andropus</i> , <i>W. elasoleuca</i> , <i>W. dymodora</i> , <i>W. baria</i> , <i>W. megalodora</i> , <i>W. matva</i> , <i>W. aryrura</i> .	
New name: <i>Anopheles cruzii</i> .	
GILL, THEODORE. Charodon in place of Chærops for a Labroid Genus of Fishes.—No. 1638. October 31, 1908 <sup>a</sup> .....	155-156

<sup>a</sup> Date of publication.

HAIN, WALTER L. Notes on the Mammals and Cold-blooded Vertebrates of the Indiana University Farm, Mitchell, Indiana.—No. 1655. December 7, 1908 <sup>a</sup> .....	545-581
HAY, OLIVER P. Descriptions of Five Species of North American Fossil Turtles, Four of which are New.—No. 1640. November 9, 1908 <sup>a</sup> .....	161-169
New species: <i>Hoplochelys calata</i> , <i>Echmatemys rivalis</i> , <i>Terrapene longinsula</i> , <i>Aspideretes granifer</i> .	
———. On certain Genera and Species of Carnivorous Dinosaurs, with special Reference to <i>Ceratosaurus nasicornis</i> Marsh.—No. 1648. October 31, 1908 <sup>a</sup> .....	351-366
HOLMES, SAMUEL J. The Amphipoda collected by the U. S. Bureau of Fisheries Steamer Albatross off the West Coast of North America in 1903 and 1904, with Descriptions of a New Family and several New Genera and Species. —No. 1654. November 20, 1908 <sup>a</sup> .....	489-543
New family: <i>Stilipredida</i> .	
New genera: <i>Valcttiopsis</i> , <i>Lakota</i> , <i>Koroga</i> , <i>Aruga</i> , <i>Gracilipes</i> , <i>Acanthopleustes</i> , <i>Stilipes</i> .	
New species: <i>Vibilia californica</i> , <i>Orchomenella affinis</i> , <i>Valcttiopsis dentatus</i> , <i>Tryphosa coca</i> , <i>Lakota carinata</i> , <i>Scoplocheirus coca</i> , <i>Koroga megalops</i> , <i>Aruga oculata</i> , <i>Ampelisea cristata</i> , <i>A. plumosa</i> , <i>A. pacifica</i> , <i>A. californica</i> , <i>A. coca</i> , <i>A. lobata</i> , <i>Paraphoxus robustus</i> , <i>Harpinia oculata</i> , <i>H. affinis</i> , <i>Metopa pacifica</i> , <i>Gracilipes natator</i> , <i>G. distincta</i> , <i>Neopleustes oculatus</i> , <i>Acanthopleustes annexens</i> , <i>Stilipes distincta</i> , <i>Mara spinicauda</i> , <i>Eurystheus dentatus</i> .	
HRDLIČKA, ALEŠ. New Examples of American Indian Skulls with Low Forehead.—No. 1641. November 9, 1908 <sup>a</sup> .....	171-175
KEARFOTT, WILLIAM DUNHAM. Descriptions of New Species of North American Crambid Moths.—No. 1649. October 31, 1908 <sup>a</sup> .....	367-393
New species: <i>Saratha</i> (?) <i>santella</i> , <i>S. indentella</i> , <i>Mesolia oraculella</i> , <i>M. huachuacella</i> , <i>Prionapteryx serpentella</i> , <i>Eugrotea</i> (?) <i>yavapai</i> , <i>Crambus cocklellus</i> , <i>C. youngellus</i> , <i>C. polingi</i> , <i>C. intermedius</i> , <i>C. dorsipunctellus</i> , <i>C. nevadellus</i> , <i>C. simplicellus</i> , <i>Thaumatopsis coloradella</i> , <i>T. gibsonella</i> , <i>T. atomosella</i> , <i>T. crenulatella</i> , <i>Diatryxa parallelus</i> , <i>Chilo multipunctellus</i> , <i>C. puritellus</i> .	
KNAB, FREDERICK. See under Dyar, Harrison G.: .....	53-70
KNOWLTON, FRANK HALL. Description of New Fossil Liverwort from the Fort Union Beds of Montana.—No. 1639. November 9, 1908 <sup>a</sup> .....	157-159
New species: <i>Marchantia pulci</i> .	

MASON, OTIS T. Vocabulary of Malaysian Basketwork: a Study in the W. L. Abbott Collections.—No. 1631. November 7, 1908 <sup>a</sup> .....	1-51
NUTTING, CHARLES C. Aleyonaria of the Californian Coast.—No. 1658. February 20, 1909 <sup>a</sup> .....	681-727
New species: <i>Telesto ambigua</i> , <i>Anthomastus ritteri</i> , <i>Haliscyprum cystiferum</i> , <i>Acanthoptilum album</i> , <i>A. annulatum</i> , <i>Balticina pacifica</i> , <i>Halipteris contorta</i> , <i>Stachyptilum quadridentatum</i> , <i>Umbellula loma</i> , <i>Eumuricea pusilla</i> , <i>Psammogorgia simplex</i> , <i>P. torreyi</i> , <i>P. spauldingi</i> , <i>Stenogorgia kofoidi</i> .	
OBERHOLSER, HARRY C. A Revision of the Kingfisher Genus <i>Ramphaleyon</i> (Pelargopsis).—No. 1657. February 9, 1909 <sup>a</sup> .....	657-680
New subspecies: <i>Ramphaleyon capensis isoptera</i> , <i>R. c. nesocca</i> , <i>R. c. cyanopteryx</i> , <i>R. c. hydrophila</i> .	
RATHBUN, MARY J. Descriptions of Fossil Crabs from California.—No. 1647. November 14, 1908 <sup>a</sup> .....	341-349
New genera: <i>Branchiolambrus</i> , <i>Archaeopus</i> .	
New species: <i>Cancer fissus</i> , <i>Branchiolambrus altus</i> , <i>Archaeopus antennatus</i> .	
REHN, JAMES A. G. Two New Species of Neotropical Orthoptera of the Family Acrididae.—No. 1650. October 30, 1908 <sup>a</sup> .....	395-398
New species: <i>Inusia antillarum</i> , <i>Proctolabus bullatus</i> .	
RICHARDSON, HARRIET. Some New Isopoda of the Superfamily Aselloidea from the Atlantic Coast of North America.—No. 1633. October 30, 1908 <sup>a</sup> .....	71-86
New genera: <i>Rhacura</i> , <i>Haplouiscus</i> .	
New species: <i>Iolella glabra</i> , <i>Rhacura pulchra</i> , <i>Haplouiscus cicisus</i> , <i>H. retrospinis</i> , <i>Janirella lobata</i> , <i>Munna truncata</i> , <i>Heteromesus granulatus</i> , <i>H. spinescens</i> , <i>Eurycope magnispinis</i> .	
New name: <i>Ischnomesus</i> .	
———. Some New Isopods of the Family Gnathiidae from the Atlantic Coast of North America.—No. 1653. November 20, 1908 <sup>a</sup> .....	483-488
New species: <i>Bathygnaithia curvirostris</i> , <i>Gnathia multispinis</i> , <i>G. serrata</i> .	
RICHMOND, CHARLES W. Generic Names applied to Birds during the Years 1901 to 1905, inclusive, with further Additions to Waterhouse's "Index Generum Avium."—No. 1656. December 16, 1908 <sup>a</sup> .....	583-655
SHARPE, RICHARD W. A further Report on the Ostracoda of the United States National Museum.—No. 1651. November 19, 1908 <sup>a</sup> .....	399-430
New species: <i>Spirocypris tuberculata</i> , <i>Hiodromus pectinatus</i> , <i>Cythere americana</i> , <i>C. papillosa</i> .	

- SMITH, JOHN B. A Revision of some Species of Noctuidæ heretofore referred to the Genus *Homoptera* Boisduval.—No. 1645. November 10, 1908 <sup>a</sup> ..... 209-275  
 New species: *Phycoryna insuda*, *P. norda*, *P. metata*, *P. curcma*, *P. helata*, *P. largera*, *P. bethunei*, *P. colorado*, *P. rubiata*, *P. yarapai*.
- SNYDER, JOHN OTTERBEIN. Descriptions of Eighteen New Species and Two New Genera of Fishes from Japan and the Riu Kiu Islands.—No. 1635. October 30, 1908 <sup>a</sup> .... 93-111  
 New genera: *Doryptena*, *Xenisthmus*.  
 New species: *Leptocephalus flavirostris*, *Gymnothorax odiosus*, *G. chlamydatus*, *Lepidaplois loxozonus*, *L. mirabilis*, *Chocrops jordani*, *Callyodon lunula*, *Heteroleotris arenarius*, *Gnatholepis sindonis*, *Amblygobius naraharac*, *Doryptena okinawae*, *D. tancgasima*, *Xenisthmus proriger*, *Alticus margaritarius*, *A. novemmaculosus*, *Salarias muscarus*, *S. sinuosus*, *Enchelyurus hepburni*.
- . Notes on Two Rare California Fishes, *Rimicola eigenmanni* and *Plagiogrammus hopkinsi*.—No. 1643. October 31, 1908 <sup>a</sup> ..... 183-186
- ULRICH, EDWARD O., and RAY S. BASSLER. New American Paleozoic Ostracoda. Preliminary Revision of the Beyrichiidae, with Descriptions of New Genera.—No. 1646. November 10, 1908 <sup>a</sup> ..... 277-340  
 New genera: *Scofieldia*, *Treposella*, *Hollina*, *Klodenella*, *Kirkbyina*, *Jonesina*.  
 New subgenus: *Steuslofia*.  
 New species: *Beyrichia moodeyi*, *B. waldronensis*, *Klodenia centricornis*, *K. fimbriata*, *K. marginalis*, *K. pravnuntia*, *K. punctilosa*, *K. retifera*.  
 New name: *Beyrichia granulifera*.
- WILSON, CHARLES BRANCH. North American Parasitic Copepods: a List of those found upon the Fishes of the Pacific Coast, with Descriptions of New Genera and Species.—No. 1652. December 10, 1908 <sup>a</sup> ..... 431-481  
 New genera: *Artacolar*, *Pseudochondracanthus*, *Achtheinus*, *Opimia*, *Phrirocephalus*.  
 New species: *Chondracanthus epacthes*, *Pseudochondracanthus diceraus*, *Leprophtherius parvus*, *L. constrictus*, *L. insignis*, *Achtheinus oblongus*, *Eudactylina uncinata*, *Hatschekia pinguis*, *Lernænicus medusæus*, *Opimia erilis*, *Phrirocephalus cincinnatus*, *Brachiella gracilis*, *B. anserina*, *Lernæopoda gibber*, *L. beani*, *L. bicauliculata*, *L. fulculata*.  
 New genus name: *Artacolar* (*Bomolochus*) *ardcola*.

<sup>a</sup> Date of publication.

# LIST OF ILLUSTRATIONS.

## TEXT FIGURES.

	Page
Close, oblique checkerwork with inwoven border, showing finished basket and detail of border.....	8
Figure-of-8 borderwork.....	9
Looped and braided borderwork.....	9
Borderwork concealing rough ends with hoops and knotwork.....	10
Ends of warps turned down for borderwork.....	10
Rattan stems braided in pairs over bent-down warps.....	11
Lattice bottom, with twined upsett in boustroph.....	12
Bottom of globular wicker basket.....	13
Braidwork in carrying zone of burden basket.....	14
Braidwork loops for carrying band.....	14
Four-strand braid in carrying zone.....	14
Braids in two colors in carrying zone.....	15
Carrying zone strengthened by hoopwork.....	15
Upright and oblique checkerwork.....	16
Coiled basket, single-rod foundation, spiral bottom.....	17
Curled work in pandanus leaf.....	18
Methods of forming handles.....	20
Plain hexagonal technic and border.....	21
Hexagonal elements in pairs.....	22
Hexagonal technic with wide horizontals.....	23
Overhand knot in single strand.....	25
Ornamental knotwork on shields.....	25
Single knots in Malaysian basketwork.....	26
Round turns and half hitches in a wooden cradle.....	26
Malay knots.....	27
Mousing knots on borders.....	27
Knotwork on Malaysian shields.....	28
Knotwork and braidwork united.....	28
Single lacing in Engano basketwork.....	29
Double lacing in Engano basketwork.....	30
Process of making a basket over a wooden mold.....	32
Process of making a basket over a mold of stiff bark.....	33
Active elements in sets.....	36
Double sewing on shield.....	37
Sewing forming 3-strand twine.....	38
Beginning of single-stem basket.....	40
Processes on single-stem basket.....	41
Finishing processes on single-stem basket.....	42
Three-directions technic with varying elements.....	43
Wrapped twinedwork.....	47
Single-wrapped weft.....	48
<i>Iolella glabra</i> .....	72
<i>Rhacura pulchra</i> .....	74
<i>Rhacura pulchra</i> . Maxilliped.....	74
<i>Haploniscus excisus</i> .....	75

	Page.
<i>Haploniscus retrospinis</i> . Abdomen of female.....	76
<i>Haploniscus retrospinis</i> . (Second antenna).....	76
<i>Haploniscus retrospinis</i> . Abdomen of male.....	76
<i>Janirella lobata</i> .....	78
<i>Janirella lobata</i> . First leg of female.....	78
<i>Janirella lobata</i> . Seventh leg of female.....	79
<i>Janirella lobata</i> . First pleopod of male.....	79
<i>Munna truncata</i> .....	80
<i>Munna truncata</i> . First pleopoda of male.....	80
<i>Heteromesus granulatus</i> . Female.....	82
<i>Heteromesus granulatus</i> . Second antenna of female.....	82
<i>Heteromesus granulatus</i> . First leg of female.....	82
<i>Heteromesus granulatus</i> . Middle part of body of male.....	83
<i>Heteromesus granulatus</i> . Abdomen of male.....	83
<i>Heteromesus spinescens</i> . Male.....	83
<i>Eurycope truncata</i> .....	85
<i>Eurycope magnispinis</i> .....	85
Diagram showing the course of the axial canals in <i>Isocrinus decorus</i> and <i>Metacrinus rotundus</i> .....	87
Diagram showing the course of the axial canals in <i>Isocrinus decorus</i> in their natural position.....	88
Portion of stem of very young <i>Isocrinus decorus</i> , before the development of the Petaloid sectors.....	88
Joint faces in a very young stem of <i>Isocrinus decorus</i> , but somewhat older than the stem shown in the preceding figure.....	88
Lateral view of an isolated infrabasal of <i>Isocrinus decorus</i> or <i>Metacrinus rotundus</i> , showing the furrow which forms half of the canal containing the primary axial cord.....	89
The infrabasals of <i>Isocrinus decorus</i> or <i>Metacrinus rotundus</i> spread outward, showing the course of the furrows along their apposed sides.....	89
The circle of infrabasals of <i>Isocrinus decorus</i> or <i>Metacrinus rotundus</i> , showing the apertures by which the primary axial canals leave the circle of infrabasals to enter the basals.....	89
A basal of <i>Isocrinus decorus</i> or <i>Metacrinus rotundus</i> viewed from the inner end, showing the single aperture by which the primary axial cord enters from the circle of infrabasals and the two apertures by which the two branches leave the basal and enter the radials.....	89
The same basal, ground down to the plane passing through the center of the three apertures to show the course of the canals and the transverse connective within the basal.....	89
The same basal, viewed ventrally (distally), showing the two apertures by which the two branches of the primary axial canal leave the basal and enter two adjacent radials.....	89
Dorsal (proximal) view of a radial, showing the two apertures by which the canals enter from two adjacent basals, and the two apertures by which the circular commissure leaves the radial.....	90
The same radial ground down to a plane passing through all the apertures, showing the course of the canals within the radial.....	90
A direct (not foreshortened) view of the ground surface of the same radial.....	90
A basal of <i>Endocrocinus parva</i> viewed from the interior of the calyx, showing the two apertures by which the branches of the primary cord enter the basal, and the two apertures by which they leave the basal and enter two adjacent radials; the course of the canals within the basal is indicated by dotted lines..	90



	Page.
Diagram showing the course of the canal in <i>Endoxocrinus parva</i> .....	90
Diagram illustrating the difference in the arrangement of the axial canals between <i>Isocrinus decorus</i> and <i>Metacrinus rotundus</i> and <i>Endoxocrinus parva</i> ; the diagram, with the omission of the dotted line, represents the condition in <i>Isocrinus decorus</i> and <i>Metacrinus rotundus</i> ; in <i>Endoxocrinus parva</i> the infra-basals are entirely resorbed and the basals are resorbed as far as the dotted line, with a corresponding increase of the small central area.....	91
Articular face of a "straight muscular" articulation.....	115
Articular face of an "oblique muscular" articulation.....	115
An axillary with "straight muscular" distal faces.....	115
Dorsal view of an axillary united to the preceding joint by "synarthry," and to the two succeeding by "straight muscular" articulations.....	116
Articular face of a "synarthry".....	116
An axillary with "oblique muscular" distal faces.....	116
Articular face of a "syzygy".....	116
Dorsal view of an axillary, all three of whose faces are "oblique muscular;" the articulation between the two post-axillary joints is also "oblique muscular".....	117
<i>Pentametrocrinida</i> ; <i>Pentametrocrinus</i> .....	117
Proximal part of arm of <i>Pentametrocrinus tuberculatus</i> , showing the external appearance of the articulations.....	117
Proximal part of arms of <i>Thaumatometra tenuis</i> , showing the external appearance of the articulations.....	117
<i>Pentametrocrinida</i> ; <i>Thaumatocrinus</i> .....	118
<i>Pentametrocrinida</i> ; <i>Decametrocrinus</i> .....	118
<i>Zygometrida</i> ; <i>Eudiocrinus</i> .....	118
<i>Zygometrida</i> ; <i>Zygometra</i> .....	118
<i>Zygometrida</i> ; <i>Catoptometra</i> .....	119
<i>Antedonida</i> ; <i>Heliometra</i> .....	119
<i>Atelecrinida</i> ; <i>Atelecrinus</i> .....	119
<i>Thalassometrida</i> ; <i>Charitometra</i> .....	120
<i>Himerometrida</i> ; <i>Himerometra</i> ; also, <i>Comasterida</i> ; <i>Phanogenia</i> .....	120
<i>Comasterida</i> ; <i>Comatula</i> .....	120
<i>Comasterida</i> ; <i>Comatula</i> .....	121
<i>Comasterida</i> ; <i>Comatula</i> .....	121
<i>Comasterida</i> ; <i>Comaster</i> .....	122
<i>Untacrinida</i> ; <i>Untacrinus</i> ; the "interradial" and interbrachial plates are omitted so as to more clearly bring out the arms and pinnules.....	125
<i>Pentacrinida</i> ; <i>Endoxocrinus</i> .....	126
<i>Pentacrinida</i> ; <i>Isocrinus</i> .....	126
<i>Pentacrinida</i> ; <i>Metacrinus</i> .....	127
Sketch showing occurrence of geodes in Knobstone shales.....	136
Posterior portion of carapace of <i>Glyptops plicatulus</i> .....	161
Portion of carapace of <i>Echmatemys rivalis</i> .....	164
Plastron of <i>Echmatemys rivalis</i> .....	166
Side view of the Missouri skull.....	174
1. Left side of entire specimen of <i>Leperditia fabulites</i> . 2. Left valve of <i>Isochilina ? subnodosa</i> . 3. Right valve of <i>Isochilina ? clavigera</i> . 4. Left valve of <i>Beyrichia tuberculata</i> . 5. Right valve of <i>Beyrichia clavata</i> Kolmodin. 6. Left valve of <i>Ctenobolbina alata</i> Ulrich. 7. Left valve of <i>Ctenobolbina ciliata</i> (Emmons). 8. <i>Beyrichia (Steusloffia) linnarssoni</i> (Krause). Right valve. 9. <i>Beyrichia salteriana</i> Jones. 10. Different views of a left valve of <i>Beyrichia tuberculata-buchiana</i> Reuter.....	282
Copy of McCoy's original sketches of <i>Beyrichia kludeni</i> .....	283

	Page.
Left valve and side and edge views of another left valve of <i>Bollia regularis</i> (Emmons). Left valve of <i>Beyrichia buckiana</i> Jones.....	288
A left valve of <i>Beyrichia tuberculata</i> , with the lines of a <i>Drepanella</i> drawn over it..	290
Right valve of <i>Drepanella macra</i> Ulrich. Left valve of <i>Beyrichia tuberculata</i> (Kløden). Right valve of <i>Drepanella crassinoda</i> Ulrich for comparison with left valve of <i>Beyrichia noctlingi</i> Reuter. Left valve of <i>Drepanella nitida</i> (Ulrich) for comparison with the corresponding valve of <i>Beyrichia baueri</i> Reuter.....	291
Left valve of <i>Drepanella richardsoni</i> (Miller). Right valve of <i>Beyrichia tumida</i> (Ulrich). Right valve of <i>Beyrichia lata</i> Hall. Right valve of <i>Treposella lyoni</i> (Ulrich).....	292
Right valve of <i>Ctenobolbina subcrassa</i> Ulrich. Right valve of <i>Beyrichia plicata</i> (Krause). Left valve of <i>Beyrichia reuteri</i> Krause. Right valve of <i>Beyrichia salteriana</i> Jones. The figures illustrate the relation and probable derivation of the <i>Beyrichia salteriana</i> group from a <i>Ctenobolbina</i> like <i>subcrassa</i> .....	293
Left valve of <i>Beyrichia clavata</i> Kolmodin. Left valve of <i>Beyrichia granulifera</i> , new name. Right valve of <i>Beyrichia tumida</i> (Ulrich). The figures illustrate the resemblance of the <i>Beyrichia clavata</i> group to the <i>B. interrupta</i> group and show the similar antero-ventral prolongation of the posterior lobe.....	294
Left valve of <i>Beyrichia (Steusloffia) linnarssoni</i> (Krause). Right valve of <i>Strepula concentrica</i> Jones and Holl. Left valve of <i>Strepula irregularis</i> Jones and Holl. Left valve of <i>Beyrichia (Tetradella?) erratica</i> Krause. Left valve of <i>Strepula? lineata granulosa</i> Steusloff. Shows similar development of superficial linear crests in <i>Steusloffia</i> and <i>Strepula</i> .....	296
Left valve of <i>Ctenobolbina umbonata</i> (Steusloff). Right valve of <i>Ctenobolbina fulerata</i> (Ulrich). Right valve of <i>Ctenobolbina impressa</i> (Steusloff). Left valve of <i>Ctenobolbina subcrassa</i> Ulrich. Left valve of <i>Beyrichia (Steusloffia) antiqua</i> (Steusloff). Left valve of <i>Beyrichia (Steusloffia) acuta</i> (Krause).....	297
Right valve of <i>Beyrichia reticulata</i> (Krause), and the same valve of <i>Eurychilina reticulata</i> (Ulrich), showing the similarity of the two forms referred to in the text.....	298
Right valve of <i>Beyrichia interrupta</i> (Jones). Left valve of <i>Beyrichia v-scripta</i> (Krause). Right valve of <i>Eurychilina subradiata</i> Ulrich. Left valve of <i>Beyrichia clavata</i> Kolmodin. Left valve of <i>Beyrichia (Steusloffia) acuta</i> (Krause). The illustrations show possible derivation of the <i>Beyrichia interrupta</i> group from <i>Eurychilina</i> and its relation to the <i>Beyrichia clavata</i> group and to <i>Steusloffia</i> .....	299
Right valve of <i>Klodenia wilkensisiana</i> (Jones) (female individual), and <i>Beyrichia salteriana</i> Jones, respectively, showing the relation of <i>Klodenia</i> to the <i>B. salteriana</i> group. Left side, end, and ventral views of complete carapace of <i>Klodenella pennsylvanica</i> (Jones). Right and left valves of <i>Klodenia nearpassi</i> (Weller). Left and right valves, the latter a female form, of <i>Kyammodes kiesowi</i> (Krause). Left valve and anterior view of complete carapace of <i>Kyammodes whidbornei</i> Jones. The similarity of <i>Klodenia</i> , <i>Klodenella</i> , <i>Kyammodes</i> , and the <i>Beyrichia salteriana</i> group are shown in the above figures.....	304
Left valve of <i>Bollia symmetrica</i> (Hall). Right valve of <i>Klodenella halli</i> (Jones). Right valve of <i>Klodenella turgida</i> , new species. Right valve of <i>Beyrichia? paratella</i> Ulrich. These figures illustrate the similarity of expression of <i>Bollia</i> to <i>Klodenella</i> , and the possible derivation of <i>Klodenella</i> from the Richmond species <i>Beyrichia? paratella</i> .....	319
<i>Ceratosaurns nasicornis</i> . Pight side of skull.....	360
<i>Ceratosaurns nasicornis</i> . Skull seen from the left side.....	369
<i>Ceratosaurns nasicornis</i> . Skull seen from the right side.....	361

	Page.
<i>Ceratosaurns nasicornis</i> . Inner face of left mandible. 1, angular; 2, supra-angular; 3, articular; 4, splenial; 5, dentary.....	362
Venation of <i>Uscodyx cestalis</i> .....	368
Two views of head structure of <i>Uscodyx cestalis</i> .....	368
Venation of fore wing of <i>Sarattha santella</i> .....	371
Venation of <i>Eugrota yarapai</i> .....	378
Venation of <i>Eufernaldia argentconverella</i> .....	385
Head of <i>Eufernaldia argentconverella</i> .....	386
Head and enlarged antenna of <i>Thaumatopsis coloradella</i> .....	387
Head and enlarged antenna of <i>Thaumatopsis gibsonella</i> .....	388
Head and enlarged antenna of <i>Thaumatopsis atomosella</i> .....	389
Head and enlarged antenna of <i>Thaumatopsis crenulata</i> .....	390
Head and enlarged antenna of <i>Thaumatopsis repanda</i> .....	390
Head and enlarged antenna of <i>Thaumatopsis perella</i> .....	391
Venation of <i>Diatraea parallela</i> .....	392
Head and palpi of <i>Diatraea parallela</i> .....	392
<i>Inusia antillarum</i> . Lateral view of type.....	395
<i>Inusia antillarum</i> . Dorsal view of head and pronotum.....	396
<i>Proctolabus bullatus</i> . Lateral view of type.....	397
<i>Proctolabus bullatus</i> . Dorsal view of head and pronotum.....	398
<i>Proctolabus bullatus</i> . Dorsal view of apex of abdomen.....	398
<i>Bathygnathia curvirostris</i> .....	484
<i>Bathygnathia curvirostris</i> . Mandible.....	484
<i>Bathygnathia curvirostris</i> . First leg of male.....	484
<i>Gnathia multispinis</i> .....	486
<i>Gnathia multispinis</i> . Mandible.....	486
<i>Gnathia serrata</i> .....	487
<i>Gnathia serrata</i> . Underside of anterior portion of head.....	487
<i>Vibilia californica</i> . Head and antennae; first gnathopod; second gnathopod; first pereopod; fourth pereopod.....	491
<i>Vibilia californica</i> . Uropods and telson; fifth pereopod.....	491
<i>Orchomenella affinis</i> . First antenna; first pereopod; fifth pereopod; first uropod.....	493
<i>Orchomenella affinis</i> . Third segment of the abdomen; first gnathopod; second gnathopod; second maxilla; telson; third uropod.....	493
<i>Valettiopsis dentatus</i> . First antenna; second antenna; fourth segment of the abdomen; mandible; first maxilla; second maxilla; maxilliped; telson; third uropod.....	494
<i>Valettiopsis dentatus</i> . First gnathopod; second gnathopod.....	495
<i>Tryphosa caeca</i> . First antenna; third segment of the abdomen; fourth segment of the abdomen; mandible; maxilliped; first pereopod.....	496
<i>Tryphosa caeca</i> . First gnathopod; second gnathopod.....	497
<i>Lakota carinata</i> . Third abdominal segment; first gnathopod; second gnathopod; mandible; maxilliped; telson; second uropod; third uropod.....	499
<i>Scopelocheirus cucus</i> .....	500
<i>Scopelocheirus cucus</i> . First gnathopod; lower lip; mandible; first maxilla; second maxilla; maxilliped; telson; first uropod; third uropod.....	501
<i>Scopelocheirus cucus</i> . First antenna; second antenna; second gnathopod; first pereopod.....	501
<i>Koroqa megalops</i> . Third segment of the abdomen; fourth segment of the abdomen; left mandible; first gnathopod; second gnathopod; first maxilla; second maxilla; maxilliped; telson; third uropod.....	504

	Page.
<i>Aruga oculata</i> . Third segment of the abdomen; first gnathopod; second gnathopod; telson; third uropod .....	506
<i>Aruga oculata</i> . Mandible; first maxilla; second maxilla; maxilliped; first pereopod; fifth pereopod; first uropod; second uropod.....	506
<i>Ampelisca cristata</i> , female. First antenna; third segment of the abdomen; fourth segment of the abdomen; first pereopod; telson; first uropod; third uropod.....	507
<i>Ampelisca cristata</i> , female. First gnathopod; second gnathopod; third pereopod; fifth pereopod.....	508
<i>Ampelisca plumosa</i> , female. Third segment of the abdomen; fourth segment of the abdomen; first gnathopod; third pereopod; fifth pereopod; telson; first uropod; third uropod.....	509
<i>Ampelisca macrocephala</i> , female. Third segment of the abdomen; second pereopod; third pereopod; fifth pereopod; telson; third uropod.....	510
<i>Ampelisca pacifica</i> , female. First antenna; fourth abdominal segment; gnathopod; fourth pereopod.....	511
<i>Ampelisca pacifica</i> , female. Second gnathopod; second pereopod.....	512
<i>Ampelisca pacifica</i> , female. Third abdominal segment; mandible; tip of maxilliped; fifth pereopod; telson; first uropod; third uropod.....	512
<i>Ampelisca californica</i> , female. Third segment of the abdomen; fourth segment of the abdomen; first gnathopod; second pereopod; third pereopod; fifth pereopod; telson; first uropod; third uropod.....	514
<i>Ampelisca caeca</i> . Third segment of the abdomen; fourth segment of the abdomen; first gnathopod; second gnathopod; first pereopod; fourth pereopod; fifth pereopod; telson; third uropod.....	515
<i>Ampelisca lobata</i> . Third segment of the abdomen; fourth segment of the abdomen; first gnathopod; third pereopod; fourth pereopod; fifth pereopod; telson; third uropod.....	517
<i>Haploops tubicola</i> . Third segment of the abdomen; first gnathopod; second gnathopod; first pereopod; fourth pereopod; fifth pereopod; telson; third uropod.....	519
<i>Paraphorus robustus</i> , female. Third segment of the abdomen; first gnathopod; second gnathopod; mandible; first maxilla; second maxilla; maxilliped; palp of mandible which is not shown in the figure; fourth pereopod; fifth pereopod.....	520
<i>Harpina oculata</i> , female. Third segment of the abdomen; first gnathopod; end of palp of maxilliped; fourth pereopod; fifth pereopod; third uropod.....	521
<i>Harpina affinis</i> , female. First antenna; third segment of the abdomen; first gnathopod; fourth pereopod; fifth pereopod; telson; third uropod.....	523
<i>Metopa pacifica</i> , male. First gnathopod; mandible; maxilliped; telson; second uropod.....	525
<i>Metopa pacifica</i> , male. Second gnathopod; first pereopod; second pereopod.....	525
<i>Gracilipes natator</i> .....	527
<i>Gracilipes natator</i> . First gnathopod; second gnathopod; mandible; first maxilla; second maxilla; upper lip.....	528
<i>Gracilipes natator</i> . Maxilliped; first pereopod; uropod and telson; first uropod.....	528
<i>Gracilipes distincta</i> , female. Second gnathopod; lower lip; mandible; second pereopod; telson; third uropod.....	530
<i>Neopleustes oculatus</i> , female. Third segment of the abdomen; first gnathopod; second gnathopod; maxilliped.....	532
<i>Neopleustes oculatus</i> , female. Telson; first uropoda; third uropod.....	532
<i>Acanthopleustes annexens</i> .....	534
<i>Acanthopleustes annexens</i> . First gnathopod; second gnathopod; lower lip; maxilliped.....	534

	Page.
<i>Acanthopleustes annectens</i> . First antenna; mandible; first maxilla; second maxilla; telson; upper lip; first uropoda; third uropod.....	535
<i>Stilipes distincta</i> . Anterior part of body; end of abdomen; right mandible; first maxilla; second maxilla.....	537
<i>Stilipes distincta</i> , left mandible.....	537
<i>Stilipes distincta</i> . Maxilliped; first pereopod; fourth pereopod; telson; first uropod; third uropod.....	538
<i>Stilipes distincta</i> . First gnathopod; second gnathopod; fifth pereopod.....	539
<i>Mara spinicauda</i> . Segment of the abdomen; first gnathopod; second gnathopods of the right and left sides; telson; first uropod; third uropod.....	540
<i>Eurystheus dentatus</i> . Third segment of the abdomen; first gnathopod; second gnathopod; lower lip; first maxilla; first pereopod; telson; first uropod; third uropod.....	542

## PLATES.

	Facing page.
1. Types of Malaysian basketwork.....	52
2. Burden basket from Siaba Bay.....	52
3. Six-sided burden basket, Pagi Islands.....	52
4. Drills and prickers for basket-making.....	52
5. Twilled basket from West Borneo.....	52
6. Covered burden basket.....	52
7. Burden crate in hexagonal work.....	52
8. Burden basket, showing hoopwork.....	52
9. Coarse leafwork basket.....	52
10. Coarse spathework baskets.....	52
11. Primitive basket forms.....	52
12. Basket showing mad weave.....	52
13. Carrying frame in single element.....	52
14. Basket of spathework, with cycloid cover.....	52
15. Malaysian basketry tools.....	52
16. Basket showing wickerwork.....	52
17. Burden basket in single-wrapped web.....	52
18. A siliceous geode and a geodic cavity.....	142
19. Invertebrate fossils illustrating formation of geodes.....	144
20. Crinoidal remains illustrating formation of geodes.....	146
21. Crinoidal remains illustrating formation of geodes.....	148
22. Brachiopods showing stages in formation of geodes.....	150
23. Brachiopods showing stages in formation of geodes.....	152
24. Invertebrate fossils illustrating formation of geodes.....	154
25. A new fossil liverwort, <i>Marchantia pcalci</i> .....	160
26. Carapace, plastron, and skull of <i>Terrapene longinsula</i> .....	170
27. Costal and peripheral bones of fossil turtles.....	170
28. Side view of the Oregon skull.....	176
29. Land shells from Mexico.....	182
30. Fresh-water shells from Mexico and New Zealand.....	182
31. Male genitalia of <i>Phaocyma</i> .....	276
32. Male genitalia of <i>Phaocyma</i> .....	276
33. Male and female genitalia of <i>Phaocyma</i> .....	276
34. Female genitalia of <i>Phaocyma</i> .....	276
35. Female genitalia of <i>Phaocyma</i> .....	276
36. Structural details of leg of <i>Phaocyma lunata</i> .....	276
37. Groups of <i>Beyrichia</i> .....	326
38. <i>Beyrichia</i> , <i>Steusloffia</i> , and <i>Klvdonia</i> .....	328
39. <i>Tetradella</i> , <i>Kicsoura</i> , and <i>Ceratopsis</i> .....	330

	Facing page.
40. <i>Ctenobolbina</i> .....	332
41. <i>Drepanella</i> and <i>Scofieldia</i> .....	334
42. <i>Trepostella</i> and <i>Hollina</i> .....	336
43. <i>Kloedenella</i> , <i>Kirkbyina</i> , <i>Beyrichiella</i> , and <i>Beyrichiopsis</i> .....	338
44. <i>Jonesina</i> .....	340
45. <i>Loxorhynchus grandis</i> .....	350
46. <i>Loxorhynchus grandis</i> .....	350
47. <i>Loxorhynchus grandis</i> ; <i>Branchiolambus altus</i> ; <i>Archaeopus antennatus</i> .....	350
48. <i>Archaeopus antennatus</i> .....	350
49. <i>Cancer fissus</i> ; <i>Archaeopus antennatus</i> .....	350
50. <i>Spirocypris tuberculata</i> , <i>Cypris dentifera</i> , and <i>Cycloocypris laevis</i> .....	430
51. <i>Candona parallela</i> .....	430
52. <i>Paracandona euplectella</i> .....	430
53. <i>Cypris fuscata</i> .....	430
54. <i>Cypris incongruus</i> , <i>Spirocypris tuberculata</i> , and <i>Cycloocypris laevis</i> .....	430
55. <i>Spirocypris tuberculata</i> , new species.....	430
56. <i>Ilyocypris gibba</i> and <i>Ilyocypris bradipi</i> .....	430
57. <i>Ilyodromus pectinatus</i> , new species.....	430
58. <i>Cypris marginata</i> .....	430
59. <i>Notodromas monacha</i> .....	430
60. <i>Cythere americana</i> , new species.....	430
61. <i>Cythere papillosa</i> , new species.....	430
62. <i>Cylindroleberis oblonga</i> .....	430
63. <i>Cylindroleberis lobianci</i> .....	430
64. <i>Pyrocypris americana</i> .....	430
65. <i>Philomedes brenda</i> and <i>Cylindroleberis lobianci</i> .....	430
66. The male and female of <i>Chondracanthus epachthes</i> .....	482
67. The male and female of <i>Pseudochondracanthus dicraeus</i> .....	482
68. The female of <i>Lepeophtheirus purvus</i> .....	482
69. The female of <i>Lepeophtheirus constrictus</i> .....	482
70. The female of <i>Lepeophtheirus insignis</i> .....	482
71. The male and young female of <i>Lepeophtheirus insignis</i> .....	482
72. The male and female of <i>Trebis tenuifurcatus</i> .....	482
73. The female and a chalimus of <i>Achtheinus oblongus</i> .....	482
74. The female of <i>Eudactylina uncinata</i> .....	482
75. The male and female of <i>Hatschekia pinguis</i> .....	482
76. The females of <i>Lernaeonicus medusarum</i> , <i>Phrioccephalus cincinnatus</i> , and <i>Opimia exilis</i> .....	482
77. The male and female of <i>Brachiella gracilis</i> .....	482
78. The female of <i>Brachiella anserina</i> .....	482
79. The male and female of <i>Brachiella anserina</i> .....	482
80. The female of <i>Lernaeopoda gibber</i> .....	482
81. The female of <i>Lernaeopoda beani</i> .....	482
82. The female of <i>Lernaeopoda bicauciculata</i> .....	482
83. The female of <i>Lernaeopoda falculata</i> .....	482
84. Aleyonaria of the California coast.....	728
85. Aleyonaria of the California coast.....	728
86. Aleyonaria of the California coast.....	728
87. Aleyonaria of the California coast.....	728
88. Aleyonaria of the California coast.....	728
89. Aleyonaria of the California coast.....	728
90. Aleyonaria of the California coast.....	728
91. Aleyonaria of the California coast.....	728

# VOCABULARY OF MALAYSIAN BASKETWORK: A STUDY IN THE W. L. ABBOTT COLLECTIONS.

By OTIS T. MASON,

*Head Curator, Department of Anthropology, U. S. National Museum.*

## INTRODUCTION.

This vocabulary is the result of studies in large collections of basketwork from the Andamans and Nicobars, the Peninsula of Malacca, Sumatra and the islands thereabout, and Borneo south of Sarawak, with the view of having a lucid nomenclature in describing the Abbott specimens more at length in a larger work. The collections were personally gathered and presented to the United States National Museum by Dr. William L. Abbott, of Philadelphia.

The Abbott collections are of greatest scientific value as types, because after studying the wants of the Museum he labeled each specimen carefully according to the latest requirements, and they come in the most opportune time to compare with the vast material now being sent from the Philippines. The Abbott collections also ally themselves with the textile handicrafts of Japan, China, the southeastern Asiatic states, and the islands of the Pacific.

The terms "basketry" and "basketwork" are here taken to embrace all handicrafts used in the manufacture of Malaysian baskets proper and in other industries as well, in which the same technical processes occur. Later will be shown the varied and wide application of the terms.

The word Malaysia is preferred to Malaya, since the latter, as commonly used, is more restricted. The term also leaves room for the racial diversities known to exist from the Philippines to the Sunda Islands.

Plate I shows how different in form, structure, and technic the Malaysian basketwork is. The figures on the plate, beginning at the left, are first, a carrying basket (Cat. No. 232633, U.S.N.M.), in close oblique checker weaving, of pandanus. At the border the elements are turned down over a hoop and inwoven. The carrying zone is bound by two small stems run through the texture, forming a band

an inch and one-half wide. Two loops of twined work furnish the hold for the carrying band of bast. The specimen is from Banka Island.

The second figure represents a covered, jar-shape basket (Cat. No. 237103, U.S.N.M.), from the island of Engano. It is in what is called single lacing. (See *Lacing*.) The foot of the basket is a braided ring of rattan split, and the bottom is set in.

The third specimen is a rough basket, or ambong, of bark (Cat. No. 232652, U.S.N.M.), from Klabat Bay, Banka Island, for carrying various articles, from live animals to yams. It is made of five coarse strips, U-shape, woven in open checkerwork at the bottom, bent up and held in place by coarse twined weaving of vine. On the front of the picture will be seen the rude handle. (See *Barkwork*.)

The fourth figure, lying on its side (Cat. No. 229406, U.S.N.M.), from Singapore, is a rice steamer. The cylindrical body is made of a strip of hard, tough bark, the ends sewed together. The borders are of hoopwork, sewed on with Malay knots. The movable bottom is an elaborate grating of bamboo strips. The handles are bails of rattan. The top is of pandanus leaf. The rice is placed in a steamer, which is set over boiling water, and the steam does the cooking.

The fifth specimen (Cat. No. 221516, U.S.N.M.), from Labuan Jawa, South Pagi Island, is of wickerwork in rattan stems, showing the body and the method of turning down, inweaving, and fastening off. For the beginning of the work at the bottom, see fig. 8.

The figure on the extreme right (Cat. No. 221338, U.S.N.M.), from Simalur Island, is a small hand basket of fine rattan splits, in what is called wrapped weaving.<sup>a</sup> The border is of false braidwork. It is interesting to find on this side of the world a technic identical with that among the Makah Indians of Vancouver Island. (See fig. 40.)

In my work entitled *Aboriginal American Basketry*<sup>b</sup> it was found convenient, after consulting with many fellow-students, to adopt a uniform set of names for the materials, forms, structural parts, technical processes, and appliances involved. As in the former work, so here, words in common use are adopted with their conventional meanings. Native names for all specimens have been carefully gathered by Doctor Abbott, and they are priceless; but they must be employed sparingly in a glossary, since there are almost as many different dialects spoken in the Malaysian area as were found in the United States by the first settlers.

In no other part of the world are such accommodating plants to be found for our art. The varied forms of basketry grow out of the demands of a tropical climate and the industries occasioned thereby.

<sup>a</sup> See *Aboriginal American Basketry*, fig. 22, p. 236.

<sup>b</sup> Report, U. S. National Museum, 1902, pp. 193-197.



The structural parts—bottom, body, framework, border, cover, carrying and other added portions, have relation to peoples who by reason of climate wear little clothing and to whom the saving of an ounce in load is an advantage.

The principal claim to attention and interest, however, is the infinite variety of technical processes and their combinations, including rootwork, stemwork, and leafwork; barkwork, bastwork, skinwork, and spathework; loomless weaving under many names; coiling in great varieties; besides winding, lacing, plaiting, braiding, netting, knotwork, and joinerwork, in bewildering technic. These for the purposes of proper classification should be examined carefully and described in unmistakable terms, which may be employed in a comparative study of the Abbott specimens with others from neighboring peoples and from the world at large. While many of the processes have a general resemblance in the two hemispheres, the special problems are quite different. The American woman in each piece of work follows one general plan throughout. To borrow a word from natural history, her work is not so highly organized, although the manipulation is quite as skilful.

In the American examples, bottoms and borders are indeed somewhat varied. The Pomo woman does know several ways of starting her work, and she gets at it sooner and more gracefully. The Tlinkit weaver is a genius in borders, and yet her materials restrict her in her motifs.<sup>a</sup> The Abbott baskets, made of rattan, bamboo, and other woody substances, have the foot, if present, made in all sorts of ways—a part of the bottom and separate from it. The bottom in such a basket is conspicuously distinct from the body, has not the same outline, and is definitely bounded. The outline of the body is round, or at least curved. When the active textile elements of the bottom pass up to the warp, or passive part of the body, the technic changes and also the name. With the softer elements, the same holds true. The Malaysian has greater variety. The checkers, twills, rhomboid, hexagon, and octagon work greatly excel the American in their development and elaboration.

Among the special peoples visited by Doctor Abbott in making the collections here described are the following:

Andamanese. (See Mincopi.)

Battaks: Natives of Sumatra.

Chowpal: Négritos of Trong, Lower Siam.

Dyaks: Various Malay tribes of Borneo.

Enganese: Of Engano Island, west of Sumatra.

Jakuns: Of Rumpin River, Pahang, Malay Peninsula.

<sup>a</sup> See G. T. Emmons, *The Basketry of the Tlinkit*. Mem. Amer. Mus. Nat. Hist., New York, 1903, III, Pt. 2.

Malays: General brown people, in many subdivisions, ethnic and cultural.

Mincopi: Aborigines of Andaman Islands.

Niasese: Of Nias Island, west of Sumatra.

Nicobarese. (See Shompeng.)

Sakais: On the Malay Peninsula.

Sellungs: In Mergui Archipelago, west of Malay Peninsula.

Semangs: An aboriginal people of Malacca Peninsula.

Shompeng: Aborigines of the Nicobar Islands.

#### VOCABULARY.

*Abbreviations.*—If they are to be used, the following rules are suggested: In bibliography, those adopted for the International Catalogue would be the best. For special basketry expedients the letter *x* may stand for an indefinite number, as in the sentence, "At the upsett, about the carrying band, and on the borders of burden baskets, *x* rows of close work are added for additional strength."

There would be no obscurity in putting ver., hor., dex., and sin. for vertical, horizontal, dextral, and sinistral, in describing the intricate technic of certain classes of basketwork. Also, in describing twilled work, the fractional formula may be employed, for example, "under-two-over-one," could be  $\frac{2}{1}$ ; or hor. =  $\frac{\text{dex.}}{\text{sin.}}$  would mean "the horizontal splits all pass under the dextral and over the sinistral splits." Care should be taken to explain what is meant by an abbreviation and to have it signify always the same idea.

Dr. J. Lehmann reduces the whole nomenclature of loomless textiles (Geflechtsarten) to formulæ, in which Roman and Arabic numerals, capitals, and lower-case type, and Greek letters are employed to show at a glance the most intricate textures.

*Added parts.*—Include all attachments for adapting baskets to their specialties. The betel basket will have pockets for the different substances; at the bottom of the bolo basket will be a block of spongy wood to receive the point; the bird cage, the fish basket, the protector for hot food, will all be fitted for their several functions.

*Ambong.*—General Malay name for a carrying or burden basket.

*Awl.*—The Malaysian basket-makers practice something like sewing and make hundreds of fine holes for the rattan filaments that do the work of thread. The holes are made with piercers (see *Pierced work*), but as the effect is produced by a thrust, with revolutions, the instruments will be described and illustrated under *Drill*. (See Plate IV.)

*Backpad.*—A smooth piece of spathe or bark sewed on the side of a burden basket that is worn against the naked back of the carrier. Though this type of basket has rounded body, the squared foot and

framework and the fixed backpad make it proper to speak of sides. (See Plate III.)

*Bajus*.—In Nias, jackets made of *bark cloth*, which see.

*Bamboo skin*.—The outer skin of young bamboo stems, when peeled off and properly cured, is used like spathe and bast for making hats and for other smooth textures.

*Bamboo work*.—To the natives of Malaysia, bamboo stems serve the double use of receptacles and as the basis and material for much basketry technic. Bamboo is the common name for the large tree-like grasses belonging to the genus *Bambusa*, of which more than thirty species are known. Some send up canes from their rhizomes 50 to 60 feet high in a single season. In others, one of the hollow internodes may reach a foot in diameter and more than 3 feet in length. The bamboo canes are employed for no end of uses in Malaysia, both whole and split. Masts, sails, mats, roofs, walls, floors, furniture, and the finest baskets are made from stems, leaves, and finely-shredded outer skin.

*Bark cloth*.—The bast, or inner bark, of *Ficus bicuspis* and other exogens is beaten into *tapa*, narrow strips of which form the harness for attaching the burden basket to the body of the carrier.

*Barkwork*.—The various uses of bark in the basket-making art—outer bark and inner bark of exogens, both natural and textilized. The large bracts of leaves and spathes of flowers and the green skin of bamboo stems do most excellent service in the making and fitting of receptacles. (See *Tapa*.) These substances are rounded with the grain as they grew on the plant or across the grain and wrapped about a mold. They are cut into large pieces, to be made into hats or into strips to be woven. (See Plate I.)

*Basketwork*.—The basket, in Malaysia as elsewhere, is a receptacle and a vehicle. The myriad utensils there performing these functions go by the general name of basketry. The numberless varieties of loomless handicrafts in flexible materials to be found in and on baskets may be grouped under the word "basketwork." These same processes in other associations may bear different names. In materials, Malaysian peoples would have barkwork, canework, leafwork, rootwork, spathework, and stemwork. Or, if necessary, one could speak of bamboo work, "ejoo" work (meaning the long, black, tough hairs on the wine palm), palm-leaf work, pandanus work, rattan work, and as many more kinds as there might be substances furnishing the chief material.

In all these operations there is the attempt to produce a utensil or to imitate its processes on or in something else. Looked at from the naturalist's point of view, all the things here in mind have structures and functions, and may be studied as specimens for scientific investigation. In structure, the objects are made of flexible, or flexible mate-

rials, into this, that, or the other: but one characteristic remains—the material is pliant and pliable and is used by bending it into place.

Another step in the structural history of textiles before reaching the functional stage, may be called the "technic," under which the material becomes a knot, a braid, a chain, a twine, a weft, a coil, a lacing—all done by hand, without loom or other substitute for hand-work, and all assembled as contributors in that intricate composition called basketwork.

Under function, two things come to pass: The true basketwork multiplies its offices and becomes walls, floor, matting, and roof for the house; hat, shoe, garment, and adornment for the body; covering and offering for the dead; the minister of industries and decorative arts, where it is no longer receptacle nor vehicle. (See *Uses*.)

It is in this broad acceptation that the word basketwork is here used. Whatever processes have been absorbed by the basket-maker will be taken into consideration, no matter if they be employed elsewhere. Indeed, some of the prettiest examples of basketwork are to be found on shields, shafts of spears, hilts of edged weapons, and in personal ornaments. They also furnish motives for the carver and painter.

The term "Malaysian basketwork" will be made comprehensive enough to cover all textile work that is loomless. As one example among many, the bamboo stem is not basketwork, but (1) its joints are made into receptacles and vehicles; (2) basketwork will be put on them before they can be useful; and (3) the tough and flexible and beautiful outer surface renders a wide range of textile services. The same may be said of the pandanus and other leaves, which lend themselves to basketry, so everything made of them may be studied in basketwork.

Marsden (p. 55) says that baskets, "bronong baccole," are a considerable part of the furniture of a Sumatran house and the number is the token of the owner's wealth. In them his harvests of rice or pepper are gathered and brought home. They are made of slices of bamboo connected by means of split rattans, and are carried chiefly by the women, on the back, supported by a string or band across the forehead.

*Bastwork*.—(See *Barkwork*.)

*Beading*.—Ribbon-like strips of pretty material run into open basketwork, for decoration.

*Bejuco*.—Also Behuco. (See *Calamus*.)

*BeLAYING*.—The process thus named by sailors is used by the Abbott peoples as an ornamental knotwork on the borders of baskets, which seems to be the original meaning of overlaying. The Dyak basket-makers tuck the moving part under the passive parts in passing and

make a kind of false braid or knotwork. (See also *Figure-of-8* work.) Captain Tozier calls it "overhand-knot in single strand."

*Betel basket*.—One of the forms of basketry on which the Malay-  
sian craftswoman expends her utmost skill. Betel is chewed uni-  
versally after the manner of tobacco. The quid is made up of betel  
nut, pepper leaf, and dry slaked lime. Marsden says (p. 71) that  
the "penang," or betel-nut tree, is in growth and appearance not  
unlike the cocoanut. The betel is the astringent seed of this palm  
(*Arca catechu*), about as large as a nutmeg. Large plantations are  
made of the "siri" (*Piper betel*), a creeping plant, whose leaf, of a  
strong aromatic flavor, they wrap about the nut, dip in powdered  
lime, and put into the mouth. The basket for holding all these and  
the utensils that belong with them is quite an exquisite affair, hung  
to the belt. (See figs. 31, 32.)

*Bird Cage*.—See *Technic*.

*Body*.—The part of a basket above the bottom, for which all other  
parts exist and to which they are attached. The materials, shapes,  
structural parts and their relations, technics, attachments, and decora-  
tions demand the closest study, inasmuch as they furnish the best  
means for classification. Okey speaks of the body as "sides." This  
is quite proper in Malaysia, since a large proportion of the baskets  
are attached to the person and have back and front and sides differ-  
entiated. Especial notice should be taken of the relations which  
added parts bear to the body. In some examples they are worked in  
when the body is forming; in others they are added afterwards. (See  
*Carrying basket, Cover, Framework, Ornamentation, Rim, Technic,*  
*Upsett, Warp, Wearing, Weft*.)

Cat. No. 221534, U.S.N.M., Plate II, is a burden basket from Siaba  
Bay, Nias Island, west of Sumatra, illustrating in an excellent man-  
ner the diversified technic that may be connected with it.

1. The body is a cylinder of rattan in three forms and woven in  
three directions. The horizontal elements are thin hoops; the right  
obliques are slender splits latticed on the hoops half an inch apart  
and slightly inclined; the left obliques are the active miting elements,  
being also slender splits, going inside the hoops and outside the right  
obliques, lying flat against the former and making a twist or curl  
around the latter each time one is passed. The lower portion of the  
body is in quite open work, but above the strengthening hoop the  
technic is as close as possible.

2. The attachments and accessory technics to the body of this speci-  
men are many. (a) The foot is a hoop, whose overlapping ends are  
joined by wrapping and which is held on by a sewing in long stitches.  
(b) The framework consists of uprights of rattan splits doubled  
over the hoop of the carrying zone, lashed to the body and to the  
bottom by a series of Malay knotwork.

3. Carrying parts are the stout hoop on the body a few inches from the top, answering to a hoop on the inside, for backing, and all held to the body technic by a series of knots. On the two uprights that limit the back of the body are knotted loops, or grommets, for the carrying band of soft bark cloth.

4. Borderwork will always be a chief point of interest. In this example it consists of two half hoops of rattan fitted against the upper rim of the body, a thin piece of rattan laid over the joint, and all neatly bound with two sets of knots close together, their connecting splits prettily interwoven. In other examples three or more sets of knots produce broad bands of ornamental work by their interweaving.

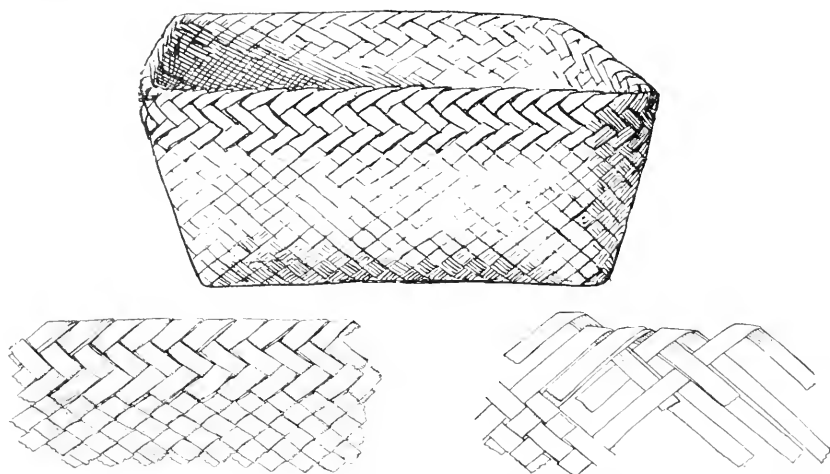

FIG. 1.—CLOSE, OBLIQUE CHECKERWORK WITH INWOVEN BORDER, SHOWING FINISHED BASKET AND DETAIL OF BORDER

*Borderwork.*—If the upper margin of the body technic in a basket be called "rim," borderwork will apply to that great variety of treatment bestowed by Malaysian basket-makers upon the margin, or rim. Some of the American Indian women were not far behind them.<sup>a</sup> It is the part receiving the most scrupulous care on account of strain and stress, but it offered to decorative motives their best opportunities. Here will be found braidwork, coiledwork, hoopwork, knotwork, and twinedwork. All at once the basket-maker is thinking how best to fasten off body technic at the rim; what technic shall the distinctive borderwork receive. Here terminates also the framework, here rests the cover, and how shall they all be harmonized. Practically, borders are checker, double-hoop, two-hoop, thin hoop, sloping shoulder, wrapped, moused, interlocking helical, and inwoven.

<sup>a</sup> See Emmons, Mem. Amer. Mus. Nat. Hist., New York, 1903, III, Pt. 2.

Cat. No. 232672, U.S.N.M. (fig. 1.), is an example of oblique checkerwork in pandanus leaf, and the accompanying drawings show the detail of bending downward and tuck-in at the border. The basket-maker has achieved two good results: she has given a neat and safe finish and, by turning checker into  $\frac{2}{2}$  twill, adds the ornamental feature of variety. There is no end of the ways in which the Malaysian basket-makers do their tucked borders. (See also Plates I, XVII, and figs. 2-6.

Cat. No. 244280, U.S.N.M. (fig. 2), shows an example of figure-of-8 borderwork on plain checker or in wicker. The borderwork movement of each split is seen in the upper drawing (*a*). The result of using two splits of different colors is given in front (*b*) and back (*c*) view in the drawings.

Cat. No. 221538, U.S.N.M. (fig. 3), illustrates borderwork in which are combined a pretty braided effect on the upper margin with loops

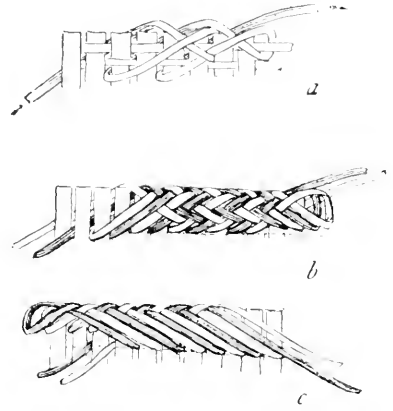

FIG. 2.—FIGURE-OF-8 BORDERWORK.

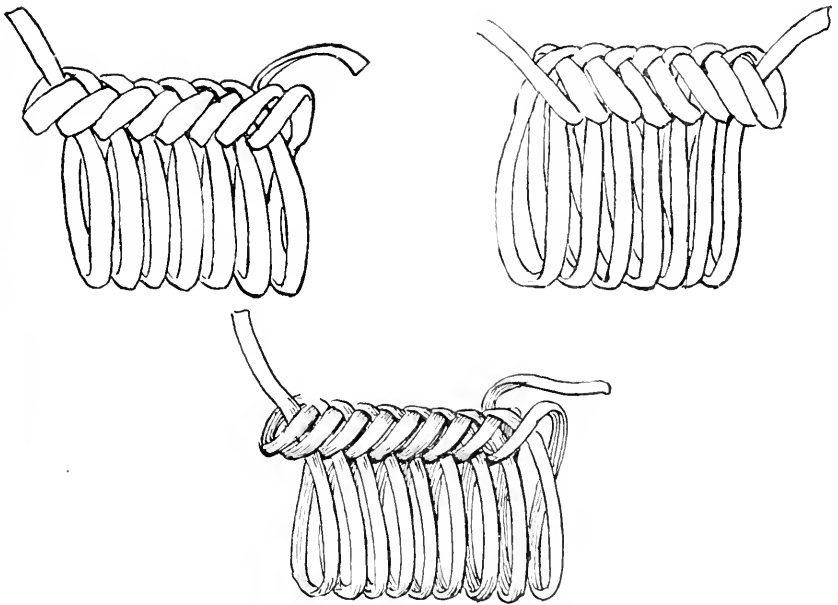

FIG. 3.—LOOPEO AND BRAIDED BORDERWORK.

deep enough to take in several rows of body technic. This is often necessary not only for strength, but to cover up stiff, unsightly ends ever obtruding themselves in the bamboo and rattan country.

Cat. No. 232630, U.S.N.M. (fig. 4), is borderwork in which a row of stiff warps are turned down between two half hoops of rattan, the whole bound together by two series of Malay knotwork and the

ugly gap between the hoops covered by three rows of wrapped weft done in the tops of the turns in the Malay knots. The upper drawing (a) shows side view of the warps, hoops, knot series, and the covering of

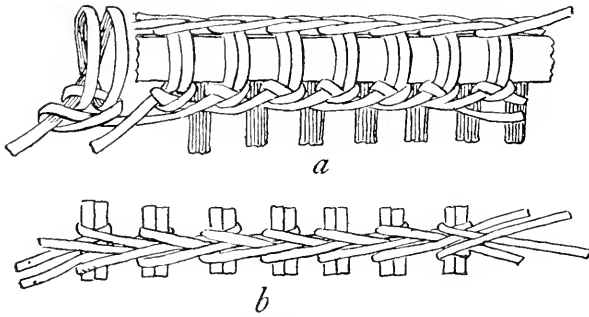

FIG. 4.—BORDERWORK CONCEALING ROUGH ENDS WITH HOOPS AND KNOTWORK.

the space between hoops. The lower (b) gives a top view of the three wrapped wefts so interlaced as to produce a three-strand braid effect on the upper turns of the knots.

Cat. Nos. 221510, 221523, and 221513, U. S. N. M., are brought together (fig. 5) to show the procedure from a simple turn in border to more complex forms without recourse to knotwork of any kind. It is wickerwork on warps in pairs. The borderwork in the upper drawing shows the bending down of one of each pair to the right, the other to the left, skipping the neighboring pair in each case and thrusting the ends into the wickerwork two warps away.

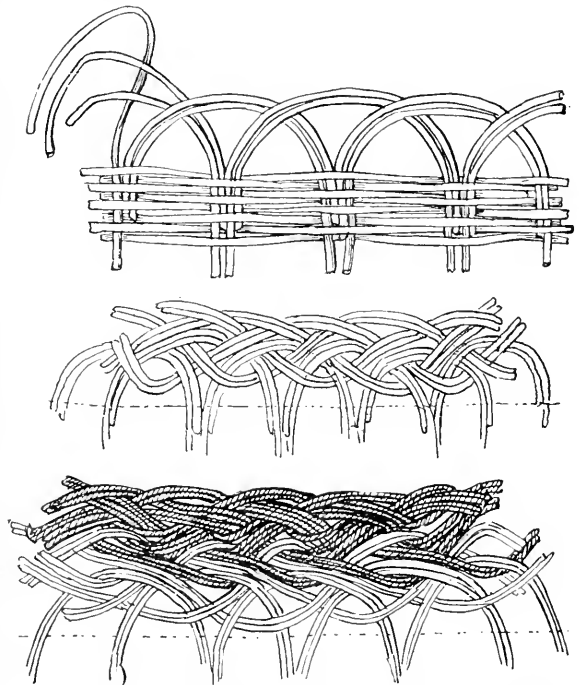

FIG. 5.—ENDS OF WARPS TURNED DOWN FOR BORDERWORK.

In the middle drawing this border serves as the basis of twined work among the bends of the warps, the separate elements of the twine being stems in pairs.



In the lower drawing it is braidwork among the bends and the stems are in twos and fours.

Cat. No. 221516, U.S.N.M., gives a border in braidwork without knotwork (fig. 6), in which three stems of rattan braid together in pairs, *ab*, *ac*, *bc*, over the bends of warps. Such combinations are found on ornamental baskets in wickerwork.

*Bottomwork.*—Malaysian basketry, though it varies greatly, finds its prime motive in the bottomwork, especially the burden baskets.

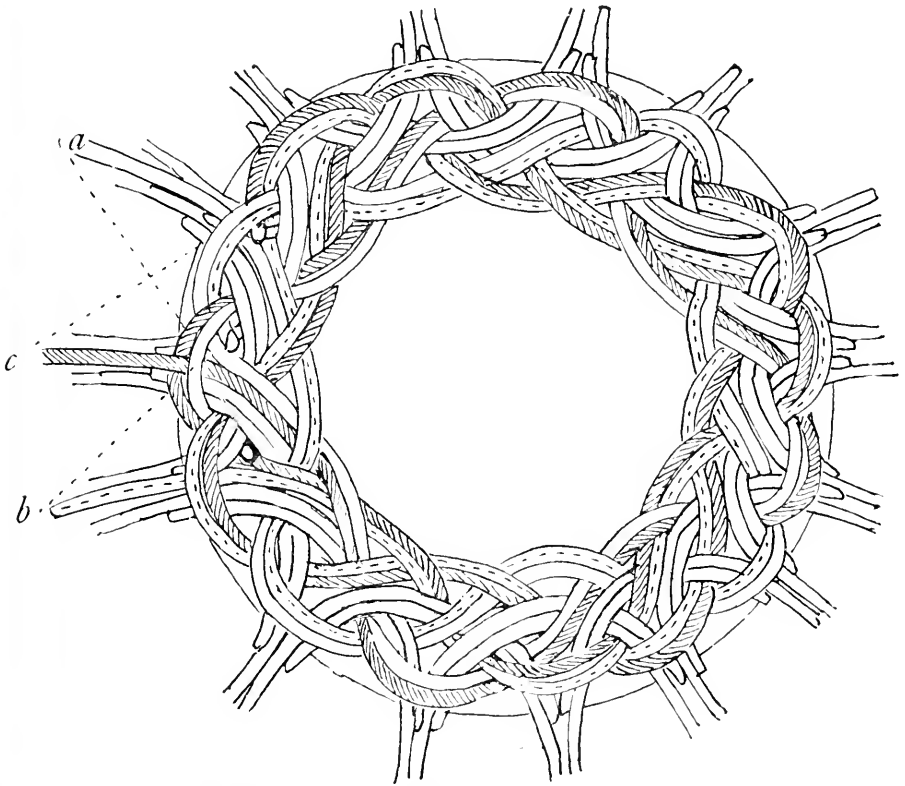

FIG. 6.—RATTAN STEMS BRAIDED IN PAIRS OVER BENT-DOWN WARPS.

with their square footing and framework for cylindrical and conical bodies. A deal of bottomwork is simplest checker or twilled work in what will be the stakes, the warp, the active elements in forming the body. Added to these will be the stiffening parts, the footing, the knotting, the sewing, and the staying parts, or accessories. The following varieties are easily distinguished:

1. Bottom and body in one indistinguishable.
2. Bottom in similar technic, much plainer.
3. Bottom elements all warps of sides.

4. Bottom bounded by upsett in different technic.
5. Bottom with foot.
6. Bottom separate and set in.
7. Bottom entirely movable.

Cat. No. 232636, U.S.N.M., is a type of bottom seen in a great number of Malaysian baskets (fig. 7). It consists of two series of thin splits latticed at right angles in their middles. They are held securely in place by a double row of boustrophic twinedwork forming the upsett, and also braced by single rows of twining crossed diagonally. The splits are then all bent up at right angles to become the warps

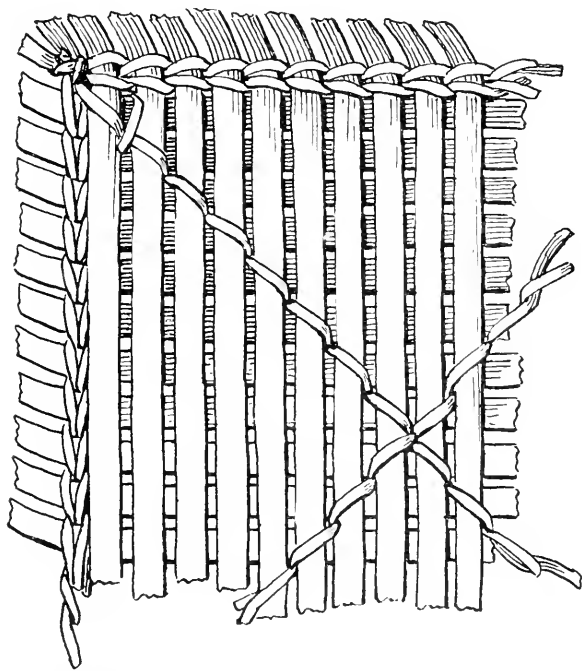

FIG. 7.—LATTICE BOTTOM, WITH TWINED UPSETT IN BOUSTROPH.

of the body, which is built up by various technics over a mold. (See *Molding*.)

Fig. 8 (Cat. No. 221513, U.S.N.M.) shows the bottom of a globular wicker basket. Fifteen rattan stems in groups of fives laid side by side are bent and laid on and under one another so that each stem will cross one from another group, all in place resembling curved spokes of an iron wheel. In this position they are held

together in pairs by two rows of wrapping about alternate crossings. Adjacent stems are then brought together in pairs and fastened with another double row of wrapping. Just outside of this the regular wickerwork begins, forming the upsett. The pairs of stems continue as warp up to the rim.

*Boustrophic*.—Applied to twined or other technic that does not pass round and round spirally, but back and forth dextrally and sinistrally.

*Braidwork*.—Narrow fabric, in which three or more elements are interwoven, but there is no distinction between passive and active parts: all are pliant and active. The Malaysian women are wonderfully adept in making and applying it. Braidwork may be flat, like semmit, or round, or square. Braiding may be a part of general

technic, as in borders, or ready-made sennit or other braid may be an element in different kinds of weaving. (See figs. 9, 10, 11, 12.)

*Brooms.*—Made from fiber of coco palm by basket-making processes.

*Bumban batu* ("bemban," Skeat).—A large tough reed of dark color, growing on the hills of West Borneo. Used much in basket-making.

*Burden basket.*—A carrying basket for heavy loads. Usually supported on the body by means of a bark cloth band over the shoulders, like a knapsack. Sometimes the band goes across the breast and occasionally across the forehead. The burden baskets are the acme of the maker's art.

*Calamus.*—A genus of palms having over 80 species, in Asia, some in Australia and Africa. Slender, solid stems, sometimes 1 to 2 inches in diameter, growing to great lengths, clambering among the branches of trees by means of the hooked prickles on the stalks of their pinnate leaves. *C. rotang*, *C. rudentum*, *C. verus*, *C. viminalis*, and probably other Indian and Malaysian species are the source of the largely imported rattan canes used for the seats of chairs, and in their native countries for cables and a variety of other purposes.

*C. montanus* is twisted into suspension bridges over the river Sikkim. *C. scipionum* is the thicker Malacca cane, imported from Singapore for walking sticks, and *C. australis* is the Loya cane, from Australia.

In the Abbott collections its versatility seems to have no limit. A basket with no rattan in its make-up is a rarity. Hoopwork, footing,

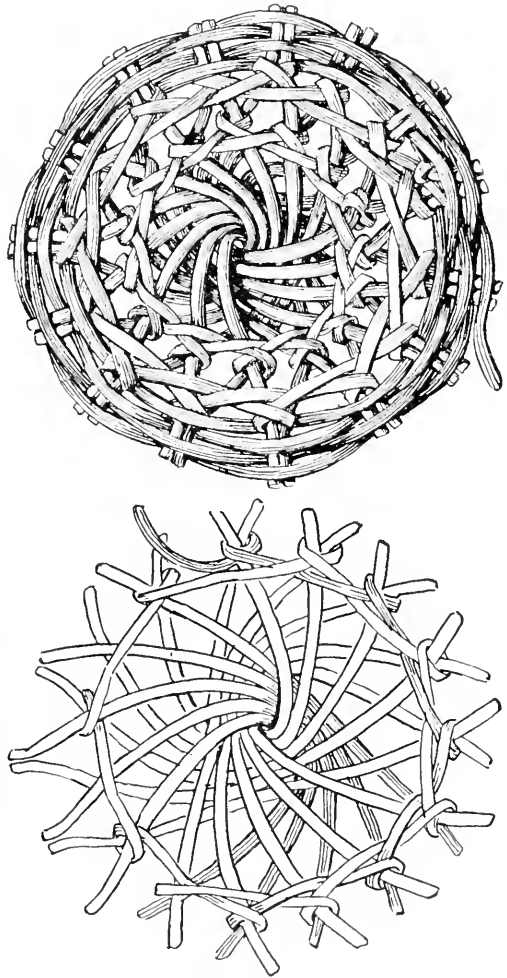

FIG. 8.—BOTTOM OF GLOBULAR WICKER BASKET.

framework, borders, knotwork, and body technic are dependent on it. Its tough, glossy surface is split into delicate filaments to serve as thread for sewing borders, into active elements in weaving, like the "cane" for chair seats, and the carrying parts of baskets. From the study of Malaysian textiles, rattan will never be absent.

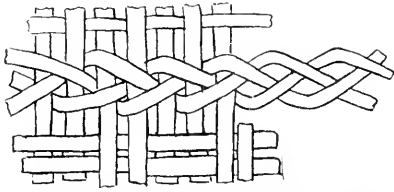

FIG. 9.—BRAIDWORK IN CARRYING ZONE OF BURDEN BASKET.

*Carrying basket.*—A name borne by a multitude of basket forms in Malaysia. Owing to the hot climate little clothing is worn, so special provision must be made for everything that is borne about—from the siri quid to the heaviest burden—including food and drink, clothing, implements, weapons, and articles of commerce. For these, the burden basket must have capacity, strength, carrying parts, comfort, and resting parts. Maxima and minima—the greatest strength and room with the least weight—seem to have been worked out by these primitive engineers. The abundant use of the triangle, the placing of a support where it is immediately needed, and protection of the

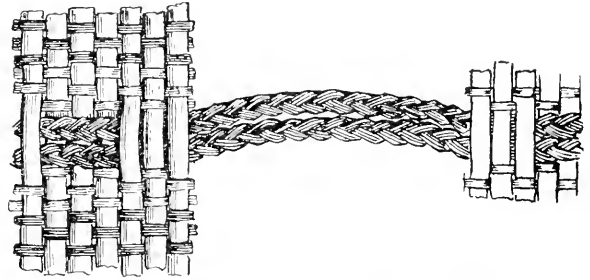

FIG. 10.—BRAIDWORK LOOPS FOR CARRYING BAND.

naked body could not be better looked after. Besides all the technic of ordinary baskets, there must be shoulder, head, and breast bands, backpacks, framework, footing, strengthening parts, and stays. In

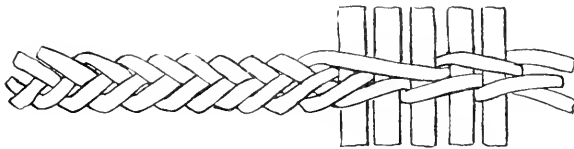

FIG. 11. FOUR-STRAND BRAID IN CARRYING ZONE.

weaving the body of the burden basket the woman has this fact of carrying in mind. A few inches below the border she makes the technic stronger on both sides of the space where the carrying band and strengthening parts go around. A wale of stouter material is inserted, the courses are forced closer together, more strands are added in the technic, and half hoops with proper backing are knotted on. In this glossary the space thus guarded and strengthened is spoken of as the "carrying zone" and the structural parts added, with the burden function in mind as the "carrying parts."

Fig. 11, from Cat. No. 244267, U.S.N.M., shows the common open-work of a rattan basket and the insertion in the carrying zone of four rows of twined weaving in twilled, boustrophic technic.

Fig. 13, from Cat. No. 232630, U.S.N.M., illustrates the strengthening of the carrying zone by hoops fastened on with cross-wrapping single knots. Above and below the hoops two rows of half hitches over alternate warps are intertwined.

Figs. 9-12 (Cat. Nos. 244284, 244267, 244286, U.S.N.M.), illustrate the ingenious ways in which the strengthening technic in the carrying zone may, when new duties demand, be braided away

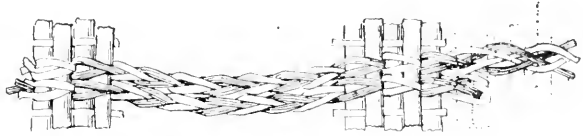

FIG. 12.—BRAIDS IN TWO COLORS IN CARRYING ZONE.

from the texture to form handles or to become loops about the carrying bands. In fig. 10 there are two rows of 3-strand braid which form the loops. In fig. 11 is a compact single 4-strand braid. In fig. 12 there are two rows of 4-strand braid. All of these are designed to function in the same way.

Plate III represents a six-sided carrying basket (Cat. No. 221504, U.S.N.M.) from Pagi Islands, Mentawi Group, west of Sumatra. It shows the smooth pad of bast for the carrier's naked back; the head-band of soft bark for supporting the load; the zone of strong, double hoopwork, to strengthen the basket at its point of greatest strain. In

other baskets there is a great diversity of expedients to accomplish this end. In this specimen no sling of split passes from the carrying loops to be knotted under

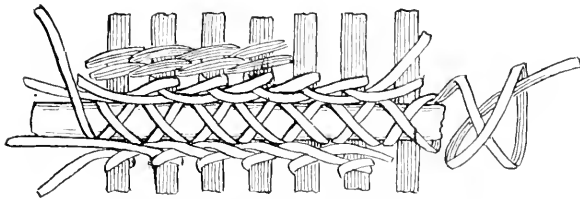

FIG. 13.—CARRYING ZONE STRENGTHENED BY HOOPWORK.

the bottom, that strain being relieved by the six uprights bounding the sides and brought together to form the foot. This is a fine specimen of hexagon weave and of a hoopwork border.

*Carrying parts, carrying zone.*—(See *Carrying basket*.)

*Chainwork.*—A technic in a single element, resembling chain stitching in needlework. It finds its nearest relative with wrapped weaving.

*Check.*—Where two elements cross each other. (See also *Decussation*.)

*Checkerwork.*—Basketwork in which the crossing elements are equally flexible and the checks are rectangular. It may be open or close, vertical, or oblique. (See figs. 1, 7, 14, 16.)

Fig. 14, from Rumpin River, Pahang (Cat. No. 219966, U.S.N.M.), and Plate I make plain what is meant by the term "close checkerwork," both in upright and oblique technic. The only difference between them and open checkerwork is in spacing and not in method. In the Malaysian area the basket-makers produce all sorts of fanciful shapes in checker by folding back the strips.

*Chevron.*—V-shape technic in which two or more colored lines meet at an angle. (Compare *Herringbone* and *Zigzag*.)

*Chinking.*—Soft materials between hard stems and soft technic. Seen in the bottoms and upsetting of many Abbott baskets, to protect delicate work.

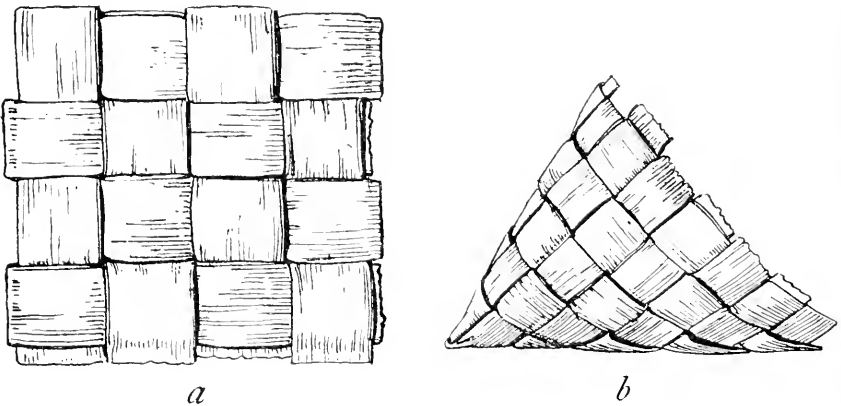

FIG. 14.—UPRIGHT (a) AND OBLIQUE (b) CHECKERWORK.

*Classification.*—(See *Structural parts* and *Technic*.) The parts of basketwork in Malaysia are so numerous and varied, their technical processes so diversified and associated, and the uses of the products are so multiplied, that classification is difficult for the whole fabric. A division by materials, function, bottom, body, framework, carrying parts, decoration, or technical processes must end there. A bark gutta tub will be a regular museum of added knotwork and a paddy basket a wonderful study in braiding.

*Coiled basketry.*—Basketwork in which a foundation of hard or soft material, arranged in a flat, cylindrical, or conic spiral, is held together by means of over-and-over sewing or wrapping. In the Abbott collections, owing to the abundance and fitness of rattan, the single-rod foundation is far the most common kind, and beautiful examples are seen. The fineness of close coiling depends on the number of turns to the inch.

Fig. 15 (Cat. No. 216279, U.S.N.M.) illustrates the most popular method of coiled work in Malaysian basketry. The rattan and its allies are so abundant and so well adapted that there is no need of the many kinds of coiled work seen in America. The upper drawing (*a*) shows a portion of a coiled basket near the rim; the middle drawing (*b*) is a diagram of the technic; the lower figure (*c*) explains the beginning at the bottom. It is the single-rod coil throughout and the border is finished off with a single split wound on the rim between the turns of the active part.

*Color.*—Malaysian basketry does not abound in bright colors. Living on the shady side of the forests, the women's textile work is not brilliant. Beautiful effects come from different woods, from aging, from native dyes, and from trade colors. It may be also that the motives for color are lacking. (See *Jernung*.)

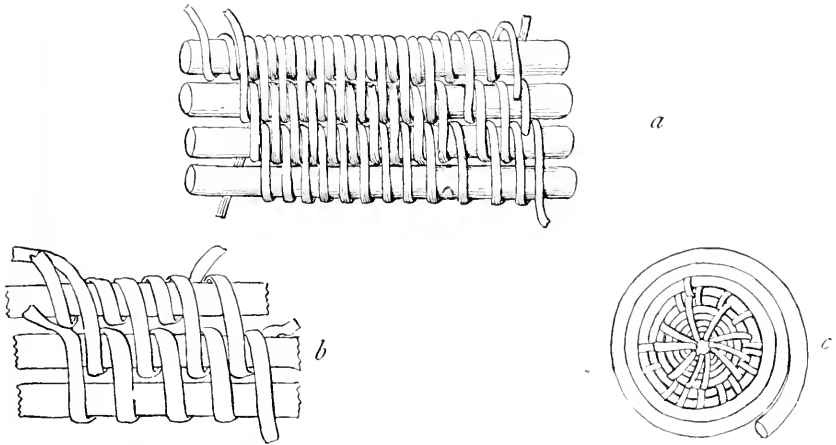

FIG. 15.—COILED BASKET, SINGLE-ROD FOUNDATION, SPIRAL BOTTOM.

*Cover.*—That part of the basket which closes the receptacle. What might be termed coverwork is here in mind, and the crude, primitive ways of building up a shoulder and fitting the cap are interesting. (See Plates I, V, VI, XII, XIV.)

*Crossed warp.*—Two sets of passive parts cross each other at an angle, as in hexagonal technic. They may be latticed or intertwined. Examples will show.

*Curlwork.*—Especially in pandanus leafwork, the overlying strips are curled, to produce relief effects. (See fig. 16, and Plate II.)

*Cycloidwork.*—One or more stems bent round and round by cycloidal movement. The separate turns may be free or interlocked. Used in decorative foots, borders, covers, etc. (See fig. 33, and Plate XIV.)

*Decoration.*—(See *Ornamentation*.)

*Decussation.*—Crossing of warps at an acute angle. (See *Check*.)

*Design.*—Figure or pattern in the ornamentation of basketry. Not to be confounded with symbol.

*Diætral.*—Applied to the elements of basketwork that lean toward the right. (See *Horizontal*, *Sinistral*, and *Vertical*.) Common in Malaysian basketry.

*Diagonalwork.*—Passing the active elements over two or more warps, but not the same in adjoining rows. (See *Twilledwork*.)

*Diaper.*—A surface decoration produced by the technic showing a pattern by the crossing of the elements. The refinement of twilled-work.

*Drill.*—For the delicate sewing which is seen most abundantly on the borders of carrying baskets, the very fine holes are made through

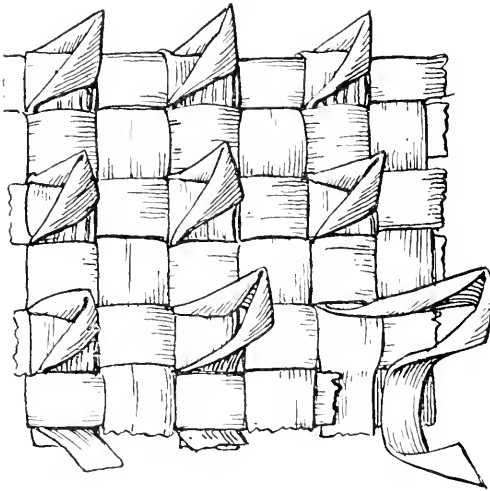

FIG. 16.—CURLED WORK IN PANDANUS LEAF.

bamboo, rattan, and other hard materials with long pointed drills made from old files. The point of the drill is drawn out almost needle-like, while the angular form of body is preserved. Plate IV shows a few varieties and also blunt prickers in monkey bone and in iron. (See *Pricker*.)

On the top row of Plate IV are basket-makers' drills, or awls (Cat. Nos. 249051-249054, U.S.N.M.), "simbal," of the Dyaks of Bayu and

Gray, Sempang River, West Borneo. In sewing the borders, footings, and other parts of baskets with finely split rattan, holes must be drilled through hoops and other woodwork. The "simbal" is just the tool, not a needle nor an awl precisely, but a very fine drill, the blade made of an old file usually, and quadrilateral to the very tip.

On the lower part of Plate IV are the so-called prickers (Cat. Nos. 249049, 249050, U.S.N.M.), "pemudat," of the Dyaks of Bayu, Sempang River, West Borneo. The first specimen is made of iron; the latter of orang bone. This implement is used to pass between the elements of a finished texture, in order to open the way for weaving backward or overlaying as in the "*mad weave*."

Plate V shows an elegant old piece of twilled basketwork (Cat. No. 249413, U.S.N.M.) from Dyaks of Gray, West Borneo, introduced here to illustrate the use of the fine drills, but possessing many noteworthy characters. Among them especial attention is called to the



arabesque ornament in red diaper twill all over the body and the cover; the "hook-and-eye" work, the broad shoulder, the fine sewing, and the neat hoopwork at the border; and the same processes in the margin of the cover.

*Ejoo*.—A fiber compassing the stems of the kabun palm in Sumatra and seemingly bound on by thicker fiber or twigs, of which the Malays make pens for writing. It resembles coarse black horsehair and is used, among other purposes, for making ropes and mixing with mortar. (Marsden, p. 77.)

*Embroidery*.—Textile ornament added to the surface after the basket technic is finished. Usually it is false embroidery, which appears to have been added, but is really done with the weaving.

*Ends*.—On the rim of a basket the fastening of the ends of technic elements receives a vast deal of attention. They are cut off flush, merely turned back and inwoven, or, to give finish, change the technic altogether. It is a part that must never be overlooked. (See also *Borderwork* and *Rim*.)

*Fagoting*.—Same as hemstitching, or the gathering two or more warp threads into a bundle by wrapping.

*False braid*.—An appearance of braidwork very common in basketwork, made with a single strand or split, in what is called ball stitch, or racking seizing. (See *Seizing*.)

*False embroidery*.—An appearance given in basket-making by wrapping the strands that show on the outside of the structure with colored material.

*Fiber*.—Any flexible substance composed of filaments. Malaysia abounds in such material of the best quality.

*Figure-of-8*.—One of the technic movements in Malaysian basketwork by which the active element, either as principal or as bond, resembles at each bout the figure 8. In uniting coiledwork it may be clear, hitched above, hitched below, or twisted.

*Filament*.—Any delicate fiber used in basketwork. The sewing on the borders of Dyak burden baskets is done with filaments of rattan.

*Fire fan*.—The Nicobarese produce fans for fire-making from the sheathing petioles of palm trees. (Kloss, Andamans and Nicobars, p. 48.)

*Flat spiral*.—The form of coiled work seen in basket covers, wherein the result is a flat surface.

*Folding*.—In pandanus and other soft leafwork the Malaysian basket-makers produce ornamental effects on the surface by folding back the strips or by curling the edges, making the checks stand up.

Fig. 16 (Cat. No. 219975, U.S.N.M.) is a good example of what, for a better term, is here called "folding," and sometimes "curling" or "twisting." In pandanus leafwork it is often desirable to have the inside and the outside of a basket both smooth; then the strips

are doubled, just as they are in the basketwork of our southern Indians. In such baskets, for pretty effects, the Malaysian women, at the proper intervals fold back the active pandanus strips like a coat collar. In some examples of the mad weave (Plate XII) the patterns are quite intricate. (See *Curlwork* and *Twistwork*.)

*Foot*.—The part of a basket for resting on the ground. The foot may be, as in the baskets of commerce, a part of the body technic or something quite different. In the latter case it is usually hoopwork, angular or rounded. It is really interesting to note how the makers have struggled with this problem of footings. They are in rattan, bamboo, or hardwood. The rattan stem is soft inside and tough as

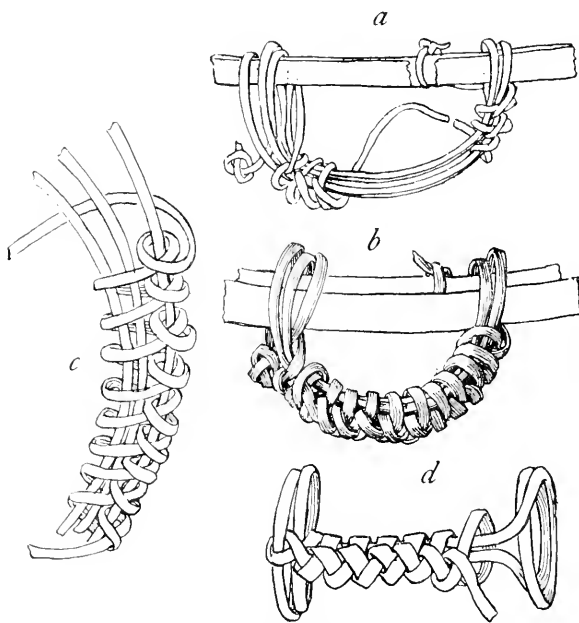

FIG. 17.—METHODS OF FORMING HANDLES.

leather on the outside. You have merely to cut out a miter and bend the stem at the proper place and the thing is done. (See Plates I, II.)

*Form*.—This has reference to the outer shape of the finished basket or other product of basketwork. The clear and ready comprehension of the reader is the safest guide for giving names to forms in basketry. The Malaysian women excel in

both the practical and ornamental forms of their baskets. Economy has been worked out especially in the shapes of the burden baskets.

*Framework*.—Malaysian baskets are often made of such thin materials that additional support has to be given by framework. This consists of foot, uprights, and borderwork, which will be separately described. An interesting fact in the study of the division of labor is that the soft, textile parts of the basket are said to be made by women; the framework falls to the men.

Plate VI shows a basket from the Dyaks, West Borneo, which may be called a perfect specimen (Cat. No. 249407, U.S.N.M.) of Malaysian basket, on account of the framework and its relations with other parts. If it were removed it is doubtful whether the basket would

stand alone. Its capacity is almost that of half a flour barrel. Everywhere proportion and beauty are united with strength and utility.

*Frap.*—To bind parts of a basket together, in order to strengthen the structure.

*Furcated.*—Said of the elements of basketry that are intentionally and symmetrically split a part of their length. The rattan lends itself willingly to such treatment.

*Fyke.*—An ever-set, detaining trap; a cage-pound for fish. (See Hugh M. Smith on The Fyke Nets, etc.)

*Grommet.*—A ring of stem or split made by crossing it and then laying or twisting the long end round the ring three times and neatly tucking in the end.

*Handle.*—Part of basket employed in carrying it in the hands. This is not common. In going through the jungle the hands are needed for other purposes. The basket is supported from the belt, the breast, the shoulders, or from the front of the head. Modern influences are creeping in and putting bails of rattan on some specimens. (See *Carrying parts.*)

Fig. 17 (Cat. No. 221534, U.S.N.M.) shows the ease with which a long thin split may become a grommet, a loop, a handle. Drawing *a* would be the coarsest form of loop for suspending a basket or guiding a carrying strap, the split being wrapped a few times back and forth and bound by half hitches. It might be on a border or on an upright, vertical, or horizontal. Drawings *b* and *c* are similar, but more neatly finished. Drawing *d* is in imitation of borderwork of the coiled type, the split at the same time forming chainstitchwork for a handle.

*Helical coil.*—That form of coil that would result from wrapping a wire about a cylinder. This is the method of coiled basket building in America, but it is greatly modified in Malaysia, as will appear in description.

*Hemstitch.*—Drawing warps together in groups of two or more and holding them by twined weaving

*Hens' nests.*—Baskets, bag-shape and wide-meshed, for the hens to lay in, hang from the piles under Nicobarese houses. (Kloss, Andamans and Nicobars, p. 48.)

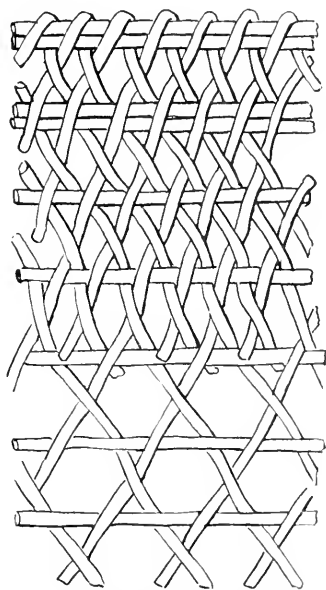

FIG. 18.—PLAIN HEXAGONAL TECHNIC AND BORDER.

*Herringbone*.—Basketry technic in which chevron patterns are in parallel series.

*Hexagonal work*.—Basketwork in which dextral, sinistral, and horizontal splits or strips of equal width and flexibility are so intertwined as to produce hexagons in the cheeks. (See Plates III, VII, figs. 18, 19, 20, and Lehmann, figs. 48, 53, 54, 55.)

Cat. No. 221524, U.S.N.M., is an excellent specimen of hexagonal work. (Plate VII.) The plate shows a burden crate reminding one impressively of the California Indian cradles. Noteworthy are (*a*) the light, strong framework and border of rattan half stems bound together over the rim of the weaving all around and having the gap on the margin covered with a thin split; (*b*) the rhomb and triangle

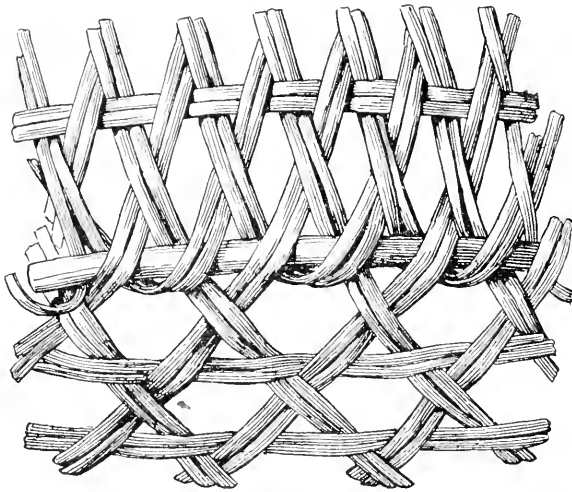

FIG. 19.—HEXAGONAL ELEMENTS IN PAIRS.

work in the footing, produced by different technic of the three elements; (*c*) the broad backing of bark; (*d*) the strengthening of the carrying parts with additional half stems, and (*e*) the head strap of tough bast. The multiplying of structural parts in Malaysian basketry and the diversity of technical process as compared with American baskets are well illustrated in this specimen. If the horizontal splits be removed the other elements are latticed, the dextrals being outside. The horizontals bind all by passing outside of dextrals and inside of sinistrals. The obliques on the footing are not latticed, but closely woven, the horizontals crossing the intersections in pairs.

Cat. No. 237121, U.S.N.M., explains the crossing of parts in hexagon weaving (fig. 19). In this example the textile elements are in pairs. The introduction of a hoop for a horizontal split and doubling the number of uprights produces oblong pentagons.

Fig. 20, Cat. No. 221563, U.S.N.M., from an Abbott basket of Siaba Bay, Nias Island, illustrates another type of the hexagonal work, differing from Cat. No. 221524, Plate VII, in having the horizontals wide and thin hoops, while the obliques are slender splits.

*Hitched work*.—Technic in which the process called hitching is used. The brown race are the masters of it. The Malay knot, which

takes the place of nails, screws, pegs, etc., in holding the parts together, plays the whole gamut of uniting and decoration. (See *Knott*.)

*Hook-and-eyework*.—An ingenious method of uniting joints and fastening off ends in rattan, specially useful in making hoops and in fixing heavy borders. The rattan is whittled away, like the point of a quill pen, often many inches long, giving also a convenient shoulder. The thin point is drawn through a hole or about a border and caught down on the other side in the textile work. (See Plates II, III, V, VI, VII.)

*Hoopwork*.—The part played by hoops of wood in Malaysian basketwork is of great importance to the student of technology. In America it played a minor part with the Indians, but, on the other side of the Pacific, it entered into the bottom, body, stayings and strengthenings, footing, framework, carrying parts, and covers of baskets. Strictly speaking, a hoop is round, but, in this area, precisely the same technic is so often employed on angular forms that one may be pardoned for speaking of triangular, quadrangular, hexagonal, and octagonal hoops, or of their incurved sides and pinched corners.

Hoops in the Abbott basketwork are in the whole stems, slipped stems, half stems, splits, strips of different thickness, in rattan or other tough elastic wood, as the exigencies demand. The joinings of the ends may be splicing of most kinds known to mechanics, though the hooked splice of common barrels does not appear.

But there are others quite to the manner born, such as hook-and-eye splice, knotted, sewed, and pegged splices. The figures and plates will show how ingenious these practical basket-makers have been in putting their hoops at the right places to strengthen the basket without greatly increasing the weight; in combining angular bottoms with rounded bodies; in providing stable attachments for the loops, knotwork, strengthenings, and headbands of the carrying parts.

Plate VIII shows several structural and technical characters (Cat. No. 221546, U.S.N.M.) of hoopwork and reveals a diversity in other forms of handiwork worth noticing, such as the square bottom becoming the rounded body, the mixture of twined and wicker weaving, the strengthening of the texture at the carrying zone, the multiplication of hoops about the border, the shaping, splicing, adjusting, drilling and attaching of hoops, the loops and adjustments of the carrying band. (See *Joinerwork*.)

*Horizontal*.—Term applied to the level elements in hexagonal and other technic lying in three or more directions.

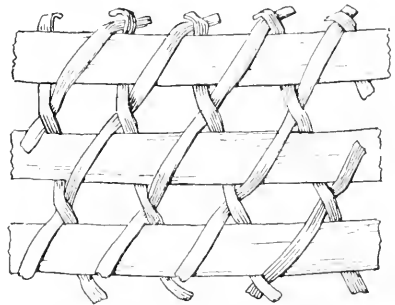

FIG. 20.—HEXAGONAL TECHNIC WITH WIDE HORIZONTALS.

*Hurdle*.—A very coarse form of basketwork in brush and cane fences, on land or in water, for hunting or fishing.

*Impacted*.—Driven close together. Not common in Abbott baskets.

*Inset*.—A structural part made separately and set into the structure. The funnels of fish traps and the ends of cylindrical baskets are so treated.

*Interlacing*.—The crossing and twining of parts.

*Interrupted coil*.—Work in which the active split is wrapped about the passive part for a space and then caught under the foundation below. Decorative figures are made in this manner. (See fig. 26.)

*Interstices*.—Open spaces left in basketwork.

*Inweave*.—To weave a pattern into the texture of a basket, to interweave, intertwine. Ends are bent down and inwoven.

*Jernung*.—Red stain resembling lacquer, applied to Dyak baskets, sword-sheaths, blowgun-dart cases, etc., in West Borneo. It is made by boiling the fruit of a small species of rattan and smearing the jelly on the surface, where it dries with a smooth finish.

*Joinerwork*.—That portion of basketwork which deals with solid wood and is done with tools. Usually wrought by men. It includes making hoops, uprights, solid rims, covers, staying, and bracing. Miter, kerf, carving, and whittling demand the joiner's skill. The American craftswoman gives strength and rigidity to her texture in the weaving; but here lightness is most desirable and strength comes through wise joinerwork. In making joints with his somewhat intractable materials and most primitive tools the artisan is not able to conceal his work and leaves ugly gaps. To remedy this is the motive of much ingenious knotwork and braidwork. (See Plates I, II, III, V, VI, VII, VIII, XIV.)

*Kabun palm*.—The wine palm of the coast. The black, hairlike fiber, "ejoo," is used for string on Banka Islands.

*Kain*.—Cloth passed around the loins and between the legs. Worn by Indonesians of Malaysia and Malays.

*Kajang*.—Pandanus roof-mat. Every Malay boat and every Chinese sampan uses them. One of the most widely spread and useful things in Malaysia.

*Kawin*.—Rotan kawin. A small, very flexible rattan, growing in the hills of West Borneo, of which one of the weaves in the trident spear heads, serapang, is done.

*Kerf*.—A notch cut out of rattan or other stem so as to permit it to bend at an angle. In footing on burden baskets, the corners, made of rattan stem, have kerfed miters. The material is then bent to form triangles, rectangles, or polygons.

*Keyed lattice*.—Latticework in which the crossed passive parts are held in place by bending in and out between them stiff strips. (See Lehmann, figs. 65–68.)

*Knives.*—(See *Tools.*)

*Knotwork.*—The structure, successions, and series of knots are of immense account to the student of Malaysian basketwork. In speaking of them the illustrations and names given under the word "knot" in the Standard Dictionary should be used. In some cases the native

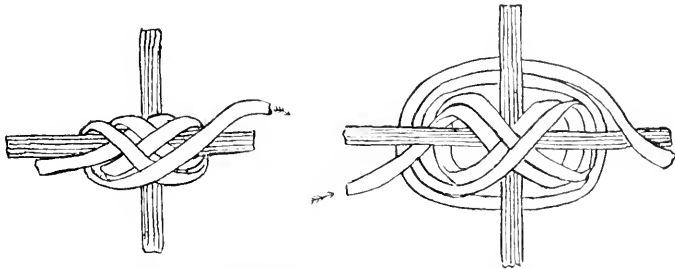

FIG. 21.—OVERHAND KNOT IN SINGLE STRAND.

name would be desirable.<sup>a</sup> The knots found on basketwork by Lehmann are: *Overhand, simple knot*, in several variations; *weaver's knot*, several positions; *single bow knot*; *double bow knot*; *carriek bend*; *square knot*; *slip knot*, *Flemish bend*; *figure-of-8 knot*; and *clove hitch*. The *two-round turn* and *two-half-hitch knot*, extremely common in Malaysia, and here called Malay knot, or hitch, must be added.

Knots may be named after their technic and after their functions. There are single knots of any kind or series of knots or knots in a single series; they may be in the texture or superadded; for use or for ornamentation; in the middle of a strand, at the ends of a strand, the tying together of the two ends, or the joining of an end to a bend or middle; there are binding knots, sewing knots, slip knots, nooses, snares, trap knots, net knots, and covering knots to hide ugly splices, corners, rims, and joints. Of the covering variety, the overhand knot in single strand, hiding the tops of the little posts at the margin of carrying baskets, deserves special notice. (See fig. 21.)

Fig. 22 shows a species of knotwork, in single splits, seen on shields as well as baskets, to hold parts together and be ornamental. Four

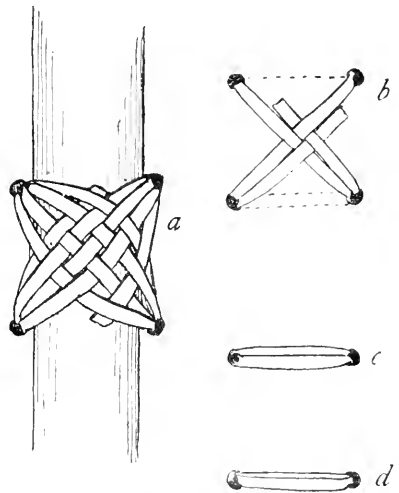

FIG. 22.—ORNAMENTAL KNOTWORK ON SHIELDS.

<sup>a</sup> See Stokes, in Mem. Bernice Pauahi Bishop Museum, II, pp. 105-162.

holes are bored in the cover of the shield beside the frame, and the binding material is passed back and forth through them, crossing the frame piece diagonally on the outside, so as to form plain weav-

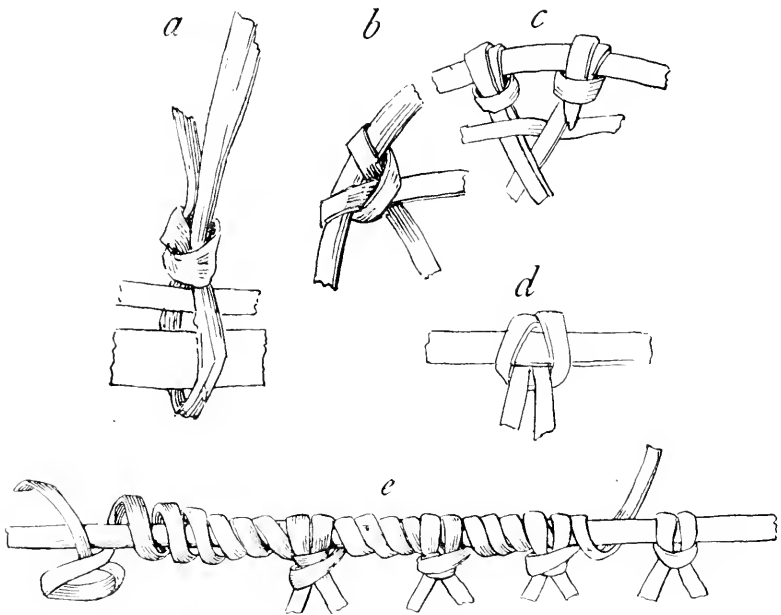

FIG. 23.—SINGLE KNOTS IN MALAYSIAN BASKETWORK.

ing (*a* and *b*). On the back, the binding passes horizontally (*c* and *d*).

Fig. 23, *a* (Cat. No. 221563, U.S.N.M.), illustrates how the single bowknot is often used in attaching the ends of the bark headband to the carrying parts of a burden basket; while *b*, *c*, and *d* illustrate the appearance of the double half hitch on borders. In drawing *e* (Cat. No. 221504, U.S.N.M.) the loops in *d* are finished off by a single wrapping of the whole border with splits.

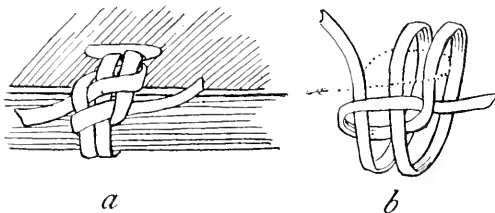

FIG. 24.—ROUND TURNS AND HALF HITCHES IN A WOODEN CRADLE.

Fig. 24, *a* (Cat. No. 221524, U.S.N.M.), is made up of two round turns and two half hitches, as the knot appears in joining the parts of a wooden cradle, the active part working toward the right. In *b* the knot is dissected.

Fig. 25, *a*, *b*, *c*, *d* (Cat. No. 221504, U.S.N.M.), illustrates the tying of far the most common knot in all Malaysia. Inasmuch as



industrial products there are usually made up and are scarcely ever in the whole piece, and, moreover, since nails, screws, and rivets and the like are not suitable to bamboo and rattan, the importance of this particular knot will be realized. Only the free end is needed in tying it. Usually it is found in sets or series, and in some cases four or five sets are woven into intricate and decorative effects. The first

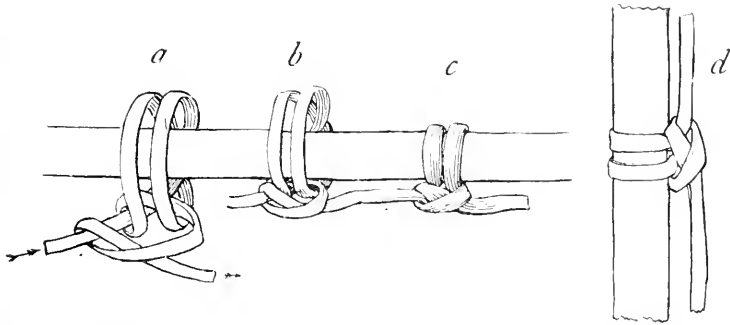

FIG. 25. —MALAY KNOTS —THE MOST COMMON IN BASKETRY OF MALAYSIA.

drawing (a) is the knot in the process of forming; in b the parts are drawn together; in c all is made fast, and in d a vertical example is shown, the active end of the split working downward.

Fig. 26, a and d (Cat. No. 237089, U.S.N.M.) and b and c (Cat. No. 237078, U.S.N.M.), illustrates a knotwork very common in the Abbott

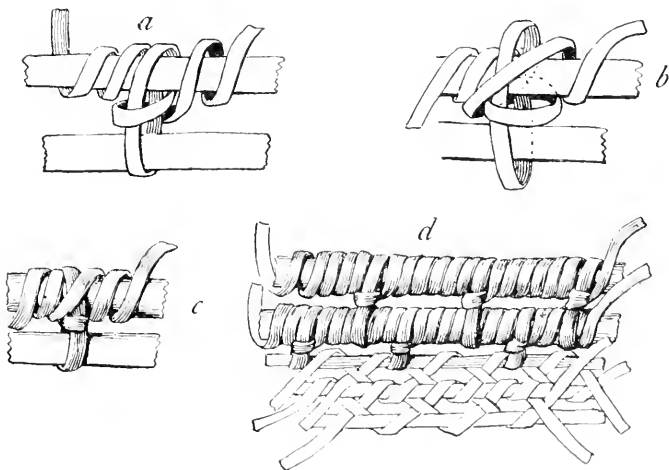

FIG. 26. —MOUSING KNOTS ON BORDERS.

Malaysian baskets, especially on borders. It is in the nature of what the sailors call "mousing," and reminds one of the script lower case "f." The process is susceptible of several varieties in the upright as well as in the horizontal portion of the knot. Lehmann's figs. 38, 39, and 44, Plate I, present three of these. In the drawings here shown the knots belong in a series of border wrappings, every seventh one

becoming a single mousing. In the drawings of fig. 26, *a* is the mousing knot in forming; *b* is another form; *c* shows the knot drawn tight, and *d* a section of the finished border of a basket in double lacing. (See *Borderwork, Lacing, and Mousing.*)

Fig. 27 (Cat. No. 237063, U.S.N.M.), *a* and *b* give two varieties of quite similar knotwork uniting two parts of a shield and to give ornament.

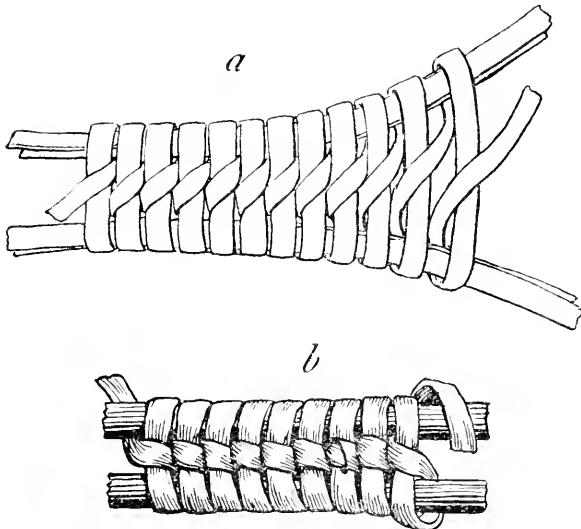

FIG. 27.—KNOTWORK ON MALAYSIAN SHIELDS.

It is scarcely knotwork, since, if the passive parts were slipped out, the active part would no longer be tied. In the drawing *a* the active split passes (1) behind the upper frame piece and forward, (2) downward in front of both, (3) around behind the lower frame piece leftward of (2), movement (4) is across (2) rightward and backward to the starting point. In drawing *b* the movements of (1) and (2) are the same, but in (3) the active part is moved rightward and then leftward around to starting point.

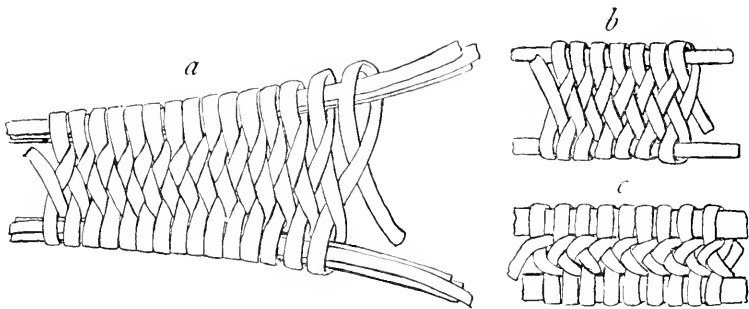

FIG. 28.—KNOTWORK AND BRAIDWORK UNITED.

Fig. 28, *a*, *b*, *c* are processes also on the shield (Cat. No. 237063, U.S.N.M.). The knotwork combines two movements, both half hitches, making pretty braid between. Drawing *a* should be compared with the same letter in fig. 27. The moving split makes a half hitch over the upper warp, then beneath the under warp, and moves up-

ward to repeat the process. Drawing *b* is the same over parallel warps and *c* is the same process over closely approaching warps.

Fig. 21 is the overhand knot in single strand, seen in wrapping kite strings on their sticks and the belaying of ropes on vessels. The simple form here shown will be seen in the slings that attach small bowlders to nets as weights. More complicated and ornate examples will be seen on the borders of burden baskets at the tops of the uprights which are a part of the framework.

*Lacework.*—The technic of both point and bobbin lace occurs in Eastern basketry. With a single element there may be two or more splits or stems moving side by side and these may at any moment become braidwork. The single-element type is found in cycloid work.

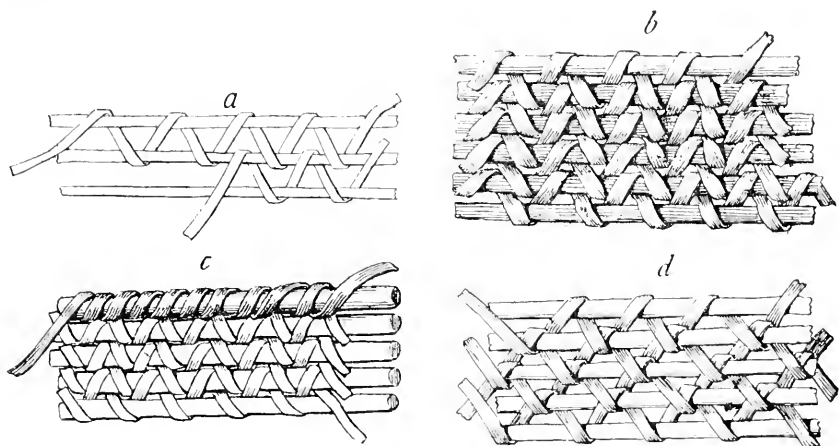

FIG. 29.—SINGLE LACING IN ENGANO BASKETWORK.

*Lacing.*—Coiled basketwork on the island of Engano imitates the technic often seen in the lining of hats throughout Malaysia. It is here called lacing, and may be single, as with one end of a shoe string, or double, as with both ends. In both cases the active part passes by a figure-of-8 movement. Fig. 29, *a, b, c, d* (Cat. Nos. 237079 and 237103, U.S.N.M.), show the single lacing. Drawing *a* gives the variety in which the zigzag movements of the active splits in adjoining rows are parallel; drawing *b* is the same finished; drawing *c* adds the wrapped border. In drawing *d* another variety of technic appears—the active split passes through the angles of the lacing below, the lacings from row to row interlocking at right angles.

Fig. 30, *a, b, c, d* (Cat. Nos. 237084, 237112, and 237081, U.S.N.M.), shows the double lacing. Drawing *a* gives the process, *b* is close double lacing, *c* is openwork with wrapped border, and *d* a closer example of the same. All of them give hexagonal effects in the meshes, the active parts going through the angles underneath.

*Lattice.*—Basketry technic in which the parts cross, but do not interlace. They are held in place by further treatment. The dextral and sinistral elements in hexagonal weaving may be latticed or interlaced. (See fig. 7.) Latticework may also be named from the ways of fastening it together, as twined lattice, wrapped lattice, etc.

*Lay.*—To cover by wrapping or winding. The sailor lays a rope with yarn. The Malay basket-maker often lays a grommet loop, handle, or border neatly with fine splits.

*Leafwork.*—Includes products made from the whole leaf or the spathe and those from pandanus and other long, textile leaves cut into strips. The former serve as handy improvised vessels; the latter are wrought into endless varieties of form and technic.

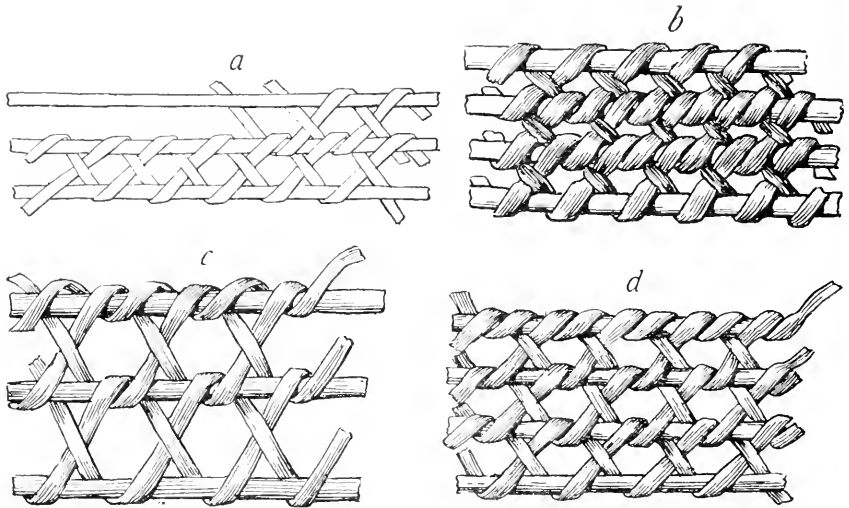

FIG. 30.—DOUBLE LACING IN ENGANO BASKETWORK.

Plate XI (upper figure) is a basket (Cat. No. 211801, U.S.N.M.) of the Shompen tribe, Pulo Kunyi, west coast of Great Nicobar Island. It is 8 inches square and 6 inches high.

A single long palm leaf is wrapped on itself three-fold, to form square sides. Two small vines are run in and out through the leaf to hold the parts together and to form handles. The ends, which are joined underneath, support a large deciduous leaf which serves for the bottom of the basket. This is a rude and most primitive form of receptacle.

The lower figure on Plate XI is a boat-bailer (Cat. No. 176038, U.S.N.M.), from Trong, Lower Siam, made from a spathe, or leaf sheath, by folding the ends together, as in wrapping a bundle, and rolling up another part of the leaf to form a handle. The parts are joined together, as seen in the example, by sewing with a split of rattan. Height, 9 inches. See also Plates IX, X, and XIV.

*Left oblique*.—Applied to textiles leaning toward the left hand from below upward. Seen in checker, twill, hexagon, octagon, and rhomb technic. Also called *Sinistral*.

*Leugkar banon buoy*.—Native name in Simalur of a basket for suspending a water vessel. (Cat. No. 216307, U.S.N.M.)

*Loomless*.—Name adopted for textile processes not carried on in looms. It includes awlwork, bark- and bastwork, basketwork, braidwork, featherwork, hoopwork, knitting, knotwork, lacework, leafwork, matwork, needlework, network, osierwork, quillwork, rattanwork, ropework, spathework, splitwork, stringwork, and threadwork.

The primitive hand, or loomless, textiles are at the foundation of artwork in several varieties, for example: Fingerwork, producing basketry and matting; stiletwork, producing embroidery; knotwork, producing netting; bobbinwork, producing pillow lace; crochetwork, producing hook fabrics; needlework, producing sewing, embroidery, and point lace; needles in sets, producing knitting; shuttlework leads to weaving on the loomwork series.

*Luting*.—The Malaysians lute their carved wooden buckets with gutta when they become cracked. The Jakuns employ also the wax from the honey of the wild bee.

*Mad weave (Anyam gila)*.—A technic in strips of pandanus leaf worked in pairs, in three directions, so as to present the appearance of rhomb, cubes, and six-pointed stars in different lights. The work begins at the center of the bottom, proceeds outward to the border and upward to the rim, where the strips are turned back and worked under to the place of starting by means of a dull bodkin, called a pricker. Plate XII shows the bottom and the top of the mad weave—the rhomb decussations, the six-pointed stars, the cubic forms, the turning back at the borders for the double weave and figures made by curling are all shown. Some of the Sempang Malay mats appear to be thus woven; the prepared leaf strips are doubled over lengthwise and alternately inclose and go between the corresponding opposite double strip in the weave, instead of going first to one side and then the other—that is, in and out over the opposite strands.

*Manila hemp*.—(See *Poolay*.)

*Mat*.—A convenient name for basketwork not made into receptacles. From pandanus and like materials the Malaysian peoples make all sorts of things for household use. A mat acquires a multitude of names from its uses. (Kloss, *Andamans and Nicobars*, p. 48.)

*Materials*.—This term includes all the substances that enter into Malaysian basketwork in its most liberal acceptation—mineral, vegetal, and animal; raw and prepared; native and commercial; root, stem, and leaves; filaments, strips, splits, half stems; "cane pith," spathes, and joints.

*Miter.*—To give angular forms to rattan hoops, they are kerfed at the proper places. More than that, though the people in their primitive state know not the use of the saw, still they manage to produce angular parts, even from hard woods, and cover ugly joints with knotwork. (See *Kerf*.)

*Molding.*—In the unfinished baskets sent by Doctor Abbott for study the body is being molded over a form. In the cylindrical pieces

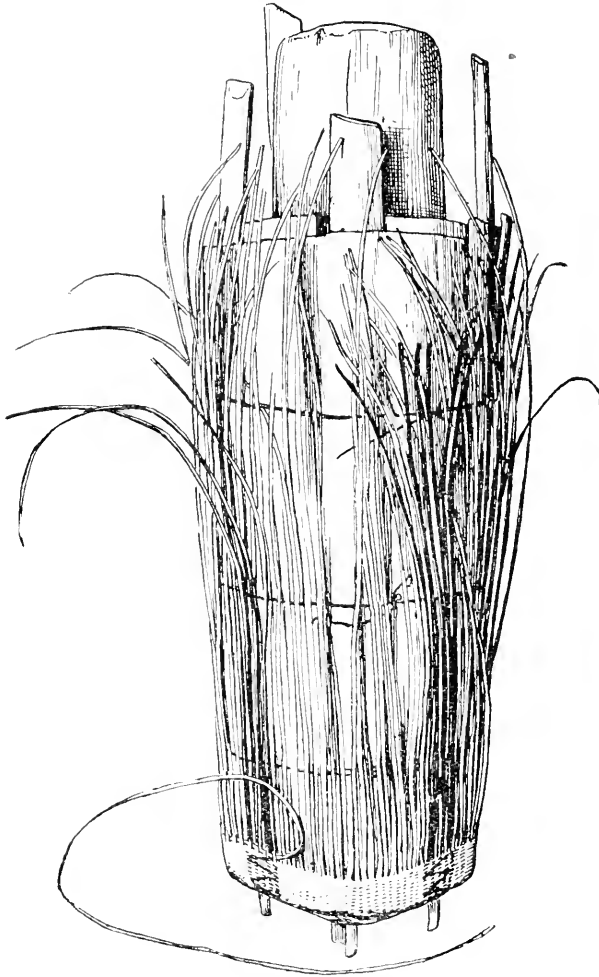

FIG. 31. PROCESS OF MAKING A BASKET OVER A WOODEN MOLD.

this may be a coil of bark or a round stick of wood to the outside of which four sharp strips of bamboo are lashed for shaping the bottom and starting the round body. For two conical specimens from West Borneo the molds are old baskets with a number of bamboo sticks lashed about them.

Fig. 31. (Cat. No. 244347, U.S. N.M.) shows the method of setting up the mold and beginning the work on a small, pretty siri basket from Lower Sakaian River, Borneo. The interior mold is a cylindrical block of

wood, not necessarily perfect in form, since outer wrappings will remedy defects. At what are to be the angles of the bottom, strips of bamboo are set, the pointed ends being downward, and leaf or bast is tied about the outside. Before the mold is applied, the bottom is woven in checker or twill, from fine strips, all of which turn up for warps. The upsett is the connection between the square base and the

cylindrical mold. The body may be then completed in any style of technic.

Fig. 32. (Cat. No. 244354, U.S.N.M.) is a nearly completed siri basket in which the mold is based on a roll of very tough and rigid bark and the corners of the bottom are established on four strips of bamboo, the glossy sides outward. The elements of the bottom are turned up for warps and, in this specimen, the cylinder was but partly achieved, the corners only being rounded. The upsett is distinctly patterned and the process of figuring the body is shown. The plain weaving might be replaced by endless varieties of technic.

*Mousing.*—In coiled basketwork, a double wrapping of the active part, resembling the sailor acceptance of the term. In its simplest forms it looks like the script letter *f*. (See fig. 26 and Lehmann, figs. 38, 39, 44.)

*Movements.*—The active parts of a technical process of the Malaysians move in general from left toward the right, while the civilized woman works toward the left. In this general process toward the right the Malaysian woman makes subsidiary movements for each check or unit in the work. These may be spoken of as up or down, in or out (toward the worker or on the side away from the worker), inside or outside (referring to a receptacle), right side or wrong side (referring to the fabric); right or left, if horizontal, and right oblique or left oblique, if inclined; under, over, around, or through, to suit each case.

*Needle.*—The needle with an eye is not known in Malaysian basketwork, but needlework, or something resembling it, is very common and quite ornamental on basket borders. Holes are drilled through

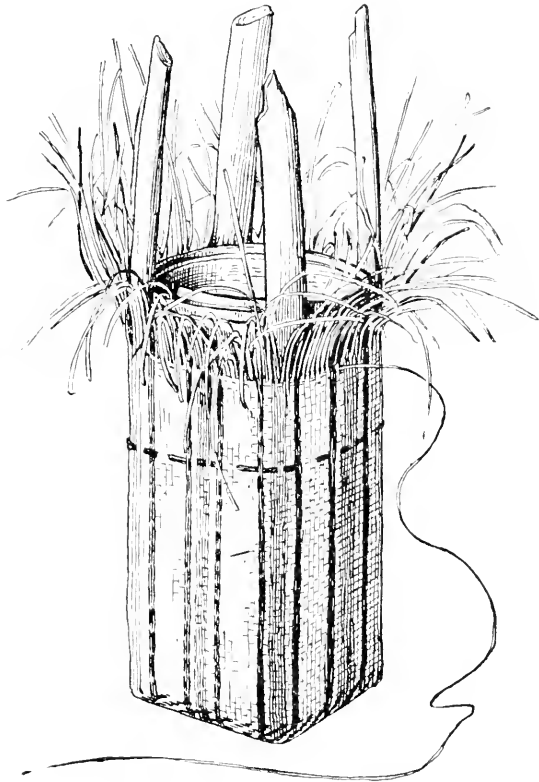

FIG. 32. PROCESS OF MAKING A BASKET OVER A MOLD OF STIFF BARK.

the hoops and the sewing is done with fine filaments of rattan. (See *Drill*.)

*Nibong*.—A palm whose leaf sewed with rattan serves for a boat bailer. (Cat. No. 232680, U.S.N.M.)

*Nipa*.—A palm *Nypa fruticans* whose leaves are made by the Malays into coarse, strong "bikars," or sleeping mats.

*Oblique technic*.—A process that begins at one corner of a mat or other-structure. In twills, hexagons, octagons, the elements that lean to the right are dextral, or right oblique; to the left, are sinistral, or left oblique.

*Openwork*.—Technics in which the parts are not close together. The results are slits, triangles, rectangles, rhombs, pentagons, octagons, and irregular open spaces.

*Ornamentation*.—Artistic effects in basketwork. It includes the choice and association of a great variety of materials; the adoption of correct shapes and colors in the things made and their parts; in the refinement of technical processes—checker, twine, coil; diamond and scroll patterns in twill and color; in knotwork and braiding; in carving, overlaying, and embroidery. The body is the foundation and background of ornamentation.

*Overhand*.—The knotwork at the tops of uprights on basket borders covering the rim stays are in sailor language called overhand weaving in single strand. The strand may be stem, split, strip, string, or filament.

*Overlaying*.—In American basketry the term is applied to the process of laying a pretty straw on a tough fiber; but the Eastern women hide unattractive features with a charming variety in knotwork, braidwork, and sewings. Overlaying in Malaysia occurs rarely in the American sense.

*Packing, or padding*.—The insertion of soft material between hard joinerwork and delicate textile, to equalize the strain.

*Pandanus*.—Of many uses in Malaysian basketry. (See Haeckel, *India and Ceylon*, N. Y., 1883, p. 99.)

The pandanus (*Pandanus odoratissimus*) belongs to the most singular character of plants of the Tropics. It is closely allied to the palm, and is also called screw-palm, or, more improperly, screw-pine. The low cylindrical stem, which grows from 20 to 40 feet high, is twisted, and branched like a candelabrum; at the extremity of every branch grows a thick tuft of large sword-shape leaves similar to those of the dracena and the yucca. Some of the leaves are a light green, others a much darker hue; they are gracefully twisted, and their spiral arrangement around the stem gives it the appearance of a perfectly regular screw. From the base of every tuft hangs a cluster of white, deliciously fragrant flowers, or a large red fruit like the anona. But the plant's most remarkable feature is the slender adventitious roots, which give it the appearance of walking on stilts. A clump of pandanus trees offers a fantastic sight as the stems rise on their stilts above the lower shrubbery or stalk about over the rocks along the shore.



*Parts of baskets.*—Malaysian baskets are much more broken up into parts than American. In both areas there will be, in the plainest structures, such as mats, wallets, and checkerwork baskets, wrong side and right side, outside and inside, top, bottom, and sides. But the full-fledged carrying basket is a bewildering association of parts. A technic part or unit is the full movement of the active parts once. The result is one check, decussation, twill, stitch, twist, curl, bend, bight, hitch, coil, or knot. (See also under *Structural parts.*)

*Pierced work.*—Applied to all uses of the awl, or piercer, in basketwork. The abundant employment of wood brings sewing into this art, which is not done with the needle, but after the shoemaker's fashion, with a sharpened filament of rattan through holes pierced with metal tools. (See *Drill.*)

*Pīna.*—Delicate texture from pineapple leaf, *Ananas ananias*.

*Pinned work.*—The joining of palm, pandanus, and other leaves by pinning them with splinters of rigid material run in and out through them. (See Plates IX, X, XI.)

*Plaiting.*—Folding leaves like the plaiting in garments. To be distinguished from braiding.

*Plants.*—The plants used in the Malaysian basketwork have not all been studied for native or scientific names. The best known are the bamboos, rattans, palms, and climbing ferns. (For Borneo, see Becari, pp. 507-636; for the Philippines, E. D. Merrill.)

*Ply.*—To be used in speaking of flat surfaces, as 2-ply, 3-ply, and so on. Work in pandanus leaf, palm leaf, bamboo skin, spathe, or bast may be thus made. Not to be confounded with *Strand*.

*Poolay.*—Filament of the pesang (*Musa textilis*). (Marsden's Sumatra, p. 146.) A tall perennial herb of the same genus as the banana. Manila hemp. When dressed it is of two qualities, finer for shawls, coarser for rope.

*Pricker.*—A tapering bone or piece of metal used in mad weave and other basketwork for inserting ends into the existing texture. (See Plate IV.)

*Processes.*—There are certain processes in basketwork that may be described, whose procedures are quite independent of the result. Among them are braiding, coiling, knotting, looming, matting, netting, omitting, sewing, spinning, twilling, and wrapping. These combine in all possible ways to their results.

*Products.*—The products of basketwork will be found under *Uses* of basketwork.

*Rattan.*—(See *Calamus.*)

*Rhomboidal work.*—Basketwork in pandanus leaf and other thin material in which the surface is made up of a series of rhombs or diamonds. Called also "*Mad weave*," which see.

*Right oblique.*—Same as *dextral*. Applied to the textile elements that lean to the right looking upward. Seen in twills, hexagonal, octagonal, and rhomb weaves.

*Rim.*—As distinguished from the added border, the rim of a basket is the upper edge of the special technic which constitutes the body. The ways in which the body elements are cut off, turned down and plicated, wrapped and fastened off give names to rims, their nature resulting from the work on the body—checker, twill, twine, etc.

Fig. 18 (Cat. No. 221521, U.S.N.M.) gives an idea of the way in which the long ends of oblique stems in hexagonal work are turned back and inwoven to give variety to the texture.

*Rotan sega.*—The toughest of all rattans for basketwork—borders, carrying parts, sewing, strengthening, supporting. Planted extensively by Dyaks.

*Sago palm.*—Midribs are stripped and bolted together for shields in Nias. (Cat. No. 237214.)

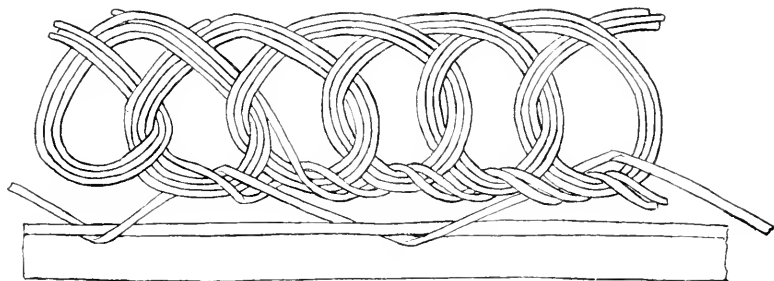

FIG. 33.—ACTIVE ELEMENTS IN SETS.

*Sand paper.*—Applied to various species of plants whose leaves have a siliceous surface and are used in polishing.

*Sarong.*—In Malaysia, a piece of woven stuff enveloping the body. Worn by both sexes.

*Seizing.*—The process or result of lashing the parts of basketwork together by turns of flexible material. To the sailor terms "round seizing," "throat seizing," and "racking seizing" the Abbott baskets add many other puzzling ways of joining the textile parts.

*Scunit.*—A convenient name to retain for flat braidwork, which may be used apart or worked into other technic. (See *Braidwork*.)

*Scrapang.*—Trident fish spear, West Borneo. There are four sorts of "anyi" (weaving or braiding) on each scrapang properly made and three kinds of rattan.

*Sets.*—The cycloidal curling of a single element is very common in Malaysia; but this element may be two, three, or more stems, splits, etc., that lie parallel in the work. They should be spoken of as single, double, triple, quadruple. In knotwork double or triple

sets of elements may all be functioned alike, or the knotworks may be in sets, as about the border of a siri basket. (See fig. 33.)

*Sewing.*—A convenient name for technic in basketry in which holes are pierced and slender filaments of rattan are used singly or in series for joining and for ornament. Seen on shields as well as baskets. On the latter it serves to hold the foot, the uprights, the border hoops together and in place. Many examples in the Abbott collection, especially from Borneo.

Fig. 34 (Cat. No. 221625, U.S.N.M.) illustrates the double sewing associated with imitation of twined weaving done on Malaysian shields. In the drawing the dark split or stem is doubled in the middle and passed through the first hole in the shield. The two ends are then laced through the other holes, making a twine at each stitch. At the same time each end is twined a few times with another split that does not go through the holes in the shield excepting the first one.

Fig. 35 (Cat. No. 237061, U.S.N.M.) is of the same type, but two outside splits are twisted in, making a three-strand twine.

*Shoulder.*—The rim of a basket fitted to receive a close cover. (See *Cover*.)

*Sides.*—The English and American makers call the body of a basket "sides." The sides of a Malaysian basket may be quite distinct or all alike. The latter may be three-sided, four-sided, or many-sided, depending on the shape of the framework.

*Single.*—Term applied to that variety of technic in which there is no passive part or foundation, and one active, moving element or set of elements. Examples of such basketwork are to be seen in America, but they are not classed apart. (See figs. 42 and 100 of *Aboriginal American Basketry*.) In Malaysia the long, rigid, and elastic stems render it possible to make wider excursions of technic. The word "single" does not necessarily mean one stem, for there may be several side by side, as shown in the illustrations; but they are all doing active service and all performing the self-same motions, curving and interlocking. (See Plate XIII.)

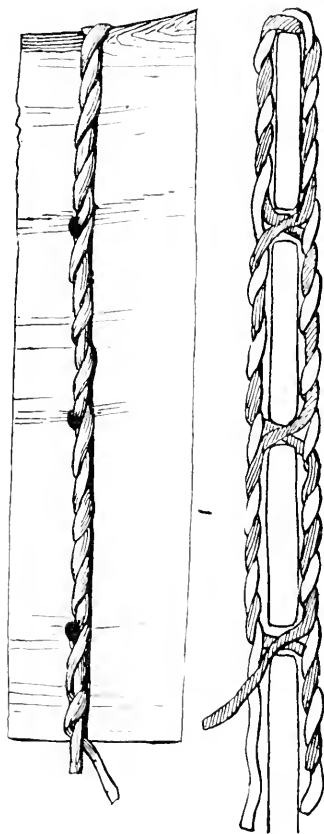

FIG. 34.—DOUBLE SEWING ON SHIELD.

Plate XIV (Cat. No. 221525, U.S.N.M.) is a good example of the interlocking cycloid, with three stems cooperating, the dropping out of a stem and another taking the place while the motive goes on. This plate shows the technic in position. It is a carrying basket from Sikakap Strait, Pagi Islands, west of Sumatra. The body is a single piece of spathe or inner bark rolled into the form of an inverted cone. On the top the technic shown in the drawing is in place. It was made independently of the basket and sewed on afterwards with

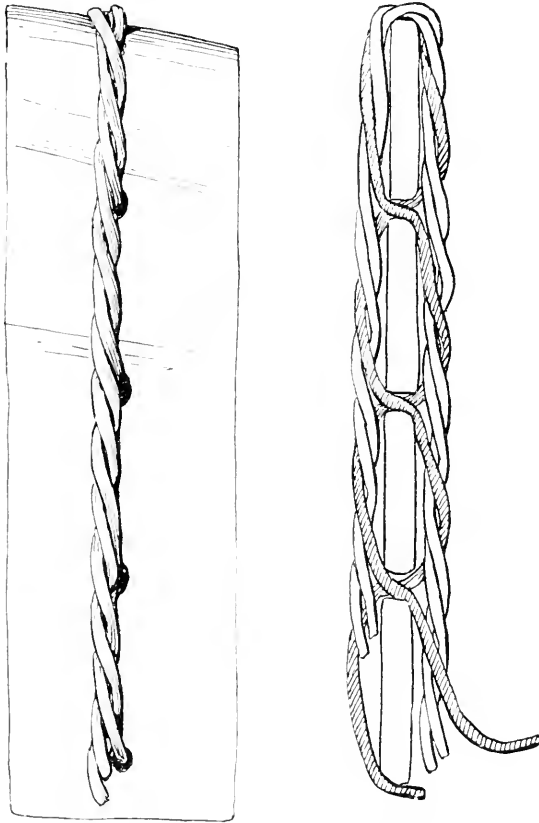

FIG. 35.—SEWING FORMING 3-STRAND TWINE.

*Skewer*.—A strip of bamboo or hardwood sharpened at both ends and thrust into a texture to stiffen it.

*Slath*.—In English basketwork, two rods or splits used to hold together and in place the bottom sticks at the beginning of a round basket (Okey). Malaysian baskets start differently. (See *Bottom-work*.)

*Spathework*.—(See *Leafwork*.)

*Spiral*.—This term may be used in describing much Malaysian textile work, for ornamentation as well as for use. There may be flat, conical, or cylindrical spiral.

a split of the same material. The bottom is of wood, set in. The hoops at the top and bottom are in pairs and are held in place by single rows of the Malay knotwork. The running of splits in and out and the knots tied on the edges of the bark are to be noted.

Cat. No. 247749, U.S.N.M., Plate XIII, may be called a burden crate, with bowed framework, back of bast and sides of rattan in single technic element, one-stem and two-stem, forming interlocking cycloids. The shape should be compared with that of California cradles.

*Sinistral*.—See (*Left oblique*.)

*Splicework*.—Methods employed in Malaysian basketwork for uniting the ends of two pieces of wood or the two ends of a hoop. Where applicable the usual names of splices given by mechanics may serve, as halving, lap splice, dovetail, scarfed joint, fished joint, ship lap. The hook splice of the barrel hoop does not appear; but, owing to the wonderful qualities of rattan, some new forms occur, as the hook-and-eye splice, loop splice, sewed splice, pinned splice.

*Split*.—One of the parts into which a rattan or other stem is divided for textile work after it has been gauged and shaved. Preferred to splint. Splitwork will be any kind of technic in which splits are the materials.

*Stay*.—In Malaysian basketwork, something on the inside of a basket, as a strip or split of rattan, to keep knotwork from pulling through the delicate textile, as bottom stay, upright stay, border or rim stay.

*Stitches*.—On fine borders, footing, and elsewhere, small holes are bored and delicate fibers of rattan and other plants are passed through and around, as in sewing. No needle is used, but in this way parts are "whipped" together. The separate rounds may be called stitches. (See also *Drill*.)

*Strand*.—One of the elements of thread, twine, rope, or braid. These are spoken of as 1-strand, 2-strand, etc., and may themselves become the elements of textile fabrics.

*Strengthening parts*.—Term applied to the framework and other parts of basketwork put in the right place to effect the purpose and add little to the weight. These natives are past masters in economic use of such structures. They are worked in or added on. Hoops, single or in pairs; additional wales in the weaving; splits wrapped about a structure; woodwork, braces, stays—all give strength, with the minimum of material.

*Strip*.—A ribbon-like section cut from a leaf or other thin substance and used in checker or other flat technic.

*Structural parts*.—The complete Malaysian burden basket (Plates II, III, V, VI, VII, VIII, XIII) has many structural parts, while the American Indian makes hers almost in one piece. There will be a little special treatment at the start, more about the border, but practically her work is a unit. The possible parts of a Malaysian basket are bottom, braces and stays, foot, upsett, body, border, cover, framework, carrying parts, ornaments, and accessories. Of these it is possible to note the presence or absence; the materials in their variety, preparation, and combinations; shape, technic, and quality of each part. In some Malaysian baskets the structural parts are all merged, as in the American. In others these parts have different methods of expression and degrees of independence. The many possible ways of effecting these combinations give unlimited scope to

the imagination of the artist. The term structural part as applied to materials includes stems, half stems, splits, strips, fibers, filaments, leaves, roots, and whatever other parts of a plant enters in. Cat. No. 221504, U.S.N.M., Plate III, is a graceful burden basket in hexagonal technic, six-sided, pointed at the bottom, with abundance of hoopwork at the carrying zone and on the border.

*Symbolism.*—Upon this word American and Malaysian basketwork part company. In America the spirit world lives and has its being on basketry and pottery; but Malaysian textiles of every sort, even the most adorned, are as mute on religion "as though that soul were dead." Of a pictorial epoch or stage there are no survivals in the fictile or textile art. If one ever existed, hundreds of years under Buddhistic and then Mohammedan power have obliterated every trace.

*Tapa.*—Original clothing of the Sumatrans, still used among the Rejangs for their working dress. It is the inner bark of the "calawee," a bastard breadfruit, beat out to the fineness required. (Marsden, p. 43.) It is sometimes dyed yellow, but usually remains the natural light brown color. Occurs practically all over the islands.

*Technic* (technique).—All the textile processes employed in basketwork and other handicrafts. It embraces the preparation of materials and all the methods of putting them together, as well as the results of those processes. Baskets and basketwork may be classified by the technic. This was done for the American ware (Aboriginal American Basketry, Report U. S. National Museum, 1902, p. 190), and is here attempted for the Malaysian.

Many of the American processes will appear in Malaysia and will receive the same names; other processes and variants will require additional terms.

In the Abbott collections from his areas in Malacca, Sumatra, Borneo, and vicinity, one is struck with the numberless variations in each class of technic and with their combinations.

1. For example, from the single-element technic, which consists of the bending, winding, and interlocking of the most simply curved, sinuous, spiral figure-of-8 movement of a single rattan stem or other long element, the weaver multiplies her stems and proceeds to work with two or more laid side by side to create new artistic patterns.

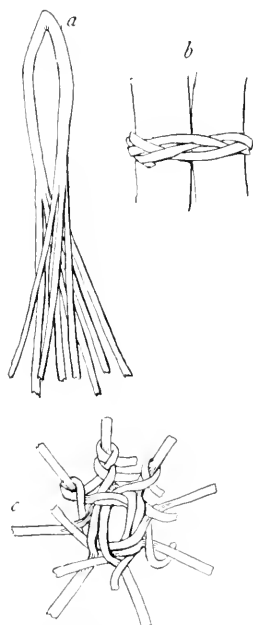

FIG. 36. — BEGINNING OF SINGLE-STEM BASKET.

Figs. 36-38 (Cat. No. 216305, U.S.N.M.) show a single-stem basket from Simalur Island, northwest of Sumatra. It is a wonder how a savage woman ever thought of so intricate a thing. The handle is a rod or stem of rattan doubled in the middle. After being clasped together with a ring of braidwork, each end is split into four parts, making eight warp stems, which are knotted at the bottom and from that point become wrapped weft. See drawings *a, b, c*, fig. 36, showing the doubled and split stem, the attachment of braidwork, the knotting of the warps at the bottom, and the commencement of the wrapped weaving.

Each split makes a turn or half hitch around a warp, passes the next one, and continues to make a half hitch around every alternate warp until exhausted. About half way up, the ends of these are tied to additional splits of rattan, continuing the process of half hitches; but, the spaces between the warps being wider, the wefts form plaits. See drawings *d, e, f, g*, figs. 37, 38, for the finishing processes. At the rim the ends are fastened off by simply passing into the old knots.

2. Checkerwork, both close and open, erect and oblique, abounds in the Abbott Malaysian collections. If made in strips of soft material, like pandanus leaf, this technic lends itself ever for both useful and decorative work—for matting, baskets, wallets, reticules, and so on. In more delicate fibers it leads up to the finest loomwork, while in rigid materials it gives itself most readily to the fabric of bottoms, the elements becoming spokes or warps of the body of the basket. (Figs. 1, 14.)

3. Twillwork, in which all elements are active and pass under and over different numbers of strands, two or more, or not the same strands from one course to another, is at home all over Malaysia,

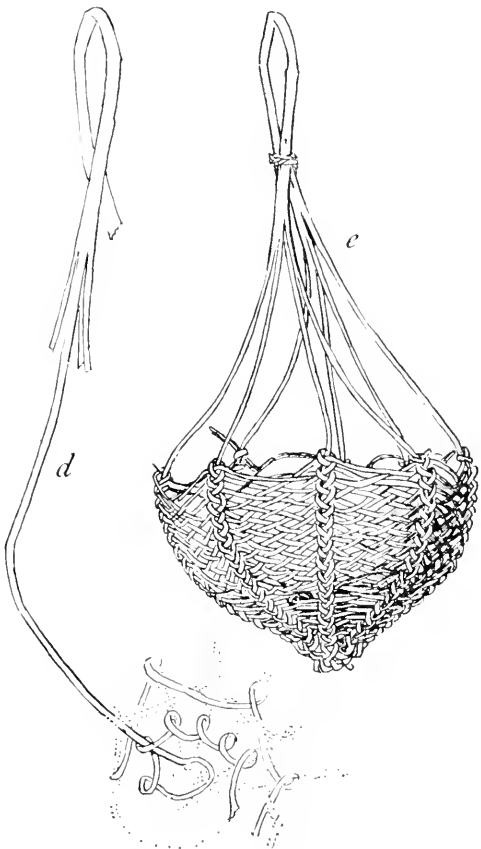

FIG. 37.—PROCESSES ON SINGLE-STEM BASKET.

owing to the abundance of materials everywhere for such technic. It may be divided into erect and oblique, plain and diagonal, and great differences are possible through varying thickness, width, color, and number in crossing. These in many examples produce artistic effects of great beauty. (See Plates V, VI, and fig. 1.)

4. Wicker is basket technic, in which rigid passive elements, or stakes, are crossed regularly, over and under, by active elements that are flexible. Rattan and like plants are specially adapted to wickerwork, which in its coarsest forms, such as game fences and fish weirs, must have furnished the earliest types of basketwork. Wicker, in its finest specimens, may be made ornate; it runs easily into twillwork and twinework. (See Plates I, XVI, and figs. 5, 8.)

5. Wrapped work includes all hand textiles in which the passive parts are held together by a flexible active part which at regular places is wrapped about them. I have elsewhere called this "bird-

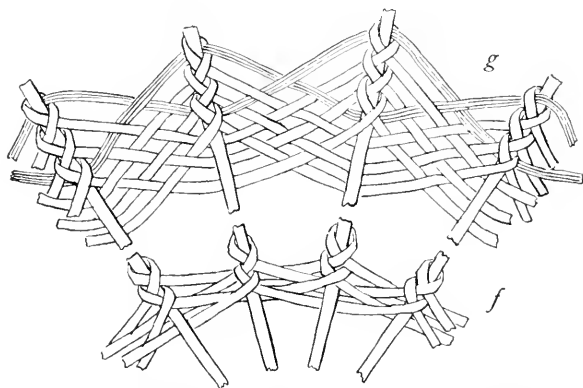

FIG. 28.—FINISHING PROCESSES ON SINGLE-STEM BASKET.

cage" technic, referring to the wire cages wherein the stiff wires cross at right angles and the intersections are wrapped about with fine wire. Many varieties of the wrappedwork exist in Malaysia, and they will be illustrated under special examples.

The passive parts are not always weft, but latticed foundations are encircled by the active running up and down, in and out, like clinging vines. (See figs. 40, 41.)

6. Twinedwork includes those hand textiles in which the passive parts, called "stakes" by English basket-makers, are held together and in place by twine of two or more strands. The technic is called 2-strand, 3-strand, and so on, according to the number of strands in the active part. Associated with twined work is braidwork, in which the active elements are braided in and out among the passive, but the appearance is quite the same.

Twinedwork may be wicker or twilled, open or close, fine or coarse, and by making one of its elements rigid it may be merged into wrappedwork. On a basket the twinedwork may be continuous in one direction from round to round, or the consecutive rounds may be boustrophic. An openwork effect is secured by including alternate pairs of stakes in going around.



7. Coiled technic in Malaysia covers a multitude of variations. The long, tough staples are favorable to its development. In all the so-called coiling processes the actives do not cross the passives, but go around them and around with them. There is no distinction of warp and weft. Coiled ware has been classified by the number and treatment of passive parts in the foundation and by the methods of working the active parts about them, singly or in pairs, as wrapping, half-hitching, twisting, mousing, and figure-of-8 work. The combining of two or more varieties of coiled work gives the basket-maker all the chance she asks for her versatility. (See *Aboriginal American Basketry*, p. 247.) In Malaysian coiled basketry the nine American varieties are not copied, but there are both similarities and differences. For example, in the Eastern ware the active split often pierces the foundation stem beneath, a thing not frequent in America.

8. Three or more series of textile elements moving in separate directions give rise to

triangular, rhomboidal, hexagonal, and octagonal patterns of technic. The vertical, horizontal, right oblique, and left oblique elements may be all alike and active, or certain of them may differ from the rest in

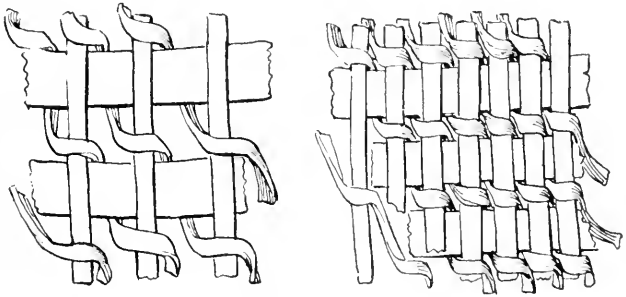

FIG. 39.—THREE-DIRECTIONS TECHNIC WITH VARYING ELEMENTS.

width, thickness, color, and pliability. The technic may be openwork or close and the varied methods of superposition create differences in the result. All over the Orient the polygonal styles of basketwork have had a wonderful development. The Japanese reach extraordinary results in their practice. (See Plates III, VII, XII, and figs. 18-20.)

9. For basketwork, chainwork, sennit, knotwork, hoopwork, and other joinerwork, the separate words must be consulted. The combining and mixing of all the varieties mentioned constitutes the ever-present surprise in Malaysian basketwork. In describing a number of specimens it makes classification difficult, for each structural part seems to follow categories of its own.

Cat. No. 221534, U.S.N.M. (see Plate II and fig. 39), is a good example of the three-direction technic, the elements differing in width, rigidity, and treatment. The wide horizontal and the narrow vertical are latticed so as to make openwork below and closework near

the border. The left obliques are not merely laced among the others, but curl in passing so as to have the soft inside of the split against the other elements.

Lehmann<sup>a</sup> has brought together the hand textiles of the world under the term *Geflechtsarten*, as distinguished from *Gewerbe*, which would include the machine textiles, or loomwork. There are 3 plates and 195 illustrations, and some of them cover two or more technics. His analysis of the *Geflechtsarten* is as follows:

(1) Elements run in two directions, both active. Includes open and close checker, upright and oblique twills, and ornamental work under the same definition. (Plate I, figs. 2-6.)

(2) Active parts unite a definite number of passive parts. Includes wicker-, twined-, wrapped-, and coiledwork of every kind. (Figs. 1, 7-10, 12-25, 27-31, 34-46.) This is by far the largest of Doctor Lehmann's groups.

(3) Passive parts running parallel are united with flexible parts running in two directions. Two oblique flexible sets are united by rigid horizontal elements. (Figs. 47-52.)

(4) Active textile elements in three or four directions, making A hexagonal weave, B octagonal or chair-bottom weave. (Figs. 53-58.)

(5) Technic in a single moving part or element, though it may consist of two or more stems side by side. There are three ground forms, the continuous coil (A); the sinuous movement (B); and the figure-of-8 (C). (Figs. 59-63.)

(6) Technic of two sets of passive elements lying parallel, the sets generally latticed at right angles and fastened together by means of elements interlaced in like particular direction. (Figs. 65-83.) It is latticework, fastened together by interlacing or wrapping. The bird-cage technic of the American ware. (Figs. 65-84.)

(7) Technic from two or more active elements bending in two or more directions. A, made by varying other technics (figs. 15, 32, 33, 23, 24); B (fig. 84), interlocking bights at right angles; C (fig. 90), interlocking sinuosities; D (fig. 85), interlocking half hitches. The courses of the single actives are given in figs. 154, 155, 157, 158, 159.

(8) False braiding, chain stitching, etc., of elements so far as not included in other methods.

(9) Technics not truly textile. Half textiles, A (fig. 91), strips bent hood-shape; B, horizontal seized close to the vertical, horizontals pierce the vertical; C, strips sewed or thatched together, as in hats, etc.; D, two sinuous elements bound together at their contacts (fig. 64).

*Thatchwork*.—On Nicobarese houses; generally of "lallang" grass; sometimes of palm leaf, fastened to vertical rafters of the midribs of

<sup>a</sup> Abh. Anthropol.-Ethnol. Museums, Dresden, XI, 1907.

the coco palm, joined crossways by battens of areca wood, of which the grated floor is made. (Kloss, Andamans and Nicobars, p. 49.)

*Throat seizing*.—Lashing the crossed ends of basket elements. Used in loops for suspension and in carrying parts.

*Tikars*.—Sleeping mats. Malays make them from nipa palm.

*Tingayl* ("Kinggale").—A sort of bamboo, West Borneo, for baskets. Called also *Tingehl*, *Tinggayl*.

*Tools*.—The words "joinerwork" and "tools" must not awaken pictures of the great chests of our carpenters and cabinetmakers. The utensils employed on Malaysian basketwork are of very primitive kinds. The ever present parang, including a woman's variety (two top specimens, Plate XV); curved knives with their long, slender handles; awls with needle points; drills quite as delicate; prickers for inserting wefts; an old file or two; and siliceous leaves for sandpaper, are all.<sup>a</sup> The chief reliance is on the cunning hands and trained eyes of the basket-maker. (See Plates IV, XV.)

On Plate XV are shown basket-makers' knives, "sinar" (Cat. Nos. 249038, 249043, U.S.N.M.), used as all-round tools in making baskets and mats by the Dyak women on Sempang River, West Borneo. They all belong to the same type, curved alike in blade and handle from end to end, the cutting parts quite similar, handles of wood or antler. The implement fits the hand perfectly and rests on the arm, enabling the woman to guide the finest motions and regulate the pressure. At the bottom of the plate the bast rolled up serves as a scabbard for the blade when not in use.

Cat. Nos. 249045 and 249046, U.S.N.M. (top of Plate XV), are woman's parangs, "parang bodong," from the Dyaks of Sempang River, West Borneo. Length 12 inches and 14 inches respectively. It is interesting to note on these small objects the razor-shape blade bent back at an angle with the long tang, the hook on the lower side where blade and tang come together for removing thorns from leaves and stems, and the grip of wood, perfectly plain. In the men's parangs the grips preserve a semblance of ancient symbolism; there is none here—just a simple survival of useful shapes.

*Toung áp*.—Native name for triangular pyramid in checkered basketry.

*Trap*.—A species of *Artocarpus*, used by Dyaks and Sakais in making bark cloth. Other species are also used. The Dyaks also make cord of it and of other kinds of bark.

*Twilledwork*.—Fabric in basketwork in which the textile parts of one set of elements pass over and under more than one element of the other set. A great variety of patterns are produced in the Abbott baskets by different materials, surfaces, thickness, width, color, direction, and technic in the parts. (See Plates V, VI.)

<sup>a</sup> Marsden, p. 144, says that the Sumatrans were ignorant of the use of the saw.

*Twine*.—"Calooee" is a species of nettle, of which excellent twine is made. It grows to the height of about 4 feet, without branches, the stem being imperfectly ligneous. It is cut down and beaten, after which the rind is stripped off and twisted as we do hemp. Twine is also made of the bark of a shrub called "*Endeetoo*." A twine is made in the Lampoon district of the bark of the "bago" tree, beaten out like hemp, for the construction of large fishing nets. On the island of Nias they make a twine of the "baroo" tree, which they afterwards weave into coarse cloth for bags. A kind of thread for sewing is procured by stripping filaments from the midribs of the leaves and from the trunk of the "pesang" or plantain. (Marsden, pp. 75-76.)

*Twinedwork*.—A refined and varied technic, based on wattling, in which the active part consists of two or more strands that in passing make a part of a turn about one or more passive parts leaving one strand inside. The method of doing this gives rise to several varieties—plain, twilled, wrapped, latticed (or tee), three-strand, etc. The process is used very extensively, especially in openwork, and differs from the American in not ascending by a perfectly uniform spiral. (See Plates I, VIII, and figs. 7, 34, 35.) (See *Wrap*.)

*Twist or twistwork*.—A number of filaments in a single strand twisted together. The rattan is a bundle of long fibers and can be readily changed from its hard, glossy appearance into a yarnlike texture, as in the turning down of warp ends.

*Uprights*.—The vertical elements in the framework of a basket.

*Upsett (Upsetted, Upsetting)*.—A modern basket-maker's name for changing the bottom technic of a basket to the body technic. May be useful in describing Malaysian ware, though it must be remembered that a great deal of work on the latter is done afterwards about the foot.

*Uses*.—Armor, in fabric and ornament; bags of every sort; baskets; beaters for rice harvest; bird baskets, cages, and traps; canoe parts and furnishings; carrying devices of infinite variety in size, parts, functions, and qualities; chairs; clothing in every part, both useful and ornamental (belts, bindings, caps, fans, fringes, hats and other head coverings, pockets, sandals, shirts, shoes, stockings); coffins; cooking utensils, covers, cradles, crates, drinking vessels; drums; eating utensils; fences of many kinds; fishing gear; flask covers, holders, and servers; floors; furniture; grain vessels and utensils; handles; hangings; harvesting ware; houses and their parts, for use and decoration; knotwork for endless uses; lacing and lacework; lashings; lines; masks; matting and mats; milling; nets for land and water capture and network in general; nooses; ornaments for the body and for every useful thing; palisades; panels in upholstery; playthings; quivers; receptacles besides baskets; reels; sacks; scabbards; seats; sennit; sieves; slings; string in general; tableware;

thatch; thongs; tiles; tools, with cases; toys; traps (air, land, and water); wallets; walls; water-crafts; weapons (lacings and lashings); weirs; whips; winnowing apparatus.

*Vertical.*—Applied to elements in an upright position.

*Vessels.*—Of giant bamboo joints. Andamanese. (Kloss, Andamans and Nicobars, p. 33.) Mentioned here because they have basket functions, associate with them, and basketry technic abounds on them.

*Warp.*—The elements on which woven baskets are built up. In Malaysian ware the bottom splits become warps of the body. Warps may be parallel, spreading, decussated, latticed, radiated, zigzag.

*Water bottles.*—Cocoanut shells joined in pairs by a short rattan handle, used by the Nicobarese to hold drinking water. (Kloss, Andamans and Nicobars, p. 49.) Water is carried from the spring in bamboos, cut 5 to 6 feet in length, and borne over the shoulder, or in a number of single joints that are put together in a basket. It is drunk

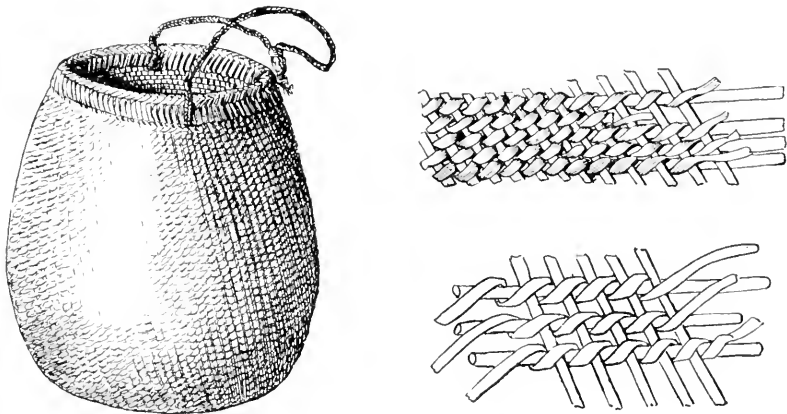

FIG. 40.—WRAPPED TWINEDWORK.

out of a fruit called "laboo," resembling the calabash, a hole being made in the side of the neck, and another at the top, for vent. In drinking, they hold the vessel at a distance above their mouths and catch the stream as it descends. (Marsden, Sumatra, p. 55.)

*Wattling.*—Coarse fence or fish weir in wicker or twined work. Used in many ways both for traps and accessories.

*Weaving.*—A term that should be saved for loomwork and used here only for basketwork in which the passive and active elements form distinct warp and weft. The active, or weft element, has many varieties both in form and in process. Even fabrics, like flat sennit, may be woven into baskets. In passing warps, the weft may be checker, wicker, twill, wrapping, half hitched, knot, belaying, figure-of-8, etc.

*Weft.*—The active parts of basketwork founded on warps or "stakes."

*Whipped, whipping*.—Joined with an overcast movement, as in coiled basketry.

*Wicker*.—Basketwork in which the passive parts are rigid and the active are flexible, passing in and out among the former. (See Plates I, XVI.)

*Widening*.—A great deal of Malaysian basketry is wider at the top. In openwork this is accomplished by simply increasing the distances between the warps in ascending. Another way is to insert new

warps above the corners of the footing.

*Wind (wound)*.—To pass spirally around a fixed core or axis. A useful word for the very common technic of passing a thin split spirally about a stem or a number of splits, to make them one. In American basketry a bunch of splits are wound and at the same time caught to the coil below; but the Malays do more of this winding, because they have much longer and more uniform material.

*Woodwork*.—(See *Joinerwork*.)

*Work*.—The termination "work" may be applied in describing basketry, to the materials, the processes, or the products of the industry. There may be spathew<sup>work</sup>, barkwork, bastwork, woodwork, leafwork, stemwork, and rootwork, either in the rough or prepared. There

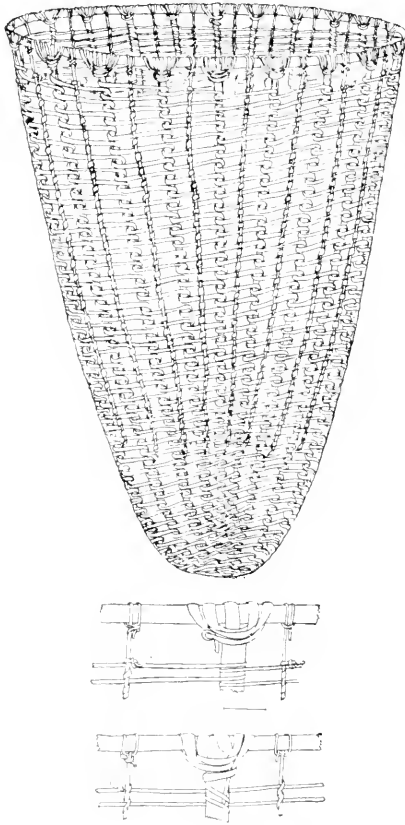

FIG. 41.—SINGLE-WRAPPED WEFT.

will be knotwork, braidwork, checkerwork, twillwork, twinework, coilwork, wrapwork, and combinations of these. Each of these processes may also be employed elsewhere, giving rise to roofwork, wallwork, floorwork, matwork, hoopwork, and joinerwork. The plant world will for a long time be in the way throughout Malaysia, offering superabundance of material to the textile art.

*Wrap*.—To pass around, as where a flexible e<sup>l</sup> about one or more rigid ones. There is a wrap<sup>work</sup> found in Southern California, in the mounds of the Mis<sup>ppi</sup> Valley, and

among the Andamanese, in which a weft makes one turn about each warp in passing; another form in Oregon and the Andamans, in which one strand of a twine goes straight and the other wraps about it. Wrapped lattice is another name for it. (See Plate XVII and figs. 40, 41.)

There are specimens of this single-wrapped weft in the Abbott collection. Fig. 41 and Plate XVII show the general appearance of the wrapped weft on whole rattan stems united with alternate finer vertical warps on which the wrappings are also upright and suggest the American Makah, or bird-cage technic. The half hitching and the overhand wrapping with the cutaway warps at the rim must not be overlooked. The ten warp stems are bent V-shape and cross on the bottoms.

Cat. No. 221538, U.S.N.M., shown in fig. 40, is a genuine surprise, an example of wrapped twinedwork from Simalur Island. The three elements are present, as in the Makah work of the Vancouver Island baskets, only the wrapping is done with stiffer material. (See *Aboriginal American Basketry*, pp. 235, 236.)

*Yarn*.—Fibers loosely twisted together in 2-strand twine.

*Zigzag*.—A broken line of equal angular portions, applied to structure or decoration. Dr. Edgar A. Mearns gave a carrying basket from Mindanao having an open checker bottom. About the outer row of checkers, in order to hold the parts firm for the upsett, is a zigzag wrap in rattan, a turn and a half about each square. The lacing doubles alternately on the back and on the front.

#### BIBLIOGRAPHY.

The bibliography for this region of wonderfully mixed cultures is extremely rich in English, Dutch, French, German, and Italian publications. The literature will be found both in journals and in standard works. The principal English journals are the following:

- AMERICAN ANTHROPOLOGIST. Washington, 1888-1898, new ser., 1899+. In each number of the present series is a summary of anthropological literature.
- ASIATIC RESEARCHES. Vols. I-XX. Calcutta, 1788-1839, 4to.
- GEOGRAPHICAL MAGAZINE. London, 1874-1878, 4to.
- INDIAN ANTIQUARY. Bombay, 1872+.
- JOURNAL OF THE ANTHROPOLOGICAL INSTITUTE OF GREAT BRITAIN AND IRELAND. London, 1843-1908.
- JOURNAL OF THE ASIATIC SOCIETY OF BENGAL. Calcutta, 1832+. Indian Archipelago and Eastern Asia.
- JOURNAL OF THE ROYAL ASIATIC SOCIETY OF GREAT BRITAIN AND IRELAND. London, 8vo., 1834+.
- JOURNAL OF THE STRAITS BRANCH OF THE ROYAL ASIATIC SOCIETY. Singapore,

A few of the standard works are mentioned, chiefly on account of their comprehensive information and their illustrations. In some of them will be found good bibliographies.

- ANNANDALE, NELSON, AND ROBINSON, H. C. Fasciuli Malayensies. (Anthropological and Zoological Results of an Expedition to Perak and the Siamese Malay States.) London, 1903, Anthropology, Pt. 1.
- BALL, V. On Nicobarese Ideographs. *Journal of the Anthropological Institute*, X, London, 1880, p. 103, with bibliography.
- BECCARI, ODOARDO. *Nelle Foreste di Borneo*. Firenze, 1902, 668 pp., Svo. The appendixes give excellent account of plants, native names, scientific names, and uses.
- BOCK, CARL. *The Head-hunters of Borneo*. London, 1882, 344 pp., 30 pls., map.
- BREITENSTEIN, H. *Einundzwanzig Jahre in Indien*. Part 1, Borneo. Leipzig, 1899, 264 pp., 8 figs. Part 2 is Java, Part 3 is Sumatra.
- BRIGHAM, WILLIAM T. *Mat and Basket Weaving of the Ancient Hawaiians*. With an account of Nets and Nettings. *Memoirs of the Bernice Pauahi Bishop Museum*. Honolulu, H, 1906, No. 1, pp. 105-162, 166 figs., 14 pls.
- EMMONS, G. T. *The Basketry of the Tlinkit*. *Memoirs of the American Museum of Natural History*. New York, 1903, III, Pt. 2, p. 229, 14 pls., 73 figs. Especially good for comparison of borders.
- FLOWER, WILLIAM H. *Papers on the Andaman Skulls*. *Journal of the Anthropological Institute*, IX, 1879, p. 108, and 1884, p. 115; *Journal of the Royal Institute*, London, Appendix, 1888.
- FURNESS, WILLIAM HENRY. *The Home-life of Borneo Head-Hunters, Its Festivals and Folk-Lore*. Philadelphia, 1902, 196 pp., 88 pls.
- . *Glimpses of Borneo*. *Proceedings of the American Philosophical Society*, Philadelphia, XXXV, 1897, p. 309.
- HADDOX, A. C. *Evolution in Art as illustrated by the Life.—Histories of Designs*, London, 1895.
- HAECKEL, ERNST. *India and Ceylon*. New York, 1883, 174 pp.
- HOSE, CHARLES. *A Journey up the Baram River, etc., Borneo*. *Geographical Journal*, London I, 1893, p. 193. In the Heart of Borneo, *idem.*, 1900, XVI, p. 39.
- HÜGEL, A. V. *The Land of Bataks*. *Geographical Journal*, London, 1896. Index.
- JAYNE, CAROLINE FURNESS. *String Figures. A Study of Cats-cradle in many lands*. New York, 1906, 408 pp., 17 pls., 867 figs., 10 pls. from W. E. Roth, Bibliography.
- KLOSS, C. BODEN. *In the Andamans and Nicobars*. The narrative of a cruise in the schooner "Terrapin," with notices of the islands, their fauna, ethnology, etc. London, 1903. Map, plates, text, figures. Illustrations and text on aborigines, houses, basketry, and woman's work. The "Terrapin" is Doctor Abbott's vessel, and the book is the result of an expedition to make a good representative collection for the U. S. National Museum.
- . *Lapicques Forschungsreise auf den Andamanen*. *Globus*, Braunschweig, LXIX, 1896, p. 167.
- LEHMANN, J. *Systematik und geographische Verbreitung der Geflechtsarten*. *Abhandlungen d. Anthropologisch-Ethnographischen. Museums zu Dresden*, XI, No. 3, 1907, 3 pls., 166 figs. on baskets, 29 figs. on knots.
- MAN, E. H. *Descriptive Catalogue of Nicobar objects*. *Indian Antiquary*, February, April, May, June, 1895. *The Aboriginal Inhabitants of the Andaman Islands*, *Journal Anthropol. Inst.*, London, Vols. VII, XI, XII. Index.
- MARSDEN, WILLIAM. *The History of Sumatra, containing an account of the Government, Laws, Customs, and Manners of the Native Inhabitants, etc.* 2d ed. London, 1784, pp. 374, xii, map.
- MARTIN, RUDOLF. *Die Inlandstämme der Malayischen Halbinsel*. Jena, 1905, 1052 pp., Svo, 137 figs., 26 pls., 1 chart. Excellent bibliography, pp. 1042-1052.



- MARTIN, RUDOLF. Die Ureinwohner der Malayischen Halbinsel. *Correspondenzblatt d. deutsch. Anthropol. Gesell.*, Munich, 1899, No. 10, p. 125.
- MASON, OTIS T. *Aboriginal American Basketry*. Report of the United States National Museum, 1902 (1904), with Bibliography and Glossary.
- MERRILL, ELMER D. *A Dictionary of Plant Names of the Philippine Islands*. Bureau of Government Laboratories, no. 8, 1903.
- MODIGLIANI, ELIO. Fra i Batacchi indipendenti. *Bullettino della Società Geografica Italiana*, Rome, February, 1892. 190 pp., 23 pls., 35 figs., map.
- . *L'Isola delle Donne*. Viaggio ad Engano, Milano, 1891, 312 pp., 25 pls., 50 figs., map. Good bibliography.
- . Materiale per lo Studio dell'Isola Sipõra (Mentawõi) pp. 1-46. Rome, 1898. 1 pl., 13 figs.
- OKEY, THOMAS. Basket-making. *Journal of the Society of Arts*, London, January 11, 1907, pp. 186-197, fig. 1.
- PLEYTE, C. M. Die Mentawõi Inseln und ihre Bewohner. *Globus*, Braunschweig, LXXIX, 1901, pp. 1, 21.
- RAAP, H. Reisen auf der Insel Nias bei Sumatra. *Globus*, Braunschweig LXXXIII, 1903, pp. 149-171.
- ROSENBERG, H. VON. Der Malayische Archipel. Leipzig, 1878.
- ROTH, H. LING. *The Natives of Sarawak and British North Borneo*. New York, 1896, 2 vols., 550 illustrations. Bibliography.
- SKERT, W. W. *Malay Magic*. London, 1900.
- , and C. O. BLAGDEN. *Pagan Races of the Malay Peninsula*. London, 1906, 2 vols., 8vo. Many plates. Bibliography up to date renders a long list, here unnecessary.
- SMITH, HUGH M. *The Fyke Nets and Fyke Net Fisheries of the United States*. Bulletin of the U. S. Fish Commission, Washington, 1892, pp. 299-355, pls. 72-91.
- TEMPLE, COL. R. *Blue Book on the Andamans; also with V. Solomon. Diaries from Car Nicobar*. *Journal of the Anthropological Institute*, London, XXXII, p. 202.
- WALLACE, A. R. *The Malay Archipelago. The land of the orang utan and the bird of paradise*. New York, 1869, 638 pp., 51 ill., 9 maps, vocabularies.

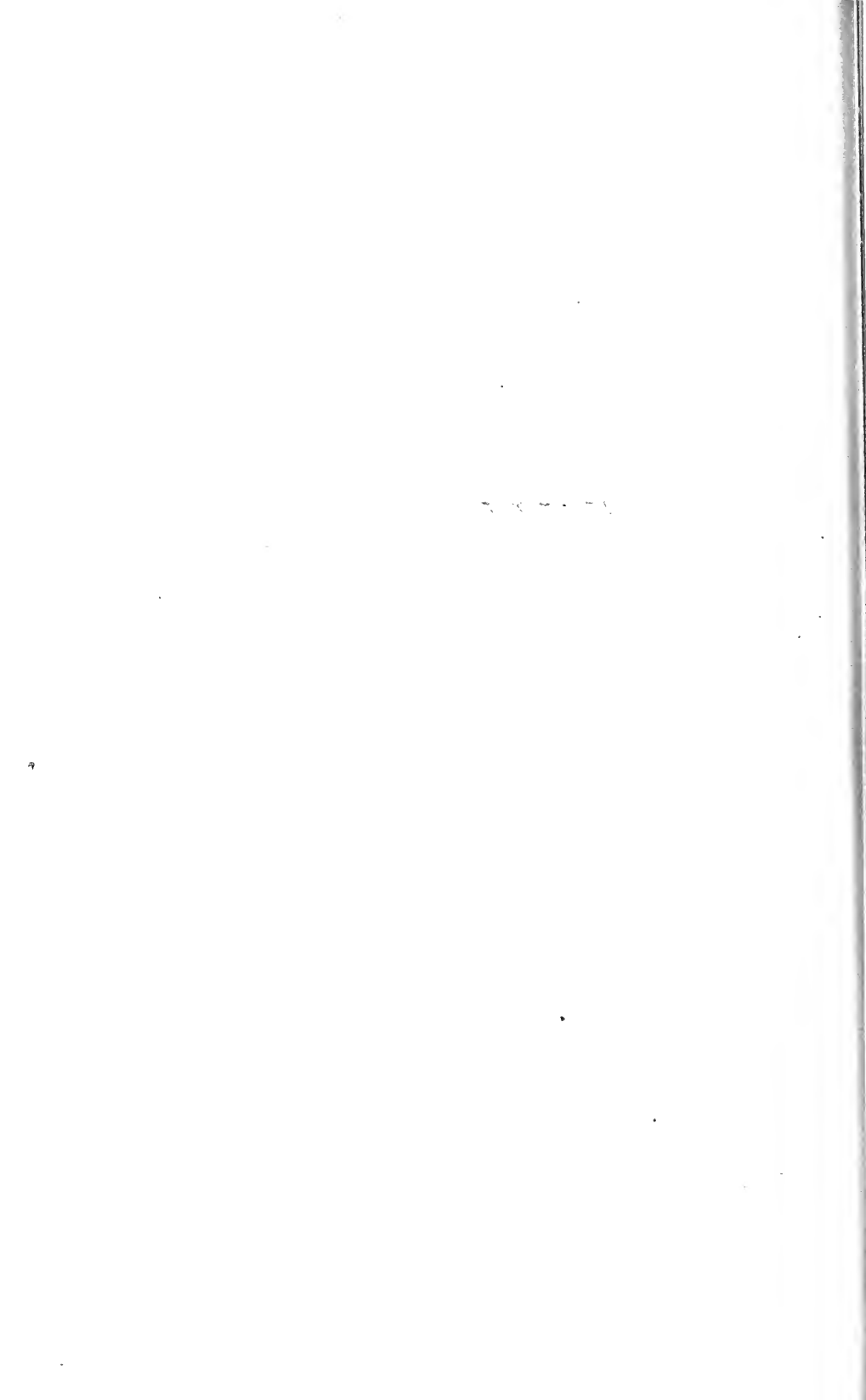

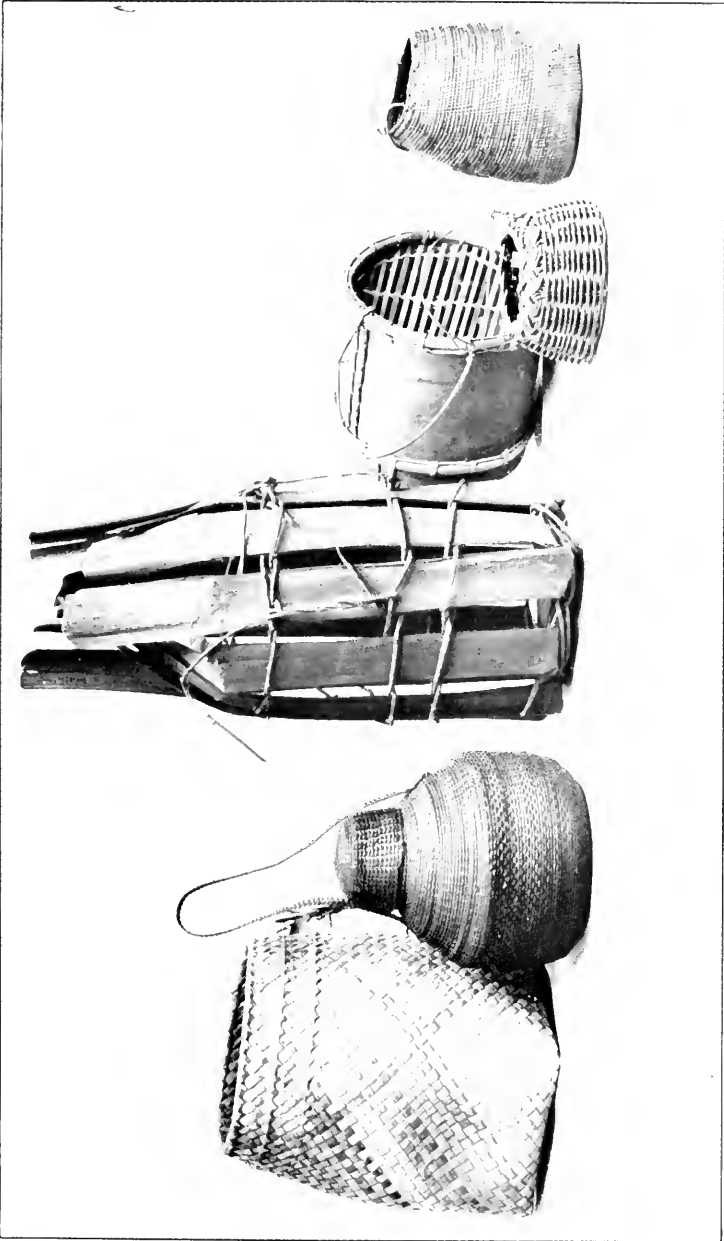

TYPES OF MALAYSIAN BASKETWORK.

FOR EXPLANATION OF PLATE SEE PAGES 1, 2.

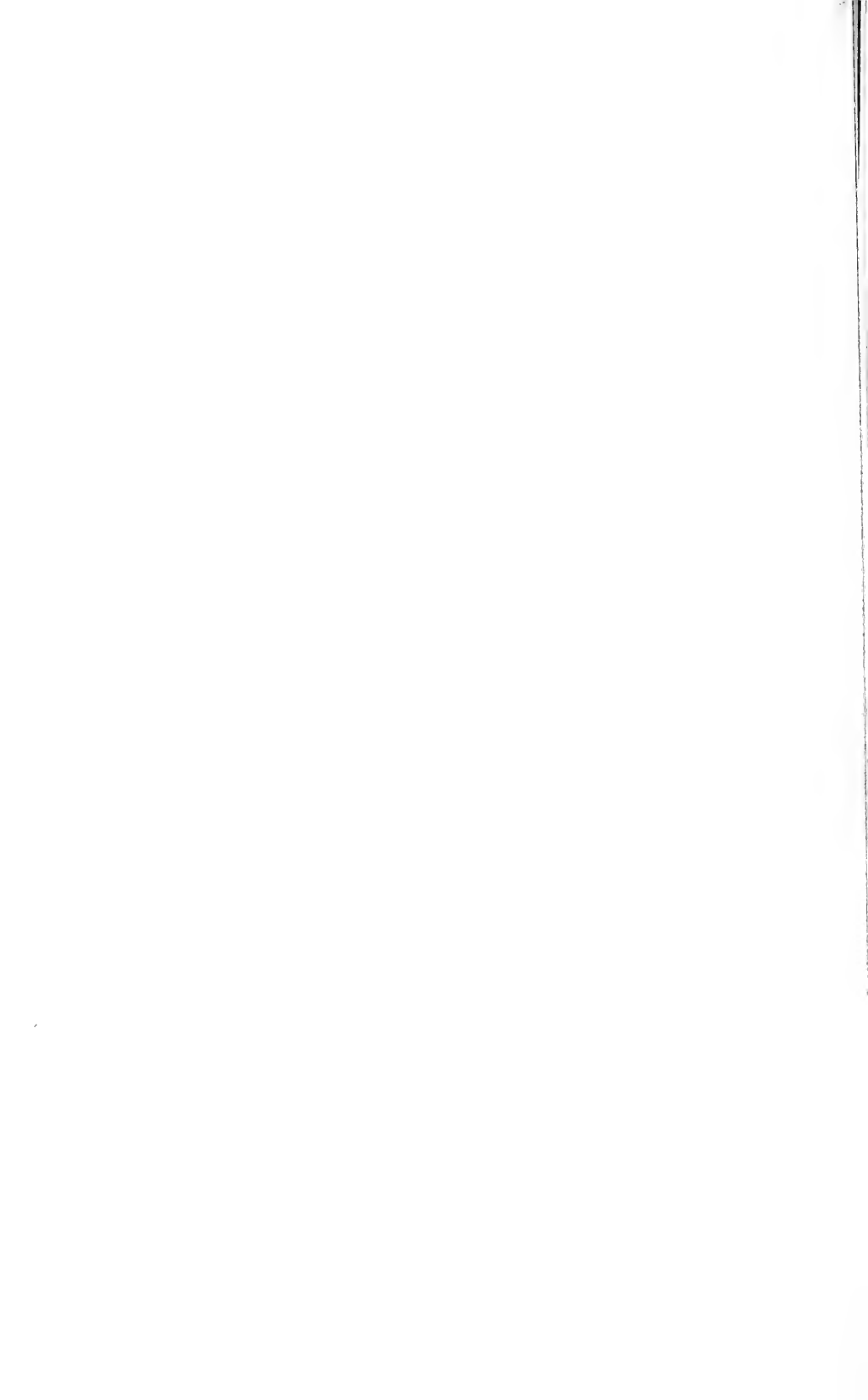



BURDEN BASKET FROM SIABA BAY.

FOR EXPLANATION OF PLATE SEE PAGE 7.

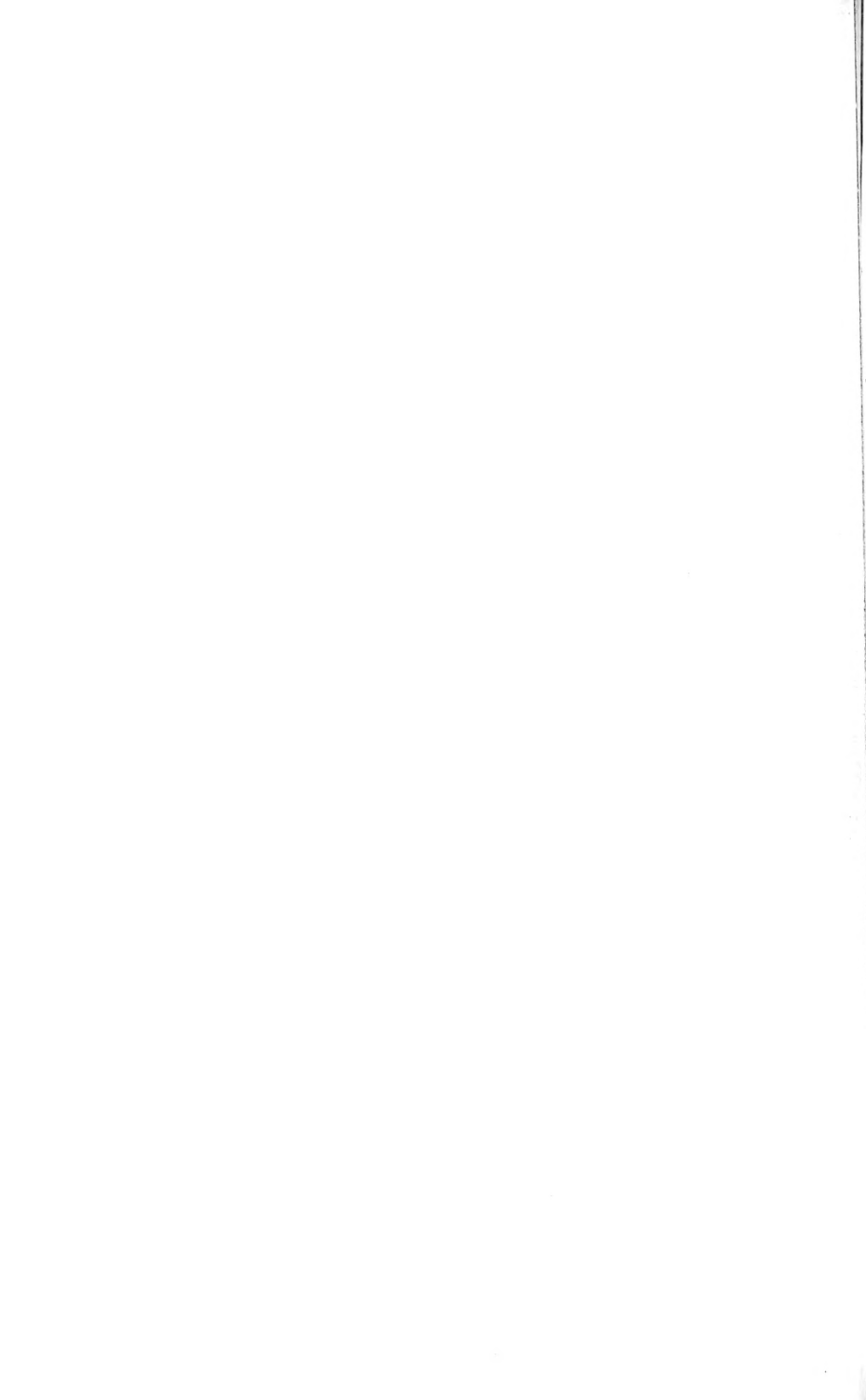



SIX-SIDED BURDEN BASKET, PAGI ISLANDS.

FOR EXPLANATION OF PLATE SEE PAGE 15.

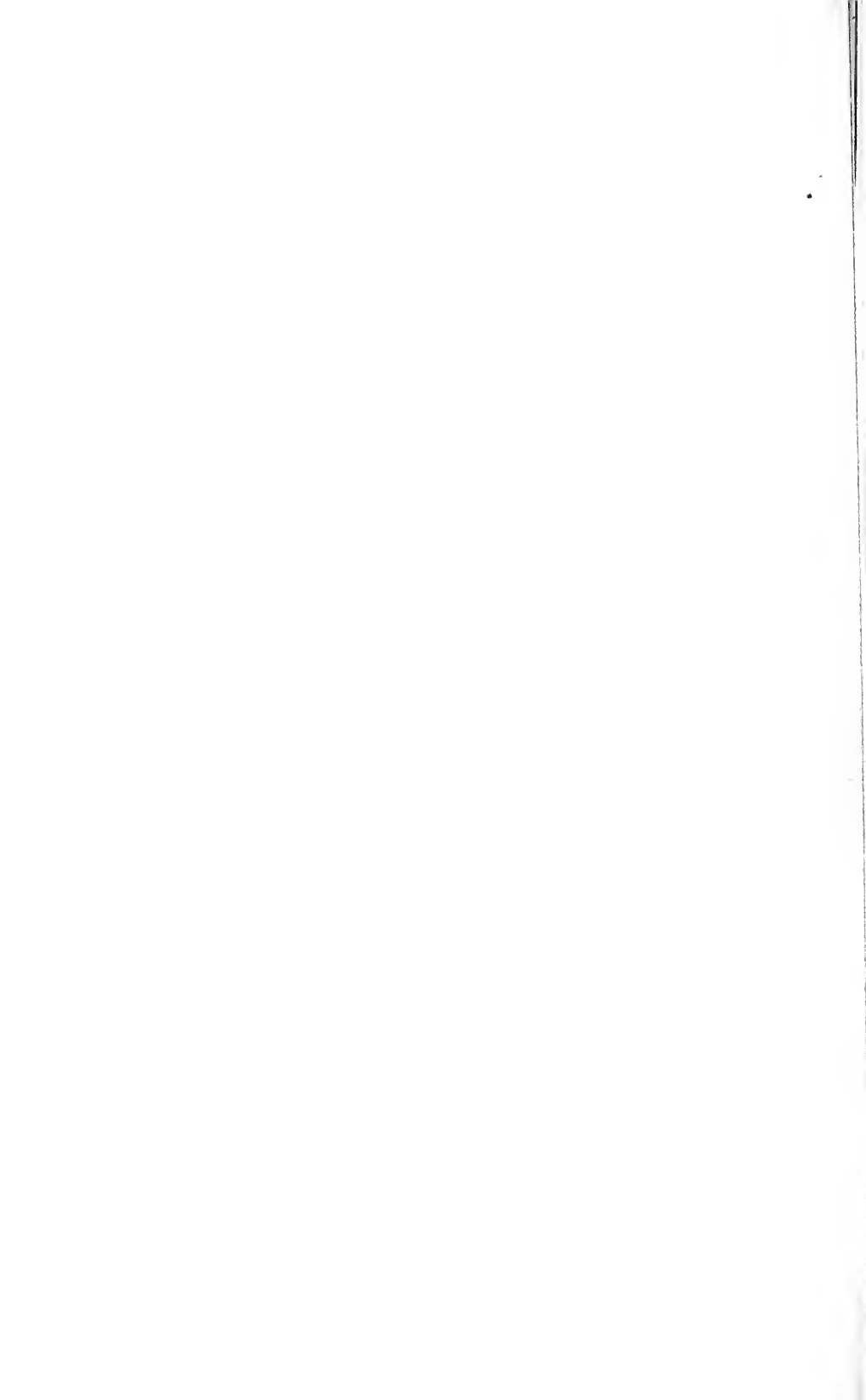





DRILLS AND PRICKERS FOR BASKET-MAKING.

FOR EXPLANATION OF PLATE SEE PAGE 18.





TWILLED BASKET FROM WEST BORNEO.

FOR EXPLANATION OF PLATE SEE PAGE 18.

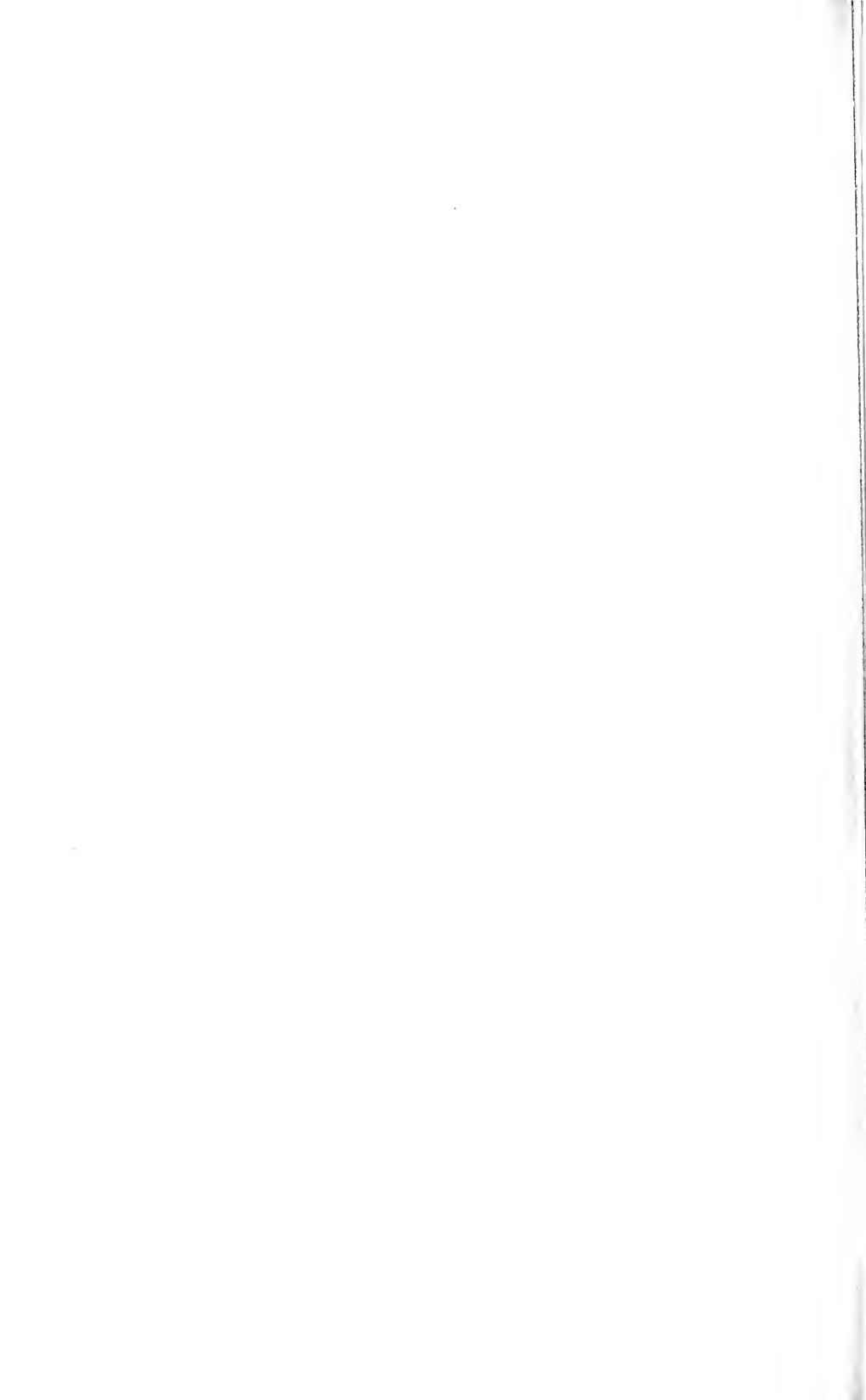



COVERED BURDEN BASKET.

FOR EXPLANATION OF PLATE SEE PAGE 20.

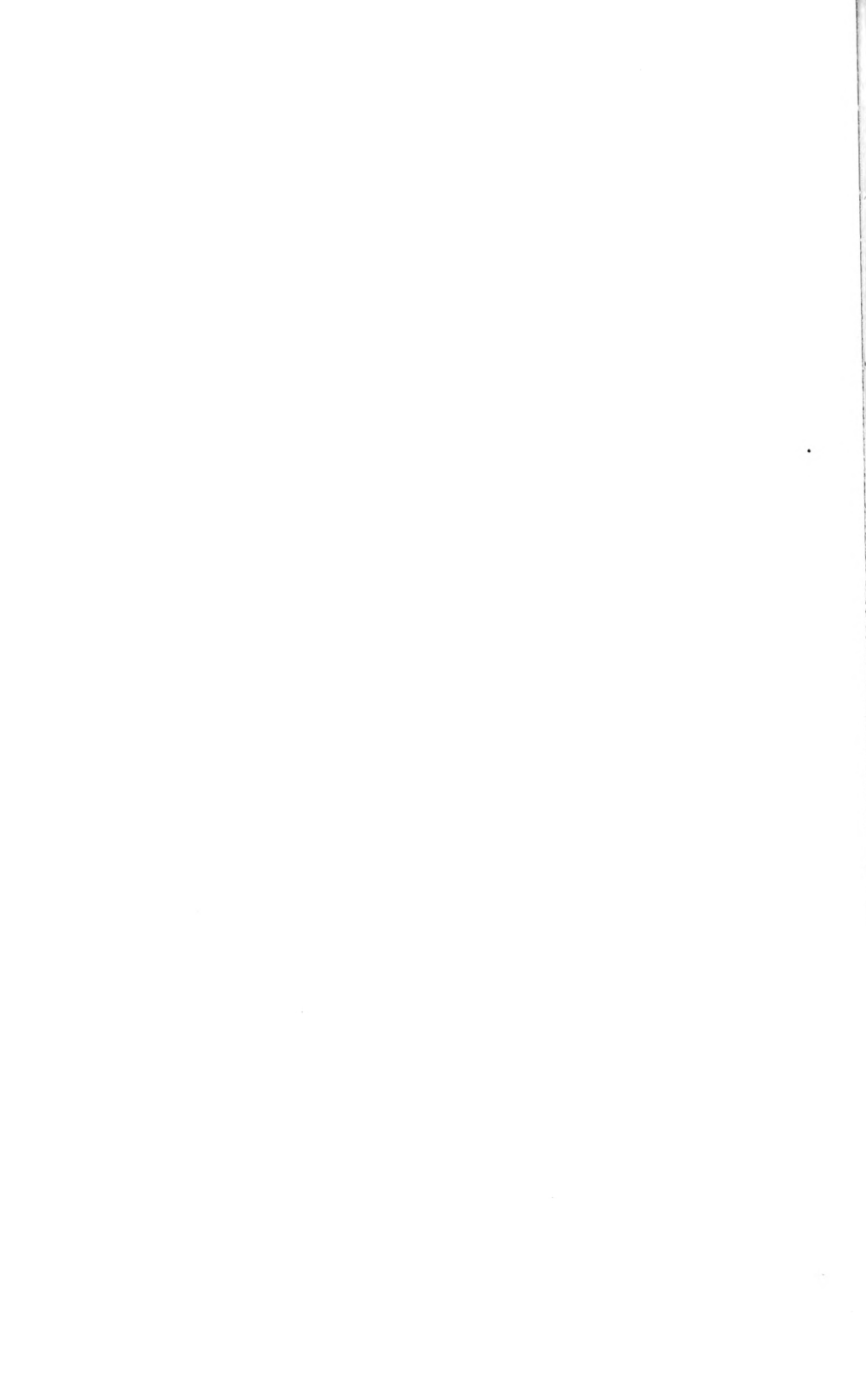

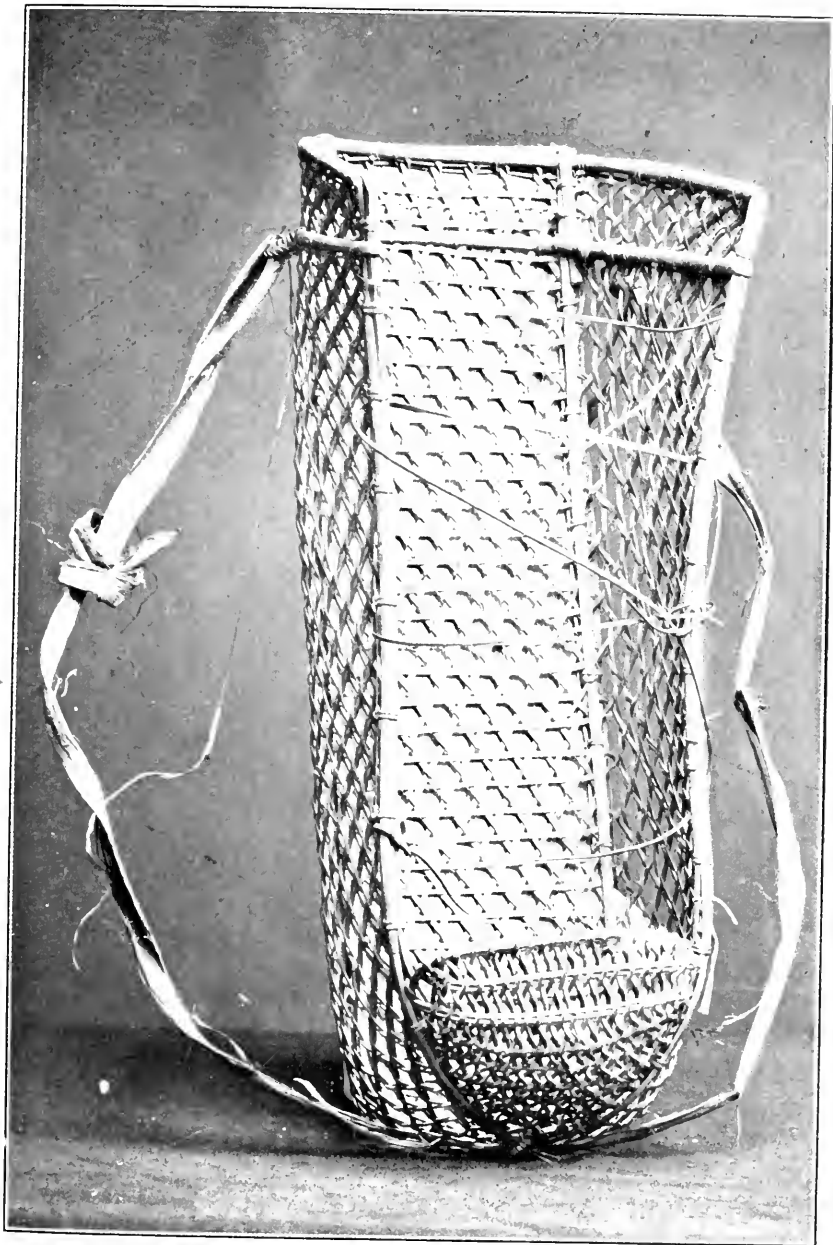

BURDEN CRATE IN HEXAGONAL WORK.

F. 117. ANATI. PLATE SEVEN 22.





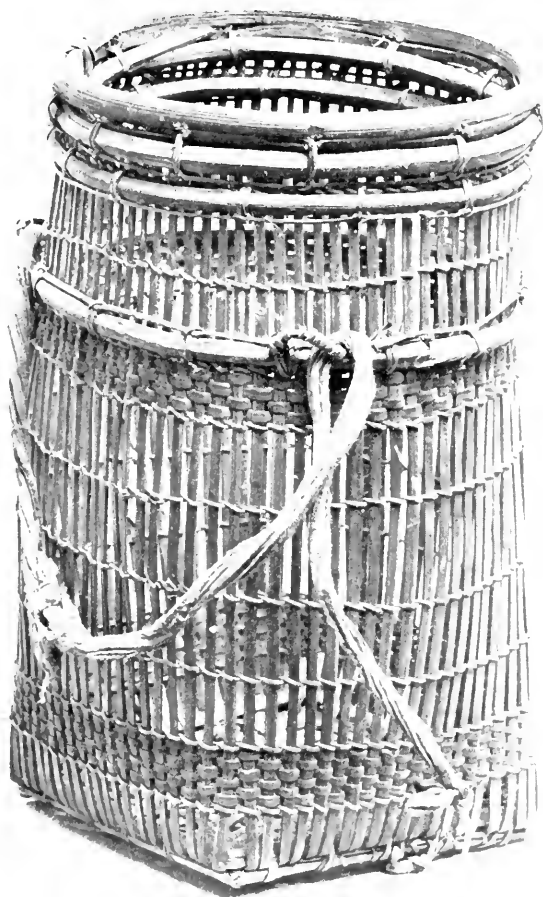

BURDEN BASKET, SHOWING HOOPWORK.

FOR EXPLANATION OF PLATE SEE PAGE 23.

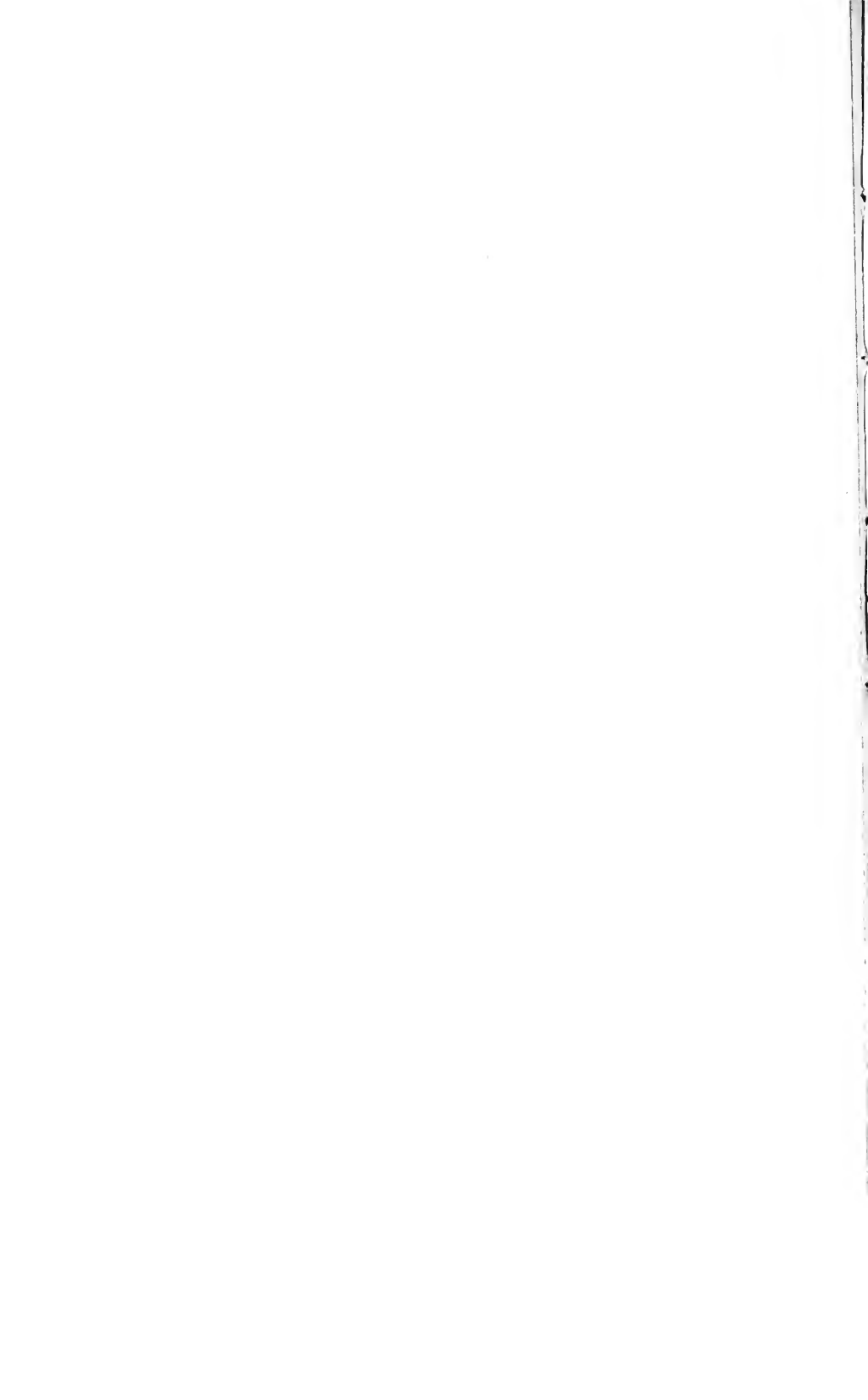



COARSE LEAFWORK BASKET.

FOR EXPLANATION OF PLATE SEE PAGE 30.

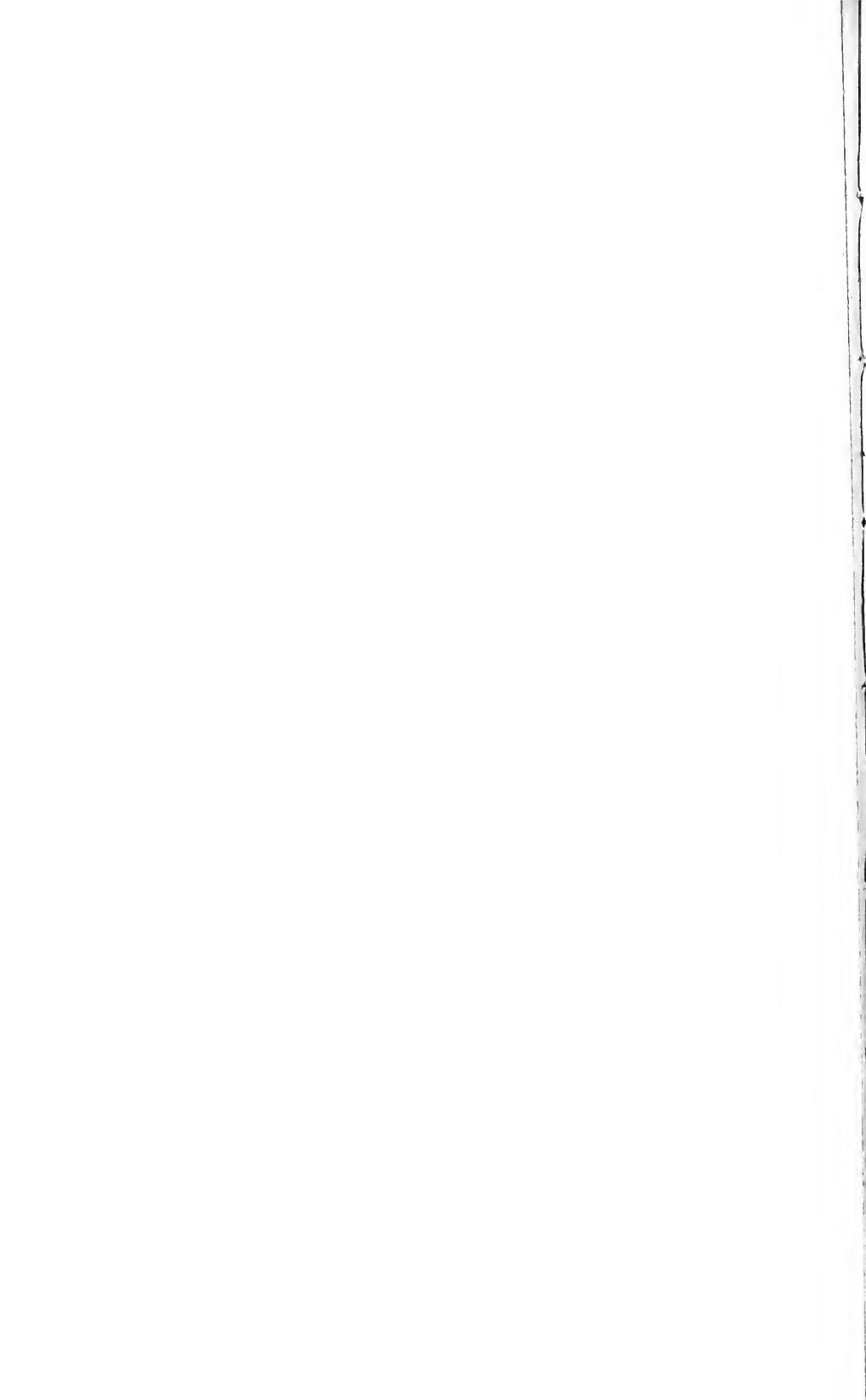

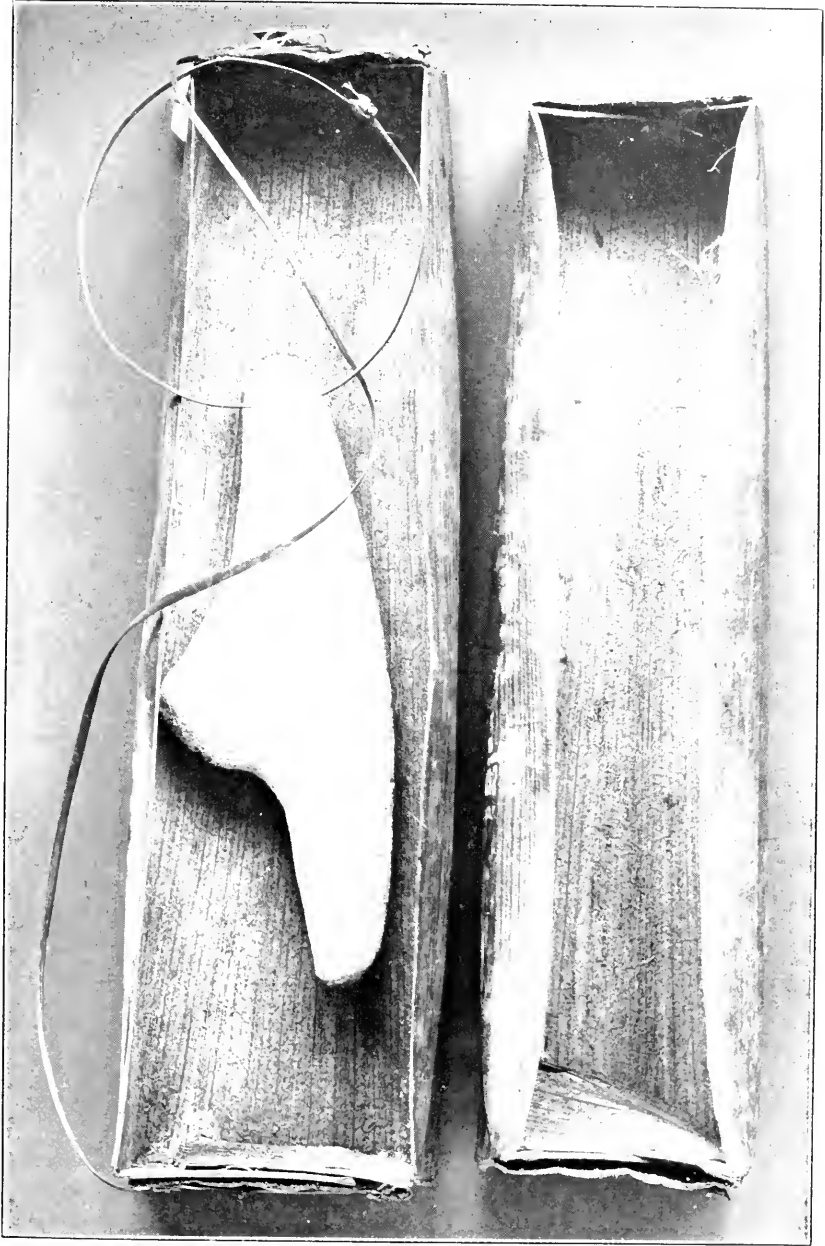

COARSE SPATHEWORK BASKETS.

FOR EXPLANATION OF PLATE SEE PAGE 30.



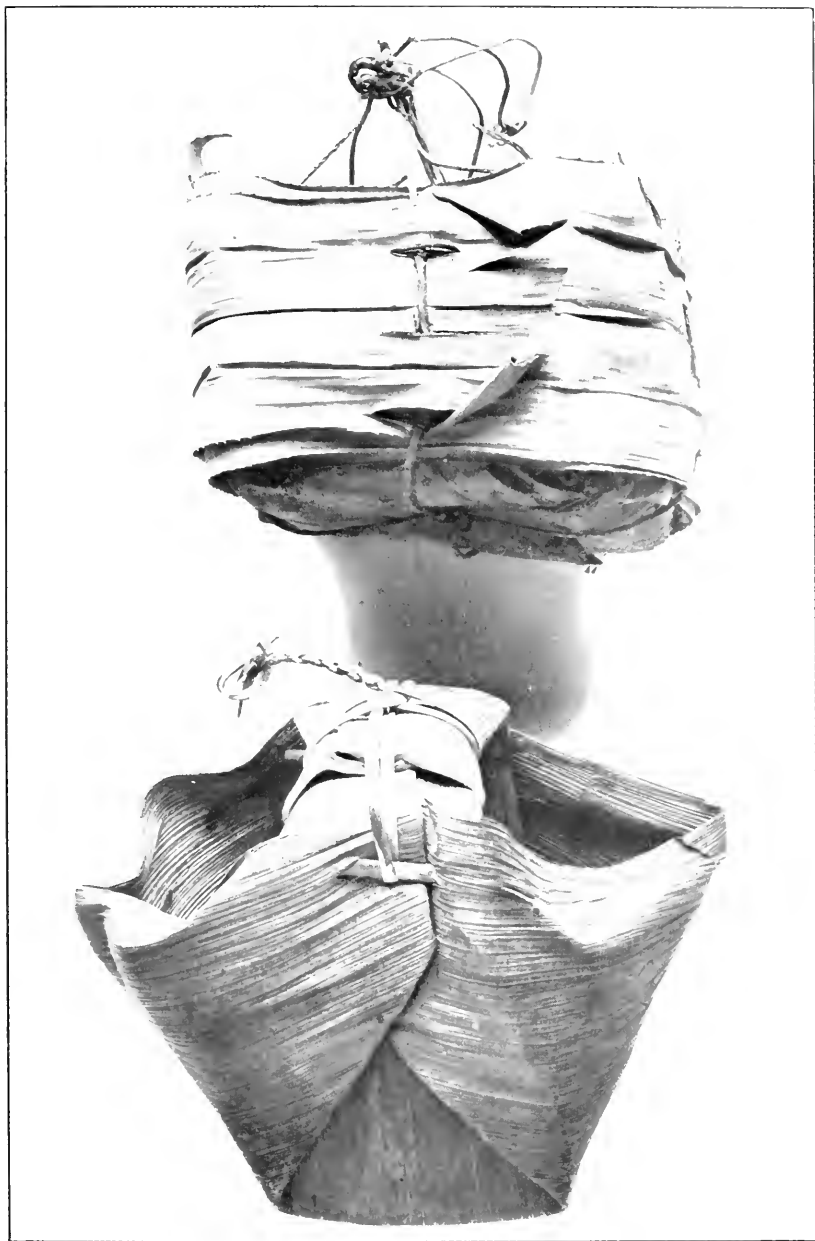

PRIMITIVE BASKET FORMS.

FOR EXPLANATION OF PLATE SEE PAGE 30.





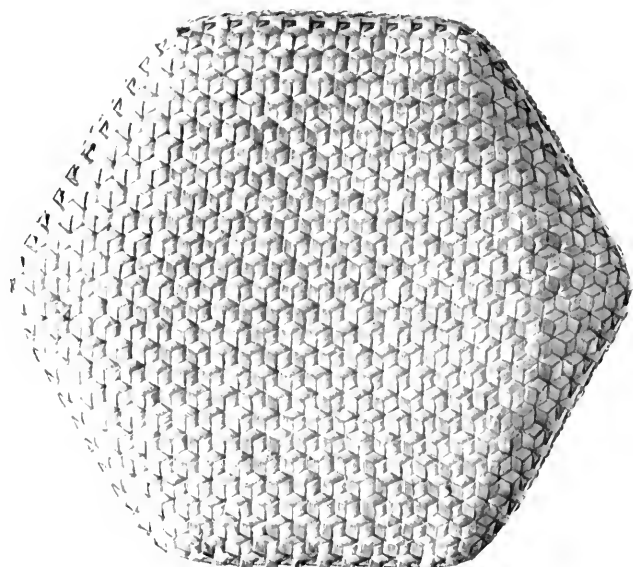
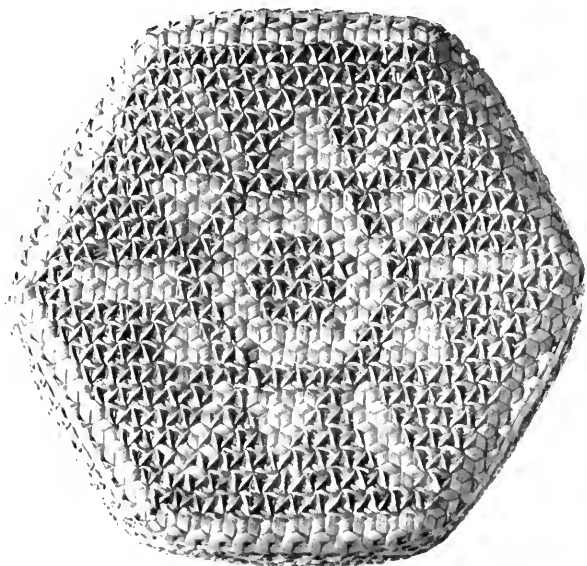

BASKET SHOWING MAD WEAVE.

FOR EXPLANATION OF PLATE SEE PAGE 31.



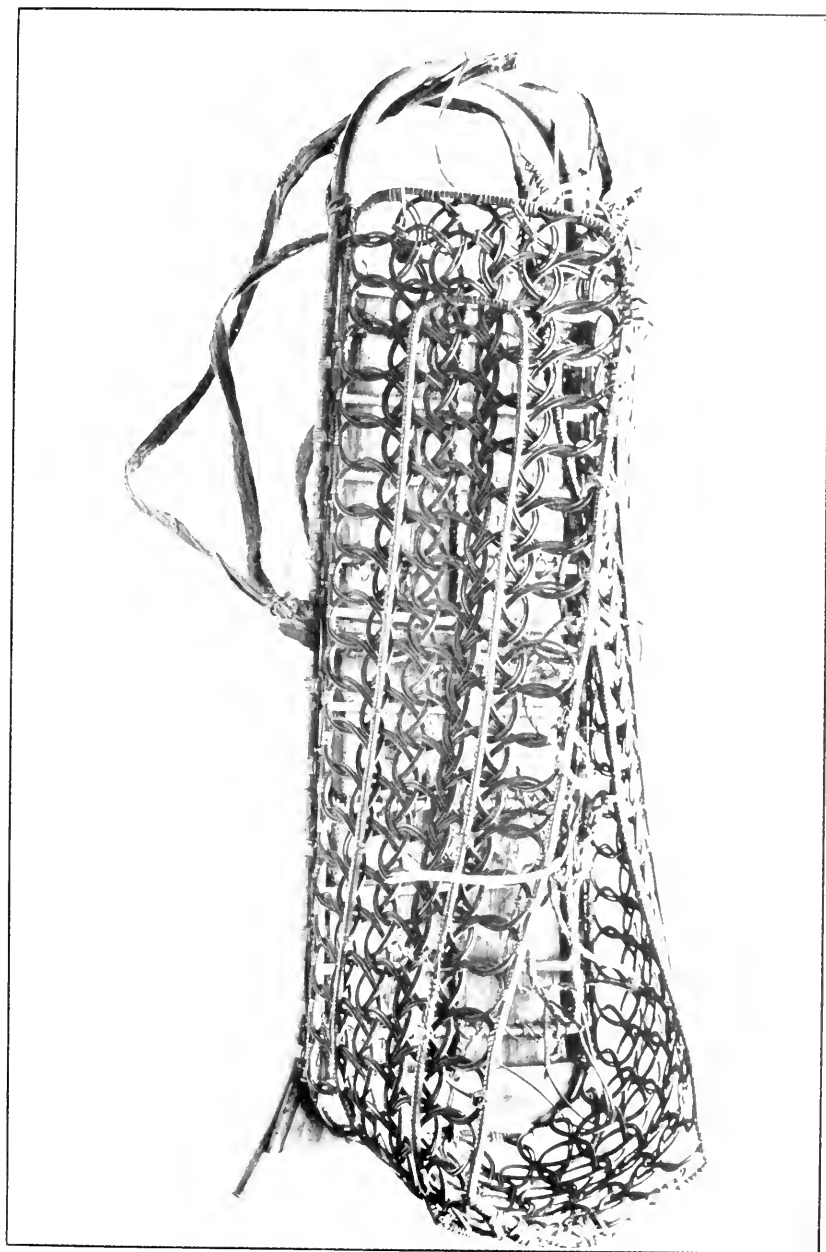

CARRYING FRAME IN SINGLE ELEMENT.

FOR EXPLANATION OF PLATE SEE PAGE 38.





BASKET OF SPATHEWORK, WITH CYCLOID COVER.

FOR EXPLANATION OF PLATE SEE PAGE 38.



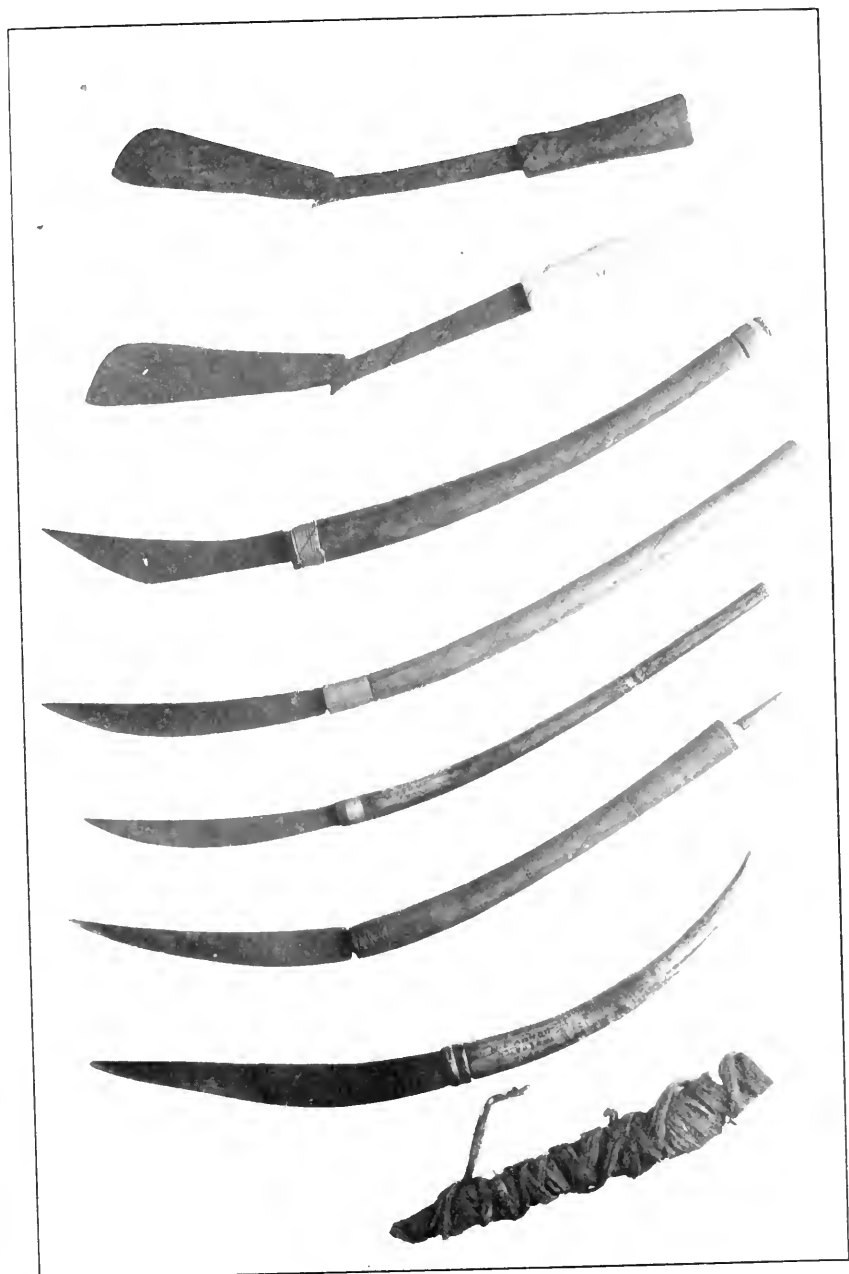

MALAYSIAN BASKETRY TOOLS.

FOR EXPLANATION OF PLATE SEE PAGE 45.





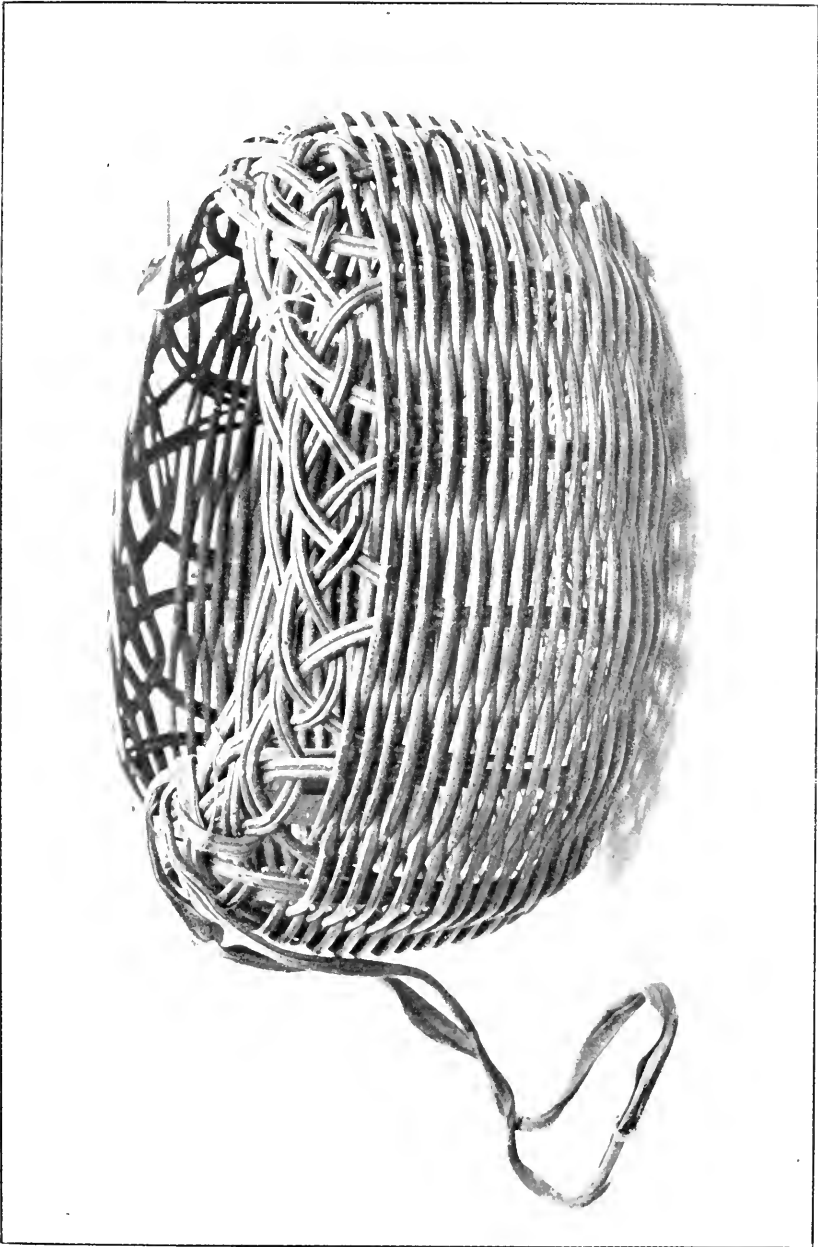

BASKET SHOWING WICKERWORK.

FOR EXPLANATION OF PLATE SEE PAGE 48.



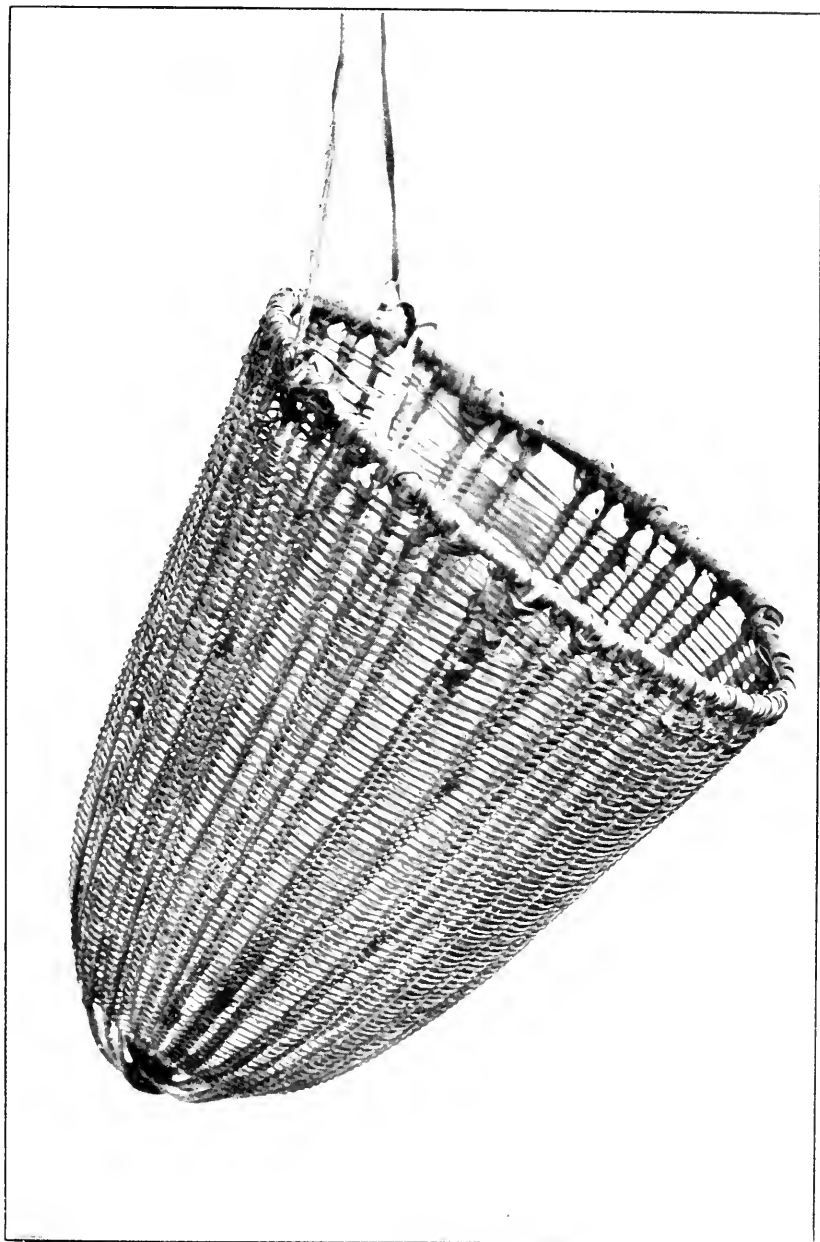

BURDEN BASKET IN SINGLE-WRAPPED WEFT.

FOR EXPLANATION OF PLATE SEE PAGE 49.



## DESCRIPTIONS OF SOME NEW MOSQUITOES FROM TROPICAL AMERICA.

By HARRISON G. DYAR and FREDERICK KNAB,  
*Of the U. S. Department of Agriculture.*

The following new species have been recognized among the material collected for study in the preparation of the forthcoming monograph of Culicidae by Dr. L. O. Howard and the present authors.

### ANOPHELES CRUZII, new name.

We propose this name to replace *Myzomyia lutzii* Theobald, which is preoccupied by *Myzorhynchella lutzii* Cruz, since we do not recognize either *Myzomyia* or *Myzorhynchella* as distinct from *Anopheles*. We note further the existence of *Manguinhosia lutzii* Peryassú,<sup>a</sup> which will also require a new name, if it prove, as we now suppose, that the new genus *Manguinhosia* is not separable from *Anopheles*.<sup>b</sup>

It gives us much pleasure to dedicate this interesting species to Dr. Oswaldo Cruz, the well-known hygienist and bacteriologist of Rio de Janeiro.

The larva has been discovered by Mr. A. H. Jennings in the Panama Canal Zone, living in the water between the leaves of bromeliaceous plants, which appears to be its only habitat.

### AËDES EPIACTIUS, new species.

*Female*.—Proboscis long and slender, black; palpi entirely black-scaled; vertex of the head anteriorly with broad whitish scales, posteriorly with darker scales; thorax deep brown-scaled, with slight bronzy luster and with whitish markings; these markings consist of two very broad outcurved bands on the anterior half of the mesonotum, which become approximated and narrowed at the middle, and run parallel with each other to the scutellum; the sides of the meso-

<sup>a</sup> Os Culicídeos do Brazil, Trabalho do Instituto de Manguinhos, 1908, p. 112.

<sup>b</sup> We would suggest the name *Anopheles percyassui* as a substitute, in honor of the author of the paper here cited.

notum and the hind margin of the scutellum are whitish-scaled; pleura with patches of white scales; abdomen black-scaled above, with rather narrow white basal bands, black and white-banded beneath; the wing-veins are clothed with long and narrow dusky scales; legs black, the knees white, involving both ends of the joints; the front legs with base and apex of the first tarsal joint and the base of the second white-ringed; middle legs with the base and apex of the first tarsal joint narrowly white-ringed, base and apex of the second joint still more narrowly so, the base of the third joint narrowly ringed; hind legs with the last tarsal joint entirely white, the remaining ones broadly white-ringed at base and apex; front and middle tarsal claws toothed, the hind ones simple. Length, 4 mm.

In the male the palpi are long, but do not attain the apex of the proboscis by about one-fourth its length, sparsely hairy, black-scaled without annulations; the head is densely whitish-scaled; the mesothoracic markings are similar to those of the female, but the white scaling is heavier; the antescutellar bare space is surrounded by white scales, which are poorly indicated in the female; abdomen black-scaled above, with basal white bands, black and white-banded beneath. Length, 4 mm.

Ten specimens from Córdoba, Mexico, and Almoloya, in the State of Oaxaca, Mexico, bred from larvae in holes or hollows in bowlders in stream beds. (F. Knab.)

*Type*.—Cat. No. 11963, U.S.N.M.

This species is closely related to *Aedes atropalpus* Coquillett, but differs in the coloration of the thoracic markings.

*AÈDES CUNEATUS*, new species.

*Female*.—Proboscis rather long, black-scaled; palpi entirely black-scaled; occiput pale yellowish-scaled, with a brown spot at each side; mesonotum deep brown-scaled, with slight luster, and with two narrow pale yellowish subdorsal stripes; these stripes are thickened along the median portion and become much narrowed on the posterior third, reaching the scutellum outwardly of the antescutellar bare space; they have a more or less distinct brassy luster; there are a few of these yellowish scales along the sides of the antescutellar bare space and the mid-lobe of the scutellum is clothed with similar scales; abdomen black-scaled above, without bronzy luster, with cream-white lateral basal segmental triangular patches; beneath cream-white scaled, with apical black segmental bands; wings with dark narrow scales along the veins; legs black-scaled, with bronzy luster; femora ventrally and basally white; tibiae of all the legs whitish-scaled on the inner side; tarsi not ringed; claws all toothed. Length, 4.5 mm.

In the male the palpi somewhat exceed the proboscis, black-scaled, with bluish luster, the terminal segments clothed with numerous long hairs; head densely yellowish scaled on the occiput, with a silvery luster; the yellowish thoracic stripes are much more diffuse behind the middle than in the female: the stripes become greatly expanded on the sides and they also coalesce more or less with the yellowish scaling around the antescutellar bare space; the abdomen is black-scaled above, the second segment with pale basal band, the succeeding segments with lateral basal triangular segmental white patches; the under surface white-scaled, with narrow apical black bands on the segments. Length, 5.5 mm.

Thirty-five specimens from Córdoba, Mexico, bred from larvæ in temporary puddles. (F. Knab.)

*Type*.—Cat. No. 11964, U.S.N.M.

AËDES ARGENTESCENS, new species.

*Female*.—Proboscis long and slender, black-scaled; palpi black-scaled; head with the occiput clothed with silvery scales, a large and dark spot on each side; mesonotum clothed with deep brown scales and with two subdorsal lines of silvery scales; these lines are much broadened along their middle third, becoming much attenuated posteriorly, reaching the scutellum well to the sides of the antescutellar bare space; bare space bordered with silvery scales; scutellum silver-scaled; abdomen deep black, with coppery luster above, and with lateral basal segmental triangular silvery white spots; beneath creamy white, with large triangular black apical segmental lateral spots, which do not unite to form bands; wings with dark long and narrow scales along the veins; legs dark-scaled, with pronounced bronzy luster; the femora pale at base and beneath, tibiæ narrowly pale-scaled on the under side; tarsi not ringed; claws toothed on all the feet. Length, 2.5 mm.

In the male the palpi exceed the proboscis, black-scaled, the terminal portion densely clothed with long black hairs; head with the vertex clothed with dull silvery scales; the markings of the mesonotum similar to those of the female, but the submedian stripes greatly expanded on the middle portion; abdomen black-scaled above, with slight coppery luster, the basal segmental lateral spots becoming united into bands on segments 3, 4, 6, and 7, eighth segment mostly whitish scaled. Length, 3.5 mm.

Six specimens from Córdoba, Mexico, and Almoloya, State of Oaxaca, Mexico, bred from larvæ in temporary puddles. (F. Knab.)

*Type*.—Cat. No. 11965, U.S.N.M.

The light markings show a silvery metallic luster, with a grayish cast, which varies in intensity in different specimens.

## AÈDES HARUSPICUS, new species.

*Female*.—Proboscis rather short, slender, brown-scaled, with a sprinkling of lighter ones, a light ring near the middle; palpi dark-scaled; occiput clothed mostly with whitish scales and with four quadrate patches of darker scales; mesonotum bright brown-scaled, mottled with patches of white scales, these white scales densest in the region before the scutellum; scutellum clothed with shining whitish scales; scales of the pleura white; abdomen black-scaled above, with broad apical soiled white bands on all but the last segment; beneath mottled, with dull whitish and light brown scales, the segments becoming lighter apically, but without defined bands; femora and tibiae black-scaled, with a sprinkling of lighter scales, a whitish ring on each femur toward the apex; tarsi black, with white basal rings, becoming successively narrower on each joint; wings broad, the scales on the veins black and white, giving a mottled effect; claws simple. Length, 3.5 mm.

*Male*.—The abdominal bands are clearer white and narrower than in the female; otherwise the coloration is similar.

Twenty-one specimens, Port Antonio, Jamaica, bred from larvae in seaside pools, November 15, 1906. (M. Grabham.)

*Type*.—Cat. No. 11995, U.S.N.M.

We expected that Doctor Grabham would himself describe this species, but after the destruction of his collection by the earthquake he has requested us to describe it from the specimens he had previously sent us.

## AÈDES HORRIDUS, new species.

Proboscis and palpi clothed with violet-black scales; occiput whitish-scaled, with a violet-black spot at the side; mesonotum broadly yellowish white-scaled at the sides, a band of deep brown scales occupying about one-third of the width of the disk and extending back to the antescutellar space, the lateral yellowish white scales surrounding the antescutellar space behind; scutellum yellowish white-scaled; postscutellum densely yellowish white-scaled; abdomen above violet blue with lateral apical yellowish spots on all but the last segment, beneath yellowish-scaled, the seventh segment with basal violet scales, eighth segment entirely violet-scaled. Legs deep violet-scaled, the basal two-thirds of the femora yellowish, the knees silvery white, the hind legs with the scales on the tibiae and tarsi roughened, suberect, the last two joints white. Length, 4.5 mm.

Fifty-six specimens: Victoria, Texas, May 31 (W. E. Hinds); Cypress Bayou, Texas, August 23, 1903 (J. D. Mitchell); Greenville, Texas, June 30, 1904 (H. S. Barber); Dallas, Texas, June 28 (H. S. Barber); Dennison, Texas, June 24 (H. S. Barber); Westpoint, Mississippi, August 11, 1904 (H. S. Barber); Corinth, Missis-



Mississippi, August 14 (H. S. Barber); Jackson, Mississippi, August 8, 1904 (H. S. Barber); Vanburen, Arkansas, July 6, 1904 (H. S. Barber); Fort Smith, Arkansas, July 8 (H. S. Barber); Little Rock, Arkansas, July 11, 1904 (H. S. Barber); Danville, Arkansas, July 10 (H. S. Barber); Helena, Arkansas, July 30 (H. S. Barber); Chattanooga, Tennessee, August 20, 1904 (H. S. Barber); Rives, Tennessee, July 27 (H. S. Barber); Wister, Oklahoma, July 2 (H. S. Barber); Woodstock, Virginia, August 4, 1904 (F. C. Pratt); Plummer's Island, Maryland, July 18, 1904 (R. P. Currie).

*Type*.—Cat. No. 11999, U.S.N.M.

This species has been identified heretofore as *Janthinosoma lutzii* Theobald and *Janthinosoma albipes* Theobald, but differs obviously from these more southern forms.

#### AËDES ALDRICHI, new species.

Similar to *A. hirsuteron* Theobald and *A. aestivalis* Dyar, but the vestiture of the occiput and the sides of the disk of the mesonotum are frosted white with a very slight yellowish cast; the anterior angles of the mesonotum are not brown-scaled; the abdomen has a distinct bronzy luster; the stems of the forked cells are longer; the species is smaller; otherwise the three species are very similar. Length, 3.5 mm.

Six specimens, all females, Market Lake, Idaho (J. M. Aldrich).

*Type*.—Cat. No. 12010, U.S.N.M.

The specimens were sent us by Professor Aldrich mixed with *A. idahoensis* Theobald. Aldrich's remarks, quoted by Theobald,<sup>a</sup> obviously refer to this small species and not to *idahoensis*, which is larger. We take pleasure in naming this species for Prof. J. M. Aldrich.

#### CULEX CHRYSNOTUM, new species.

*Female*.—Proboscis black-scaled, rather long, gradually enlarged toward the apex; palpi black-scaled, with a few metallic scales at the apices; occiput clothed with golden scales, becoming brownish at the sides, margins of the eyes whitish-scaled; mesonotum clothed with narrow golden scales, the posterior portion dark brown-scaled, two golden lines extending from the golden area backward to the scutellum on each side of the antescutellar bare space; scutellum golden-scaled; plenra with whitish scales; abdomen depressed, blunt at the apex, dark-scaled, with strong coppery luster and dark blue reflections in some lights, no dorsal segmental bands; segments 5, 6, and 7 with silvery basal lateral spots; beneath the segments have broad silvery white bands at the bases, the apices dark-scaled, with coppery luster; wings with narrow dusky scales along the veins; legs dark-scaled.

<sup>a</sup> Mon. Culicid., III, 1903, p. 250.

with strong bronzy luster, the ventral surface of the femora silvery-scaled, the inner side of the tibiae obscurely silver-scaled, the knees touched with silver scales; tarsi not ringed; claws simple. Length, 3 mm.

*Male*.—Proboscis long and slender, enlarged at the apex; palpi considerably longer than the proboscis, black-scaled, without annulations, the apical portion clothed with long black hairs; head and thoracic markings as in the female; abdomen dark-scaled above, with coppery luster; segments 4 to 8 with basal lateral silvery spots; the under surface with silvery basal segmental bands. Length, 3 mm.

Nine specimens, Ancon, Canal Zone, Panama; Cartagenita, Paraiso District, and Miraflores in the Canal Zone, bred from larvae in a ditch, from a small patch of algae beside railroad track, and from a swamp. (A. H. Jennings.)

*Type*.—Cat. No. 11966, U.S.N.M.

Similar to *C. spissipes* Theobald and *C. fur* Dyar and Knab, but easily distinguished by the narrow wing-scales and the more extensive golden area of the mesonotum.

CULEX DAUMASTOCAMPA, new species.

*Female*.—Proboscis long and slender, swollen at the apex; palpi black-scaled; occiput golden-scaled, with black scales sparsely intermixed, a large dark spot on each side; thorax deep brown scaled, the front and lateral margins on the anterior half very broadly bright golden-scaled; scutellum dark-scaled; abdomen dark-scaled above, with bronzy luster, slightly lighter colored beneath, but without distinct banding; scales along the wing veins long and narrow, darkly colored; legs dark-scaled, with bronzy luster; hind legs with the under surface of the femora silvery white-scaled, the apices of the tibiae and a rather broad ring at the base of the first tarsal joint silvery white-scaled; second and third tarsal joints very narrowly silver-white-ringed at the bases, the rings obsolete on the fourth and fifth joints; front and middle legs without rings; tarsal claws simple. Length, 2 mm.

*Male*.—Palpi long and slender, nearly as long as the proboscis, black-scaled, without annulations; head and thoracic markings as in the female; abdomen dark-scaled above, with strong coppery luster; beneath the scaling is more brassy, but there are no segmental bands; knees of the hind legs silvery scaled; tibial and tarsal markings as in the female. Length 2 mm.

Three specimens, Porto Bello, Fort San Felipe, Panama, bred from larvae in water between the leaves of bromeliaceous plants. (A. H. Jennings.)

*Type*.—Cat. No. 11967, U.S.N.M.

## CULEX PINAROCAMPA, new species.

*Female*.—Proboscis moderately long and slender, not distinctly swollen at the tip; black-scaled above and beneath; palpi black-scaled; occiput clothed with recumbent whitish and bronzy brown scales and with upright dark forked ones; the whitish scales form a margin to the eyes, a median line and large lateral patches; mesonotum bronzy brown-scaled, with several spots of light scales—a pair of median subdorsal spots, a pair farther forward at the lateral margin, another pair above the roots of the wings; the front margin is light-scaled, as also the margin of the antescutellar bare space; scutellum light-scaled, with a brassy luster; abdomen above black-scaled, with bluish luster, the segments with narrow basal bands, which are broadened mesially on all but the last two segments; on the last three segments the bands are expanded toward the lateral margins; ventrally the abdomen is pale-scaled, the apices of the segments obscurely dark-banded; femora dark-scaled above, light-scaled beneath nearly to the apices, knees yellowish white-scaled; tibiae yellowish white-scaled at bases and apices, tarsi of all the legs with the first, second, third, and fourth joints yellowish white-ringed at bases and apices; mid and hind legs with the fifth tarsal joint entirely yellowish white-scaled; last tarsal joint of the forelegs in part obscurely bronzy-scaled; wings with the scales along the veins dusky, long, and very narrow; claws simple. Length, 5.5 mm.

*Male*.—Proboscis stouter than in the female, black-scaled, with a white mark on the ventral surface before the middle; palpi long and slender, dark-scaled, longer than the proboscis, with narrow yellowish white annulations, more than half of the apical portion clothed with long hairs; head and thoracic markings as in the female; abdomen long and slender, black-scaled above, with clear white basal segmental bands, broader than in the female, the eighth segment nearly entirely white-scaled; venter light-scaled, with apical dark bands, lateral margins of the abdomen with numerous long pale cilia; tarsi marked as in the female. Length, 5 mm.

One hundred and seventeen specimens, Córdoba, Mexico, bred from larvæ in puddles along the Rio San Antonio. (F. Knab.)

*Type*.—Cat. No. 11968, U.S.N.M.

## CULEX CONSTERNATOR, new species.

*Female*.—Proboscis long and slender, not distinctly swollen at the apex, entirely dark-scaled, with bronzy luster; palpi nearly one-fourth the length of the proboscis, slender, dark-scaled, with bronzy luster; occiput dark-scaled, the margins of the eyes distinctly and rather broadly silver-white-scaled; mesonotum dark brown scaled, with slight luster; pleura green, with patches of white scales; abdo-

men depressed, truncate at tip, clothed above with dark scales, with distinct coppery luster, the bases of the segments with lateral triangular silvery white spots; venter dull whitish-scaled, unbanded; wings with the scales along the veins dusky, long and very narrow; legs dark-scaled, with bronzy luster, the underside of the femora pale-scaled; tarsi not ringed; claws simple. Length, 4 mm.

*Male*.—Palpi long and slender, very slightly longer than the proboscis, dark-scaled, with bronzy luster and without annulations; head and mesothorax colored as in the female; abdomen long and slender, dark-scaled above, with coppery luster, the segments with basal silvery white lateral spots; venter pale-scaled. Length, 3 mm.

Thirty-nine specimens, Córdoba, Mexico, bred from larvæ in water in a hollow tree. (F. Knab.)

*Type*.—Cat. No. 11969, U.S.N.M.

CULEX STENOLEPIS, new species.

*Female*.—Proboscis rather long and slender, black-scaled, labellæ pale-scaled; palpi entirely black-scaled; occiput clothed with pale brownish scales, with brassy luster, the margin of the eyes narrowly white-scaled, broadened into a patch at the sides, numerous erect forked scales particularly basally; mesonotum deep brown-scaled, with bronzy luster and mottled with patches of brassy scales; these scales are most conspicuous along the margins and form two oblique subdorsal bars; anteriorly they form a dorsal patch and are also abundant around the antescutellar bare space and the bases of the wings; scutellum covered with brassy scales; abdomen depressed, truncate at the tip, dull black-scaled above, with narrow white basal segmental bands; beneath the basal bands occupy about half of each segment; wings with the veins clothed with brownish long and very narrow scales; legs black; femora white-scaled beneath except the apical portion; knees white-scaled; tibiæ with their apices pale-scaled, a line of pale scales along their inner surfaces; tarsi of all the legs white-ringed at base and apex of each joint, the front legs very narrowly so, on the hind legs very broadly; last tarsal joint of the hind legs entirely white-scaled; claws simple. Length, 3.5 mm.

*Male*.—Proboscis long, rather slender, black-scaled, with a white ring around the middle, the labellæ pale-scaled; palpi long, exceeding the proboscis, slender, clothed with black scales, narrowly annulated with white, the apical half covered with long black hairs; head and thorax marked as in the female; abdomen deep black-scaled above, without luster, the basal segmental white bands much broader than in the female; legs marked as in the female. Length, 4 mm.

Forty-seven specimens, Córdoba, Mexico, bred from larvæ in water between the leaves of bromeliaceous plants. (F. Knab.)

*Type*.—Cat. No. 11970, U.S.N.M.

## CULEX AIKENII, new species.

*Female*.—Unknown.

*Male*.—Proboscis long and slender, the apical portion somewhat stouter, clothed with brownish and grayish scales, giving a mottled effect, without light ring; palpi very long and slender, slightly thickened in their apical halves, clothed with brownish scales and mottled with grayish ones; the second segment with a broad white ring before the middle; apical half of the palpi clothed with long hairs; occiput clothed with gray and pale brown scales, the margin of the eyes white-scaled, the usual upright dark forked scales present; mesonotum clothed with light yellow-brown and grayish scales, without distinct lines or pattern; abdomen dusky-scaled above, the segments broadly banded with white basally; on the sixth and seventh segments the bands extend along the lateral margins to the apices of the segments; eighth segment mostly black-scaled above; beneath the abdomen is light-scaled without bands, ciliation of the abdominal margins pale, long, and abundant; veins of the wings clothed with pale brownish long and narrow scales, those along the costa black; legs blackish-scaled, with lighter mottling on the femora and tibiae; the tarsi show a faint bronzy luster and are not ringed; under surfaces of the femora pale-scaled; tibiae paler scaled on the inner side. Length, 3 mm.

Three specimens, New Amsterdam, Dutch Guiana, February 17, 1908. (J. Aiken.)

*Type*.—Cat. No. 11977, U.S.N.M.

We realize the undesirability of describing species of *Culex* from the male sex alone, on account of the difficulty of ever associating the proper female; but in this case Doctor Aiken has communicated to us the larva, which makes future identification of the female easy. The larva is almost the exact counterpart of our *Culex regulator*, described from Santo Domingo, but the male adult differs strikingly from the male of *regulator*, so that there is no question but that the two forms are distinct species. It is proper to state that the larva sent us by Doctor Aiken is a whole larva, not the skin from a bred specimen, and therefore the authority for the association rests with him.

Named for Dr. J. Aiken, who collected the specimens and has kindly sent us a series of species from Dutch Guiana.

## CULEX EUMIMETES, new species.

*Female*.—Proboscis moderately long and slender, not swollen at the tip, black-scaled, a rather broad white ring at the middle; palpi slender, black-scaled, the apices white-scaled; occiput clothed with brownish scales with brassy luster; eyes narrowly margined with sil-

very white, much broadened at the sides; mesonotum bright brown-scaled, with brilliant bronzy luster and with traces of pale shining scales along the margins and around the antescutellar bare space; mesially there are two subdorsal spots of pale scales; scutellum pale-scaled; abdomen depressed, dull black-scaled, the segments with rather narrow basal white bands; venter pale-scaled, with obscure apical dark bands; wings with the scales along the veins dark, long and very narrow; legs black; femora with the under surface white-scaled; knees narrowly white-scaled; apices of the tibiae white-scaled, the inner side of the tibiae and tarsi with a line of pale scales; tarsi of all the legs white-ringed at both ends of the joints, the rings very broad on the hind legs, the last tarsal joint of the hind legs white with a small black ring; claws simple. Length, 3.5 mm.

*Male*.—Proboscis rather long, not swollen at apex, white-ringed at the middle; palpi slender, considerably longer than the proboscis, black-scaled, with white annulations, the apical two-thirds clothed with long hairs; head and thoracic markings as in the female; abdomen long and slender, dull black-scaled above, the segments with very broad basal white bands, expanded laterally on the sixth, seventh, and eighth segments; venter pale-scaled, with an indication of subapical dark banding; legs marked as in the female. Length, 3.5 mm.

Ten specimens, Orizaba, Mexico, bred from larva found in a puddle of drainage water in the suburbs of the city. (F. Knab.)

*Type*.—Cat. No. 11971, U.S.N.M.

The adult so closely resembles that of *C. stigmatosoma* Dyar that it is almost impossible to distinguish them; but the larvae are very dissimilar.

SABETHES TARSOPUS, new species.

*Female*.—Proboscis moderately long, slender, swollen at the apex, clothed with black scales, with a metallic blue luster; palpi black-scaled, with blue luster; prothoracic lobes brilliantly blue-scaled; mesonotum similar, becoming paler in color with a greenish silvery tinge on the scutellum; pleura and coxæ silver-scaled; metanotum with a group of bristles near the apex, its surface clothed with flat silver scales; postscutellum brilliantly light blue-scaled; abdomen with metallic blue scales above and at the sides, beneath silvery white-scaled, the colors separated in a straight line; tip of the abdomen with coarse black bristles; legs mostly metallic blue-scaled, with purple luster; the front and mid legs ciliate, hind pair simple; the front legs are ciliate on the apical half of the tibiae and the base of the first tarsal joint, the ciliation following the upper and lower surfaces; the apical portion of the second and all of the following joints silvery white marked beneath; mid-legs with the ciliation on the apical half of the tibiae and the first and second tarsal joints, very

long along the dorsal margin of the tibia and first tarsal joint; second tarsal joint, including its ciliation, silvery white; third tarsal joint and most of the fourth silver-white, the apex of the fourth above and all of the fifth black-scaled; there is an elongate white spot on the ventral surface of the tibia just above the ciliation; hind legs without ciliation and with the fourth and fifth tarsal joints silver white on the inner side. Length, 4.5 mm.

Three specimens, Bocas del Toro, Panama, September 28, 1903 (P. Osterhout); Paraiso, Canal Zone, Panama, November 1, 1907 (A. H. Jennings); Córdoba, Mexico, March 16, 1908 (F. Knab).

*Type*.—Cat. No. 11972, U.S.N.M.

This and the following species are close to the one identified as *Sabethes longipes* Fabricius by Theobald, but wrongly, as Fabricius's description obviously implies another insect.

SABETHES SCHAUSI, new species.

*Female*.—Proboscis very slender, swollen at the tip, rather short, dark-scaled, with blue luster; palpi dark-scaled; occiput clothed with light metallic blue scales; prothoracic lobes clothed with pale iridescent scales; mesonotum with bright greenish and iridescent scales, becoming blue upon the scutellum; pleura and coxæ silver-white-scaled; metanotum covered with silver scales, a group of bristles near the apex; abdomen above and at the sides dark-scaled, with deep blue and purple iridescence; venter silvery white scaled; tip of the abdomen with coarse black bristles; sixth segment black-scaled beneath along median line; legs mostly dark metallic blue-scaled with purple reflection, all three pairs ciliate, the cilia forming broad paddles on the middle pair; front legs ciliate along nearly the entire upper surface of the tibiae and two-thirds of the lower surface; first tarsal joint ciliate along upper surface; second tarsal joint white-marked on the apical half of the inner surface; mid-legs with the apical half of the tibiae, all of the first tarsal joint broadly ciliate along front and hind margin; second tarsal joint ciliate along hind margin; the tibiae have a long white dash on the inner side above the paddle; the second joint with its ciliation and the third joint are snow white, fourth and fifth black-scaled; hind legs with the apical third of the tibiae ciliate, the ciliation rather short; fourth and fifth joints white-scaled on the inner side; some dark scales at their apices. Length, 7 mm.

One specimen, Omai, British Guiana. (W. Schaus.)

*Type*.—Cat. No. 11973, U.S.N.M.

It gives us pleasure to dedicate to our good friend, Mr. William Schaus, the only specimen of mosquito that he has sent us from tropical America.

## LESTICOCAMPA SCHEDOCYCLIA, new species.

*Female*.—Proboscis long, moderately slender, not swollen at the apex, clothed with black scales with bluish iridescent reflection; palpi slender, about two-fifths the length of the proboscis, clothed with black scales, with blue and iridescent luster; occiput clothed with flat iridescent scales, blue and green predominating, and quite dark in appearance in some lights, in other lights entirely silvery; there is a large silver patch on the vertex; prothoracic lobes well separated, the upper portion clothed with dark blue and violet iridescent scales, the lower portion with silvery white scales; mesonotum brown-scaled, with bronzy luster; scutellum clothed with flat, light greenish, and iridescent scales; metanotum with a group of setae near the apex, without scales; postscutellum clothed with blue and green iridescent scales; abdomen long and slender, subcylindrical, blunt at the end, clothed above and at the sides with dark scales, which show blue, green, and bronzy reflections; beneath white-scaled, the lateral margins shallowly indented on each segment; tip of the abdomen with numerous coarse bristles; veins of the wings clothed with bronzy brown broad scales; legs mostly dark-scaled, with blue, bronzy, and iridescent reflections; femora pale-scaled beneath; front and mid legs without white markings; hind legs with a white spot at the apex of the femora beneath, a white spot on the under sides of the tibiae beyond the middle, the tarsi with basal white dashes on the under side, becoming progressively longer on each segment and reaching nearly to the apex of the fifth joint; legs without ciliation. Length, 4 mm.

Two specimens, interior of Nicaragua, without precise locality. (Dr. F. W. Thornton.)

*Type*.—Cat. No. 11974, U.S.N.M.

## PROSOPOLEPIS JOCOSA, new species.

*Female*.—Proboscis moderately long and slender, the apical portion swollen, black-scaled; palpi short, slender, black-scaled; clypeus blackish, clothed with silvery gray scales; eyes contiguous; occiput dark-scaled, with faint metallic reflection, the margin of the eyes narrowly silver-gray-scaled; prothoracic lobes well separated, prominent, clothed with blackish scales, with faint luster; mesonotum dark-scaled, with faint metallic luster and with grayish reflections over the roots of the wings and on the scutellum; metanotum with a group of setae near the apex and without scales; postscutellum with numerous long pale hairs and with dark scales like those of the abdomen; abdomen clothed above with blue-black scales, with very faint metallic luster; beneath silver-white-scaled, the lateral margins straight; tip of the abdomen with numerous coarse bristles; scales of the wing-



veins brown, broad, those along the costa blue-black; legs dark-scaled, with blue and bronzy luster and without white markings; femora whitish beneath. Length, 4 mm.

One specimen, Caldera, Canal Zone, Panama. (A. H. Jennings.)

*Type*.—Cat. No. 11975, U.S.N.M.

The genus *Prosopolepis* Lutz was founded on the presence of scales on the clypeus, which is not a fundamental character. However, the species before us is separable from *Lesticocampa* by the slender proboscis of the latter, not enlarged at the tip, and we therefore recognize the generic name.

PHONIOMYIA SIMMSI, new species.

*Female*.—Proboscis long and slender, black-scaled; palpi short, slender, black-scaled; occiput dark-scaled, with bronzy and blue reflections; eyes margined with whitish scales, which are more conspicuous on the vertex; wedge between the eyes white-scaled; prothoracic lobes dark-scaled, with blue reflection; mesonotum dark-brown-scaled, with bluish reflection; metanotum with a group of setæ near the apex, without scales; postscutellum clothed with scales like those of the abdomen; abdomen dark-scaled above, with coppery and blue reflections; beneath silvery white-scaled, the lateral margins straight; tip of abdomen blunt, bristly; wing-veins clothed with brown, rather broad scales; legs dark-scaled, with blue and bronze reflections; under side of the femora and tibiæ whitish-scaled; on the hind legs the tarsi are light-scaled beneath, becoming clear silvery white upon the last tarsal joint. Length, 3.5 mm.

One specimen, Porto Bello, San Felipe, Panama, bred from a larva in water in the leaves of bromeliaceous plants. (A. H. Jennings.)

*Type*.—Cat. No. 11976, U.S.N.M.

Named, at the suggestion of Mr. A. H. Jennings, in honor of Mr. H. Simms, a most efficient sanitary inspector at Empire, in the Canal Zone, Panama.

WYEOMYIA ABASCANTA, new species.

*Female*.—Proboscis moderately long and slender, somewhat swollen at the apex, black-scaled; occiput dark-scaled, with blue and green metallic reflection, the margin of the eyes dull white-scaled; prothoracic lobes dark-scaled, with blue, purple, and bronzy reflections, a patch of silvery white scales at the apex, basal portion silvery white scaled; mesonotum bronzy brown scaled, with dark bluish reflection; pleura silvery white scaled; abdomen dark-scaled above, beneath coarsely white-scaled, the colors separated on the sides in a straight line; legs dark, with bronzy and blue reflections, the mid legs with the apex of the second tarsal joint, all of the third and fourth joints

and part of the fifth silvery white-scaled on the under side. Length, 3.5 mm.

*Male*.—The markings are as in the female.

Two specimens, Trinidad, British West Indies, June. (A. Busck.)

*Type*.—Cat. No. 11983, U.S.N.M.

WYEOMYIA GYNÆCOPUS, new species.

*Female*.—Proboscis moderately long, slender, much dilated toward the apex, black-scaled; palpi black-scaled, with bronzy luster, the tips silvery white; occiput dark-scaled, with green and blue iridescence, the margin of the eyes narrowly silvery white scaled; prothoracic lobes dark-scaled, with bluish iridescence, the apices narrowly silvery tipped, the basal portion mostly white-scaled; mesonotum bronzy brown-scaled, with obscure bluish reflection; abdomen deep bronzy brown above, with blue reflection, beneath coarsely white-scaled, the colors separated on the sides in a straight line; legs dark, with bronzy and bluish reflections, the hind legs with the under side of the fourth and fifth tarsal joints white-marked; on the fourth joint the white extends from the base nearly to the apex, the fifth white at the base. Length, 3.5 mm.

One specimen, Esparta, Costa Rica, September 18, 1905. (F. Knab.)

*Type*.—Cat. No. 11984, U.S.N.M.

WYEOMYIA ABLECHRA, new species.

*Female*.—Proboscis long and slender, dilated at the apex, black-scaled; palpi slender, black-scaled; occiput dark-scaled, with blue and green reflections, the margin of the eyes dull whitish scaled, interrupted on each side below the vertex; prothoracic lobes metallic violaceous, a large patch of silvery scales at the apex, basal portion silvery-scaled; mesonotum dark-scaled, with faint bronzy and blue reflections; abdomen dark-scaled above, with slight blue reflection, beneath white-scaled, the colors separated on the sides in a straight line; legs dark-scaled, with bronzy reflection; on the mid-legs the apical portion of the second tarsal joint and all of the third, fourth, and fifth silvery white beneath; hind legs with a dash of silvery white at the bases of all the tarsal joints beneath. Length, 3.5 mm.

Eighteen specimens, Sonsonate, Salvador, August 16, 1905. (F. Knab.)

*Type*.—Cat. No. 11985, U.S.N.M.

WYEOMYIA ABLABES, new species.

*Female*.—Proboscis long and slender, somewhat enlarged towards the apex, black-scaled; palpi black-scaled; occiput dark-scaled, with blue and green reflections, the margin of the eyes narrowly whitish scaled and forming a distinct silver spot on the vertex; prothoracic lobes dark-scaled, with violaceous luster, the tips silvery-scaled;

mesonotum dark-scaled, with faint bronzy and blue reflections; pleura silvery white-scaled; abdomen black-scaled, above, with slight blue and bronzy reflections, beneath white-scaled, the colors separated on the sides in a straight line; legs dark-scaled, with bronzy and blue luster; on the middle legs the extreme apex of the second tarsal joint and all of the third and fourth white beneath; on the hind legs the fourth and fifth tarsal joints are white beneath except at their extreme apices. Length, 3.5 mm.

*Male*.—Resembles the female in coloration.

Eighteen specimens, selected from a series, Córdoba, Mexico, bred from larvæ in water between the leaves of bromeliaceous plants. (F. Knab.)

*Type*.—Cat. No. 11986, U.S.N.M.

WYEOMYIA ABEBELA, new species.

*Female*.—Proboscis rather long and slender, enlarged toward the apex, black-scaled; palpi black-scaled; occiput dark-scaled, the margin of the eyes clear white scaled, forming a patch on the vertex; prothoracic lobes pearly violaceous in the middle, the tip and base silvery white; mesonotum dull brown-scaled, with obscure bronzy and blue reflection; pleura silvery white-scaled; abdomen dark-scaled above, with faint bronzy and blue luster, beneath coarsely white-scaled, the colors separated on the sides in a straight line; legs entirely dark-scaled, with bronzy and blue reflection, the femora and hind tibiæ light-scaled beneath; tarsi without white markings. Length, 3 mm.

*Male*.—Coloration as in the female.

Six specimens, Córdoba, Mexico, bred from larvæ in water between the leaves of bromeliaceous plants. (F. Knab.)

*Type*.—Cat. No. 11987, U.S.N.M.

WYEOMYIA ABIA, new species.

*Female*.—Proboscis slender, moderately long, much swollen at the apex; palpi dark-scaled; occiput dark-scaled, with obscure blue and green luster, the eyes narrowly margined with dull white scales, the margin interrupted toward the vertex; prothoracic lobes clothed with pearly iridescent scales, the apices without white tips; mesonotum bronzy-scaled, with obscure bluish reflection; abdomen bronzy-scaled above, with bluish reflection, beneath coarsely white-scaled, the colors separated on the sides in a straight line; legs dark-scaled, with bronzy and blue reflections; mid-tarsi with the apical half of the second and all of the third and fourth joints silvery white-scaled on one side; front and hind tarsi unmarked. Length, 3 mm.

*Male*.—Coloration as in the female.

Two specimens, Dominica, West Indies. (F. E. Campbell.)

*Type*.—Cat. No. 11988, U.S.N.M.

## WYEOMYIA ANDROPUS, new species.

*Female*.—Proboscis rather short and stout, swollen toward the apex, black-scaled; palpi black-scaled; occiput dark-scaled, with greenish and brownish reflections, the eyes not distinctly white-margined above, the marginal scales being of a grayish cast; prothoracic lobes dark-scaled, with greenish and bronzy luster and without pale scales on the apices; mesonotum dull brown-scaled, with obscure bronzy and bluish luster; abdomen dark-scaled above, nearly black, beneath yellowish white-scaled, the colors separated on the sides in a straight line; legs dark-scaled, with bronzy and bluish reflections, without white markings on the tarsi. Length, 3 mm.

*Male*.—The proboscis somewhat longer and more slender than in the female, abdomen expanded toward the tip, the claspers widely separated and conspicuous; fore tibiae and tarsi silvery yellowish-scaled beneath, the color whitest and most conspicuous on the second, third, and fourth joints; mid-legs, with the tibia, the basal half of the first tarsal joint silvery white marked beneath, the apical half of the second joint and all of the succeeding joints silvery white marked above and beneath; hind legs entirely dark.

Twenty-six specimens, Porto Bello, Fort San Felipe, and Caldera Island, Porto Bello Bay, Panama, bred from larva in water between the leaves of bromeliaceous plants. (A. H. Jennings.)

*Type*.—Cat. No. 11989, U.S.N.M.

## WYEOMYIA CLASOLEUCA, new species.

*Female*.—Proboscis moderately long and slender, the apical third much swollen, black-scaled; palpi black-scaled; occiput dark-scaled, without light margin to the eyes; prothoracic lobes dark metallic blue-scaled with purple reflection, the apices without lighter scales; mesonotum dark dull brown-scaled, nearly black; abdomen dark-scaled above, with obscure bronzy and bluish reflections, beneath silvery white-scaled, the colors separated on the sides in a straight line; legs dark-scaled, with bronzy and blue reflection; on the hind legs the fourth tarsal joint is silvery white-marked beneath from the base nearly to the apex, the fifth tarsal joint silvery white-marked beneath throughout; fore and mid tarsi entirely dark. Length, 3.5 mm.

Two specimens, Caldera Island, Porto Bello Bay, Panama. (A. H. Jennings.)

*Type*.—Cat. No. 11990, U.S.N.M.

## WYEOMYIA DYMODORA, new species.

*Female*.—Proboscis very long and slender, as in *Phoniomyia*, but slightly swollen at the tip, black-scaled; palpi black-scaled; occiput dark-scaled, with blue and green iridescence, margin of the eyes not

distinctly light-scaled, and without white spot on the vertex; prothoracic lobes dark-scaled, with obscure bluish luster, without light scales at the apices; mesonotum obscurely brown-scaled; abdomen dark-scaled above, with bluish reflection, white-scaled beneath, the colors separated on the sides in a straight line; wings with the scales on the veins elongate, rather narrow; legs dark-scaled, with bronzy and blue reflection, fore and mid tarsi without white beneath; hind tarsi with the fourth and fifth joints silvery white-marked beneath, the fourth joint black at the apex, the white on the fifth joint continuous. Length, 3.5 mm.

Two specimens, Caldera Island, Porto Bello Bay, and Fort San Felipe, Porto Bello, Panama, bred from larvae in water between the leaves of bromeliaceous plants. (A. H. Jennings.)

*Type*.—Cat. No. 11991, U.S.N.M.

The species resembles *W. clasoleuca* Dyar and Knab in coloration, but the long proboscis, almost like that of a *Phonomyia*, and the narrow wing scales will easily separate it.

WYEOMYIA BARIA, new species.

*Female*.—Proboscis moderately long and slender, much swollen apically, dark-scaled; palpi dark-scaled; occiput dark-scaled, with obscure bronzy luster; at the sides the eyes very narrowly white-margined; on the vertex a minute white spot; prothoracic lobes dark-scaled, the apices silvery scaled, the basal portion also silver-scaled; mesonotum dark brownish-scaled, with bronzy and bluish luster; abdomen dark-scaled above, with brownish and bluish luster, beneath white-scaled, the colors separated on the sides in a straight line; legs dark-scaled, with bronzy and blue reflections; front and mid tarsi unmarked; hind tarsi with the fourth joint silvery white scaled to the apex beneath; the fifth joint silvery white-marked beneath on its basal two-thirds. Length, 3 mm.

One specimen, Sonsonate, Salvador, August 30, 1905. (F. Knab.)

*Type*.—Cat. No. 11992, U.S.N.M.

WYEOMYIA MEGALODORA, new species.

*Female*.—Proboscis long and rather slender, swollen at the apex; occiput dark-scaled, obscurely iridescent, margin of the eyes narrowly dull white-scaled; prothoracic lobes pale violaceous, iridescent, without light scales at the apices; mesonotum dark brownish-scaled, with obscure bronzy and bluish luster; abdomen above blackish-scaled, with faint bronzy and bluish luster, beneath coarsely white-scaled, the colors separated on the sides in a straight line; legs dark-scaled, with bronzy and bluish reflections; the tarsi of the front and hind legs unmarked; the middle legs, with the apical half of the

second and all of the succeeding joints, silvery white-marked beneath. Length, 3.5 mm.

Two specimens, Sonsonate, Salvador, August 30, 1905. (F. Knab.)

*Type*.—Cat. No. 11993, U.S.N.M.

The prothoracic lobes in certain lights have a shining appearance at their apices, but do not seem to be clothed with differently colored scales from those of the general surfaces of the lobes.

WYEOMYIA MATÆA, new species.

*Female*.—Proboscis long and slender, swollen at the apex, dark-scaled, with a line of whitish scales on the under surface; palpi dark-scaled; occiput dark-scaled, with faint bluish and bronzy reflections, the margin of the eyes dull white-scaled, interrupted on each side of the vertex; prothoracic lobes dark blue and violaceous, with strong iridescence; mesonotum dark bronzy brown-scaled; abdomen above blackish brown-scaled, with obscure bronzy and blue reflections, beneath coarsely white-scaled, the colors separated on the sides in a straight line; legs dark-scaled, with bronzy and blue reflection, the under surfaces of the femora and tibiae pale brassy-scaled; mid-legs with the apical half of the second joint and all of the third, fourth, and fifth silvery white-marked on one side; front and hind tarsi unmarked. Length, 3.5 mm.

Two specimens, Sonsonate, Salvador, August 19, 1905, and Santa Lucrecia, State of Vera Cruz, Mexico, June 21, 1905. (F. Knab.)

*Type*.—Cat. No. 11994, U.S.N.M.

WYEOMYIA ARGYRURA, new species.

*Female*.—Proboscis moderate, swollen at the tip, black-scaled; occiput dark-scaled with iridescent reflections, a diffuse silvery spot at the vertex, sides of the head white-scales, running up part way along the ocular margin; prothoracic lobes entirely silvery-scaled; mesonotum dark bronzy brown-scaled; abdomen black-scaled above with bluish reflection, the tip silver-scaled; beneath silvery-scaled, the colors separated on the sides in a straight line. Legs deep brown-scaled with bluish and bronzy reflections, femora and tibiae white beneath as also the front tarsi, the white broader and more distinct on the third joint; on the hind legs all the tarsal joints have silvery white basal marks beneath, which extend well towards the apex; mid tarsi with the apex of the second, and all of the succeeding joints silver white-scaled above and beneath. Length, 2.5 mm.

One specimen, San Antonio de los Baños, Cuba (J. H. Pazos).

*Type*.—Cat. No. 12009, U.S.N.M.

Nearest to *W. sororecula* Dyar and Knab, but distinguished by the silvery tip of the abdomen.

# SOME NEW ISOPODA OF THE SUPERFAMILY ASELOIDEA FROM THE ATLANTIC COAST OF NORTH AMERICA.

By HARRIET RICHARDSON.

*Collaborator, Division of Marine Invertebrates, U. S. National Museum.*

In the U. S. Bureau of Fisheries collection recently received by the U. S. National Museum from Prof. A. E. Verrill, Yale University Museum, are a number of new and interesting forms belonging to the superfamily Aselloidea. Several new genera belong to the families, Janiridae and Desmosomidae, and also a new species of *Eurycope*, are herein described.

## Family JANIRIDÆ.

Genus IOLELLA Richardson, 1905.

IOLELLA GLABRA, new species.

Body oblong-ovate, about twice as long as wide; surface of body without spines or tubercles.

Head much wider than long with the front produced in the middle in a long rostrum, which is about as long as the length of the head; the antero-lateral angles are also produced in acute, triangular processes, which are about half as long as the rostrum. The eyes are small, round, composite, and are placed halfway between the lateral margin and the median longitudinal line and halfway between the anterior and posterior margins of the head. The first pair of antennæ have the first two articles of the peduncle about equal in length; the third article is about half as long as the second; the flagellum, which consists of twenty-four articles, extends a little beyond the fifth article of the peduncle of the second pair of antennæ. The second pair of antennæ have the first two articles of the peduncle very short; the third article is equal in length to the first two taken together, and is furnished on the exterior margin with an antennal scale; the fourth article is also short; the fifth and sixth articles are elongate and are about equal in length; the flagellum is long and is composed of nearly one hundred articles.

The first segment of the thorax has the lateral margins produced in one triangular process on either side, directed anteriorly; the second, third, and fourth segments are each produced on either side in two triangular processes, one anterior and the other posterior; the last three segments have the lateral margins produced on either side in one long process directed posteriorly, with a rudimentary posterior process indicated on the posterior margin.

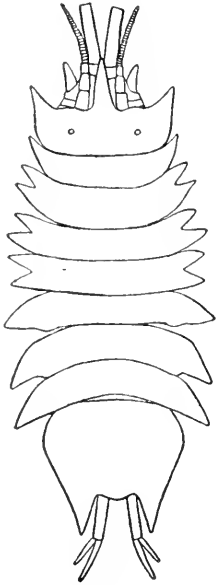

FIG. 1.—*IOLELLA GLABRA*.

The abdomen has the post-lateral angles produced in one long acute triangular process on either side of a small median rounded lobe. The uropods have the basal article about equal in length to the post-lateral angles of the abdomen; the inner branch is almost as long as the basal article; the outer branch is a little shorter.

The first pair of legs are prehensile; all the others are ambulatory and furnished with biunguiculate dactyli.

The single specimen is a male, and comes from Station 2116, off Cape Hatteras. It was collected at a depth of 888 fathoms in blue mud and fine sand by the U. S. Bureau of Fisheries' steamer *Albatross*.

The type is in the U. S. National Museum. Cat. No. 38963.

This species is very similar to *Iolella spinosa* (Harger), and differs chiefly from that species in lacking spines on the dorsal surface of the body.

#### Genus RHACURA, new.

Head without rostrum, but with a triangular median frontal process. Lateral margins of head with two triangular processes; eyes small, but distinct. First pair of antennae with a peduncle of three articles and a multi-articulate flagellum; second pair of antennae with the third article of the peduncle furnished with an antennal scale.

First and fourth thoracic segments with one lateral process on either side; second, third, fifth, and sixth segments with two lateral processes; seventh thoracic segment with three lateral processes.

Abdomen furnished with four lateral triangular processes on either side.

Legs as in the genus *Iolella*.

This genus differs from *Acanthaspidia* Stebbing,<sup>a</sup> the type of which is *Acanthaspidia typhlops* (Sars),<sup>b</sup> in the presence of eyes,

<sup>a</sup> *Acanthaspidia* Stebbing=*Acanthoniscus* Sars, Hist. Crust., 1893, p. 378.

<sup>b</sup> Norwegian North-Atlantic Expedition, XIV, Zoology, Crust., I, 1885, pp. 119-121, pl. x, figs. 27-30.



in having the first pair of legs prehensile, and not similar to the following pairs as in that genus, in having the legs furnished with bi-unguiculate dactyli; in not having a bifurcate rostrum, in having the fourth thoracic segment produced laterally in one process and not two, in having the fifth and sixth thoracic segments produced laterally in two processes and not three, in having the lateral margins of the abdomen produced in four large processes and not eight as in that genus.

It differs from *Iolanthe* Beddard<sup>a</sup> in the presence of eyes, in having the first pair of legs prehensile, and not similar to the succeeding pairs as in that genus, in having the fourth thoracic segment produced laterally in one process and not two, as in both species of *Iolanthe*, *I. acanthonotus* Beddard, and *I. decorata* Hansen,<sup>b</sup> in having the fifth and sixth segments produced in two processes laterally and the seventh segment in three, and not as in the two species mentioned in which the lateral margins of the fifth, sixth, and seventh segments are produced in one long spine. In the genus *Rhacura* the lateral margins of the abdomen are produced in four processes, while in *I. acanthonotus* there are three long processes and in *I. decorata* there are eight short ones.

This genus differs from *Ianthopsis* Beddard<sup>c</sup> in having the first pair of legs prehensile and not similar to the succeeding pairs as in that genus, in having the first and fourth thoracic segments produced laterally in one process and not two, in having the fifth and sixth segments produced in two processes, the seventh in three, and not as in *Ianthopsis borallii* (Studer),<sup>d</sup> which has the last three thoracic segments produced laterally in one long process, and in having four long processes on the lateral margins of the abdomen and not rudimentary ones as in that genus.

This genus seems closer to *Iolella*<sup>e</sup> Richardson than to any of the genera referred to above. It differs, however, in having the rostrum reduced to a triangular expansion, in having two lateral processes to the head instead of one, in having one lateral process to the fourth thoracic segment instead of two, in having two lateral processes to the fifth and sixth segments and three to the seventh segment, while in *Iolella* there is one process to each of these segments, and in having four triangular processes to the lateral margin of the abdomen instead of one post-lateral process as in *Iolella*.

<sup>a</sup> Challenger Report, Zool., XVII, Pt. 48, Report on the Isopoda, Pt. 2, 1886, pp. 15-18, pl. iv, figs. 9-14; pl. v, figs. 1-4.

<sup>b</sup> Plankton Expedition, II, 1895, pp. 6-7, pl. 1, figs. 1-1c.

<sup>c</sup> Challenger Report, Zool., XVII, Pt. 48, Report on the Isopoda, Pt. 2, 1886, p. 15, pl. v, fig. 5.

<sup>d</sup> Abh. k. Akad. Wiss. Berlin, 1883, pp. 10-12, pl. 1, fig. 2.

<sup>e</sup> Bull. U. S. Nat. Mus., No. 54, 1905, p. 457 (footnote).

The differences between *Rhacura* and *Iolcella* are greater than those between *Iolanthe* and *Acanthaspida* and seem to warrant keeping them apart.

*Type of the genus.*—*Rhacura pulchra*, new species.

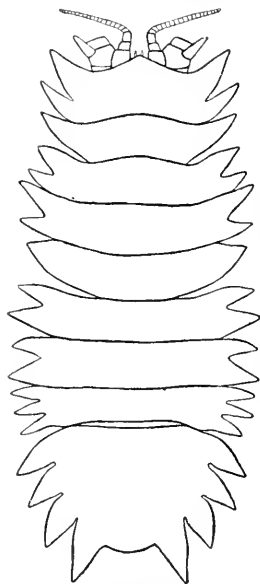

FIG. 2.—RHACURA PULCHRA.

RHACURA PULCHRA, new species.

Body oblong-ovate, about twice as long as wide. Dorsal surface covered with granulations.

Head much wider than long, with the front produced in the middle in an obtuse triangular process, which does not extend as far as the antero-lateral processes; the lateral margins are drawn out on either side in two acute triangular processes, both directed anteriorly; the posterior one is slightly narrower than the anterior process. The eyes are minute and are situated closer to the posterior margin than to the anterior margin. The first pair of antennae have the first article of the peduncle largest; the second and third are subequal and are a little shorter than the first; the flagellum is composed of eighteen articles. The second pair of antennae are broken at the fourth article of the peduncle in the only specimen; the third article is furnished with an antennal scale. The maxillipeds have the first three articles of the palp expanded and dilated.

The first segment of the thorax has the lateral margins drawn out on either side in one triangular expansion, acute at the extremity and directed anteriorly; the second and third segments have the lateral margins drawn out on either side in two triangular expansions, about equal in width, one anterior and the other posterior; the fourth segment has one triangular expansion to the lateral margin on either side; the fifth and sixth segments have the lateral margins drawn out on either side in two triangular expansions of about equal size; the seventh and last segment of the thorax has the lateral margins drawn out in three triangular processes on either side, all of equal size.

The abdomen has the lateral margins drawn out on either side in four triangular expansions, the last expansion corresponding to the post-lateral expansion in the species of the genus

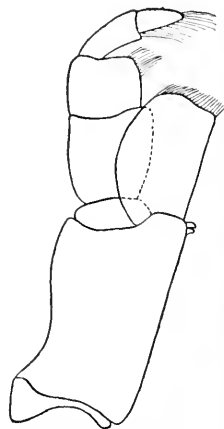

FIG. 3.—RHACURA PULCHRA. MAXILLIPED.

*Isotella*; between the post-lateral expansions is a small rounded lobe. The uropoda are lost in the only specimen.

The first pair of legs are prehensile, the other six ambulatory in character and furnished with bi-unguiculate dactyli. The margins of the entire body are armed with minute acute spinules.

The only specimen, a female, was found at Station 2572, steamer *Albatross*, southeast of Georges Bank, at a depth of 1,769 fathoms.

The type is in the U. S. National Museum, Cat. No. 38964.

Genus HAPLONISCUS, new.

Head without rostrum. First pair of antennæ with the peduncle composed of only two articles; flagellum composed of several articles; second antennæ with the peduncle composed of six articles, the third article furnished with an antennal scale. Eyes absent.

Terminal segment of body with posterior median lobe, on either side of which is a small triangular process; uropoda small, consisting of a single article.

The legs are all ambulatory, similar, with dactylus uni-unguiculate. They are alike in both sexes.

This genus differs from *Nannoniscus* Sars, its closest ally, in lacking the large median lobe of the head, in not having an olfactory papilla to the first antenna, in the differently shaped abdomen, and in having the uropoda composed of a single article and not double-branched as in that genus.

The type of the genus is *Nannoniscus bicuspis* Sars.<sup>a</sup> In 1899, Sars admitted that this species was not congeneric with the type species of the genus *Nannoniscus*, but allowed it to remain there.

The following species also belongs to this genus and is very similar to Sars's species.

HAPLONISCUS EXCISUS, new species.

Body oblong-ovate, a little less than twice as long as wide. Color in alcohol whitish. Surface smooth.

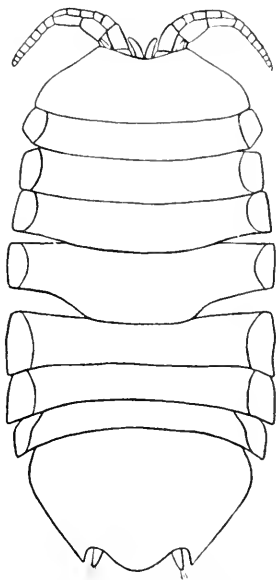

FIG. 4.—HAPLONISCUS EXCISUS.

<sup>a</sup> Norwegian North-Atlantic Expedition, XIV, Zoology, Crustacea, I, 1885, pp. 122-123.

Head wider than long, with the anterior margin slightly excavate between the antero-lateral angles; the head is wider posteriorly than anteriorly. There are no eyes. The first pair of antennæ have the first article of the peduncle short. The second article is much longer; the flagellum is composed of five articles and extends to the end of the peduncle of the second antennæ. The first four articles of the second antennæ are short; the last two are longer and subequal; the third article of the peduncle is furnished with an antennal scale; the flagellum is composed of eight articles.

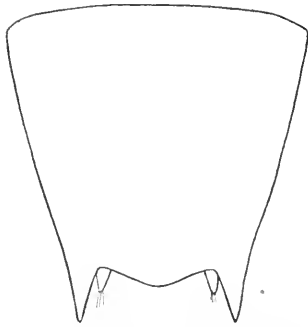

FIG. 5.—*HAPLONISCUS RETROSPINIS*. ABDOMEN OF FEMALE. (DORSAL VIEW.)

The first three segments of the thorax are about equal in length; the fourth segment is the longest and especially long in the middle region; the fifth and sixth segments are about equal in length, and are shorter than the fourth; the last segment is shorter than either of the two preceding segments; the lateral margins of all the segments are straight, the epimera occupying the entire lateral part of the segment.

The abdomen consists of a single segment, the lateral margins of which converge gradually to the posterior extremity, which has a large rounded median lobe, on either side of which

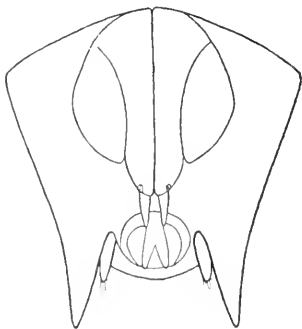

FIG. 7.—*HAPLONISCUS RETROSPINIS*. ABDOMEN OF MALE. (VENTRAL VIEW.)

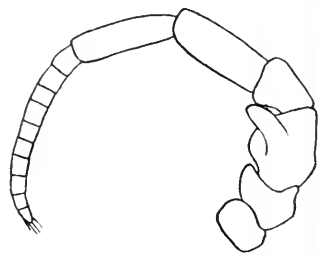

FIG. 6.—*HAPLONISCUS RETROSPINIS*. (SECOND ANTENNA.)

is an acute triangular process. The uropoda consist of a single small article, not extending beyond the post-lateral tooth, and placed between that and the median lobe.

All the legs are ambulatory in character, similar and with dactylus uni-unguiculate. They are alike in both sexes.

Three specimens, two males and one female, come from Station 2572, U. S. Bureau of Fisheries' steamer *Albatross*, southeast of Georges Bank, taken at a depth of 1,769 fathoms.

The type is in the U. S. National Museum, Cat. No. 38965.

<sup>a</sup> Norwegian North-Atlantic Expedition, XIV, Zoology, Crustacea, I, 1885, pp. 122-125.

This species differs from the species described by Sars,<sup>a</sup> *Haplomiscus bicuspis*, in having the front of the head excavate, in having the flagellum of the second antenna composed of eight articles instead of thirteen, and in the broader abdomen in proportion to its length with the larger and differently shaped median lobe.

HAPLONISCUS RETROSPINIS, new species.

This species is more similar to *Haplomiscus bicuspis* (Sars) in the shape of the head, which does not have the front excavated as in the preceding species. It differs, however, from Sars's species in having the flagellum of the antennæ composed of ten articles instead of thirteen and in having the post-lateral teeth of the abdomen longer; the teeth are twice as long as the uropoda in the female and about four times as long in the male, while in Sars's species they do not exceed the length of the uropoda.

About seventeen specimens, two males and fifteen females, were collected at Station 2547, south of Marthas Vineyard; they were taken at a depth of 390 fathoms.

The type is in the U. S. National Museum, Cat. No. 38966.

Genus JANIRELLA Bonnier, 1896.

Head with a prominent rostrum; lateral margins of head and of all the segments of the body produced in prominent processes. Eyes absent. First pair of antennæ with the peduncle composed of three articles; flagellum composed of several articles. Second pair of antennæ with the third article of the peduncle furnished with an antennal scale.

Terminal segment of body triangularly produced at the apex; uropoda biarticulate, consisting of two small articles.

Legs all ambulatory.

The second antennæ of this and the preceding genus, as in the genus *Nannomiscus* Sars, resemble the *Janirida* in having the peduncle composed of six articles, the third furnished with an antennal scale; they also with *Nannomiscus*, in the total absence of eyes, and in the character of the uropods (which are biarticulate and composed of two subequal articles in the present genus, but unarticulate in the preceding genus) resemble the Desmosomida; but, as Sars says of *Nannomiscus*, in the general form of the body, in the structure of the legs and antennæ they resemble the *Janirida*.

This genus differs from *Nannomiscus* in lacking the olfactory papilla to the first antenna, in having the peduncle of the first antenna composed of three articles, in having all the lateral margins of the body produced in processes, in the shape of the terminal segment of the body, and in having the uropoda composed of two articles, biarticulate and not double-branched as in that genus.

The type of the genus is *Janirella nanseni* Bonnier.<sup>a</sup>

<sup>a</sup> Ann. Univ. Lyon, 1896, pp. 587-593.

## JANIRELLA LOBATA, new species.

Body oblong-ovate, about twice as long as wide. Color, in alcohol, whitish.

Head wider than long, with the front produced in a long, prominent rostrum, which is bifid at the extremity and has a rounded tooth or lobe on either side of the bifid extremity a little posterior to it; the lateral margins of the head, just back of the antero-lateral angles, are also produced in large lobes, one on either side, directed anteriorly and having broad extremities; on the dorsal surface of the head, on either side of the median line, is a small tubercle near the posterior margin.

The eyes are entirely absent. The first pair of antennæ have the first article of the peduncle large; the two following articles are subequal in length and are each about half as long and half as wide as the basal article; the flagellum is composed of six articles. The second pair of antennæ have the first four articles of the peduncle short, the third furnished with an antennal scale. In all the specimens (ten in number) the antennæ are broken at the fourth article.

The first segment of the thorax has the lateral margins produced on either side in a large lobe, broad at the extremity, similar in shape to the lateral lobes of the head, and also directed anteriorly; the second, third, and fourth segments have the lateral margins produced on either side in three lobes, the posterior lobe being the largest and very broad at the extremity, the median lobe the smallest, and the anterior lobe rounded; in the third and fourth segments the middle lobe is inclined to be double; the fifth and sixth segments have the lateral margins produced in a large rounded anterior lobe and a smaller posterior lobe, the posterior lobe in the fifth segment being subdivided into three small lobes; the seventh segment has the lateral margins produced in one large broad lobe on either side; the segments are about equal in length, and each is furnished with two tubercles, one on either side of the median line. In the four anterior segments the tubercles are placed on the anterior margin; in the three posterior segments they are placed in the middle transverse line of the segment.

FIG. 9.—JANIRELLA LOBATA. FIRST LEG OF FEMALE.

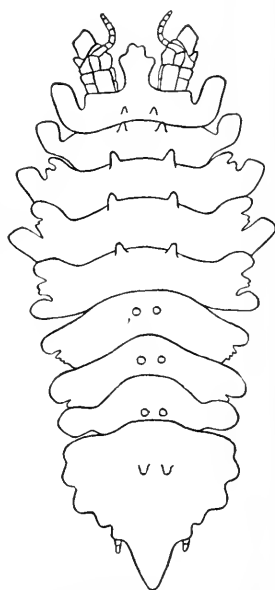

FIG. 8.—JANIRELLA LOBATA.

The abdomen is composed of a single segment, which is broad at the base and converges to a narrow extremity. The lateral margins are

produced in five rounded lobes, which occupy the anterior two-thirds of the length of the segment; below the last lobe the lateral margins are straight and converge to an acute triangular extremity, the apex of which is rounded; this triangular extremity occupies one-third of the length of the segment; on the dorsal surface of the abdomen, about one-third the distance from the anterior margin are two prominent tubercles, one on either side of the median longitudinal line. The uropoda are placed below the last lateral lobe, and are bi-articulate, consisting of two small subequal articles. The legs are alike in both sexes. The first pair are stouter than the following which are all ambulatory and furnished with uni-unguiculate dactyli.

Ten specimens of this species, three males and seven females, are from southeast of Georges Bank.

Three specimens come from Station 2571, steamer *Albatross*, taken at a depth of 1,356 fathoms, one from Station 2572, taken at a depth of 1,769 fathoms, and six from Station 2573, taken at a depth of 1,742 fathoms.

The type, from Station 2571, is in the U. S. National Museum, Cat. No. 38967.

In some of the smaller and younger specimens the smaller lobes are not distinct, and seem to be fused, but in general character they resemble the type as described.

This species differs from *Janirella nanseni* Bonnier in having the lateral processes wider and more rounded like lobes than spine-like as in that species, in having the base of the rostrum not dilated as in that species, in having two spines on all the thoracic segments and not one on the first and three on the second, third, and fourth as in that species.

#### Family MUNNIDÆ.

Genus MUNNA Krøyer, 1839.

MUNNA TRUNCATA, new species.<sup>a</sup>

Body oblong-ovate, about twice as long as wide. Surface smooth. Color, in alcohol, whitish.

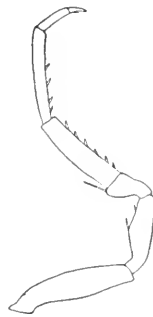

FIG. 10.—JANIRELLA LORATA. SEVENTH LEG OF FEMALE.

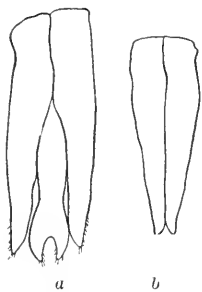

FIG. 11.—JANIRELLA LORATA. FIRST PLEPOD OF MALE. *a*. AS FOUND IN ONE SPECIMEN. *b*. AS FOUND IN TWO SPECIMENS.

<sup>a</sup> I have placed this species with *Munna*, although I am inclined to think that it should be made the type of a new genus. If there is a consensus of opinion in favor of this, I would suggest the name *Cacimunna* for this form, and for the species described from the Pacific coast of North America, which I called *Munna caca*, I would suggest the name *Haplomunna*. (See Bull. U. S. Nat. Mus., No. 54, 1905, pp. 483-485.)

Head large, with the front produced in the middle in a large, broad median lobe, truncate at the extremity; on either side of the median lobe is a prominent triangular process; on either side of the triangular process the lateral margin is produced in a long acute spine-like process, which is about twice as long as the triangular process; these projections probably represent the ocular processes, but the eyes are entirely absent. The first pair of antennae are short; the two peduncular articles are subequal in length, but the second is more slender than the first; the flagellum is composed of six articles. The second pair of antennae are broken in all the specimens.

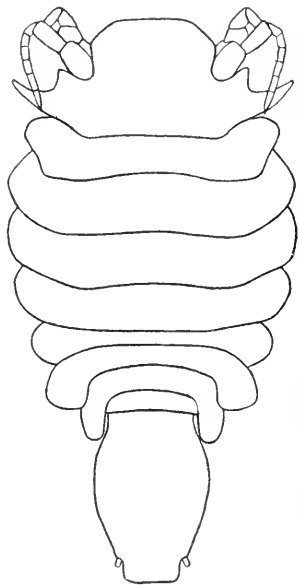

FIG. 12.—*MUNNA TRUNCATA*.

The first four segments of the thorax are the largest, the first being somewhat shorter than the three following; the fifth is the shortest, being less than one-third as long as the preceding segment; the sixth and seventh segments are subequal in length and are also short, but are about one and a half times as long as the fifth; the lateral margins of all the segments are rounded.

The first segment of the abdomen is short, not quite as long as the last thoracic segment; the terminal segment is large, with the lateral margins somewhat rounded, and the extremity truncate. On the ventral side of this segment at the extremity between the median line and the uropod are five sharp teeth as in *Munna fabricii* Krøyer. The uropoda are minute, simple, consisting of a single article, and are situated on either side of the truncate extremity. The first pair of pleopoda in the male are narrow, elongate, with lateral margins straight and not expanded; the extremity is truncate.

The first pair of legs are shorter than those following and are prehensile. The others are long and ambulatory.

About eight specimens of this species come from Station 2547, steamer *Albatross*, south of Marthas Vineyard, and were taken at a depth of 390 fathoms. Three other specimens were found at Station 2507, between Middle Ground and Halifax from a depth of 80 fathoms.

The type from Marthas Vineyard is in the U. S. National Museum, Cat. No. 38968.



FIG. 13.—*MUNNA TRUNCATA*. FIRST PLEOPOD OF MALE.



This species differs from the other species of the genus, found on the Atlantic coast, *M. fabricii* Krøyer and *Munna krøyeri* Goodsir, in the absence of eyes, in having, instead of peduncle-like projections of the head, spine-like processes, and in the truncate character of the terminal segment of the body.

### Family DESMOSOMIDÆ.

#### ISCHNOMESUS, new name.

The above name is suggested for the genus *Ischnosoma* Sars, which is preoccupied, having been used for a genus of fishes in 1829, and also in 1832 for Coleoptera. Sars used the name for Crustacea in 1866, the type of the genus being *Ischnosoma bispinosum*. In the typical form the uropoda consist of two articles, and are bi-articulate. Later Sars describes another species which he also refers to the genus *Ischnosoma*, *I. quadrispinosum*. In this form the uropoda consist of a single article. I would suggest for this form the generic name *Haplomesus*. The two forms described by Beddard as *Ischnosoma bacillus* and *Ischnosoma bacilloides* have the uropoda bi-articulate as in the type-species, but the abdomen is composed of two segments instead of one as in that species. For these two forms I would suggest the generic name *Rhabdomesus*. For the forms described by Beddard as *Ischnosoma thomsoni* and *Ischnosoma spinosum* and the form described by Tattersall as *Ischnosoma greeni*, all of which agree in having the uropoda formed of a single article and the abdomen composed of two segments, I would suggest the generic name *Heteromesus*. The following key gives the generic characters in a concise form:<sup>a</sup>

a. Uropoda consisting of two articles; third article of peduncle of second antennæ not elongate.

b. Abdomen consisting of a single segment; fourth and fifth segments of thorax elongate, not produced in spines *Ischnomesus*, *I. bispinosus* (Sars).

b'. Abdomen consisting of two segments; fourth and fifth segments of thorax exceedingly narrow and elongate, and produced laterally in spines,

*Rhabdomesus* <sup>b</sup> { *R. bacillus* (Beddard).  
*R. bacilloides* (Beddard).

a'. Uropoda consisting of a single article; third article of peduncle of second antennæ elongate.

b. Abdomen composed of a single segment; peduncle of first antennæ composed of three articles..... *Haplomesus*, *H. quadrispinosus* (Sars).

b'. Abdomen consisting of two segments; peduncle of first antennæ composed of two articles,

*Heteromesus* { *H. thomsoni* (Beddard).  
*H. spinosus* (Beddard).  
*H. greeni* (Tattersall).  
*H. spinescens*, new species.  
*H. granulatus*, new species.

<sup>a</sup> A similar arrangement has been suggested by Tattersall, Fisheries, Ireland, Sci. Invest., 1904, II [1905], p. 22.

<sup>b</sup> The antennæ in these two species were lost, but I have placed them in this section because of the character of the uropoda.

## HETEROMESUS GRANULATUS, new species.

Body of female about three and a half times longer than wide; surface closely covered with low granules. The head and all the segments of the thorax, with the exception of the anterior and middle portion of the fifth segment, closely covered with irregular wavy markings or impressions. The first segment of the abdomen is also similarly marked; the first three articles of the peduncle of the second antennae are spinulose.

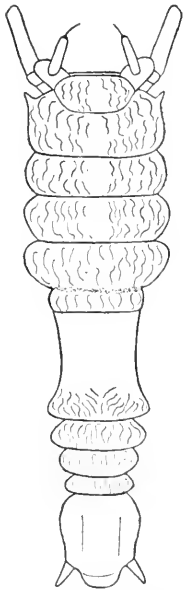

FIG. 14.—HETEROMESUS GRANULATUS, FEMALE.

The frontal margin of the head is straight. The eyes are absent. The first pair of antennae are composed of two articles, the basal article large and inflated, the second narrow and elongate; there is a rudimentary flagellum consisting of a single article, minute and almost imperceptible. The second pair of antennae have the first two articles of the peduncle short; the third article is narrow and elongate; the fourth is short; the fifth and sixth are narrow and elongate, the sixth being about one and a half times longer than the fifth, and the fifth about twice as long as the fourth, the sixth<sup>a</sup> article is about equal in length to the third, but is about half as wide; the flagellum is composed of fourteen articles, the first three being elongate. In the male the flagellum is composed of sixteen articles, and only the first article is elongate.



FIG. 15.—HETEROMESUS GRANULATUS, SECOND ANTENNA OF FEMALE.



FIG. 16.—HETEROMESUS GRANULATUS, FIRST LEG OF FEMALE.

The head is immersed in the first thoracic segment, which surrounds the posterior half; the lateral margins of the first segment are drawn out on either side in one prominent spine. The first three segments are about equal in width and length; the fourth segment is longer, becoming narrower toward the posterior extremity and constricted; the fifth segment is narrow, elongate, about three times the length of the preceding segment. In the male this segment is narrower than in the female. The sixth and seventh segments are short and subequal in length. The seventh is a little narrower than the sixth.

<sup>a</sup>The peduncle of the second antennae is six-jointed and not five-jointed as other authors have described it for other species.

The first segment of the abdomen is short; the terminal segment is longer than wide and has the posterior margin produced in a prominent rounded lobe. In the female the uropoda are shorter than in the male, and scarcely extend much beyond the median lobe of the abdomen. In the male they are a little more than twice the length of the median lobe of the abdomen. They consist in both sexes of one long, pointed, spine-like article.

About fifty-seven specimens were collected by the steamer *Albatross* in the following localities: Forty-one females and four males at Station 2547, south of Marthas Vineyard, taken at a depth of 390 fathoms; two males and one female at Station 2572, southeast of Georges Bank, taken at a depth of 1,769 fathoms; one male at Station 2571, southeast of Georges Bank, taken at a depth of 1,356 fathoms; one male and six females at Station 2208, south of Block Island, taken at a depth of 1,178 fathoms, and one female at Station 2078, off Georges Bank, taken at a depth of 499 fathoms.

The type from Marthas Vineyard is in the U. S. National Museum, Cat. No. 38969.

This species is perhaps closer to *Heteromesus grecei* (Tattersall)<sup>a</sup> than to any others of the genus; it differs, however, from that species in the character of the surface of the body which is covered with low granulations, and not with "spine-like tubercles;" in having a rudimentary flagellum to the first antennæ;<sup>b</sup> in the shorter uropoda of the female (Tattersall figures only the female); in the fewer articles in the flagellum of the second antennæ which also has the three elongate first articles; and in the peculiar markings on the body.

**HETEROMESUS SPINESCENS, new species.**

This species is very close to the preceding, but differs in having a two-jointed flagellum to the first antennæ; in the



FIG. 17. —HETEROMESUS GRANULATUS, MIDDLE PART OF BODY OF MALE.



FIG. 18. —HETEROMESUS GRANULATUS, ABDOMEN OF MALE.

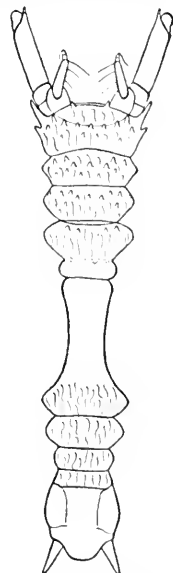

FIG. 19. —HETEROMESUS SPINESCENS, MALE.

<sup>a</sup> Fisheries, Ireland, Sci. Invest., 1904, II [1905], pp. 20-22, pl. iv, figs. 1-6.

<sup>b</sup> In all fifty-seven specimens the flagellum is rudimentary. I examined each one carefully, because at first I supposed the flagellum was broken, but a minute article was finally discovered, which is almost imperceptible.

more elongate second article of the first antennæ; in having a prominent spine at the distal extremity on the inner side of the third article of the peduncle of the second antennæ; in having the lateral margin of the first thoracic segment provided with two spines on either side, the anterior one long and prominent; in having the first four segments of the body furnished on the dorsal surface with spine-like tubercles definitely arranged, and the head furnished with two tubercles.

This species differs from *Heteromesus greeni* (Tattersall) in the definite arrangement of the spine-like tubercles on the head and first four segments of the body, which are lacking elsewhere; in the prominent spine at the distal extremity of the inner side of the third article of the peduncle of the second antennæ, and in lacking the "two-jointed" spine at the proximal end of this same article; in having a two-jointed flagellum to the first antennæ instead of a three-jointed one; and in the fewer number of articles to the flagellum of the second antennæ, there being fourteen, instead of eighteen or twenty.

About ten specimens were collected at the following localities by the steamer *Albatross*: One male at Station 2105, off Virginia, taken at a depth of 1,395 fathoms; two females at Station 2714, south of Marthas Vineyard, taken at a depth of 1,825 fathoms; one male at Station 2208, south of Block Island, taken at a depth of 1,178 fathoms; one female at Station 2084, off Georges Bank, taken at a depth of 1,290 fathoms; and five females from Station 2571, southeast of Georges Bank, taken at a depth of 1,356 fathoms.

The type from off Virginia is in the U. S. National Museum, Cat. No. 38970.

### Family MUNNOPSISÆ.

Genus EURYCOPE Sars, 1863.

EURYCOPE TRUNCATA Richardson.

*Eurycope truncata* RICHARDSON, Proc. U. S. Nat. Mus., XXXIV, 1908, pp. 67-69.

*Localities*.—Marthas Vineyard; southeast of Georges Bank.

Since the description of the above species has been published two more specimens have been found in the material from New Haven. These specimens, a male and a female, are from Station 2572, southeast of Georges Bank, and are from a depth of 1,769 fathoms. This is the first male found, all the other specimens being females. It agrees in every respect with the type.

EURYCOPE MAGNISPINIS, new species.

Body oblong-ovate, about twice as long as wide.

Head with the front produced in the middle in a rostrum with the extremity truncate and the sides incurved; on either side of the

rostrum the frontal margin has a double excavation; the antero-lateral angles are acute. The eyes are absent. The first pair of antennae have the basal article large and armed with one long spine; the two following articles are subequal in length and are small; the flagellum is lost in the only specimen. The first article of the peduncle of the second antennae is short, and is furnished on the outer margin with a single spine; the second article is a little longer than the first and is unarmed; the third article is a little longer than the second and is armed with two spines, one on the outer and one on the inner margin; the antennae are broken at the end of the fourth article.

The first segment of the thorax has the antero-lateral angles produced in one long spine on either side, directed anteriorly; the second segment has the lateral margin produced in one long anterior spine directed anteriorly and one small posterior one on either side; the third and fourth segments have the lateral margin produced on either side in three spines, two small ones

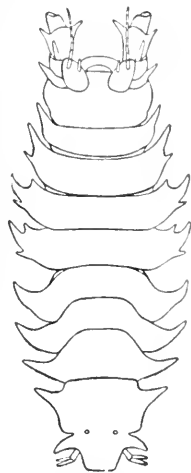

FIG. 20.—EURYCOPE TRUNCATA  
×14½.

on either side of one long one directed anteriorly; the last three segments have the lateral margins produced on either side in a single long spine, directed anteriorly in the fifth and sixth segments and a little posteriorly in the seventh segment.

The abdomen has the lateral margin produced on either side at the base in one long spine directed a little posteriorly; below these spines, the lateral margins are nearly parallel to about the middle of the segment, where there is an abrupt incision; below this incision is a single long spine, directed posteriorly; below these spines the lateral margins of the segment converge slightly to a truncate extremity. The uropoda have the basal article short; the inner branch is about twice as long as the basal article; the outer branch is a little more than half the length of the inner branch.

The first four segments of the thorax are each armed on the dorsal surface in the median longitudinal line with a single spine on the anterior margin, the spine on the fourth segment being the longest and very prominent; on the three following segments there are two

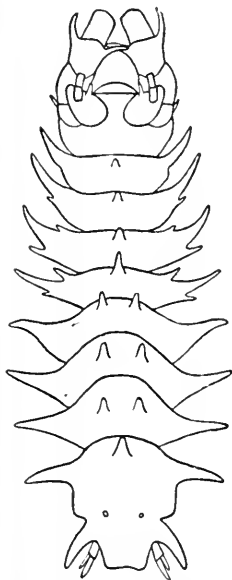

FIG. 21.—EURYCOPE MAGNISPINIS.

long spines, one on each side of the median longitudinal line on each segment, those on the sixth and seventh segments being nearer the middle transverse line of the segment. The abdomen has one long median spine near the base, and two rudimentary spines or tubercles on the dorsal surface, just opposite the incisions in the lateral margins.

Only one specimen, a male, from Station 2043, steamer *Albatross*, off Nantucket Shoals. It was taken at a depth of 1,467 fathoms.

The type is in the U. S. National Museum, Cat. No. 38971.

This species differs chiefly from *Eurycope truncata*, to which it is closely related, in the presence of spines on the dorsal surface of the body.

# THE AXIAL CANALS OF THE RECENT PENTACRINITIDÆ.

By AUSTIN HOBART CLARK,  
*Of the United States Bureau of Fisheries.*

The discovery of infrabasals in *Metacrinus* by Prof. Ludwig Döderlein,<sup>a</sup> which was made simultaneously by the present writer<sup>b</sup> in two other species of that genus and in *Isocrinus decorus*, has raised an interesting question in regard to the axial canals, through which runs the antiambulacral nervous system.

First of all, it may be mentioned that fifteen specimens of *Isocrinus decorus* have been examined to determine the presence or absence of infrabasals, which were found in every case; there is no trace whatever of any resorption, and the infrabasals appear to be constantly present in this species throughout life. Also, in six specimens of *Metacrinus* (five *rotundus* and one *superbus*) infrabasals were found as described and figured. Unfortunately, only three specimens of *Endocrinus parva* (*Pentacrinus mülleri* of authors) were available for dissection; but all were similar, and in all *infrabasals were absent*; moreover, the inner ends of the basals had been somewhat resorbed. It is possible, therefore, that *Endocrinus* may constantly differ from *Metacrinus* and *Isocrinus* in the absence of infrabasals.

Reichensperger,<sup>c</sup> in his paper on the anatomy of *Isocrinus decorus*, gives an account of the axial canals supposedly in that species; unfortunately, however, the figure he gives represents a specimen of

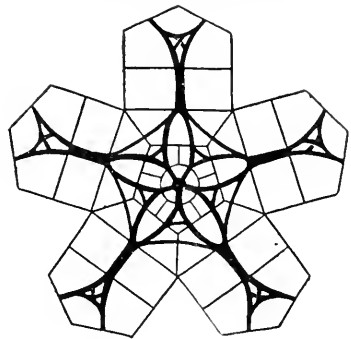

FIG. 1.—DIAGRAM SHOWING THE COURSE OF THE AXIAL CANALS IN *ISOCRINUS DECORUS* AND *METACRINUS ROTUNDUS*.

<sup>a</sup> Die Gestielten Crinoiden der Siboga-Expedition, p. 20.

<sup>b</sup> Proc. U. S. Nat. Mus., XXXIII, p. 671.

<sup>c</sup> Bull. Mus. Comp. Zool., XLVI, No. 10, p. 172 (fig. p. 173).

*Endoxocrinus parra*, in which the conditions are quite different from those in *Isocrinus decorus*; the two II Br series represented, as well as the mode of origin of the cords, make the identification certain.

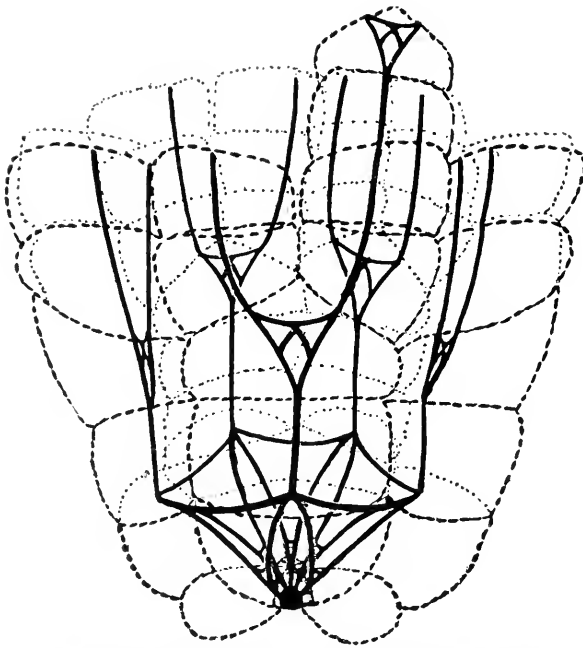

FIG. 2.—DIAGRAM SHOWING THE COURSE OF THE AXIAL CANALS IN *ISOCRINUS DECORUS* IN THEIR NATURAL POSITION.



FIG. 3.—PORTION OF STEM OF VERY YOUNG *ISOCRINUS DECORUS*, BEFORE THE DEVELOPMENT OF THE PETALOID SECTORS.

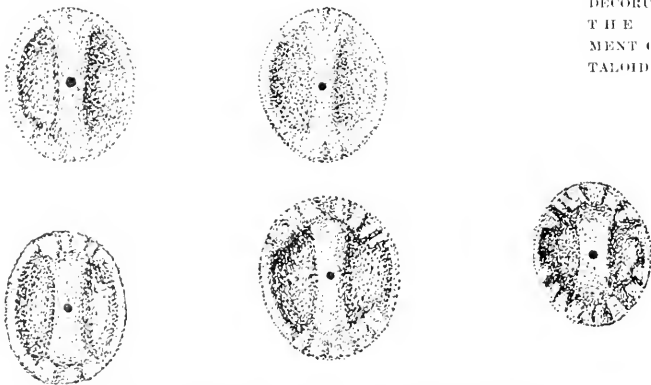

FIG. 4.—JOINT FACES IN A VERY YOUNG STEM OF *ISOCRINUS DECORUS*, BUT SOMEWHAT OLDER THAN THE STEM SHOWN IN THE PRECEDING FIGURE.

The axial canals in *Isocrinus decorus* and *Metaerinus rotundus* (figs. 1 and 2) appear to be similar, so much so that I can not find any differences between them; also, the canals in an individual of the



former, only 40 mm. in total length, with (ten) arms 25 mm. long, are indistinguishable from those in fully mature specimens. The infra-



FIG. 5.—LATERAL VIEW OF AN ISOLATED INFRABASALS OF *ISOCRINUS DECORUS* OR *METACRINUS ROTUNDUS*, SHOWING THE FURROW, WHICH FORMS HALF OF THE CANAL CONTAINING THE PRIMARY AXIAL CORD.

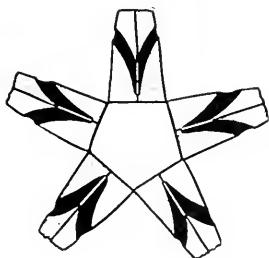

FIG. 6.—THE INFRABASALS OF *ISOCRINUS DECORUS* OR *METACRINUS ROTUNDUS* SPREAD OUTWARD, SHOWING THE COURSE OF THE FURROWS ALONG THEIR APPPOSED SIDES.

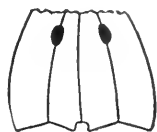

FIG. 7.—THE CIRCLET OF INFRABASALS OF *ISOCRINUS DECORUS* OR *METACRINUS ROTUNDUS*, SHOWING THE APERTURES BY WHICH THE PRIMARY AXIAL CANALS LEAVE THE CIRCLET OF INFRABASALS TO ENTER THE BASALS.

basals in the very small specimen just mentioned (the stem of which distally still retains its larval *Antedon*-like character<sup>a</sup>) are in shape

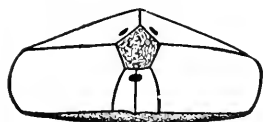

FIG. 8.—A BASAL OF *ISOCRINUS DECORUS* OR *METACRINUS ROTUNDUS* VIEWED FROM THE INNER END, SHOWING THE SINGLE APERTURE BY WHICH THE PRIMARY AXIAL CORD ENTERS FROM THE CIRCLET OF INFRABASALS AND THE TWO APERTURES BY WHICH THE TWO BRANCHES LEAVE THE BASAL AND ENTER THE RADIALS.



FIG. 9.—THE SAME BASAL, GROUND DOWN TO THE PLANE PASSING THROUGH THE CENTER OF THE THREE APERTURES TO SHOW THE COURSE OF THE CANALS AND THE TRANSVERSE CONNECTIVE WITHIN THE BASAL.

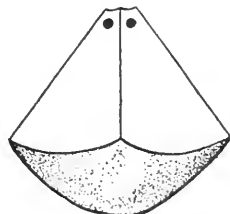

FIG. 10.—THE SAME BASAL, VIEWED VENTRALLY (DISTALLY), SHOWING THE TWO APERTURES BY WHICH THE TWO BRANCHES OF THE PRIMARY AXIAL CANAL LEAVE THE BASAL AND ENTER TWO ADJACENT RADIALS.

and proportions like those of the adult, though the basals are very short, and the radials much elongated.

The chambered organ in *Isocrinus decorus* and in *Metacrinus rotundus* lies within the dorsal part of the ring of infrabasals; the

<sup>a</sup> Dr. P. H. Carpenter says (Challenger Reports, XI, Zoology, p. 291, 1881) of the stems of young specimens of Pentacrinidae, "the petaloid markings are evident from the first, as might be expected;" but in the youngest specimen of *Isocrinus decorus* he figures (pl. xxxv, fig. 1), the distal part of the stem has the appearance of the stem of *Rhizocrinus*, except for the cirriferous nodal joints. This figure aroused my curiosity, and, on examining the original, I found that my suspicions were well founded. I have since been able to dissect part of a stem rather younger than that figured by Carpenter, and find (figs. 3 and 4) the articulations to consist of a pair of ligament pits separated by a longitudinal central ridge.

primary cords pass diagonally upward, through canals formed by corresponding grooves on the apposed sides of the infrabasals (figs. 5 and 6) (thus passing *between* the infrabasals), emerging exteriorly near the ventral surface of the ring of infrabasals (fig. 7), and immediately passing into the basals, through a single opening (fig. 8);

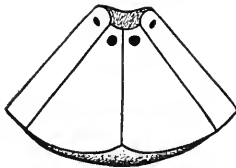

FIG. 11.—DORSAL (PROXIMAL) VIEW OF A RADIAL, SHOWING THE TWO APERTURES BY WHICH THE CANALS ENTER FROM TWO ADJACENT BASALS, AND THE TWO APERTURES BY WHICH THE CIRCULAR COMMISSURE LEAVES THE RADIAL.



FIG. 12.—THE SAME RADIAL GROUND DOWN TO A PLANE PASSING THROUGH ALL THE APERTURES, SHOWING THE COURSE OF THE CANALS WITHIN THE RADIAL.



FIG. 13.—A DIRECT (NOT FORESHORTENED) VIEW OF THE GROUND SURFACE OF THE SAME RADIAL.

within the basals the cords immediately fork (fig. 9), the two divisions diverging, and appearing on the ventral (distal) surface of the basals on each side of the median line, equidistant between the median line and the outer edge (fig. 10): a transverse connective (fig. 9) connects the two divisions of the primary cord just before they emerge on the ventral (distal) surface; entering the radials through two holes in the dorsal (proximal) surface (fig. 11) (which receive cords from

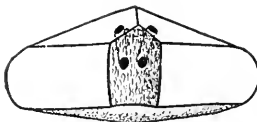

FIG. 14.—A BASAL OF *ENDOXOCRINUS PARRE* VIEWED FROM THE INTERIOR OF THE CALYX, SHOWING THE TWO APERTURES BY WHICH THE BRANCHES OF THE PRIMARY CORD ENTER THE BASAL, AND THE TWO APERTURES BY WHICH THEY LEAVE THE BASAL AND ENTER TWO ADJACENT RADIALS; THE COURSE OF THE CANALS WITHIN THE BASAL IS INDICATED BY DOTTED LINES.

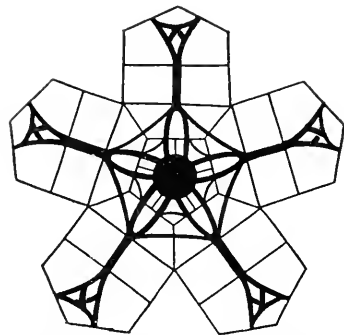

FIG. 15.—DIAGRAM SHOWING THE COURSE OF THE CANAL IN *ENDOXOCRINUS PARRE*.

two adjacent basals) the cords run almost parallel (figs. 12 and 13), then converge, coming together just within the distal surface of the radial; from the point where the two cords join a cord is given off on either side which passes through into the adjacent radials, forming a

circular commissure (figs. 1 and 2) which connects the points of union of the cords received from the basals, around the entire circle of radials. Leaving the radials through a single opening in the distal face, the canal continues undivided through the I Br<sub>1</sub> (figs. 1 and 2) forming a chiasma in the I Br<sub>2</sub> (axillary), as described by Reichen-sperger.

In *Endoxocrinus parva* (and in *E. wyville-thomsoni* and *E. alternicirrus*, so far as I can judge from the figures in the Challenger Report), infrabasals are absent, and the primary cords pass into the basals by two holes (fig. 14), situated side by side, instead of by one; the course of the canals through the basals, radials, and arms is as described for *Isocrinus decorus* and *Metacrinus rotundus* (fig. 15). The double instead of single entry of the cords into the basals of *Endoxocrinus parva* at first sight seems to be a difference of considerable importance; but in reality it has no significance whatever; the infrabasals, present at all stages in *Isocrinus decorus* and *Metacrinus rotundus*, are in *Endoxocrinus parva* resorbed at an early age, and, with them, the inner end of the basals; now, as in *Isocrinus* and *Metacrinus* the cords fork immediately on entering the basals, it is evident that a very small resorption of the end of the basals will result in transforming the single hole into a pair, more particularly since the course of the cords is diagonally upward, at a comparatively slight angle to the inner surface of the basal (fig. 16).

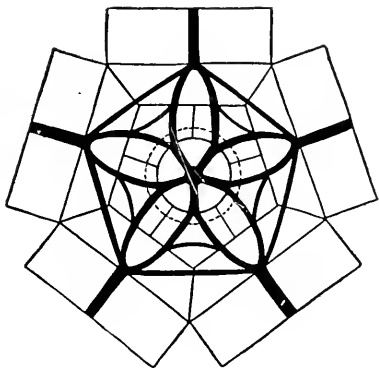

FIG. 16.—DIAGRAM ILLUSTRATING THE DIFFERENCE IN THE ARRANGEMENT OF THE AXIAL CANALS BETWEEN *ISOCRINUS DECORUS* AND *METACRINUS ROTUNDUS* AND *ENDOXOCRINUS PARVA*; THE DIAGRAM, WITH THE OMISSION OF THE DOTTED LINE, REPRESENTS THE CONDITION IN *ISOCRINUS DECORUS* AND *METACRINUS ROTUNDUS*; IN *ENDOXOCRINUS PARVA* THE INFRABASALS ARE ENTIRELY RESORBED, AND THE BASALS ARE RESORBED AS FAR AS THE DOTTED LINE, WITH A CORRESPONDING INCREASE OF THE SMALL CENTRAL AREA.

A very small specimen of *Endoxocrinus parva* with arms only 26 mm. long has the infrabasals and interior ends of the basals already resorbed fully as much as in the adult, and has precisely the same arrangement of the axial canals, although the radials, as usual in the young of *Isocrinus*, *Endoxocrinus*, and *Metacrinus*, are much elongated, and the basals (which, as is the case in this species, form a compact closed circle) are very short.



DESCRIPTIONS OF EIGHTEEN NEW SPECIES AND TWO  
NEW GENERA OF FISHES FROM JAPAN AND THE  
RIU KIU ISLANDS.

---

By JOHN OTTERBEIN SNYDER,

*Of Stanford University.*

---

A study of the shore fishes of Japan, collected during the recent explorations of the U. S. Bureau of Fisheries steamer *Albatross* in the north Pacific Ocean and along the shores of Japan, was assigned to the writer by Dr. Charles H. Gilbert, naturalist in charge. Pending the preparation of a complete report, it is thought best to publish the following preliminary descriptions of new species and genera.

Family LEPTOCEPHALIDÆ.

LEPTOCEPHALUS FLAVIROSTRIS, new species.

Head 1.7 in trunk; 3.2 in tail; 5.9 in length; head and trunk 1.2 in tail; eye 4.7 in head; snout 4.7; depth of body 2.3.

Snout rather pointed, the upper jaw projecting somewhat beyond the lower; nostril tube very short; posterior nostril farther from angle of mouth than tip of snout. Branchial cleft wide, 5.7 in head, its upper edge at base of third ray of pectoral, counting from above. Mouth small, the cleft extending to a point below middle of pupil; upper lips thin, the lower somewhat thicker and pendent; tongue acutely pointed, the tip and edges free. Teeth of jaws small, slender, in bands; the bands broad anteriorly, growing narrow posteriorly where they lie in a single row; median teeth of upper jaw in a band of 4 or 5 rows, short and rather blunt.

Lateral line pores distinct, without color, 13 anterior to a point above anal opening. Dorsal inserted anterior to base of pectoral a distance equal to width of branchial cleft; membranes of dorsal and anal thin, the rays plainly showing; height of dorsal equal to length of snout, anal about equal to width of branchial cleft; caudal very short; pectorals obtuse, the upper rays longest, 3.2 in head.

Color in spirits dark brown or blackish brown; tip of snout light; posterior half of lips light; an indefinite light area midway between eye and branchial cleft; anterior edge of branchial cleft light; pectoral dusky at base, light elsewhere; dorsal and anal broadly edged with blackish, the dorsal with oblique, very indistinct dark stripes.

The type, Cat. No. 62230, U.S.N.M., is a specimen 370 mm. long from Misaki. Another example, slightly longer, does not differ from the above. Both were said to have come from near shore. Cotype, Cat. No. 21100; Stanford University collection.

### Family MURÆNIDÆ.

#### GYMNOTHORAX ODIOSUS, new species.

Head 6.5 in length, 2.3 in trunk, 3.2 in tail; head and trunk equal in length to tail; depth 1.6 in head; snout 5.5; eye 10.5.

Body rather short and heavy, the tail pointed. Mouth large, the eye located midway between tip of snout and angle of mouth. Teeth in a single series, rather short; 2 depressible canines in median series of upper jaw. Gill opening about equal in diameter to eye. Dorsal inserted midway between gill opening and eye, its height contained 3.6 in head. Height of anal 1.5 in snout.

Color in spirits, brown with very indistinct, dark spots which are most evident on the tail; the ground color broken up by a fine, indistinct reticulation of dull gray; snout, lips, and lower jaw lighter; fins colored like the body, the borders somewhat darker posteriorly, where they are narrowly edged with white.

*Type*.—Cat. No. 62231, U.S.N.M., a specimen 600 mm. long, from Kagoshima. A rather characterless species, with a heavy body, a short tail and high dorsal.

#### GYMNOTHORAX CHLAMYDATUS, new species.

Head 10.1 in length; 3.5 in trunk; 5.6 in tail; depth 2.6 in head; snout 6; cleft of mouth 2.8; eye 2 in snout.

Body very long and slender, the tail pointed; jaws equal; eye about midway between tip of snout and angle of mouth. Teeth, canines of moderate size, in a single series and rather widely spaced, 8 or 9 in each side of upper jaw; 11 or 12 in the lower; 2 or 3 short, median teeth far back in upper jaw, partly concealed by the huge lateral folds of muscle in the roof of mouth; branchial cleft slightly wider than diameter of eye. Dorsal inserted midway between branchial cleft and anterior border of eye; its height on anterior portion equal to length of snout, growing gradually lower posteriorly, its height near end of tail about equal to diameter of orbit. Anal very low, about equal in height to diameter of orbit.

Color in life: Body with 13 complete light brown rings, darker on the dorsal fin and on the tail, where the last one is almost black;

rings somewhat over half as wide as interspaces; head and interspaces spotted with same color as the rings; throat with a large, brown blotch; rings narrowly bordered with dead white, the borders gradually growing broader and becoming pearly toward the tail; areas between white borders with a pink ground color, which has an indistinct, light orange border, the latter growing deeper in tint and spreading inward on the posterior parts; under surface white, tinged with orange on the throat, bluish on the belly; tip of snout bright pink; dorsal finely spotted between the bands; anal immaculate, except posteriorly where the body rings encroach on the fin. In spirits the body is gray, the spots and rings brown.

A remarkably beautiful eel from the market at Naha. The type, Cat. No. 62232, U.S.N.M., is a specimen 630 mm. long. Another, slightly smaller though otherwise similar, was obtained at the same time. It is in the Stanford University collection. Cotype, Cat. No. 21101.

### Family LABRIDÆ.

#### LEPIDAPLOIS LOXOZONUS, new species.

Three specimens of a *Lepidaplois* obtained in the Naha market are like that figured by Günther as *L. macrurus*.<sup>a</sup> They differ markedly from the *L. macrurus* of Lacépède,<sup>b</sup> and likewise from *Crenilabrus chabrolii* of Lesson,<sup>c</sup> which no doubt is synonymous with the species of Lacépède. They have the ventrals black, and instead of a broad black band extending across the body from near the middle of the soft dorsal to the posterior third of the anal and covering half the caudal peduncle, as in *C. macrurus*, they have a conspicuous mark like a reversed comma, the large basal part of which covers the proximal half of the soft dorsal and reaches downward to the lateral line, while the tail extends downward and backward across the caudal peduncle to base of caudal fin and then outward along the edge of the inferior lobe to its tip, passing entirely free of the anal fin. A specimen similar in all points to the Naha examples is recorded from Manila by Jordan and Seale.<sup>d</sup>

The form represented by the Naha specimens and figured by Günther is here described as a new species, *Lepidaplois loxozonus*.

Head 3 in length to base of caudal; depth 2.8; depth caudal peduncle 6.6; snout 2.7 in head; eye 5; interorbital width 3.8; D. XII, 10; A. III, 12; scales in lateral line 33; between lateral line and origin of dorsal 5; between lateral line and origin of anal 11.

<sup>a</sup> Sudsee, pl. CXXIXA.

<sup>b</sup> Hist. des Poiss., III, p. 438, pl. IX, fig. 3.

<sup>c</sup> Voy. Coq. Zool., Poiss., p. 133, pl. XXXVIII.

<sup>d</sup> Bull. U. S. Bur. Fish., XXVI, p. 29.

The head is pointed, the dorsal and ventral contours curved equally and evenly between dorsal, ventral and snout. The maxillary, entirely concealed beneath the suborbital, extends to a vertical through anterior edge of orbit; interorbital space convex; lips very thin, the lower with a pendent flap; upper lip with a series of very thin parallel longitudinal ridges which are broken up anteriorly, forming bunches of minute papillae. Gillrakers short and flat, 8 on lower arch. Base of dorsal with two to three rows of scales; fin low, the rays longer than the spines; longest (posterior) spine twice the length of the first,  $2\frac{1}{2}$  in head; longest ray 2 in head. Base of anal with scales; spines graduated in length from first to third, the latter contained 3.2 in head; both dorsal and caudal reaching a vertical through end of last vertebra when depressed. Caudal truncate except for the tips of the upper and lower rays, which project about an eye's diameter beyond the posterior edge of fin; middle rays 1.6 in head. Upper rays of pectoral longest, 1.6 in head. Ventrals rather falcate, 1.3 in head, almost reaching origin of anal.

Color in spirits, 7 or 8 dusky lines extending along upper half of body from snout to a dark posterior band, the lines more or less broken up into spots on the scales; posterior part of body with a large band shaped like a reversed comma, the basal part of which covers the lower half of soft dorsal and extends to the lateral line, the tail continuing downward and backward across caudal peduncle and along lower edge of caudal fin to the tip of the inferior lobe; dorsal with a round black spot somewhat smaller than eye between second and third spines; tips of spines and rays narrowly edged with dusky; anterior half of anal black, the dark color extending along edge of posterior half of fin; ventrals jet black throughout.

*Type*.—Cat. No. 62233, U.S.N.M., a specimen 205 mm. long, from the market at Naha, Okinawa. *Cotype*, Cat. No. 21102, Stanford University Museum.

A dissection of the specimens in hand seems to show the presence of both sexes, though not without doubt, as the viscera are poorly preserved.

LEPIDAPLOIS MIRABILIS, new species.

Head 3.2 in length; depth 2.4; depth caudal peduncle 6.2; snout 2.5 in head; eye 4.5; interorbital space 3.6; D. XII-8; A. III-10; scales in lateral line 28; between origin of dorsal and lateral line 3; between origin of anal and lateral line 9.

Anterior profile rather steep, curving evenly from the blunt snout to origin of dorsal; interorbital space slightly convex. Maxillary extending to a vertical through anterior edge of orbit; upper lip with longitudinal frills within, the frills replaced anteriorly by bunches of papillae which hang down between the teeth; lower lip very thin, with pendent flaps on the sides. Gillrakers very short, 6 or 7 on lower



arch. Teeth united into a single cutting edge which is broadened and flattened anteriorly; a posterior canine on each side of upper jaw; anterior part of upper jaw with 6 canines, the innermost pair minute, the outer ones considerably larger, the others equal in length to diameter of pupil; lower jaw with 4 canines, the outer ones equal in size to the largest upper ones, curving outward and backward; the inner pair somewhat smaller. Lateral line continuous, its curve following the dorsal contour of body. Snout, interorbital space and lower jaw naked; preopercle with about 5 rows of small scales, its posterior and lower borders naked, the edge smooth; opercle and the bases of dorsal and anal with scales.

Spines of dorsal low, the longest 2.7 in head, each with a thickened membrane projecting beyond its tip; membrane deeply serrated in the spinous portion, with an even edge in the rayed part. Anal with 3 strong spines, the longest (third) 2.4 in head; membrane notched between the spines, and with a thickened projection attached to each; caudal slightly concave, the length 1.3 in head. Pectoral 1.2 in head; ventrals 1.6, rather pointed.

Color in spirits pale greenish yellow, the head and body with 7 conspicuous dark bands; the first extending over interorbital space and downward across the chin, and sending 2 transverse branches across the snout; the second passing over occiput and down across preopercle; the third crossing posterior edge of opercle; the fourth, fifth, and sixth encircling the body behind the pectoral; the seventh, equal in width to 2 of the others, crossing the posterior region between the rayed portions of the dorsal and anal and also covering the greater portion of the caudal peduncle; the first spine of the dorsal and its membrane jet black, the other spines tipped with black; the soft dorsal with a narrow black edge, the basal part dusky; caudal narrowly edged and tipped with black; anal blackish, bordered by a stripe of jet black; ventrals with an anterior black border; pectorals immaculate, teeth and the spines of fin green.

In life the anterior of the vertical bands are yellowish olive, the posterior ones becoming darker, the last purplish black; interspaces bright orange red, each bordered by a narrow band of pearly blue which fades out ventrally; posterior part of caudal peduncle greenish white; the bright colors of the body fade out ventrally, the under surface being mostly white with a bluish tinge; dorsal orange red, the spines and rays tipped with pearly blue, a stripe of the same color extending along fin just above the basal scales; anal deep red, the central portion darker, the edge pearly blue, a short, curved stripe of same color near middle of fin, below which is a faint yellow cloud; caudal tinged with yellow beyond the basal scales, then red; pectoral reddish orange at base, fading to bright yellow distally; ventral spine deep blue, the larger part of the fin dark red, bordered by pearly

white; teeth vitriol green. In life this species is more brilliantly colored than any other known to the writer.

Two specimens, the type, Cat. No. 62234, U.S.N.M., measuring 190 mm. in length, and the cotype No. 20957, Stanford University collection.

CHOEROPS JORDANI, new species.

Head 3 in length to base of caudal; depth 3.5; depth caudal peduncle 8.6; length snout 2.8 in head; diameter eye 4.5; width interorbital space 3.2; D. XIII, 7; A. III, 10; scales in lateral line 27; between lateral line and base of dorsal 2; between lateral line and origin of anal, counting upward and forward 9.

Anterior contour strongly arched; lower jaw projecting slightly beyond the upper; interorbital region convex, a little less so than the occiput; mouth rather large, the concealed maxillary extending to a vertical through anterior edge of pupil. Inner teeth coalesced, the cutting edge rather narrow laterally but becoming broadened anteriorly, the plates of upper jaw having a pair of small teeth at the symphysis; 4 widely spaced canine teeth in each jaw, the outer, lower ones largest, curved backward; each of the median upper pair with a small canine at its base; posterior canines large. Gill-rakers very short, slender, and pointed; 7 or 8 on lower limb of first arch. Preopercle very finely serrated. Scales of cheek in 5 rows, small and nonimbricate; occiput and border of preopercle naked; 6 scales in a line between first dorsal spine and the occiput. Lateral line following contour of body to a point below beginning of soft dorsal, where it bends downward and then passes along middle of caudal peduncle. Dorsal spines highest posteriorly, the longest contained 3.2 in head; longest ray 2.8; dorsal and anal projecting an equal distance posteriorly, not reaching base of caudal. Caudal truncate, the tips of upper rays projecting; length 1.5 in head. Ventrals 1.5 in head, their tips just reaching anal opening. Pectoral 1.3 in head.

Color in alcohol pale brownish above, lighter below; a dark stripe originating just above axil of pectoral and extending to base of caudal, the lower edge coinciding with the median line of body, the stripe broadening gradually posteriorly, the dorsal edge passing upward to base of last dorsal spine and intruding somewhat on base of soft dorsal; broad posterior part of stripe including an oblong yellowish spot which passes saddle-like over the caudal peduncle; upper edge of caudal dusky.

Four specimens from the market at Naha.

*Type*.—Cat. No. 62235, U.S.N.M., 135 mm. long. Cotype, Cat. No. 21103, Stanford University collection.

Named for President David Starr Jordan of Stanford University.

## Family SCARIDÆ.

## CALLYODON LUNULA, new species.

This species closely resembles *Callyodon bataricensis* Bleeker<sup>a</sup> and also *C. elere* Jordan and Seale.<sup>b</sup> It differs from the former in the absence of lateral canines, in not having a median dark stripe on the dorsal, and in having 2 green bands across the interorbital area and a row of scales on the lower edge of the preopercle. From *C. elere* it may be known by the white teeth without lateral canines, the long lips which cover the teeth, the very small scales on the lower limb of preopercle, and the more arched interorbital space with its 2 green bands, *C. elere* having the largely exposed teeth deep green in color, with prominent white lateral canines, 4 large scales on lower edge of preopercle, the interorbital space lower and of one color.

Head 3 in length; depth 2.7; depth caudal peduncle 6.2; eye 6.5 in head; snout 2.7; interorbital space 2.7; scales in lateral series 21; between origin of anal and base of dorsal, counting upward and forward 9; D. IX, 10; A. II, 9.

Anterior profile rather abrupt, the interorbital area with an evident hump, making the position of the eye appear somewhat low. Lips full, almost covering the teeth. Teeth white; no lateral canines present; 3 rows of scales below eye, a row of 2 or 3 small scales on lower limb of preopercle, 4 scales anterior to origin of dorsal, 5 rows on caudal peduncle. Posterior dorsal spines slightly longer than anterior ones, height 3 in head; rays somewhat higher than spines. Anal equal in height to spinous dorsal. Lobes of caudal projecting beyond the otherwise truncate edge. Pectoral 1.5 in head; ventral 1.5.

Color in spirits brownish tinged with green, each scale with a lighter edge; middle of chin and throat deep green; a green stripe passing from chin to lower edge of orbit; a similar stripe passing obliquely downward and backward across upper lip and uniting with another which fringes the lower lip, extends upward and backward through lower half of eye; upper lip edged entirely with green; 2 green bands passing over the interorbital area; dorsals and anal with a broad basal stripe of green and a narrow edging of the same color; caudal bordered with green above and below; a green crescent on posterior part of fin, the cornua of which reach the tips of the lobes; upper edge of pectoral green, the basal portion suffused with same color.

*Type*.—Cat. No. 62236, U.S.N.M., measuring 403 mm. in length, from the market at Naha, Okinawa. But 1 specimen obtained.

<sup>a</sup> Java, IV, p. 342.

<sup>b</sup> Bull. U. S. Bur. Fish., XXVI, p. 31, fig. 11.

## Family GOBIIDÆ.

## HETERELEOTRIS ARENARIUS, new species.

Head 3.5 in the length; depth 6.5; depth caudal peduncle 9.2; snout 4 in head; eye 7.2; interorbital space 4; D. VI, 12; A. 10; scales in lateral series 35; transverse 12.

Head rather long, broad and flat; eyes located high up, their rims projecting above contour of head, directed upward more than side-wise; interorbital space flat; cleft of mouth broad, oblique, falling far short of a vertical through anterior edge of orbit; lower jaw slightly projecting. Jaws with simple teeth in bands; no canines; no teeth on vomer and palatines; tongue truncate. Gill opening restricted to the sides, extending downward somewhat below base of pectoral. Nostrils tubular, the anterior one near tip of snout. Head and nape naked; 5 large mucous pores behind eyes; snout with several fringed dermal flaps; side of head with 4 beaded dermal ridges, the lowermost of which bears a few elongate barbels and extends from chin backward, curving upward in region of edge of opercle; throat with barbels. Body with large cycloid scales, somewhat ctenoid posteriorly; about 35 in a lateral series, 12 or 13 in a transverse series; abdomen with scales; scales of sides and ventral surface partly or entirely concealed in fresh specimens; no lateral line.

Dorsals separate, the anterior with 6 slender spines, the posterior with 12 rays; anal of 12 rays inserted below base of third dorsal ray; no membranes connecting posterior rays of dorsal or anal with body; both fins extending an equal distance posteriorly when depressed. Caudal obtusely pointed, 4.5 in the length. Pectoral similar in shape, 4.8 in the length. Ventrals united, free from the abdomen, the rays slender, the longest contained about 5.5 times in the length; membranes of fin thin and frail.

Color in spirits pale yellowish; dorsal region of head brown; back crossed by 4 brown bands, the first above bases of pectorals, the second through base of spinous dorsal, the third and fourth through base of soft dorsal; side of body with a broad brown stripe which unites with the dorsal crossbands and sends 4 or 5 projections downward on the sides, and extending on base of caudal fin abruptly widens to form a narrow vertical band.

*Type*.—Cat. No. 62237, U.S.N.M., an example 270 mm. long, from Naha, Okinawa. *Cotype*, Cat. No. 21104, Stanford University collection, from Tanegashima.

The species, represented by 2 specimens from Okinawa and 3 from Tanegashima, was found in sandy pools, and appears to be rare. It is referred with some doubt to the genus *Heteroleotris*,<sup>a</sup> and is

<sup>a</sup> Bleeker, Arch. Neerl. Gobioides, p. 306.

apparently related to *H. clara* Jordan and Seale.<sup>a</sup> That species, however, is not naked, but has the body covered with scales, according to Mr. B. A. Bean, who has kindly reexamined the type.

GNATHOLEPIS SINDONIS, new species.

Head 3.4 in length to base of caudal; depth 3.5; depth caudal peduncle 6.2; eye 4 in head; snout 2.8; width interorbital space 2 in eye; D. VI-12; A. 10; scales in lateral series 24; in series between insertion of anal and dorsal, counting upward and forward, 10.

Body rather deep and short, the head large; jaws equal; eye nearer tip of snout than origin of dorsal by a distance about equal to its diameter. Mouth oblique, the maxillary extending to a vertical through anterior edge of orbit. Teeth simple, in narrow bands on the jaws; none on palatines and vomer; tongue truncate; gillrakers short, rather slender and pointed.

No barbels or conspicuous mucous pores. Body with large, etenoid scales; those on occiput, nape, and throat cycloid and not greatly reduced in size; scales on base of pectoral small; snout naked; cheeks with large, cycloid scales which are divided into three distinct patches by lines of minute pores; opercles with large, etenoid scales. Dorsal fins separate, the spines very high and slender, the longest (second) contained 3 times in the length; membrane scalloped between the spines; soft dorsal high, the longest rays  $4\frac{1}{2}$  in the length, the depressed fin just reaching base of caudal; anal when depressed not reaching base of caudal; neither dorsal nor anal connected with caudal peduncle by membrane; pectoral obtusely pointed, 3.3 in the length; ventrals completely united, 4.5 in the length.

Color in spirits very pale brownish, the posterior scales with scarcely perceptible light centers; anterior part of body with an indefinite dusky mantle which extends backwards about to tip of pectoral, the included scales having dark spots; spinous dorsal with elongate dusky spots arranged in about 6 oblique rows; soft dorsal and upper two-thirds of caudal with small dusky spots; ventrals with inner parts dusky.

One specimen, the type, Cat. No. 62238, U.S.N.M., from the Naha market, Okinawa, measures 110 mm. in length.

Named for Mr. Michitaro Sindo.

AMBLYGOBIUS NARAHARAE, new species.

Head 3.5 in length to base of caudal; depth 3.7; depth of caudal peduncle 2.1 in head; eye 3.2; snout 4.7; D. VI-12; A. 10; P. 18; scales in lateral series 30; in transverse series above anal 11.

<sup>a</sup> Fishes Samoa, p. 392.

Body notably thick-set, deep, and compressed; head wide, snout blunt; eyes high in head, the dorsal rims projecting high above contour of head; interorbital space very narrow, its width equal to about one-half the diameter of pupil. Mouth oblique, the lower jaw projecting slightly beyond the upper; jaws with narrow bands of minute teeth bordered on the outer and inner edges by a row of larger teeth, one of which is developed as a canine on each side of lower jaw; tongue large, truncate anteriorly; gillrakers slender and pointed. Both nostrils tubular. Mucous pores of head papillose, arranged in rows.

Body, including nape, throat, abdomen, and bases of pectorals, covered with weakly ctenoid scales; cheeks naked; upper edge of opercles with a few large scales.

Dorsal fins separate, the spines slender, about equal in height to rays, 1.7 in head; posterior rays when depressed just reaching base of caudal. Anal equal in height to soft dorsal, the rays when depressed not reaching caudal. Pectoral large, obtusely pointed; the length of longest rays equal in length to head. Ventrals pointed, the membranes delicate and easily parted; length, 1.4 in head.

Color in spirits dusky, each scale with a dark edge; head and body with 12 light, vertical bands, the anterior two passing through eye, the third touching posterior edge of orbit, fourth crossing opercle, fifth on base of pectoral, seventh passing between dorsals, sixth, eighth, and ninth extending upward on dorsals, tenth, eleventh, and twelfth on caudal peduncle; dorsals and caudal with minute dark spots; other fins immaculate.

*Type*.—Cat. No. 62239, U.S.N.M., a specimen 50 mm. long, from a tide pool at Naha, Okinawa.

Three smaller examples are somewhat brighter in color than the type, but appear to differ in no other particular.

One example was taken at Tanegashima.

Cotype, Cat. No. 21105, Stanford University collection.

Named for Baron Shigeru Narahara, governor of Okinawa.

#### Genus DORYPTENA, new.

Body elongate, nearly cylindrical, the head broad and rather flat, cheeks bulging; head with beaded dermal flaps and ridges; tongue small and truncate; teeth simple, in narrow bands on both jaws, those of outer row slightly enlarged; vomer and palatines without teeth; isthmus broad; gillrakers long and pointed; head and breast naked, body with small cycloid scales; dorsals separate, spines 6, rays 12 to 15; caudal and pectorals long and pointed, the latter without detached rays; ventrals completely united.

Two known species living along the shores of southern Japan and the Riu Kiu Islands.

*Type of the genus*.—*Doryptena okinawae*, new species.

*DORYPTENA OKINAWAE*, new species.

Head 4.2 in length to base of caudal fin; depth 6.2; depth of caudal peduncle 2.3 in head; eye 4.5; snout 4; D. VI-12; A. 9; P. 15; scales in lateral series about 50; in transverse series above origin of anal 16.

Body elongate, subcylindrical, the caudal peduncle compressed. Head broad, depressed, the cheeks bulging out beyond eyes which are directed obliquely upward, their rims extending somewhat above dorsal contour of head. Mouth terminal, broad, the maxillary not extending posteriorly halfway from snout to eye. Head with many conspicuous beaded dermal flaps and ridges; mucous pores of head with pronounced rims or tubes; nostrils with large tubes. Tongue small, narrow, truncate anteriorly. Teeth on both jaws simple, in narrow bands, those of the outer row slightly enlarged; vomer and palatines without teeth. Isthmus broad, the gill clefts extending downward to a level with lower edge of base of pectoral. Gillrakers long and pointed, 8 on lower side of arch.

Head and breast naked; body except base of pectoral and breast anterior to ventrals with imbricate, cycloid scales, a little larger posteriorly where there are several greatly enlarged ones near middle and posterior part of caudal peduncle; smaller anteriorly, minute and crowded above base of pectoral.

Dorsals separated by a distinct space; spines slender, the third or fourth longest, 1.6 in head; tip of soft dorsal overlapping base of caudal, the next to last ray longest, 1.2 in head; tip of depressed anal not reaching base of caudal, the rays about equal in length to those of dorsal. Caudal pointed, 2.7 in the length; 3 rays near middle of fin conspicuously beaded by small tubercles. Pectorals pointed, none of their rays detached, 3.5 in the length. Ventrals united, the tips of rays free, giving edge of fin a frayed appearance; 4.7 in length.

Color in spirits brownish, with a faintly outlined dark saddle over back near middle of spinous dorsal; a similar though scarcely noticeable mark below base of soft dorsal; a faint, narrow, dark band extending backward from snout through eye to upper edge of gill opening. Spinous dorsal clouded with dusky; other fins lightly spotted on the rays; spots of dorsal and anal arranged in oblique lines; those of caudal in somewhat broken vertical rows.

Described from type Cat. No. 62240, U.S.N.M.; length, 64 mm. Locality, Naha, Okinawa, where the species is rather common in the tide pools. Cotype, Cat. No. 21106, Stanford University collection.

Small examples are more brightly colored than the larger ones. The background is lighter and the dark parts are more prominent and well defined. A distinct dark band extends downward from eye, and another appears on base of caudal.

Color in life, body dark brown, each scale with a lighter area; stripes of head brownish gray, the cheeks with vertical, whitish lines; throat tinged with orange; spinous dorsal, pectorals, and ventrals suffused with yellow; soft dorsal and anal dark brown, the rays of the former tipped with yellow.

DORYPTENA TANEGASIMÆ, new species.

Head 5 in length to base of caudal fin; depth 7; depth of caudal peduncle 2.5 in head; eye 4; snout 3.8; D. VI-15; A. 13; P. 15; scales in lateral series about 57; in transverse series above anal about 18.

Body markedly elongate, subcylindrical, the caudal peduncle compressed; head broad, depressed; cheeks bulging far out beyond eyes, which are directed obliquely upward. Head with conspicuous beaded dermal flaps and ridges which are definite and intricate in their arrangement; mucous pores of head with pronounced rims or tubes, prominent among which are 2 minute black tubes on occiput; nostrils with large tubes. Mouth terminal, broad, but with a very narrow cleft, the maxillary not reaching over halfway to eye; tongue small, narrow, truncate anteriorly; teeth simple, in narrow bands on both jaws, those of outer row slightly enlarged, vomer and palatines without teeth. Isthmus broad, the gill clefts extending downward to a level with lower edge of base of pectoral. Gillrakers long and pointed, 8 on lower side of arch.

Sides of body with a series of 18 or 20 small, vertical, beaded ridges, the longest about equal in length to cleft of mouth. Head entirely naked; breast, base of pectoral and axil naked; scales of body very thin, minute, cycloid, far apart, and deeply embedded in the epidermis.

Dorsal fins barely separate, their bases nearly connected by membrane; spines slender and very flexible, the longest (third) contained 1.8 in head; rays higher than spines, the next to last longest, about equal in length to head. Anal lower than dorsal, not extending so far posteriorly, although the tips of both overlap bases of upper and lower caudal rays. Caudal sharply pointed and extremely long, 2.2 in the length. Pectorals with a strong muscular base somewhat like that of *Periophthalmus*, the upper rays not separate, the middle ones much the longest, about 4 in the length, the fin pointed like the caudal. Ventrals completely united, the length about equal to that of head.

Color in spirits light brown, a minute white spot on each scale; a conspicuous narrow dark brown saddle over back at middle of spinous dorsal, posterior to which are 3 others, the third being the most prominent, the fourth narrow, on end of caudal peduncle; head with a faint dark bar extending from tip of snout through eye to occiput, narrow anteriorly, broader posteriorly where it almost meets



bar on opposite side; sides of head with round light spots; fins checkered with brown spots. In young examples the general color is brownish gray, the bars standing out boldly, except the second on body, which is often indistinct or even absent.

The species is here described from the type Cat. No. 62241, U.S.N.M., a specimen 96 mm. long from Tanegashima, where it is rather common in the tide pools. Examples were also taken at Akune in Satsuma. Cotype is Cat. No. 21107, Stanford University collection.

Genus XENISTHMUS, new.

Body elongate, head pointed, lower jaw projecting. Tongue free, rounded. Teeth simple, in a single row on jaws. Gill-membranes extending forward below and uniting, their edges free from the isthmus. Edge of shoulder girdle with a tooth. Head naked, body with small cycloid scales. Dorsals separate; soft dorsal and anal free from the caudal; ventrals separate, divided at the base.

One species known, from Naha, Okinawa.

*Type of the genus.*—*Xenisthmus proriger*, new species.

XENISTHMUS PRORIGER, new species.

Head, measured from tip of upper jaw, 4.3 in length to base of caudal; depth 6.5; depth of caudal peduncle 2.1 in head; eye 5; snout 5; D. VI-14; A. 13; P. 15; scales in lateral series about 56; in transverse series above anal 20.

Body deeper than wide; head long and pointed; lower jaw projecting considerably beyond upper; maxillary extending to posterior part of pupil. Tongue large, free, rounded at tip. Teeth simple, in a single row on jaws, none on vomer and palatines. Gill-membranes extending forward below and uniting, their edges free from the isthmus. Inner edge of shoulder girdle with a tooth covered by a small dermal protuberance. Gill-rakers on first arch 3-9, long, slender, and pointed. Anterior nostrils tubular; the posterior ones with a large dermal flap.

Head entirely naked; a row of minute dermal tubercles extending backward from tip of maxillary along lower edge of cheek; a conspicuous mucous pore behind eye; 5 similar ones on top of head arranged thus (:·:). Body, including throat, breast, nape, and bases of pectoral fins, with slightly ctenoid scales of medium size, which are largest on caudal peduncle.

Dorsals separate, the first with slender spines about equal in length to the rays, the longest (third and fourth) contained 2.5 in head. Anal slightly higher than first dorsal, the longest (middle) rays 2.1 in head; first ray inserted below base of second dorsal ray; base of fin not extending quite so far posteriorly as that of dorsal, the tips of neither anal nor dorsal touching base of caudal when depressed.

Caudal evenly rounded, slightly shorter than head. Pectorals rounded, 1.3 in head. Ventrals separate, divided at base, 1.5 in head. Anal papilla about equal in length to diameter of eye.

Color in spirits; dorsal part of head and body, chin, throat, and abdomen creamy white; sides covered with minute dots, closely grouped so as to form a tolerably definite brown stripe extending from point of lower jaw and snout through eye, across cheek, base of pectoral, and along lower part of body to near end of caudal; the color stripe more intense on the head and caudal fin, where it is more or less broken up into spots; dorsals with a few minute, indistinct spots extending in a line along middle of fins; anal, pectorals, and ventrals immaculate.

Described from the type Cat. No. 62242, U.S.N.M., a specimen 33 mm. long, from a tide pool at Naha, Okinawa. Cotype, Cat. No. 21108, Stanford University collection.

Two smaller specimens do not appear to differ from the type.

### Family BLENNIIDÆ.

#### *ALTICUS MARGARITARIUS*, new species.

?*Salarias biscriatus* KNER, Novara Reise, Fische, p. 197, pl. VIII, fig. 5.—  
JORDAN and SEALE, Fishes Samoa, Bull. U. S. Bur. Fish., XXV, 1905, p. 427. Not of CUVIER and VALENCIENNES, Hist. Nat. Poiss., XI, p. 316, nor of GÜNTHER, Fische der Südsee, p. 208.

Head 4.8 in length to base of caudal; depth 5; depth caudal peduncle 10.3; eye 4 in head; interorbital space 6; D. XII, 19; A. 22; P. 15.

Anterior profile of head vertical, the outline convex; head narrowed above, broadened below, the cheeks prominent. Eyes located in anterior upper part of head, their rims projecting slightly above the dorsal contour, directed somewhat forward and upward. Mouth inferior, very broad, the lips full and pendulous at the corners; both jaws with a single row of long, slender, close-set teeth, loosely embedded, and arranged in groups of seven, the median ones of which are higher than the others, thus giving the cutting edge of the jaw a scalloped appearance; 2 large canines in lower jaw, each fitting a pit in the roof of mouth. Large pseudobranchiae present; gillrakers very short, pointed, 11 or 12 on first arch. Head with a crest about equal in height to diameter of eye; the anterior and posterior edges vertical. Upper border of eye with a long cirrus, the edge of which is fringed; posterior nostril with a pointed cirrus.

Lateral line of widely spaced, elongate tubes, decurved above pectoral, disappearing at a point beneath tip of fin.

Dorsal fins with a dividing cleft, but connected at bases by membrane; longest spine 1.8 in head; ray, 1.2. Origin of anal below base

of tenth dorsal spine: both dorsal and anal free from caudal, the depressed rays extending a short distance beyond base of fin: membrane of anal deeply scalloped between the rays: posterior ray not connected with caudal peduncle by membrane: longest ray 2 in head. Caudal of peculiar shape, the lower median rays somewhat longer than those above, the ventral rays growing successively shorter, giving the lower portion of the fin, when not expanded, the appearance of being clipped. Pectoral rather acutely rounded, the length being equal to that of head. Ventrals 2 in head.

Color in spirits dusky, with two rows of pearly ocelli along the side of body and numerous smaller ones along the back: the cheeks with numerous and distinct black specks: sides of body with 6 indistinct, dark bands, each being divided and more apparent on the back, and also extending upward on bases or dorsals: first dorsal with an indistinct, dark spot between first and second spines, and a brownish edging which grows broader posteriorly: second dorsal broadly edged with brownish: both fins with numerous pearly spots, those of second dorsal elongate and narrow, especially so, near base of fin. Anal and caudal with very indistinct light spots. Pectoral with minute black specks. Ventrals dusky.

The shape of the head shows some variation, the anterior outline being often straight instead of convex: usually vertical but in some cases sloping backward. The crest is occasionally very low. In some examples the dark lateral bands are each completely divided: in others the pearly spots are not distinctly ocellate, the margins being scarcely dusky. In ten examples the dorsal spines are 12 in number, the rays 18 or 19, the anal rays 19 to 22.

*Type*.—Cat. No. 62243, U.S.N.M., a specimen 72 mm. long, from the pools at Tanegashima. Cotype, Cat. No. 21109, Stanford University collection.

This is certainly not the *S. biseriatus* of Cuvier and Valenciennes nor of Günther, as those authors distinctly say that there are no canines. Canines are present, however, and their great size precludes any possibility of their being overlooked. It may possibly be the species described and figured by Kner, although he is equally positive about the absence of canines.

ALTICUS NOVENMACULOSUS, new species.

Head 5 in length to base of caudal: depth 5.4; depth caudal peduncle 10.3; eye 3.8 in head; width interorbital space 11; D. XII, 21; A. 23; P. 14.

Anterior contour of head concave, the line in front of eyes bulging outward; eyes very close together, their vertical diameter longest, the anterior edge of orbit almost directly above edge of upper lip. A low crest on head, the anterior edge of which slopes gradually

backward; a simple tentacle above eye; a branched one on anterior nostril. Mouth broad, inferior, the lips pendulous at angles. Teeth slender, simple, loosely attached; in a single row, the cutting edge even; strong, curved canines on inner side of lower jaw. Pseudo-branchiæ large; gillrakers on first arch 12, very short, their tips widened and digitate. Lateral line arched over pectoral, ending just above tip of depressed fin.

Dorsal inserted directly above upper edge of gill opening; connected with base of caudal by membrane; a deep notch between spinous and rayed portion; spines much lower than rays, 1.5 in head; longest (middle) rays about equal in length to head. Origin of anal below bases of eleventh or twelfth dorsal spines, not connected with caudal, the posterior ray having no membrane back of it; membrane of anal deeply scalloped between the tips of rays; longest ray 1.3 in head. Caudal rounded, the lower rays somewhat more stiff than the upper ones and close together, the fin having a worn appearance on the inferior edge; middle rays 4.5 in the length. Pectoral obtusely pointed, its length 1.2 in head, the base muscular. Ventrals 1.8 in head.

Sides with 9 conspicuous brownish spots, the anterior ones large and connected by upward extensions which intrude on bases of dorsals, the posterior 2 very small; indistinct, narrow, dark lines extending along sides; a sharply outlined, blue-black spot on upper edge of opercle; a narrow, slightly curved, vertical band behind eye, and a similar though less distinct one extending downward from eye. Spinous dorsal very dark above and with numerous narrow, elongate, black spots; soft dorsal with small, closely apposed, brownish spots on the upper portion, the lower part with oblique, sharply defined, black lines, interrupted on the rays and growing less distinct posteriorly. Anal with a broad, dark margin. Caudal with many small pearly spots; the lower border dusky, the posterior white. Pectorals with a few minute, black specks.

This description is of a brilliantly colored male specimen. Other male examples of the species are duller in appearance, the bands of the sides being indistinct and dark lines appearing on the body. In some cases the anterior spots have ventral projections.

The females are so different that they might be mistaken for another species. The occipital crest is very low, sometimes scarcely evident; the dorsals, caudal, and anal are checkered, and the lateral bands send downward projections on the ventral parts of the sides.

Reference to a number of specimens gives the following fin formula: D. XII or XIII, 20 or 21; A. 22 or 23. The species appears to be abundant at Naha, fairly swarming in some of the pools.

*Type*.—Cat. No. 62244, U.S.N.M., a specimen 99 mm. long from Naha, Okinawa. Cotype, Cat. No. 21110, Stanford University Museum.

*SALARIAS MUSCARUS*, new species.

Head 4.5 in length to base of caudal; depth 5.2; depth of caudal peduncle 2.2 in head; eye 3, interorbital space 8; D. XII, 20; A. 21; P. 14.

Eyes placed far forward and elevated, the rims projecting above dorsal contour of head. Forehead not projecting beyond mouth. Mouth inferior, the jaws each with a band of minute, bristle-like, loosely attached teeth; no canines. No crest on head; a minute cirrus on each side of occiput, a long, slender one on upper part of eye, and a branched tentacle on nostril. Lateral line curved above pectoral; not extending beyond tip of depressed fin.

Dorsals separated by a deep notch, the membrane extending over basal third of first ray; origin of spinous dorsal directly above gill opening, its height less than that of articulated portion, 2 in head; longest ray 1.5. Origin of anal below eleventh dorsal spine, the longest ray 1.6 in head; both dorsal and anal free from caudal. Caudal truncate, 1.1 in head. Pectoral acutely rounded, equal in length to head.

Color in spirits light brownish gray, the sides with 7 dark cross bands which are divided above and below, the upper branches extending on bases of dorsals, the lower tapering and disappearing on ventral region; head, bases of pectorals and region above them with minute white specks; body, posterior to pectorals, with many irregularly placed, sharply outlined, black specks; spinous dorsal with numerous small brown spots; anal with a broad dusky margin, the rays tipped with lighter; caudal with 2 dusky spots at base; pectoral immaculate.

One specimen, the type, Cat. No. 62245, U.S.N.M., from Naha, Okinawa, 50 mm. long.

*SALARIAS SINUOSUS*, new species.

Head 4.4 in length to base of caudal; depth 4.2; depth of caudal peduncle 2 in head; eye 2.8; interorbital space 5; D. XI, 18; A. 20; P. 14.

Eyes large, far forward, their edges projecting beyond anterior profile. Mouth inferior; lips with deeply scalloped edges; teeth minute, loosely embedded, no canines; large pseudobranchiae present; gillrakers short, pointed, 17 on first arch. No crest; a pair of minute tentacles on nape, a slender filament on upper part of eye, and a branched tentacle on nostril. Lateral line extending above pectoral and ending shortly beyond tip of depressed fin. Dorsal inserted directly above gill opening, the spinous and articulated parts separated by a notch, the membrane extending upward beyond middle of

first ray; edge of membrane more deeply incised between spines than between rays; highest spine 1.6 in head; ray 1.3. Origin of anal below eleventh dorsal spine; third, fourth, and fifth rays elongate; neither anal nor dorsal attached to caudal by membrane. Caudal truncate, the length equal to that of head. Pectoral rather pointed, nearly equal in length to head.

Color in spirits pale brownish gray, the black peritoneum showing through the abdominal walls; a dark spot on upper part of opercle; edge of preopercle dusky; chin and upper lip mottled; body with an irregular series of small, round, sharply defined, black spots along upper side, below and above which are numerous dark specks, some of which are closely clustered, forming vermiculations on sides of abdomen. Dorsal dusky; a series of indistinct, elongate, narrow bars extending obliquely upward and backward from base to near middle of fin; caudal speckled on median portion; an indistinct, dusky spot on posterior part below center of fin; anal dusky, with an indistinct, white border and a light basal area.

Described from the type, Cat. No. 62246, U.S.N.M., an example 43 mm. long, from Naha, Okinawa. Cotype, Cat. No. 21111, Stanford University collection.

The filamentous anal is a character peculiar to the male sex. The female differs from the male in this particular only, the anterior anal rays being somewhat shorter than the others. The females appear to be slightly larger than the males. In 6 specimens there are 18 to 20 anal rays.

The species resembles *S. undecimalis*<sup>a</sup> from the Philippines. It differs from *S. undecimalis* in having a branched nostril tentacle, scalloped upper lip, a less projecting forehead, and in color.

ENCHELYURUS HEPBURNI, new species.

Head 4.5 in length to base of caudal; depth 4.4; depth of caudal peduncle 2.5 in head; eye 3.5; interorbital space 4; D. XII, 17; A. 22; P. 13.

Body deep; the head large. No crest or filaments; a small flap on nostril. Each jaw with a row of strong, flat, closely apposed teeth bordered on either side by a very strong, curved canine. No pseudobranchiae; gillrakers very short and blunt. Gill opening restricted to a small slit somewhat less in width than diameter of eye, and entirely above the base of pectorals. Dorsals without notch, the origin directly above gill opening, the posterior part connected with caudal by membrane; articulated rays 18, none of which are branched; longest rays near posterior part of fin, their length contained 1.5 in head. Anal originating below tenth dorsal spine, connected with base of caudal by membrane; the longest (posterior)

<sup>a</sup>Jordan and Seale, Proc. U. S. Nat. Mus., XXVIII, p. 800.

rays, 1.8 in head. Caudal rounded; more than half of fin free from dorsal and anal; length 1.2 in head. Pectoral rounded, 1.3 in head. Ventrals 1.4 in head; the rays cleft almost to bases. Lateral line complete, represented by scattered pores curving above the pectoral.

Color in spirits blue black without variation of any sort, except a very narrow, white border on anal, including only the tips of the rays and the edge of the scalloped membrane, and also an indistinct light border on the caudal.

*Type*.—Cat. No. 62247, U.S.N.M., Naha, Okinawa, measuring 42 mm. long. Cotype, Cat. No. 21112, Stanford University collection.

Five cotypes show a variation of 29 to 30 rays in the dorsal fin.

The species is easily distinguished from *E. ater*<sup>a</sup> in the more posterior insertion of the dorsal, the rounded caudal, which is more free from dorsal and anal, and also in having a more restricted gill opening, the latter, in examples of *E. ater* from Pago Pago, extending downward to near middle of base of pectoral. From *E. flavipes*<sup>b</sup> this species differs in having 29 or 30 dorsal rays instead of 33, and the plain color. The description of *E. flavipes*, without illustration, is entirely too brief for use in identification, and this form may possibly prove to be identical with it.

Named for Lieut. A. J. Hepburn, U. S. Navy, executive officer of the U. S. Bureau of Fisheries steamer *Albatross*.

<sup>a</sup> Günther, Fische der Südsee, p. 199, pl. cxv, fig. c.

<sup>b</sup> Peters, Monatsb. k. preuss. Akad. Wiss. Berlin, 1868, p. 268.





# THE HOMOLOGIES OF THE ARM JOINTS AND ARM DIVISIONS IN THE RECENT CRINOIDS OF THE FAMILIES OF THE COMATULIDA AND THE PENTACRINITIDÆ.

By AUSTIN HOBART CLARK,  
*Of the United States Bureau of Fisheries.*

Hitherto, most writers on the recent crinoids have considered the arms as beginning with the first joints beyond the ("primary") radials; but so far no one has pointed out the exact relations between the arms and arm joints of the different genera and families.

Dr. P. H. Carpenter, in his most admirable essay on the genus "*Actinometra*"<sup>a</sup> (i. e., *Comaster* and *Comatula*), pointed out that in the Comatulida the first two joints beyond each axillary are always articulated in the same way as the two first post-radial joints, no matter how many axillaries may intervene between the radials and the free, undivided arms. He does not here mention the genus *Eudiocrinus*, as understood by him, but in his monograph of the recent stalked crinoids<sup>b</sup> he says:

In the five-armed *Eudiocrinus indirisus* the next joints beyond the radials are syzygial, with pinnules on the epizygals, which clearly shows that they must be considered as arm joints and not as belonging to the calyx, although they undoubtedly represent the so-called second and third radials of a ten-armed crinoid. The other species of *Eudiocrinus* have these two primitively separate joints not united by syzygy but articulated, just as in *Thaumatocrinus*. The second one bears a pinnule both in *Thaumatocrinus* and in *Eudiocrinus varians*; but in *Eudiocrinus semperi* and *Eudiocrinus japonicus* the first pinnule is on the fourth joint after the radial. This would correspond to the second brachial of a ten-armed crinoid, but it is really the fourth brachial in *Eudiocrinus*. Lastly, in Perrier's *Eudiocrinus atlanticus*<sup>c</sup> the first pinnule is on the fifth brachial, which corresponds to the third brachial of an *Antedon*.

<sup>a</sup> On the genus *Actinometra*, Müll., with a morphological account of a new species (A.) *polymorpha* from the Philippine Islands, Trans. Linn. Soc. (Zool.), [2], II, pp. 1-122, pls. I-VIII, (1879).

<sup>b</sup> Report upon the Crinoidea collected during the voyage of H. M. S. Challenger during the years 1873-1876; Pt. 1, the Stalked Crinoids, Challenger Reports, vol. XI of Zoology, p. 47 (1884).

<sup>c</sup> In reality the first pinnule in *semperi*, *japonicus*, and *atlanticus* is on exactly the same joint; but Perrier considered syzygial pairs as two joints, Carpenter as a single joint "with a syzygy;" hence the confusion.

While correct so far as *Eudiocrinus indivisus* goes, this construction is quite wrong for *semperi*, *japonicus*, and *atlanticus*, as will be shown later.

In regard to *Metacrinus*, Doctor Carpenter says that the first post-radial joint "is actually a syzygial joint with a pinnule on the epizygal, just as in the simpler *Eudiocrinus indivisus*, but an axillary appears a few joints farther on and the rays begin to divide." Now, although no definite statement is made, the inference is that he considers the two first post-radial joints in *Metacrinus* to be, as in the case of *Eudiocrinus indivisus*, homologous with the first two post-radial joints of a ten-armed crinoid. This is erroneous; but had he compared *Metacrinus* to "*Eudiocrinus*" *varians*, *semperi*, *japonicus*, or *atlanticus* it would have been correct, as will appear later.

Of the remaining recent genera (as then known) he says:

In the other Pentacrinidae, however, in *Bathycrinus*, *Holopus*, and in most Comatulæ, as well as in the fossil *Eucrinus* and *Apioerinidae*, the second joints above the primary radials are axillaries, and it is not till the second (or rarely the first<sup>a</sup>) joints beyond these that the pinnules appear. In all these types, the axillary and the joint immediately below it are of the same width as the primary radials in the calyx. But in *Marsupites* and in many Palæocrinoids (*Platycrinus*, *Cyathocrinus*, etc.) they are very much smaller than the primary radials, just as the homologous joints are in *Hyoecrinus*.

The first thing in discussing brachial homologies in the crinoids is to determine upon some method by which we may, with a fair degree of certainty, fix upon single joints, or a pair of joints, as being homologous in all the genera and species considered, no matter where we may find them: when this point is once decided it will be easy enough to work backward and forward from it, and to arrive at the homologies of the adjacent parts. Fortunately the determination of such a joint is comparatively simple, when we have a clear understanding of the types of articulation occurring among the recent crinoids of the families under consideration. These fall at once into two groups, *muscular articulations*, and *nonmuscular articulations*, differing, as their name implies, in the presence and absence of muscle bundles. The differences between them may be shortly summarized as follows:

MUSCULAR ARTICULATIONS (divided into (a) *straight*, and (b) *oblique*).

Muscle bundles present.

May bear pinnules, or may be doubled, thus forming an axillary with an additional arm.

Whether pinnulate or not always affects the position of the next following pinnule, throwing it to the opposite side of the arm from the immediately preceding pinnule.

NONMUSCULAR ARTICULATIONS (divided into (a) *synarthric* or *bifascial articulations* and (b) *syzygic*).

Muscle bundles absent.

Never bear pinnules, and are never doubled.

Have no effect on pinnulation; the succeeding pinnule occupies exactly the same position as it would were the nonmuscular articulation not there, but the two joints connected by it merely a single joint.

<sup>a</sup> See beyond, under *Comaster* and *Isocrinus*, and also *Metacrinus*.

It is evident that there is a very radical difference between these two types of articulation morphologically in their effect upon the arm structure as well as in their composition.

*Muscular articulations* fall naturally into two types, which, so far as I have seen, are always perfectly distinct, and are not interchangeable in position:<sup>a</sup>

(a) *Straight muscular articulations* (fig. 1), which have the transverse ridge separating the large dorsal ligament fossa from the interarticular ligament fossae perpendicular to the dorso-ventral axis of the joint face, and the two interarticular and muscular fossae similar and equal in size.<sup>b</sup> This is the type of articulation by which the radial articulates with the next following joint, and it is never found beyond the distal faces of the last axillary in any arm, and sometimes does not occur even so far out as that. (See below under *Metacrinus*, *Isocrinus*, and *Comaster*.)



FIG. 1.—ARTICULAR FACE OF A "STRAIGHT MUSCULAR" ARTICULATION.



FIG. 2.—ARTICULAR FACE OF AN "OBLIQUE MUSCULAR" ARTICULATION.

In an external dorsal view of an arm a *straight muscular articulation* may be distinguished by having the two points of contact of the two joints lateral and equidistant from the median dorsal line (figs. 10 and 11).

(b) *Oblique muscular articulations* (fig. 2), which have the transverse ridge separating the large dorsal ligament fossa from the interarticular ligament fossae strongly oblique (either to left or right) to the dorso-ventral axis of the joint face, accompanied by a corresponding distortion of the interarticular and muscular fossae. This type of articulation is first found at the

*second articulation beyond the last straight muscular articulation*, and immediately succeeding the last synarthry (see below), and continues thence throughout the arm, except for the occasional interpolation of *syzygies*.

*Oblique muscular articulations* are at once recognizable in an external dorsal view of an arm (figs. 10 and 11) by having the two points of contact, representing the ends of the transverse ridge, one dorso-lateral the other ventro-lateral; when occurring on the distal faces of axillaries (figs. 6 and 8) they may be distinguished from *straight muscular articulations* (figs. 3 and 4) by having the dorsal points of contact on either side of the anterior angle of the dorsal surface of the joint, instead of exactly at the anterior angle as is the case with *straight muscular articulations*.



FIG. 3.—AN AXILLARY WITH "STRAIGHT MUSCULAR" DISTAL FACES.

<sup>a</sup> See footnote on p. 118.

<sup>b</sup> In the case of *straight muscular articulations* on the distal faces of axillaries, the outer elements of the joint faces are somewhat cut away.

*Nonmuscular articulations* fall also into two types; but, contrary to what we found to be the case in *muscular articulations*, the second type may partially or wholly replace the first in a given arm, though the reverse is not true:

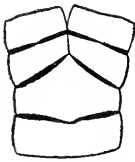

FIG. 4.—DORSAL VIEW OF AN AXILLARY UNITED TO THE PRECEDING JOINT BY "SYNARTHRY," AND TO THE TWO SUCCEEDING BY "STRAIGHT MUSCULAR" ARTICULATIONS; THE TWO POST-AXILLARY JOINTS ARE UNITED BY "SYNARTHRY."

in an arm is always immediately followed by an *oblique muscular articulation*, as stated above.

*Synarthries* are readily distinguishable in a dorsal external view of an arm by having the points of contact exactly in the median dorsal line (figs. 4, 10, and 11).

(b) *Syzygies* (fig. 7): the joint faces are unmarked, or are marked with striations radiating outward from the central canal, the articulation being extremely close, effected by numerous short ligament fibers which are not segregated



FIG. 6.—AN AXILLARY WITH "OBLIQUE MUSCULAR" DISTAL FACES.

into bundles. *Syzygies* may replace any or all *synarthries*, and occur at intervals throughout the arm. *Syzygies* are at once recognizable dorsally by the extreme closeness of the articulation, which appears as a very fine or dotted line. In drawings *syzygies* are always represented by dotted lines (figs. 10 and 11). From the above discussion it is evident that there are two joints in each arm which, by their mode of articulation with each other and their neighbors, are sharply differentiated from all the other joints; I refer to the joints on either side of the last *synarthry*; these joints have articulating faces as follows: a *straight muscular articulation*, binding the first to the preceding joint, a *synarthry*, by which the joints are bound together, and an *oblique muscular articulation*, which binds the more distal of the two to the succeeding joint. Of course, as has been mentioned, the *synarthry* may be replaced by a *syzygy*; but there is no difficulty in distinguishing the pair even in that case, for it is the only *syzygial* pair united to the preceding

(a) *Synarthries* or *bifascial articulations* (fig. 5): these are distinguished by having the joint faces with a pair of large shallow pits, separated by a ridge which traverses the joint face along its dorso-ventral axis; this is the type of articulation which is *always* found on the distal end of a joint the proximal end of which is united to the preceding by a *straight muscular articulation*, and occurs nowhere else; any, or all, *synarthries* in an arm may be replaced by *syzygies*. The most distal *synarthry*



FIG. 5.—ARTICULAR FACE OF A "SYNARTHRY."



FIG. 7.—ARTICULAR FACE OF A "SYZYGY" (ADAPTED FROM CHADWICK).

joint by a *straight muscular*, and to the succeeding by an *oblique muscular articulation*. Having now discovered a pair of joints, which we may for convenience call  $Z_1$  and  $Z_2$ , which are, no matter where they may be, always readily identifiable, we are now ready to enter into a detailed discussion of the brachial homologies.

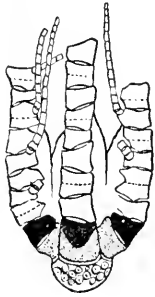

FIG. 9.—PENTAMETROCRINIDE; PENTAMETROCRINUS (ADAPTED FROM P. H. CARPENTER.)

*trocrinus* (fig. 13) and with *Thaumatoctrinus* (fig. 12) which also have undivided arms, with which I united them under the family name of Pentametrocrinidae.

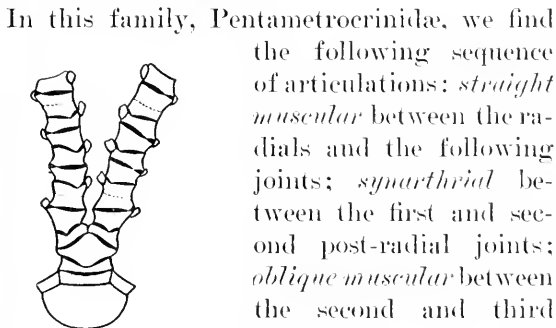

FIG. 11.—PROXIMAL PART OF ARMS OF THAUMATOMETRA TENUIS, SHOWING THE EXTERNAL APPEARANCE OF THE ARTICULATIONS.

rarely, *syzygic*. Thus the family Pentametrocrinidae exhibits the

NOTE.—In the illustrations  $Z_1$  is in all cases dotted, and  $Z_2$  is solid black.

*Pentametrocrinidae* (figs. 9, 10, 12, and 13).—I recently<sup>a</sup> separated under the name of *Pentametrocrinus* (figs. 9 and 10) the species *atlanticus*, *japonicus*, *semperi*, *tuberculatus*, and *varians*, which had previously been confused, because of their undivided arms, under the generic name of *Eudiocrinus*, with *Eudiocrinus indivisus* and *granulatus*, on account of the simplicity of their arm structure, which agrees with that of the species *Decame-*



FIG. 8.—DORSAL VIEW OF AN AXILLARY, ALL THREE OF WHOSE FACES ARE "OBLIQUE MUSCULAR;" THE ARTICULATION BETWEEN THE TWO POST-AXILLARY JOINTS IS ALSO "OBLIQUE MUSCULAR."



FIG. 10.—PROXIMAL PART OF ARM OF PENTAMETROCRINUS TUBERCULATUS, SHOWING THE EXTERNAL APPEARANCE OF THE ARTICULATIONS.

once recognize, therefore, the joints  $Z_1$  and  $Z_2$ , for all the succeeding articulations, as is always the case after the first *oblique muscular articulation*, are also *oblique muscular*, or more

<sup>a</sup> New Genera of Unstalked Crinoids, Proc. Biol. Soc. Washington, XXI, pp. 125-136 (April 11, 1908).

simplest type of arm structure possible,  $Z_1$  and  $Z_2$ , followed by brachials of the type common to the distal part of the arm in all the other types.



FIG. 12.—PENTAMETROCRINIDÆ: THAUMATOCRINUS (ADAPTED FROM P. H. CARPENTER).

proximally adjacent joints: *synarthry* (with, of course, no pinnule); *oblique muscular*, a pinnule being developed on the proximally adjacent joint on the opposite side to the first pinnule, as pinnules always alternate in position at succeeding articulations, unless the articulation is a primarily nonpinnulate *synarthry* or *syzygy*, which has no effect on pinnulation. In the third and fourth post-radial joints we can again immediately recognize our  $Z_1$  and  $Z_2$ ; therefore, the first two post-



FIG. 14.—ZYGOMETRIDÆ: ENDIOCRINUS.

radial joints in the Pentametrocrinidæ are homologous with the third and fourth post-radial joints in *Endiocrinus*. But what are the two joints between the radials and  $Z_1$ ? It is evident that the first post-radial joint agrees with  $Z_1$  in the manner of its proximal and distal articulations, except that the normally present *synarthry* is replaced by a *syzygy*, which, as it is morphologically the same thing, is a point of interest, but not of importance;  $Z_2$  agrees with the second post-radial joint in having proximally a *synarthrial* articulation, distally a *muscular* (but *straight* instead of *oblique muscular*); thus we find that the arms of *Endiocrinus* resemble those of the Pentametrocrinidæ, *except that  $Z_1$  and  $Z_2$  are repeated, the additional pair being interpolated between  $Z_1$  and the radials.*<sup>a</sup>

<sup>a</sup> In cases like this where  $Z_1$  and  $Z_2$  are repeated, the primarily *oblique muscular articulation* on the distal face of  $Z_2$  is, on the interpolated repetitions, transformed into a *straight muscular articulation*. This articulation would normally be *oblique muscular* when considered as the distal articulation of a  $Z_2$ ; but, considered as the proximal articulation of the following  $Z_3$ , it is, of course, *straight muscular*; whenever an articulation is morphologically both *straight* and *oblique muscular*, the former, being dominant over the latter, is always found.

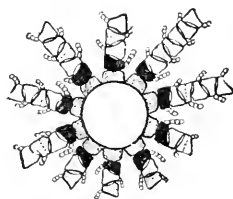

FIG. 13.—PENTAMETROCRINIDÆ: DECAMETROCRINUS (ADAPTED FROM P. H. CARPENTER).

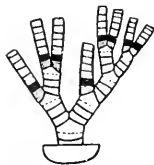

FIG. 15.—ZYGOMETRIDÆ: ZYGOMETRA.

*Atelecrinida* (fig. 18) and *Antedonida*<sup>a</sup> (fig. 17).—In these families the arms, instead of remaining single throughout, fork at the second post-radial joint; this is a matter of no real importance so far as the arm structure goes, for it must be remembered that any muscular articulation, whether *straight* or *oblique*, occurring at the distal end of a joint may divide and form two, from which two similar arms arise; the important thing is not the forking of the arms, but *the determination to what type of muscular articulation belong the articular faces on the distal end of the axillary*.

Bearing this in mind it will be found that the sequence of articulations of these two families is as follows: *straight muscular* between the radials and first post-radial joints; *synarthrial* between the first two post-radial joints; *straight muscular* between the second post-radial (axillary) and third post-radial (first post-axillary) joints; *synarthrial* between the third post-radial (first post-axillary) and fourth (second post-axillary) joints, and *oblique muscular* between the fourth and fifth post-radial (second and third post-axillary) joints. The first and second post-axillary, or third and fourth post-radial joints, therefore, are our  $Z_1$  and  $Z_2$ , while the first and second post-radial joints (the second an axillary) correspond to the first and second post-radial joints in



FIG. 17.—ANTEDONIDA; HELIOMETRA.

*Eudiocrinus* (in which the second is not an axillary, bearing merely a pinnule instead of an additional arm), and are really an interpolated reduplication of the first and second post-axillary joints interpolated between them and the radials. Now in the *Atelecrinida* and *Antedonida*, and in ten-armed species belonging to genera in other families (which are constructed upon the same plan as the universally ten-armed genera and species of *Atelecrinida*, and the primarily such of *Antedonida*) we are so fortunate as to find additional proof of the correctness of this analysis of the proximal arm structure. In certain species, such as *Perometra diomedea*, enormous tubercles are developed at the *synarthry* between  $Z_1$  and  $Z_2$ ; these are always repeated on the *synarthry* between the first and sec-

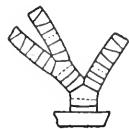

FIG. 16.—ZYGOMETRIDAE; CATOPTOMETRA.



FIG. 18.—ATELECRINIDA; ATELECRINUS.

<sup>a</sup> *Adclometra angustiradia* and occasionally specimens of *Antedon bifida* have more than ten arms, their structure being then similar to that of the Himerometridae, and multibrachiate comatulids in general, except *Comaster* (see below); *Antedon* (restricted), considered by Doctor Carpenter as a primitive type, is in reality one of the most specialized genera in the family, approaching the Himerometridae in many ways.

ond (axillary) post-radial joints, *but nowhere else*; in *Tropiometra*  $Z_1$  and  $Z_2$  are disproportionately large and broad, and we find the first and second (axillary) post-radial joints similarly enlarged; any ornamentation or carination of  $Z_1$  and  $Z_2$  is always duplicated on the two preceding joints.

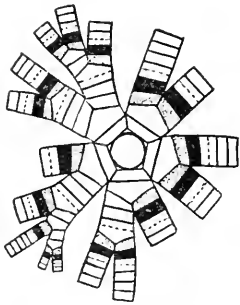

FIG. 19.—THALASSOMETRIDE: CHARITOMETRA.

Passing now to the Comatulida with more than ten arms (excepting *Comaster marie*, *C. fimbriata*, *C. coppingeri*, *C. borncensis*, *C. multiradiata*, *C. iowensis*, *C. scintosa*, *C. lineata*, and *C. discoidea*) (figs. 15, 16, 19, 20, 22, and 23); these multibrachiate forms are always ten armed until of considerable size, when, by a process of autotomy, the arm is cast off at the *synarthry* (or *syzygy*) between the third and fourth post-radial (first and second post-axillary) joints, or at the *syzygy* between the fifth and sixth post-radial (third and fourth post-axillary) joints, and from the stump an axillary grows replacing the cast-off arm by two or more. This process of arm reduplication by autotomy was described by Minckert in 1905, but was independently discovered by the present author through observations made on quite different material before Minckert's paper was consulted. In the Comatulida, as is well known, the various "division series" of the arm or ray between the first post-radial axillary (second post-radial joint) and the free undivided arm are composed of either two or four joints. If of two, they are united either by *synarthry* or *syzygy*; if of four, the third and fourth are always united by *syzygy*, while the first and second are almost always united by *synarthry*, but occasionally are united by *syzygy*; the two pairs, the first and the second, and the third and the fourth, are united by a *straight muscular articulation* between the second and third. No matter how many axillaries may intervene between the radials and the free undivided arm, we are always able to recognize  $Z_1$  and  $Z_2$  as the first and second joints beyond the last axillary; and when the division series

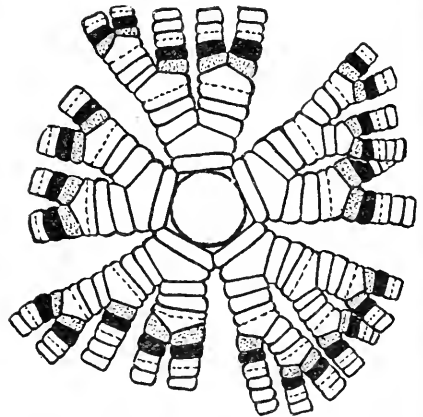

FIG. 20.—HIMEROMETRIDE: HIMEROMETRA; ALSO, COMASTERIDE: PHANOGENIA.



FIG. 21.—COMASTERIDE: COMATULA.

undivided arm, we are always able to recognize  $Z_1$  and  $Z_2$  as the first and second joints beyond the last axillary; and when the division series



are all of two joints, joined by *synarthry* (or, more rarely, *syzygy*), the distal faces of the axillary are always *straight muscular articulations*. Thus we see that, whereas in the Antedonidae and ten-armed genera and species of other families (except the Pentametrocrinidae and Uintacrinidae) the first post-radial joint and the axillary are merely repetitions of  $Z_1$  and  $Z_2$  interpolated between  $Z_1$  and the radials, so we find that *all* the division series, no matter how many there are, are all additional repetitions of  $Z_1$  and  $Z_2$ , interposed between the true  $Z_1$  and  $Z_2$  and the first post-radial reduplication of those joints. When the division series consist of four instead of two joints, it is merely a case of a doubling of the more common primary two, so that, instead of single division series of two joints the division series are double, the two component pairs being united by a *straight muscular articulation* like that on the distal face or faces of the second joint of a division series of two joints only. It is interesting to note that in *Thalassometra gigantea*, in which species  $Z_2$  bears a very sharp median keel, quite lacking on all the other joints of the free undivided arm, this keel is repeated on the second post-radial joint (first axillary), the second and fourth (the latter an axillary) joints of



FIG. 22.—COMASTERIDE; COMATULA.

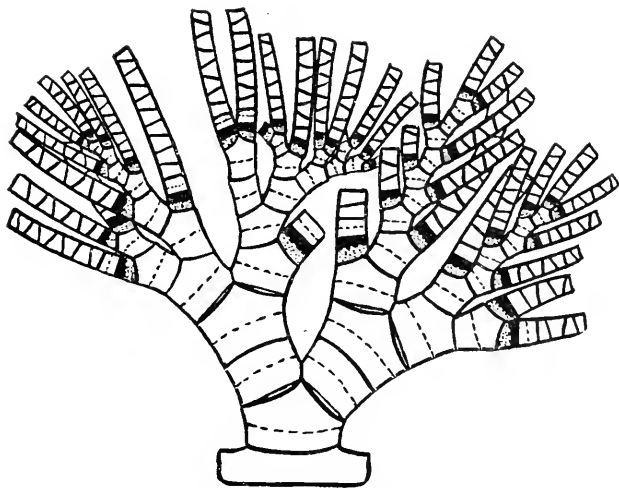

FIG. 23.—COMASTERIDE; COMATULA.

division series of four joints (the remaining first and third joints being quite without it), and the second joint of division series consisting of two joints.

In the young ten-armed stage of all comatulids, so far as I have been able to find out,  $Z_1$  is always the first post-axillary (third post-

radial) joint, and  $Z_2$  the next following; succeeding  $Z_2$  are two joints united by *syzygy*; now  $Z_2$  always has distally an *oblique muscular articulation*; but a 4 (3+4) or 4 (1+2; 3+4) second post-radial division series always has the two component parts separated by a *straight muscular articulation*; the explanation appears to be that when an *oblique muscular articulation* on the distal face of  $Z_2$ , through autotomy taking place beyond it, comes to occupy the position of a *straight muscular articulation*, the dominance of the latter asserts itself, and the *oblique muscular articulation* of the young gradually transforms into the *straight muscular articulation* of the adult.

Now, since the second (and following) post-radial division series of the comatulid arm are frequently doubled, appearing as 4 (3+4)

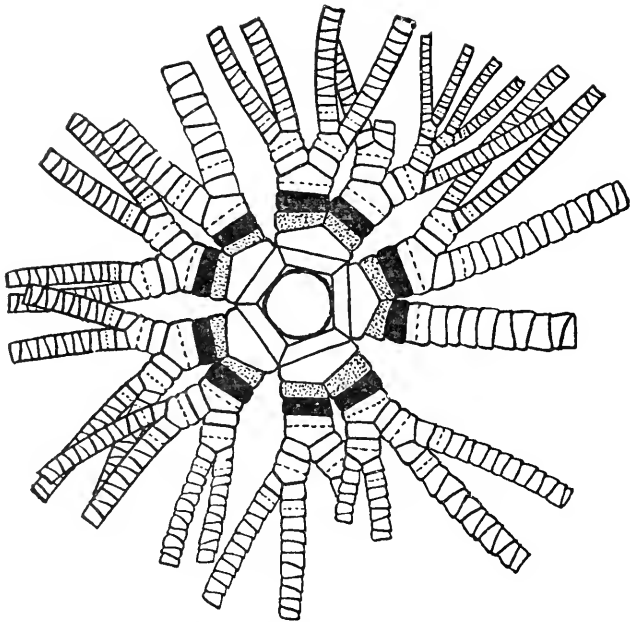

FIG. 24.—COMASTERIDÆ; COMASTER.

(figs. 15, 16, 19, and 20) or 4 (1+2; 3+4) (fig. 23) instead of 2 (fig. 22), we should expect that the first post-radial division series would occasionally be doubled, since it is morphologically comparable to the more distal division series, and we find that such, though rarely, is the case; for Carpenter<sup>a</sup> records that in one "*Antedon*" that passed through his hands "one of the rays consists of five joints, the axillary being a *syzygy*."

<sup>a</sup> Challenger Reports, XI, Zoology, p. 51.

In *Comaster mariv*, *C. fimbriata*, *C. coppingeri*, *C. boruensis*, *C. multiradiata*, *C. iowensis*, *C. scutosa*, *C. lineata*, and *C. discoidea* (fig. 24), and in a number of undescribed species from the West Indies, we find a somewhat anomalous condition: the second post-radial division consists of four joints, 4 (3+4); but the next joint succeeding the second post-radial axillary bears a pinnule, whether it be the first joint of another division series or the first joint of an undivided arm; in other words, all the joints following the second post-radial axillary are pinnulate, except of course, the axillaries. It is at once evident, then, that the first joint in the free undivided arm can not be  $Z_1$ , for it bears a (*oblique*) *muscular articulation* instead of a *nonmuscular articulation* distally. Where, then, is  $Z_1$ ? The articulations subsequent to the first post-radial axillary are, *straight muscular articulation*, by which the first post-radial axillary articulates with the next succeeding joint, *synarthry* connecting that joint with the next; *oblique muscular articulation*, *syzygy*, and, on the distal faces of the axillary, *oblique muscular articulations*. By the application of our definition, we find that  $Z_1$  and  $Z_2$  are the *first and second joints following the first post-radial axillary*, instead of the first and second joints of the free undivided arm, as we found in all cases heretofore. The axillaries and division series subsequent to the first post-radial axillary are, therefore, not morphologically homologous with the first division series, and the division series in all the other forms which we have considered, although, of course, they are physiologically analogous. We may designate the division series formed by the presence of repetitions of  $Z_1$  and  $Z_2$  interposed between the primitive  $Z_1$  and  $Z_2$  and the radials as *interpolated division series*, while division series formed by a splitting of the arm at a certain joint, which therefore becomes an axillary, may be called *extraneous<sup>a</sup> division series*.

It seems to me that such a radical departure from the ordinary comatulid type of *interpolated* arm division occurring in a group of species entitles them to recognition as a valid genus, more especially as *Metacrinus* has been separated from *Isocrinus* along exactly similar lines; and, since a generic name has been based on a species in each group of the genus *Comaster*, I propose to reinstate Lovén's name *Phanogenia*, and to consider the family Comasteridae to be naturally divisible as follows:

*a*<sup>1</sup>. Synarthries all replaced by syzygies.....COMATULA (figs. 21, 22, and 23)

*a*<sup>2</sup>. Synarthries present between the first two post-radial joints.

*b*<sup>1</sup>. *interpolated* arm divisions throughout.....PHANOGENIA (fig. 20)

*b*<sup>2</sup>. first arm division *interpolated*, all following *extraneous*.....COMASTER (fig. 24)

<sup>a</sup> From *extraneous*, external (in reference to  $Z_1$  and  $Z_2$ ) as opposed to *interpolated* (between the radials and  $Z_1$ ).

The described species would therefore arrange themselves as follows:

COMATULA Lamareck, 1816.

*Genotype*.—*Comatula solaris* Lamareck, 1816.

- |   |                                       |
|---|---------------------------------------|
| <i>Comatula distincta</i> (P. H. Carpenter).      | <i>Comatula paucicirra</i> (Bell).    |
| <i>Comatula multibrachiata</i> (P. H. Carpenter). | <i>Comatula pectinata</i> (Linnaeus). |
| <i>Comatula notata</i> (P. H. Carpenter).         | <i>Comatula solaris</i> Lamareck.     |

PHANOGENIA Lovén, 1866.

*Genotype*.—*Phanogenia typica* Lovén, 1866.

- |   |   |
|---|---|
| <i>Phanogenia alata</i> (Pourtalès).                  | <i>Phanogenia nobilis</i> (P. H. Carpenter).      |
| <i>Phanogenia alternans</i> (P. H. Carpenter).        | <i>Phanogenia nova-guineae</i> (J. Müller).       |
| <i>Phanogenia belli</i> (P. H. Carpenter).            | <i>Phanogenia orientalis</i> (A. H. Clark).       |
| <i>Phanogenia benndti</i> (J. Müller).                | <i>Phanogenia parvicirra</i> (J. Müller).         |
| <i>Phanogenia briareus</i> (Bell).                    | <i>Phanogenia peronii</i> (P. H. Carpenter).      |
| <i>Phanogenia carpenteri</i> (A. H. Clark).           | <i>Phanogenia quadrata</i> (P. H. Carpenter).     |
| <i>Phanogenia diraricata</i> (P. H. Carpenter).       | <i>Phanogenia regalis</i> (P. H. Carpenter).      |
| <i>Phanogenia duplex</i> (P. H. Carpenter).           | <i>Phanogenia robustipinna</i> (P. H. Carpenter). |
| <i>Phanogenia chinoptera</i> (J. Müller).             | <i>Phanogenia rotalaria</i> (Lamareck).           |
| <i>Phanogenia elongata</i> (P. H. Carpenter).         | <i>Phanogenia rubiginosa</i> (Pourtalès).         |
| <i>Phanogenia gracilis</i> (Hartlaub).                | <i>Phanogenia schlegelii</i> (P. H. Carpenter).   |
| <i>Phanogenia grandicalyx</i> (P. H. Carpenter).      | <i>Phanogenia serrata</i> (A. H. Clark).          |
| <i>Phanogenia japonica</i> (J. Müller).               | <i>Phanogenia solaster</i> (A. H. Clark).         |
| <i>Phanogenia meridionalis</i> (Agassiz and Agassiz). | <i>Phanogenia stelligera</i> (P. H. Carpenter).   |
| <i>Phanogenia littoralis</i> (P. H. Carpenter).       | <i>Phanogenia trichoptera</i> (J. Müller).        |
| <i>Phanogenia macrobrachius</i> (Hartlaub).           | <i>Phanogenia typica</i> Lovén.                   |
| <i>Phanogenia maculata</i> (P. H. Carpenter).         | <i>Phanogenia valida</i> (P. H. Carpenter).       |
| <i>Phanogenia magnifica</i> (P. H. Carpenter).        | <i>Phanogenia variabilis</i> (Bell).              |

COMASTER L. Agassiz, 1836.

*Genotype*.—*Comatula multiradiata* Lamareck, 1816 = *Asterias multiradiata* Linnaeus, 1758.

- |  |  |
|--|--|
| <i>Comaster borneensis</i> (Grube).          | <i>Comaster maria</i> (A. H. Clark).       |
| <i>Comaster coppingeri</i> (Bell).           | <i>Comaster multiradiata</i> (Linnaeus).   |
| <i>Comaster discoides</i> (P. H. Carpenter). | <i>Comaster scabosa</i> (P. H. Carpenter). |
| <i>Comaster fimbriata</i> (Lamareck).        | <i>Comaster lineata</i> (P. H. Carpenter). |
| <i>Comaster iowensis</i> (Springer).         |  |

Having discussed all the types of arm division commonly found in the Comatulida, I now pass on to the stalked crinoids, after calling

attention to two points of interest. In *Uintacrinus* (fig. 25), which is most nearly related to the Comasteridae, the peculiarities of the pinnulation<sup>a</sup> are at once explained if we consider  $Z_1$  and  $Z_2$  to be the third and fourth joints after the axillary, instead of the first and second, as would be expected; moreover, the size and the shape of the joints and the examination of the external lines of contact of the articulations lead us to the same conclusion, while I have already shown<sup>b</sup> that the abnormalities recorded by Mr. Springer in his monograph of the genus again favor this interpretation. The arms of *Uintacrinus*, therefore, after the costal axillary, resemble those of *Eudiocrinus* in having a repeated  $Z_1$  and  $Z_2$  series of which the second is not an axillary. I have already<sup>c</sup> called attention to a similar state of affairs occurring abnormally in a specimen of *Heliometra tanneri*. It was stated that muscular articulations were occasionally divided, so that an axillary was formed giving rise to a pair of arms instead of to a single arm. The thought naturally arises, does the *straight muscular articulation* on the distal face of the radial ever divide; and do the *oblique muscular articulations* of the distal part of the arm ever divide? In answer to the first ques-

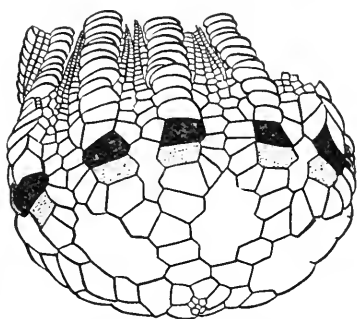

FIG. 25.—UINTACRINIDE; UINTACRINUS (ADAPTED FROM SPRINGER); THE "INTERRADIAL" AND INTERBRACHIAL PLATES ARE OMITTED SO AS TO MORE CLEARLY BRING OUT THE ARMS AND PINNULES.

<sup>a</sup> In *Uintacrinus* the first pinnule is on the second post-axillary joint, the next on the fourth, and on the opposite side of the arm. Now, these pinnules are separated by two articulations. Were they both *muscular*, they would, so far as the position of the pinnule is concerned, counteract each other, and the second pinnule would be on the same side as the first; were they both *non-muscular* neither would have any effect on the pinnulation, and the second pinnule would again be on the same side as the first; but it is on the opposite side; therefore, one of the articulations must be *muscular*, and the other *nonmuscular*. A pinnule can not be developed at a *nonmuscular* articulation; therefore, the articulation at the distal end of the second post-axillary joint is *muscular*; hence the articulation between the third and fourth post-axillary joints must be *nonmuscular*, either a *synarthry* or a *syzygy*. In the comatulids, the pinnule on  $Z_2$  is almost universally different from that on all succeeding brachials, but resembles those on all the interpolated repetitions of  $Z_2$ . In *Uintacrinus* the second pinnule resembles the first, and not those following (in size); hence, the conclusion is reached that the joint which bears the second pinnule is homologous with that which bears the first, and that the first and second post-axillary joints in *Uintacrinus* are an interpolated  $Z_1$   $Z_2$  series, of which the second is not, as is usually the case, an axillary.

<sup>b</sup> Proc. U. S. Nat. Mus., XXXIV, p. 269.

<sup>c</sup> Idem., XXXIV, p. 267.

tion. Carpenter<sup>a</sup> mentions a specimen of *Phanogenia alata* ("*Actinometra pulchella*") in which one of the radials is an axillary, supporting two post-radial series, and I have recently recorded a specimen of *Helio metra maxima* which presents the same condition; more-

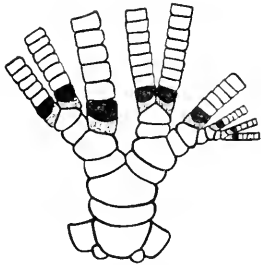

FIG. 26.—PENTACRINITIDÆ; ENDOCRINUS.

over it is probable that *Promachocrinus* and *Decametrocrinus* originally came into existence through a division of the muscular articulation on the distal end of the radial, which later became more and more firmly fixed, finally resulting in a division of the radials themselves, so that the two genera now have ten radials instead of the original five. If this were true we should expect reversions to occur, and *Promachocrinus* to sometimes be found with one or more radials single instead of double, and bearing a post-radial series comparable to those in *Helio metra*, the most closely allied genus; and *Decametrocrinus* to occasionally occur with fewer than ten rays, thus approximating the most nearly related genus, *Pentametrocrinus*; and it is somewhat remarkable that, considering the small number of specimens representing species of these two genera which has been discovered, one, the type of *Decametrocrinus rugosus*, should be only nine armed, through the persistence of one entire radial (the right posterior), and the division of the remaining four.

*Isocrinus* (fig. 27).—In *Isocrinus narsianus* we find a condition exactly similar to that described for the Atelecrinidæ and Antedonidæ:  $Z_1$  and  $Z_2$  are the third and fourth post-radial joints, or the first two joints following the axillary. In *Isocrinus wyville-thomsoni*, *I. parva* (= *Pentacrinus mülleri* + *P. maclearanus*), *I. alternicirrus*, and *I. siboga* (fig. 26)  $Z_1$  and  $Z_2$  are the first and second joints of the free undivided arm. The arm structure is therefore similar to that described for the comatulids with more than ten arms, excepting those in the genus *Comaster*; in these species

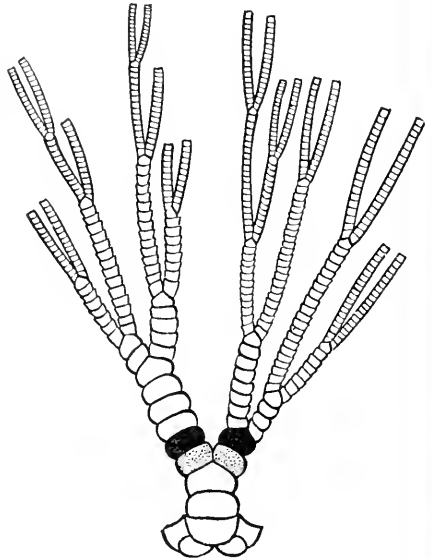

FIG. 27.—PENTACRINITIDÆ; ISOCRINUS.

<sup>a</sup> Challenger Reports, XXVI, Zoology, p. 27.

of *Isocrinus* all the synarthries are replaced by syzygies, and all the divisions are interpolated, consisting of two joints. *Isocrinus decorus* and *I. blakei*, in the ten-armed immature state, are exactly similar in arm structure to *Isocrinus navesianus* and the ten-armed comatulids, excepting *Uintacrinus* and *Decametrocrinus*. In the adult multi-brachiate condition, however, instead of adding interpolated joint pairs as in the comatulids and in the species of *Isocrinus* just considered (*parva*, *wyville-thomsoni*, *alternicirrus*, and *sibogæ*), the arm branching, as in *I. asteria* (fig. 27), is of the *extraneous* type, as in *Comaster* (as restricted),  $Z_1$  and  $Z_2$  remaining *always* the first and second joints after the first axillary, or the third and fourth after the radial, as was found to be the case in *Comaster*; and, as in *Comaster*, the syzygy between the two joints following  $Z_2$  is morphologically the syzygy between the third and fourth joints of the undivided arm in the ten-armed young, and comparable to the similarly situated syzygy in all ten-armed comatulids, while in *Phanogenia* and other forms in which the second division series is of four joints, the two outer united by syzygy, the syzygy is morphologically homologous with the *synarthry* between the first two joints in the free undivided arm, and all other syzygies and synarthries proximal to it. In other words, the syzygy between the third and fourth joints after the first axillary in *Comaster*, *Isocrinus blakei*, *I. decorus*, and *I. asteria*, is homologous with the first syzygy in the free undivided arm in all other forms (except in cases where the first syzygy replaces a synarthry) and with no other, no matter how many syzygies may intervene between that syzygy and the radials.

An *extraneous division*, arising as it does from a division of the arm at an *oblique muscular articulation*, might reasonably be supposed to be of somewhat uncertain nature in the position of the succeeding axillaries, because of the fact that all the arm joints after  $Z_2$ , except occasional syzygies, are thus articulated, and, of course, every such articulation is a potential axillary; and, as a matter of fact, this is the case; while in the type of *Comaster* considered the division was regular in the number of joints between successive axillaries, in

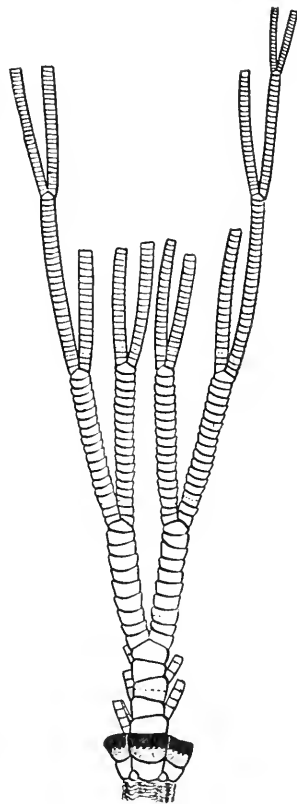

FIG. 28.—PENTACRINITIDE;  
METACRINUS.

*Comaster maria* and in a species mentioned, but not named, by Carpenter<sup>a</sup> (of which I have been able to examine specimens), it is very irregular, and in *Isocrinus blakei*, *decorus*, and *asteria* it is usually more or less, and sometimes very, irregular, especially in the last named. In all the species in which *extraneous division* occurs, the irregularity increases with each successive arm division, so that, in *Metacrinus* and in *Isocrinus asteria*, with their numerous division series, the later division series are of very numerous joints, and much more variable than the division series of *I. blakei* and *I. decorus*, whose most distal series correspond to one of the more proximal series of *I. asteria* and *Metacrinus*.

*Metacrinus* (fig. 28).—The species of *Metacrinus* are remarkable in possessing a type of arm structure different from any we have considered. There are no synarthries in the *Metacrinus* arm; the first two post-radial joints are always united by *syzygy* (the second bearing a pinnule), the second and third by an *oblique muscular articulation*; all the subsequent articulations are *oblique muscular*, with the exception of occasional *syzygies*. Therefore  $Z_1$  and  $Z_2$  are recognized as the *first two post-radial joints*, occupying the same position in which we found them in *Pentametrocrinus*, *Decametrocrinus*, and the peculiar *Thaumatoocrinus*; but while in these genera the arms are undivided, in *Metacrinus*, *extraneous division* always occurs, often as many as five times. All the axillaries in *Metacrinus*, therefore, always have the proximal and both distal faces *oblique muscular*, while in *Isocrinus blakei*, *decorus*, and *asteria*, the first post-radial axillary has *straight muscular* faces, distally, synarthrial proximally, the remainder all *oblique muscular*; and in *I. wyville-thomsoni*, *I. parva*, *I. alternicirrus*, and *I. siboga* all the axillaries have distal faces with *straight muscular articulations* and proximal with *syzygial*. Now, in the young stages of most of the comatulids and in the genus *Isocrinus* where the adults are multibrachiate, the young have only ten arms,  $Z_1$  being separated from the radials by a single interpolated series, representing an additional  $Z_1$  and  $Z_2$ ; in adult life,  $Z_1$  is, in most multibrachiate comatulids, and in *Isocrinus wyville-thomsoni*, *I. parva*, *I. alternicirrus*, and *I. siboga*, separated from the radials by a number of *interpolated* division series; in *Comaster* (as restricted) and in *Isocrinus blakei*, *decorus*, and *asteria*,  $Z_1$  remains in its primitive position, while *extraneous division* occurs beyond it; but in *Metacrinus*  $Z_1$  is *always* the first post-radial joint, and is *never* separated from the radial by an interpolated series. This is interesting; for the ten-armed young stage of multibrachiate forms depends on the presence of a single interpolated series, and, as this series (which invariably persists in after life) is absent in *Metacrinus*, the natural inference is that *Meta-*

<sup>a</sup> Challenger Reports, XXVI, Zoology, p. 328.



*crinus*, in its young stage corresponding to the ten-armed condition of *Isocrinus*, has but five arms; consequently we await with more than usual interest the discovery of the very young of *Metacrinus*.

This result of the analysis of the arms in *Isocrinus* and *Metacrinus* raises the question, are they really so different as is commonly supposed? Is the separation of *Isocrinus* and *Metacrinus* as at present understood natural? Both these questions must be answered in the negative. *Metacrinus* was separated from *Isocrinus* because of its more numerous "radials," the homologies of the joints not being considered. Thus it appears that *Isocrinus blakei*, *I. decorus*, and *I. asteria* (to which must be added *I. narsianus*) are intermediate in structure between *Isocrinus wyville-thomsoni*, *I. parva*, *I. alternicirrus*, and *I. siboga*, and the numerous species of the genus *Metacrinus*. The *I. asteria* group has  $Z_1$  and  $Z_2$  united by synarthry, and separated from the radials by a single interpolated series; extraneous division occurs distal to  $Z_2$ ; the *I. parva* group always have the synarthries replaced by syzygies, and  $Z_1$  and  $Z_2$  always in the free undivided arm, separated from the radials by a series of interpolated divisions; extraneous divisions never occur. *Metacrinus* has  $Z_1$  the first post-radial joint, no interpolated series, but all the arm divisions extraneous; the single possible synarthry is replaced by a syzygy. The interrelations of *Metacrinus*, the *Isocrinus asteria*, and the *I. parva* groups, may be summarized as follows:

<i>Metacrinus</i> (fig. 28).	<i>I. asteria</i> (fig. 27).	<i>I. parva</i> (fig. 26).
No synarthries.	Synarthries present.	No synarthries.
$Z_1$ first post-radial joint.	$Z_1$ third post-radial joint.	$Z_1$ separated from the radials by numerous interpolated series.
Extraneous division only.	One interpolated series only: distal divisions extraneous.	All interpolated divisions.

It is plain that the *Isocrinus parva* and *I. asteria* groups are as different from each other as *Metacrinus* is from the latter; and if *Metacrinus* is to be recognized as a valid genus, the *Isocrinus parva* and *I. asteria* groups should also be kept separate. Treating these three divisions as of equal value generically, it is interesting to find that they fall into definite faunal areas, and occupy characteristic bathymetric altitudes. The three divisions, with the species in each as now understood, are as follows:

- $a^1$ .  $Z_1$  and  $Z_2$  the first two post-radial joints, not repeated; all arm division extraneous; second post-radial joint not an axillary, but bearing a pinnule; basals very broad, forming, when viewed dorsally, a rounded pentagonal figure; infrabasals large and prominent<sup>a</sup>..... METACRINUS (fig. 28)
- $a^2$ .  $Z_1$  and  $Z_2$  repeated at least once; the second post-radial joint an axillary.
- $b^1$ .  $Z_1$  and  $Z_2$  the third and fourth post-radial joints; infrabasals present?
- $c^1$ . One interpolated series only; basals broad, forming, when viewed dorsally, a rounded pentagonal figure; infrabasals?

HYPALOCRINUS (cf. figs. 11 and 17)

<sup>a</sup> Infrabasals have been found in *M. serratus* by Döderlein, and in *M. superbus* and in several specimens (all dissected) of *M. rotundus* by Clark,

- c*<sup>2</sup>. One *interpolated* series, followed by one or more *extraneous* series; basals narrow, forming, in dorsal view, a rounded stellate figure; infrabasals large and prominent <sup>a</sup>-----ISOCRINUS (fig. 27)
- d*<sup>1</sup>. First two post-radial joints united by syzygy; lower pinnules serrate; reentrant angles of stellate figure formed by basals shallow.  
[subgenus *Cenoocrinus*]
- d*<sup>2</sup>. First two post-radial joints united by synarthry; lower pinnules smooth; reentrant angles of stellate figure formed by basals deep.  
[subgenus *Isocrinus*]
- b*<sup>2</sup>. *Z*<sub>1</sub> and *Z*<sub>2</sub> the first and second joints of the free undivided arm, separated from the radials by two or more *interpolated* series; infrabasals always (?) absent <sup>b</sup>-----ENDOXOCRINUS (fig. 26)

Genus METACRINUS P. H. Carpenter, 1882.

*Genotype*.—*Metacrinus wyvillii* P. H. Carpenter, 1884.

*Geographical distribution*.—Northern Australia and East Indies northward to Japan.

*Depth*.—60 to 630 fathoms:

*Included species*:

<i>Metacrinus acutus</i> Döderlein.	<i>Metacrinus serratus</i> Döderlein.
<i>Metacrinus angulatus</i> P. H. Carpenter.	<i>Metacrinus stewarti</i> P. H. Carpenter.
<i>Metacrinus cingulatus</i> P. H. Carpenter.	<i>Metacrinus sulcensis</i> Döderlein.
<i>Metacrinus costatus</i> P. H. Carpenter.	<i>Metacrinus superbus</i> P. H. Carpenter.
<i>Metacrinus mosteyi</i> P. H. Carpenter.	<i>M. superbus</i> , var. <i>borealis</i> <sup>c</sup> A. H. Clark.
<i>Metacrinus murrayi</i> P. H. Carpenter.	<i>M. superbus</i> , var. <i>tuberculatus</i> <sup>d</sup> A. H. Clark.
<i>M. murrayi</i> , var. <i>nobilis</i> P. H. Carpenter.	<i>Metacrinus tuberosus</i> P. H. Carpenter.
<i>M. murrayi</i> , var. <i>timorensis</i> Döderlein.	<i>Metacrinus varians</i> P. H. Carpenter.
<i>Metacrinus nodosus</i> P. H. Carpenter.	<i>Metacrinus wyvillii</i> P. H. Carpenter.
<i>Metacrinus rotundus</i> P. H. Carpenter.	
<i>M. rotundus</i> , var. <i>interruptus</i> P. H. Carpenter.	

Genus HYPALOCRINUS, new.

*Genotype*.—*Pentacrinus narisianus* P. H. Carpenter, 1882.

*Geographical distribution*.—Kermadec Islands, Meangis Islands, Fiji, Celebes, and Philippines.

*Depth*.—500 to 1,350 fathoms.

<sup>a</sup> In fifteen specimens of *I. decorus*, including a very small ten-armed specimen with arms 25 mm. long the infrabasals are large and prominent, showing no trace of resorption; material of other species was not available.

<sup>b</sup> Infrabasals are absent in all specimens dissected, including one with arms only 25 mm. long.

<sup>c</sup> This variety differs from the typical form mainly in having the division series and arm bases smooth instead of very rough.

<sup>d</sup> This form has the division series with strong tubercles, but otherwise resembles the preceding.

*Included species:**Hyalocrinus narcesianus* (P. H. Carpenter).

## Genus ISOCRINUS, L. Agassiz, 1836.

*Genotype*.—*Isocrinus pendulus* von Meyer, 1837.

## Subgenus CENOCRINUS Wyville Thomson, 1864.

*Genotype*.—*Enerinus caput-medusae* Lamarek, 1816 (= *Isis asteria* Linnaeus, 1766).*Geographical distribution*.—Caribbean Sea and Gulf of Mexico.*Depth*.—30 (?) to 320 fathoms.*Included species:**Isocrinus (Cenocrinus) asteria* (Linnaeus).

## Subgenus ISOCRINUS L. Agassiz.

*Geographical distribution*.—Caribbean Sea and Gulf of Mexico.*Depth*.—67 to 667 fathoms.*Included species:**Isocrinus (Isocrinus) blakei* (P. H. Carpenter).*Isocrinus (Isocrinus) decorus* (Wyville Thomson).<sup>a</sup>

## Genus ENDOXOCRINUS, new genus.

*Genotype*.—*Enerinus parra* Gervais, 1835 (= *Pentacrinus mülleri* Örsted, 1856).*Geographical distribution*.—West Indies and Gulf of Mexico, Atlantic coasts of southern Europe and northwest Africa (including the outlying islands), and East Indies to Timor, the Philippines, the Kermadec, and the Meangis Islands.*Depth*.—20 to 1,095 fathoms.*Included species:**Endoxocrinus allericrinus* (P. H. Carpenter). *Endoxocrinus siboga* (Döderlein).*Endoxocrinus parra* (Gervais).<sup>b</sup> *Endoxocrinus wyville-thomsoni* (Wyville-Thomson).<sup>a</sup> Also many fossil species.<sup>b</sup> *Pentacrinus mülleri* Örsted is a synonym of this species; *P. nuclearius* Wyville Thomson is merely a rather strongly marked variety.



# THE FORMATION OF GEODES WITH REMARKS ON THE SILICIFICATION OF FOSSILS.

---

By RAY S. BASSLER,

*Curator, Division of Invertebrate Paleontology, U. S. National Museum.*

---

Spherical, or irregular spheroidal, concretion-like masses, hollow and lined with crystals pointing inwardly, are known to geologists as geodes. Externally the similarity of these objects to concretions is so great that breaking is often required to determine their true nature. In matter of origin, there is little, if any, relation between the two. Geodic cavities are common in all kinds of rocks. Amygdaloidal cavities in igneous rocks are sometimes lined with crystals, thus giving rise to rounded masses coming within the above definition. Openings in veins of ore likewise may be lined with crystalline matter, and the term geode is sometimes applied even though the resulting object is far from spherical in shape. More often, however, these structures are found in sedimentary rocks, limestones and shales being particularly favored, but the general method of formation ascribed to them, namely that of the deposition of crystals from some mineral solution upon the walls of a cavity, is the same in all instances. Several limestone and shale formations have been so prolific of geodes that they are well known in geologic literature under such names as geodiferous limestone or the geode beds. Thus the geodes in the Niagara (Lockport) limestone, particularly at Lockport and Rochester, New York, early gave the name geodiferous limestone to the formation. These geodes are simply crystal-lined cavities, often of considerable size and number, scattered through the rock. The cavities owe their existence in many cases to the removal by solution of fossils; again they are simply fractures in the strata which become enlarged by the expanding force of crystallization. The material in these particular geodes is usually dolomite or gypsum, and the individual crystals are often large enough to make handsome mineralogical specimens. Some of the more striking materials found in these Niagara geodes are masses of silvery selenite, crystalline anhydrite, and crystals of amber-colored calcite and of pinkish dolomite. Similar occurrences of geodes in other limestones

are well known and the specimen figured on Plate XVIII may be taken as an illustration of this particular phase of the subject.

In the first instance mentioned, the original cavity in the rock may have been left by the removal of a fossil by solution, but just as frequently the fossil itself furnishes the cavity. Figs. 3 to 8 on Plate XIX are from photographs of some common Upper Ordovician fossils well illustrating this occurrence. The large brachiopod, *Platystrophia lynx* (figs. 3 and 5), was evidently buried without being filled with mud or other materials. Its hollow interior then afforded an excellent place for the deposition of crystalline material. Only a portion of the interior of the smaller brachiopod, *Rhynchotrema capax*, figured on the same plate (figs. 6-8), was left unfilled with clay, and a correspondingly small geode resulted. What may be called a compound or, better, multiplex geode, results from the deposition of crystals in the hollow chambers of cephalopods. The *Orthoceras*, figured on Plate XIX, is an example of this on a small scale, but larger specimens are not infrequent. In this group of animals the shell, when intact, is less likely to become filled with clay, since the only means of ingress to the interior of the camerated portion is through the breakage of the walls of the camerae or of the siphuncle. No resistance is offered to the passage of water through the empty shell, and, as a result, almost every cephalopod in certain strata can be rated also as a geode. In all of this second group of geodes the crystalline material is calcite, usually in the form of dog-tooth spar. The most striking and best-known geodes, however, are siliceous, and it is to this class that the writer wishes to call special attention. The examples referred to previously, as well as those that follow, are of such common occurrence that the facts here presented must have been noted by many observers. It was therefore with some hesitancy that the present paper was undertaken. A search of the literature, however, revealed little published information upon the subject. Doubtless references to geodes and geodization exist, but they are, apparently, as in the case of Professor Shaler's work referred to below, hidden under other titles.

Among the many problems of silicification the one of most interest to the paleontologist is unquestionably that bearing upon the replacement of fossils. Shells and other fossil forms entirely replaced by silica are of common occurrence in the cherty or siliceous débris resulting from the waste of limestones. These siliceous pseudomorphs, as they are called, often preserve the original shape and markings of the fossil form so perfectly that the peculiar interest of such a process to the paleontologist is obvious. Indeed, some very interesting faunas of geological time would be practically unknown if it had been necessary to work out the individual species from the hard, refractory limestone containing them. As an example of this, the

many fine cystids and crinoids of the Curdsville formation in the central Kentucky Ordovician would never be known were it not for this replacement of these fossils by silica, nor would the hundreds of species of exquisitely preserved bryozoa, ostracods, corals, and other fossils from the Devonian strata at the celebrated Falls of the Ohio locality be available for study and comparison with specimens from less favorable localities. This phase of silicification has been explained by most writers as due to a replacement of the original calcareous material of the fossil by silica at the time of deposition. Under this view, the fossil shell, for example, is replaced by silica either on the ocean bottom at the time of deposition or shortly thereafter. In the case of a limestone then, the fossil would be simply a siliceous shell embedded in a calcareous groundmass. When in the course of weathering the limestone is dissolved away, the insoluble siliceous shells would then be left behind.

A few observers have noted that the limestone yielding such siliceous pseudomorphs upon weathering contains, in the unweathered state, only calcareous fossils. They have also observed that, as the weathering of the fossiliferous limestone proceeds, the fossils are replaced by silica and consequently are not carried away in solution as in the case of the matrix itself. In support of this view, the surface of a fossiliferous limestone layer is often seen sprinkled with fossils of which the portion still embedded in the limestone is calcareous and the exposed parts are siliceous. With this view the time of the silicification is necessarily assumed as very recent, in fact, as going on at the present time. The writer has had many opportunities to study and collect in areas where such silicification has occurred, and all of the facts observed have been in support of the latter idea. The object of this paper is not, however, to discuss this particular form of silicification, and the preceding remarks upon this recent replacement by silica are introduced only on account of their bearing upon the problem of the formation of siliceous geodes.

The best known siliceous geodes come from the Keokuk geode bed, which consists of blue shale and thin limestone 30 to 35 feet thick, particularly well shown at Keokuk, Iowa, and Warsaw, Illinois. The name of Amos H. Worthen will always be associated with these geodes, since years ago he distributed many barrels full of good specimens to the leading scientific men and institutions of this country and Europe. Mr. Worthen's localities are, therefore, best known to the scientific world, and the Keokuk geode bed is even better known than the geodiferous Niagara limestone of New York. The Keokuk geodes vary in size from that of a pea, or even less, up to rounded masses 2 feet in diameter. Quartz is the predominating crystalline material, but agate and crystals of calcite and dolomite are often accessory constituents. Such metallic minerals as millerite, in the form of hair-like needles or tufts of needles, sphalerite, and pyrite, are likewise

found lining the cavities. Dana, in his *Manual of Geology*, says these geodes have been supposed to occupy the center of fossil sponges that were at some time hollowed out by siliceous solutions and then lined with crystals by deposition from the same or some other mineral solution. The writer has been unable to secure a full set of geodes from the Keokuk bed to illustrate their method of formation, but the specimens figured on the plates here presented are from shales and thin limestones of a horizon in Kentucky not strictly equivalent but similar in geological conditions.

These geodiferous shales and thin limestones belong to the Knobstone division of the lower Carboniferous or Mississippian period. Their strata cap the rounded hills of Indiana and Kentucky, encircling that portion of these two States immediately underlaid by Devonian and Silurian rocks. Southern Indiana, in the vicinity of New Albany, and the "Knob" region of Kentucky, extending south

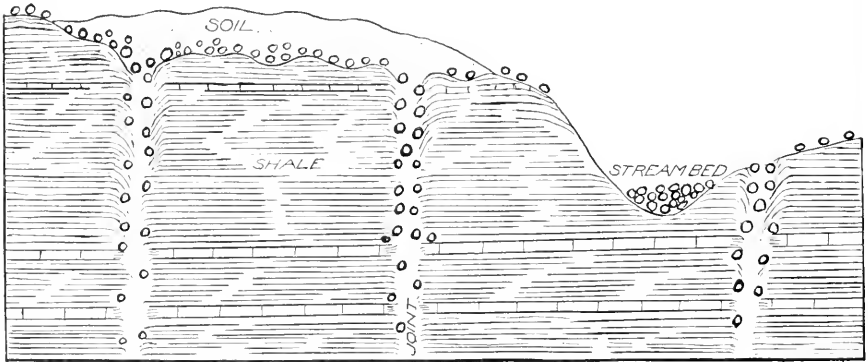

SKETCH SHOWING OCCURRENCE OF GEODES IN KNOBSTONE SHALES.

and then southeast of Louisville, give many exposures of the Knobstone group. Button Mold Knob, several miles south of Louisville and just opposite St. Jacobs Park of that city, is a celebrated locality for Knobstone fossils, and here the writer made most of his collections and observations. The geodes described in this paper from Button Mold Knob occurred in the lowest division of the Knobstone, a series of blue shale termed the New Providence shale. These strata are so compact that water can not readily pass through them. A few thin, ferruginous limestone layers are interbedded with the shale, but they are so infrequent as to have little effect upon the porosity of the strata. The rainfall upon these shales is, therefore, carried away almost entirely by surface drainage, and in the case of level areas underlaid by the shale, a damp, unproductive clay soil is the result of this imperviousness to water. Still, these shales are often crowded with geodes, objects which require the presence of water for their formation. This apparent association of many geodes and no water



led to a study of the local conditions, with the result that the geodes were found to occur only in zones or areas reached by surface waters. Usually the geodes were lying on the surface itself, free or partially covered by the soil, and digging in the compact shale immediately beneath them would reveal no trace of other specimens. In other cases they were apparently buried in the shale, but, in every instance of this kind, closer examination showed these examples to lie on the edge or very close to joint planes or rifts in the strata through which water had easy access. The beds of streams heading in the Knobs are often crowded with geodes washed down from the higher strata. A sketch of these conditions of occurrence would, therefore, be something like that shown on the preceding page.

Having noted the occurrence of geodes, at least in these particular strata, it is next in order to inquire into their method of formation. To determine this point, the many specimens from the Knobstone group are here employed, although examples from other geode-bearing horizons, such as the Upper Niagaran shales of West Tennessee, could be used. At this point it seems best for the present discussion to insert some observations by the late Prof. N. S. Shaler. These are incorporated in an article entitled *Formation of Dikes and Veins*,<sup>a</sup> from which title one would never suppose that a discussion of geodes was included. The writer is indebted to Prof. J. C. Branner for calling attention to this article.

Some light on the foregoing question [the formation of dikes and veins] appears to be afforded by observations which may be readily made on the formation of geodes. As is well known, these bodies in their typical form are spheroidal masses, usually of quartz, which are formed essentially in the manner of veins. They may, indeed, be termed globular deposits in this class; in fact, by extending the inquiry over a large field I have been able to trace a tolerably complete series of forms from spherical geodes to ordinary fissure veins, a series sufficiently without breaks to warrant the assumption that all these bodies belong in one category. A study of these geodes as they occur in Kentucky and elsewhere, especially in the shales of the sub-Carboniferous rock, has afforded me some interesting and instructive suggestions concerning the process of vein-making which I will now briefly set forth.

Normal geodes are hollow spheroids and are generally found in shales. They clearly represent in most cases a segregation of silica, which has evidently taken place under conditions of no very great heat, brought about by deep burial beneath sediments or other sources of temperature. It is difficult in all cases to observe the circumstances of their origin, but in certain instructive instances this can be traced. It is there as follows: Where in a bed in which the conditions have permitted the formation of geodes the calyx of a crinoid occurs, the planes of junction of the several plates of which it is composed may become the seat of vein-building. As the process advances these plates are pushed apart and in course of time enwrapped by the silica until the original sphere may attain many times its original diameter and all trace of its origin lost to view, though it may be more or less clearly revealed by breaking the mass.

<sup>a</sup> Bull. Geol. Soc. Amer., X, 1899, pp. 253-262.

In the process of enlargement which the geodes undergo they evidently provide the space for their storage by compressing the rock in which they are formed. In the rare instances where I have been able clearly to observe them in their original position they were evidently cramped against the country rock, the layers of which they had condensed and more or less deformed. Although when found upon the talus slopes or the soil these spheres usually contain no water in their central cavities, these spaces are filled with the fluid while they are forming and so long as they are deeply buried. There can be no doubt that this water is under a considerable though variable pressure.

The conditions of formation of spheroidal veins or geodes clearly indicate that an apparently solid mass of crystalline structure may be in effect easily permeated by vein-building waters, and this when the temperatures and pressures could not have been great. It is readily seen that the walls of these hollow spheres grow interstitially while at the same time the crystals projecting from the inner side of the shell grow toward the center. We therefore have to recognize the fact that the siliceous-bearing water penetrated through the dense wall. In many of these spherical veins we may note that the process of growth in the interior of the spheres has been from time to time interrupted and again resumed. These changes may be due to the variations in pressure to which the water in the cavities is necessarily subjected as the conditions of its passage through the geode-bearing zone are altered.

The most important information we obtain from the study of spherical veins or geodes is that no distinct fissures or rifts are required for the passage of vein-building waters through existing masses of lodes. It is true that the distances they traverse in these spherical lodes is limited to, at most, a few inches; but there is in these cases no other impulse than diffusive action to bring about the movement, while in an ordinary tabulate vein we may generally assume, in addition to the influence operating in bringing the dissolved materials into the geode, a pressure which impels the fluid upward. Thus, while it is not to be denied that many veins are prepared for by the formation of somewhat gaping fissures, and that these rents, after being more or less completely closed, are reopened by faulting on the plane of the deposit, such original or secondary spaces are not required for the development of a vein. The other point is that the pressure of the growing vein, which in the case of the geode is able so to condense the rock matter about it as to win room for the deposit, is likely to be even more effective in the group of tabulate deposits in forcing the walls asunder.

While the purpose of Professor Shaler's remarks is primarily to show the relationship of geodes to veins, he has also pointed out some factors in the formation of the former. The writer must object to the following of his conclusions: First, that geodes are formed when deeply buried; second, that the water of formation is under a considerable though variable pressure; third, that the geodes are apparently solid masses of crystalline material, which may in effect be easily permeated by vein-building waters; fourth, that the siliceous-bearing water necessarily penetrated through the dense wall; and fifth, that no distinct fissures or rifts are required for the passage of vein-building waters in the formation. Professor Shaler's statements upon the formation of these objects were based upon a study of specimens from the same horizon as those used by the writer, so that both sets of specimens must have had a common origin. The geodes in these Subcarboniferous, or Knobstone strata, are invariably siliceous and appar-

ently always have a fossil as their basis of formation. Under the discussion of mineral veins, Professor Branner, in his Syllabus of Elementary Geology (p. 226), cites geodes as examples of enlargements of fractures by the expansion due to the crystallization of minerals in the incipient crevice. On page 228 of the same work he figures crinoid stems broken asunder, describing the figures as "Geodes formed in the stem of a crinoid. The deposition of quartz began in the hollow stem which was finally broken asunder." As may be observed from later remarks, the observations of the writer agree with Professor Branner's explanation save in the place of deposition of the silica. The subject of the force of growing crystals has been discussed by Merrill in 1895<sup>a</sup> and by Becker and Day in 1905.<sup>b</sup>

The majority of geodes in the Knobstone group may be traced directly or indirectly to a crinoidal origin for the simple reason that these strata are often crowded with fragments of this class of organisms. Probably next in order as a geode maker is the common brachiopod *Athyris lamellosa*, but no class of fossil is exempt from replacement by silica when the proper conditions obtain. Fragments of crinoid columns particularly are so abundant that series showing the complete development of geodes are readily obtained. These crinoidal columns are made up of a series of segments or "buttons" pierced centrally by a rounded or five-sided hole or canal. Professor Branner believed that the deposition of silica started in this canal and continued until the column was fractured by the expansive force of crystallization. This is a very reasonable assumption, but none of the many unfractured crinoid columns before the writer shows a trace of silica in the central canal. These crinoidal columns are particularly subject to fracturing in the shale because of this central canal. The shape of the canal, as well as the five-sided symmetry prevailing in the class, usually causes five longitudinal fractures to form when the crushing is direct (see Plate XX, figs. 2 and 3). If pressure is exerted obliquely upon the column, a slipping of the segments upon each other is likely to occur (Plate XX, fig. 4), although fracturing may also accompany this slipping (Plate XX, fig. 5). All of the geodes originating in crinoid columns can be traced back to such fractured stems, and, also, only such fractured specimens occupying a position of ready access to water shown in the sketch on page 136 were geodized. Numerous fragments similar to the originals of figs. 1-6 on Plate XX, can be dug up from the impervious shales and no signs of silicification observed, but in the water horizons almost all the fractured specimens show some trace of silica. It therefore seems apparent that the deposition of silica is

<sup>a</sup> On the formation of stalactites and gypsum incrustations in caves, Proc. U. S. Nat. Mus., XVII, pp. 77-81, pls. II-V.

<sup>b</sup> The linear force of growing crystals, Proc. Washington Acad. Sci., VII, pp. 283-288.

not in regular cavities where the water can circulate freely, but along fracture lines in which capillary attraction is responsible for the penetration of the mineral bearing solutions. Complete series, in which these fractures are occupied by only a thread-like trace of silica up to the normal geode, showing no trace of crinoidal matter, have been seen, but the specimens illustrated on Plates XX and XXI were deemed sufficient for the purpose. Filling of a longitudinal and transverse fracture is shown in fig. 7 of Plate XX; fig. 8 illustrates three of the five silica-filled fractures of another column. In fig. 9 the mineral deposit in the five main fractures has exerted such a pressure that the intermediate crinoidal material has been broken into small fragments. Each of these minor fractures would have developed stringers of silica had the deposition continued. Such minute breaks are illustrated in figs. 6 and 13, the latter showing the siliceous deposition in a specimen fractured like the original of fig. 6. In fig. 10 the regular arrangement of the silica along five prominent lines is obscured by replacement of side "veins," the original specimen being, apparently, similar to that shown in fig. 3. Figs. 11 and 12 illustrate specimens showing deposition along oblique as well as longitudinal fracture lines. In fig. 14 the mineral matter has been deposited most abundantly at the intersections of two sets of fractures, thus producing a botryoidal appearance in the resulting geodes. This botryoidal effect is more pronounced in figs. 3, 8, 9, 10, and 11 on Plate XXI, but the same origin is evident from the adhering crinoidal remains. Such specimens are usually hollow and lined with drusy quartz (figs. 5 and 7). The crust is often so thin that the geode itself may be crushed (fig. 12). In the final stage all trace of the crinoidal material is lost, although the original five fractures often determine the shape and indicate the origin of the geode. Occasionally the fragments of crinoidal matter between the ridges of silica are removed by solution and leave fluted masses of silica as in fig. 6. That the geodes of this particular geological horizon are not always confined to fossils for their growth, is evidenced by the fragment of crinoidal limestone figured on Plate XXI, fig. 14. Evidently two parallel fractures and a third at right angles have penetrated this specimen and the deposition of silica has followed. Except the last, all of the foregoing illustrations have been based on crinoid columns. In the case of the calyx of a crinoid, little or no fracturing is necessary to give rise to the deposition of silica, since the plate sutures furnish an excellent place for crystalline growth. This particular phase is sufficiently illustrated on Plates XIX and XXIV to require no further mention. Nor does it seem necessary to describe the various stages in geode growth starting from a brachiopod as Plates XXII and XXIII are deemed explanatory enough. As the arrangement of the fractures in crushed brachiopods is usually indefinite, the geodes resulting from this class are traced with more difficulty. It is,

therefore, only when fragments of the original shell are retained, as in figs. 9 and 10 of Plate XXII, that no doubt as to the origin can exist. In these brachiopods it will be noted that the main fracture line is at right angles to and passes through the beak. From this line other fractures often radiate, so that in case of removal of the intervening calcareous shell matter a septarian like effect is produced (Plate XXIII, fig. 11).

In all of the specimens just described the deposition of silica in the fracture has been preceded by a complete silicification of the fossil itself, in the manner described on page 135. Sometimes this complete replacement of calcite by silica leaves a perfect representation of the fossil, but again silicification may destroy all the details of structure (Plate XXIV, fig. 5). Should the fossil when silicified present no fracture, no deposition of crystals preliminary to the formation of a geode occurs, but fractured silicified specimens are subject to geodization. The column figured on Plate XXIV (fig. 6) is completely silicified and small stringers of quartz occupy the fracture. Less frequently these two processes of silicification seem to occur simultaneously.

Returning to the suggestion in Dana's Manual of Geology that the Keokuk geodes are hollowed out sponges lined with crystals, it seems more reasonable, in view of the absence of such sponges in that formation and the presence of numerous specimens indicating the origin described above, that the latter is nearer the truth. Professor Shaler's idea that this class of geodes is formed when deeply buried is not in accord with the facts, at least as observed by the writer, nor does there appear to be any necessity for the water of formation to be under a considerable though variable pressure. Ordinary surface waters charged with silica seem to be sufficient. The other objections to Professor Shaler's views regarding the method employed by the siliceous waters to reach the interior of the geode are explained in tracing their origin to fractured fossils. The deposition of crystals on opposite sides of a fracture will always leave a space free to the passage of water, so that no necessity exists for this water of formation to penetrate the solid mass.

In conclusion, the best known geodes are free, rounded, siliceous, hollow masses lined internally with crystals, and occurring usually in shaly, fossiliferous strata. Fossils lying in the path of surface waters are subject to a complete replacement of their substance by silica; when crushed or fractured, fossils may have the breaks lined with a siliceous deposit. In the latter case, continued deposition and the expansive force of the crystals will result in a hollow, rounded mass, or geode, lined with inwardly pointing crystals and on the outside covered with remnants of the fossil. The chemical side of this subject is a problem which is not in the province of the present paper.

EXPLANATION OF PLATE XVIII.

Fig. 1. A fragment of an ordinary siliceous geode from the Keokuk geode bed at Keokuk, Iowa.

2. Portion of a geodic cavity from North Park, Colorado. In this case a cavity in limestone is lined with crystals of calcite.

1

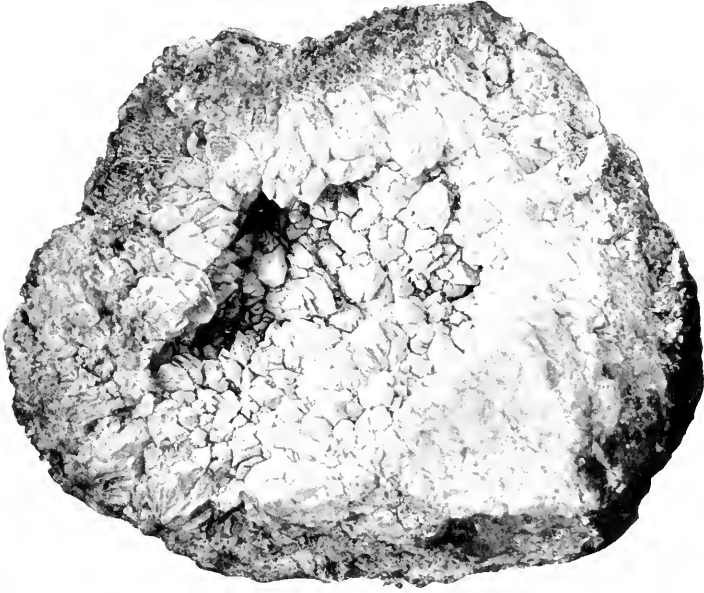

2

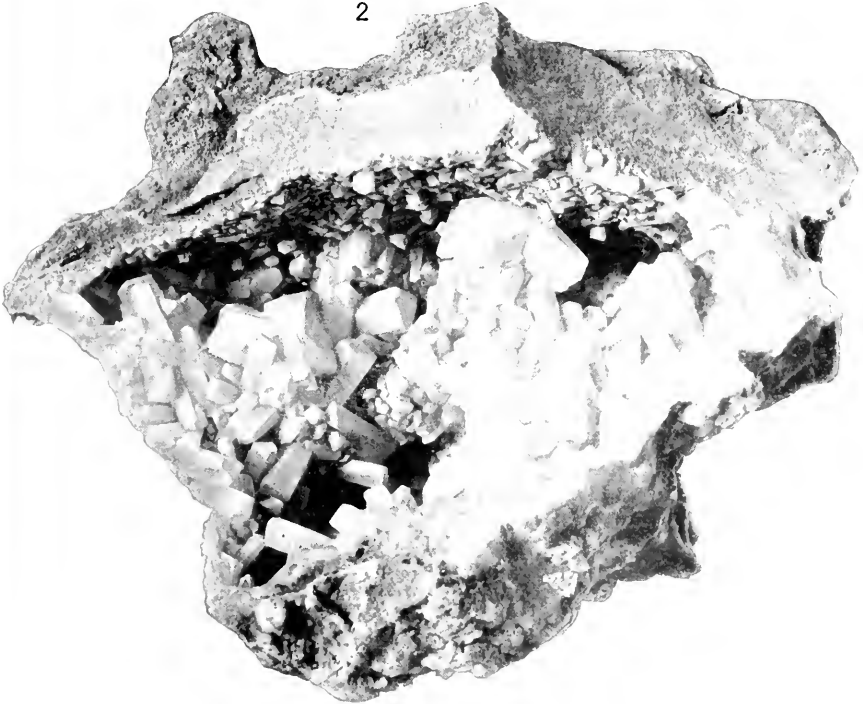

(1) A SILICEOUS GEODE AND (2) A GEODIC CAVITY

FOR EXPLANATION OF PLATE SEE PAGE 142.







EXPLANATION OF PLATE XIX.

All of the figures on this plate, except 3, 6, and 9, are slightly enlarged.

Fig. 1. A fragment of the cephalopod shell *Orthoceras duseri* broken through the middle and showing the chambers lined with dog tooth spar.

2. The wall of one of the crystal lined chambers viewed from above.

3, 4, and 5. Natural size view of the brachiopod *Platystrophia lynx* and enlarged views of its halves, showing the geode nature of the shell.

6, 7, and 8. The brachiopod *Rhynchotrypa capax*, natural size, and enlargements of its halves. In this case the geode occupies only a part of the shell, the remaining portion being filled with indurated clay.

The originals of figures 1 to 8 are from the Ordovician rocks of southwestern Ohio.

9. Basal view of a crinoid calyx, natural size, in which the deposition of silica in the plate sutures has not progressed far.

10. View of the cross-section of the original of fig. 7, Plate XX. The interior of this specimen is almost completely filled with quartz crystals. In this as well as in figs. 11 and 12, the dark colored material is of unchanged crinoidal calcite.

11 and 12. Transverse views of the original of fig. 8, Plate XX, and of another specimen when fractured. The live silica-filled fractures and the hollow central area are characteristic.

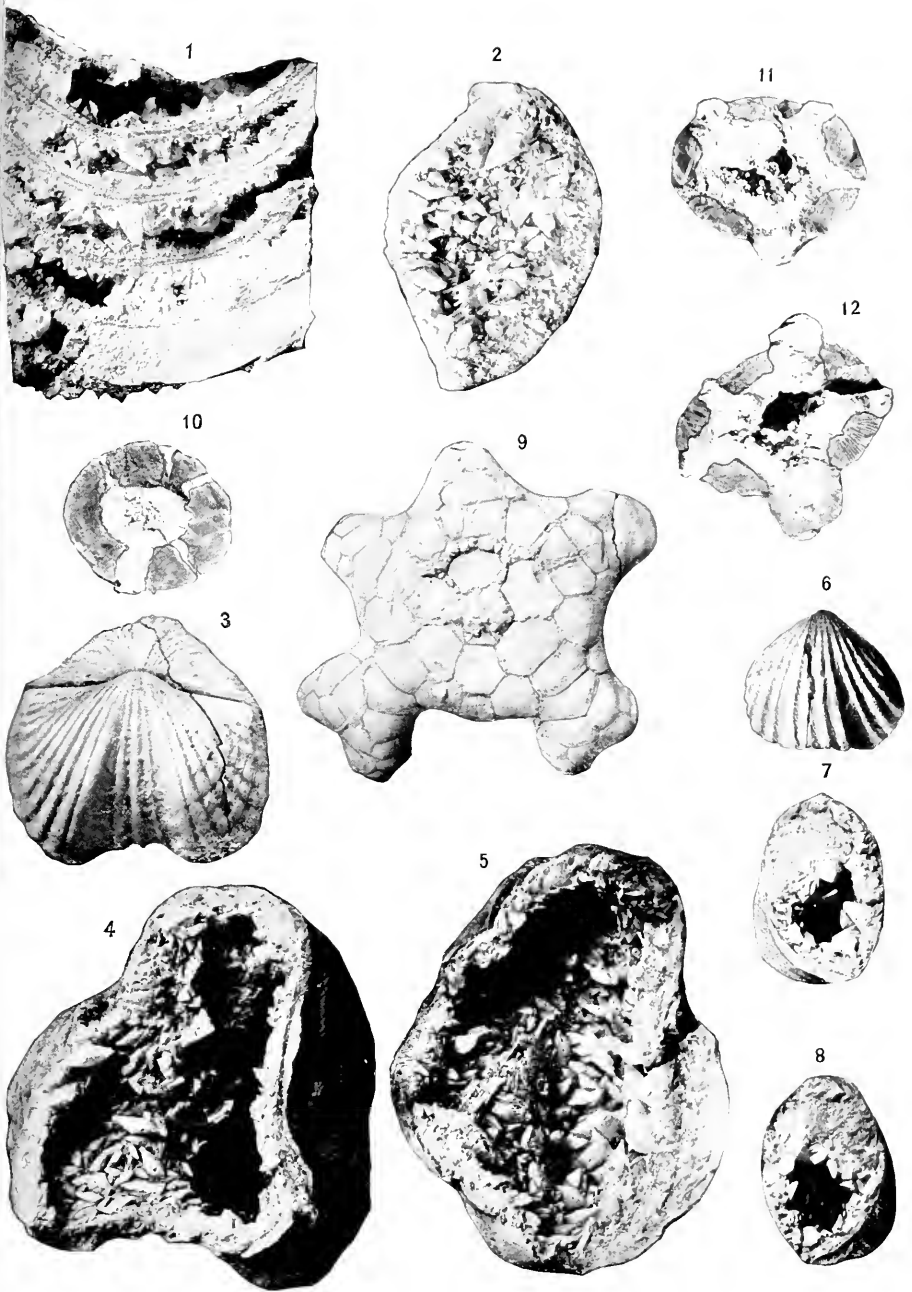

INVERTEBRATE FOSSILS ILLUSTRATING FORMATION OF GEODES.

FOR EXPLANATION OF PLATE SEE PAGE 144.

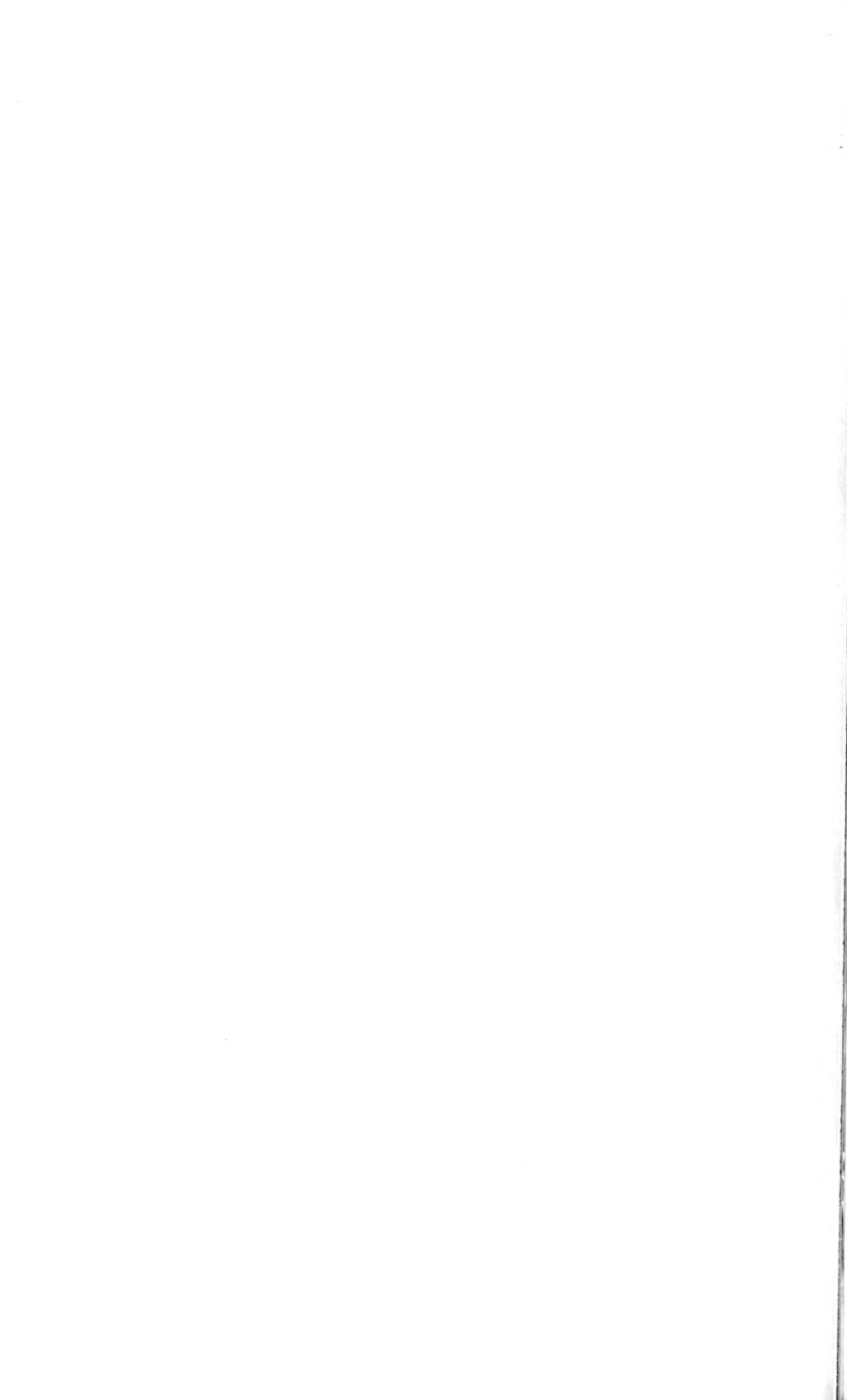



EXPLANATION OF PLATE XX.

All of the figures on this plate are  $\times 1.5$  with the exception of 7-9, and 11, which are natural size. The specimens are from the Lower Knobstone shales at Button Mold Knob, Kentucky.

Fig. 1. View of two segments of a crinoid column illustrating the five sided central canal.

- 2 and 3. Views of opposite sides of a crushed crinoid column. The principal longitudinal fractures correspond in number and arrangement with the pentagonal central canal shown in fig. 1.
4. Portion of a crinoid column in which the individual segments have been slightly pushed apart.
5. Another fragment illustrating slipping of the segments and longitudinal fracturing.
6. A crushed crinoid column with many small fractures as well as the principal longitudinal breaks.
7. A crinoid column with the principal longitudinal fracture, and the ends contain a smaller amount of silica.
8. Another crinoid column with the five main fractures and the ends filled with silica. In this specimen the individual segments of the column were not found apart previous to silicification and hence no transverse bands of silica have been deposited. Transverse views showing the interior of figs. 7 and 8 are given on Plate XIX.
9. A crinoid column in which a great amount of longitudinal fracturing has occurred. Only the five principal fractures corresponding to the pentamerous symmetry of the organism are filled with distinct bands of silica, although the small breaks contain thread-like masses of this material.
10. A crinoid column with irregular fractures filled with silica.
- 11 and 12. Two fragments of crinoid columns which have suffered longitudinal fracturing as well as transverse slipping of the segments previous to the deposition of silica.
13. A crinoid column fractured in the manner of the original in fig. 6 and the spaces then filled with silica.
14. An obliquely crushed crinoidal column with the deposits of silica segregated at the junction of fracture so as to assume a botryoidal structure.

The originals of figs. 1 to 6, inclusive, are calcareous specimens from the compact shales in which no silicification occurs. The remaining specimens, figs. 7 to 14, were found either on the surface or in a zone of silicification.

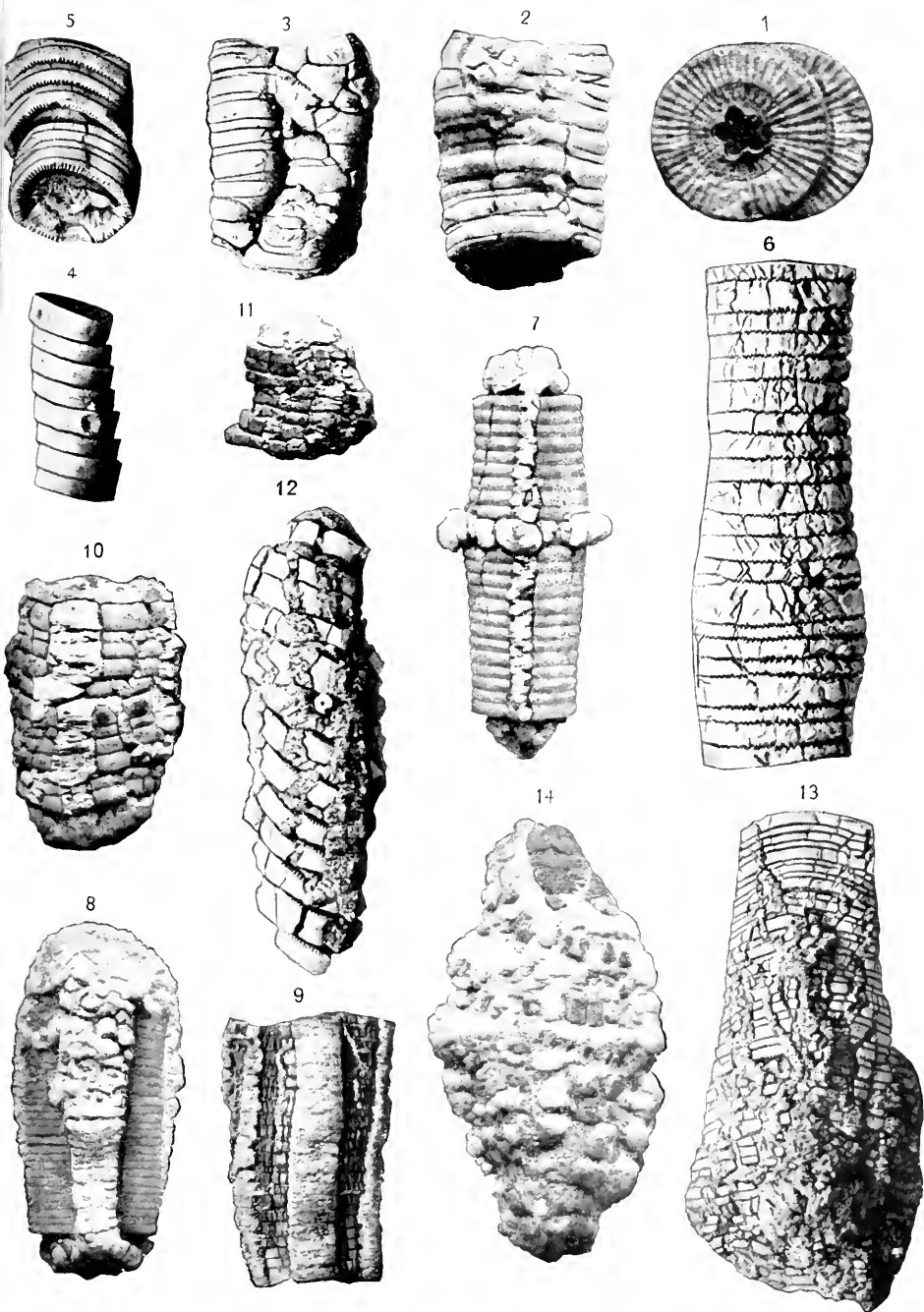

CRINOIDAL REMAINS ILLUSTRATING FORMATION OF GEODES.

FOR EXPLANATION OF PLATE SEE PAGE 146.







#### EXPLANATION OF PLATE XXI.

Figs. 1-3, and 8-11, are  $\times 1\frac{1}{2}$ , while the rest are natural size. All of the specimens were collected in the Lower Knobstone shales at Button Mold Knob, Kentucky.

Figs. 1 and 2. A geode with a crinoid column as a basis.

3. A small geode with small fragments of the crinoid column still showing on its surface.

4. A larger example retaining little trace of crinoidal matter.

5. The interior of a specimen similar to fig. 3, lined with drusy quartz.

6. A geode similar to fig. 2, with the crinoidal calcite removed.

7. Another geode derived from a much fractured crinoid column.

8 to 11. Four small geodes showing their derivation by deposition of silica in crinoid columns.

12 and 13. Top and side views of two small geodes whose formation from crinoid columns is apparent from their five-sided outlines.

14. A mass of crinoidal fragments showing silica replacing the larger fractures.

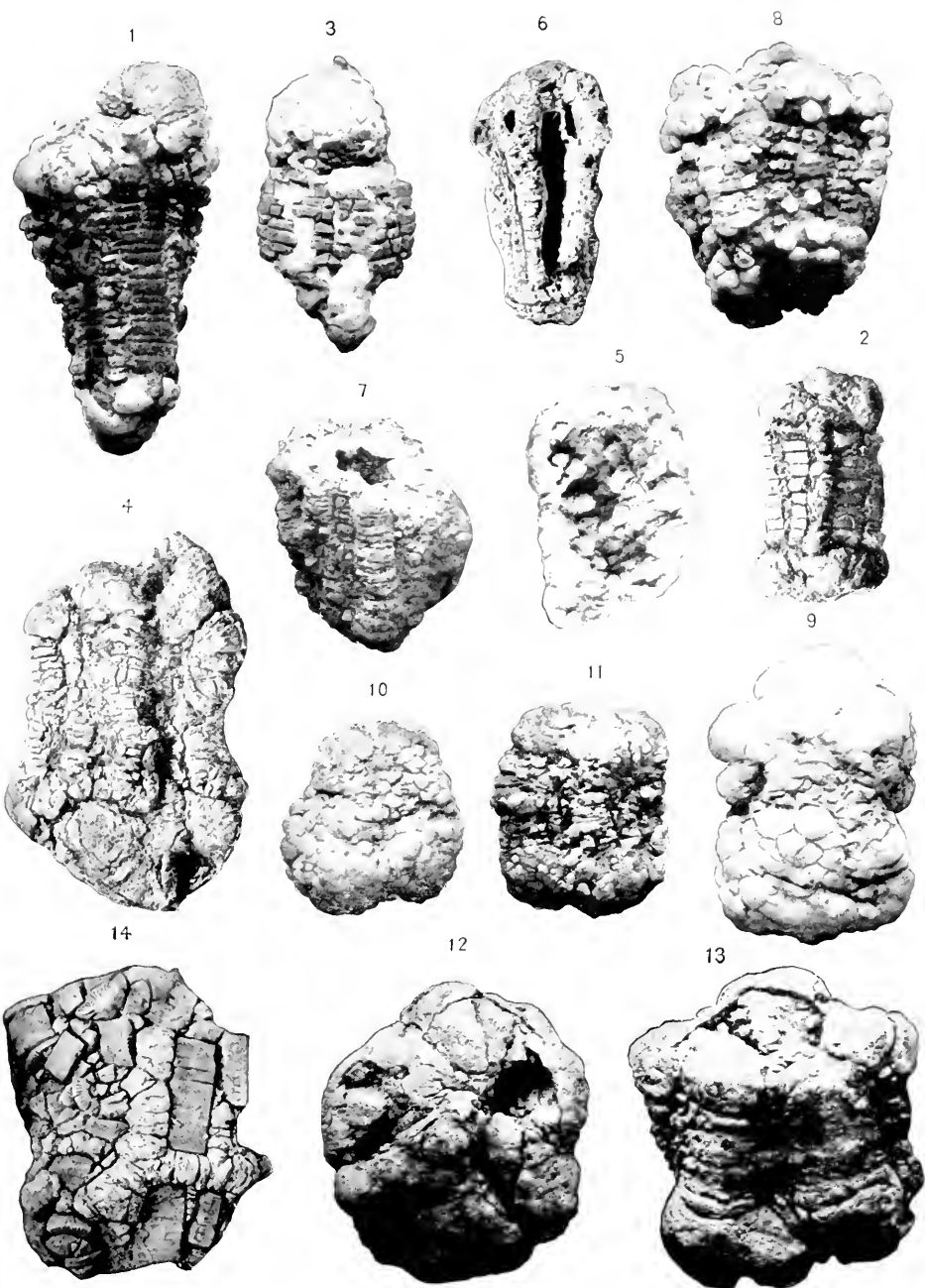

CRINOIDAL REMAINS ILLUSTRATING FORMATION OF GEODES.

FOR EXPLANATION OF PLATE SEE PAGE 148.





#### EXPLANATION OF PLATE XXII.

The views on this plate are natural size and are taken from brachiopods belonging to a species of *Productus* occurring commonly in the Lower Knobstone shales of Kentucky.

- Figs. 1 and 2. Dorsal and ventral views of a rather large specimen which has been only slightly fractured. The two valves of this species are less than one-eighth of an inch in thickness.
- 3 and 4. Opposite views of another shale specimen, which, however, has suffered crushing as well as fracturing of the shell.
- 5 and 6. Dorsal and ventral sides of an example from a water zone. The interior and the main fracture lines at more or less right angles to the beak have been filled with silica so that the thickness of the shell is almost equal to the length.
- 7 and 8. Two examples still further enlarged by silica.
- 9 and 10. A geode with a *Productus* as its basis. In fig. 9 the dorsal valve of the shell is seen while the view in fig. 10 shows the edge of both valves.

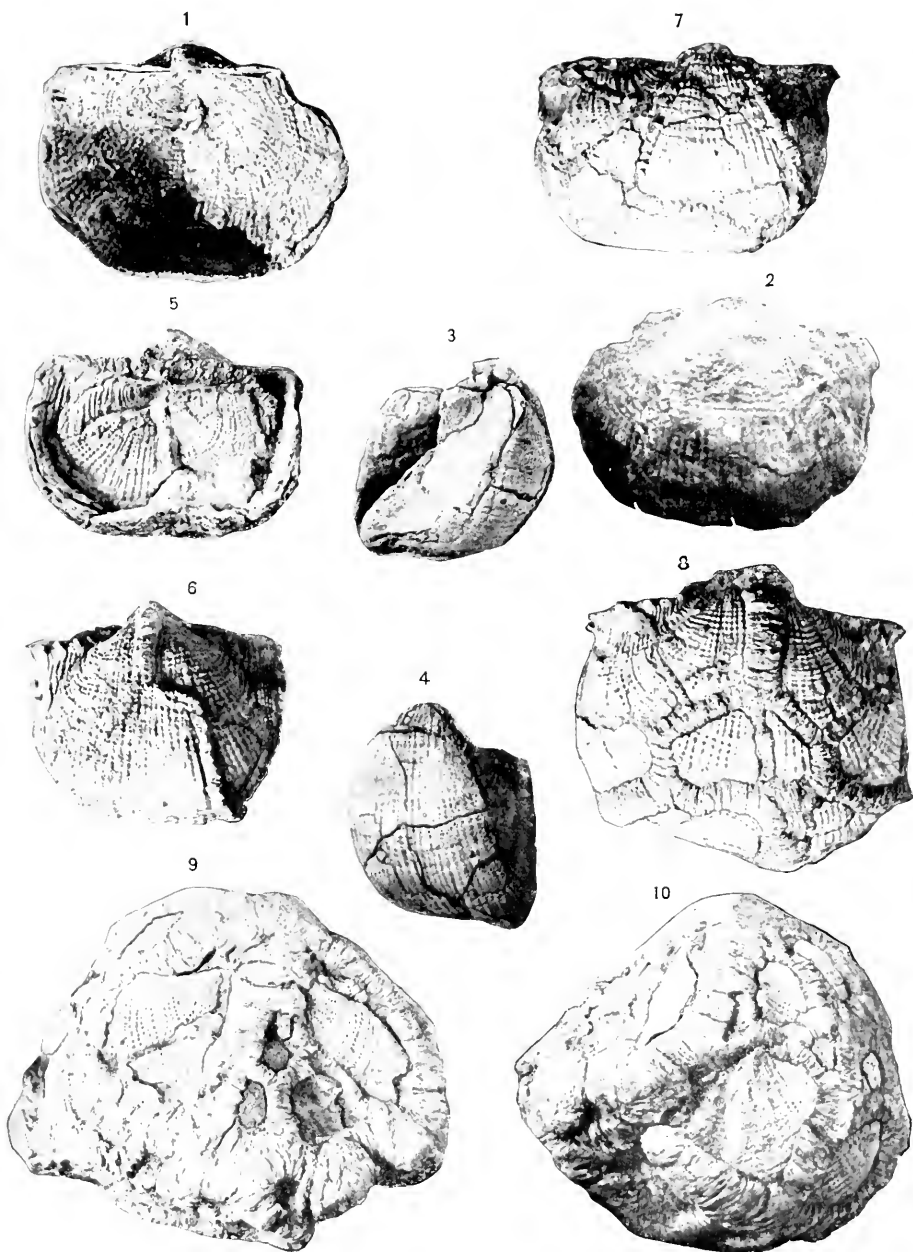

BRACHIOPODS SHOWING STAGES IN FORMATION OF GEODES.

FOR EXPLANATION OF PLATE SEE PAGE 150.







#### EXPLANATION OF PLATE XXIII.

All the views on this plate are natural size and are of the brachiopod *Athyris lamellosa* L'Eveille, from the Lower Knobstone shales of Kentucky.

Fig. 1. A normal example (after Hall and Clarke).

2. A flattened example, showing the main fracture line at right angles to the beak.

3 to 5. Three specimens (foreshortened) with the hinge area lengthened by crushing.

6 and 7. Two specimens distorted by oblique pressure. The main fracture lines coincide with the oblique dissection of the shell.

8. An example with the hinge length greatly shortened.

The above specimens were collected in the impervious shales and consequently the fractures are not filled with silica.

Fig. 9. An example from a water channel in the shale. This shell is so swollen by silica that the length and thickness are about equal.

10. A specimen still further enlarged by the deposition of silica.

11 and 12. Two siliceous goodes showing their derivation from the *Athyris* by deposition of silica in the original shell. In this case the calcareous shell fragments between the siliceous ridges have been worn away.

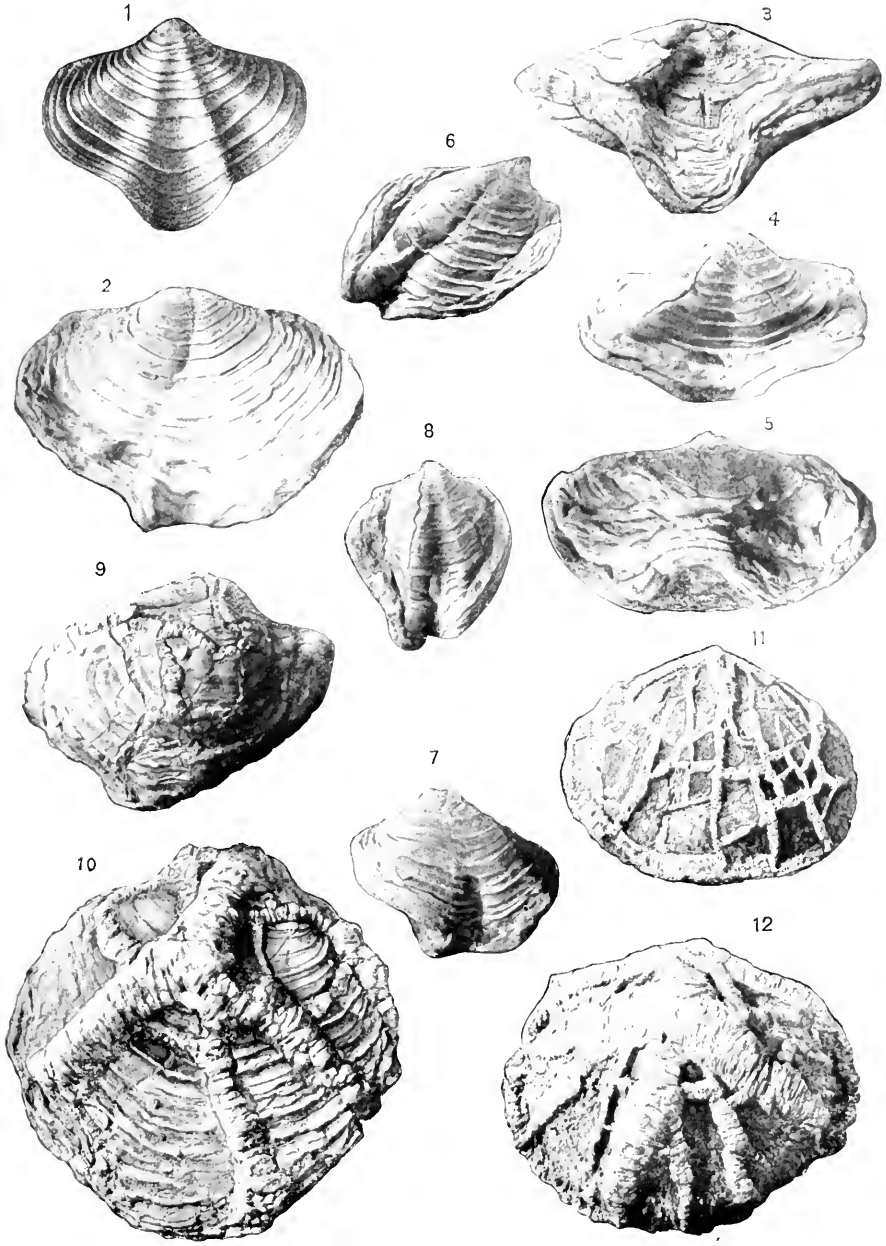

BRACHIOPODS SHOWING STAGES IN FORMATION OF GEODES.

FOR EXPLANATION OF PLATE SEE PAGE 152.





EXPLANATION OF PLATE XXIV.

All the figures on this plate are two-thirds natural size.

- Figs. 1 and 2. Views of a coral, a species of *Amplexus* from the Knobstone shales of Kentucky, in which the deposition of silica has occurred along fracture lines following the septa.
- 3 and 4. Hinge views of two specimens of a brachiopod (*Schuchertella* sp.) from the Knobstone shales of Kentucky, the first fractured but unreplaced, the second swollen with silica.
5. A siliceous pseudomorph after a crinoid in which the details of the fossil have been destroyed. The specimen is Troost's type of *Asterias tennesseca*, from the Tullahoma formation, Cannon County, Tennessee.
6. Fragment of silicified crinoid column from the Keokuk formation of Kentucky. All the original crinoidal material has been replaced by silica and the deposition of quartz crystals in the fractures has commenced.
7. A brachiopod from the Lower Knobstone shales of Kentucky, showing the usual fractures radiating from the beak but having transverse breaks filled with silica.
8. A crinoid, the type of Troost's *Actinocrinites humboldti*, with the silica following the suture lines and occasionally traversing a plate, Tullahoma formation, White Creek Springs, Tennessee.
- 9 and 10. Two views of a silicified crinoid calyx with geodization starting in the sutures. Keokuk formation, Barren County, Kentucky.
11. A specimen of *Caryocrinus* from the Upper Niagaran shales of West Tennessee. The entire specimen is silicified and a second deposit of silica follows the suture lines or traverses the plates.

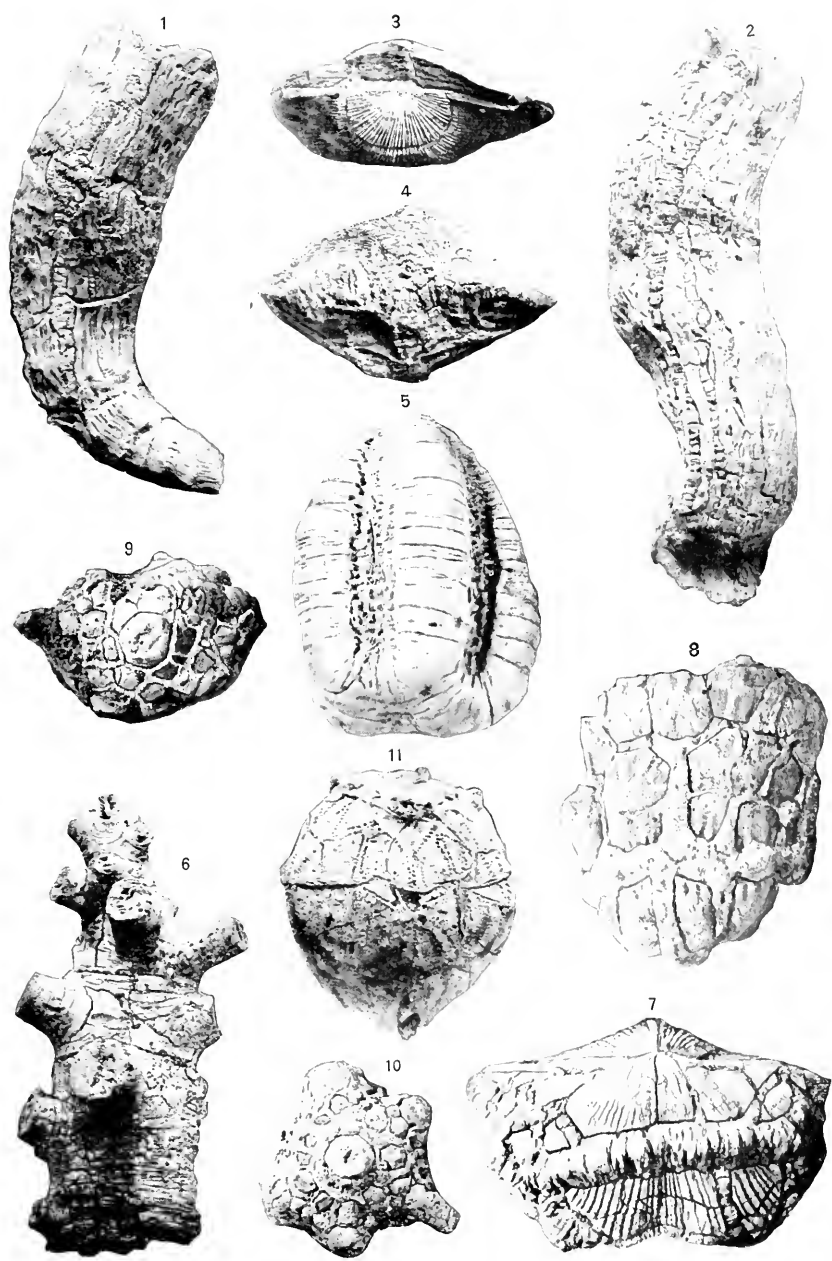

INVERTEBRATE FOSSILS ILLUSTRATING FORMATION OF GEODES.

FOR EXPLANATION OF PLATE SEE PAGE 154.





# CHERODON IN PLACE OF CHEROPS FOR A LABROID GENUS OF FISHES.

By THEODORE GILL,

Associate in Zoology, U. S. National Museum.

President Jordan, of Stanford University, having asked me to ascertain the relative claims of *Cossyphodes* and *Chorops* to priority, I devoted some time to the inquiry. My surprise was great to find that a name unrecorded by late ichthyologists had been the first proposed. The earliest reference to the name *Cossyphodes* that I have been able to find is by Bleeker himself, who mentions it as a synonym of *Chorops*; in his "Conspectus generum Labroideorum Analyticus"<sup>a</sup> he merely records "*Chorops* Rüpp.=*Hypsigenys* Günth.=*Cossyphodes* Blkr." No reference is made to *Cossyphodes* by Günther in the following year<sup>b</sup> nor by Bleeker in his Atlas Ichthyologique more specific than the "Syn. *Chorodon*<sup>c</sup> et *Cossyphodes* Blkr. olim." further than a mention of "*Chorodon* sp." in the synonymy of "*Chorops macrodon*." Nevertheless, in 1847<sup>d</sup> Bleeker published his Overzicht der te Batavia voorkomende gladschubblige Labroïeden in the Verhandelingen van het Bataviaasch Genootschap van Kunsten en Wetenschappen (deel XXII). The first two species are "*Cossyphus macrodon* Blkr." (= *Labrus macrodontus* Lacépède) and "*Cossyphus mesothorax* Cuv. Valenc., XIII, p. 93."<sup>e</sup> The former has been universally named *Chorops macrodon* or *macrodontus* since 1861. This has been on the assumption that the name *Chorops* was the earliest generic designation for the type. Bleeker, however, in the

<sup>a</sup> Proc. Zool. Soc., 1861, p. 415.

<sup>b</sup> Cat. Fishes, IV, 1863, p. 93.

<sup>c</sup> *Chorodon* was a new form in 1861, the more correct form *Cherodon* having been used in 1845 and 1847.

<sup>d</sup> 1847 is the date indicated at the bottom of the page; the monograph is not noticed in the Archiv für Naturgeschichte for any year (1847-1850).

<sup>e</sup> Het lijkt dus wel geen' twijfel, dat deze soort moet gerangschikt worden onder het geslacht *Cossyphus*. Vroeger, toen mij het 13de deel van de Histoire naturelle des Poissons nog ontbrak, had ik van deze soort een nieuw geslacht gevormd en hetzelfde *Chorodon* genoemd, naar de groote naar buiten uitstekende kromme buitenste slagstanden van de onderkaak. Dit genus behoort echter buiten gebruik te blijven. Bleeker, p. 10, 11.

memoir cited (p. 10) records that before receiving the thirteenth volume of Cuvier and Valenciennes he had formed for the species a new genus which he called *Choerodon*, and distinguished it on account of the large and much curved front teeth of the lower jaw. This genus, however, he thought should not be retained.<sup>a</sup>

Notwithstanding Bleeker's suppression of his own genus, according to modern views the generic name should be revived. Bleeker gave an appropriate name, indicated certain generic characters, and specified a type. The fact that he ignored the name later is immaterial.

The status of the several names proposed is indicated in the following synonymy.

A comparison of species of *Choerodon* and *Harpe* in the U. S. National Museum has convinced the writer of the close relationship of the two, notwithstanding their reference to distinct subfamilies by Doctor Günther.

#### CHÆRODON.<sup>b</sup>

##### SYNONYMY.

*Choerodon* BLEEKER, *Ov. gladschub. Labroid.*, 1847, p. 10. (Type, *C. macrodon* Lacépède.)

*Choerops* RÜPPEL *Verz. Mus. Senckenberg. N. G. Samml.*, IV, 1852, p. 20. (Type, *C. melcagris*.)

*Hypsigenys* GÜNTHER, *Ann. and Mag. Nat. Hist.*, (3) VIII, 1861, p. 383. (Type, *H. macrodon* Lacépède.)

*Cossyphodes* BLEEKER, *Proc. Zool. Soc. London*, 1861, p. 416. (Named as syn. of *Choerops*.)

<sup>a</sup> So far as the definition goes, that by Rüppell for *Choerops* has no advantage over *Choerodon*. There is no character in his diagnosis which is not equally applicable to *Bodianus* or *Harpe* (= *Cossyphus*) and several other genera. The only reference to a type is "*Choerops* (nov. gen.) *melcagris* Rüpp. Sic. Mare Javanicum." No definition then or later was attached to the name. Bleeker, in 1859, in his *Enumeratio specierum Piscium hucusque in Archipelago Indico observatorum*, enumerates the genus *Choerops* (p. xviii) and the species *Choerops melcagris* (94) but did not recognize the identity of the latter with the species he then called *Cossyphus macrodon* (93). In his *Atlas Ichthyologique* he remarked: "C'est à M. Rüppell qu'est dû l'établissement de ce genre, mais ne le définissant pas suffisamment et n'en décrivant pas l'espèce typique qu'il nomma *Choerops melcagris* [i. e., *melcagris*], il laissa, quant à son type, des doutes, qui ne sont dissipés qu'après que j'ai pu me convaincre, lors de mon séjour à Francfort sur le Main, en l'an 1861, que le *Choerops melcagrides* [*melcagris*] n'est autre que le *Labrus macrodon* Lac."

<sup>b</sup> Reference is made by Bleeker, in his *Atlas Ichthyologique des Indes Orientales néerlandaises*, I, 1862, p. 162, to "Bijdr. Geneesk. Topogr. Batavia, p. 513." A search reveals that the publication referred to is in the *Natuur-en-Geneeskundig Archief voor Néerland's-Indië, tweede Jaargang, 1845*; at p. 513 is a list of the "Labroiden," and of them is mentioned "1 [soort] van *Choerodon* (nov. g.)." This is the only indication, and the name is therefore a pure *nomen nudum*.

DESCRIPTION OF NEW FOSSIL LIVERWORT FROM THE  
FORT UNION BEDS OF MONTANA.

---

By FRANK HALL KNOWLTON,

*Custodian of Mesozoic Plants, U. S. National Museum.*

---

The Liverworts or Hepaticae in a fossil state are of such extremely rare occurrence that each additional authentic instance becomes a matter of exceptional interest, and it is therefore with great pleasure I am able to record the presence, in the Fort Union (Eocene) beds, of what seems an indisputable member of this group for which I propose the name:

**MARCHANTIA PEALEI**, new species.

Thallus of large size, at least 8 cm. long and 1.25 cm. wide, distinctly forking and with the margins erose or erose-undulate; "mid-rib" broad and diffused with the bundles of closely appressed rhizoids radiating obliquely from it in such a manner as to simulate veins; fruit not preserved.

*Type-locality*.—Hedges coal mine, north side of Yellowstone River, opposite Miles City, Custer County, Montana.

*Horizon*.—Lower portion of Fort Union (Eocene).

*Type-specimen*.—Cat. No. 33928, U.S.N.M.

The splendid specimen, so well shown in the figure, was collected by Dr. A. C. Peale and Mr. A. J. Collier in August, 1907, from material excavated at a point about 8 feet above the principal coal vein of the vicinity and was the only specimen of the species secured. It is preserved in a soft, fine-grained grayish white clay, and as much of the carbonaceous matter is still present, it exhibits the characters very distinctly. It has been very little distorted and still has much the appearance of one of the living species growing over the surface of the ground; in fact, it is rather difficult in the absence of fruit to find characters by which to definitely separate it from the living *Marchantia polymorpha* Linnaeus, of such wide geographical distribution. As may be seen from the figure, it is very distinctly forked, one

of the largest thalli showing three such branches. The carbonaceous matter has come off over the "midrib," showing it to be broad and diffuse, this being a well-known character of the living *Marchantia*. The obliquely disposed bundles of rhizoids, which, as already stated, somewhat simulate veins, are exactly paralleled in many well preserved specimens of *M. polymorpha* in the herbarium of the U. S. National Museum. One thing which may militate against its reference to *Marchantia* is the absence of the fine areolations which are so conspicuous in the thallus of the living species. Otherwise it is so close to the living *M. polymorpha* as to preclude the propriety of referring it to other than the living genus. It is entirely possible that subsequent exploration in the beds whence it came may disclose the presence of fruit, but until such is discovered its relation may remain as above set forth.

So far as I know only two species of Hepaticæ have previously been reported in a fossil state in this country, though specimens of the living *Marchantia polymorpha* have been found in calcareous tuff, evidently of recent age. The oldest of these is a doubtful specimen from the Jurassic beds of Douglas County, Oregon, referred by Fontaine<sup>a</sup> to *Marchantites erectus* (Bean) Seward, but it is very unlike the present species, and it is doubtful if it is properly referred to the Hepaticæ.

The other form is *Preissites wardii* Knowlton,<sup>b</sup> found in beds of the same age as the form under discussion, and coming from Burns's Ranch on the lower Yellowstone, 30 miles below Glendive, Montana. *Preissites wardii* is a much smaller species than *M. pealei*, the extremes of size as observed being a length of from 8 to 15 mm. and a width of about 6 mm. It strongly suggested the living *Marchantia polymorpha*, but on account of the presence of prominent vein-like lines nearly at right angles to the midrib it was thought to be probably most closely related to the living genus *Preissia*. In this genus the under side of the thallus is provided with scales which it was thought might appear as lines if fossilized. The vein-like lines are present in *M. pealei*, but they are clearly due, as already explained, to bundles of rhizoids and not to ventral scales. It is possible, however, that with further material of both forms the supposed generic lines might break down, but specifically they would differ in the smaller size and different mode of branching in *P. wardii*.

A form that is very much closer to *M. pealei* is *Marchantia sezau-nensis* Brongniart, which was found by Saporta<sup>c</sup> so well preserved

<sup>a</sup> Fontaine in Ward, U. S. Geol. Surv., Mon. 48, 1905, p. 52, pl. VII, figs. 1, 2.

<sup>b</sup> Bull. Torr. Bot. Club, XXI, 1894, p. 458, pl. CCXIX.

<sup>c</sup> Mém. Soc. Géol. d. France, 2 ser., VII, 1868, p. 308, pl. XXII, figs. 1-8.

and in fruit in the travertines (Eocene) of Sezaune. This species, which Saporta also compares with *M. polymorpha*, is similar to *M. pealei*, though it is considerably smaller, and differs slightly in the character of the margin, while the areolation of the thallus appears to have been very well preserved. As this feature was not preserved in the Miles City specimen, it would be necessary to keep them distinct for the present if for no other reason. It is not necessary to speak of the fruit of *M. sezaunensis*, since the fruit has not been found in *M. pealei*.

In concluding it may be pointed out that it seems a rather singular fact that the two authentic examples of fossil Hepaticæ thus far found in this country should both have come from the same part of the Fort Union beds of Montana.



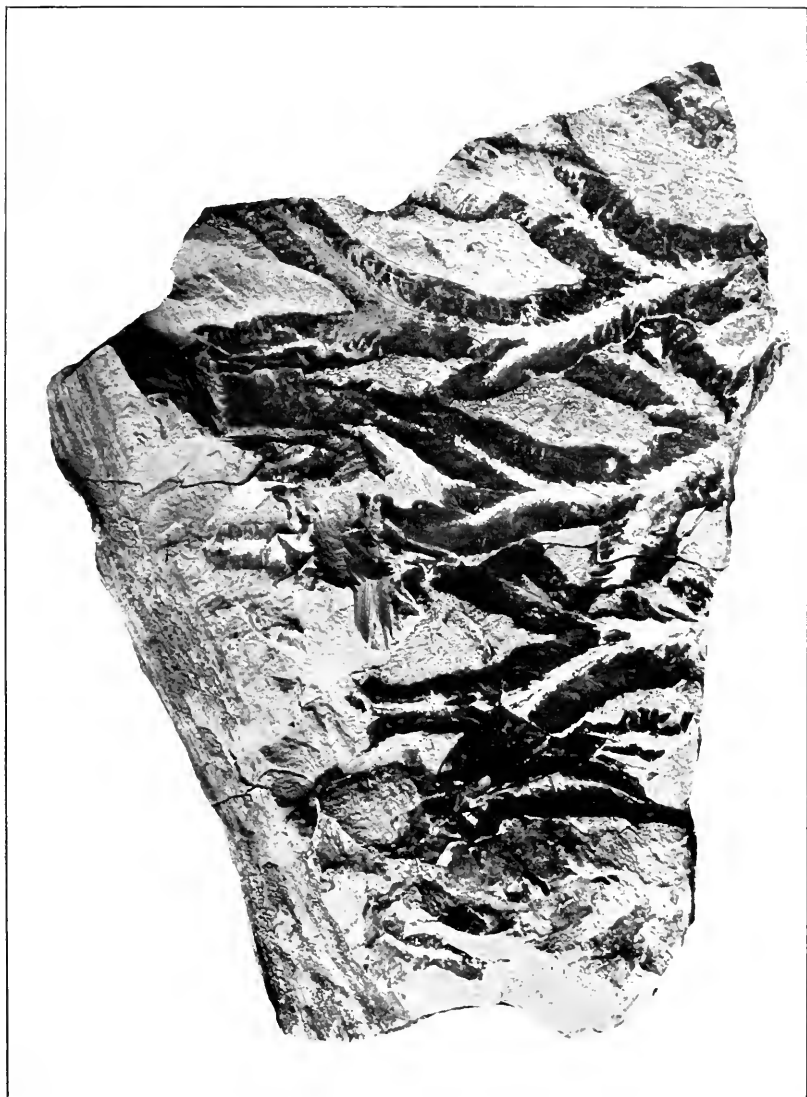

A NEW FOSSIL LIVERWORT, MARCHANTIA PEALEI.

FOR REFERENCE TO PLATE SEE PAGE 157.





# DESCRIPTIONS OF FIVE SPECIES OF NORTH AMERICAN FOSSIL TURTLES, FOUR OF WHICH ARE NEW.

By OLIVER P. HAY,

*Of Washington, District of Columbia.*

Through the liberality of the authorities of the United States National Museum the writer has been permitted to study and describe a number of specimens of fossil North American turtles. The results of his investigations are here presented.

## GLYPTOPS PLICATULUS (Cope).

In the collection of the U. S. National Museum are various specimens of this species, most of them fragmentary. One of these is of special interest, inasmuch as it displays distinctly the sulci bounding the areas of the dermal scutes of the carapace. This specimen is Cat. No. 5458, and it was collected by a member of one of Prof. O. C. Marsh's parties at Como, Wyoming, in 1884. Only about the hinder half of the carapace and a fragment of one mesoplastron are preserved. The parts of the carapace are shown in fig. 1. The neurals begin with the third. On the right side the peripherals begin with the seventh; on the left, with the eighth.

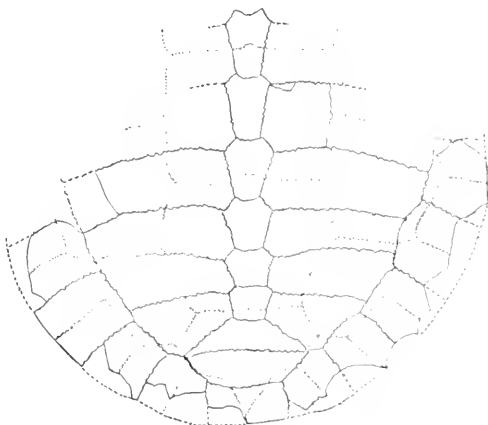

FIG. 1.—POSTERIOR PORTION OF CARAPACE OF GLYPTOPS PLICATULUS.

The peripherals of the hinder border curve slightly upward toward the subaerate free border. Those of the bridge region have the free border uprolled somewhat, thus presenting a sort of gutter

over the bridge. The dimensions of the peripherals are given in the table. The pygal is 33 mm. from side to side and only 16 mm. fore and aft. The neural bones have the usual forms and proportions.

This specimen shows distinctly that there were two large suprapygals, instead of one, as hitherto supposed by the writer. Plate VI and fig. 17 of the writer's forthcoming *Fossil Turtles of North America* show what was supposed to be a single suprapygal. The figure on the plate referred to is, however, crossed by a white line, which perhaps represents a suture, but which was taken to be a fracture. The figure here presented shows the forms of the two bones. The anterior measures 15 mm. on the midline; the posterior, 19 mm. The greatest width of each is 50 mm. Baur<sup>a</sup> stated that there were two suprapygals, but he did not describe them. From a figure prepared for Baur and awaiting publication by the writer<sup>b</sup> it was supposed that Baur had regarded the small bone succeeding the eighth

*Dimensions of peripherals.*

Peripheral.	Length.	Height.
<i>mm.</i>	<i>mm.</i>	<i>mm.</i>
7	30	26
8	30	33
9	23	26
10	25	25
11	27	24

neural as a suprapygal. Marsh represents only a single suprapygal in the specimen figured by him.<sup>c</sup>

On the inferior surface of the carapace here described are seen the well-developed heads of the ribs. The buttress of the hypoplastron was strongly developed and fitted into an excavation in the contiguous

borders of the fifth and sixth costal bones. The buttress rose about 18 mm. above the lower ends of these costals and was about 15 mm. thick fore and aft. Another specimen in the U. S. National Museum, Cat. No. 5733, shows that there were similar axillary buttresses.<sup>d</sup>

The sulci between the various dermal scutes are extremely narrow and threadlike, but all are traced with little difficulty. That between the second and the third vertebral scutes crosses, as usual in turtles, on the third neural bone. The length of the third vertebral scute is 52 mm.; of the fourth, 61 mm.; of the fifth, 46 mm. The fourth has a width of 72 mm.; the fifth, a width of 60 mm. The marginal scutes are mostly confined to the peripheral bones, rising to near the costoperipheral sutures. The eleventh pair, however, overlaps slightly on the eighth costal and the twelfth on the hinder suprapygal. The fifth vertebral extends backward to within 7 mm. of the hinder border of the bygal.

It is estimated that the carapace of this individual had a length of 255 mm.

<sup>a</sup> Proc. Acad. Nat. Sci. Phila., 1891, p. 411.

<sup>b</sup> *Fossil Turtles of North America*, p. 48, fig. 18.

<sup>c</sup> Amer. Jour. Sci., XL, 1890, pl. vii.

<sup>d</sup> *Fossil Turtles of North America*, pl. v, fig. 5.

## HOPLOCHELYS CÆLATA, new species.

Plate XXVII, figs. 1-3.

The present species is based on rather meager remains, but it is believed that they indicate clearly the position of the animal and will enable one to identify other individuals furnishing the same parts. The materials consist of a peripheral, thought to be the seventh of the left side and the two succeeding ones; the eighth, ninth, and tenth of the right side; and some small fragments of costal bones. These have the Cat. No. 5958 in the U. S. National Museum. These remains were found by Mr. A. C. Silberling, in 1908, on section 35, township 6 north, range 15 east, being north of Big Timber, Sweet Grass County, Montana. The beds are regarded as belonging to the Fort Union epoch. The writer is informed by Mr. J. W. Gidley that the mammalian remains indicate equivalence with the Torrejon of New Mexico.

A comparison of these bones with corresponding parts of *Kinosternon integrum* makes it probable that the carapace of the new species had a length of about 114 mm. Fig. 1, Plate XXVII, gives a view of the outer surface of the peripherals of the right side; while fig. 2 shows the inner surface of those of the left side. It is seen at once from fig. 2 that the plastron articulated with the carapace principally by means of finger-like processes sent into the bridge peripherals. It seems quite certain that the upper borders of the peripherals were joined to the costals by jagged sutures. Likewise, the ends of the costal ribs entered deeply into the peripherals, as shown by the lower vertebra of fig. 2.

The peripherals are almost plane on their outer surfaces; on their inner they are convex from the free border to two-thirds their height, the upper third being concave. The free edge is acute. Probably a sharp carina crossed fore and aft the peripherals of the bridge. The peripherals present have the following lengths along the free border: The seventh, 13 mm.; the eighth, 14 mm.; the ninth, 16 mm.; the tenth, 16 mm. The seventh is 8.5 mm. thick at the front end; the greatest thickness of the ninth and tenth is a little less than 5 mm. On the inner surface of the peripherals behind the seventh the horny scutes rose about half the height of the bones.

The sulci that separated the various scutes are deeply and sharply impressed. Those descending between the marginals are nearer the front of their respective peripherals. What is regarded as the ninth marginal is strongly angulated above, as is also the eleventh.

A fragment of costal bone (Plate XXVII, fig. 3) has a maximum width of 10 mm. and a thickness of hardly 2 mm. It is probably a part of the seventh.

The sculpture of this turtle will distinguish it from any related Lower Eocene species yet known. The fragment of costal is crossed

diagonally by one prominent, narrow, and sharp ridge and by a number of less conspicuous ridges. As a result, the surface has a very uneven appearance. The peripherals also are, or have been, similarly sculptured. As shown by the tenth and eleventh (Plate XXVII, fig. 1), the area in front of the descending sulcus is ornamented by ridges nearly parallel with the sulcus, while the area behind it has grooves and ridges running downward and backward. A somewhat similar sculpture is observed on a specimen of *Pseudemys rubriventris*.

This species appears to be most closely related to *H. crassa* (Cope), fully described and figured in the writer's forthcoming monograph.<sup>a</sup> This species was described by Cope from the Lower Eocene of New Mexico, but whether from the Puerco or the Torrejon is uncertain. From this *H. calata* differs in having the bones strongly sculptured; also apparently in having the peripherals more closely sutured to the costals and less concave outwardly.

ECHMATEMYS RIVALIS, new species.

The turtle which forms the subject of this description is represented by a damaged shell which was found by Mr. E. E. Smith, of

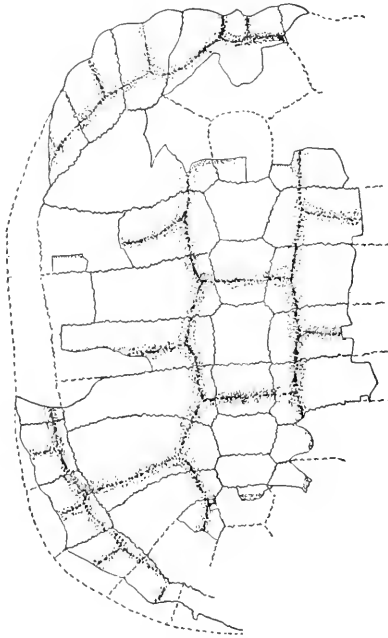

FIG. 2.—PORTION OF CARAPACE OF ECHMATEMYS RIVALIS.

the U. S. Geological Survey, in 1907, on the line between sections 19 and 20, township 23 north, range 93 west, in what is known as the North Rawlins coal field, in the eastern part of Sweetwater County, Wyoming. I am informed by Dr. T. W. Stanton that the beds in this region belong to the Wasatch, or are at most not older than the Wasatch. This conclusion is confirmed by this turtle. This specimen, now in the U. S. National Museum, is Cat. No. 5781. The parts of the shell preserved are shown by the figures.

The total length of the carapace (fig. 2), in a straight line, was originally close to 260 mm.; the breadth close to 190 mm. The nuchal bone has its hinder parts wanting. The free border has a width of 40 mm. It is conspicuously notched on each side of the nuchal scute. The first, second,

<sup>a</sup> Fossil Turtles of North America, p. 263, pl. XXXVIII, figs. 4-9, text-fig. 325.

third, and eighth peripherals and large parts of those succeeding are present. The free borders of the first and the second measure each 33 mm.; the height of the first is 32 mm.; that of the second, 25 mm., each measured at its hinder border. The width of the eighth is 25 mm.; its free border is wanting, as well as that of the peripherals behind it. Most of the first neural is gone; its hinder end was placed 75 mm. behind the front of the shell. The following table gives the dimensions of those neurals present:

Neural.	Median length.	Greatest width.
<i>mm.</i>	<i>mm.</i>	<i>mm.</i>
2	24	30
3	26	26
4	23	24
5	20	23
6	16	26
7	13	24

The eighth appears to have been 18 mm. long and 22 mm. wide. No part of the suprapygals remains.

The vertebral scutes are of moderate width, being longer than wide. The following table presents their dimensions:

Scute.	Length.	Width at hinder end.	Greatest width.
<i>mm.</i>	<i>mm.</i>	<i>mm.</i>	<i>mm.</i>
1	51	40	45
2	47	35	44
3	47	38	48
4	41	38	..
5	..	..	..

The nuchal scute is 15 mm. long and 11 mm. wide. The marginals do not rise as high as the peripherals that bear them, the second and the third lacking about 12 mm. of doing so. All the sulci of the carapace run along at the bottom

of broad grooves varying from 8 to 10 mm. in width.

The plastron (fig. 3) had a length of 230 mm. The front of the epiplastral lip is damaged and the hinder angles of the xiphiplastra are missing, though they have left their impress in the sandstone matrix. The anterior lobe has a length of 60 mm. and a width of 107 mm. From the axilla the border of the lobe passes by a regular curve to the base of the epiplastral lip. The latter has a width of 37 mm., and it projected beyond the ends of the gular sulci at least 11 mm. The upper surface of this lobe is hidden. The entoplastron is 27 mm. long and 42 mm. wide, the greatest breadth being at the middle of the length. The hinder border is broad and rounded.

The bridge is 78 mm. wide, and of this the hyoplastron occupies 48 mm.

The hinder lobe had a length close to 92 mm.; the width at the base and at the ends of the hypo-xiphiplastral sutures is 105 mm. Half-way between the two points named the width is 108 mm. From the hypo-xiphiplastral sutures the width contracts rapidly to the ends of the femoro-anal sulci, where there are deep notches. Here the width is only 70 mm., perhaps less, inasmuch as the bones of the two sides appear here to be spread apart. The hinder angles of the xiphiplastra seem to have been acute.

All the sulci of the plastron, as of the carapace, occupy broad grooves. The gulars were 37 mm. wide in front and they overlap slightly the entoplastron. The humero-pectoral sulcus crossed the plastron just behind the entoplastron. The humerals occupy 28 mm. of the midline; the pectorals, 25 mm.; the abdominals, 61 mm.; the femorals, 40 mm. The length of the anals can not be satisfactorily determined.

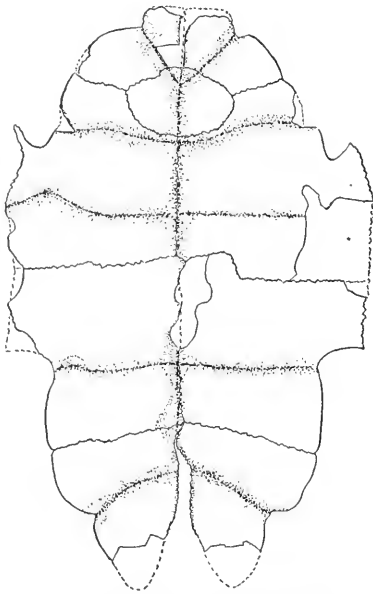

FIG. 3.—PLASTRON OF *ECHMATEMYS RIVALIS*.

This species resembled most of all Cope's *Emys lativertebralis*, described from the Wasatch of New Mexico.<sup>a</sup> The latter species had, however, both the neurals and the vertebral scutes relatively wider. The carapace and the plastron were not channeled along the course of the sulci. The epiplastral lip did not project so abruptly from the anterior lobe of the plastron and the hinder lobe was not conspicuously notched at the sides. The entoplastra of the two species differ in form.

**TERRAPENE LONGINSULÆ, new species**

Plate XXVI, figs. 1-3.

This species has as its type and only known specimen a nearly complete shell, the skull complete, the neck, the right and left scapulae and coracoids, and both humeri. This specimen was collected in 1884 by Mr. J. B. Hatcher at Long Island, Phillips County, Kansas. The deposits are regarded as belonging to the Upper Miocene or Lower Pliocene. Mr. J. W. Gidley, of the U. S. National Museum, informs me that these beds have afforded remains of the short-legged rhinoceros, *Teloceros fossiger*. The new species is accompanied by portions, including the characteristic epiplastral beak, of the turtle *Testudo orthopygia*, which occurs so abundantly in Decatur County. The white siliceous sand that adheres to the bones of the *Testudo* is identical with that filling the shell of the *Terrapene*.

The specimen is Cat. No. 5983 in the U. S. National Museum.

This species had a broad and rather depressed carapace. Its length (Plate XXVI, fig. 1) in a direct line is 133 mm.; the width at the hinder

<sup>a</sup> Wheeler's Surv. W. 100th Merid., IV, 1877, p. 53, pl. xxvii, figs. 1, 2; pl. xxviii, figs. 1, 2.

ends of the fifth peripherals measures 110 mm., but was originally possibly not more than 100 mm.; the width at the front ends of the eighth peripherals, 100 mm. The height above the lower surface of the plastron is not more than 55 mm. The region occupied by the vertebral scutes is flat, with perhaps a mere suggestion of a depression near the borders of the scutes mentioned. The second and third peripherals are flared rather strongly upward. Those of the eighth and succeeding pairs are flared only slightly upward.

The nuchal bone originally measured about 28 mm. fore and aft. The extreme width is 41 mm., the width in front is 17 mm. The following table presents the dimensions of the neurals:

Neural.	Length.	Width.
<i>mm.</i>	<i>mm.</i>	<i>mm.</i>
1	12	10
2	11	11
3	12	14
4	11	14
5	11	16
6	11	15
7	13	13

As one of the anomalies of this carapace, we find a small bone that appears to be cut out of the area of the first costal. It borders the nuchal. The costals of the seventh pair meet on the midline. A process of the one of the left side turns backward to the suprapygal, thus preventing the left eighth from meeting its fellow. The suprapygal is 17 mm. high

and 25 mm. from side to side. The pygal is 11 mm. high and 13 mm. wide at the upper border.

The scutes of the carapace are extremely irregular and anomalous. On the left, the intercostal sulci, instead of descending on the second, fourth, sixth, and eighth costal plates, descend on the first, third, fifth, and seventh. Those of the right side are normally placed. As a result of this disturbance, the second, third, and fourth vertebral scutes are directed diagonally from the right to the left and forward. They are then each divided by a sulcus running diagonally to the left and backward. The first and the fifth are unsymmetrical.

Of the plastron (Plate XXVI, fig. 2) there is missing the right epiplastron and a little of the left. The total length was close to 134 mm. Of this, the anterior lobe occupied about 50 mm. The width at the transverse hinge is 83 mm. The entoplastron is 31 mm. long, with equal width. The width of the hinder lobe, at the lateral hinge-lines, is 91 mm.; at the hypo-xiphiplastral suture, 84 mm. The rear is nearly truncate in outline. The lateral hinge-lines are about 25 mm. long.

The gulo-humeral sulci extend well backward on the entoplastron. The humero-pectoral sulcus crosses the entoplastron a little behind the middle of its length. The pectoral and the abdominal scutes each measures 22 mm. on the midline; the abdominals, 21 mm.; the anals, 42 mm.

The skull (Plate XXVI, fig. 3) resembles in general that of *T. carolina* and *T. ornata*. The quadrato-jugal bones were wholly unde-

veloped. The length from the snout to the occipital condyle is 33 mm. The width at the articulation of the lower jaw is 23 mm.; at the base of the postorbital arch, 22 mm. The width of the interorbital space, at the fronto-prefrontal suture, is 9.5 mm. The orbit has a diameter of 10 mm., while the distance of the postorbital arch from the rim of the auditory chamber is only 6.5 mm. The opening of the auditory chamber is 5 mm. The distance from the tip of the lower jaw to a line joining the hinder ends of the rami is 20 mm.; from this line to the hinder end of the symphysis, 18 mm.

This species appears to be most closely related to *T. ornata*, a species now occupying Kansas and the regions to the southwest. It differs, however, in having the carapace narrower, or, at most, not wider, across the eighth peripherals than near the transverse hinge-line. Indeed, it seems to differ from all the living species in the same respect. In most specimens of *T. ornata* there is a low ridge along the midline and on each side of it a depression, features missing in *T. longinsula*. The rami of the lower jaw of the fossil species are nearly parallel as far forward as the coronoid process, whereas, in *T. ornata* and *T. carolina* they converge very perceptibly. The total absence of a median carina distinguishes the fossil from *T. carolina*.

ASPIDERETES GRANIFER, new species.

Plate XXVII, figs. 4, 5.

In the U. S. National Museum there is one nearly complete costal bone and some fragments of other costals of a trionychid turtle which appears to be hitherto undescribed. This material was collected by the late John B. Hatcher, July 10, 1887, at Cow Island, Montana. The deposits here belong to the Judith River Cretaceous. The specimen is Cat. No. 5736, U.S.N.M.

The costal to be described is 199 mm. long. The width near the neural border (fig. 5) is 40 mm.; at the free border (fig. 4), 62 mm. The thickness where it joined the neural is 4 mm.; near the free border, 9 mm. The free border is cut off at nearly a right angle with the upper surface, but the upper layer of the bone does not overhang the deeper layers. The rib did not extend beyond the free border of the disk, an indication of the great age of the animal. The disk must have been somewhat more than 400 mm. wide.

It is the character of the sculpture of the upper surface that distinguishes this turtle from all others yet known. The general appearance is that of a network of narrow, smooth, and sharply defined ridges surrounding flat-bottomed pits. Of these pits there are 4 in a line 10 mm. long. At the proximal end of the bone (fig. 5) the bottoms of the pits are slagreened; and in some of them there is a little elevation that resembles a glass bead or a grain of sand.



On the middle third of the bone the ridges are much interrupted, sometimes ending suddenly in a bead or a series of them. The pits, therefore, open into one another extensively, and most of them inclose a bead, others four or five of them.

Toward the free border (fig. 4) the ridges tend to run across the costal and more or less in rows parallel with the free border.

This species is referred to the genus *Aspideretes* for the reason that up to the present time no other genus of trionychids is known to have existed during the Cretaceous. All specimens sufficiently complete show the presence of a preneural bone.

#### EXPLANATION OF PLATES.

##### PLATE XXVI.

##### *Terrapene longinsular* $\times \frac{5}{8}$ .

Fig. 1. Carapace.

In front the first peripheral of the right side is missing; also the free border of the nuchal bone, on the left side, has been gnawed away by a rodent. On the sides and behind, some of the peripherals are wanting.

2. Plastron.

The right epiplastron and a small part of the left are missing.

3. Skull viewed from above.

##### PLATE XXVII.

##### *Hoplochelys calata* $\times 1$ .

Fig. 1. Ninth, tenth, and eleventh peripherals of right side, showing the upper surface. The sculpture is not well shown.

2. Seventh, eighth, and ninth peripherals of left side, showing the lower surface. In the left border of the ninth is a notch. In this is seen a fragment of the free rib-end of a costal, occupying a pit in the peripheral. In the seventh are seen pits for processes of the hypoplastron.

3. Fragment of a costal bone, showing sculpture.

##### *Aspideretes granifer* $\times 1$ .

4. A nearly complete costal bone.

5. Part of same costal as fig. 4.

The lower end of fig. 5 is to be applied to the upper end of fig. 4, so as to make the white line on the one join that on the other. The figures should be viewed with the light coming from the left. The lighter areas are the bottoms of pits, not convex surfaces.

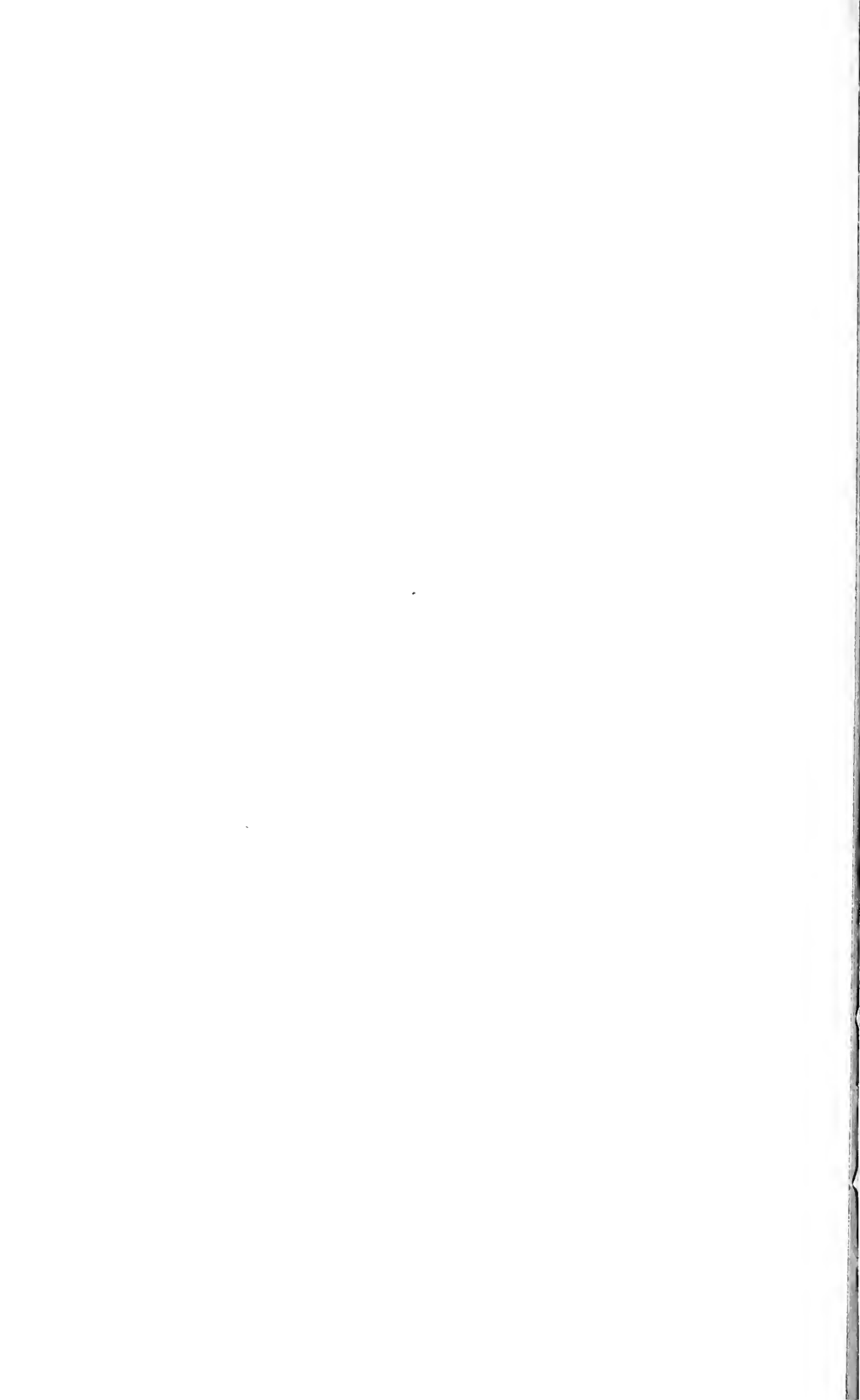

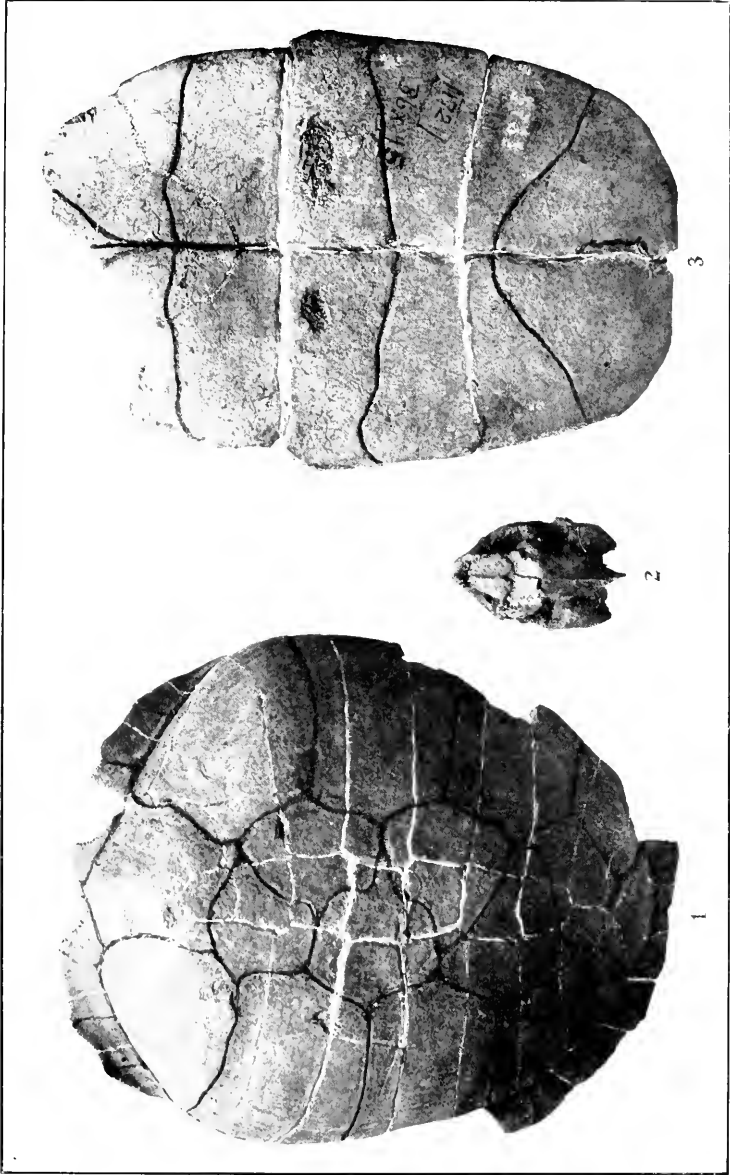

CARAPACE, PASTRON, AND SKULL OF *TERRAPENE LONGINSULÆ*.

FOR EXPLANATION OF PLATE SEE PAGE 169.



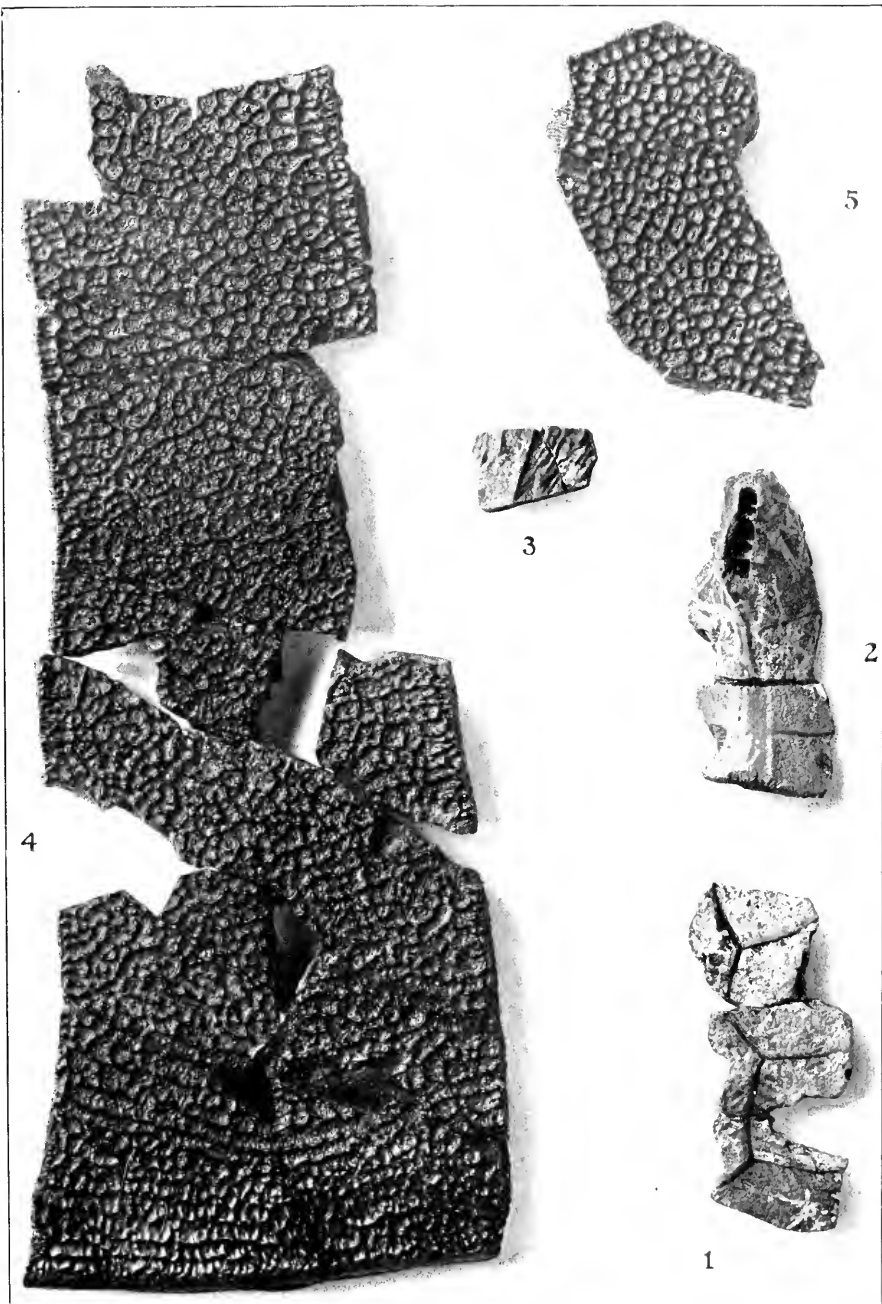

COSTAL AND PERIPHERAL BONES OF FOSSIL TURTLES.

FOR EXPLANATION OF PLATE SEE PAGE 169.



## NEW EXAMPLES OF AMERICAN INDIAN SKULLS WITH LOW FOREHEAD.

By ALEŠ HRDLIČKA,

*Assistant Curator, Division of Physical Anthropology, U. S. National Museum.*

Since the writer's report in the latter part of last year<sup>a</sup> upon modern Indian crania with low foreheads, the U. S. National Museum received two additional specimens of this character, one from a small mound in western Oregon and one from a tumulus in western Missouri. The two skulls, about neither of which there is any belief of great antiquity, appear, on cursory inspection, to possess their most distinctive feature, namely, the low front, to about the same degree, and they are also related as to the general type of the cranial form. But on close examination the two specimens are found to be very dissimilar, and there appear so many points of interest that it becomes desirable, in view of the importance of the still imperfectly understood question of low foreheads, to describe them.

### THE OREGON SKULL.

This specimen, Cat. No. 248994, U.S.N.M., was discovered and given to the Museum by Mr. J. G. Crawford, a photographer and amateur archeologist of Albany, Oregon. Mr. Crawford dug it out, on February 8, 1908, from a low mound at Kings Point, Lincoln County, Oregon. The details of the find are rather meager. The fragments of the skull lay, with a few pieces of bones from other parts of the skeleton, in "a thoroughly burnt ground, about 4 feet from the surface, with a layer of sandstone pieces lying immediately above the human remains," while the soil "was the ordinary one of that locality." No impression arose that the burial might be one of great age.

The specimen is an imperfect calvarium, almost the entire left half of which, as well as the base and a larger part of the back, are lacking. A few unconnected fragments include the damaged chin part of the

<sup>a</sup> Skeletal Remains suggesting or attributed to Early Man in North America, Bull. 33, Bur. Amer. Ethnol., Washington, 1907.

lower jaw. The bones are dirty brownish on the surface, yellowish-white to dull ochre-yellow on break, and in spots somewhat corroded or scaled; they are largely devoid of animal matter, but are not chalky or mineralized.

The skull is that of a male, of perhaps 60 years of age, the coronal and lambdoid sutures showing advanced synostosis. It is neither artificially nor accidentally deformed, and what is left of it shows no artefacts or disease. It was of moderate, but perhaps not subaverage Indian, internal capacity: the only external measurement bearing on its size that can be approximated is the length, which was near 19 cm. In shape the skull was dolichocephalic, or somewhere near the boundary of dolicho- and mesocephaly. Its walls are thicker than usual, the right parietal measuring above and along the squamous suture from 6 to 8 mm. There are signs of strong but not excessively developed muscularity. The ventral surface shows a dearth of brain impressions.

The principal features of interest about the specimen are its prominent supraorbital arcs, or crests, and a low forehead. The arcs extended over the whole distance from the glabella to the external angular process of the frontal bone on each side, though they are most pronounced over the median two-thirds of the supraorbital border, the space corresponding to the frontal sinuses. The more distal parts appear as if drawn forward through the development of the proximal; they doubtless expanded in consequence of the growth of the ridges proper. The frontal sinuses were, it is seen from the remnant of the one on the right, of large dimensions: about 1.5 cm. from the median line the right cavity measures 1.1 cm. antero-posteriorly by 1.8 cm. in length, and its original length was near 3 cm. The shallow depression which usually exists between the supraorbital ridges and the frontal bend is exaggerated. A dull low ridge extends over the middle third of the forehead in the median line—an external metopic crest seen often in varying grade in the dolichocephalic Indian. The ventral metopic crest is of moderate dimensions.

The prominent supraorbital ridges and the depression above them accentuate and to not a small extent create the appearance of lowness and slope of the forehead in this skull: without these features the fore part of the frontal bone could hardly be termed exceptional, when compared with average, dolichocephalic, Indian crania. When the skull is examined ventrally, a fair and uniform concavity, corresponding to quite well-developed frontal lobes of the brain and standing in no visible relation with the external protrusion is found. All this leads to the conclusion that this particular skull represents a type of a distinct class of crania with apparently low or sloping foreheads, a class of cases due in the main to an extraordinary development of the frontal sinuses.



In connection with this specimen it is possible to point out a lesson which relates to the importance of properly posing the object for a photograph. The Oregon skull was photographed before it was sent to the National Museum by one not familiar with the requirements of the case. The result was a too great inclination of the specimen, with consequent marked exaggeration of the frontal slope and protrusion of the supraorbital crest. The photograph is reproduced as fig. *a*, Plate XXVIII, while fig. *b* of the same plate gives a view of the same skull posed properly.

#### THE MISSOURI SKULL.

This specimen, No. 249679 U.S.N.M., was recovered from a mound in the proximity of the Missouri River, in western Missouri, in the earlier part of this year, by Mr. Gerard Fowke. Unfortunately, before being sent to the Museum, it became mixed with other bones, so that the exact locality where it was found can not be determined. It is certain, however, that there was nothing about the burial from which it proceeds to attract special attention, or it would have received better care at the hands of Mr. Fowke, who is an experienced explorer.

The specimen is very much unlike the one from Oregon just described and constitutes a type of another class of low foreheads. It is very defective, consisting of only a part of the vault, including about three-fifths of the frontal and a small portion of the top of each parietal. Judging from the supraorbital ridges, the skull was that of a male, and a complete obliteration ventrally of the coronal and what is present of the sagittal suture indicates an individual beyond the middle of adult life. The bones are yellowish in color, with numerous black spots dorsally, due probably to deposits of the black manganese dioxide, and are not chalky or mineralized.

The skull was apparently narrow and long in form, and a nasion-bregma arc of 11.8 cm., besides other features, indicates that it was not of uncommonly small size. It was not deformed, and shows nothing pathological. It was, however, unusually delicate for a male, the thickness of the frontal bone ranging only between 3 and 5 mm. Were it not for its supraorbital ridges, it could easily be taken for a female skull.

The feature of particular interest about the specimen is a low forehead, and this, unlike what was found in the Oregon skull, is marked even better ventrally than dorsally. The frontal part of the brain itself in this case was decidedly low.

The supraorbital ridges are only of about the average masculine dimensions and extend over the nearer two-thirds of the border on each side. They are not prolonged into a complete crest, yet the bone

distad from them slants forward from the forehead proper, showing that the convexity of the frontal is not only lower, but also relatively somewhat more posterior than usual. The frontal sinuses are of only moderate size, the total length of the right cavity being 1.7 cm., its greatest antero-posterior diameter a little over 0.6 cm. There is no dorsal metopic crest in this case and the ventral one is of subaverage dimensions. The external bulge of the forehead is really quite fair, the defect being only the lowness.

Here then is a case in which a low forehead is a separate condition, independent of and not materially affected by any factors proper to the lower anterior portion of the frontal bone.



SIDE VIEW OF THE MISSOURI SKULL.

The two cases reported here are in the line of demonstration of the fact that the low or sloping appearing forehead is not morphologically a simple feature, due always to the same causes and having but one significance. They make it clear that there are at least two general, though perhaps in the end not unrelated, categories under which this peculiarity may be classed, one embracing the cases due to excessive development of the forestructures of the forehead proper, the other including those of defective development of the forehead part of the frontal bone itself, irrespective of anything else. When both conditions coexist, and that seems to be most often the case, they accentuate each other, and in extreme cases the results are such human cranial forms as the Neanderthal, Spy No. 1, or No. 8 from the Gilder mound in Nebraska.

The ultimate causes of each of the above defined categories of cases are not as yet clearly established. They are in all probability sometimes biological and sometimes pathological in nature, the first comprising reversions of form, subaverage development of the brain or the frontal lobes, and rarely, perhaps, a great development of the temporal muscles,<sup>a</sup> while the latter may conceivably include pathological expansion of the frontal sinuses, a hyperplasia of the antero-inferior portions of the frontal bone, pathological defects of the frontal lobes, and such conditions of the frontal squama as would result in an abnormal resistance of the bone to the forward expansion of the growing brain. Regarding the last item, it must be borne in mind that the brain expands in the direction of least resistance, a fact amply demonstrated in the study of pathological as well as artificial deformations of the skull,<sup>b</sup> and any increase in the normal resistance of the forehead part of the frontal bone before the growth of the brain has been completed—an increase such as may follow a premature closure of the metopic articulation—is bound to be followed by a less perfect development of the frontal convexity.

---

<sup>a</sup> In the anthropoid apes and some of the lower old-world primates the extensive attachment and development of the temporal muscles has a marked effect on the formation and dimensions of the distal portion of the supraorbital crest. The orang shows this to the best advantage. It may be worthy of remark in this place that the skull of Dubois's pithecanthropus is much more related in this respect to the orang than to any of the other living anthropoids.

<sup>b</sup> See in this connection writings on deformed skulls, an extensive bibliography of which can be found in the Catalogue of the Surgeon-General's Library, U. S. A., and particularly R. Virchow's "Ueber den Cretinismus, namentlich in Franken, und über pathologische Schädelformen"; Ges. Abh. z. wiss. Medicin, Svo, Frankfurt a. M., 1856, p. 891 et seq.



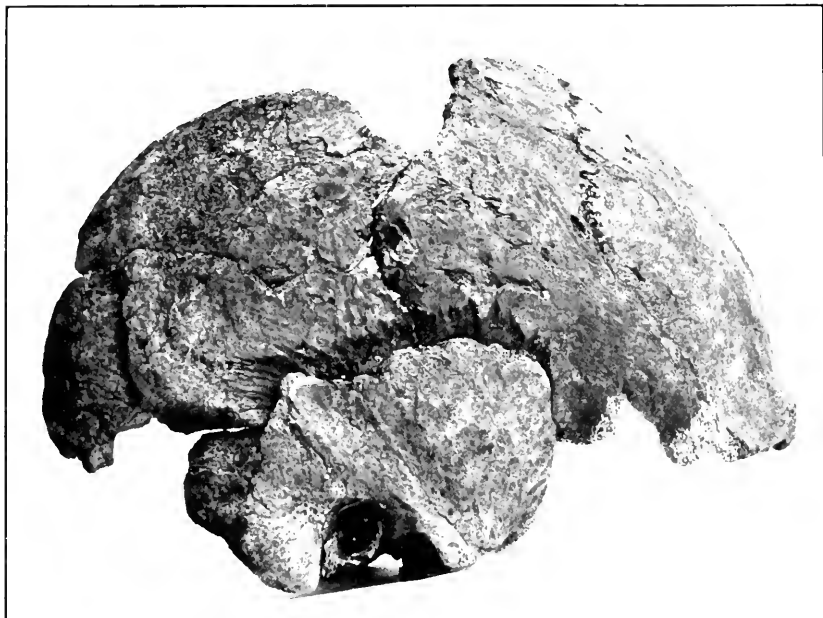

A.—SKULL SHOWN IN PROPER POSITION.



B.—SKULL SHOWN AS ORIGINALLY PHOTOGRAPHED.

SIDE VIEW OF THE OREGON SKULL.

FOR REFERENCE TO PLATE SEE PAGE 173.



DESCRIPTIONS AND FIGURES OF SOME LAND AND  
FRESH-WATER SHELLS FROM MEXICO, BELIEVED TO  
BE NEW.

---

By WILLIAM HEALEY DALL,

Curator, Division of Mollusks, U. S. National Museum.

---

In 1907 Dr. E. Palmer sent in to the United States National Museum a few land shells from Tamaulipas, Mexico, two of which appear to be undescribed, one of them exhibiting a new form of armature on the axis. These are here described, and to these are added some species collected by Nelson and Goldman in 1898, which, though recognized as new and figured at that time, have not hitherto been published.

Genus CŒLOCENTRUM Crosse and Fischer.

Section CROSSOSTEPHANUS Dall, new.

A *Coelocentrum* with axis armed with a turgid spiral ridge, extending through the space of several whorls and axially sculptured with numerous cord-like short ribs, which on the anterior face of the ridge overhang like a fringe, ceasing with the penultimate whorl; the axis in the last whorl behind the last half of the whorl is twisted and obliquely truncate.

*Type*.—*Coelocentrum palmeri* Dall and Bartsch.

CŒLOCENTRUM (CROSSOSTEPHANUS) PALMERI Dall and Bartsch, new species.

Plate XXIX, figs. 2, 5.

Shell with more than twenty-four whorls of which, in the adult, about thirteen remain, the rest having been detached; color a bright yellowish brown when fresh, the interior of the aperture whitish; whorls moderately rounded, obsolete spirally striated; sculpture consisting of a thread-like fine keel just in front of the suture, which is flattened behind it; a second wider and less distinct thread marginates the base; the effect of these threads is to give the

suture a channeled look; axial sculpture of numerous (on the penultimate whorl about 80) slightly elevated threads, equal and more or less equally distributed, rising abruptly from the surface of the whorl with the much wider interspaces flattish between them; the threads are concavely arcuate and slightly retractive; on the base they are continued to the axis, closer and sometimes bifurcate; the same sculpture as that on the permanent whorls also appears on the truncate portion of the spire; aperture produced, with a slightly reflected entire lip; form of the opening obscurely triangular; axis proportioned as figured, the ribs of the fringe in the penultimate whorl showing a tendency to break up into drops or beads; in the upper part of the spire, as the axis becomes attenuated, the ribs are less prominent, less distinct, and less numerous; on the later whorls they number about 2 to a millimeter; there are about 28 in the last whorl containing them; they are slightly retractively oblique and tend to overlap each other in a forward direction. The measurements of several adult specimens are as follows, in millimeters:

Height.	Whorls.	Maximum diameter.	Diameter at truncation.
52	14.0	13.5	4.5
45	12.0	13.0	6.2
52	13.0	14.0	5.5
51	13.0	13.0	6.0
50	14.0	14.0	5.5
Average. .50	13.2	13.5	5.35

*Type*.—Cat. No. 198083, U.S.N.M. Collected at Tamaulipas, Mexico, by Dr. Edward Palmer.

There is some variation in the outlines of the shells, some being more cylindrical, and in others the maximum diameter is not always in the same relative position.

#### Genus STREPTOSTYLA Shuttleworth.

##### STREPTOSTYLA BARTSCHII Dall, new species.

Plate XXIX, fig. 1.

Shell short, stout, subcylindric, with  $7\frac{1}{2}$  whorls, a thin yellow-brown periostracum over a milk-white test; spire bee-hive shaped, bluntly pointed, with moderately convex whorls; first  $2\frac{1}{2}$  whorls smooth, polished, white; subsequent whorls by degrees more strongly sculptured with fine, nearly vertical, close-set, rounded, slightly flexuous riblets, subequal and subequally distributed, with very narrow interspaces, and extending from suture to suture; on the last whorl the riblets are decidedly feebler in front of the middle of the whorl; suture deep, distinct, not channeled or appressed; aperture



rather narrow; outer lip slightly flexuous, produced near the middle; inner lip with a slight glaze on the body; pillar very short, strongly twisted, its outer edge slightly thickened, a deep, rounded oblique sulcus in front of it; anterior margin of the aperture extended in front of the end of the pillar. Length 32; of spire 15; maximum diameter 16.5 mm. Another measures 35 mm. long and 17 in maximum diameter.

*Type*.—Cat. No. 198090, U.S.N.M. Tamaulipas, Mexico, Dr. E. Palmer.

Named for Dr. Paul Bartsch of the U. S. National Museum.

Especially characteristic are the rounded, bee-hive shaped spire and the flexuous outer lip.

**STREPTOSTYLA TOYUCA** Dall, new species.

Plate XXIX, fig. 6.

Shell melampiform, rather large, flesh-colored, with about 7 whorls, separated by a narrow, rather deeply channeled suture; spire conic, subturritid; nucleus of less than 1 whorl, obscurely radially wrinkled; following whorl and a half with flexuously radial small wrinkles, which at the periphery break up into numerous hair-like prolongations, the whole not unlike a paint brush except for the flexuosity; adult sculpture in front of the suture of fine, sharp, elevated, vertically axial lines, with wider flattish interspaces about half a millimeter wide; in the interspaces are one or two faint axial wrinkles; at about the beginning of the penultimate whorl these wrinkles, about midway between the sutures, rise to an equality with the elevated lines and so continue, even and regular, to the anterior end of the shell; there is no spiral sculpture except occasional impressed lines apparently due to fractures; last whorl flattish at the sides, conic, aperture narrow; outer lip thin, excavated in front where it turns to meet the axis; pillar thin, strongly contorted, but not pervious. Altitude of shell 27; of aperture 17; maximum diameter 15 mm.

*Type*.—Cat. No. 107822, U.S.N.M. Collected by E. A. Goldman, of the U. S. Biological Survey, at Metlal toyuca, Puebla, Mexico.

Remarkable for its apical sculpture and channeled suture.

**STREPTOSTYLA JILITLANA** Dall, new species.

Plate XXIX, fig. 8.

Shell thin, light straw-colored, subtranslucent, with about  $6\frac{1}{2}$  whorls, separated by a distinct but not channeled or denticulate suture; spire short and blunt; nucleus brilliantly polished, smooth, glassy for about  $2\frac{1}{2}$  whorls, when the axial sculpture is gradually developed; adult sculpture of slightly flexuous, rather broad, flattish, equal riblets with sharply grooved linear interspaces, about

three riblets to a millimeter: the riblets become feeble near the anterior end of the shell; whorls evenly rounded, with no spiral sculpture; aperture narrow behind, a thin glaze on the body and pillar; axis thin, strongly twisted, minutely pervious. Altitude of shell 23; of last whorl 20; of aperture 15; maximum diameter 13 mm.

*Type*.—Cat. No. 107821, U.S.N.M. Collected by E. W. Nelson, U. S. Biological Survey, at Jilitla, San Luis Potosi, Mexico.

Of the general type of *S. bartschii*, but with different proportions and a less deeply impressed suture. The beautifully polished smooth nucleus in these species contrasts strongly with the costulate nucleus of *S. toyuca*. The two types seem to represent the melampiform profile, one in *Streptostyla* s. s. and the other two in *Chersomitra*.

#### Genus EUGLANDINA Pilsbry.

##### EUGLANDINA LIVIDA Dall, new species.

#### Plate XXIX, fig. 7.

Shell thin, elongate, slender, with about  $7\frac{1}{2}$  slightly rounded whorls, of a dark livid purple-brown color; suture simple, not channeled, here and there irregularly crenate on the upper whorls by the ends of the axial wrinkles; apex somewhat swollen and quite blunt; nucleus beginning with a very small coil and perfectly smooth and polished for rather more than three whorls before any indication of wrinkling appears: on the fourth, fifth, and sixth whorls the surface is sculptured with feeble, nearly vertical axial wrinkles; these are more or less irregular in size, with here and there still smaller and more feeble wrinkles intercalated; occasionally at the suture the ends of the wrinkles are prominent, but not uniformly so and not all so on the last whorl; there are no traces of any kind of normal spiral sculpture; aperture shorter than the spire; narrow behind, outer lip thin and sharp; body without glaze, pillar arcuate and truncate; axis not pervious; altitude of shell 61; of last whorl 43; of aperture 27; maximum diameter 22 mm.

*Type*.—Cat. No. 107820, U.S.N.M. Collected by J. N. Rose, of the U. S. National Museum, between Bolanos and Guadalajara, Jalisco, Mexico.

Nearest to *E. rosea* Férussac, but of different color and sculpture.

##### ANODONTA COARCTATA Anton.

#### Plate XXIX, figs. 3, 4.

Cat. No. 109282, U.S.N.M. Collected at Ocotlan, Jalisco, Mexico, by E. W. Nelson, U. S. Biological Survey. Lake Chapala, State of Jalisco, Mexico, Crosse and Fischer.

This species has been figured before, but the opportunity of illustrating the uneroded beak sculpture seemed to be a good one.

## LAMPASILIS (PROPTERA) SALINASENSIS Simpson, new species.

Plate XXX, fig. 3.

Shell somewhat obovate, subcompressed or convex, inequilateral, moderately solid; beaks small, nearly or quite smooth, pointed and turned forward over a small lunule, subcompressed; posterior ridge rounded, ending in a blunt point below the median line of the shell; anterior end narrowed, rounded, basal and dorsal outlines lightly curved; surface with irregular growth lines, and traces of microscopic radial sculpture; dorsal slope feebly nodulously sculptured; epidermis yellowish green with feeble wide or narrow greenish rays and a yellowish band near the border; pseudocardinals subcompressed, ragged, two in each valve; laterals remote, delicate, double in the left valve, single in the right, much elevated behind; muscle scars rather shallow; naere blue, with a wide prismatic border. Length, 70 mm.; height, 40 mm.; diameter, 20 mm.

Salinas River, Coahuila, Mexico, Nelson and Goldman; also from Valles River, Valles, Mexico, A. A. Hinkley.

The types are Cat. No. 163156, U.S.N.M.

Three shells were collected, all of which are probably young. It is quite likely that adult shells will prove to be brown. The species seems nearest to *L. explicata* Morelet, several fine specimens of which are in the National Museum collection. It is obovate instead of true rhomboid, as is that species, and has more compressed and sharper beaks. The posterior slope of *L. explicata* is nearly or quite smooth, while in the present species it is corrugated. Our specimens are probably all females.

## DIPLODON WEBSTERI Simpson.

Plate XXX, figs. 1, 2.

*Diplodon websteri* SIMPSON, Nautilus, XVI, No. 3, p. 30, July, 1902.

Collected by Rev. W. H. Webster, of Wauiku, New Zealand. Cat. No. 162342, U.S.N.M.

A figure of this species, of which the type is in the U. S. National Museum, has been frequently called for, and the present opportunity was thought suitable, the drawing by the late Dr. J. C. McConnell having been in hand a long time.

## EXPLANATION OF PLATES.

## PLATE XXIX.

Fig. 1. *Streptostyla bartschii* Dall; length 32 mm.; p. 178.

2. *Calocentrum (Crossostephanus) palmcri* Dall and Bartsch; exterior, with part of the truncated spire restored; height of shaded portion 50 mm.; p. 177.

3. *Anodonta coarctata* Anton; magnification of umbo to show concentric undulate sculpture; p. 180.

4. *Anodonta coarctata* Anton; length of shell 44 mm.; p. 180.

5. *Calocentrum (Crossostephanus) palmcri* Dall and Bartsch; section showing armature of axis; total length 67 mm., the upper whorls restored; p. 177.

6. *Streptostyla toyuca* Dall; alt. 27 mm.; p. 179.

7. *Euglandina livida* Dall; alt. 61 mm.; p. 180.

8. *Streptostyla jilillana* Dall; alt. 23 mm.; p. 179.

## PLATE XXX.

Fig. 1. *Diplodon websteri* Simpson; interior view of left valve; length 66 mm.; p. 181.

2. The same, exterior of right valve.

3. *Lampsilis salinasensis* Simpson, showing exterior of right and hinge of left valve; length 69 mm.; p. 181.

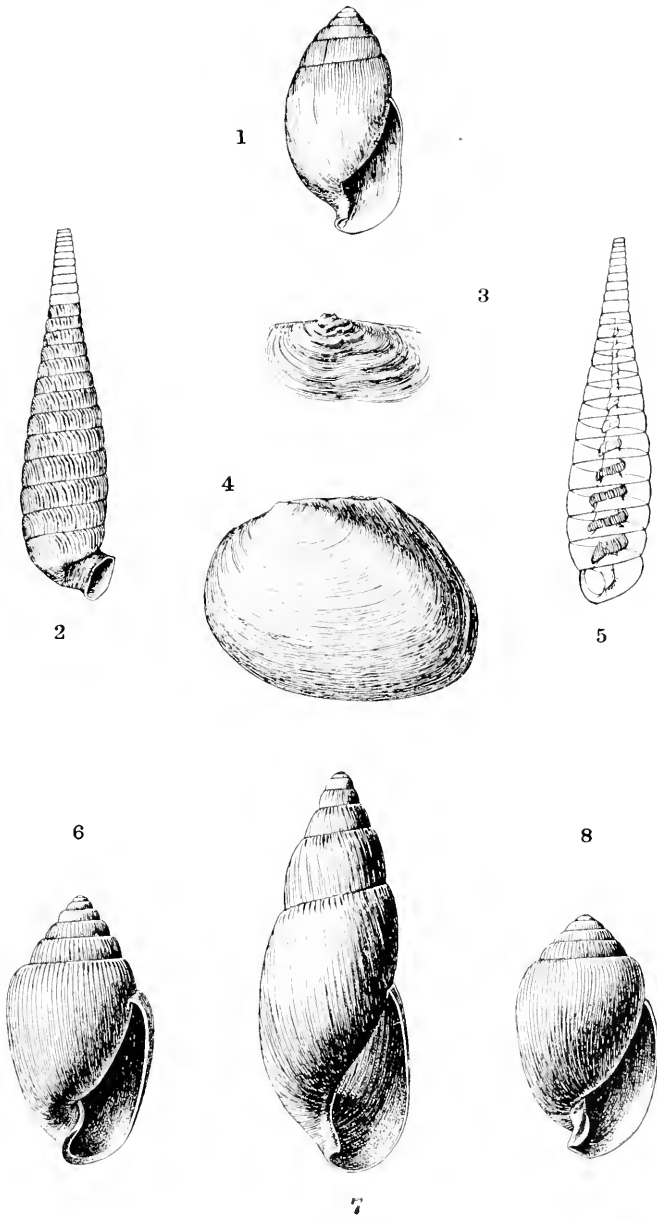

LAND SHELLS FROM MEXICO.

FOR EXPLANATION OF PLATE SEE PAGE 182.



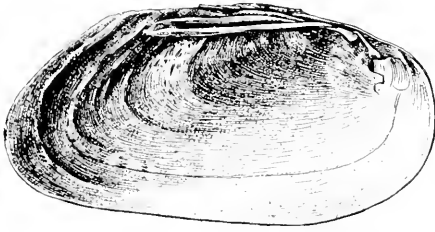

1

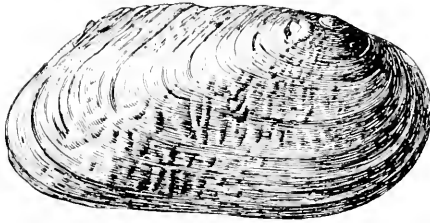

2

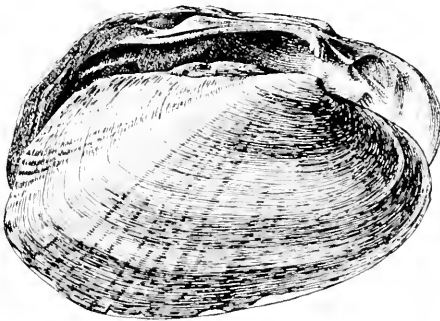

3

FRESH-WATER SHELLS FROM MEXICO AND NEW ZEALAND.

FOR EXPLANATION OF PLATE SEE PAGE 182.





NOTES ON TWO RARE CALIFORNIA FISHES, *RIMICOLA*  
*EIGENMANNI* AND *PLAGIOGRAMMUS HOPKINSI*.

---

By JOHN OTTERBEIN SNYDER,

Assistant Professor of Zoology, Stanford University, California.

---

The following notes are offered as an addition to what is known concerning two rare California shore fishes, *Rimicola eigenmanni* and *Plagiogrammus hopkinsi*.

RIMICOLA EIGENMANNI (Gilbert).

An interesting little cling fish, *Gobiosox eigenmanni*, was described in 1890 by Doctor Gilbert <sup>a</sup> from a specimen about an inch long taken at Point Loma near San Diego, California, together with several others from San Cristobal Bay. A second species, *G. muscarum*, was later described and figured by Meek and Pierson <sup>b</sup> from two small specimens dredged at a depth of 10 fathoms in Monterey Bay. Jordan and Evermann <sup>c</sup> then placed the two species in a new genus, *Rimicola*, and in the same paper presented a figure of *R. eigenmanni*. Other references have been made to these species, but the above is a brief outline of their history.

Several years ago, early in the month of January, Doctor Harold Heath collected a number of specimens of a species of *Rimicola* in a large tide pool near Pacific Grove. He found them depositing their eggs on the leaves of the great bladder kelp *Neoreocystis*. The small fishes strongly resembled in color the brownish kelp, and clinging closely to it they almost escaped observation. They were considerably lighter beneath, however, and this character led to their discovery, the whitish ventral surfaces showing through the thin leaves of the plant. In the preservation of the specimens, the dark color disappeared, the skin becoming a pale pinkish yellow, without spots or other marks. These were lately examined by the writer and found to resemble *R. eigenmanni* in every particular, a small example of

---

<sup>a</sup> Proc. U. S. Nat. Mus., XIII, 1890, p. 96.

<sup>b</sup> Proc. Cal. Acad. Sci., 1895, p. 571, with plate.

<sup>c</sup> Idem., 1896, p. 231. (The figure of *Rimicola eigenmanni* here given is evidently not of the type, as it shows 5 dorsal and 6 anal rays, while the specimen illustrated is said to have come from Todos Santos Bay.)

that species from La Jolla serving for comparison. It was also noted that they did not differ in any structural detail from *R. muscarum*, the type of which was available for study. It was apparent, therefore, that the two species were identical, but to make the matter certain, the writer sent two of Doctor Heath's specimens to the U. S. National Museum, at the same time asking Mr. B. A. Bean to compare them with the type of *R. eigenmanni*. This Mr. Bean kindly did, with the following observations:

Mr. McKnew and I have examined the specimens of *Rimicola* in this Museum and find that the type of *R. eigenmanni* has but four rays in the dorsal fin; in the only additional specimen of *R. eigenmanni* preserved here there are five rays in the dorsal. This fish, which is about the size of the type, was taken in 1898 off Point Loma, California. The cotype of *R. muscarum* seems to have but five rays in the dorsal fin; the count, however, is uncertain, owing to the mutilated condition of the fin. One of the specimens recently received from you has six rays, but the smaller one of the two has five. We think with you that *R. muscarum* and *R. eigenmanni* are identical, the smaller specimens having fewer developed rays in the dorsal. Otherwise the specimens look alike to us.

In reading the original descriptions of *R. eigenmanni* and *R. muscarum* it will be noted that the species differ in color, in the number of dorsal rays, and perhaps in minor details. The color of *R. muscarum* was described and figured from an alcoholic specimen, and differs from that of *R. eigenmanni* (which is said to be uniform light olive green) in having a yellowish body with small, reddish spots and a lateral stripe of the same color. That the color pattern is variable is shown by the cotype of *R. muscarum*, which has spots on the head only, while the lateral stripe is imperfectly developed. The light body color has been accounted for. A parallel case of color change is found in two species of *Aspasma*, a related genus from Japan, where specimens change from brownish to pinkish yellow in the preservative, while in some individuals pinkish spots and a lateral stripe appear. Regarding the dorsal rays, of which *R. eigenmanni* is said to have 4 and *R. muscarum* 6, a reference to the appended table will show that among 8 specimens from Pacific Grove they vary from 4 to 5. In each case the first dorsal ray has been regarded as single, when if closely examined it will be found to consist of a slender, spine-like ray closely attached to a larger, branched one. The rays in the type of *R. muscarum* have been thus separated and counted as 6. The body grows more robust and heavy with age, the smaller individuals being comparatively slender. The length of the head, diameter of eye, height of fins, and other characters vary somewhat as shown by the table of measurements. The anterior nostril has a tube the posterior edge of which is prolonged, forming a tentacle equal in height to half the diameter of eye. There is a conspicuous anal papilla.

*Rimicola cigenmanni* as here defined is known to range from Todos Santos Bay, Lower California, northward to Pacific Grove, California.

*Measurements<sup>a</sup> of 8 specimens of Rimicola cigenmanni.*

Length of body.....	mm.,	51	50	49	47	46	44	41	40
Length head.....		0.27	0.27	0.26	0.26	0.25	0.25	0.27	0.24
Depth body.....		.17	.15	.15	.14	.13	.11	.13	.12
Depth caudal peduncle.....		.08	.08	.075	.06	.055	.05	.05	.05
Length snout.....		.10	.10	.10	.09	.09	.08	.10	.10
Diameter eye.....		.03	.03	.03	.035	.035	.035	.04	.04
Interorbital width.....		.12	.12	.105	.10	.10	.10	.11	.10
Depth head.....		.13	.12	.13	.11	.10	.10	.12	.10
Snout to dorsal.....		.71	.74	.72	.74	.75	.745	.74	.73
Snout to anal.....		.68	.70	.70	.71	.72	.73	.72	.72
Height dorsal.....		.10	.09	.10	.095	.075	.09	.08	.08
Height anal.....		.08	.09	.10	.09	.07	.085	.08	.08
Length pectoral.....		.13	.12	.12	.12	.12	.12	.12	.13
Length caudal.....		.11	.13	.13	.125	.12	.135	.14	.13
Dorsal rays.....		5	4	5	5	4	5	5	5
Anal rays.....		6	5	6	6	5	6	5	6

<sup>a</sup> Recorded in hundredths of length.

**PLAGIOGRAMMUS HOPKINSI** Bean.

This species has been known heretofore from only a single individual which was described and figured by Dr. Tarleton H. Bean<sup>a</sup> in 1893. It was caught along with other species in the tide pools near Pacific Grove by students of the Hopkins Seaside Laboratory and given to the representatives of the U. S. Fish Commission, who were then making a collection for the World's Columbian Exposition. Last summer, late in July, the writer obtained six specimens varying in length from 65 to 190 mm. from the outlying pools at low tide, opposite the light-house near Pacific Grove, perhaps not far from where the species was first taken.

The skin of the head is rather thick and soft, and when shrunken by the preserving fluid lies in wrinkles and folds, forming a slight supraorbicular rim and partly concealing a low crest which extends from the interorbital region forward on the snout. There are 6 branchiostegals. The dorsal spines number from 37 to 41, the anal rays (spines 2) 26 to 29. The membranes of the fins are very thick, and the rays of the pectorals, ventrals, and anal are considerably broadened and thickened toward the tips. There are 43 vertebrae. The specimens in hand show no "subpentagonal plate-like bodies" on the ventral surface, but there are 9 or 10 areas inclosed by branches of the lateral lines, which differ in no way from other parts of the body surface. The "abdominal ridge" (a median line of mucous pores), also mentioned in the original description, leads one to think

<sup>a</sup> T. H. Bean, Proc. U. S. Nat. Mus., XVI, 1893, p. 699, and Jordan and Evermann, Bull. 47, U. S. Nat. Mus., p. 2428; "Monterey, California; a few specimens dredged among the rocks" is evidently a mistake.

that an unusual amount of shrinkage and hardening of the tissues had taken place in the type-specimen, thus causing the appearance of plates and a ridge. In the figure the anal opening is represented as located below the tip of the pectoral fin, an evident error, it being close to the origin of the anal, below the eleventh dorsal spine, as described.

There is a large, oval, blackish spot just above the gill opening, conspicuous in light-colored examples, but not so plainly seen in the darker ones. The pectorals, anal, and caudal are broadly edged with white, the light color being made prominent by a subterminal blackish band.

A GENERIC REVISION OF AMERICAN MOTHS OF THE  
FAMILY ECOPHORIDÆ, WITH DESCRIPTIONS OF  
NEW SPECIES.

---

By AUGUST BUSCK,

*Of the U. S. Department of Agriculture.*

---

The family Ecophoridae comprises a well-defined natural group of Tineid moths, which may be recognized by the following characters: Head normally smooth, with appressed scales, sometimes with loose scales and spreading side tufts. Antennae normally with pecten on basal joint, though in some genera without. Labial palpi well developed, generally curved upward; terminal joint acutely pointed. Maxillary palpi obsolete or very small, simple, appressed. Forewings normally with 12 veins (sometimes 11 by coincidence); veins 7 and 8 stalked (or rarely coincident); 7 to costa or termen; veins 2 and 10 from before the angles of the cell; 1<sup>b</sup> furcate at base. Hindwings with 8 veins (or rarely with only 7, through coincidence); veins 6 and 7 remote, parallel; 3 and 4 normally connate or stalked (though in a few genera separate and in one genus coincident); 8 free. Posterior tibiae clothed with rough hairs above.

These characters suffice to distinguish the family from all other Microlepidoptera except the allied family Blastobasidae and a few genera of the Gelechiidae, which partake of most or all of them.

These Gelechiidae are, however, readily distinguished by the sinuate hindwings, and the Blastobasidae are easily separated by the following differences: The very long cell in the forewing, as compared with the lengths of the apical veins and the massing of these veins (2-10) at the end of the cell, which, together with the subbasal origin of vein 11, causes veins 10 and 11 to be unusually distant. To make up for the resulting weakening of the wing, the membrane is more or less thickened along the costa (the "stigma" of Zeller). Another character, in which the Blastobasidae normally differ from the Ecophoridae, is the proximity or coincidence of veins 3, 4, and 5 in the hindwing, but this is approached or equaled in certain Ecophorid genera (as *Triclonella*).

The peculiar secondary sexual characters of the antennæ I consider of no generic value, and as they are found only in about half the forms undoubtedly related to *Blastobasis*, they afford no help in the family separation except in so far that they are not known to occur in the family Cœcophoridae.

The family Cœcophoridae is represented rather numerously in all faunal regions, though predominant only in Australia. Several of the genera and a few species are cosmopolitan.

Very little special study has hitherto been given the North American species of this family, and the existing lists need considerable revision. Our fauna is closely related to the European, and most of the genera (though only very few species) are common to both continents.

In Doctor Dyar's List of North American Lepidoptera 92 species are recorded in this family, of which I find six do not belong here and have been disposed of in the following under the genera in which they are placed in Dyar's List. Since the publication of that list 29 species have been described and three species before regarded as synonyms have been recognized as valid; two species have been transferred to this family from elsewhere, and five new species are now described, making our list in this family number 121 species. All but half a dozen of these are represented in U. S. National Museum collection, and only two species are known to the writer by description alone. The types of all new species described in the present paper are deposited in the U. S. National Museum.

Thirteen genera are recorded in Dyar's List; one of these (*Chambersia* Riley) can hardly be included in this family from the description, and one was erroneously credited to our fauna. On the other hand, three genera have been transferred to this family from elsewhere; one good American genus has been resurrected from the synonymy, one European genus has been recognized from California, and four new genera are erected in the following, making a total of 21 genera of this family at present recognized in North America. Of these, nine are cosmopolitan or nearly so, two are common to Europe and America, and nine have as yet not been recognized outside of America.

The larvæ of the Cœcophoridae have very various life modes, though the majority live either in spun leaves or feed in decayed wood: one American genus is parasitic on *Kermes*. The larvæ are often prettily marked with dark tubercles on whitish or yellowish ground; they have six true legs and ten prolegs. The pupæ have segments 9-11 movable and do not protrude from the cocoon when the imago emerges.

A few of the species are of some economic importance as enemies of cultivated crops. Many of the species overwinter as adults in

thatch or under bark or, as in the case of some *Depressaria*, in houses, thereby occasionally causing unnecessary alarm when they appear in numbers at the approach of warm weather.

Several additional undescribed species are represented in the National Museum and very many species of the family will yet be discovered when the fauna is better worked up.

The writer had intended to make the present paper monographic and to have included redescriptions of all the species as well as descriptions of these additional species; but other pressing matters intervened and would have postponed the work for at least another year. It was not deemed advisable to withhold the generic rearrangement, and to this such descriptions of new species as were on hand have been added.

Fuller treatment of the family and figures of the generic characters I hope to publish in a not-far-distant future.

I am under much obligation to my learned friend, Mr. Edward Meyrick, of England, whose intimate knowledge of this family all over the world I have felt it my pleasant duty to consult freely, and who has untiringly responded in his usual liberal manner; also to Lord Walsingham and Mr. J. Hartley Durrant am I indebted for various helpful notes.

The genus *Chambersia* Riley, (*Blepharocera* Chambers, not Blanchard), which is included in the (Ecophoridae in Doctor Dyar's List, is as yet unknown to me, and it is not possible from Chambers's description and figure definitely to place the genus before the species is rediscovered. I have omitted it from the present paper.

The genus *Endrosis* Hübner, which was placed in the family Elachistidae in Doctor Dyar's List, following Meyrick's Handbook, and which Lord Walsingham and Rebel have included in the Blastobasidae, is in my judgment closely related to *Borkhausenia* Hübner, and is therefore included in this paper.

The American genera may be recognized by the following table:

1. Forewings with vein 7 to termen.....	2
Forewings with vein 7 to costa or apex.....	8
2. Second joint of labial palpi straight, porrected.....	2. <i>Pleurota</i> ,
Second joint of labial palpi curved.....	3
3. Forewings with vein 9 out of 7.....	4. <i>Martyringa</i> ,
Forewings with vein 9 separate.....	4
4. Labial palpi with long tuft on second joint.....	5
Labial palpi smooth or nearly so.....	6
5. Hindwings with vein 5 nearest 6.....	3. <i>Eumeyrickia</i> ,
Hindwings with vein 5 nearest 4 [?].	4. <i>Eido</i> ,
6. Veins 2 and 3 in forewings approximate.....	7. <i>Psilocorsis</i> ,
Veins 2 and 3 in forewings remote.....	7
7. Hindwings with 6 and 7 diverging toward the tip.....	5. <i>Gerdana</i> ,
Hindwings with 6 and 7 parallel throughout.....	6. <i>Cryptolechia</i> ,
8. Abdomen flattened.....	9
Abdomen not flattened.....	10

9. Forewings with veins 2 and 3 stalked.....	8. <i>Agonopteryx</i> .
Forewings with veins 2 and 3 separate.....	9. <i>Depressaria</i> .
10. Hindwings with but 7 veins; 3 and 4 coincident.....	18. <i>Endrosis</i> .
Hindwings with all veins present.....	11
11. Hindwings with veins 3 and 4 separate.....	12
Hindwings with 3 and 4 connate or stalked.....	13
12. Forewings with 11 veins; 7 and 8 coincident.....	13. <i>Decantha</i> .
Forewings with 12 veins; 7 and 8 stalked.....	14. <i>Euclimensia</i> .
13. Forewings with 11 veins; 7 and 8 coincident.....	15. <i>Fabiola</i> .
Forewings with 12 veins; 7 and 8 stalked.....	14
14. Antennæ thickened with scales toward base.....	16. <i>Æcophora</i> .
Antennæ not thickened with scales.....	15
15. Hindwings with vein 5 connate or stalked with 3+4.....	17. <i>Triclonella</i> .
Hindwings with vein 5 free.....	16
16. Basal joint of antennæ with pecten.....	19. <i>Borkhausenia</i> .
Basal joint of antennæ without pecten.....	17
17. Hindwings with vein 5 nearest 6.....	18
Hindwings with vein 5 nearest 4.....	19
18. Hindwings with cross-vein between 7 and 8.....	20. <i>Tamarrha</i> .
Hindwings with vein 8 free.....	21. <i>Ethmia</i> .
19. Forewings with 2 and 3 approximate or stalked.....	11. <i>Semioscopis</i> .
Forewings with 2 and 3 distant.....	20
20. Forewings obtuse; termen but slightly oblique.....	10. <i>Inga</i> .
Forewings pointed; termen oblique.....	12. <i>Epicallima</i> .

### 1. Genus MARTYRINGA Busck.

*Martyringa* Busck, Jour. New York Ent. Soc., X, 1902, p. 96.

Antennæ stout, slightly serrate toward tip; basal joint without pecten. Labial palpi long, recurved; second joint somewhat thickened with scales, and rough beneath; terminal joint shorter. Forewings elongate, costa and dorsum nearly straight, apex and termen evenly rounded; 11 veins; one cubital vein absent; 2 and 3 coincident; 4 stalked with 2+3 from the corner of the cell; 8 and 9 out of 7; 7 to termen. Hindwings as broad as the forewings; 7 veins; 3 and 4 coincident; 4 and 5 connate; 6 and 7 parallel.

*Type*.—*Martyringa latipennis* (Walsingham).

Contains only the single species *latipennis* Walsingham, Dyar List N. Am. Lep., No. 5476; allied forms occur in China and Japan.

### 2. Genus PLEUROTA Hübner.

*Pleurota* Hübner, Verzeichniss bekannter Schmetterlinge, 1818, p. 406.

Labial palpi very long, porrected; second joint straight, densely clothed with long projecting scales throughout its entire length above and beneath; terminal joint short, slim, pointed. Antennæ finely ciliated, with pecten on basal joint. Tongue long, spirally coiled. Forewings elongate, pointed; termen very oblique; 12 veins; 7 and 8 stalked; 7 to termen. Hindwings as broad as forewings, ovate; cilia long; 8 veins; 6 and 7 parallel; 3 and 4 connate.



*Type*.—*Pleurota bicostella* (Clerck).

Only the following species is at present recognized in North America. The genus is represented in Europe and Australia.

PLEUROTA ALBASTRIGILELLA (Kearfott).

*Dorota albastrigilella* KEARFOTT, Can. Entom., XXXIX, 1907, p. 8.

I have carefully examined Mr. Kearfott's unique type; it is a typical *Pleurota*, near to the European *bicostella* Clerck, and thus establishes the occurrence of this interesting genus in North America for the first time.

In the U. S. National Museum are specimens of this species from San Diego, California (W. S. Wright, collector).

The genus *Dorota* Busek, which was tentatively referred to the Ecophoridae on its erection, does not belong in this family, but will find its proper place in the Tineidae.

The other species described by Mr. Kearfott as *Dorota* (*Dorota*) does not belong to this genus, differing both in venation and oral characters; *medioliniella* Kearfott is, however, truly allied to *Dorota* and may be temporarily retained in that genus, until additional material is forthcoming. At present it is known only through the unique type, which Mr. Kearfott kindly brought to Washington for my inspection.

3. Genus EUMEYRICKIA Busek.

*Eumeyrickia* BUSEK, Jour. New York Ent. Soc., X, 1902, p. 94.

Second joint of labial palpi with long projecting, pointed tuft; terminal joint erect, slender, acute, longer than second joint. Antennae  $\frac{2}{3}$ ; evenly ciliated throughout except on the basal joint, which is long, smooth without pecten. Forewings elongate, pointed; termen oblique; 12 veins; 7 and 8 stalked; 7 to termen just below apex; 2 from before angle of cell; 3, 4, and 5 equidistant. Hindwings ovate, nearly as broad as forewings; 8 veins; 6 and 7 parallel; 3 and 4 connate; 5 nearest 6. Female with protruding horny ovipositor.

*Type*.—*Eumeyrickia trimaculella* (Fitch).

Only the one species is at present recognized.

EUMEYRICKIA TRIMACULELLA (Fitch).

*Char. oculus trimaculella* FITCH, Rept. Nox. Ins., II, 1856, p. 233.

*Ypsolophus trimaculellus* CHAMBERS, Bull. U. S. Geol. Surv., IV, 1878, p. 167.—RILEY, Smith's List Lep. Bor. Am., 1891, No. 5532.

*Anarsia ? abapatrella* CHAMBERS, Can. Entom., VII, 1875, p. 147.

*Chimabache ? haustellata* WALSINGHAM, Trans. Am. Ent. Soc., X, 1882, p. 173.—RILEY, Smith's List Lep. Bor. Am., 1891, No. 5209.

*Eumeyrickia trimaculella* BUSEK, Jour. New York Ent. Soc., X, 1902, p. 94.—DYAR, List. N. Am. Lep., 1903, No. 5843.

Antennae blackish, each joint with a large white scale on the upper side. Labial palpi blackish fuscous, with apex of second joint and of

the tuft white; terminal joint with two longitudinal white lines. Forewings blackish brown, sprinkled with scattered white scale, especially on apical third; three small yellowish costal spots, one on the middle of costal edge, a somewhat larger one at apical third and a third just before apex. Cilia alternately dark brown and yellowish white and with a black basal line along the edge of the wing. Hindwings dark fuscous.

*Alar expanse*.—15 to 18 mm.

*Habitat*.—Northeastern United States; Canada.

The types of Fitch and Chambers are in the U. S. National Museum; topotypes of Lord Walsingham's species are also there; his type is in the collection of Professor Fernald.

I have included full references and description of this species so as to facilitate comparison with the unrecognized type of the following genus, which from description appears to be closely allied:

#### 4. Genus EIDO Chambers.

*Eido* CHAMBERS, Can. Entom., V, 1873, p. 72; Jour. Cinn. Soc. Nat. Hist., II, 1879, p. 202, fig. 18.

*Venilia* CHAMBERS (NOT DUPONCHEL), Can. Entom., III, 1872, p. 207.

The following is Chambers's generic description:

Terminal joint of the labial palpi as long as the second, slender, almost acicular. Tuft at the end of the second joint scarcely concealing the base of the third joint and pointing downward rather than forward. Antennæ very slender, indistinctly pectinated, and microscopically pubescent, scarcely reaching the apical third of the wings.

Wings rather wide. Primaries ovate, lanceolate, faintly falcate beneath the tip. The costal attains the margin; the subcostal sends from before the middle a long branch to the costal margin and two other approximate branches from the end of the cell, from the first of which it bends down to its union with the discal vein, whence it proceeds toward the apex, before which it divides, sending one branch to the costal and one to the dorsal margin near the apex. Discal cell wide at the end, closed, the discal vein emitting two branches to the dorsal margin; the median emits two branches before the end of the cell, from which it curves to the dorsal margin. Submedian furcate at base. Hindwings with the costal margin nearly straight, a little arched toward the base; costal vein straight, long, attaining the margin before the apex; subcostal very faint from the base to the distal vein, distinct from thence to the apex, straight; cell closed by a distinct discal vein, which sends two branches to the dorsal margin; median oblique, nearly straight, furcate at the end of the cell and with a branch to the dorsal margin before the end of the cell. Hind margin regularly curved, not emarginate; narrower than the forewings.

*Type*.—*Eido albapalpella* (Chambers).

This unusually detailed description, together with Chambers's figure of the venation, indicates that the genus belongs to the Cecophoridae and that it is very near if not identical with the foregoing genus *Eumeyrickia*. As, however, several small discrepancies occur, and

as Chambers's descriptions and especially his figures are not always to be relied on, it would be unwise in the absence of any authentic material to unite the two genera on the present evidence, the more so because very small differences in structure will rightly differentiate genera in this family and because the specific descriptions clearly represent two different species.

I therefore leave the genus *Eido* as unrecognized at present, and the distinctive characters utilized in the generic table, being derived from description and figure alone, are tentative only, and may prove of no value on the discovery of the species, which should not be difficult.

EIDO ALBAPALPELLA (Chambers).

*Venilia albapalpella* CHAMBERS, Can. Entom., IV, 1872, p. 208.

*Eido albapalpella* CHAMBERS, Can. Entom., V, 1873, p. 72; Jour. Cinn. Soc. Nat. Hist., II, 1879, p. 202, fig. 18—DYAR, List. N. Amer. Lep., 1903, No. 5502.

*Eido albopalpella* RILEY, Smith's List. Lep. Bor. Am., 1891, No. 5543.

Apical joint of the palpi snowy white, with a narrow brown ring at the base; second joint white at its apex and on the inner surface; grayish brown on the outer surface. Antennæ grayish brown, annulate with white. Head, thorax, and primaries grayish brown with a row of yellowish ochreous spots around the apex of the wings at the base of the cilia.

*Alar expanse*.— $\frac{9}{16}$  inch; 14 to 15 mm.

Captured in June in Kentucky.

The above is Chambers's description; no such insect is at present known to the writer, but it would seem easy to identify it, whenever found, by the striking form and color of the labial palpi.

5. Genus GERDANA, new.

Labial palpi rather short, not reaching vertex; second joint somewhat thickened with scales, which are slightly roughened underneath the tip; terminal joint shorter than second. Tongue long, scaled, curled. Antennæ a little longer than half the wing length, simple; basal joint with pecten. Forewing elongate, ovate, apex not acutely pointed, cell rather long; 12 veins; 7 and 8 stalked; 7 to termen; 3, 4, and 5 approximate from end of cell; 2 distant. Hindwings as broad as the forewings; costa excised from the middle; termen straight, oblique; dorsum straight, inner angle well developed; 8 veins; 6 and 7 parallel, but flaring towards the tip; 3 and 4 connate or stalked; 5 nearest 4, cubital.

*Type*.—*Gerdana caritella* Busek.

Only one species is at present known.

GERDANA CARITELLA, new species.

Labial palpi deep saffron-yellow. Face, head, and thorax lighter yellow. Forewings light yellow, suffused with darker saffron-yellow;

basal half of costal edge darkened with black dusting; on the middle of the cell is a blackish brown spot and obliquely below on the fold is a similar, but less prominent dark spot; at the end of the cell is a transverse, blackish brown spot, faintly connected with dark costal and dorsal spots above and below, so as to form an ill-defined and indistinct, narrow, transverse fascia at apical third of the wing; just before the tip of the wing is a more distinct, outwardly sharply angulated fascia of blackish dots, and the extreme tip is liberally dusted with black scales. Cilia light ochreous. The dark markings on the forewings are easily rubbed, so that only perfect specimens show all of the above ornamentation. Hindwings whitish fuscous; cilia ochreous. Abdomen ochreous. Legs ochreous, liberally dusted with black on the exposed sides.

*Alar expanse*.—13 to 14 mm.

*Habitat*.—Plummers Island, Maryland, July (Busck); Kerrville, Texas, April; Cohasset, Massachusetts, August (O. Bryant).

*Type*.—Cat. No. 11939, U.S.N.M.

A very pretty and easily recognized little moth with the ground color of *Aristotelia natalella* Busck and superficially resembling a Gelechiid.

#### 6. Genus CRYPTOLECHIA Zeller.

*Cryptolechia* ZELLER, Lep. Microp. Caffr., 1852, p. 106.

*Machimia* CLEMENS, Proc. Acad. Nat. Sci. Phila., 1860, p. 211.

Labial palpi very long, tip of second joint reaching above vertex, slender; second joint somewhat thickened with smoothly appressed scales, which are but slightly roughened in front; terminal joint long, but decidedly shorter than second joint, slender, pointed. Antennae without pecten on basal joint; in the males ciliated, in some species with very long ciliation; in the female simple. Tongue well developed. Forewings with 12 veins; 7 and 8 stalked; 7 to termen just below apex; vein 2 remote from vein 3. Hindwings as broad as the forewings, with 8 veins; 3 and 4 connate; 5 nearest 4; 6 and 7 parallel.

*Type*.—*Cryptolechia straminella* Zeller.

The genus is at present recognized from America, Africa, and Australia.

This genus is equal to and supersedes *Machimia* Clemens and the Australian genus *Hoplitica*<sup>a</sup> Meyrick, of which about thirty Australian species are described. This latter synonymy was suggested to me and concurred in by Mr. Meyrick, who has kindly sent me several species of this genus in a large representative collection of Australian Microlepidoptera, and who has had American species from the writer.

<sup>a</sup> Proc. Linn. Soc. N. S. W., VII, 1883, p. 493.

Some of the American species (*concolorella*, *canariella*, *huachu-  
cella*, *ciliella*) included by the writer in this genus have the ciliation  
of the male antennæ strikingly long (3 to 5), and Mr. Meyrick has  
utilized this character to separate closely allied Australian genera.  
All the American species referred to *Cryptolechia* by the writer have  
ciliated male antennæ, and I can only regard the different lengths of  
the cilia as degrees of the same character and not of sufficient value  
to separate the forms generically.

Mr. Meyrick himself would hardly insist upon the generic value  
of these differences, but he has repeatedly found it expedient to  
utilize them to break up otherwise excessively large groups in Aus-  
tralia. This reason does not exist in America, and I am glad to be  
able to disregard as a primary means of separation this and other  
secondary sexual characters, which in the writer's experience are  
excellent specific distinctions, but not indicative of well founded  
generic divisions.

To *Cryptolechia* I refer, besides the species described below, the fol-  
lowing American species:

*Leutoriferella* Clemens, Dyar List N. Am. Lep., No. 5853.

*erctacca* Zeller, Dyar List N. Am. Lep., No. 5846.

*obseuromaculella* Chambers, Dyar List N. Am. Lep., No. 5848.

*concolorella* Beutenmüller, Dyar List N. Am. Lep., No. 5845.

CRYPTOLECHIA CANARIELLA, new species.

Labial palpi very long, reaching far above the vertex; light yel-  
low, sprinkled with darker reddish yellow exteriorly. Tongue yel-  
lowish white. Antennæ yellowish with white annulations; in the  
female simple, in the male with very long (5) ciliation on the under-  
side. Face, head, and thorax light canary-yellow. Forewings uni-  
formly light canary-yellow, the color only slightly deeper yellow at  
base of costa. Cilia whitish yellow. Hindwings semitransparent,  
light whitish yellow. Abdomen yellow. Legs light canary-yellow,  
mottled exteriorly with darker ochreous.

*Alar expanse*.—24 to 25 mm.

*Habitat*.—Huachuca Mountains, Arizona.

*Type*.—Cat. No. 11940, U.S.N.M. Cotype in collection of Mr. W.  
D. Kearfott, to whom I am under obligation for this and other inter-  
esting species.

A large striking canary-yellow species not mistakable for any de-  
scribed American species.

CRYPTOLECHIA HUACHUCELLA, new species.

Labial palpi whitish with brownish base and touched exteriorly  
with rose-red; terminal joint with a dark-brown annulation around

the base and a narrow black longitudinal line in front. Antennae in male strongly ciliated on the underside (4). Face ochreous white. Head and thorax salmon-colored. Forewings salmon-ochraceous, unicolored. Cilia ochreous. Hindwings light ochreous fuscous; cilia ochreous. Abdomen ochreous. Legs light ochreous; tarsal joints slightly dark-mottled.

*Alar expanse*.—22 to 23 mm.

*Habitat*.—Huachuca Mountains, Arizona.

*Type*.—Cat. No. 11941, U.S.N.M. Cotype in Mr. Kearfott's collection.

Closely allied to the foregoing species and equally striking in color. The ciliation of the antennae in the male is hardly as long as in *canariella*.

CRYPTOLECHIA CILIELLA, new species.

Labial palpi light ochreous with base of second joint black. Antennae blackish, in male with long (3) cilia on the underside. Face, head, and thorax light dirty ochreous. Forewings light ochreous, finely dusted with fuscous, especially toward apex; first and second discal spot blackish brown; at apical third is an undulating, outwardly curved row of small blackish dots. Cilia dirty ochreous. Hindwings dark fuscous. Abdomen ochreous fuscous. Legs light ochreous; tarsal joints sprinkled with fuscous.

*Alar expanse*.—19 mm.

*Habitat*.—Baboquivari Mountains, Pima County, Arizona, July (O. C. Poling, collector).

*Type*.—Cat. No. 11942, U.S.N.M. Cotype in the collection of Mr. W. D. Kearfott, from whom the specimens were received.

A plain species, very similar to the type of the genus, but smaller and with much longer ciliation of the male antennae. In this it approaches *concolorilla* Beutenmüller, as well as in color; but this species is a more loosely scaled insect with more rounded wings.

7. Genus PSILOCORSIS Clemens.

*Psilocorsis* CLEMENS, Proc. Acad. Nat. Sci. Phila., 1860, p. 213.

Labial palpi very long and slender, smooth; second joint hardly thickened with appressed scales; terminal joint nearly as long as second joint. Antennae simple in both sexes, without pecten on basal joint. Tongue developed, scaled, spiraled. Forewings with rather squarely cut termen; 12 veins; 7 and 8 stalked; 7 to termen; 2 approximate to 3. Hindwings nearly as broad as the forewings; 8 veins; 6 and 7 parallel; 3 and 4 connate; 5 nearest 4, cubital.

*Type*.—*Psilocorsis quercicella* Clemens.

The genus is at present recognized only from America.

I have but little to add to my remarks on the species of this genus,<sup>a</sup> and I include the following distinct species:

*quercicella* Clemens, Dyar List N. Am. Lep., No. 5851.

*absolotella* Zeller, Dyar List N. Am. Lep., No. 5849.

*ferruginosa* Zeller, Dyar List N. Am. Lep., No. 5847.

*faginella* Chambers, Dyar List N. Am. Lep., No. 5847, part.

*cryptolechiella* Chambers, Dyar List N. Am. Lep., No. 5847, part.

*dubitatella* Zeller, Dyar List N. Am. Lep., No. 5847, part.

*reflexella* Clemens, Dyar List N. Am. Lep., No. 5848.

With *crossonella* Chambers, Dyar List N. Am. Lep., No. 5847, part; a synonym.

The larva, described as that of *Cryptolechia quercicella* by Mr. Arthur Gibson<sup>b</sup> feeding on *Populus*, does not belong to that species, the larva of which feeds on oak and is well described by Clemens. Mr. Gibson's moth is an undescribed species of *Psilocorsis*.

Besides the species now disposed of in the genera *Cryptolechia* and *Psilocorsis*, and *sparsiciliella* Clemens, which is made type of a new genus in the following pages, only one species, included in *Cryptolechia* in Dyar's List, remains, namely, *piperatella* Zeller (Dyar's List, No. 5850), which does not belong to the present family at all, but to the Gelechiidae, and for which I make the following new genus:

Genus DURRANTIA, new (Gelechiidæ).

Labial palpi long, curved; second joint slightly thickened with smoothly appressed scales; terminal joint long, but shorter than second, acute. Tongue well developed, spiraled. Maxillary palpi small, simple. Antennæ somewhat more than half the wing length, in the female simple, in the male finely serrate and pubescent. Forewings elongate ovate, apex bluntly pointed; termen rounded; 12 veins; 7 and 8 stalked (or coincident), both to costa; 3, 4, and 5 approximate at the end of the cell; 2 from outer fifth of cell; 1<sup>b</sup> furcate at base. Hindwings as broad as the forewings; costa nearly straight; apex blunt; termen and dorsum evenly rounded; 8 veins; 3 and 4 stalked; 5 cubital, approximate to 3 and 4; 6 and 7 stalked; 8 free; cell wide; discal vein very oblique. Posterior tibiae thickly clothed with rough hairs. The female with protruding horny and hairy ovipositor.

*Type*.—*Durrantia piperatella* (Zeller).

The type has veins 7 and 8 in forewings stalked; I include as generic character "or coincident" in order not to exclude another closely related and very similar, undescribed Texan species, which I believe congeneric, in spite of this single difference.

The genus is named in honor of my friend and co-worker, John Hartley Durrant, to whom I am under pleasant obligations through

<sup>a</sup> Proc. Ent. Soc. Washington, V, 1903, p. 207.

<sup>b</sup> Can. Entom., XL, 1908, p. 84.

many years for much valuable assistance and advice, and together with whom I studied and discussed the present genus at Merton Hall three years ago.

### 8. Genus AGONOPTERYX Hübner.

*Agonopteryx* HÜBNER, Verzeichniss bekannter Schmetterlinge, 1818, p. 410.

Labial palpi long, curved; second joint with well-developed, furrowed brush on the underside; terminal joint slender, acute, shorter than second joint. Antennae simple in both sexes, with pecten on basal joint. Tongue developed, scaled at base. Forewings elongate; apex usually obtuse; termen rounded; 12 veins; 7 and 8 stalked, both to costal edge; 2 and 3 stalked. Hindwings as wide or wider than the forewings, with costa nearly straight, termen evenly rounded; inner angle strongly developed, so as to cause a sinuation in the dorsal edge; 8 veins; 6 and 7 parallel; 3 and 4 connate or short-stalked; 5 cubital, approximate to 4. Abdomen flattened.

*Type*.—*Agonopteryx ocellana* (Fabricius).

This genus comprises Meyrick's section A of *Depressaria*, which differs from section B in having veins 2 and 3 in the forewings stalked. Through the kindness of Mr. Durrant I have lately received advance proofs of parts of Lord Walsingham's paper in Proceedings of the Zoological Society of London for 1907, from page 955 of which I learn that he has adopted Wallengren's idea of separate genera for the two groups, which indeed seems logical.

The described American species, which are referable to this genus, are:

- atrodorsella* Clemens, Dyar List N. Am. Lep., No. 5854.
- ambriticostella* Walsingham, Dyar List N. Am. Lep., No. 5855.
- thoracuinigracella* Chambers, Dyar List N. Am. Lep., No. 5856.
- gracilis* Walsingham, Dyar List N. Am. Lep., No. 5857.
- ocella* Busek, Proc. U. S. Nat. Mus., XXVII, 1904, p. 764.
- nebulosa* Zeller, Dyar List N. Am. Lep., No. 5870.
- scabella* Zeller, Dyar List N. Am. Lep., No. 5892.
- ciniflorella* Zeller, Dyar List N. Am. Lep., No. 5869.
- klamathiana* Walsingham, Dyar List N. Am. Lep., No. 5868.
- psoralicella* Walsingham, Dyar List N. Am. Lep., No. 5865.
- walsinghamicella* Busek, Dyar List N. Am. Lep., No. 5864.
- nigrinotella* Busek, Proc. Ent. Soc. Washington, IX, 1908, p. 88.
- curritiniella* Beutenmüller, Dyar List N. Am. Lep., No. 5874.
- amyriscella* Busek, Dyar List N. Am. Lep., No. 5872.
- clemensella* Chambers, Dyar List N. Am. Lep., No. 5862.
- rosacilicella* Busek, Dyar List N. Am. Lep., No. 5863.
- pulvipennella* Clemens, Dyar List N. Am. Lep., No. 5858.
- gelidella* Busek, Proc. Ent. Soc. Washington, IX, 1908, p. 90.
- thoracofuscicella* Chambers, Dyar List N. Am. Lep., No. 5867.
- arvicella* Walsingham, Dyar List N. Am. Lep., No. 5859.
- fulva* Walsingham, Dyar List N. Am. Lep., No. 5871.
- nocimundi* Walsingham, Dyar List N. Am. Lep., No. 5866.



- muricolorella* Busck, Dyar List N. Am. Lep., No. 5873.  
*sanguinella* Busck, Dyar List N. Am. Lep., No. 5861.  
*argillacca* Walsingham, Dyar List N. Am. Lep., No. 5860.  
*amissella* Busck, Proc. Ent. Soc. Washington, IX, 1908, p. 89.  
*pallidella* Busck, Proc. U. S. Nat. Mus., XXVII, 1904, p. 765.  
*pergandeella* Busck, Proc. Ent. Soc. Washington, IX, 1908, p. 89.  
*flaricomella* Engel, Ent. News, XVIII, 1907, p. 276.  
*scuccionella* Busck, Dyar List N. Am. Lep., No. 5875.  
*sabutella* Walsingham, Dyar List N. Am. Lep., No. 5876.  
*arucella* Schiffermüller, Dyar List N. Am. Lep., No. 5877.  
*canadensis* Busck, Dyar List N. Am. Lep., No. 5878.  
*lythrella* Walsingham, Dyar List N. Am. Lep., No. 5879.  
*posticella* Walsingham, Dyar List N. Am. Lep., No. 5880.  
*nubiferella* Walsingham, Dyar List N. Am. Lep., No. 5881.  
*robinicella* Packard, Dyar List N. Am. Lep., No. 5882.  
*lecontella* Clemens, Dyar List N. Am. Lep., No. 5883.

AGONOPTERYX PLUMMERELLA, new species.

Second joint of labial palpi slim and smooth on basal half; with short trumpet-formed brush on outer half; light ochreous gray, externally speckled with dark fuscous; terminal joint rather thick; light ochreous gray, strongly mottled with black scales, which congregate into an ill-defined basal spot and a broad annulation before the tip. Antennæ dark fuscous with narrow black annulations. Face light ochreous gray. Head and thorax dark ochreous fuscous, mottled with darker fuscous. Forewings pepper-and-salt colored; under a lens with the ochreous fuscous ground color thickly mottled with white and black scales; no lighter basal patch; a round white second discal dot is preceded by a few black scales and easily overlooked; along the costal edge is a series of small ill-defined black spots, separated by white and ochreous scales. Cilia ochreous fuscous. Hindwings shining fuscous, whitish on basal half and darker toward the tip. Abdomen light ochreous fuscous. Legs ochreous; tarsal joints mottled with black.

*Alar expanse*.—24 mm.

*Habitat*.—Plummers Island, Maryland (Busck); Cincinnati, Ohio (Miss A. F. Braum).

*Type*.—Cat. No. 11943, U.S.N.M.

Very near to *nebulosa* Zeller, but considerably larger and with base of the hindwings more whitish.

AGONOPTERYX SCABELLA (Zeller).

*Epiclestia scabella* ZELLER, Dyar List N. Am. Lep., No. 5892.

Not being acquainted with this species in nature at the time of my review of the genus *Depressaria*,<sup>a</sup> I concluded from Zeller's descrip-

<sup>a</sup> Proc. U. S. Nat. Mus., XXIV, 1902.

tion that if the species belonged to the group at all it would have veins 2 and 3 separate, and it was placed accordingly in Doctor Dyar's list. My friend Mr. Durrant kindly corrected me in this and I have since had the opportunity of examining Zeller's unique type in Lord Walsingham's collection at Merton Hall, England. The species is an *Agonopteryx*, having veins 2 and 3 in the forewings stalked, and there is nothing very remarkable about it, aside from the small tufts of raised scales on the forewings. I agree with Mr. Durrant in placing it next to *nebulosa* Zeller, which it much resembles.

#### 9. Genus DEPRESSARIA Haworth.

*Depressaria* HAWORTH, Lep. Brit., 1812, p. 505.

This genus has the same characters as the foregoing, from which it differs only in veins 2 and 3 being separate instead of stalked in the forewings. The color pattern of the forewing is normally characteristic enough to readily indicate to which of the two genera a species belongs.

The described American species belonging to this genus are the following:

- alicella* Busek, Dyar List N. Am. Lep., No. 5884.
- togata* Walsingham, Dyar List N. Am. Lep., No. 5885.
- juliella* Busek, Proc. Ent. Soc. Washington, IX, 1908, p. 91.
- ? *apicella* Hübner, *nerrosa* Haworth, Dyar List N. Am. Lep., No. 5887.
- barberella* Busek, Dyar List N. Am. Lep., No. 5888.
- heracliana* De Geer, Dyar List N. Am. Lep., No. 5889.
- betulella* Busek, Dyar List N. Am. Lep., No. 5886.
- groteella* Robinson, Dyar List N. Am. Lep., No. 5890.
- maculatella* Busek, Proc. Ent. Soc. Washington, IX, 1908, p. 90.
- cinerocostella* Clemens, Dyar List N. Am. Lep., No. 5891.

#### 10. Genus INGA, new.

Labial palpi long, curved; second joint thickened with smoothly appressed scales, slightly roughened in front; terminal joint long, slender, acute, shorter than second joint. Tongue long, spiraled. Antennae without pecten on basal joint, simple in both sexes. Forewings with apex blunt, termen oblique; 12 veins; 7 and 8 stalked, both to the costal edge. Hindwings as broad as the forewing; 8 veins; 6 and 7 parallel; 3 and 4 comate; 5 cubital, approximate to 4. Female with protruding horny and hairy ovipositor.

*Type*.—*Inga sparsiciliella* (Clemens).

Closely related to *Agonopteryx*, differing mainly in the absence of pecten on basal joint of the antennae and by the abdomen not being depressed.

Only the one species is at present recognized.

## INGA SPARSICILIELLA (Clemens).

*Cryptolechia sparsiciliella* (CLEMENS), Dyar List, N. Am. Lep., No. 5844.

## 11. Genus SEMIOSCOPIIS Hübner.

*Semioscopis* HÜBNER, Verzeichniss bekannter Schmetterlinge, 1818, p. 402.

Labial palpi moderately long, curved; second joint with appressed scales, which protrude somewhat at apex; terminal joint shorter than second joint. Antennæ without pecten on basal joint, shortly ciliated in the male, simple in the female. Tongue developed, though rather short. Forewings ample, elongate; apex blunt, termen very oblique; 12 veins; 7 and 8 stalked; 7 to costa or apex; 2 and 3 stalked or approximated. Hindwings as broad as forewings, ovate; 8 veins; 7 and 6 parallel; 3 and 4 connate or closely approximated; 5 cubital, nearest 4.

*Type*.—*Semioscopis steinkellneriana* (Schifferrmüller).

The genus is also represented in Europe.

The following American species belonging to this genus are at present described:

*packardella* Clemens, Dyar List Lep. N. Am., No. 5893.

*merriceella* Dyar, Can. Entom., XXXIV, 1902, p. 319.

*aurorella* Dyar, Can. Entom., XXXIV, 1902, p. 319.

*megamicroella* Dyar, Can. Entom., XXXIV, 1902, p. 320.

*inornatella* Walsingham, Dyar List N. Am. Lep., No. 5895.

*alleneella* Walsingham, Dyar List N. Am. Lep., No. 5894.

## 12. Genus EPICALLIMA Dyar.

*Epicallima* DYAR, Bull. U. S. Nat. Mus., No. 52, 1903, p. 525.

Labial palpi very long, recurved; second joint slightly thickened with smoothly appressed scales; terminal joint long, slender, but shorter than second joint. Antennæ without pecten on basal joint, simple, slightly serrated toward the tip in the males. Tongue developed. Forewings rather narrow, pointed, termen oblique; 12 veins; 7 and 8 stalked, both to costa. Hindwings not as broad as the forewings; 8 veins, 6 and 7 parallel; 3 and 4 connate; 5 distant but cubital.

*Type*.—*Epicallima argenticinctella* (Clemens).

The genus is widely distributed. The following European species, hitherto placed in the genus *Borkhausenia*, are referable to *Epicallima*: *procerella* Schifferrmüller; *schaffereella* Linnaeus; *grandis* Desvignes; *augustella* Hübner; *luctuosella* Duponchel; *stramella* Fabricius; *tripuncta* Haworth, and *rhatika* Frey; probably also other intervening species, with which I am not familiar.

The following American species belong in the genus:

*argenticinctella* Clemens, Dyar List N. Am. Lep., No. 5920.

*edithella* Busck Jour. New York Ent. Soc., XV, 1907, p. 138.

*coloradella* Walsingham, Dyar List N. Am. Lep., No. 5923.

*dimidiella* Walsingham, Dyar List N. Am. Lep., No. 5925.

*quadrimaculella* Chambers, Dyar List N. Am. Lep., No. 5927.

### 13. Genus DECANTHA, new.

Labial palpi moderately long; second joint somewhat thickened with appressed scales, slightly rough in front; terminal joint shorter than second joint, rather thick, pointed. Antennæ with strong pecten on basal joint; simple. Tongue developed. Forewings elongate, pointed; termen very oblique; 11 veins; 7 and 8 coincident to costal edge. Hindwings narrower than the forewings; 8 veins; 6 and 7 parallel; 3 and 4 separate; 5 nearest 4, cubital.

*Type*.—*Decantha borkhauseni* (Zeller).

Includes only the one species, common to Europe and North America:

*borkhauseni* Zeller, Dyar List N. Am. Lep., No. 5922, with *borcasella* Chambers, Dyar List N. Am. Lep., No. 5921, as a synonym.

### 14. Genus EUCLEMENSIA Grote.

*Euclemensia* GROTE, Can. Entom., X, 1878, p. 69.

Labial palpi long, slender, curved, smooth; terminal joint shorter than second joint. Antennæ somewhat thickened with scales, without pecten on basal joint. Tongue obsolete. Forewing narrow, elongate, pointed; 12 veins; 7 and 8 stalked; both to costa. Hindwings nearly as broad as forewings; 8 veins; 6 and 7 parallel; 3 and 4 separate.

*Type*.—*Euclemensia bassettella* (Clemens).

An American genus, not identified elsewhere; the two species known are parasitic on *Kermes*.

*bassettella* Clemens, Dyar List N. Am. Lep., No. 5918.

*schwarzella* Busck, Dyar List N. Am. Lep., No. 5919.

### 15. Genus FABIOLA, new

Labial palpi long, curved; second joint with smoothly appressed scales; terminal joint slender, nearly as long as second joint. Antennæ without pecten on basal joint; in the male with rather long (2) cilia. Tongue developed. Forewings elongate, ovate, obtusely pointed; 11 veins; 7 and 8 coincident to costal edge. Hindwings narrower than the forewings; 8 veins; 6 and 7 parallel; 3 and 4 connate.

*Type*.—*Fabiola shallericella* (Chambers).

The European *pokorny* Nickerl belongs to this genus.

Only the one North American species is at present known:

*shallericella* Chambers, Dyar List N. Am. Lep., No. 5928.

### 16. Genus ŒCOPHORA Latreille.

*Œcophora* LATREILLE, Gen. Crist. et Insect., 1806.

Labial palpi long, curved; second joint thickened with appressed scales; terminal joint shorter than second. Tongue developed. An-

tennæ without pecten on basal joint; thickened with rough scales on basal half; in the males strongly ciliated. Forewings with 12 veins; 7 and 8 stalked; both to costal edge. Hindwings nearly as broad as the forewings; 8 veins; 6 and 7 parallel; 3 and 4 connate or stalked.

*Type*.—*Ecophora sulphurella* (Fabricius).

The genus consists of a few European and the following North American species:

*ucumanella* Clemens, Dyar List N. Am. Lep., No. 5932.

#### 17. Genus TRICLONELLA Busck.

Labial palpi long, smooth, recurved; second joint somewhat thickened with smoothly appressed scales; terminal joint long, slender but shorter than second joint. Antennæ with pecten on basal joint, simple, slightly serrate and ciliate in the male. Tongue long, spiraled. Forewings elongate, ovate, obtusely pointed; 12 veins; 7 and 8 stalked, both to costa. Hindwings narrower than the forewings; 8 veins; 6 and 7 parallel; 3 and 4 connate or stalked; 5 connate with or stalked from 4.

*Type*.—*Triclonella pergandeella* Busck.

A small American genus with a peculiar Australian aspect, not yet satisfactorily recognized from elsewhere.

*Villella* Busck (Dyar List N. Am. Lep., No. 5917), described under this genus, is a Blastobasid belonging to the genus *Holcocera* Clemens.

The following are the North American species referable to this genus:

*pergandeella* Busck, Dyar List N. Am. Lep., No. 5916.

*determinatella* Zeller, Dyar List N. Am. Lep., No. 5924.

#### 18. Genus ENDROSIS Hübner.

Labial palpi moderately long, curved, smooth; second joint somewhat thickened with appressed scales; terminal joint nearly as long as second. Antennæ with pecten on basal joint; in the males slightly serrated toward tip and ciliated. Tongue developed. Forewings elongate, pointed, with 12 veins; 7 and 8 stalked both to costal edge. Hindwings not as broad as the forewings; 7 veins; 6 and 7 parallel; 3 and 4 coincident; 5 connate or short-stalked with 4.

*Type*.—*Endrosis lacteella* (Schiffermüller).

The genus contains only the one semidomestic, widely distributed species:

*lacteella* Schiffermüller, Dyar List N. Am. Lep., No. 6170.

#### 19. Genus BORKHAUSENIA Hübner.

*Borkausenia* HÜBNER, Verzeichniss bekannter Schmetterlinge, 1818, p. 420.

Labial palpi moderately long, curved; second joint somewhat thickened and roughened beneath with scales; terminal joint shorter than

second. Tongue developed. Antennæ with pecten on basal joint; ciliated in the males. Forewings elongated, pointed; 12 veins; 7 and 8 stalked both to costa. Hindwings narrower or nearly as broad as the forewings; 8 veins; 7 and 6 parallel; 3 and 4 connate.

*Type*.—*Borkhausenia minutella* (Linnaeus).

A large, widely distributed genus; the larvæ feed on dry vegetable matter.

The species placed under this genus (*Æcophora* Authors) in Doctor Dyar's list have mostly been disposed of under *Epicallima*, *Fabiola* and *Decantha* in the foregoing.

*Thoracella* Walsingham (Dyar's List, No. 5929) is a Gelechiid and a synonym of *Epitheetis bicostomaculella* Chambers, as examination of the type proves.

*Constrictella* Zeller (Dyar's List, No. 5930) is a *Thuisoa*, and is repeated under No. 6130.

*Ascriptella* Busek (Can. Entom., June, 1908) belongs, according to Mr. Meyrick, in his Australian genus *Crossophora*, which differs from *Borkhausenia* only in the longer male antennal ciliation. As the other species of *Borkhausenia* have similar ciliated antennæ, only in less degree, I prefer to retain the species in the genus as described.

The four Californian species described by Lord Walsingham<sup>a</sup> were placed by an oversight under the Blastobasid genus *Hypatopa* Walsingham, but cotypes of the first three species, generously presented to the U. S. National Museum by his lordship, prove them to belong to the present genus, and Mr. Durrant has kindly informed me that *orites* Walsingham is congeneric with the three others.

The following North American species, then, belong in *Borkhausenia*:

*pseudospretella* Stainton, Dyar List N. Am. Lep., No. 5926.

*ascriptella* Busek, Can. Entom., XI, June, 1908.

*episcia* Walsingham, Proc. U. S. Nat. Mus., XXXIII, 1907, p. 211.

*conia* Walsingham, Proc. U. S. Nat. Mus., XXXIII, 1907, p. 212.

*fasciata* Walsingham, Proc. U. S. Nat. Mus., XXXIII, 1907, p. 213.

*orites* Walsingham, Proc. U. S. Nat. Mus., XXXIII, 1907, p. 213.

## 20. Genus TAMARRHA Walker.

*Tamarrha* WALKER Cat. Lep. Het. Br. Mus., XXIX, 1864, p. 816.

Labial palpi slender, smooth, curved; terminal joint shorter than second. Antennæ without pecten on basal joint, simple in both sexes. Tongue developed. Forewings elongate, apex blunt; 12 veins; 7 and 8 stalked to costa; rest separate. Hindwings as broad as the forewings, elongate-ovate; 8 veins; vein 8 is connected at the end of the cell with vein 7 by an oblique cross vein, and basal part of

<sup>a</sup>Proc. U. S. Nat. Mus., XXXIII, 1907, pp. 211-213.

7 is obsolete; veins 6 and 7 parallel; 5 radial, nearest to 6; 3 and 4 connate.

*Type*.—*Tamarra nivosella* Walker.

The genus *Babaiara* Busck (type, *dellicella* Fernald) is a synonym of *Tamarra*, as shown by the writer.<sup>a</sup>

My friend Mr. Meyrick has all along contended that the peculiar aberrant structure of the venation in the hindwing is of slight importance generically and he considers the present genus synonymous with *Ethmia*. Having found a similar cross-vein in the males of some of the South American Stenomidae, where it is plainly the normal subcostal cross-vein, found in the family Gelechiidae, connecting veins 7 and 8, which has been pushed outwards in order to strengthen the costal region, which is widened on account of a large hair pencil, I am inclined to accept Mr. Meyrick's view, the more so as some apparently typical species of the genus *Ethmia* (*hilarella* Zeller, *funerella* Fabricius) possess a similar cross-vein. This vein is thus to be explained as the persisting cross-vein, modified on account of a hair tuft, which itself may not have persisted. In this connection it is significant that the type of *Tamarra* and some other species of the genus have a costal tuft on the hindwings.

There is, however, no difficulty in the North American fauna in keeping the genus *Tamarra* distinct from *Ethmia*, and I prefer to do so for the present.

The presence of the cross-vein mentioned above, together with the relationship of vein 5 of the hindwings to the radial system of the neurulation, indicates that further study of these two genera, on which I am now engaged at Merton Hall, may justify the erection of a new family for their reception.

The following North American species are referable to this genus:

*dellicella* Fernald, Dyar List N. Am. Lep., No. 5935.

*bittencella* Busck, Proc. U. S. Nat. Mus., XXX, 1906, p. 730.

#### TAMARRHA DELLIELLA (Fernald).

I am glad to be able to record the food plant of this beautiful species. It was bred by Mr. J. D. Mitchell at Victoria, Texas, from *Ehretia elliptica* de Candolle. Adult issued August 7, 1907.

The food plant belongs to the family Boraginaceae, to which the genus *Ethmia* is normally partial.

#### 21. Genus ETHMIA Hübner.

*Ethmia* HÜBNER, Verzeichniss bekannter Schmetterlinge, 1818, p. 163.

Labial palpi moderately long, second joint thickened with smoothly appressed scales or with a more or less developed rough tuft; ter-

<sup>a</sup>Proc. U. S. Nat. Mus., XXX, 1906, p. 728.

minal joint shorter than second. Antennæ without pecten on basal joint; shortly ciliated in the males; simple in the females. Tongue developed. Forewings elongate, with obtuse apex and rather oblique termen; 12 veins; 7 and 8 stalked to costal edge; rest separate. Hindwings as broad as the forewings; 8 veins; 8 free; 6 and 7 parallel; 3 and 4 connate; 5 radial, approximate to 6.

*Type*.—*Ethmia aurifluella* Hübner.

A widely distributed genus.

The following North American species are referable to this genus:

*albistrigella* Walsingham, Dyar List N. Am. Lep., No. 5897.

*ambromarginella* Busck, Proc. Ent. Soc. Washington, VIII, 1907, p. 94.

*coquilletella* Busck, Proc. Ent. Soc. Washington, VIII, 1907, p. 95.

*lassenella* Busck, Proc. Ent. Soc. Washington, IX, 1908, p. 92.

*albitogata* Walsingham, Proc. U. S. Nat. Mus., XXXIII, 1907, p. 199.

*monticola* Walsingham, Dyar List N. Am. Lep., No. 5905.

*fuscipedella* Walsingham, Dyar List N. Am. Lep., No. 5914.

*caliginosella* Busck, Jour. New York Ent. Soc., XII, 1904, p. 44.

*arctostaphylella* Walsingham, Dyar List N. Am. Lep., No. 5898.

*obscurella* Beutenmüller, Dyar List N. Am. Lep., No. 5906.

*macchiosella* Busck, Proc. Ent. Soc. Washington, VIII, 1907, p. 93.

*mirusella* Chambers, Dyar List N. Am. Lep., No. 5904.

*discostrigella* Chambers, Dyar List N. Am. Lep., No. 5899.

*semilucubrella* Dyar, Jour. New York Ent. Soc., X, 1902, p. 204.

*subcaerulea* Walsingham, Dyar List N. Am. Lep., No. 5900.

*confusella* Walker, Dyar List N. Am. Lep., No. 5915.

*josephineella* Dyar, Jour. New York Ent. Soc., X, 1902, p. 205.

*marmorca* Walsingham, Dyar List N. Am. Lep., No. 5903.

*semilugens* Zeller, Dyar List N. Am. Lep., No. 5907.

*trifurcella* Chambers, Dyar List N. Am. Lep., No. 5911.

*semionbra* Dyar, Jour. New York Ent. Soc., 1902, p. 206.

*hagenella* Chambers, Dyar List N. Am. Lep., No. 5901.

*apicipunctella* Chambers, Dyar List N. Am. Lep., No. 5902.

*longimaculata* Chambers, Dyar List N. Am. Lep., No. 5912.

*coranella* Dyar, Jour. New York Ent. Soc., X, 1902, p. 207.

*zelleriella* Chambers, Dyar List N. Am. Lep., No. 5913.

Including the synonymy as worked out by Doctor Dyar,<sup>a</sup> which I am pleased to adopt in full, with the exception noted below, the above list accounts for all North American species referred to this genus except the names under No. 5910 of Doctor Dyar's list, which have been the cause of some misconception in the past. Chambers's *Anesychia texanella*<sup>b</sup> was naturally placed in the genus *Ethmia* (*Psecadia*) by Lord Walsingham<sup>c</sup> on the evidence of Chambers's description and generic name, and it has been retained in this genus since; but Chambers himself expressed a doubt, and his unquestionably authentic type in the Museum of Comparative Zoology in Cambridge proves it to be a large *Glechia* species near *Larnesiella* Busck.

<sup>a</sup> Jour. New York Ent. Soc., V, 1902, pp. 202-208.

<sup>b</sup> Jour. Cinn. Soc. Nat. Hist., 11, 1880, p. 179.

<sup>c</sup> Insect Life, I, 1888, p. 149.



Through a mistake of the paging, Doctor Dyar supposed that this *texanella* Chambers was preoccupied by *Ethmia texanella* (*zelleriella* Chambers), and gave it in his list the new name *chambersella*, which thus was unnecessary and becomes a synonym of *Gelechia* (*Anesychia*) *texanella* Chambers. But on discovering his mistake as to the paging and after correcting it,<sup>a</sup> Doctor Dyar continued:

I have a single specimen without label, which I attribute to this species, but which may possibly not be the same. If not, the name *chambersella* can be used for it.

And he then gives a description of it and a type number in the U. S. National Museum.

This latter *chambersella* Dyar is neither an *Ethmia* nor *Gelechia* (*Anesychia*) *texanella* Chambers, but is a Gelechiid, referable to the genus *Durrantia* Busck. The name thus being preoccupied, it may be known as *Durrantia obiterella*, new name, with the synonym *Ethmia chambersella* Dyar (not Dyar), and the type is Cat. No. 6625, U.S.N.M.

---

<sup>a</sup>Jour. New York Ent. Soc., X, 1902, p. 208.



A REVISION OF SOME SPECIES OF NOCTUIDÆ HERETOFORE REFERRED TO THE GENUS HOMOPTERA BOISDUVAL.

---

By JOHN B. SMITH,

*Of Rutgers College, New Brunswick, New Jersey.*

---

The species of *Homoptera* Boisduval, as they have been listed in our fauna, are typified by the most common and best known of our species, *lunata*, or *edusa*, as it has been indifferently known. As based on that species the genus has naked, hemispherical eyes, a smooth moderately convex front clothed with scaly vestiture, which is divergent, not smooth nor closely applied. The antennæ are long, a little thicker in the male, in which the joints are also a little marked and furnished with lateral ciliae. The tongue is well developed and functional. The palpi are long, curved obliquely upward, closely scaled, third joint almost as long as the second but more slender, more closely scaled and usually truncate at tip. There is a little difference in the sexes and more between the different species; but on the whole the general character of the palpal structure is distinctive and much the same throughout.

The thorax is not large in proportion to the size of the insects, quadrate or nearly so, the vestiture consisting of long flattened hair with broader scales intermixed, thick but smoothly applied. The collar is round and closely applied. Patagia always well marked and sometimes conspicuously developed. They may be flattened and divergent into wing-like structures posteriorly, or they may be uplifted so as to form a brush-like mass; but they are always at least well marked and divergent. Between the patagia there is usually a posterior tuft which is generally truncated behind and may overhang the basal segment of the abdomen. The abdomen is cylindrical, stout, extending to or exceeding anal angle of secondaries; closely scaled, with a variably developed series of dorsal tufts. Usually there is a broad tuft on the basal segment, supplementing that on the thorax and like it cut off square behind; the others are as a rule little upright scale masses that are easily removed and are rarely complete in captured specimens. Not infrequently one or the other of these dorsal

tufts is more prominent than any other and gives that species a characteristic appearance.

The legs are always stout and well developed, the anterior always, the posterior usually without spinules or other than the normal armature. Middle tibiae always spinose, the spines varying somewhat in number and prominence even within the limits of the same species.

In examining some of the mounts of legs made in the course of the preliminary work with *lanata*, I noted quite a difference in the amount and character of the spinulation of the middle tibia and I noted also that occasionally, on the hind tibiae, there would be one or two distinct spinules between the two pairs of spurs. As this spinulation is a structural character that has been given much systematic value, it became important to determine whether there was not, perhaps, a mixture of species and whether by separating out those with the spines present on the posterior tibiae, it would not be possible to correlate the structure with some superficial character. Every example in all the collections then in my hands was therefore carefully examined with the following results:

The Ottolengui collection contained 21 males and 15 females, and of the males 7 had the blue lunules distinct while 14 were of the type in which the blue was reduced to narrow lines. Of the 7 males in which the blue lunules were well developed, 2 had distinct spines on the hind tibiae. Of the 14 males in which there were no blue lunules, not one had any trace of such spinules. Of the 15 females, 7, or nearly one-half, had distinct spinules on the posterior tibiae. In the females there was no sort of correspondence between the depth of coloration and the presence of the spinules, and in the males the percentage of spinose examples, 2 out of 21, was so small that no rule could be even hinted at.

In the collection of the U. S. National Museum there were 53 males and 43 females, and of the 53 males there were 25 with distinct blue lunules and 28 in which the blue was reduced to lines. Of the males, 5 of those with blue lunules and 6 of those with blue lines only had the posterior tibiae spinulated. Of the females, 16 out of the 43 had that character well developed.

In my own collection I had 25 males and 33 females, and of the males 10 had the blue lunules distinct, while 15 had only the blue lines. Only one example with blue lunules had any trace of spines on the hind tibiae. In the females, however, 13 out of the 33 examples had one or two distinct spinules between the two pairs of spurs. The females were separated out into two series: those with the median space distinctly paler and those with the surface concolorous, and 3 of the spined specimens were ranged among the former and 10 came into the latter series.

Altogether I examined 99 males and 91 females and found 14 males and 36 females with spines on the posterior tibiæ. I found no sort of relation between locality, date, color, sex, or maculation and the presence or absence of spines, and the only thing that could be said was that the spines on the posterior tibiæ were more commonly present in the female than in the male.

No other species was so systematically and fully examined as *lanata*, but in almost every species where a number of examples were looked at, this same variation in the presence of spines on the posterior tibia was observed. It is not in this series of species a character of even specific value.

In the male the typical species has the middle femora a little enlarged, inwardly grooved, laterally fringed with hair of variable length and density, forming receptacles which contain masses of specialized scales, sometimes in enormous, sometimes in small quantity only. But not all the species referred here are so characterized, and some of them have no trace of this sexual character.

When the insect has the legs normally held against the breast little is noticeable of this tuft even when it is well developed; but when the leg is removed and the tuft is stirred with a needle, it forms a mass several times as great as the original. The tibia has a small tuft of hair which is not specialized or formed into a definite pencil. In the female there is a fringe of hair to the femur; but it is much smaller than in the male, and there is no contained mass of specialized hair.

The wings are broadly trigonate and in a general way the secondaries are ornamented much like the primaries. The apex of the primary is distinct or even acute, and the outer margin is more or less dentate or scalloped, this being a variable feature. There is nothing very characteristic about the venation. In the primaries 6 is from the lower margin of accessory cell, 7 and 8 + 9 are from its end, and 10 is from its upper margin near the tip. On the secondaries the median cell is very short, 3 + 4 fork at the end of the median, and 5 is from a short oblique spur, parallel with and quite as strong as 4.

As thus characterized, *Ypsia* Guenée does not differ very markedly from *Homoptera* Boisduval, and I have united the species referred to the latter genus with those treated here. The thoracic tufting is not so well marked and the patagia are not so divergent; otherwise I find nothing that is of especial importance. The structural details are exactly the same and so are the sexual characters, which will be referred to in more detail presently.

*Phococyma* Hübner, as based on *lanifera* Hübner, is an earlier name for the same conception, and except for the fact that we have a somewhat more slightly built species, there is no structural differ-

ence. Hübner's name is the one that must be used for the conception above described, including those species in which the middle femora of the male have the mass of specialized scales normally developed. The species referred to *Phaocyma* by Mr. Grote do not belong there.

*Zale* Hübner is a still earlier name for almost the same conception, structurally speaking, but this offers greater differences in certain directions.

Based on our species *horrida*, the more divergent thoracic tufts, emphasized because discolorous, and the more conspicuous dorsal tufts of the abdomen make the genus recognizable; but these differences are only of degree and scarcely greater than occur elsewhere in the series of species. In the male the middle femora have no mass of specialized scales, and as there is quite a little series of species that agree in this character or lack of character, I propose to hold *Zale* Hübner in a subgeneric sense as applicable to those species of *Phaocyma* in which the middle femora of the male are not in any way modified.

As they appeared in collections when I began, the species of *Homoptera* were considerably mixed up, and except for a few of the better marked species names were doubtful. Under *calycanthata* at least three distinct species were masquerading and neither of them was the form described by Smith and Abbot. Morrison's species were rarely identified at all, and as a rule erroneously when any attempt had been made to name them. *Lunifera* Hübner and *squamularis* Drury were not correctly identified, and as a whole the straightening out of the synonymy was the first and not least interesting portion of the task before me.

My own material was in no better shape than any other, and for some years I had refused to apply names to species of this genus except in a tentative way. Some years ago Dr. R. Ottolengui had begun the accumulation of material with the view of monographing the species, but press of other work caused the abandonment of this intention. He was good enough to turn all his specimens over to me, and this furnished the greatest variety of species in any one collection.

From the U. S. National Museum I secured their entire North American series through the courtesy of the Curator, Dr. L. O. Howard, and this was rich in examples from Texas and some other portions of the South and Southwest. Some material of Doctor Dyar's collecting in the Kootenai district was interesting in this connection, and was supplemented by a very nice series of examples received from Mr. William J. Cockle through Dr. James Fletcher, who also sent me a number of other examples for examination and study.

Dr. William Barnes was as usual ready with his material which aided materially in completing certain series, and Mr. Otto Buchholz was good enough to let me have a remarkable series of examples taken by him in Yavapai County, Arizona.

In addition, I have had quite a number of smaller collections from other collectors and correspondents, all of which aided in fixing the range of variation and distribution of the species, and to all of these correspondents I owe thanks for their courtesies.

Not the least valuable little lot of specimens was received from the Rev. Dr. C. J. S. Bethune, who was the pioneer American worker in this genus and whose paper in the Canadian Journal was a real help to me.

Finally, I owe thanks to Dr. H. G. Dyar for courtesies extended to me in Washington, where I compared my determinations of some of the southern intruders into our fauna, with the material in the Schaus collection.

One of the interesting features that developed in the study of these species is the remarkable asymmetry in the sexual structures of both males and females of some of the species and the strong characters that were found in the females, which, in the Noctuids, generally lack all structural peculiarities.

In the males the asymmetry is between the harpes of the two sides, which in extreme cases are totally dissimilar, with processes on one side for which there is no counterpart on the other, and which are rarely entirely alike. The sheath of the penis or intromittent organ is always more or less curved or bent, or even hooked, and this structure is directly correlated to the differences found in the female.

In all save a very few, the seventh abdominal segment of the females is more or less modified both above and below. In the descriptions the term anal segment or last segment is sometimes used in referring to this structure; but what is meant is this apparent seventh segment counting from the base, or the penultimate, counting from the terminal points bearing the minute cerci.

Seen from above, the abdomen of the female of most species seems to narrow very abruptly, and at the sides of the base of this segment there are distinct depressions or grooves, often a little discolored or with little tufts of discolorous hair. On the under side this segment is apparently lobed or divided, and when denuded it is found that these lobes are chitinous, that they are usually dissimilar in size and outline, and that somewhere along the right side there is a distinct opening to the *bursa copulatrix* or copulating pouch.

It might be explained here that in describing these structures those of the males are figured and described as if seen in position from the upper side, the head of the insect being nearest the eye. The females, on the other hand, are described and figured as if the specimen were

held bottom up, the tip of the abdomen nearest the eye. The range of variation in these structures is better shown in the figures and in the discussions under individual species.

It has been already indicated that there are two groups, based on the character of the middle femora of the male, and the difference is absolute. There is no case where there is any question of amount. The mass of specialized scales is either definitely present, *Phaocyma vevae*, or definitely absent, series *Zale*.

Among the *Phaocyma* the first series separable on superficial characters comprises three species which constitutes a foreign element in our fauna. They are all large forms, resembling the *lmata* type in a general way, and always distinguishable by having the t. p. line narrow, single, and outwardly denticulate in the interspaces. None others of our species have this sort of t. p. line, while it is a common feature in the subtropical and tropical species, from which these are intruders into our fauna.

In addition, there is a tendency to flatten the thoracic tuftings posteriorly and to expand them laterally, somewhat wing-like. The basal tuft of the abdominal series is much flattened, squarely cut off behind and extends across the entire segment like a little fan. In all of them the femoral tufting of the male is well developed and the mass of specialized scales is enormous.

I have made no attempt to relate these species to the others in the fauna to which they really belong, because I had neither the material nor the literature for the task. I have simply identified them specifically, and have described them so as to be recognizable whenever they are taken in our fauna. They are easily enough distinguished.

*Echausta* Guenée is a somewhat short winged species, with a dark base and dark brown costal patch between t. p. and s. t. lines. It runs to light colors, especially in the male, which is sometimes creamy gray, ranging from that to leaf-brown. On the secondaries the bluish area beyond the extra median lines tends to become almost ocellate in character. It has been taken in Florida only.

*Pictilis* Guenée is a very even species, without contrasts: gray brown in the male, darker more strigillate in the female. The best defined marking is on the secondaries, where the extra-median black lines are close together and tend to form a band, the outer margin of which is dentate toward the costal margin.

*Viridans* is the largest species and most resembles the normal *lmata* type; but in the male it is distinguished from all our other species in having the disc of secondaries beneath, densely clothed with long, silky hair. In the females the wings are a mass of transverse strigillations, more or less intermingled with greenish or bluish scales.

In all these species the underside is yellowish and crossed by numerous transverse lines and strigillations, forming no distinctly localized



shades or bands. So far as genitalic structure is concerned, there is no near agreement between the species in either sex; but in the female the tendency is to symmetry, to a complete plate inferiorly, with the opening to the *bursa copulatrix* posteriorly, or at about the usual point of the anal opening. Correspondingly in the male, the structures are quite similar on the two sides, and the intromittent organ is only a little curved.

The next series of specimens may be strictly typified by *lunata* so far as character of maculation is concerned. The t. a. line is usually geminate, very oblique inwardly, with a slight outward arquation, but without teeth or angles. There are usually two or three, more or less waved or sinuate oblique lines on the disc; the t. p. line is usually distinct, often geminate, never with outward denticulations in the interspaces. On the secondaries the type of maculation is similar to that on the primaries, and particularly the terminal area is practically the same on both wings.

*Lunata*, *salicis*, and *edusina* are distinct from all the others in the series in not having the seventh segment of the female distinctly lobed beneath. In *lunata* the segment is complete but asymmetrical, and the opening to the *bursa* is at the extreme right of the segment, protected by a cercus-like process. There is no modification of the upper part of the segment and there are no lateral depressions. The males have the harpes wildly asymmetrical and the intromittent organ is strongly hooked and twisted. This is the largest of our common species and in the male tends to form two blue terminal lunate areas on primaries and one on secondaries.

*Salicis* is the Pacific coast representative of the eastern *lunata*. It is a little smaller, a little more uniform in ornamentation, and has a number of other slight habitual peculiarities that are not easily described. In genitalic structure it is very like its eastern relative, so that, in fact, it becomes a matter of detail rather than of type of structure.

*Edusina* is a greatly reduced *lunata*, and resembles the *Zale* series in appearance if not in structure. It comes from Texas and parts of Arizona, and is of a dull ashen gray color without brilliant or striking contrasts of any kind. In the male the sexual structures are not unlike those of *lunata* in general type, though differing much in detail; but in the female the seventh segment beneath is broken up into a number of chitinous fragments, which border but do not outline the opening to the copulatory pouch. This is one of the smallest of our species and not often mistaken in collections.

All the rest of the species of this series have the seventh segment of the female distinctly lobed beneath, and laterally at the anterior angles above, the depressions are very distinct.

*Undularis* is very dark smoky, almost black, with velvety black lines and the s. t. line is broken by white scales opposite the cell. There is none other like it, and recognition should be easy. It is one of the species that was referred to *Ypsia* Guenée.

The variety *umbripennis* differs from the type in that the median area below cell is a little paler, more brown in color, and over the line of the s. t. line from the inner margin toward the middle there is a somewhat violaceous shading. The white interruption to the s. t. line tends to become lost in the variety.

*Eryginosa*, which has also been placed as a variety of *undularis*, is really a very good species, recognizable at all times by the bright mossy green powdering on the primaries of both sexes. A real fresh example of this form looks very handsome with its bright green against the nearly black base.

*Insuda* is more gray, especially in the male, but has the same general type of marking as in *undularis*. In the male the terminal area in both wings is paler, and in both sexes the reniform is outwardly marked by white scales. This species occurs in Arizona only and seems to be not uncommon, locally.

*Norda* and *minerea* are much more contrastingly marked, especially in the male, and they are streaked and mottled with yellowish and dark brown. They have essentially the *lanata* type of maculation, but are somewhat smaller, a little slighter, and a great deal more mottled. In the female, in which there might at times be a question between the species, the abdominal structure affords a ready point of distinction.

*Norda* is much darker, mahogany brown in the male, less strigillate or mottled, with the terminal areas often brilliantly bluish. The females are usually strigulated and crossed by undulated transverse lines.

*Minerea* is much more mottled throughout, never so dark nor so brilliantly contrasting, but after all of the same general type, the difference again being more a matter of degree. In the female, too, the colors are not nearly so dark, and the transverse markings are correspondingly more obvious.

*Lunifera* and *lineosa* are two other allied species, smaller and of slighter build than those just preceding and, on the whole, gray rather than brown in color, without contrasting blue areas at any time. There is quite a bit of variation in the wing form here, and while some examples of *lanifera* have the wings typically *Homoptera*-like, others, especially of *lineosa*, seem to have them much broader, with more arched costa and outer margin, like some Geometrids. The change is gradual, however, and there is no other character that seems to distinguish these forms from the rest of the species.

*Lunifera* is the best marked of the species, the t. p. and s. t. lines being black, and the double extra-median line of the secondaries also black. The tendency on both wings is to a black filling between these lines, so as to form a more or less distinct band, and sometimes a black shading extends prominently into the median area.

*Lineosa* has none of this contrasting maculation and the lines are only blackish or brown. Sometimes it becomes a matter of nice judgment as to just where to place a given individual, well marked *lineosa* and flown *lunifera* overlapping in either direction. Structurally the species are alike or nearly so, yet I believe them to be distinct.

*Unilineata* stands by itself in several points. From all the preceding it differs in the greater simplicity of the maculation, lacking the predominating transverse fasciation, and in this it agrees with the immediately following species. The t. a. line, however, is even, without angulation below the costa, and the s. t. and t. p. lines are united into a single line below vein 7. The outer margin also is much more strongly denticulated than in the other species, so that with its rusty grayish brown color we have a form that is recognizable at all times.

The next series of nine species have the wing form somewhat less triangular than in the typical *lunata* type. The primaries have the costa more arched at base, and the apex is rectangular rather than pointed. The transverse fasciation is much less marked, and the extremely oblique character of the markings is modified into a tendency to become almost upright. The t. a. line is single, forms an acute outward tooth on the subcosta, is strongly drawn back on that vein, and then is almost upright in general course to the inner margin. The t. p. line is outwardly bent over the cell, more or less indented or drawn in opposite the reniform so as to make an upright W, and is then incurved again on its course to the inner margin.

The largest of these species is *obliqua*, in which none of the markings are well defined or strongly contrasted, and there is a uniform bluish or violet powdering over the pale brown ground. The reniform is not or only a little darker, and altogether this is a very handsome species without any very positively marked characters.

*Metata* is a smaller, better marked species, which lacks the hoary appearance and has the reniform black or at least dusky.

In *eurema* the t. a. line is black, as it is in the two next following species as well; the color is a darker, very smooth even brown; the median shade is scarcely marked and the reniform is black and contrasting.

*Helata* is a somewhat rougher, better marked species, the median shade more defined, the t. p. and s. t. lines much better marked, and the s. t. space darker than the rest of the wing.

*Squamularis* is still better defined, has the median shade as a prominent feature, and the area between it and the basal line gray, so as to form a fairly obvious smooth fascia.

*Benesignata* has this fascia very much intensified. The entire insect is more powdery, the median shade is really a well developed upright band, and the pale space between it and t. a. line is light gray or even whitish, forming a very conspicuous species.

*Largera* equals *obliqua* in size and somewhat in appearance, but is powdery throughout, the colors are ash gray and diffuse, and while the median shade is conspicuous, none of the markings are black or contrasting.

*Duplicata* is a rough, powdery species without strong contrasts of any kind. The lines and shades are all traceable and all well enough marked; but they are all obscured by the dark powdering and must be closely scanned to be made out. In the male there is an area of white scales above the hind angle of primaries that relieves matters somewhat, at the expense of even less definition for the rest of the wing.

*Bethunei* is smaller than *duplicata* and even more powdery and obscure, without the white shading in the male. But there is an obvious shade of red in the ground color, which is marked in the area over the reniform.

In the section *Zale* there are only a few species, not so closely allied as a whole, and yet not more divergent than those of the *Phwozyma* series.

Two species, *cingulifera* and *woodii*, stand out from the others by their conspicuous transverse strigillation, and yet in other respects they are not at all alike.

*Cingulifera* has the thorax unusually short, the tuftings uplifted posteriorly, and whitish marked so as to be quite conspicuous, not unlike the same feature in *horrida*. The primaries have the costa unusually arched toward base, making them less than usually triangular. The basal area is conspicuously darker and the reniform is pale, marked with brown lines.

*Colorada* is more normal as to wing form and thoracic tufting, and has the reniform dusky. The basal area is also dark, but in this species the s. t. line is very distinctly marked, outwardly angulated at the middle, and the terminal area is whitish marked and well defined.

*Rubiata* is a yellowish brown species with the basal space darker, the t. p. and s. t. lines well defined, and together forming a well-marked outward angulation at the middle. From this there may be a brown shading into the median space, but the terminal area is usually left as the palest part of the wings.

*Rubi* is the same thing in gray; a little softer and more evenly marked throughout. It is not improbable that the differences as they

appear now from limited material may become evanescent with better collections at hand, but I am quite as ready to expect the contrary.

*Yarapai* is the same thing in blackish; but this is unquestionably a good species. It is very similar to some forms of *edusina* in maculation, but the sexual characters are quite different. The female also differs from those of the two preceding forms which have the normally lobed seventh abdominal segment by having the segment broken up into irregular plates or pieces around the opening of the *bursa copulatrix*.

*Calycanthata* and *horrida* agree in having the s. t. and t. p. lines coincident below vein 7 and in appearance the s. t. line only is represented. In both, also, the terminal area is paler; but while that is a normal matter in both sexes of *horrida*, it is exceptional and occurs only in the male of *calycanthata*.

*Calycanthata* is on the whole almost the smallest species in the genus and is characterized in well-marked examples by white dorsal abdominal tufts.

*Horrida* has the thoracic tufts elevated, discolorous, and prominent, while the abdominal tuftings are unequal in size and quite conspicuous.

In tabular form the arrangement is as follows:

- |  |                   |
|--|-------------------|
| 1. Middle femora of male with a mass of specialized scales.....  |                   |
| .....subgenus <i>Pharocyma</i> , 2   |                   |
| Middle femora of male without such a mass of specialized scales.....   |                   |
| .....subgenus <i>Zala</i> , 21   |                   |
| 2. T. a. line usually geminate, inwardly oblique with a slight outward convexity; even, not angulated or dentate.....  | 3                 |
| T. a. line usually single, with an acute outward tooth on subcosta, strongly drawn in on that vein; more or less angulated or bent below.....  | 14                |
| 3. T. p. line single, slender, outwardly dentate in all the interspaces....  | 4                 |
| T. p. line geminate, irregular, but never outwardly denticulate in the interspaces.....  | 6                 |
| 4. Base and a triangular costal area between t. p. and s. t. lines of primaries darker brown; secondaries with a leaden gray or bluish area beyond the curved extra-median band; more conspicuous in the male..... | <i>exhausta</i> . |
| Basal and costal areas concolorous or nearly so.....   | 5                 |
| 5. Gray, the lines very fine, not well marked; no contrasts in shading... <i>fictilis</i> .  |                   |
| Wood or leather brown, lines well marked, primaries in the males with blue linear shadings beyond s. t. line, in females with intermingled blue and greenish scales.....   | <i>viridans</i> . |
| 6. Penultimate segment of the female abdomen beneath, complete, though asymmetrical.....   | 7                 |
| Penultimate segment of the female abdomen beneath, broken into irregular pieces.....   | 8                 |
| Penultimate segment of the female abdomen beneath, divided into two lobes.....   | 9                 |
| 7. Larger, darker, more conspicuously marked; occurs east of the coast range.....  | <i>lunata</i> .   |

- Smaller, lighter brown, less conspicuously marked; occurs on the Pacific coast ----- *salicis*.
8. Smoky brown, powdery, s. t. line well defined, no dark shading from the outward angulation to the outer margin; reniform marked with white scales; no black line on collar ----- *edusina*.
9. T. p. and s. t. lines form no prominent outward tooth at middle; color uniform, terminal space not paler in either sex, reniform concolorous, with a darker outline ----- 10
- T. p. and s. t. lines form a more or less obviously prominent outward tooth above the middle; coloring more or less mottled; in the male the terminal area more or less obviously paler and contrasting ---- 11
- T. p. and s. t. lines united below vein 7 into a single yellowish brown line ----- 13
10. Very dark brown, almost black, lines velvety black; a pale or white spot interrupting s. t. line opposite the cell ----- *undularis*.
- The median space below costal area is lighter brown, and a lilac gray shading extends over the t. p. and s. t. lines from the inner margin above the middle of the wing; ----- *ambripennis*.
- Blackish brown with mossy green powderings, forming a more or less obvious band beyond the t. a. line ----- *aruginosa*.
11. In the female very evenly dark brown with darker transverse lines, a broad continuous blackish band beyond the s. t. line; in the male the terminal area gray, not blue; in both sexes the reniform white marked ----- *insuda*.
- Mottled in both sexes; no obvious dark band beyond s. t. line; male with terminal area tending to blue; reniform dark, not outlined -- 12
12. Dark red or mahogany brown, not mottled nor contrasting except in the terminal area in males, which is often brilliantly bluish or violet ----- *norda*.
- Mottled yellow to blackish brown, usually contrastingly marked especially in the male, the terminal area in the latter often sordid and rarely clear in tint ----- *mincrea*.
- Pale leather brown; s. t. and t. p. lines distinct, black, intervening space often black or blackish; a dusky shade often extends from angulation of s. t. line to the outer margin ----- *lunifera*.
- Gray or grayish brown, none of the lines contrasting, and no dusky shade from angulation of s. t. line to outer margin ----- *lincosa*.
13. Color rusty grayish brown, powdery, outer margin very strongly dentate ----- *unilincata*.
14. Vestiture of wings smooth, not rough, powdery, nor velvety ----- 15
- Vestiture of wings roughened, powdered so as to obscure the maculation or give a velvety appearance ----- 18
15. Basal and t. a. lines wanting or at least not well defined nor black --- 16
- Basal and t. a. lines well defined, black ----- 17
16. Larger; a uniform bluish or violet powdering over pale brown; hoary; no well-defined contrasts; reniform not or only a little darker ----- *obliqua*.
- Smaller, better marked, not hoary in appearance nor powdery; reniform dusky, sometimes black ----- *metata*.
17. Very smooth and even, median shade very little marked; reniform contrasting, black ----- *carcma*.
- Somewhat more mottled; s. t. and t. p. lines better marked, the s. t. space darker; median shade well defined ----- *hctata*.
- Less mottled, all the lines and spaces well defined; a gray shading between t. a. and median shade ----- *squamularis*.

18. All the maculation bright, median shade band distinct; space between it and t. a. line contrastingly gray..... *beneisignata*,  
Space between t. a. and median shade not gray, contrasting..... 19
19. Median shade conspicuous, diffuse; color ash gray; none of the lines black or contrasting..... *largera*,  
Median shade obscure or not well defined, colors dull or smoky, lines usually distinct and black..... 20
20. Larger, darker, better marked, no conspicuous reddish shade; in the male the terminal space is powdered with white and there is a whitish blotch at anal angle..... *duplicata*,  
Smaller, more obscure; an obvious reddish shade through the basal color; no white in terminal area of male primaries..... *bethunei*.
21. Primaries with numerous black, transverse strigillations..... 22  
Primaries not obviously strigillate..... 23
22. Patagia divergent, whitish discolorous; reniform whitish with brown lines..... *cingulifera*,  
Patagia normal, not discolorous; reniform dusky, not outlined..... *colorado*.
23. T. p. and s. t. lines distinct, forming an obvious outward angle at middle..... 24  
T. p. and s. t. lines coincident below vein 7..... 25
24. Some shade of wood or leather brown..... *rubiata*,  
Some shade of ash gray..... *rubi*,  
Almost black, with black markings..... *garapai*.
25. Red or leather brown; thoracic tuftings normal; terminal area tending to become pale or discolored in the male only..... *calycanthata*,  
Deep chocolate brown; thoracic tufts discolored, uplifted, conspicuous; terminal area of primaries discolorous pale in both sexes..... *horrida*.

## PHÆOCYMA EXHAUSTA (Guenée).

1852. *Homoptera exhausta* GUENÉE, Spec. Gen., Noct., III, p. 14.1857. *Homoptera exhausta* WALKER, C. B. Mus., Het., XIII, p. 1053.

Ranges in ground from creamy or blue gray to yellow brown. In the brown specimens the head, thorax, and abdomen are concolorous; in the pale specimens the head is usually gray, the collar and anterior portion of thorax brown; rest of thorax and abdomen gray. Collar always with a black transverse line. Primaries with basal area, a triangular costal area between t. p. and s. t. lines and often a diffuse area at middle of costa darker brown and in the gray specimens contrasting. T. a. line marked chiefly by the difference in tint between basal and median space, very oblique, only a little outcurved. Ordinary spots vaguely indicated or altogether wanting. Orbicular small, brown, punctiform; reniform upright, narrow, a little constricted, concolorous and only definable when there is a brown shading at middle of costal area. T. p. line black, slender, outwardly denticulate in all the interspaces below the cell. S. t. line brown, tending to become broken and partially lost, inwardly convex to the middle where it extends in a brown shade to the outer margin and thence again, not so much incurved toward the inner margin. Secondaries with a double extra-median line, of which the outer is the more con-

spicuous. Basally there are obscure alternate lighter and darker shade lines; exteriorly there is a bluish band which in the male tends to form an oval spot or mark. Beneath yellowish brown crossed by brown strigillations which tend to become massed into a darker sub-marginal shading.

Expands, 1.60–1.80 inches=40–45 mm.

*Habitat*.—Florida: Chokaloskee in July.

Four males and two females are before me, all save one male from Doctor Ottolengui's collection. There are others from various Central and South American points in the Schaus collection, U. S. National Museum, and there is no doubt that this is distinctly a subtropical and tropical form. It is probable that all the specimens come from one source originally, and that it is from one of those localities that receives southern visitors or has really a subtropical element in its fauna. Guenée describes it from Brazil, with the addition of a doubtful specimen from "Am. Sept." Walker records the British Museum example from Santo Domingo.

The females are darker than the males, less conspicuously marked and obviously strigillate. The males tend to the creamy gray type and to a form which has the blue area in secondaries almost ocellate in type.

The spinulation of the middle tibia is well marked. The sexual tufting in the male is very conspicuous and the mass of specialized scales relatively enormous.

The sexual structures are very characteristic in both sexes. In the male the harpes are not strikingly dissimilar; but the supra-anal plate is prolonged posteriorly into a flat plate, from the lower side of which comes the slender, corneous uncus. In the female there are two small, slightly asymmetrical plates on the posterior margin of the terminal segment, and at the upper angle of the junction of these two plates is the opening to the copulatory pouch.

#### PHÆOCYMA FICTILIS (Guenée).

1852. *Homoptera fictilis* GUENÉE, Spec. Gen., Noct., III, p. 10.

1852. *Homoptera quadripensis* GUENÉE, Spec. Gen., Noct., III, p. 10.

1857. *Homoptera fictilis* WALKER, C. B. Mus., Het., XIII, p. 1063.

1857. *Homoptera quadripensis* WALKER, C. B. Mus., Het., XIII, p. 1063.

A rather light gray brown in the male, deeper and more reddish in tinge in the female. Collar with a black median line. Thoracic tufts flattened and explanate or somewhat wing-like in character. Basal abdominal tufts also flattened and very broad; other dorsal tuftings small. Primaries very even in color, without darker areas or strong contrasts. Basal line indicated by geminate costal spots in some specimens. T. a. line geminate, obscure, very oblique. Orbicular small, punctiform, often lost. Reniform more or less com-



pletely outlined in yellowish scales. T. p. line very slender, black, single, outwardly denticulate in the interspaces, a little emphasized and thickened just below vein 2. S. t. line hardly traceable as such; a leaden gray or brown band from inner margin near anal angle with a slight incurve to middle of outer margin. A series of blackish interspaceal terminal marks. Secondaries with disc crossed by obscure lighter and darker shade lines. A pair of narrow black extra median lines of which the inner is even or nearly so and the outer forms outward dents in the interspaces between 5 and 6 and 6 and 7. In the male there is a blackish spot at anal angle from which a bluish shading extends toward the apical angle; in the female a leaden gray or brown band extends from apex to anal angle below the black lines. A series of interspaceal dark or black spots. Beneath yellowish, crossed by numerous brown strigillations.

Expands, 1.80-2.12 inches=45-53 mm.

*Habitat*.—Brownsville, Texas, in June; Marco, Florida, in July; Egmont, Florida, April 29.

A series of 10 males and 2 females from the above localities; others are in the Schaus collection, U. S. National Museum, from various South and Central American points. The species is very characteristic and Guenée's descriptions apply perfectly. The specimens in the Schaus collection were directly compared with the types by Mr. Schaus, and the determinations correspond with those made by me from the descriptions. There is enough difference between the sexes to justify a separation into species, with limited material. The males are very uniform and very characteristic in color and in the extramedian line of the secondaries. The females are much darker, more like *lunata* in color, much more strigillate and with the peculiarities of extra-median line of secondaries less marked. The only strong point that the two sexes have in common is the yellowish scale edging to the reniform. The denticulate t. p. line, of course, serves to distinguish it from any form of *lunata* which it might otherwise resemble.

The femoral tufting of the male is large and the mass of specialized scales is huge, larger in proportion and actually, than in any other of our species.

The genital structure of the male is almost symmetrical, the lateral pieces moderate in size and simple in form. The uncus, however, is unusually long, stout, and heavy, transversely somewhat flattened and with a membranous secondary structure within and parallel to it.

The female has the anal plate entire and the opening to the copulatory pouch is from the median line at the inferior margin; symmetrical in all respects.

## PHÆOCYMA VIRIDANS (Guenée).

1852. *Homoptera viridans* GUENÉE, Spec. Gen., Noct., III, p. 13.

Yellow brown, ranging to smoky in the female. Primaries, in the male, the basal area a little darker, outwardly limited by the very oblique, geminate, brown t. a. line. There is a narrow shade band of blue in which the brown, punctiform orbicular is visible; there are two incomplete transverse dusky lines and the reniform is obscurely indicated by a few pale scales and a slightly darker shading. T. p. line slender, black, single, outwardly denticulate in the interspaces. S. t. line broken, obscure, brown, on the whole almost parallel with the outer margin, emphasized on the costa by an apical smoky shade and below the middle by a blackish brown fascia from the middle of outer margin, curved to the inner margin just within anal angle. There is a yellowish, broken terminal line, preceded by dark interspaceal blackish marks which are most conspicuous just above the anal angle. Secondaries with obscure discal lines to the double extra-median black lines which tend to form a band, outwardly margined by yellow and followed by a shading of blue. In the female the primaries are so crossed by brown strigillations, more or less mixed with mossy green scales and shades, that no other maculation is recognizable except the characteristic t. p. line, which is brown rather than black and not conspicuous. The marking of the outer portion of the wing is barely indicated. On the secondaries the transverse striations are equally abundant, but the double outer black line is distinct, and there is more or less green or blue in the dusky shading beyond it. Beneath, both sexes are yellowish with numerous transverse brown striations.

Expands, 2-2.20 inches = 50-55 mm.

*Habitat*.—Miami and Marco, Florida.

I have only two males and three females, none of them perfect and all of them with thoracic vestiture defective. I have cited only the original description of the species because I am not at all sure that the species has been correctly referred to later and still less certain that some other names should not be referred here. The species that I have agrees fairly well with Guenée's characterization and is the same as that in the Schaus collection, U. S. National Museum, marked as compared with the type in Paris.

The species differs from all others of those in our fauna by having on the underside of the male secondaries a large area of fine long hair which covers a large part of the disc, and on the cell of the primaries a less conspicuous clothing of similar hair. The tuftings of the middle femora of male are also large and similar to that in *fictilis*.

The male genitalia are symmetrical or nearly so. The harpes are moderate in size, but stout and with obliquely spatulate tips; the

uncus is similar to that in *fictilis* and equally stout, though somewhat different in form.

The female genitalia are also symmetrical. The ventral plate of the terminal segment is complete and the opening to the copulatory pouch is from the median line at its inferior margin.

PHÆOCYMA LUNATA (Drury).

1770. *Noctua lunata* DRURY, Illustr., I, p. 40, pl. xx, fig. 3.  
 1773. *Noctua edusa* DRURY, Illustr., II, pl. xxiv, fig. 4.  
 1829. *Homoptera putrescens* GUERIN, Icon. Règne Anim., pl. lxxxix.  
 1830. *Erabus lunata* WESTWOOD, ed. DRURY, I, p. 37, pl. xx, fig. 3.  
 1830. *Erabus edusa* WESTWOOD, ed. DRURY, II, p. 46, pl. xxiv, fig. 4.  
 1852. *Homoptera lunata* GUENÉE, Spec. Gen., Noct., III, p. 12.  
 1852. *Homoptera edusa* GUENÉE, Spec. Gen., Noct., III, p. 11.  
 1852. *Homoptera putrescens* (= *edusa*) GUENÉE, Spec. Gen., Noct., III, p. 14, larva.  
 1857. *Homoptera lunata* WALKER, C. B. Mus., Het., XIII, p. 1053.  
 1857. *Homoptera edusa* WALKER, C. B. Mus., Het., XIII, p. 1054.  
 1857. *Homoptera involuta* WALKER, C. B. Mus., Het., XIII, p. 1055.  
 1864. *Homoptera saundersii* BETHUNE, Proc. Ent. Soc. Phil., IV, p. 215.  
 1865. *Homoptera lunata* BETHUNE, Can. Journal, X, p. 252.  
 1865. *Homoptera edusa* BETHUNE, Canadian Journal, X, p. 9.  
 1865. *Homoptera involuta* BETHUNE, Can. Journal, X, p. 253.  
 1865. *Homoptera saundersii* BETHUNE, Can. Journal, X, p. 257.  
 1877. *Homoptera lunata* (= *edusa*) BEAN, Can. Ent., IX, pp. 174, 228.  
 1877. *Homoptera edusa* BEAN, Can. Ent., IX, pp. 174, 228.  
 1877. *Homoptera saundersii* (= *lunata*) BEAN, Can. Ent., IX, p. 174.  
 1878. *Homoptera edusa* (= *lunata*) LINTNER, Ent. Cont., IV, p. 108.  
 1878. *Homoptera saundersii* (? = *lunata*) LINTNER, Ent. Cont., IV, p. 109.  
 1882. *Homoptera lunata* FRENCH, Can. Ent., XIV, p. 131, life history.  
 1893. *Homoptera involuta* (= *edusa*) SMITH, Bull. 44, U. S. Nat. Mus., p. 369.  
 1901. *Homoptera edusa* BEUTENMÜLLER, Journl. N. Y. Ent. Soc., IX, p. 192, larva on willow.  
 1903. *Homoptera lunata* HOLLAND, Moth Book, p. 278, pl. xxxvii, fig. 17.  
 1903. *Homoptera edusa* HOLLAND, Moth Book, p. 278, pl. xxxvii, fig. 16.

Ground color luteous to chocolate brown. Head concolorous. Collar with a black median line, and usually in the female a broad dusky band below tip. Thorax crossed by broad dusky bands; one of them, behind the middle, posteriorly edged with gray, so that in some cases it forms quite a conspicuous whitish fascia. Abdomen with the segments tending to become finely black ringed; the dorsal tufts very small and often wanting. Primaries varying greatly in tint and in distinctness of maculation. Basal space usually a little darker and crossed by brown shade lines. Basal line geminate, rarely distinct, usually indicated. T. a. line geminate, sometimes fasciate, very markedly oblique, reaching the inner margin within basal fourth while starting at basal third of costa. T. p. line geminate, usually only the inner line distinct, black or brown, outwardly oblique to vein 4, roundedly exerted in the interspaces, sometimes

forming obtuse teeth; very oblique below vein 4, more or less irregular but never forming long or sharp outward dents. The median space may or may not be crossed by 2 or 3 very oblique shade lines at or before the middle, and there may or may not be a darker brown shade over the costal region. In the male there is more or less blue powdering just beyond the t. a. line. Orbicular a small brown dot which may or may not be obvious. Reniform oblique, lunate, dusky, not outlined, outwardly marked by a few white scales. S. t. line very incomplete, usually distinct only below vein 4, whence it makes a slight incurve, is accompanied by a pale outer line and followed, in the female, by a conspicuous blackish brown band; in the male this band may be traversed by a line of lilac blue scales and sometimes the entire lower portion of the terminal area is blue filled. Above vein 4 the s. t. line is very obscurely traceable to vein 7, above which the s. t. space is dark filled and forms an edging to the line. When this dark filling is not well marked the line itself becomes obscure or lost. There is usually a dusky apical spot and, in the male, there may be an edging of blue scales outside of the line, or the terminal area may be washed with blue, forming in the best marked cases two blue lunate marks, separated in the middle of the wing by a brown shade which extends to the outer margin. There is a more or less obvious brown terminal line, and the pale fringes have a dusky interline. Secondaries a little paler at base, followed by a series of alternate pale and dusky discal shade lines. A very slender blackish line continues the s. t. line across the secondaries, and beyond that a better marked line, which is more or less outcurved in the interspaces, extends with a slight incurve approximately from apex to anal angle. Beyond this, in the female, there is a blackish-brown shade band which, in the male, becomes blue edged, or the entire terminal area may be washed with blue. Beneath more yellowish, strigillate, and powdered, with a large dark discal lunule, a lunulate extra-median line, and an obscure, diffuse outer shade on all wings.

Expands, 1.72-2.20 inches=43-55 mm.

*Habitat*.—Throughout the United States, from Canada to Florida, west to the Rocky Mountains, into Texas and Arizona, at dates ranging from March to December.

This is perhaps the most common of our species and the most widely distributed. It is also the largest and the principal late autumn species. None of the specimens in my hands are spring examples except a few from Texas, which may be hibernates, and by far the greater number are in September and later. *Mincrea* is typically a spring species and few examples hold on into July. Where these two occur together, *mincrea* has usually disappeared before *lunata* makes its appearance. The two may resemble each other very closely, especially in the female, and I have found them mixed in

collections. *Mincerca* is usually much more strigillate, however, and has a rather well-defined small lunate reniform, while *lunata* has the reniform much longer, narrower, and usually indefinite superiorly. There is not, of course, any really close relation between the two; but they do occasionally resemble each other so much as to cause trouble.

The range of variation has been largely indicated in the description. In general there are two types, those with the median space distinctly paler and those with the wings as a whole concolorous. This range occurs in both sexes, and it is quite easy to arrange two very well marked series with limited material. In the males there are also two forms, those that have the terminal area washed with blue, forming 2 lunate areas on primaries and one on secondaries, and those in which there is only an edging of scales or a blue line beyond the s. t. line. Aside from that almost any one feature may vary in prominence, so that with fifty examples at hand it may be difficult to find two of them exactly alike.

The spinulation of the median tibiae is obvious in both sexes, and in a fair proportion of cases there are spines between the two pairs of spurs of the posterior tibiae. This feature has been already discussed sufficiently to bring out the range of variation. In the male the sexual tufting of the median femora is distinct and the mass of specialized scales is large and conspicuous.

The male genitalia are grotesquely asymmetrical. The left harpe is single, broad at base but rapidly narrowed to a slender flattened strip, which becomes roughened, a little enlarged, and irregular at tip. The right harpe is double; that is, the base is broad and single, but it divides almost at once into a slender upper and lower process, of which the upper is first bowed up, then bent down and furnished with a little prong not far from tip. The lower process follows the reverse course and bends upward, is also forked toward tip, but the forks are much longer and they almost engage the fork of the upper process. There is considerable variation in the specimens in this forking; but in essentials the structure is identical in all the examples observed. The corneous penis sheath is very sharply bent and really crook-like in outline seen from the side.

The female is in its way as characteristic as the male and has the terminal segment complete, not divided into lobes. At the extreme right of the segment is a corneous ring which forms the opening to the copulatory pouch, and this is furnished with a single, jointed, cercus-like appendage. A reference to the figures will be necessary to really understand the structure.

The synonymy given at the head of this species is probably not complete, but it is as complete as I feel certain about it. Under the name *lunata* there are at least two and probably three species from

South and Central America, as indicated by the specimens so labeled in the Schaus collection. Cramer's figure (Plate CCCVIII, fig. *c*), heretofore cited to *lanata*, certainly does not represent that species at all. Whether *putrescens* Guerin really belongs here I consider distinctly questionable. Guenée seems to consider them the same on larval characters, and I am simply following his citation without further personal knowledge.

Walker refers to *viridans* Guenée, and indicates its possible identity with *lanata* Cramer. *Viridans* Walker, however, seems to be really a form of *lanata* Drury, and not the species in mind by Guenée.

*Edusa* Drury is merely the male of *lanata*, the sexual differences being regarded as of specific rank. It is the form in which the terminal area is filled with blue powderings, making two lunate areas on primaries and one on secondaries.

The form named *saundersii* by Doctor Bethune is that in which the median area becomes paler, more yellowish, and sometimes contrasting. Inasmuch as this form occurs in both sexes, limited material would easily seem to justify the separation. In the collection of the American Entomological Society in Philadelphia there is a specimen labeled by Mr. Grote as having been compared with type, and that bears out the characters given in the description. The actual type is no longer in existence.

The *incoluta* of Walker represents that form of *lanata* in which the exterior lines are unusually well marked, and the darker areas are along the costal region, really very much like *saundersii*. I marked it in my notes in 1892 as being the *edusa* form with the blue out. The possibility of error on my part is not excluded, however, for the description applies more nearly to some forms of *minerea* which I was not in position to discriminate in all cases in 1892. At all events the name can not be restored for any existing species even if the present reference is erroneous.

How many, if any, of the names applied to West Indian and South American forms must be cited here I am in no position to determine at present.

PHÆOCYMA SALICIS (Behr).

1870. *Homoptera salicis* BEHR, TRANS. AM. ENT. SOC., III, p. 28.

1870. *Homoptera rosa* BEHR, TRANS. AM. ENT. SOC., III, p. 28.

In the essential characters of maculation this is like *lanata*, differing from that species in the somewhat smaller size and the less contrasting colors and markings. Line for line the ornamentation is the same in the two species, but the California specimens have a smoother appearance throughout, the lines are not so well marked and what contrasts there are in the color and maculation are very much less conspicuous.

Expands, 1.60-2.00 inches=40-50 mm.

*Habitat.*—California: Sonoma County, Los Angeles County, in November; San Louis Obispo in February; San Francisco, Behr.

I have a specimen of *salicis* given me by Doctor Behr himself, and I have seen the type of his *rosa*. My impression is that he described the sexes of the one species, but that is not certain: at all events there are no two closely related forms on the Pacific coast so far as the material in my hands indicates. It is not even absolutely certain that we have a species distinct from the eastern *lanata*, although that I believe. Superficially, if the Californian examples were mixed with a lot of eastern material they might attract attention as being less well defined than the ordinary run of examples, but would not be suspected of representing a distinct species. Structurally, the differences are hardly greater. In the male the lateral pieces are identical in type and the differences in detail are not greater than I might consider within specific range. The uncus, however, is quite markedly different and is drawn out to a slender point unlike any *lanata* that I have seen. In the female the differences are somewhat greater and can be best appreciated by a comparison of the figures.

It may be that when both eastern and western forms have been fully compared in all their stages, the question of their specific identity can be more easily determined.

PHÆOCYMA EDUSINA (Harvey).

1875. *Homoptera edusina* HARVEY, Bull. Buff. Soc. Nat. Sci., III, p. 14.

1875. *Homoptera atritincta* HARVEY, Bull. Buff. Soc. Nat. Sci., III, p. 14.

1878. *Homoptera atritincta* (=female of *edusina*) GROE, Bull. U. S. Geol. Surv., IV, p. 185.

1893. *Homoptera atritincta* (= *edusina*) SMITH, Bull. 44, U. S. Nat. Mus., p. 370.

Ground color dull smoky brown. Head concolorous, sometimes with a dark median line. Collar darker at base and below tip, leaving a paler brown central line, often gray tipped; no distinct black line in any specimens. Thorax with alternate darker and paler lines more or less distinct, sometimes gray. Abdominal tufting small. Primaries with all the lines usually well defined. Basal space usually a little darker. Basal line brown or blackish, geminate, usually well defined. T. a. line geminate, the component lines quite widely separated, the inner less obvious, outer black or blackish, irregular, a little outcurved but on the whole inwardly oblique. Just beyond this line is usually a little the palest area in the wing, in the males usually and in the females often powdered with gray. Beyond this the median space is crossed by three more or less obvious undulated transverse lines, of which two are nearly upright, while the outer is curved around the outside of the reniform. T. p. line narrow, thread-like, black or brown, irregular, broadly and rather squarely exerted over cell, just a little indented opposite reniform, oblique rather than in-

curved from cell to inner margin. Orbicular a black or brown dot, sometimes very distinct, sometimes not traceable. Reniform lunate or kidney shaped, often defined inwardly by black scales, outwardly more or less marked by white scales. S. t. line black, and usually the most distinct feature in the wing, making an incurve from each margin to an acute outward tooth at middle. The line may be a little diffuse inwardly, and the entire s. t. space may be a little darker. Terminal area usually a little lighter than the rest of the wing and sometimes conspicuously gray powdered; most obviously and usually in the male. There is a brown terminal line following the indentations of the margin, a little thickened at the indentations, where it is outwardly emphasized by white lunules. Secondaries paler than the primaries toward base, and disk crossed by three darker, undulated lines. Outwardly there is a distinct black line continuing the s. t. line of primaries, and within that there is a less defined, usually brown line continuing the t. p. line. Both these lines are a little rivulous and the space between them is often darker. Outwardly the outer line is edged with pale scales or a pale line, and the terminal area is usually continuous with and similar in character to the terminal area of the primaries, with a similar outer line. Beneath smoky, sometimes varying to reddish or yellowish, more or less powdery, with more or less obvious discal spots and variably obvious dusky lines, of which there are usually one on primaries and two on secondaries; sometimes none on either.

Expands, 1.20-1.60 inches = 30-40 mm.

*Habitat*.—Texas, February to August.

In the series before me, Bastrop County, Bennett County, Brazos County, Shovel Mountain, San Antonio, and Kerrville are specifically represented and in the dates every month between the limits given is also represented. In addition I have an example labeled "N. Y." and another labeled "Ky.," which I consider doubtful but worth mentioning.

The species seems to be common and distinctly variable. As between the sexes the males are usually smaller, more contrastingly marked, and have a considerable admixture of gray scales in the terminal area. In the females the color is on the whole darker and more uniform. Typical *edusia* are all males; typical *atrilinea* are all females; yet there are light and dark forms of both sexes. A little series of specimens from San Antonio in the Barnes collection are almost as dark as *garapai* in both sexes and might, at first blush, be easily confused with that species. The easiest superficial character to separate them is in the clearly defined black line on the collar of *garapai*; in *edusia* there may be some black scales at base of collar, but there is a pale shade above it and it is not a median line. Specimens of both forms, labeled by Mr. Grote, are in the U. S. National Museum collection, and there are also specimens from Belfrage,



agreeing in collection number with those described by Doctor Harvey, so that there can be no question as to the Harvey species.

The spinulation of the middle tibiae in both sexes is scant: but the spinules are long and are as a rule readily made out through the vestiture. The femoral tufting in the male is distinct and the mass of specialized scales is large and conspicuous.

The genital structure of the male is grotesquely asymmetrical. The left side has, beside the broader lateral piece, an accessory structure which is long, slender, and extends beyond the tip of the broader portion. The uncus is unusually long and is transversely compressed or flattened into a blade, utterly unlike the usual forms.

In the female the upper surface of the segment is not modified, but on the under surface it is curiously broken up into small chitinous plates, surrounding the large opening to the copulatory pouch, which is on the lower part of the segment. There is no appearance of a division into distinct lobes or plates.

PHÆOCYMA UNDULARIS (Drury).

1770. *Noctua undularis* DRURY, Illustr., I, pl. ix, fig. 4.

1816. *Anthraxia undularis* HÜBNER, Verzeichniss, p. 275.

1852. *Ypsia undularis* GUENÉE, Spec. Gen., Noct., III, p. 18.

1857. *Ypsia undularis* WALKER, C. B. Mus., Het., XIII, p. 1074.

1864. *Homoptera nigricans* BETHUNE, Proc. Ent. Soc. Phil., IV, p. 214.

1865. *Homoptera nigricans* BETHUNE, Canadian Journal, X, p. 252.

1877. *Homoptera umbripennis* GROTE, Can. Ent., VIII, p. 109.

1893. *Homoptera umbripennis* (var. of *undularis*) SMITH, Bull. No. 44, U. S. Nat. Mus., p. 373.

Ground color ranging from very dark smoky brown to sooty black, often somewhat shining. Head and thorax without obvious markings; dorsal tuftings of abdomen small. Primaries very uniform in color. Basal line geminate, dead black or velvety black so as to be visible on the dark ground. T. a. line geminate, the outer portion of line usually velvety black, the inner less obvious; as a whole rather evenly oblique from costa to inner margin. The median area is crossed by three broad, somewhat diffuse dead black lines. Orbicular sometimes marked as an intense black spot. Reniform narrow, oblique, laterally defined by intense black scales. T. p. line black, sometimes geminate, the lines very slender, outcurved over the cell, a little drawn in opposite reniform and then almost evenly oblique to inner margin, not much beyond its middle. S. t. line better marked, broader, more intensely black, interrupted by a white or pale spot opposite cell, moderately outcurved just below this spot, else very even in course. A darker terminal line, sometimes emphasized by venular white dots. Secondaries basally a little more brown in most specimens, the disk crossed by three, somewhat diffuse, slightly undulating lines. A conspicuous intensely black line continues the s. t. line of primaries across the secondaries to the anal angle. Beneath,

somewhat rusty smoky brown, with darker discal spots and a variable number of transverse shade lines.

Expands, 1.52-1.88 inches=38-47 mm.

*Habitat*.—Canada to Florida, west to Colorado.

In the large series of specimens before me, only the range from Canada to the District of Columbia is represented; dates ranging from May to early July.

There is no appreciable difference between the sexes and very little variation of any kind in the typical form. The very dark blackish brown base varies a little so that the dead black undulating shade lines may be more or less obvious, and in the same way the velvety black transverse lines are variably relieved. The most conspicuous feature of the primaries is the white blotch interrupting the s. t. line between veins 5 and 6; it may be reduced to only a few white scales, or it may be a conspicuous spot; but it is always present and is absolutely characteristic.

The variety *umbripennis* has the area below the cell from t. a. to s. t. lines of a rich brown shade, and along the course of the t. p. a powdering or even a broad shade of lilac gray scales that is very conspicuous. The white spot in the s. t. line is wanting in all examples. The secondaries have the basal area brown like the median area of primaries, and the lilac shading over the outer lines is continuous with that of the primaries. There is never any question as to which is *undularis* and which is *umbripennis*, and I was strongly inclined, at first, to consider them specifically distinct. But there is absolutely no material difference in genital structure so far as I can make out, and this type of variation is quite usual in the genus, although not equally well marked in any other species.

The spinulation of the middle tibia is scant and inconspicuous; in the male almost invisible in the heavy vestiture. The middle femora of the male are conspicuously tufted and hold a very large mass of specialized scales.

The male genitalia are very nearly symmetrical so far as the harpes are concerned, both sides being long, very much curved, drawn to a point, but with a little, spatulate enlargement before the tip. The supra-anal plate is unusually narrow, and the penis sheath is unusually bent and angled.

In the female the depressions of the upper side of anal segment are well defined; on the under side the lobes are well marked and approximately equal. The opening to the copulatory pouch is at the inner upper angle of the right lobe and comes from the inner side rather than from the top.

The species is usually a common one where it occurs. It should be added that the reference of *Homoptera nigricans* Bethune to the synonymy is made on the basis of Doctor Bethune's own statements

in letters to Doctor Dyar and myself, and the description, which is very good indeed, would leave no doubt in any case. The type is no longer in existence.

PHÆOCYMA ÆRUGINOSA (Guenée).

1852. *Ypsia aruginosa* GUENÉE, Spec. Gen., Noct., III, p. 17, pl. XVIII, fig. 7.

1857. *Ypsia aruginosa* WALKER, C. B. MUS., Hel., XIII, p. 1074.

1857. *Homoptera plenipennis* WALKER, C. B. MUS., Hel., XIII, p. 1055.

1865. *Ypsia aruginosa* BETHUNE, Canadian Journal, X, p. 259.

1878. *Ypsia aruginosa* GROTE, Bull. U. S. Geol. Surv., IV, p. 185.

1883. *Ypsia aruginosa* (= *undularis*) GROTE, Papilio, III, p. 73.

1893. *Ypsia aruginosa* var. *undularis* SMITH, Bull. 44, U. S. Nat. Mus., p. 373.

1893. *Homoptera plenipennis* (= *aruginosa*) SMITH, Bull. 44, U. S. Nat. Mus., p. 373.

Ground color very deep brown to almost black. Collar with a velvety black median line, tipped with blue green scales. Thorax with three more or less obvious transverse lines that may be either obscured or emphasized by green scales. Dorsal tufts of abdomen tipped with green. Primaries more or less powdered with green scales having usually the tint of verdigris, but sometimes more blue. These scales, while they may be distributed throughout the wing, are usually massed so as to form a diffuse shade beyond the t. a. line, a conspicuous shading in and over the reniform, and venular marks in the terminal space. The t. a. line is black, even, single, inwardly oblique, with a slight and even outcurve in its course. Orbicular a black dot, usually visible in the green shade band. Median shade lines usually obscure. Reniform large, broad, defined only at the sides by black scales or lunate marks. T. p. line slender, black, single, outwardly bent over the cell, deeply but obtusely indented opposite the reniform, rather evenly oblique below vein 4. S. t. line black, inwardly diffuse, tending to become broken on the veins, more or less completely interrupted from veins 5 to 7; in course it forms a little inward angle on vein 4 and is then a little inwardly arcuate on its way to the margins. There is a series of green terminal dots on the veins. Secondaries usually a little more brown to the black line which is continuous with the s. t. of primaries, the disc crossed by three more or less obvious undulating darker lines and powdered with green; most obviously so at extreme base. Beyond this outer black line, which tends to be inwardly diffuse, there is an edging of green scales, and there is more or less green in the terminal area, tending a little to mass at the anal angle. A series of green venular points at base of fringes. Beneath rusty brown, powdery, a series of conspicuous whitish terminal dots on veins, and these white dots preceded by black points. Both wings with a dusky lunule and crossed

by a variable number of undulating transverse lines or shades; usually more numerous on the secondaries.

Expands, 1.48–1.80 inches = 37–45 mm.

*Habitat*.—Canada to Southern Florida, west to the Mississippi and probably to the Rocky Mountains.

In the series before me all the specimens from the northern range are in May. In a little series from Tryon, North Carolina, from the Fiske collection (U. S. National Museum), dates are April 30, May 6, July 7, and August 9.

The range of variation is chiefly in the amount of green powdering; but there is also some difference in the ground, and occasionally there will be an example that bears almost the same relation to the type form that *umbripennis* does to *undularis*; but the distinction does not become so marked at any time and there is never any hesitation as to where such a specimen belongs.

The species has been referred as a variety of *undularis*; but it is distinct throughout from that species, when close comparison is made. The green powdering which is present in every example of *aruginosa* and never present in any *undularis* is sufficient for all ordinary purposes. In addition, the shape of the reniform is altogether different, the course of the s. t. line is characteristic in each species, and, finally, the genitalic structure is decidedly unlike in both sexes. The spinulation of the middle tibia is scant in both sexes and not easily found. The sexual tufting on the middle femora of the male is conspicuous and the mass of specialized scales is large.

The male genitalia are markedly asymmetrical, the left harpe formed into a much longer, narrow, curved process than the right, which, broad for the greater portion of its course, is abruptly narrowed to a slender bent process.

The female genitalic structure is equally characteristic. Above, the depressions on the last segment are rather conspicuously marked with rusty yellow scales; beneath, the lobes are markedly dissimilar in size, the right much the smaller, almost oval, and having the opening to the copulatory pouch at almost the middle of the upper margin.

The species seems to be less abundant than its near ally,

PHÆOCYMA INSUDA, new species.

Ground color dull leather brown, with smoky shadings, the female much darker than the male. Front of the head white or yellowish, limited above by a transverse black bar, which in turn is surmounted by a white line limiting the concolorous vertex. Collar with a dusky transverse line more or less obviously shaded by a paler tint on one or both sides. Thorax crossed by two darker lines, more or less obviously margined posteriorly by paler scales. Basal space to the t. a. line crossed by narrow brown and grayish lines, which are more obvi-

ous and brighter in the male. T. a. line black, a little curved, irregular on the cell, as a whole inwardly oblique. In the male this line is followed by a belt of bluish scales which are quite conspicuous; in the female there is a similar band, but the scales are more scattering, of a duller tint, and over a much darker ground, so that they are not relieved. A punctiform black orbicular may or may not be included in this band. Two undulating dusky lines cross before the middle and aid in darkening that area; a third and sometimes a fourth are more obscure and cross beyond the middle, which is the palest portion of the wing. The reniform is narrow, upright, a little darker, anteriorly marked by black and posteriorly by white scales; both of these distinctions more obvious in the female. T. p. line black, slender, continuous, outwardly edged by yellow scales in some females, irregular, in general outwardly oblique from costa to near middle, then with a rounded angle bent inwardly and oblique to the inner margin. S. t. line broader, more diffuse, tending to become broken on the veins by bluish dots, parallel to but well removed from t. p. line to vein 7, where it diverges and runs outwardly oblique to the costa. The space between these lines is darker than the median space, and the s. t. line is followed by a broad band which in the male is as dark and in the female much darker than the included shade. Beyond this band is a paler brown shade which in the male is blue powdered, and in the female is strigillate with darker brown. Outwardly there is a darker brown marginal shade, broken by pale lunules at the incisions. The fringes have a yellowish line at base and are strigillate with brown. Secondaries pale brown to the middle, then with two or three more or less obvious, somewhat diffuse transverse lines before the double, black, extra-median line, the inner portion of which is narrow, thread-like, even; the outer edged with yellow scales, and forming a small  $\Sigma$  near the upper part of its course. Beyond this is a much darker band in the female, and in the male a blue powdering. The terminal area and fringes are as in the primaries. Beneath brown, powdery, all wings with a discal spot and an extra-median brown line, secondaries sometimes with two lines within and one or two beyond this line. A series of whitish dots at the incisions on both wings.

Expands, 1.25–1.92 inches=31–48 mm.

*Habitat*.—Southern Arizona: Yavapai County, August 11–25 (Hutson); Santa Rita Mountains, 5–8,000 feet, July (Snow); Chiricahua Mountains (Barnes); Prescott, July, August (Buchholz).

*Type*.—Rutgers College Collection: cotypes U.S.N.M. Type No. 12023; also collection O. Buchholz.

The color contrast between the sexes is very strongly marked in this species and yet there is less difference in the actual amount of blue powdering than occurs in some other species. In the female the blue

powderings are simply a little more scattered and are absorbed in the dark ground instead of contrasting with it. In both sexes there is considerable variation in tint, and some females are almost uniformly deep chocolate brown, with darker transverse lines edged with gray atoms. In all such cases the white outer edging of the reniform stands out strongly. There is no other species in our fauna that can be confused with this.

A fine series of 25 males and 23 females collected by Mr. Otto Buchholz gives the greatest range of size and also the longest period of flight, from early July to the middle of August.

The spinulation of the middle tibiae is very distinct, the spines being large and stout, though few in number, and easily discernible among the vestiture. In the male the mass of specialized scales covered by the femoral fringing forms a great wad that is very conspicuous when the middle leg is slightly moved, yet may be so closely appressed to the thorax as to be readily overlooked.

The abdominal tuftings are much reduced in this species, and in flown specimens they are likely to be totally absent. The genitalia of the male are decidedly asymmetrical, the harpes slender, irregular, and extremely unlike. The uncus is very long, slender, and has a sharply curved very pointed hook at tip.

In the female there is no apparent modification of the terminal segments on the upper side. On the underside the lobing is incomplete; the plate on the right is fully developed and takes up more than half the segment; the lobe on the left is very much smaller, and while it is fully chitinized along its inner margin, it is not well differentiated outwardly, and seems to merge into the texture of the segment. The opening to the copulatory pouch is at the upper inner margin of the right lobe, but forms no distinct tubular structure. It forms rather a space between the two lobes at that point and all from the lateral margin. There is nothing quite like this in any other of our species, and it seems in a way intermediate between the fully lobed types and such forms as *lanata*, in which there is no true lobing at all.

PHÆOCYMA NORDA, new species.

1904. *Homoptera calucanthata* DYAR, Proc. U. S. Nat. Mus., XXVII, p. 879, larva on birch.

Ground color a rich deep brown, more yellowish in the female than in the male, but varying in depth in both sexes. Head concolorous or with a gray frontal spot. Collar with a median black line, with or without an edging of bluish scales. Thorax with a more or less obvious transverse gray line across the disc and patagia behind the middle; posterior tuft well marked, sometimes a little gray-tipped. Abdominal tufts well defined in good specimens, but consisting of long upright scales which are easily disturbed and lost, so that the

majority of examples have no tufts at all; some of the scales gray tipped. In the males, primaries to the t. a. line darker brown, crossed by indistinct wavy lines; the t. a. inwardly oblique, only a little curved, quite sharply defined by a line of bright blue scales which usually extend outwardly so as to form a powdery blue fascia merging gradually into the ground color. The small punctiform black orbicular is usually included in this fascia. The reniform is lunate, elongate, nearly upright, dusky and without definite outlines. T. p. and s. t. lines run close together when both are present, but either of them may be wanting and rarely are both of them equally defined; usually one of them is black and very distinct from the inner margin, parallel with the outer margin to the middle of the wing. At that point they form a rounded angle and the t. p. proceeds a little irregularly, but on the whole obliquely to the costa a little beyond outer third, while the s. t. curves in and then out, so as to reach the costa a little before the apex. Usually it is the s. t. line that is black and most obvious toward the costal area, and usually also the costal area between these two lines is as dark as the base and darker than the rest of the wing. Beyond the s. t. line is a powdering of bright blue scales which may extend almost to the margin, interrupted at the middle by a brown shading so as to give the characteristic appearance of two lunate blue areas. At the apex is a conspicuous blackish blotch. There is a brown terminal line, parallel with the small indentations of the outer margin, and the fringes have a brown interline. Through the terminal area there are fine transverse brown strigæ that vary in number and intensity in the specimens. Secondaries brown, with inconspicuous darker transverse lines to the geminate extra-median line, of which the outer element is usually black, conspicuous, and extends rather evenly from the anal angle to costal margin, forming a small  $\Sigma$  near the upper end of its course. Beyond this line there is a powdering of bright blue scales, which usually fills most of the terminal area, which otherwise is more conspicuously strigillate with brown. There is a pale line at the base of the brown fringes.

In the female there are no blue powderings, and the maculation is on the whole much more obscurely marked. The t. a. line is rarely marked, and the dusky basal shade extends to or even beyond the middle of the wing and along the costa so as to include the reniform. The costal area between t. p. and s. t. lines is well marked and often a little purplish, and a broad shading of a similar tint is beyond the s. t. line from inner margin to the middle of the wing. On the secondaries a similar shade is beyond the extra median line, and this is sometimes traversed by lines of gray scales.

Beneath, the sexes are practically alike: smoky brown, with more or less obvious but generally vague transverse lines, and on all wings

an obvious discal spot. There is a small black dot, followed by a larger white one at each indentation of the outer margin.

Expands, 1.40-1.80 inches = 35-45 mm.

*Habitat*.—Kaslo, British Columbia, in May and June; Rossland, British Columbia, in early June; Arrowhead Lake, British Columbia, in May; Cartwright, Manitoba, in June.

*Type*.—Rutgers College Collection; cotypes U.S.N.M., Type No. 12024; also Cockle and Barnes collections.

In the fine series of examples before me, 20 males and 18 females, comprising material from Mr. Cockle, from Doctor Barnes, from the U. S. National Museum, and from my own collection, this species stands out from all its allies in the rich, dark coloring, especially of the male, in which the blue powdering is more brilliant than in that of any other species. As to the range of variation, that is, in general, similar to that of *minerea*. In the male the blue scales may be reduced to marginal lines or they may form diffuse shadings; the median space may be entirely concolorous, or it may be in whole or part paler, more yellowish than the rest of the wing. In the female the forewings may be almost uniform, or there may be a broad paler shading that takes the outer half of the median space and extends to the outer margin above the middle.

This is the species referred to by Dr. Harrison G. Dyar as *calycanthata*,<sup>a</sup> and the description of the early stages there given applies here and not to Abbot and Smith's species.

This is a close ally of *minerea*, and in fact is *minerea* intensified and more brilliant. It may prove to be a geographical race when the larvæ of both forms have been compared; but the fact that, with so large a series of *minerea* covering so wide a range of territory, there are none that in the male match the brilliant contrasts of *norda*, has induced me to keep this form distinct.

The sexual characters are on the whole very much like those of *minerea*; in fact, the small differences in detail that do appear I would consider within the range of specific variation in both sexes.

PHÆOCYMA MINEREA (Guenée).

1852. *Homoptera minerca* GUENÉE, Spec. Gen., Noct., III, p. 15, pl. xviii, fig. 6.

1857. *Homoptera minerca* WALKER, C. B. Mus., Het., XIII, p. 1054.

1857. *Homoptera obliqua* WALKER, C. B. Mus., Het., XIII, p. 1054.

1865. *Homoptera minerca* BETHUNE, Canadian Journal, X, p. 254.

1865. *Homoptera albofasciata* BETHUNE, Canadian Journal, X, p. 256.

1865. *Homoptera minerca=obliqua* WALKER, not GUENÉE, GROTE and ROBINSON, Trans. Am. Ent. Soc., II, p. 79.

Varies in color from tawny yellow to chocolate brown, marked and shaded with darker brown or black. Head concolorous. Collar with

<sup>a</sup> Proc. U. S. Nat. Mus., XXVII, 1904, p. 879.



a median black line and usually a slightly darker shade below tip. Thorax with three dusky brown transverse lines, the one behind the middle often edged with blue-gray scales. Primaries with usually a more or less mottled appearance; basal area darker as a rule and the triangular costal area between t. p. and s. t., lines usually as dark or darker than any other portion of the wing. Basal line usually traceable, sometimes evident, geminate, in the male often picked out by bluish white scales. T. a. line best emphasized by the difference in shade between basal and median space: rarely geminate, the lines black edged, interval brown; often a pale line separates off a narrow band from the rest of the basal space; in course inwardly oblique, only a little irregular or outcurved. In the male there is usually a pale blue edging beyond the line which may expand into a rather broad fascia. Median space usually a little paler than the rest of the wing, but it may be concolorous in either sex. As a rule there are three transverse undulating dusky lines which tend to darken the space a little at or before the middle, leaving the outer portion paler; quite usually also there is a darker brown shade over the costal area. T. p. line geminate, very fine, rarely black and then tending to lose the outer portion; in course outwardly oblique to the interspace between veins 6 and 7, there acutely bent, making a deep incurve followed by an equal outcurve and then oblique, evenly sinuate to the inner margin. S. t. line inwardly oblique from costa to vein 5, then outcurved and parallel with the t. p. line for the balance of its course. From the costa to vein 7 it is edged with black inwardly, and the space to the t. p. line is dark brown or even blackish; to vein 4 the line is interrupted or feebly marked on the pale ground, and below that point to the inner margin it is often black and conspicuous. Over or beyond this line, especially in the female, a dusky or blackish shade may extend from inner margin upward to the angle of the line and then outward on or below vein 4 to the outer margin, interrupting the terminal space and forming a break for the pale median shade to extend outward to the margin. In the male this shade may be powdered with bluish white, or there may be a lilac blue line, or the entire terminal area may be bluish, interrupted always by the dark shading on or below vein 4. There is a dusky terminal line which may be broken and partly lunulate and is sometimes preceded by brown or bluish dots. The fringes are interlined with pale at base and darker at middle. Orbicular a black or brown dot which is often wanting. Reniform rather small, lunate, dusky, without defining lines as a rule. Secondaries usually a little paler basally, the disk crossed by a series of lighter and darker transverse, somewhat undulated shade lines. A distinct, slightly incurved and slightly irregular black line, outwardly pale edged, continues the s. t. of primaries. The terminal space in the male is usually more

or less blue shaded or powdered; in the female it may be merely strigillate or there may be a dusky band similar to that beyond s. t. line on primaries. Beneath powdery, with linear discal spots on all wings: primaries with median and an extra median transverse shade lines, secondaries crossed by several undulating lines.

Expands, 1.60-1.88 inches = 40-47 mm.

*Habitat*.—Canada to Florida along the Atlantic coast; west to the Rocky Mountains; Arizona.

Dates in the more northern part of its range are May, June, and July, the latter usually worn females; from the Southern States there are specimens in August.

A series of over one hundred examples, representing the entire range of distribution, is before me and gives an excellent chance to determine the extent of variation. This is aided by a series of 27 specimens from one locality in the Catskill Mountains, taken by Mr. R. F. Pearsall, which shows that the entire geographical range may be matched within the limits of a single locality.

At first sight it seems almost hopeless to attempt to describe these variations; but if we separate the sexes, we find that they group into types. Taking first the males, we have those in which the terminal space is divided into two lunate bluish areas, and these usually have the anterior portion of the median space also blue powdered. Then come the less contrasting forms in which the blue is reduced to an edging, or it may be an almost continuous line, as in the example that formed the type of Doctor Bethune's *albofasciata*. With either of these forms there may occur examples that have the median space much paler than the rest of the wing. In the female the range is somewhat less because the blue is eliminated. We have forms that are almost evenly blackish except for a light sub-apical shading, and forms that have the median space contrastingly paler, and everything in between. Throughout it all, however, the species remains characteristic and specimens from New York and from Arizona are placed with equal readiness.

The spinulation of the middle tibia is distinct, though not conspicuous, and sometimes there is a spinule or two between the spurs of the posterior pair. The tufting on the middle femora of the male is obvious and the mass of specialized scales is large and conspicuous.

The genitalia of the male are moderately asymmetrical, the left harpe much broader at base and narrowing abruptly into an elongate flattened process; the right much more elongate, narrower throughout. I have examined specimens of the most divergent appearance superficially, and from the extremes in geographical range, without discovering any material departure in form.

In the female the depressions on the upper surface are usually well marked and the terminal segments are usually more or less

marked with ochereous. Beneath, the lobes are approximately equal, the opening of the copulatory pouch at the upper inner angle, taking in the angle itself and not any material portion of either upper or inner margin.

PHÆOCYMA LUNIFERA Hübner.

1818. *Phæocyma lunifera* HÜBNER, Zuträge, p. 19, figs. 97, 98.  
 1818. *Phæocyma lunifera* HÜBNER, Verzeichniss, p. 275.  
 1857. *Phæocyma lunifera* WALKER, C. B. Mus., Het., XIII, p. 1045.  
 1865. *Phæocyma lunifera* BETHUNE, Canadian Journal, X, p. 249.  
 1875. *Homoptera pennæ* MORRISON, Proc. Bost. Soc. N. H., XVIII, p. 241.  
 1878. *Phæocyma pennæ* GROTE, Bull. U. S. Geol. Surv., IV, p. 185.  
 1893. *Homoptera pennæ* SMITH, Bull. 44, U. S. Nat. Mus., p. 371.

Ground color a dirty luteous gray or brown, more or less tinted with red brown. Head with a brown or black frontal line. Collar with a more or less obvious black or brown medial line. Thorax with obscure transverse light and dark alternating shades. Abdomen gray to luteous, the dorsal tuftings small. Primaries with the transverse markings usually distinct and the s. t. line, at least, black and contrasting. Basal space usually darker and sometimes contrastingly so. Basal line marked in some specimens; usually as a dark shade between pale marginal lines. T. a. line always obvious, geminate, brown, the intervening space tending to darken so as to form a band, and in such case often preceded by a paler line. Median space usually paler at the t. a. line than elsewhere, and darkening from the middle outward; but it may be absolutely concolorous, may have a pair of nearly upright diffuse median lines, or may be simply washed with darker outwardly. Orbicular a black or brown dot, distinct in most of the specimens. Reniform of moderate size, lunate, uniformly dusky or blackish, edged with yellowish scales. T. p. line slender, threadlike, usually black, tending to become lost inferiorly, outwardly bent over cell, roundedly indented opposite reniform, thence from vein 4 inwardly oblique and sinuate to the margin. S. t. line black, usually complete, sometimes broken opposite the reniform and occasionally obscure toward costa. It is irregular and a little denticulate in the upper part of its course, forming an incurve from costa to vein 4, where it is outwardly dentate and carried to vein 3, where it reaches the greatest outward bend, thence more evenly to the inner margin. The s. t. space is more or less completely dark-filled; sometimes entirely, so as to form a distinct band, sometimes only at costa to form a dark triangular blotch, and sometimes the dark shading extends inward into the median space. Usually the lower half of the line is broader and more conspicuously contrasting. The terminal area may be concolorous, which is the rule in the females; it may be more or less powdered with bluish gray, forming an obscure band, and that is more common in the males; there may be a dusky shading

beyond the lower half of s. t. line extending to the outer margin from the outward indentation of the s. t. line, and that is not common in either sex. There is usually a dusky apical shade and a yellowish line at base of fringes. Secondaries a little paler at base than primaries, disc crossed by two or three dusky shade bands that sometimes form an obscure fascia. An extra-median double line, the inner slender and often brown, the outer conspicuous, black, inwardly diffuse. The lines diverge toward the costa and the space between them tends to become and sometimes is completely dark filled. The terminal space may be concolorous, may have a bluish gray band through its middle or a leaden gray shading. Beneath dull yellowish, more or less powdery, ranging from almost immaculate to forms with a discal lunate, a median dusky line and a t. p. and s. t. line on all wings.

Expands, 1.40-1.64 inches = 35-41 mm.

*Habitat*.—Massachusetts to Texas, west through the Central States and probably to the Rocky Mountains.

This is one of the several different forms that has been in collections as *calycanthata*. It is sometimes named *penna* Morrison, correctly enough, and occasionally *galbanata* Morrison, which is not so far out of the way. As a matter of fact I believe this to be the form that Hübner had before him and that served as the original of his figure in the *Zutrage*. Careful comparison shows that no other species answers all the requirements of the figures and that this species does do so in all save a few minor details that are within range of artistic error. Those very points which Mr. Morrison emphasizes in his description of *penna*, notably the dark filling of s. t. space, are well brought out by the figure, and so is the dusky basal area. I have never seen any specimen with quite so well marked a yellow ring around the reniform, but examples with a yellow edging are not infrequent. The irregular s. t. line with the little dents on veins 3 and 4 is quite characteristic, and the secondaries I can match perfectly in the series before me.

The species figured under this name by Guenée is *cingulifera* Walker, the mistake occurring through too great a reliance on the dark basal area and pale reniform. Guenée seems not to have had anything like the real species before him.

As to the range of variation, that is considerable in both sexes, and puzzling when it comes to making a separation from *lincosa* Walker. In the typical form the basal and s. t. spaces are dark and there is an upright median shade which fades outwardly. In such cases there is usually a paler terminal area, and, in the male, more or less blue powdering, so that there may be a resemblance to *minerea* or yet more to the *colorado* or *rubi* type. In rare cases there is a heavy inward darkening from the s. t. space on both wings, leaving a pale band beyond the t. a. line, which gives those examples a very unusual

appearance. The median space may be entirely uniform, and in that case there is often a dark shade band beyond the lower half of the s. t. line from the angle of which a dark shade may extend to outer margin. When this is accompanied by a dark apical blotch we have two large pale terminal lunate areas as is characteristic in *lunata* and *minevea*. The extreme in the other direction comes when the wings are very uniform, without contrasts, and only the t. p. and s. t. lines stand out in whole or part, black and contrasting.

Just where to draw the line between this form and *lineosa* becomes puzzling and a matter of nice judgment, particularly when the species occur together at the same time and are taken under absolutely identical conditions. I can find no tangible structural difference of any kind between them and I have arranged them to show a full line of intergrades from one to the other; yet the line is unsatisfactory and the arrangement into two series is on the whole most satisfactory. I believe there are two species. I admit my inability to separate them by any positive characters. *Lunifera* is on the whole a smoother species, less strigate, less obviously crossed by undulating darker shades, and with more definite ornamentation throughout.

The middle tibiae are set with a moderate number of rather long spinules, easily seen, and the middle femora of the male have the mass of specialized scales very large and the tufting conspicuous.

The male genitalia are distinctly asymmetrical, both harpes very much curved and forked at tip, but in a totally different way, as appears by a reference to the figures. The uncus is very long and slender and is a little sinuate toward the tip, which is acute and a little hooked.

The females have the impressions of the upper surface of penultimate segment well marked and the tufts a little discolored. On the under side the segment is distinctly lobed, the lobes not markedly different, yet sufficiently so to be characteristic. The opening to the copulatory pouch is from the upper inner angle and comes from the angle itself rather than from either upper or lateral margin.

#### PHÆOCYMA LINEOSA (Walker).

1857. *Homoptera lineosa* WALKER, C. B. Mus., Het., XIII, p. 1056.

1865. *Homoptera lineosa* BETHUNE, Canadian Journal, X, p. 259.

1875. *Homoptera galbanata* MORRISON, Proc. Acad. Nat. Sci. Philadelphia, 1875, p. 435.

1878. *Phœocyma lunifera* ‡ GROTE, Bull. U. S. Geol. Surv., IV, p. 185.

1880. *Phœocyma lunifera* ‡ GROTE, Can. Ent., XII, p. 87.

1893. *Homoptera lineosa* (= *lunifera* GROTE, not HÜBNER) SMITH, Bull. 44, U. S. Nat. Mus., p. 368.

Ground color a rather uniform pale or creamy gray, tending to reddish brown. Head with a variably evident frontal line, collar

with a blackish transverse line at middle. Thorax with obscure paler and dusky transverse lines, which are rarely well marked and often obsolete. Abdomen of the palest ground color, the dorsal tuftings small. Primaries having a powdery or dusty appearance, more or less strigate and with rivulous dusky lines that obscure all the maculation and undoubtedly suggested the name *lineosa*. None of the lines distinct or black and none of the markings contrasting. Basal area quite usually a little darker than the median space; the basal line geminate, brown, diffuse; t. a. line geminate, brown, sometimes preceded by a paler line or outwardly edged with darker followed by gray scales. The median space is usually a little paler basally; at middle and beyond crossed by two or three dusky shade lines. T. p. line very slender, brown or black not contrasting, outwardly bent over reniform, angularly and usually well indented opposite reniform, oblique and sinuate from vein 3 to inner margin. S. t. line brown, a little diffuse, incurved from costa to the interspace between veins 3 and 4, there with a rather well marked outward tooth, below that inwardly oblique and a little sinuate rather than incurved. Beyond this there may be a more or less defined yellow shade line, a dusky band beyond lower half, a dusky outward shade from angle of line to outer margin, or there may be only an obscure strigillation. Very often there is a slight apical shade and in the male there is usually more or less bluish gray in the form of shading or powdering. There may or may not be a brown terminal line, with the incisives pale marked and the veins dark tipped. There is usually a dull brown, punctiform orbicular, and the reniform is dark, lunate, more or less edged with yellowish. The secondaries are paler at extreme base, the disc crossed by a series of alternate paler and darker undulating lines, of which either series may be the more prominent. The exterior line is best marked, narrow, black, or edged with black scales, not conspicuous, outwardly followed by a yellow or whitish line. The terminal area is usually more or less blue or violet-gray powdered, tending to form a band in the male, sometimes changed to a leaden gray band. Terminal line as in primaries. Beneath yellowish brown, powdery, primaries with a large, secondaries with a small, discal spot, both wings with an irregular extra-median line.

Expands. 1.32-1.60 inches=33-40 mm.

*Habitat*.—Canada to Texas, west to Colorado; Kansas, New Mexico, Winnipeg, Manitoba. Dates range from the end of May to August.

I have a long series of specimens from the various collections, representing the entire range above given, and some very good local collections, notably one of 24 males and 28 females from Dr. O. S. Westcott, collected near Chicago in May and June. In this series

were 8 males and 15 females that were separated out as representing the true *lanifera* and which gave opportunity to study local variation.

In ground color the variation is from very light creamy gray to a rusty brownish gray; the latter more general in the specimens from the southwest (Texas), which are also notably larger. *Galbanata* Morrison is based on one of the neatly marked gray forms.

The difference between the sexes is not uniformly marked and it is not always possible to separate them from the wing characters alone; nevertheless, as a rule, there is more gray powdering in the terminal space in the males than there is in the females, and in size the female usually exceeds the male.

Typical specimens have no sharply defined lines or marks and the wings seem to be crossed by a mass of slightly undulating dusky lines. From that point variation runs to forms which it is not easy to differentiate from some forms of *lanifera*.

In structure of legs and in the male and female genitalic characters I can find no substantial differences; in fact, the northern gray and southern red forms actually show more divergencies than do the typical *lineosa* and *lanifera*. Yet for reasons already given I have preferred to hold the species distinct.

PHÆOCYMA UNILINEATA (Grote).

1876. *Homoptera unilineata* GROTE, Can. Ent., VIII, p. 108.

1883. *Homoptera unilineata* GROTE, Can. Ent., XV, p. 123.

1903. *Homoptera unilineata* HOLLAND, Moth Book, p. 278, pl. xxxvii, fig. 14.

Ground color rusty yellow or leather brown, more or less washed with gray. Head usually deeper brown. Collar sometimes steel gray just below tip. Thorax with three vaguely marked transverse dull gray bands which are often obsolete. The posterior tufting is unusually thick and the patagia are divergent and alate in well preserved specimens. Dorsal tufts of abdomen very small, and in flown examples are more often altogether absent. Primaries rusty in appearance, more or less strigillate or powdered with dark brown or even blackish scales; sometimes arranged so as to form a series of vague discal transverse lines. Basal space usually a little darker, a narrow pale line separating off an outer band which serves as the t. a. line and may be itself outwardly edged with paler scales. Orbicular a small black dot, visible in most specimens. Reniform narrow, upright, a little lunate, small or moderate in size, dusky, usually not outlined, but sometimes edged with rusty or yellowish scales. The t. p. and s. t. lines are united for most of their course, and between vein 6 and the inner margin there is an even narrow yellow line, outwardly bordered by a rusty brown line. This forms an obtuse outward angle between veins 3 and 4, and above vein 6 it divides, the t. p. line running obliquely inward to the costa, while the s. t. line continues its course a

little outward to the costa. The triangular area thus inclosed is often darker than the rest of the wing and forms its most conspicuous feature. There is a tendency to a dusky shade band beyond the s. t. line, and the terminal area becomes more gray, forming the palest portion of the wing. There is a narrow brown terminal line followed by a yellow line at base of fringes, and from the terminal line a series of rays extend into the interspaces, giving the whole a crenulated appearance that intensifies the denticulate appearance of the outer margin. Secondaries a little paler and less powdery; three vague dusky shade lines crossing the disk before the conspicuous black extra-median line, which is usually not extended above vein 6. Terminal area concolorous, the terminal brown line and pale line at base of fringes being as a rule continued from primaries. Beneath pale yellowish brown, powdery, without obvious markings in most cases; sometimes with a discal spot, rarely with transverse lines.

Expands, 1.60-1.92 inches=40-48 mm.

*Habitat*.—Canada to the District of Columbia, April and May.

A series of 8 males and 15 females is at hand representing, as actual points of capture, New Hampshire, Webster, May 12-16; New York, Center, May 12-17; Long Island, May 14; New Jersey, no specific localities nor dates; Washington, District of Columbia, April 15-22; Iowa, May 9 and 22, no specific locality. There is, on the whole, little variation; some specimens are darker than others and some are much more powdery, one Iowa example becoming almost steel gray to the terminal space. There is more or less contrast in the basal space and the costal area between the t. p. and s. t. lines is sometimes conspicuously the darkest part of the wing.

The species is one of the most characteristic of our fauna; the unusually elevated or alate patagia, the strongly dentate outer margins, and the conjoint t. p. and s. t. lines form a combination that seems unmistakable.

In the male the femoral tufting on the middle leg is not conspicuous; but the femur is excavated, there is a fringing on both sides, and there is a mass of specialized scales. As a whole the legs are stout, the spines of the median pair being long and arranged in a series along the sides.

The sexual parts of the male are symmetrical or nearly so. The uncus is slender and has a long drawn-out, curved point. The lateral pieces are slender, hooked like the uncus itself, and somewhat dilated toward the tip. The penis sheath is almost semicircular in outline. The anal plates of the female are nearly symmetrical, the opening to the copulatory pouch from the upper inner angle of the right half as seen from below, but from the upper margin itself.

The species does not seem to be abundant anywhere.



## PHÆOCYMA OBLIQUA (Guenée).

1852. *Homoptera obliqua* GUENÉE, Spec. Gen., Noct., III, p. 16, pl. xv, fig. 7.

Ground color mouse gray to fawn brown, more or less washed with blue gray. Head usually a little more brown. Collar and thorax concolorous; posterior tuft sometimes brown tipped, as is also the large tuft at base of abdomen. Dorsal tufts of abdomen distinct in well preserved specimens, and sometimes white tipped. Primaries with a wash of violet gray over the entire surface, more or less marked; lines usually traceable, but none of them black or contrasting. Basal space usually a little darker, and the outer edge of this is often bordered by darker brown scales forming the t. a. line; there is an outward tooth on the subcostal and below this the line while inwardly oblique is a little outcurved in the interspaces. Beyond the t. a. line is the palest area of the wing, extending to an upright or slightly angulated median shade beyond which the space is a little more brown. Orbicular small, punctiform, brown. Reniform lunate, usually diffuse, sometimes brown and fairly well defined but not outlined, followed by a more or less obvious rusty reddish shading. T. p. line slender, brown, tending to become lost, sometimes preceded by a cinerous shade; inwardly angulate opposite the reniform and not much incurved below the cell; outwardly a little shaded with brown toward costa in some specimens. S. t. line obvious only below vein 4, thence to the inner margin parallel with and close to the t. p. line, but darker and better marked, sometimes emphasized by black scales. The upper part of the line is usually traceable by a line of gray or brown scales or by both, but in many cases it is entirely lost. The terminal area is more or less mottled with gray, strigillate, and sometimes there is a darker shade beyond the visible portion of the s. t. line. There may or may not be a brown terminal line, with pale dots at the incisions. Secondaries usually with two, sometimes with three visible transverse shadings on disk before the distinct brown band which extends from anal angle with a slight incurve to costa just within the apex, becoming much less obvious as it approaches the costa. The outer portion of this band is determinate, edged by brown or black scales, and often followed by a yellowish line; the inner portion is more or less diffuse in most specimens. The terminal area is usually without markings, a terminal line being occasionally present. Beneath dull yellowish to pale brown, more or less powdery, with or without discal spots or extramedian transverse lines on all wings.

Expands, 1.48–1.92 inches=37–48 mm.

*Habitat*.—New York to Florida and probably throughout the Atlantic coast region to Canada and westward to the Mississippi. Specific localities are: New York, Center, April 29–May 28, Long

Island; Pennsylvania; Washington, District of Columbia, May 19, 24; North Carolina, Raleigh, July 25; Florida, Seven Oaks in September; Missouri.

In the series before me there are 9 males and 12 females and they are, after all, very much alike. There is a little difference in the amount of contrast between the various spaces and a little difference in the ground color; but over all is the gray wash that is characteristic of the species and which no other has in the same way.

In the male the middle femora have the sexual tufts distinct but not really conspicuous, inclosing a large mass of specialized scales. The spinulation of the median tibiae in both sexes is scanty and not conspicuous.

The genitalia in the male are markedly asymmetrical, the lateral process or harpe of the right side as seen from above being markedly shorter and more slender than that of the left, which also has an accessory process which curves from the lower margin upward on the inner side and shields the base of the uncus.

In the female the anal segments tend to become ochereous and the depressions on the upper surface are very well marked. The lobes of the divided segment beneath are very dissimilar in form and the entrance to the copulatory pouch is shifted to the outer upper angle of the right plate.

This appears to be the most abundant of the species of this series.

*PHÆOCYMA METATA*, new species.

Light fawn brown tending to gray, the primaries more or less washed with gray. Head and thorax immaculate. Abdomen tending to more yellowish or rusty. Primaries with the basal space usually a little darker. Basal line traceable in some specimens, but never black, distinct. T. a. line usually marked only by the difference in tint between basal and median space, sometimes a little more defined by an edging of dark scales; never a black line; in course outwardly dentate on subcosta and then with a slight and tolerably even outcurve to the inner margin. Beyond this line there is a broad band-like area to the middle of the median space that is usually lighter than the rest of the wing and is gray powdered, the punctiform blackish orbicular visible in most cases. At the middle is a somewhat irregular median line and beyond that the space may be evenly deeper in tint or there may be two other diffuse lines crossing it. The reniform is moderate in size, lunate, dusky or in a few cases even blackish; beyond it a more reddish shading to the t. p. line. The t. p. line is usually distinct enough from costa to the middle of the wing, indented as usual opposite the middle of reniform, and it is lost or very obscurely marked toward the inner margin. The s. t. line is distinct, black, or blackish between vein 4 and the inner margin, forming an even curve; but between costa and vein 4 it is altogether lost, marked

by a little contrast between s. t. and terminal spaces only, or rarely by an edging of darker or paler scales. Beyond the s. t. line is a dusky somewhat glaucous band or shade, best marked opposite the angulation of the line and usually distinct to the inner margin, while toward the costa it is lost before it reaches the apical area. There is a tendency toward strigillation of the terminal space and toward a series of pale terminal spots. Secondaries with a black extra-median line extending from anal angle almost to costa well within the apex. This line is usually edged with yellowish scales or a yellowish line outwardly, and with a brown shade inwardly, in some cases forming a real band that extends from the angle to vein 5. There is a tendency to a bluish powdering in the terminal area, which is best marked in the males. Beneath, yellowish brown, powdery, secondaries usually with a discal spot. Sometimes the primaries also have such a spot and occasionally a transverse line will be traceable, usually on the secondaries.

Expands, 1.60–1.80 inches=40–45 mm.

*Habitat*.—Center, New York, in May; Pennsylvania; Washington, District of Columbia; Tryon, North Carolina, in August; Virginia; Florida.

*Types*.—Coll. U.S.N.M., Type No. 12025; also Rutgers College Collection.

Four males and six females are at hand; all very similar, yet exhibiting a considerable range of variation. As a whole the males are a little more brilliant and better marked than the females, one of the latter having almost no contrasts. There is quite a bit of difference in the reniform; but it is always darker than the ground and never quite black. The terminal area usually shows the dusky band distinct, but even that may disappear almost entirely. In the definition of the median shade there is every range between distinct and almost entire uniformity; but the latter is exceptional.

The spinulation of the middle tibia is scattering and not conspicuous in either sex; in the male the spines are not easily found in the dense vestiture. The tufting of the middle femora in the male is quite distinct and there is a large mass of specialized scales.

The genitalia of the male are distinctly asymmetrical, the lateral processes or harpes of the right side being much more curved and slender than those of the left, while the left side has the same sort of supplemental piece found in *obliqua*, except that it is here narrower and longer, and rounded at tip; altogether a smaller and less conspicuous structure.

In the female the depressions on the upper side of the anal segment are well marked and sometimes the segment is ochereous. On the under side the lobes are not markedly dissimilar and the opening to

the copulatory pouch is at the upper inner angle of the right lobe, taking in the angle itself and not either side or top alone.

This species is one of those that has been confused with *obliqua* and is very like it. Superficially it lacks the gray washing, and while this does not seem very much of a distinction, yet a comparison of two series shows a very marked difference in appearance. It also averages smaller in size, although the smallest *obliqua* is smaller than any of my *metata*; but the average *obliqua* uniformly exceeds the average *metata*. The transverse marking is more conspicuous and the reniform more contrasting and these factors when added to the lack of gray wash give a characteristic appearance that is recognizable. Finally, and this of course is the determining factor, the genital structures of both sexes shows obvious differences, less marked, perhaps, in the male than in the female, where the character of the lobes and the location of the opening of the copulatory pouch are quite different. A comparison of the figures will make this point more clear.

PHŒOCYMA CUREMA, new species.

Varies from fawn to mouse gray, the base being a light red-brown, more or less overlaid by a wash of blue-gray; the vestiture even, not rough or velvety. Head and thorax concolorous; head sometimes a little darker brown, and collar sometimes a little more rusty than the general ground. Abdomen more rusty brown, the dorsal tufts small but conspicuous when they are not altogether lost. Primaries rather even in color, without strong contrasts, the transverse maculation clean cut. Basal line single, black, distinct. T. a. line single, narrow, usually black and distinct, irregular, an outward tooth on the subcostal and a long inward angle on the median vein. T. p. line often obsolete, sometimes only partially traceable, brown and thread-like, rarely distinct throughout its course, and only occasionally black. In course it has the usual exertion over the reniform, with an inward angulation opposite the middle of cell, and the deep incurve, parallel with the s. t. line, below it. S. t. line usually black and distinct through the lower part of its course, but above the angulation at its middle it is indistinct, marked chiefly by the margin of the darker s. t. space. There is more or less gray powdering in the terminal space, but there is no terminal line and the fringes are uniform. The basal portion of the median space is usually a little the palest portion of the wing, and is limited outwardly by a straight shade line that is scarcely darker in most examples and never distinct, marking the edge of the somewhat darker portion of the median space. No trace of an orbicular in any specimen. Reniform lunate, usually black, contrasting, always obviously darker than the ground, and beyond it is a rusty red shade which extends to the t. p. line or the place where it should be. Secondaries somewhat duller in color

than the primaries, without traceable transverse maculation until the distinct, narrow, black extra median line is reached. This is most distinct toward the inner angle, does not reach the costa and is outwardly edged by a bluish-gray line or by a more diffuse shading of blue-gray scales. In the male there is a tendency to a whitish blotch at the anal angle, and on the primaries this is a rather conspicuous feature in nearly all the examples at hand. Beneath, dull smoky brown, powdery, with a more or less obvious discal lunule on all wings, and a tendency to a pair of transverse lines which are not often distinct.

Expands, 1.48–1.68 inches=37–42 mm.

*Habitat*.—Center, New York in May; Pennsylvania; Kirkwood, Missouri, March 25; Raleigh, North Carolina, in May, and Tryon, North Carolina, June 4; Seven Oaks, Florida, in September. Palm Beach, Florida, in March.

*Types*.—Coll. U.S.N.M., Type No. 12026; also in collections of Barnes and Rutgers College.

In the series of 5 males and 7 females now before me there is very little variation. Two of the Floridian examples diverge in the direction of a more defined median shade and a little more hoary washing; but they do not cause any conflict with any other species, the characteristic features of the present one being well marked.

The spinulation of the middle tibiæ in both sexes is scant and easily overlooked in the vestiture, although the individual spines are long. In the male it is difficult to see them at all, *in situ*, and even in the mounted preparation they are not conspicuous.

The tufting of the middle femora in the male is not at all conspicuous and is easily overlooked; but there is an obvious excavation on the inner side filled with the usual specialized scales, although in bulk it is small compared with some of the allied species.

The genital structure is distinctly asymmetrical, the left lateral piece or harpe being distinctly longer, broader, and less curved than the right, which is a little enlarged toward the tip.

In the female the upper side of the terminal segment has the impressions very distinct, but not discolored in any of my examples. Beneath, the lobes are distinctly marked, the right a little the larger, while the opening to the copulatory pouch is at the upper inner angle of the right lobe and on the inner rather than the upper margin.

This is the dullest and darkest of the species with smooth vestiture, and distinct from its allies in the conspicuous black reniform and single, well-defined black basal and t. a. lines. The males have a conspicuous white patch at the anal angle of primaries, and as a whole there is little doubt as to the location of any individual.

Its nearest ally is *metata*, and this is also indicated by the genital structure of both sexes. But even here there are obvious distinctions which bear out the superficial differences. In the males the right

clasper of *curcma* is materially broader than in *metata*, and instead of terminating in a slender, rounded tip, it broadens and becomes more spatulate in character; the left clasper in *curcma* is both longer and broader and the tip is not drawn out to a point. In the female *curcma* the lobes of the anal plates are decidedly smaller and different in outline, while the left lobe is the larger, instead of the right, as in *metata*. The opening to the copulatory pouch is in approximately the same location, and in general the appearance of the structure is very similar.

Considering all the differential features, structural as well as superficial, I have concluded it best to consider that we have a distinct species to deal with.

PHÆOCYMA HELATA, new species.

Ground color dull smoky brown. Head and thorax more or less powdered with gray scales, forming no distinct markings. Abdominal tufts prominent. Primaries obscured by irregularly disposed brown shadings. Basal area darker. Basal line black, diffuse. T. a. line black, inwardly diffuse and margined by a brown shading; acutely toothed on the subcostal and with an obtuse or rounded outward angulation just above the submedian. At the center of the wing begins a series of three or four more or less obvious, somewhat diffuse transverse lines that darken the outer portion of the median space. The brown, punctiform orbicular is present in most examples. Reniform lunate, blackish, conspicuous. T. p. line distinct in all specimens, black, narrow, complete, outwardly bent over cell and strongly indented toward the middle of the reniform, the outward angles rounded; incurved below cell and only a little irregular. S. t. line obvious throughout its course, distinct and black only from vein 4 to the inner margin. There is a little outward tooth on veins 3 and 4, and between these veins a blackish shade extends to the outer margin. The space between t. p. and s. t. lines is irregular and is darker filled, most distinctly so on the costal area, giving the appearance of an irregular band. The terminal area is strigillate and more or less powdered with gray scales in both sexes. In the male there is a conspicuous white blotch at the anal angle. Secondaries dull, fuscous brown to the extra-median black line, which is prominent at anal angle but does not reach the costa. This line is outwardly edged by a gray line and by some gray powderings which become more conspicuous toward the anal angle; inwardly the line is edged by a brown shade, which may merge into the ground or may be limited by a brown line for part of its course, so as to form a distinct band part way across the wing. Beneath yellow brown, more or less powdery, all wings with a discal spot; primaries with an extra-median, secondaries with basal and extra-median transverse

lines more or less obvious; in some examples only the discal spots are distinct.

Expands: 1.40–1.60 inches=35–40 mm.

*Habitat*.—New Hampshire, probably Webster; Center, New York, in May; Brooklyn, New York; Amherst, Massachusetts.

*Types*.—Rutgers College Collection; also eotype Doctor Ottoni.

Three males and two females, all very much alike. The chief superficial difference between the sexes is the conspicuous white blotch at the anal angle of the primaries; but with more material this may not prove constant.

As compared with *eurema*, to which this is perhaps most nearly allied, the most obvious difference is the more roughly powdered vestiture and the absence of a red tinge in the ground. Next the fact that both t. p. and s. t. lines are complete, and the space between them is darker. All the transverse maculation is more conspicuous, and the median shade lines are as a rule better defined.

The spinulation of the median tibia is well defined but sparse, the long spinules being easily made out in the vestiture. The femoral tufting of the male is only moderate, and the mass of specialized scales is not at all conspicuous.

The genitalia of the male are very similar to those of *squamularis* and differ more from those of *eurema*, to which the species is nearer on superficial characters. The right clasper is unusually long, slender, and down-curved.

In the female also the resemblance is to *squamularis* rather than *eurema*, though there is a markable difference in the outline of the lobes beneath. The location of the opening to the copulatory pouch is about the same—at the upper inner angle of the right lobe; but it is distinctly nearer to the middle of the segment as a whole.

#### PHÆOCYMA SQUAMULARIS (Drury).

1770. *Noctua squamularis* DRURY, Illustr., I, p. 18, pl. IX, fig. 3.

1857. *Noctua squamularis* (= *coracias* Guenée) WALKER, C. B. Mus., Het., XIII, p. 1075.

1865. *Anthracia squamularis* BETHUNE, Canadian Journal, X, p. 248.

1874. (? *Noctua squamularis*=*coracias*) GROTE, Bull. Buff. Soc. Nat. Sci., II, p. 46.

1893. *Pseudanthracia squamularis* SMITH, Bull. 44, U. S. Nat. Mus., p. 373.

Pale leather brown, more or less washed with gray. Head usually a little darker in front. Collar and thorax concolorous. Primaries with all the maculation distinct, conspicuous, the transverse maculation well marked, brown or black. Basal space a little darker, basal line distinct, single, brown or black; t. a. line distinct, single, brown or black, with an acute outward tooth on the subcosta and usually a

marked outcurve in the submedian interspace. Beyond this line is a broad gray area extending to the median shade, and this is the palest part of the wing, including the small, punctiform, brown orbicular. The median shade consists of a pair or three somewhat wavy brown lines, more or less obscured by the deeper brown shading that extends to the t. p. line. Reniform brown or black, lunate, not defined, followed by a more reddish shade. T. p. line black or brown, sometimes complete, more often partially lost below the middle, with a deep inward angulation opposite cell, forming an obvious  $\Sigma$  and a moderate incurve below the cell. S. t. line black below the middle, tending to become lost above that point. When complete, it starts from the costa within the apex, makes a moderate incurve and forms an acute outward tooth on vein 4; there is a smaller tooth on vein 3, and then there is the usual incurve to the inner margin just within the anal angle. There is a tendency to darken the s. t. space which is best marked in the costal region. Beyond the s. t. line there is a broad dark band extending from inner margin to the angle of the line, interrupted in the male by a whitish blotch; otherwise the terminal space is gray powdered, more or less strigillate. There is no obvious terminal line. Secondaries with three more or less obvious brown lines across the disk, followed by a brown band between black or brown defining lines. This band becomes broader and is less marked toward the costa and the inner line is much less distinct. Beyond the outer line is an edging of pale scales or even a complete whitish line and the terminal area toward anal angle tends to become gray powdered. Beneath, pale gray-brown, powdery, with a discal lunule and extra-median line on both wings, occasionally an obscure discal line and sometimes a short line above anal angle.

Expands, 1.48–1.60 inches=37–40 mm.

*Habitat*.—Pennsylvania; Maryland; Washington, District of Columbia, "Pupa found, Iss. March 2, 82."

Three males and two females, labeled as above and all very much alike. The species resembles a miniature *obliqua* with all the maculation intensified and made more contrasting. This expresses the chief superficial differences, added to the absence of the violet gray wash and the presence of the white blotch near anal angle of primaries in the male. It is the intermediate step to *benesignata*, being less powdery and much less contrasting in maculation than that species.

The spinulation of the middle tibia is fairly well marked in both sexes, less visible in the heavier vestiture of the male. In the latter the middle femora are obviously tufted and the mass of specialized scales is quite large.

The male genitalia are moderately asymmetrical and very like those of the related species, the right clasper or harpe being much



more slender and more curved than the left. A comparison of the figures will better bring out the differences than any description.

In the female the indentations on the upper surface of the anal segment are well marked. Beneath, the lobes of the anal plate are large and well marked, the left being conspicuously larger than the right. The opening to the copulatory pouch is at the upper inner angle of the right plate and is all from the upper margin, differing markedly in position from that of *obliqua*, to which the species has the greatest superficial resemblance.

This species is listed in our catalogues as a synonym of *Pseudanthracia coracius* Guenée, a name of much later date, and Walker is responsible for the original identification. Mr. Grote, while he followed the reference, doubted its correctness, and I made no changes from lack of better information in 1893. In 1891 I found that the *squamularis* of Walker as represented in the British museum was *Ypsia undularis*, a small, flown example of which might readily be mistaken for *coracius* as figured by Guenée.

Reference to Drury's figure indicates a species the original of which could not possibly have been the *coracius* of Guenée, although neither does it represent at all accurately anything else in our fauna. But the description helps:

Alis cinereis, antice fascia irregulari centrali ferruginea, lineis duabus externa cineta, posticis fasciis duabus obscuris.

The expanse is given as 1.75 inches and the habitat as New York, May 11.

In the Westwood edition the English description is yet more specific:

*Upper side*.—The antennæ are brown, like fine threads. The colors on the anterior wings are divided by a strong bar of chocolate, running cross the wing near the middle, from the anterior to the posterior edges. This softens into a deep slate color, covering that part of the wings down to the external edges. The part next the shoulders is of a light ash or pearl gray color whereon are two small black spots or stripes, situated near the anterior edge. On the dark part near the lower corner run two small black irregular lines from the posterior edge; one running cross the wing, the other only half across. The posterior wings are of a lightish brown, having two bars of deep brown (almost black) rising from the abdominal edge, and crossing the wing upward, grow broader and fainter as they approach the middle and anterior edge.

Underside is of a faint russet color, having little or no markings thereon. All the wings are slightly dentated.

This figure and description could apply to nothing in our fauna save *obliqua* or the form with which I identify it here. It is too sharply marked for *obliqua*, and on the whole the description fits excellently well to the specimens now before me. It restores Drury's name without displacing any other now in use.

## PHÆOCYMA BENESIGNATA (Harvey).

1875. *Homoptera benesignata* HARVEY, Bull. Buff. Soc. Nat. Sci., III, p. 14.

Ground color gray, washed and powdered with brown and black. Head and collar usually darker, ranging from red- to black-brown; collar with a black transverse line. Thorax more or less gray, with two brown or blackish transverse lines. Abdomen pale yellowish brown, the dorsal tuftings distinct. Primaries with basal space more or less brown; basal line geminate, usually black, always obvious. T. a. line black, sometimes shaded inwardly so as to resemble a band, with an acute outward tooth on the subcostal, and outcurve in the submedian interspace, and an abrupt inward bend below vein 1. Between the t. a. and median lines the median space is conspicuously pale ash-gray, forming the most characteristic feature of the wing. The median shade line is usually double, tending to form a band, the inner portion black, sometimes almost upright, more often a little out-bent on the median, a little incurved in the interspace below it, and a little out-bent below vein 1, so that the gray band is broadest on the inner margin. Beyond this median shade the median space shades off gradually to the t. p. line, which is slender, black, complete, and preceded by gray powderings: opposite the cell it is deeply indented and moderately incurved from vein 4; usually a little marked on all the veins. There is no obvious orbicular in any specimen before me. Reniform narrow, lunate, blackish, outwardly followed by a yellowish brown cloud. S. t. line incurved from costa to vein 4, where it forms an acute outward tooth, then with another incurve to the inner margin, well within anal angle. Usually the line is black or blackish, a little diffuse inwardly, but sometimes it tends to become lost or obscure toward the costa. The s. t. space is mottled with gray and brown, but hardly contrasting. Beyond the s. t. line the terminal area is gray, strigillate with brown, with a brown terminal line and brown cuts on the fringes. Secondaries paler, whitish-gray to yellowish-fuscous, the disk crossed by two or three diffuse darker lines which may unite into a dark fascia; beyond the middle a complete brown line, followed at a little distance by a more distinct black one which is usually lost before it reaches the inner margin. The space between these two lines more or less darkened. Beyond the outer black line is a pale edging which sometimes forms a distinct whitish line. The terminal area is sometimes a little lighter, strigillate, and tends to a brown terminal line. Beneath pale, more or less yellowish, powdery, primaries with median, t. p. and s. t. lines and a discal lunule more or less obvious; secondaries with extramedian and s. t. lines and a discal lunule.

Expands, 1.40-1.60 inches = 35-40 mm.

*Habitat.*—Webster, New Hampshire, in May; Indian River, Florida.

Only two males and two females of this very distinct and handsome species are at present before me. I know of a few others in collections and they are as a rule correctly determined. There is little variation represented other than that incidentally mentioned in the description, and there is no apparent difference between the sexes.

The spinulation of the middle tibia is distinct in both sexes, and in one of the females there are two distinct spines between the two pairs of spurs. The middle femora of the male are conspicuously thickened, and the fringing of long hair incloses a large mass of specialized scales.

In the male the genitalia are very like the others of this series, offering only differences in detail rather than in type, and best shown by a comparison of the figures.

In the female the depressions of the upper surface of the terminal segment are well marked and the lobes of the under side are well marked and decidedly asymmetrical. The right lobe is much the smaller and the opening to the copulatory pouch is from the upper inner angle, but all from the upper margin, so that it is well to the right of the middle.

All things considered, this is one of the most brilliant of our species and I strongly suspect that when more material is available, it will be found that Mr. Morrison's name *cinerea* will be found applicable.

PHÆOCYMA LARGERÆ, new species.

Bluish ash-gray over a pale chocolate-brown base. Head brown. Collar with a darker brown line medially and at tip, edged with gray scales. Thorax with alternate gray and brown lines. Abdominal tuftings small. Primaries as a whole gray, all the markings more or less well defined in brown or blackish, not contrasting. Basal line brown, broad, inwardly diffuse. T. a. line single, brown, diffuse, irregular, as a whole inwardly oblique. Median shade very distinct, inwardly bordered by a darker brown or blackish line which is almost upright in effect, feebly bisinuate in course, outwardly shading off to the ground just before the t. p. line inferiorly, and at the reniform in the cell. The reniform is a very distinct, narrow, blackish lunule, which may be preceded by pale scales and is followed by a rusty yellowish shading. Orbicular a small black dot. T. p. line single, brown, diffuse, irregular, outwardly curved over the cell, moderately indented opposite the reniform, deeply incurved below the cell. S. t. line a brown diffuse shading, inwardly in whole or part edged with blackish scales, forming obvious outward teeth on veins 3 and 4, a lunule between them, with a slight incurve to the margins; that toward inner margin being most marked. There is a narrow brown

terminal line, and a series of brown interspaceal marks before the fringes. Secondaries smoky or fuscous, paler at base, with obscure discal line and a double brown or blackish exterior line. There is a gray, powdery marking toward anal angle, an irregular terminal line, and a series of gray lunules. Beneath yellowish, with a smoky discal lunule and two outer lines on all wings.

Expands, 1.80 inches=45 mm.

*Habitat*.—Winnipeg, Manitoba; Vancouver Island, May S. G. W. Taylor.

*Types*.—Rutgers College collection and collection Barnes.

One male and 1 female; the former from Doctor Fletcher, the Vancouver example; the latter from Doctor Barnes, the Winnipeg example. The male lacked an abdomen when it reached me, but was otherwise in good condition.

The two examples are very much alike, the male a little darker as a whole, the female with a little more of the rusty yellow shading from the reniform. These are not sexual differences and they probably occur in both males and females.

The species is larger and much less contrastingly colored than *benesignata*, yet resembles that species in the definition of the median shade. It is also larger than *duplicata*, much grayer, and with the transverse markings more diffuse. It is not likely to be confused with any other of the species and is, indeed, one of the most distinct of the series.

The spinnulation of the median tibia is moderately distinct in both sexes and easily seen. In the male the middle femora are not conspicuously tufted, and the mass of specialized scales is not great.

The indentations on the upper surface of the anal segment of the female are well marked; on the under surface the lobes are markedly asymmetrical, that on the right being decidedly smaller than the left and more ovate. The opening to the copulatory pouch is from the middle of the upper surface of the right lobe.

PHÆOCYMA DUPLICATA (Bethune).

1856. *Homoptera duplicata* BETHUNE, Canadian Journal, X, p. 257.

Ground color fuscous to smoky brown, the males darker throughout and more obscurely marked. Collar usually with a ferruginous tinge, a black line across the middle. Thorax crossed by two black and gray bands. Abdomen dark, the terminal segments ochereous, dorsal tuftings distinct. Primaries with all the markings distinct in most females and many males. Basal space darker; basal line black, single. T. a. line black, single, inwardly brown margined, sharply produced on the subcostal, a little outcurved below the cell and inwardly oblique below vein 1. The median line is usually well marked, nearly upright, brown, double, tending to form an obscure

fascia, the space between it and t. a. line more or less gray powdered in the female and usually a little paler in the male. There is an orbicular dot in some examples, while in others it is entirely absent. Reniform lunate, smoky, outwardly edged with pale scales and tending to become outlined in pale; a reddish or gray shade to the t. p. line which is narrow, linear, black or brown, and tends to become lost in whole or in part. Opposite the cell it has the usual indentation forming a W, with the outer angles more or less rounded. S. t. line black, tending to become diffuse inwardly, sharply toothed on vein 4 and thence forming the usual inward curves toward costal and internal margins respectively. There is a more or less obvious dusky shade beyond the lower half of this line in some specimens, which obscures the otherwise paler terminal area, which is strigillate with brown. There is a distinct brown crenulated terminal line in most females and in some the fringes are narrowly cut with brown. In the male there is an obvious white blotch above the anal angle, forming a conspicuous feature of the wing. Secondaries more sordid fuscous or yellowish-brown with obscure median shade lines, an outer black line inwardly bordered by a brown shade, which forms a more or less distinct band and may be inwardly margined by a more or less distinct brown line; outwardly this black line is bordered by pale scales, and there are gray powderings in the terminal area tending to form strigillations. There is a brown terminal line, the incisions tending to become marked by white scales. Beneath much paler, yellowish brown, powdery; all wings with a more or less obvious discal lunule; usually there is an extra-median transverse darker line, and sometimes a median line as well.

Expands, 1.40–1.60 inches = 35–40 mm.

*Habitat*.—Maine; New York; Pennsylvania; New Hampshire (Webster and Manchester).

I have 5 males and 6 females under examination, none of them dated and most of them with the State label only. No two examples are alike. All the males have the conspicuous white spot above the anal angle and none of the females have any trace of it; but as for the rest, the terminal space varies equally in both sexes in the amount of gray or distinctness of strigillation. The conspicuous terminal line of most females is characteristic, and is an aid in referring occasional examples that have a smoother vestiture than usual. In the male the tendency is to almost absolute uniformity in color from base to s. t. line, and one of the examples comes close to reaching this point. The median band is not well defined in any example of this sex, while in all save one of the females it is very distinct.

The tendency is toward *benesignata* in the female, and occasionally a specimen of this sex may cause trouble in placing; but this is on the whole so distinctly a powdery form that this must happen but rarely, while in the male no confusion is possible.

The spination of the middle tibia is not strongly marked, and in the male not easily demonstrated in the thick vestiture. The sexual tufting on the middle femora of male is not conspicuous and the mass of specialized scales is small.

The genitalia of the male are of the general type in the group, and while they differ in detail from the related species, offer nothing conspicuously peculiar.

In the female the impressions on the upper surface of the anal segments are very well marked, and the lobes of the under side are equally obvious. They are less asymmetrical than usual and the opening to the copulatory pouch is at the upper inner angle, coming from the upper margin rather than the angle.

PHÆOCYMA BETHUNEI, new species.

Ground color dull smoky brown, with a more or less well defined rufous tinge, which is conspicuous in all cases on the primaries, between the reniform and t. p. line. Head concolorous. Collar with a black line at base, a smoky line across the middle, and a blackish line at tip; each line may be edged with white scales and, on the other hand, all the lines may be lost or barely indicated. Two gray lines cross the thorax, and these may be quite distinct or barely traceable, while in flown examples they may appear to be altogether absent. Abdomen dull brown, terminal segments often ochreous; dorsal tuftings very distinct. Primaries with the vestiture a little uplifted so that the wing has a sort of velvety appearance, on which all the markings appear somewhat diffuse and none are sharply limited or contrasting. Basal space usually darker and apparently crossed by transverse dusky shadings. Basal line traceable in most specimens. T. a. line darker brown or blackish, single, irregularly out-curved, with a little outward tooth on the subcostal and a more obtuse bend on the submedian. The median shade is upright and may consist of a solid broad band of smoky brown or blackish, or of two parallel diffuse lines close together, broadening a little on the cell so as to include the narrow lunate reniform which is rarely separate from the band. Before this median band there may be a gray powdering, and between it and the t. p. line there is usually a decided reddish tinge which, as already noted, becomes most conspicuous just beyond the reniform and, in fact, gives the impression of a large, kidney-shaped, discolorous reniform. T. p. line brown to blackish, single, outwardly toothed on veins 4 and 6, with a deep inward indentation between and strongly incurved below the cell. S. t. line tending to become lost through the upper part of its course, and always better marked below middle; forms the usual obtuse outward angulation at its middle, and incurved from that point toward costa and inner margin. There is a more or less obvious dentate terminal line at base of the paler fringes. Secondaries

smoky, a little paler than primaries, with two diffuse transverse smoky lines just within middle, and a more or less obviously double extra-median line, the space between which may be darkened to form a band. A smoky terminal line following the irregularities of the wing margin, and lunate whitish spots marking the indentations. Beneath much paler, more yellowish-brown, with t. a., t. p., and s. t. lines and a discal spot more or less obvious on all wings: the space between the outer lines sometimes a little darker so as to form a band.

Expands, 1.25–1.50 inches=31–38 mm.

*Habitat*.—Washington, District of Columbia, June and August; Tryon, North Carolina, August, Fiske collection; Maine.

*Types*.—U.S.N.M., Coll. No. 12027; also Rutgers College collection.

Two males and 6 females. The specimens from District of Columbia and North Carolina are from the U. S. National Museum, and one male bears a label "Larva found feeding on Pine, Imago iss. June 19, 82."

There is very little difference between the sexes in the material under examination; but there is a little gray powdering beyond the s. t. line which may become more marked at times. As for the rest, it is merely a matter of more or less obscurity in maculation.

The spinulation of the middle tibia is scant and not readily demonstrated in the heavy vestiture. In the male, the femoral tufting is not prominent and the mass of specialized scales is not large.

The genitalia of the male do not differ in any material point from those of *duplicata*.

In the female the impressions on the upper surface of the anal segments are obvious, and tend to become discolored. On the lower surface the lobes are distinctly asymmetrical and are relatively small, compared with the size of the opening to the copulatory pouch. The latter is at the upper inner angle of the right lobe, and entirely on the upper margin.

As a whole this is a well marked form, differing from all others by its elevated rough vestiture and absence of all sharply defined maculation.

#### PHÆOCYMA CINGULIFERA (Walker).

1852. *Phæocyma lunifera*, ♂ GUENÉE, Spec. Gen., Noct., III, p. 3, pl. xv, fig. 9.

1857. *Homoptera cingulifera* WALKER, C. B. Mus., Het., XIII, p. 1056.

1857. *Homoptera intenta* WALKER, C. B. Mus., Het., XIII, p. 1070.

1877. *Homoptera woodii* GROTE, Chb. Ent., IX, p. 88.

1893. *Homoptera cingulifera* (= *intenta*) SMITH, Bull. 44, U. S. Nat. Mus., p. 370.

1893. *Homoptera cingulifera* (= *woodii*) SMITH, Bull. 44, U. S. Nat. Mus., p. 370.

1903. *Homoptera cingulifera* HOLLAND, Moth Book, p. 278, pl. XXXVII, fig. 17.

Ground color smoky brown. Head uniform rusty brown. Collar only a little darker, with a median transverse black line and a white

tip. Thorax crossed by dark and gray transverse lines, the posterior tuftings uplifted and gray-tipped. Dorsal tuftings of abdomen small, sometimes gray-tipped. Primaries transversely strigillate, the strigillation continuous, brown, and many of them completely crossing wing. Basal space darker than the rest of the wing. Basal line brown, geminate, usually obvious. T. a. line a broad, rather even, deep brown band, preceded by a yellowish line, almost direct from costa to middle, then bent inwardly oblique to inner margin. The median space as it begins at the t. a. line is gray, and is the palest portion of the wing, relieving the dark t. a. line; outwardly it shades into the ground, sometimes before the middle, sometimes hardly before the t. p. line. The orbicular is a small brown dot, which is sometimes lost. Reniform gray, lunate, with a rusty brown annulus within its area, and poorly defined by a darker border. T. p. line narrow, linear, rich velvety brown, irregular, outwardly bent from costa to vein 7, then inwardly bent opposite the reniform and then, with three sinuations, obliquely inward to the internal margin. From the apex a dark shade extends obliquely inward to the s. t. line opposite cell. S. t. line blackish brown, irregular, rather close to and as a whole parallel with t. p. line; inwardly diffuse, outwardly bordered by rusty brown. Terminal area usually only a little darker than the inner portion of median space, darkened by the brown strigæ, with a narrow, crenulate terminal line. Secondaries smoky-yellowish at base, and usually to an extra-median brown shade, which is like the paler ground of primaries. The disk is crossed by dusky transverse shadings, and the terminal area is strigillate. Beneath yellowish, powdery, more or less strigillate with brown, sometimes gray along costa and outer margin; a dusky discal humule and a median and extra-median dusky line on all wings; the latter with an outward angle below costa of primaries.

Expands, 1.52-1.92 inches=38-48 mm.

*Habitat*.—Maine to Florida, west to Wisconsin.

In the material before me there is a very dark richly colored example from Mount Katahdin, Maine, dated in July. Specimens from Webster, New Hampshire, are dated in May, and some very handsome material from New Brighton, Pennsylvania, was collected by Mr. H. D. Merrick in late April.

This is one of the most characteristic species of the genus, and while it varies somewhat in brilliancy of coloring and amount of contrast, there is never enough to raise a doubt as to the species. The peculiar elevation of the posterior thoracic tufting and its contrasting color are distinctive features belonging to none other of these species except *Zale horrida*.

The spination of the middle tibia is distinct in both sexes, and in some examples spines occur also between the two pairs of spurs



of the posterior tibiae. The middle femora of the male have no sexual tufting nor store of specialized scales.

The male genitalia are symmetrical or nearly so, but the penis sheath is bent and curved to a moderate extent.

The depressions on the upper side of the penultimate segment are well defined and marked by discolored scales. The lobes on the under side are almost equal in size and approximately so in form. The opening to the copulatory pouch is at the upper inner angle of the right lobe, almost central as to the segment, and comes from the inner margin entirely.

There seems to be no doubt that Guenée's figure in the Species General refers to this species and not to the true *lunifera* of Hübner, and the latter's figure lends itself very easily to this misidentification. It is equally certain that Hübner did not have this particular species before him in his work.

PHÆOCYMA COLORADO, new species.

Ground color dull fuscous, more or less washed with gray or brown. Head lighter or darker than ground, with or without a dark frontal line, sometimes with a gray line as well. Collar with a distinct black line inferiorly, and a broader, brown band near tip. Thorax with two more or less obvious transverse lines, which may or may not be edged with white scales posteriorly. Abdomen with the dorsal tuftings conspicuous. Primaries with the wings conspicuously strigilate, the basal and s. t. spaces always darker than the other portions. Basal line geminate, black, usually well marked. T. a. line geminate, often in the form of a broad, brown, even band, preceded by a narrow pale line, only a little irregular outwardly. Beyond this line there is in the male always, and in the female sometimes, a whitish or very pale area merging gradually into the darker outer portion of the median space. There is no orbicular in any of my specimens. Reniform small or moderate, lunate, uniformly dark brown or blackish, yet not conspicuous and without defining lines. T. p. line narrow, single, black or brown, always complete, with the usual inward tooth on the cell moderate, and the line otherwise only a little irregular. S. t. line slender, black, nearly parallel with the t. p. line from inner margin to middle, where it forms an obtuse angle and diverges outwardly so as to reach the costa well within the apex. The s. t. space is dark throughout, but above the angulation it tends to become paler than elsewhere, and it darkens again on the costa, forming a conspicuously darker, roughly triangular patch. Terminal area more or less gray in the male and sometimes in the female; usually with an oblong dark apical patch. There is a black, crenulated terminal line, exaggerating the lines of the outer margin, with a white dot at the incisions and a tendency to a dusky line across the fringes

at the extensions. A whitish line at the base of the fringes, which are interlined with brown. Secondaries with the disk crossed by three obscure dusky lines, the intervals between which may be gray powdered. The outer black line extends from anal margin to apex with a slight incurve, usually a little indented on the veins and out-curved between, preceded by a darker shading which becomes most obvious at anal angle, followed by a paler shading which, in the male, tends to occupy most of the terminal area. There is a distinct, black, thread-like terminal line, with more or less marked white dots at the incisions, and there is a pale line at the base of the fringes. Beneath smoky, with more or less obvious gray shadings and powderings; sometimes almost immaculate, more often with only discal spots; often with an exterior common line and rarely, on secondaries, two or three darker lines across the disk.

Expands. 1.40–1.80 inches=35–45 mm.

*Habitat*.—Colorado, May and June, Manitoba, Denver, Glenwood Springs; Arizona in June, Palmerlee and Williams; Texas in March; probably all collected by Belfrage.

*Types*.—U.S.N.M., Coll. No. 12028; Rutgers College Collection; cotypes, Coll. Barnes, Ottolengui, Brooklyn Institute.

A series of 23 males and 9 females is at hand for comparison and shows a considerable range of variation. The large females from Texas resemble *cingulifera* so closely at first sight that I was not surprised to find specimens so placed in collections. The uniformly dusky reniform of this species, however, separates it at a glance. Some of the males at first seem referable to *rubiata*, and there is one form, occurring in both sexes, in which the median space becomes yellowish brown and a resemblance to *minerva* is established. The tendency is for the females to become uniformly dull brown, without obvious gray shadings, but with the basal and subterminal spaces conspicuously dark. In all cases the transverse strigillation is distinct or even conspicuous, but it is least marked in the specimens with yellow brown median space.

The spinulation of the middle tibia is sparse, but the spines are long and are easily distinguishable in the vestiture. There are no conspicuous femoral tuftings in the male and on the middle legs there is no mass of specialized scales.

The genitalia of the male are only a little asymmetrical, both harpes very strongly down-curved and a little enlarged near the tip, having the general type of *rubi* and *rubiata*, but differing in detail as shown in the figures; it does not resemble *cingulifera* at all.

In the female the genitalia are asymmetrical. The depressions on the upper surface of the penultimate segment are distinct, but not marked by discolorous scales. On the under side the lobes are altogether different in outline. The one to the right is not more than half

the size of that on the left, obliquely oval in form, with the opening to the copulatory pouch taking up most of the upper margin.

The species is probably not at all uncommon.

PHÆOCYMA RUBIATA, new species.

Ground color a grayish, luteous brown, dull and sordid. Head concolorous. Collar with a blackish line inferiorly. Thorax without markings. Abdomen with the tuftings small, especially in the female. Primaries very little powdery, very flat in tint. Basal space a little darker, especially in the male. Basal line geminate, brown, traceable in most specimens. T. a. line geminate, forming a broad brown band which is outwardly edged with black, and inwardly defined by a narrow yellowish line; in course very even, forming no obvious dents or angulations. There is no obvious orbicular. In the males the median space usually becomes a little more reddish-brown outwardly, but in all the females at hand it remains uniform. The reniform is of moderate size, lunate or kidney shape, usually a little darker, more or less obviously defined by an edging of darker scales and by a pale outer line which may extend all around the macula. T. p. line very slender, usually blackish, but sometimes only a little darker than the ground; a very moderate indentation opposite the cell and in most specimens a slight though well-marked angle on vein 2. In the males the s. t. space is usually darker than the other spaces; in the females it is concolorous. S. t. line black, usually the most distinct feature of the wing, inwardly diffuse, followed by a variably evident pale line which, in some specimens, tends to interrupt the line on the veins and give it a somewhat lunate appearance. In course the line is parallel with the t. p., and equidistant from it from the internal margin to vein 7, whence it extends outwardly oblique to the costa. An oblique brown to blackish shade extends from the edge of the s. t. line on vein 7 to the apex. Terminal space in the female concolorous throughout; in the male it contrasts a little against the darker s. t. space and there is a tendency to a gray powdering beyond the s. t. line, especially below the middle. There is a brown terminal line, preceded by a series of black points in the interspaces, and there is a pale line at base of fringes. Secondaries with two or three obscure brown shade lines across the disk, followed by a geminate outer line, which represents the continuation of the t. p. and s. t. lines of primaries; the intervening space more or less distinctly brown-filled in both sexes. The outer of these lines is the most distinct, and there is usually an obvious outward dent in the interspace beyond the cell, forming a small W. The terminal lines and dots are as in the primaries. Beneath yellowish, more or less powdery, ranging from im-

maculate to forms with a discal spot and two irregular transverse lines on all wings.

Expands, 1.32-1.52 inches = 33-38 mm.

*Habitat*.—Arizona; January, May, August.

*Types*.—Coll. U.S.N.M., Coll. No. 12029; also cotypes Coll. Rutgers College and Doctor Ottolengui.

Only 2 of the 18 examples before me have specific localities—Phoenix and Nogales—but several of them are dated. There are 13 males to 5 females, and the difference between the sexes is conspicuous. The females are all very even, but by no means alike, since the ground varies in shade and no two are alike in the relative distinctness of the lines, especially of the s. t. line. In the males the chance for variation is greater, because the median space darkens or deepens in tint outwardly, and because there is a tendency to lighten up the terminal area in greater or less contrast to the s. t. space.

Whether this species is really distinct from *rubi* is perhaps a question. It seems so to me at present, judging from the scanty material of *rubi* now in my hands. As the species stand now, *rubiata* is always of some shade of dull yellow-brown and has a peculiar dead flat tint. *Rubi*, on the contrary, is gray, and has no obvious red or yellow shadings at all. The differences may be racial or geographic, or they may prove merely individual when better material is at hand.

The spinulation of the middle tibia is sparse and often difficult to make out in the vestiture. The middle femora of the male have no obvious tuftings, and there is no mass of specialized scales.

The male genitalia are not markedly asymmetrical; the harpes differ a little in width and outline, but are similar in length and curvature. Compared with those of *rubi* they are distinctly broader and stouter.

In the female there is not much evidence of modification on the upper surface of the penultimate segment. Beneath, the lobes are similar in size and form, with the opening to the copulatory pouch from the upper inner angle, and mostly from the inner margin. There is very little difference in detail between *rubi* and *rubiata*, and such as there is can be better determined by a comparison of the figures.

PHÆOCYMA RUBI (Henry Edwards).

1881, *Homoptera rubi* HENRY EDWARDS, *Papilio*, 1, p. 28.

Gray, tending to smoky. Head concolorous; collar with a black median line; thorax in the specimens before me without markings. Primaries very uniform in tint, without strong contrasts except that the s. t. line is distinctly black. Basal space a little darker to the band-like t. a. line, which consists of geminate, very narrow blackish lines, with the intervals dusky filled. It is preceded by a pale line

and on the median vein and costa are some dark scales indicating a geminate basal line. Median space concolorous or crossed by vague, transverse dusky shadings. Orbicular wanting in the specimens. Reniform rather long, kidney-shaped, almost lunate, edged with yellow scales. T. p. line very slender, black, outwardly exerted over the cell to vein 4, then with a decided incurve obliquely to the inner margin; a little drawn in opposite the reniform. S. t. line black, distinct, inwardly oblique from costa to the indrawing of t. p. line opposite reniform, then close to and parallel with that line for the balance of its course. The outward angle is well marked between veins 3 and 4, and a dusky shade may extend from that point to the margin. There may be an oblique, dusky apical shade. There is a very narrow, crenulated terminal line, followed by an equally narrow pale line at the base of fringes, a very minute dusky dot marking the indentations of these lines on the interspaces. Secondaries basally a little paler, disk crossed by obscure transverse dusky shadings. Beyond this the usual double line, of which the inner is black and thread-like, continuing the t. p. line of primaries, and the outer better marked, broader, inwardly diffuse, outwardly bordered by a pale shade line; this combination tends to terminate at apex rather than on the costa. Terminal lines as on the primaries. Beneath yellowish gray, powdery, all wings with a discal spot and an extra-median line; that on the secondaries more or less crenulate.

Expands, 1.48–1.60 inches = 37–40 mm.

*Habitat*.—Soda Springs, Siskiyou County, May 31; Yosemite Valley; both in California.

I have only one male and one female, the former from the Dyar collection in the U. S. National Museum, taken by Mr. J. B. Lambert, the latter given me by Mr. Henry Edwards, and almost a duplicate of his type. The Arizona localities given refer, I think, to the species that I have called *rubiata*, and whose relations I have already discussed. In addition to what has been previously said it may be pointed out that the angle of s. t. line in *rubi* is decidedly more acute and produced, and does not tend to form an obtuse curve involving the interspaces between the 4th and 5th, as well as 3d and 4th veins.

As for the structure of legs and genitalia, they are as described for *rubiata*, with such differences as are best brought out by a comparison of the figures given.

PHÆOCYMA YAVAPAI, new species.

Ground color very dark brown, powdered with black, so that at first sight the insects appear almost black. Head powdered with gray; a more or less obvious gray and black frontal line, and a similar line on the vertex. Collar gray tipped, with a distinct black median transverse line in all specimens. Primaries with basal space a little

darker. Basal line distinct, black, more or less obviously geminate. T. a. line forming a broad deep brown band, outwardly edged by a black line, and inwardly by pale scales. Median space scantily powdered with white scales, usually more massed toward t. a. line; three broad, diffuse, smoky transverse lines beyond the middle. The reniform is somewhat lunate, elongate, inwardly edged with black scales, outwardly with a more or less complete white line. Orbicular a black dot or entirely absent. T. p. line very slender, black, even, rather evenly outcurved over the cell, and oblique, only a little wavy, below it. S. t. line a little broader, equally distinct, forming an acute outward angle on vein 5, reinforced by a lunate black mark between veins 7 and 8, and from this a blackish shade extends to the apex. The space between t. p and s. t. lines is usually darker, and there is a darker brown shade beyond the s. t. line, divided from it by an edging of white scales. Terminal space strigillate with black; a pale terminal line. Fringes interlined black and white. Secondaries lighter brown, the disk crossed by three broad, brown lines, alternated with narrow whitish lines. A geminate extramedian line, of which the intermediate space is dark filled, forming a broad band edged with narrow black lines, of which the outer is the more distinct and followed by a narrow white line. A white terminal line, and fringes with white interline. Beneath very dark fawn gray, somewhat mottled with brown, with a common extramedian line and dark discal spots. The costa is marked and spotted alternately blackish and gray, there is a narrow black terminal line, followed by a whitish line at the base of the fringes, and there is a white dot at the incisions between the veins.

Expands, 1.32-1.52 inches = 33-38 mm.

*Habitat*.—Yavapai County, Arizona, July 22-August 5; Glenwood Springs, Colorado, in May.

*Types*.—Rutgers College Collection: cotypes, Coll. U.S.N.M., No. 12030, and Doctor Barnes.

One male and 3 females collected by Mr. Hutson; 2 males and 1 female from Doctor Barnes. This species is quite different from its nearest allies in a number of ways. There is very little variation in the material before me and very little difference between the sexes. The male has perhaps a little more white powdering, but otherwise the two are alike.

In type of maculation it is like *edusina*, so like that it is difficult to find points of distinction between the two, and with the San Antonio males of the other species at hand for comparison, it seems but a short step from one to the other. The only really tangible and constant character in *yavapai* besides the very dark color is the clean-cut black line on collar, which is not present in any *edusina* that I have seen. Nevertheless, the two species are markedly distinct, for while in *edusina* the femoral tufting of the male is conspicuous and

the mass of specialized scales is large, in *yavapai* the tufting is reduced to a mere fringe of long hair, and there are no specialized scales at all. I have only 3 males of *yavapai*, but all these had the legs perfect, so that I could verify the point; of *edusina* I have a large series of males, and even the darkest of them which most resemble the new form have the femoral mass of scales conspicuous.

In male genitalic characters *yavapai* differs only in details from *edusina*; the differences are obvious enough on comparison, but not so marked as might be anticipated from the difference in the secondary characters; the type is identical.

In the female the differences from *edusina* are greater. There is a series of chitinous plates surrounding the genital opening; but the plates are much larger, very characteristic in form, and utterly unlike those found in *edusina*. A comparison of the figures will make this matter very clear at first glance, and that these differences are constant I have verified by an examination of two preparations of *yavapai* and of several *edusina*.

PHÆOCYMA CALYCANTHATA (Smith and Abbot).

1797. *Phalana calycanthata* SMITH AND ABBOT, Ins. Ga., II, p. 207, pl. CIV.

1816. *Phæocyma calycanthata* HÜBNER, Verzeichniss, p. 275.

1852. *Homoptera calycanthata* GUENÉE, Sp. Gen., Noct., III, p. 15.

1875. *Homoptera uniformis* MORRISON, Can. Ent., VII, p. 148.

Ranges in ground color from dirty yellow- to light chocolate-brown, more or less powdered and strigillate with darker brown. Head concolorous; collar with an obscure darker line; thorax with vague dusky transverse shadings. Abdominal tuftings small, and in well preserved examples white-tipped. Primaries with basal space usually a little darker; t. a. line indicated chiefly by the difference in shade between the two spaces. T. p. line lost. S. t. line yellow or pale, continuous or broken, sometimes preceded and sometimes followed by a dark shading or an edging of black scales, in direction oblique from costa to inner margin, almost rectangularly exerted on vein 4; the angle sometimes well marked, sometimes rounded. Orbicular punctiform, black, distinct in all my specimens. Reniform moderate, not well defined, upright, dusky or blackish, more or less edged or marked with paler scales. The terminal area is usually paler than the rest of the wing, but may be concolorous or even darker. A crenulated terminal line in some examples, with a series of black points at the inward teeth. Secondaries may be lighter or darker than or concolorous with primaries, with a variably distinct outer line that continues the s. t. of primaries and is very much like it in its make-up and variation. As a rule it does not reach the costal margin and sometimes falls well short of it; but it may be yellow and preceded by a dark shade, well defined all the way across. Terminal area usually a little paler. Beneath yellowish to fuscous,

powdery or strigillate, usually with a dark discal lunule, sometimes with more or less obvious transverse lines or shades.

Expands, 1.28-1.48 inches; 32-37 mm.

*Habitat*.—North Carolina; Georgia; Florida.

Three males and four females are now under observation, and I have not seen many more in collections. The only dated example is from "Vade Mecum, N. C., VII, 3." No two specimens are alike, and yet there is no doubt of their association. The comparatively small size, broad primaries, conspicuous s. t. and absent t. p. lines, and the dark, ill-defined reniform all unite to form an absolutely unique combination.

The species has been curiously misidentified in American collections, at least three if not four distinct species doing duty under the name, and never have I seen the species here described among them. The species indeed seems rare. Abbot refers to this fact in his description, but says it is more common in Virginia; but what he had from Virginia may be questioned. Guenée had only Abbot's figures, and his description fits one of my examples very nicely. He criticises Abbot's engraving and says it is badly rendered; but I have examples that suit that engraving very well indeed. Morrison had the species from Georgia, but did not recognize its identity with Abbot's form, and redescribed it as *uniformis*. It is probable, indeed, that he never even compared it with the figure. Doctor Bethune identified *Zale horrida* with this name, and that is no worse than the other identifications, some examples of *calycanthata* resembling reduced brown *horrida*.

The spinulation of the middle tibiae is distinct in both sexes, and in some cases there may be spines on the posterior tibiae between the usual spurs. The middle femora of the male are not tufted and have no store of specialized scales.

The male genitalia are markedly asymmetrical, the harpes bearing no resemblance to each other; the figures must be referred to for details.

The females have the terminal segment on the upper side without obvious impressions, and the underside is not lobed. There is a large anal orifice surrounded by irregular chitinous pieces, and inside of this, to the left, is the opening to the copulatory pouch.

#### PHÆOCYMA HORRIDA (Hübner).

1818. *Zale horrida* HÜBNER, Zutrage, I, p. 11, figs. 31, 32.

1818. *Zale horrida* HÜBNER, Verzeichniss, p. 275.

1852. *Zale horrida* GUENÉE, Spec. Gen., Noct., III, p. 281.

1857. *Homoptera calycanthata* ‡ WALKER, C. B. Mus., Het., XIII, p. 1054.

1858. *Drasteria horrida* WALKER, C. B. Mus., Het., XIV, p. 1457.

1865. *Homoptera calycanthata* ‡ BETHUNE, Canadian Journal, X, p. 251.

1868. *Homoptera horrida* (= *calycanthata* WALKER, not GUENÉE) GROTE and ROBINSON, Trans. Am. Ent. Soc., II, p. 79.

Ground color varying from light chocolate brown to almost blackish. The patagia and posterior thoracic tufts discolorous yellowish



brown behind. Primaries of the ground color to the s. t. line, beyond which it is a much lighter brown, ranging almost to whitish, with fine transverse brown strigillations. The t. p. and s. t. lines are coincident from vein 7 to the inner margin, with an outward lobe at middle and a deep incurve below. Above vein 7 the t. p. line separates and goes obliquely inward to the costa in the form of a double pale line. The t. a. line is rather irregular and not very well marked; but is traceable in the paler specimens and is black, preceded by a yellowish mark on costa. The basal line is also indicated by a yellowish costal line, which sometimes extends across the costal area. The disk is crossed by three more or less obvious dusky shade lines. Secondaries a little paler than the primaries to the terminal area, which is separated off by a denticulated pale line, the paler terminal area with brown strigillations. The disk is crossed by three or four somewhat darker shade bands. Beneath smoky, crossed by numerous wavy shade bands.

Expands, 1.40–1.60 inches = 35–40 mm.

*Habitat*.—Canada to Texas, west to the Rocky Mountains, May to August in the northern part of its range, Texas in March and August.

This is a very characteristic species which does not vary to any considerable extent, nor enough to confuse its identity at any time.

The genitalia of the males have the harpes similar in size but quite dissimilar in form; both are rather narrow and bent downward; but the left harpe is continuous, flattened toward the tip and squarely cut off, while the right is extended at the angulation into a flattened process like a short fork.

The female has the penultimate segment lobed, the lobes subequal, the opening to the copulatory pouch at the upper inner angle of the right lobe, and all from the side of the lobe, no part of the top being involved.

#### HOMOPTERA CINEREA Morrison.

1875. *Homoptera cinerea* MORRISON, Can. Ent., VII, p. 148.

The following is Morrison's original description:

Expanse, 45 mm. Length of body, 20 mm.

Palpi gray, of normal form. Collar, thorax, and abdomen cinereous black. Pterygodes well marked. Abdomen strongly tufted, the two anal segments ochreous, very distinctly so beneath. Both wings shining, cinereous, on a black ground; the outer half of the wings have a slight purple tinge in certain lights; orbicular spot a black dot; median shade well marked, angulate on the median vein, followed by a blackish, less cinereous shade line, twice angulate opposite the brown diffuse reniform spot; subterminal line distinct inferiorly only a yellow brown shade along the costa of the posterior wings; the disk of the wings is occupied by alternating cinereous and blackish shades, the former predominating; one distinct black median line preceded by a blackish shade. Beneath uniform cinereous, gray, discal dots not prominent.

Hab. Massachusetts.

The beautiful cinereous and black coloration of this fine species will at once separate it.

I have not been able to apply this description satisfactorily, but suspect that it refers to *benesignata* Harvey. "There is no other that has the same contrasting gray and black maculation; but, on the other hand, I could not call the primaries "Shining, cinereous, on a black ground." I am compelled, therefore, much to my regret, to leave this name without definite application.

Among the material sent me by Doctor Dyar for examination was a single example from the Schaus collection, labeled Miami, Florida, and without much doubt actually taken there. It was associated in the collection with South American examples marked *Homoptera sexplagiata* Walker, and is apparently the same species.

This form is utterly unlike any other of our American species and is tropical in type. It is an example of that element that extends into our political boundaries at certain points, but is not a part of the faunal region to which all but a very small area of North America north of the Mexican boundary line naturally belongs.

Had the species fitted naturally into any of the groups of our species I would have included and called attention to it there. As it does not, I present a copy of Walker's original description:<sup>a</sup>

#### HOMOPTERA SEXPLAGIATA.

Mas. *Cerrina*, *subtus cinerea*; *thorax c punctis albis subfasciatus*; *pectus fuscum*; *abdomen cinereum*; *ala lineis plurimis transversis undulatis nigris*; *antica fascia incompleta basali, lituris costalibus plagiisque duobus magnis submarginalibus subviridiscutibus albis*; *postica basi testacea, fascia abbreviata subfusiformi submarginali alba*.

*Male*.—Fawn colour, cinereous beneath. Thorax with some white speckles, which form incomplete bands. Pectus brown. Abdomen cinereous. Wings with numerous transverse undulating black lines. Fore wings with an incomplete white band near the base, with white marks along the costa, and with two large submarginal white indistinctly iridescent patches, forming a broad interrupted band. Hind wings with a subfusiform submarginal band like that of the fore wing in colour, shortened in front; base testaceous. Length of the body  $7\frac{1}{2}$  lines; of the wings 20 lines.

*a*. Brazil. From Mr. Stevens' collection.

#### LIST OF THE SPECIES OF PILEOCYMA Hübner.

SUBGENUS PILEOCYMA <i>vera</i> .	SUBGENUS PILEOCYMA <i>vera</i> —Cont'd.
<i>P. exhausta</i> Guenée.	<i>P. edusina</i> Harvey.
<i>P. fetilis</i> Guenée.	<i>atrifuncta</i> Harvey.
<i>guadalupeensis</i> Guenée.	<i>P. undularis</i> Drury.
<i>P. viridans</i> Guenée.	<i>nigricans</i> Bethune.
<i>P. lunata</i> Drury.	var. <i>umbripennis</i> Grote.
<i>edusa</i> Drury.	<i>P. aruginosa</i> Guenée.
<i>putrescens</i> Guerin.	<i>plenipennis</i> Walker.
<i>involuta</i> Walker.	<i>P. insuda</i> Smith.
<i>saundersii</i> Bethune.	<i>P. norda</i> Smith.
<i>P. salicis</i> Behr.	<i>P. minerca</i> Guenée.
<i>rosa</i> Behr.	<i>obliqua</i> ‡ Walker.
	<i>albofasciata</i> Bethune.

<sup>a</sup> Catalogue of Heterocera, etc., XIII, 1857, p. 1064.

SUBGENUS *PHÆOCYMA vera*—Cont'd.

- P. lunifera* Hübner.  
*penna* Morrison.  
*P. lincosa* Walker.  
*lunifera* ‡ Grote.  
*galbanata* Morrison.  
*P. unilincata* Grote.  
*P. obliqua* Guenée.  
*P. melata* Smith.  
*P. curvata* Smith.  
*P. helata* Smith.  
*P. squammularis* Drury.  
*P. benesignata* Harvey.  
*P. largera* Smith.  
*P. duplicata* Bethune.  
*P. bethunci* Smith.

SUBGENUS *ZALE* Hübner.

- P. cingulifera* Walker.  
*intenta* Walker.  
*woodii* Grote.  
*lunifera* ‡ Guenée.  
*P. colorado* Smith.  
*P. rubiata* Smith.  
*P. rubi* Henry Edwards.  
*P. yarapai* Smith.  
*P. calycanthata* Smith and Abbot.  
*uniformis* Morrison.  
*P. horrida* Hübner.  
*calycanthata* ‡ Walker.  
  
*Unknown to me.*  
*P. cinerica* Morrison.

## EXPLANATION OF PLATES.

## PLATE XXXI.

- Fig. 1. *Phæocyma exhausta*, dorsal view of male genitalia. Shows the flattened extension shielding the uncus.  
 2. *Phæocyma fecilis*, male genitalia from side so as to show the form of the uncus. The harpes are not greatly dissimilar.  
 3. *Phæocyma lunata*, male genitalia from above; brings out more particularly the double process of right harpe.  
 3a. *Phæocyma lunata*, same from below, showing the curved penis sheath and the left harpe with its irregular tip.  
 3b. *Phæocyma lunata*, the right harpe seen from below, showing the relation of the two divisions to each other.  
 3c. *Phæocyma lunata*, the left harpe seen from below.  
 3d. *Phæocyma lunata*, frame of supra-anal plate with uncus.  
 3e. *Phæocyma lunata*, the penis sheath from below.  
 4. *Phæocyma salicis*, male genitalia from above.  
 5. *Phæocyma edusina*, male genitalia from above; the left harpe is divided into two parts.  
 5a. *Phæocyma edusina*, male genitalia from side, to bring out the form of the very long transversely flattened uncus.  
 6. *Phæocyma undularis*, male genitalia from above.  
 7. *Phæocyma umbripennis*, male genitalia from above; this is the same as *undularis*, but the two figures are slightly different to bring out the peculiar form of the harpes. The supra-anal plate is really extraordinarily narrow and the uncus very slender.  
 8. *Phæocyma aruginosa*, male genitalia from above.

## PLATE XXXII.

- Fig. 1. *Phæocyma insuda*, male genitalia from above; harpes and uncus forced a little to the right to bring out the form better.  
 2. *Phæocyma norda*, male genitalia from above.

‡ Species cited in error.

Fig. 3. *Phaocyma minerca*, male genitalia from above. Very like the preceding, the differences in the figures being in part due to a little difference in point of view.

4. *Phaocyma lunifera*, male genitalia from above.
5. *Phaocyma lineosa*, male genitalia from above. Directly comparable with the preceding, both views being a little from the right to bring out form better.
6. *Phaocyma unilincata*, male genitalia from above: almost symmetrical.
7. *Phaocyma obliqua*, male genitalia from above.
8. *Phaocyma mutata*, male genitalia from above.
9. *Phaocyma curvata*, male genitalia from above.
10. *Phaocyma helata*, male genitalia from above.
11. *Phaocyma squamularis*, male genitalia from above.
12. *Phaocyma benesignata*, male genitalia from above.
13. *Phaocyma duplicata*, male genitalia from above.

PLATE XXXIII.

Fig. 1. *Phaocyma bethunci*, male genitalia from above; somewhat distorted by pressure.

2. *Phaocyma cingulifera*, male genitalia from above; almost symmetrical.
3. *Phaocyma colorado*, male genitalia, obliquely from above and right side.
4. *Phaocyma rubiata*, male genitalia from above and a little to the right.
5. *Phaocyma rubi*, male genitalia from above and a little to the right; directly comparable with the preceding.
6. *Phaocyma yarapai*, male genitalia from above; should be compared with the similar structure in *edusina*.
7. *Phaocyma calycanthata*, male genitalia from above and a little to the right.
8. *Phaocyma cchausta*, terminal segments of female abdomen from beneath.
9. *Phaocyma ficifilis*, terminal segments of female abdomen from beneath.
10. *Phaocyma lunata*, terminal segments of female abdomen from beneath; the bursa copulatrix is shown at the right, connected with the ringed opening.
11. *Phaocyma salicis*, terminal segments of female abdomen from beneath.
12. *Phaocyma edusina*, terminal segment of female abdomen from beneath; showing opening to copulatory pouch at left side of plate.

PLATE XXXIV.

Fig. 1. *Phaocyma undularis*, terminal segments of female abdomen from beneath, with opening to bursa copulatrix at the upper angle of right plate. On the other figures the opening is indicated in a similar way and approximately it is near the upper junction of the two plates but always from the right plate.

2. *Phaocyma umbripennis*, same as the preceding and shows about the extent of the variation found within specific limits.
3. *Phaocyma aruginosa*, terminal segments of female abdomen from beneath.
4. *Phaocyma insuda*, terminal segments of female abdomen from beneath.
5. *Phaocyma norda*, terminal segments of female abdomen from beneath.
6. *Phaocyma minerca*, terminal segments of female abdomen from beneath; practically like the preceding.
7. *Phaocyma lunifera*, terminal segments of female abdomen from beneath.

- Fig. 8. *Phacocyma lincosa*, terminal segments of female abdomen from beneath; practically like the preceding.
9. *Phacocyma unilincata*, terminal segments of female abdomen from beneath.
10. *Phacocyma obliqua*, terminal segments of female abdomen from beneath.
11. *Phacocyma metata*, terminal segments of female abdomen from beneath; note the difference in the location of the opening to the bursa copulatrix as compared with the preceding and next following species.
12. *Phacocyma curcma*, terminal segments of female abdomen from beneath.

## PLATE XXXV.

- Fig. 1. *Phacocyma helata*, terminal segments of female abdomen from beneath.
2. *Phacocyma squammularis*, terminal segments of female abdomen from beneath.
3. *Phacocyma benesignata*, terminal segments of female abdomen from beneath.
4. *Phacocyma largera*, terminal segments of female abdomen from beneath.
5. *Phacocyma duplicata*, terminal segments of female abdomen from beneath.
6. *Phacocyma bethunci*, terminal segments of female abdomen from beneath.
7. *Phacocyma cingulifera*, terminal segments of female abdomen from beneath.
8. *Phacocyma colorado*, terminal segments of female abdomen from beneath.
9. *Phacocyma rubiata*, terminal segments of female abdomen from beneath.
10. *Phacocyma rubi*, terminal segments of female abdomen from beneath.
11. *Phacocyma yarapai*, terminal segments of female abdomen from beneath. In this and the following the segment is broken into fragments and the opening to the copulatory pouch is not well marked.
12. *Phacocyma calycanthata*, terminal segments of female abdomen from beneath.

## PLATE XXXVI.

- Fig. 1. *Phacocyma lunata*, leg of male from the inner side showing the mass of specialized hair and scales in place.
2. Same, with the specialized mass removed and only the fringe of hair in place.
3. Varieties of scales and hair found in the mass; the broad scales are striated and form the outer covering to the mass.
4. A bundle of hair or rod-like scales forming the great bulk of the fluffy mass when teased out.



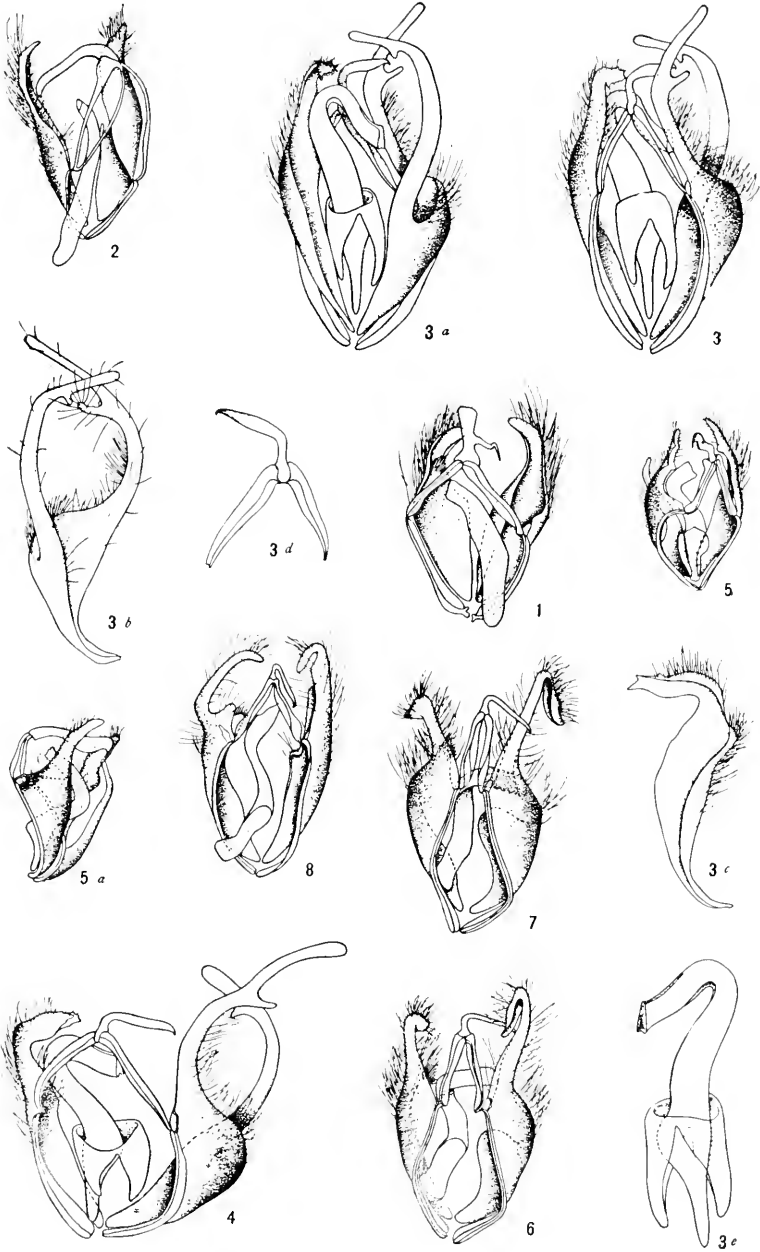

MALE GENITALIA OF PHÆOCYMA.

FOR EXPLANATION OF PLATE SEE PAGE 273.





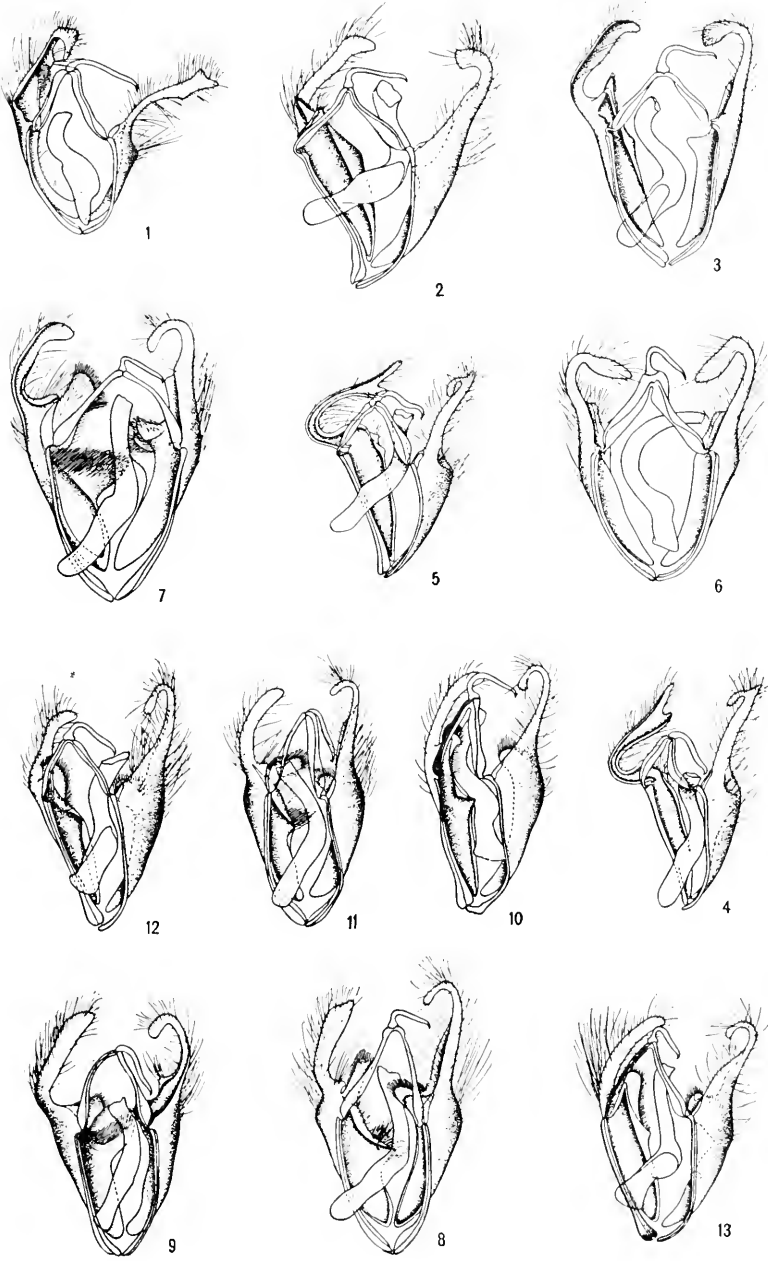

MALE GENITALIA OF PHÆOCYMA.

FOR EXPLANATION OF PLATE SEE PAGES 273, 274.



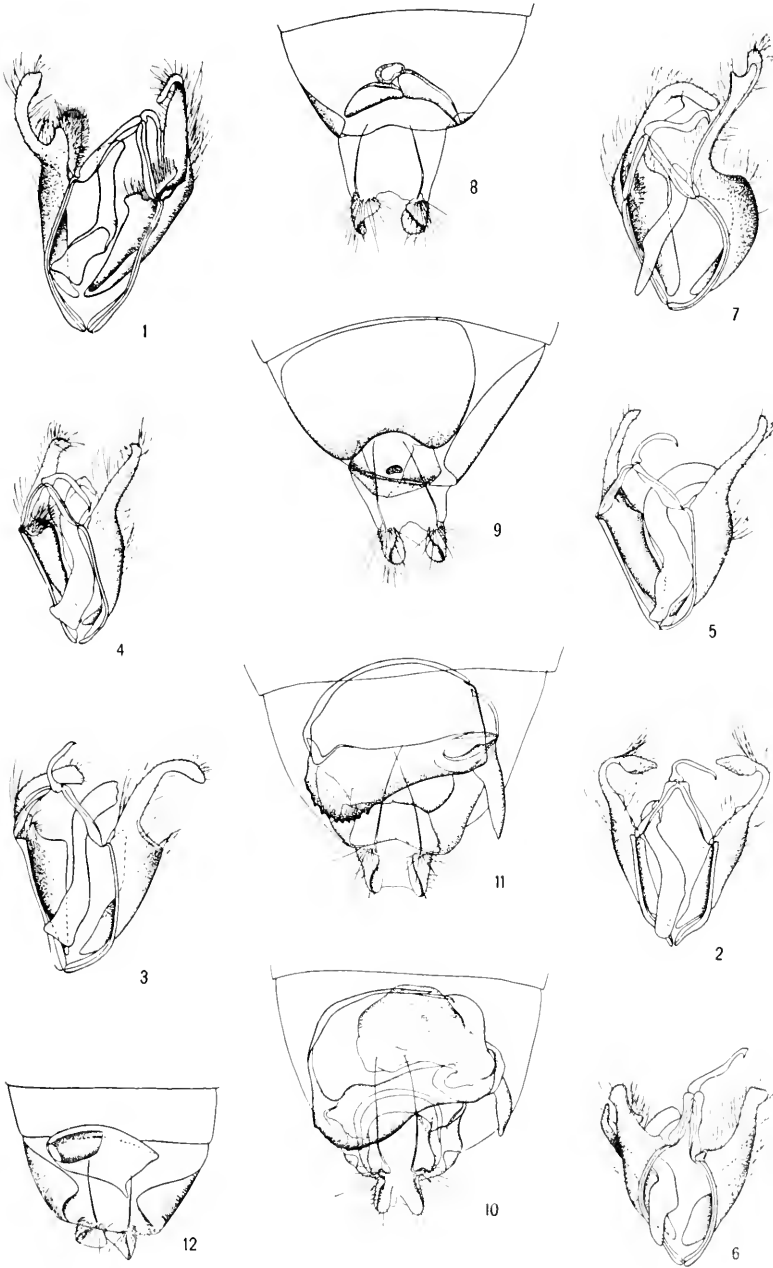

MALE AND FEMALE GENITALIA OF PHÆOCYMA.

FOR EXPLANATION OF PLATE SEE PAGE 274.



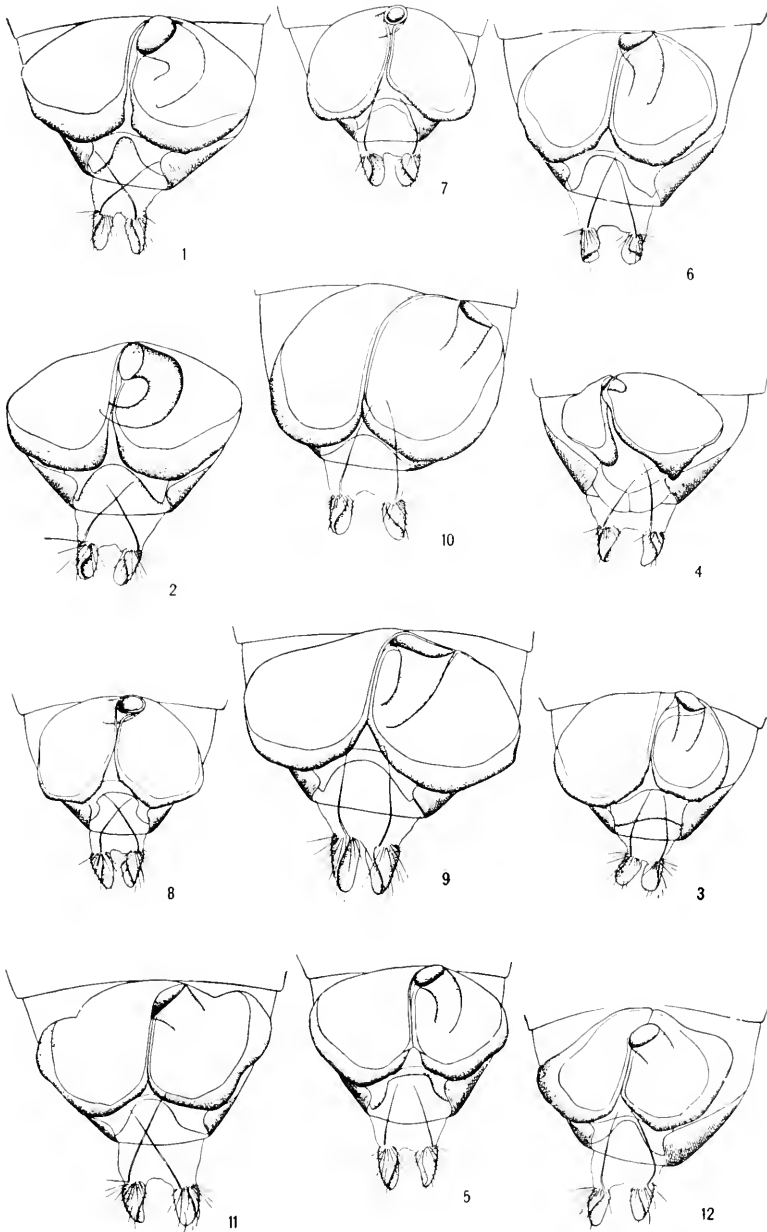

FEMALE GENITALIA OF PHÆOCYMA.

FOR EXPLANATION OF PLATE SEE PAGES 274, 275.



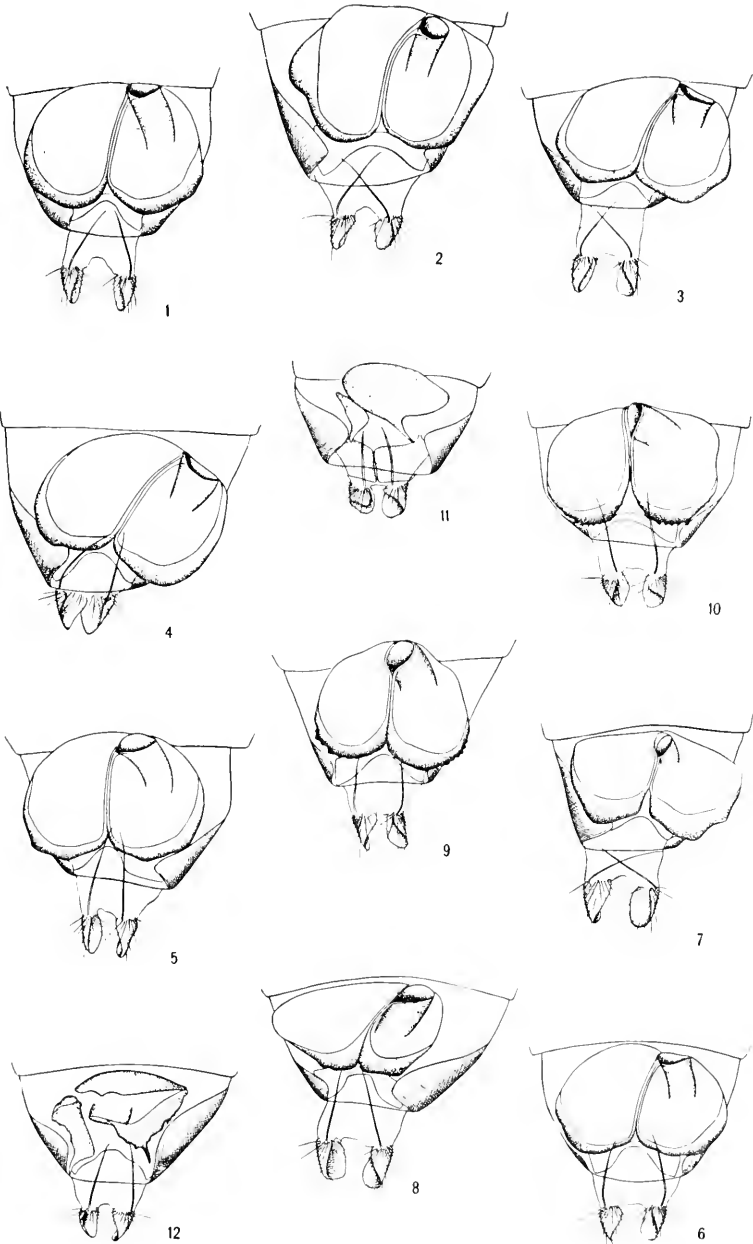

FEMALE GENITALIA OF PHÆOCYMA.

FOR EXPLANATION OF PLATE SEE PAGE 275.





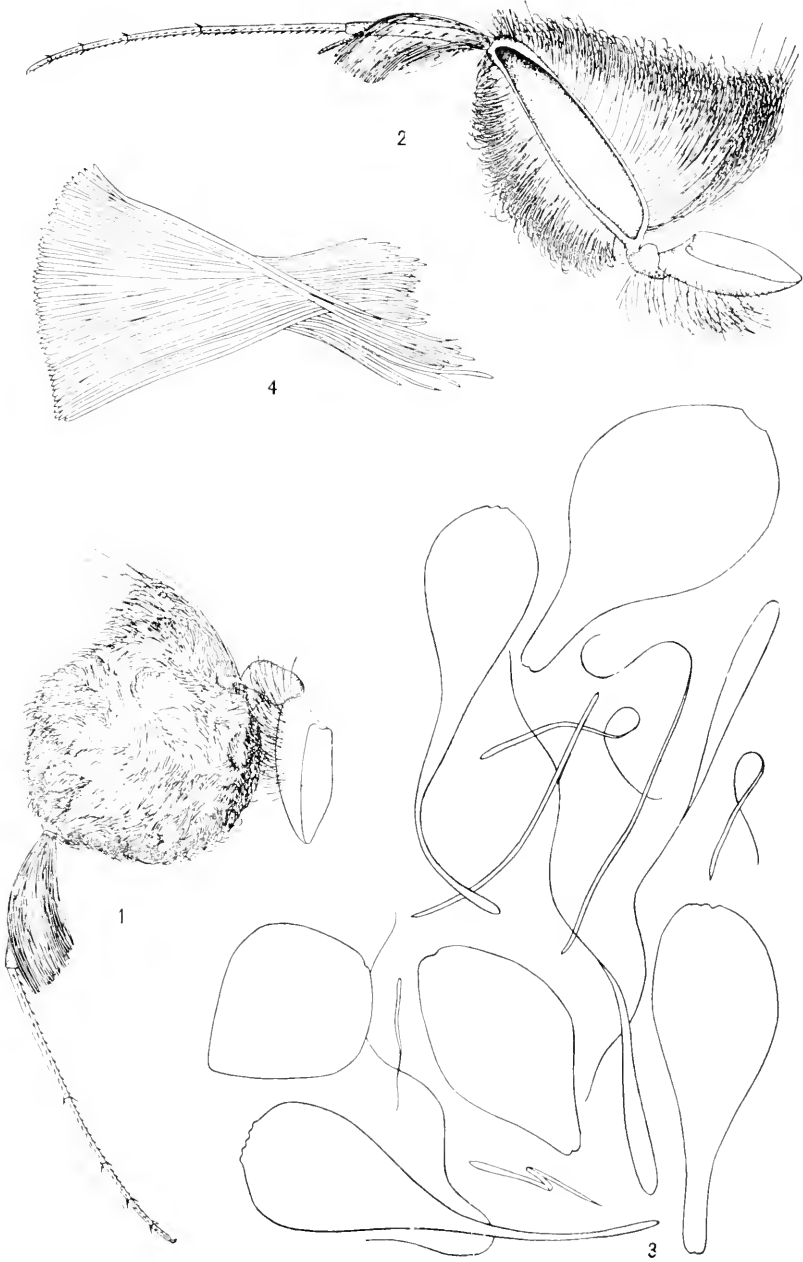

STRUCTURAL DETAILS OF LEG OF *PHAEOCYMA LUNATA*.

FOR EXPLANATION OF PLATE SEE PAGE 275.



NEW AMERICAN PALEOZOIC OSTRACODA.

PRELIMINARY REVISION OF THE BEYRICHIIDÆ, WITH  
DESCRIPTIONS OF NEW GENERA.<sup>a</sup>

By EDWARD O. ULRICH,

*Geologist, U. S. Geological Survey.*

AND

RAY S. BASSLER,

*Curator, Division of Invertebrate Paleontology.*

INTRODUCTION.

As defined in modern text-books, the Paleozoic family of Ostracoda, Beyrichiidae, embraces a large and constantly growing assemblage of genera and species. The unwieldiness of the typical genus *Beyrichia* became apparent some forty years ago, when T. Rupert Jones, the well-known and highly conservative English authority, and H. B. Holl first suggested the separation of the "simplices" as a distinct generic group under the name *Primitia*.<sup>b</sup> At a later date these authors proposed the separation of the less sharply defined "Corrugata" group, typified by *Beyrichia wilckensiana*, under the name *Kladenia*.<sup>c</sup> In the same paper they propose the genus *Bollia*.<sup>d</sup> and in the next succeeding number of that periodical two other generic groups are distinguished as *Strepula*<sup>e</sup> and *Placentula*.<sup>f</sup>

Working independently, Jones had also instituted the genus *Kirkbya*<sup>g</sup> for a Permian species thought to have relations to the Bey-

<sup>a</sup> For previous articles of this series see Jour. Cincinnati Soc. Nat. Hist., XIX, 1900, pp. 179-185, and Proc. U. S. Nat. Mus., XXX, No. 1446, 1906, pp. 149-164, pl. xi.

<sup>b</sup> Ann. and Mag. Nat. Hist. (3), XVI, 1865, p. 415.

In 1855 (Ann. and Mag. Nat. Hist. (2), XVI, p. 85), Jones divided *Beyrichia*, as then defined by him, into three groups, (1) "simplices," including the forms subsequently referred to *Primitia* and allied genera; (2) "Corrugatae," with *B. wilckensiana* as the type of the group, and (3) "Jugosae," including, besides *B. kladeni*, the type of the genus, also certain Ordovician species subsequently referred to *Tetradelta* and *Ctenobolbina* by Ulrich.

<sup>c</sup> Ann. and Mag. Nat. Hist. (5), XVII, pp. 317, 362.

<sup>d</sup> Idem, p. 360.

<sup>e</sup> Idem, p. 403.

<sup>f</sup> Idem, p. 407.

<sup>g</sup> Trans. Tyneside Nat. Field Club, IV, 1859, pp. 129, 134, 136.

richiidae. Later, in their papers on Carboniferous and Permian Ostracoda, Jones and Kirkby, while maintaining that *Beyrichia* is the genus under which the majority of the late Paleozoic species with grooved or sulcate valves should be placed, yet thought it necessary to distinguish, first the two groups *Beyrichiella* and *Beyrichiopsis*,<sup>a</sup> and a few years later *Synaphe*.<sup>b</sup> Finally, Jones separated the binodose Primitiæ from the more simple types, as *Ulrichia*,<sup>c</sup> and the most simple, nonsulcate types, as *Aparchites*.<sup>d</sup>

In 1890 the senior author of the present paper published the first results of investigations begun in the hope that they might end in a complete revision of the American Paleozoic Ostracoda. For various reasons the realization of this hope has been greatly delayed, and seems yet far in the future. In the first place the effort to procure material for study proved so overwhelmingly successful that the task assumed proportions quite beyond expectations. The unusual difficulty of the subject was recognized in the beginning, but with this unsuspected expansion of the material its difficulties seemed to grow greater and greater, while the mere description of the new and the revision of the old species has itself become a formidable piece of work. Another distressing obstacle was the necessity of finding some more accurate and satisfactory yet cheap method of illustration than had been employed hitherto. After long experimentation the writers believe they have finally solved the problem to the extent of offering at least serviceable if not uniformly artistic representations of the objects. However, these difficulties might all have been overcome long before this had not other more imperative duties consumed by far the greater part of the time that has elapsed since 1890. With this unavoidable drawback even future progress on the monographical treatment of the Paleozoic Ostracoda must necessarily continue to be somewhat sporadic.

In the first of Ulrich's papers on Ostracoda<sup>e</sup> six new genera of Beyrichiidae were proposed. All of these, except *Joucsella*, were based on or include species previously referred to either *Beyrichia* or *Primitia*. Thus *Tetradella* was proposed for the *B. complicata* group, *Ceratopsis* for the horned but otherwise similar group typified by *B. chambersi*, *Ctenobolbina* for the *B. ciliata* group, *Drepanella* for a mostly undescribed section, but including *B. richardsoni*, and *Eurychilina* likewise for a largely undescribed group that was thought to

<sup>a</sup> Geol. Mag., 3d Dec., III, 1886, pp. 431, 438.

<sup>b</sup> Carboniferous Ostracoda from Ireland, Sci. Trans. Roy. Dublin Soc. (2), VI, 1896, p. 190.

<sup>c</sup> Quart. Journ. Geol. Soc. London, XLVI, 1890, p. 543.

<sup>d</sup> Ann. and Mag. Nat. Hist. (6), III, 1889, p. 381.

<sup>e</sup> New and Little Known American Paleozoic Ostracoda, Journ. Cincinnati Soc. Nat. Hist., XIX, 1890-91, pp. 104-137, 173-211.

include at least one or two of the broadly margined Primitiæ. In a later publication<sup>a</sup> two other simple Beyrichian genera were introduced, namely, *Primitiella* and *Halliella*, both founded on groups of species previously referred to *Primitia*. In the same work two somewhat aberrant Primitian genera, *Dilobella* and *Dicranella*, were also described.

Except *Synaphe*, all of these twenty-one genera have turned out to be reasonably natural generic groupings of the species previously, and in most part since, referred to the Beyrichiida. With the recent multiplication of species through the discovery of new forms, it happens, as might be expected, that many of the species referred to the new genera, in the perhaps pardonable wish to emphasize the importance of the latter, now appear to belong to other not less well defined groups whose discrimination seems equally essential in an adequate classification of the wealth of specific forms now known. Because of the small range of diagnostic characters furnished by the shells, and more the inconstancy of these characters when a great group like Jones's Beyrichiida is considered, it is impossible to formulate a broad family definition without going into undesirable detail. In the classification of living Ostracoda the family groups are based on anatomical modifications, the shells being scarcely considered. In fossil forms, obviously, the systematist is limited to modifications of the carapace. While the paleontologist's classification is, therefore, liable to grave misassociations, it should be remembered that the results of his efforts may be the best obtainable with the criteria available to him.

After a considerable study of living Ostracoda, the writers have been forced to the conviction that students of fossil species, especially those found in Paleozoic rocks, can not expect much help in their labors from even an extensive knowledge of living forms. The Cypridæ, even, which family, perhaps on account of lack of diagnostic characters, is at present thought to range back in time to early Ordovician, may yet be shown to be distinguishable from their presumed Paleozoic representatives. The Leperditidæ and Beyrichiida, however, stand alone with no recognized close affinities to post-Paleozoic Ostracoda. These fossils, therefore, the paleontologist must work out for himself and do the best he can with the material at his command.

After the foregoing introductory remarks, some attempt to re-define the existing classification of Paleozoic Ostracoda is necessary. As the investigations are far from complete, the attempt must, to a considerable extent, be preliminary to the final effort to be made in

<sup>a</sup> Geol. and Nat. Hist. Surv. Minnesota, Final Rept., III, Pt. 2, 1894, pp. 629-693.

the proposed monograph. While confessing its preliminary nature, it should not be supposed that the results here presented are founded on studies of only a part of the species immediately concerned. On the contrary, the authors have taken into account not only every recognizably described or figured Beyrichian, but also a host of unpublished species. If a classification of any family or subfamily could be made final without first, or at the same time, subjecting all related families to a similar close investigation, the following might lay claim to being so. But as it is manifestly impossible to do this without extending the field of study beyond the point attained, the present contribution pretends to nothing better than a report of progress.

#### ORIENTATION OF THE VALVES.

The feature of the study of Paleozoic Ostracoda, about which the literature of the subject seems to show greatest variability and uncertainty among authors, is the determination of which of the two ends of the carapace and valves is the anterior. The rule most generally applied is to call the thicker end posterior. The present writers are agreed with this as a general principle or rule, but not as a law. Close comparisons, and especially exact analyses of the lobes of Beyrichian forms, showed so many exceptions to the rule that it seemed necessary to seek other and if possible more reliable criteria. The position and trend of the median furrow was the first feature to be investigated. Next the lobes were compared, and finally the outline of the valves. It was found that all three of these features afford more reliable evidence than does the relative thickness of the ends. With the application of these several criteria certainty and uniformity in orientation is attained, which, for purposes of description and comparison, is, after all, the chief essential; but there are no positive means, and perhaps never will be, of determining that the end of the fossil shell here called posterior did not really lodge the cephalic organs of the living animal. Still the propriety of the orientation adopted is supported by plausibility based on facts, the bearing of which seems incontrovertible if not wholly decisive.

The principal line of evidence on which the orientation of the valves of *Beyrichia* and allied ostracods is based is derived from the position of the eye tubercle and the outline of the valves of *Leperditiida*. That the small tubercle referred to was really connected with the visual organs of the animal of *Leperditia* is universally accepted by paleontologists. Hence we are justified in assuming that its location marks the anterior end of the carapace. Starting with this accepted fact, we note (1) that the eye-bearing end of the valve is almost always narrower than is the other end; (2) that the outline of the valves exhibits a backward swing so that a rec-

tangular line drawn from the middle of the straight cardinal edge divides the area of the valve into two more or less unequal parts of which the posterior is the longer and usually the greater. In other words, the valve is more or less oblique and its outline suggests a parallelogram rather than an oblong. Now, in by far the majority of Primitiidae and Beyrichiidae, the narrower and, rather less generally, the thinner half of the carapace is determined to be anterior also by the retral swing of the outline and the comparative analysis of the nodes, lobes, and furrows.

The retral (parallelogram) swing of the outline is perhaps the most persistent of the criteria, being applicable in even those cases (certain Leperditellidae) in which the valves are without nodes, their surface uniformly convex, and the ends nearly or quite equal in height. In many of the true Beyrichiæ the resulting obliquity of outline and inequality of the ends are both very inconspicuous (as, for instance, *B. kochii*, *B. maccoyiana*, *B. salteriana*), and in this genus it is often necessary in deciding which is the right and which the left valve to rely almost entirely on the correlation of the lobes. The data for this correlation are furnished by species like *Beyrichia clavata*, in which the "swing" and the difference in height of the two ends is sufficient to leave no doubt as to which is the anterior. A study of such a species shows that the median lobe is united below with the larger anterior lobe by means of a low and thin isthmus, and that the posterior lobe, if its ventral extremity extends forward at all, passes beneath this isthmus. It is observed further that the median lobe is located nearer the posterior than the anterior lobe; in other words, that the anterior furrow is almost without exception the wider of the two. Now, bearing these facts in mind, the anterior lobe is recognized at once as the one that is connected below with the median lobe. When this ventral union of the anterior and median lobes is obsolete, as in *B. tuberculata* and its immediate allies, the posterior lobe is usually recognized by the location of the median lobe which, as said, is commonly placed more or less distinctly behind the center of the valve. When this and all other tests seem indecisive, as they may rarely be in a species like *B. bronni* Reuter, then it is still possible to orient the valves by comparing minor nodes and furrows on the lobes with similar markings on less difficult species.

Additional evidence tending to show that the criteria relied on by the writers in orienting the valves of Beyrichiidae is furnished by the Chazy ostracod erroneously referred to *Beyrichia* by Jones under the name *B. clavigera*. This species, though strikingly like a *Beyrichia* in having a median node within the bend of a strongly curved, low ridge, seems yet to belong to the Leperditidae. It has an eye tubercle and agrees in all other respects, save the curved ridge, with species of

*Isochilina*, and the ridge even is represented in subdued form in *I. sub-nodosa*. The significant fact in this connection is that in this, we might almost say prophetic species, the above discussed criteria by

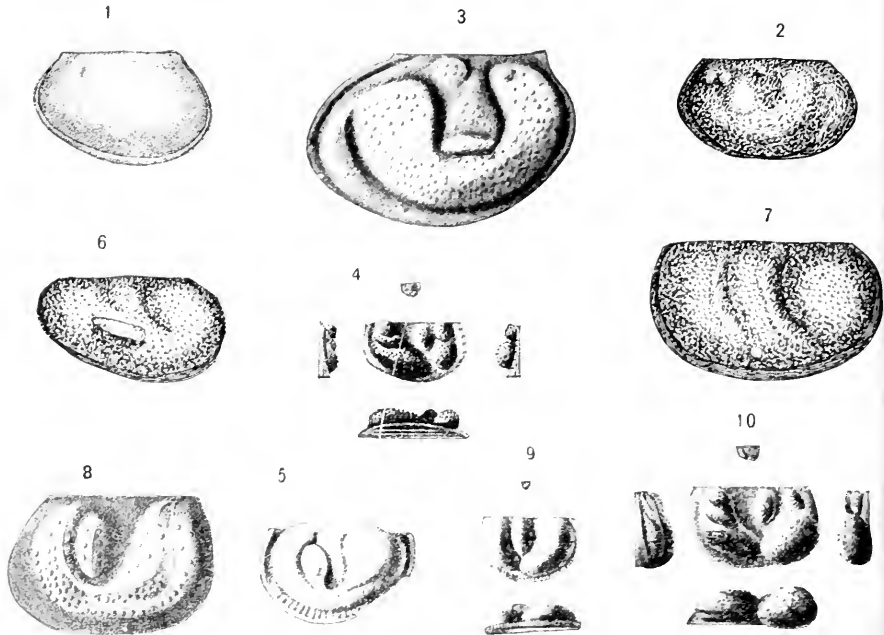

FIGS. 1-10.—1. LEFT SIDE OF ENTIRE SPECIMEN. 2 OF *LEPERDITHIA FABULITES* (CONRAD). ANTERIOR END INDICATED BY THE SMALL "OCULAR" TUBERCLE, ITS LESSER HEIGHT, AND BACKWARD SWING OF VALVE. 2. LEFT VALVE OF *ISOCHILINA? SUBNODOSA* ULRICH,  $\times 3$ ; A NEARLY EQUAL FORM. ANTERIOR SIDE INDICATED BY OCULAR AND OTHER TUBERCLES, THAT WHEN PRESENT ARE ALWAYS IN FRONT HALF OF VALVES. 3. RIGHT VALVE OF *ISOCHILINA? CLAVIGERA* (BEYRICHIA *CLAVIGERA* JONES)  $\times 10$ , SHOWING THE OCULAR TUBERCLE AND MUSCLE SPOT OF *LEPERDITHIDÆ*, THUS DETERMINING WHICH IS THE ANTERIOR SIDE AND INCIDENTALLY AFFORDING A GOOD EXAMPLE OF RETRAL SWING. ORDOVICIAN (CHAZY SHALE), NEAR OTTAWA, CANADA. 4. LEFT VALVE OF *BEYRICHIA TUBERCLATA* (KLOEDEN)  $\times 5$  (AFTER REUTER). ANTERIOR SIDE RECOGNIZED BY ITS INFERIOR HEIGHT, SLIGHT RETRAL SWING, AND BY CORRELATION OF NODES OF VALVE. 5. RIGHT VALVE OF *BEYRICHIA CLAVATA* KOLMODIN (AFTER KLESOW). ORIENTATION DETERMINED BY SAME CRITERIA AS IN FIGURE 4. 6. LEFT VALVE OF *CENOBOLOBINA ALATA* ULRICH,  $\times 18$  (AFTER ULRICH). ANTERIOR END RECOGNIZED BY ITS TAPER AND BY THE RETRAL SWING OF THE OUTLINE. 7. LEFT VALVE OF *CENOBOLOBINA CILIATA* (EMMONS),  $\times 18$  (AFTER ULRICH). ORIENTATION DETERMINED BY COMPARISON OF LOBES WITH THOSE OF *C. ALATA*, IN WHICH THE ANTERIOR END IS NARROWER AND THE RETRAL SWING MORE PRONOUNCED. 8. *BEYRICHIA (STEUERSLOFTIA) LINNARSSONI* (KRAUSE). RIGHT VALVE,  $\times 15$  (AFTER REUTER). ORIENTED BY COMPARISON OF LOBES WITH THOSE OF *BEYRICHIA CLAVATA* AND *B. TUBERCLATA*. 9. *BEYRICHIA SALTERIANA* JONES,  $\times 10$  (AFTER REUTER). THE ENDS BEING ALMOST EXACTLY EQUAL IN THIS SPECIES THE ORIENTATION OF ITS VALVES IS POSSIBLE ONLY BY COMPARISON OF ITS LOBES WITH THOSE OF OTHER *BEYRICHIDÆ*, LIKE *B. CLAVATA*. IN THESE, OTHER CORROBORATIVE CRITERIA ARE AVAILABLE, SUCH AS THE TAPER OF THE VALVES ANTERIORLY AND THE RETRAL SWING OF THE OUTLINE. ACCORDINGLY THE FIGURE REPRESENTS A RIGHT VALVE. 10. DIFFERENT VIEWS OF A LEFT VALVE OF *BEYRICHIA TUBERCLATA-BUCHIANA* REUTER,  $\times 6$  (AFTER REUTER). THE EXAMPLE FIGURED POSSESSES THE VENTRAL POUCH, WHICH FEATURE REUTER AND OTHER WRITERS REGARD AS DISTINGUISHING THE FEMALE IN *BEYRICHIA* AND ALLIED GENERA. THE POUCH IS LOCATED INVARIABLY ON THE LOWER PART OF THE POSTERIOR LOBE.

which the right valve is distinguished from the left is supported by the evidence of the eye-tubercle.



Finally, the posterior location of the peculiar ventral pouch that Reuter and others have interpreted, we believe correctly, as ovarian inflations, is wholly in accord with the other criteria.

BEYRICHIA OF AUTHORS.

The genus *Beyrichia* was founded by McCoy in 1846.<sup>a</sup> His "rough sketch" of the valves of the Irish species that first convinced McCoy that these fossils were bivalved crustacea and not trilobites gives a crude idea of the common Silurian form subsequently identified by Jones and others with *B. klødeni* McCoy. As McCoy ranks "*Battus tuberculatus*" of Kløden as a synonym of his *Beyrichia klødeni*, and as the two forms are distinguishable species, it is difficult to decide which of the two should rank as the genotype. However, as they are unquestionably congeneric, the point is of little consequence.

Subsequent authors have referred a considerable variety of Ostracoda to the genus. In fact, for many years it served as the temporary lodging place for nearly all of the Paleozoic species with furrowed or ridged valves. As noted above, a large part of these has been removed and distributed among other genera, but at the present writing no less than 150 species and varieties are still credited to *Beyrichia*. Many of these remaining species are not strictly congeneric with the type and hence will be removed, chiefly to new genera and to the long misunderstood *Klødenia*, the other more obvious departures from the generic type having been already mostly weeded out through the efforts of Jones, Holl, Kirkby, Krause, and Ulrich.

The genus *Klødenia* constitutes a close ally of the typical *Beyrichia*. The practical discrimination of the two groups, in certain cases at least, suggests that the boundary is artificial and probably results in occasional unnatural associations. But it is impossible to wholly escape this condition in any classification that is not too involved to be practical. Therefore, since the distinctive characters relied on in separating the two groups operate, as a rule, in apparent accord with genetic lines, *Klødenia* is accepted, with some justifiable modifications of the original diagnosis, as a useful designation. The comparatively few species about which there is doubt are provisionally left with *Beyrichia*.

Accepting *Beyrichia klødeni* and *B. tuberculata* as the types of the genus, and bearing in mind the ground to be occupied by the revised *Klødenia*, the restricted genus *Beyrichia* may be defined as follows:



FIG. 11.—COPY OF MCCOY'S ORIGINAL SKETCHES OF BEYRICHIA KLØDENI.

<sup>a</sup> Syn. Sil. Foss. Ireland, p. 57.

## Genus BEYRICHIA McCoy, emended.

- Beyrichia* MCCOY, Synop. Sil. Foss. Ireland, 1846, p. 57.  
*Beyrichia* BELL and FORBES, in Burmeister's Org. Tril., London, Suppl. App., p. 124.  
*Beyrichia* MCCOY, Brit. Pal. Rocks and Foss., 1854, p. 135.  
*Beyrichia* (part) JONES, Ann. and Mag. Nat. Hist. (2), XVI, 1855, p. 85.  
*Beyrichia* (part) HALL, Nat. Hist. New York, Pal., III, 1859 [1861], p. 377.  
*Beyrichia* (part) BARRANDE, Syst. Sil. du Centre Boheme, I, Suppl., 1872, p. 490.  
*Beyrichia* (part) ZITTEL, Handbuch d. Pal., II, 1885, p. 553.  
*Beyrichia* REUTER, Zeits. d. d. geol. Gesell., XXXVII, 1885, p. 628.  
*Beyrichia* (part) JONES and HOLL, Ann. and Mag. Nat. Hist. (5), XVII, 1886, pp. 338, 345.  
*Beyrichia* JONES and KIRKBY, Proc. Geol. Assoc., IX, 1886, p. 505.  
*Bollia* (part) JONES, Ann. and Mag. Nat. Hist. (5), XIX, 1887, p. 408.  
*Beyrichia* VERWORN, Zeits. d. d. geol. Gesell., XXXIX, 1887, p. 27.  
*Beyrichia* (part) KRAUSE, Zeits. d. d. geol. Gesell., XLI, 1889, p. 17.  
*Bollia* (part) KRAUSE, Zeits. d. d. geol. Gesell., XLI, 1889, pp. 13, 14.  
*Beyrichia* MILLER, North Amer. Geol. and Pal., 1889, p. 534.  
*Beyrichia* VOGDES, Annals New York Acad. Sci., V, 1889, p. 8.  
*Ctenobolbina* (part) ULRICH, Jour. Cincinnati Soc. Nat. Hist., XIII, 1890, p. 111.  
*Strepsila* (part) KRAUSE, Zeits. d. d. geol. Gesell., XLIII, 1891, p. 498.  
*Beyrichia* (part) ULRICH, Geol. and Nat. Hist. Surv. Minnesota, Final Rept., III, Pl. 2, 1894, p. 657.  
*Beyrichia* KOKEN, Die Leitfossilien, 1896, p. 40.  
*Beyrichia* GURICH, Verh. d. Russ.-Kais. Mineral Gesell. zu St. Petersburg (2), 1896, p. 385.  
*Beyrichia* GRABAU, Bull. Buffalo Soc. Nat. Sci., VI, 1899, p. 306.  
*Beyrichia* ULRICH and BASSLER, Proc. U. S. Nat. Mus., XXX, 1906, p. 151.

Carapace comparatively large, 2 mm. to 5 mm. in length, semiovate or semicircular to oblong in outline, with sharp dorsal and rounded ventral angles. Valves only moderately convex, strongly impressed with two vertical furrows, extending from the straight dorsal edge to the ventral portion of the valve so as to divide the intramarginal part of the surface into three unequal and unsymmetrical lobes. These vary considerably in size with respect to each other and with respect to their separation; also in the development of their ventral ends. The furrows may be much narrower or they may equal the ridges in width. The ovate median lobe is the most constant in form and size, usually the smallest, and ordinarily begins some distance beneath the dorsal edge. The anterior lobe, though generally the largest, is the most variable in size and form, being also often broken up into subsidiary nodes. The posterior ridge is, as a rule, the narrowest, runs nearly parallel with the posterior border, is rounded and thickest above, sometimes constricted near its middle, and often tapers to the vanishing point near the middle of the ventral edge. In other species it joins the ventral prolongation of the anterior lobe, in which cases commonly all three lobes are joined. When only two of the lobes are connected, it is, perhaps invariably, the median and the anterior. Ventral pouch (presumably of female) egg-shaped or

subglobular, as large or larger than either of the ordinary lobes, arising from the ventral part of the posterior lobe, hence located wholly or mostly behind the middle of the valve. A flange-like border around the ends and the ventral side. This may be narrow or wide, simple or rimmed, and variously ornamented with granules or spines. The flange overhangs the real contact edges which are beveled inward, the opposite edges meeting either flush or that of the right valve very slightly overlaps the edge of the left. Surface of valves smooth, granulose, punctate, or reticulate, or granulo-reticulate.

The following species have the characters of the genus as here restricted:

ORDOVICIAN SPECIES.

- |   |  |
|---|--|
| <i>Beyrichia (Steusloffia) acuta</i> ( <i>Beyrichia erratica</i> , var. <i>acuta</i> Krause). | <i>Beyrichia (Steusloffia) signata</i> ( <i>Beyrichia signata</i> Krause). |
| <i>Beyrichia (Steusloffia) antiqua</i> ( <i>Beyrichia antiqua</i> Steusloff).                 | <i>Beyrichia tumida</i> ( <i>Ctenobolbina tumida</i> Ulrich).              |
| <i>Beyrichia granulifera</i> , new name ( <i>Bollia granulosa</i> Krause).                    | <i>Beyrichia v-scripta</i> ( <i>Bollia v-scripta</i> Krause).              |
| <i>Beyrichia (Steusloffia) linnarssoni</i> ( <i>Streptula linnarssoni</i> Krause).            |  |

SILURIAN SPECIES.

- |  |  |
|--|--|
| <i>Beyrichia admixta</i> Jones and Holl.   | <i>Beyrichia kladeni</i> McCoy.  |
| <i>Beyrichia acquilatera</i> Hall.   | <i>Beyrichia kladeni acadica</i> <sup>a</sup> Jones.                           |
| <i>Beyrichia baueri</i> Reuter.  | <i>Beyrichia kladeni antiquata</i> Jones.                                      |
| <i>Beyrichia baueri tripartita</i> Reuter.   | <i>Beyrichia kladeni bicuspis</i> Kiesow.                                      |
| <i>Beyrichia (Steusloffia) beyrichioides</i> ( <i>Streptula beyrichioides</i> Jones and Holl). | <i>Beyrichia kladeni granulata</i> Jones.                                      |
| <i>Beyrichia bolliana</i> Reuter.  | <i>Beyrichia kladeni infecta</i> Jones.  |
| <i>Beyrichia bronni</i> Reuter.  | <i>Beyrichia kladeni intermedia</i> Jones.                                     |
| <i>Beyrichia buchiana</i> Jones.   | <i>Beyrichia kladeni intermedia</i> , subvar. <i>subspissa</i> Jones and Holl. |
| <i>Beyrichia buchiana angustata</i> Reuter.  | <i>Beyrichia kladeni kladeni nuda</i> Jones.                                   |
| <i>Beyrichia buchiana incisa</i> Reuter.   | <i>Beyrichia kladeni protuberans</i> Boll.                                     |
| <i>Beyrichia buchiana lata</i> Reuter.   | <i>Beyrichia kladeni subtorosa</i> Jones.                                      |
| <i>Beyrichia buchiana nutans</i> Kiesow.   | <i>Beyrichia kladeni torosa</i> Jones.   |
| <i>Beyrichia clarata</i> Kolmodin.   | <i>Beyrichia kladeni verruculosa</i> Jones.                                    |
| <i>Beyrichia damesi</i> Krause.  | <i>Beyrichia kochii</i> Boll.  |
| <i>Beyrichia diffusa</i> Jones.  | <i>Beyrichia lata</i> <sup>a</sup> Hall.                                       |
| <i>Beyrichia dubia</i> Reuter.   | <i>Beyrichia laucensis</i> Kiesow.   |
| <i>Beyrichia grandis</i> Kolmodin.   | <i>Beyrichia lindstromi</i> Kiesow.  |
| <i>Beyrichia granulosa</i> <sup>a</sup> Hall.  | <i>Beyrichia maccoyiana</i> Jones.   |
| <i>Beyrichia interrupta</i> ( <i>Bollia interrupta</i> Jones).                                 | <i>Beyrichia maccoyiana sulcata</i> Reuter.                                    |
| <i>Beyrichia jonesii</i> Boll.   | <i>Beyrichia moodyi</i> , <sup>a</sup> new species. <sup>b</sup>               |
|  | <i>Beyrichia muldensis</i> Chapman.  |
|  | <i>Beyrichia nodulosa</i> Boll.  |

<sup>a</sup> American species.

<sup>b</sup> This species is very similar to *B. maccoyiana* and is probably the American form referred to this latter species by Jones. It is distinguished by the greater isolation of the median lobe and the very finely punctated surface of the lobes. See Plate XXXVII, fig. 8.

*Formation and locality.*—Cayuga formation, near Cacapon, West Virginia.

*Cotypes.*—Cat. No. 53936, U.S.N.M.

- Beyrichia nodulosa expansa* (B. Lindström, var *expansa* Kiesow).  
*Beyrichia noellingeri* Reuter.  
*Beyrichia noellingeri conjuncta* Reuter.  
*Beyrichia plagosa*<sup>a</sup> Jones.  
*Beyrichia plicata* (*Entomis plicata* Krause).  
*Beyrichia pustulosa*<sup>a</sup> Hall.  
*Beyrichia reticulata* (*Strepula reticulata* (limbata in text) Krause).  
*Beyrichia reuteri* Krause.  
*Beyrichia salteriana* Jones.  
*Beyrichia seancensis* Kolmodin.  
*Beyrichia* (*Steusloffia*) *simplex* (*Strepula simplex* Krause).  
*Beyrichia spinulosa* Boll.  
*Beyrichia steusloffii* Krause.  
*Beyrichia trilobata* (*Entomis trilobata* Krause).  
*Beyrichia tuberculata* (*Battus tuberculatus* Kloeden).  
*Beyrichia tuberculata bigibbosa* Reuter.  
*Beyrichia tuberculata foliosa* Jones.  
*Beyrichia tuberculata spicata* Jones.  
*Beyrichia tuberculato-kochiana* Reuter.  
*Beyrichia umbonata* (*Beyrichia bolliana umbonata* Reuter).  
*Beyrichia waldronensis*<sup>a</sup> new species,<sup>b</sup>

## DEVONIAN SPECIES.

- Beyrichia aurita* Richter.  
*Beyrichia deconica* Jones and Woodward.  
*Beyrichia*, new species (*B. klardoni* var. Jones).

Approximately 225 named species and varieties, varying in time from the Cambrian to the Permian, have, in the past sixty years, been referred to *Beyrichia*. Of the total number, only the seventy-three species and varieties listed above may be accepted as conforming strictly to the genus as here characterized. Only a few of these are Ordovician, and only two or three Devonian. The Cambrian species are regarded as widely different and probably not Ostracoda at all, while none of the Carboniferous species is strictly referable to the genus. As restricted, then, *Beyrichia* is preeminently a Silurian genus.

It is interesting to note further that only four of these species are as yet known in American deposits, and of these but one, *Beyrichia granulosa* Hall, is found in the Ohioan province, the other three occurring in the Atlantic and Polar provinces. All the remaining true *Beyrichia* seem to be confined to Baltic and British deposits, none of the central and southern European species being, so far as known, strictly referable to the genus. The list will be increased by two or three as yet unpublished east American Silurian species, but even with these the American representation is so weak that it is justifiable

<sup>a</sup> American species.

<sup>b</sup> Related to *B. moodeyi* and *B. maccoyana*, but has a much broader marginal border, a rather longer median lobe, and a distinctly reticulate surface which is especially marked on the lobes. The species presents considerable resemblance to *Beyrichia reticulata* as figured by Krause, but differs in wanting the crest-like ridge. See Plate XXXVII, figs. 9, 10.

*Formation and locality*.—Niagaran (Waldron shale), Waldron, Indiana.  
*Cotypes*.—Cat. No. 41660, U.S.N.M.

to regard *Beyrichia* as essentially a north European genus. The direct opposite is true of the group of Beyrichiidae typified by *B. wilkensisiana* Jones, for which Jones and Holl subsequently erected the genus *Kladdenia*. That is to say, the latter genus is much more strongly developed in America than in Europe.

About ninety of the species originally described as *Beyrichia* remain to be distributed among their proper genera. A large part of this number will be accounted for in the following discussions of the other genera of the family. But a considerable number will remain even then that for one reason or another cannot yet be definitely placed. In most cases it is lack of knowledge that suggests delay in deciding their systematic positions. A few, however, require further study and comparison, being too peculiar to fall readily into place.

The species here definitely referred to *Beyrichia* fall into seven, in part genetic, in part perhaps artificial groups. The first three of these, the *B. kladeni*, the *B. tuberculata*, and the *B. buchiana* groups, are made up entirely of unequivocal species of the genus. The other four groups, however, are more or less synthetic, and, though including species that cannot be clearly distinguished from *Beyrichia*, they are yet closely connected with species that must be referred to other genera. In other words, they represent different lines of development that seem to have originated in diverse Ordovician types but ended through what might be called convergent evolution in much more uniform stages. It appears further that in the decline of the genus a partial reversion to ancestral stages took place. Suggestive observations bearing on these points will be found in the following notes.

#### GROUP OF *B. KLADENI*.

This group embraces *B. kladeni*, *B. maccoyiana*, *B. bolliana*, *B. kochii*, *B. tuberculato-kochiana*, *B. moodeyi*, new species, *B. lindstromi*, and most of the forms described by various authors as varieties of the first-named species. Its valves are usually short, semi-elliptical in outline, and sharply lobed. The lobes are of medium thickness, the anterior one tending to enlargement and dissection, while the middle lobe is nearly as large as the posterior and commonly exhibits a tendency to union with the incurved ventral extremity of the anterior lobe. The posterior lobe is more or less acuminate and incurved below, but does not extend forward beyond the base of the median lobe. The type usually is shorter and always has somewhat thicker and more bulbous lobes than the *buchiana* section, and it is commonly shorter, with less dissected anterior and posterior lobes, and a longer median lobe than the *tuberculata* group. It constitutes, therefore, an admirable central type for the genus, and its

least synthetic, hence most characteristic phase. None of the species belonging to the group suggests genetic relations to species not included in the genus as here defined.

GROUP OF *B. BUCHIANA*.

In *B. buchiana* and its nearest allies and varieties the anterior and median lobes are joined, as commonly happens in *Beyrichia*, but the anterior lobe is thinner and the ventral connection proportionally thicker than usual, the combination giving to the united lobes a striking similarity to the horse-shoe ridge in the *B. ungula* section of *Bollia*. Indeed, *Beyrichia buchiana* and the Cincinnati *Bollia regularis* (Emmons) and *B. persulcata* (Ulrich) are sufficiently alike in general aspect to have induced so thorough a student of Ostracoda as T. Rupert Jones to refer a partially covered specimen of the last

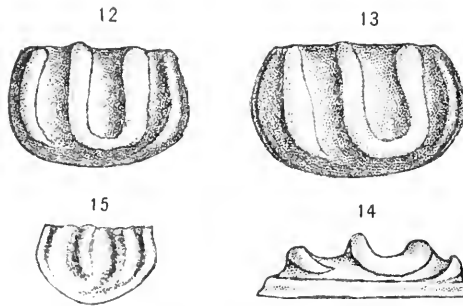

FIGS. 12-15.—12-14, LEFT VALVE AND SIDE AND EDGE VIEWS OF ANOTHER LEFT VALVE OF *BOLLIA REGULARIS* (EMMONS),  $\times 30$ , ARNSHEIM BEDS OF RICHMOND GROUP, WAYNESVILLE, OHIO. 15, LEFT VALVE OF *BEYRICHIA BUCHIANA* JONES,  $\times 8$  (AFTER JONES). THE FIGURES ARE INTENDED TO ILLUSTRATE THE POSSIBLE DERIVATION OF THE *B. BUCHIANA* GROUP OF *BEYRICHIA* FROM *BOLLIA*.

to the Silurian *Beyrichia*. The resemblance might be regarded as indicating genetic affinity between the two, the younger *B. buchiana* being evolved through the continued and finally total obsolescence of the anterior marginal ridge of the *Bollia*.

Though admitting the possibility of such a derivation, it has yet seemed to the writers an improbable relationship. The marginal ridge is one of the most stable characters of *Bollia*, and though its ventral part is often low and sometimes quite obsolete, there is no evidence to show that the anterior part is even lost entirely. The arrangement of the ridges in *Bollia* is bilateral with respect to a median furrow, in *Beyrichia* with respect to a median lobe. In *Bollia regularis* the anterior marginal ridge is paired with a less well-developed posterior ridge, the pair of median ridges uniting below as usual. In testing the possible derivation of *Beyrichia buchiana* from *Bollia regularis*, it should be remembered that in the *Beyrichia* it is the anterior and median lobes that are united, and that if the suggested derivation were a fact, it must have been by anterior shrinkage of the *Bollia* and final loss of the part bearing the anterior marginal ridge. Instead of this it seems certain that the stronger of the terminal ridges on valves of *B. regularis* is the anterior one, proving that in this species at least the conditions are the opposite of what they should be.

The *B. buchiana* group is characterized by its comparatively long shells, but passes by easy gradation into the *B. kladeni* group, the mere proportionate shortening of the valves sufficing to bring about some of the differences between them. On the other side it grades by thickening and division of lobes into the *B. tuberculata* section. *B. laucensis* Kiesow is regarded as an extreme member of the group, differing from the other species in the dissection of the anterior lobe and its separation from the median lobe.

#### GROUP OF *B. TUBERCULATA*.

This section of the genus comprises a number of species and varieties in which the anterior and posterior lobes are broken up by minor furrows, the posterior lobe into two, the anterior lobe into from two to six or seven node-like parts. Reuter's *B. buchiano-tuberculata* would represent about the simplest type and *B. pustulosa* Hall and *B. natlingi* Reuter the most complex. The anterior lobe is, as a rule, larger than in other groups, and when not too much dissected, retains the "leg-of-mutton shape" pertaining to this lobe in the majority of the species of the genus. In the most simple species of the group the posterior lobe is sharply constricted about its midlength, or somewhat above this point, the upper bulb being usually considerably smaller than the lower. The anterior lobe in these is crossed obliquely by a single curved furrow dividing the vertical upper part from the much larger ventral portion. In the next stage of dissection (as, for instance, *B. tuberculata* and *B. browni*) the posterior lobe is usually completely divided, while the anterior lobe is crossed by two parallel furrows instead of one. In further stages the lower and largest of the three divisions of the anterior lobe is broken up into a series of three nodes and the middle division commonly into two, while the upper may also be divided into two much smaller tubercles.

Except in the most simple species, which of course are not far removed from *B. kladeni* and *B. buchiana*, none of the lobes are connected ventrally. This fact sets the group somewhat apart from the majority of the remaining species here referred to the genus, and allies it to the subgenus *Steusloffia*. A coarsely granulose surface ornament of the lobes usually obtains except in the most highly dissected species. As a rule, the main lobes are well separated and the carapaces large, thus differing from the otherwise similar group of *B. salteriana*.

Respecting the derivation of this group of species, the problem seems at first sight very obscure. However, on closer analysis of the lobes and comparison with Ordovician genera, the possibility of its having sprung from *Drepanella* becomes more and more evident, so that finally the idea assumes the rank of high probability and needs but the discovery of one or two links to make it a certainty. To illus-

trate the supposed evolution, the lines of a *Drepanella* have been drawn in black over a figure of *B. tuberculata*. This shows that by merely dividing the sickle-shaped marginal ridge of *Drepanella* into a series of three or more node-like parts, the result is in essential accord with the structure characterizing the group of *B. tuberculata*. Above the submarginal ridge the valves of *Drepanella* have two persistent lobes corresponding to the median and anterior lobes of most *Beyrichia*. They may be dissected into subsidiary nodes (as, for instance, *D. crassinoda* and *D. nitida*) and are sometimes connected ventrally (*D. bigeneris*), as is commonly the case in the groups of *B. buchiana* and *B. kladeni*. The subsidiary nodes of the dissected anterior lobe in *Drepanella macra*, *D. crassinoda*, and *D. nitida* can be matched exactly in respectively *Beyrichia tuberculata*, *B. natlingi*, and *B. baueri*. But the tendency to dissection of the median lobe exhibited by the oldest species of *Drepanella* is never observed in species of *Beyrichia*. Indeed, this lobe soon became the most constant feature for the whole family. Aside from this occasional difference,

the greatest distinction between *Drepanella* and the *tuberculata* section of *Beyrichia* is that, whereas in the former the outer sickle-shaped ridge is the most constant feature, in the latter it became through dissection the least stable.

The youngest unquestionable *Drepanella* known is the *D. richardsoni* of the Richmond in Ohio. In this the anterior end of the sickle-shaped submarginal ridge is thick and tends to connect with

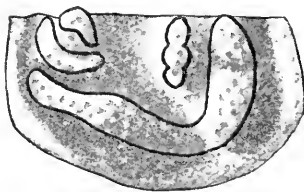

FIG. 16.—A LEFT VALVE OF BEYRICHIA TUBERCULATA (KLEIBEN),  $\times 15$ , WITH THE LINES OF A DREPANELLA DRAWN OVER IT.

the basal part of the expanded and prominent, though still partially dissected anterior lobe. Continuing this line of departure from the older, typical species of the genus, a stage might be expected in which the anterior lobe would be swollen to such a degree that the component nodes or tubercles of the earlier dissected stages would be entirely obscured. In fact, we have such a stage in a late Richmond species described by Ulrich as *Ctenobolbina tumida*. As stated in the discussion of that genus, the species is not a *Ctenobolbina*, the bulbous part of the carapace which was thought to correspond to the similarly bulbous posterior end of *C. ciliata* being, in fact, anterior. The original specimens of the species were not in condition to permit working out all its characters exactly, nor had any reason occurred at that time to lead the author to suspect that the swollen end of the carapace is anterior and not posterior. Such a suspicion, ending finally in conviction, arose only during the course of the present revision of the family. Recognizing the median lobe of *Beyrichia* in the small vertical node or ridge located well to one side of the middle



of the valve in *C. tumida*, and having learned that this is invariably situated *behind* the middle, no other course remained than to interpret the bulbous end as anterior.

Having oriented the valves in this manner, the relations of *C. tumida* to *Drepanella richardsoni* became fairly clear; but even then it required a more perfect specimen than the original types to enforce conviction. This specimen, recently collected at Moreland, Kentucky, has a thick marginal ridge running from the post-dorsal angle to the middle of the ventral edge, where its further extent is lost in the ventral slope of the anterior bulb. But its anterior extremity reappears on the opposite side of the bulb as a distinct node. Taking essentials alone into account, the characters of *C. tumida* are not greatly different from those of *Beyrichia* like *B. protuberans*, *B.*

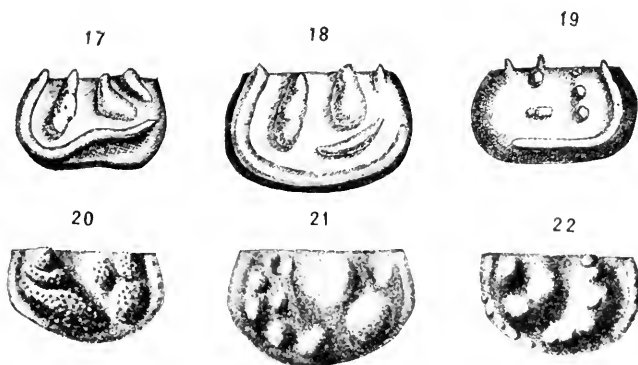

FIGS. 17-22.—17, RIGHT VALVE OF DREPANELLA MACRA ULRICH FOR COMPARISON WITH FIG. 20. LEFT VALVE OF BEYRICHIA TUBERCULATA (KLOEDEN). 18, RIGHT VALVE OF DREPANELLA CRASSINODA ULRICH FOR COMPARISON WITH LEFT VALVE OF BEYRICHIA SOETLINGI REUTER (FIG. 21). 19, LEFT VALVE OF DREPANELLA NITIDA (ULRICH) FOR COMPARISON WITH THE CORRESPONDING VALVE OF BEYRICHIA BAUERI REUTER, SHOWN IN FIG. 22. (COPIED AFTER ULRICH AND REUTER.)

*jonesi*, or *B. clavata*, in which also the anterior lobe is the most prominent part of the valves and the posterior lobe extends forward beneath the middle and anterior lobes. Therefore, despite the rather strong dissimilarity in aspect, there seems really to be no very essential difference between *C. tumida* and *Beyrichia*. The posterior half is nearly the same in both, and only the great development of the anterior lobe gives the Ordovician species a strange look. However, as the writers are convinced that the latter is related genetically to unquestionable species of *Beyrichia*, and that the differences noted are not of greater importance than those obtaining between, for instance, the *B. tuberculata* and the *B. klodeni* groups, the species *tumida* is removed from *Ctenobolbina*, where it certainly does not belong, to *Beyrichia*.

The relations of *B. tumida* to the Clinton *B. lata*, suggested in 1894,<sup>a</sup> have been confirmed in the present investigation. Though widely different in general aspect, the evolution of the latter from the former is regarded as not unlikely. In the rapid and sometimes extravagant mutation that is indicated, not only for the ostracoda but also in other classes of animals, at and immediately following the close of the Ordovician, it is readily conceivable that both the anterior and the posterior lobes of *B. tumida* might have been greatly reduced and thus to have brought about a temporary stage like *B. lata*.

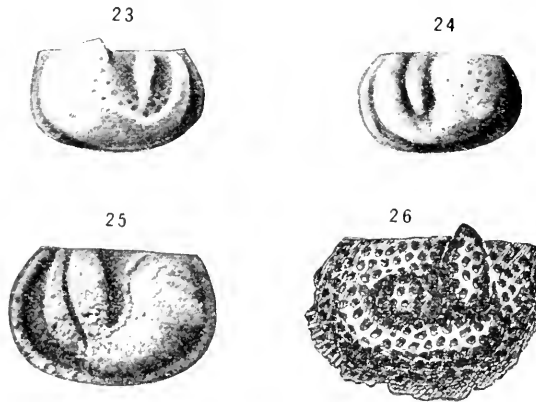

FIGS. 23-26.—23, LEFT VALVE OF *DREPANELLA RICHARDSONI* (MILLER),  $\times 10$ , INTRODUCED FOR COMPARISON WITH *BEYRICHIA TUBERCULATA*. UPPER BEDS OF THE RICHMOND GROUP, NEAR WILMINGTON, OHIO. 24, RIGHT VALVE OF *BEYRICHIA TUMIDA* (ULRICH),  $\times 10$ , SHOWING ITS DERIVATION FROM *DREPANELLA*. TOP OF RICHMOND GROUP, MORELAND, KY. 25, RIGHT VALVE OF *BEYRICHIA LATA* HALL,  $\times 10$ , FOR COMPARISON WITH *BEYRICHIA TUMIDA* AND *DREPANELLA RICHARDSONI*. CLINTON GROUP, NEW HARTFORD, N. Y. 26, RIGHT VALVE OF *TREPOSELLA LYONI* (ULRICH),  $\times 20$ , A DERIVATION OF *BEYRICHIA* IN WHICH THE POSTERIOR LOBE HAS BECOME OBSOLETE. (AFTER ULRICH.) ONONDAGA LIMESTONE, FALLS OF THE OHIO.

the loop formed by the ventral union of the nodes, *B. lata* also suggests a *Bollia*,

#### GROUP OF *B. SALTERIANA*.

The species of this group do not, as a rule, attain the average size of those included in the *B. tuberculata*, *B. kladeni*, and *B. buchiana* groups. They differ rather obviously, too, from these other groups in the fullness of their lobes and the proportionate narrowness of the furrows. The departure from the more typical sections is toward *Kladenia*, in which the furrows are obscure or die out entirely in

The Clinton species is chiefly remarkable because of the slight development of its posterior lobe. In the Devonian decadence of typical *Beyrichia* a similar obsolescence of the posterior ridge is noted in the modified stage represented by *Treposella lyoni* (Ulrich). At this time the *Beyrichiidae* assumed various atavistic expressions, some suggesting *Ctenobolbina*, others *Bollia*, while a third may recall *Tetradella*. In the partial obsolescence of the posterior lobe and the proportionate distinctness of the median and posterior

<sup>a</sup> Ulrich, Geol. and Nat. Hist. Surv. Minnesota, Final Rept., III, Pt. 2, p. 674.

the swollen ventral half of the valves. While clearly intermediate in character between typical *Beyrichia* and *Klardenia*, it yet seems unlikely that either was derived from the other through the *salteriana* group. On the contrary, a study of *B. salteriana* Jones, *B. reuteri* Krause, *B. plicata* (Krause), and *B. trilobata* (Krause) seems to indicate a closely knit line of development that diverged, like the *B. linnaarssoni* group, from some early stage of *Ctenobolbina*. The resemblance exhibited by *B. plicata* to *Ctenobolbina subcrassa*, for instance, is too close to be regarded as otherwise than genetic; and the agreement between *B. plicata* and *B. reuteri*, and between the latter and *B. salteriana*, is so intimate that a similar relationship seems undeniable.

Compared with the other sections of the genus, the *salteriana* group agrees best with the *B. tuberculata* group in the isolation of its median lobe. The dissection of the other two lobes occurring so generally in that group, however, is not even suggested.



FIGS. 27-30. 27, RIGHT VALVE OF CTENOBOLBINA SUBCRASSA ULRICH,  $\times 20$ . (AFTER ULRICH.) 28, RIGHT VALVE OF BEYRICHIA PPLICATA (KRAUSE),  $\times 20$ . 29, LEFT VALVE OF BEYRICHIA REUTERI KRAUSE,  $\times 15$ . (FIGS. 28 AND 29 ARE COPIED FROM KRAUSE.) 30, RIGHT VALVE OF BEYRICHIA SALTERIANA JONES,  $\times 10$ . (AFTER REUTER.) THE FIGURES ILLUSTRATE THE RELATION AND PROBABLE DERIVATION OF THE BEYRICHIA SALTERIANA GROUP FROM A CTENOBOLBINA LIKE SUBCRASSA. TWO INTERMEDIATE STAGES ARE SHOWN IN FIGS. 39 AND 41.

*Beyrichia granulosa* Hall, from the Waldron shale of Indiana, is a good American example of this section of the genus. This species is of exceptional interest because it is one of the few species of the genus that occur in Silurian deposits of the Ohioan Province.

#### GROUP OF *B. CLAVATA*.

Of the foregoing groups, those of *B. kladeni*, *B. buchiana*, and *B. tuberculata* represent the fully established and most typical stages of the genus. The group of *B. salteriana* evidently originated in some species of *Ctenobolbina* and probably is the stock from which *B. kladeni* was derived. It is also the only known group from which the genus *Klardenia* might have sprung. The small group of *B. clavata*, which includes *B. jonesii* Boll and possibly *B. umbonata* Reuter, likewise has a character suggesting an earlier genus, namely, the posterior ridge curves forward along the ventral margin, and, though attached to the slender isthmus connecting the anterior and median lobes, is often distinguishable as far as the antero-ventral angle where it merges into the great, pear-shaped anterior lobe. So

far as essentials go, the result is not unlike the Ordovician genus *Drepanella*, with its great, sickle-shaped marginal ridge.

Much similarity is traceable also between *B. clarata* and the synthetic *B. interrupta* group. The posterior ridge is not so well developed in that group, but in *B. r-scripta* and *B. granulifera* it is clearly suggested to where it is lost in the low anterior lobe; and just over its ventral part is the antero-median isthmus. Whether either of these resemblances are indicative of close genetic alliances can not be decided with the evidence now available. The youngest unquestionable *Drepanella*, *D. richardsoni* (Miller), of the Richmond group, analyzes more in accord with *Beyrichia tuberculata* than with *B. clarata*. As stated in another note, the union of the posterior lobe of *B. tuberculata* with the lower of the three parts of the anterior lobe (see figure) would give every essential of *Drepanella*. While the importance of the difference is recognized, and it is a fact that links establishing the relation are unknown, the writers, nevertheless,

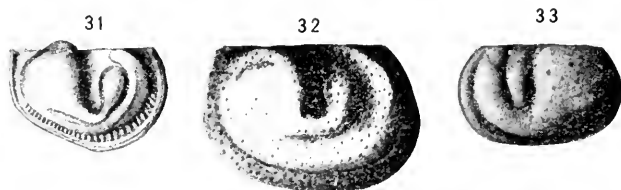

FIGS. 31-33.—31. LEFT VALVE OF BEYRICHIA CLAVATA KOLMODIN. 32. LEFT VALVE OF BEYRICHIA GRANULIFERA, NEW NAME (BOLIA GRANULOSA KRAUSE),  $\times 15$ . (AFTER KRAUSE.) 33. RIGHT VALVE OF BEYRICHIA TUMIDA (ULRICH),  $\times 10$ . THE FIGURES ILLUSTRATE THE RESEMBLANCE OF THE BEYRICHIA CLAVATA GROUP TO THE *B. INTERRUPTA* GROUP AND SHOW THE SIMILAR ANTERO-VENTRAL PROLONGATION OF THE POSTERIOR LOBE.

are convinced that the *B. tuberculata* section was evolved out of *Drepanella*.

Despite the unbroken antero-ventral continuation of the posterior ridge in *B. clarata*, the direct derivation of this species from *Drepanella* seems unlikely, except it be through *B. tumida* (*Ctenobolbina tumida* Ulrich)<sup>a</sup>. Derivation from something like *B. granulifera* and *B. r-scripta* is at least equally plausible. However, neither of these possible solutions is entirely satisfactory, so that for the present the origin of *B. clarata* must be left as undecided.

As for *B. umbonata*, which is somewhat doubtfully referred to this group, the alliance with *Drepanella* seems much more natural. Except that the valves are, on the whole, more convex, and the lobes thicker and less sharply defined, every other essential feature may be duplicated in typical *Drepanella* like *D. crassinoda* and *D. macra*.

Another drepanelloid Beyrichian and possible member or derivation of this group is the Devonian *B. kolmodini* Jones. This species has

<sup>a</sup> See notes on *Drepanella richardsoni* and *Beyrichia tumida* on page 290.

a thick, yet sharply defined, sickle-shaped ridge with two separate rounded nodes above and a variable short ridge just within the anterior edge. Except the interiorly concave marginal border, smaller size, and proportionally narrow anterior end, the general aspect, especially in the matter of lobation, is highly suggestive of *Drepanella*. Here again, however, the writers doubt the reality of the suggested genetic relation. On the contrary, it is thought the true affinities of the species lie with other middle Devonian species that could not be suspected of alliance to *Drepanella* except in a very remote degree. These species, namely, constitute a peculiar group, described and mostly referred by Ulrich, as is now believed incorrectly, to *Ctenobolbina*. Conspicuous members of this group are *C. informis*, *C. antispinosa*, *C. spiculosa*, *C. cavimarginata*, and *C. insolens*. These species, it will be noted, vary greatly in general expression, and because of their spinosity, probably indicate decadence of the Silurian type of Beyrichiidae, and rapid evolution toward the establishment of the final, again comparatively long-lived type of the family. In the transition, various atavistic stages are indicated, some recalling *Ctenobolbina*, some *Bollia*, and others, like *B. kolmodini*, more nearly resembling *Drepanella*. Previously highly important and constant features have become most unstable, but through all the vagaries the steady evolution of the two rounded nodes which constitute the essential characteristic of the dominant and generically distinct later Paleozoic Beyrichian type is manifest. These two nodes, which represent the median and anterior lobes of typical Beyrichiæ, are well developed in *B. kolmodini*, but the general expression of the valves in this transitional stage in the development of the family is so at variance with that of the typical Silurian groups of *Beyrichia* that the writers have decided to recognize it by erecting the new genus *Hollina*.

Subgenus **STEUSLOFFIA**, new.

*Beyrichia* (part) of AUTHORS.

*Strepsula* (part) of AUTHORS.

GROUP OF *B. LINNARSSONI*.

*Beyrichia antiqua*, *B. acuta*, *B. simplex*, *B. linnarssoni*, *B. signata*, *B. beyrichioides*, and probably *B. erraticæ* Krause, which is provisionally not included in the above list, constitute a peculiar group suggesting *Strepsula* in having thin, elevated ribs or crests running over the surface of the valves. It is believed that these ribs served the purpose of strengthening the valves and that they are developed in genetically distinct groups of species. Depending primarily on the lobation of the valves and on their form in deciding questions of relationship, the group under consideration conforms in all essential respects with typical *Beyrichia*.

Beside the presumably dominating alliance of the *B. linnaerSSoni* group to *Beyrichia* s. s., and the suggested relation to *Strepula*, other in part apparently true alliances are indicated, in some by the arrangement of the superficial ribbing, in others by the form and disposition of the lobes. Thus the tetrameroid arrangement of the ribs in *B. erratica* and *B. signata* recalls *Tetradella*. The same may be said of certain more typical and possibly true strepulae like *S. lineata* Krause and the two varieties described by Steusloff as *granulosa* and *separata*. The more simple *B. antiqua* Steusloff and *B. acuta* Krause are like certain species of *Ctenobolbina*. In the opinion of the writers, this resemblance is of real genetic significance, the indicated relationship and probable derivation of at least some Beyrichiae from *Ctenobolbina* seeming fairly easy to establish.

In tracing out this relationship we begin, not with the genotype, *C. ciliata*, and the four or five closely allied species found in the Cincinnati rocks, but with the older Stones River and Mohawkian

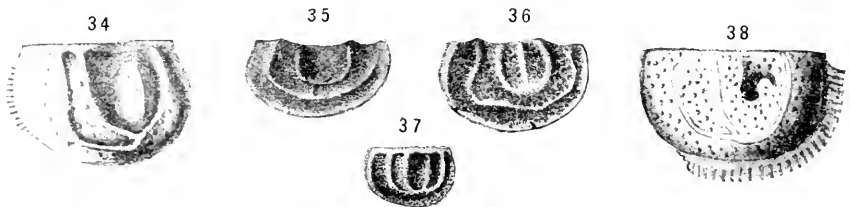

FIGS. 34-38.—34. LEFT VALVE OF BEYRICHIA (STEUSSLOFFIA) LINNAERSSONI (KRAUSE),  $\times 20$ . (AFTER KRAUSE.) 35. RIGHT VALVE OF STREPULA CONCENTRICA JONES AND HOLL,  $\times 15$ . (AFTER JONES AND HOLL.) 36. LEFT VALVE OF STREPULA IRREGULARIS JONES AND HOLL,  $\times 15$ . (AFTER JONES AND HOLL.) 37. LEFT VALVE OF BEYRICHIA (TETRADELLA?) ERRATICA KRAUSE. (AFTER KRAUSE.) 38. LEFT VALVE OF STREPULA? LINEATA GRANULOSA STEUSLOFF,  $\times 20$ . (AFTER STEUSLOFF.) SHOWS SIMILAR DEVELOPMENT OF SUPERFICIAL LINEAR CRESTS IN STEUSSLOFFIA AND STREPULA. IN TRUE STREPULA THE BEYRICHIAN LOBES ARE NOT CLEARLY DETERMINABLE.

forms. In the *ciliata* section of *Ctenobolbina* the median lobe is undistinguishably merged in the larger posterior bulb which characterizes this section. It began in species like the early Trenton *C. obliqua* Ulrich and the foreign Ordovician *C. oblonga* (*Entomis oblonga* Steusloff), in which this median lobe is merely indicated by the abruptness of the inner slope of the main lobe; and these species seem to have been derived from the previously established *C. subcrassa* section.

In the *subcrassa* section the median lobe is generally distinguishable, appearing as a small or larger node or ridge situated immediately behind the main, median sulcus. Usually the posterior side of the lobe is not sharply defined from the more or less swollen surface behind it. Sometimes, as in *C. umbonata* (*Entomis umbonata* Steusloff) and *C. subcrassa* Ulrich, it forms a small, rounded node on the inner slope of the main posterior bulb. In others (as, for instance, *C. crassa* and *C. fulcrata* Ulrich) it makes a low ridge rising

slightly above the rest of the swollen posterior lobe, and of which it forms the greater part, while in some of the later Silurian species, namely *C. auricularis* (*Bollia auricularis* Jones and Holl), and *C. minor* (*Bollia minor* Krause), it is rendered even more prominent by the almost total obsolescence of the posterior part of the *Ctenobolbina* bulb (the obsolete part corresponds to the posterior lobe of a *Beyrichia*).

Having reached the stages of *C. subcrassa* and *C. fulcrata*, a further discrimination of the median lobe might result in a species like *C. impressa* (*Entomis impressa* Steusloff) and finally in one like *Beyrichia antiqua* of the same author. In this last the median lobe is at least as large as in the average *Beyrichia*, and the species differs from the more usual types of this genus only in the less sharp defini-

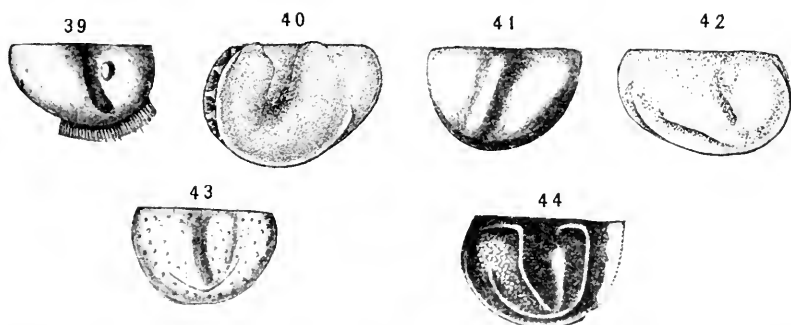

FIGS. 39-44.—39, LEFT VALVE OF CTENOBOLBINA UMBONATA (STEUSSLOFF). 40, RIGHT VALVE OF CTENOBOLBINA FULCRATA (ULRICH). 41, RIGHT VALVE OF CTENOBOLBINA IMPRESSA (STEUSSLOFF). 42, LEFT VALVE OF CTENOBOLBINA SUBCRASSA ULRICH. 43, LEFT VALVE OF BEYRICHTIA (STEUSSLOFFIA) ANTIQUA (STEUSSLOFF).  $\times 20$ . 44, LEFT VALVE OF BEYRICHTIA (STEUSSLOFFIA) ACTTA (KRAUSE). (FIGS. 40 AND 42 ARE AFTER ULRICH, 39, 41, AND 43 AFTER STEUSSLOFF, AND 44 AFTER KRAUSE. ALL  $\times 20$ .)

tion of the post-median furrow and in the slight elevation and general lack of definition that pertains to both the anterior and posterior lobes.

It is probably significant that most of these ribbed or crested species comprising the *B. linmarssoni* group are of Ordovician age, in which rocks *Ctenobolbina* and *Tetradella* are the prevailing genera, and unribbed, true *Beyrichias* almost unknown. The group, therefore, may be viewed as an intermediate stage in the development of at least one of the groups of *Beyrichia* from *Ctenobolbina*.

If accurately figured, Krause's *Strepula reticulata* should perhaps be referred to this group. On account of the proportionately elongate form of its valves and the great width of its marginal frill, the species would stand somewhat apart from the more typical representatives of the group. Because of a similarly fringed and reticulated *Beyrichia* in the Waldron shale of Indiana, it seems just pos-

sible that the figure given by Krause is a little defective at the base of the median and posterior lobes. The Waldron species sometimes even exhibits a suggestion of the V-shaped crest, but, as is shown on Plate XXXVII, the ventral part of the posterior lobe is distinctly contracted, giving an appearance quite different from the same part in Krause's figure of *B. reticulata*, but closely simulating the fringed species of the *B. maccoyi* group.

As figured, *B. reticulata* appears to be somewhat obscurely lobed, which, with the broad frill, is somewhat suggestive of *Eurychilina*. But it has no sharply defined median pit, and it is thought unlikely that the marginal frill is hollowed out on its inner surface. The median lobe also is too long. It seems probable, therefore, that the general resemblance to *Eurychilina* does not indicate close genetic relations.

The *B. Linmarssoni* group has a sufficiently uniform expression to suggest the advisability of its separation as an independent though decidedly synthetic genus. The crested valves recall *Strepsula*, the

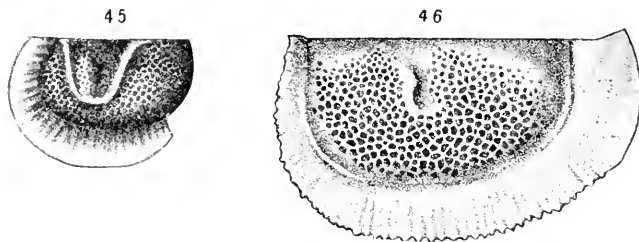

FIGS. 45-46.— RIGHT VALVE OF BEYRICHTIA RETICULATA (KRAUSE),  $\times 20$ , AND THE SAME VALVE OF EURYCHILINA RETICULATA ULRICH,  $\times 20$  (AFTER ULRICH), SHOWING THE SIMILARITY OF THE TWO FORMS REFERRED TO IN THE TEXT.

mode of lobation is very much as in the *Beyrichia salteriana* group, and through this resembles on the one hand the typical Beyrichian section of *B. tuberculata* and on the other *Kladenia*. In still another direction, close alliance with *Ctenobolbina*, as above outlined, is established. If *Ctenobolbina* were expanded to take in a part of the group, consistency would demand that species of the *B. salteriana* group be also included. But this would render the boundary between *Ctenobolbina* and *Beyrichia* more artificial than it is desired to make it. Besides, it would split up an apparently very natural association of species.

The group as a whole is undoubtedly more in accord with *Beyrichia* than *Ctenobolbina*, and in the first suggestion of the heterogeneous mass of Beyrichiidae, its species were left with or referred to the restricted genus without much hesitation. However, in the still considerable and variable mass of species having the essential characters of *Beyrichia*, the comparative entity of the *B. Linmarssoni* group is lost sight of. In order to secure its deserved recognition without



at the same time completely disassociating it from its most obvious alliance, it is provisionally suggested that the group be distinguished merely subgenerically from *Beyrichia*, and that it be known by the proposed name *Steusloffia*, with *Beyrichia linnarssoni* as the type.

GROUP OF *B. INTERRUPTA*.

Another resemblance that has led to unnatural associations is that borne to *Bollia* by a small group comprising *Beyrichia granulifera*, new name (*Bollia granulosa* Krause, specific name preoccupied under *Beyrichia*), and *B. v-scripta* (Krause), two Ordovician species, *B. damesi* Krause, and *B. interrupta* (Jones and Holl), two Silurian species. In fact, with the exception of *B. damesi*, all of these species were originally referred to *Bollia*, but, as will be clear enough when

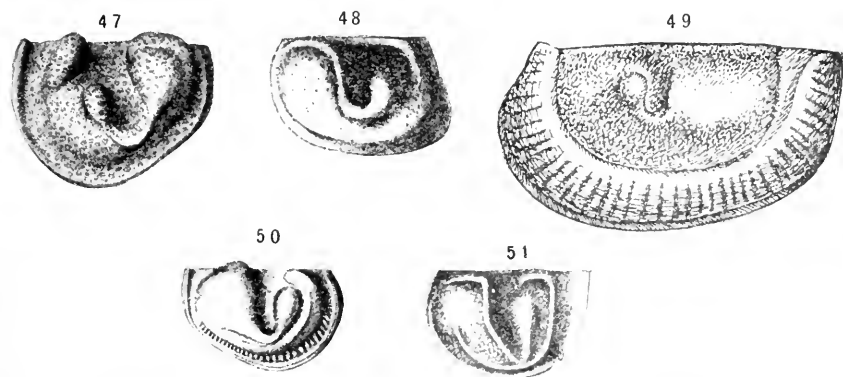

FIGS. 47-51.—47, RIGHT VALVE OF BEYRICHIA INTERRUPTA (JONES),  $\times 20$ . 48, LEFT VALVE OF BEYRICHIA V-SCRIPTA (KRAUSE),  $\times 15$ . 49, RIGHT VALVE OF EURYCHILINA SUBRADIATA ULRICH,  $\times 20$ . 50, LEFT VALVE OF BEYRICHIA CLAVATA KOLMODIN. 51, LEFT VALVE OF BEYRICHIA (STEUSSLOFFIA) ACUTA (KRAUSE). (FIG 47 IS AFTER JONES, 48 AFTER KRAUSE, 49 AFTER ULRICH, 50 AFTER KIESOW, AND 51 AFTER KRAUSE.) THE ILLUSTRATIONS SHOW POSSIBLE DERIVATION OF THE BEYRICHIA INTERRUPTA GROUP FROM EURYCHILINA AND ITS RELATIONS TO THE BEYRICHIA CLAVATA GROUP AND TO STEUSLOFFIA.

that genus is considered, they do not belong there. The curved ridge in these species seems really to have no greater taxonomic significance than the similar node and ridge often seen in typical *Eurychilina*. On the other hand, the lobation of their valves, though in part obscure, is essentially that of *Beyrichia*, the connection with species of this genus like *B. jonesi* and *B. clavata* being, apparently at least, very clear.

The group suggests passage from Primitiidae to *Beyrichia*, but whether this suggestion is based on fact or is merely apparent and thus misleading, can not be decided with the evidence at hand. However, the possibility of species conforming to the generic diagnosis of

*Beyrichia* having been developed from diverse stocks by convergence in evolution, is worth bearing in mind. In general aspect, and especially in having a well-defined median pit, *B. granulifera* and *B. r-scripta* certainly indicate Primitian ancestry, close affiliations being suggested to both *Primitia* and *Eurychilina* (as, for instance, *E. schmidti*). However, an analysis of their lobes seems to show more positive alliances on the one hand to the *B. clavata* group of *Beyrichia*, and on the other to the proposed subgenus *Steusloffia*. Perhaps it would be well to institute another subgenus for this group.

#### Genus KLÆDENIA Jones and Holl.

*Kladenia* JONES and HOLL, Ann. and Mag. Nat. Hist. (5), XVII, 1886, p. 362.

*Kladenia* (part) KRAUSE, Zeits. d. d. geol. Gessell., XLI, 1889, p. 21.

*Kladenia* (part) MILLER, North Amer. Geol. and Pal., First App., 1892, p. 708.

*Kladenia* (part) KOKEN, Die Leitfossilien, 1896, p. 39, text fig. 26A.

*Beyrichia* (part) of AUTHORS.

Carapace of moderate size, 1 mm. to 4 or 5 mm. in depth. Valves very nearly equal, the ventral edge of the right valve sometimes very slightly overlapping the edge of the left. Outline oblong, subquadrate to subovate, rarely subtriangular, the hinge line long and straight, the remaining sides more or less curved. Surface of valves strongly convex, especially in the unlobed ventral half; dorsal half with two furrows deep above but growing obsolete before or shortly after crossing half the valve. Anterior furrow deeper and broader than the posterior one and located near the mid-length. Of the three lobes the median is the most constant in size and form. It is generally rounded and somewhat bulbous, more rarely obtusely pointed above, and its diameter usually about one-fifth of the length of the valve. Posterior and anterior lobes sharply defined only along the furrows, the outer parts usually sloping more or less gently to the end rims and below merging into the swollen ventral surface, their dorsal extremities occasionally projecting beyond the horizon line. Posterior lobe varying in width from rather less than to nearly twice the diameter of the median lobe. Anterior lobe constituting the greater part of this half of the valve, sometimes divided so as to form a broad inner lobe and one or two narrower ridges in front. When the anterior lobe is thus prolonged and divided (as, for instance, *K. plicata* Jones), the separating furrows extend entirely across the valve. Ventral pouch (as in *Beyrichia* presumably of female) mostly posterior, merely an extra, obscurely outlined swelling, not globular as in *Beyrichia*. A simple, narrow, flange-like border commonly present but may be wanting. Surface of valves granulose, punctate, reticulate, or without ornament.

*Genotype*.—*Klædenia wilckensiana* (*Beyrichia wilckensiana* Jones).

LIST OF SPECIES HAVING THE CHARACTERS OF KLÆDENIA AS ABOVE DEFINED.

- Klædenia apiculata* Jones.  
*Klædenia barretti*<sup>a</sup> (*Beyrichia barretti* Weller).  
*Klædenia centricornis*,<sup>a</sup> new species.<sup>b</sup>  
*Klædenia concinna* (*Beyrichia concinna* Jones and Holl).  
*Klædenia fimbriata*,<sup>a</sup> new species.<sup>c</sup>  
*Klædenia granulata*<sup>a</sup> (*Beyrichia granulata* Hall).  
*Klædenia initialis*<sup>a</sup> (*Beyrichia initialis* Ulrich).  
*Klædenia intermedia* (*Beyrichia intermedia* Jones and Holl).  
*Klædenia intermedia marginata* Jones and Holl.  
*Klædenia jerseyensis*<sup>a</sup> (*Beyrichia jerseyensis* Weller).  
*Klædenia kummeli*<sup>a</sup> (*Beyrichia kummeli* Weller).  
*Klædenia mantlicensis*<sup>a</sup> (*Beyrichia mantlicensis* Weller).  
*Klædenia mantlicensis deckerensis*<sup>a</sup> (*Beyrichia deckerensis* Weller).  
*Klædenia marginalis*,<sup>a</sup> new species.<sup>d</sup>  
*Klædenia montaguensis*<sup>a</sup> (*Beyrichia montaguensis* Weller).  
*Klædenia nearpassi*<sup>a</sup> (*Beyrichia nearpassi* Weller).  
*Klædenia oculina*<sup>a</sup> (*Beyrichia oculina* Hall).  
*Klædenia parasitica*<sup>a</sup> (*Beyrichia parasitica* Hall).  
*Klædenia prænuntia*,<sup>a</sup> new species.<sup>e</sup>  
*Klædenia punctilosa*,<sup>a</sup> new species.<sup>f</sup>

<sup>a</sup> American species.

<sup>b</sup> The unusual length of the valve, spine-like central node, and coarse pitting are features which will cause the easy identification and differentiation of this species from others of the genus. See Plate XXXVIII, fig. 23.

*Formation and locality*.—Coeymans limestone, Cumberland, Maryland.

*Holotype*.—Cat. No. 53305, U.S.N.M.

<sup>c</sup> This fine species will be recognized at once by its spinous margin. This spiny frill, together with the reticular surface ornament and general neatness of form, impart a striking elegance to the shell. See Plate XXXVIII, fig. 22.

*Formation and locality*.—Coeymans limestone, Herkimer County, New York.

*Holotype*.—Cat. No. 53306, U.S.N.M.

<sup>d</sup> This species is similar to *Klædenia mantlicensis* (Weller), but has a wider margin, is more elongate, and its sulci are much shallower. The surface is smooth, without ornament. See Plate XXXVIII, fig. 16.

*Formation and locality*.—Helderbergian, Dalhousie, New Brunswick.

*Holotype*.—Cat. No. 53307, U.S.N.M.

<sup>e</sup> The distinctive features of this species are the unusual narrowness of the posterior lobe and the sharp impression yet unusual brevity of the sulci. The smooth surface and obscurely defined marginal rim will likewise assist in the discrimination of the species. See Plate XXXVIII, fig. 15.

*Formation and locality*.—Ordovician (local bed in upper part of Hermitage formation). Four miles south of Carthage, Tennessee.

*Holotype*.—Cat. No. 41643, U.S.N.M.

<sup>f</sup> This new species is similar to *Klædenia nearpassi* (Weller) and *K. barretti* (Weller) in outline, but its dorsal angle is more nearly rectangular and the marginal rim narrower. The surface is finely punctate. See Plate XXXVIII, fig. 17.

*Formation and locality*.—Helderbergian, Dalhousie, New Brunswick.

*Holotype*.—Cat. No. 53308, U.S.N.M.

*Kludenia relifera*<sup>a</sup> new species,<sup>b</sup>

*Kludenia scolica* (*Beyrichia kludeni*, var. *scolica* Jones and Holl.)

*Kludenia simplex*<sup>a</sup> Jones.

*Kludenia smoeki*<sup>a</sup> (*Beyrichia smoeki* Weller).

*Kludenia susserensis*<sup>a</sup> (*Beyrichia susserensis* Weller).

*Kludenia tuberculata* (*Beyrichia tuberculata* Salter).

*Kludenia wallpackensis*<sup>a</sup> (*Beyrichia wallpackensis* Weller).

*Kludenia wilkensisiana* (*Beyrichia wilkensisiana* Jones).

*Kludenia wilkensisiana plicata* (*Beyrichia wilkensisiana plicata* Jones).

Of the above species, *K. initialis* and *K. prawnutia* are middle Ordovician and *K. simplex* late Devonian. All the others are of Silurian, mainly late Silurian, age.

It will be seen from this list of species that *Kludenia*, as here defined, includes only six of the twelve species and varieties which have been referred to it. Most of the others constitute a distinguishable group of which *K. pennsylvanica* Jones is a good example, and which it is proposed to separate as a new genus under the name *Kludenella*. The new genus, as will be more fully set forth on a following page, differs from true *Kludenia*, as understood by the writers, chiefly in the more cylindrical form of its shells and the greater inequality of its valves. In both of these respects, typical *Kludenia* is essentially the same as *Beyrichia*, the differences between the two lying in the relative convexity and lobation of the valves.

In *Beyrichia* the valves are depressed convex, the three lobes are represented by sharply defined ridges or elevations which rise abruptly above the flattened floor of the valves. The ridges are separated by deep, vertical furrows, which, though varying in width, are yet very constant in their length. As a rule, the posterior furrow extends across the valve to the ventral rim. The anterior furrow commonly is limited below by the ventral junction of the anterior and median lobes, but when the latter is isolated it passes around the lower side of the median lobe and merges with the posterior furrow.

In *Kludenia* the main furrows never extend across the valves, but are confined to its dorsal half. They mark off a rather large submedian node and often converge beneath so as to isolate it. The anterior and posterior lobes are broad and never ridge-like, but, as a rule, form part of the general convexity of the valve. In fact, the majority of the species might be described as approximately uniformly convex save for the short furrows inclosing the median node.

<sup>a</sup> American species.

<sup>b</sup> The surface ornament, practically obsolete marginal rim, the small spine at posterior extremity of hinge, and the unusually slight depth of the sulci are characters which will distinguish this species. See Plate XXXVIII, fig. 18.

*Formation and locality.*—Helderbergian, Dalhousie, New Brunswick.

*Holotype.*—Cat. No. 53969, U.S.N.M.

The relations of the genus to the group of *Beyrichia salteriana*, which section of *Beyrichia* includes the species most like *Klædenia*, have been discussed on a preceding page.

*Klædenia* may have been evolved through several rather widely different ways. First, it may have been derived from the *salteriana* group of *Beyrichia* by the ventral coalescence of the three lobes. Though possible, even reasonable, the known species afford no satisfactory evidence of such an alliance. In the absence of intermediate stages, the evidence must be admitted as wholly negative, if not positively opposed to this view. Considering that the *salteriana* group of *Beyrichia* is Silurian, and that *Klædenia*-like ostracoda began already in middle Ordovician time, it is clear that only a part of the genus could have been descended from *Beyrichia*.

According to the second view, *Klædenia* was derived from some unisulcate Primitian stock by the segregation and enlargement of the post-median node. Suggestive resemblances may be noted on comparison with the Ordovician *Primitia tumidula*, *P. cincinnaticensis*, *Eurychilina reticulata*, and *E. subaquata*. Regarding the two valves of *P. tumidula* figured by Ulrich<sup>a</sup> as right valves, and comparing them with the right valve of *Klædenia initialis* (*Beyrichia initialis* Ulrich) figured on the same plate, the possible derivation from *Primitia* is clearly indicated by correlation of the nodes and furrows. It should be borne in mind, however, that this comparison merely indicates the *kind* of steps by which passage from *Primitia* to *Klædenia* may have been effected, and not the links themselves, because *K. initialis* is older than either of the two *Primitias* mentioned.

Still other derivations are suggested by the new Ordovician species, *K. prænuntia*. This is a larger shell than any *Primitia* and has the median lobe too well separated to recall that genus. Except for the much sharper definition of the *Klædenia* characteristics, this species resembles leperditellæ like *L. germana* and *L. dorsicornis*. But it recalls even more *Drepanella elongata*, which differs in little that may be called essential except that it has the sickle-shaped ridge of *Drepanella*. This ridge is weaker in *D. elongata* than usual, and it is really conceivable that it might have become obsolete early in the descendants of this species, and thus give origin to a stage that, with our present limited knowledge, must be referred to *Klædenia*.

These diverse, yet all reasonably possible, derivations of *Klædenia* illustrate the extreme difficulties encountered in determining the genetic relations of the major groups of the family Beyrichiidae. Though inclined to favor the view that the majority of the species referred to *Klædenia* were evolved out of *Primitia*, it must be admitted that the evidence is far from conclusive.

<sup>a</sup> Geol. and Nat. Hist. Surv. Minnesota, Final Rept., III, Pt. 2, 1894, pl. XLIII, figs. 62-65.

The genus *Kyammodes* Jones, founded on a British Devonian species, but thought to include also a few Silurian forms (as, for instance, *Kladenia kiesowi* Krause), doubtless is closely allied to and probably evolved out of typical *Kladenia*. Though distinguished chiefly by the much greater inequality of its valves, the thick ventral edge of the right overlapping the smaller left valve, there are some peculiar differences in lobation also. In all the species there is a deep median furrow that, however, dies out before reaching the middle of the valve. In *Kyammodes kiesowi* (*Kladenia kiesowi* Krause) the parts

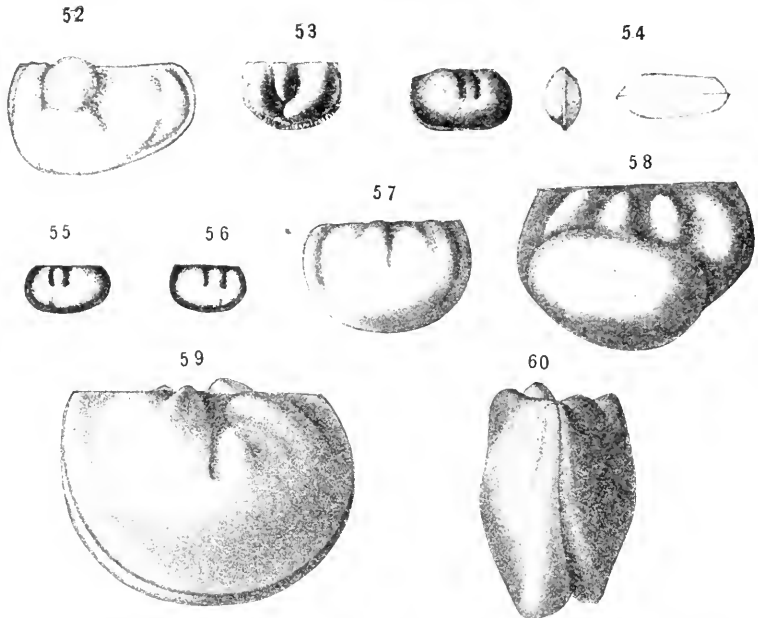

FIGS. 52-60. 52, 53, RIGHT VALVE OF KLØDENIA WILCKENSIANA (JONES),  $\times 8$  (FEMALE INDIVIDUAL), AND BEYRICHTIA SALTERIANA JONES,  $\times 10$ , RESPECTIVELY, SHOWING THE RELATION OF KLØDENIA TO THE B. SALTERIANA GROUP. (AFTER JONES AND REUTER.) 54, LEFT SIDE, END, AND VENTRAL VIEWS OF COMPLETE CARAPACE OF KLØDENELLA PENNSYLVANICA (JONES),  $\times 15$ . (COPIED FROM JONES.) 55, 56, RIGHT AND LEFT VALVES OF KLØDENIA NEARPASSI (WELLER),  $\times 6$ . (AFTER WELLER.) 57, 58, LEFT AND RIGHT VALVES, THE LATTER A FEMALE FORM, OF KYAMMODES KIESOWI (KRAUSE),  $\times 10$ . (AFTER KRAUSE.) 59, 60, LEFT VALVE AND ANTERIOR VIEW OF COMPLETE CARAPACE OF KYAMMODES WHIDBORNEI JONES,  $\times 20$ . (AFTER JONES.) THE SIMILARITY OF KLØDENIA, KLØDENELLA, KYAMMODES, AND THE BEYRICHTIA SALTERIANA GROUP ARE SHOWN IN THE ABOVE FIGURES.

of the valve are arranged almost regularly bilaterally with respect to this furrow, which separates two subequal, low nodes, each taking up about one-fifth the total length of the valve. The outer limits of these nodes are defined by shallower converging furrows, which in turn set off another matching pair of similarly curving low ridges. In *K. whidbornei*, the type of the genus, the lobes are both less regular and less constant in their development, the posterior median lobe, which corresponds to the median lobe of *Kladenia*, being especially variable. As a rule it is smaller and set farther down than the antero-

median one, and, furthermore, tends to merge with the post-dorsal node.

The type of the genus *Klodenia*, *K. wilckensiana*, occupies an intermediate position between two sections into which the genus is divisible. One of these sections, the smaller, includes, with the genotype, most of the European species, while all the known American forms fall into the second. The first section is characterized by a tendency to produce and to attenuate the anterior extremity and to develop on this part one or two accessory furrows. In consequence the outline of the valves is more or less triangular and comparatively elongate. In the American section of the genus the valves are usually shorter, the ends approximately equal and the anterior one without distinct furrows.

Of American species, *K. oculina* (Hall) and *K. notata* (Hall) probably are to be regarded as nearest to *K. wilckensiana*. It is certain at least that they are congeneric, and it seems no less a fact that these species belong to the same genus as those constituting the prevailing American type of Beyrichiidae found in the late Silurian Manlius and Coeymans, members of Hall's Lower Helderberg group. The writers therefore feel little hesitancy in revising and restricting the genus as indicated above. The elimination of the *K. pennsylvanica* group is the most important departure from Jones's later conception of *Klodenia*. Another is the inclusion of certain species, like *K. tuberculata* (Salter), which he had left with *Beyrichia*, indeed, in the case mentioned, as a variety of *B. klodeni*. Speaking of *K. tuberculata*, it is worth noting that this is one of the very few European Beyrichiidae that is represented in America by a form so nearly like Scandinavian specimens that a specific distinction is scarcely justified. Hall called the American variety *Beyrichia granulata*.

Except the two Ordovician species, *K. prænuntia*, new species, and *K. initialis*, and the Chemung species, *K. simplex*, all of which, though doubtless possessing the essential features of the genus, are yet referred here with some misgivings, the genus *Klodenia* is confined to Silurian rocks. In its typical expression, indeed, the genus might be regarded as one of the most characteristic fossils of this system. In America there are numerous, in part undescribed species. By far the greater number of these are found in the upper parts of the Silurian and principally in the Manlius and Coeymans limestones. So far none has been seen in the overlying New Scotland formation. It is interesting and important to note further that all the known species are confined to Appalachian and more eastern Atlantic provinces, the genus apparently having failed to gain a foothold in the interior Ohioan Province.

The new species figured on Plate XXXVIII are only a part of those determined during the course of the present studies.

## Genus TETRADELLA Ulrich.

*Tetradella* ULRICH, Jour. Cincinnati Soc. Nat. Hist., XIII, 1890, pp. 112-114.

*Tetradella* MILLER, North Amer. Geol. and Pal., First App., 1892, p. 711.

*Tetradella* ULRICH, Geol. and Nat. Hist. Surv. Minnesota, Final Rept., III, Pt. 2, 1894, p. 677.

*Beyrichia* (part) of AUTHORS.

Based on *Tetradella quadrilivata*, the genotype, and drawn up so as to include the subjoined list of unquestioned species, this genus may be characterized as follows:

Carapace small, 1 mm. to 2 mm. long, equivalved, never tumid, somewhat oblong, varying from subquadrate to subovate, with the hinge line straight. Valves depressed-convex, deeply trisulcate, the furrows separating four more or less sharply elevated ridges. As a rule the ridges connect ventrally, but are quite distinct at their dorsal extremities, the result being a semielliptical submarginal ridge with two simple or double, equal or unequal, and less curved ridges within the inclosed space. These inner ridges commonly unite with the ventral part of the marginal ridge and extend upward from it toward the dorsal edge, the posterior one often failing to reach it. Free margins usually with a simple flattened border, which in certain cases extends beyond and conceals thickened contact edges. Surface of valves usually smooth, occasionally minutely granose.

All of the species of *Tetradella* and of the new subgenus *Kiesowia*, a list of which follows, are derived from Ordovician strata.

## LIST OF SPECIES OF TETRADELLA.

*Tetradella* ? *affinis* (*Beyrichia affinis* Jones).

*Tetradella bohemicæ* (*Beyrichia bohemicæ* Barrande MSS. Jones).

*Tetradella bussacensis* (*Beyrichia bussacensis* Jones).

*Tetradella carinata* (*Beyrichia carinata* Krause).

*Tetradella complicata* (*Beyrichia complicata* Salter).

*Tetradella complicata decorata* (*Beyrichia complicata*, var. *decorata* Jones).

*Tetradella* ? *digitala* Krause (*Beyrichia digitala* Krause).

*Tetradella* ? *digitala separata* (*Beyrichia digitala*, var. *separata* Steussloff).

*Tetradella* (*Kiesowia*) *dissecta* (*Beyrichia dissecta* Krause).

*Tetradella* ? *erratica* (*Beyrichia erratica* Krause).

*Tetradella harpa* (*Beyrichia harpa* Krause).

*Tetradella* ? *lacunata* (*Beyrichia lacunata* Jones and Holl).

*Tetradella lunatiferæ*<sup>a</sup> (*Strepsula lunatiferæ* Ulrich).

*Tetradella* (*Kiesowia*) *mamillosa* (*Beyrichia mamillosa* Krause).

*Tetradella marchica* (*Beyrichia marchica* Krause).

*Tetradella marchica angustata* (*Beyrichia marchica*, var. *angustata* Krause).

*Tetradella marchica lata* (*Beyrichia marchica*, var. *lata* Krause).

*Tetradella palmata* (*Beyrichia palmata* Krause).

<sup>a</sup> American species.



*Tetradella quadrilirata*<sup>a</sup> (*Beyrichia quadrilirata* Hall and Whittfield).

*Tetradella* (*Kiesowia*) *radians* (*Beyrichia radians* Krause).

*Tetradella ribeiriana* (*Beyrichia ribeiriana* Jones).

*Tetradella simplex*<sup>a</sup> (*Tetradella quadrilirata* var. *simplex* Ulrich).

*Tetradella subquadrans*<sup>a</sup> Ulrich.

In the original description of the genus<sup>b</sup> the species subsequently distinguished as *Ceratopsis*<sup>c</sup> were included. In 1889<sup>d</sup> the typical species was erroneously referred to *Strepula* Jones and Holl. In 1894,<sup>e</sup> when the revised description of *Tetradella* was published, certain European species were referred to the genus, which it is now thought advisable to view as doubtful or to place elsewhere. Thus, *T. signata* Krause, as mentioned on page 295, is now referred to *Stensloffia*, a proposed subgenus of *Beyrichia*. *T. (Beyrichia) cratica* Krause may belong to the same subgenus, but it is preferred to regard it provisionally as questionable, because, with the evidence available to the writers, it is impossible to decide that it is not a *Strepula* rather than a *Tetradella* or a *Stensloffia*. *T. (Beyrichia) lacunata* Jones may be a degenerated species of the genus, but in the absence of satisfactory specimens it should be placed as doubtful. *T. (Beyrichia) affinis* Jones also is doubtful, and the same is true of *T. (Beyrichia) digitata* Krause. Of the species there designated as "somewhat doubtful upper Silurian representatives," *B. nodulosa* is returned to *Beyrichia*, but *B. dissecta* Krause, *B. radians* Kiesow, and *B. mamillosa* Krause must be removed or continue to be regarded as questionable. The dissection of the lobes in the latter two is somewhat similar to what occurs in *Beyrichia* of the group of *B. tuberculata* (see page 289). Critically compared, however, the breaking up of the lobes is not exactly the same. No *Tetradella* could be dissected so as to look like *B. tuberculata* or any of its immediate allies; but if the vertical part of the ridges of, say, *Tetradella subquadrata*, were divided transversely and the furrows were extended ventrally through the marginal ridge, the result would be, in every essential respect, precisely as in *B. dissecta*. The size of the valves also accords much better with the average for *Tetradella* than for *Beyrichia*. Under the circumstances, a separation from both *Beyrichia* and *Tetradella* is suggested, but should it be decided, as the writers believe, that the two species were derived from *Tetradella*, the demands of classification might very well be satisfied by subgeneric discrimination. The name *Kiesowia* is proposed, with *Beyrichia dissecta* Krause as the type of the new genus or subgenus.

<sup>a</sup> American species.

<sup>b</sup> Jour. Cincinnati Soc. Nat. Hist., XIII, 1890, p. 112.

<sup>c</sup> Ulrich, Geol. and Nat. Hist. Surv. Minnesota, Final Rept., III, Pt. 2, 1894, p. 675.

<sup>d</sup> Ulrich, Geol. Surv. Canada, Cont. Micro-Pal., Pt. 2, 1889, p. 54.

<sup>e</sup> Ulrich, Geol. and Nat. Hist. Surv. Minnesota, Final Rept., III, Pt. 2, 1894, p. 677.

## Genus CERATOPSIS Ulrich.

*Ceratella* ULRICH, Jour. Cincinnati Soc. Nat. Hist., XIII, 1890, p. 113 (not established).

*Ceratopsis* ULRICH, Geol. and Nat. Hist. Surv. Minnesota, Final Rept., III, Pt. 2, 1894, p. 675.

*Beyrichia* (part) of AUTHORS.

Carapace essentially as in *Tetradella* except that the post-dorsal end of the marginal ridge is raised into a strong, spine-like, or a mushroom-shaped process, which is commonly beaded or fimbriated along one edge or around the flattened top. Free edges of carapace blunt, the contact line between the two valves concealed by well-developed false borders.

*Genotype*.—*Ceratopsis chambersi* (*Beyrichia chambersi* Miller).

This genus stands to-day in essentially the same position given it in the original definition. The species referred to it then are still retained, and few new species or varieties of the genus have been discovered in the past fourteen years. Among the specimens then referred to the genotype several minor varieties might have been distinguished, but the propriety of doing so was not appreciated at the time. At least one, and probably two, of these varieties seem to be confined to different stratigraphic horizons. Their discrimination, therefore, in a subordinate degree might be desirable on this account alone. However, as the prime object of this paper is to discuss generic rather than specific and minor variations, it is thought advisable to defer such matters to a time when it will be possible to treat the subject monographically.

In addition to *C. chambersi*, the genus includes *C. robusta* Ulrich, *C. intermedia* Ulrich, *C. oculifera* Hall, all American upper Ordovician species, and *C. hastata* (*Beyrichia hastata* Barrande), a Bohemian species of similar age. *Beyrichia rostrata* Krause, from Ordovician drift in northern Germany, seems referable to *Ceratopsis* rather than *Tetradella*. The same is to be said of *Beyrichia quadrifida*, described by Jones as from the "Trenton" at Lorette Falls, Canada. In the figured specimen of the latter the horn is evidently broken away. In the former, providing Krause's figures represent the species fully and accurately, the horn is not so well developed as in the Cincinnati species. Assuming that the last two are correctly understood, then the genus, as at present known, comprises seven species, ranging in time from about Black River to the close of the Ordovician. Apparently the stock became extinct with the close of this period.

## Genus CTENOBOLBINA Ulrich.

- Ctenobolbina* ULRICH, Jour. Cincinnati Soc. Nat. Hist., XIII, 1890, p. 108.  
*Ctenobolbina* MILLER, North Amer. Geol. and Pal., First App., 1892, p. 706.  
*Bollia* (part) KRAUSE, Zeits. d. d. geol. Gesell., XLIV, 1892, p. 392.  
*Entomis* (part) STEUSLOFF, Zeits. d. d. geol. Gesell., XLVI, 1894, p. 780.  
*Ctenobolbina* ULRICH, Geol. and Nat. Hist. Surv. Minnesota, Final Rept., III,  
 Pt. 2, 1894, p. 673.  
*Ctenobolbina* GRABAU, Bull. Buffalo Soc. Nat. Sci., VI, 1899, p. 309.  
*Ctenobolbina* ULRICH, Jour. Cincinnati Soc. Nat. Hist., XIX, 1900, p. 180.  
*Beyrichia* (part) of AUTHORS.

Carapace small, usually less than 2 mm. in length, subquadrate or subovate in outline, the hinge line long and straight: posterior two-fifths more or less decidedly bulbous or subglobular in the typical section of the genus, but in the *C. subcrassa* section the corresponding parts of the carapace are smaller and usually of lesser thickness than certain portions in front of it. In the latter section a small node (the homologue of the median lobe of *Beyrichia*) is sometimes distinguishable on the inner slope of the posterior lobe. One deep, long, narrow, generally curved and more or less oblique sulcus extends from the middle of the dorsal edge toward the post-ventral angle, occasionally reaching the border. Area in front of median sulcus either simply convex or divided by a shallower furrow usually paralleling the main sulcus. Valves equal, the free edges thick, the contact margins generally concealed, partly or wholly, in a lateral view, by a variously modified overhanging border. Surface granulose, smooth, or punctate.

*Genotype*.—*Ctenobolbina ciliata* (*Beyrichia ciliata* Emmons).

Since 1890, when this genus was first described, Ulrich has on two occasions (both cited above) added to the list of species originally referred to the genus. Recent studies of the family have convinced the writers that a good part of these later additions represents, as indicated on page 295, atavistic Devonian stages in the development and decadence of the predominating Silurian phase of the family. Admitting this as probably true, it is thought desirable and of distinct advantage in classification to remove these species from *Ctenobolbina* and to refer them, together with a few species hitherto placed with *Beyrichia* and *Bollia*, to a new genus for which the name *Hollina* is proposed on a following page.

Even after the elimination of this peculiar Devonian group, the remaining species fall into two easily distinguishable subgenera or sections of the genus. The first of these two groups includes *C. ciliata* and its immediate Ordovician allies—all of them with a granulose surface ornament—one early Trenton, one Silurian species with finely reticulate surface, one Helderbergian, and one middle Devonian papillose species. This section is characterized by the

thick, bulb-like form of the posterior lobe, which single swelling comprises both the median and the posterior lobe of a true *Beyrichia*, and by its surface ornament. The second group consists of species without surface ornamentation and whose average size is inferior to that of the first group. The posterior lobe is smaller and commonly exhibits a tendency to segregate a small node or undefined swelling on its inner slope that doubtless represents the larger and more definitely separated median lobe of *Beyrichia*. So far this section is known by seven Ordovician species, one Silurian, one Devonian, and one early Mississippian species. It seems probable that the two Ordovician forms described by Krause as *Bollia minor* and *Bollia major*<sup>a</sup> are also referable to this section. They are most certainly not true *Bollias*.

As now restricted and defined, *Ctenobolbina* includes the following species:

GROUP OF CTENOBOLBINA CILIATA.

ORDOVICIAN SPECIES.

- Ctenobolbina alata*<sup>b</sup> Ulrich.  
*Ctenobolbina bispinosa*<sup>b</sup> Ulrich.  
*Ctenobolbina ciliata*<sup>b</sup> (*Beyrichia ciliata* Emmons).  
*Ctenobolbina curta*<sup>b</sup> (*Ctenobolbina ciliata*, var. *curta* Ulrich).  
*Ctenobolbina duryi*<sup>b</sup> (*Beyrichia duryi* Miller).  
*Ctenobolbina emaciata*<sup>b</sup> (*Ctenobolbina ciliata*, var. *emaciata* Ulrich).  
*Ctenobolbina guillicri* (*Beyrichia guillicri* Tromelin).  
*Ctenobolbina hammelli*<sup>b</sup> (*Beyrichia hammelli* Miller and Faber).  
*Ctenobolbina obliqua*<sup>b</sup> Ulrich.  
*Ctenobolbina oblonga* (*Entomis oblonga* Steusloff).

SILURIAN SPECIES.

- Ctenobolbina granosa*<sup>b</sup> Ulrich.  
*Ctenobolbina punctata*<sup>b</sup> Ulrich.

DEVONIAN SPECIES.

- Ctenobolbina papillosa*<sup>b</sup> Ulrich.

GROUP OF CTENOBOLBINA SUBCRASSA.

ORDOVICIAN SPECIES.

- Ctenobolbina crassa*<sup>b</sup> Ulrich.  
*Ctenobolbina fulcrata*<sup>b</sup> Ulrich.  
*Ctenobolbina impressa* (*Entomis impressa* Steusloff).  
*Ctenobolbina major* (*Bollia major* Krause).  
*Ctenobolbina minor* (*Bollia minor* Krause).  
*Ctenobolbina subcrassa*<sup>b</sup> Ulrich.  
*Ctenobolbina umbonata*<sup>b</sup> (*Entomis umbonata* Steusloff).

<sup>a</sup> Zeits. d. d. geol. Gesell., XLIV, 1892, pp. 391, 392, pl. XXI, figs. 15, 18.

<sup>b</sup> American species.

## SILURIAN SPECIES.

*Ctenobolbina auricularis* (*Bollia auricularis* Jones).

## DEVONIAN SPECIES.

*Ctenobolbina minima*<sup>a</sup> Ulrich.

## MISSISSIPPIAN SPECIES.

*Ctenobolbina oculata*<sup>a</sup> Ulrich.

Krause<sup>b</sup> and Stensloff<sup>c</sup> have described and referred a number of unisulcate Ordovician species to *Entomis*. This arrangement of the species is probably incorrect, the present writers doubting even that the typical Entomidae are Ostracoda at all. Krause's and Stensloff's entomids, on the contrary, seem to be closely allied to *Ctenobolbina*, and, in part at least, congeneric with species referred to this genus. Others like Krause's *E. sigma* and *E. obliqua* are so completely bilobed as to suggest *Dilobella*. Pending an opportunity to study specimens of all these species, those not elsewhere referred in this work may be provisionally left where their authors placed them.

As stated on page 290, *Ctenobolbina tumida* Ulrich<sup>d</sup> (see fig. 24, p. 292) is now thought to be a peculiar *Beyrichia* and to have no very intimate relations to the typical species of *Ctenobolbina*. Indeed, the bulbous end of the carapace in *B. tumida* is regarded as anterior, whereas in *C. ciliata* the thicker end is posterior. Hence, if the species is allied to *Ctenobolbina* at all, it must be to the *C. subrossa* section and not to the typical section of the genus.

The genetic alliance of *Ctenobolbina* to *Beyrichia* (more especially to the subgenus *Stensloffia*) has been discussed on pages 296 to 299.

## Genus DREPANELLA Ulrich.

*Depranella* ULRICH, Jour. Cincinnati Soc. Nat. Hist., XIII, 1890, pp. 117, 118.

*Depranella* MILLER, North Amer. Geol. and Pal. First App., 1892, p. 707.

*Drepanella* (part) ULRICH, Geol. and Nat. Hist. Surv. Minnesota, Final Rept., III, Pt. 2, 1894, p. 670.

Carapace equivalves, usually about 2.5 mm. long, compressed convex, somewhat oblong, subquadrate to subelliptical in outline; dorsal edge straight, ventral side gently convex, ends subequal, the post-dorsal angle sharper than the anterior. A constant sickle-shaped, sharply defined ridge runs nearly parallel with and generally not far within the posterior and ventral edges of the valves. Central and

<sup>a</sup> American species.

<sup>b</sup> Zeits. d. d. geol. Gesell., XLIV, 1892, pp. 383-399; XLVIII, 1896, p. 935.

<sup>c</sup> Idem, XLVI, 1894, p. 777.

<sup>d</sup> Jour. Cincinnati Soc. Nat. Hist., XIII, 1890, p. 111, pl. vii, figs. 5a, 5b.

dorsal regions with two to seven nodes, the larger numbers resulting through dissection of the primary two. When only two, they may form a loop by union of their ventral parts. Surface smooth or coarsely reticulated.

*Genotype*.—*Drepanella crassinoda* Ulrich. Other species referred here, all of Ordovician age, are: *D. ampla* Ulrich, *D. bigeneris* Ulrich, *D. crassinoda nitida* Ulrich, *D. elongata* Ulrich, *D. macra* Ulrich, *D. richardsoni* (*Beyrichia richardsoni* Miller) and *D. richardsoni canadensis* Ulrich.

This apparently wholly American genus is remarkable for the extreme variability of the nodes within the central area of the valves. The binodose *D. ampla* probably represents the most simple type. From this we pass to *D. elongata*, with its ventrally fuller valves and Klædenia-like reduction and disposition of the nodes. There is a depression or sulcus between the nodes in this species. A similar depression of the surface outside of the nodes, without a reduction in altitude of the nodes and the lower boundary of the median sulcus, would result in a form essentially like *D. bigeneris*, which is strikingly like a *Bollia*. In *D. macra*, *D. crassinoda*, and *D. nitida* the nodes range in number from three in the first to seven in the last. A comparison of the nodes of these three species established beyond question that the larger numbers are produced by dissection. Indeed, the seven nodes of *D. nitida* are all indicated by corresponding wholly or partially separated nodes in *D. crassinoda*, and the corresponding parts are no less easily recognized in *D. macra*.

The only constant features of *Drepanella* are the sickle-shaped submarginal ridge, and, within reasonable bounds, the size of the carapace. In other respects the species are sometimes highly suggestive of in part probably very distinct contemporary and later genera. Thus, as stated on page 303, *D. elongata* might be classed as a *Klædenia* if it had not the characteristic, submarginal ridge, while it is really difficult to point out sufficient reasons for excluding *D. bigeneris* from *Bollia*. But *Drepanella* is an old genus—probably the oldest of the true rigid Beyrichiida—having been already well established in the Stones River epoch. These diverse resemblances may, therefore, be explained as synthetic vacillations of an ancient type prior to the fixation of generic characters marking later developmental stages within the family. The sickle-shaped ridge, however, was a fixed character and doubtless left its imprint in the history of the family. It is, therefore, not surprising that in the decadence of the main Silurian genus *Beyrichia* this ridge is again occasionally recognized. It is well shown, for instance, in the peculiar Devonian descendant of *Beyrichia*, *Hollina kolmodini* (Jones).

The probable relations of *Drepanella* to *Beyrichia*, especially to the *tuberculata* and the *clarata* sections, have been sufficiently dis-

cussed on pages 289 and 294. It is a remarkable fact that these two alliances are more obvious and apparently more intimate than are those between *Drepanella* and such nearly equally old genera as *Ctenobolbina* and *Tetradella*. There is so little evidence of transition between them that derivation of either of the latter from the first, or of the first from either of the latter, seems out of the question. Though it is highly probable that all three were derived out of the same stock—presumably *Primitia*—it seems certain that the departures from that primitive line were entirely independent and in all cases rapid. Indeed, *Primitia* itself, which contains the oldest of the distinctly furrowed Ostracoda, does not, geologically speaking, greatly antedate *Drepanella*. The Cambrian seems to contain no Ostracoda at all,<sup>a</sup> the oldest known representatives of the class being Leperitiidae, found in rocks of Beekmantown age. The Primitiidae and Beyrichiidae did not appear till post-Beekmantown.

The species described in 1894 by Ulrich as *Drepanella bilateralis*<sup>b</sup> is so peculiar that it seems unwise to continue listing it as a species of this genus. Though exhibiting a general resemblance to *D. crassinoda*, it seems on closer comparison that the surface lobation is really very different. In the first place, the marginal ridge is developed only along the ventral border, terminating abruptly on both sides, when it begins to turn up on the ends. Next the nodes above the ridge do not correlate satisfactorily with those of any of the other species. There is a bilateral symmetry in their form and arrangement with respect to the small mid-dorsal node that can not be duplicated in typical *Drepanella*, nor readily explained. The explanations occurring to the writers entail departures from that generic type of such importance that the removal of the species from *Drepanella* seems imperative. If the posterior node is assumed to be in part made up of the post-dorsal portion of the marginal ridge, then its inner part must represent the lower two-thirds of the trinodate post-median ridge of *D. crassinoda* and the mid-dorsal node the upper third of that ridge. According to another interpretation the mid-dorsal node of *D. bilateralis* would correspond to the dorsal part of the antero-median node of *D. crassinoda* and the main but antero-median node, together with the crescentic ridge beneath it and the small antero-dorsal node in the latter. In either case it would mean that the mid-dorsal node occupies a different position from the corresponding part of typical *Drepanella*; also modification of the posterior lobes scarcely compatible with a strict conception of

<sup>a</sup> A comprehensive study of the supposed Cambrian Ostracoda recently completed has led to the conviction that these are Phyllocerida and not Ostracoda.

<sup>b</sup> Geol. and Nat. Hist. Surv. Minnesota, Final Rept., III, Pt. 2, 1894, p. 671, pl. XLVI, figs. 35-38.

*Drepanella*. Under the circumstances the writers feel justified in proposing a new genus, with the following brief diagnosis.

Genus SCOFIELDIA, new.

*Drepanella* (part) ULRICH, Geol. and Nat. Hist. Surv. Minnesota, Final Rept., III, Pt. 2, 1894, p. 670.

Carapace 2 mm. to 3 mm. in length, oblong, subquadrate, compressed; surface of valves broken up into ridges and nodes arranged bilaterally with respect to a small node situated close to the middle of the straight hinge line; on either side a large, irregularly triangular, ridged node, and along the ventral edge a thick, sharply elevated, bar-like ridge.

*Genotype*.—*Scofieldia bilateralis* (*Drepanella bilateralis* Ulrich).

The generic name is given in remembrance of Mr. Wilbur H. Scofield, with whom the senior author was pleasantly associated in the study of the Ordovician Gastropoda of Minnesota.

Genus TREPOSELLA, new.

*Beyrichia* (part) ULRICH, Journ. Cincinnati Soc. Nat. Hist., XIII, 1891, p. 190.

Carapace small, about 1 mm. in length, semiovate or subquadrate, the hinge long and straight, the other margins curved and supplied with a radially striated frill. Ventral part of valves swollen, the fullness forming a low, not sharply defined longitudinal ridge. Just above this, two unequal nodes, the smaller being of hemispheric form and located just behind the center of the valve. The larger node is somewhat balloon-shaped, situated in front of the middle, connected to the ventral ridge by a narrow neck, from which it extends upward to or slightly beyond the dorsal edge. Between the two nodes, a narrow, sharply excavated sulcus, terminating below in a pit. Female (?) provided with a sharply defined, egg-shaped, ventral pouch, located practically midway between the ends.

*Genotype*.—*Treposella lyoni* (*Beyrichia lyoni* Ulrich).

This genus is proposed for the reception of what is supposed to be an important link in the evolution of *Hollina* from *Beyrichia*. The female is still provided with a ventral pouch, but it is essentially median in position, while in all true *Beyrichia* it is placed well behind the mid-length. The anterior lobe also is essentially as in *Beyrichia*, but the indefinite ventral swelling is suggestive of *Kladonia* rather than *Beyrichia*. Compared further with *Beyrichia*, the entire obsolescence of the posterior ridge of that genus in *Treposella* is perhaps the most striking difference. The presence of a sharply defined median pit, as in *Eurychilina* and other Primitiidae, is probably a reversion to ancestral characteristics.



Except the ventral pouch, all the above-mentioned departures from the typical Silurian *Beyrichia* are toward the new Devonian and Carboniferous genus *Hollina*. Indeed, were it not that *T. lyoni* still possesses the Beyrichian ventral pouch, the writers would undoubtedly have referred the species to *Hollina*. But, having a pouch, and being also in other features nearer *Beyrichia* than is any one of the species of *Hollina*, the intermediate position of *T. lyoni* seems assured. As its inclusion in either of these genera would introduce undesirable elements of uncertainty in their respective diagnoses, it has been thought advisable to give it and any other similar species that may be discovered an independent position.

#### Genus HOLLINA, new.

*Ctenobolbina* (part) ULRICH, Jour. Cincinnati Soc. Nat. Hist., XIII, 1891, p. 187; XIX, 1900, p. 182.

*Beyrichia* (part) JONES, Quart. Jour. Geol. Soc. London, XLVI, 1890, p. 538.—ULRICH, Jour. Cincinnati Soc. Nat. Hist., XIII, 1891, p. 189.

*Bollia* (part) ULRICH, Jour. Cincinnati Soc. Nat. Hist., XIII, 1891, p. 205.

Carapace elongate, produced and tapering somewhat anteriorly, essentially equivalved. Valves provided with a marginal frill, concave on the inner side, overhanging the contact edge, often wanting at the anterior end. Except for two constant rounded nodes, the lobation of the surface varies greatly. One of the constant nodes is situated close to and partly in front of the middle of the hinge line; the other, usually the smaller, is placed lower and more or less behind the center of the valve. Occasionally the hollow between these two nodes is excavated. In most species there is a continuous or broken ridge in the ventral part; in one (*H. kolmodini*) this ridge continues up the hinder end to the dorsal angle, in others (*H. insolens* and *H. tricollina*) the post-dorsal extremity remains prominent and forms a rounded node, the remainder of the ridge being dissected and tending to obsolescence; in two other species (*H. granifera* and *H. antespinoza*) the ventral ridge joins the two constant nodes, the result being a loop as in *Bollia*. Finally, in a later stage (as, for instance, *H. radiata*) the ventral ridge is obsolete and only two rounded nodes remain. Occasionally an extra node is developed near the anterior margin. A ventral pouch, as in *Beyrichia*, has not been observed.

*Genotype*.—*Hollina insolens* (*Ctenobolbina insolens* Ulrich). Seven other middle Devonian species and four Carboniferous species are referred here as follows: *H. antespinoza*, *H. armata*, *H. carimarginata*, *H. informis*, *H. spiculosa*, all described by Ulrich as species of *Ctenobolbina*, and *H. kolmodini* and *H. tricollina*, originally referred to *Beyrichia*, the first by Jones, the second by Ulrich. The Carboniferous species are *H. granifera*, a Spergen species described

as a *Bollia* by Ulrich, *H. radiata* (*Beyrichia radiata* Jones and Kirkby), variety *cestriensis* Ulrich, *H. longispina* (*Beyrichia longispina* Jones and Kirkby), and *H. emaciata* (*Beyrichia ? emaciata* Ulrich and Bassler).

Comparison of the figures on Plate XLII gives a good idea of the unusual range of variability of the species associated in this new genus. On closer study, however, strong elements of similarity will be noted running through the whole assemblage, the observer being finally convinced of the essential naturalness of the association. It is not contended that the group is natural in the sense of being composed of species descended from a single ancestor. On the contrary, it is believed they were derived from perhaps several preceding species of *Beyrichia* and possibly *Utenobolbina*, and that the singularities resulted through atavistic tendencies developed in the Devonian decadence of the Silurian *Beyrichiidae*.

The Devonian species of the genus may be regarded as vacillating intermediate stages between the trilobate Silurian *Beyrichia* and the final, again long-lived, simply binodate Carboniferous phase of the new genus, namely, the small group of species of which *H. radiata* (Jones and Kirkby) is a typical example. Whereas most of the Devonian species occur at the Falls of the Ohio in a thin bed thought to be of Onondaga age, indicating rapid evolution, *H. radiata* ranges with very slight change from the Chester to near the close of the Pennsylvanian.

Compared with true *Beyrichia*, which has constantly three vertically elongated lobes, the new genus *Hollina* is distinguished (1) by the progressive obsolescence of the posterior lobe, (2) by the rounded form of the median and anterior nodes or lobes, (3) by the restriction of these nodes to the dorsal half of the valve, (4) by the relative fullness of the ventral parts (agreeing in this respect with *Kladenia*), and (5) by the constant development of an anteriorly incomplete marginal frill. A probable sixth difference is indicated by the apparent absence of a ventral pouch.

The fullness of the ventral region, also the rounded form of the median (posterior) node suggests even closer alliances with *Kladenia*, but the rather obvious relations of *Hollina* to *Trepostella lyoni* and the probable derivation of that species from *Beyrichia* tends to negative this suggestion. The Devonian species would never cause one to think of *Kladenia*. It is only the more simple *H. radiata* group that might recall that Silurian genus. But these even will be distinguished at once by the anterior node, the like of which never occurs in *Kladenia*.

In a former paper,<sup>a</sup> the writers mention the possible desirability of including *B. radiata* and its immediate allies in *Ulrichia*. It is

<sup>a</sup> Proc. U. S. Nat. Mus., XXX, 1906, p. 152.

now quite clear that such a course would be unwarrantable. Taking into account only this, that both have two constant and similarly placed nodes, the logical course would be to unite them. But if the apparently unquestionable derivation of *H. radiata* from the Devonian species of *Hollina* is considered, the impropriety of the suggested reference cannot be ignored. *Ulrichia* is one of the Primitiida; *Hollina* is a derivative—presumably somewhat atavistic—of Beyrichiida.

As is evident from several preceding references in the paper to *Hollina*, the writers now regard the resemblance of certain species to *Ctenobolbina*, and of others to *Bollia*, as atavistic stages in the Devonian and Mississippian evolution of the typical Beyrichian stock, and not as survivals of the generic types to which they were originally referred. Ulrich placed most of the Devonian species under *Ctenobolbina* because of their general similarity in form, location, and range of variation to the *C. subcrassa* group of that genus, while the later *H. granifera* was referred to *Bollia* solely because the ventral union of its two nodes forms a loop precisely like the inner loop of typical species of that genus. In neither case were the characters now relied on, such as the two constant rounded nodes and the broad frill on the posterior and ventral margins, taken into account, and the genetic relations to *Beyrichia*, though suspected, were not appreciated as they should have been. "Loops" strikingly like that in *Bollia* occur in other types. This was recognized by Ulrich in 1894<sup>a</sup> in discussing *Drepanella bigeneris*, a notable instance of this kind.

#### Subfamily KLÆDENELLINÆ.

#### Genus KLÆDENELLA, new.

*Beyrichia* (part) JONES and AUTHORS.

*Klædenia* (part) JONES, ULRICH, and most AUTHORS.

*Bollia?* (part) ULRICH, Geol. and Nat. Hist. Surv. Minnesota, Final Rept., III, Pt. 2, 1894, p. 669.

Carapace small, strongly convex, elongate, somewhat barrel-shaped, the length usually less than 1.5 mm.; dorsal edge nearly straight, ventral edge usually somewhat concave, ends approximately equal in height but differing in outline, the antero-dorsal angle often rectangular and always more distinct than the post-dorsal. Valves unequal, the right overlapping the left around the ends and the ventral side. Of the lobation, the constant features are two sharply impressed vertical or slightly oblique furrows, separated by a narrow lobe, in the posterior half. In the more simple forms, these furrows extend only about half across the valve. Anterior half may be uniformly convex, but, as a rule, is more or less clearly bisected vertically by a straight or curved furrow. When present, this anterior furrow

<sup>a</sup> Geol. and Nat. Hist. Surv. Minnesota, Final Rept., III, Pt. 2, 1894, p. 671.

often produces an appearance suggesting the "loop" of a *Bollia*. Surface generally smooth and polished, and without ornamental markings.

*Genotype*.—*Kladenella pennsylvanica* (*Kladenia pennsylvanica* Jones).

Of unquestioned species of this genus, some eight or ten, two of them perhaps being merely varieties, are contained in the collections of the U. S. National Museum. These range in time from the Clinton to middle Devonian. A British Carboniferous species, published by Jones and Kirkby under the name *Beyrichia? bicassa*, probably belongs to this genus. Except this and the two Devonian species, all the others are confined to the Silurian rocks of the Appalachian province. As a rule, the species are exceedingly prolific in the way of individuals, the layers of limestone in which they occur being almost literally made up of their remains. In most cases they occur as entire shells, which, being easily freed from the matrix, are admirably suited for detailed study.

Only about half of the known forms have been described, and one of these (described as *Beyrichia trisulcata* by Hall) has never been adequately figured. *Kladenia pennsylvanica*, as figured by Jones in 1889<sup>a</sup>, includes two distinct species and a variety, which are represented by thousands of specimens in the material available to the writers. The form represented by Jones's figures 5*a*, *b*, *c*, *d*, and 6 is accepted as the *Kladenella pennsylvanica*. His figures 8 and 9 are regarded as based on examples of our *K. turgida*, new species,<sup>b</sup> while 7*a* and 7*b* probably represent a variety of the latter, here distinguished by the subordinate name *scutrosa*.<sup>c</sup>

<sup>a</sup> Amer. Geol., IV, p. 341, figs. 5-9.

<sup>b</sup> *Kladenella turgida* is distinguished from *K. pennsylvanica*, as here restricted, by the strong development of the anterior sulcus. This sulcus delimits a well-marked anterior lobe and produces a somewhat concentric arrangement of the lobes behind it, the effect being quite different from the usual appearance of *K. pennsylvanica*.

Length of a normal right valve, 1.10 mm.; height, 0.64 mm.; length of a short left valve, 0.97 mm.; height, 0.60 mm. See Plate XLIII, figs. 6, 7.

*Formation and locality*.—Coeymans limestone, Cumberland, Maryland.

*Types*.—Cat. No. 53278, U.S.N.M.

<sup>c</sup> This form is more like *K. pennsylvanica* than *K. turgida* in lobation of the valves, being without a well-marked anterior sulcus, but in the less elongate form and general aspect it is so like *K. turgida* that it has been placed as a variety of this species. Its main peculiarity lies in a ventral swelling which causes an apparent break in the antero-median lobe. The ventral flange is unusually well developed and the series of granules along the antero-ventral edge has not been observed in any other species of the genus. See Plate XLIII, fig. 8.

*Formation and locality*.—Coeymans limestone, Cumberland, Maryland.

*Holotype*.—Cat. No. 53279, U.S.N.M.

The genus is divisible into two sections, the first comprising the greater part of the known species, among them the genotype. In this group the posterior and median furrows are shorter than in the second, and the anterior furrow either wanting or more or less well developed. In the second group, of which *Beyrichia halli* Jones (*Bollia halli* Ulrich) is a good example, the posterior and anterior furrows are long, subequal, and extending nearly or quite across the valve. The general expression is rather strikingly dissimilar in the two groups, but on close comparison it is found that the differences are not essential and, moreover, that the extremes are bridged by connecting links.

The *Klædenella halli*, as it should now be called, simulates *Bollia symmetrica* (Hall) to such a degree as to suggest its derivation from that earlier Silurian (Rochester shale) species. The *Bollia*, however, has not overlapping valves as has the *Klædenella*. Besides, the latter type appears to have been established already in Clinton time, indicating that its ancestors are to be looked for among Ordovician



FIGS. 61-64.—61, LEFT VALVE OF *BOLLIA SYMMETRICA* (HALL). 62, RIGHT VALVE OF *KLÆDENELLA HALLI* (JONES). COPIED FROM JONES. 63, RIGHT VALVE OF *KLÆDENELLA TURPIDA*, NEW SPECIES. 64, RIGHT VALVE OF *BEYRICHIA? PARALLELA* ULRICH,  $\times 20$ . (AFTER ULRICH.) THESE FIGURES ILLUSTRATE (1) THE SIMILARITY OF EXPRESSION OF *BOLLIA* TO *KLÆDENELLA*, AND (2) THE POSSIBLE DERIVATION OF *KLÆDENELLA* FROM THE RICHMOND SPECIES *BEYRICHIA? PARALLELA*.

species. Such a possible ancestor is found in the peculiar Richmond species described by Ulrich as *Primitia* or *Beyrichia parallela*. The general form of the valves and the lobes are sufficiently like *Klædenella* to encourage the belief that it fulfills the requirements of the case. It is to be regretted, however, that only separated valves of this Richmond species are known, so that it is difficult, if not impossible, to decide the question by showing agreement also in the matter of inequality of its valves.

Because of the mentioned resemblance to *Bollia*, Ulrich in 1894 tentatively referred species of the *K. halli* section, including *K. clarkei* (*Beyrichia clarkei* Jones) and two new species, to *Bollia*. Although this reference is now thought to have been in error, it must be admitted that it is not easy to show just why the group was not descended from *Bollia regularis* and *B. symmetrica*. At that time the senior author had very few specimens of the type now discriminated under the name *Klædenella*, and *K. halli* and *K. clarkei* were known to him only from the rather indefinite figures and descriptions published by Jones, which neither showed nor mentioned the unequal-

ity of their valves. Hence, he had had no opportunity to observe the principal evidence in the case, namely, the transition from *K. pennsylvanica* to *K. clarkci*,<sup>a</sup> and the fact that while the valves of *Bollia* are equal, those of *Klædenella* are unequal. In passing, it may be said that *Bollia* is regarded as an early derivative of *Primitia*, that it established an independent line having no subsequent connection with the true Beyrichiidae and that it represents the most complex stage of lobation attained by the Primitiidae.

The Klædenellinae are Beyrichiidae with valves more or less distinctly overlapping. As a rule, the overlap is confined to the ventral side and ends. *Beyrichiopsis* Jones and Kirkby, *Beyrichiella* Jones and Kirkby, *Jonesina*, and *Kirkbyina*, new genera, are referred to the subfamily. Technically *Kyammodes* Jones fulfills the requirements, but, being convinced of the genetic alliance of that genus to *Klædenia*, the writers hesitate to remove it from the Beyrichiidae.

#### CARBONIFEROUS BEYRICHIIDÆ.

Two years ago,<sup>b</sup> the writers had occasion to discuss the Carboniferous Beyrichiidae. Among the conclusions were (1) that the group of *Beyrichia radiata* is worthy of generic separation, a view carried out in the present communication by the erection of the new genus *Hollina*; (2) that the remaining, inequivalved Beyrichiidae, including *Beyrichiopsis*, *Beyrichiella*, and *Synaphe*, of Jones and Kirkby, besides a number of species referred by these authors to *Beyrichia*, probably constituted a single comprehensive genus; (3) that *Synaphe* should be relegated to synonymy under *Beyrichiella*; and (4) that two subgenera might be recognized, of which *Beyrichiopsis* would be one. Similar conclusions were reached in the present more comprehensive study of the family, the principal difference being that *Beyrichiopsis* and *Beyrichiella* are recognized as genera, and a new genus, *Jonesina*, is proposed instead of "a second subgenus." Finally, a fourth genus, *Kirkbyina*, is proposed for two species doubtfully referred to *Beyrichiella* by Jones and Kirkby, and which were not considered in 1906.

<sup>a</sup>A new variety of *K. clarkci* is here instituted under the name of *paupera* of which the following are the characteristics: The valves and the ridges especially are thinner than in the species itself, giving the whole a somewhat emaciated appearance. Furthermore, the furrows present somewhat irregularly distributed but numerous papille which have not been observed in the typical form of the species. See Plate XLIII, fig. 5.

*Formation and locality*.—Coeymans limestone, Cumberland, Maryland.

*Holotype*.—Cat. No. 53280, U.S.N.M.

<sup>b</sup>Proc. U. S. Nat. Mus., XXX, 1906, pp. 151-155.

Considerable instability of character in these inequivalved Beyrichiidae was recognized in the preceding publication: also the fact that many of them exhibited more or less obvious resemblances to Ordovician and Silurian types. These facts were explained as resulting from reversion and arrested development incident to the degeneration and extinction of the family in Carboniferous time.

In now recognizing four genera instead of a single broad genus, it is not intended to convey the impression that the writers have materially changed their opinions respecting the close alliance of the several groups. Neither are the groups of species thought to be more natural genetic associations than they were believed to be in 1906. It is only in deference to the matter of convenience in classification, and to insure greater clearness and brevity in definition, that the change from one to four is made. Considering them as one genus, it seemed impossible to draw up a reasonably brief diagnosis that would not cover a variety of really very distinct pre-Carboniferous types. Though it can not be denied that the whole group is bound together by intimate alliances, it is yet a fact that but a single feature of generic or family rank pertains to all its members, namely, slight inequality of the valves. But this feature, of course, is not peculiar to this group, since it occurs in many otherwise very different Ostracoda. By dividing the group into four genera and using the feature common to them all as characterizing a subfamily of Beyrichiidae, the resulting classification is at least convenient and probably as natural as it can be made so long as established characters are consulted as not less important than genesis in the forming of zoological classifications.

In the present arrangement of the Carboniferous Klædeniellinae, all of the British species described by Jones and Kirkby are accounted for save *Beyrichia tuberculospinosa*, *B. multiloba*, and *B. varicosa*. The published figures of these three species<sup>a</sup> indicate peculiarities, the value of which it would be unwise to decide without first verifying them by study of good specimens. Until that is done, it is advisable to leave them in the still large residuum of undetermined and doubtful species of *Beyrichia*. In the meantime it may be said that *B. multiloba* and *B. varicosa* would have been placed with *Lonesina* were it not that in both cases, as figured by Jones and Kirkby, the left instead of the right valve is the smaller. In this respect the two species agree with *Klædenella*. The figures of *B. tuberculospina* are indecisive on this point, and the most that may be said of this species at the present time is to suggest that it may be an aberrant *Hollina* and as probably related to *H. longispina*.

<sup>a</sup> Jones and Kirkby, Ann. and Mag. Nat. Hist. (5), XVIII, 1886, pl. VIII.

Beginning with the most simple type, the genera may be defined briefly as follows:

Genus KIRKBYINA, new.

*Beyrichiella* ? JONES and KIRKBY, Ann. and Mag. Nat. Hist. (5), XVIII, 1886, p. 260.

Carapace small, less than 1 mm. in length, rather short, subovate to subquadrate, ventricose, thickest anteriorly, with a simple primitian sulcus about the middle of the dorsal half. Valves unequal, the right slightly larger and overlapping the edges of the left.

*Genotype*.—*Kirkbyina reticosa* (*Beyrichiella* ? *reticosa* Jones and Kirkby).

In the same paper <sup>a</sup> Jones and Kirkby describe a second more tumid species, likewise referring it doubtfully to *Beyrichiella* under the name *B. ? ventricornis*. At present only these two British species may be safely placed in the genus *Kirkbyina*. There are a few as yet unstudied, Primitia-like Ostracoda in American deposits of Carboniferous age that may turn out to belong here.

*Kirkbyina* resembles *Primitia*, but is readily distinguished by its overlapping valves and thicker anterior end. In *Primitia* it is the posterior half that is usually the thicker. *Beyrichiella* has a more elongate shell and broader sulcus, while its left valve and not the right is the larger.

Genus BEYRICHIELLA Jones and Kirkby.

*Beyrichiella* JONES and KIRKBY, Geol. Mag., Dec. 3, III, 1886, p. 438; Proc. Geol. Assoc., IX, 1886, p. 506.

*Beyrichiella* (part) ULRICH and BASSLER, Proc. U. S. Nat. Mus., XXX, 1906, pp. 151-155.

*Synaphe* JONES and KIRKBY, Trans. Royal Dublin Soc. (2), VI, 1896, p. 190.—ULRICH and BASSLER, Proc. U. S. Nat. Mus., XXX, 1906, p. 152.

*Kirkbyia* COSSMANN, Revue Critique de Paléozoologie, III, 1899, p. 45 (proposed for *Synaphe*, preoccupied).

Carapace small, 1 mm. or less in length, elongate subquadrate, thickest anteriorly, with a rather broad median sulcus giving the shell a bilobed aspect; a low, transverse ridge in the ventral part cuts off the sulcus and unites the lower parts of the two lobes. Valves unequal, the edge of the smaller right valve being set into the overlapping ventral and end parts of the larger left valve.

*Genotype*.—*Beyrichiella cristata* Jones and Kirkby.

The writers fail to see more than specific differences between *B. cristata* and *Kirkbyia annectens*, the type of *Synaphe* Jones and Kirkby (not *Synaphe* Huebner). It is, therefore, placed here as a

<sup>a</sup> Ann. and Mag. Nat. Hist. (5), XVIII, 1886, p. 260.



second species of *Beyrichiella*. A third, the only known species from American strata, was described by Ulrich as *Ulrichia confluens*. Viewed in the narrow sense in which this genus was proposed and in which it is now thought desirable to recognize it, *Beyrichiella* is clearly distinguished from other members of the subfamily. The shell is relatively longer than that of *Kirkbyina* and its larger valve is not the right as in that genus, but the left. The lobation of the valves is also less simple, the low ventral ridge, connecting the two larger lobes, being a character not observed in *Kirkbyina*. The general shape of the carapace is decidedly like that of *Beyrichiopsis*, but the characteristic rounded, median—or rather post-median—node of that genus is wanting in *Beyrichiella*.

Genus BEYRICHIOPSIS Jones and Kirkby.

*Beyrichiopsis* JONES and KIRKBY, Geol. Mag., Dec. 3, III, 1886, p. 434; Proc. Geol. Assoc., IX, 1886, p. 506; Quart. Journ. Geol. Soc. London, XLII, 1886, p. 506.

*Beyrichiopsis* ULRICH and BASSLER, Proc. U. S. Nat. Mus., XXX, 1906, p. 152.

Carapace small, about 1 mm. in length, oblong, subquadrate to sub-elliptical, straight on the dorsal side, tapering slightly and thickest anteriorly; on the whole, rather strongly convex. A broad based, rounded swelling or lobe occupies the greater part of the anterior half. A second, smaller rounded eminence occurs behind the middle and usually above the mid-height of the valve. It is often surrounded by a slight depression usually deepest on the anterior side. Free edges of valves usually with a broad, spiny frill; in other cases merely denticulate. Two or three thin, crest-like ribs commonly cross the surface in a longitudinal direction.

*Genotype*.—*Beyrichiopsis fimbriata* Jones and Kirkby. Other typical species are *B. cornuta*, *B. subdentata*, *B. fortis*, *B. granulata*, and *B. simplex*, all described by Jones and Kirkby from British Carboniferous specimens.<sup>a</sup> Two new species in the Ulrich collection in the U. S. National Museum were collected from the basal shales of the Tullahoma formation in central Tennessee. One of these has a frill like *B. fimbriata*, the other is more like *B. cornuta*.

Compared with the other genera of the subfamily Klædenellinæ, *Beyrichiopsis* is distinguished at once by the small, rounded post-median node. Otherwise the genus is not greatly different from *Beyrichiella*, its nearest ally, the usual presence of a spiny marginal frill being of subordinate importance. Another difference, however, is found in the transverse ventral ridge seen in *Beyrichiella* but which is absent in *Beyrichiopsis*.

<sup>a</sup> Geol. Mag., Dec. 3, III, 1886, pp. 434-437.

*B. simplex* and *B. granulata*<sup>a</sup> depart somewhat from the other species in the more subdued development of both the anterior and the median lobes. These two species strongly resemble *Klodenia*. Indeed, it is difficult to point out satisfactory differences. However, as that genus became almost extinct with the close of the Silurian, it seems highly unlikely that these Carboniferous species were directly connected with it.

Genus JONESINA, new.

*Beyrichia* (part) JONES and KIRKBY, Ann. and Mag. Nat. Hist. (5), XVIII, 1886, p. 258; Geol. Mag., Dec. 3, III, 1886, p. 438.

*Beyrichiella* (part) ULRICH and BASSLER, Proc. U. S. Nat. Mus., XXX, 1906, pp. 151-155.

Carapace small, about 1 mm. in length, usually elongate, the outline varying from subelliptical to oblong or approximating a parallelogram; greatest thickness in anterior half. Valves strongly convex, variously lobed, unequal, the left being the larger, sometimes overlapping the edge of the right on all sides. The most simple types (*J. craterigera* and *J. arcuata*) are marked with a rather deep dorsal sulcus situated somewhat behind the middle. The whole area in front of this sulcus may be almost uniformly convex, or a node may be obscurely defined in its post-dorsal quarter (that is, just in front of the sulcus). Behind the sulcus a more clearly defined node is always observable. In more complex species (*J. fastigiata*) three nodes are distinguishable, two, subequal, situated on opposite sides of the main sulcus, and a larger, less definitely outlined, lobe occupying the anterior third. Finally, in *J. fodicata*, the anterior lobe is divided by the separation of a node simulating the other two in size and form, while all three nodes will appear as connecting below with a low marginal ridge. A more or less obscure and variable ridge commonly unites the two median nodes, occasionally producing an effect simulating *Bollia*.

*Genotype*.—*Jonesina fastigiata* (*Beyrichia fastigiata* Jones and Kirkby).

The following additional species are referred to *Jonesina*: *J. arcuata* (Bean) (as figured by Jones and Kirkby under the genus *Beyrichia*),<sup>b</sup> *J. bradyana* (*Beyrichia* Jones and Kirkby),<sup>c</sup> *J. craterigera* (*Beyrichia* Brady Ms., Jones and Kirkby),<sup>d</sup> *J. fodicata* (*Beyrichia*

<sup>a</sup> Jones and Kirkby describe the latter as a variety of *B. fortis*. It seems to the writers as allied to *B. simplex* rather than *B. fortis*, the post-median node as well as the general expression of the valves, aside from the surficial crests, being the same as in the former and quite different from the latter.

<sup>b</sup> Geol. Mag., Dec. 3, III, 1886, p. 438, pl. XII, figs. 12-14.

<sup>c</sup> Idem., fig. 11.

<sup>d</sup> Idem., figs. 7a, 7b.

Jones and Kirkby),<sup>a</sup> all from the Carboniferous rocks of Great Britain, and *J. bolliiformis* and var. *tumida* (*Beyrichiella* Ulrich and Bassler),<sup>b</sup> and *J. gregaria* (*Beyrichiella* Ulrich and Bassler)<sup>c</sup> from rocks of Pennsylvanian age in Kansas and Texas. Other American species are known, but remain to be described.

*Jonesina* sometimes resembles *Kladenella* to a marked degree. This is true especially of *J. craterigera*, but with entire specimens the observer should experience little difficulty in distinguishing them, the matter of relative size of the valves being reversed in the two genera. In the older genus the right valve is the larger, whereas in *Jonesina* it is the left.

In correlating the nodes of *Jonesina* with those of a typical *Beyrichia*, it is to be observed that the median lobe of the latter corresponds to the post-median node of *Jonesina*, the one, two, or three nodes in front of the median sulcus being equivalent to the single or dissected anterior lobe of *Beyrichia*. Obviously the location of the homologous parts in the two genera is widely different.

---

<sup>a</sup> Ann. and Mag. Nat. Hist. (5), XVII, 1886, p. 258, pl. VIII, figs. 4-6.

<sup>b</sup> Proc. U. S. Nat. Mus., XXX, 1906, p. 158, pl. XI, figs. 7-11.

<sup>c</sup> Idem., fig. 18.

EXPLANATION OF PLATE XXXVII.

- Figs. 1-4. Group of *Beyrichia tuberculata*.
1. Four views of a left valve of *Beyrichia tuberculata*.
  2. Similar views of a right valve of female individual of same.
  3. Four views of a right valve of *B. tuberculata bigibbosa* Reuter.
  4. Similar views of a right valve of *B. noctlingi* Reuter. All the figures are magnified five times and copied from Reuter.
- 5-10. Group of *Beyrichia kladeni*.
5. Two views of a left valve of *Beyrichia maccoyiana sulcata* Reuter,  $\times 8$ .
  6. Similar views of left valve of female individual of same,  $\times 8$ .
  7. Left valve of *Beyrichia lindstromi* Kiesow,  $\times 8$ .  
Figs. 5 and 6 are copied from Reuter and fig. 7 from Kiesow.
  8. Left and right valves of *Beyrichia moodayi*, new species,  $\times 10$ . Cayuga formation, Cacapon, Maryland.
  - 9, 10. Right and left valves of *Beyrichia waldronensis*, new species,  $\times 10$ . Niagara (Waldron), Waldron, Indiana.
- 11-13. Group of *Beyrichia buchiana*.
11. Left valve of *Beyrichia buchiana* Jones,  $\times 8$ . Copied from Jones.
  12. Four views of a right valve of *Beyrichia buchiana angustata* Reuter,  $\times 6$ . (After Reuter.)
  13. A right valve of *Beyrichia laucusis* Kiesow. (After Kiesow.)
- 14, 15. Group of *Beyrichia salteriana*.
14. Lateral and ventral views of a right valve of *Beyrichia salteriana* Jones,  $\times 10$ . (After Reuter.)
  15. Right valve of *Beyrichia granulosa* Hall. (After Hall.)
- 16, 17. Group of *Beyrichia clarata*.
16. Right valve of *Beyrichia clarata* Kolmodin. (After Kiesow.)
  17. Right valve of *Beyrichia jonesii* Boll. (After Kiesow.)

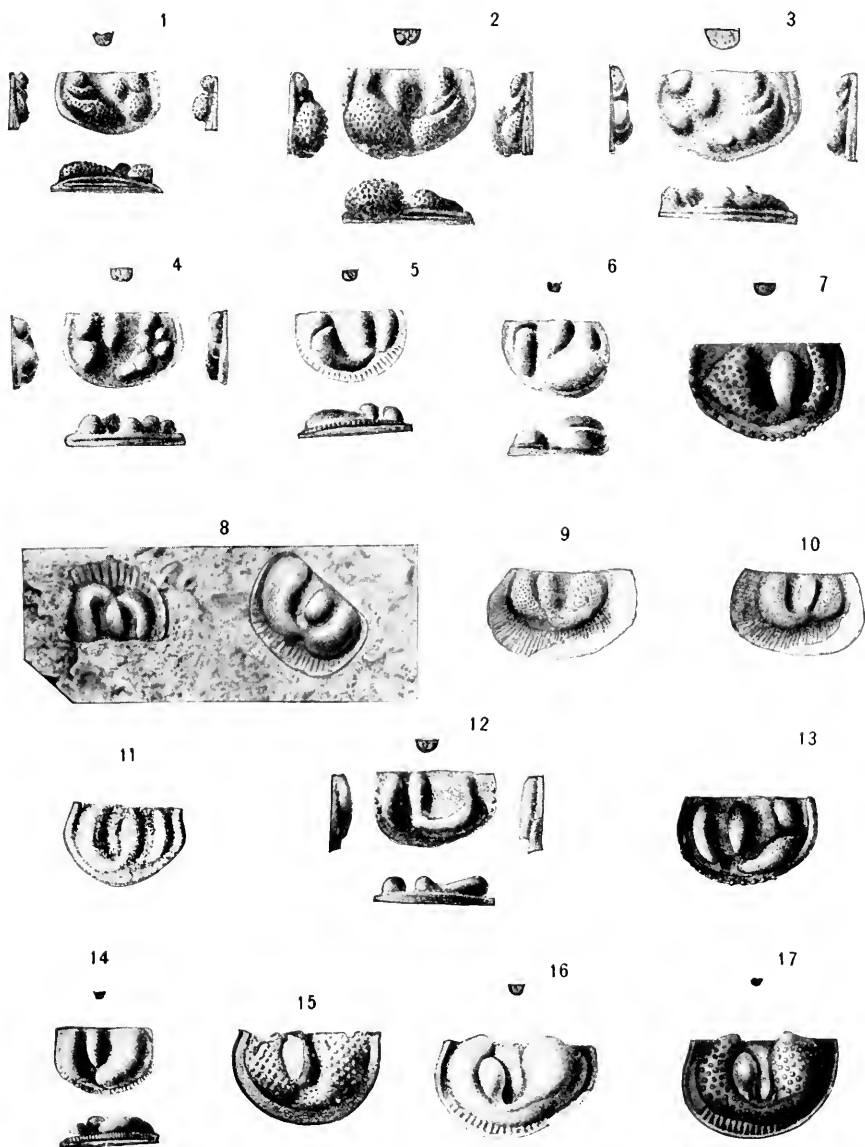

GROUPS OF BEYRICHIA.

FOR EXPLANATION OF PLATE SEE PAGE 326.





EXPLANATION OF PLATE XXXVIII.

- Figs. 1-5. Group of *Beyrichia linnaerissoni* (= subgenus *Steusloffia*.)
1. Left valve of *Beyrichia (Steusloffia) linnaerissoni* (Krause), × 20.
  2. Left valve of *Beyrichia (Steusloffia) antiqua* (Steusloff), × 20.
  3. Right valve of *Beyrichia (Steusloffia) simplex* (Krause), × 15.
  4. Left valve of *Beyrichia (Steusloffia) acuta* (Krause), × 20.
  5. Left valve of *Beyrichia (Steusloffia) signata* (Krause), × 10.  
Figure 2 is copied from Steusloff; the rest are after Krause.
- 6-11. Group of *Beyrichia interrupta*.
6. Right valve of *Beyrichia interrupta* (Jones), × 20.
  7. Left valve of *Beyrichia granulifera*, new name, proposed for *Bollia granulosa* Krause, preoccupied in the genus *Beyrichia*, × 15.
  8. Left valve of *Beyrichia r-scripta* Krause, × 15.
  - 9-11. Left and right valves and dorsal edge view of the complete carapace of *Beyrichia damesi* Krause, × 15.  
Figure 6 is copied from Jones, while 7 to 11 are from Krause.
- 12, 13. *Kladenia initialis* (Ulrich).  
Side and ventral edge views of a right valve, × 20. (After Ulrich.)
14. *Kladenia wilkensisata* (Jones).  
Right valve of female individual, × 8. (After Jones.)
15. *Kladenia praeantia*, new species.  
Right valve, × 10.  
Ordovician (Hermitage). 4 miles south of Carthage, Tennessee.
16. *Kladenia marginalis*, new species.  
A right valve, × 10.  
Helderbergian, Dalhousie, New Brunswick.
17. *Kladenia punctiliosa*, new species.  
Lateral view of a right valve, × 10.  
Helderbergian, Dalhousie, New Brunswick.
18. *Kladenia rectifera*, new species.  
Left valve, × 10.  
Helderbergian, Dalhousie, New Brunswick.
- 19, 20. *Kladenia susserensis* (Weller).  
Two left valves, × 10.  
Helderbergian, Dalhousie, New Brunswick.
21. *Kladenia manliusensis* (Weller).  
Left valve of a female individual, × 10. This specimen agrees fairly well with Weller's description and figures of his *Beyrichia manliusensis* from Manlius of New Jersey, except in the apparently less development of the border. The surface is very finely punctate.  
Helderbergian, Dalhousie, New Brunswick.
22. *Kladenia fimbriata*, new species.  
Left valve, × 20.  
Coeymans limestone, Herkimer County, New York.
23. *Kladenia centricornis*, new species.  
Left valve of a female individual, × 20.  
Coeymans limestone, Cumberland, Maryland.



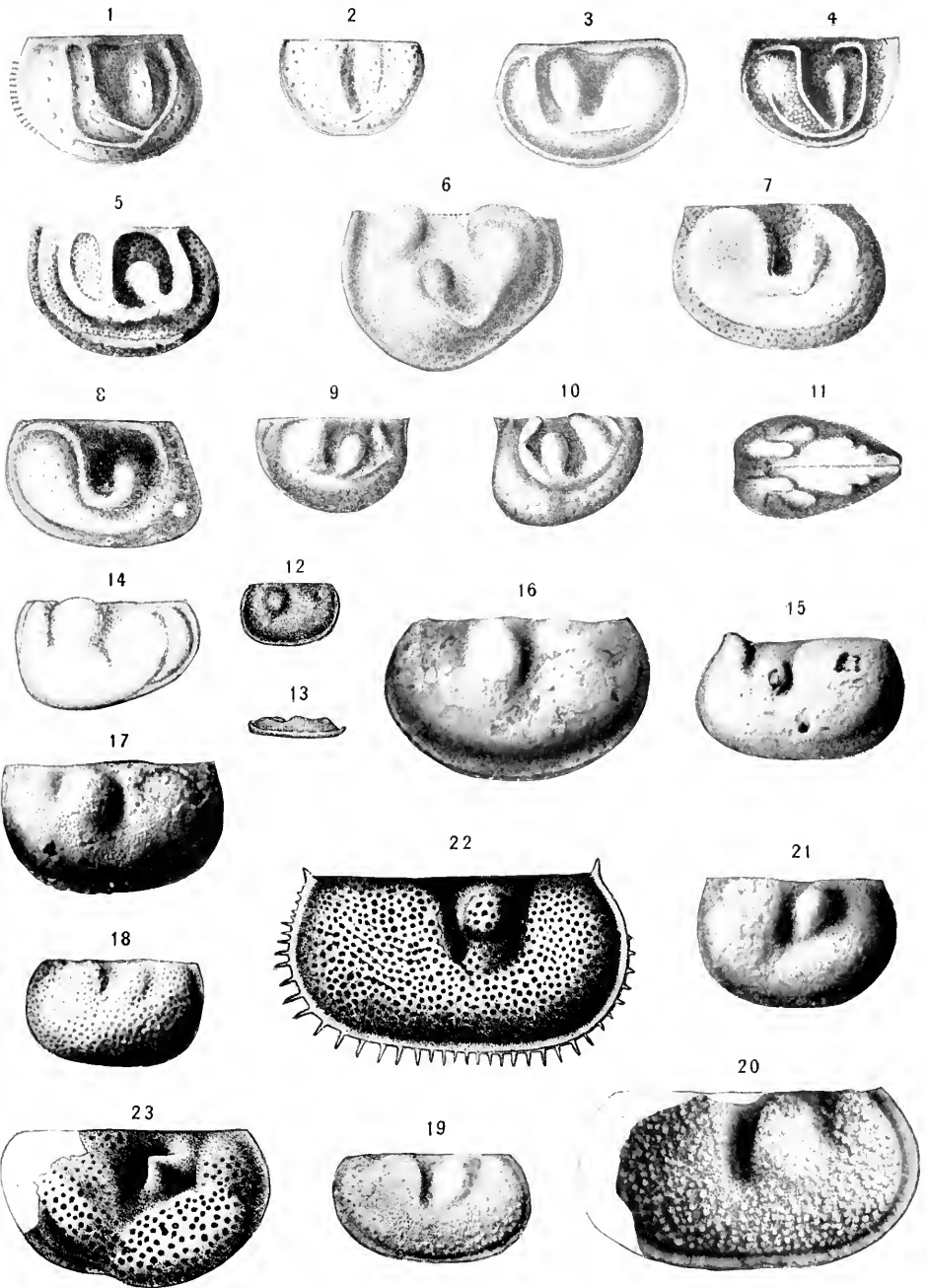

BEYRICHIA, STEUSLOFFIA, AND KLÆDENIA.

FOR EXPLANATION OF PLATE SEE PAGE 328.





EXPLANATION OF PLATE XXXIX.

Unless otherwise marked, the figures on this plate are copied from Ulrich.

- Figs. 1-3. *Tetradella subquadrans* Ulrich.  
1. Left valve,  $\times 20$ .  
2. Dorsal view of same.  
3. Posterior end view.
- 4, 5. *Tetradella quadrilirata* (Hall and Whitfield).  
4. Side view of a right valve,  $\times 20$ .  
5. Posterior view of same specimen.
6. *Tetradella lunatifera* (Ulrich).  
Side view of right valve,  $\times 22$ , showing the usual characters.
7. *Tetradella marchica* (Krause).  
Right valve,  $\times 15$ . (After Krause.)
- 8, 9. *Tetradella ? digitata* (Krause).  
Side views of left and right valves respectively of this doubtful *Tetradella*. The obsolescence of the ventral margin is particularly characteristic of this species.
10. *Tetradella (Kicsorvia) dissecta* (Krause).  
Left valve,  $\times 10$ . (After Krause.)
11. *Tetradella (Kicsorvia) mamilliosa* (Krause).  
Left valve,  $\times 20$ . (After Krause.)
12. *Tetradella (Kicsorvia) radians* (Krause).  
Left valve,  $\times 10$ . (After Krause.)
- 13-16. *Ceratopsis chambersi* (Miller).  
13. Side view of a left valve of the usual form,  $\times 20$ .  
14. Ventral view of the same valve.  
15. View of inner side of more elongate right valve,  $\times 20$ .  
16. A right valve,  $\times 20$ , with the posterior median ridge divided.
- 17, 18. *Ceratopsis chambersi robusta* Ulrich.  
Side and posterior end views of a complete carapace,  $\times 20$ .
- 19, 20. *Ceratopsis oculifera* (Hall).  
19. A left valve,  $\times 15$ , showing the mushroom shaped process. (After Jones.)  
20. Dorsal view of a complete carapace,  $\times 18$ .
- 21, 22. *Ceratopsis quadrijida* (Jones).  
21. Side view of right valve,  $\times 15$ . (After Jones.)  
22. Ventral edge view of same. (After Jones.)

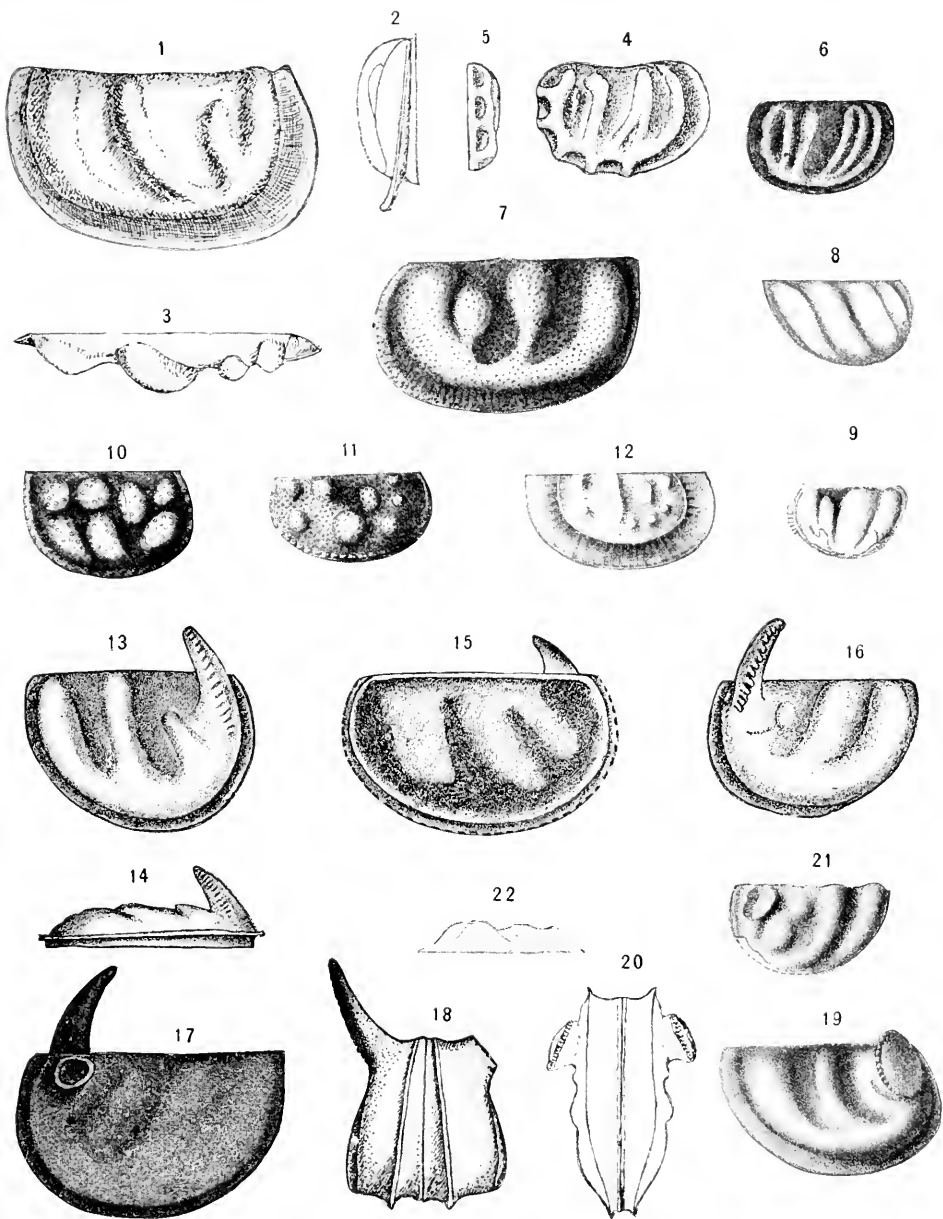

TETRADELLA, KIESOURA, AND CERATOPSIS.

FOR EXPLANATION OF PLATE SEE PAGE 330.





## EXPLANATION OF PLATE XL.

Unless otherwise stated, the figures are copied from Ulrich.

- Figs. 1, 2. *Ctenobolbina ciliata* (Emmons).  
1. Side view of left valve,  $\times 15$ .  
2. Interior of right valve.
- 3-5. *Ctenobolbina emaciata* (Ulrich).  
3. Left valve,  $\times 20$ .  
4, 5. Ventral and end views of same.
- 6-8. *Ctenobolbina alata* Ulrich.  
6. Left valve,  $\times 18$ .  
7. Dorsal edge view of complete carapace,  $\times 25$ .  
8. Ventral edge view of same specimen.
9. *Ctenobolbina bispinosa* Ulrich.  
Right valve,  $\times 18$ .
10. *Ctenobolbina obliqua* Ulrich.  
A right valve,  $\times 20$ , in which some of the flange is missing.
11. *Ctenobolbina oblonga* (Steusloff).  
View of a right valve of this species,  $\times 20$ . (Copied from Steusloff.)
12. *Ctenobolbina granosa* Ulrich.  
View of a perfect left valve,  $\times 20$ .
- 13, 14. *Ctenobolbina fulcrata* Ulrich.  
Lateral and posterior views of a left valve, illustrating the usual characters of the species,  $\times 20$ .
- 15, 16. *Ctenobolbina crassa* Ulrich.  
Lateral and posterior views of a left valve,  $\times 20$ .
- 17, 18. *Ctenobolbina subcrassa* Ulrich.  
Lateral views of a left and right valve, respectively,  $\times 20$ .
- 19, 20. *Ctenobolbina punctata* Ulrich.  
Lateral and dorsal views of a right valve,  $\times 20$ .
- 21, 22. *Ctenobolbina papillosa* Ulrich.  
Lateral and ventral views of a left valve,  $\times 20$ .
23. *Ctenobolbina minima* Ulrich.  
A right valve,  $\times 30$ .
24. *Ctenobolbina impressa* (Steusloff).  
Lateral view of a right valve,  $\times 20$ . (After Steusloff.)
- 25-27. *Ctenobolbina auricularis* (Jones).  
25. Lateral right side view of the complete carapace which is slightly tilted,  $\times 25$ .  
26, 27. Ventral and posterior views of the same carapace. (Copied from Jones.)
28. *Ctenobolbina umbonata* (Steusloff).  
Left valve,  $\times 20$ . (Copied from Steusloff.)
29. *Ctenobolbina major* (Krause).  
Lateral view of right valve,  $\times 15$ . (After Krause.)
- 30-31. *Ctenobolbina loculata* Ulrich.  
30. Exterior of an apparently perfect right valve,  $\times 20$ .  
31. Interior of a left valve,  $\times 20$ .



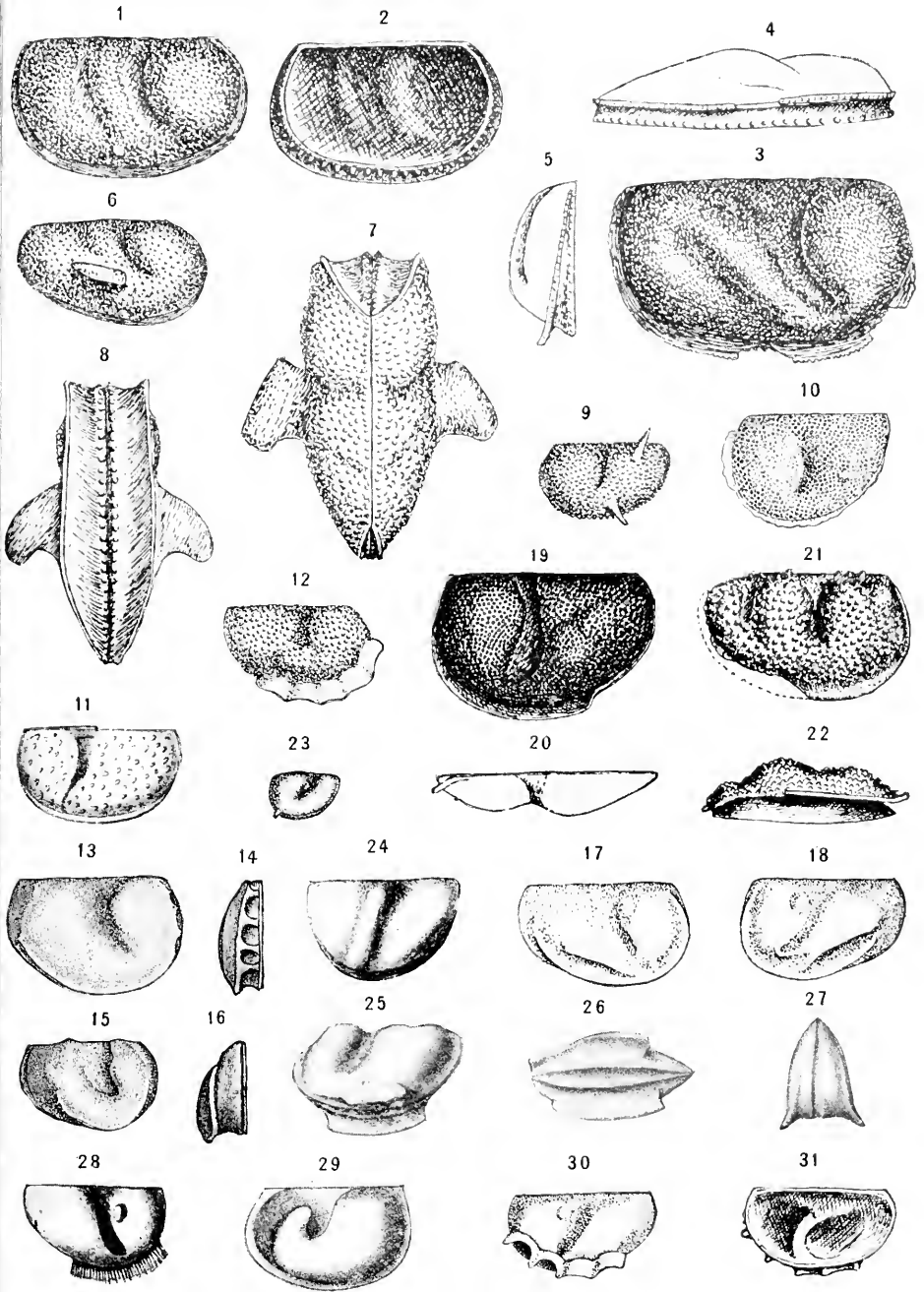

CTENOBOLBINA.

FOR EXPLANATION OF PLATE SEE PAGE 332.





EXPLANATION OF PLATE XII.

Unless otherwise mentioned, all the figures on this plate are  $\times 15$ , and are copied from Ulrich.

Figs. 1-3. *Drepanella bigeneris* Ulrich.

1. Side view of left valve.
2. Posterior view of same valve.
3. Longitudinal sectional view across the central part of the same.

4-6. *Drepanella crassinoda* Ulrich.

4. Side view of right valve.
5. Dorsal view of same valve.
6. Posterior end view of complete carapace.

7, 8. *Drepanella nitida* (Ulrich).

7. Left valve of an average complete specimen.
8. Ventral view of same.

9. *Drepanella ampla* Ulrich.

Lateral view of right valve.

10, 11. *Drepanella elongata* (Ulrich.)

10. Left valve.
11. Longitudinal sectional view.

12-14. *Drepanella macra* Ulrich.

12. Side view of right valve.
13. Longitudinal and vertical sectional views across central part of same valve.

15. *Drepanella richardsoni* (Miller).

Side view of a left valve (original).

16-18. *Scofieldia bilateralis* (Ulrich).

16. Side view of a right valve of the usual appearance.
- 17, 18. Ventral and posterior views of a left valve.

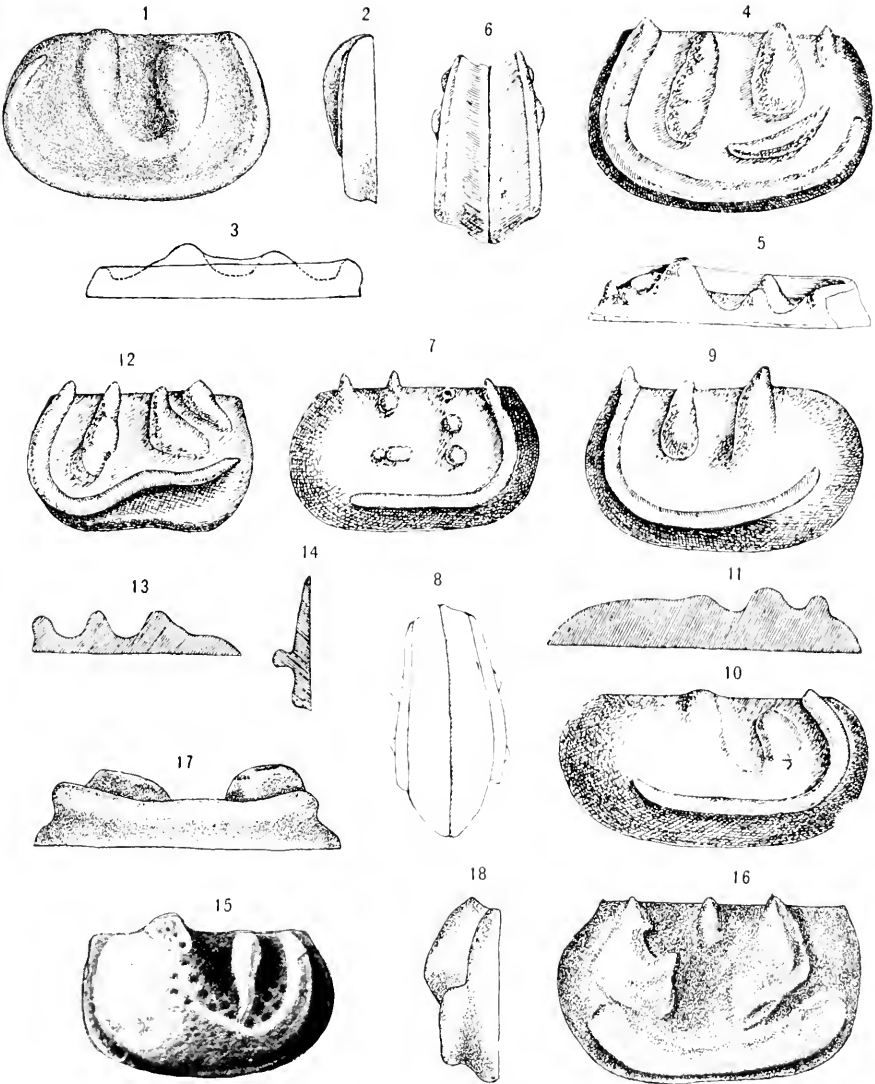

DREPANELLA AND SCOFIELDIA.  
FOR EXPLANATION OF PLATE SEE PAGE 334.





EXPLANATION OF PLATE XLIII.

All of the figures on this plate, except 21 and 22, are copied from Ulrich and are  $\times 20$ .

Figs. 1-4. *Trepostella lyoni* (Ulrich).

1. Side view of a right valve.
- 2, 3. Dorsal and posterior views of the same specimen.
4. A left valve showing the subcentral ventral pouch.

5-7. *Hollina kolmodini* (Jones).

5. A right valve showing the similarity of the ridges to *Drepanella*.
6. Interior of a right valve.
7. Dorsal edge view of same.

8, 9. *Hollina insolens* (Ulrich).

8. Exterior of a left valve.
9. Interior of another left valve.

10-12. *Hollina cavimarginata* (Ulrich).

- 10, 11. Lateral and posterior views of a left valve.
12. View of interior of another left valve.

13. *Hollina spiculosa* (Ulrich).

Side view of a nearly perfect right valve.

14. *Hollina armata* (Ulrich).

A right valve showing the usual characters.

15. *Hollina tricollina* (Ulrich).

Lateral view of a left valve.

16, 17. *Hollina granifera* (Ulrich).

Lateral and posterior views of a right valve.

18. *Hollina radiata* (Jones and Kirkby).

Right valve of an American example, apparently agreeing in all essential respects with the English types of the species.

19, 20. *Hollina radiata cestricensis* (Ulrich).

19. Side view of a left valve.  $\times 28$ .

20. Posterior view of same example.

21, 22. *Beyrichia? tuberculospinosa* Jones and Kirkby.

Side views of two examples of this doubtfully placed Carboniferous species, which may be a *Hollina*,  $\times 25$ . (After Jones and Kirkby.)



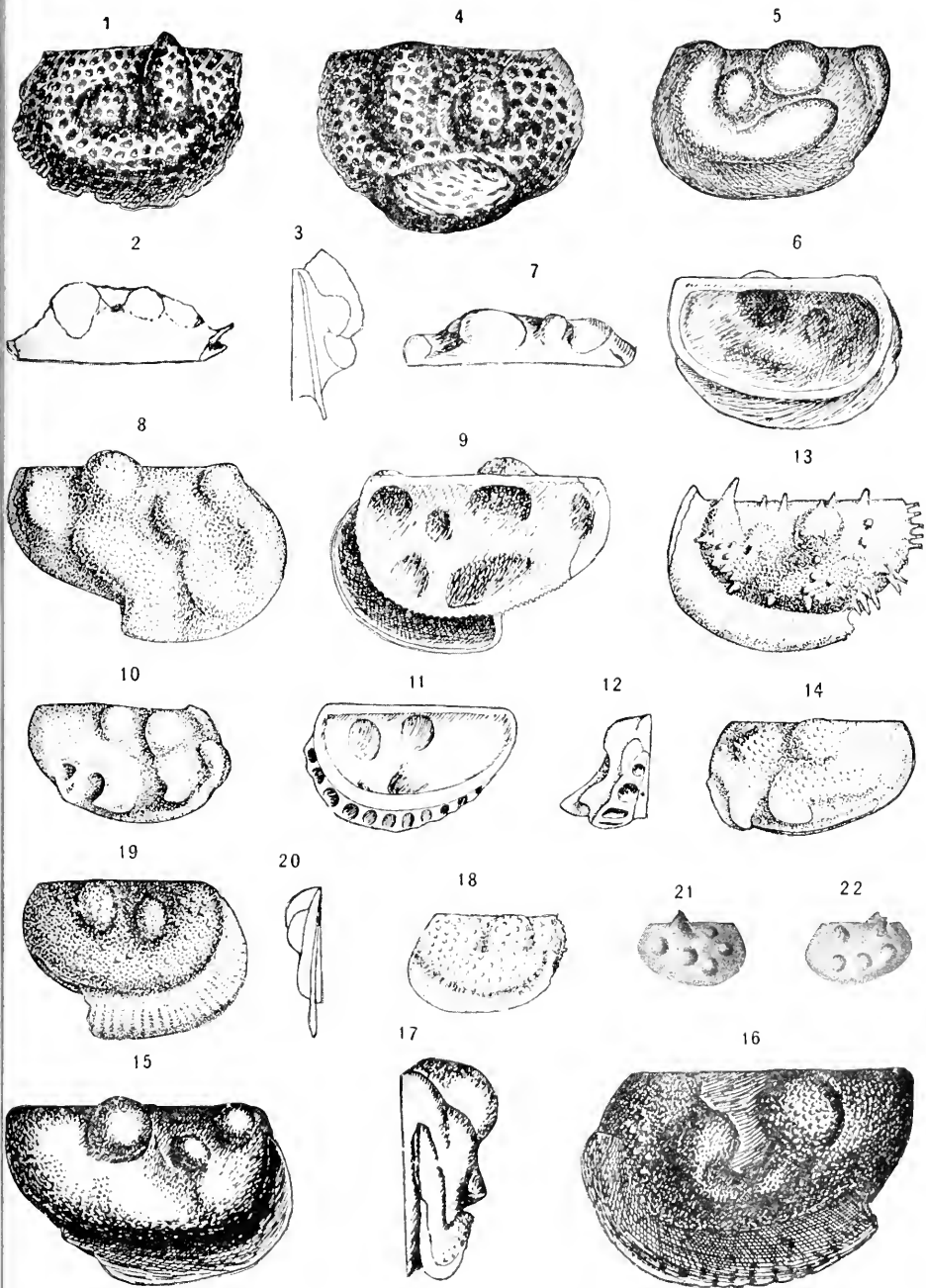

TREPOSELLA AND HOLLINA.

FOR EXPLANATION OF PLATE SEE PAGE 336.





EXPLANATION OF PLATE XLIII.

Figures 1-4 and 9-29 are copied from Jones.

- Figs. 1-3. *Kladocella pennsylvanica* (Jones).  
Left side, end and ventral views of complete carapace,  $\times 15$ .
4. *Kladocella hallii* (Jones).  
A right valve,  $\times 20$ .
5. *Kladocella clarkii paupera*, new variety.  
Lateral view of left valve,  $\times 20$ .  
Coeymans limestone, Cumberland, Maryland.
- 6, 7. *Kladocella turgida*, new species.  
Right and left valves, respectively,  $\times 20$ .  
Coeymans limestone, Cumberland, Maryland.
8. *Kladocella turgida ventrosa*, new variety.  
Lateral view of a left valve,  $\times 20$ .  
Coeymans limestone, Cumberland, Maryland.
- 9, 10. *Kladocella bicatca* (Jones and Kirkby).  
Left and right valves of this Carboniferous species,  $\times 25$ .
- 11-14. *Kirkbyina reticosa* (Jones and Kirkby).  
11. Left valve,  $\times 25$ .  
12. Right valve,  $\times 25$ .
- 13, 14. Dorsal and ventral views of a complete carapace.
- 15-18. *Kirkbyina ventricornis* (Jones and Kirkby).  
15. A left valve,  $\times 25$ .  
16. A right valve showing the spine more conspicuously,  $\times 25$ .
- 17, 18. Ventral and end views of complete carapace.
- 19, 20. *Beyrichiella cristata* Jones and Kirkby.  
Right side and dorsal view of complete carapace,  $\times 25$ .
21. *Beyrichiella conflucus* (Ulrich).  
Left valve,  $\times 20$ , of the only known American species.
- 22-24. *Beyrichiopsis fimbriata* Jones and Kirkby.  
22. Right valve,  $\times 40$ , apparently perfect.  
23. Right valve with the fringe partially broken away,  $\times 25$ .  
24. Ventral view of complete carapace.
25. *Beyrichiopsis subdentata* Jones and Kirkby.  
Lateral view of a right valve,  $\times 25$ .
- 26, 27. *Beyrichiopsis granulata* Jones and Kirkby.  
26. A left valve,  $\times 25$ .  
27. End view of same.
28. *Beyrichiopsis simplex* Jones and Kirkby.  
Lateral view of left valve,  $\times 25$ .
29. *Beyrichiopsis cornuta* Jones and Kirkby.  
Left valve,  $\times 25$ .

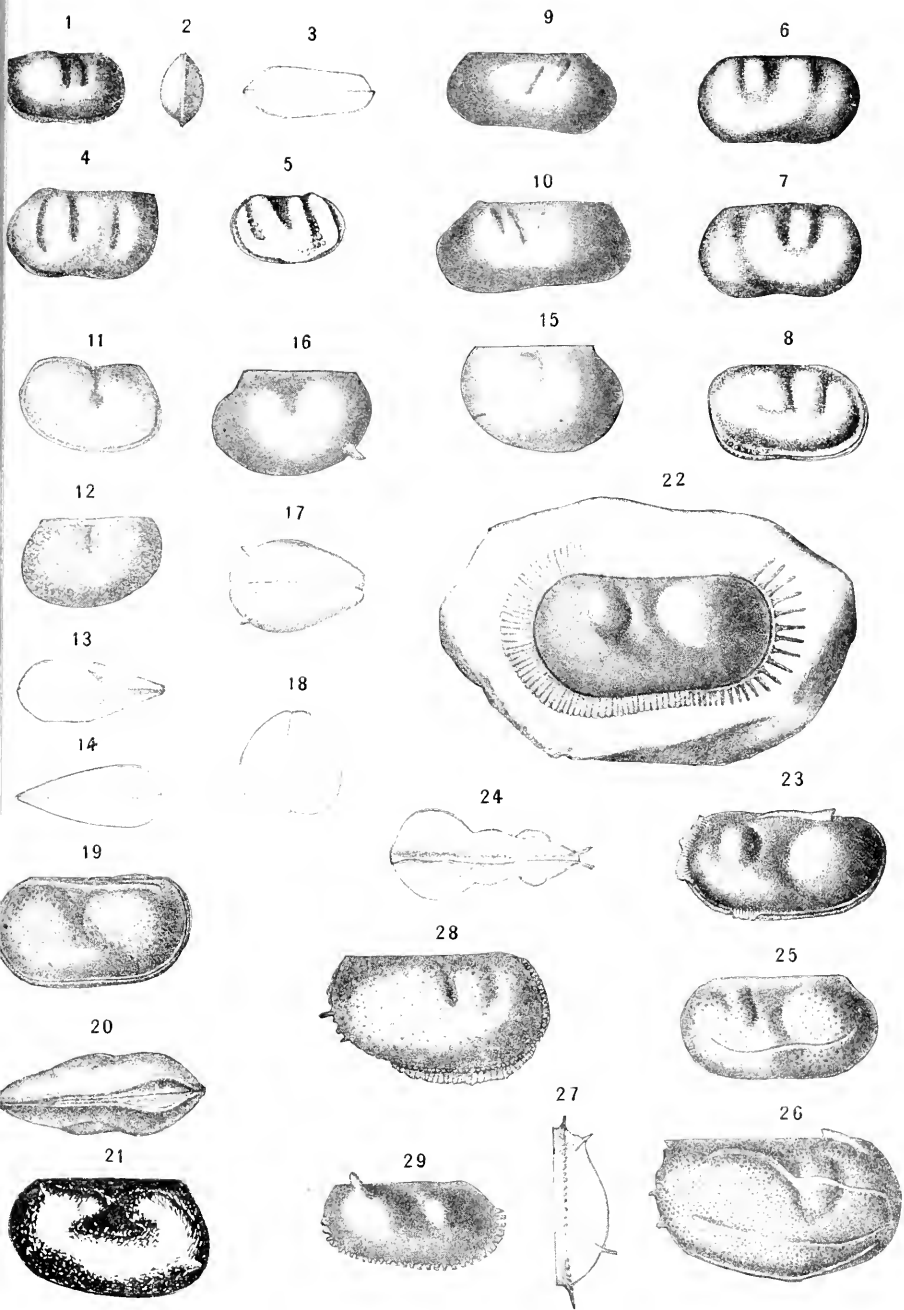

KLÆDENELLA, KIRKBYINA, BEYRICHIELLA, AND BEYRICHIOPSIS.

FOR EXPLANATION OF PLATE SEE PAGE 338.





EXPLANATION OF PLATE XLIV.

Figs. 1-6 are copied from Ulrich and Bassler and are  $\times 30$ ; figs. 7-19 are from Jones and Kirkby and are  $\times 25$ .

Figs. 1, 2. *Jonesina bolliiformis* (Ulrich and Bassler).

1. Left valve of entire carapace.
2. Dorsal view of same showing channeled back.

3-5. *Jonesina bolliiformis tumida* (Ulrich and Bassler).

3. Left valve, incomplete at the antero-dorsal angle.
4. Lateral view of another left valve.
5. Ventral view of original of fig. 4.

6. *Jonesina gregaria* (Ulrich and Bassler).

Left valve of an average old example.

7-9. *Jonesina fodicata* (Jones and Kirkby).

7, 8. Two left valves showing slight variation in outline and surface characters.

9. A right valve in which the surface is further modified.

10-12. *Jonesina fastigiata* (Jones and Kirkby).

10. Lateral view of a right side of complete carapace.

11, 12. Two left valves.

13, 14. *Jonesina craterigera* (Jones and Kirkby).

Right side and ventral view of complete carapace.

15, 16. *Jonesina bradyana* (Jones and Kirkby).

15. Right side of complete carapace.

16. Ventral view of same specimen.

17-19. *Jonesina arcuata* (Bean).

17, 18. Two left valves showing variation in outline.

19. Right side of complete carapace.



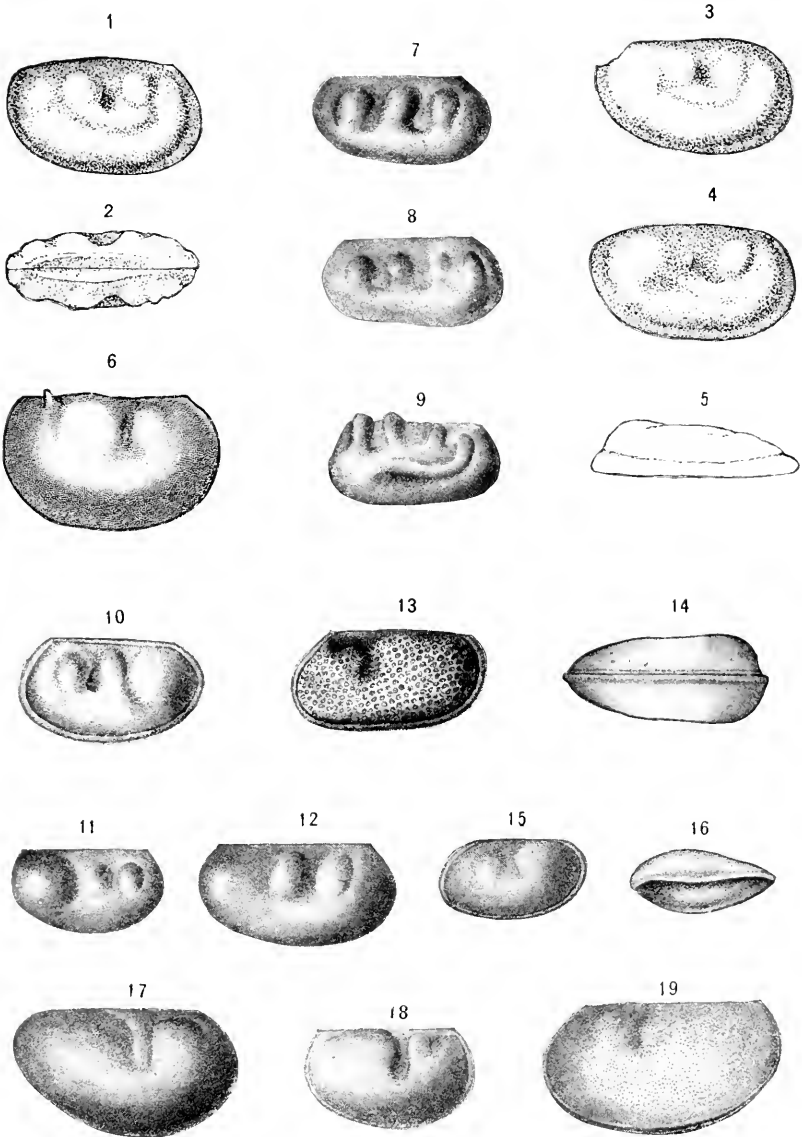

JONESINA.

FOR EXPLANATION OF PLATE SEE PAGE 340.



## DESCRIPTIONS OF FOSSIL CRABS FROM CALIFORNIA.

---

By MARY J. RATHBUN,

Assistant Curator, Division of Marine Invertebrates, U. S. National Museum.

---

This paper is based on specimens collected in California in 1907 by Dr. Ralph Arnold, Paleontologist, U. S. Geological Survey.<sup>a</sup> Three species are from the Miocene of Fresno and Kern counties; the remaining species is from the Cretaceous beds of San Mateo County.

The Tertiary forms differ markedly from one another as to their resemblance to existing types. One is a species of *Loxorhynchus* identical with *L. grandis*, which now occurs locally off the California coast; another is a *Cancer* which is distinct from any of the nine recent species of the genus inhabiting California, but may be the ancestor of one or more of them; while the third, probably a Parthenopid, is quite unlike any now known. The degrees of relationship which these fossil crabs bear to their living allies correspond to the age of the strata in which they are found, the *Loxorhynchus* being stratigraphically above the *Cancer*, though both are in the Miocene, and the *Cancer* in turn far above the Parthenopid, which is also in the Miocene.

The single species from the Cretaceous is a new type which I have designated as *Archæopus antennatus*. In its dorsal aspect it is allied to *Plagiolophus vancouverensis* Woodward from the Cretaceous of Vancouver Island. Of the latter species only the carapace and fragments of the limbs are known, so that it is impossible to tell whether it possesses the peculiar characters existing in *Archæopus*, especially the rudimentary and elevated fifth pair of feet. More interesting is the resemblance to the genus *Retropiuma* (see below), represented by an anomalous form from the depths of the Indian Ocean, which was described by its authors as of an archaic type.

---

<sup>a</sup> Doctor Arnold has furnished the notes on localities and also the lists of fossils inserted here.

## Family INACHIDÆ.

## LOXORHYNCHUS GRANDIS Stimpson.

Plate XLV; Plate XLVI; Plate XLVII, fig. 1.

*Lororyguchus grandis* STIMPSON, Proc. Boston Soc. Nat. Hist., VI, 1857, p. 85.*Lororhynchus grandis* STIMPSON, Jour. Boston Soc. Nat. Hist., VI, 1857, p. 452, pl. xx, fig. 1; pl. xxii, fig. 1.

One specimen, adult female, without appendages except a portion of the coxal joints of some of the legs. Cat. No. 165476, U.S.N.M.; U. S. Geological Survey Locality No. 4783.

This crab occurs in a rather hard, coarse blue-gray sandstone layer about 125 feet stratigraphically below the top of the Etchegoin formation (Upper Miocene) on Canoas Creek, three-fourths of a mile below Hugo Kreyenhagen's ranch house, 16 miles southeast of Coalinga, Fresno County, California.

The specimen is apparently of the same species as the recent *L. grandis*. The spines of the carapace, the form of the buccal cavity and the abdomen correspond to the same parts in *L. grandis*. The rostral and orbital region is lacking.

*Measurements*.—Greatest width of carapace 93 mm., width at hepatic regions 58.5 mm.

*Present distribution*.—From the Farallone Islands and San Francisco to San Diego, in 6½ to 68 fathoms. Uncommon.

Only one other species of the genus is known, *L. crispatus* Stimpson,<sup>a</sup> which has almost the same marine distribution as the above, but has not been recorded in a fossil state.

No other fossils were found in the immediate bed with *L. grandis*, but overlying it about 25 feet was a bed containing *Ostrea lurida* Carpenter, while in beds equivalent to those 300-350 feet below it are found the following species:

*List of fossils from upper Etchegoin formation (Miocene), Zapata Creek, 13 miles southeast of Coalinga, California.*

## ECHINOIDEA.

*Astrodapsis perrini* Merriam.*Scutella beverriana* Rémond.*Echinurachus gibbsii* Rémond.

## BRACHIOPODA.

*Terebratalia occidentalis* Dall.

## PELECYPODA.

*Arca trilineata* Conrad.*Pecten nutteri* Arnold.*Chama peltucida* Sowerby.*Pecten waltzi* Arnold.*Macoma nasuta* Conrad.*Saridomus gracilis* Gould.*Pecten coalinguensis* Arnold.

## GASTEROPODA.

*Nassa californiana* Conrad.*Nererita reclusiana* Petit.

<sup>a</sup> Jour. Boston Soc. Nat. Hist., VI, 1857, p. 453, pl. xxii, figs. 2-4.

## Family CANCRIDÆ.

## CANCER FISSUS, new species.

Plate XLIX, fig. 1.

*Type*.—Cat. No. 165477, U.S.N.M.; U. S. Geological Survey Locality No. 4756.

This crab is found toward the base of the Etchegoin formation near Henry Spring on the east face of "1900 foot hill" 4 miles south of Coalinga, Fresno County, California.

This horizon is about 800 feet stratigraphically below the bed containing *Loxorhynchus grandis* Stimpson.

One specimen showing dorsal view of carapace only. Outer layer of surface absent except along the lateral teeth. Proportion of length to width (measured at the anterior angle of the eighth or penultimate side tooth) as 1 to 1.45. Convexity and areolation much as in *C. magister* Dana.<sup>a</sup> The depression about the cardiac region is deeper than in *C. magister* and the region itself is more distinctly divided in the middle into two elevations.

The anterior angle of each lateral tooth scarcely projects sideways beyond the tooth immediately in front of it. The teeth are subtruncate, separated from one another by shallow V-shaped notches and long closed fissures; they are eight in number (including the tooth at the outer angle of the orbit), and are irregular in size and shape; the first, third, fifth, and seventh are larger than the intervening teeth; the shape of the ninth tooth (at the lateral angle of the carapace) is not clear, but it is very narrow as is customary in the genus; the fifth, sixth, seventh, and eighth teeth each have a small horny point at their anterior angle. The surface of the teeth is granular. The most anterior tooth visible on the right side is very evidently the outer tooth of the orbit, the close granulation characteristic of the margin being continued along the inner side of the tooth, which forms a part of the upper border of the orbit. The margin of the first five teeth is preserved on the right side, while that of the third to the eighth inclusive, as well as part of the margin of the second and ninth teeth, is visible on the left side.

Very little of the front is preserved; that is, the tip of a blunt median tooth, the tip of a much smaller lateral tooth on the right not far from the middle, and beyond this last a cavity which may represent still another tooth before the frontal border curves into the tooth which forms the inner border of the orbit. The latter is visible on the left side of the specimen, as are also the two fissures of the orbital margin. The fissures are closed on the margin of the orbit, but widen

<sup>a</sup> Proc. Acad. Nat. Sci. Phila., VI, 1852, p. 73; Crust. U. S. Expl. Exped., I, 1852, p. 151; atlas, 1855, pl. vii, fig. 1a-d.

posteriorly, forming a sort of buttonhole effect. A portion of these fissures shows on the right side.

The thickened granulate line which forms the postero-lateral border of the carapace is continued across the posterior margin.

*Measurements.*—Length of carapace, 30.5 mm.; extreme width at the eighth tooth, 44.2 mm.; fronto-orbital width, 16.5 mm.; width of front between the inner orbital angles, 8.6 mm.

While in form this species resembles *C. magister* more than any other recent Californian species, yet *C. magister* has more prominent, triangular side teeth, 10 in number, its orbital fissures are linear, and the postero-lateral margin is discontinuous with the posterior margin.

The bed containing the crab consists of fine conglomerate and coarse sand, and contains the following fauna:

*List of fossils from lower Etchegoin formation (upper Miocene), Henry Springs, ¼ miles south of Coalinga, California.*

ECHINOIDEA.

*Echinurachus gibbsii* Rémond.

PELECYPODA.

*Arca trilincata* Conrad.

*Mulinia densata* Conrad.

*Clidiophora punctata* Carpenter.

*Panopea generosa* Gould.

*Diplodonta harfordi* Anderson.

*Solen cf. sicarius* Gould.

*Glycymeris*, species.

GASTEROPODA.

*Nassa californiana* Conrad.

*Pisania* aff. *fortis* Carpenter.

CIRRIPEDIA.

*Balanus concavus* Bromm.

Family PARTHENOPIDÆ.

Genus BRANCHIOLAMBRUS, new.

Carapace rhomboidal, very convex in an antero-posterior as well as in a transverse direction. Branchial regions very extensive and nearly touching each other at the median line. Front and antero-lateral margins dentate; postero-lateral margin a sinuous line, below which the surface is steeply inclined.

Appendages unknown.

(*βράχια*, gills, branchiæ, in allusion to the extent of the branchial region; *Lambrus*, until recently the name of a genus of crabs.)

*Type of the genus.*—*Branchiolambrus altus*, new species.

## BRANCHIOLAMBRUS ALTUS, new species.

Plate XLVII, figs. 2 and 3.

*Type*.—Cat. No. 165478, U.S.N.M.; U. S. Geological Survey Locality No. 4859. One specimen.

This crab is found in a yellow calcareous layer in the gypsiferous shales immediately underlying the Vaqueros (lower Miocene) beds on Wagon Wheel Mountain, southeast quarter, section 36, township 25 south, range 18 east, Devils Den District, Kern County, California, about 36 miles southeast of Coalinga. Associated with the crab are *Yoldia impressa* Conrad, *Phacoides acutilineatus* Conrad, and an abundant species of *Arca*. The beds are believed to be of lower Miocene age, and closely related to the overlying Vaqueros.

Carapace about five-sevenths as long as wide, front subtriangular, antero-lateral margin long and arcuate, postero-lateral margin sinuous. The widest and highest part of the carapace is at about its posterior third; from the summit of the branchial region the surface slopes to the margins, the longest incline being toward the front.

Entire surface covered with sharp granules. Cervical suture shallow for its anterior two-thirds, becoming deep and narrow posteriorly, where the gastric region is much constricted, ending in an obtuse point. Cardiac region correspondingly narrow, depressed below the branchial level and furnished with two tubercles side by side. At the inner angle of the branchial region and either side of the gastro-cardiac furrow, there is a small but sharp tubercle.

Frontal teeth three, subequal, broad and blunt, the two outer directed a little obliquely, their inner margins having an almost transverse direction. The intervals between the tips of the median and lateral teeth are a little less than those between the tips of the lateral and inner orbital teeth, the second sinus being more concave. Orbital tooth acute; width of orbit equal to sinus just in front of it.

Antero-lateral margin very incomplete; hepatic portion perhaps straight or a little concave; teeth along the branchial region at least seven, shallow and broad, separated by closed sinuses, tips broken off. A notch just behind the lateral angle forms a small blunt postero-lateral tooth similar to that which occurs so often in the genus *Cancer*. Postero-lateral margin for most of its length concave, posteriorly convex; margin slightly raised and ornamented with a line of fine granules. The posterior end of the carapace is broken off so that its outline is conjectural. The surface below the postero-lateral margin is steep but not perpendicular, and in a direct view its upper border appears convex (Plate XLVII, fig. 3); this surface may represent a distinct facet, as near its anterior end and bounding it below there is a remnant of a horizontal granulated ridge.

*Measurements.*—Length (approximate), 18.2 mm.; width (approximate), 27.2 mm.; height at least 5 mm.

*Relationship.*—There is no recent form closely approximating the above. The characters of the carapace point more strongly to the Parthenopidae than to any other family, but it is possible that a knowledge of the appendages would compel the removal of the genus to another family. The general shape as well as the antero-lateral teeth and the orbits are Parthenopid. The front is more Cancerid. The suberect postero-lateral surfaces may be analogous to those in *Solenolambrus*. The amplitude of the branchial regions and the corresponding contraction of the cardiac and gastric regions are unique.

*List of fossils from Vaqueros formation (lower Miocene), immediately overlying beds containing Branchiolambrus altus at Wagon Wheel Mountain, Kern County, 36 miles southeast of Coalinga, California.*

ECHINOIDEA.

*Astrodupsis merriami* Anderson.

PELECYPODA.

*Chione lemborcensis* Anderson.

*Pecten andersoni* Arnold.

*Melis*, species.

*Pecten crassicardo* Conrad.

GASTEROPODA.

*Conus*, species.

*Siphonalia* (?), species.

*Turritella ocyonana* Conrad.

Family OCYPODIDÆ.

Genus ARCHÆOPUS, new.

Carapace transverse, sides converging anteriorly, posterior angles rounded. Front or rostrum linear; orbits deep and wide. Basal joint of antennules very large, inflated, and much exposed. Buccal cavity wide. Chelipeds of moderate size; fingers long and slender. Last pair of legs very small, subdorsal and probably attached at the margins of the abdomen which does not cover the whole width of the sternum at its base.

(*αρχαῖος*, belonging to former times; *πῶς*, foot, in allusion to the reduction of the last pair.)

*Type of the genus.*—*Archæopus antennatus*, new species.

Allied to *Plagiolophus* Bell,<sup>a</sup> in which, however, the four ambulatory legs are similar to one another, and the orbits are less extensive. The carapace of our species has a strong resemblance to that of the so-called *Plagiolophus Vancouverensis* Woodward,<sup>b</sup> but in that species, although the orbits extend to the anterior corners of the carapace, the front or rostrum is of considerable width and bifid, and, as mentioned above, the hind feet are not known.

<sup>a</sup> Mon. Fossil Malac. Crust. Great Britain, Pt. 1, 1857, p. 49.

<sup>b</sup> Quart. Jour. Geol. Soc. London, LII, 1896, p. 226, text figs. 5, 6.



In the reduction of the last pair of legs, *Archæopus* shows an affinity to the deep-sea Ocypodan genus *Retropluma* Gill<sup>a</sup> = *Archæoplax* Alcock and Anderson<sup>b</sup> (not Stimpson) = *Ptenoplax* Alcock and Anderson,<sup>c</sup> which has also a large ovoid basal antennular article and similar chela.

ARCHÆOPUS ANTENNATUS, new species.

Plate XLVII, figs. 4-7; Plate XLVIII; Plate XLIX, figs. 2-4.

*Type*.—Cat. No. 31069, U.S.N.M. One adult female, type; one immature female, cotype; one male, cotype. Locality 27, Santa Cruz Quadrangle.

Found in a soft blue grey sandstone of Chico, upper Cretaceous, age at Bolsa Point one mile north of Pigeon Point, San Mateo County, California.

Carapace about  $1\frac{2}{3}$  times as broad as long, antero-lateral margins straight and anteriorly converging, postero-lateral margins very convex, curving into the bilobed posterior margin.

Surface uneven: a transverse ridge across cardiac and branchial regions; cervical suture well marked, its anterior portion straight and oblique; the depressions in the center of the carapace form a broad H. A groove parallel to the posterior margin defines the intestinal region. Surface punctate. A few irregular bands of small well-separated granules are distinguishable on the more elevated portions. A conical tubercle crowns the hepatic region: five conical tubercles, irregular in size and position, are ranged on the antero-lateral margin, one is hepatic, the others branchial: of the latter the anterior is the largest and most elevated, the next two are small, the last is considerably larger.

Anterior margin sinuous. Front or rostrum slender, acuminate, obliquely inclined, extending forward to a point opposite the outer angles of the orbit. Each orbit occupies about one-fourth of the anterior border of the carapace and is deep and well defined (Plate XLVII, fig. 4): its highest part (at its middle) nearly as great as its transverse width; upper margin with a triangular tooth or spine near the inner angle (Plate XLVIII, fig. 1), and a more prominent tooth at the outer angle (Plate XLVII, fig. 6) which forms also the antero-lateral angle of the carapace; lower margin also marked at its inner end with a tooth or spine (Plate XLVIII, fig. 2) which is nearer the median line of the crab than that of the upper border. On either side of the rostriform point of the front (which may, however, be a sub-frontal prolongation of the true rostrum), there is a large, swollen

<sup>a</sup> Amer. Nat., XXVIII, 1894, p. 1044.

<sup>b</sup> Jour. Asiat. Soc. Bengal, LXIII, Pt. 2, 1894, p. 180.

<sup>c</sup> Illus. Zool. Investigator, Crust., Pl. 3, 1895, explanation of pl. xv.

and somewhat prismatic nodule (Plate XLVIII, fig. 2) which doubtless represents the basal segment of the antennules.

Antennae and maxillipeds unknown. Buccal cavity with parallel sides, and very broad, equaling half the width of the carapace (Plate XLIX, fig. 2).

The chelipeds of the female (Plate XLVIII) are of moderate size, subequal, and if extended, would measure in length about  $1\frac{1}{2}$  times the width of the carapace. Merus thick, not much longer than wide. Dorsal aspect of carpus about  $1\frac{1}{2}$  times as long as wide. Chelae narrow and strongly arcuate, fingers somewhat longer than palm, very slender, grooved, their apposed edges meeting and edged with low teeth. Low granular rugae can be detected on the palm. The margins of the various segments appear to be bluntly rounded.

Between the insertion of the cheliped and that of the first ambulatory, there is a considerable space (Plate XLVII, fig. 6; Plate XLVIII, fig. 3) which tends to indicate the presence there of a large afferent branchial opening. The first three pairs of ambulatory legs are similar and of ordinary size; they are too fragmentary for description; the merus is flattened, a cross section being nearly twice as long as wide. The bases of these three legs occupy the entire length of the after part of the sternum (Plate XLVII, fig. 6; Plate XLVIII, fig. 3). The fourth and last leg, unfortunately missing, must obviously have a subdorsal position and be of slender build; the indications are that the legs of this pair were attached not at the outer margin of the broad sternal plate, as in *Paleicus Philippi*,<sup>a</sup> but nearer together close to the outer edge of the abdomen (Plate XLVII, fig. 7; Plate XLIX, fig. 4), where the latter folds against the sternum, as in *Retropluma*.<sup>b</sup>

The abdomen of the type female (Plate XLVIII, fig. 3) is as broad as the length of the fourth to seventh segments inclusive and does not nearly cover the sternum; second, third, and fourth segments subequal in length; fifth a little longer; sixth the longest and twice as long as the fourth; seventh broader than long, subtriangular. In the male also (Plate XLVII, fig. 6) the sixth segment is the longest but may represent the fusion of two or more segments; the two segments preceding it are subequal in length; the more proximal segment or segments are crushed and indistinguishable.

*Measurements.*—Type female (Plate XLVII, fig. 7; Plate XLVIII): length of carapace, 24.5 mm.; width of same, 34.5 mm.; width between anterior angles, 27.5 mm. Male (Plate XLVII, figs. 4-6): width of carapace, 25.7 mm.; width between anterior angles (approximate), 20.7 mm.

Associated with *Archaopus antennatus* at the same locality or within the same formation at near-by localities is the following fauna.

<sup>a</sup> Zweiter Jahresber. d. Vereins f. Naturk. in Cassel, 1838, p. 11.

<sup>b</sup> Amer. Nat., XXVIII, 1894, p. 1044.

(Those species marked by an "\*" are found at the same locality as the crab.)

List of Chico, upper Cretaceous, fossils from the Santa Cruz Quadrangle.

## PELECYPODA.

<i>Anatina tryoniana</i> Gabb.	<i>Ostrca breuerii</i> (?) Gabb.
<i>Arca rancouverensis</i> Meek.	<i>Panopca concentrica</i> Gabb.
<i>Cucullaa bowersiana</i> Cooper.	* <i>Pholadomya subelongata</i> Meek.
* <i>Glycymeris reatchii</i> Gabb.	* <i>Pinna calamitoides</i> Stumard.
* <i>Inoceramus subundatus</i> Meek.	<i>Trigonia cransiana</i> Meek.
* <i>Mactra stantoni</i> Arnold.	<i>Trigonia leana</i> Gabb.
<i>Nucula truncata</i> Gabb.	

## GASTEROPODA.

* <i>Cinulia obliqua</i> Gabb.	* <i>Perissolar brevierostis</i> Gabb.
* <i>Lunatia</i> , new species.	<i>Turritella pescaderoensis</i> Arnold.
* <i>Margaritella</i> , new species.	

## EXPLANATION OF PLATES.

## PLATE XLV.

- Fig. 1. *Lororhynchus grandis*, nat. size, dorsal view.  
2. *Lororhynchus grandis*, nat. size, front view.

## PLATE XLVI.

- Fig. 1. *Lororhynchus grandis*, nat. size, ventral view.  
2. *Lororhynchus grandis*, nat. size, rear view.

## PLATE XLVII.

- Fig. 1. *Lororhynchus grandis*, left side, nat. size.  
2. *Branchiolambrus altus*, dorsal view,  $\times 2$ .  
3. *Branchiolambrus altus*, rear view,  $\times 2$ .  
4. *Archaeopus antennatus*, male, front view,  $\times 2$ .  
5. *Archaeopus antennatus*, male, dorsal view,  $\times 2$ .  
6. *Archaeopus antennatus*, male, ventral view,  $\times 2$ .  
7. *Archaeopus antennatus*, type female, rear view,  $\times 2$ .

## PLATE XLVIII.

- Fig. 1. *Archaeopus antennatus*, type female, dorsal view,  $\times 2$ .  
2. *Archaeopus antennatus*, type female, front view,  $\times 2$ .  
3. *Archaeopus antennatus*, type female, ventral view,  $\times 2$ .

## PLATE XLIX.

- Fig. 1. *Cancer fissus*, dorsal view,  $\times 2$ .  
2. *Archaeopus antennatus*, immature female, dorsal view,  $\times 2$ .  
3. *Archaeopus antennatus*, immature female, front view of palm,  $\times 2$ .  
4. *Archaeopus antennatus*, immature female, rear view,  $\times 2$ .

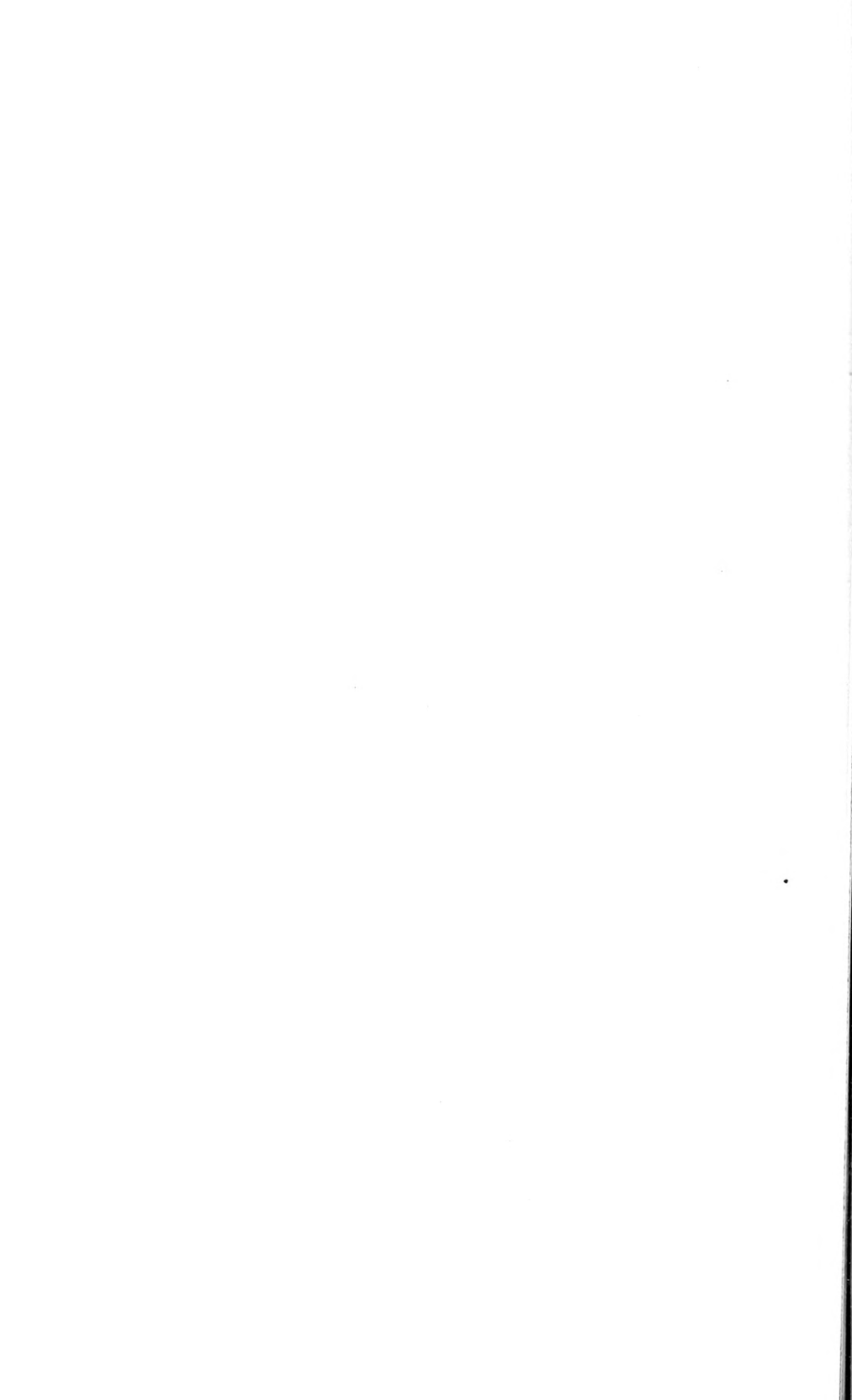

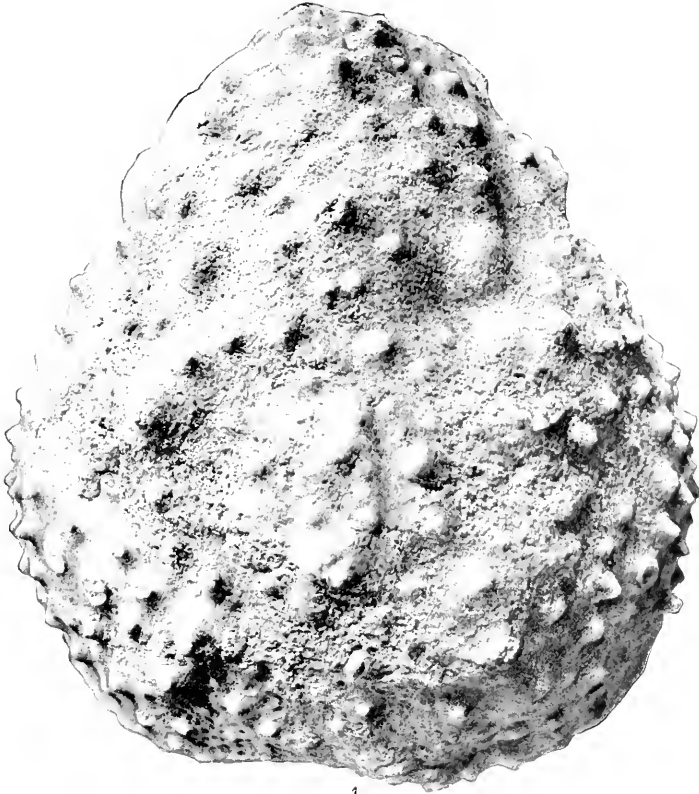

1

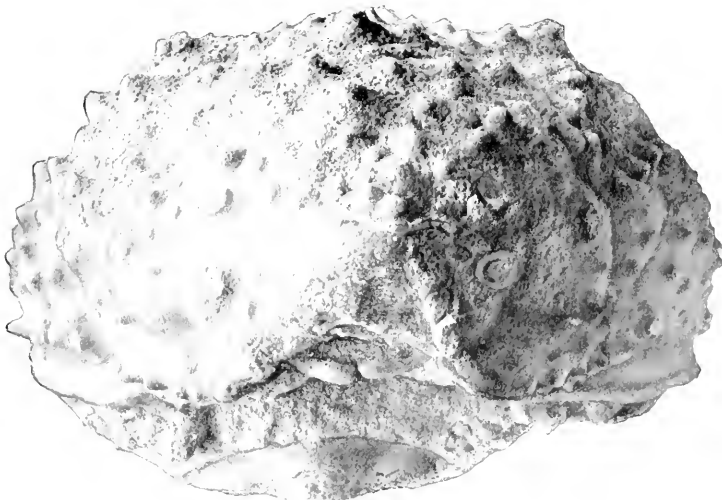

2

*LOXORHYNCHUS GRANDIS.*

FOR EXPLANATION OF PLATE SEE PAGE 349.





1

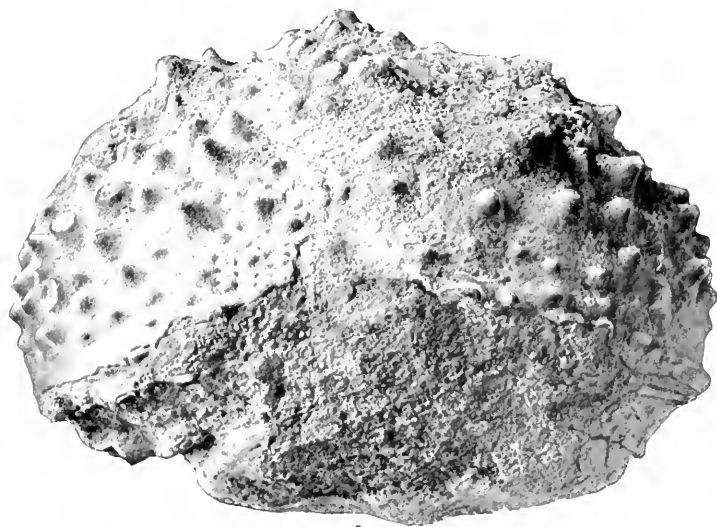

2

*LOXORHYNCHUS GRANDIS.*

FOR EXPLANATION OF PLATE SEE PAGE 349.





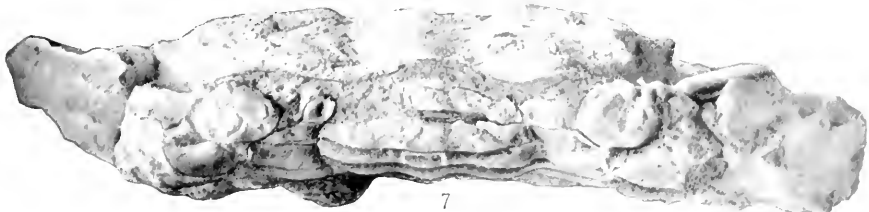
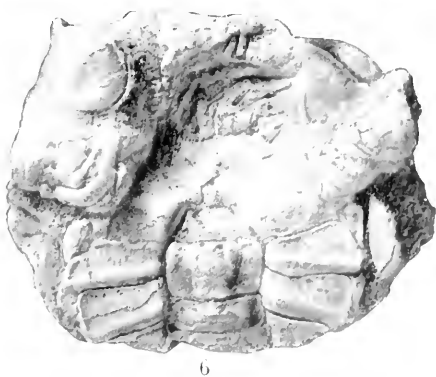
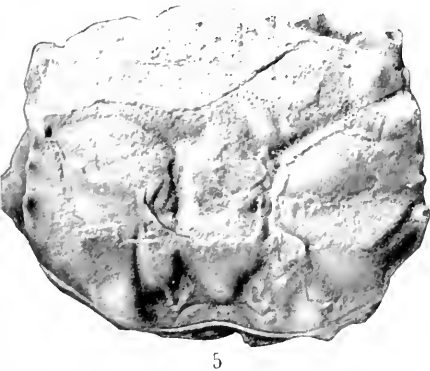
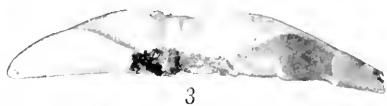
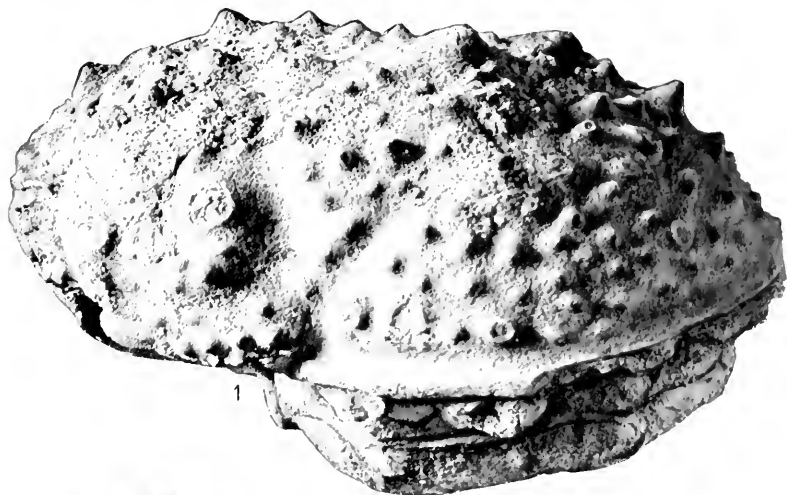

1, *Loxorhynchus grandis*; 2 and 3, *Branchiolambrus altus*; 4-7, *Archæopus antennatus*.





1



2



3

ARCHÆOPUS ANTENNATUS.

FOR EXPLANATION OF PLATE SEE PAGE 349.





1

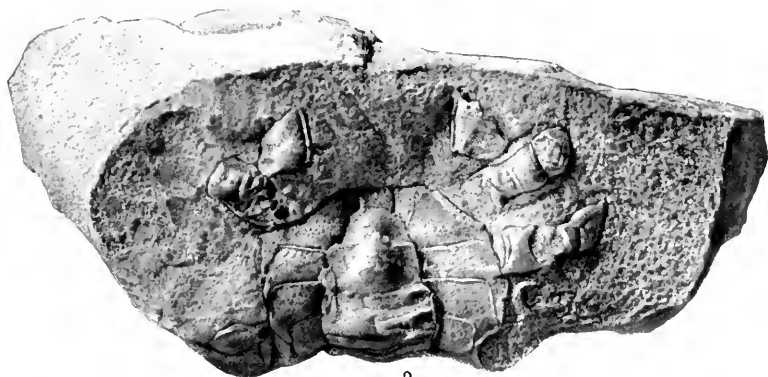

2



3



4

1, *CANCER FISSUS*; 2-4, *ARCHÆOPUS ANTENNATUS*.

FOR EXPLANATION OF PLATE SEE PAGE 349.



ON CERTAIN GENERA AND SPECIES OF CARNIVOROUS  
DINOSAURS, WITH SPECIAL REFERENCE TO CERA-  
TOSAURUS NASICORNIS MARSH.

---

By OLIVER P. HAY,

*Of Washington, District of Columbia.*

---

Through the liberality of the officers of the United States National Museum the writer has been enabled to prepare the following paper, which is based mainly on specimens in the possession of the Museum. Nearly all these specimens were originally collected by Prof. O. C. Marsh while acting as Vertebrate Paleontologist of the U. S. Geological Survey.

1. THE GENUS *LABROSAURUS* MARSH AND ITS SPECIES.

In 1879<sup>a</sup> Marsh established the genus *Labrosaurus*, with his *Allosaurus lucaris* as the type. This species had been described in 1878<sup>b</sup> and was based on materials found in the Upper Jurassic of Colorado. In this earliest description there was mentioned only an anterior dorsal vertebra. In the description of 1879 cervical and dorsal vertebrae and fore-limb bones were briefly described. So far as the writer knows, no part representing this species has ever been figured.

In 1884<sup>c</sup> Marsh added a second species to the genus, *Labrosaurus ferax*. The only part of this animal that was mentioned is the left dentary. Marsh here made the statement that in *Labrosaurus* the teeth are more triangular than in the other genera of the order; but whether or not this statement had its basis in this specimen is doubtful, inasmuch as the crowns of all the teeth are missing and the roots almost wholly concealed by matrix. This dentary bone (Cat. No. 2315, U.S.N.M.) probably came from the same locality and level as the type of *L. lucaris*.

In 1896<sup>d</sup> Marsh again mentioned this species and presented the same figures. In a footnote on page 163 he remarked that the skull

---

<sup>a</sup> Amer. Jour. Sci., XVII, p. 91.

<sup>b</sup> Idem., XV, p. 243.

<sup>c</sup> Idem., XXVII, p. 333, pl. ix, figs. 1-6.

<sup>d</sup> Dinosaurs of North America, pp. 163, 270, pl. xiii, figs. 2-4.

of *Allosaurus ferox* had an aperture in the maxillary in front of the antorbital opening. The context appears to indicate that "*Allosaurus ferox*" is a slip of the pen for *Allosaurus fragilis*, just as *Labrosaurus ferox* seems to be called *Labrosaurus fragilis* on page 270. At any rate, this is the only mention that Marsh made of the skull of either *L. ferox* or *A. fragilis*. In the definition of the family Labrosauridæ<sup>a</sup> he mentioned no part of the skull but the lower jaw.

On page 270 of the work last cited Marsh referred a third species to *Labrosaurus*, namely, *L. sulcatus*. This is done in the explanation of Plate XIII, fig. 1; and, so far as the writer is aware, Marsh nowhere else mentioned this species. Three views of a single tooth are given, but there is no description and no statement as to the origin of the specimen.

Inasmuch as no teeth or parts of the skull were, so far as Marsh informs us, present with the type of *L. lucaris*, and only teeth or parts of the lower jaw appear to have been represented in the types of the other species, one is at a loss to understand on what grounds the second and third species were referred to *Labrosaurus*. Furthermore, it may be worth while to inquire whether *L. ferox* and *L. sulcatus* are congeneric.

The type of *L. sulcatus* is a tooth which, judging from Marsh's figures, presents a crown 30 mm. high, with a base whose antero-posterior diameter is 12.5 mm. and whose transverse diameter is 12 mm. There is a posterior face which appears to have been somewhat concave, its outer boundary being formed by a crenulated, its inner by a smooth, carina. The outer face of the tooth is ornamented at the base by about eight ridges, of which only three remain at the apex. The inner and the posterior faces are represented as being smooth.

As already stated, the jaw of *L. ferox* presented to Marsh little or nothing of the teeth. The crowns of all the functional teeth are missing and the roots were almost wholly concealed by matrix. A section of the base of the crown furthest in front showed above the enveloping sandstone. Of this matrix the writer has removed enough to expose a part of the outer and front faces of the tooth. The inner face had been almost wholly absorbed by the successional tooth, of whose apex about 9 mm. are now laid bare. The functional tooth had an antero-posterior diameter of 15 mm. and a transverse diameter of 9 mm. The latter diameter was near the front of the tooth, a fact which indicates that the anterior cutting edge had subsided far above the base of the crown. The hinder edge seems to have reached the base. The outer and anterior faces and the little that remains of the inner face are wholly smooth. The inner face, too, of the successional tooth is perfectly smooth and both the anterior and posterior cutting edges are crenulated.

<sup>a</sup>Amer. Jour. Sci., L, 1895, p. 493; Dinosaurs of North America, p. 239.



The writer has likewise exposed the tooth which was displacing the sixth functional tooth, the outer wall of whose base still remains. The apex of the successional tooth is broken off. The long diameter at the section thus furnished is 8.5 mm.; the short diameter, 5.5 mm. The inner and outer faces are equally convex, both are smooth, and both cutting edges are crenulated.

Such being the structure of the teeth of the types of *Labrosaurus ferox* and *L. sulcatus*, it becomes evident that the two species belong to quite distinct genera and almost certainly to different families; but which of them belongs to *Labrosaurus*, if either, can be determined only by future discoveries.

In the lower jaw of *L. ferox* there were plainly 12 teeth. The first was placed 63 mm. behind the tip of the jaw, between which and the tooth there is a deep notch. The posterior part of the dentary is bent downward in an extraordinary way, somewhat like that of a fringilline bird. These peculiarities show that this species belongs to a family entirely distinct from that typified by *Allosaurus*.

## 2. NOTE ON ANTRODEMUS LEIDY.

In the writer's Bibliography and Catalogue of the Fossil Vertebrata of North America, 1902, p. 489, all the species of *Labrosaurus* are referred to *Antrodemus* Leidy. The responsibility of this assignment must be shared by the writer and his friend, Frederic A. Lucas. The writer is now inclined to recede from the position there taken.

*Antrodemus* was established by Leidy<sup>a</sup> on the hinder half of a caudal vertebra of some carnivorous dinosaur. This vertebra (Cat. No. 218, U.S.N.M.) had been found by Dr. F. V. Hayden in Middle Park, Colorado, and was supposed to have come from Cretaceous deposits. Now, inasmuch as no caudal vertebræ have been described or even mentioned in connection with any of the species of *Labrosaurus*, and inasmuch as it is very doubtful if *Antrodemus valens* came from the same level as *Labrosaurus lucaris*, there appears to be no sufficient reason for displacing Marsh's generic name in favor of *Antrodemus*.

By an inexplicable error the writer<sup>b</sup> referred to *Antrodemus* the remains described by Marsh as *Allosaurus medius*. These remains had been found in Potomac deposits at Muirkirk, Maryland, and were placed by Marsh in *Allosaurus* only provisionally.

## 3. ON ALLOSAURUS MARSH AND CREOSAURUS MARSIL.

The genus *Creosaurus* is a subject of discussion. Dr. S. W. Williston<sup>c</sup> has called attention to the fact that a lumbar vertebra which

<sup>a</sup> Proc. Acad. Nat. Sci. Phila., 1870, p. 3; Contrib. Ext. Vert. Fauna West. Terrs., 1873, p. 267, pl. xv, figs. 16-18.

<sup>b</sup> Bibliog. and Cat. Foss. Vert. N. Amer., p. 489.

<sup>c</sup> Amer. Jour. Sci., XI, 1901, p. 111.

Marsh<sup>a</sup> first attributed to *Allosaurus fragilis* was afterwards, without expression of reasons therefor, referred<sup>b</sup> to *Creosaurus atrox*. Nevertheless, we can hardly suppose that Marsh ever regarded this vertebra as a part of the type of *A. fragilis*; and, if we can depend on Marsh's figure, said to be one-sixth the natural size, this vertebra is not the one whose measurements are given by Marsh, inasmuch as its length is 119 mm., instead of 105 mm.

The type of *Creosaurus atrox* is a left ilium, which Marsh figured more than once.<sup>c</sup> Marsh informs us in his earliest description that there were some teeth which he referred to this species and which had trihedral crowns and crenulated cutting edges; and he has figured the right premaxillary with its five teeth. This premaxillary is probably a part of the individual that furnished the ilium. In the last-mentioned citation Marsh stated that the anterior end of the ilium might be imperfect. He gave, as the extreme length of the bone, 700 mm. It may be confidently assumed that the anterior border of the bone had approximately the form seen in the ilium of *Allosaurus*<sup>d</sup> and that the front of the pubic process has suffered some loss. Almost certainly Marsh was mistaken when he suggested that a prepubic bone had articulated with this process. The original length of the ilium may be regarded as having been close to 720 mm. It is proposed to compare some of its dimensions, taken from Marsh's figure, with corresponding dimensions taken from the ilium, also 720 mm. long, of the specimen of *Allosaurus fragilis*, now in the U. S. National Museum, Cat. No. 4734, from which were made fig. 2, Plate X, and fig. 2, Plate XI, of Marsh's *Dinosaurs of North America*. The second column under each species presents the percentage which each measurement is of the length of the ilium.

Table of measurements and percentages.

Part measured.	<i>Allosaurus fragilis.</i>		<i>Creosaurus atrox.</i>	
	Dimension.	Percent- age.	Dimension.	Percent- age.
	Mm.		Mm.	
Greatest length of ilium .....	720	100	720	100
Length of acetabulum .....	232	31	190	26.4
Length from acetabulum to end of ilium .....	336	47	310	43
Length from bottom of anterior notch to hinder end of ilium .....	547	77	530	73
Width of bone where narrowest above acetabulum .....	279	39	300	42
Height of upper border above acetabulum .....	335	47	320	44

It will be observed that the differences in the measurements of the two species do not reach 5 per cent of the length of the bone. The

<sup>a</sup> Amer. Jour. Sci., XVII, 1879, pl. x, figs. 3, 4.

<sup>b</sup> Idem, XXVII, 1884, p. 334, pl. xiv, figs. 3, 4.

<sup>c</sup> Idem, XV, 1878, p. 243, figs. 1, 2; XVII, 1879, p. 90, pl. x, figs. 1, 2; XXVII, 1884, p. 335, pl. xiv, figs. 1, 2; *Dinosaurs of N. Amer.*, 1896, pl. xii, figs. 2, 3.

<sup>d</sup> *Dinosaurs of North America*, pl. x, fig. 2.

acetabulum of *Creosaurus* is relatively small, the neck above the pubic and ischiadic processes broad, and the crest high above the acetabulum. The notch above the pubic process does not extend backward as far as the front of the acetabulum; but there is another ilium in the U. S. National Museum (Cat. No. 2323), believed to belong to *Allosaurus fragilis*, which is intermediate in the depth of this notch. Whatever may be true of other parts of the skeleton of *Creosaurus*, there do not appear to be any characters in the ilium that distinguish it generically from *Allosaurus*. The metapodial whose measurement was given by Marsh<sup>a</sup> has the same length relative to the length of the ilium that the fourth metapodial of *Allosaurus fragilis* has to its ilium, being about 40 per cent.

Dr. S. W. Williston<sup>a</sup> has published a figure of a scapula, coracoid, and some fore-limb bones which certainly differ from those of *Allosaurus*; but there is as yet no certainty that any of these belong to *Creosaurus*. Osborn<sup>b</sup> has figured as that of *Allosaurus* a scapula which differs greatly from that of Marsh's specimen and which resembles closely Williston's figure of the scapula thought to belong to *Creosaurus*.

Osborn has likewise described and figured<sup>c</sup> a skull as that of *Creosaurus*; but he grants that the genus has not been clearly separated from *Allosaurus*. When this figure is compared with that of a skull identified by Osborn<sup>d</sup> as *Allosaurus* no important differences are discoverable.

The skull last mentioned and the scapula figured by Osborn belong to the fine skeleton of a carnivorous dinosaur which is on exhibition in the American Museum of Natural History in New York. It is to be regretted that there has not yet appeared a full critical description of this animal. However, a popular account of it, authorized by Professor Osborn, was published in December, 1907,<sup>e</sup> by Mr. Walter L. Beasley, and was accompanied by three figures reproduced from photographs. In this article Professor Osborn contributed a paragraph in which he identified the reptile as *Allosaurus*. Almost certainly, however, it is not *Allosaurus fragilis*, for various reasons. While the length of the fore limbs of the American Museum specimen has almost exactly the same ratio to the length of the hinder limb that we find in the type of *Allosaurus fragilis*, the various segments of the fore limbs of the two are quite unlike. There appears to be no good reason why one cannot rely on Marsh's figure of the fore limb and shoulder girdle. In the New York specimen the hand is relatively enormous, being fully as long as the humerus

<sup>a</sup> Amer. Jour. Sci., XV, 1878, p. 243.

<sup>b</sup> Bull. Amer. Mus. Nat. Hist., XXII, 1906, p. 291.

<sup>c</sup> Idem, XIX, 1903, p. 697, figs. 1, 2.

<sup>d</sup> Idem, XXII, 1906, p. 286, fig. 2.

<sup>e</sup> Scientific American, XCVII, p. 446.

and one and three-fourths times the length of the fore arm; while in *Allosaurus fragilis* the hand is about six-tenths as long as the humerus and about equal to the fore arm. The deltoid crest of the New York specimen is broader and more abruptly formed than in *Allosaurus fragilis* and the bones of the fore arm are much stouter. When the figures of the New York specimen are compared with those of the shoulder girdle and limb published by Williston, as mentioned, one finds the resemblances between the common parts to be very close indeed. It seems probable that the American Museum specimen belongs to *Crocodylus* rather than to *Allosaurus*.

#### 4. THE GENERA DEINODON LEIDY, DRYPTOSAURUS MARSII, AND ALBERTOSAURUS OSBORN.

Mr. Lambe has published<sup>a</sup> an instructive description of two skulls of a species of carnivorous dinosaur under the name of *Dryptosaurus incrassatus*. The name *Lalaps incrassatus* (= *D. incrassatus*) was first applied by Cope<sup>b</sup> to two teeth found in the Judith River beds, Montana; afterwards<sup>c</sup> to a dentary bone from the same region and level and retaining some of the teeth. Later<sup>d</sup> Cope described under the same name the two skulls which Lambe has made the subject of his communication. These skulls were derived from the beds of the Edmonton series in Alberta, deposits that are probably equivalent to the Ceratops beds of Wyoming.

Lambe concluded, and without doubt with justice, that the Edmonton skulls did not belong to the same species as the teeth and the dentary bone that had originally borne the name *Lalaps incrassatus*. He then proceeded to do two things that are open to criticism. He identified the Judith River specimens alluded to as being probably *Deinodon horridus* Leidy, and then proposed that the Edmonton specimens should hereafter be regarded as the types of *Dryptosaurus incrassatus*.

That the Judith River specimens described by Cope do not belong to *D. horridus* seems evident from the fact that none of the various teeth originally described by Leidy under this name had the transverse diameter greater than that parallel with the jaw. As regards the transfer of a specific name from one type to another, it is needless to remark that this is not permitted by the rules of nomenclature. Mr. Lambe should have described those skulls under a new specific name. This was later done by Osborn,<sup>e</sup> who bestowed on them the name *Albertosaurus sarcophagus*.

<sup>a</sup> Contrib. Canad. Paleont., III, 1904, Pt. 3, pp. 5-27, pls. I-VIII.

<sup>b</sup> Proc. Acad. Nat. Sci. Phila., 1876, p. 248.

<sup>c</sup> Idem, 1876, p. 340.

<sup>d</sup> Proc. Amer. Philos. Soc., XXX, 1892, p. 240.

<sup>e</sup> Bull. Amer. Mus. Nat. Hist., XXI, 1905, p. 265.

Whether or not Osborn's genus *Albertosaurus* will prove to be well founded only future discoveries can decide. The Edmonton beds are considerably younger than the Judith River. In the interval that elapsed, the genera of dinosaurs may have wholly changed; but we are not certain of this. That *Dryptosaurus*, an Upper Cretaceous genus, the type of which was found in New Jersey, may have existed in the nearly contemporaneous Judith River epoch and region is wholly probable. *Trachodon* is believed by paleontologists to include species from the Upper Cretaceous of New Jersey, the Judith River beds of Montana, and the Ceratops beds of Wyoming. *Ornithomimus* appears to have continued from the Eagle epoch, older still than the Judith River,<sup>a</sup> and from the Judith River epoch itself, to the Edmonton.<sup>b</sup> The type of the genus *O. velox* was found in the Denver beds.<sup>c</sup> Even many species of vertebrates of the Ceratops beds are as yet indistinguishable from those of the Judith River, as noted especially by Williston.<sup>d</sup>

It seems likely that Osborn has laid greater emphasis on the probable generic distinctness of the dinosaurs from the Upper Cretaceous of New Jersey, the Belly River, the Judith River, and the Edmonton beds respectively, because of his view that the Belly River beds do not belong to the Upper Cretaceous, but to a much lower, though as yet undefined, horizon.<sup>e</sup>

Osborn's definition of *Dryptosaurus* does not seem to exclude from that genus the Judith River dentary described by Cope. In both, some of the anterior mandibular teeth had the long diameter of the section at the base of the crown directed transversely to the axis of the jaw. Furthermore, in case the species *incrassatus* does not belong to *Dryptosaurus*, the establishment of a new genus for its reception appears to be required. In any case, Osborn's mild reproach that Lambe had referred the Edmonton skulls to a New Jersey genus loses its force. To say that Lambe had referred those skulls to a Judith River species is incorrect, as has been shown above.

In *Albertosaurus sarcophagus* a tooth that may be regarded as the first incisor has, according to Lambe's description, the hinder face flat, so that the cross section is D-shaped, while the corresponding tooth of *Dryptosaurus incrassatus* has the anterior cutting edge brought far around toward the inner side of the tooth, thus representing a stage somewhat more primitive than that of *Albertosaurus sarcophagus*. The species may therefore be generically distinct. As

<sup>a</sup> Hatcher, Bull. U. S. Geol. Surv., No. 257, p. 87.

<sup>b</sup> Lambe, Contrib. Canad. Paleont., III, Pt. 2, 1902, p. 53.

<sup>c</sup> Cross, Monogr. U. S. Geol. Surv., XXVII, p. 227.

<sup>d</sup> Science, XVI, 1902, p. 952.

<sup>e</sup> Contrib. Canad. Paleont., III, Pt. 2, pp. 7-19.

regards the alveolar partitions, there appears to be little difference. On this point compare Cope's description<sup>a</sup> and that of Lambe on page 16 of his paper cited above.

That *Albertosaurus* is distinct from *Deinodon* is still more doubtful. Osborn has presented what he regards as the probable characters of the latter genus.<sup>b</sup> Now, of the maxilla and the mandible of *Deinodon* nothing is known: hence nothing of the alveolar partitions and triangular interdental plates. It is not known that the anterior mandibular teeth were large and truncate in cross section. The small tooth with D-shaped section which was figured by Leidy<sup>c</sup> may have occupied the place of first mandibular incisor, just as it does in *Albertosaurus sarcophagus*.<sup>d</sup> What the structure of the premaxillary teeth of *Deinodon* was is not known. It is in the premaxillæ that may have been inserted those large teeth with D-shaped section that are represented by Leidy's figures 35-40 of the plate cited. *Dryptosaurus*, as represented by Cope's Judith River dentary, was, at most, probably not far removed from *Deinodon*, and in close proximity to that dentary Cope found a large tooth with D-shaped section. This he thought had been in the position of an upper canine; but it might quite as well have been an upper incisor. In case all the teeth originally referred by Leidy to *Deinodon* really belonged to one animal, it seems to me that the present evidence indicates that the small teeth with D-shaped section belonged in the front of the lower jaw, while the large teeth with similar section belonged in the premaxillæ. And the writer sees nothing to exclude *Albertosaurus sarcophagus* from association with the species of *Deinodon*.

It may not be improper to remark here that Osborn erred when he stated<sup>e</sup> that the present writer has held the view that the name *Deinodon* is invalid. The writer needs only cite a paper in the American Geologist<sup>f</sup> and his Bibliography and Catalogue of Fossil Vertebrata of North America<sup>g</sup> to show that he has both used and defended the use of *Deinodon*. Nor is it correct to say that Cope rejected the name because of the indefiniteness of the type. Cope regarded the name as preoccupied by *Dinodon* of Dumeril and Bibron, as I have shown in the article cited in the American Geologist.

In his interesting paper here considered Osborn appears to imply that Leidy's generic name *Aublysodon* may become available in case it shall be shown that those teeth originally referred to *Deinodon*

<sup>a</sup> Proc. Acad. Nat. Sci. Phila., 1876, p. 342.

<sup>b</sup> Bull. Amer. Mus. Nat. Hist., XXI, 1905, p. 261.

<sup>c</sup> Trans. Amer. Philos. Soc., XI, 1859, pl. ix, figs. 41-45.

<sup>d</sup> Lambe, Contrib. Canad. Paleont., III, Pt. 3, p. 11.

<sup>e</sup> Contrib. Canad. Paleont., III, 1902, p. 18; Bull. Amer. Mus. Nat. Hist., XIX, 1905, p. 259.

<sup>f</sup> Vol. XXIV, 1899, p. 346.

<sup>g</sup> Page 488.

which had a **D**-shaped section belonged in fact to an animal distinct from the one which possessed the saber-shaped teeth. The writer regards as remote the contingencies under which this is possible.

Leidy applied the name *Deinodon* to teeth of various forms and sizes, without specifying any as types. Cope was the first who restricted the name and he<sup>a</sup> applied it to those teeth with the **D**-shaped section; and as first reviser his act must be respected. Leidy's having first mentioned the saber-shaped teeth in his description, and given them a lower number on his plate certainly have nothing to do with the matter, and his subsequent application of the name *Aublysodon* to the teeth with **D**-shaped section can avail nothing against Cope. On this point Canon XXI of the American Ornithologists Union's Code of Nomenclature and the remarks following it may be consulted.

To the present writer it seems that there are only two possible conditions under which *Aublysodon* may become available. The first is that hereafter it shall be found that the name *Deinodon* had been employed for some animal before its use by Leidy. The second is that it shall at some time be shown that the tooth represented by Leidy's figures 35 and 36 belonged to one genus, while that represented by figures 37-40 belonged to another. In such a case it may possibly be allowable to employ *Deinodon horridus* for one tooth, *Aublysodon mirandus* for the other. The teeth represented by Leidy's figures 41-45 are excluded, inasmuch as Leidy expressed a doubt respecting their relation to the other teeth. This expression of doubt renders nugatory Marsh's restriction of the name *mirandus* to these teeth.<sup>b</sup>

##### 5. OBSERVATIONS ON THE SKULL OF CERATOSAURUS NASICORNIS MARSH.

The skull which forms a part of the type of Marsh's *Ceratosaurus nasicornis* belongs to the U. S. National Museum and bears the catalogue No. 4735.

During its entombment this skull became somewhat distorted and much compressed, so that its thickness, from side to side, is now only about 4 inches. Marsh's figures present a somewhat restored view of the skull. Furthermore, at the time that these figures were made the matrix had not been removed from the orbits and the antorbital vacuities, and consequently the bones of the palate were not depicted. However, the matrix seems to have been removed at the time that Marsh wrote the description for his *Dinosaurs of North America*. Inasmuch as this is probably the most complete known skull of a carnivorous dinosaur, it has been thought proper to present photo-

<sup>a</sup> Proc. Acad. Nat. Sci. Phila., 1866, p. 279.

<sup>b</sup> Amer. Jour. Sci., XLIV, 1892, p. 174.

graphs of both sides of it and to figure and describe as accurately as possible the lower jaw and the palatopterygoid region. Four text figures, two being reproductions of retouched photographs, are fur-

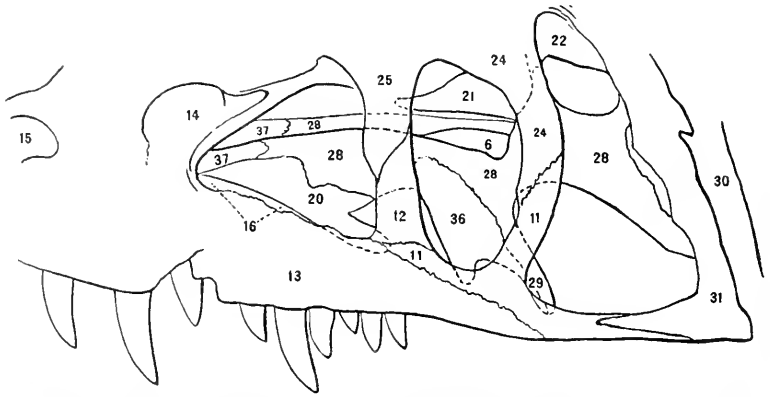

FIG. 1.—*CERATOSAURUS NASICORNIS*.  $\times \frac{1}{3} +$ . RIGHT SIDE OF SKULL. FOR EXPLANATION OF NUMERALS SEE FIG. 2.

nished. Fig. 1, drawn to scale, shows the most important parts of the left side of the skull. It is intended to illustrate especially the structures forming the roof of the mouth.

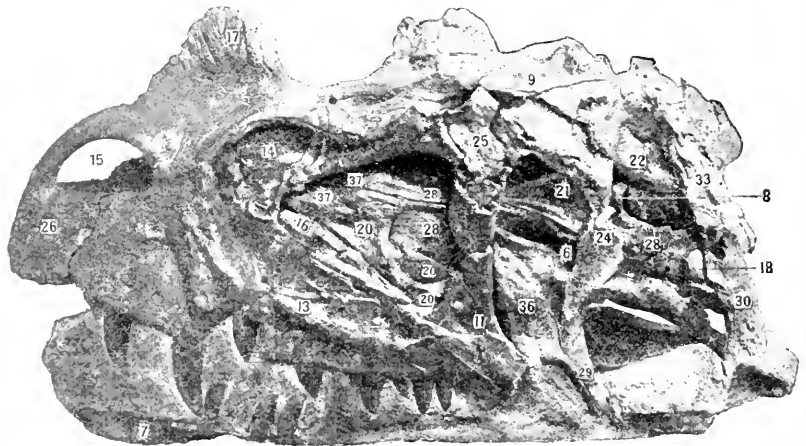

FIG. 2.—*CERATOSAURUS NASICORNIS*.  $\times \frac{1}{3} +$ .

FIG. 2. SKULL SEEN FROM THE LEFT SIDE. IN THIS FIGURE THE NUMERAL 25 STANDS ON THE MATRIX WHICH FILLS THE CAVITY OF THE PREFRONTAL BONE, THE OUTER WALL OF WHICH HAS BEEN BROKEN AWAY. THE UPPER 37 IS PLACED ON THE RIGHT VOMER; THE UPPER 28 ON THE RIGHT PTERYGOID.

- |                              |                           |                        |
|------------------------------|---------------------------|------------------------|
| 1. Angular.                  | 13. Maxilla.              | 25. Prefrontal.        |
| 2. Antorbital vacuity.       | 14. Maxillary depression. | 26. Premaxilla.        |
| 3. Articular.                | 15. Nares, external.      | 27. Postnasal foramen. |
| 6. Cleft between pterygoids. | 16. Nares, internal.      | 28. Pterygoid.         |
| 7. Dentary.                  | 17. Nasal horn.           | 29. Pterygoid process. |
| 8. Epiterygoid.              | 18. Occipital condyle.    | 30. Quadrate.          |
| 9. Frontal.                  | 19. Orbit.                | 31. Quadratojugal.     |
| 10. Hyoid bone.              | 20. Palatine.             | 33. Squamosal.         |
| 11. Jugal.                   | 21. Parasphenoid.         | 34. Suprangular.       |
| 12. Lacrymal bone.           | 22. Parietal.             | 36. Transverse bone.   |
|                              | 24. Postfrontal.          | 37. Vomer.             |



In taking the photographs it has been thought better to remove the lower jaw of the left side, a part of the jugal, the quadratojugal, and the articular end of the quadrate (fig. 2), thereby presenting to better advantage the bones of the palatopterygoid arch. On the right side of the skull (fig. 3) are seen all the bones that bound the orbit, the infratemporal fossa, and the antorbital vacuity. The postfronto-squamosal bar remains. On the left side this is missing.

On the right side is seen the prefrontal protuberance complete. The anterior half or more of this process is scooped out (fig. 3, in front of 25), the upper part deepest, so that the prefrontal bone is a mere shell. From the hinder border of this excavation a perpendicular slit 30 mm. long opens into a cavity that occupies the descending process of the prefrontal. On the left side the outer wall of the prefrontal is broken away, so that the matrix filling the cavity

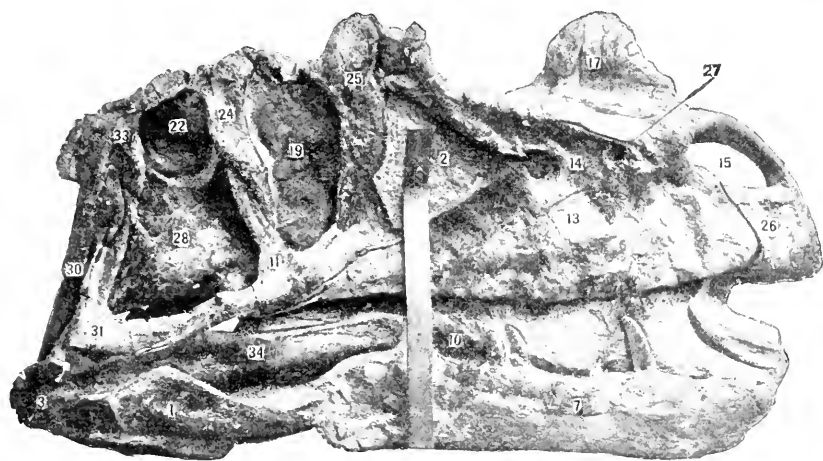

FIG. 3.—*CERATOSAURUS NASICORNIS*.  $\times \frac{1}{3} +$ . SKULL SEEN FROM THE RIGHT SIDE. FOR EXPLANATION OF NUMERALS, SEE FIG. 2.

is exposed. In fig. 2 the numeral 25 is placed on the matrix which fills the cavity. The opening into the cavity is in front of the 25.

On the left side the crowns of three teeth belonging to the lower jaw are seen adhering to the matrix. A large part of the crown of the fourth maxillary tooth, which was pushing itself through the bone, has at some time been exposed by removal of bone. On the right side most of the maxillary teeth are missing. The large tooth lying in the matrix with the apex pointing backward seems, from its narrowness, to be a mandibular tooth. Three mandibular teeth remain in place.

It will be observed that there is a large uneven depression in front of and partly above the antorbital vacuity (fig. 2, numeral 14). This is not well shown in Marsh's figure. This depression probably corresponds to the postnarial vacuity figured by Lambe as belonging

to *Dryptosaurus* and that figured by Osborn as belonging to *Ceratosaurus* and *Allosaurus*. There is a similarly placed vacuity in the skull of *Diplodocus*, whose nasal openings are located far toward the rear of the skull. Inasmuch as this vacuity in the *Theropoda* and in *Diplodocus* appears to be wholly in the maxillary bone, it might be well called the maxillary vacuity. On the left side of the skull of our specimen of *Ceratosaurus* no actual opening is seen through the bone, but on the right side, near the front of the depression, 47 mm. behind the nostril, there seems to be a foramen.

Baur stated<sup>a</sup> that there was a foramen between the outer surface of the quadrate and the quadratojugal, as in *Sphenodon*. The present writer has not observed this. Seen from behind there is a considerable depression where this foramen might be expected to occur; but the bone, though thin, seems to be continuous.

The articular surface of the quadrate is about 65 mm. wide, but it is short fore and aft. It may be said to consist of two convexities



FIG. 4.—*CERATOSAURUS NASICORNIS*.  $\times 3$ . INNER FACE OF LEFT MANDIBLE. 1, ANGULAR; 2, SUPRAANGULAR; 3, ARTICULAR; 4, SPLENIAL; 5, DENTARY.

separated by a broad groove running obliquely outward and backward.

The left ramus of the lower jaw (fig 4) permits examination of both faces, but it has been somewhat restored and in places the sutures are not distinct. The right ramus remains attached to the matrix and presents only the outer face. Fig. 3 shows distinctly that the bones of its hinder part have been somewhat displaced. The supraangular (fig. 4, numeral 2) is seen to form the upper border of the jaw behind the dentary, extending forward above the lateral foramen in the jaw. The angular, 1, is seen beneath the foramen. Its hinder end has probably been broken off, but the bone probably did not reach the angle of the jaw. The relations of this bone to its neighbors was probably the same as shown by Lambc's figure,<sup>b</sup> except that the bone regarded by him as the hinder end of the dentary is almost certainly the angular. In *Ceratosaurus* the angular continues forward a little in front of the foramen. Here its outer face is overlapped by a process of the dentary, 5, while on the lower border of the jaw a process of the splenial, 4, presses itself between two processes of the angular.

<sup>a</sup> Amer. Naturalist, XXV, p. 446.

<sup>b</sup> Contrib. Canad. Paleont., III, Pt. 3, pl. VIII, fig. 20.

Lambe has represented the angular as appearing hardly at all on the outside of the jaw, but extensively on the inner side. What he regards as the angular is almost certainly a long process of the articular, such as occurs in the lizards. If in Lambe's specimen there is really a suture between the articular and the bone called by him the angular the latter is a distinct prearticular. Quite certainly in *Ceratosauros* the suture does not exist. Here the process reaches the foramen and a little below it (fig. 4, numeral 3). The cotylus of the articular, to suit itself to the quadrate, presents two grooves separated by an oblique ridge. The articular extended but little behind the cotylus.

What Lambe calls the presplénial, following Baur, the present writer regards as a part of the true splénial, the other part being what Lambe has recognized as the splénial. Thus the existence of the suture represented by Lambe between his splénial and presplénial is questioned. In the species described by Lambe the anterior end of the splénial is very slender; in *Ceratosauros* the splénial throughout nearly its whole length rises close to the alveolar border of the dentary and descends close to the lower border of the jaw. As it approaches the symphysis its lower border seems to have risen somewhat.

Fig. 1 represents a view of the left side of the skull, that which best shows the bones of the palate. In the fossil the bones of the palate stand nearly perpendicular, but without doubt this is to a great extent due to crushing. They probably sloped upward and inward at an angle of about 45 degrees, or more probably they formed a vaulted roof for the mouth.

The postero-inferior process of the pterygoid (fig 2, numeral 28) joins the inner border of the quadrate at a point about 55 mm. above the articulation of the latter bone with the lower jaw. The postero-superior process rose to the upper end of the quadrate. Whether or not the pterygoid articulated with the quadrate the whole distance between the two points mentioned is somewhat uncertain. On the left side of the skull a considerable part of the pterygoid from the middle of the quadrate forward is broken away. Marsh neither mentions any vacancy here nor does he represent it in his figure. On the right side there is a gap between the two bones, extending about 55 mm. along the border of the quadrate and forward from it less than 15 mm. It seems probable that in life this gap was filled in with bone. This region is represented in the figure as it appears on the right side. In *Sphenodon* the quadrate sends forward a broad process between the upper and lower processes of the pterygoid. It is quite certain that this was not the case in *Ceratosauros*.

Marsh informs us that there is a very short, thin epipterygoid closely articulated by suture with the pterygoid. The position of the suture is obscure, but it was doubtless present. Marsh was probably mistaken when he affirmed that the upper end of the epipterygoid

articulated with the postfrontal. Its connection must have been with the border of the parietal. The epipterygoid of the left side has its upper end missing (fig. 2, numeral 8). On the right side this bone is uninjured. Its upper end is moved well outward toward the postfrontal, but it is probably joined to the parietal. The suture between the latter bone and the postfrontal is obscure. Just behind the base of the epipterygoid the width of the pterygoid is 64 mm.

The inner and anterior end of the transverse bone (figs. 1, 2, numeral 36) overlaps the outer border of the pterygoid, as if it had been pressed somewhat out of its natural relations; but in both *Sphenodon* and *Cyclura* the transverse bone overlaps the pterygoid. From the outer border of the pterygoid and of the transverse bones a strong process, 29, descends to a point a little below the upper border of the lower jaw. Marsh indicates that this process belonged wholly to the transverse, but the suture between the two bones is distinct. The transverse measures 160mm. from its inner end to the extremity of the process mentioned. Just in front of the inner end of the transverse the pterygoid is 45 mm. wide.

The sutures separating the pterygoid, the palatine, and the vomer are not as distinct as could be desired. Nevertheless their courses may be made out more or less satisfactorily. The bones of the right and left sides did not articulate on the midline. Doubtless there was, at least posteriorly, a considerable interval between them. In the skull, as preserved, the rounded inner, or upper, border of the bones of the right side rise several millimeters above those of the left side.

Mostly hidden by the lachrymal and the jugal, in a side view of the skull, is a considerable vacuity in the bones of the roof of the mouth. Its fore and aft extent is 90 mm. This is called by Lambe the sub-orbital vacuity. It seems to correspond to the postpalatine foramen of lizards, turtles, and sphenodon. It is bounded behind by the transverse and mesially, in part, by the pterygoid. In fig. 2 the vacuity is mostly hidden by the lachrymal. A part of it, with light shading, appears between the two numerals 20; the hinder part is shaded dark and is in front of numeral 36.

Another fissure in the roof of the mouth is seen through the antorbital vacuity and is situated just above the border of the maxilla. This is the internal nasal passage (fig. 2, numeral 16). It extends forward to the anterior end of the antorbital vacuity and backward to a bar of bone that bounds the postpalatine vacuity in front. The whole extent of the internal nasal passage, as seen, is 85 mm. Possibly it extended forward some distance beyond the front of the antorbital vacuity.

The bone that lies between the postpalatine vacuity and the nasal passage is undoubtedly the palatine (figs. 1, 2, numeral 20). A

branch of this bone runs backward against the inner face of the maxilla, its hinder extremity being hidden by the maxilla, the front end of the jugal, and the base of the lachrymal. The hinder border of the bone sweeps around and bounds in part the postpalatine vacuity mesially. The suture between the palatine and the pterygoid appears to be where drawn in fig. 1, running first directly forward from the inner side of the postpalatine vacuity to a distinct ridge, then following upward and inward this ridge about 25 mm. Behind this ridge the fibers of the bone are directed fore and aft; on the ridge and in front of it they are directed upward. There can be little doubt that the surface behind the ridge belongs to the pterygoid; that in front of it, to the palatine.

When carefully examined, the ascending suture appears to end about 20 mm. below the upper border of the plate of bone of this left side. From this point there appears to be a suture that runs forward some distance. Above this supposed suture the bone fibers are directed forward; below it, near the ridge, they are directed upward; more anteriorly they run upward and forward. The part of the bone with ascending fibers is quite certainly the upper and anterior portion of the palatine. One can not be certain how far forward this bone extends; it seems to reach almost to the front of the antorbital vacuity, ending there in a point. It is possible, however, that it ends on the border of the nasal passage about 35 mm. behind the front of the antorbital vacuity.

The bone lying above the palatine and at the front of the antorbital vacuity is undoubtedly the left vomer (figs. 1, 2, numeral 37). This appears to extend backward to meet the pterygoid above the palatine, as drawn in the figure. If this is the case, the palatines did not meet at the midline of the palate. Lambe concluded that in the skull of his *Dryptosaurus incrassatus* (*Albertosaurus sarcophagus* Osborn) the palatines were in contact posteriorly.

If the conclusions arrived at here are correct, the internal nasal passage was bounded inwardly almost wholly by the palatine; only slightly by the vomer. In any case, the vomer takes a less important part in the border of the internal nostril than it does in either *Sphenodon* or *Cyclura*. In *Cyclura*, perhaps in lizards generally, the palatines meet in the midline, thus shutting off the pterygoids from the vomers. In *Sphenodon* the pterygoids join the vomers. In the broad union of the pterygoid with the quadrate and the union of the pterygoid with the vomer, *Ceratosaurus* appears to show closer relationship with *Sphenodon* than with the lizards and crocodiles. In the crocodiles access to the supratemporal fossa from behind is cut off above the paroccipital process, but not from below.

To what extent the internal nasal passage was bounded exteriorly by the palatine in *Ceratosaurus* can not be determined. Possibly a

process of the bone extended forward outside of the passage against the inner face of the maxilla.

A comparison of the palate of *Ceratosauros* with that of *Diplodocus*, as represented by Marsh<sup>a</sup> brings to light both differences and resemblances that are interesting. In describing the palate of *Diplodocus* it will be convenient to regard it as divided into anterior, second, third, and posterior fourths. In this genus, as in *Ceratosauros*, the pterygoids extend far forward, to come into contact with the small vomers. Along the midline they are applied to each other backward nearly to a line joining the articular ends of the quadrates at the hinder end of the third quarter of the length. In the lizard *Cyclura* they diverge about the middle of the length of the skull. In *Diplodocus* the postero-inferior process of the pterygoid is very short, on account of the forward swing of the quadrate. Thus the basiptyergoid processes join the pterygoids but little in front of the articular ends of the quadrates.

The anterior position of the articular ends of the quadrates has not been acquired at the expense of the posterior processes of the pterygoids alone. There seems to have occurred in *Diplodocus* a remarkable shoving forward of structures that in *Ceratosauros* lie across the second and third quarters of the length of the base of the skull. On examining Marsh's figure of *Diplodocus* it will be observed that there are four vacuities lying in a row across the palate in the second quarter of the length. The two of these which are nearer the midline are the internal nasal passages; those lying farther outward, right and left, the postpalatine vacuities. In *Ceratosauros*, as in *Cyclura*, the latter are behind the nasal passages, being separated therefrom by the palatine bones. In *Diplodocus* the postpalatine vacuities seem to have been crowded forward alongside and outside of the nasal openings.

Each postpalatine vacuity is mostly inclosed by the maxilla and its processes, only a little of its hinder end being inclosed by the palatine and the transverse bone. The hinder end of the nasal passage lies between the forks of the small palatine. The rest of its inner border is formed by the slender vomer, while it is bounded in front and outwardly by processes of the maxilla.

---

<sup>a</sup> Dinosaurs of North America, p. 177, fig. 27.

## DESCRIPTIONS OF NEW SPECIES OF NORTH AMERICAN CRAMBID MOTHS.

---

By WILLIAM DUNHAM KEARFOTT,  
*Of Montclair, New Jersey.*

---

Among the fifty-odd thousand specimens of North American microlepidoptera which I have acquired during the past ten years, there have been many specimens belonging to the subfamily Crambinae of the Pyralidae, which have been placed in storage boxes awaiting an opportunity for authentic determination and arrangement. During the early part of this year I spent several days in Prof. C. H. Fernald's hospitable home, and, with his aid, secured the names of all that were already described; but there remained a large number of species that were apparently new to science.

Only the most interesting of these, and only those that are represented usually by good series, are treated in the present paper. There is an opportunity in this family for an excellent piece of work, with the aid of the microscope and camera-lucida, which would open up a wide field in the wonderful diversity and characters of the antennae and head parts particularly, as may be noted by figs. 7 to 12 on pages 387 to 391, representing some of the Thaumtopsids. I hope some one with more time to devote to the group will become as enthusiastic as I have after this brief study. The most necessary work of reference, treating of the world's genera and species, is Hampson's Classification in the Proceedings of the Zoological Society of London, 1895, and, of course, for the North American fauna, Fernald's Revision of 1896 will be found useful.

### Genus *USCODYS* Dyar.<sup>a</sup>

Head with small tuft of broad-raised scales between antennal joints, frons slightly roughed.

---

<sup>a</sup> At the last moment, I am compelled to withdraw a new name proposed for this genus, and substitute *Uscodys*, erected by Dr. Dyar in a paper issued Sept. 15, 1908, a part of the Proceedings of the Entomological Society of Washington, Vol. X, and thus avoid a synonym.

Antenna, male, slightly dentate and microscopically pubescent; female, simple, basal joint large and ridged on inner side, forming a deep socket in which the second joint is movable.

Labial palpi extends  $3\frac{1}{2}$  times eye-width beyond head, second joint densely tufted below, tuft reaching to end of apical joint; latter obtusely pointed and except at base not hidden by scales of median joint.

Maxillary palpi, nearly half length of labial, triangularly scaled.

Tongue moderate, closely coiled between labial palpi.

Ocelli absent.

Thorax smooth.

Fore wing over  $2\frac{1}{2}$  times as long as wide; costa very slightly ached, curving more to apex; latter rounded, obtuse; termen slightly convex,



FIG. 1.—VENTATION OF *USCODYS CESTALIS*.

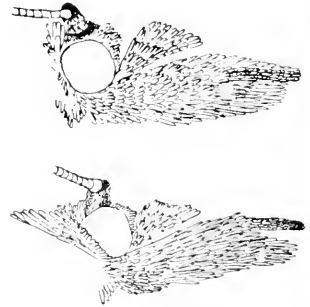

FIG. 2.—TWO VIEWS OF HEAD STRUCTURE OF *USCODYS CESTALIS*.

about  $45^\circ$ ; dorsal margin nearly straight. Vein  $1^{abc}$  present;  $1^b$  not furcate at base; 2 from outer fifth of cell; 3, 4, and 5 about equidistant at origin; 6 from below upper angle; 7, 8, and 9 stalked; 10 separate close to  $7+8+9$ ; 11 from outer third of cell.

Hind wing, lower median vein with long scales above; frenulum of one spine only in both sexes; slightly wider than fore wing; costa slightly depressed before middle and convex beyond, apex obtusely rounded; termen  $45^\circ$ . Veins  $1^{abc}$  present;  $1^b$  not furcate at base; 2 from outer fourth of cell; 3 before end of cell; 4 and 5 close at origin from lower angle <sup>a</sup>; 6 and 7 connate from upper angle; 8 very close to cell its whole length, but not coincident with it as in other Crambinae.

Legs smoothly scaled.

Habitus rather stout.

*Type*.—*Uscodys cestalis* Hulst.

<sup>a</sup> The furcation at outer end of vein 4 of hind wing as shown in fig. 1 has been only found in one side of one specimen; a number of others examined showed no trace of this abortion.



## USCODYS CESTALIS (Hulst).

- Ancrastia cestalis* HULST, Trans. Amer. Ent. Soc., XIII, 1886, p. 164.  
*Aglossa cestalis* FERNALD, Smith's List Lep. Bor. Amer., 1891, No. 4215.  
*Aglossa cestalis* FERNALD, Bull. 52., U. S. Nat. Mus., 1902, No. 4512.  
*Aglossa costalis* KEARFOTT, Smith's List Lep. Bor. Amer., 1903, No. 4883.  
*Uscodys cestalis*, DYAR, Proc. Ent. Soc. Wash., X, 1908, p. 101.

After examination of specimens of this species in 1904 Doctor Dyar advised me that it belonged to neither the Epipaschiinae nor the Pyralinae, where it had been placed by Hulst and Fernald, but should be included in the subfamily Crambinae, suggesting that it was "*n. gen. et sp.*" Shortly afterwards, when visiting the Hulst collection at New Brunswick, he saw Hulst's type, thus securing the specific name.

The species seems to be very abundant in southwestern Arizona. More than one hundred specimens have passed through my hands from both desert and mountain collections. Among the localities are Yuma County, Arizona, desert, March 26 to April 10, J. B. Smith; Yavapai County, Arizona, March 10-31, J. B. Smith; southern Arizona, August 1-15, O. C. Poling; Baboquivaria Mountains, Pima County, Arizona, July 15-30, O. C. Poling.

The species is somewhat variable in the intensity of the markings and of the light and dark shades. The females have dark gray or dark cinereous hind wings, while these wings in the male are whitish gray. The fore wings of the males are also lighter generally than the other sex. The general appearance of the fore wing is a mottled gray, with a conspicuous triangular whiter patch on upper half of wing and touching costa from middle to outer fifth; the males average from 22 to 26 mm. and the females from 25 to 32 mm.

This species seems to have been entirely ignored by both Ragonot and Hampson in the seventh and eighth volumes of Romanoff's *Mémoires sur les Lépidoptères*.<sup>a</sup> It does not appear in the specific index of either volume, nor could I find it in the text or footnotes approximating the place it should be if Hulst's generic position had been followed.

## PRIONAPTERYX STEPHENS and allied genera.

The species included in the four genera below bear a strong superficial likeness to each other and readily form a small subfamily group in the Crambinae which are not easily confused with any other species or genera of the large family. Except in one genus (*Surratha*) they are all characterized by an incision in the termen of fore wing at end of vein 5, or in more modified species the termen below 5 is well cut away, leaving a projection on the upper half of wing.

In markings the species are of combinations of cream white, ochreous to dark brown or grayish brown; the inner line is usually

<sup>a</sup> Monographie des Phycitinae et des Galleriinae.

strongly dentate and is frequently emphasized by enlarged spots on lower half. The terminal line and costal, apical, and marginal spots are the most constant marks for separation, and with good figures bringing out these characters, it would be very easy to separate the species.

The venation and structural characters seem to be subject to very little variation in each species, but there is a great divergence in the different species, quite sufficient, I think, to divide some of the genera into several others or subgenera. I have not thought it necessary to go into these differences at the present time, as the subject is so ably covered by Sir George Hampson's classification, hence particular attention is only called to the structure of such species as are characterized as new.

No doubt continued collecting in Mexico, Central and South Americas will add many interesting species to the lists, as the groups seem to be most common in the subtropical regions. Little or nothing is known of the life histories, excepting one species, *P. nebulifera* Stephens, which has been well worked out by Mr. E. Daecke.<sup>a</sup>

The larva of this species is solitary, feeding on the leaves of huckleberry (*Vaccinium* sp.) and sand myrtle (*Dendrium buxifolium*). It has the peculiar habit of constructing a tube of sand and silk on the stalk and stems of its food plant, forming a covered, protecting passage from a hole in the ground near the root, into which it retreats when danger threatens, to the fresh leaves upon which it feeds.

This clew should assist collectors in the arid regions of Arizona and New Mexico to the life histories of the several species which are quite common there, especially as these tubes must be rather conspicuous objects.

#### ANALYTICAL KEY TO GENERA.

1. Fore wing with termen entire.....*Surattha* Walker.  
Upper half of termen strongly produced..... 2
2. Vein 6, hind wing, from upper angle of cell <sup>b</sup>.....*Mesolia* Ragonot.  
Vein 6, from below angle..... 3
3. Veins 4 and 5, fore wing, separate at origin.....*Prionapteryx* Stephens.  
Veins 4 and 5, stalked or connate.....*Eugrota* Fernald.

#### Genus SURATTHA Walker.

*Surattha* WALKER, Cat. Brit. Mus., XXVII, 1863, p. 75.

*Catarina* WALKER, Cat. Brit. Mus., XXXV, 1866, p. 1770.

*Surattha* HAMPSON, Proc. Zool. Soc. Lond., 1895, p. 965.

Hampson's description of this genus is as follows:

Palpi perfect and thickly scaled, extending about one and a half times length of head; maxillary palpi triangularly scaled; frons with a conical process;

<sup>a</sup> Entom. News, XVI, pp. 12-14, pl. II.

<sup>b</sup> In some male specimens of *M. oracutella* vein 6 is from slightly below upper angle.

antennæ of male bipectenated, usually with long branches: tibiæ with the spurs long, the outer spurs about two-thirds length of inner.

Fore wing long and narrow; the apex rounded; vein 3 from near angle of cell; 4, 5 usually on a long stalk; 6, 7, and 10, 11 free. Hind wing with vein 3 from near angle of cell; 5 absent; 6 obsolete, from above middle of discocellulars; 7 anastomosing with 8.

SURATTHA(?) SANTELLA, new species.

Expanse, 19 mm.

Palpi, head and thorax dark cream, speckled with light brown; the outer ends of palpi, both inside and out, are shaded with darker brown; antennæ dark cream, annulated with light brown; abdomen whitish cream, upper side first segment shaded with reddish brown, and a brownish tinge on the next two segments, anal tuft ochreous brown; legs cream white; tarsi annulated with brown.

Fore wing white, with shades and marks of light and dark ochreous brown. There is a transverse white line in middle of wing, with two sharp angulations on outer edge, in middle of wing; before this line the basal half is white, well mottled with light and dark brown. Beyond the line there is a parallel light brown line of same width; between this and the terminal and apical lines and marks the surface is principally white, dusted with brown in horizontal streaks. About one-sixth before apex the white subterminal line starts from costa and goes straight to termen at end of veins 4 and 5; it then goes obliquely inward to fold, below end of cell, having two spurs below; it then follows fold outward nearly to termen, where it is lost in the mottled ground color. It is paralleled on both sides by brown; on the outside the brown shade extends to the white terminal patches. Just before apex is a broad white dash from costa to termen at end of vein 6, connecting there with a small white dot, on which is a black dot. Between 5 and 2 is a white terminal patch containing three black dots. The cilia is shining white, alternated with light fuscous in middle of wing and darker at apex; before the cilia is a narrow light brown line. Over the upper angle of cell is a prominent rounded brown dot.

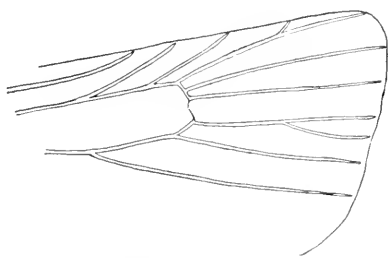

FIG. 3.—VENATION OF FORE WING OF SURATTHA SANTELLA.

Hind wings light, smoky gray, cilia whitish, underside the same. Underside fore wing pale ochreous brown, with white apical and terminal spots faintly repeated.

Described from 2 specimens collected by O. C. Poling in South Arizona.

Types in Author's collection.

This species differs from Hampson's diagnosis of *Surattha* in following items:

Antenna simple, not bipectenated.

Tibial spurs, both pairs nearly same length, outer at least three-fourths as long as inner. Otherwise the venation is identical with Hampson's figure. The conical process on front of head is a curious chitinous extension of the clypeus (?), and is no doubt used by the moth for effecting its escape from its probably earthy, dry, and hard pupal habitation. Fig. 3 shows outer end of fore wing.

*SURATTHA INDENTELLA*, new species.

Expanse, male, 22.5-23.5 mm.

Head white in front, light ochreous above; labial palpi white internally, externally pale ochreous, shaded with brown at apex; maxillary palpi pale ochreous; antenna bipectinate, with long branches, stalk whitish, branches blackish brown; thorax creamy ochreous, the outer ends of scales slightly darker, especially of patagiæ; abdomen light grayish ochreous, posterior edge of each segment narrowly white above, the three first segments shaded with ochreous above; legs whitish, dusted with pale ochreous.

Fore wing, ground color creamy ochreous; the outer ends of scales are light brown, giving a speckled appearance under lens; there is a dark brown oblique fascia from inner fifth of costa to inner third of dorsum, almost obsolete at costa, but broad and well defined on lower four-fifths; a dentate transverse brown line at middle of wing, with two strong outward spurs; both the basal fascia and the dentate inner line are edged on both sides by paler lines. The subterminal line from outer sixth of costa is only slightly oblique to upper third, then slightly convex to outer fifth of dorsum, it is white, overlaid with shining pinkish scales; inwardly it is defined by a dark brown line; below middle of wing the white extends into marginal space and is marked by three horizontal black dashes; above middle, ground color is brown with a whitish cloud before apex. Terminal edging brown. Between subterminal line and inner dentate line is a small brown discal dot on upper third of wing. Cilia whitish ochreous, shaded with light fuscous, cut by a white dash at middle; above this the basal half of cilia is conspicuously darker than outer.

Hind wing, dark smoky brown, paler toward base, cilia whitish; underside lighter, with a whitish streak from base to termen, through middle of cell and between veins 4+5 and 6. Underside fore wing light ochreous brown.

Two male specimens, from National Museum collection, Amarillo, Texas, August 30, 1902, Cockerell.

*Cotypes*.—Cat. No. 11948, U.S.N.M., and in Author's collection.

The venation and structure of this species agrees exactly with Hampson's, fig. 47, p. 965, Proc. Zool. Soc. Lond., 1895, except that termen of fore wing is slightly indented at veins 4 and 5.

## ANALYTICAL KEY TO SPECIES OF MESOLIA.

1. Fore wing with whitish or yellowish mark on middle of costa.  
*incertella* Zinck.  
 This character absent----- 2
2. Ground color fore wing principally white-----*oraculella* Kearfott.  
 Ground color principally ochreous gray----- 3
3. Dentations of inner line of fore wing acutely pointed.  
*huachucella* Kearfott.  
 Points of these dentations rounded or obtuse-----*baboquivariella* Kearfott.

## MESOLIA ORACULELLA, new species.

Expanse, male, 20–24 mm; female, 27–30 mm.

Head with conical process in front, light brown in front, darker brown around and between bases of antennæ, these shades separated by a cream white transverse line; labial palpi cream white, heavily overlaid externally, in male with grayish-brown, more lightly in female; maxillary palpi cream white, apical joint shaded with light brown; antennæ, male flattened and broadened, female simple, grayish cinereous; thorax, collar and patagia cream white, former shaded with light brown dorsally and latter at base, centrally the thorax is bronzy gray; abdomen dark cream or pale coffee color, posterior edges of first three segments ochreous; legs cream white, tarsi banded with light brown.

Fore wing, a broad median white streak and the costa edged with white, beginning at inner third and broadening outwardly; elsewhere the ground color is light grayish brown. The inner line begins on costa between middle and outer third as an outwardly oblique brown dash on the white ground color; below this are two superimposed horizontal dashes of darker brown, their outer ends connected by an ochreous brown curved line; the lower dash is in the middle of the white median streak; beyond middle of wing on vein  $1^b$  is a dark brown streak with a short upper limb beneath the white median band and a longer lower limb following  $1^b$  to tornus; between this dorsal mark and the spots in middle of wing the inner line is obsolete. The subterminal line is an oblique brown line from outer fifth of costa to upper third of wing, thence to tornus, slightly outwardly concave, it is edged outwardly with a white line of equal width; beyond the color is light brown, cut on upper third by a fine white line which nearly reaches termen below apex; on the lower two-thirds is a large white oblong spot, containing no black dots or dashes. Before the cilia is a fine brown, terminal line. Above the incision the cilia is white, divided by a broad brown line and edged outwardly with brownish gray; in the incision are a few long white scales without any brown markings; below incision cilia is white, shading outwardly into grayish brown. The lines from costa on upper third of wing are all parallel to each other. The white shade between the

inner and subterminal lines in some specimens forms a distinct white fascia, more or less dusted, especially on the veins with brown. There is a variation in the specimens, caused by the intensity of the brown scaling.

Hind wing whitish cinereous, elia white, with a fine pale brown line beyond base; underside the same. Underside of fore wing pale ochreous.

Six specimens, Baboquivaria Mountains, Pima County, Arizona, July 15-30, O. C. Poling; South Arizona, August 1-15, Poling; Oracle, Arizona, July 12, E. A. Schwartz.

*Cotypes*.—Cat. No. 11949, U.S.N.M., and in the Author's collection.

This species may prove to be a light form of *baboquivariella* Kearfott, basing the type of the latter upon the dark form from Huachuca Mountains. From this specimen the description was written. Since then I have obtained additional specimens of both sexes, which can undoubtedly be referred to *baboquivariella*. In these dark forms the white median streak is nearly obsolete, the white subterminal area is not distinctly defined, but the veins are slightly outlined with white. I shall therefore eliminate the four badly rubbed specimens received from Professor Snow, as cotypes of *baboquivariella*. I hope additional material in perfect condition will prove the correctness of these views.

#### MESOLIA BABOQUIVARIELLA (Kearfott).

*Prionapteryx baboquivariella* KEARFOTT, Can. Ent., XXXIX, 1907, p. 5.

Certain structural details omitted in the description should be recorded.

*Male*.—Antenna thickened and flattened; projection in termen of fore wing acute but hardly hooked. Venation fore wing: 4 absent; 6 from very near upper angle of cell; 7, 8, and 9 stalked; 10 and 11 from cell, free. Venation hind wing: 3 and 4+5 separate at base; 4 and 5 stalked two-thirds; 6 present from upper angle of cell; 7 and 8 coincident beyond cell, then separately to margins.

*Female*.—Venation same as male; antenna simple.

The structure places this species in the very closely related genus *Mesolia* Ragonet, and in section I, between divisions A and B, as defined by Hampson.<sup>a</sup>

#### MESOLIA HUACHUCAELLA, new species.

Expanse, male, 15-16 mm; female, 17-20 mm.

Head grayish brown, white in front; palpi darker than head, ochreous internally; antenna flattened and broadened in male, simple in female, ochreous gray; thorax cream white, more or less shaded with ochreous brown, especially the anterior end; abdomen

<sup>a</sup> Proc. Zool. Soc. Lond., 1895, pp. 962-963.

light ochreous brown, darker above on first three segments; legs white, tarsi banded with dark brown.

Fore wing dark grayish brown; under a lens this dark color is very mottled, as the bases of the scales are lighter, ochreous or whitish, than the tips. On and below the fold is a whitish streak, defined by an oblique dark streak on inner third and the dark brown of inner line at outer third. There is a distinct white spot on outer third of costa, between the inner and subterminal lines. The inner line is dark brown from outer third of costa, with two long and sharp outward angulations at upper and lower thirds; from the latter it sends a long line, dilated at end, to middle of dorsum; it is edged inwardly with white. The brown subterminal line from outer fifth is straight and almost runs into incision; below this it is not distinctly defined, but indicated by brown scales on the veins, giving a wavy appearance, to termen. The space between these lines is more white than elsewhere on the wing, but is dusted with brown, in some specimens heavily. The subterminal line is edged with white on upper third, beyond which is a broad olivaceous brown line, then a line white line, followed by a darker brown triangular apical spot. Below incision, on termen, is an oblong white spot. Terminal line, before cilia, very narrow, brown. Cilia above incision white, divided by a blackish line near base and blackish outwardly; below incision grayish white.

Hind wing cinereous gray, cilia white, with a faintly darker line close to base; underside paler. Underside fore wing light gray, with white costal marks faintly repeated.

Eighteen specimens, Globe, Arizona, August 25, Kunzé; Phoenix, Arizona, August, Kunzé; Yuma County, Arizona, through J. B. Smith; Huachuca Mountains, Arizona, Poling; Nogales, Arizona, July 22, Oslar; Santa Catalina Mountains, Arizona, July 24-31, from U. S. National Museum; Albuquerque, New Mexico, July 21, Oslar; Oracle, Arizona, July 9, Schwarz; Mesilla Park, New Mexico, 3,800 feet, Cockerell; Baboquivaria Mountains, Pima County, Arizona, July 15-30, Poling.

*Cotypes*.—Cat. No. 11950, U.S.N.M., and the Author's collection.

This species is unlike any of our *Mesolia-Prionapteryx* group in the decided grayer hue of the fore wings; all the other species have a superficially ochreous or ochreous-brown tinge, and it can be easily separated by this character; the average size is also smaller.

ANALYTICAL KEY TO SPECIES OF PRIONAPTERYX.

- |   |                              |
|---|------------------------------|
| 1. Fore wing with white cloud at inner third.....               | <i>ucbulifera</i> Stephens.  |
| Fore wing without this cloud.....                               | 2                            |
| 2. With sinuate transverse white line at base of fore wing..... | <i>serpentella</i> Kearfott. |
| Without this character.....                                     | 3                            |
| 3. With white dash on middle of termen.....                     | <i>achatina</i> Zeller.      |
| Without this white dash.....                                    | <i>cuncolalis</i> Hulst.     |

## PRIONAPTERYX SERPENTELLA, new species.

Expanse, 18-21 mm.

Head white, slightly speckled with brown, a brown spot in front; on top and behind it are two smaller ones; labial palpi, basal joint externally and basal and median joints internally white, outer half above, internally shaded with leaden fuscous; externally there is a black patch on basal joint (a small dot of same color behind it under eye); second joint narrowly white at base, then brown above, shading into leaden fuscous; maxillary palpi with a black spot at extreme base, another about middle of first joint, and a brown shade above and below the outer joint, internally white; antenna annulated white and dark brown; thorax white, heavily mottled with brown; abdomen ochreous white; there is a posterior dark brown streak on second segment; underside whitish with subventral brown line on middle segments; legs pale ochreous; tarsi banded with brown.

Fore wing dark chocolate brown, marked with pearly white. From the base below costa a sinuate line goes to inner fifth, curves under across fold, then proceeds obliquely to dorsum at inner third; there it curves upward and inward, ending at fold. At the base is a whitish dorsal patch which joins the inner end of this sinuate line. There is a broken middle transverse line, much angulated; the upper part starts beyond middle of costa, curves obliquely outward, and sends a very fine line outward to subterminal; in the middle of wing is a crescent-shaped mark which forms the middle section; this sends a fine inwardly oblique line to the outer part of the sinuate line. There is a white streak on outer fourth of costa and a dusting of white below it on lower half of wing. The terminal line is shining white; from the costa it is sharply oblique into the angle above the termen incision, thence as sharply oblique inward to under its starting point on costa, thence nearly straight to dorsum, with a slight angle at lower fifth; adjoining it outwardly is a broad triangular white patch in middle of wing and a small white patch at tornus; a triangular white apical streak is narrowly edged outwardly with brown. Above the incision the cilia is white at base, brown outwardly; below it is white at base, shading into gray externally.

Hind wing whitish gray, cilia white; underside the same. Underside fore wing light cinereous gray, with the dark and whitish spots in apex repeated.

Six specimens, Vernon and Sabine parishes, Louisiana, June and July, collected by George Coverdale; Coconut Grove, Florida, E. A. Schwarz, from National Museum collections.

*Cotypes*.—Cat. No. 11951, U.S.N.M., and the Author's collection.

The venation is the same as *P. nebulifera* Stephens, and the colors are alike in both species, but the markings are entirely different.



## ANALYTICAL KEY TO SPECIES OF EUGROTEA.

1. Veins of outer third fore wing outlined in white.....*yavapai* Kearfott.  
 Veins not outlined in white.....*dentella* Fernald.

## EUGROTEA (?) YAVAPAI, new species.

Expanse, 19-22 mm.

Head whitish ochreous, speckled with brown; palpi whitish ochreous, shaded with brown externally and on top at base of apical joint; maxillary palpi shaded externally at outer end with light brown; antenna whitish ochreous, broadly annulated with brown, the latter speckled with whitish; thorax creamy ochreous, with whitish patches in middle and on patagia, somewhat speckled with brown, especially marginally and posteriorly; abdomen pale ochreous, darker on dorsal part of each segment; legs whitish ochreous, tarsi banded with brown.

Fore wing mottled white, ochreous and brown. The white occurs in the base, dorsally, in the fold; a transverse twice angulated line in middle of wing, a broad patch on costa before subterminal line; a small spot on costa at beginning of subterminal, a large spot in apex, and on termen between the veins; between 2 and 5, the spots are confluent; the white subterminal line is angulated outwardly to vein 6, then inwardly to dorsum before tornus. The ochreous shades are on inner half of costa, on upper and lower veins of cell, and in the dark patch before the subterminal line. The dark brown is dusted over the whole wing, except where the ochreous and white replace it; the most conspicuous marks are a prominent round spot over upper angle of cell; two or three horizontal short lines in the white patch on termen between 2 and 5; a costal spot between subterminal line and white apical spot, a similar one below it; a terminal line of brown is succeeded by a thin whitish line at the base of the shining leaden brown cilia.

Hind wing pale ochreous gray, cilia whitish. Underside both wings whitish, the fore wing mottled with pale ochreous.

Described from thirteen specimens; twelve from Yavapai County, Arizona, April, from J. B. Smith; one specimen, Colorado, New Mexico, at light, July 10, Cockerell, from National Museum collections.

*Cotypes*.—Cat. No. 11952, U.S.N.M., and in Author's collection.

There is some variety in the intensity of the colors. Some specimens have but little of the dark brown scaling, but there does not seem to be any variation in the arrangement of the markings.

I am in doubt where to place this species. As will be seen by fig. 4, the outline of fore wing and venation are very different from *nebulifera* Stephens, the type of genus *Prionapteryx*; it is nearer to *Surattha* Walker, differing in the simple antenna and in 6 and 7 of fore wing from a point, but owing to stalking of 4+5 of fore

wing. I prefer to place it under *Eugrotesca* with a query. The principal points of structure are as follows:

Head with conical chitinous process in front; rather loosely scaled.

Antenna simple.

Labial palpi extends  $2\frac{1}{2}$  times eye-width beyond head; second joint long tufted below, concealing the terminal joint.

Maxillary palpi nearly half length of labial; triangularly scaled.

Tongue moderate.

Ocelli present.

Thorax smoothly scaled.

Fore wing less than  $2\frac{1}{2}$  times long as wide; costa straight, apex obtusely rounded, not produced; termen slightly rounded and lightly indented at end of vein 4, angle about  $15^\circ$  from vertical; dorsum slightly rounded. Venation: Veins  $1^a$  and  $1^c$  obsolete;  $1^b$  not furcate

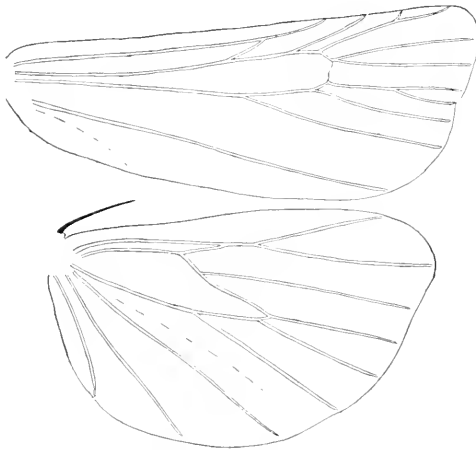

FIG. 4.—VENATION OF *EUGROTESCA YAYAPAL*.

at base; 2 from outer fourth of cell; 3 from near end of cell; 4+5 long stalked; 6+7 short stalked or strongly connate; 7 out of 8 beyond middle; 10 free from before end of cell; 11 coincident with 12 for its outer two thirds.

Hind wing  $1\frac{1}{3}$  as wide as fore wing; lower median vein hairy above; costa nearly straight, apex rounded, termen straight in middle of wing, rounding at torus. Venation:  $1^{a,b,c}$  present,  $1^b$  not furcate

at base; 2 from outer third of cell; 3 from before lower angle; 4+5 coincident from angle; 6 from middle of cell; 7 and 8 coincident for a short distance beyond cell, former from upper angle.

*CRAMBUS COCKLEELLUS*, new species.

Expanse, 25–30 mm.

Head white, collar yellow; maxillary palpi white; labial palpi creamy white inside, dark coppery brown outside; antenna coppery gray, faintly annulated with white, shaded with white on basal segments; thorax white on middle, laterally and patagia coppery yellow; abdomen grayish fuscous, first three joints above and anal tuft shaded with ochreous brown; legs, femur, and tibia of front pair whitish, otherwise ochreous brown.

Fore wing coppery yellow; the silvery white stripe is very narrow, of about equal thickness throughout, with a slight spur below at inner third; outer end obtusely pointed and not quite reaching to subterminal line. The ground color above it is a little wider than stripe; costa not edged with white. On dorsal margin from base to subterminal line is a white line of half the width of median stripe, edged above with dark scales. There is a narrow white streak on costa at outer fourth, before the subterminal line; the latter begins at outer fifth, goes slightly obliquely outward to upper third, then obliquely inward to dorsum, it is shining white; beyond it on costa is a small triangular, inwardly oblique white patch, duplicated below apex, leaving a ground color spot in apex. The lower two-thirds of margin is white, inwardly dotted with brown and with a marginal row of five black dots on veins 2 to 6. Radiating from the median stripe, the veins are overlaid with silvery gray; these radiations do not extend beyond end of stripe, leaving a broad ground color band before the subterminal line. Cilia pearly gray, white at base of upper third.

Hind wing light gray, cilia whitish; underside the same. Underside fore wing dark gray, ochreous on costa, a terminal row of black dots.

Three specimens, Bear Lake and Jacksons Creek, near Kaslo, British Columbia, August 10-11, collected by J. W. Cockle, and in whose honor it is named.

Type in Author's collection, paratype in Cockle collection.

Probably closer to *C. dumetellus* Hübner than any other species known from North America.

#### CRAMBUS TRICHUSALIS Hulst.

*Crambus trichusalis* HULST, Trans. Amer. Ent. Soc., XIII, 1886, p. 165.

*Crambus dumetellus* FERNALD, Spl. Bull. Mass. Agri. Coll., 1896, p. 33.

Expanse, 24-27 mm.

Head white, faintly gray in front; labial palpi white internally, shining gray outside; maxillary palpi white, gray at base; antenna ochreous gray, basal joints shaded with white; abdomen white, shining ochreous gray laterally and on patagia, collar behind eyes, ochreous; abdomen white, shaded with ochreous above on first four segments; legs light ochreous.

Fore wing yellowish gray. The median silvery white stripe is narrow, running out to a fine point nearly touching subterminal line; a short spur at inner third sends a short white line into fold; the stripe below for inner third is edged with ochreous. Below the costa is a white line from base to middle; above it the costa is edged with dark gray. The subterminal line is silvery white; the angle

is below upper third; before and behind it on costa are large triangular white streaks; on each side of the mottled gray and brown apical spots are smaller white spots. Below the angle of the subterminal line the margin is white, outwardly marked with a row of four or five black dots. Dorsal edge narrowly white; beyond the middle the extreme edge is gray, below the white line. Beyond end of cell the veins are overlaid with silvery white, but not extending to subterminal line. Cilia pearly gray, white at base.

Hind wing whitish gray, darker along costa and in apex, underside the same. Underside fore wing dark gray, termen white, veins dotted with black.

Four specimens, High Bridge, Alberta (Thos. Baird), Regina, July 24, all received from Mr. T. N. Willing; Redvers, Saskatchewan, A. J. Croker.

Homotype in Author's collection.

I had the foregoing description written, under a new name, when a visit to the Hulst collection at New Brunswick showed that my supposed new species was *trichusalis*. Hulst's type is in excellent condition, and I hardly see how it could have been made a synonym of *dumetellus* Hübner. The median silver line of the latter ends at outer third; beyond it and below it is an elongated silver spot; in *trichusalis* the silver streak extends in a continuous line, nearly touching the subterminal line, at the outer sixth or seventh of the wing. I have no European specimens of *dumetellus*, but the figures in both British Pyralides by Leech, 1886, and Lepidoptera of the British Islands by Barrett, 1905, show this character. It is also shown in Fernald's fig. 2, Pl. III, Crambidae of North America. I feel entirely safe in restoring Hulst's name to specific rank.<sup>a</sup>

CRAMBUS YOUNGELLUS, new species.

Expanse, 17-18.5 mm.

Palpi, head, and thorax white, labial palpi on exterior surface, maxillary palpi at base, and patagia shaded with ochreous brown; antenna grayish white, abdomen white, with a slight yellowish tinge, anal tuft darker; legs white, dusted and banded with brown.

Fore wing bright ochreous brown, a darker shade along costal edge. The usual silvery white stripe is very broad to middle of wing. To this point its lower edge is bounded by the fold, and from which it angles from both upper and lower edges to a point ending midway between veins 5 and 6 and one-third the distance from end of cell to termen. On the inner half of wing the costa is dark gray brown, in

<sup>a</sup> Since the above was written I have received a long series of European specimens of *dumetellus*, and they fully confirm this opinion; in fact, I have seen no specimens from North America which could possibly be referred to this species, and believe it should be stricken from our lists.

a narrow line, about one-fourth the width of the silver stripe. At the lower angle of stripe there is a very slight tooth. Beyond the stripe in middle of wing is a short silvery white streak, outwardly touching the angle of the subterminal line and inwardly slightly underlapping the end of the silvery stripe. On costa before subterminal line is a long, narrow, triangular, outwardly oblique white mark, and beyond the line a much smaller white costal dash. The subterminal line starts from outer fifth on costa, angles obliquely outward to upper third, then parallels termen to dorsum; it is shining grayish white, outlined inwardly by a clear brown line; above the angle is a light ochreous brown triangular spot in apical space; below the angle the subterminal is bounded outwardly by a line or shade of mottled white and grayish brown. The terminal line is black, above the angle solid, below the angle divided into four or five black dots, the latter are ground color in the interspaces; in the upper third this black line is bordered on both sides by a vertical white line, on the outer side overrunning the cilia. On the outer third of wing the veins are overlaid with shining gray, more or less outlined with scattered black scales. The dorsal edge is narrowly silvery white from base to tornus; the outer half is edged above with scattered black scales. Cilia iridescent pearly white.

Hind wing light gray, cilia paler; underside the same shade below middle, above and under side fore wing darker gray.

Described from ten specimens, Mer Bleue, Ontario, July 2-10, collected by C. H. Young, whose name it is a great pleasure to honor.

"Mer Bleue" is a huge sphagnum swamp about 20 miles south of Ottawa. This species is nearer to *bidens* Zeller than any other North American form known to me; it is slightly smaller, but of the same dainty appearance; it can be readily separated by the white streak between stripe and termen. In this respect it is nearer *pascuellus* Linnaeus.

*Cotypes*.—Cat. No. 12060, U.S.N.M., Mr. Young's and the Author's collections.

CRAMBUS BIDENS Zeller.

Mr. Young was successful in collecting a large series of this rare species near Ottawa about the middle of July, including many females, which possess a peculiarity that I have not seen recorded. In this sex the broad white stripe is suffused on the upper half with brown: this suffusion does not extend to the upper edge, which is narrowly silvery. I have also captured this species in a piece of bogland in the pine barren district of New Jersey, near Lacy, about the middle of the State, about 10 miles from the ocean. Curiously the same species of orchid were growing in this spot as I observed a year before in the sphagnum swamp at Mer Bleue. None of the Lacy specimens showed this suffusion.

Aweme, Manitoba, is another locality for this species, collected by Mr. Criddle August 9.

CRAMBUS POLINGI, new species.

Expanse, 16-19 mm.

Head and palpi white, labial externally and maxillary palpi at base shaded with grayish brown; antenna cinereous; thorax shining white with a yellowish gray hue; abdomen whitish brown; legs white, lightly shaded with brown.

Fore wing white, thickly speckled with light purplish brown; above the cell the dark scales have a cinereous tinge and are closer together, forming a stripe on the inner two-thirds; between this and fold the dark scales are almost absent. Median line is indicated by an outwardly oblique dash from costa at outer third, a horizontal dash before it on fold, and below this a small dot on dorsal margin. The subterminal line from outer sixth of costa is white, bounded on each side by purplish brown lines; the outer one merges into a spot on costa before apex; this line curves outwardly to vein 7, then parallels termen; between each two veins it is inwardly rounded. Between it and the dark purple terminal line is a broader whitish line. Cilia shining yellowish cinereous.

Hind wing pale ochreous, underside whiter; underside fore wing same shade, but darker.

Described from fifteen specimens, South Arizona, August 1-15, collected by O. C. Poling.

In shape, size, and general appearance this species is very close to *elegans* Clemens, but the markings are very distinct; the easiest one by which to separate them is the subterminal line, which in this species is beautifully and evenly corrugated its entire length, these corrugations affecting the paralleling lines in the termen; the marginal row of black dots of *elegans* is entirely absent in this species.

*Cotype*.—Cat. No. 11953, U.S.N.M., and in Author's collection.

CRAMBUS INTERMEDIUS, new species.

Expanse, 16-20 mm.

Head and thorax whitish ochreous, patagia darker; labial palpi short and pendant, whitish ochreous internally, shaded with gray externally; maxillary palpi same as head; antenna light ochreous; abdomen light cinereous, ochreous above on first three segments; legs whitish, powdered with ochreous.

Fore wing dark ochreous above the median white streak, light ochreous below it and on outer third. The median white streak is narrow and extends from base, through lower half of cell to beyond end of cell, where it is lost in the whitish ochreous shade of outer third; its lower edge follows the lower vein of cell; it gradually

widens, upwardly, from base to inner third, then diminishes to middle; beyond it is a fine line. There is a dark brown, broken, terminal line; before it on the costa is a short parallel white dash. The subterminal line is nearly obsolete, on some specimens; there is a shining whitish line from dorsum, at outer sixth, to middle of wing, paralleling the termen. The light ochreous shade of the outer third gradually becomes whitish at termen and the cilia is the same shade, whitish ochreous.

Hind wing, male, white; female, whitish gray; underside white. Underside fore wing ochreous white.

Four specimens, labeled "Arizona." One from Professor Fernald's collection is labeled "*Crambus intermedius* Ragonot—86, yellow label 122." This MSS. name of Ragonot's I am glad to give to the species. In size and median stripe it is close to *hemiochrellus* Zeller and *haytiellus* Zinck. I have four other specimens from Burnet County, Texas, March and April (F. G. Schaupp), which are slightly smaller and much darker, and in which the subterminal line is complete to costa, the area beyond it being heavily sprinkled with white on an ochreous brown ground color, which I believe are darker varieties of this same species, and have so labeled them in my collection.

*Cotype*.—Cat. No. 11955, U.S.N.M., and in Author's collection.

CRAMBUS DORSIPUNCTELLUS, new species.

Expanse, 24–28 mm.

Head and thorax and palpi light ochreous, latter darker externally; antenna fuscous in front, dusted with light ochreous elsewhere; abdomen grayish ochreous; legs light ochreous.

Fore wing above the fold, light fawn ochreous; below fold, light fawn; the dorsal margin below fold is sparsely dusted with brown; a very few of these dark dots occur in middle of wing in outer half of cell and below lower angle of cell. There is barely a trace of a subterminal line in one specimen; a very faint deeper ochreous line crosses the outer end of fold on the lower third of wing. On the termen, at end of veins 2 to 5, is a small brown dot; above them is a nearly obsolete darker terminal line. Termen is edged with a shining grayish yellow line, the cilia beyond of the same shade, but less shining.

Hind wing smoky gray; cilia, except at apex, whitish gray; under side lighter. Under side fore wing dark ochreous gray.

Described from four specimens, Rounthwaite, Manitoba, July, L. E. Marmont; Verdi, Nevada, June 20–30, A. H. Vachell.

Types in Author's collection.

This species is close to *varicoellus* Zeller and *vulgaricellus* Clemens. It can be separated from either by the practical absence of all markings and by the much lighter shining line at base of cilia of fore

wing; it is probably closer to *laciniellus* Grote, but lacks the white terminal line of that species and also has much darker hind wings.

CRAMBUS NEVADELLUS, new species.

Expanse, 17–26 mm.

Head pale ochreous; labial and maxillary palpi dark ochreous, paler internally; antenna ochreous brown; thorax pale ochreous, darker laterally; abdomen pale ochreous, first three segments shaded above with darker ochreous; legs whitish ochreous, shaded with light brown.

Fore wing light ochreous brown, darkest on upper half, gradually shading into whitish ochreous on outer third; below the fold the wing is streaked and mottled with white, especially on outer two-thirds, except over vein 1<sup>b</sup>, which is brown; on the fold is a dotted line of white; between the fold and 1<sup>b</sup> the whitish shade is dotted with a darker brown in a line paralleling the fold; over vein 2, half way between end of cell and termen, is an irregular dark brown line, preceded by a white patch; vein 3 is similarly marked. In the majority of specimens before me these white and dark brown scales on lower half are absent, partly obsolete, doubtless from their transient character. The brown subterminal line is curved outwardly from costa to below middle, then obliquely inward to dorsal margin; it also is more or less obsolete in some specimens. There is a more or less distinct dotted dark line preceding the cilia. The latter is whitish at base and pale ochreous outwardly.

Hind wings above and below light gray, cilia paler. Underside fore wings dark grayish ochreous.

The majority of the specimens are rubbed and present a different appearance from the above description. Color, both above and below middle, pale ochreous, a dark brown median streak from base to end of cell, broken at middle of wing by ground color. Other marks, except the subterminal line, are almost obsolete.

Thirty specimens, Verdi, Nevada, June 10–30, Sierra Nevada Mountains, on border line between California and Nevada, collected by A. H. Vachell.

Nearest to *trisectus* Walker and *albolinellus* Fernald, differing from both by the narrowness of the fore wing.

*Cotype*.—Cat. No. 11954, U.S.N.M., and in Author's collection.

CRAMBUS SIMPLICIELLUS, new species.

Expanse, 23–31 mm.

Head, thorax, and fore wing, light ochreous gray; both pairs of palpi are white internally, speckled ochreous gray outside; antenna ochreous brown in front, frosted with white elsewhere; abdomen



shining ochreous fuscous, browner on upper side of first three segments: legs white, anterior pair heavily dusted with brown in front.

The fore wing is almost unicolorous, a light ochreous gray or mouse color, with an ochreous tinge. It is somewhat darker on upper third and inner half: the entire inner two-thirds are more ochreous than the outer third, which is an ashy gray, but these shades merge into each other so gradually, and are really so nearly alike, that the wing presents almost a single tone. The inner and subterminal lines are slightly paler, but very faint, the subterminal, from outer sixth of costa, is convex to below middle, then an outward convexity on lower third of wing. There is a faint, darker, broken line before the cilia, which are only slightly shining of a pale leaden hue.

Hind wing dark smoky gray, cilia shining; underside paler. Underside fore wing smoky gray, cilia whitish at base.

*Type*.—In Author's collection. From Denver, Colorado, May 2, 1904, E. J. Osler: eight paratypes, Essex County, New Jersey, June 11; Georgia (from Strecker collection), Washington County, Arkansas, July–August, A. J. Brown. The specimens labeled "paratype" are included with some hesitation, and may prove to be a different species.

This is closest to var. *ulva* Cockerell, differing from it in the absence of the strong reddish and purple shades.

#### Genus EUFERNALDIA Hulst.

*Eufernaldia argenteonervella* HULST, Jour. N. Y. Ent. Soc., VIII, 1900, p. 224.

The type and only species was described from one female. I have recently received a series of both sexes from E. J. Osler, collected in the Huachuca Mountains, Arizona, August 15–29; also Prescott, Arizona, Dr. R. E. Kunzé, July 7, and Stockton, Utah, September 10, Tom Spalding. From the last locality the fore wings are a deep ochreous brown and the hind wings dark smoky brown. The Arizona specimens agree with Hulst's description, fore wings light ochreous,



FIG. 5.—VENATION OF EUFERNALDIA ARGENTEONERVELLA.

hind wings silvery white; the outlining of the veins in silver is the same in both forms and makes this species easily recognized. As the venation and head parts have not before been figured, I include them with a few corrections or additions to the original description.

In one of my specimens the maxillary palpi is sharply triangular in outline, less so in the others, but due, I think, to loss of scales. Antenna of male finely pubescent on front side. Venation: Fore



FIG. 6.—HEAD OF EUFERNALDIA ARGENTONEVELLA.

wing, 3 is absent (coincident with 4) in all my specimens; 7, 8, and 9 are variable; in some 8 and 9 are coincident, and both 7 and 8+9 are to termen; in others 9 is present as a spur from 8 half way between the stalk and apex, and both 8 and 9 go to costa, 7 to termen; this does not seem to be a sexual variation. Hind wing, 3 and 4 are not from a point, but well separated at their bases; 7 and 8 are coincident from shortly beyond upper angle half way to end of 8.

*Type*.—*Eufernaldia argentonevella* Hulst.

Superficially, this species reminds me of certain species of the Phycitinae.

ANALYTICAL KEY TO SPECIES OF THAUMATOPSIS.

1. Male antenna crenulate.....	<i>crenulatella</i> Kearfott.	
Male antenna not crenulate.....		2
2. Male antenna unipectinate.....		3
Male antenna bipectinate.....		8
3. Fore wing whitish gray.....	<i>repanda</i> Grote.	
Fore wing ochreous or brown.....		4
4. Fore wing chocolate brown.....		5
Fore wing light ochreous or whitish brown.....		6
5. White median streak to termen.....	<i>pectinifer</i> Zeller.	
White median line ending at about outer third.....	<i>striatella</i> Fernald.	
6. Subterminal and inner lines nearly obsolete.....	<i>atomosella</i> Kearfott.	
These lines well developed.....		7
7. Fore wing bright ochreous.....	<i>fernaldella</i> Kearfott.	
Fore wing whitish brown.....	<i>notella</i> Kearfott.	
8. Veins fore wing overlaid with white.....	<i>magnifica</i> Fernald.	
Veins not overlaid with white.....		9
9. Median streak white.....	<i>edonis</i> Grote.	
Median streak not white.....		10
10. Cross lines obsolete.....	<i>gibsonella</i> Kearfott.	
Cross lines distinct.....		11
11. Fore wing whitish brown.....	<i>coloradella</i> Kearfott.	
Fore wing pale ochreous.....	<i>perella</i> Zeller.	

THAUMATOPSIS COLORADELLA, new species.

Expanse, 26-32 mm.

Male antenna bipectinate, branches ciliated; stalk white, narrowly annulated with brown; branches black, cilia whitish. Labial palpi six times longer than width of eye, rather loosely scaled, fuscous gray, tips of scales creamy white; maxillary palpi loosely scaled,

cream white, lightly speckled with fuscous on the outside. Head and thorax light ochreous brown, heavily speckled with fuscous, internal edges of patagia and posterior ends of same whitish. Abdomen light ochreous brown, banded above with fuscous and brown on anterior segments and blackish on posterior segments. Legs cream white, heavily dusted with light fuscous.

Fore wing creamy ochreous, strongly marked with distinct dark brown lines. There is a narrow whitish line through middle of cell from base to end of cell; its outer half is bounded above by a thicker dark brown line; below is a similar but less distinct line from beyond base nearly to end of cell. From apex a strong well-defined line goes to dorsum at outer fourth; it is  $45^\circ$  oblique from apex to upper fourth, then is slightly convex outwardly to lower fourth, where there is a shallow outward pointing tooth. In the middle of lower half is an obscure oblique brown line which points toward end of cell. There is a faint brown streak from end of cell to terminal line below apex, which is a continuation of the brown line above the white median line. The lower half of wing and outer half are more or less dusted with light brown and there is a rather heavily brown scaling at base of dorsal margin. Cilia whitish, speckled with light brown.

Hind wing light grayish fuscous, cilia paler underside the same. Underside fore wing a shade darker than hind wing.

Eight specimens, Pueblo, Colorado, September 24, H. N. Nash; Durango and Denver, Colorado, May, E. J. Oslar; San Luis Obispo, California, February and March, Arthur H. Vachell.

*Cotype*.—Cat. No. 11957, U.S.N.M., and in Author's collection.

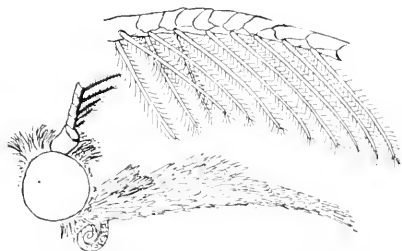

FIG 7.—HEAD AND ENLARGED ANTENNA OF *THAUMATOPSIS COLORADELLA*.

*THAUMATOPSIS GIBSONELLA*, new species.

Expanse, male, 26–28 mm; female, 27–31 mm.

Male antenna bipectinated, with branches six to seven times width of stalk, each branch shortly ciliated on each side. Female antenna simple. Labial palpi with rather closely appressed scales on sides, with longer, looser scales on top; porrect, about four times width of eye; maxillary palpi rather loosely scaled, about as long as width of eye. Tongue long, upper end thickly scaled. Face and head light ochreous brown, labial palpi heavily dusted with dark brown, outer joint with grayish brown; maxillary palpi pale light ochreous

at base, tips of scales shaded with gray brown. Antenna, stalk cream fawn, annulated with light brown, branches black, cilia whitish gray. Thorax light fawn, speckled with brown, shading into a whitish posterior patch. Abdomen pale fawn, ringed above with brown on four anterior segments and with dark gray on three posterior segments. Legs pale fawn, finely dusted with brown.

Male fore wing, pale fawn, heavily dusted with brown; the ground color below costa on inner third of wing and over upper and lower median veins is of an ochreous shade. Terminal line nearly obsolete, only showing faintly in one specimen; it is outwardly concave opposite end of cell and sharply dentate above dorsal margin. One specimen has a thin, straight white line through middle of cell; this specimen is of a general darker grayish brown shade, and quite heavily overlaid with white scales on the dorsal margin and outer half of wing. The subterminal line is only faintly indicated by a few darker scales on dorsal half. There is a black dot at end of each vein in termen. Cilia brownish gray, divided by a pale line.

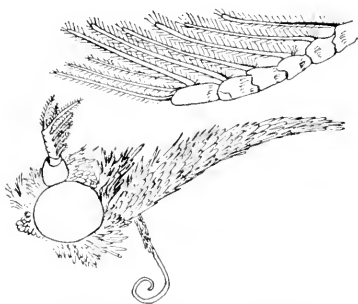

FIG. 8. HEAD AND ENLARGED ANTENNA OF *THAUMTOPSIS GIBSONELLA*.

Hind wing pale fuscous gray, slightly darker before termen and apex. Cilia whitish, preceded by a darker line; underside the same. Underside fore wing brownish gray.

Described from fourteen males and two females collected at Rostrevor, Ontario, Canada, September 2-16, by Mr. Arthur Gibson, in whose honor the species is named.

The females are of a much lighter color than the males, caused by the absence of the heavy fuscous brown sprinkling. The fore wings are also more elongate and rounded at the apex and anal angle than the male; the female hind wing is whiter.

*Cotype*.—Cat. No. 11958, U.S.N.M., Mr. Gibson's and the Author's collections.

*THAUMATOPIS ATOMOSELLA*, new species.

Expanse, 27-30 mm.

Male antenna, unipectinate, branches four to five times width of stalk, shortly ciliated on each side of branches. Labial palpi slender, scales closely appressed, about six times as long as width of eye; terminal joint drooping. Head light ochreous cream color, thorax a whiter shade; stalk of antenna white, branches dark fuscous brown, cilia whitish; labial palpi cream ochreous, thickly speckled with dark fuscous and lightly sprinkled with white; maxillary palpi cream

color, with the long scales tipped with fuscous. Abdomen cream ochreous, slightly darker on top of each segment. Legs paler.

Fore wing pale creamy ochreous, or creamy white terra-cotta; there is a dull white, narrow band from base, over lower vein of cell nearly to termen; before middle of wing it begins to increase in width, so that at outer end it covers all space between veins 2 and 7; the lower part and outer end are overlaid with whitish fuscous; all of the dorsal margin to above the fold is of the same shade. These two whitish streaks are separated by a clear line of ground color; the median white streak is outlined on both sides by blackish brown dots and a line of the same limit the upper edge of the dorsal white shade. Both of the white shades are interrupted by the subterminal line, which is ground color; it cuts through the median at the end of cell and the dorsal before the middle of wing. There is a broad band of ground color before termen, divided by a parallel terminal line of shining whitish scales thickly dotted with brownish fuscous. At the end of each vein, in the middle of termen, is a tiny black dot. Cilia narrowly white at base, followed by a narrow fuscous line, then by a shining whitish line; beyond it is white, thickly sprinkled with light brownish fuscous; extreme tips of scales white.

Hind wing light fuscous, with a trace of a darker line before the cilia; cilia white, divided by a darker line near base; underside the same. Underside fore wing darker fuscous, finely atomized with paler specks; the lines of the cilia are repeated from above.

Two specimens, Phoenix, Arizona, April and May, collected by Dr. R. E. Kunzé.

*Type*.—In Author's collection.

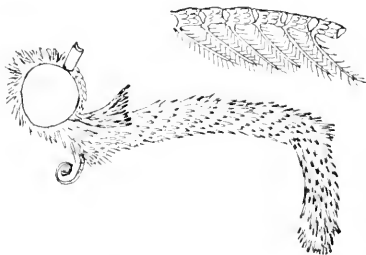

FIG. 9.—HEAD AND ENLARGED ANTENNA OF *THAUMATOPSIS ATOMOSELLA*.

*THAUMATOPSIS CRENULATELLA*, new species.

Expanse, 30 mm.

Male antenna crenulate, the teeth being  $1\frac{1}{2}$  times thickness of stalk; the teeth are thickly ciliated on their upper sides and outer ends, the internal cilia arising from raised processes or warts. Labial palpi rather smoothly clothed, length about four times the width of eye; maxillary palpi loosely scaled, about as long as width of eye. Head, thorax, and palpi white, heavily dusted with brownish fuscous. Antenna, stalk and cilia whitish fuscous, teeth black. Abdomen whitish

fuscous, banded above with blackish on posterior segments. Legs creamy ochreous, anterior pair heavily dusted with fuscous.

Fore wing white, overlaid with fuscous and blackish brown. The white occurs as follows: A broad median streak from base to end of cell, a fine line on fold, and a dusting on dorsal margin below fold; all veins on outer half of wing overlaid in white; between veins 5 and 8 the white predominates; at the termen the white forms a continuous band. The fuscous occurs along costa, between median white band and fold, below fold and between veins in outer half of wing. The blackish brown occurs only as fine lines, outlining vein 1<sup>b</sup>, all veins between end of cell and termen, and is rather heavier between end of cell and apex than elsewhere.

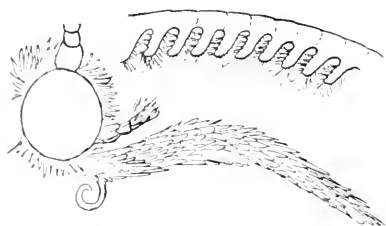

FIG. 10. HEAD AND ENLARGED ANTENNA OF THAUMATOOPSIS CRENULATA.

The terminal line is ochreous fuscous; it is close to termen, and is sharply angled below costa and dentate at lower end. The subterminal line is of the same color, but somewhat obscure; it follows end of cell, then sharply angles outward halfway to termen in a tooth-shaped process, the lower half of which runs backward to inner third of dorsal margin; it is lightly outlined with white on both sides. The terminal line is outwardly edged with a row of dark brown dots. The cilia is shining leaden, cut by white on the upper half. Preceding the cilia is a line of black dots and lines; between the veins there are four short lines on upper half of wing, three dots below them, and a nearly continuous line of torus.

Hind wing light fuscous, with a line darker marginal line, which at apex is preceded by a few whitish scales; cilia white, divided by a pale fuscous line at base. Underside both wings grayish fuscous; both are margined outwardly with white, with the marginal and ante-ciliate lines and dots repeated.

One male specimen, from Baboquivaria Mountains, Pima County, Arizona, latter part of July, 1903, collected by Mr. O. C. Poling.

*Type.* In Author's collection.

This species is remarkably like *T. repanda* Grote, and the only way to distinguish them is by the difference in the male antennæ, an enlargement of both, with head structure, is shown by figs. 10 and 11.

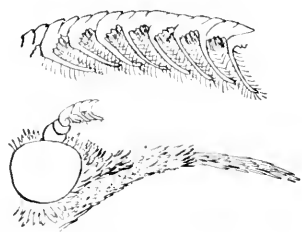

FIG. 11. HEAD AND ENLARGED ANTENNA OF THAUMATOOPSIS REPANDA.

I have another specimen of *repanda* from Pima County, Arizona, received from Dr. John B. Smith, which is marked and colored exactly like my type, except that the dark shadings are a little more intense. These two are so exactly alike in every detail, except the form of their antennæ, that I am rather inclined to doubt the stability of the latter. Extensive series may show sufficient intermediate variation to sink the new name as a synonym of *repanda*.

**THAUMATOPSIS PEXELLA** Zeller.

A drawing of the head structure, with an enlargement of the antenna is given in fig. 10 for comparison with similar parts of other species in this genus.

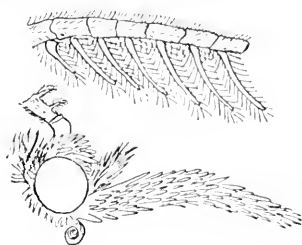

FIG. 12.—HEAD AND ENLARGED ANTENNA OF *THAUMATOPSIS PEXELLA*.

ANALYTICAL KEY TO SPECIES OF DIATRÆA.

1. Fore wing with a silver median stripe..... *parallela* Kearfott.  
Fore wing without silver median stripe..... 2
2. Fore wing bluish gray, without marks or dots..... *idalis* Fernald.  
Fore wing yellow or brown..... 3
3. Fore wing with dorsal white shading..... *allenii* Fernald.  
Fore wing without this distinct shade..... 4
4. Fore wing with duplicated subterminal line..... *saccharalis* Fabricius.  
Without these lines, expanse over 40 mm. .... *differentialis* Fernald.

**DIATRÆA PARALLELA**, new species.

Expanse, 22–30 mm.

Head white, slightly shaded with cream between antennæ; labial palpi white internally, beyond middle dotted with gray, externally heavily dotted with gray and brown; maxillary palpi white, with external patches of gray scales at base of second joint and at outer end of tuft; thorax white, with short indistinct subdorsal ochreous streaks; patagia light fawn, becoming whitish at posterior ends and dorsally edged with white; abdomen and legs cream white, latter slightly shaded with light ochreous.

Fore wing pale fawn or light ochreous terra-cotta. This ground color is uniform throughout the wing and makes a very effective background for the silver stripes. The median stripe is from base to termen, of uniform thickness except on inner fourth, where it gradually diminishes in width to base; above it is a ground color stripe of equal width; above this the costa is narrowly white from base to apex; veins 2, 3, 4, and 7 are overlaid with white at termen. The dorsal margin is narrowly white and vein 1<sup>b</sup> is overlaid with white its

entire length. The median stripe is outlined with scattered black dots. These dots are entirely absent from the costal stripe, but on all other white lines the black dots are sprinkled sparsely over the white; on veins 2, 3, and 4 the black dots follow the veins to cell. There is no trace of a subterminal line, and all of the white stripes extend directly to the terminal line, which is cream white, edged on either side with a fine brown line; beyond this the cilia is white at base and outwardly speckled with gray and brown.

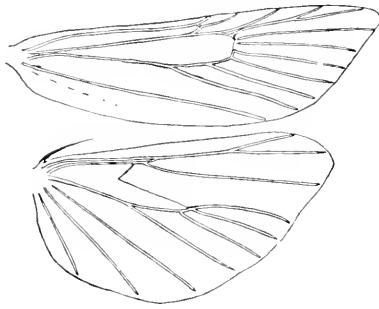

FIG. 13.—VENATION OF DIATREA PARALLELA.

Hind wing above cream white, lightly speckled outwardly with pale brown; underside white. Underside fore wing pale ochreous lightly dusted with pale brown.

Described from twenty-three specimens from Almagordo, New Mexico, April 19 to May 5, collected by H. L. Vierick and J. A. G. Rhen.

*Cotypes*.—Cat. No. 11959, U.S.N.M., in collection of Philadelphia Entomological Society, and in Author's collection.

The venation of this species, as shown by fig. 5, agrees better with Fernald's figure of *D. saccharalis* Fabricius<sup>a</sup> than with Hampson's figure of *saccharalis*.<sup>b</sup> The majority of Hampson's palpal figures in this revision are misleading, as they show the terminal joint as though it were differently scaled than the median joint. This is scarcely ever the case in the Crambinae. The long overlapping scales of the median joint entirely hide the junction with the apical and usually the same scaling extends to the apex. These characters in this species are shown by fig. 14.

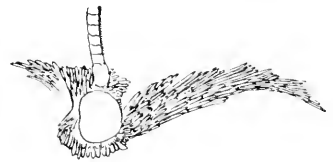

FIG. 14.—HEAD AND PALPI OF DIATREA PARALLELA.

ANALYTICAL KEY TO SPECIES OF CHILO.<sup>c</sup>

- |   |                              |
|---|------------------------------|
| 1. Fore wing with metallic cilia.....                       | 2                            |
| Fore wing without metallic cilia.....                       | 3                            |
| 2. Fore wing with inner and subterminal lines well defined. |                              |
|   | <i>placidellus</i> Hainbach. |
| With these lines not distinct.....                          | <i>placidellus</i> Zinck.    |
| 3. Fore wing with veins outlined in brown.....              | <i>densellus</i> Zeller.     |
| Fore wing with veins not outlined in brown.....             | 4                            |

<sup>a</sup>The Crambidae of North America, Plate C, figs. 10, 11, 12.

<sup>b</sup>Proc. Zool. Soc. London, 1895, p. 953.

<sup>c</sup>*Crambus inornatellus* Walker, included in *Chilo* in Smith's list, 1903, No. 4983, is retained by Hampson in *Crambus*.



- |  |                                  |
|--|----------------------------------|
| 4. Fore wing ground color white.....   | 5                                |
| Fore wing ground color brown.....  | 7                                |
| 5. Fore wing with complete inner and subterminal lines... <i>squamutellus</i> Zeller. <sup>a</sup> |                                  |
| No lines on fore wing.....   | 6                                |
| 6. Fore wing almost immaculate, over 30 mm. expanse... <i>puritellus</i> Kearfott.                 |                                  |
| Fore wing speckled with brown, under 25 mm. expanse.   |                                  |
|  | <i>multipunctellus</i> Kearfott. |
| 7. Hind wing dark fuscous.....   | <i>comptulatalis</i> Hulst.      |
| Hind wing principally white.....   | <i>forbescellus</i> Fernald.     |

## CHILO MULTIPUNCTELLUS, new species.

*Expanse*, 20–24 mm.

Head, palpi, thorax, and fore wing white, with a very faint yellowish tinge, palpi externally dusted with brown; abdomen more strongly shaded with yellowish gray above.

The fore wing is finely speckled with brown all over, roughly arranged in horizontal lines on and between the veins, not visible except through a lens. Before the white cilia is a fine brown line.

Hind wing above and below white. Underside fore wing cinereous white.

Eleven specimens, Oracle, Arizona, June 10, E. J. Oslar; southern Arizona, Poling; Huachuca Mountains, Arizona, Poling; Chiricahua Mountains, Arizona, July 4, H. G. Hubbard.

The venation agrees with Fernald's figure of this genus in his revision of the Crambidae.

*Cotype*.—Cat. No. 11960, U.S.N.M., and in Author's collection.

## CHILO PURITELLUS, new species.

*Expanse*, 31–35 mm.

Head, palpi, thorax, fore wings above and hind wings above and beneath white, with a faint ochreous tinge. Upper side of abdomen lightly shaded with ochreous.

The fore wings are sparsely and microscopically dusted with whitish fuscous. Underside white, with a grayish hue.

One male and one female, Baboquivaria Mountains, Pima County, Arizona, July 15–30; Huachuca Mountains, Arizona, both from O. C. Poling.

*Type*.—In Author's collection.

This species may be a large race of *multipunctellus* Kearfott, but I am inclined to think it is distinct. Its large size is sufficient to separate it, at least until additional collecting in these regions turn up a series showing intermediate sizes.

Besides the above, I have six species of *Diatraea* and three of *Chilo* undescribed in my collections, but await longer series before making them known.

<sup>a</sup> Hampson, Proc. Zool. Soc. Lond., 1895, 946, places this species under *Platytes* Guenee (*Argyria* Hübner). As I have no specimens for examination of structure, I prefer to let it remain in this genus, according to Fernald's revision.



TWO NEW SPECIES OF NEOTROPICAL ORTHOPTERA OF  
THE FAMILY ACRIDIDÆ.

By JAMES A. G. REHN.

*Of the Academy of Natural Sciences of Philadelphia.*

The following new species of Acrididæ were recognized in studying a large amount of Neotropical material belonging to that family.

Genus *INUSIA* Giglio-Tos.

*INUSIA ANTILLARUM*, new species.

*Type*.—Cat. No. 11961, U.S.N.M. Female; collected on St. Thomas Island, West Indies, in December, 1882, by A. Koebele.

Size medium; form slender, elongate; surface uniformly punctate. Head with its dorsal surface three-fourths the length of the pronotum, occiput not ascending; interspace between the eyes extremely narrow.

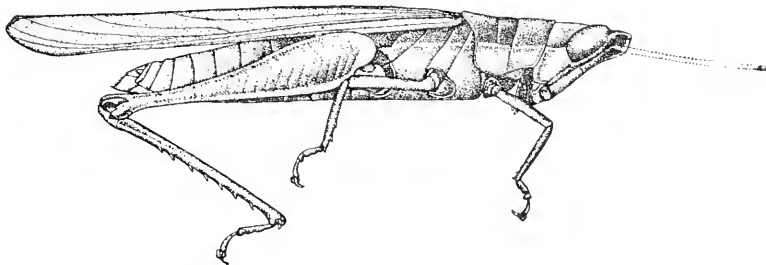

FIG. 1.—*INUSIA ANTILLARUM*. LATERAL VIEW OF TYPE. ( $\times 3$ .)

slightly sulcate; fastigium sublanceolate, the caudal width slightly less than the length, the apex blunt, the sides arcuate, dorsal surface rugulose, with an irregular low median carina; fastigium when seen from the side rotundato-truncate, face strongly retreating, distinctly concave; frontal costa narrow, subequal, shallowly sulcate and punctate except at the apex; lateral facial carinae hardly diverging; eyes ovoid, distinctly flattened ventro-caudad, considerably longer than the infra-ocular sulcus, moderately prominent when viewed from the dorsum. Pronotum with the greatest caudal width of the dorsum slightly more than half the length; cephalic margin of the disk arcuate, caudal margin rotundato-truncate, median carina very low but distinct, transverse sulci three in number; metazona nearly

two-thirds the length of the prozona; lateral lobes distinctly longer than deep, cephalic margin oblique, ventral margin arcuate caudad, obliquely emarginate cephalad, caudal margin arcuate emarginate. Tegmina surpassing the tips of the caudal femora by about the length of the pronotum, very narrow, subequal, apex subacute, intercalary area filled with an irregular network of cells, a false intercalary vein being present distad where the cells are chiefly rectangular in shape.



FIG. 2.—  
INUSIA AN-  
TILLARUM.  
DORSAL VIEW  
OF HEAD AND  
PRONOTUM.  
( $\times 3$ .)

Wings long and narrow, the greatest width contained about two and three-quarter times in the length. Prosternal spine slender, somewhat compressed. Interspace between the mesosternal lobes about twice as long as broad, widened cephalad and caudad; metasternal lobes contiguous caudad. Caudal femora as long as the pronotum and twice the length of the head, slender, the greatest width contained about four and a half times in the length, pattern of the pagina distinct but not deeply impressed; caudal tibiae armed on the external margins with seven spines, the margins with distinct lamellate ridges distad.

General color raw umber dorsad, pale ochre yellow ventrad, a dividing line of white extending from the caudal margin of the eye to immediately dorsad of the articulation of the caudal limbs. Face clouded with red brown; eyes tawny olive; genicular lobes with a spot of black; tibial spines and spurs tipped with black.

	<i>Measurements.</i>	<i>Mm.</i>
Length of body	-----	22.8
Length of pronotum	-----	4.2
Length of tegmen	-----	20.8
Length of caudal femur	-----	12.0

The type alone has been examined.

#### Genus PROCTOLABUS Saussure.

##### PROCTOLABUS BULLATUS, new species.

*Type*.—Cat. No. 11962, U.S.N.M. Male; collected in the Piches and Perene valleys, 2,000 to 3,000 feet, Peru. (Soc. Geog. de Lima.)

This species is quite distinct from the previously known forms, the small size and peculiar yellow and bluish coloration being quite distinctive. In the general form of the fastigium it agrees with the Costa Rican *P. pulchripennis*, but the form of the genitalia is quite different.

Size medium; form moderately robust. Head with the dorsal surface about two-thirds the length of the pronotum; occiput well rounded, but hardly elevated, distinctly descending to the interocular space, which is very narrow, narrower than the apex of the fastigium and sulcate; fastigium truncate conic, the caudal width less than the length and the distal truncation very abrupt and marked immediately caudad of the margin by a transverse groove; median portion of the fastigium with a depression regularly widening cephalad, apex of fastigium when seen from the lateral aspect sub-truncate; frontal costa somewhat expanded ventrad of the insertion of the antennæ, then strongly contracted ventrad of the ocellus, somewhat punctuate dorsad of the ocellus, sulcate ventrad of the same, the whole costa absent on the ventral portion of the face; angle of the face distinctly retreating; eyes subovate, very distinctly longer than the infra-ocular portion of the genæ, quite prominent when viewed from the dorsum. Pronotum with the caudal width of the disk contained about one and one-half times in the length of the same, cephalic

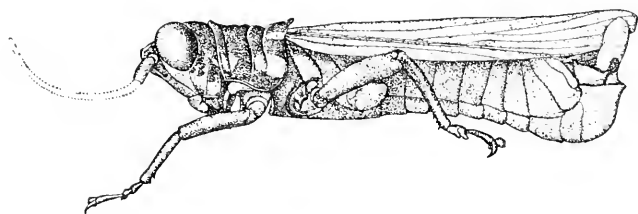

FIG. 3. PROCTOLABUS BULLATUS. LATERAL VIEW OF TYPE. ( $\times 3$ .)

margin of the disk produced mesad with a distinct central emargination, caudal margin very broadly obtuse-angulate; transverse sulci four in number, the cephalic being marginal in position and weak mesad, the remaining three strongly impressed, the two caudal ones present, as is the cephalic, on the lateral lobes; metazona slightly more than half the length of the prozona, strongly punctate and with a distinct median carina; lateral lobes slightly longer than deep, the cephalic and caudal margins oblique, subparallel, ventral margin obtuse-angulate, the ventro-caudal angle slightly produced. Tegmina reaching to the apex of the abdomen, apex rotundato-truncate; an intercalary vein present in the distal portion of the apex, the median and proximal portions with irregular cells. Prosternal spines very blunt pyramidal; interspace between the mesosternal lobes subquadrate, slightly broader caudad than cephalad; metasternal lobes subcontiguous. Apex of the abdomen very considerably inflated; supra-anal plate regularly narrowing, with the apex broadly truncate, the proximal half plane and slightly depressed, the distal

half with two longitudinal parallel grooves extending to the apical margin; cerci slightly exceeding the supra-anal plate, subequal in the proximal half, sharply constricted mesad and slightly expanding to the subspatulate apex, the apical portion bent at an angle of about  $45^\circ$  to the proximal half, when viewed from the dorsum the apex is seen to have a very slight sigmoid curve; subgenital plate very large, slightly compressed, the apical margin rectangulate when viewed from the dorsum; a compressed preapical process projects dorsad a distance equal to the depth of the remainder of the subgenital plate. Cephalic and median limbs moderately robust; caudal limbs missing.

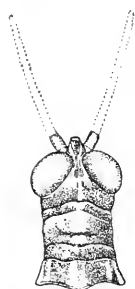

FIG. 4.—*PROCOTOLABUS BULLATUS*. DORSAL VIEW OF HEAD AND PRONOTUM ( $\times 3$ .)

General colors blue black, glaucous blue, and lemon yellow. Head blue black, paler dorsad with the inter-ocular region, fastigium, center of face, and ventral portions of gena dull yellow, a median line on the occiput, edgings of fastigium, proximal antennal joint and infra-antennal areas blackish; eyes cinnamon. Pronotum blue black, with bright lemon yellow spots as follows: on median line cephalad and caudad, on the lateral angle on metazona, on the median portion of lateral lobes cephalad and caudad. Tegmina with the costal portion blue black, the median and sutural regions dull glaucous blue. Abdomen, venter, and limbs dull lemon yellow, median dorsal portion of abdomen and supra-anal plate black; cerci black distad, margin and median line of subgenital plate black.



FIG. 5.—*PROCOTOLABUS BULLATUS*. DORSAL VIEW OF APEX OF ABDOMEN. ( $\times 3$ .)

*Measurements.*

	<i>Mm.</i>
Length of body.....	20.8
Length of pronotum.....	3.8
Length of tegmen.....	14.6

The type is unique.

# A FURTHER REPORT ON THE OSTRACODA OF THE UNITED STATES NATIONAL MUSEUM.

By RICHARD W. SHARPE,

*Instructor in Biology, DeWitt Clinton High School, New York City.*

In a previous paper bearing a similar title<sup>a</sup> a number of species of fresh-water Ostracoda belonging to the U. S. National Museum were briefly discussed, and two presumably new species described. Most of these forms were from scattered localities in the United States and Mexico, and represented the known ostracod fauna of these countries but meagerly. Since that paper was published, a number of marine as well as fresh-water forms have come to my hands for study. The marine forms were mostly collected by the U. S. Fisheries steamer *Albatross*.

It therefore remains for me to give an account of these forms, and the present paper offers some results. Four species, apparently new to science, are here figured and described. It also seems wise to insert a revised systematic summary, indicating the extent of the National Museum collections examined to date of this paper.

### *Systematic Summary.*

Tribe.	Family.	Subfamily.	Genus.	Species.
Podocopa	Cyprididae	Candoninae	2	2
		Cypridinae	2	8
		Cypridopsinae	2	2
		Cylocypridinae	3	5
		Heterocypridinae	3	4
		Notodromadinae	2	2
Myodocopa	Cytheridae		1	2
	Cypridimidae		3	1
Total			18	29

<sup>a</sup> Report on the Fresh-water Ostracoda of the United States National Museum, including a Revision of the Subfamilies and Genera of the Family Cyprididae, Proc. U. S. Nat. Mus., XXVI, p. 969.

Revised summary of species of Ostracoda of the National Museum.

1. Family CYPRIDIDÆ.

(a) Subfamily Candoninae.

1. Genus *Candona*.

1. *C. parallela* G. W. Müller, Colorado; May.

2. Genus *Paracandona*.

2. *P. euplectopa* (Brady and Norman), New Jersey; March.

(b) Subfamily Cypridinae.

3. Genus *Cypris*.

3. *C. fuscata* (Jurine), common in United States and Mexico; spring.

4. *C. pellucida* Sharpe, Illinois, Idaho, Mexico.

5. *C. pubera* Jurine, Oregon.

6. *C. reticulata* Zaddach, Illinois, Massachusetts, New York (Catskill Mountains), New Jersey.

7. *C. circus* Jurine, Massachusetts, Ohio, Mexico.

8. *C. incongruus* (Ramdohr), Florida, Ohio, Pennsylvania.

4. Genus *Spirocypris*.

9. *S. passaica* Sharpe, Massachusetts, New Jersey.

10. *S. tuberculata* Sharpe, Indiana, Illinois; May.

(c) Subfamily Cypridopsinae.

5. Genus *Cypridopsis*.

11. *C. vidua*, common everywhere.

6. Genus *Potamocypris*.

12. *P. smaragdina* Vavra, Illinois, Mexico.

(d) Subfamily Cycloocypridinae.

7. Genus *Cycloocypris*.

13. *C. larvis* (O. F. Müller), Delaware, Indiana, Illinois, New Jersey, New York (Catskill Mountains).

8. Genus *Cyprid*.

14. *C. dentifera* Sharpe, Illinois, Ohio, New York, New Jersey.

15. *C. carculpta* Fischer, common everywhere.

9. Genus *Ilyocypris*.

16. *I. gibba* (Ramdohr), Colorado; March.

17. *I. bradyi* G. O. Sars, Colorado; March.

(e) Subfamily Herpetocypridinae.

10. Genus *Chlamydotheca*.

18. *C. azteca* Sanssurre, Texas; October.

19. *C. mexicana* Sharpe, Mexico; September.

11. Genus *Herpetocypris*.

20. *H. reptans* Baird, California; September.

12. Genus *Hyodromus*.

21. *H. pectinatus* Sharpe, stomach of *Spatula clypeata* Linnaeus, South Carolina, Europe? (Jeffreys collection).

(f) Subfamily Notodromadinae.

13. Genus *Cyprois*.

22. *C. marginata* (Strauss), Jackson Park, Chicago; May.

14. Genus *Notodromas*.

23. *N. monacha* (O. F. Müller), Indiana, Minnesota; May.

2. Family CYTHERIDÆ.

15. Genus *Cythere*.

24. *C. americana* Sharpe, brackish pools, Long Island; June.

25. *C. papillosa* Sharpe, brackish pools, Long Island; June.



## 3. Family CYPRIDINIDÆ.

16. Genus *Cylindrolaberis*.26. *C. oblonga* (Grube), California coast.27. *C. lobianci* G. W. Müller, California coast, Catalina Islands.17. Genus *Pyrocypriis*.28. *P. americana* G. W. Müller, off Honolulu, Hawaiian Islands; May; night anchorage.18. Genus *Philomedes*.29. *P. brenda* (Baird), Gulf of St. Lawrence, Greenland coast.

## 1. Family CYPRIDIDÆ.

## Subfamily CANDONINÆ.

## 1. Genus CANDONA Baird, 1850.

## 1. CANDONA PARALLELA G. W. Müller.

Plate LI, figs. 1-5.

*Candona parallela* MÜLLER, Zoologica, XII, Heft 30, 1900, p. 25, pl. v, figs. 5-6, 23-25.*Dimensions of female*.—Length, 0.78 to 0.85 mm.; height, 0.42 to .46 mm.; breadth, 0.35 to 0.42 mm. Males unknown.

Seen from the side (fig. 1), the highest part lies at the posterior part, where the shell edge forms an angle, from which the dorsal margin runs nearly straight and approximately parallel to the ventral edge to about the region of the eyespot, from which it abruptly slopes forward with even an appreciable concavity to a narrowly rounded anterior margin.

Ventral margin slightly sinuate, the most so just opposite the muscle impressions.

Height to length about as 1:18. The growing line is farther from the shell edge anteriorly and posteriorly, its distance anteriorly being about one-fourth the distance to the muscle impressions. Shell comparatively plain, with but a few scattered papillæ and setose both anteriorly and posteriorly.

Seen from above (fig. 2), the shell is bluntly pointed anteriorly, more so posteriorly, the left shell clearly overlapping the right one. The greatest breadth is approximately in the middle, its ratio to the length being about as three to seven.

Seta on anterior edge of penultimate segment of second antenna of female longer than the last segment.

Shorter seta of terminal segment of second foot (fig. 5) more than twice as long as terminal segment. Second foot 5-segmented, no seta at distal outer angle of third segment. Seta on median side of penultimate segment of mandibular palp not plumose, short.

Genital plate of female flat, without a backwardly directed process. Caudal ramus (fig. 3) rather stout, about one-seventh as wide in the

middle as the greatest length; dorsal seta about twice width of ramus from subterminal claw and reaching slightly beyond tip of ramus; terminal claw about seven-ninths length of furca measured along the anterior edge; subterminal claw slightly shorter, and both toothed in a peculiar manner, a double set of teeth apparently being present (fig. 4), the upper set being coarser and defined by larger teeth at either limit, the other or distal set being smaller and more numerous. Terminal seta aborted and scarcely discernible.

Described from a number of specimens sent me by Prof. A. E. Beardsley, of the State Normal School, Greeley, Colorado. Collected near Greeley, Colorado, May 5, 1901.

## 2. PARACANDONA Hartwig, 1899.

*Paracandona* HARTWIG, Zool. Anzeiger, XXII, 1899, pp. 309-311.—SHARPE, Proc. U. S. Nat. Mus., XXVI, 1903, p. 997.

Terminal claws of the second antennæ very long; the penultimate segment at least as long as the united second and third segments. The terminal segment of the mandibular palp provided with two very strong claws, of which one is united by fusion to the segment. Second feet with an extra long seta on each of the third and fourth segments. Appendages otherwise as in *Candona*, but small and slender.

Shell tumid, reticulate pitted, as a honey-comb. Small, beautiful forms not more than 0.8 mm. long. Branchial plate of two setæ. Second antennæ of both sexes 5-segmented.

This genus was established by Hartwig to include forms the type of which is *Paracandona* (*Candona*) *euplectella* Robertson. Represented by only the species *euplectella*, which has not heretofore been reported from America. Heretofore reported only from England and Germany.

## 2. PARACANDONA EUPLECTELLA (Brady and Norman).

Plate LII, figs. 1-5.

*Candona euplectella* BRADY and NORMAN, Trans. Royal Dublin Soc., IV, 2d ser., 1889, p. 105, pl. ix, figs. 7-8.—MÜLLER, Zoologica, XII, Heft 30, 1900, p. 37, pl. ix, figs. 1-9, 14.

*Dimensions of female*.—Length, 0.56 to 0.65 mm.; breadth, 0.32 to 0.34 mm.; height, 0.32 to 0.36 mm. Male, somewhat larger.

Seen from the side (fig. 1), the shell is about twice as long as high, dorsal margin nearly straight, ventral margin weakly sinuate, nearly the same width throughout, and both extremities evenly and very similarly rounded.

Seen from above (fig. 2), the shell appears very plump, the breadth being to the length about as 1:2 or as 3:5, the greatest breadth lying just posterior to the middle. Anterior end rather more pointed than

the posterior, both quite gently rounded. Both shells similar in appearance and size.

The most striking character of this species is seen on the shell, it being covered with a profuse ornamentation of polygonal areas (fig. 1) or reticulations, thus causing a net-like appearance, which at once attracts attention. I know of no other *Candona*-like Ostracod having a similar appearance; the specific name very happily refers to this striking external appearance. The shell is also covered with a number of conspicuous papillar elevations, which show more thickly and conspicuously anteriorly when noted in profile from above.

Terminal claws of the second antennæ plain and unusually long, longer than the last three segments. Terminal segment of the mandibular palp (fig. 4) with two strong toothed claws, one of which is fused to the segment.

Terminal claw of first foot as long as the rest of the foot. Second foot (fig. 3) 5-segmented, the terminal segment being but slightly longer than broad, or one-half the length of the preceding segment, which is slightly longer than the antepenultimate segment. The shorter terminal claw is about the length of the terminal segment, or about one-fifth the length of the other similarly directed claw. The third and fourth segments each armed with unusually long setæ. Furca (fig. 5) thick and stout, nearly straight, average width one-sixth the length as measured along the dorsal edge. Terminal seta weak, scarcely evident; terminal claw stout, slightly curved, plain, and one-half length of furca; subterminal claw but slightly shorter, and both faintly toothed near tip. Dorsal seta less than width of ramus from subterminal claw and about same length as subterminal claw. Second maxillary palp of male unusually long and slender.

This species has been reported from England (Brady) and Germany (Lienenklaus, Hartwig, and Müller, G. W.). Not heretofore reported from America.

Rather sparsely found in the shallower parts of a swamp near a small branch of the Elizabeth River, northwest of Roselle Park, New Jersey, March 28, 1908.

#### Subfamily CYPRIDINÆ.

### 3. CYPRIS O. F. Müller, 1792.

#### 3. CYPRIS FUSCATA (Jurine).

Plate LIII, figs. 1-4.

*Monoculus fuscatus* JURINE, Histoire des Monocles, etc., 1820, p. 174, pl. XIX, figs. 1-2.

*Cypris fuscate* ZADDACH, Synop. Crust. Pruss. Prodr., 1844, p. 32.—LILJEBORG, De Crust. ex ord. tribus, etc., in Scania occurrentibus, 1853, p. 114, pl. x, figs. 6-9; pl. XII, fig. 3.

*Cypris hirsuta* FISCHER, Mém. des Sav. étrang. Acad. St. Pétersbourg, VII, 1854, p. 159, pl. x, figs. 6-8.

*Cypris fusca* BRADY, Trans. Linn. Soc. London, XXVI, 1868, p. 362, pl. XXIII, figs. 10-15.

*Cypris fusca* BRADY and NORMAN, Trans. Royal Dublin Soc., IV, 2d ser., 1889, p. 73, pl. XII, figs. 3-4.—VAVRA, Archiv. Naturw. Durchforsch. Böhmen, VIII, Heft 3, 1891, p. 98.—CRONEBERG, Bull. Soc. Imp. Natur. Moscou, VIII, 1894, p. 305, fig. 22.—SHARPE, Bull. Illinois State Lab. Nat. Hist., IV, Art. 15, 1897, p. 442, pl. XLIII, fig. 5.—G. W. MÜLLER, Zoologica, XII, Heft 30, 1900, p. 66, pl. XVI, figs. 5-9.—KAUFMANN, Revue Suisse de Zool., VIII, 1900, p. 270, pl. XV, figs. 14-16; pl. XVIII, figs. 14-20.

*Dimensions*.—Length, 1.48 to 1.45 mm.; breadth, 0.80 to 0.85 mm.; height, 0.85 to 0.95 mm. Shell plain, not reticulate, and sparsely covered with small papillar elevations.

Seen from above (figs. 2, 3), the shell is broadly ovate, breadth being to length about as 5 is to 9, the greatest breadth lying just behind the middle; left shell slightly overlapping the right. The general color is dark green except in the region of the eyes. The variety *minor* after Müller,<sup>a</sup> in addition to showing the light patches near region of the eyes, also shows similar patches just posterior to the middle of the body and on the sides. This variety is somewhat smaller in all its dimensions.

Seen from the side (fig. 1), the shell is decidedly humped just back of the eye-spot, so as to form a noticeable angle when viewed in exact profile. Extremities well rounded and ventral margin slightly convex.

Natatory setæ of the second antennæ reach about to the tips of the terminal claws, long enough so that the animal is free swimming. Terminal claw of first leg rather short, two-thirds of its length being shorter than the last three segments of the leg, while in *Cypris reticulata* this is just reversed. Spines of the first maxillary process toothed.

Caudal ramus (fig. 4) finely toothed on dorsal edge, long, slender, weakly S-shaped to nearly straight, from 18 to 20 times as long as wide; terminal claw very slender, finely toothed at tip, from one-half to three-fifths as long as the ramus; subterminal claw two-thirds as long as the terminal one, nearly straight; terminal seta weak, about one-third as long as terminal claw; dorsal seta about width of ramus from subterminal claw and about one-half as long as the terminal seta. Propagation sexual.

Both varieties, *major* and *minor*, were found in great abundance in all the shallow grassy ponds or swamps southeast of Chicago, Illinois, as far as Clarke Junction, Indiana. Most of them were collected during the month of May. Scarcely a collection was made during the month but contained both varieties and both sexes.

<sup>a</sup> Zoologica, XII, 1900, p. 65.

An attempt was made to breed them true, with a view to ascertaining if they would cross, but all specimens invariably died within a week or so when placed in any of the ordinary aquaria. Their life period is evidently very short and transitory, which may account in part for lack of success. Of course, a short life history might be expected from the transitory nature of their habitat.

They were found associated with *Cypria obesa*, *Spirocypris tuberculata*, *Cypridopsis vidua*, *Cypria dentifera*, *Cyclocypris lacis*, *Candona recticauda*, and *Cyprois marginata*. These, of course, were not certainly present in any one locality. For instance, *Cyprois marginata* was found in only one small temporary grassy pool in Jackson Park, which very soon dried up, while most of the remaining forms occurred quite generally in all the swamp and dune ponds of the region southeast of Chicago and of northwestern Indiana. For the character of the plant life of the waters of this region see under *Notodromas monacha*.

Distribution world-wide; all Europe; Guanajuato, Mexico, in a collection sent to the U. S. National Museum by Dr. A. Dugès, French consular agent. Accession No. 15606. A few specimens were here found associated with *Cypris pellucida*.

#### 8. CYPRIS INCONGRUENS (Ramdohr).

Plate LIV, figs. 1-3.

*Cypris incongruens* RAMDOHR, Mag. der Gesell. Naturforsch. Freunde, Berlin, II, 1808, p. 86.

*Cypris aurantia* BAIRD, Nat. Hist. Brit. Entomos., London, 1850, p. 159, pl. XIX, fig. 13.—FISCHER, Abh. der Mathem. Phys. Klasse der kgl. Bayerischen Akad. der Wiss., VII, 1855, p. 650, pl. I, figs. 29-31, 60, 61.

*Cypris incongruens* BRADY, Trans. Linn. Soc. London, 1868, XXVI, p. 362, pl. XXIII, figs. 16-22.—BRADY and NORMAN, Trans. Royal Dublin Soc., 1889, IV, 2d ser., p. 73, pl. XII, figs. 8-9.—VAVRA, Arch. Naturw. Durchforsch. Böhmen, VIII, Heft 3, 1891, p. 95.—CRONEBERG, Bull. Soc. Imp. Natur. Moscou, VIII, 1894, p. 304, fig. 21.—KAUFFMAN, Revue Suisse de Zool., VIII, Fasc. 3, 1900, p. 264, pl. xv, figs. 10-12; pl. xviii, fig. 5.—MÜLLER, Zoologica, XII, Heft 30, 1900, p. 77; pl. XIII, figs. 12-22.

*Cyprinotus incongruens* SHARPE, Bull. Illinois State Lab. Nat. Hist., IV, 1897, p. 437.—SARS, Ann. Musée Zool. de l'Acad. Imp. des Sci. de St. Pétersbourg, VIII, 1903, p. 222 [28].

*Dimensions*.—Length, 1.58 to 1.75 mm.; height, 1 to 1.04 mm.; breadth, 0.85 to 0.90 mm.

Seen from above (fig. 2), the shell is widest at its posterior one-third, about one-half as wide as long, rounded posteriorly and anteriorly, the left shell overlapping the right. Seen from the side (fig. 1), the right shell is highest just back of the middle, the height here being about three-fifths as great as the length and sloping rapidly anteriorly from just back of the eye-spot; the anterior and lower posterior margins of the right valve armed with a row of prominent tubercles (fig. 1).

The left shell is somewhat larger than the right and not armed with tubercles at its anterior and posterior margins. The color varies from brownish yellow to a clear yellow.

Natatory setae of the second antennae reach slightly beyond the tips of the terminal claws. Spines of the first maxillary process toothed.

Terminal claw of the second foot slender, slightly longer than the terminal segment. Furca (fig. 3) approximately straight, the terminal claw about one-half its length; subterminal claw about two-thirds the length of the terminal one; dorsal seta about width of furca from subterminal claw, and approximately as long as the claw; terminal seta slender, nearly one-half length of terminal claw.

A large number of these forms were found in recent indurated mud deposits near Carlisle, Pennsylvania. The specimens were picked from the dried mud, soaked in a solution of potassium hydroxide for a number of hours, then placed in dilute glycerin. In this manner the apparently hopelessly dried specimens were put into such condition as to permit of dissection.

Kaufmann,<sup>a</sup> speaks of this form as not being sexual except possibly in favorable localities, while Müller,<sup>b</sup> speaks of this form as being occasionally sexual. No doubt most, if not all, Entomostraca may prove to be both sexual and parthenogenetic, depending upon the surrounding conditions, so much so that this character may prove of slight value either as a generic or as a specific character.

Distribution, Europe, Asia, and America.

#### 4. SPIROCYPRIS Sharpe, 1903.

##### 10. SPIROCYPRIS TUBERCULATA, new species.

Plate L, figs. 1, 2; Plate LIV, fig. 4; Plate LV, figs. 1-6.

*Dimensions*.—Length, 0.93 mm.; height, 0.53 mm.; breadth, 0.7 mm.

A beautiful purplish brown tuberculate form, always showing a transverse dorsal band of a lighter color in region of the eye-spot, and occasionally another similar band similarly situated posteriorly. Preserved specimens show these bands rather indistinctly, the general purplish color showing, however.

The shell (Plate L, figs. 1, 2) is thickly covered with a large number of unusually large and prominent papillary elevations. This feature is so strikingly apparent as at once to distinguish the species, even neglecting the color markings, which are also unusual. Shell also covered with short hairs, mostly situated upon the tubercles.

Seen from the side (Plate LIV, fig. 4), the shell is nearly the same width throughout, both extremities evenly rounded, and fully four-sevenths as high as long.

<sup>a</sup> *Revue Suisse de Zool.*, VIII, 1900, p. 268.

<sup>b</sup> *Zoologica*, XI, 1900, p. 79.

Seen from above (Plate L, figs. 1, 2), the shell is very broadly oval, even approximately subcircular, so plump is it. Right valve slightly overlapping left anteriorly.

Palps of the right and left maxillæ of the male (Plate LV, figs. 4, 6) with hooked terminal segments, these each terminating with a recurved hyaline tip. As is usual with the genus *Spirocypris*, the testes of the male arise in a number of concentric circles in the anterior part of the shell (Plate LIV, fig 4), and after separating into two groups just back of the eye-spot, extend postero-ventrally.

Natatory setæ simple, extending but slightly beyond terminal claws.

Terminal claws toothed at tip, the three larger the same length, and somewhat longer than the penultimate segment.

Terminal claws of the first feet strong, toothed at tip, slightly curved, and about one-half longer than the penultimate segment.

Terminal claws of second feet (fig. 1) one and one-half times length of terminal segment. Terminal segment beak-shaped; terminal reflexed seta about twice as long as terminal claw.

Ejaculatory duct of male in sack (fig. 2) elongate and narrow, and with about 20 wreaths of spines.

Furca nearly straight, very slender (fig. 3), about 32 times as long as average width; dorsal margin smooth. Terminal claw nearly straight, very faintly pectinate at tip, one-half as long as furca; subterminal claw four-fifths as long as terminal one. Terminal seta less than two-fifths as long as terminal claw. Dorsal seta slender, twice width of furca from subterminal claw and reaching about to tip of furca.

This form differs from *Spirocypris passaica*, the only other described member of the genus, in the prominent tubercles of the shell, shell coloration, much smaller size, plumpness, and slenderness of furca, its length to breadth being about as 32 to 1, while in *S. passaica* the ratio is about as 23 to 1.

*Observations.*—This form is not especially free swimming, and is usually pretty well confined to the débris and algæ of the bottom. It was found in company with many *Cladocera*, *Hydra*, *Hydrachnids*, *Cypris monacha*, *Cypris fuscata*, *Cypris dentifera*, etc. A number of cultures were made in battery jars, also in Syracuse watch glasses. Those made in the watch glasses were started April 26, 1906, and kept in good shape until the latter part of May of the same year in an attempt to get their eggs, but none noted.

*Occurrence.*—The specimens examined were collected from various localities southeast of Chicago, Illinois. They were first noted in an aquarium started January 28, 1905, with débris, etc., taken through the ice from a shallow permanent pond, situated near the water-works station in the south end of Jackson Park, Chicago. They were continuously noted in collections made in April and May from

nearly all the ponds and swamps of this region and from ditches and shallow sphagnum swamps near Roby, Indiana, May 6, 1906.

In some respects this species somewhat superficially resembles the figures given for *Candonia euplectella* Robertson in Brady and Norman.<sup>a</sup> Alcoholic or formalin specimens retain a purplish appearance. Furthermore, so plump are these forms that when placed in water in Syracuse glasses for superficial examination instead of lying on their sides, as is so commonly the case with most Ostracods, they nearly invariably remain dorsal or ventral side up.

*Type-locality*.—Swampy ponds, Jackson Park, Chicago, Illinois.

*Type*.—Cat. No. 38345, U.S.N.M.

Subfamily CYCLOCYPRIDINÆ.

7. CYCLOCYPRIS Brady and Norman, 1889.

*Cypris* AUTHORS, 1785-1820.

*Cypris* ZENKER, Wieg. Archiv. f. Naturg., XX Jahrg., 1, 1854.

*Cyctocypris* BRADY and NORMAN, Trans. Royal Dublin Soc., 1889, p. 70.—VAVRA, Arch. Naturw. Durchforsch. Böhmen, VIII, 1891, p. 67.—MÜLLER, Orig. Abh. aus dem Gesamt. der Zool., XII, Heft 30, 1900, p. 39.—KAUFMANN, Revue Suisse de Zool., VIII, Fasc. 3, 1900, p. 319.—SHARPE, Proc. U. S. Nat. Mus., XXVI, 1903, p. 994.

Natatory setæ very long. Terminal segment of second foot long and narrow, three times as long as broad. Ductus of numerous long filaments and no distinct central axis. Fourth segment of second antenna of male with no sense organ on its distal end.

- a*. Length at least 0.8 mm. Anterior edge of furca about three times length of terminal claw. Terminal claws strong, nearly straight, weakly bent near end. Furca toothed on anterior edge, and with a comb of teeth on its side ----- *C. globosa*.
- a*<sup>2</sup>. Length at most 0.55 mm.
- b*. Dorsal seta evident.
- c*. Furca of female without a comb of teeth near its base. Terminal claws hook-shaped ----- *C. forbesi*.
- c*<sup>2</sup>. Furca of female with a comb of teeth near its base ----- *C. pygmaea*.
- b*<sup>2</sup>. Dorsal seta lacking, or seen with difficulty. Terminal claws but slightly curved ----- *C. larvis*.

13. CYCLOCYPRIS LÆVIS (O. F. Müller).

Plate I, fig. 5; Plate LIV, figs. 5-7.

*Cypris larvis* O. F. MÜLLER, Entomos, seu Insecta testacea, etc., 1785, p. 52, pl. III, figs. 7-9.

*Cyctocypris larvis* VAVRA, Arch. Naturw. Durchforsch. Böhmen, VIII, Heft 3, 1891, p. 68, figs. 21-25.—KAUFMANN, Revue Suisse de Zool., VIII, Fasc. 3, 1900, p. 320, pl. XIX, figs. 23-25; pl. XXIII, figs. 9-12; pl. XXIX, fig. 17.—MÜLLER, Zoologica, XII, Heft 30, 1900, p. 41, pl. x, figs. 14-22.

<sup>a</sup>Trans. Royal Dublin Soc., IV, 1889, p. 105.



*Dimensions*.—Length, 0.45 to 0.48 mm.; breadth, 0.24 to 0.28 mm.; height, 0.3 to 0.34 mm.

The shell varies in color from a lemon yellow to chestnut red. Vavra, 1891, even reporting them of a whitish color but ordinarily horn-brown. I have seen none of any other color than lemon yellow to chestnut red.

Seen from the side (Plate LIV, fig. 5), the highest point of the shell is almost exactly in the middle, approximately seven-ninths as high as long. The dorsal margin is rather plainly humped in the middle, posterior margin evenly rounded, ventral margin nearly straight, or weakly convex.

Seen from above (Plate L, fig. 5), the shell is egg-shaped, pointed anteriorly, the left shell slightly overlapping the right anteriorly; greatest width in the middle, the width being slightly more than one-half or about three-fifths of the length.

Terminal segment of the second foot (fig. 7) about three times as long as wide. Terminal claw about as long as the width of the terminal segment; shorter seta about four times as long as the claw; penultimate segment about five-thirds as long as the terminal one, and armed with two setae on its inner edge, while *C. forbesi* has but one such seta, the outer margin of the segment having three combs of minute teeth. The terminal claw of one of the specimens examined was weakly S-shaped. Kaufmann<sup>a</sup> mentions this peculiarity as a common occurrence, and uses it as of specific worth. It would rather seem to be characteristic of the younger stages of growth, however, as it was in no wise a constant character in the American specimens examined.

Furca (fig. 6) stout, nearly straight, one-sixth as wide as long, measured along the anterior edge; terminal seta varying from one-half to two-thirds length of the terminal claw. Terminal claw stout, slightly curved near tip, toothed near tip, and about one-half length of ramus measured along anterior margin, while in *C. globosa* this proportion is about as 1 to 3. Subterminal claw also slightly curved near tip, toothed, and but little shorter than terminal claw. Dorsal seta hardly distinguishable, and, indeed, usually entirely lacking.

This species seems to be a somewhat variable one, which likely in part accounts for the unusually large synonymy as given by some authors.

Described from several specimens collected rather commonly from ponds and swamps southeast of Chicago, Illinois, and at Clarke Junction, Indiana. They were collected amongst rushes, water lilies, sphagnum moss, typha, etc.; also found at Kissena Park lake, Long

<sup>a</sup> Revue Suisse de Zool., VIII, 1900, p. 320.

Island. The latter collections were made November 10, 1907, while all the former were made from May 3 to May 20, 1906.

Distribution world-wide. Fossil in the Tertiary, England.

8. CYPRIA Zenker, 1854.

14. CYPRIA DENTIFERA Sharpe.

Plate L, figs. 3, 4.

*Cypria dentifera* SHARPE, Bull. Illinois State Lab. Nat. Hist., IV, 1897, pp. 463-465, pl. XLVII, figs. 6-11.

*Dimensions*.—Length, 0.69 mm.; height, 0.38 mm.; breadth, 0.26 mm.

Described from several specimens found in the Zoölogical Gardens, Cincinnati, Ohio, August, 1881. Also found in museum collections from ponds in Long Island, New York, and a pond near Westfield, New Jersey, June, 1908. Those from the pond near Westfield were collected by Mr. John J. Schoonhoven, president of the department of microscopy, Brooklyn Institute of Arts and Sciences.

This species is distinguished by having combs of remarkably long teeth on the distal halves of the terminal claws of the ramus.

9. ILYOCYPRIS Brady and Norman, 1889.

16. ILYOCYPRIS GIBBA (Ramdohr).

Plate LVI, figs. 1, 2.

*Cypria gibba* RAMDOHR, Mag. der Gesell. Naturforsch. Freunde Berlin, II, 1808, p. 91, pl. III, figs. 13-17.

*Cypria biplicata* KOCH, Deutschlands Crustaceen, Myriopoden und Arachniden, etc., 1838, Heft 21, fig. 16.

*Cypria sinuata* FISCHER, Mém. des. Sav. étrang. Acad. St. Pétersbourg, VI, 1847, p. 193, pl. x, fig. 4.

*Cypria biplicata* FISCHER, Mém. des Sav. étrang. Acad. St. Pétersbourg, VII, 1851, p. 150, pl. v, figs. 5-8.

*Cypria gibba* BRADY, Trans. Linn. Soc. London, XXVI, 1868, p. 369, pl. XXIV, figs. 47-51; pl. XXXVI, fig. 2.

*Ilyocypris gibba* BRADY and NORMAN, Trans. Royal Dublin Soc., IV, 1889, p. 107, pl. XXII, figs. 1-5.—VAVRA, Arch. Naturw. Durchforsch. Böhmen, VIII, Heft 3, 1891, p. 57, fig. 17 (1-7).—MÜLLER, Zoologica, XII, Heft 30, 1900, p. 88, pl. XIX, figs. 7, 8, 10, 14-19; pl. XX, figs. 17, 18.

*Dimensions of female*.—Length, 0.85 to 0.95 mm.; height, 0.42 mm. to 0.48 mm.; breadth, 0.38 to 0.44 mm.

Seen from the side (fig. 1), the shell is quite similar to *I. bradyi*, excepting that there are two prominent tubercles just back of the eye-spot, another in the region of the muscle impressions, and yet two others posterior to this one situated at about the beginning of the posterior third of the shell. The smaller tubercles at the anterior and posterior ends are more prominent than those of *I. bradyi*.

Seen from above (fig. 2), the shell is proportionately broader than that of *I. bradyi*, being about four-ninths of the length, while with *I. bradyi* this proportion is about as 1 to 3.

Anterior and posterior ends showing a number of prominent tubercles, a prominent constriction just back of the region of the eye-spot, and still another laterally just about the middle of the body region. The posterior third of the shell is widest of all, but suddenly incurved dorsally, so as to cause an appearance of two very decided rounded swellings of shell along postero-dorsal margin (fig. 2). All these furrows and humps give the shell a decidedly crumpled appearance; this appearance may vary somewhat from the figure given, but, in the main, averages as shown.

Natatory setae of the second antennae reach about to tips of terminal claws. Second foot as in *I. bradyi*. Furca very much as in *I. bradyi*, except that the terminal seta is longer, it being approximately two-fifths length of terminal claw, or about two and one-half times as long as the average width of furca, the subterminal claw being slightly longer than the terminal one. These proportions varied somewhat in different specimens, so that I am of the opinion that both *I. gibba* and *I. bradyi* are very variable in details of structure, so much as to cause great confusion in diagnosis.

I believe that Müller<sup>a</sup> very wisely chose to speak of these forms as occurring under four variations, namely, with humps or without humps, or with long natatory setae (reaching beyond tips of end claws) or short natatory setae (reaching not beyond base of end claws). The terminal seta of the furca also seems to be somewhat variable in length in the same species, as is also the length of the subterminal as compared with the terminal claw.

Described from a number of specimens kindly sent me by Prof. A. E. Beardsley, which were collected by him in the same locality as *I. bradyi* (Carters Slough, March, 1905).

Distribution same as *I. bradyi*.

17. *ILYOCYPRIS BRADYI* G. O. Sars.

Plate LVI, figs. 3-6.

*Ilyocypris bradyi* Sars, Forh. Vid. Selsk., Christiania, 1890, No. 1, p. 59.—MÜLLER, Zoologica, XII, Heft 30, 1900, p. 90, pl. VIII, figs. 9, 11-13.—KAUFMANN, Revue Suisse de Zool., VIII, 1900, p. 353, pl. XXIV, figs. 1, 2; pl. XXV, figs. 17, 18.

*Dimensions of female*.—Length, 0.85 to 0.95 mm.; height, 0.45 to 0.5 mm.; breadth, 0.32 to 0.5 mm. Male slightly larger.

Seen from the side (fig. 4), the shell is about twice as long as high, dorsal margin nearly straight, ventral rather decidedly sinuate, an-

<sup>a</sup> Zoologica, XII, 1900, p. 88.

terior and posterior ends evenly rounded and tuberculate. Anterior end slightly wider than the posterior, and tubercles more numerous.

Seen from above (fig. 3), the shell is elongate, sides nearly parallel, anterior end pointed, with left shell overlapping right; posterior margin rather bluntly rounded. The characteristic protuberances and furrows of the shell in the region of its anterior third are not so decided as in *I. gibba*. *I. gibba* has, in addition, a protuberance on each shell just posterior to its middle, which is larger than the others and characterizes the species; several other small tubercles at the anterior and posterior margins may also be plainly seen from above.

Natatory setae of the second antennae reach but to the tips of the terminal claws.

Terminal segment of second foot (fig. 5) conical, five-eighths as broad as long and bearing three setae, the two terminal backwardly directed, the shorter being about one-half the length of the longer, the longer being approximately seven times the length of the terminal segment. A third seta is present which is commonly pointed in the same direction as the two terminal ones, thus causing an appearance of three terminal backwardly directed setae. This seta is situated laterally rather than terminally, approximately near the middle of the segment, and is nearly as long as the longer of the two terminal setae. Inner margins of penultimate segment of second foot with two long setae, of which the distal one is the longer, the shorter one being two-thirds its length, or about the length of the shorter terminal seta.

Furca (fig. 6) strong, curved, much broadened at base, and approximately ten times as long as width at middle. The two terminal claws slender, plain, approximately same length, and seven-twelfths as long as furca; terminal seta very weak, about as long as average of furca. Dorsal seta situated at one-third length of furca from tip, slender, plumose, bent near tip, and reaching about three-fourths distance to tip of furca. Distal half of dorsal part of furca ciliate, also sparsely ciliate laterally.

This species is not free swimming, but creeps or burrows. It appears to be closely similar to *I. gibba*, var. *repens*, of Vavra,<sup>a</sup> excepting that the natatory setae are longer than is the case with *repens*.

Described from a number of specimens kindly sent me by Prof. A. E. Beardsley, of the State Normal School, Greeley, Colorado. Professor Beardsley collected them from Carters Slough, near Greeley, Colorado, March 9, 1905. He has already made note of its occurrence.<sup>b</sup>

*Distribution*.—Europe (Sars, Müller, and Kaufmann), Britain (Brady and Norman), Colorado.

<sup>a</sup> Arch. Naturw. Durchforsch. Böhmen, VIII, 1891, p. 60.

<sup>b</sup> Science, new ser., XXI, pp. 587-588.

## Subfamily HERPETOCYPRIDINÆ.

## 12. ILYODROMUS Sars, 1894.

*Herpetocypris* BRADY and NORMAN, Trans. Royal Dublin Soc., 1889, p. 84.

*Herpetocypris* Sars, Forh. Vid. Selsk. Christiania, No. 1, 1890, p. 60.

*Cypris* VAVRA, Arch. Naturw. Durchforsch. Böhmen, VIII, 1891, p. 82.

*Herpetocypris* CRONEBERG, Bull. Soc. Imp. d. Moscou, 1894, p. 11.

*Ilyodromus* Sars, Vid. Selsk. Skr. Math. Natur. Klasse, 1894, p. 38.—KAUFMANN, Revue Suisse de Zool., VIII, 1900, p. 298.—SHARPE, Proc. U. S. Nat. Mus., XXVI, 1903, p. 975.—MÜLLER, Ergeb. der deutsch. Tiefsee-Expedition, 1898-99, VII, 1906, p. 136 (Valdivia).

Natatory setæ sparse and much shortened. Surface of shell of most species striated longitudinally. First maxillary process with two toothed spines. Caudal ramus ending in three strong claws which increase in length distally, the usual dorsal seta being replaced by a spine or claw. Terminal seta present as usual. Propagation sexual.

*Remarks.*—This genus was first established by Prof. G. O. Sars in 1894 to receive a new species from New Zealand. As originally described, it was one of two new subdivisions of the genus *Herpetocypris*, the other division being the genus *Candonocypris*, which seems to be less definitely established, as the distinction rests very largely upon comparative size and overlapping of valves of shells. *Candonocypris* appears little more, therefore, than at most a subgenus of the genus *Herpetocypris*. Sars evidently found no males, hence describes the genus "with propagation exclusively parthenogenetical." The collections belonging to the U. S. National Museum contained at least one male, hence the generic description is revised to that extent.

## 21. ILYODROMUS PECTINATUS, new species.

Plate LVII, figs. 1-5.

Length of male, 1.18 mm.; height, 0.58 mm.; breadth, 0.49 mm. Female slightly smaller.

Shell sparsely covered with small papillar elevations, and showing small parallel longitudinal striations (fig. 1).

Seen from the side (fig. 1), the shell is twice as long as high, the upper margin evenly and gently curved, the lower edge nearly straight, weakly sinuate.

Seen from above (fig. 4), the shell is narrowly oval, both ends similar.

The second antennæ are large, terminal claws as long as the last two segments. Natatory setæ very rudimentary, scarcely noticeable. The two spines of the first maxillary process stout and toothed.

Terminal claw of second foot (fig. 5) stout, broad, nearly straight, with curved tip.

Furca (fig. 3) very faintly curved at middle, approximately 15 times as long as wide throughout, the dorsal edge armed with a row of closely set, coarse teeth for about one-half its length.

Terminal claw stout, nearly straight, about six and one-half times as long as width of furca. Subterminal claw about four and one-half times as long as width of furca, the terminal seta being about the same length. The usual dorsal seta of *Cypris* is replaced by a spine, which is one and one-half times as long as average width of furca, and situated about one-half width of furca from subterminal claw. This spine is one of the chief characteristics of the genus. All of the claws are smooth and show little evidence of pectinations.

Maxillary palps of the male (fig. 2) resembling those of the genus *Cypris*, but blunt and strong. Copulatory organs of male plate-like.

This species may be at once distinguished from all other described species of the genus by the strongly pectinated furca. But nine species of the genus have heretofore been described, seven from Australia by Prof. G. O. Sars and two from Europe by Dr. G. S. Brady. Most of these were characterized by faint longitudinal striations on the shell, which I fancy might not always be in evidence, depending on age.

The shell of the female is somewhat smaller than that of the male, all dimensions being in proportion.

Described from a number of specimens belonging to the U. S. National Museum from Europe?, type locality. (Jeffreys collection, No. 707.) The male was described from a single specimen found in the stomach of *Spatula clypeata* (Linnaeus), South Carolina. Biological survey Nos. 12645 and 59664.

*Type*.—Cat. No. 38346, U.S.N.M.

Subfamily NOTODROMADINÆ.

13. Genus CYPROIS Zenker, 1854.

*Cyprois* ZENKER, Wieg. Archiv. f. Naturg., XX, 1854, Pt. 1, p. 80.—BRADY and NORMAN, Trans. Royal Dublin Soc., 1889, p. 96.—DADAY, Termesz. Fuzs., XVIII, 1895.—KAUFMANN, Revue Suisse de Zool., VIII, 1900, p. 258.—MÜLLER, Zoologica, XI, Heft 30, 1900, p. 49.—SHARPE, Proc. U. S. Nat. Mus., XXVI, 1903, p. 975.

Shell high, compressed, smooth, and showing a similarity to that of the genus *Notodromas*. Second antenna 5-segmented in both sexes. First maxillary process with six strong toothed spines. Natatory setæ reach the tips of the terminal claws. Second foot ending with a claw and a reflexed seta. Furca with the two terminal claws seta-like, therefore an appearance as though four long setæ at tip of ramus. Furca of the male more bent than that of the female. No American forms heretofore reported. Sexual.

## 22. CYPROIS MARGINATA (Strauss).

Plate LVIII, figs. 1-5.

*Cypris marginata* H. E. STRAUSS, Mem. du Mus. d'Hist. Nat., VII, 1821, p. 59, pl. 1, figs. 20-22.

*Cypris flava* ZADDACH, Synop. Crust. Pruss. Prodr., 1844, p. 33.

*Cypris flava* BRADY and NORMAN, Trans. Royal Dublin Soc., Pt. 1, 1889, p. 97, pl. VIII, figs. 18-19; pl. XII, figs. 13-21, 38.—CLAUS, Arb. aus den Zool. Inst. Wien, X, 1892, Heft 2, pl. v, fig. 10; pl. vi, fig. 6.—MÜLLER, Zoologica, XII, 1900, Heft 30, p. 49, pl. XII, figs. 1-10, 12-16.

*Cypris marginata* SARRS, Forh. Vid. Selsk. Christiania, 1890, p. 54.—BRADY and NORMAN, Trans. Royal Dublin Soc., V, 1896, p. 727.—KAUFMANN, Revue Suisse de Zool., 1900, p. 259, pl. xv, figs. 5-9; pl. xvii, figs. 11-19; pl. xviii, fig. 4; pl. xxix, fig. 16.

*Dimensions*.—Length, 1.52 mm.; breadth, 0.75 mm.; height, 0.96 mm.

A very markedly peculiar form, uniformly yellowish in color, with no especial markings except numerous small papillæ and a few scattered hairs.

Seen from the side (fig. 1), the dorsal edge is humped just back of the eye-spots, thence sloping rapidly to the evenly rounded posterior margin. The ventral edge nearly straight, the anterior edge evenly rounded. A hyaline margin is very plainly evident about the entire edge of shell, especially wide and prominent anteriorly, less so posteriorly and least of all dorsally and ventrally. This, no doubt, gave rise to the specific name as given by Strauss in 1821. The entire margin of the shell just within the hyaline flange appears to be tuberculate, because of the presence of unusually prominent "pore-canals."

Seen from above (fig. 2), the shell is elongate, oval, sharply pointed anteriorly, less so posteriorly, the greatest breadth in the middle being about one-half the length. Testes and ovaries show plainly through the shell.

Natatory setæ of the second antennæ plumose, and reaching to tips of the terminal claws. Terminal claws of the last segment rather slender, nearly straight, three and one-half times length of terminal segment. Terminal claw of penultimate segment reaching to tips of terminal claws.

The second foot ends in a beak-like segment (fig. 5); the terminal claw bent at right angles to the foot; the terminal three-fourths part being straight and about three times length of terminal segment, the terminal segment being about as long as broad.

The first maxillary process has six strong, toothed spines (fig. 4), these being much similar to those of *Notodromas*, but more coarsely toothed.

Furca stout (fig. 3), slightly curved, about seven times as long on dorsal edge as the average width, and terminating in four long setæ;

the two terminal being coarser, and somewhat claw-like, faintly toothed, the other two rather plumose. Terminal seta three-fifths as long as anterior edge of furca; dorsal seta longer, four-fifths as long as furca, and sharply bent near the tip, the two terminal claw-like setae about the same length, and as long as the anterior edge of the furca. The dorsal seta here is unusually long, more strikingly so than amongst any Ostracods with which I am familiar.

*Remarks.*—I know of but one other species of *Cyprois* having been described—*C. madaraszii* Orley. This species is about twice the size of *C. marginata*, it being about 3 mm. in length, while *C. marginata* is only about 1.50 mm. long. It is evidently closely related to *Notodromas* in habits, and, in part, structurally, noticeably the six spines on the first maxillary process. Both genera are sexual, the different sexes showing slight differences of furca and form of shell.

*Observations.*—This form was kept for several weeks in aquaria. It was quite active, restless, and swam freely through the water, numbers of them coming to the surface of the water, where it has a unique habit of swimming along in an erratic way just below the surface film, acting as though trying to support itself there; in fact it may often be seen resting quiescent just below the surface film, at some distance from the edge of the aquarium. Many were also noticed creeping among débris at the bottom of the aquarium. Many were noted copulating.

*Occurrence.*—Large numbers frequented a shallow grassy pool just south of the old Columbian Exposition grounds in Jackson Park, Chicago. This pond was a temporary one, lasting from early spring to early June, when it became perfectly dry. This agrees with all hitherto recorded reports on habitat. It has hitherto been reported only from Europe, in England (Brady and Norman, 1896), Norway (Sars, 1891), Switzerland (Kaufmann, 1900), Germany (Müller, 1900), and Russia.

Collected May 3, 1906, Jackson Park, Chicago.

#### 14. NOTODROMAS Lilljeborg, 1853.

*Monocentus* JURINE, Histoire des Monocles, etc., 1820.

*Cyprois* ZENKER, Monog. der Ostracoden, 1854, p. 80.

*Notodromas* LILLJEBORG, De Crust. ex Ord. tribus, 1853, p. 51.—BRADY and NORMAN, Trans. Royal Dublin Soc., 1889, p. 95.—KAUFMANN, Revue Suisse de Zool., VIII, 1900, p. 251.—MÜLLER, Zoologica, 1900, p. 46.—SHARPE, Proc. U. S. Nat. Mus., XXVI, 1903, p. 974.

Shell high, smooth. Natatory setae reach to tips of terminal claws. Second antennae six-segmented in both sexes. First maxillary process with six toothed spines. Second foot five-segmented, terminating in three setae, of which two are backwardly directed. Furca with two terminal claws seta-like, and terminal missing, so that furca seems to end in three setae. Two eyes, separate. Sexual.



Five species of this genus have been described—*N. entzi* Daday (Ceylon), *N. fuscatus* Brady (Australia), *N. madaraszi* Orley (Hungary), *N. monacha* O. F. Müller, *N. ocellatus* Sars (Sumatra). *Newnhamia patagonica* Vavra, 1898, was originally described as a species of *Notodromas*, but was later decided by Vavra to be a *Newnhamia*. *N. madaraszi* seems to be a type of a new genus, as it differs from the typical *Notodromas* in many ways, notably the spine-like setae of the furca being five in number, in place of three, character of armature of the terminal segment of the second foot, the end segment being beak-shaped and with short claws, more similar to the Cypriidinae. It is therefore my opinion that the species *N. madaraszi* Orley should be the type of a new genus.

23. NOTODROMAS MONACHA (O. F. Müller).

Plate LIX, figs. 1-8.

*Cypris monacha* O. F. MÜLLER, Entomos, seu Insecta testacea, 1785, p. 60, pl. v, figs. 6-8.—ZADDACH, Synop. Crust. Pruss. Prodr., 1844, p. 31.—FISCHER, Mém. des Sav. Étrang. de l'Acad. de St. Pétersbourg, VII, 1854, p. 146, pl. iv, figs. 1-11.

*Notodromas monacha* LILLJEBORG, Om de inom Skane förekommande Crust. af Ord. Cladocera, Ostracoda och Copepoda. Lund., 1853, p. 95, pl. viii, figs. 1-15; pl. xii, figs. 1, 2; pl. xxv, fig. 16.—BRADY and NORMAN, Trans. Royal Soc. Dublin, 1889, p. 96.—VAVRA, Arch. Naturw. Durchforsch. Böhmen., 1891, p. 32, figs. 6-9.—KAUFMANN, Revue Suisse de Zool., VIII, 1900, p. 251, pl. xv, figs. 1-4; pl. xvii, figs. 1-10; pl. xviii, figs. 1-3; pl. xxix, fig. 15.—MÜLLER, Zoologica, XII, Heft. 30, 1900, p. 47, pl. xi, figs. 8-22; pl. xii, fig. 11.

*Dimensions*.—Length, 1.18 mm.; breadth, 0.75 mm.; height, 0.9 mm.

Seen from the side (fig. 1), this peculiar form is at once distinguished by its humpbacked appearance. The dorsal and ventral margins of the anterior half of the shell nearly parallel, after which the dorsal edge suddenly diverges to form a dorsal hump just back of the eyes, this shell widest just back of the middle. Posterior end bluntly rounded, sparingly hairy; the anterior end with a wide hyaline flange, sparingly hairy, and appearing as though crenulate, because of the small tuberculations which more or less cover the anterior part.

Seen from above (fig. 2), the shell is regularly oval, egg-shaped, but pointed anteriorly. Eyes two, plainly separate.

Second antenna 6-segmented. Natatory setae reaching almost to tips of terminal claws, five in number, and plumose. Terminal and penultimate segments approximately the same length. Antepenultimate segment but two-thirds as long. Terminal segment narrow, eight times as long as wide; penultimate segment wider, about four times as long as wide.

First maxillary process with six broad spines, which are faintly ciliate at tip (fig. 7). Right maxillary foot of male (fig. 3) with a sickle-like terminal claw, which is about two-thirds length of terminal segment. Left maxillary foot much shorter, with a strong sickle-like terminal claw, which is about four-fifths length of terminal segment. Outer distal angle of terminal segment with a strong protuberance.

Terminal spine of first foot strong, about three times length of terminal segment, or about same length as penultimate segment. Second segment broad, with a tuft of hair on the curved dorsal edge, also a plumose seta on its dorsal distal margin which reaches to the end of the following segment. The third segment is two-thirds length of the following one, with a decided angular projection at its proximal dorsal edge, and a short seta at its distal dorsal edge, which is about two-thirds length of the following segment.

Terminal segment of the second foot very small, about as long as broad, about one-eleventh as long as preceding segment, and with three setae of unequal lengths, two of which are terminal, and extend in the direction of the length of the foot; the third, subterminal and pointing in the opposite direction (fig. 5). One terminal seta about three-fourths length of longer one, which is seven-eighths length of penultimate segment; the remaining or subterminal seta being about the length of the longer one of the three.

Furca strongly bent (fig. 8), with two terminal bristles in place of the usual terminal claws of the Cyprididae, these bristles being nearly the same length, the shorter about three-fourths length of the longer one, which is slightly more than two-thirds length of the posterior or dorsal edge of the furca; the dorsal bristle situated less than width of furca from subterminal bristle, and about two-thirds length of same. The anterior bristle, corresponding to the usual terminal seta of the Cyprididae, is entirely lacking. The furca of the female is hardly so much bent as that of the male, but otherwise nearly similar.

The specimens studied by me were collected from the dune ponds of the southern shore of Lake Michigan, near Clarke Junction, Indiana. This is a typical undrained swamp region, with many peat bogs. The ponds were originally formed between established dunes, and in most cases are but reliets at present, having been destroyed by successive encroachments of different types of vegetation—first bulrush (*Scirpus*), sedge (*Carex*), willow (*Salix*), and the grasses. The filling-in process has usually been accelerated by abundant growths of *Chara*, the water lilies *Castalia* and *Nymphaea*, and *Utricularia*. These were all found in great abundance in this region. Among the marginal plants noted were the swamp cinquefoil (*Potentilla palustre*), buckbean (*Menyanthes trifoliata*), and the

leather leaf (*Chamaedaphne calyculata*). Other shrubs noted were the dwarf birch (*Betula pumila*), the alder (*Alnus incana*), the swamp blueberry (*Vaccinium corymbosum*), and the poison sumach (*Rhus vernix*). This region was also characterized as the home of various orchids, the sundew (*Drosera rotundifolia*), the pitcher plant (*Sarracenia purpurea*), and the peat moss (*Sphagnum*).

*Observations.*—These Ostracods were somewhat brownish yellow in color, a little darker ventrally, and a light yellow blotch just posterior to and below the eye-spot. There are two distinct eyes, a red eye-spot surrounded by a black pigment band. They swim very actively and persistently, remaining near the bottom most of the time. They also resemble the Cladocera in many of their swimming motions, at times turning so that the anterior part of the body is upwards, until they reach the surface of the water, where they hang, back downward, a very unusual and especially curious position for an Ostracod.

*Distribution.*—This form seems to occur only in permanent bodies of pure fresh water which is also rich with aquatic vegetation. They usually appear in April, and are abundant during the summer months, disappearing in the early autumn. It has been reported from all northern and middle Europe and from Minnesota.<sup>a</sup> A few specimens were found by me near Clarke Junction, Indiana, May 12, 1906, in permanent dune ponds. Found in company with *Cypris fuscata*, *Cypris dentifera*, and *Cypridopsis vidua*.

## 2. Family CYTHERIDÆ.

### 13. Genus CYTHERE O. F. Müller.

*Cythere* O. F. MÜLLER, Entomos, seu Insecta testacea, 1785, p. 63.—SARS, Forh. Vid. Selsk. Christiania, 1865, p. 28.—DAHL, Zool. Jahrb., III, 1888, Heft 4, p. 605.—G. W. MÜLLER, Die Ostracoden des Golfes von Neapel, 1894, p. 350, pl. xxvii, figs. 25-35; pl. xxviii, figs. 11-13, 15-18, 20, 28, 29; pl. xxix, figs. 11, 12, 14, 16.

Shell thick, mostly pitted, without distinct flanges; muscle impressions 4, which form a row. The growing line runs at a moderate distance from the shell edge, however, in the anterior half this is always nearer than the muscle impressions.

Seen from above, always somewhat strongly compressed, not so broad as high, compound eyes prominent. Hinge margin always with large teeth on the right shell at its anterior and posterior ends. The shell edges do not overlap anteriorly or posteriorly.

First antenna short and thickset, 5-segmented, the penultimate segment formed of the union of the fifth and sixth segments; the penultimate and antepenultimate segments short, hardly longer than

<sup>a</sup> Herrick, 10th Ann. Rept. Minn. Geol. and Nat. Hist. Survey, 1882, p. 252.

broad, the ultimate slender, more than twice as long as broad, and originating on the under terminal half of the penultimate segment. The setae shorter than the limb, mostly spine-like and bent.

Second antenna 4-segmented, segments 3 and 4 united, and flagellum always well developed in both sexes. Mandible with short, strong, mandibular process and 4-segmented palp; its penultimate segment much broadened beyond the middle, its dorsal edge forming a plain blunt angle, at which the dorsal seta group originates (fig. 4). The terminal segment short, thick, little, or very little, longer than its breadth at base.

Maxilla of typical structure, thickset, maxillary process and palp with short strong bristles; respiratory plate without mouthwardly directed or abnormal rays.

First to third pairs of legs moderately elongate, their first segments with one seta on the anterior and posterior edges (without knee-seta).

Furca of female formed of a small basal part with two bristles.

G. W. Müller divides the genus into two groups:

(1) Those with females with shells of length less than once the height.

(2) Those with females with shells of length more than once the height.

All species show a plainly apparent yellowish color, formed because of a pale yellow color of the entire shell and from pigment spots in the body.

Dahl<sup>a</sup> mentions as of generic worth that the penultimate segment of the first antenna is many times as thick as the terminal segment and all locomotor appendages of a yellowish color. This is also true, at least, of the genera *Cytheridea* and *Cythereis*.

24. CYTHERE AMERICANA, new species.

Plate LX, figs. 1-6.

*Dimensions*.—Length, 1.2 mm.; height, 0.66 mm.; breadth, 0.64 mm.

Seen from the side (fig. 1), the shell is about 1.8 times as long as high, both ends evenly rounded, dorsal edge sloping anteriorly a little more rapidly. Ventral edge slightly sinuate, greatest height just back of the middle.

Seen from above (fig. 6), the shell is about one-half as wide as long, pointed anteriorly and broadest at the posterior third, where it is about four-sevenths as wide as long; surface of shell covered rather sparsely with small papillar elevations.

The preserved specimens as seen by reflected light appear of a porcelain color, covered with a few papillar elevations and not sculptured, as is the case with the great majority of the Cytheridae.

<sup>a</sup> Zool. Jahrb., Abth. System, Geogr. v. Biol. der Thiere., 1888, p. 603.

As seen from above, the right shell shows from 8 to 10 small blunt teeth in the region of the hinge (fig. 2).

Seen from the side, the growing line runs approximately at about the same distance from the shell edge and with pore canals about the entire margin, numerous, and not branching (fig. 1).

First antenna stout, 5-segmented; terminal segment slightly more than four times as long as broad; penultimate segment with two spines and two spine-like setae (fig. 5), which alternate; its terminal spine and seta being about the same length; the lateral spine being about seven-ninths the length of the terminal one; its lateral seta being slightly longer than its lateral spine. Antepenultimate segment broader than long, with a strong spine.

Second antenna 4-segmented, flagellum 2-segmented, as usual, and reaching slightly beyond tip of terminal segment. Mandible with strong 4-segmented palp, the penultimate segment of which is broadly widened just beyond the middle (fig. 4), thus forming a sharp angle, at which place is located a group of setae.

Respiratory plate without any abnormal or mouthwardly directed rays. First pair of legs (fig. 2) strong, basal segment with a seta on each margin, the posterior one unusually thick; both of them plumose and barred, two toothed spines of about the same length at its outer angle. Antepenultimate segment with a strong spine as long as the last two segments; last two segments the same length, and no armature. Terminal spine sickle-shaped, and as long as the last two segments.

Second and third legs similar (fig. 3), having one spine in place of two at the knee joint and other spines more slender.

Collected by means of a Birge net from shallow tidal pools near Brighton Beach, New York, June 6, 1906 (type locality); also near old mill, Jamaica Bay, June 21, 1908, where it was more common.

Described from five specimens which were obtained only after repeated hauls with the Birge net. They burrowed about in the slime, and could not swim.

They are distinguished from most other species, especially by the regular character of the shell, which with most species of *Cythere* is more or less ridged or pitted or tuberculate, as also by its more regular gray color in life.

*Type*.—Cat. No. 38347, U.S.N.M.

25. *CYHERE PAPPILLOSA*, new species.

Plate LXI, figs. 1-4.

*Dimensions*.—Length, 0.8 to 0.85 mm.; height, 0.49 to 0.51 mm.; breadth, 0.42 to 0.45 mm.

Seen from the side (fig. 2), the shell is approximately 1.6 times as long as its greatest height: highest in the middle just back of eyes.

sloping gently anteriorly, but quite rapidly posteriorly for a short distance, then again produced so that the posterior end is almost truncate, and thus forming a dorso-posterior angle; lower margin essentially straight.

Muscle impressions four, lying one above another in a straight line. Just posterior to the muscle impressions are situated two large conical protuberances or tubercles, so prominent as to at once characterize the species.

Seen from above (fig. 1), the shell is broadest in the middle, about half as broad as long, rather sharply pointed anteriorly, more evenly and broadly rounded posteriorly, and plainly showing the two large protuberances of each side, situated just posterior to the widest part. Surface of the shell sparsely covered with small papillar elevations; the central area also, as seen from the side, with from 30 to 40 small lucid spots. Shell grayish in color. Pore canals not as evident as in most species of *Cythere*.

First antenna (fig. 3) about as usual for the genus, the terminal spine of the penultimate segment the largest, the seta proximal to it spine-like, and about the same length, the next spine blunt and shorter; the proximal seta slender, and not more than three-fourths length of spine beside it. In *Cythere americana* these proportions are different, the proximal seta of the penultimate segment being longer than the spine just distal to it.

Second antenna stout and of the usual type (fig. 4). Penultimate segment of the mandibular palp widened just beyond the middle. Feet slender and as usual with the genus.

Collected, along with *Cythere americana*, from shallow tidal pools near Brighton Beach, New York, June 6, 1906.

A very few of these forms could be obtained by repeated use of the Birge net, not more than four to five specimens of each of the two forms just described, from at least a dozen hauls of the net.

They are poor swimmers, and were only with difficulty seen, as they burrowed about in the slime and ooze when placed in shallow glass vessels.

*Type*.—Cat. No. 38348, U.S.N.M.

### 3. Family CYPRIDINIDÆ.

#### 16. Genus CYLINDROLEBERIS Brady.

*Cypridina* AUTHORS, 1868.

*Asterope* PHILIPPI, Arch. Naturg., 6 Jahrg. 1840, Pt. 1, p. 186.—CLAUS, Untersuch. zur Erforsch. der genealog. Grundlage des Crustaceensystems, Wein, 1876, p. 94.—SARS, Arch. Math. Naturv., Christiania, XII, 1887, p. 11.—MÜLLER, Zool. Jahrb., Abth. Syst., V, 1890, p. 239.

*Cylindroleberis* BRADY Intellectual Observer, London, XII, 1867, p. 127; Trans. Linn. Soc. Lond., XXVI, 1868, p. 464.—MÜLLER, Die Ostracoden des Golfes von Neapel, XXI, 1894, p. 216.

Shell smooth, more or less oblong or elliptical, and always with a distinct rostral sinus. Both sexes present and with well developed eyes. Frontal organ long and slender. First antenna 6 or 7 segmented; in both sexes the fifth joint with a sensory organ; in the female the terminal segment bearing only rather short setæ, while the male bears two that are unusually long, almost as long as the entire animal. Natatory branch of the antenna well developed; secondary branch small in the female, sometimes jointed; in the male three-jointed, the third joint reflexed upon the second, forming a grasping organ. First maxilla without masticating process, in its stead a group of long plumose setæ; main portion of limb falcate, with many long, stiff setæ on the inner margin; in front a naked lamella arises from the main limb. The second maxilla consists of a tongue-like plate which is setose on its inner margin, and a large semicircular lamina which bears many long plumose setæ on its margin. The first pair of legs arises directly behind the mouth; not jointed and without lobes; bearing some plumose setæ on the ventral margin. The vermiform limb has a double row of teeth at its extremity. Furca broader than long, bearing several claws. There are seven pairs of rather large dorsal branchiæ. Sexual.

It seems wise to follow the lead of Dr. G. W. Müller in using the genus name *Cylindroleberis* rather than *Asterope* for reasons very well discussed by him in his splendid work on the Ostracoda of the Gulf of Naples.

26. CYLINDROLEBERIS OBLONGA (Grube).

Plate LXII, figs. 1-4.

*Cypridina maria* BAIRD, Proc. Zool. Soc. London, 1850, p. 257, pl. xvii, figs. 5-7.

*Cypridina oblonga* GRUBE, Archiv. für Naturg., 1859, p. 322, pl. xii.

*Cylindroleberis maria* BRADY, Intellectual Observer, 1867, p. 127, pl. II, figs. 11-14; Trans. Linn. Soc., XXVI, 1868, p. 465, pl. xxxiii, figs. 18-22.

*Asterope oblonga* SARS, Archiv. for Mathem. og Naturvid., XXII, 1887, p. 31, pl. I, figs. 5-8; pl. II, figs. 1, 2; pls. v, vi.

*Cylindroleberis oblonga* G. W. MÜLLER, Die Ostracoden des Golfes von Neapel, 1894, p. 219, pl. IV, figs. 14-18, 39, 41, 49-55; pl. V, figs. 1, 4, 5, 13, 14, 33, 41-44; pl. VIII, fig. 4.

*Cylindroleberis maria* CUSHMAN, Proc. Boston Soc. Nat. Hist., XXXII, 1906, No. 10, p. 366, pl. xxix, figs. 19-25.—JUDAY, Univ. of Cal. Pub., III, 1907, No. 9, p. 143, pl. xix, figs. 7-11.

*Dimensions*.—Length, 1.45 mm.; height, 0.8 mm.

Seen from the side (fig. 1), the shell is nearly twice as long as high, elongate, upper and lower margins nearly parallel, the greatest height just back of the middle. Upper margin higher posteriorly, the lower margin slightly sinuate anteriorly; posterior extremity broadly and evenly rounded.

Rostral sinus oblique, narrow, situated below the middle. Surface of the shell finely punctate, and yellowish red in color.

The vermiform limb (fig. 4) has both apical lips serrately divided, and with but a few spine-like setæ on its margin.

Caudal lamina each with eight rather slender spines and setæ (fig. 2), thus appearing as though sixteen in a row, the spines twelve in a row, and larger, very faintly serrate; the smaller four in number, seta-like.

Higher magnification of a claw (fig. 3) plainly shows characteristic serrations, every eighth or tenth one being larger than the rest.

*Distribution*.—British seas (Brady); Mediterranean Sea (Müller); Scandinavian seas (Sars); California coast (Juday); Vineyard Sound (Cushman); San Diego Bay, California, Cat. No. 13108; U.S.N.M.

27. CYLINDROLEBERIS LOBIANCI G. W. Müller.

Plate LXIII, figs. 1-5; Plate LXV, figs. 3-7.

*Cylindroleberis lobiaci* G. W. MÜLLER, Die Ostracoden des Golfes von Neapel, 1894, p. 220, pl. IV, figs. 40-42; pl. V, figs. 2, 3, 26, 32, 34, 40.

*Dimensions of male*.—Length, 5.25 mm.; height, 3.65 mm.

*Dimensions of female*.—Length, 5.85 to 6 mm.; height, 4.8 to 5 mm.

Shell of the male (fig. 2) longer than that of the female (fig. 1) and of different shape; the height being to length approximately as 1 to 1.45, while the shell of the female is approximately as 1 to 1.2, thus being slightly oblong to almost circular in outline. Surface of shell covered with small pittings in both sexes.

The rostral incision is rather obliquely set, not deep, narrow, and a little above the middle.

First antennæ rather stout, elongate, terminal segment short, about one-fifth as long as the fifth segment; second segment with seven lateral setæ and three marginal outer ones, two of the latter long and plumose; third segment about half as long as the second, outer margin about twice as long as the inner, and armed with about seven long plumose setæ, most of them clustered at the outer distal margin. Terminal spine stout, slightly curved, and as long as the part distal to the fourth segment.

About all the natatory setæ of the second antennæ armed on their lower margins with a row of teeth (fig. 7).

Inner rudimentary branch of the second antennæ of the female composed of three segments, the basal one as long as the other two, with a tuft of short setæ at its base, and seven to eight marginal ones. Penultimate segment about one-half length of basal one, with four to five short setæ; terminal segment conical, and terminating in a long ringed seta (Plate LXV, fig. 5). Occasionally another form of branch is to be seen (Plate LXV, fig. 4), which, however, is evidently that of the younger stages. This is usually four-segmented, the basal segment with two or three short setæ, antepenultimate segment with a



seta at its inner distal angle; penultimate segment with a long ringed seta at its outer distal angle; terminal segment conical, about length of previous segment, and terminating in a short seta.

Mandibular process falcate (Plate LXIII, fig. 5), pointed and with many hooked serrations, and a slender outer branch. Vermiform limb broadened at end, the last forty to fifty segments setose, the last six or eight segments often with two setae on each margin. Its tip is armed with a double row of toothed spines (Plate LXIII, fig. 4), each with a curved tip.

Furcal plate with three strong claws (Plate LXV, fig. 3), the second and third on special processes of the furcal plate, and from seven to nine curved seta-like spines, these being mostly toothed and barbed near tip (fig. 3). The base of each claw is armed with two or three rows of setae, mostly arranged in clusters. Claws very strongly toothed, except near tip. Lower posterior margin of furcal plate very densely setose.

*Observations.*—The many collections of the United States Bureau of Fisheries containing this form also contained many that were evidently the young, and all showed various modifications of the inner branch of the second antenna, but these in the main resembling fig. 5. Inner rudimentary branch of the second antenna of the male composed of two segments, the terminal one reflexed against the basal one, thus forming a prehensile organ for grasping (fig. 6). Basal segment about four times as long as broad, inner margin swollen about the middle, and with six short setae; terminal segment irregularly falcate, with a seta near its union with the basal segment, and a serrate tip (fig. 6a.)

*Remarks.*—Müller, 1894, first describes this species as occurring in the Mediterranean Sea in a depth of about 5 fathoms, among coarse sand, in company with *Amphioxus*. He based his description on but two examples, both of which were females, males being therefore unknown to him.

The males are seemingly not very abundant. Two males were found among the twenty or more specimens critically examined by the author.

*Distribution.*—Mediterranean Sea (Müller, 1894); San Pedro, California, Acc. No. 43766, U.S.N.M.; San Diego Bay, California, Cat. No. 13791, U.S.N.M.; San Pedro, California, Acc. No. 37972, U.S.N.M.; off Abreojos Point, Lower California, 5½ fathoms, station 2835, *Albatross*, and off San Diego, California, 25 fathoms, station 4304, *Albatross*; San Diego Bay, California, Cat. No. 13107, U.S.N.M.; Catalina Islands, California, and Ensenada, Lower California, Acc. No. 22456, U.S.N.M. (Orcutt).

The two males examined were from a collection taken at Ballenas Bay, Lower California, U. S. Bureau of Fisheries, No. 1884 (*Albatross*).

## 17. Genus PYROCYPRIS Müller, 1890.

*Cypridina* AUTHORS, 1852 (Dana), 1868.

*Pyrocypris* G. W. MÜLLER, Zool. Jahrb., Abth. Syst., V, 1890, p. 231, pl. xxv, figs. 1-8; pl. xxvi, figs. 10, 12, 16, 19; pl. xxvii, figs. 1, 2, 18, 24, 34-37.—BRADY, Trans. Zool. Soc. Lond., XVI, 1902, p. 185.—G. W. MÜLLER, Ostracoda, Abdr. aus Wiss. Ergeb. der deutsch. Tiefsee Expedition "Valdivia," 1898-99, 1906, p. 107.

*Eupathistoma* BRADY, Trans. Zool. Soc. Lond., 1898, XIV, Pt. 8, p. 437, pl. XLIV, figs. 21-26.

Shell membranous, about 2 mm. long, and produced posteriorly to form a prominent rounded beak or process.

Especially characteristic is the upper lip, which Müller <sup>a</sup> believes serves as a phosphorescent organ. It is unusually well developed to form six finger-like processes (Plate LXIV, fig. 5), the two anterior unpaired, and four are in pairs, of which the two posterior ones are the longest. It is always peculiarly pigmented with a dark-colored pigment which presumably possesses the power of producing phosphorescent light by chemical means.<sup>b</sup>

Rudimentary branch of the second antennæ similar in both sexes, hardly noticeable, and with five setæ.

Furca always with nine toothed spines, of which the second is immovably fixed with the furcal plate. Vermiform limb with a terminal armature of from three to five unequal slender claw-like setæ, all curved to one side. Brady <sup>c</sup> figures *P. americana* as having a furca with but seven spines or spine-like setæ. This is undoubtedly an error, probably due to poor specimens.

Commonly caught at night with a surface net in tropical seas. Many instances are on record of hauls containing as high as 15,000 to 20,000 individuals. Sexual. Heretofore recorded as occurring off the American coast only by the Galatea expedition, September 10, 1875, the species *P. americana* being reported off the west coast of Central America.

Brady believes this genus intermediate in character between *Cypridina* and *Philomedes*.

## 28. PYROCYPRIS AMERICANA G. W. Müller.

Plate LXIV, figs. 1-5.

*Pyrocypris americana* MÜLLER, Zool. Jahrb., Abth. Syst., V, 1890, p. 233, pl. xxv, fig. 3.—BRADY, On new or imperfectly known Ostracoda, chiefly from a collection in the Zool. Museum, Copenhagen, 1902, p. 185, pl. XXI, figs. 11-19.

*Dimensions*.—Length, 1.55 mm.; height, 0.85 mm.; breadth, 0.56 mm.

<sup>a</sup> Neue Cypridinen, Zool. Jahrb. Abth. Syst., V, 1890, p. 231.

<sup>b</sup> Watanabe, H., 1897, Jour. R. Micr. Soc., Pt. 5, p. 384.

<sup>c</sup> Trans. Zool. Soc. London, XVI, 1902, p. 185.

Seen from the side, the shell is about twice as long as broad (fig. 1), ventral margin very much curved, dorsal margin less so; antennal notch narrow, vertical, and with a small tuft of setæ; rostral arch much produced, posterior extremity much produced into a conspicuous beak which is gently curved ventrally, but dorsally forms a very decided angle with the shell (fig. 1).

Secondary branch of the second antenna is formed of six setæ (fig. 3). The vermiform limb is armed at tip with five slender curved claws (fig. 2).

Furca with nine toothed spines (fig. 4), of which the second or subterminal one is united with the furcal plate, the remainder being plainly articulated to the plate.

The upper lip (fig. 5) as seen from the side is very strikingly developed, the hindmost tooth being the largest and notched, the others finger-like.

The pigmentation, which is supposed to be the seat of its ability to produce phosphorescent light, shows plainly as a dark pigmentation. I have never seen anything of like character associated with any other Ostracoda.

One specimen studied by me which was collected by the Bureau of Fisheries Steamer *Albatross*, Station 3921, May 6, 1902, 8.45 p. m., night anchorage; surface; off Honolulu.

#### 18. Genus PHILOMEDES Lilljeborg 1853.

*Cypridina* AUTHORS, 1853.

*Euryppylus* BRADY, Descriptions of Ostracoda, Les Fonds de la Mer, 1867-1886, Bordeaux, I, p. 141, pl. XVIII, figs. 1, 2.

*Philomedes* LILLJEBORG, Om de inom Skåne för. Crust. af ord. Cladocera, Ostracoda och Copepoda. Lund., 1853, p. 175.—BAIRD, Proc. Zool. Soc. Lond., XXVIII, 1860, p. 202.—SARS, Arch. Math. Naturv. Christiania, XII, 1887, p. 45.—BRADY and NORMAN, Trans. Royal Dublin Soc., Pt. 2, 1896, p. 653.—G. W. MÜLLER, Die Ostracoden des Golfes von Neapel, p. 207, 1904, pl. III, figs. 1-33, 36-44.—JUDAY, Univ. of Cal. pubs., III, 1907, No. 9, p. 139.

*Bradycinctus* SARS, Forh. Vid. Selsk. Christiania, 1865, p. 109.—BRADY, Trans. Linn. Soc. Lond., XXVI, 1868, p. 466.

Shell always with a distinct rostral sinus which is overhung by a broad, blunt rostral process. First antenna six-segmented, with medium long, sparsely plumose setæ, and female with no sensory setæ. Second antenna with a weak secondary branch. Secondary branch of second antenna of male three-jointed, prehensile, the last joint reflexed upon the second. First maxilla of female rather large and strong; of male indistinctly joined, weak, and armed with delicate setæ. Second maxilla of female with two rather large teeth at its anterior angle, the inner tooth the smaller and bifid; the maxilla of the male without teeth. Eyes of female rudimentary or lacking; those of male well developed. First pair of legs more or less distinctly jointed.

## 29. PHILOMEDES BRENDA (Baird).

Plate LXV, figs. 1, 2.

*Cypridina brenda* BAIRD, Nat. Hist. British Entomos., 1850, p. 181, pl. XXIII, figs. 1a-g.

*Bradycinetus brenda* BRADY, Trans. Linn. Soc., XXVI, 1868, p. 466, pl. XXXIII, figs. 1-5; pl. XLI, fig. 5.—NORMAN, Proc. Roy. Soc., XXV, 1875, p. 206.

*Philomedes brenda* NORMAN, Ann. Mag. Nat. Hist., 6th ser., VI, 1891, p. 119.—BRADY and NORMAN, Trans. Royal Dublin Soc., Pt. 2, 1896, p. 654.—G. W. MÜLLER, Nordisches Plankton, VII, Ostracoda, Kiel, 1901, p. 10, figs. 18, 19.

*Dimensions*.—Length, 3 mm.; height, 1.85 mm.; breadth, 1.52 mm.

Color a pale straw yellow. As seen from the side (fig. 1), the shell of the male is oblong, dorsal margin gently curved; ventral margin slightly sinuate, posterior margin obliquely truncate, thus forming an angle at the infero-posterior margin. The anterior sinus is ciliate, widely opened, the anterior extremity produced much beyond the sinus.

Secondary or grasping branch of the second antenna of the male (fig. 2), with its terminal segment long and narrow, twelve to fourteen times as long as wide, curved, and reflexed against the second segment, thus forming a grasping organ, and with a short ringed seta near its point of union with the second segment. Second segment bent backwards, and with three-ringed setæ of nearly equal length situated along its inner margin.

One specimen was sent to the U. S. National Museum, which was collected by Dr. J. Schmitt from off the coast of Anticosti Island, Gulf of St. Lawrence, Acc. No. 39193.

*Distribution*.—British coasts (Brady and Norman, 1896), Holsteinbourg Harbor, Greenland (Valorous, 1875), Scandinavian harbors (Norman, Sars, Lilljeborg).

## EXPLANATION OF PLATES.

## PLATE I.

- Fig. 1. *Spirocypris tuberculata*, new species, dorsal view.  
 2. *Spirocypris tuberculata*, new species, dorsal view (variety).  
 3. *Cypria dentifera*, dorsal view.  
 4. *Cypria dentifera*, lateral view.  
 5. *Cycloocypris lacis*, dorsal view.

## PLATE II.

- Fig. 1. *Candona parallelata*, lateral view.  
 2. *Candona parallelata*, dorsal view.  
 3. *Candona parallelata*, furca.  
 4. *Candona parallelata*, terminal claws of furca.  
 5. *Candona parallelata*, second foot.

## PLATE LII.

- Fig. 1. *Paracandona euplectella*, lateral view.  
 2. *Paracandona euplectella*, dorsal view.  
 3. *Paracandona euplectella*, second foot.  
 4. *Paracandona euplectella*, mandibular palp.  
 5. *Paracandona euplectella*, furca.

## PLATE LIII.

- Fig. 1. *Cypris fuscata*, lateral view.  
 2. *Cypris fuscata*, variety *minor*, dorsal view.  
 3. *Cypris fuscata*, variety *major*, dorsal view.  
 4. *Cypris fuscata*, furca.

## PLATE LIV.

- Fig. 1. *Cypris incongruus*, lateral view.  
 2. *Cypris incongruus*, dorsal view.  
 3. *Cypris incongruus*, furca.  
 4. *Spirocypris tuberculata*, new species, lateral view.  
 5. *Cyloocypris larvis*, lateral view.  
 6. *Cyloocypris larvis*, furca.  
 7. *Cyloocypris larvis*, terminal segments of second foot.

## PLATE LV.

- Fig. 1. *Spirocypris tuberculata*, new species, terminal segments of second foot.  
 2. *Spirocypris tuberculata*, new species, ejaculatory duct, in sack.  
 3. *Spirocypris tuberculata*, new species, furca.  
 4. *Spirocypris tuberculata*, new species, right maxillary foot of male.  
 5. *Spirocypris tuberculata*, new species, portion of shell, showing tubercles.  
 6. *Spirocypris tuberculata*, new species, left maxillary foot of male.

## PLATE LVI.

- Fig. 1. *Hyoocypris gibba*, lateral view.  
 2. *Hyoocypris gibba*, dorsal view.  
 3. *Hyoocypris bradyi*, dorsal view.  
 4. *Hyoocypris bradyi*, lateral view.  
 5. *Hyoocypris bradyi*, terminal segments of second foot.  
 6. *Hyoocypris bradyi*, furca.

## PLATE LVII.

- Fig. 1. *Hyodromus pectinatus*, new species, lateral view.  
 2. *Hyodromus pectinatus*, new species, maxillary palps of male.  
 3. *Hyodromus pectinatus*, new species, furca.  
 4. *Hyodromus pectinatus*, new species, dorsal view.  
 5. *Hyodromus pectinatus*, new species, terminal segments of second foot.

## PLATE LVIII.

- Fig. 1. *Cyprois marginata*, lateral view.  
 2. *Cyprois marginata*, dorsal view.  
 3. *Cyprois marginata*, furca.  
 4. *Cyprois marginata*, first maxillary process.  
 5. *Cyprois marginata*, terminal segments of second foot.

## PLATE LIX.

- Fig. 1. *Notodromas monacha*, lateral view.  
 2. *Notodromas monacha*, dorsal view.  
 3. *Notodromas monacha*, right maxillary foot of male.  
 4. *Notodromas monacha*, left maxillary foot of male.  
 5. *Notodromas monacha*, terminal segments of second foot.  
 6. *Notodromas monacha*, ventral view.  
 7. *Notodromas monacha*, spines of maxillary process.  
 8. *Notodromas monacha*, furca.

## PLATE LX.

- Fig. 1. *Cythere americana*, new species, lateral view.  
 2. *Cythere americana*, new species, first leg.  
 3. *Cythere americana*, new species, second leg.  
 4. *Cythere americana*, new species, mandibular palp.  
 5. *Cythere americana*, new species, first antenna.  
 6. *Cythere americana*, new species, dorsal view.

## PLATE LXI.

- Fig. 1. *Cythere papillosa*, new species, dorsal view.  
 2. *Cythere papillosa*, new species, lateral view.  
 3. *Cythere papillosa*, new species, first antenna.  
 4. *Cythere papillosa*, new species, second antenna.

## PLATE LXII.

- Fig. 1. *Cylindroleberis oblonga*, lateral view.  
 2. *Cylindroleberis oblonga*, furca.  
 3. *Cylindroleberis oblonga*, part of a terminal claw of furca.  
 4. *Cylindroleberis oblonga*, extremity of vermiform limb.

## PLATE LXIII.

- Fig. 1. *Cylindroleberis lobianci*, lateral view of female.  
 2. *Cylindroleberis lobianci*, lateral view of male.  
 3. *Cylindroleberis lobianci*, dorsal view.  
 4. *Cylindroleberis lobianci*, terminal part of vermiform limb.  
 5. *Cylindroleberis lobianci*, mandibular process.

## PLATE LXIV.

- Fig. 1. *Pyrocypriis americana*, lateral view.  
 2. *Pyrocypriis americana*, terminal part, vermiform limb of female.  
 3. *Pyrocypriis americana*, inner branch, antenna of female.  
 4. *Pyrocypriis americana*, furca.  
 5. *Pyrocypriis americana*, upper lip, side view.

## PLATE LXV.

- Fig. 1. *Philomedes brenda*, lateral view.  
 2. *Philomedes brenda*, secondary branch of antenna of male.  
 3. *Cylindroleberis lobianci*, furca, showing an enlarged seta.  
 4. *Cylindroleberis lobianci*, another young stage, as fig. 5.  
 5. *Cylindroleberis lobianci*, rudimentary inner branch; second antenna of female (young).  
 6. *Cylindroleberis lobianci*, rudimentary inner branch, second antenna of male.  
 7. *Cylindroleberis lobianci*, portion of a natatory seta,

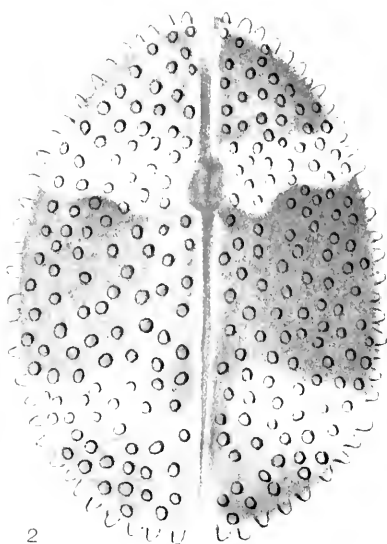
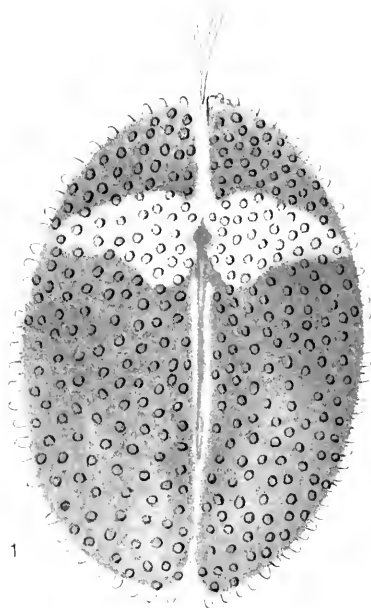

3

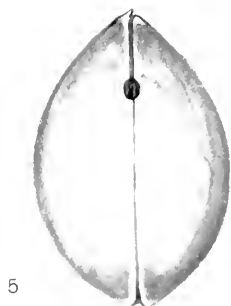

4

*SPIROCYPRIS TUBERCULATA*, *CYPRIA DENTIFERA*, AND *CYCLOCYPRIS LAEVIS*

FOR EXPLANATION OF PLATE SEE PAGE 428





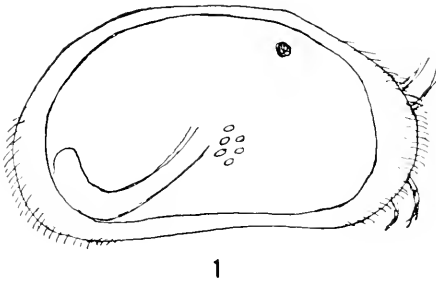

1

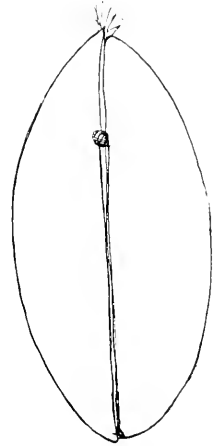

2

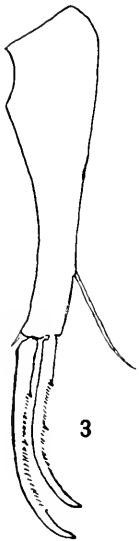

3



4

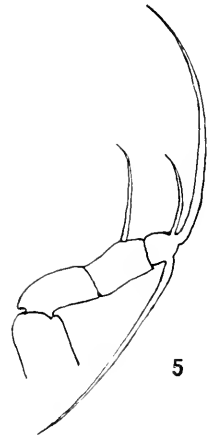

5

CANDONA PARALLELA.

FOR EXPLANATION OF PLATE SEE PAGE 428.



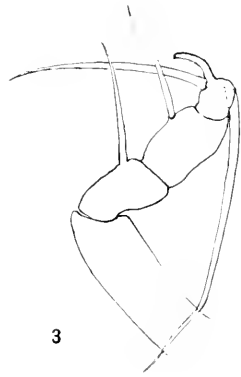
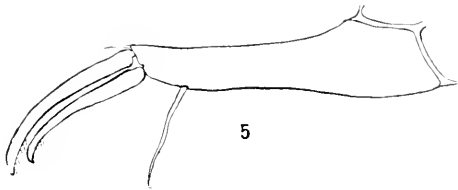
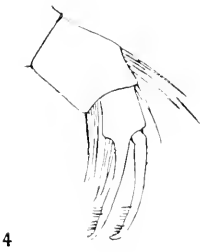
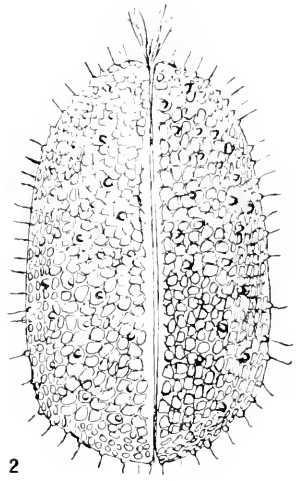
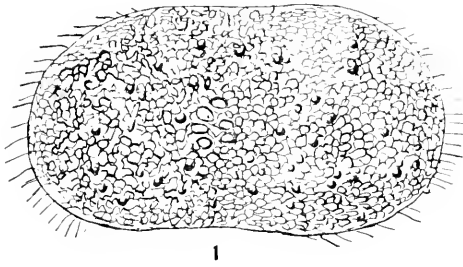

PARACANDONA EUPLECTELLA.

FOR EXPLANATION OF PLATE SEE PAGE 429.



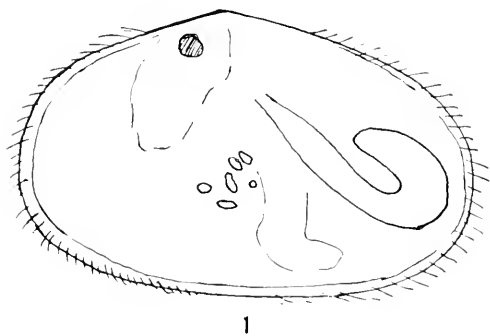
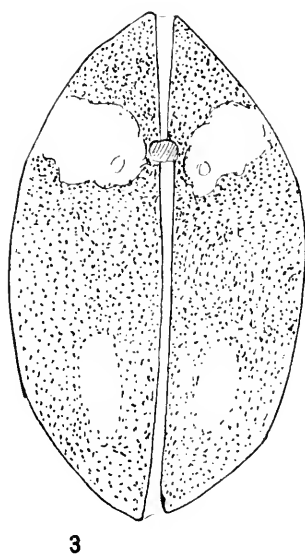
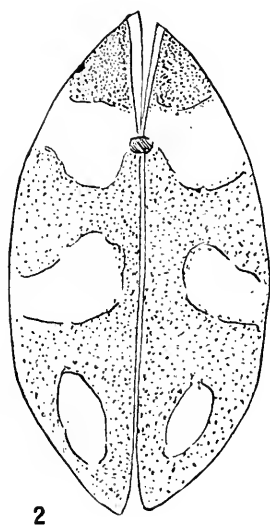

CYPRIS FUSCATA.

FOR EXPLANATION OF PLATE SEE PAGE 429.

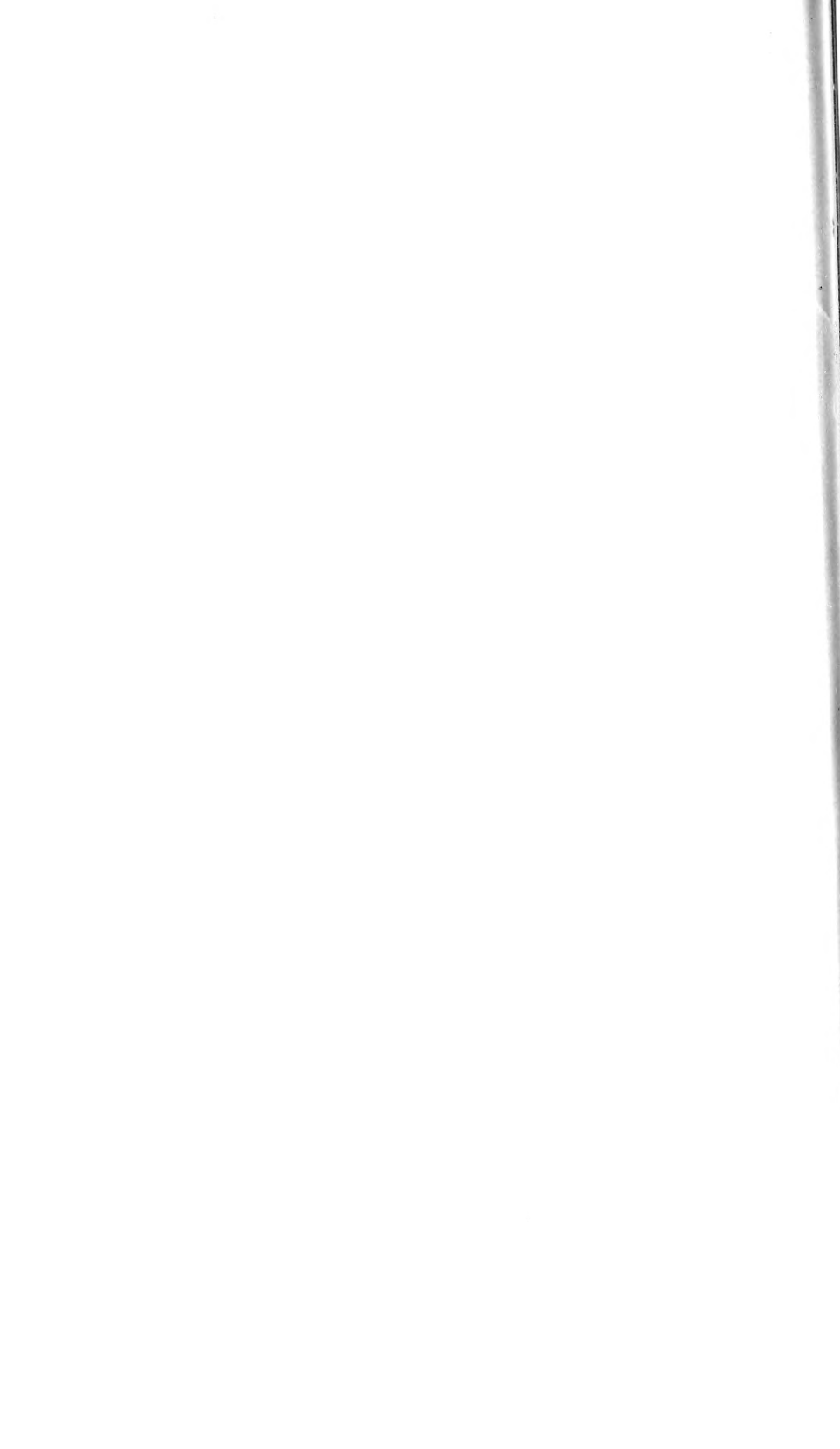

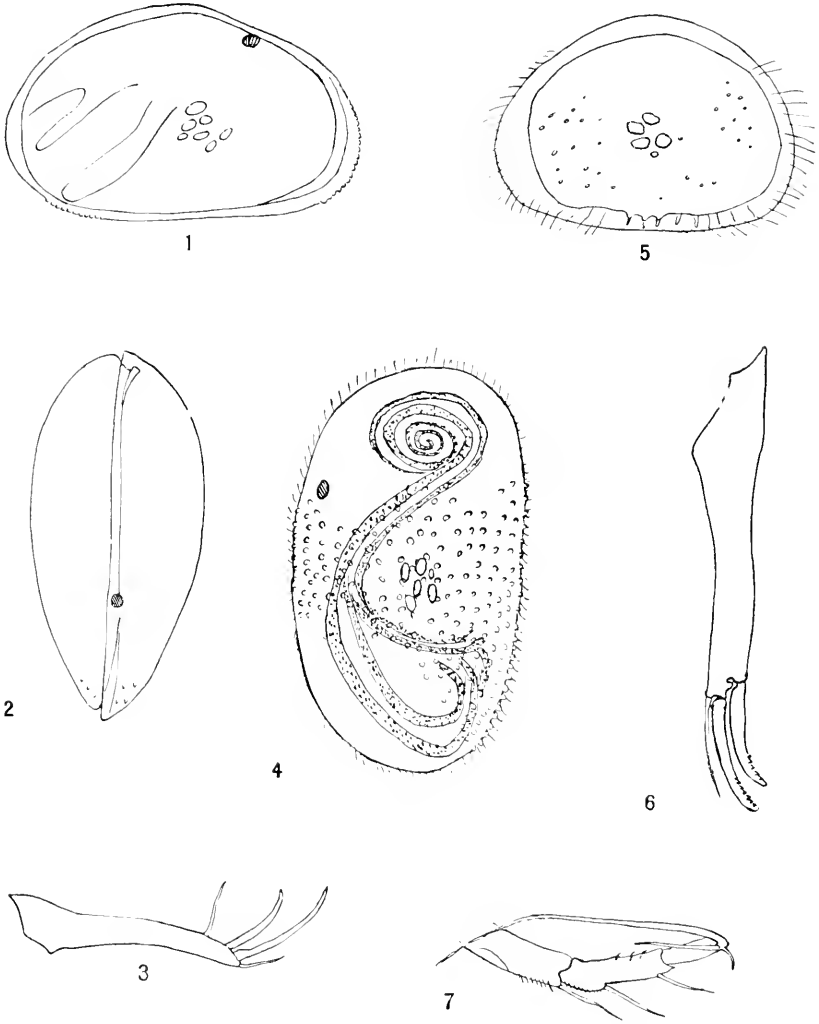

CYPRIS INCONGRUENS, SPIROCYPRIS TUBERCOLATA, AND CYCLOCYPRIS LÆVIS.

FOR EXPLANATION OF PLATE SEE PAGE 429.





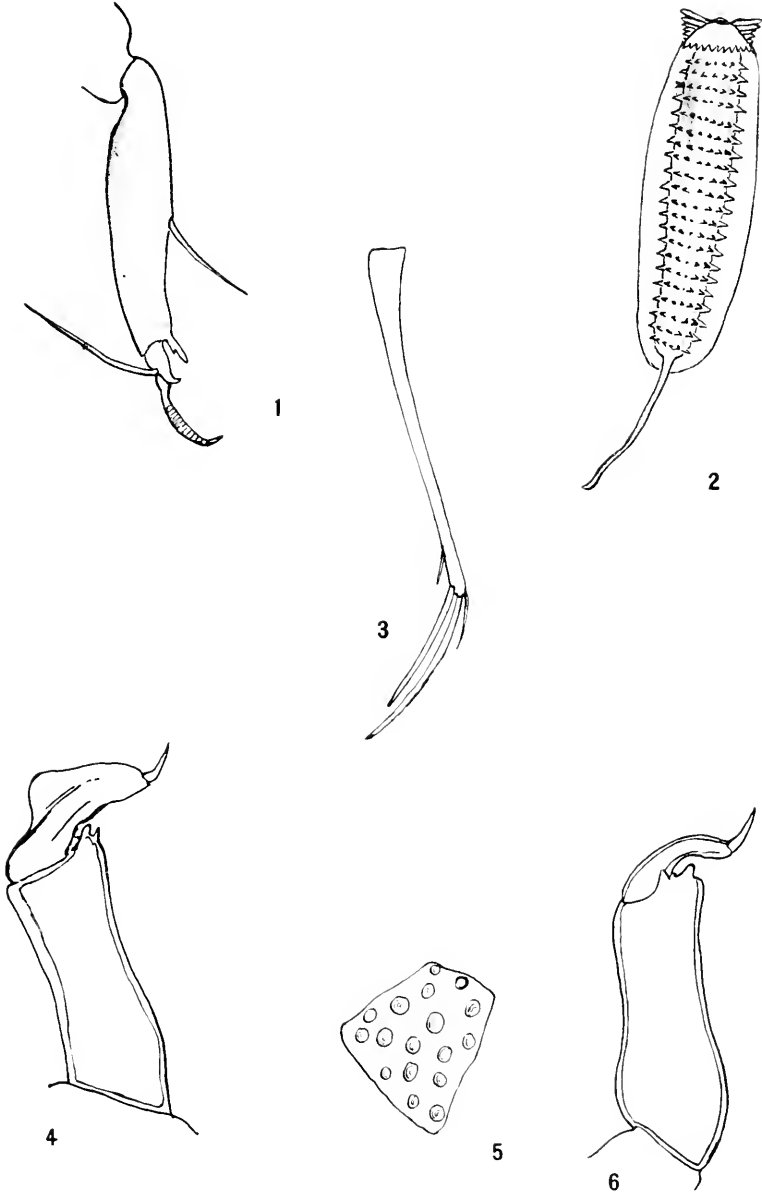

SPIROCYPRIS TUBERCULATA, NEW SPECIES.

FOR EXPLANATION OF PLATE SEE PAGE 429.

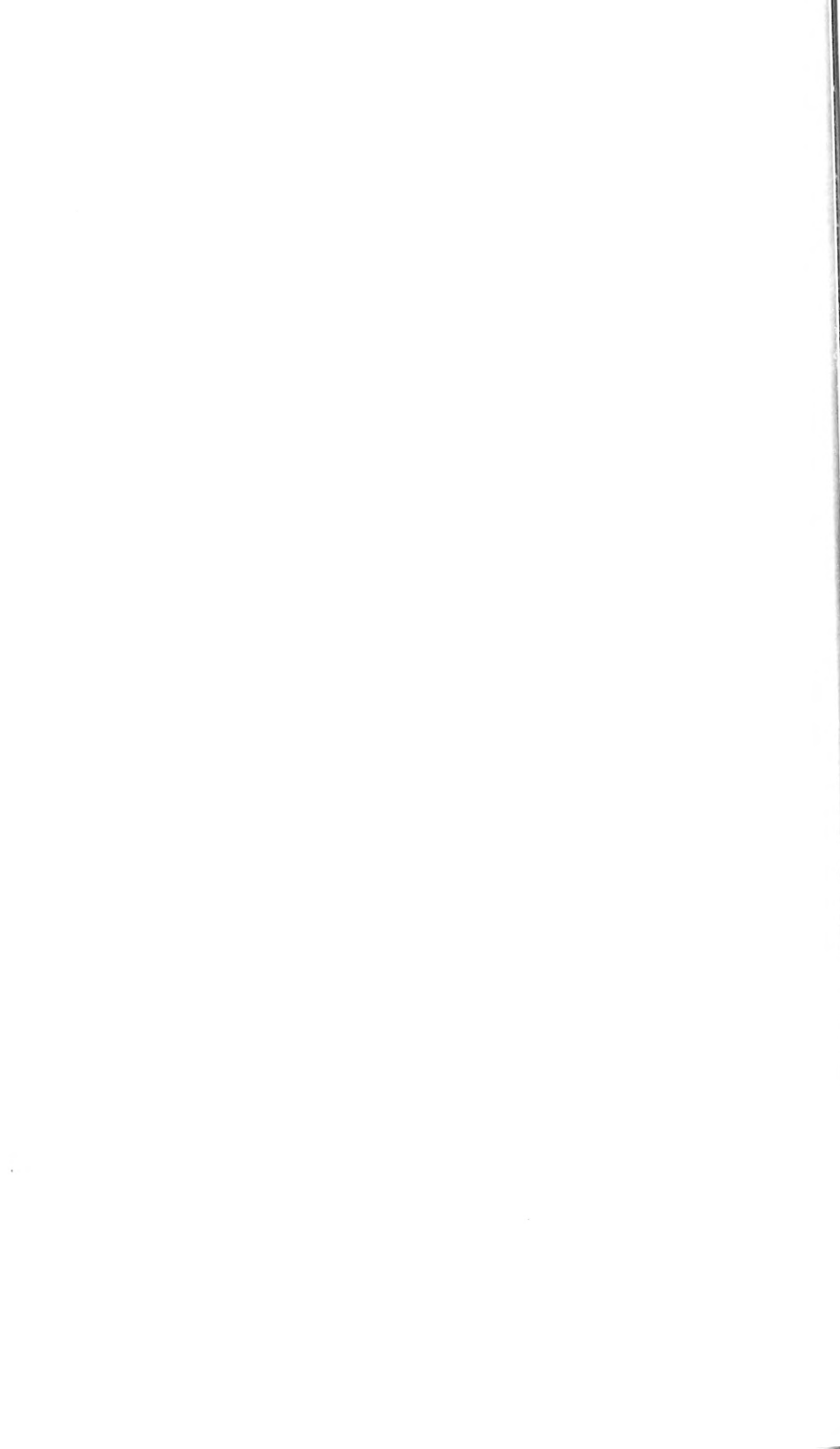

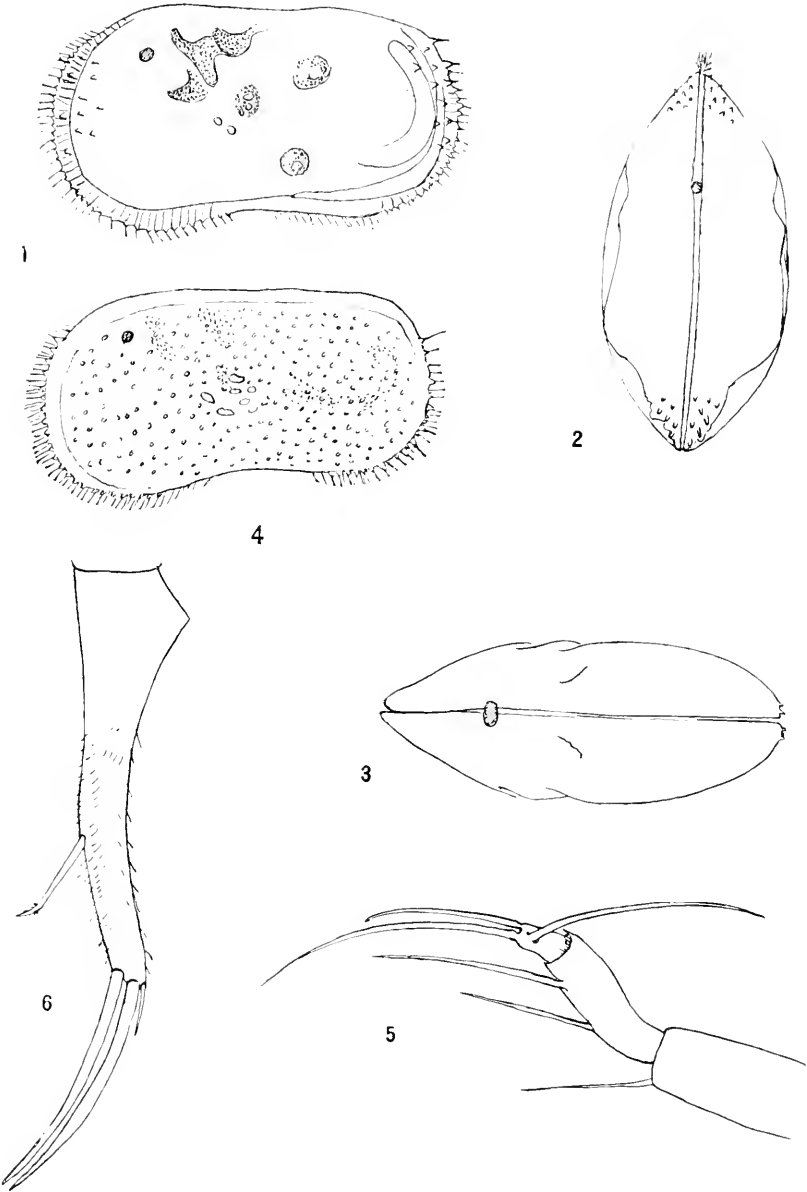

*ILYOCYPRIS GIBBA* AND *ILYOCYPRIS BRADYI*.

FOR EXPLANATION OF PLATE SEE PAGE 429.

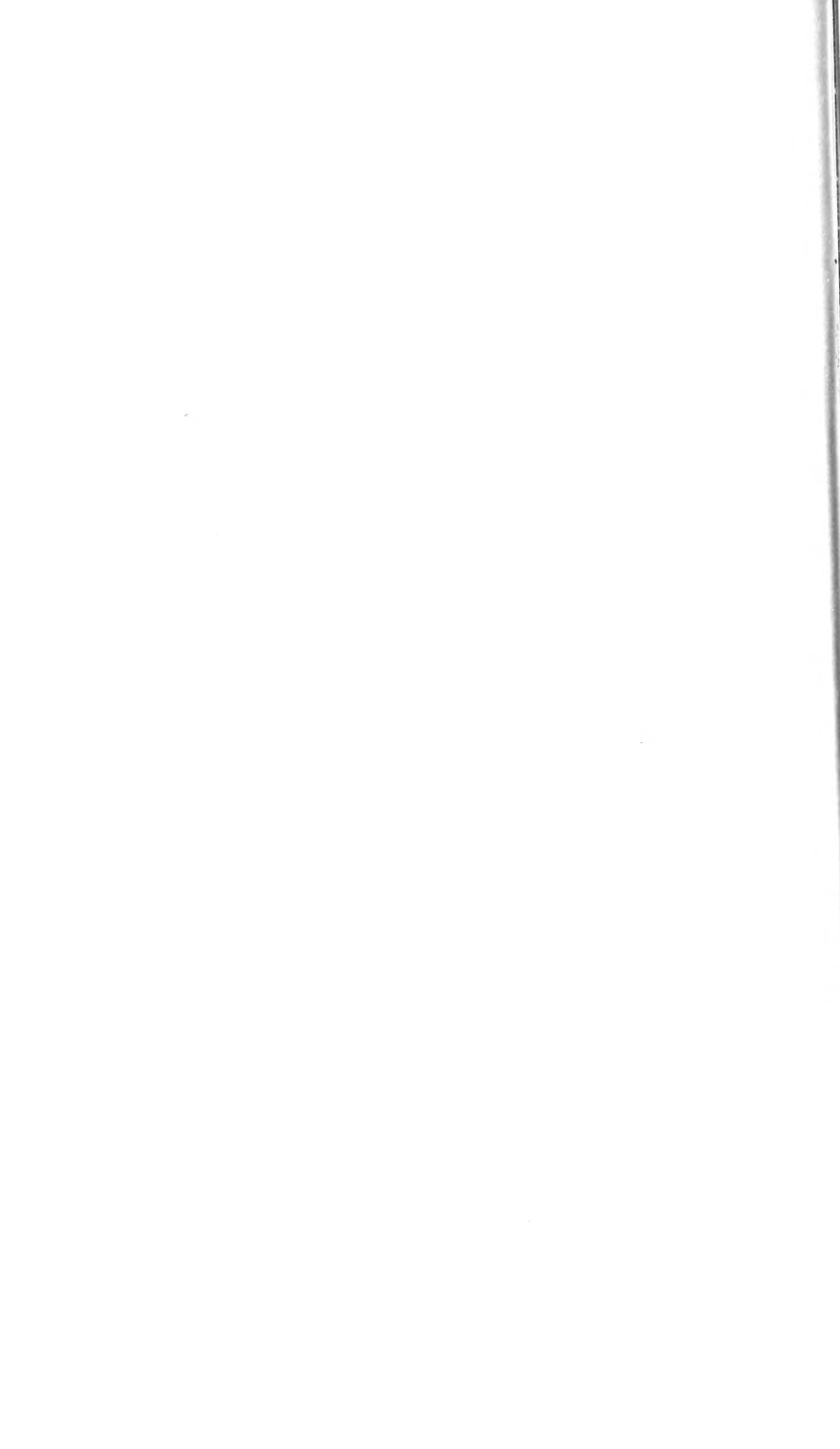

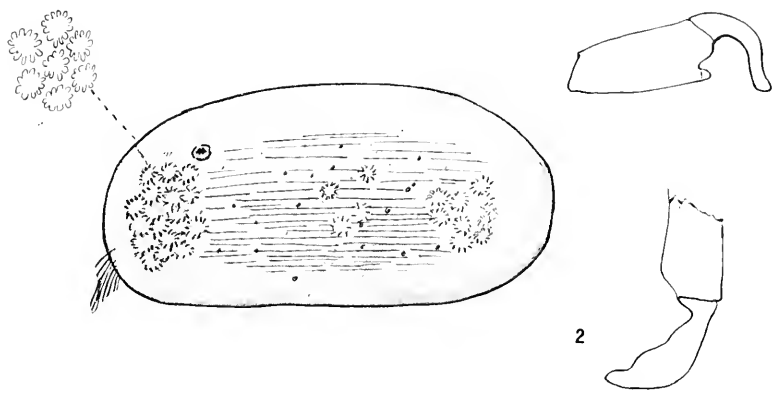

1

2

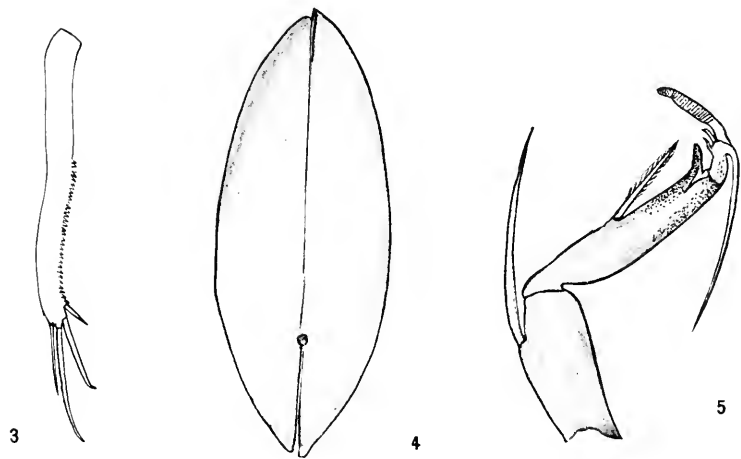

3

4

5

*ILYODROMUS PECTINATUS*, NEW SPECIES.

FOR EXPLANATION OF PLATE SEE PAGE 429.



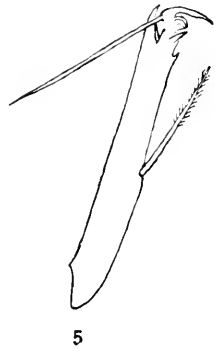
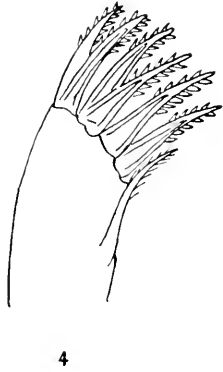
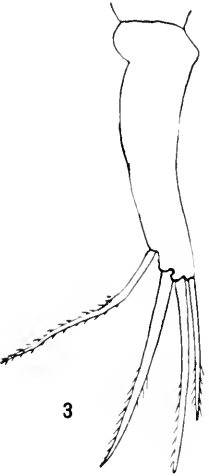
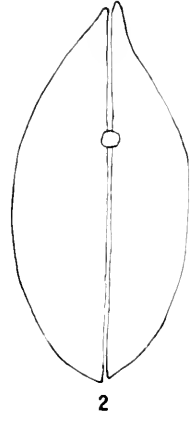
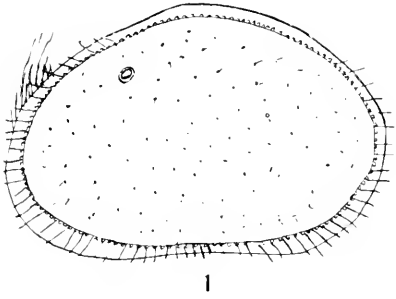

CYPROIS MARGINATA.

FOR EXPLANATION OF PLATE SEE PAGE 429.





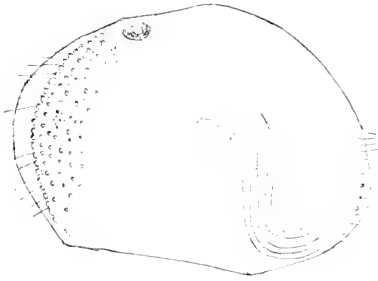

1

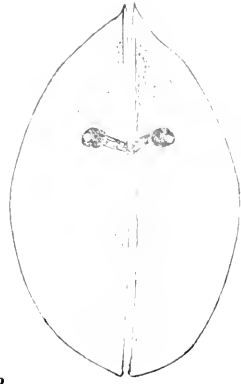

2

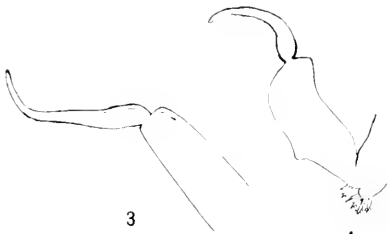

3

4



5

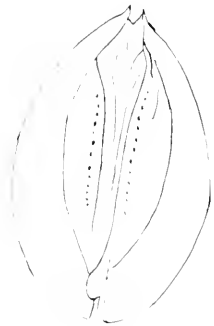

6



7



8

NOTODROMAS MONACHA.

FOR EXPLANATION OF PLATE SEE PAGE 430.



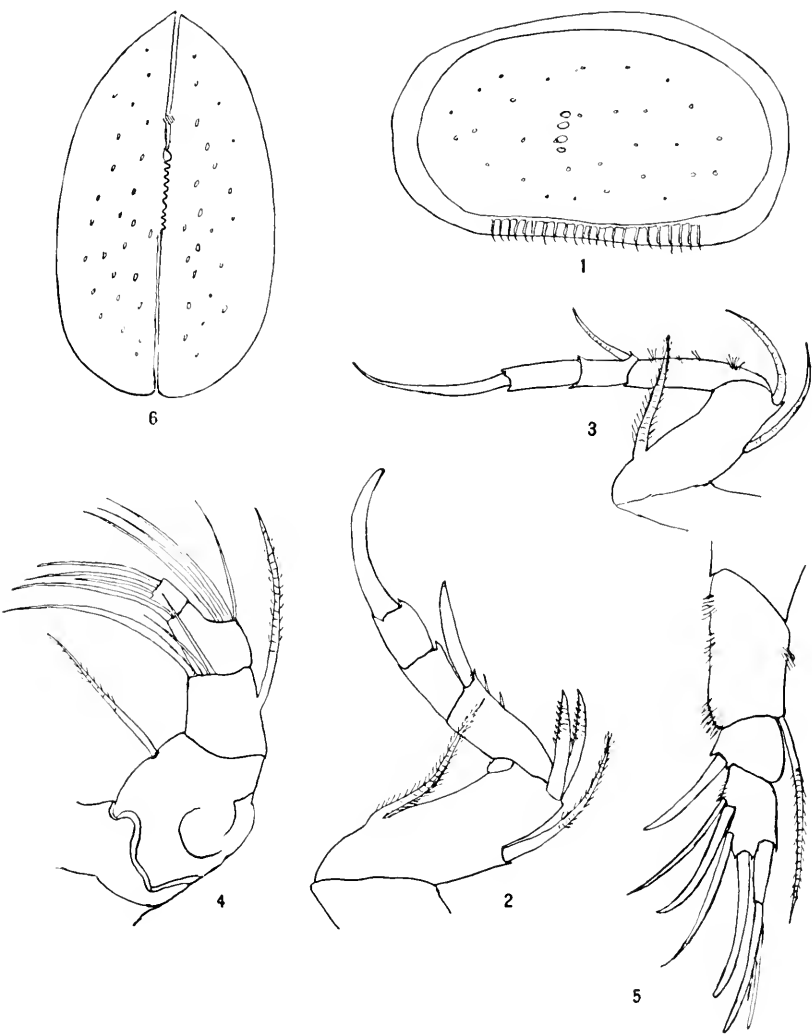

CYHERE AMERICANA, NEW SPECIES.

FOR EXPLANATION OF PLATE SEE PAGE 430.



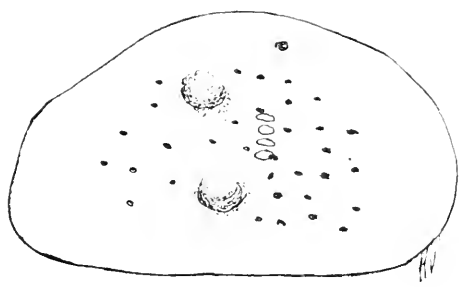

2

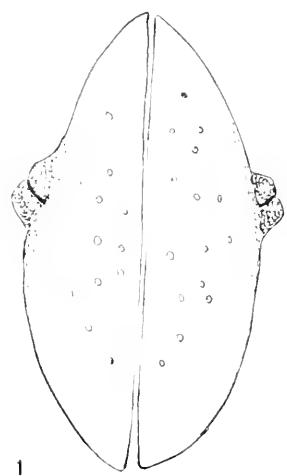

1

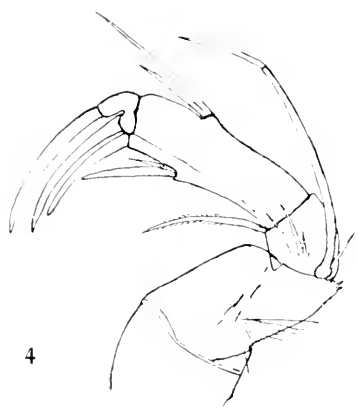

4

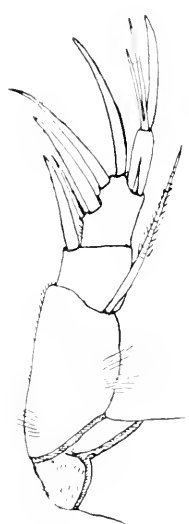

3

CYHERE PAPILLOSA, NEW SPECIES

FOR EXPLANATION OF PLATE SEE PAGE 430.



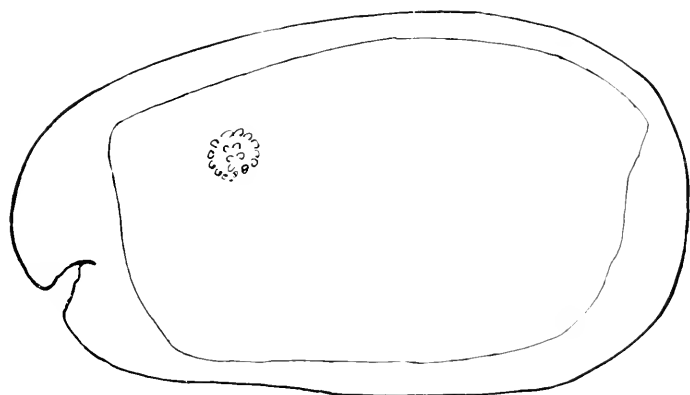

1

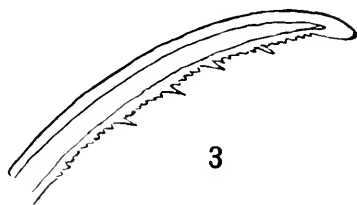

3

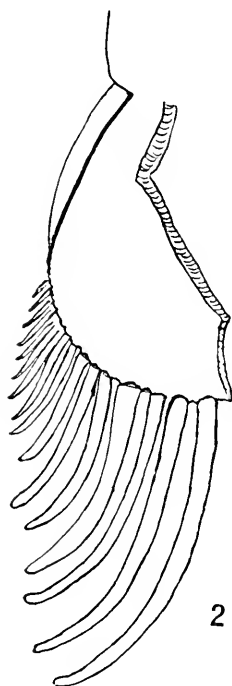

2

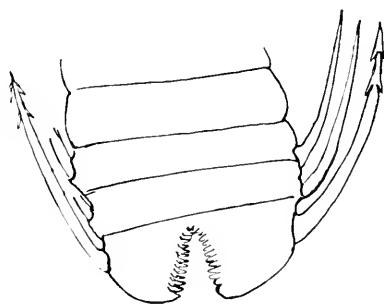

4

CYLINDROLEBERIS OBLONGA.

FOR EXPLANATION OF PLATE SEE PAGE 430.

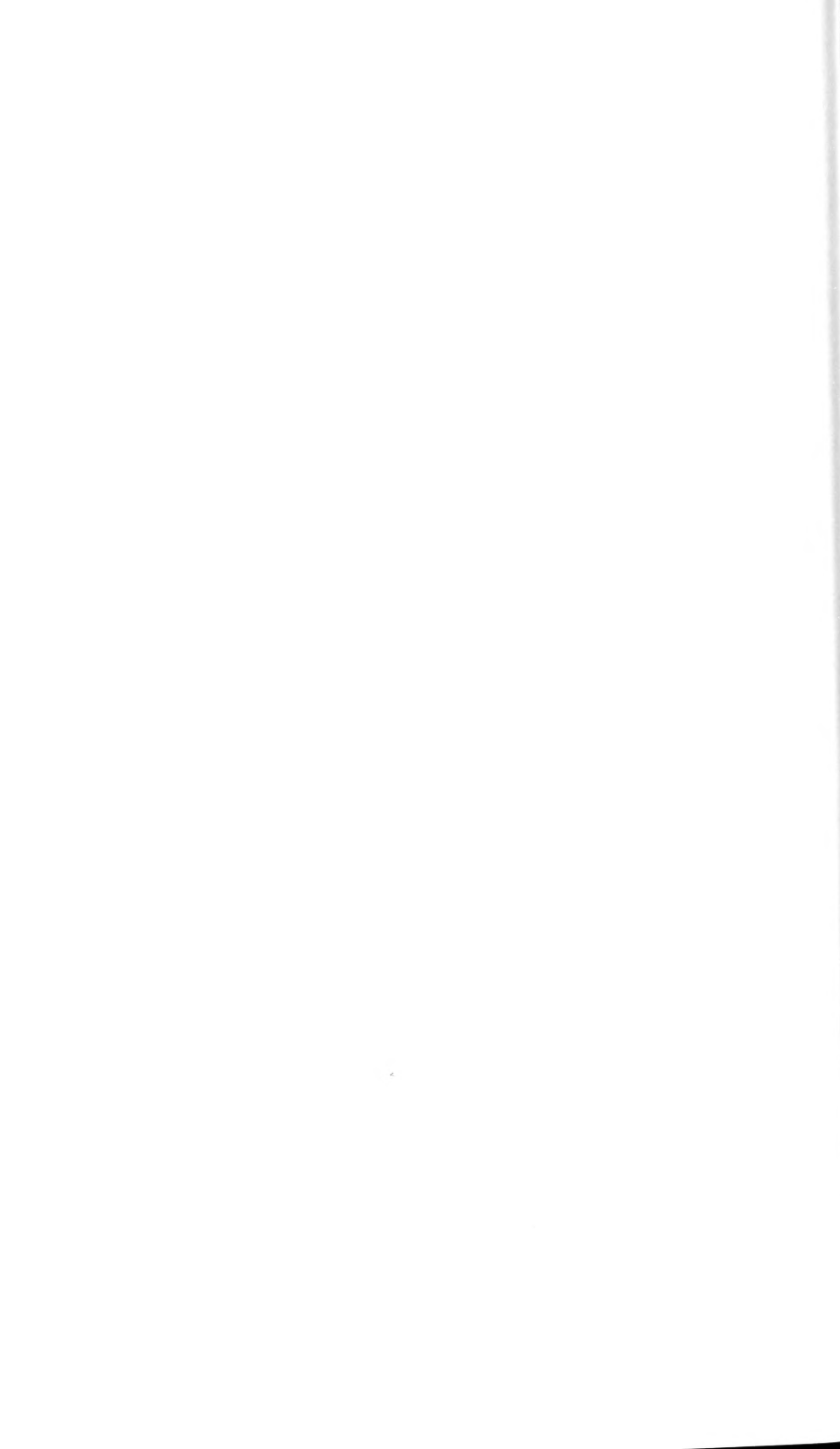



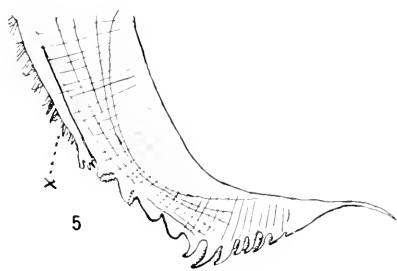
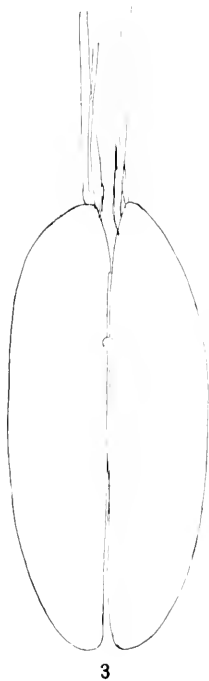

CYLINDROLEBERIS LOBIANCI.  
FOR EXPLANATION OF PLATE SEE PAGE 430.



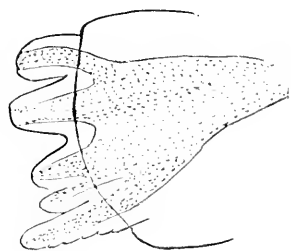

5

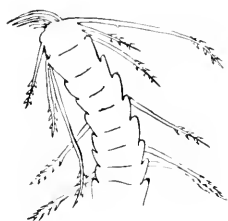

2

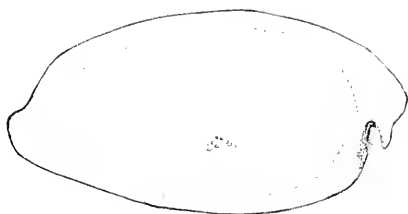

1



3

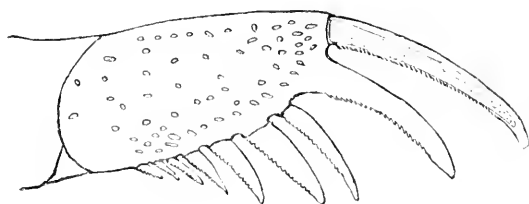

4

PYROCYPRIIS AMERICANA.

FOR EXPLANATION OF PLATE SEE PAGE 430.



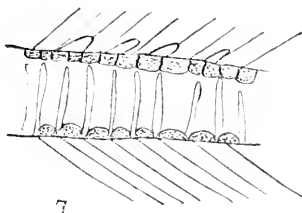
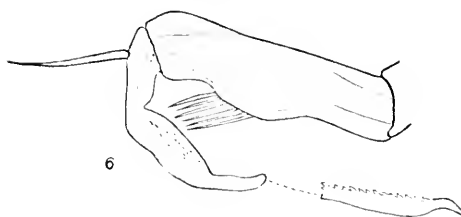
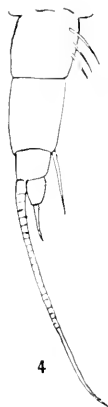
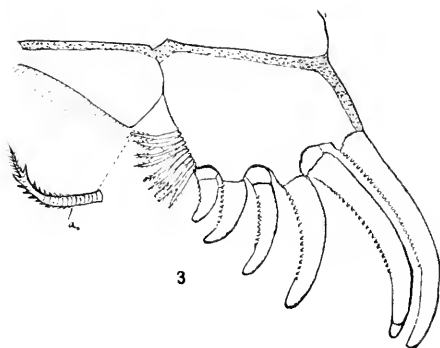
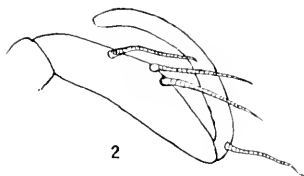
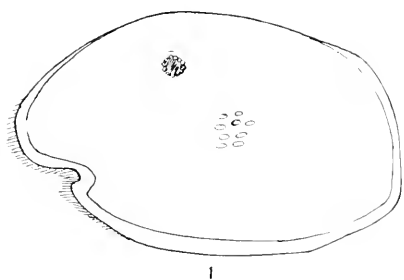

PHILOMEDES BRENDA AND CYLINDROLEBERIS LOBIANCI.

FOR EXPLANATION OF PLATE SEE PAGE 430.

With the exception of a lot of material sent by Dr. C. A. Kofoid and another lot, comprising the results obtained by the steamer *Albatross* during her Pacific cruise in 1904, sent by Dr. William E. Ritter, all the specimens collected under the auspices of the Bureau of Fisheries had been turned over to the U. S. National Museum, and came to the author in the collection sent from that institution.

It has been the aim to include all this material in the present list together with those copepod parasites which have been described by other authors as occurring on the Pacific coast fishes. But it must be remembered that this is the first attempt at anything of the sort, and that such primary collections are more or less defective. It is hoped, however, that it may serve as a basis for future investigations. In those cases in which the parasites have already been acceptably described elsewhere it has been considered necessary to give merely the name and a reference to the literature which tells of their occurrence on Pacific coast fishes, or which describes and figures them.

The sources from which have been received the material illustrating each species have been given as far as known, with the addition of such brief comments as seemed advisable.

On the other hand, those genera and species which have proved new to science have been fully described and figured.

While the proportion of these new species is apparently very large, this is no more than should be expected in changing from one ocean to another, or even from the Asiatic to the American side of the Pacific. But the novelty of the characters of these new forms is of much less importance than the close relationship which they show between species inhabiting widely remote localities. He who really cares to go into details will find that there are close correspondences between the Atlantic and Pacific copepods similar to those found in other groups of animals, particularly, perhaps, in the fishes which serve as hosts for these parasites. As at present prepared the list includes 41 species, of which 17 are new to science, including 5 new genera.

### Family ARGULIDÆ.

#### ARGULUS PUGETTENSIS Dana.

*Argulus pugettensis* DANA, 1852, p. 1351, pl. xciv, fig. 2.—WILSON, 1902, p. 711, pl. xv.

*Host and record of specimens.*—The host of the specimens obtained by Dana was unrecorded. A single female was taken from a Coho salmon, *Oncorhynchus kisutch*, at Union Bay in June, 1903, and was obtained and sent with the other material by Doctor McClelland. It is Cat. No. 38561, U.S.N.M.

## ARGULUS NIGER Wilson.

*Argulus niger* WILSON, 1902, p. 714, pl. xviii.

*Host and record of specimens.*—The two specimens on which this species was founded were obtained by the steamer *Albatross* in October, 1899, from the Pacific coast near Portland, Oregon. The name of the host was not given.

## Family ERGASILIDÆ.

## Genus ARTACOLAX, new.

First thorax segment united with the head to form the carapace, which is much wider than it is long. Second thorax segment free and as wide as the carapace or nearly so. Third and fourth segments fused and the same width as the second segment or but little narrower. Fifth segment free and abruptly narrowed to a half or even a third of the width of the preceding fused segments. Genital segment enlarged but little; abdomen narrow and linear.

First antennæ very large; basal joint often armed with large spinous processes. Second antennæ two-jointed. Mouth organs close to the antennæ; second maxillipeds large and attached outside the other organs as in *Bomolochus*; furnished, as in that genus, with S-shaped terminal claws, but without any plumose setæ. First swimming legs with very wide rami, armed with large flattened plumose setæ; exopod one-jointed, endopod three-jointed.

Male like the female, but with the second maxillipeds in normal position behind the other mouth parts and armed with the usual terminal curved claw.

*Type-species.*—*Artacolax (Bomolochus) ardcola* Kröyer.

(*Artacolax*, ἀρτάω, to hang on, and κῶλαξ, a parasite).

This genus is distinguished from *Bomolochus* by the great comparative width of the first four thorax segments, by the fusion of the third and fourth segments, so that there are apparently but three free segments in front of the genital segment instead of four, as in *Bomolochus*, by the lack of plumose setæ on the second maxillipeds, by the increased width of the rami of the first swimming legs, and the fact that the exopod has but a single joint.

This new genus will include the following species in addition to the type: *Bomolochus chatocssi* Kröyer; *B. cornutus* Claus; *B. scomberesocis* Kröyer; and probably *B. hirsutus* Hesse, although the last mentioned species is so poorly described that it is impossible to locate it exactly.

## ARTACOLAX (BOMOLOCHUS) ARDEOLÆ Krøyer, new genus name.

*Artacolar* (*Bomolochus*) *ardcola* KRØYER, 1863, p. 220, pl. XI, figs. 3 a to c.

*Host and record of specimens*.—A single female was taken from the gills of the little garibaldi, *Hypsypops rubicundus*, at La Jolla, by Doctor McClendon, and is Cat. No. 38597, U.S.N.M.

On examining the described species of *Bomolochus* it is found that there are differences between them which can not consistently be included in a single genus. These differences are found in the body segmentation and in the structure and arrangement of the mouth parts and the first swimming legs. The same rule must be applied here that is used in dealing with other genera. In all the species really belonging to the genus *Bomolochus* there must be the same number of thoracic segments, however much those of the abdomen may vary. The appendages must also be of the same general character and similarly arranged. But this is not found to be true, and, accordingly, the preceding new genus must be established for certain species hitherto included in the genus *Bomolochus*, which agree among themselves, but do not agree with the original *Bomolochus* type.

## Family CHONDRACANTHIDÆ.

## CHONDRACANTHUS EPACTHES, new species.

## Plate LXVI.

*Host and record of specimens*.—Five females and two males were taken by Doctor McClendon from a chimera or elephant fish, *Hydrolagus collicii*, at La Jolla, and are Cat. No. 38580, U.S.N.M. These are made the types of the new species.

*Female*.—General body form elongate with rounded outlines and without any horns or processes. Head small and ovate, considerably narrowed anteriorly and covered with a carapace of the same shape but smaller, not reaching the posterior margin of the head.

First thorax segment only three-fifths the diameter of the head, twice as wide as long, and distinctly separated from the following segment. Second segment twice the width of the first, narrowed anteriorly, and also distinctly separated from the following segments. Genital portion divided at its center by a marked constriction on either margin and a well-defined groove; the two halves very different in form, the anterior one oblong with straight and parallel sides and but slightly rounded corners, the posterior half elliptical, with strongly convex sides and long club-shaped processes at the posterior corners. Abdomen small and conical, bluntly rounded at the tip, less than half the length of the posterior processes, and without anal laminae. Egg strings one-fourth the diameter of the genital portion and a little longer than the entire body, tapering toward the posterior ends; eggs small, about ten longitudinal rows,



First antennae swollen and two-jointed, terminal joint much smaller than the basal, as wide as long and armed with a few minute spines. Second antennae in the form of large sickle-shaped hooks, their bases enlarged into hemispherical knobs and articulated directly with the ventral surface of the head. Mouth and mouth parts at the extreme posterior border of the head; mouth opening a transverse slit partially covered by the upper lip, which is ribbon-shaped, much wider than long, and has a straight posterior margin.

Maxillae and maxillipeds visible at the sides of the mouth opening, mandibles concealed beneath the upper lip. Mandibles of the usual shape, a flattened and curved lamina, twice as long as wide, pointed at the tip, and armed along either margin with a row of large bluntly pointed teeth, about 30 on the convex margin and 25 on the concave. Maxillae two-jointed, the basal joint swollen and cylindrical and attached just at the posterior margin of the upper lip; the terminal joint an elongate pointed lamina, with six or seven large rounded teeth on its posterior margin near the tip. Maxillipeds also two-jointed, the basal joint swollen and attached close to the maxillae, the terminal joint smaller and divided at the tip into a dorsal and ventral knob. The former is covered with small spines, the latter carries a single large conical spine.

Total length, 10.5 mm. Length of head, 1.5 mm. Width at posterior margin, 1.5 mm. Length of first two thorax joints, 1.75 mm.; of genital portion, 7.25 mm. Width of latter, 2.75 mm. Length of egg strings, 11.5 mm.

*Color*.—This is of a muddy gray, somewhat mottled on the dorsal surface, lighter beneath. Egg strings a sulphur yellow.

*Male*.—Head joined with the first thorax segment and swollen into an ovoid mass much larger than the rest of the body. Free thorax distinctly segmented and curved over ventrally; genital segment slightly enlarged and evenly rounded; no abdomen; two narrow conical anal laminae attached directly to the genital segment, each tipped with two minute spines.

First antennae in the form of small finger-like projections just over the bases of the second pair. Other mouth parts similar to those of the female. Two pairs of rudimentary legs on the first two thorax joints, each consisting of a short cylindrical basal joint tipped with two conical spines.

Total length, 1.6 mm. Length of carapace, 0.88 mm. Width of same, 0.6 mm.

Color, a clear yellow, much lighter than the female; found attached to the abdomen of the latter between the posterior processes of the genital portion.

(*epachthes*, ἐπαχθής, troublesome, annoying.)

All the specimens are excellently preserved and each of the females carries a pair of fully developed egg strings.

## Genus PSEUDOCHONDRACANTHUS, new.

*Diagnosis.*—Head distinctly separated from the rest of the body and covered dorsally with a small carapace. First thorax segment only free, the others fused into the elongate genital portion, which is without any traces of segmentation. Abdomen small and two-jointed. Egg strings long; eggs multiseriate. Second antennæ in the form of stout falcate hooks. Mouth parts at the posterior margin of the head. Mandibles similar to those of *Chondracanthus*. Maxillæ sickle-shaped laminae like the mandibles, armed with a row of broad blunt teeth along either margin, and carrying at the base on the dorsal surface a blade-like palp. Maxillipeds relatively very large and attached to the extreme lateral margins of the head; their basal joints are flattened laminae, strongly muscular and bordered by muscular flaps on either side; their terminal joints are bilobed, one lobe armed with a stout claw, the other covered with short spines.

When closed these organs cover the bases of the other mouth parts and the entire sides of the face, giving to the latter a swollen appearance; when open they expose the front of the face to its extreme lateral margins. There is but a single pair of rudimentary swimming legs, flattened and bilobed at their tips.

*Type-species.*—*Pseudochondracanthus diceraus*,  
(*pseudo*, and *Chondracanthus*.)

PSEUDOCHONDRACANTHUS DICERAUS, new species.

Plate LXVII.

*Host and record of specimens.*—Two females with fully developed egg strings, and each with a male attached to its abdomen, were taken from a species of puffer at La Jolla, California, by Doctor McClendon and are Cat. No. 38581, U.S.N.M. (See also p. 477.)

It has been found on the Atlantic coast as well as the Pacific; a fine lot of specimens were obtained from the gills of the common puffer, *Spharoides maculatus*, by Doctor McClendon at Woods Hole, Massachusetts, in 1906, and these have been made the types of the species; they are Cat. No. 38603, U.S.N.M.

Another lot, Cat. No. 38604, U.S.N.M., was obtained from the same fish by Doctor Linton, also at Woods Hole.

The author was fortunate enough to obtain some living specimens while at Beaufort, North Carolina, in the summer of 1905.

*Female.*—General body form short and plump; head as long as wide, the anterior margin convex, the lateral and posterior margins concave, all four corners projecting and well rounded. From each anterior corner a short and bluntly rounded horn extends out later-

ally. The head is partially covered with a carapace, ovate in shape, much narrowed anteriorly, and with a deep groove along the mid-line for two-thirds of its length. There is but a single free thorax segment behind the head; this is nearly as wide as the head and carries a single pair of rudimentary legs.

The genital portion of the body is elliptical, slightly narrowed posteriorly, one-third wider than the head, and entirely covered with small triangular flattened spines. It shows no traces of segmentation, not even in the form of indentations along the lateral margins. At its posterior corners it is produced into broad conical processes, short and bluntly rounded at their tips. Egg-tubes one-third the diameter of the genital portion and as long as the entire body; eggs quite large and arranged in five or six longitudinal rows. Abdomen small, about as long as the posterior processes, and either conical, with a triangular outline similar to that of the processes, or sometimes in the shape of a trefoil, the base swollen on either side.

First antennae small, with a swollen base and a much narrower terminal portion, tipped with two setae. Second antennae in the form of sickle-shaped claws, very sharp and having their bases articulated directly with the ventral surface of the head.

Mouth and mouth parts at the posterior margin of the head as in *Chondracanthus*, but in the present genus the sides of the head opposite the mouth (the cheeks) are swollen out into a hemisphere on either side, as though suffering from a bad attack of the mumps. This swelling is due to the enlargement of the basal joints of the maxillipeds. Mouth opening narrow and covered with a semicircular upper lip, very different from the long and ribbon-like one usually found in *Chondracanthus*. To increase the difference, the upper lip of the present genus is armed with a row of short hairs around its margin.

The mandibles are curved rather strongly, especially at the tips, and are furnished with a row of sharp teeth along either margin, as in *Chondracanthus*. The maxillae are similarly curved and are armed with a row of large, blunt teeth on either margin and a long spur or palp at the base on the dorsal surface, shaped like a knife blade and directed diagonally backward and inward. The maxillipeds are very different from those in *Chondracanthus*; instead of being slender, but little larger than the maxillae, and attached to the front of the face close to the mid-line, they are so much enlarged that they cover the bases of the other mouth parts and occupy the whole side of the face. Their swollen basal joints are filled with powerful muscles, as can be seen in fig. 15, which must render them useful organs of prehension. Their terminal joint is bilobed, each lobe forming a knob; the dorsal one is covered with short spines and is much larger than the ventral, which is armed

with a single strongly curved claw. These organs are articulated with the face at its extreme lateral margins, so that on opening they expose the entire width of the face.

There is but a single pair of rudimentary swimming legs, which are short, narrow, and bluntly rounded at their tips.

Total length, 3 mm. Length of head, 0.8 mm.; width the same. Length of genital portion, 2 mm. Width, 1.1 mm. Length of egg strings, 3 mm.

*Color*.—That of transparent cartilage, with the exception of the coiled oviducts in the genital portion, which are white and opaque. The small spines which cover the genital portion break the light and give this part of the body a grayish appearance. The eggs are snow white when first laid, becoming yellow as they ripen and afterwards a beautiful rose red or pink. There is so much of this pigment in the matured nauplius that the entire egg strings assume a deep rose color.

*Male*.—A pigmy attached to the abdomen of the female; the first thorax segment united with the head to form a cephalothorax much larger than the rest of the body, and covered with a three-lobed carapace whose lateral margins are broadly rounded and project some distance back of the central portion. Free thorax not distinctly segmented; no abdomen; anal laminae in the form of long conical processes, divided at the ends for half their length. Second antennae and mouth parts similar to those of the female; maxillipeds relatively as large and opening similarly; rudimentary legs entirely lacking.

Total length, 0.43 mm. Width of cephalothorax, 0.2 mm.

*Color*.—A uniform light yellow.

*Nauplius*.—Body broadly elliptical, with an evenly curved outline unbroken either at the anterior or posterior ends. The usual three pairs of appendages, all of which are relatively large for the size of the body. Eyes three in number and arranged in the form of a triangle close to the anterior margin, the apex of the triangle pointing forward. Balancers short, stout, and close together on either side of the mid-line; each is conical in form and curves outward and backward away from its fellow.

Total length of body, 0.15 mm. Width of same, 0.12 mm.

*Color*.—A deep rose red, filling the entire anterior four-fifths of the body. Not only the yolk, which is the portion usually taking the pigment, but the entire anterior half of the body, which in most nauplii is clear and transparent and without pigment, is here covered with a heavy rose wash, nearly concealing the muscles and eyes.

(diceraus,  $\delta\acute{\iota}\varsigma$ , double, and  $\kappa\epsilon\rho\acute{\alpha}\acute{\omicron}\varsigma$ , horned.)

This new genus is sufficiently distinguished from *Chondracanthus* by the fact that there is only one free thorax segment and a single

pair of rudimentary legs, and by the structure and attachment of the second maxillipeds. They do not have a very strong hold on the gill filaments, but are easily removed without taking any of the tissues with them. On being placed in an aquarium they lie helplessly upon their backs, writhing about violently, but unable to move from the place where they are put. The single thorax joint is very pliable and allows great freedom of motion in every direction. The head can be bent over forward, backward, or even sidewise until it touches the genital portion. The sidewise movement is practiced more frequently than the others, and specimens usually die and remain out of shape in this direction unless straightened just after death. The mouth parts, particularly the maxillae and maxillipeds, are also capable of considerable motion, and the horn on either side of the head can be moved within restricted limits. The lower lip is apparently rigid.

### Family CALIGIDÆ.

#### Subfamily CALIGINÆ.

#### CALIGUS GURNARDI Krøyer.

*Caligus gurnardi* KRØYER, 1863, p. 76, pl. II, figs. 3 a to g.

*Host and record of specimens.*—One lot obtained by the steamer *Albatross* May 29, 1901, from a king salmon, *Oncorhynchus tshawytscha*, at Monterey, California; Cat. No. 38562, U.S.N.M. A single female was obtained by Doctor McClendon from the elephant fish *Hydrolagus collieri* at La Jolla, California; Cat. No. 38579, U.S.N.M.

#### LEPEOPHTHEIRUS NORDMANNII Milne Edwards.

*Lepeophtheirus nordmannii* MILNE EDWARDS, 1840, p. 155.

*Host and record of specimens.*—A lot consisting of ten females and fifteen males was obtained by the steamer *Albatross* March 31, 1901, from a sunfish, *Mola mola*, off Santa Catalina Island; Cat. No. 38563, U.S.N.M. In this lot was found a chalinus of the species attached to one of the males; these two have been separated and are Cat. No. 38564, U.S.N.M.

#### LEPEOPHTHEIRUS PARVIVENTRIS Wilson.

*Lepeophtheirus parviventris* WILSON, 1905, p. 635, pl. XXIII, figs. 275 to 284.

*Host and record of specimens.*—Five females were obtained by the steamer *Albatross* from the spanish flag, *Sebastes rubrivinctus*, 6½ miles northwest of Santa Barbara Island, in 1901; Cat. No. 38566, U.S.N.M.

Twenty females and one male were obtained by the same steamer from the atka fish, *Pleurogrammus monopterygius*, at Agattu, Alaska, June 7, 1906, and are Cat. No. 38582, U.S.N.M.

Several lots had been previously obtained by the same steamer in 1888 from the northern Pacific, and were recorded in the reference

given above. A part of them came from the American shore and the rest from the Asiatic coast.

The hosts included the common cod of the region, *Gadus macrocephalus*, the atka fish, *Pleurogrammus monoptyerygius*, and a species of *Lepidopsetta*.

The new specimens are better preserved than the old ones and not as badly bleached, and from their examination the following notes on color may be added to those already given:

Carapace and free segment a yellowish horn color, quite transparent; genital segment a deep orange yellow; egg strings a light straw yellow in early development, turning to a deep orange. Dorsal surface of the entire body often covered with small circular spots of a dark Venetian red.

LEPEOPHTHEIRUS LONGIPES Wilson.

*Lepcophtheirus longipes* WILSON, 1905, p. 618, pl. xviii, figs. 206 to 211, and 222.

*Host and record of specimens.*—A lot containing twenty females, excellently preserved, were obtained from the jew fish, *Stereolepis gigas*, at La Jolla by Doctor McClendon, and are Cat. No. 38567, U.S.N.M.

The record of these specimens renders it probable that the two females upon which the species was founded, and for which there were no data as to locality or host, were from the Pacific coast.

LEPEOPHTHEIRUS BIFURCATUS Wilson.

*Lepcophtheirus bifurcatus* WILSON, 1905, p. 637, pl. xxiii, figs. 285 to 293.

*Host and record of specimens.*—A single lot, consisting of two females, upon which the species was founded, was obtained from one of the common flounders of the Pacific coast, *Psettichthys melanostictus*, in San Francisco Bay.

LEPEOPHTHEIRUS PACIFICUS Gissler.

*Lepcophtheirus pacificus* GISSLER, 1883, p. 885, text figures.—WILSON, 1905, p. 642, pl. xxv, figs. 304 to 310.

*Host and record of specimens.*—Twenty-three females were obtained from the blueback salmon, *Oncorhynchus nerka*, on the Pacific coast, the exact locality not being given.

LEPEOPHTHEIRUS SALMONIS Kröyer.

*Lepcophtheirus salmonis* WILSON, 1905, p. 640, pl. xxiv.

*Host and record of specimens.*—Ten females obtained from a blueback salmon, *Oncorhynchus nerka*, at Karla Bay in 1903, and sent with the other material by Doctor McClendon; Cat. No. 38568, U.S.N.M.

Six females from the king salmon, *Oncorhynchus tshawytscha*, at Monterey, California, May, 1904, taken by the steamer *Albatross*; Cat. No. 38569, U.S.N.M.

Five females from the hump-backed salmon, *Oncorhynchus gorbusha*, at Karluk, Alaska, by Dr. T. H. Bean; Cat. No. 38570, U.S.N.M.

An excellent lot of one hundred females and twenty males, with many young females in different stages of development, taken from the Dolly Varden trout, *Salvelinus malma*, at Karluk, Alaska, in August, 1889, by Dr. T. H. Bean; Cat. No. 38571, U.S.N.M.

Ten females from "salmon" at Karluk, Alaska; Cat. No. 38572, U.S.N.M.

Fifteen males and females from "red salmon" and "black batte," at Karluk, Alaska, by Dr. T. H. Bean; Cat. No. 38573, U.S.N.M.

Twenty-five females from *Oncorhynchus gorbusha*, at St. Paul Kodiak, Karluk, Alaska, by Dr. T. H. Bean; Cat. No. 38574, U.S.N.M.

The lot mentioned above as taken from the Dolly Varden trout is of especial value on account of the large number of males and development stages it contains.

As is stated in the reference given under this species, the entire National Museum collection has hitherto yielded but a single male of this species, and even that one proved to be new to science and was then described and figured for the first time. In the present lot there are more than twenty males, together with development stages of the female down to 2 mm. in length.

#### LEPEOPHTHEIRUS BRACHYURUS Heller.

*Lepeophtheirus brachyurus* HELLER, 1865, p. 185, pl. XVI, fig. 4.

*Host and record of specimens.*—A single female was obtained from *Scorpana guttata* by Doctor McClendon, at La Jolla, California. It has been injured somewhat so that its identity is not perfectly certain; it is Cat. No. 38575, U.S.N.M.

#### LEPEOPHTHEIRUS THOMPSONI Baird.

*Lepeophtheirus thompsoni* BAIRD, 1850, p. 278, pl. XXXIII, fig. 2.

*Host and record of specimens.*—A single female was obtained from the mouth of the white sea bass, *Cynoscion nobilis*, at La Jolla, California, by Doctor McClendon, and is Cat. No. 38576, U.S.N.M.

#### LEPEOPHTHEIRUS PARVUS, new species.

#### Plate LXVIII.

*Host and record of specimens.*—About a dozen females were obtained by Doctor McClendon from the California red fish, *Pinctolometopon pulcher*, at San Diego, California. Every specimen is fully

developed and nearly all carry complete egg strings. This lot is taken as the type of the species and is Cat. No. 32815, U.S.N.M.

*Female*.—Carapace orbicular, slightly wider than long, its lateral margins strongly convex, the posterior margin nearly straight. Frontal plates projecting strongly with a deep incision at the center. Grooving of the dorsal surface of the carapace peculiar in that the anterior ends of the lateral grooves are bent abruptly inward toward the midline and do not run forward toward the bases of the first antennæ as in most species. A similar arrangement was found in *Caligus aliuncus*.<sup>a</sup> But in the present instance there is an additional groove running outward from the anterior end of the lateral groove almost at right angles to the median axis. Where this groove strikes the lateral margin of the carapace it produces a well-defined incision.

A similar incision was found on the carapace of *Caligus schistonyx*,<sup>b</sup> but in that species the arrangement of the grooves was radically different. The median posterior lobe is considerably more than half the entire width, with a nearly straight posterior margin. The lateral lobes are broad and well rounded, but so short that they do not reach the posterior margin of the median lobe. The fourth segment is about half the width of the genital segment, and is abruptly narrowed just in front of the bases of the fourth legs. The genital segment is barrel-shaped, as long as wide, with nearly straight anterior and posterior margins and strongly convex lateral margins. The posterior corners project slightly as blunt lobes, but there are no rudimentary legs visible on either dorsal or ventral surfaces. The abdomen has but a single segment, one-fourth the width and one-third the length of the genital segment. The anal laminae are small and each is armed with four very long setæ. The egg cases are nearly twice the diameter of the abdomen and four times its length; the eggs are large and much flattened, about twenty-five in each string.

The first antennæ are slender, the terminal joint longer than the basal and both well armed with setæ; the second antennæ are small, with a slender terminal claw. The first maxillæ also are small, the basal portion enlarged and nearly circular, the terminal part short, narrow, and strongly curved. The second maxillæ are relatively large; they project well beyond the tip of the mouth tube, and are divided for more than half their length, the two branches being of the same size and length.

The mouth tube is short and wide with a constriction near the center. The furca is long and slender, its base slightly enlarged and circular in outline, its branches conical, much longer than the base and divergent. The second maxillipeds have a stout basal joint, carrying on its ventral surface near the center a larger flattened

<sup>a</sup> Proc. U. S. Nat. Mus., XXVIII, pl. IX, fig. 103.

<sup>b</sup> Idem, pl. VI, figs. 65 and 66.



spine; the terminal claw is two-thirds the length of the basal joint, moderately curved, and armed with an accessory spine on its ventral surface near the base. The swimming legs are of the usual pattern; the terminal claws on the first pair are about as long as the terminal joint; the spines on the exopod of the second pair are exceptionally long and sharp; the rami of the third pair are close together and small, but are armed with very long setae. The fourth legs are four-jointed, the basal joint with a small spine at the outer distal corner, a minute spine on the second joint, and three spines in a row at the tip of the terminal joint, the two inner ones being twice the length of the outer.

Total length, 4 mm. Length of carapace, 2.25 mm. Width of same, 2.37 mm. Length of free segment, 0.4 mm.; of genital segment, 1 mm.; of abdomen, 0.4 mm.; of egg strings, 1.6 mm.

*Color* (preserved material).—A light straw yellow, deepening on the thicker portions of the body; genital segment and egg strings orange.

(*parvus*, small.)

LEPEOPHTHEIRUS CONSTRICTUS, new species.

Plate LXIX.

*Host and record of specimens*.—A single female specimen was obtained by Doctor McClendon from the outside surface of the spotted cabrilla, *Paralabrax maculato-fasciatus*, at La Jolla, California. Fortunately the specimen is excellently preserved and bears a pair of fully developed egg strings. It is made the type of the species and is Cat. No. 38559, U.S.N.M.

*Female*.—Carapace orbicular, of nearly the same length and width, and narrowed a little anteriorly. Frontal plates less than half the entire width; lateral areas wide, pushing the lateral grooves far inward on either side. Median posterior lobe a little more than one-third the entire width, evenly rounded and projecting somewhat behind the broad and well rounded lateral lobes. Eyes large and placed well forward. Free segment three-fifths of the width of the genital segment, narrowed abruptly to half that diameter in front of the bases of the fourth legs.

Genital segment barrel-shaped, narrowed anteriorly, with nearly straight anterior and posterior margins, and the lateral margins only slightly convex. Its posterior corners are bluntly squared with no lobes. Abdomen about one-fourth the width and three-fifths the length of the genital segment, one-jointed, with its lateral margins concave. Anal laminae small, each bearing three long terminal setae and another of the same length on the outer margin at the center. Egg-tubes of the same width as the abdomen and two-thirds as long as the entire body; eggs small and numerous.

The two joints of the first antennæ of the same length, but the terminal one much the narrower. Second antennæ of good size, with a stout terminal claw. First maxillæ nearly as long as the terminal claw of the second antennæ and consisting of a very short basal portion which is not enlarged, and a long terminal claw, of the same width throughout and bluntly rounded at the tip. Second maxillæ considerably enlarged at the base, the terminal half divided into two branches, of which the outer one is longer and wider than the inner. Second maxillipeds with a long and moderately swollen basal joint, without spines or projections, and a terminal claw half the length of the basal joint, stout at the base but tapering to a slender and sharp point.

Furca short and very stout, the basal portion trapezoidal, the posterior corners of the trapezoid forming triangular projections on either side, the terminal portion elliptical, cut a little beyond the center, the branches nearly parallel, much flattened and bluntly rounded, the central sinus wide and squarely cut at its base.

Swimming legs of the usual pattern; the three terminal claws on the tip of the first pair diminish regularly in size from in front backwards; the rami of the third pair are close together and the basal joint of the exopod with its claw is exceptionally large. The fourth legs are four-jointed, the basal joint stout and two-thirds as long as the other three, the claw on the second joint minute and blunt, while the three terminal claws are turned outward nearly at right angles to the joint itself, the two inner ones being more than three times as long as the outer one. The sixth legs appear as good sized papillæ on the ventral surface of the genital segment close to the bases of the egg strings; each is armed with three setæ on its outer margin.

Total length, 6.6 mm. Length of carapace, 3.8 mm.; of genital segment, 1.7 mm.; of abdomen, 1 mm.; of egg strings, 4.4 mm. Width of carapace, 3.8 mm.; of genital segment, 1.5 mm.

*Color* (preserved material).—A pale yellowish white, without pigment of any sort; egg strings a deeper yellow.

(*constrictus*, contracted, alluding to the narrowed fourth segment.)

LEPEOPHTHEIRUS INSIGNIS, new species.

Plates LXX, LXXI.

*Host and record of specimens*.—A large number of both sexes of this species were obtained by Doctor McClendon from a sunfish, *Mola mola*, off the coast of Southern California. About a dozen of the best specimens have been selected and are Cat. No. 32814, U.S.N.M., types of the species. There are also cotypes in the Museum of the University of California.

*Female*.—Carapace orbicular, a trifle wider than long; lateral areas wide, each about one-third the entire width; posterior corners broadly

rounded and curved slightly inward; the two thoracic areas approximately the same size. Frontal plates well fused with the carapace and less than half the width of the latter, with a shallow central incision. Eyes minute and situated one-third the distance from the anterior margin. The muscles which flex the margins of the carapace and which radiate outward from either side of the eyes are very prominent and show clearly, even in a surface view. The median posterior lobe is the same length as the lateral lobes and has rather squarish corners, making the posterior margin nearly straight.

The fourth or free segment is half the length of the genital segment and two-thirds its width, projecting prominently on either side at the bases of the fourth legs. Genital segment ovate, with an evenly rounded outline and prominent posterior corners, showing on the ventral surface a pair of large triangular sixth legs, each armed with three spines. A sixth segment is also partially differentiated in front of the base of the abdomen in mature specimens. Abdomen one-jointed, oblong or trapezoidal in form, wider anteriorly than posteriorly and about one-half the length of the genital segment.

Anal laminae of medium size and curved inward toward each other. Second antennae stout, with a long terminal claw bent at right angles near its tip and armed with a small accessory spine at the center of its anterior margin.

First maxillae prominent, the circular basal portion three or four times the diameter of the straight terminal part. The second maxillae project far beyond the tip of the mouth tube; each is fully as long as the tube itself and strongly bifurcate, the branches being slender, bluntly pointed, divergent, and as long as the rest of the maxilla. On the basal portion of each is a small papilla, the rudimentary exopod, bearing a pair of setae. Mouth tube rather slender and bluntly rounded. Second maxillipeds stout, the basal joint bearing a small protuberance on its anterior margin, the terminal claw about the same length as the basal joint and armed with an accessory spine on its ventral surface near the base.

The basal joint of the first swimming legs is armed with two spines on its posterior margin, the outer of which is flattened and bluntly rounded, and a single spine on its inner margin. The spine on the basal joint of the exopods of the third legs is very large and is curved around inward into the form of a sickle. The three terminal joints of the fourth legs are about the same length; the last one bears two spines, nearly twice as long as the joint itself and toothed along their outer margins, and a third, much smaller spine.

The coiling of the oviducts is different from that in most species belonging to the genus *Lepeophtheirus*. The oviducts open just in front of the sixth legs on either side; the external egg strings are slender and about the same length as the body. The cement glands

are very large and arranged in the form of parenthesis marks; the individual cells are also large, and there are about twelve in each gland. The spermatophores are large, more or less spherical, and are fastened to the ventral surface of the genital segment; their ducts lie side by side in the space between the posterior lobes and apparently do not cross each other at the mid line.

Total length, 11.75 mm. Length of carapace, 6.5 mm.; of the genital segment, 2.75 mm.; of the egg strings, 10.5 mm. Width of carapace, 7 mm.; of genital segment, 2.6 mm.

*Color.*—A delicate yellowish pink, the chitin ribs and thickenings of the carapace a dark purple, the internal oviducts a light orange, the external egg cases a straw yellow. These colors are blended harmoniously and make the species at once the most highly colored and the most beautiful of its genus.

*Male.*—Carapace similar to that of the female, but relatively much larger, three-fifths of the entire length and four times as wide as the genital segment. Eyes also relatively larger; posterior lobes of the carapace narrower and longer.

Free segment three-quarters as wide as the genital segment, but shorter than in the female. Genital segment ovate, with the fifth and sixth segments distinctly differentiated on both dorsal and ventral surfaces, each of the two bearing a pair of large rudimentary legs armed with spines.

The sixth legs are at the posterior corners and project backward as large lobes; the fifth pair are just in front of them and project as equally large lateral lobes from the sides of the segment. Abdomen two-jointed, the basal joint only one-fourth the length of the terminal; anal laminae larger than in the female and armed with longer setae. Appendages similar to those of the female, with the usual sexual differences in the second antennae, first maxillae, and second maxillipeds. The latter are especially large and powerful, as can be seen in fig. 46. The second maxillae are very unlike those of the female in that they show scarcely any bifurcation except at the very tip (fig. 45).

The mouth tube is more slender and fully as long as the second maxillae. The structure of the genital segment is well shown in the ventral view given in fig. 48. The coiling of the sperm duct just before entering the receptacle is especially noteworthy.

Total length, 6.6 mm. Length of carapace, 4.1 mm.; of genital segment, 1.2 mm. Width of carapace, 4.2 mm.; of genital segment, 1.1 mm.

*Color.*—The same as in the female.

*Young female.*—Carapace more elliptical than in the adult, longer than wide. Free segment as wide as the genital segment and more than half as long, its sides not protruding much at the bases of the

fourth legs. Genital segment rectangular, its margins very straight, and bearing a pair of huge sixth legs at its posterior corners. These are larger than the anal laminae and much more prominent than in any other known species, and each is armed with three large spines. The second maxillae are just showing bifurcate tips, similar to those in the adult male, while the furca has a fat globular base from which project a pair of tiny spines, which represent the prongs or rami.

The mouth-tube is more triangular than in the adult and shows a distinct constriction near the center as in some other species. The other appendages are like those of the adult.

(*insignis*, noteworthy or remarkable, in the particulars just given.)

This new species is of peculiar interest by reason of its striking coloration and also by the structure of the thorax in both sexes. It furnishes another link in the chain of evidence, and by far the most conclusive of any which has yet appeared, that the genital segment in the Caliginae is really a fusion of two segments, the fifth and sixth of the thorax. Here we not only have the two pairs of legs in both sexes, but the boundaries of the segments are also clearly indicated by means of grooves. The size of the sixth legs, particularly in young females, is also much greater than that in any other known species or genus of the Caliginae.

#### Subfamily TREBINIAE.

##### TREBIUS TENUIFURCATUS Rathbun.

#### Plate LXXII.

*Trebius tenuifurcatus* RATHBUN, 1887, p. 559, pl. xxxix, figs. 1 to 3.—WILSON, 1907, p. 679, pl. xv, figs. 8 to 10.

*Host and record of specimens*.—Eight specimens, including both sexes, were obtained from the round sting ray, *Urolophus halleri*, by Doctor McClendon, at San Diego, California, and are Cat. No. 38600, U.S.N.M.

*Female*.—Carapace horseshoe-shaped, one-third wider than long, and, including the third thorax segment, about two-fifths the entire length. Frontal plates less than half the width of the carapace, with a shallow central sinus; lateral lobes wide and bluntly rounded. Transverse grooves, separating the lateral areas situated far back, leaving the thoracic portion shorter than the cephalic as in *caudatus*. These grooves do not quite reach the lateral margins and there are no notches in the latter, as in other species.

Eyes large and well fused on the mid-line about one-third the distance from the anterior margin, dark reddish brown in color. Second and third thorax segments about the same length, but the third (the first free) segment is considerably the narrower. The sides of this third segment are strongly inclined toward the central axis, so

that the posterior margin is only half the width of the anterior. Fourth segment nearly as long as wide, and considerably swollen between the bases of the fourth legs.

Genital segment flask-shaped, considerably narrowed anteriorly, with well-rounded posterior corners. The latter are each armed on the dorsal surface with four large triangular spines like those in *caudatus*. On the ventral surface they show on either side two large spines similar to those on the dorsal surface, and a small but distinct rudimentary leg, tipped with three setae. The egg cases are very short in all the available specimens, not reaching the end of the abdomen, but are fully as wide as the latter and each contains from fifteen to twenty eggs.

The abdomen is elongated, about one-third the width of the genital segment, and five times as long as wide; it is two-jointed, the joints being of the same length; the anal laminae are long and narrow and each is tipped with three setae.

Of the appendages the first antennae are long and slender, the two joints of the same length, but the terminal one much the narrower; both joints are well armed with setae. The second antennae are also long and slender, the basal joint armed with a stout spine on its posterior margin, the terminal claw bent at about its center, and carrying a small accessory spine on its posterior side near the base.

The first maxillae have an enlarged and rounded base and a narrow terminal claw, bent abruptly near the center and more than half the length of the second antennae. The second maxillae are quite different from those of *exilis* or *caudatus*; in the former the endopod is simple to the very tip, in the latter it is slightly bifurcated, the inner branch being much smaller and shorter than the outer. Here in *tennifurcatus* it is cut nearly to the center, the two branches being the same length. As in the other two species, these maxillae project far beyond the tip of the mouth tube; the basal joint is armed with a small papilla carrying two setae, which represents the exopod.

The mouth tube is similar to that in *caudatus* and *exilis*, but a little longer, the portion beyond the hinge being longer than the basal portion. The mandibles are stout, narrowed at the very tips, and curved in toward each other, with fine saw teeth along their inner margins. The furca is ovate, with the broad end outward, the sides being slightly reentrant between the base and the arms; the latter are of medium width, strongly flattened, and curve in toward each other at the tips which are bluntly rounded.

First maxillipeds of the usual pattern, the outer terminal claw less than half the length of the inner one. Second maxillipeds very weak, the terminal claw about half the length of the basal joint, slender, and carrying an accessory spine on its inner margin near the tip. Swimming legs of the usual pattern in this genus; endopod of the

first pair fairly stout and tipped with three long and stout setae, the other legs of the same pattern seen in *caudatus*.

Total length, 4.65 mm. Length of carapace, 1.5 mm.; of free segments, 0.82 mm.; of genital segment, 1 mm.; of egg strings, 0.9 mm.; of abdomen, 1.45 mm. Width of carapace, 2 mm.

*Color*.—A dark yellowish or reddish white, thickly marked over the entire dorsal surface with a network of fine lines of a bright red-brown color. The latter tint can be plainly seen with the naked eye.

*Male*.—Carapace ovate, of about the same length and width, the grooves on the dorsal surface and the eyes being similar to those of the female. Third thorax segment considerably shorter than in the female; fourth segment wider than the genital segment, and two-thirds as long, its sides projecting in a sharp angle. Genital segment obovate, its sides indented at a point one-third the distance from the posterior border. It carries two pairs of well defined legs on its ventral surface, one at the posterior corners and the other opposite the lateral indentations (fig. 68).

Abdomen two-jointed, the terminal joint as long again as the basal; the latter is strongly constricted where it joins the genital segment. Appendages like those of the female except for the usual sexual differences and a change in the second maxilla. These latter are contracted into narrow, bluntly pointed spines, with no trace of bifurcation at their tips.

Total length, 2.175 mm. Length of carapace, 1 mm.; of genital segment, 0.34 mm.; of abdomen, 0.9 mm. Width of carapace, 1 mm.

*Color*.—The same as that of the female, but paler and with the pigmented lines very much reduced in number.

This species has been twice described, first by Rathbun in 1887 and again by the present author in 1907. But both these descriptions were from the same single, poorly preserved female specimen taken from a sting ray in Vineyard Sound. Enough was visible in that specimen to establish its claim as a new species, but there were still many details which could not be made out definitely. These missing details have been supplied in the present description and the male is here portrayed for the first time.

There are several differences between these specimens and the original type, but they are no more than would naturally be expected in material from such widely different sources. They are all of minor importance and are certainly not of enough value to establish even a variety, to say nothing of a new species. The length of the egg-strings in any of the females, taken singly, would suggest that the copepod bearing them was not fully grown. But they are the same in each of the females, and this fact, coupled with the evidence of what can be seen inside the genital segment, make it practically certain that they are all adults.

## Subfamily PANDARINÆ.

## Genus ACHTHEINUS, new.

*Diagnosis.*—Female. First thorax segment joined with the head to form the carapace; second and third thorax segments fused and furnished with a single pair of large rounded dorsal plates. Fourth segment free and armed with a similar pair of plates. Genital segment much smaller than the carapace, its fused dorsal plate with a large median posterior sinus, enlarged at its base similar to that in *Perissopus*.

Abdomen small and wholly concealed beneath the genital segment, except what is visible through the posterior sinus of the latter. Anal laminae large, visible beyond the border of the genital segment. Frontal plates completely fused with the carapace; second antennae stout and armed with a powerful claw. Mouth-tube long and slender; first maxilla lacking; second pair close to the base of the mouth-tube, short and tipped with a minute spine. Second maxillipeds with a swollen basal joint and a slender terminal claw. All the swimming legs biramose, rami of first three pairs two-jointed, of fourth pair one-jointed. All the rami rudimentary and armed with spines only; each exopod reinforced on the outside by a well-defined papilla, tipped with a stout spine.

*Type-species.*—*Achtheinus oblongus*.

(*Achtheinus*, ἀχθεινός, annoying or troublesome.)

This new genus stands between Dana's *Pholidopus* (*Lepidopus*) and Steenstrup and Lüken's *Perissopus* and is closely related to both. It is like *Pholidopus* in possessing but two pairs of dorsal plates on the thoracic segments. It resembles the male of *Perissopus* in the structure of its swimming legs and some of the mouth parts, but it also differs materially from both these genera.

*Pholidopus* has the terminal joint of the second maxillipeds flattened into a broad lamina covered with scales; the first swimming legs are uniramose and three-jointed; second, third, and fourth pairs biramose, rami of third and fourth pairs one-jointed and rudimentary. *Perissopus* has three pairs of dorsal plates on the thorax segments; terminal joint of second maxillipeds enlarged into a kidney-shaped adhesion pad, destitute of pinchers, knobs, or claws; legs all biramose, rami of third and fourth pairs one-jointed, minute, and rudimentary. These radical differences make it necessary to establish a new genus for the present species.

ACHTHEINUS OBLONGUS, new species.

Plate LXXIII.

*Host and record of specimens.*—Two adults and one chalimus female were obtained from a leopard or cat shark, *Triakis semifascia-*



*tum*, by Doctor McCleendon at La Jolla, California. These are the types of the new genus and species and are Cat. No. 38596, U.S.N.M.

*Female*.—Carapace subquadrangular, slightly swollen at the center, with the corners nearly square. Frontal plates so thoroughly fused with the carapace as to be indistinguishable in the adult, their anterior margin entire and only slightly rounded, with no trace of a central sinus.

Posterior margin of carapace evenly rounded with a slight incision at the center. Lateral areas narrow as in *Echthrogaucus*, with a transverse groove back of the center; posterior lobes short, not reaching beyond the posterior margin and bluntly rounded.

Second and third thorax segments fused and covered with a single pair of dorsal plates; these latter are fused at their base, but separated for the terminal three-fourths by a wide triangular sinus. Fourth segment free and furnished with a pair of dorsal plates very similar to the previous pair, but the central sinus separating them is considerably enlarged at the base.

Genital segment the same width as the two pairs of dorsal plates, a little longer than wide, with nearly parallel sides. Its posterior margin is rather evenly rounded and is divided at the center by a wide and deep sinus, very similar to that in *Perissopus*.

Abdomen one-jointed and triangular much wider than long, with a narrow slit-like posterior sinus. The wide and flattened anal laminae are attached to the inclined margins on either side of this sinus and some distance apart; each is armed with five short, nonplumose setae.

The first antennae are slender, the two joints of about the same length and well armed with setae. The second pair are stout, with a swollen basal joint and a large terminal claw bent in the form of a half circle.

Mouth tube long and narrow, lance-shaped as in *Pandarus* and allied genera. No first maxillae; second pair close to the base of the mouth tube, two-jointed and both joints swollen, the terminal one ellipsoidal, considerably narrower than the basal, and tipped with a short curved spine. On either side of the mouth tube at its tip is a large boot-shaped spine, like those found in the same position on *Echthrogaucus torpedinis*.

First maxillipeds of the usual pattern; second pair similar to those of *Pandarus*, with a swollen basal joint and a stout, curved terminal claw which shuts down against the squared end of the basal joint.

All four pairs of legs are biramose; the basal joints of the first pair are small, of the other pairs much enlarged and laminate. Each is furnished at its outer posterior corner, just outside of the exopod, with a projecting papilla tipped with a long and stout spine. A corresponding but relatively smaller spine is found outside the

exopod of the last three pairs of legs in *Perissopus*. The rami of the first three pairs of legs are two-jointed, of the fourth pair one-jointed. All the rami are short and rudimentary, but are much more like those of *Nesippus* than of *Perissopus*. They are armed only with spines, however, and have no plumose setae. The fifth legs appear as large papillae upon the ventral surface of the posterior lobes of the genital segment, each tipped with a single spine.

The cement glands are similar to those of *Perissopus*, but are larger, curved like parentheses marks, and considerably enlarged at the base. The semen receptacles are in the shape of inverted commas, one on either side near the base of the abdomen and between the bases of the cement glands.

Total length, 8.5 mm. Length of carapace, 4.25 mm.; of dorsal thorax plates, 2.25 mm.; of genital segment, 3 mm.; of abdomen, 1 mm. Width of carapace, 3.5 mm.; of genital segment, 2.6 mm.

*Color* (preserved material).—A clear cream color without pigment of any sort.

*Chalimus*.—Carapace acorn-shaped, a little longer than wide; frontal plates indistinctly separated from the carapace by grooves, their outer ends projecting considerably over the bases of the first antennae. Gland at the base of the attachment filaments rather small and pushed forward to the very margin of the carapace. Attachment filaments two in number, narrow and ribbon-like. Posterior margin of the carapace nearly straight; posterior lobes narrow and pointed, and projecting far behind the central margin.

Second and third thorax segments not yet fused; the second segment much the shorter and sending out a lateral lobe on either side which is curved backward and downward closely over the anterior margin of the third segment. Third and fourth segments each with a pair of rudimentary dorsal plates; genital segment the same shape as in the adult, but relatively smaller. At the posterior corners it is prolonged into broad and rounded lobes which reach back nearly to the tip of the abdomen. The latter is entirely visible in dorsal view and is of the same shape as in the adult, but the anal laminae are furnished with much longer setae, which are also plumose. Appendages the same as in the adult.

Total length, 3.8 mm. Length of carapace, 2 mm.; of free segments, 1 mm.; of genital segment, 1 mm.; of abdomen, 0.4 mm. Width of carapace, 1.75 mm.; of genital segment, 0.9 mm.

(*oblongus*, oblong, referring to the general shape of the body.)

#### ECHTHROGALEUS COLEOPTRATUS Guérin.

*Echthrogaleus coleoptratus* WILSON, 1907, p. 367, pl. XIX.

*Host and record of specimens*.—Both sexes were obtained from a shark captured near Unalaska, Alaska, and are Cat. No. 12056, U.S.N.M.

## PANDARUS CRANCHII Leach.

*Pandarus cranchii* WILSON, 1907, p. 403, pl. xxviii.

*Host and record of specimens.*—A single young female was taken by Doctor McClendon from the fin of *Galeorhinus zyopterus* at La Jolla, California. Cat. No. 38602, U.S.N.M.

## NESIPPUS CURTICAUDIS Dana.

*Nesippus curticaudis* WILSON, 1907, p. 434, pl. xxxvi.

*Host and record of specimens.*—Two males taken from a large shark off the coast of California, name of shark and locality not given.

## NESIPPUS BOREALIS Steenstrup and Lutken.

*Nesippus borealis* WILSON, 1907, p. 437, pl. xxxvii.

*Host and record of specimens.*—A single specimen collected by Dr. W. H. Dall from Alaska, the name of the host and locality not given. Cat. No. 32789, U.S.N.M.

## Subfamily CECROPINAE.

## CECROPS LATREILLII Leach.

*Cecrops latreilli* WILSON, 1907, p. 468, pls. xxxviii and xxxix.

*Host and record of specimens.*—Both sexes taken from the gills of *Nicola mola* by the steamer *Albatross* 12 miles northeast of Point Loma Light, on the coast of California; Cat. No. 32797, U.S.N.M.

## Family DICHELESTHIDÆ.

## EUDACTYLINA UNCINATA, new species.

## Plate LXXIV.

*Host and record of specimens.*—Six females taken by Doctor McClendon from the gills of the soup-fin shark, *Galeorhinus zyopterus*, at La Jolla, California; Cat. No. 38558, U.S.N.M. These are made the types of the new species.

*Female.*—Body elongated, largest at the anterior end and tapering thence regularly to the bluntly rounded posterior end.

Carapace subquadrangular, widest along the posterior margin, which is nearly straight; it does not reach the anterior margin, but leaves the broad bases of the first antennae free; its sides are somewhat irregular and reentrant.

First thorax segment entirely concealed beneath the posterior margin of the carapace. Second and third segments about the same size, as wide as the carapace and three-fifths as long; fourth segment narrower and longer; fifth segment as long as the carapace, but only half as wide; sixth, or genital, segment the same width as the fifth, but only half its length.

Abdomen short and tapering rapidly from the base to the tip; indistinctly jointed. Anal laminae small, well separated and divergent, each armed with two short spines. Egg cases each as wide as the genital segment and one-third of the entire length; eggs very large, only six or eight in each case.

First antennae large and prominent, their bases meeting at the mid-line and forming a broad margin in front of the carapace. The jointing is indistinct and shows differently in different specimens. The basal portion consists of three joints—a rounded proximal joint nearly semicircular in outline and armed with a single stout spine on its anterior and posterior margins, a median joint much widened and armed with a row of eight or ten stout spines along its anterior margin and two huge curved claws or talons at the posterior distal corner, while the rest of the posterior margin projects as a wide rounded lamina, and a distal joint much narrower and shorter than the other two and armed with a large spine on its anterior margin.

The apical portion is cylindrical, about the same size throughout, and made up of four or five joints, sparsely sprinkled with setae, with a good-sized bunch of larger and longer ones at the tip of the last joint.

The second antennae are stout and three-jointed; basal and median joints about the same size, the latter carrying a large accessory spine on its inner margin near the base; terminal joint in the form of a stout claw, abruptly bent near its center. Mouth tube long and wide, with a bluntly rounded tip from which protrude the ends of the mandibles.

The second maxillae each consist of a large basal papilla tipped with two long plumose setae which reach beyond the end of the mouth tube. First maxillipeds three-jointed, the basal joint fairly stout, the median one a little shorter and much narrower and armed at its inner distal corner with a bunch of short and stout spines and a tuft of long, wavy hairs, the terminal joint in the form of a short conical claw. Second maxillipeds large and elliptical, set close to the lateral margin of the carapace and firmly anchored by a broad chitin band which extends across the mid-line. The basal joint is stout and tapers gradually outward; at the very base on the anterior margin is a large laminate projection, two-thirds of the width and nearly one-half the length of the joint itself; its surface is corrugated with radiating ridges and short spines. The terminal joint is cylindrical, the same diameter as the distal end of the basal joint and bent in the form of a sickle. It is so much longer than the basal joint that, even though curved, its enlarged tip shuts down along the entire outer edge of the lamina just described and reaches a little beyond the base of the basal joint.

The first four pairs of legs are biramose, the endopods longer than the exopods; the former are quite distinctly three-jointed, the basal joint carrying an immense sickle-shaped spine on its inner margin and another smaller one at the outer distal corner; the terminal joint ends in two or three long spines. The exopods carry a single long curved spine at their tip and a row of short and stout ones along their outer margin. From the arrangement of these spines we get the suggestion that the exopods are three-jointed as well as the endopods, but the joints themselves can not be distinguished. The fifth legs are rudimentary and consist of a mere stump, long and finger-like, and armed with a few short spines.

Total length, 2.5 mm. Length of carapace, 0.5 mm.; width of same, 0.375 mm. Length of egg tubes, 1 mm.

*Color*.—(preserved material) a uniform grayish white, without pigment markings of any sort; egg tubes yellowish or light orange.

(*uncinata*, furnished with claws, in allusion to the large claws on the first antennae.)

This species is sufficiently distinguished from the others of the genus by its slender and tapering body form, by the large claws on the first antennae, and by the immense size and the shape of the second maxillipeds.

HATSCHEKIA PINGUIS, new species.

Plate LXXV.

*Host and record of specimens*.—Both sexes were obtained by Doctor McClendon from the gills of the California conger eel, *Lycodontis mordax*, at La Jolla, California. They are taken as the types of the new species and are Cat. No. 38560, U.S.N.M.

*Female*.—Body short and stout, made up of three parts or regions, a head, a free thorax, and a rudimentary abdomen. Head covered with a carapace circular in outline with evenly rounded margins and dorsal grooves as shown in fig. 91. This carapace differs from that of recorded species in being wider anteriorly and somewhat narrowed posteriorly.

The so-called genital segment is really in the present species a fusion of all the thorax segments, as can be plainly seen in the male. It is almost a regular ellipse in outline, only a trifle longer than wide, and gives the animal a very plump appearance, another respect in which it differs markedly from recorded species. This free thorax is twice the length of the carapace and once and three-fifths its width. At the anterior end the two segments which bear the swimming legs are indistinguishably fused, but are separated from the remainder of the segments by a fairly well defined groove, which shows as a shallow notch on each lateral margin. At the posterior end between

the egg strings is the tiny projection representing the abdomen, which bears two minute papillæ, the anal laminae, each armed with a small spine. The egg strings are large and straight, nearly one-fourth the diameter of the free thorax, and twice the length of the entire body; the eggs also are large and there are from 36 to 40 in each string.

The first antennæ are long and cylindrical, tapering but slightly. The jointing is indistinct, but there appear to be five joints, the basal one the longest and thence diminishing regularly in length outwards. The setæ are all gathered in a bunch at the tip of the last joint. The second antennæ are stout and two-jointed, the basal joint much swollen and considerably longer than the terminal one which is in the form of a stout curved claw.

The mouth-tube is short, wide, and well rounded at the end; the maxillæ are in the form of minute papillæ, each bearing three small spines. The maxillipeds are large and project quite a little beyond the sides of the carapace; they are three-jointed, the basal joint long and stout, the median joint the same length but much narrower, the terminal joint in the form of a short and stout claw, usually much curved.

There are two pairs of swimming legs close behind the maxillipeds and very similar in structure; each is biramose and the rami are two-jointed with the joints the same length. The basal joint is armed with a stout spine on its outer margin; in the exopod the proximal joint is cut off diagonally toward the outer corner, where it ends in a long curved claw or spine, which is fully as long as the terminal joint. In the first legs the distal joint ends in a bunch of four large spines; in the second legs there is but a single spine.

The proximal joint of the endopod is unarmed, the distal joint ends in a single curved spine, nearly as long as the entire appendage. The ovaries occupy the entire lateral areas of the fused thorax joints; each is club-shaped, the larger end being anterior and ending close to the head; the posterior end tapers gradually into the short oviduct that leads to the external egg-tubes.

Total length, 1.8 mm. Length of carapace, 0.5 mm.; of fused thorax segments, 1.25 mm.; of egg strings, 3.35 mm. Width of carapace, 0.625 mm.; of fused thorax segments, 1 mm.

*Color*.—(preserved material) a uniform opaque white, the ovaries a light gray.

*Male*.—Much smaller than the female, the body nearly as wide as long. Head transversely elliptical, one-fourth wider than long, the anterior margin projecting slightly at the center, the posterior one nearly straight.

The grooving of the dorsal surface is similar to that in the female except for the slight projections at the center of the anterior margin.

Fused thorax segments also transversely elliptical, one-sixth wider than long. In the center over the digestive tube the jointing of this fused portion appears distinctly, and it can be seen that there are apparently five segments fused together, all of about the same length. The first of these, however, is itself really a fusion of the first and second segments and corresponds to the similarly fused section in the body of the female. This is attested by the fact that it bears on its ventral surface the two pairs of swimming legs.

The lateral areas project backward in two large rounded knobs at the posterior corners, between which is a narrow and shallow sinus. On each side there is a small spine projecting backward from the margin opposite the base of the abdomen. This latter is small and one-jointed; it is attached to the ventral surface of the thorax and is partly concealed by the posterior lobes. The anal laminae are narrow, divergent, and considerably longer than the abdomen. Each is five times as long as wide and is armed with a stout seta on its outer margin near the base and two others at the tip, one of which is much longer than the other and curved upward. The appendages are similar to those of the female save an increase in size in the maxillipeds which project much farther beyond the lateral margins of the carapace.

The testes occupy positions corresponding to those of the ovaries in the female, except that they are inclined toward the central axis rather than parallel with it. Each is cylindrical with rounded ends and starts from a point opposite and close to the base of the posterior sinus and extends diagonally outward and forward to about the center of the second of the fused segments, not reaching the first one at all.

Total length, 0.85 mm. Length of carapace, 0.33 mm.; of fused thorax segments, 0.45 mm. Width of carapace, 0.4 mm.; of fused thorax segments, 0.55 mm.

*Color*.—More of a cream or pink than in the female, the testes a deep reddish orange; digestive tract sprinkled with red or orange, especially at the anterior end of the fused thorax.

(*pinguis*, stout, corpulent, in allusion to the general body form.)

The only other species for which a male has been described is *H. hippoglossi* Kröyer. T. Scott found a single male of this species upon a halibut in the fish market at Aberdeen and has described it in one of his excellent memoirs.<sup>a</sup> It conforms in its structure to the female, as do the two sexes of the present species. It also shows many points of generic resemblance to the male of the present species, particularly in the enlarged second antennae, the more distinct segmentation of the thorax, the visibility of the abdomen, and the relative size and elongation of the anal laminae. It may be said of these

<sup>a</sup> 1901, p. 126, pl. vii, fig. 11.

males also as Scott said of that one, that they are very small and easily overlooked. Their color also approaches more nearly to that of the gill filaments, and they have no egg strings to attract attention. It is probable that a careful examination of California congers will show both sexes of this species to be fairly common.

## FAMILY LERNÆIDÆ.

### HÆMOBAPHES CYCLOPTERINA Müller.

*Hæmobaphes cycloptericina* MÜLLER, 1776, p. 2745.

*Host and record of specimens.*—Two females taken in Alaska by Lieut. G. M. Stoney, Cat. No. 14323, U.S.N.M. The name of the host is not given, nor the exact locality.

### LERNÆENICUS MEDUSÆUS, new species.

Plate LXXVI, figs. 99 and 100.

*Host and record of specimens.*—A single female taken from the little *Nannobranchium leucopsarum* by the steamer *Albatross* in 1904 at Monterey Bay, California; it is Cat. No. 38598, U.S.N.M., and is made the type of the new species.

*Female.*—General body form plump; head but little enlarged, neck short and stout; genital portion cylindrical without posterior processes; no abdomen. Head covered anteriorly with a spherical mass of irregularly branched processes, which arise from a small area on the front of the head and branch in every direction like a mass of coral.

When buried in the tissues of the host this mass of processes forms a most effective attachment organ. In addition the head sends out a flat laminate process on either side, which is very short, curves forward, and ends in three or four knobs or laminate branches. These also aid in giving the head a firm hold upon the host.

The neck is one-third the diameter of the genital portion and with the head forms an S curve. At the anterior end it passes insensibly into the head and at the posterior end into the genital portion. The latter is cylindrical the same diameter throughout, and terminates posteriorly in a very short and blunt knob which represents the abdomen.

There are no processes or anal laminae. The egg strings are the same diameter as the neck, straight, and one-fourth longer than the body. The mouth opening is at the base of the coralline mass of processes and there is no visible mouth tube. There are two pairs of rudimentary legs on the anterior portion of the thorax, which consist of a basal joint and a single terminal ramus for each leg. No other appendages are visible.



Total length, 10 mm. Length of head, including the anterior processes, 2.35 mm.; of genital portion, 4 mm.; of egg strings, 13 mm. Width of head, 1.35 mm.; of genital portion, 1.45 mm.

*Color*.—(preserved material) a uniform light chocolate brown, the processes on the head yellowish white, the egg strings a light tan color.

(*medusa us.*, medusa-like, alluding to the mass of anterior processes on the head.)

#### Genus OPIMIA, new.

*Diagnosis*.—General form elongate and slender; head swollen into a globe or sphere, smooth and without processes; neck cylindrical and two-thirds of the entire length; genital segment narrow, three times as long as wide, and carrying posterior processes; abdomen very short and rudimentary.

Mouth terminal, upper and under lips protruding; mouth parts reduced to finger-like projections; second maxillipeds well developed and evidently used for prehension. Only one pair of swimming legs close behind the maxillipeds. Male unknown.

*Type-species*.—*Opimia exilis*.

(*Opimia*, a vestal virgin who proved unfaithful to her vow and in consequence was buried alive.)

#### OPIMIA EXILIS, new species.

Plate LXXVI, figs. 102 to 104.

*Host and record of specimens*.—Two females were obtained by Doctor McClendon from the common soup-fin shark, *Galeorhinus zyopterus*, at La Jolla, California. They are made types of the genus and species and are Cat. No. 38601, U.S.N.M.

*Female*.—Cephalothorax orbicular, considerably swollen, with the mouth tube and mouth parts projecting from its anterior margin; its surface smooth and uniformly rounded, without any trace of lobes or processes. Free segments developed into a neck two-thirds of the entire length and about two-fifths of the diameter of the cephalothorax. This neck is straight, smooth, and free from wrinkles except at the very base where it joins the genital segment. The latter widens gradually to the same diameter as the cephalothorax. At its anterior end it is wrinkled similar to the adjacent portion of the neck; at its posterior end it is thrown into two or three much larger folds, but is smooth through the center. Attached to its posterior margin, a little nearer the dorsal than the ventral surface, are two slender cylindrical processes. Each is one-third the diameter of the genital segment and nearly straight, so that the two extend back side by side and look like short egg strings. Between them and on the extreme dorsal margin is the rudimentary abdomen, which consists of little more than a pair of tiny papillae or knobs, represent-

ing the anal laminae. They scarcely project from the surface and can be easily overlooked. Neither of the females obtained carried egg strings, and so nothing is known of them.

The first antennae consist of a one-jointed papilla on either side of the mouth tube, a mere stump, apparently immovable. The second pair are three-jointed, stout, and terminate in a small curved claw; they are movable and evidently assist in prehension, particularly that part which is concerned with the burying of the head when the parasite first becomes fixed. The mouth tube is made up of the projecting upper and under lips; these are united at the base, but are separate for their terminal halves. The upper lip is semicylindrical and somewhat like a proboscis, while the under one is tongue-shaped and just covers the semicylinder, making thus when closed a tube through which nourishment can be conveyed. The mandibles and maxillae are reduced to mere finger-like processes, the former in the space between the two lips, the latter on either side of the lower lip.

There are no first maxillipeds; the second pair are two-jointed and well developed. They consist of a large swollen basal joint and a small terminal claw which closes down firmly against it. They are thus much better developed and more formidable organs of prehension than are common in this family of parasites. In most of the genera possessing a swollen cephalothorax and a long buried neck, these alone seem to attach the parasite securely to its host, and all the organs that serve for prehension in other forms are rudimentary or usually lacking. Here for some reason the second maxillipeds have retained fully their normal size.

There is but a single pair of swimming legs, one-jointed and very rudimentary, attached to the cephalothorax close behind the maxillipeds. The ovaries are in the form of oblong masses, one on either side of the digestive canal in the genital segment.

Total length, 38 mm. Length of head, 2.8 mm.; of neck, 22 mm.; of genital segment, 7 mm.; of posterior processes, 7 mm. Width of head, 2.2 mm.; of genital segment, 2.5 mm.; of neck, 0.7 mm.

*Color*.—Of preserved specimens snow white throughout except the mouth tube, mouth parts, and second antennae, which are tinged with red.

(*exilis*, slender.)

The presence of a mouth tube, however imperfectly formed, places this genus in the family Lernaeidae, but the male must be obtained and examined before this point can be finally settled. The author has taken a similar genus (as yet undescribed) from sharks along the Atlantic coast. While in the female there was little evidence of a mouth tube, in the male it was well developed and leaves no doubt as to the location of the genus. The same will probably be found to be true when the male of the present genus is obtained.

## Genus PHRIXOCEPHALUS, new.

*Diagnosis*.—Female entirely destitute of segmentation, but with the different body regions fairly distinct. Head enlarged and club-shaped, with three pairs of horns, two pairs lateral, branched, and chitinous, one pair ventral, softer and nearly simple. Head passing insensibly into an elongate neck furnished with two pairs of lateral horns and one pair of ventral ones, the latter opposite the posterior pair of lateral ones. Neck bent at a right angle where it joins the genital segment; the latter straight, cylindrical, and enlarged to several times the diameter of the neck. No posterior lobes or processes. Abdomen very small and rudimentary, without anal laminae or setae. Egg tubes long, each coiled into a tight spiral nearly as long as the entire body; eggs uniseriate. Mouth terminal, with three pairs of rudimentary mouth parts. Two pairs of uniramous, three-jointed legs attached close to the mouth.

*Type-species*.—*Phrioxcephalus cincinnatus*.

(*phrioxcephalus*, φριξός, bristling and κεφαλή, head.)

PHRIXOCEPHALUS CINCINNATUS, new species.

Plate LXXVI, fig. 101.

*Host and record of specimens*.—Two females found attached to the eyes of a species of *Citharichthys*, one of the soft flounders, at Monterey Bay, California, by the steamer *Albatross* in 1901. These are made the types of the new genus and species and are Cat. No. 38599, U.S.N.M. Both specimens carry egg strings.

*Female*.—Head enlarged and club-shaped, with a pair of short branched horns on either side and a pair of softer and stouter ones, nearly simple, on the ventral surface at the frontal margin. The anterior pair of lateral horns is branched from the very base, the two branches forming an obtuse angle with each other, the inner one extending forward and inward parallel with the anterior margin of the head, while the outer one extends at right angles to the central axis of the body and parallel to the posterior horn. These latter are branched only at their tips and the rami are short and knob-like. The head passes insensibly into a narrow neck which tapers backward, its narrowest portion being just at its junction with the genital segment, where it is bent at right angles to the latter. It is also twisted a quarter of the way around, so that when the creature is lying on the side of its genital segment the head and neck present either their dorsal or ventral surfaces. In both of the females studied the twisting was sinistral, so that the left side of the genital segment appeared in connection with the ventral surface of the neck and head.

This neck carries on either side close to the head a stout horn somewhat longer than those on the side of the head and not quite as stiff and hard. Each of these horns is slightly enlarged at its tip, where it gives off three or four small knobs or branches. About halfway between these second horns and the genital segment is a third set, four in number, one on either side and a pair close together on the ventral surface. These are all very hard and chitinous, the two lateral ones a little longer than the second pair, the ventral ones considerably shorter, and all four profusely branched. The ventral pair are so close together that their bases are partly fused and at first glance they might easily be mistaken for a single horn: but a little examination shows them to be unmistakably a pair placed close together.

The genital segment enlarges abruptly from the base of the neck to fully five times the diameter of the latter. It is cylindrical, slightly enlarged posteriorly, a little curved, and smoothly rounded, without appendages of any sort, but with a small rudimentary lobe over the base of each egg string. The abdomen is also small and rudimentary, little more than a knob or lobe projecting slightly from the dorsal surface of the posterior margin between the egg strings. It is notched at the center, indicating the position of the anus, but carries no anal laminae or setae. The egg strings are about the same diameter as the narrowest part of the neck, and very long, but they are coiled in a tight spiral of about three times their own diameter, and thus actually project behind the genital segment a distance less than the length of the body. If straightened out, however, they would prove to be more than twice that length. The eggs are small and uniseriate, and each string contains between 1,200 and 1,500.

The mouth is terminal and is surrounded by mouth parts so degenerate that they have become mere spherical knobs. There are two pairs of these close together and close to the mouth and another pair at a little distance from them on the ventral surface. This last pair is somewhat asymmetrical in their position, being twisted around to the left side, but otherwise are exactly like the first two pairs.

The only other appendages visible are two pairs of rudimentary legs close together on the ventral surface about halfway between the lateral horns on the head and the first pair on the side of the neck. These legs are very short and slender, uniramous, three-jointed, and destitute of spines or setae.

Total length, including egg strings, 30 mm. Length of head and neck, 9 mm.; of genital segment, 8 mm.; of egg strings, 14 mm. Width of genital segment, 3 mm.; of the egg-tube coils, 1.12 mm.

*Color.*—Body and chitinous horns a rich cinnamon brown tinged with yellow; egg strings and soft horns a cream yellow.

(*cincinnatus*, having or wearing curls, in allusion to the coiled egg strings.)

The head and neck with all the anchor horns are buried in the tissues of the eye of the host, leaving simply the genital segment and egg coils visible on the exterior. The bend in the neck comes just at the outer surface of the eye and is no doubt caused by the friction of the water against the genital segment of the parasite as the flounder moves forward through the water and mud. The tissues of the eye in immediate contact with the head and neck of the parasite are hardened into a sort of cyst which increases the firmness of the parasite's hold, but of course renders the eye wholly blind. Whether the parasite ever infests both eyes of the same fish so as to render it totally blind is an interesting economic question which must be left to future observation to answer.

This new genus bears most resemblance to *Hamobaphes*, but differs from it in many important particulars. The head in *Hamobaphes* is without horns, while here it is supplied with six comparatively large ones, two pairs of which are chitinous like those on *Lernæa*. Again, the neck in *Hamobaphes* is bent abruptly at an acute angle a little distance in front of its center, so that the head is brought back against the base of the neck; here the bending is simply at a right angle and at the very base of the neck, so that the head and neck stand out from the anterior end of the genital segment at right angles to the long axis of the latter.

Furthermore, while *Hamobaphes* carries a pair of soft projections on the sides of the neck near the flexure, the present genus carries six branched horns upon the neck, the posterior four of which are hard, chitinous, and profusely multiramose. In *Hamobaphes* the genital segment has a well-defined sigmoid flexure, while here it is practically straight; at least there are no traces of a double curve.

*Hamobaphes* also has a large and well defined abdomen, in one species (*ambiguus* T. Scott) as long as the egg strings. Here the abdomen is so rudimentary as easily to escape notice. Finally in *Hamobaphes* the mouth is ventral and there are two pairs of mouth parts at some distance behind it. Here the mouth is terminal, with three pairs of knob-like mouth parts close to it. In *Hamobaphes* the rudimentary thorax legs are biramose and without joints; here they are uniramose and three-jointed.

In view of these essential differences the present specimens must constitute a genus by themselves.

## Family LERNEOPODIDÆ.

## BRACHIELLA MALLEUS Rudolphi.

*Brachiella malleus* VOGT, 1877, p. 46, pl. III, figs. 1 to 8; pl. IV, fig. 1.

*Host and record of specimens.*—A single lot taken at Port Arthur by J. F. Abbott and sent to the author from Stanford University by Dr. C. H. Gilbert. There are no data as to the host. The lot is Cat. No. 38578, U.S.N.M.

## BRACHIELLA GRACILIS, new species.

## Plate LXXVII.

*Host and record of specimens.*—A lot containing both sexes and several development stages was taken by Doctor McClendon from the mouth of the white sea bass, *Cynoscion nobilis*, at La Jolla, California. These are made the types of the new species and are Cat. No. 38577, U.S.N.M.

*Female.*—General body form elongate and slender; head, including the first maxillipeds, considerably enlarged and club-shaped. Space between the first and second maxillipeds occupied by a narrow cylindrical neck, two-thirds as long as the rest of the body. Second maxillipeds slender and longer than the head and neck, placed closely side by side and held together by the outer skin but not fused; this outer skin is wrinkled into transverse folds. The base of each maxilliped where it joins the body is enlarged to form a prominent knob, which projects considerably from the surface. From these knobs the maxillipeds taper gradually toward their tips, where they are thoroughly fused and furnished with an attachment disk in the shape of a mushroom. The head and neck are bent backward at the base of the second maxillipeds so as to form an acute angle with the rest of the body. Both are curved so that the two together form a smoothly arched half-moon or semioval.

The body below the base of the second maxillipeds is again constricted for a short distance to about the diameter of the neck. It then broadens abruptly into the genital portion, which has the shape of a tall bottle or elongated flask, the sides nearly parallel and the posterior margin squarely truncated. From this posterior margin project four slender, finger-like processes in two pairs, one ventral and one dorsal. The ventral and dorsal process on either side curve in toward each other like unequal parentheses marks, the dorsal process being only three-fifths as long as the ventral. The latter pair are as long as the entire body posterior to the base of the second maxillipeds. All four processes are slightly enlarged at their bases and taper gradually toward their tips which are bluntly rounded. Between the ventral processes lies the abdomen, which is cylindrical,

of smaller diameter than the processes, and about half their length. There are no traces of anal laminae.

The first antennae are short and indistinctly jointed; they curve in toward each other and are devoid of setae except at their very tips. The second pair are large and stout with broad and bluntly rounded tips. They curve in toward each other much more than the first pair, being so closely approximated to the anterior margin of the carapace as to form a half circle with their tips in actual contact. Each bears on its ventral surface near the end a short accessory branch much narrower than the main antenna and terminating in two small spines.

The mouth tube is broadly ovate, its narrowed tip projecting slightly beyond the anterior margin of the carapace, its base well rounded and constricted into a short neck where it joins the carapace. The mouth opening is at the very tip, but ventral rather than terminal; the lips flare out into a short funnel surrounded by a fringe of hairs. The mandibles are short and stout and furnished with powerful muscles; they are toothed only on the inner margin, but the teeth are large and curved at their tips like talons.

The maxillae are two-thirds as long as the mouth tube; each is biramose, the endopod much shorter than the exopod and curved over inward. Both rami are again bipartite, the two branches of the same length and ending in short and straight spines. The first maxillipeds are large and powerful; they are so large and stand in such a relation to the head as to appear like the lower jaw of a vertebrate in side view. Each consists of a swollen basal joint armed on its inner margin with two roughened areas, a small one at the extreme base and a much larger one toward the distal end; between these is a short spine. The terminal joint is slender and tipped with two claws, the inner one much smaller than the outer.

The ovaries are paired and occupy nearly the whole of the fused genital portion of the body; the external ovisacs are cylindrical, one-third the diameter of the genital portion and one-fourth longer than the longest posterior processes. The eggs are small and arranged in ten or twelve rows.

Total length, including the posterior processes, 12 to 15 mm. Length of second maxillipeds, 4.8 mm.; of head and neck, 3.6 mm.; of genital portion, 3.7 mm.; of egg cases, 4.25 mm. Width of genital portion, 2.6 mm.

*Color*.—(preserved material) a uniform yellowish white, lighter and more transparent in the second maxillipeds, deepening into dark yellow in the genital portion; egg strings orange.

*Young female*.—Two stages of development were obtained with the adults. The youngest of these was only 3 mm. in length, and is shown in fig. 111. The general structure is the same as that of the adult, but the second maxillipeds here are twice the length of the head and neck, and are entirely separate from each other for their full length. Then they are attached close behind the first pair and there is almost no interval between the two. The body posterior to the base of the second maxillipeds is indistinctly segmented; there are no posterior processes as yet, and the abdomen is very short and rudimentary, ending in two conical anal laminae, each of which is tipped with two short setae.

In the second stage, 4.5 mm. long, the second maxillipeds have diminished in relative length and thickened considerably. There is a greater space between the first and second maxillipeds, and the posterior processes appear as short knobs on either side of the abdomen.

Total length, 3 mm. Length of second maxillipeds, 1.85 mm.; of head, 0.8 mm.; of genital portion, 1.25 mm. Width of genital portion 0.3 mm.

*Male*.—Body of the usual form found in this genus, with a hump on the back opposite the maxillipeds and a constriction a little posterior to the hump. The first antennae are relatively longer and more distinctly segmented than in the female. The second antennae are much narrower, but otherwise similarly formed; they do not, however, bend around the anterior margin of the carapace, but stand out from the side of the mouth tube parallel with the first pair. The mouth tube is relatively much larger and embraces the whole anterior portion of the cephalon, dorsal as well as ventral. The mouth opening is terminal and surrounded by a fringe of hairs similar to that in the female. Second maxillipeds adapted for prehension and, like the first pair, armed with powerful claws. They are placed well back from the mouth tube, and in side view appear near the center of the body. Abdomen and anal laminae similar to those on the youngest female.

Total length, 1.6 mm. Length of head, 0.8 mm.; of genital portion behind the constriction, 0.7 mm. Width of body through the bases of the second maxillipeds, 0.65 mm.

*Color*.—Of preserved specimens a uniform snow white.

(*gracilis*, slender.)

This species may be distinguished from others of the genus by the length and slenderness of the second maxillipeds, by the fact that in the adult they are held together for their entire length, though not fused, and by the long abdomen, which resembles a fifth or odd anterior process.



## BRACHIELLA ANSERINA, new species.

Plates LXXVIII, LXXIX.

*Host and record of specimens.*—About a dozen specimens, including both sexes, were taken from the gills of the rockfish, *Sebastes glaucus*, at Bering Island, Siberia, by Governor N. Grebnitzky. They are made the types of the new species and are Cat. No. 13685, U.S.N.M.

*Female.*—Body elongate, the long and stout neck passing insensibly into the genital portion. Head not much enlarged, the anterior margin almost squarely truncated, the posterior margin well rounded. Neck thick and muscular, considerably longer than the body, gradually increasing in size as it passes toward the body, until at the base of the second maxillipeds the two join almost insensibly.

Second maxillipeds very short and flattened on the inner sides where they come together, giving each the shape of quarter of a sphere, one of the flat sides being attached to the body and the other facing its fellow on the other maxilliped. Between them and almost in contact with the ventral surface of the body is the small attachment bulla. This has a very short petiole and a nearly spherical umbrella.

Genital portion or body proper nearly quadrilateral in dorsal outline, slightly widened posteriorly, and flattened dorso-ventrally, so that its thickness is three-fifths of its width. This genital portion terminates posteriorly in eight processes arranged in four pairs: one pair at the ventral corners, which are mere knobs and project but little, a second pair at the dorsal corners, considerably larger and in the form of conical processes bluntly rounded at their tips.

The third and fourth pairs are on the dorsal posterior margin at the center, and are fused at their bases; the fourth pair is on the median line and the two processes are completely fused except at their very tips, which are enlarged into circular laminae, flattened dorso-ventrally and somewhat irregular around their margin. The third pair stand one on either side of the fourth, and are fused with the latter for their basal half. But their terminal halves are free and extend beyond the tips of the fourth pair as conical processes, which are curved slightly away from the mid-line.

The four processes thus arranged in a row are naturally much wider than thick, and they curve over ventrally between the egg strings, very similar to the feathers of the tail of a duck or goose. The egg cases are attached to the posterior margin of the genital segment between the second and third processes on either side. They are widely separated and ellipsoidal or often spherical in form; the eggs are large and there are 50 or 60 in each case. There is no

abdomen, the anus opening on the ventral surface of the genital segment near the bases of the fourth processes.

First antennae short and indistinctly jointed; basal portion enlarged and flattened into a wide lamina from whose inner corner projects a distal portion which is cylindrical and of about the same length as the basal portion. There is one long seta outside the base of the distal portion and three at the tip, one of which is much shorter than the other two. Second antennae in the form of flattened laminae, elliptical in outline and divided at the end into two short rami. The dorsal ramus is pointed and armed with a short spine; the ventral one is rounded and covered with corrugations.

The mouth tube is large and subterminal; the mouth opening is surrounded by a fringe of long hairs. The mandibles are long and narrow, enlarged at the base but of about the same width throughout the distal portion, and armed with eight or ten irregular teeth on the inner margin at the tip. The maxillae are half the length of the mouth tube and fairly stout; they are divided into three rami, two at the tip, slender and of the same length, each ending in a long spine, and one much shorter and stouter on the ventral margin, ending in a short spine.

First maxillipeds with stoutly swollen basal joints and comparatively slender and weak terminal joints; the latter are less than half the length of the former and end in a tiny claw, evidently of no use for prehension.

Total length, 5.5 mm. Length of neck and head, 3.1 mm.; of genital portion, 2.4 mm.; of egg cases, 1.2 mm. Width of neck at its base, 1 mm.; of genital portion at its posterior end, 2 mm.; of egg cases, 1 mm.

*Color*.—(preserved material) a uniform dark orange, the egg strings inclining toward pink. Bulla and its pedicel very dark brown, almost black.

*Male*.—Body stout and strongly arched dorsally, with a slight constriction between the head and genital portion and almost no traces of segmentation. Mouth parts clustered at the anterior end close to the mouth tube.

First antennae distinctly three jointed, basal joint considerably longer than the others and carrying on its outer distal corner a long spine; the two terminal joints about the same length, the last one ending in a bunch of setae. Second antennae cylindrical like the first pair instead of being flattened into laminae, as in the female; armed at their tip with a dorsal curved claw and a ventral corrugated knob.

First maxillipeds similar to those of the female; second pair developed into large, powerful prehensile organs, the basal joint swollen and projecting on the inner margin into a long and stout spine which

curves outward to meet the strong terminal claw, thus forming a sort of chela.

Total length, 1 mm. Width of cephalic portion, 0.5 mm.

*Color*.—A lighter orange than in the female, the yellow showing more plainly than the red.

(*anserina*, *anser*, a goose, and the ending *inus* denoting likeness, alluding to the form of the adult female.)

This species is readily distinguished from all others by the general shape of the body, which is that of a miniature goose or duck, by the fusion of the two median pairs of posterior processes and by the spherical egg cases. This first determination may then be confirmed by the relative size and shape of the various appendages.

LERNÆOPODA GIBBER, new species.

Plate LXXX.

*Host and record of specimens*.—A fine lot of specimens, including developmental stages, but no males, was obtained from the gill arches of the Dolly Varden trout, *Salvelinus malma*, at Attu, Alaska, June 9, 1906, by the steamer *Albatross*. They are made the types of the new species and are Cat. No. 38583, U.S.N.M.

*Female*.—Body strongly flattened dorso-ventrally and much wrinkled; head inclined at an acute angle with the rest of the body, and the space between the second maxillipeds raised into a large hump, which gives the creature a peculiar hunchbacked appearance. Head, exclusive of the second maxillipeds, elongate triangular in dorsal outline, with none of the appendages visible. First maxillipeds hidden between the bases of the second pair; the latter cylindrical, very thick and stout, especially at their bases. They are about half the length of the rest of the body, are united at their very tips, and furnished with a large mushroom-shaped bulla. The stem of the bulla is one-third the diameter of the maxillipeds themselves and nearly one-half their length, while the umbrella part is five times the diameter of the stem.

The genital portion of the body forms nearly a perfect circle in dorsal outline; it is indistinctly segmented, but the posterior margin is unbroken by any abdomen or anal laminae, or even by the attachment of the egg strings. The latter are one-fourth the diameter of the body and one and a half times its length, and are not much narrowed at the ends; the eggs are large and arranged in five or six longitudinal rows.

The first antennae have the shape of blunt unsegmented papillae tipped with three small processes arranged at the three corners of a triangle and inclined toward one another. Second antennae stout and flattened laterally into broad laminae; they are imperfectly segmented

and divided at the tip into three parts—a ventral, a dorsal, and a lateral, the latter on the inner side. The ventral part is in the form of a two-jointed cylindrical process, the terminal joint much smaller than the basal. The dorsal part is a large flattened claw, armed on its concave margin with two small spines. The lateral part is a rounded knob covered with short spines. The mandibles have five coarse teeth on the inner margin at the tip; the maxillae are narrow and unsegmented, with a protuberance on the inner margin at the center, and three small spines at the tip, the outer one much smaller than the other two.

The first maxillipeds are attached close to the mouth tube, and consist of a swollen basal joint and a short but stout terminal claw. The latter is only one-third the length of the basal joint and is straight except at the tip, where it curves slightly.

Total length, 6.2 mm. Length of genital portion, 4 mm.; of egg strings, 8 mm. Width of genital portion, 4 mm.

*Color*.—Body a uniform yellow, deeper at the center of the genital segment over the ovaries. Attachment bulla a deep brownish black. Egg strings light yellow in early development, becoming later a dark orange.

(*gibber*, hunchbacked.)

This species may be distinguished by the large hump on the back between the bases of the second maxillipeds, by the wide and strongly flattened genital portion, and the fact that the first maxillipeds are between the bases of the second pair and yet close behind the mouth tube.

There is a second lot of five females, taken also from the gill arches of *Salvelinus malma* at Bering Island by Governor N. Grebnitzky, and are Cat. No. 38591, U.S.N.M.

LERNÆOPODA BEANI, new species.

Plate LXXXI.

*Host and record of specimens*.—A lot of twenty-five specimens, all females, were taken from the gill filaments of the Quinmat salmon, *Oncorhynchus tshawytscha*, captured in the McCloud River, California, August 4, 1881. These are taken as the types of the new species and are Cat. No. 29086, U.S.N.M.

There are also two other lots obtained by the U. S. Bureau of Fisheries from the same host, but in Battle Creek, Colorado. The first of these is Cat. No. 38584 and the other Cat. No. 38585, U.S.N.M.

A fourth lot was obtained by Dr. C. H. Gilbert from the rainbow trout, *Salmo iridens*, at a fish hatchery located at Sisson, California: Cat. No. 38605, U.S.N.M.

*Female*. Body not much flattened; head often in line with the genital portion and never much inclined to it. Head, including the

bases of the second maxillipeds, triangular, one-eighth longer than wide, and rather pointed at the tip in dorsal view. Second maxillipeds stout, cylindrical, and only half as long as the body; bulla mushroom-shaped and twice the diameter of the maxillipeds, with a long and slender petiole. Genital portion nearly circular in outline in dorsal view, but only one-half wider than the head, with no trace of segmentation. Egg strings one-fourth the diameter of the genital portion and one-third longer than the entire body. Eggs of medium size and arranged in five or six longitudinal rows.

First antennae in the form of short unsegmented processes, narrowed at the tip and armed with a single small spine. Second pair flattened laterally, imperfectly segmented, and split at the tip into two rami; the dorsal ramus is the smaller and is tipped with a conical process and a small spine. The ventral ramus is armed with a large spine, a small one close to it, and a rounded knob covered with small spines. The mandibles are longer and narrower than in *gibber*; they have the same number of teeth, but these are considerably different in pattern.

The maxillae are also longer and narrower than in the preceding species, and are armed at their tip with a short, stout spine on either side and a central conical process or palp, which carries at its tip two short spines.

The first maxillipeds are removed from the mouth tube a distance nearly equal to their own length. Their basal joints are stout and swollen, but the terminal ones are slender and weak, the claw being abruptly narrowed near its base.

Total length, 4.6 mm. Length of head, 2 mm.; of genital portion, 2.6 mm.; of second maxillipeds, without the bulla, 2.4 mm.; of the egg strings, 6 mm. Width of head, 1.5 mm.; of genital portion, 2.85 mm.

*Color*.—(preserved material) a light straw yellow deepening to orange over the ovaries in the genital portion; bulla and its stem yellowish brown. Eggs at first light yellow, afterwards becoming orange.

(*beauti*, to Dr. Farleton H. Bean, who has accomplished excellent results in the investigations of the salmon industries of the Pacific coast.)

The label accompanying the types of this new species states that they were taken from a female fish that died of the disease prevailing among the salmon in the McCloud River during the summer of 1881. The species can be distinguished by the comparative length of the second maxillipeds, by the size and shape of the bulla, and the fact that it possesses a distinct stalk, and by the distance between the first maxillipeds and the other mouth parts. Without exception, also, these parasites were attached to the tips of the gill filaments, while *L. gibber* attaches itself to the gill arches.

## LERNÆOPODA BICAULICULATA, new species.

## Plate LXXXII.

*Host and record of specimens.*—Three females were taken from the tips of the gill filaments of the Dolly Varden trout, *Salvelinus malma*, at Bering Island by Governor N. Grebnitzky. They are made the species types and are Cat. No. 38594, U.S.N.M.

A second lot of two females was obtained by L. Stejneger in 1882, also from Bering Island, but the host is not given. This lot is Cat. No. 8453, U.S.N.M.

A single female was taken from a "trout" at Mapleton, Oregon, by Dr. S. E. Meek in 1896, and is Cat. No. 38575, U.S.N.M.

*Female.*—General body form short and stout, and but little flattened. Head long and narrow and as wide at the tip as at the base, where the second maxillipeds project on either side like a pair of veritable shoulders. This is markedly different from the other species examined and constitutes a good distinguishing character. In side view the bases of the first maxillipeds are seen to be placed well back, close to the second pair. The latter are nearly as long as the genital portion, of the same diameter throughout, and squarely truncated at their tips. They are not fused at the tips, but are entirely distinct, and each gives rise to a slender petiole. These two petioles then unite to form the common petiole of the bulla, which has the ordinary mushroom shape.

The bases of these second maxillipeds are fused across the body and project strongly on either side, their combined diameter being nearly twice that of the head. Behind them the flask-shaped genital portion is narrowed into a neck of about the same diameter as the head, and thus increases the prominence of the projecting maxillipeds. This genital portion is flattened on the ventral surface and strongly arched dorsally; it is one-half longer than wide and of about the same width and thickness, and is entirely without processes, abdomen, or anal laminae.

The egg cases are attached at the extreme ventral corners, as widely separated as possible, constituting another specific characteristic. Furthermore, the tube or neck by which each is attached to the body runs some little distance along a groove in the ventral surface of the genital portion, diagonally forward and inward, to the openings of the oviducts. Egg cases four-fifths the entire length of the body and half the diameter of the genital portion. Eggs large and arranged in eight to ten longitudinal rows.

First antennae slender and more distinctly jointed than in other species, but smooth and unarmed. Second pair flattened and laminate, divided at the tip into three parts, something like those of *gibber*. The two outside parts are rounded knobs covered with short

spines, the central part is a square projection having a short and stout spine at each of its distal corners. The maxillae are stout and compact, conical in shape, and each terminating in a stout spine; each carries a short ramus or palp on its ventral surface near the center, also tipped with a stout spine; there is a third spine on the outer margin near the base, but this comes directly from the maxilla without any ramus.

The first maxillipeds have a stout basal joint which is armed with a large spine on its inner margin near the base of the terminal joint. The latter is slender and is terminated by a small curved claw and two minute spines.

Total length, 4.7 mm. Length of head, 1.15 mm.; of genital portion, 3 mm.; of egg cases, 3.12 mm. Width of head, 0.75 mm.; of bases of second maxillipeds, 2 mm.; of genital portion, 1.9 mm.; of egg cases, 1 mm.

*Color*.—Of preserved material a uniform light orange, darker over the ovaries in the genital portion.

(*bicauliculata*, furnished with two stems or stalks, in allusion to the double stem of the attachment bulla.)

This species may be recognized by these two stems of the attachment bulla, by the fact that the egg cases are attached at the extreme ventral corners in side view and as widely separated as possible in dorsal view, when really the openings of the oviducts are considerably farther forward and inward; by the narrowness of the base of the head and the anterior part of the genital portion and the contrasting width of the bases of the second maxillipeds, and by the fact that the parasites are found attached to the tips of the gill filaments and not to the arches or sides of the gill cavity.

LERNÆOPODA FALCULATA, new species.

Plate LXXXIII.

*Host and record of specimens*.—A lot of four females was obtained from the gills of the blue-back salmon, *Oncorhynchus nerka*, at Baker Lake, Washington, in 1902, by the U. S. Bureau of Fisheries. These are made the types of the new species and are Cat. No. 38586, U.S.N.M.

A single female was obtained at Bristol Bay, Alaska, for which no date or host was given; it is Cat. No. 8340, U.S.N.M.

Three lots were obtained by the U. S. Bureau of Fisheries from trout, one containing two females taken from the inside of the operculum at Hot Creek, Cassel, California, Cat. No. 38589, U.S.N.M.; another containing two females taken from the gills, in the west fork of Feather River, California, Cat. No. 38588, U.S.N.M., and the third containing a single female taken from the ventral fin, in the north fork of Feather River, Cat. No. 38590, U.S.N.M.

*Femalc.*—Body plump and only slightly flattened dorso-ventrally; head normally held at right angles to the body axis, as in the side view shown in fig. 150. Head elongate triangular, or pear-shaped in dorsal view, narrowed almost to a point anteriorly.

The first maxillipeds are close to the mouth tube and have exactly the appearance of an under jaw in side view, as was noted in the case of *Brachiella gracilis* (p. 465). The second maxillipeds are stout, cylindrical, and three-quarters as long as the entire body; they are not tapered, but are narrowed abruptly at the ends into a short petiole which connects with the bulla. The diameter of the petiole is one-third that of the second maxillipeds; the umbrella portion is more than six times the width of the petiole. The genital portion is elliptical, only a little longer than wide, and without any traces of segmentation. It is considerably wider than the head, but not much longer, and in alcoholic material is usually furrowed longitudinally along the outside of each ovary.

The egg strings are one-third the diameter of the genital portion, and as long as the entire body; the eggs are of medium size and are arranged in eight longitudinal rows.

The first antennae are longer and more slender than in *beani* or *gibber*, and are tipped with one large spine and three small ones. The second antennae are not as strongly flattened as in other species, and are bifurcate at their tips. The ventral ramus is a large flattened claw, with two accessory spines on its concave margin; the dorsal ramus is a conical process tipped with three small and strongly curved claws. The mandibles are much shorter than those of *beani* and not as slender as those of *gibber*, with the teeth considerably different in pattern from both.

The first maxillipeds have a strongly swollen basal joint like that in *gibber*, and a long and slender terminal joint. The terminal claw is stout and strongly curved, and there is an accessory spine on the inner margin of the joint near the base of the claw. These maxillipeds in their relation to the other appendages are between those of the species already described. They are not as close to the mouth tube as in *gibber*, but are considerably closer than in *beani* and *bicaudiculata*.

Total length, 5 mm. Length of head, 2 mm.; of genital portion, 3 mm.; of egg strings, 5 mm. Width of head, 1.5 mm.; of genital portion, 2.6 mm.; of egg cases, 0.8 mm.

*Color.*—Of preserved material a light orange, deeper over the ovaries; bulla dark brown, sometimes black; egg strings deep orange.

(*falcata*, furnished with little claws or talons, alluding to those on the tips of the second antennae.)



This new species may be recognized by the abruptly narrowed ends of the second maxillipeds, by the flattening of the genital portion, by the position of the first maxillipeds, and by the slenderness and length of the egg strings. These differences may then be confirmed by the structure of the various appendages.

LERNÆOPODA EXTUMESCENS Gadd.

*Lernæopoda extumescens* GADD, 1901, p. 31, pl. II, figs. 1 to 12.

*Host and record of specimen.*—A single female specimen was taken from the gill cavity of the hump-backed whitefish, *Coregonus uclouii*, in the Yukon River, Alaska, by E. W. Nelson, and is Cat. No. 29900, U.S.N.M.

LERNÆOPODA CALIFORNIENSIS Dana.

*Lernæopoda californiensis* DANA, 1852, p. 1379, pl. xCVI, fig. 1 a to b.

*Host and record of specimens.*—Dana's original types were taken from the body of a salmon (*Oncorhynchus*) captured in the Klamath River, California. In some manuscript notes made by Dr. R. R. Gurley, of the U. S. Bureau of Fisheries (1896), upon the Parasites of the Fresh-water Fishes of North America, occurs the following:

Some specimens of a *Lernæopoda* from the Columbia River basin appear to belong to this species, as far as it is possible to tell from Dana's brief description and figure, which latter, being merely an outline, admits of no very satisfactory comparison. Four specimens were taken from the gills of *Oncorhynchus nerka* by Dr. B. W. Evermann, in an inlet to Big Payette Lake, Idaho, September 27, 1891. It may be noted that *O. nerka* also occurs in Klamath River, from which Dana's types were obtained.

The author has not seen the above-mentioned specimens and so can only quote the authority given for their identity with the present species.

ANCHIORELLA UNCINATA Müller.

*Anchorella uncinata* BAIRD, 1850, p. 337, pl. XXXV, fig. 9.

*Host and record of specimens.* A single female was obtained from *Gadus macrocephalus* by L. Stejneger, at Bering Island, Siberia, in 1882; Cat. No. 7991, U.S.N.M.

Another lot of five females from the same host and at the same time is Cat. No. 7992, U.S.N.M.

A third lot was obtained from the same host by N. Gribnitzky, the governor of the island, and is Cat. No. 13706, U.S.N.M.

A fourth lot was obtained by the steamer *Albatross* at Chignik Bay during the Alaska salmon investigation in 1903. It also came from the same host and is numbered 11840.

## ACHTHERES COREGONI Smith.

*Achtheres coregoni* SMITH, 1874, p. 664, pl. III, fig. 17.

*Host and record of specimens.*—Several female specimens were taken from a species of *Coregonus* in the Yukon River, Alaska, and are Cat. No. 6113, U.S.N.M.

## ALPHABETICAL LIST OF HOSTS, WITH THE PARASITES FOUND ON EACH.

- Citharichthys*, species. The soft flounders.  
*Phriaccephalus cincinnatus*, new species, attached to eye.
- Coregonus nelsonii* Bean. The hump-backed whitefish.  
*Lernaopoda extumescens* Gadd, fastened to the sides of the gill cavity.
- Coregonus*, species. The whitefish.  
*Achtheres coregoni* Smith, from the gill cavity.
- Cynoscion nobilis* Ayres. The white sea bass.  
*Lepeophtheirus thompsoni* Baird, from the outside of the body.  
*Brachiella gracilis*, new species, from the mouth.
- Gadus macrocephalus* Tilesius. Alaska codfish.  
*Lepeophtheirus parvicentris* Wilson, from the outside surface.  
*Anchorella uncinata* Müller, from the gills and mouth.
- Galeorhinus zyopterus* Jordan and Gilbert. The soup-fin shark.  
*Pandarus cranchii* Leach, from the fins and skin.  
*Eudactylina uncinata*, new species, from the gill filaments.  
*Opimia gracilis*, new species, embedded in the flesh on the walls of the mouth and gill cavities.
- Hydrolagus colliciei* Lay and Bennett. The elephant-fish.  
*Chondracanthus epachthes*, new species, from the gill cavity.  
*Caligus gurnardi* Kröyer, from the outside surface.
- Hypsypops rubicundus* Girard. The garibaldi.  
*Artacolar* (*Bomolochus*) *ardeola* Kröyer, from the gill filaments.
- Lepidopsetta bilineata* Ayres.  
*Lepeophtheirus parvicentris* Wilson, from the outside surface.
- Lycodontis mordax* Ayres. The California conger eel.  
*Hatschekia pinguis*, new species, from the gills.
- Mola mola* Linnaeus. The sunfish.  
*Lepeophtheirus nordmannii* Milne-Edwards, and *L. insignis*, new species, from the outside surface.  
*Cecrops lutreillii* Leach, from the gills.

- Oncorhynchus gorbusha** Walbaum. The humpbacked salmon.  
*Lepcophtheirus salmonis* Kröyer, from the gills and gill cavity.
- Oncorhynchus kisutch** Walbaum. The Coho salmon.  
*Argulus pugettensis* Dana, from the outside surface.
- Oncorhynchus nerka** Walbaum. The blue-back salmon.  
*Lepcophtheirus pacificus* Gissler, from the outside surface.  
*Lepcophtheirus salmonis* Kröyer, from the gills and gill cavity.  
*Lernaopoda californiensis* Dana, presumably from the gills or gill cavity.  
*Lernaopoda falculata*, new species, from the gills.
- Oncorhynchus tshawytscha** Walbaum. The Quinmat salmon.  
*Caligus gurnardi* Kröyer, from the outside surface.  
*Lepcophtheirus salmonis* Kröyer, from the gills.  
*Lernaopoda beani*, new species, from tips of the gill filaments.
- Paralabrax maculato-fasciatus** Steindachner. Spotted cabrilla.  
*Lepcophtheirus constrictus*, new species, from the outside surface.
- Pimelometopon pulcher** Ayres. California redfish.  
*Lepcophtheirus parvus*, new species, from the outside surface.
- Pleurogrammus monoptyerygius** Pallas. The Atka fish.  
*Lepcophtheirus parvicentris* Wilson, from the outside surface.
- Psettichthys melanostictus** Girard. A flounder.  
*Lepcophtheirus bifurcatus* Wilson, from the outside surface.
- Salvelinus malma** Walbaum. The Dolly Varden trout.  
*Lepcophtheirus salmonis* Kröyer, from the gills and gill cavity.  
*Lernaopoda gibber*, new species, from the inside of the gill arches.  
*Lernaopoda bicauliculata*, new species, from the tips of the gill filaments.
- Scorpaena guttata** Girard. The scorpion.  
*Lepcophtheirus brachyurus* Heller, from the outside surface.
- Sebastes glaucus** Hilgendorf. The rockfish.  
*Brachialla anserina*, new species, from the gills and gill arches.
- Sebastes rubrivinctus** Jordan and Gilbert. Spanish flag.  
*Lepcophtheirus parvicentris* Wilson, from the outside surface.
- Sphaeroides**, species. The puffers.  
*Pseudochondracanthus diceraus*, new species, from the gills and gill cavity.
- Stereolepis gigas** Ayres. The jew fish.  
*Lepcophtheirus longipes* Wilson, from the outside surface.

**Triakis semifasciatum** Girard. The leopard or cat shark.

*Achtheinus oblongus*, new species, from the outside surface and possibly from the fins.

**Urolophus halleri** Cooper. The round sting ray.

*Trebius tenuifurcatus* Rathbun, from the outside (upper) surface of the body.

#### BIBLIOGRAPHY.

1850. BAIRD, W. The Natural History of the British Entomostraca. Printed for the Ray Society, London.
1852. DANA, J. D. Conspectus Crustaceorum quae in Orbis Terrarum circumnavigatione, Carolo Wilkes e Classe Reipublice Federatae Duce, lexit et descripsit Jacobus D. Dana.
1852. DANA, J. D. Crustacea of the United States Exploring Expedition during the years 1838, 1839, 1840, 1841, 1842, under the command of Charles Wilkes, U. S. N., XIII, Part 2.
1904. GADD, PETER. Parasit-Copepoder i Finland. Acta Societatis pro Fauna et Flora Fennica, XXVI, No. 8.
1883. GISSLER, C. F. A new Parasitic Copepod Crustacean, American Naturalist, XVII.
1865. HELLER, C. Reise der Oesterreichischen Fregatte Novara in den Jahren 1857, 1858, und 1859, Zoologische Theil, II, Part 3, Crustaceen. Wien.
1863. KRÖYER, H. Bidrag til Kundskab om Snyltekrebsene. Naturhistorisk Tidsskrift, Tredie Raekke, Andet Bind.
1840. MILNE EDWARDS, H. Histoire Naturelle des Crustacés, III. Paris.
1776. MÜLLER, O. F. Zoologie Danicae. Havniae, 1776.
1887. RATHBUN, RICHARD. Description of New Species of Parasitic Copepods belonging to the genera *Trebius*, *Perissopus*, and *Lernanthropus*. Proceedings of the U. S. National Museum, X.
1871. SMITH, S. I. Crustacean Parasites of Fresh-water Fishes. Report of the U. S. Fish Commission for 1872 and 1873, Part 2.
1877. VOGT, CARL. Recherches Cotières; second Mémoire, Geneva.
1902. WILSON, C. B. North American Parasitic Copepods of the Family Argulidae, Proceedings of the U. S. National Museum, XXV.
1905. WILSON, C. B. North American Parasitic Copepods belonging to the Family Caligidae: Part 1, The Caliginae, Proceedings of the U. S. National Museum, XXVIII.
1907. WILSON, C. B. North American Parasitic Copepods belonging to the Family Caligidae: Parts 3 and 4, A Revision of the Pandarinae and the Cecropinae, Proceedings of the U. S. National Museum, XXXIII.

#### EXPLANATION OF PLATES.

##### PLATE LXVI.

The male and female of *Chondracanthus epachthes*, new species.

Fig. 1. Dorsal view of female. Fig. 2. First and second antennae. Fig. 3. First antenna more highly magnified. Fig. 4. Mouth parts, the mandibles being concealed beneath the upper lip. Fig. 5. Mandible. Fig. 6. Maxilla. Fig. 7. Second maxilliped. Fig. 8. Lateral view of male. Fig. 9. Mandible of male, the same magnification as fig. 5. Fig. 10. Second maxilliped of male.

## PLATE LXVII.

The male and female of *Pseudochondraeuthus diceraus*, new species.

Fig. 11, Adult female, dorsal view. Fig. 12, Head and first thorax segment, ventral view, showing the first antenna (*a*), the second antenna (*a'*), the mandibles (*md.*), the maxilla (*mx.*), the maxillipeds (*mxp.*), and the first swimming legs (*l.*). Fig. 13, Mandible and maxilla, dorsal surface. Fig. 14, Maxilla, ventral surface. Fig. 15, Maxilliped, ventral surface. Fig. 16, Lateral view of the male. Fig. 17, Mouth parts of male, showing upper lip (*u. l.*), mandible (*md.*), and maxilla (*mx.*). Fig. 18, Maxilliped of male.

## PLATE LXVIII.

The female of *Lepeophtheirus parvus*, new species.

Fig. 19, Dorsal view of female. Fig. 20, Second antenna and first maxilla. Fig. 21, Mouth tube and second maxilla. Fig. 22, Furca. Fig. 23, Second maxilliped. Figs. 24 to 27, First, second, third, and fourth swimming legs.

## PLATE LXIX.

The female of *Lepeophtheirus constrictus*, new species.

Fig. 28, Dorsal view of female. Fig. 29, Second antenna and first maxilla. Fig. 30, Second maxilla. Fig. 31, Furca. Fig. 32, Second maxilliped. Figs. 33 to 35, First, third, and fourth swimming legs. Fig. 36, Ventral view of genital segment and abdomen, showing the rudimentary fifth legs.

## PLATE LXX.

The female of *Lepeophtheirus insignis*, new species.

Fig. 37, Dorsal view of female. Fig. 38, Second antenna. Fig. 39, Mouth tube and second maxilla. Fig. 40, Furca. Figs. 41 to 43, First, second, and third swimming legs. Fig. 44, Ventral surface of genital segment and abdomen, showing cement glands (*c. g.*), spermatophores (*s.*), and rudimentary fifth and sixth legs. Fig. 45, Mouth tube and second maxilla of male. Fig. 46, Second maxilliped of male. Fig. 47, Fourth swimming leg of male. Fig. 48, Ventral surface of genital segment of male, showing partial separation of a sixth segment.

## PLATE LXXI.

The male and young female of *Lepeophtheirus insignis*, new species.

Fig. 49, Dorsal view of male. Fig. 50, Second antenna and first maxilla of male. Fig. 51, Dorsal view of young female. Fig. 52, Second antenna and first maxilla of same. Fig. 53, Furca, the branches just starting. Fig. 54, Mouth tube and second maxilla; contrast the latter with those of the adult in fig. 39. Fig. 55, Furca of a little older female.

## PLATE LXXII.

The male and female of *Trechius taeniifurcatus* Rathbun.

Fig. 56, Dorsal view of female. Fig. 57, Second antenna and first maxilla. Fig. 58, Mouth tube and second maxilla. Fig. 59, Furca. Fig. 60, First maxilliped. Fig. 61, Second maxilliped. Figs. 62 to 65, First, second, third, and

fourth swimming legs. Fig. 66, Dorsal view of male. Figs. 67, Furca of male. Fig. 68, One side of the ventral surface of the male, showing the rudimentary fifth and sixth swimming legs.

PLATE LXXIII.

The female and a chalimus of *Aethlicinus oblongus*, new species.

Fig. 69, Dorsal view of adult female. Fig. 70, Second antenna. Fig. 71, Mouth tube and second maxilla. Fig. 72, Second maxilliped. Figs. 73 to 76 First, second, third, and fourth swimming legs. Fig. 77, Ventral view of genital segment and abdomen, showing the cement glands and rudimentary fifth legs. Fig. 78, Dorsal view of chalimus, showing the paired attachment filaments and the second and third thoracic segments still distinct. Fig. 79, Second maxilliped of chalimus.

PLATE LXXIV.

The female of *Eudactylina uncinata*, new species.

Fig. 80, Dorsal view of female. Fig. 81, First antenna. Fig. 82, Second antenna. Fig. 83, Mouth tube and second maxilla. Fig. 84, Second maxilliped. Fig. 85, First maxilliped. Figs. 86 to 89, First, second, fourth, and fifth swimming legs. Fig. 90, Tip of abdomen, showing anal laminae.

PLATE LXXV.

The male and female of *Hatschekia pinguis*, new species.

Fig. 91, Dorsal view of female. Figs. 92 and 93, First and second swimming legs. Fig. 94, Dorsal view of male. Fig. 95, Second antenna of male. Fig. 96, Second maxilliped of male. Figs. 97 and 98, First and second swimming legs.

PLATE LXXVI.

The females of *Lernaeicnus medusaeus*, new species, *Phrirocephalus cincinnatus*, new species, and *Opimia gracilis*, new species.

Fig. 99, Dorsal view of the female of *Lernaeicnus medusaeus*. Fig. 100, Ventral view of the head and anterior thoracic segment, showing the two pairs of rudimentary legs. Fig. 101, Ventral view of the female of *Phrirocephalus cincinnatus*, showing the rudimentary mouth parts and the two pairs of rudimentary legs. Fig. 102, Dorsal view of the female of *Opimia gracilis*. Fig. 103, Lateral view of the head and first thorax segment, showing the single pair of rudimentary legs. Fig. 104, Ventral view of the head, showing the second antenna (*a.*), the mouth tube with a rudimentary mandible (*md.*), and maxilla (*mx.*) on either side of it, and the single pair of maxillipeds (*mp.*). In this figure the head has been bent backward, thus increasing the space between the maxillipeds and the mouth parts; the normal position is shown in fig. 103.

PLATE LXXVII.

The male and female of *Brachiella gracilis*, new species.

Fig. 105, Lateral view of female with attached male. Fig. 106, Dorsal view of first and second antennae. Fig. 107, Ventral view of second antennae, mouth tube, and maxilla. Fig. 108, Mandible. Fig. 109, Ventral side of first maxilli-

pedis. Fig. 110. Lateral view of male. Fig. 111. Lateral view of young female, 3 mm. long. Fig. 112. Abdomen and anal laminae of this young female. Fig. 113. Lateral view of young female, 1.5 mm. long, showing a decrease in the distance between the first maxillipeds and the mouth parts, and an increase in the distance between the first and second maxillipeds.

## PLATE LXXVIII.

The female of *Brachiella anserina*, new species.

Fig. 114. Ventral view of the genital segment and abdomen of *Brachiella gracilis*. Fig. 115. Dorsal view of the female of *B. anserina*. Fig. 116. First antenna. Fig. 117. Second antenna. Fig. 118. Mandible. Fig. 119. Ventral view of maxilla, showing palp at the base. Fig. 120. Dorsal view of same. Fig. 121. First maxilliped. Fig. 122. Ventral view of the posterior portion of the genital segment, showing the position of the anus and the posterior processes.

## PLATE LXXIX.

The male and female of *Brachiella anserina*, new species.

Fig. 123. Lateral view of female, showing peculiar shape. Fig. 124. Dorsal view of posterior portion of the genital segment, showing processes. Fig. 125. Lateral view of male. Fig. 126. First antenna. Fig. 127. Second antenna. Fig. 128. Second maxilliped.

## PLATE LXXX.

The female of *Lernaopoda gibber*, new species.

Fig. 129. Dorsal view of the female (the head does not appear at all in this view). Fig. 130. Lateral view of female. Fig. 131. First and second antenna, mouth tube, and first maxillipeds. Fig. 132. First antenna. Fig. 133. Second antenna. Fig. 134. Mandible. Fig. 135. Maxilla.

## PLATE LXXXI.

The female of *Lernaopoda beani*, new species.

Fig. 136. Dorsal view of female. Fig. 137. Lateral view of same. Fig. 138. First antenna. Fig. 139. Second antenna. Fig. 140. Mandible. Fig. 141. Maxilla. Fig. 142. First maxilliped.

## PLATE LXXXII.

The female of *Lernaopoda bicauticulata*, new species.

Fig. 143. Dorsal view of female. Fig. 144. Lateral view of same. Fig. 145. First antenna. Fig. 146. Second antenna. Fig. 147. Maxilla. Fig. 148. First maxilliped.

## PLATE LXXXIII.

The female of *Lernaopoda fulculata*, new species.

Fig. 149. Dorsal view of female. Fig. 150. Lateral view of same. Fig. 151. First antenna. Fig. 152. Second antenna. Fig. 153. Mandible. Fig. 154. Maxilla. Fig. 155. First maxillipeds.





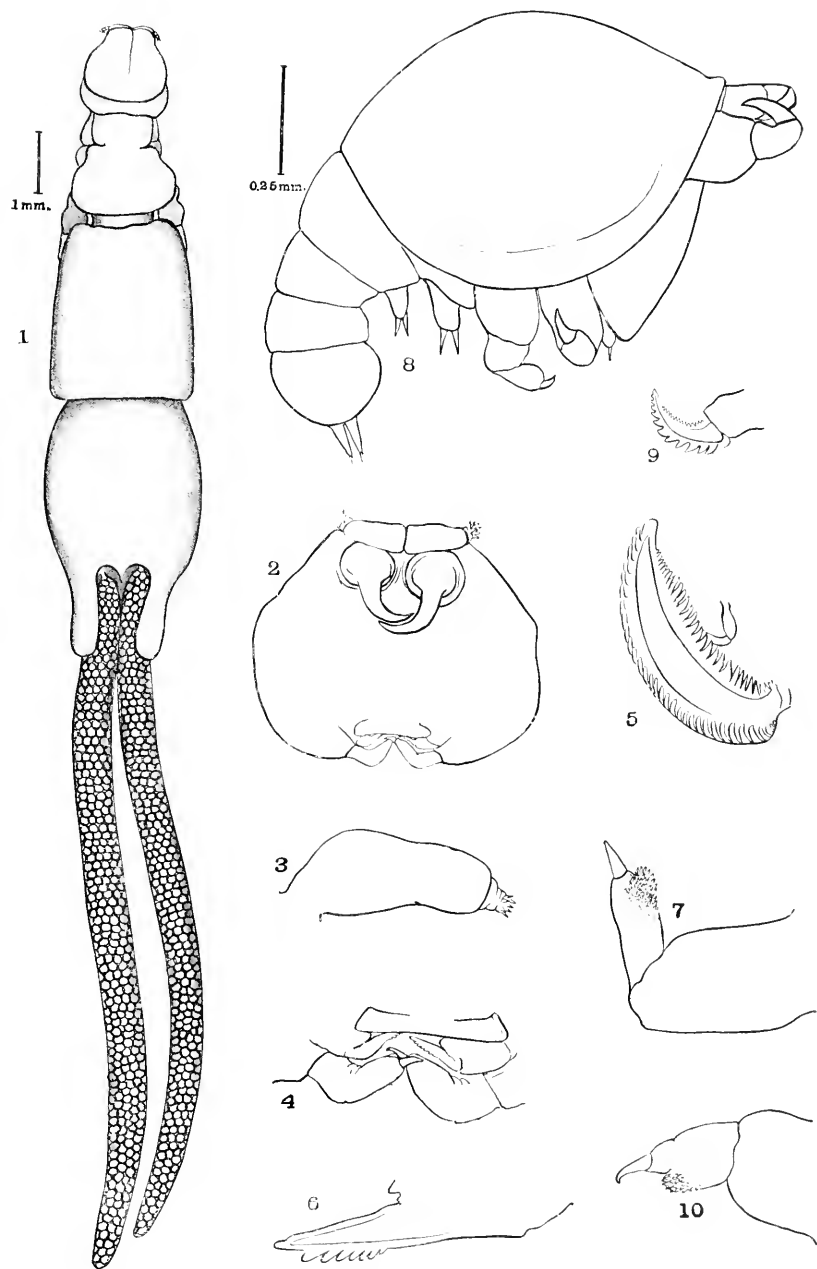

THE MALE AND FEMALE OF *CHONDRACANTHUS EPACHTHES*.

FOR EXPLANATION OF PLATE SEE PAGE 478.



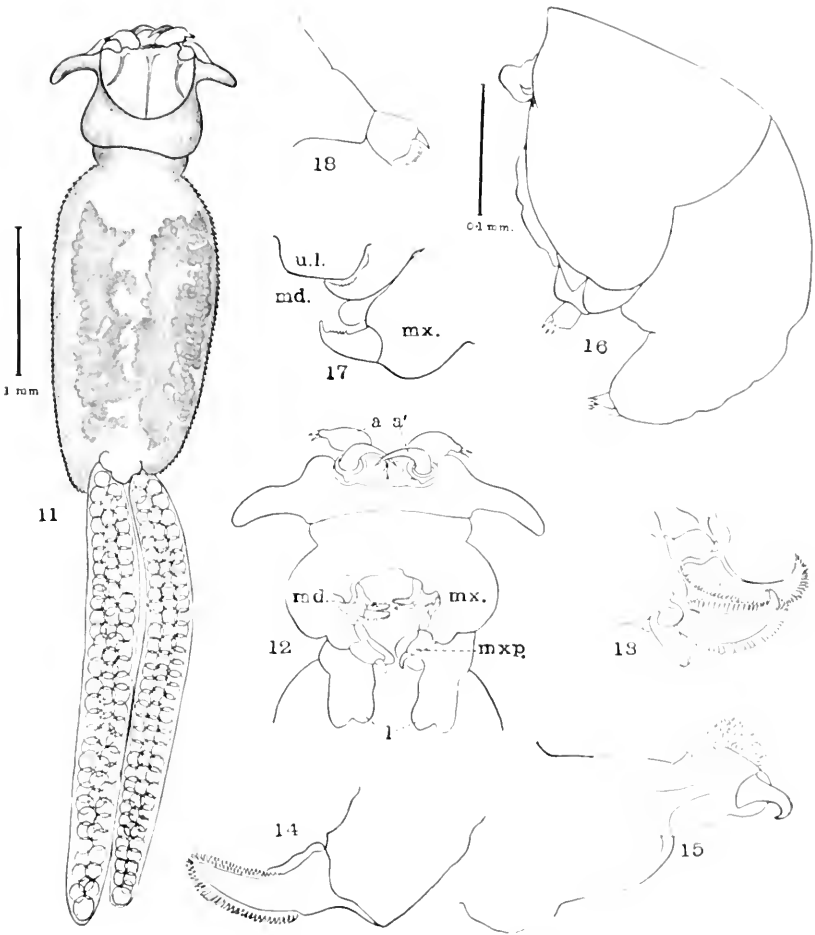

THE MALE AND FEMALE OF PSEUDOCHONDRACTHUS DICERAUS.

FOR EXPLANATION OF PLATE SEE PAGE 479.

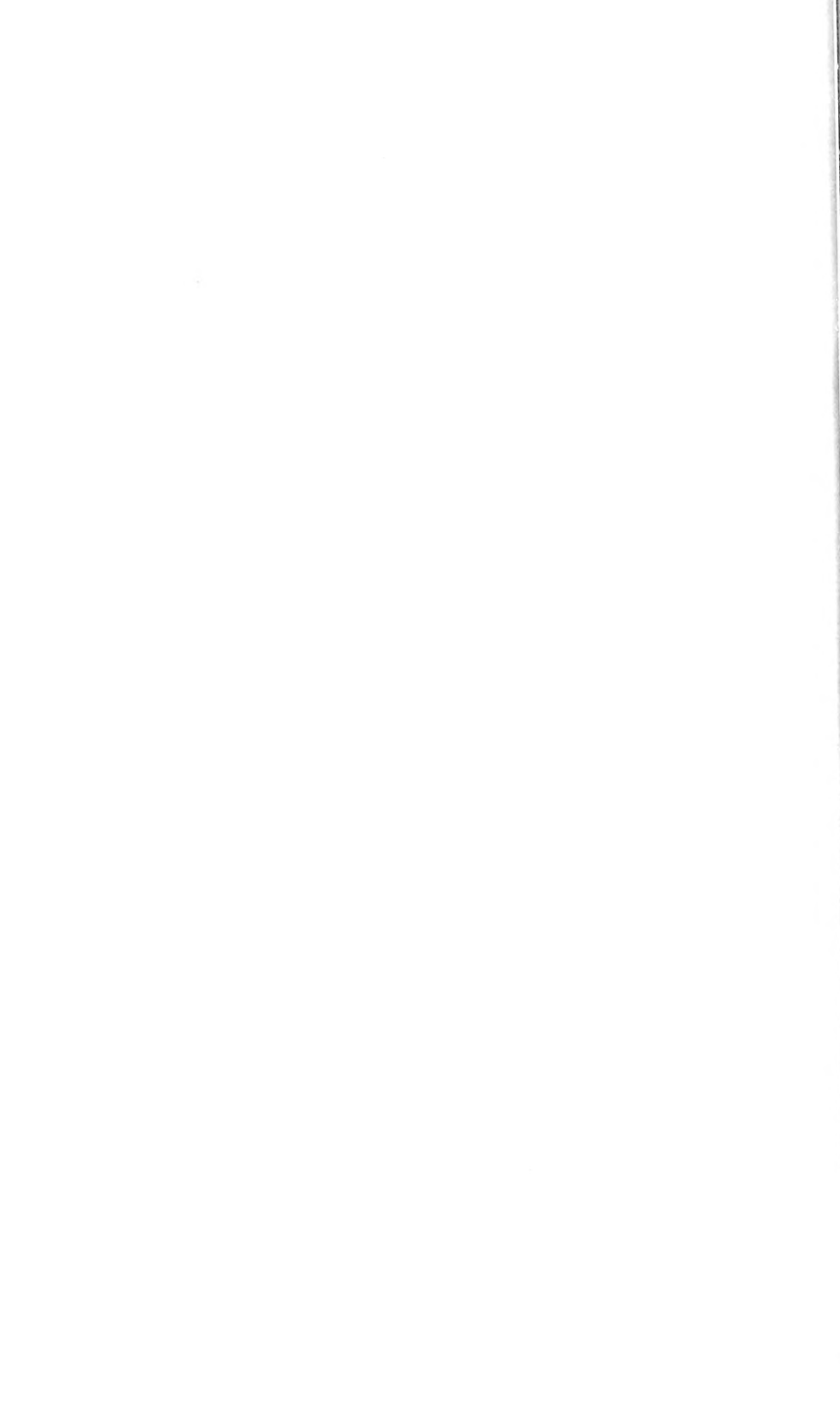

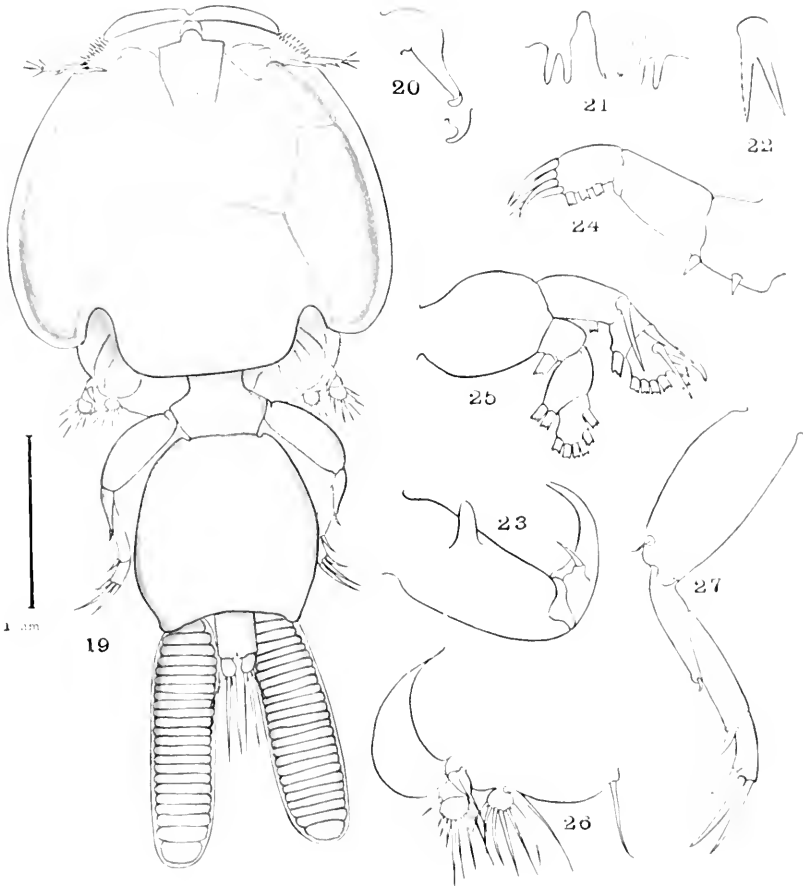

THE FEMALE OF LEFEPHTERUS PARVUS.

FIGURES 20-27, BY ALBERT S. FAHRENHOLZ.



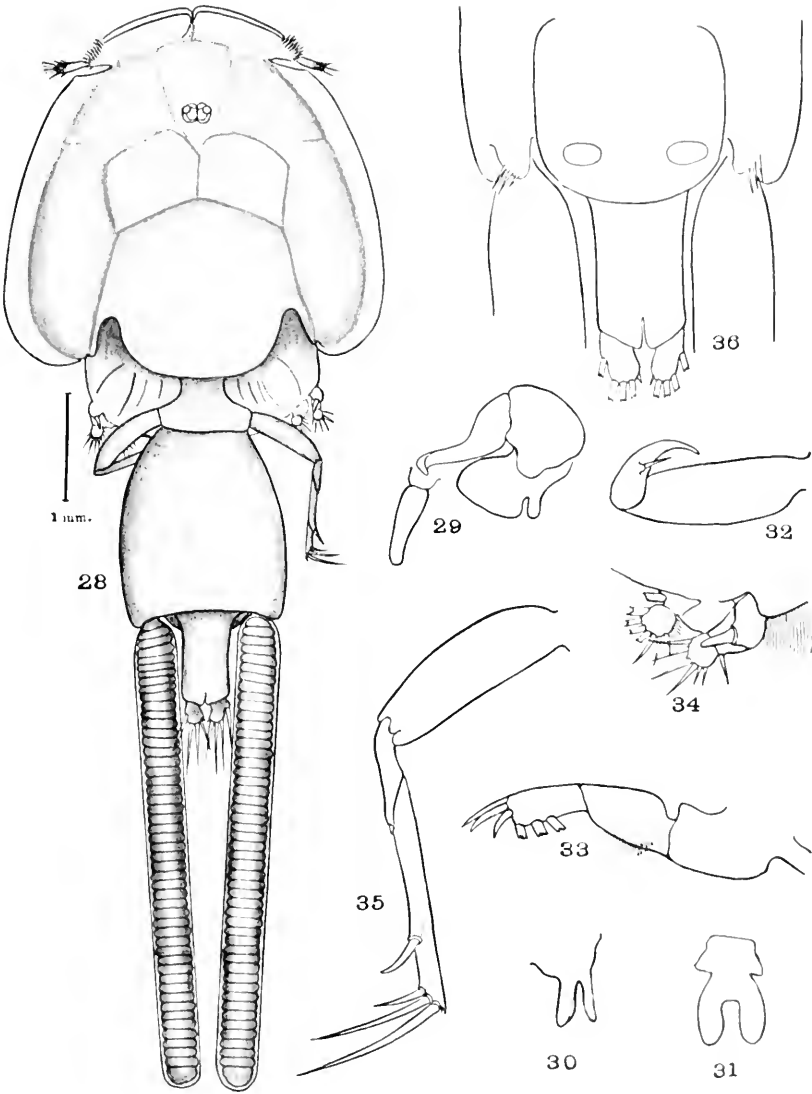

THE FEMALE OF *LEPEOPHTHEIRUS CONSTRICTUS*.

FOR EXPLANATION OF PLATE SEE PAGE 479.





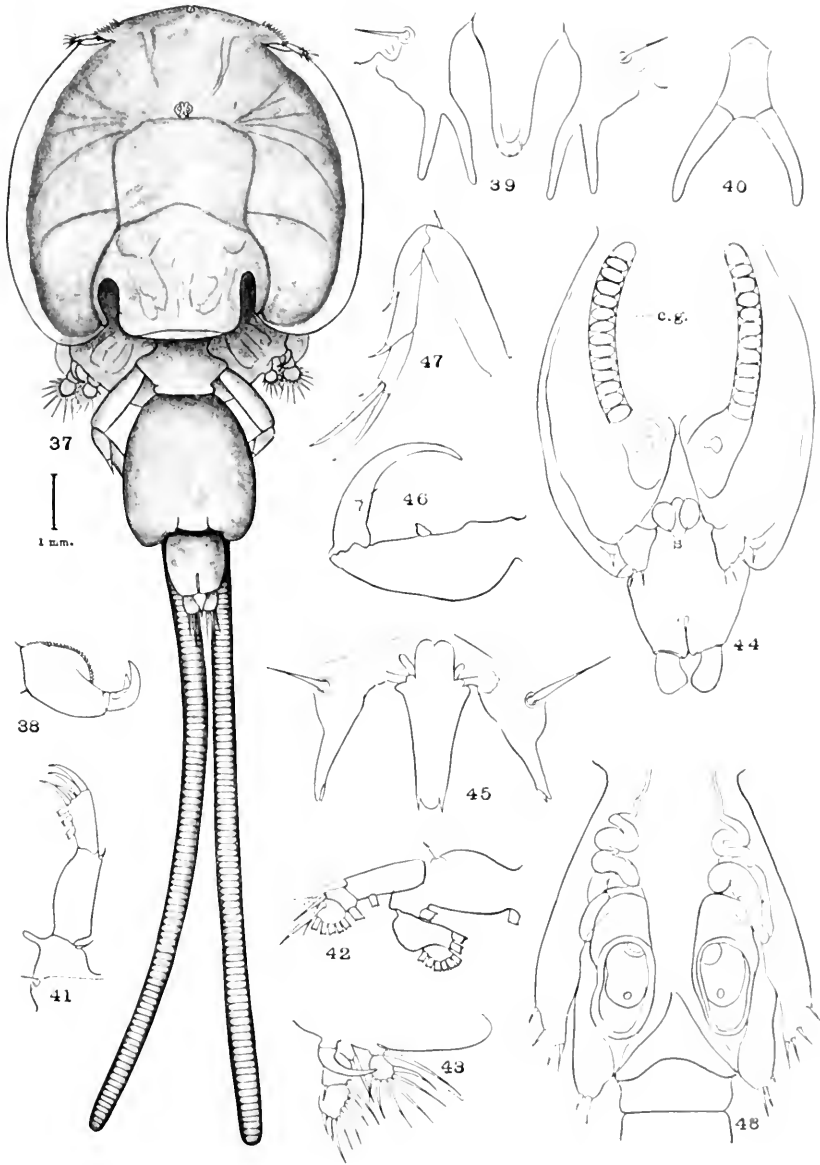

THE FEMALE OF *LEPEOPHTHEIRUS INSIGNIS*.

FOR EXPLANATION OF PLATE SEE PAGE 479.

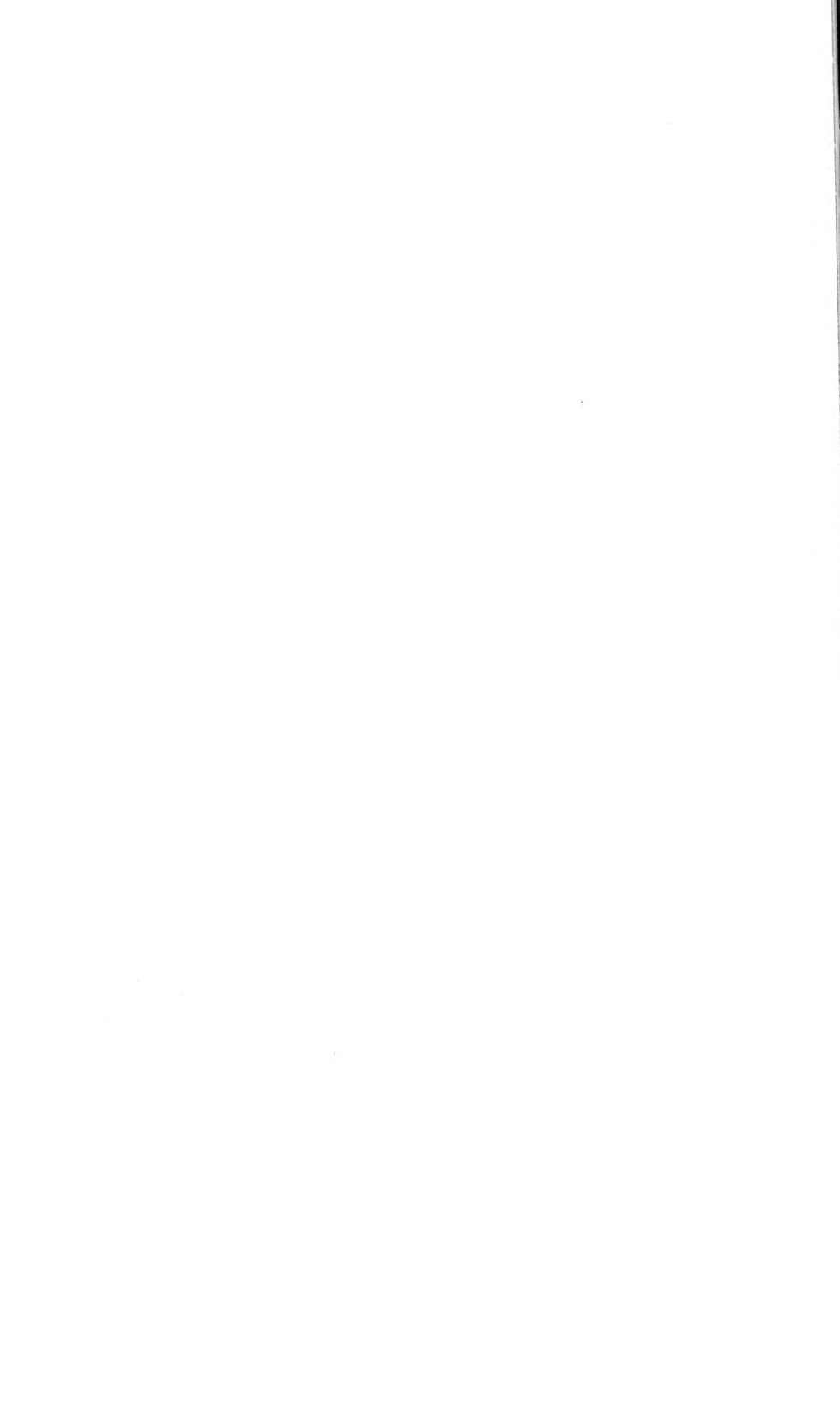

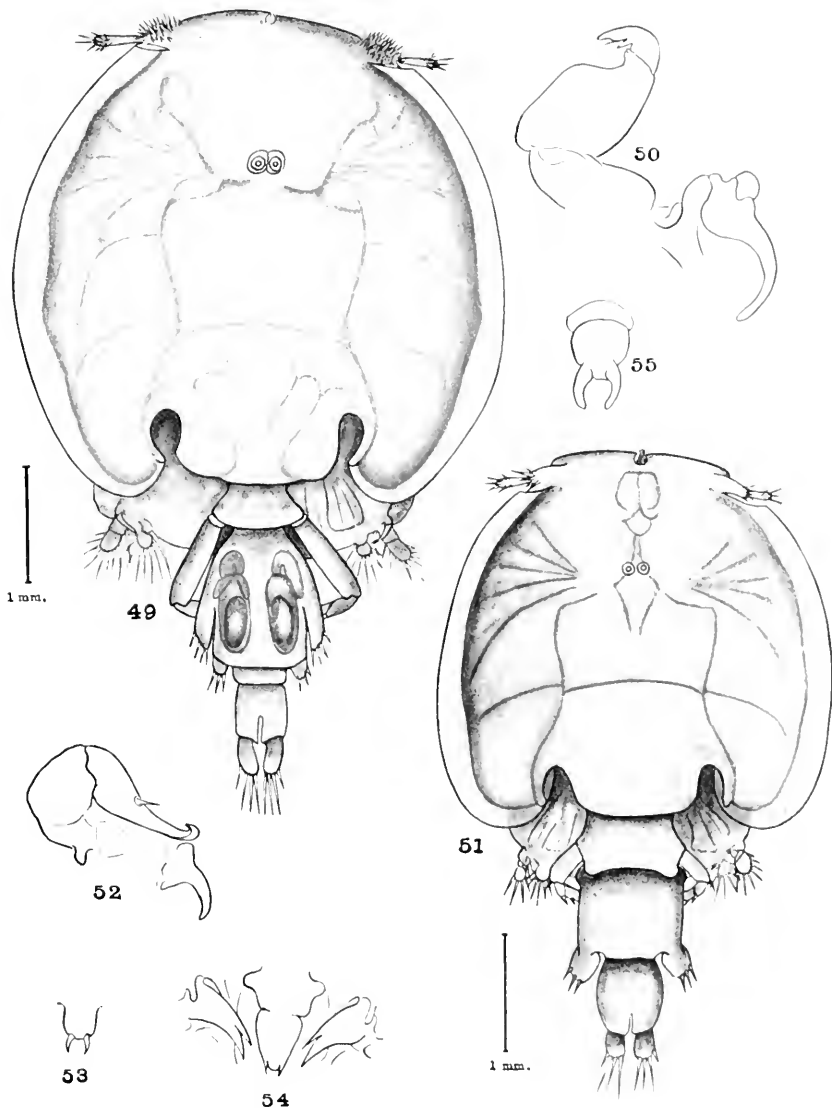

THE MALE AND YOUNG FEMALE OF *LEPEOPHTHEIRUS INSIGNIS*.

FOR EXPLANATION OF PLATE SEE PAGE 479.

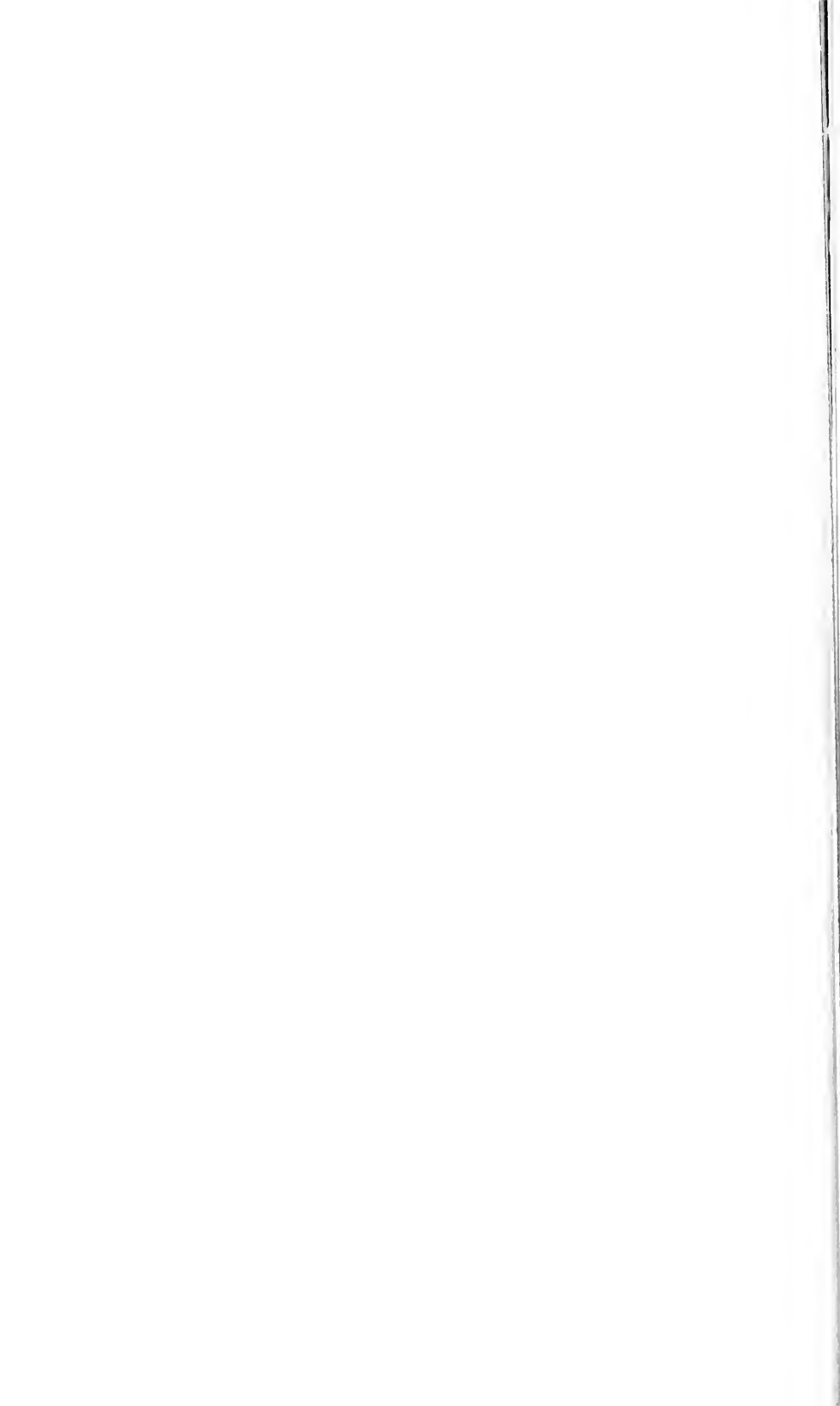

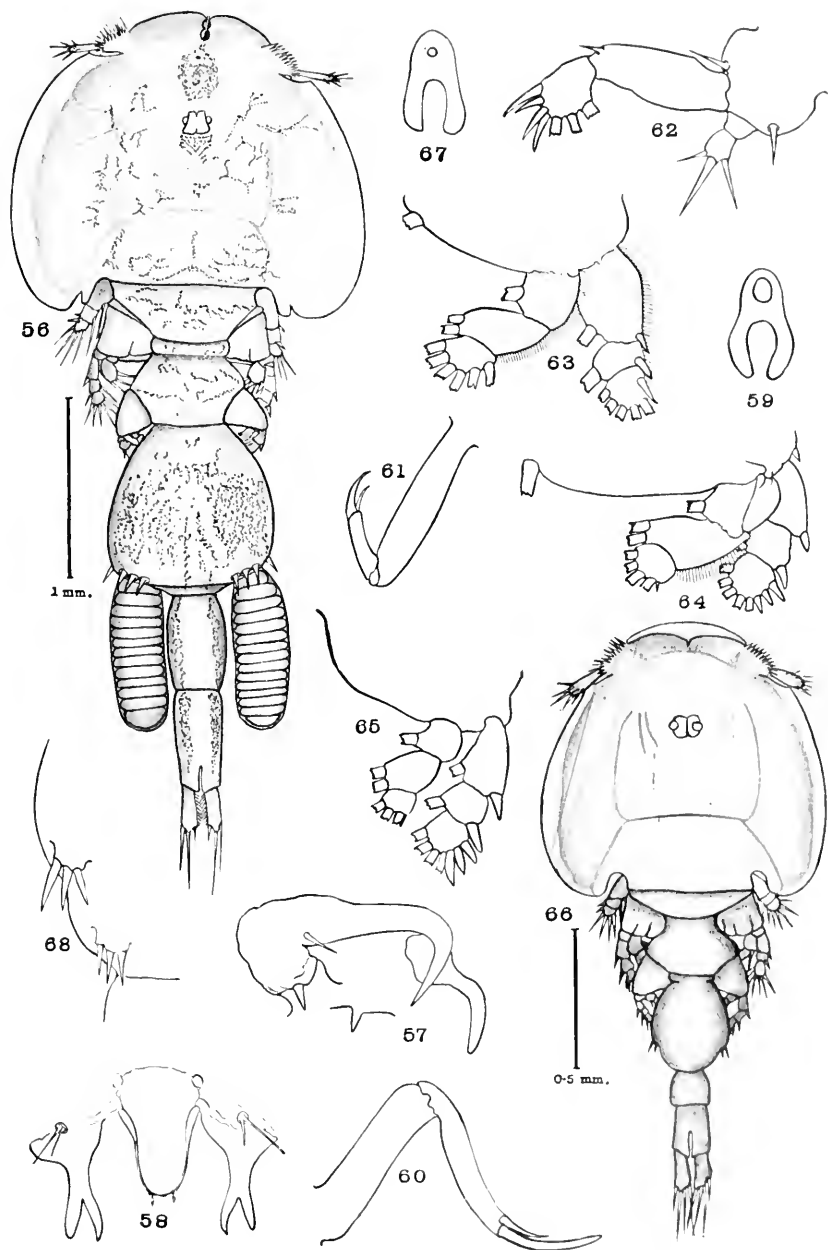

THE MALE AND FEMALE OF *TREBIUS TENUIFURCATUS*.

FOR EXPLANATION OF PLATE SEE PAGES 479, 480.



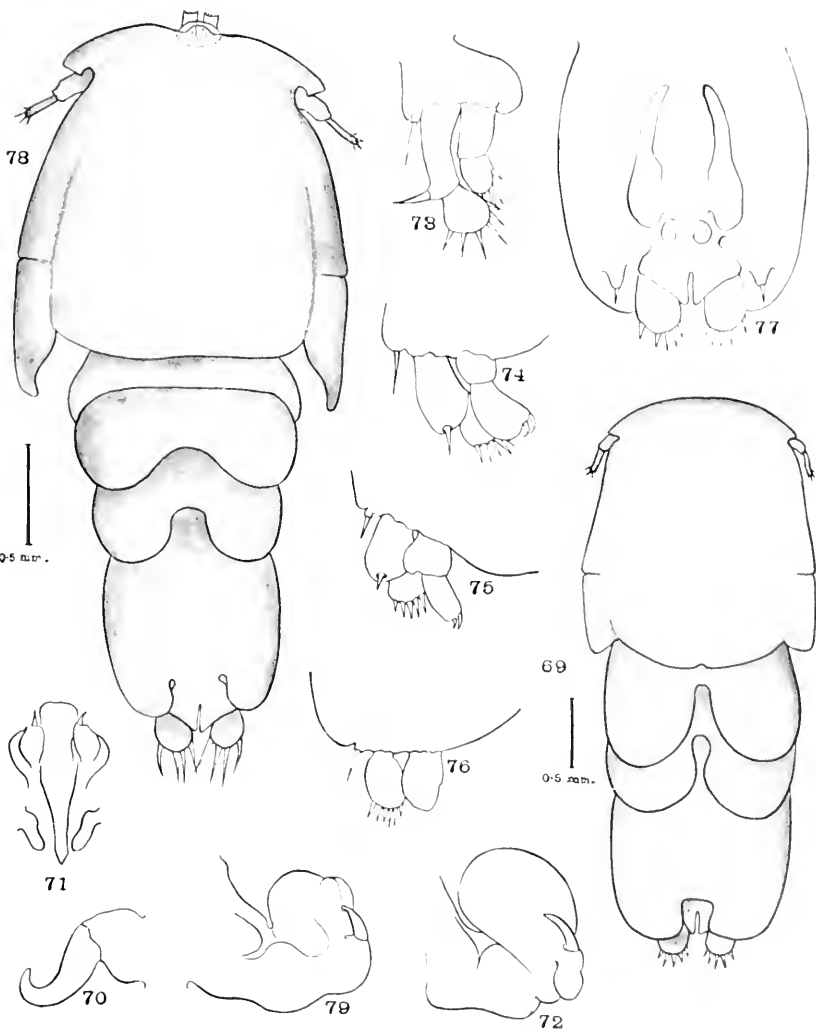

THE FEMALE AND A CHALIMUS OF *ACHTHEINUS OBLONGUS*.

FOR EXPLANATION OF PLATE SEE PAGE 480.





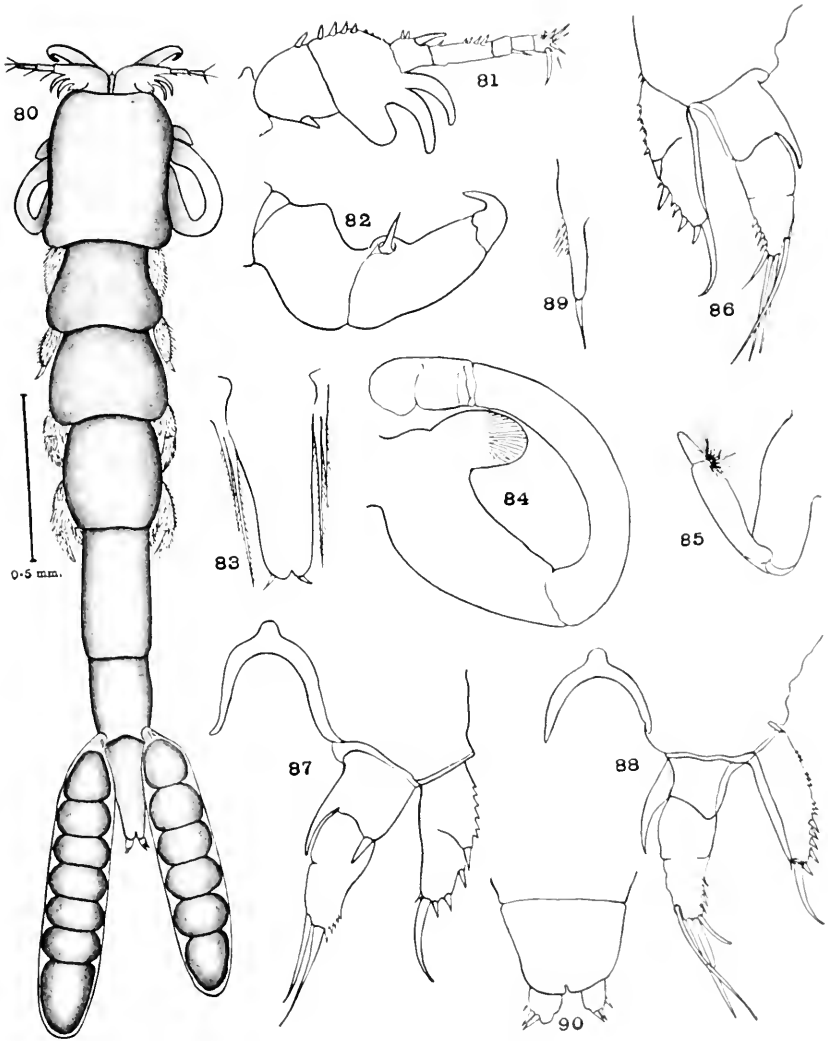

THE FEMALE OF EUDACTYLINA UNCINATA.

FOR EXPLANATION OF PLATE SEE PAGE 480.



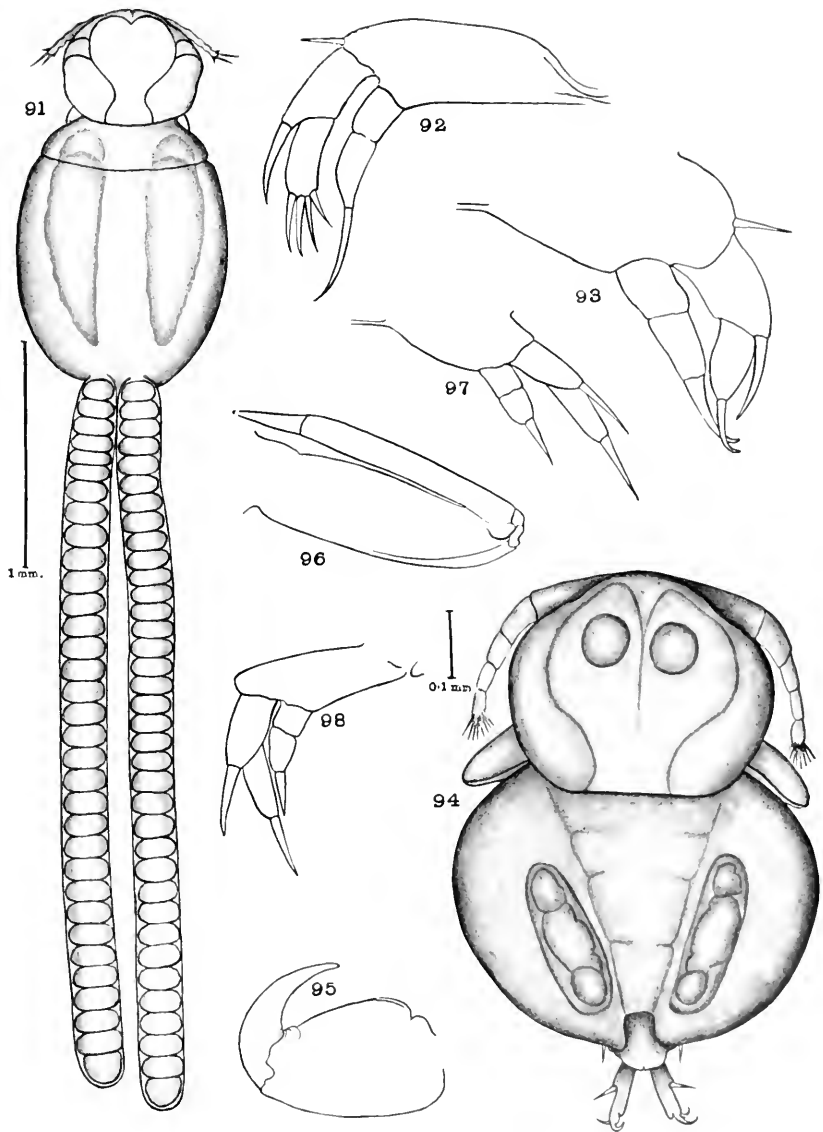

THE MALE AND FEMALE OF *HATSCHEKIA PINGUIS*.

FOR EXPLANATION OF PLATE SEE PAGE 480.

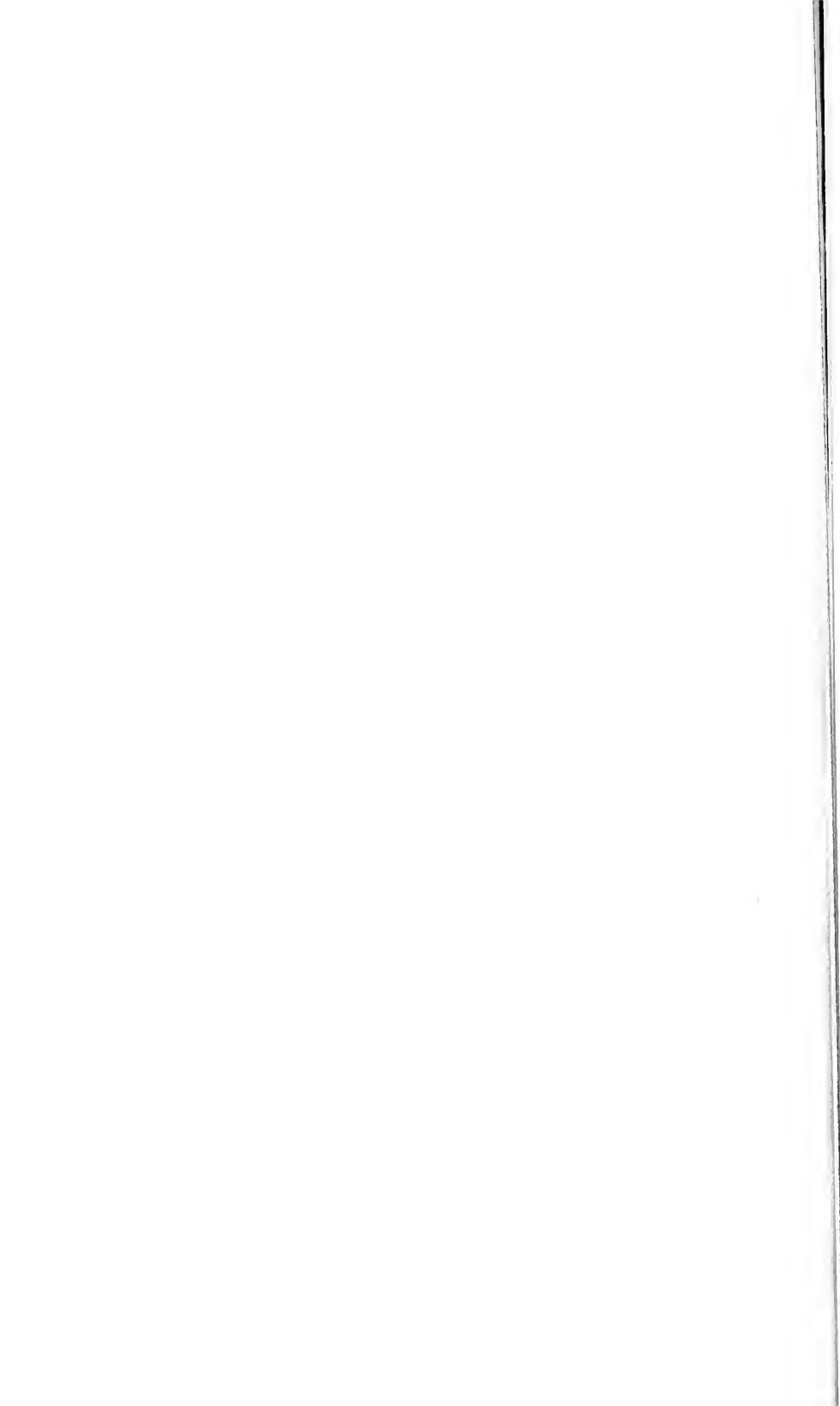

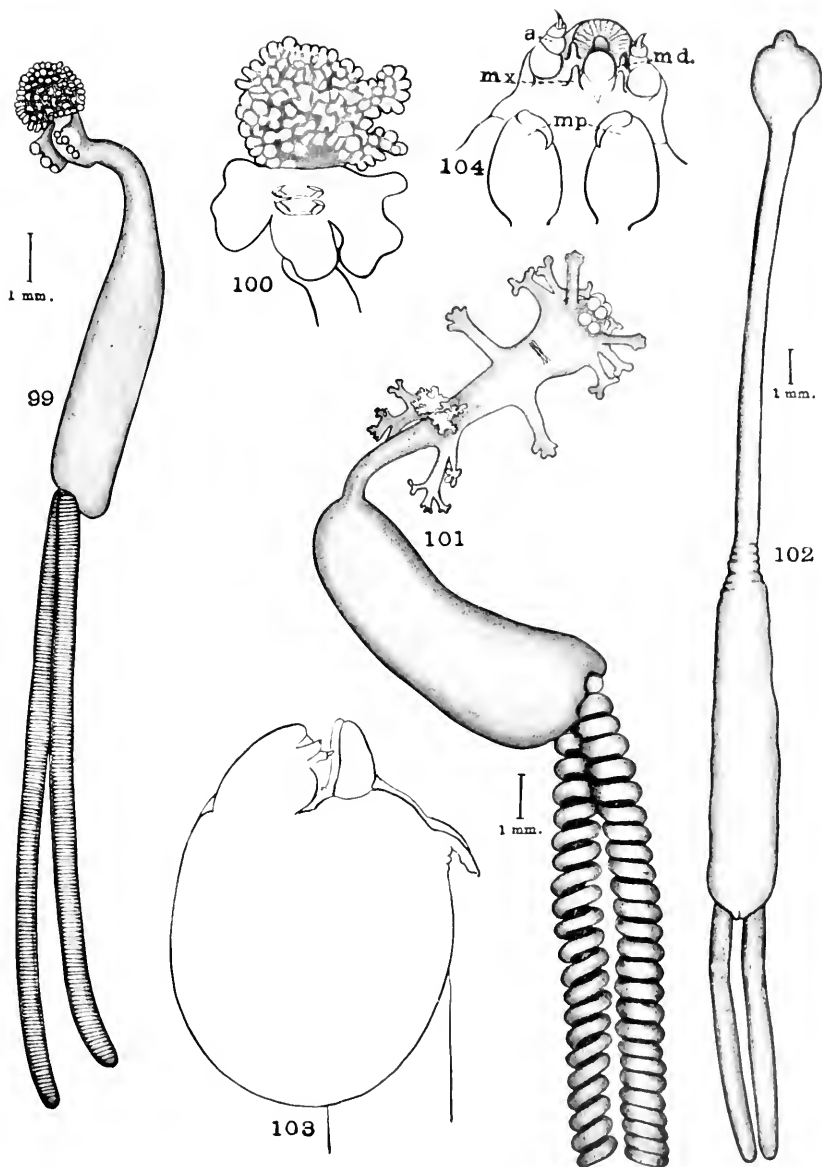

THE FEMALES OF LERNÆNICUS MEDUSÆUS, PHRIXOCEPHALUS CINCINNATUS,  
AND OPIMIA EXILIS.

FOR EXPLANATION OF PLATE SEE PAGE 480.

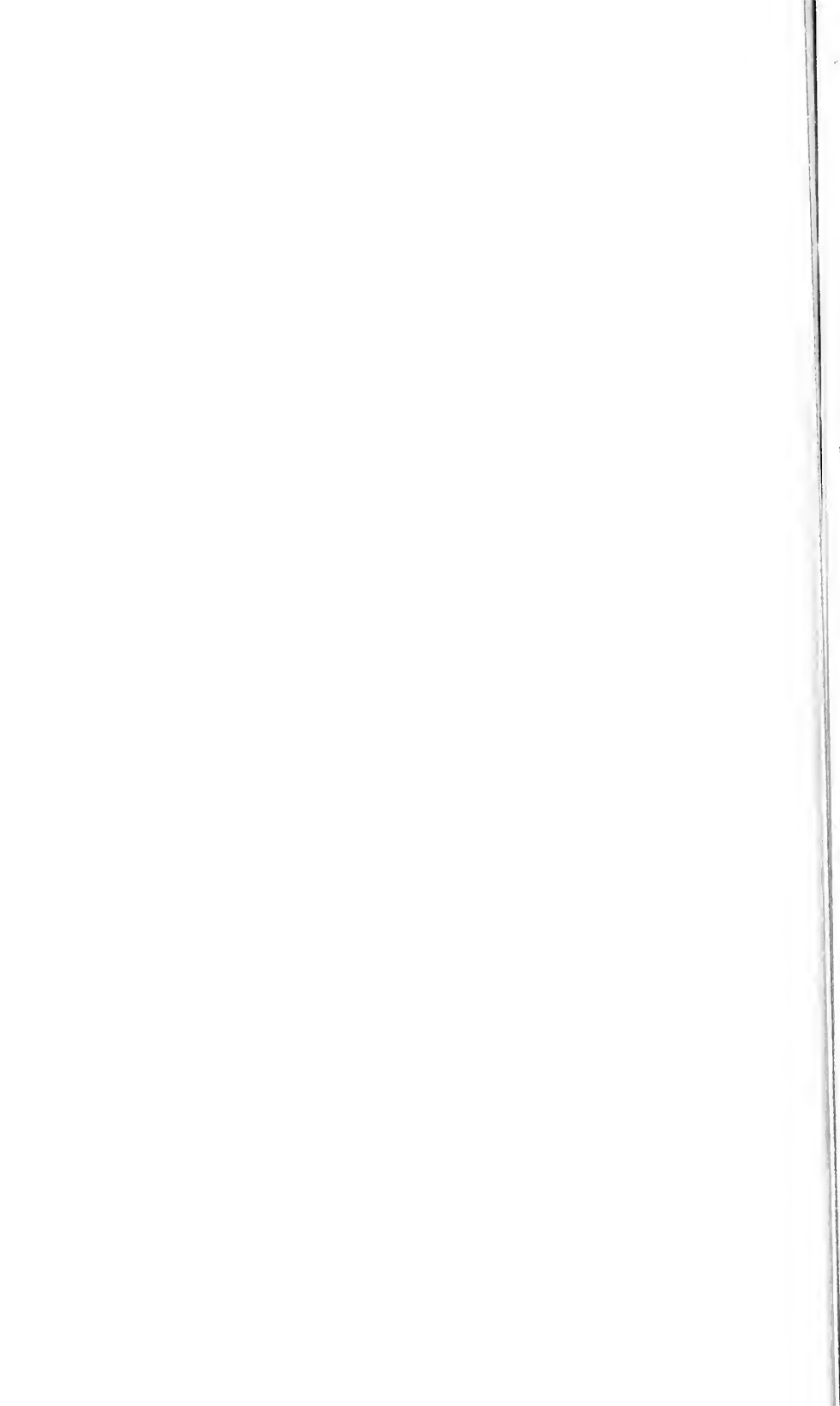

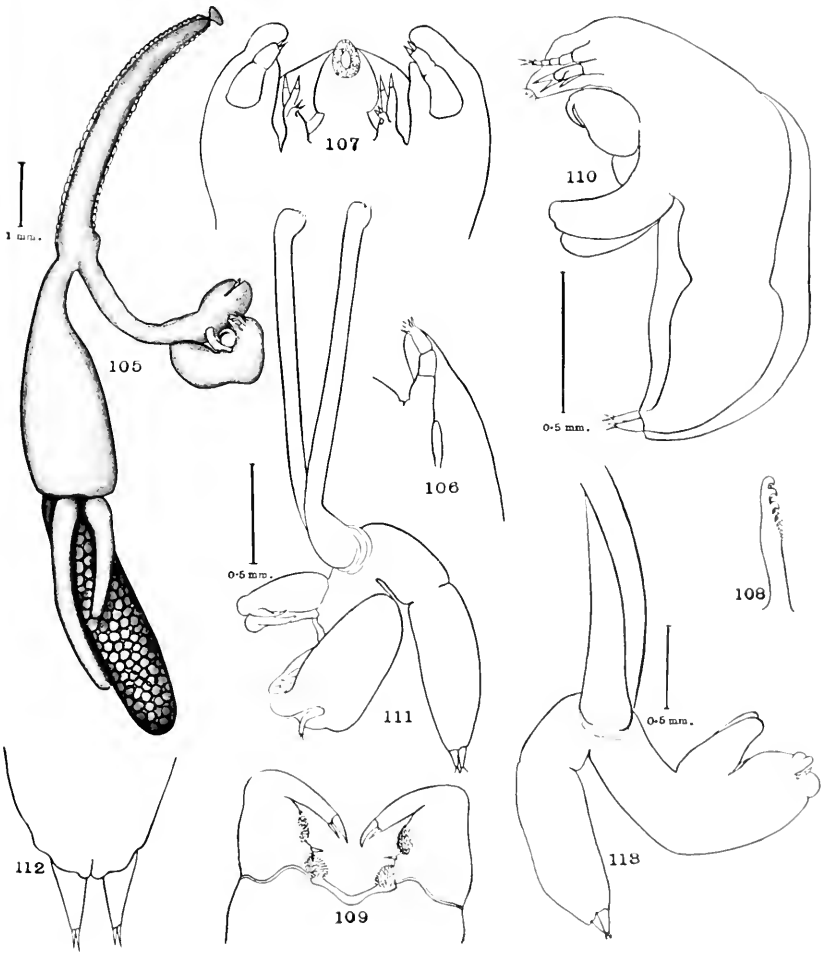

THE MALE AND FEMALE OF BRACIELLA GRACILIS.

FOR EXPLANATION OF PLATE SEE PAGES 480, 481.





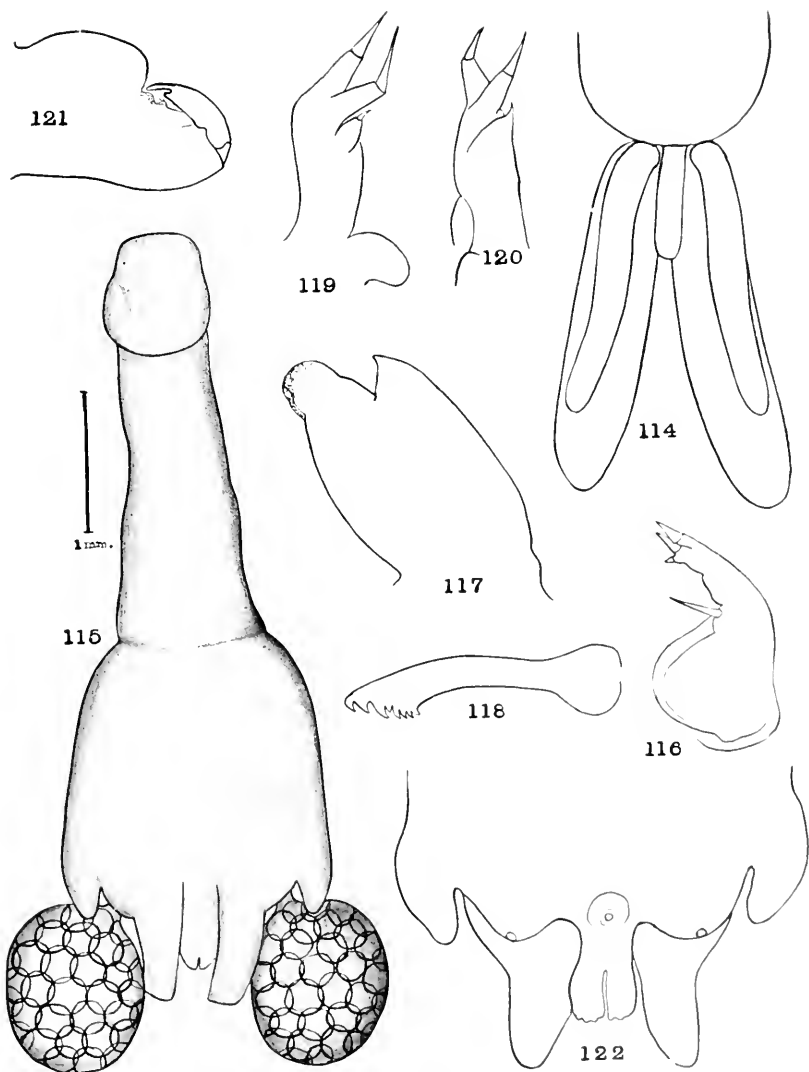

THE FEMALE OF BRACHELLEA ANSERINA.

FOR EXPLANATION OF PLATE SEE PAGE 481.

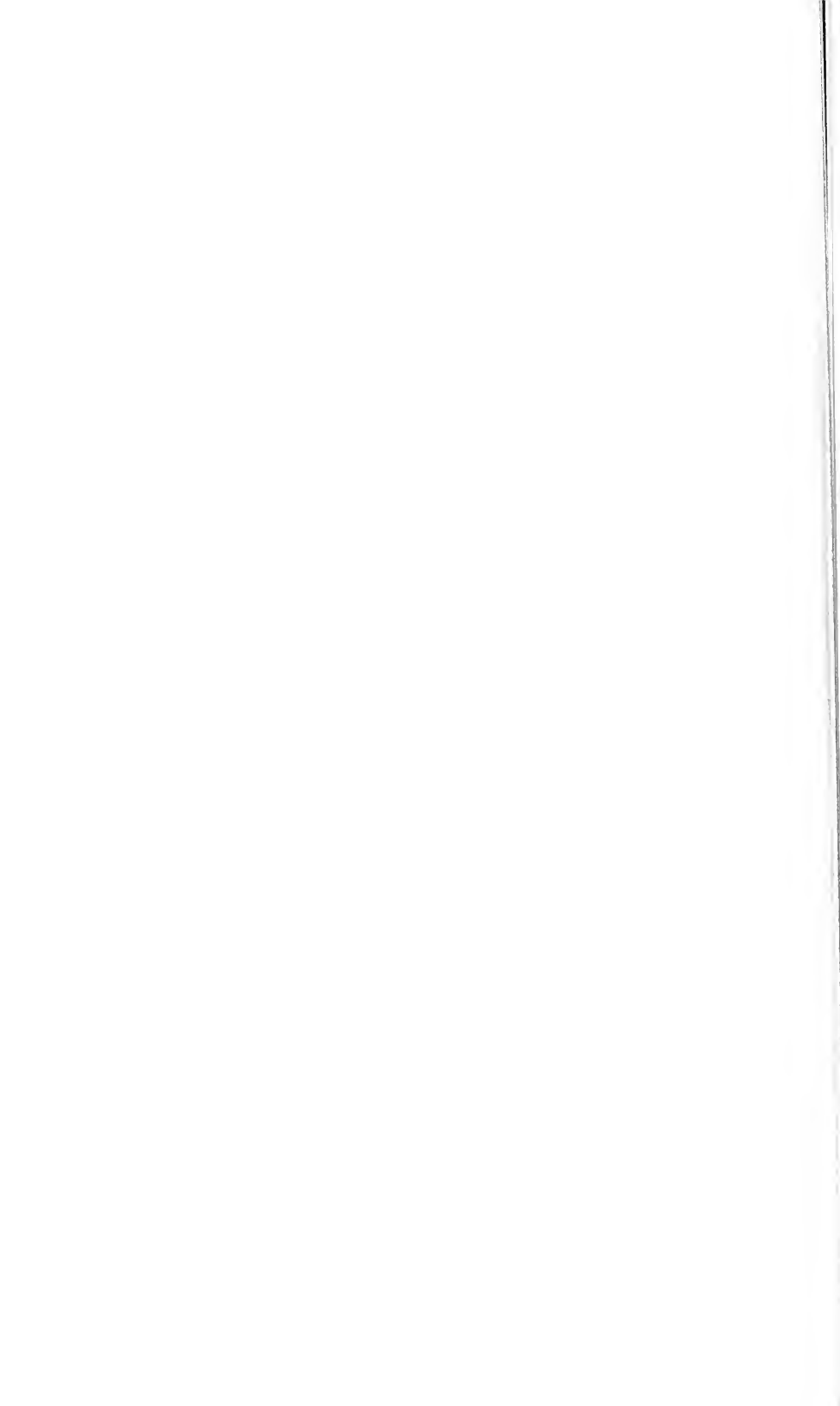

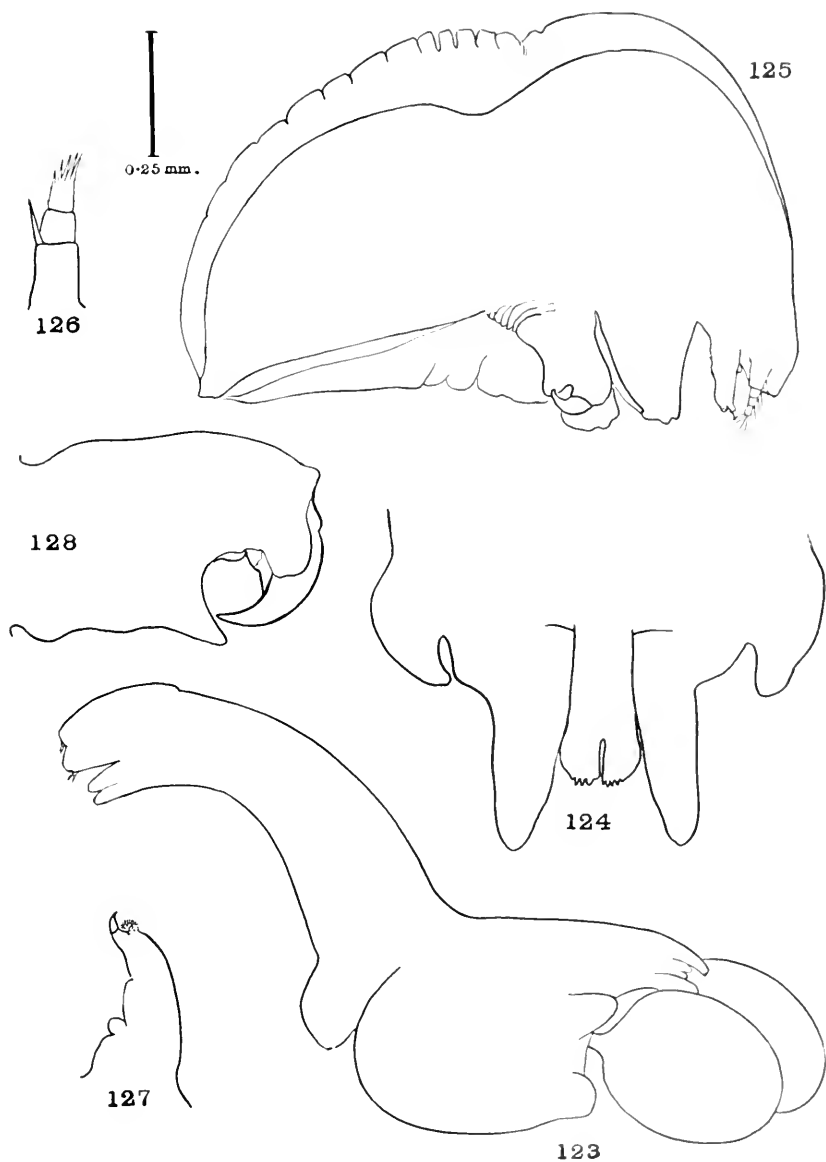

THE MALE AND FEMALE OF BRACHELLEA ANSERINA.

FOR EXPLANATION OF PLATE SEE PAGE 481.

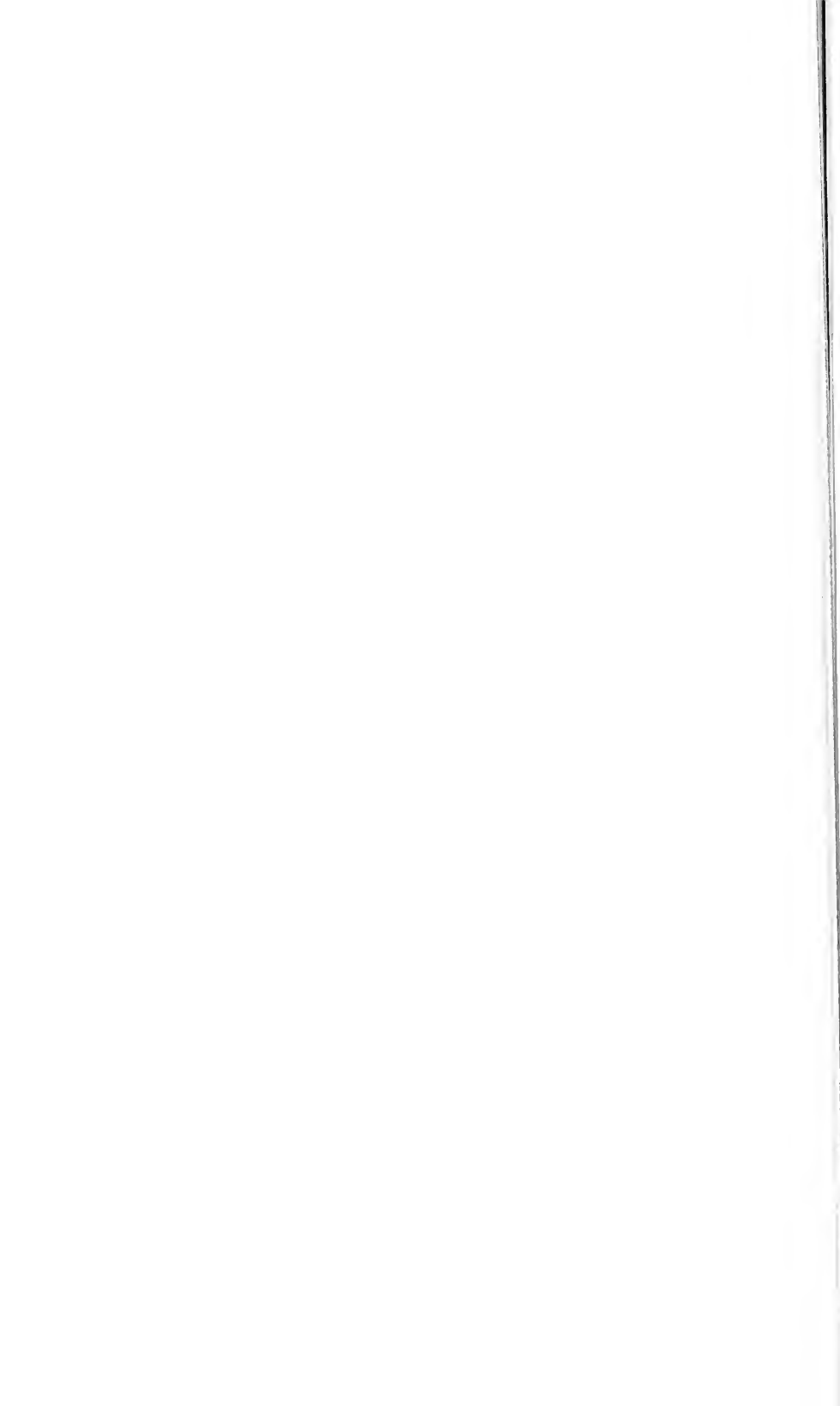

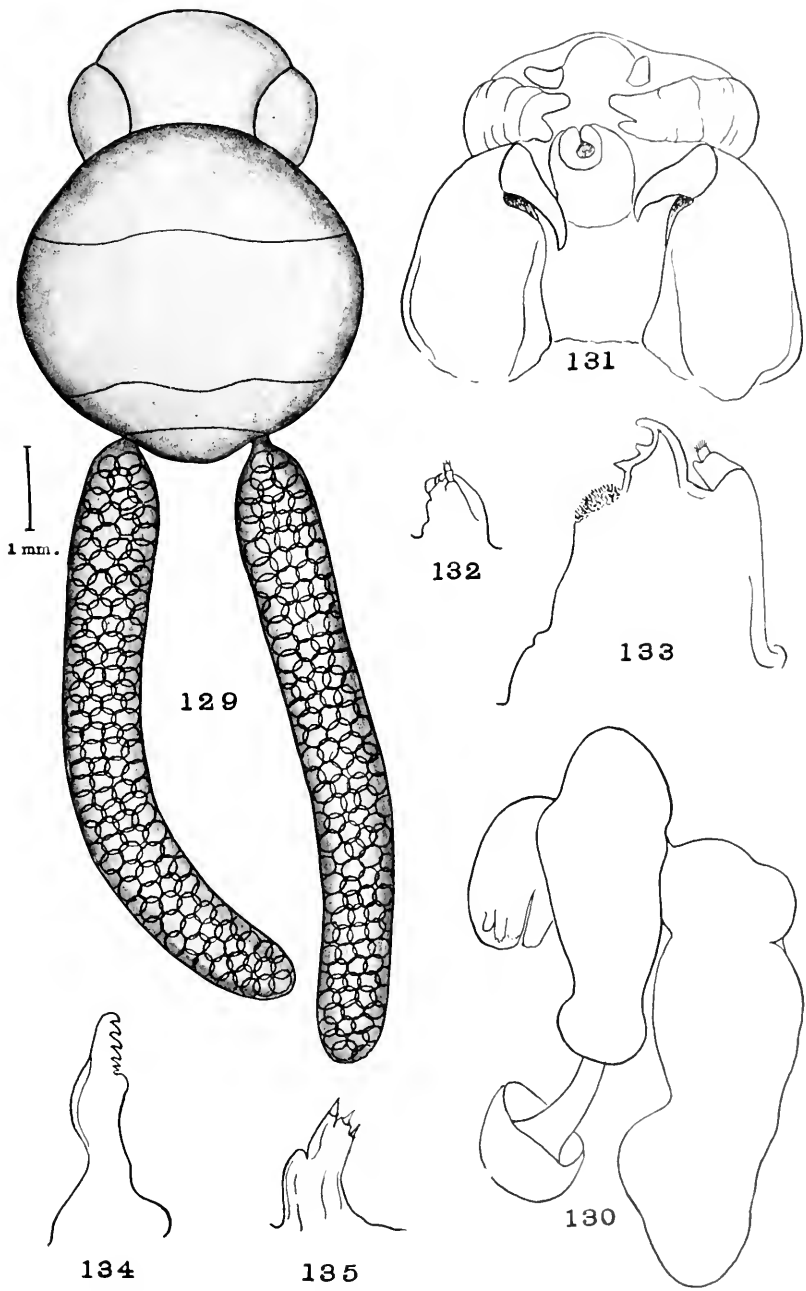

THE FEMALE OF LERNAEPODA GIBBER

FOR EXPLANATION OF PLATE SEE PAGE 481.



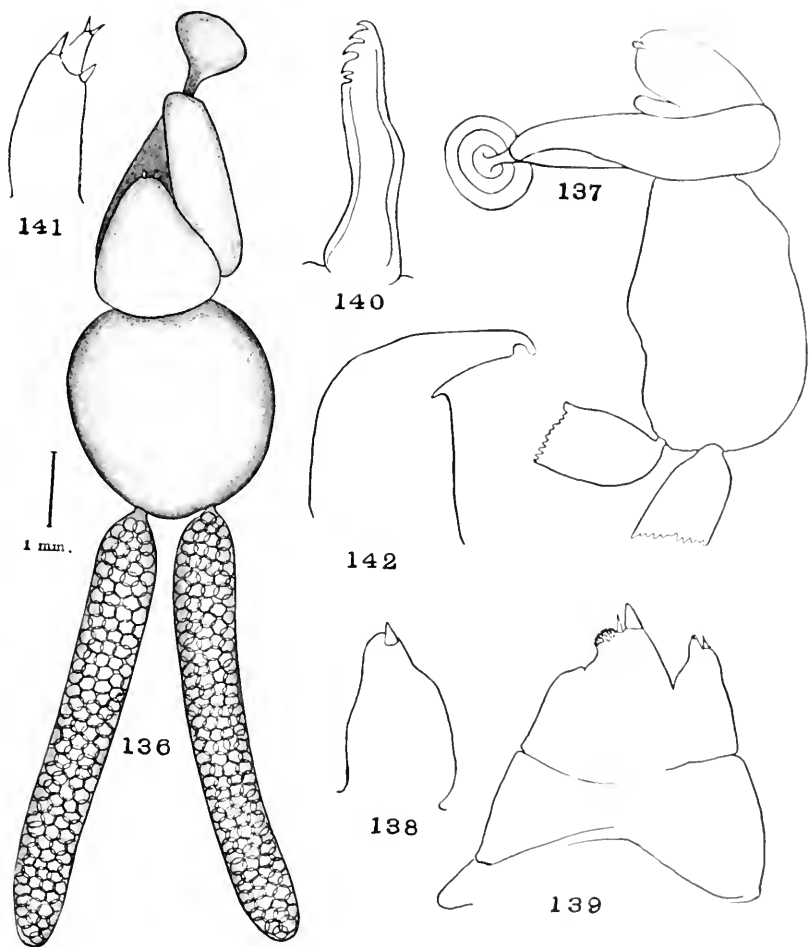

THE FEMALE OF LERNEOPODA BEANI.

FOR EXPLANATION OF PLATE SEE PAGE 481.

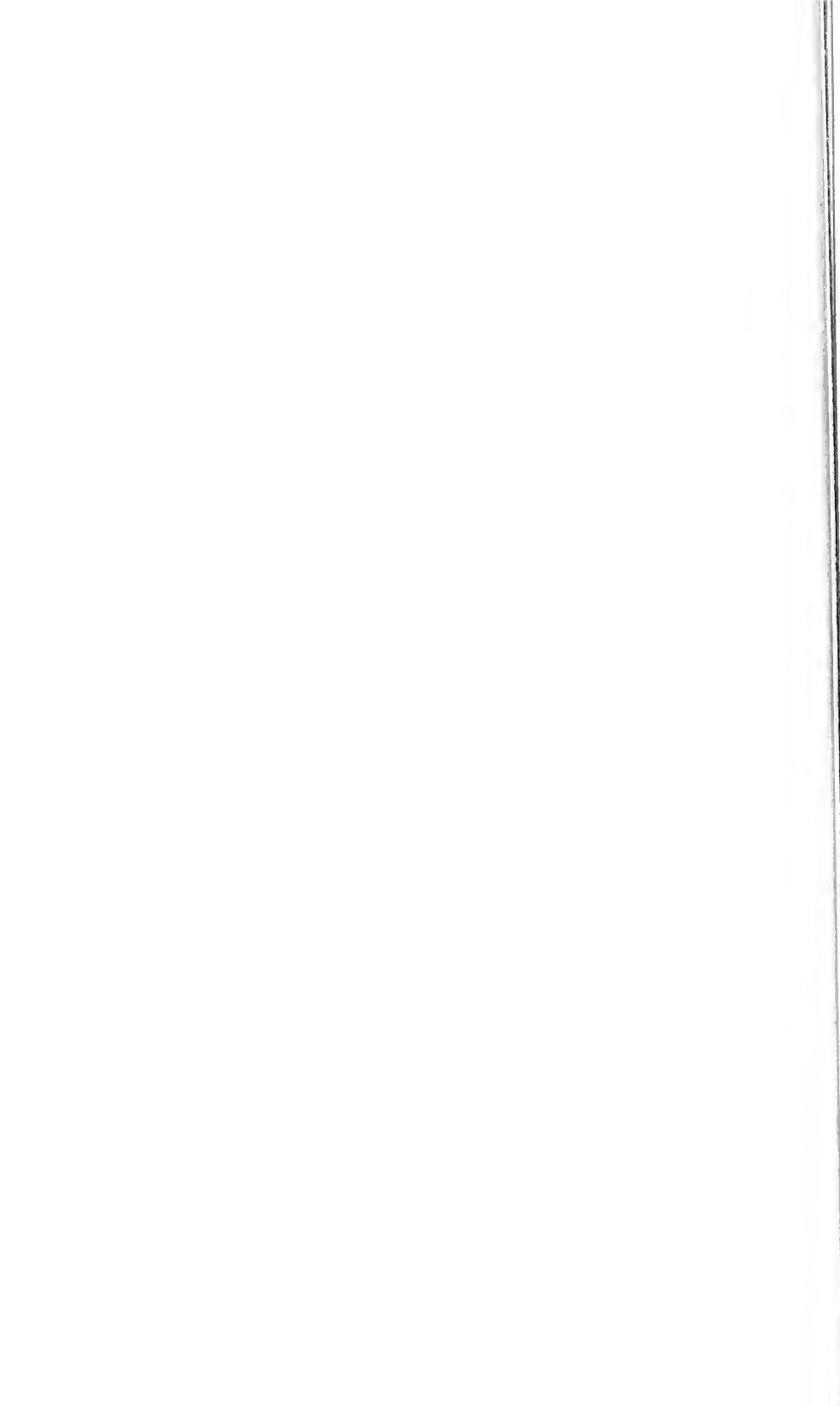



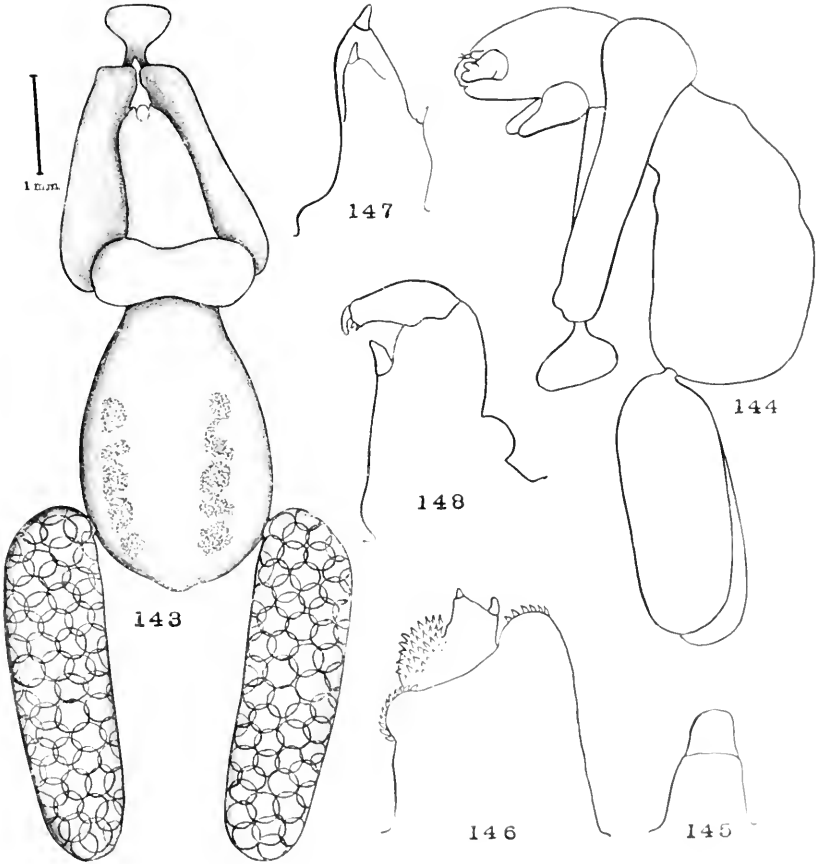

THE FEMALE OF *LERNAEOPODA BICAULICULATA*.

FOR EXPLANATION OF PLATE SEE PAGE 481.



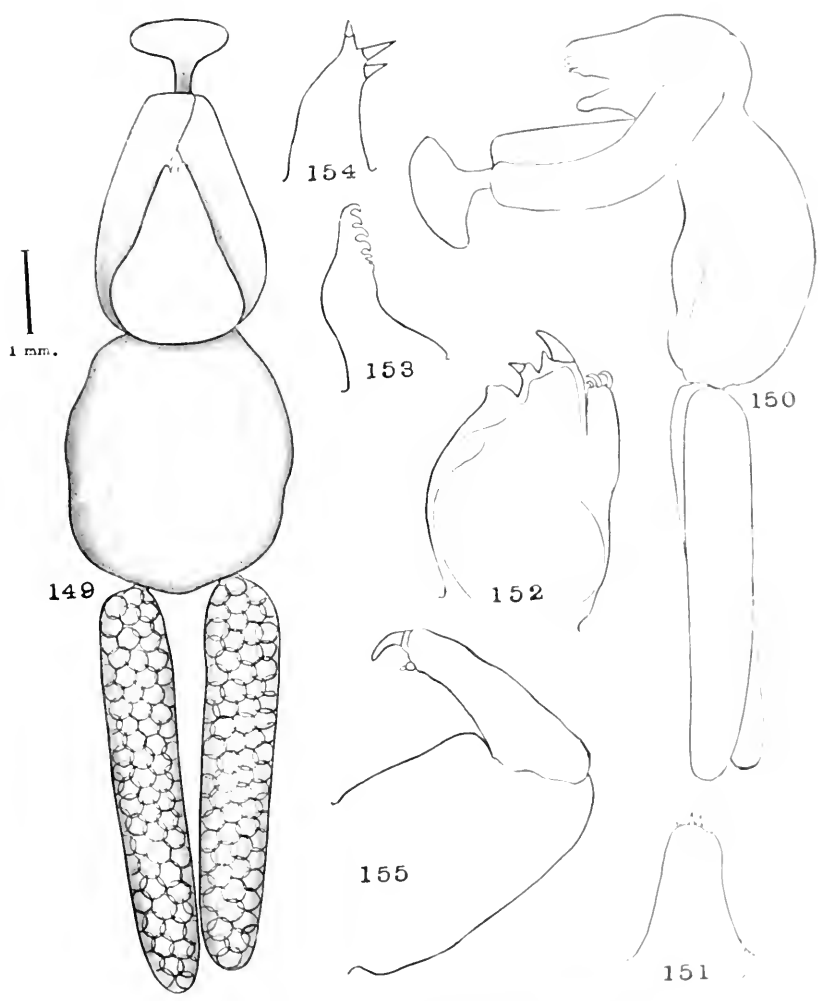

THE FEMALE OF LERNAE OF THE FISH PARASITE  
*Eurythraos* ...



SOME NEW ISOPODS OF THE FAMILY GNATHIIDÆ  
FROM THE ATLANTIC COAST OF NORTH AMERICA.

---

By HARRIET RICHARDSON,

Collaborator, Department of Marine Invertebrates, U. S. National Museum.

---

In the present paper three new species are described. One is especially interesting, as it is only the second species known of the genus *Bathygnathia*, the original species having been described from a fragment and referred to the genus *Anceus*. The other two species belong to the genus *Gnathia*. The specimens described have recently been returned by Prof. A. E. Verrill to the U. S. National Museum.

Family GNATHIIDÆ.

Genus BATHYGNATHIA Dollfus, 1901.

All seven segments of thorax free; eyes absent; head with a long, prominent rostrum; first gnathopods of male consisting of five articles; other characters as in the genus *Gnathia*.

The type of the genus is *Anceus bathybius* Beddard.<sup>a</sup>

In 1893 Stebbing<sup>b</sup> suggested that the form described by Beddard would no doubt require to be transferred to a new genus, but that inasmuch as the species was described from a fragment it would be better to wait until more material was obtained.

In 1901 Dollfus, without additional material, erected for Beddard's species the new genus *Bathygnathia*.

BATHYGNATHIA CURVIROSTRIS, new species.

Body elongate, about four times longer than wide; surface smooth.

Head squarish, with the front produced in a long, prominent rostrum, equal in width to one-third the width of the head, and about two-thirds as long as the head; lateral margins even and rounded and

---

<sup>a</sup> Challenger Report, Zool., XVII, Pt. 48, Report on the Isopoda (Pt. 2), 1886, pp. 135-137, pl. xviii, figs. 1-7.

<sup>b</sup> Hist. of Crustacea, 1893, p. 338.



converging to a pointed extremity; eyes entirely absent. First pair of antennæ with the first two articles of the peduncle subequal; third article about one and a half times longer than either of the two preceding. Flagellum composed of four articles on one side and five on the other; first article minute; second and third elongate, the third being longer than the second; fourth half as long as third; fifth half as long as fourth. First antennæ extend to end of peduncle of second pair. Second pair of antennæ with first article of peduncle long; second article half as long as first; third article almost as long as first; fourth about one and a half times longer than third; flagellum, composed of seven articles, extends to tip of mandibles. Mandibles narrow and elongate, extend one-third of their entire length beyond extremity of rostrum. About one-third the distance from the base, on the outer margin, is a prominent, acute tooth.

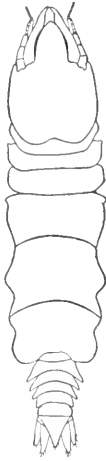

FIG. 1.—BATHYGNATHIA CURVIROSTRIS.

Tip of mandible bent and directed inward; mandibles narrower from a point beginning about opposite tip of rostrum and converging from that point to the acute extremity.

All seven segments of the thorax free; first short, about half as long as the two following which are subequal, and equal in width to those succeeding; fourth segment equal in length to second and third together; fifth longest, about one and a fourth times longer than the fourth; sixth about equal in length to the fourth; seventh extremely short, not longer than the segments of



FIG. 2.—BATHYGNATHIA CURVIROSTRIS. MANDIBLE.

the abdomen and not as wide. The second and fourth segments have the lateral margins produced at the anterior portion in small angular processes.



FIG. 3. BATHYGNATHIA CURVIROSTRIS. FIRST LEG OF MALE.

First four segments of abdomen equal in length, with their lateral margins produced in triangular processes directed posteriorly; fifth segment about one and a half times longer than the preceding; terminal segment triangular, the sides converging to a long, narrow, pointed extremity. Branches of uropoda similar in shape, with the sides converging to a rounded extremity; outer branch shorter than the inner, which extends beyond the tip of the terminal abdominal segment. The outer branch does not extend beyond the extremity of the last abdominal segment.

First pair of legs in male transformed into a sort of operculum, arching over the ventral side of the head and concealing the mouth parts; they are composed of five articles, the third being the largest. The terminal or fifth article is nearly twice as long as the fourth. The other five pairs of legs are ambulatory. There are no appendages to the seventh thoracic segment.

This species is very similar to the type species described by Beddard, but differs in the structure of the mandibles, in the additional article to the flagellum of the second antennae, in the longer terminal joint of the first gnathopods, in the differently shaped rostrum, in the absence of the bunch of hairs at the tip of the rostrum, and in having the mandibles fitting closely around the rostrum, not projecting straight forward at a distance from the rostrum.

Two fine specimens, both males, are from the following localities: One (type) from *Albatross* Station 2517, south of Marthas Vineyard, was taken at a depth of 390 fathoms; another from *Albatross* Station 2528, east of George's Bank, was taken at a depth of 677 fathoms.

*Type*.—Cat. No. 38972, U.S.N.M.

Beddard's species was taken at a depth of 900 fathoms. The division proposed by Dollfus,<sup>a</sup> in which genera provided with eyes are littoral or do not extend below a depth of 500 fathoms and those deprived of eyes live at a depth of 1,000 fathoms can not be maintained, for we have now a species belonging to a genus without eyes found at a depth of only 390 fathoms.

Genus GNATHIA Leach, 1814.

GNATHIA MULTISPINIS, new species.

Body ovate; lateral margins drawn out in small spines; dorsal surface covered with small spines and tubercles. Legs also covered with small spines.

Head broader than long, about twice as wide as long; frontal margin not produced in a rostrum, but in a small median point; antero-lateral angles produced in a bifurcated spine; lateral margins drawn out on either side in spines; dorsal surface covered with small spines and tubercles. Eyes moderately large, composite, and placed on the lateral margins. First pair of antennae with the first two articles of the peduncle short and subequal; third as long as first two taken together; flagellum composed of four articles, the first very short. Second antennae with the first two articles of the peduncle short; last two elongated and subequal; flagellum broken at the fourth article. Mandibles projecting a considerable distance in front of the head; broad at base and produced to narrow, acute extremities; on the outer margin, on the posterior half furnished

<sup>a</sup> Bull. Soc. Zool. France, XXVI, 1901, pp. 239-240.



with a row of three spines, two tubercles, and a bifurcated spine, the latter being the most anterior.

First segment of thorax partly coalesced with head and not free, narrower and also much shorter than the following segment; second and third segments (the first and second free segments) about equal in length and width, with the lateral margins produced in spines and the dorsal surface covered with small spines and tubercles; fourth segment (third free segment) longest, with the lateral margins drawn out anteriorly and posteriorly in spines and the dorsal surface covered with small spines and tubercles; fifth segment (fourth free segment) not quite as long as the preceding, with the dorsal surface divided up into areas, these areas being covered with small spines and tubercles; sixth segment

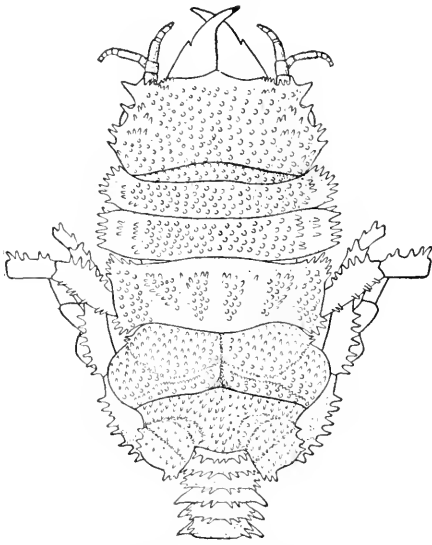

FIG. 4.—GNATHIA MULTISPINIS.

(fifth free segment) almost as long as the fourth (third free segment), with the dorsal surface also divided up into areas, which are beset with small spines and tubercles; seventh segment (sixth free segment) exceedingly short, only about half as long as the abdominal segments and not quite as wide, produced on its posterior margin in spines.

First five abdominal segments about equal in length and width, produced laterally in triangular processes and spines, with the posterior margins also produced in spines. The last segment with the uropoda is lost in the only specimen.

All five ambulatory legs are beset with spines in rows. First pair of legs, or gnathopods, composed of three articles, a large basal article, a small middle article, and a minute terminal joint.

Only one specimen, a male, was collected at *Albatross Station* 2231, off Delaware, taken at a depth of 965 fathoms.

*Type.* Cat. No. 38973, U.S.N.M.

This species is very similar to *Gnathia cristata* (Hansen)<sup>a</sup> but differs from that form in not having the front of the head produced



FIG. 5.—GNATHIA MULTISPINIS. MANDIBLE.

<sup>a</sup> Vidensk. Meddel. Naturh. Foren i. Kjøbenhavn., 1887-88, p. 182, pl. VII, figs. 2-2a. See also Richardson, Bull. U. S. Nat. Mus., No. 54, 1905, pp. 56-57.

in a rostrum (no mention is made of the rostrum in the description, but the figure shows this point), in the bifurcate antero-lateral angles of the head (this character is also taken from the figure), in all the segments of the thorax with the dorsal surfaces covered with small spines and tubercles, while in Hansen's species the sixth segment (fifth free segment) is described as smooth, the fifth segment (fourth free segment) as ornamented with a few tubercles, the median part being smooth, and the fourth segment (third free segment) as smooth posteriorly. The present species also has more spines on the legs and abdomen, and the arrangement of the spines on the lateral margins of the head and of the segments of the thorax differs from the species figured by Hansen.

*GNATHIA SERRATA*, new species.

Body elongate, about three times longer than wide. Head covered with small tubercles, the tubercles being denser on the lateral and posterior portions. First, second, third, and fifth free segments of the thorax also covered with small tubercles; fourth free segment smooth.

Head large, squarish in shape, with the front produced in the middle in a rostrum rounded anteriorly; antero-lateral angles acute. In a dorsal view the eyes are not visible; they are placed at the sides of the head and are moderately large and composite. The mandibles are small, not projecting much beyond the rostrum; curved at base and at the anterior extremity, the inner margins converging abruptly to the narrow, pointed extremity. Just back of the mandibles the anterior margin of the head, seen from the underside, is produced in wheel-like processes, one on either side (not visible from above), edged with six teeth; between these processes the anterior margin is furnished with four teeth on either side, which may be

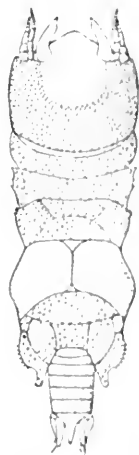

FIG. 6.—*GNATHIA SERRATA*.

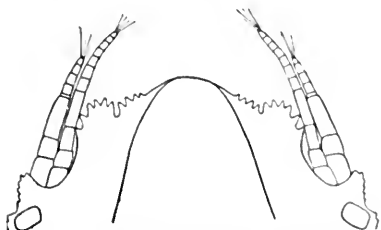

FIG. 7.—*GNATHIA SERRATA*. UNDERSIDE OF ANTERIOR PORTION OF HEAD.

seen in a dorsal view, as they are situated close to the mandibles at the base of the rostrum. First pair of antennae with a peduncle of three articles, the third the longest, about twice as long as the second, and a flagellum of five articles, the first of which is minute. Second pair of antennae with a peduncle of four articles, and a flagellum of seven.

First segment of thorax coalesced with the head; second and third (first and second free segments) subequal and furnished dorsally with

small tubercles; lateral margins of second free segment produced in a few small spines; fourth segment (third free segment) about equal in length to first two taken together, also covered dorsally with small tubercles and with the antero-lateral angles produced in a few small spines; fifth segment (fourth free segment) the longest and perfectly smooth; sixth segment (fifth free segment) almost as long as the preceding, covered dorsally with small tubercles and with the post-lateral angles produced backward in a tuberculated process on either side; seventh segment (sixth free segment) not longer than and not quite so wide as the abdominal segments.

First five abdominal segments about equal in length; sixth or terminal segment tapering to a narrow, pointed extremity. Outer branch of uropoda shorter than the inner, which extends a little beyond the extremity of the abdomen; both are furnished with long hairs.

First pair of legs or gnathopods composed of three articles, the first extremely large, the second small, and the third or terminal one minute. The gnathopods form a sort of operculum covering the mouth parts. The following five pairs of legs are ambulatory; the third pair with a crest of four spines on the ischium at the distal end. The fourth and fifth pairs of legs have a prominent process at the distal extremity of the merus, carpus, and propodus on the inferior margin.

Two specimens, both males, were taken at *Albatross* Station 2547, south of Marthas Vineyard, at a depth of 390 fathoms.

*Type*.—Cat. No. 38974, U.S.N.M.

#### BIBLIOGRAPHY.

In addition to the references given in my monograph <sup>a</sup> the following have been referred to in connection with this paper:

- DOLLEUS, ADRIEN. Etude préliminaire des Gnathilidæ recueillis dans les campagnes de l'Hirondelle et de la Princesse-Alice. Bull. Soc. Zool. France, XXVI, 1901, pp. 240-244. Paris.
- HESSE, EUGÈNE. Mémoire sur des Crustacés rares ou nouveaux des côtes de France. 23<sup>me</sup> Article: Pranziniæ et Ancées Nouveaux. Ann. Sci. Nat. (5), XIX, 1874, 29 pp., pls. XXI-XXII. Paris.
- . Description d'un nouvel Ancée (*Ancées congeri*). Revue des Sciences Nat., IV, 1876.
- . Crustacés rares ou nouveaux des côtes de France. Description d'un nouvel "Ancée," décrit et dessiné sur des individus vivants. Ann. Sci. Nat. (6), XVII, 1884, 11 pp., pl. XVIII. Paris.
- LUCAS, H. Observations sur quelques Espèces nouvelles de Crustacés du Nord de l'Afrique. Ann. Soc. Ent. France, (2), VII, 1849, p. 466, pl. xv. Paris.
- SCOTT, T. Natural History Notes from Tarbert. Proc. Nat. Hist. Soc. Glasg. (n. s.), I, 1887, pp. 369-378. Glasgow.
- WALTER, A. *Ancées* (*Pranziniæ*) *torpedinis*. Jen. Zeits. Nat., XVIII, 1885, pp. 115-151. Jena.

<sup>a</sup> Bull. U. S. National Museum, No. 51, 1905.

THE AMPHIPODA COLLECTED BY THE U. S. BUREAU  
OF FISHERIES STEAMER "ALBATROSS" OFF THE  
WEST COAST OF NORTH AMERICA, IN 1903 AND 1904,  
WITH DESCRIPTIONS OF A NEW FAMILY AND SEV-  
ERAL NEW GENERA AND SPECIES.

BY SAMUEL J. HOLMES,

*Of the Zoological Laboratory of the University of Wisconsin.*

The collection of Amphipoda which was obtained by the U. S. Bureau of Fisheries steamer *Albatross* during its cruises off the northwest coast of North America during the Salmon Investigations of 1903 and off southern California in 1904, proved to be peculiarly rich in new species. The amphipod fauna of the Pacific Ocean, and especially that portion of it bordering the North American continent, is very imperfectly known. The species hitherto described have been mainly littoral forms, and as a large proportion of the Amphipoda obtained by the *Albatross* were dredged from considerable depths it is not surprising that the percentage of new species is high. Owing probably to the depth inhabited by many of the species quite a number were found to be devoid of eyes.

One of the striking features of the collection was the number of species of Ampelisca, most of which proved to be new. The Lysianassidae were represented by seven species, all new; for four of these it was found necessary to institute new genera, one of which, *Calathiopsis*, is of interest on account of its primitive and transitional character. One species, *Stilipes distinctus*, was so unique in its characteristics that a new family had to be created to receive it, and the two species of the new genus *Gracilipes* were perhaps sufficiently aberrant to be treated in the same way, but as the Calliopiidae, by a little stretching, could be made to include them it was thought best to let them remain in that family.

## Legion HYPERIIDEA.

## Family HYPERIIDÆ.

## HYPERIA MEDUSARUM (Müller).

A single specimen from Station 4339, off Point Loma, California, 241-369 fathoms.

## Family PHRONIMIDÆ.

## PHRONIMA SEDENTARIA (Forskål).

*Localities.*—Station 4305, off Point Loma, 67-116 fathoms; 4322, off Point La Jolla, 110-199 fathoms; 4348, off Point Loma, 83-113 fathoms; 4382, off North Coronado Island, 642-666 fathoms; 4408 off Santa Catalina Island, 104-117 fathoms; 4488, Monterey Bay, 18-20 fathoms, and 4507, Monterey Bay, 308-347 fathoms.

## Family TRYPHANIDÆ.

## BRACHYSCELUS CRUSCULUM Bate.

A single specimen from Station 4356, off Point Loma, at a depth of 100 fathoms.

## Family CYSTISOMIDÆ.

## CYSTISOMA SPINOSUM (Fabricius).

A single specimen from Station 4528, Monterey Bay, 545-800 fathoms.

## Family SCINIDÆ.

A single specimen of *Scina*, too imperfect to identify, was taken at Station 4405, off San Clemente Island, 654-704 fathoms.

## Family VIBILIIDÆ.

## VIBILIA CALIFORNICA, new species.

Rostrum short. Eyes rather large, oblong. First antennæ with flagellum longer than head. Second antennæ about equaling the first; flagellum 2-jointed. Segments of the body smooth. First gnathopods with the hand truncated distally, the infero-posterior angle only slightly projecting and armed with several acute serrations or teeth which are continued upon the distal half of the posterior margin; dactyl serrate on inner margin. Second gnathopods with the merus projecting below the carpus about as far as the hand and armed with several spines; carpus produced distally into a narrow triangular lobe extending beyond the tip of the hand and armed with several acute serrations; hand oblong, the distal margin nearly

transverse and armed like the posterior margin with acute serrations or teeth, which are especially prominent around the posterior angle. First pereopods rather stout, the dactyl a little over half the length

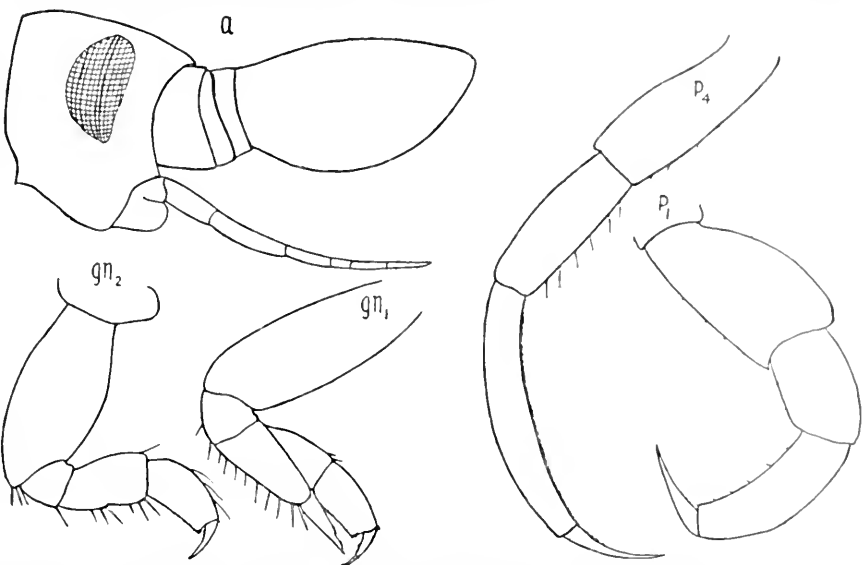

FIG. 1.—*VIBILIA CALIFORNICA*. *a*, HEAD AND ANTENNAE; *gn*<sub>1</sub>, FIRST GNATHOPOD; *gn*<sub>2</sub>, SECOND GNATHOPOD; *p*<sub>1</sub>, FIRST PEREPOD; *p*<sub>4</sub>, FOURTH PEREPOD

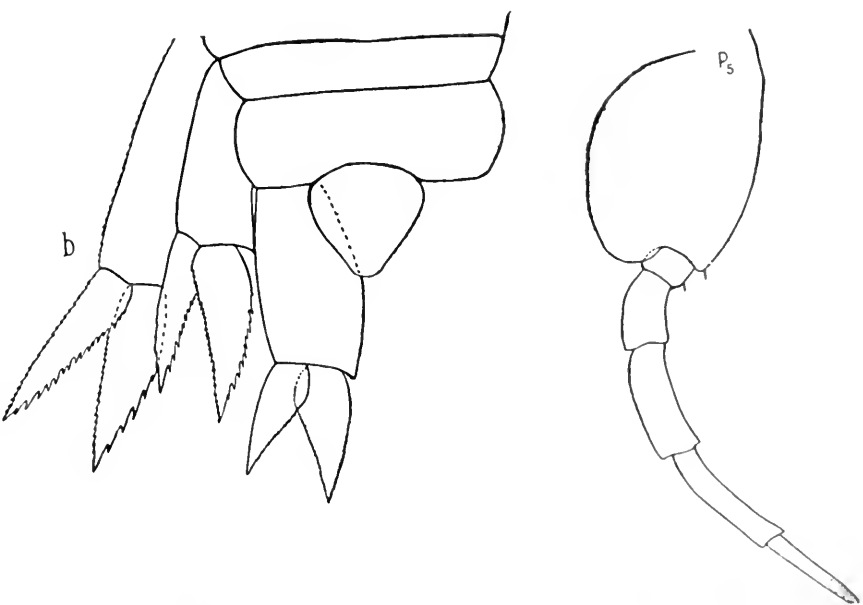

FIG. 2.—*VIBILIA CALIFORNICA*. *b*, PROPODS AND TELSON; *p*<sub>5</sub>, FIFTH PEREPOD

of the preceding joint. Fourth pereopods about a third larger than the first, the carpus armed with six or seven spines; propodus a half

longer than the carpus; anterior margin regularly pectinated with short spines; dactyl a third the length of the carpus, inner margin with several short spines. Fifth pereopods about two-thirds the fourth; last joint straight, rounded at tip and about four-fifths the length of the preceding one.

Posterior angles of the last abdominal segment not produced. Peduncles of uropods larger than rami although but slightly larger than the inner ramus in the second pair. Peduncle of first pair with outer margin serrate; margins of the other pairs smooth. Inner rami slightly longer than the outer or equal in first pair, the margins serrate except the outer margin of the outer ramus of the last pair; outer margin of outer ramus of second pair smooth on basal half but with small serrations distally. Telson broadly ovate, distally rounded and about reaching middle of peduncle of last uropods.

*Length*.—9 mm.

*Locality*.—Station 4305, 2 specimens, off Point Loma, 67–116 fathoms.

*Type*.—Cat. No. 38533, U.S.N.M.

## Legion GAMMARIDEA.

### Family LYSIANASSIDÆ.

#### ORCHIOMENELLA AFFINIS, new species.

Eyes large, with numerous facets, widened below and light brownish in alcohol. Lateral lobes of the head broadly rounded. First antennæ not longer than the head and first thoracic segment. Second antennæ are twice the length of the first. Epistome somewhat projecting. First gnathopods unusually stout, the carpus with a narrow posterior lobe, closely fitting over base of hand; the latter nearly rectangular, slightly widened at base, palm transverse, slightly curved, finely dentate, and armed with two stout spines at the end between which the finger closes. Second gnathopods with the hand narrower than the carpus and about half as long, and having the infero-posterior angle produced so as to be almost chelate. Third abdominal segment with the infero-lateral angle rounded and the posterior margin above this smooth. Fourth segment with a rounded sinus above, behind which is a rounded elevation. Terminal uropods with the inner ramus shorter than the basal segment of the outer and furnished with plumose setæ on the inner and three spines on the outer margin; outer ramus with plumose setæ and a few spines on inner margin, the outer margin armed with about eight short spines. Telson cleft nearly to the base, the lobes diverging distally, the tip with a spine on either side; lateral margins with three or four spines.

*Length*.—13 mm.

*Locality*.—Three specimens from Station 1508, Monterey Bay, 292-356 fathoms.

*Type*.—Cat. No. 38534, U.S.N.M.

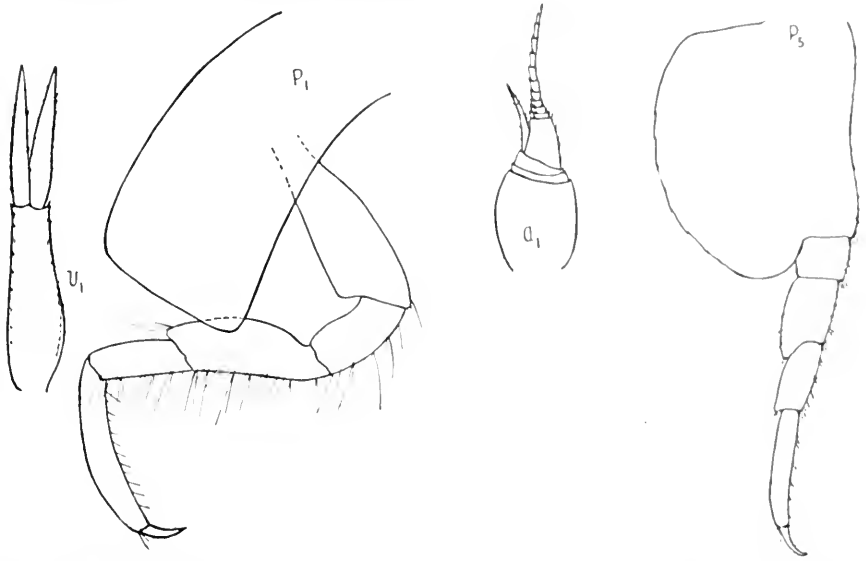

FIG. 3.—ORCHOMENELLA AFFINIS.  $a_1$ , FIRST ANTENNA;  $p_1$ , FIRST PEREPOD;  $p_3$ , THIRD PEREPOD;  $u_1$ , FIRST UROPOD.

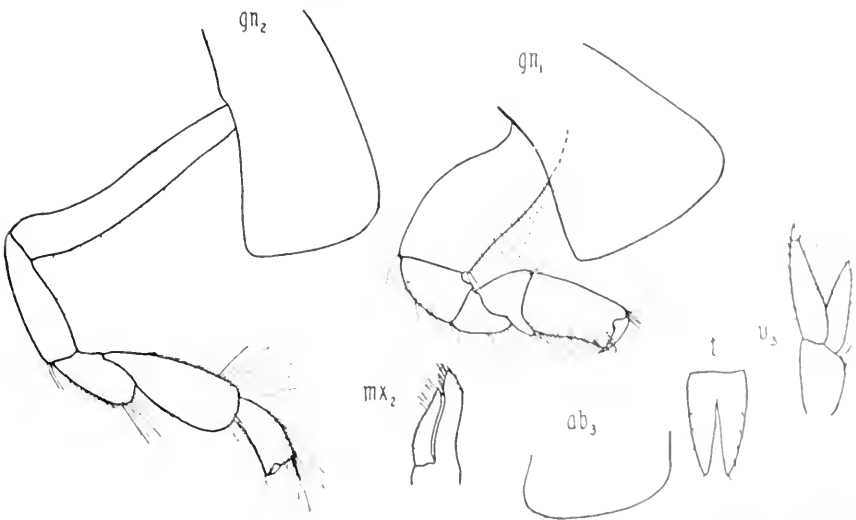

FIG. 4.—ORCHOMENELLA AFFINIS.  $ab_3$ , THIRD SEGMENT OF THE ABDOMEN;  $gn_1$ , FIRST GNATHOPOD;  $gn_2$ , SECOND GNATHOPOD;  $mx_2$ , SECOND MAXILLA;  $u_3$ , THIRD UROPOD.

This species is closely allied to *O. nanus* (Kroyer), but differs in having considerably stouter first gnathopods with a much narrower posterior lobe on the carpus; the hand of the second gnathopods is



curved backward and more strongly produced at the distal end. From *O. granulatica* (Hensen) it differs in the same features as well as in having the infero-lateral angles of the third abdominal segment rounded instead of acute. It resembles *O. pinguis* (Boeck), but has the lateral angles of the head much more broadly rounded, the merus of the third pereopods less widely expanded, the margin above the lower angle of the third abdominal segment smooth instead of finely crenulated, and the lobes of the telson more diverging. It has much larger eyes than *O. minuta* (Krøyer) and quite different first gnathopods.

Genus VALETTIOPSIS,<sup>a</sup> new.

First antennae well developed with basal joint only moderately enlarged and flagellum elongate. Mandibles with dentate cutting edge,

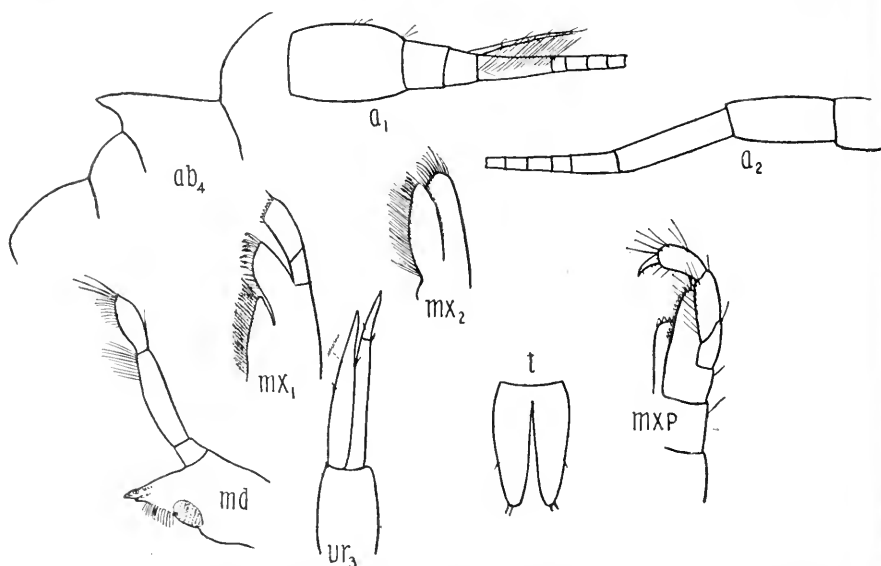

FIG. 5.—VALETTIOPSIS DENTATUS. *a*<sub>1</sub>, FIRST ANTENNA; *a*<sub>2</sub>, SECOND ANTENNA; *ab*<sub>4</sub>, FOURTH SEGMENT OF THE ABDOMEN; *md*, MANDIBLE; *mx*<sub>1</sub>, FIRST MAXILLA; *mx*<sub>2</sub>, SECOND MAXILLA; *m.x.p.*, MAXILLIPED; *t*, TELSON; *ur*<sub>3</sub>, THIRD UROPOD.

secondary plate, spine row, and a well-developed palp opposite the molar tubercle. First maxillae with the inner plate furnished with numerous plumose setae along the inner margin; outer plate with the distal margin oblique and armed with denticulate spines; palp two-jointed and armed with short spinules on distal margin. Second maxillae with subequal lobes, the inner setose along inner margin as well as tip. Maxillipeds with well-developed inner plates; outer plates armed with spines on inner margin, not reaching penul-

<sup>a</sup> From *Valettia*, a genus of Amphipods, and *ψ*is, appearance.

imate joint of palp. First gnathopod with subchelate hand; second gnathopods with well-developed subchelate hand, having the finger articulating at the antero-inferior angle. Gills simple. Uropods with narrow rami. Telson deeply cleft.

*Type of the genus*—*V. dentatus*, new species.

This genus is remarkable among the Lysianassidae in having the cutting edge of the mandible dentate. The first antennae are more like the usual type, the first joint of the peduncle being only moderately enlarged, and the second and third being longer than in most other members of this family. The hand of the second gnathopods approaches the typical form, although possessing lysianassid features. The genus is apparently a primitive and transitional one.

VALETTIOPSIS DENTATUS, new species.

Eyes absent. Lateral lobes of head narrowly rounded. First antennae about half the length of the body, the peduncle with the first

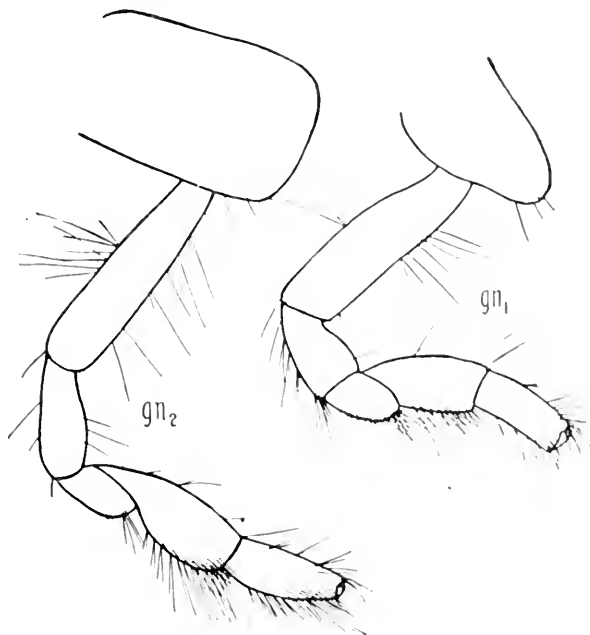

FIG. 6.—VALETTIOPSIS DENTATUS. *gn*<sub>1</sub>, FIRST GNATHOPOD; *gn*<sub>2</sub>, SECOND GNATHOPOD.

joint about twice as long as thick and a little larger than the next two; secondary flagellum four-jointed and extending beyond the elongate first joint of the primary one. Second antennae about the length of the first, the last joint of the peduncle a little longer than the preceding one. Mandibles with both primary and secondary cutting edge dentate; molar tubercle broad with its face roughened; last joint of palp half length of preceding. Outer plate of first maxilla with ten

denticulate spines at distal end; palp with eight short spines on distal margin, the inner and the outer one more slender than the others. Inner plate of maxillipeds with three short stout spines at distal end; outer plate with about twelve stout spines on inner margin. First gnathopods with nearly rectangular band; palm transverse. Second gnathopods with the band elongate, somewhat narrowed distally; palm short, transverse. Infero-lateral angle of third abdominal segment acute. Fourth segment with a large dorsal, backwardly directed tooth. Uropods with narrow rami, those of the third pair minutely pectinate along one side and armed with two or three spines each. Telson cleft nearly to the base, armed with a pair of small spines at the tip of each lobe and a spine on either side near the outer margin.

*Length*.—6 mm.

*Locality*.—A single specimen from Station 4399, off San Diego, California, 245–285 fathoms.

*Type*.—Cat. No. 38535, U.S.N.M.

TRYPHOSA CÆCA, new species.

Eyes absent, or at least not visible in preserved material. Lateral angles of the head projecting and acute. First antennæ about as long

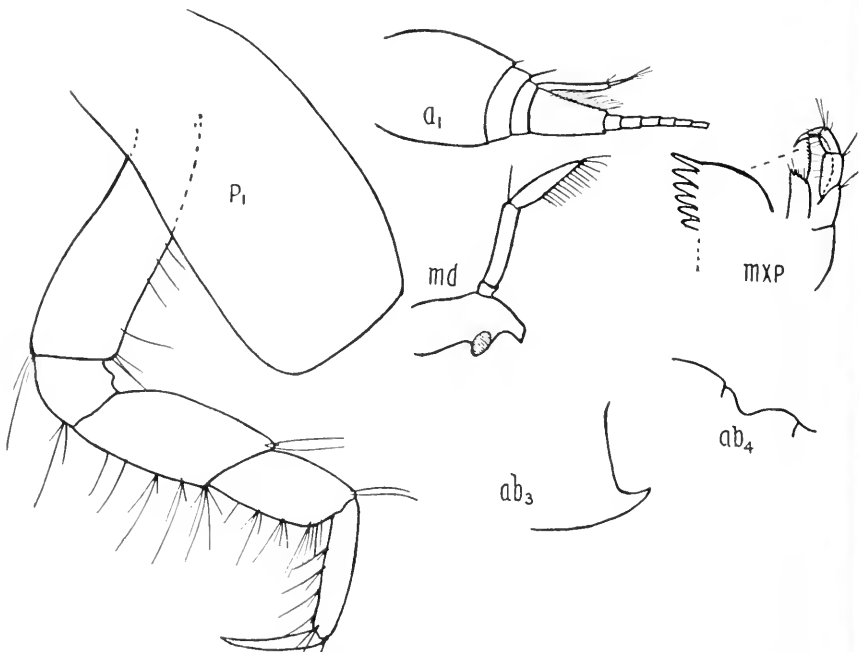

FIG. 7. TRYPHOSA CÆCA. *a*<sub>1</sub>, FIRST ANTENNA; *ab*<sub>3</sub>, THIRD SEGMENT OF THE ABDOMEN; *ab*<sub>4</sub>, FOURTH SEGMENT OF THE ABDOMEN; *md*, MANDIBLE; *mxp*, MAXILLIPED; *p*<sub>1</sub>, FIRST PEREPOD.

as the head and two following segments, the first joint twice longer than the next two. Second antennæ fully twice the length of the

first, with the last joint of the peduncle slightly longer than the preceding one. Maxillipeds with the outer plate furnished with about thirteen stout spines on inner margin; inner plate armed on oblique distal margin with three short stout spines; penultimate joint of palp reaching but little beyond outer plate. First gnathopods with the hand slightly shorter than the carpus, slightly widened distally, the palm oblique and armed at posterior angle with three spines. Second gnathopods with the hand scarcely half as long as the carpus, oblong in outline; finger articulated at middle of transverse distal margin. Infero-lateral angle of the third abdominal segment produced and acute. Fourth segment with a sinus above followed by a

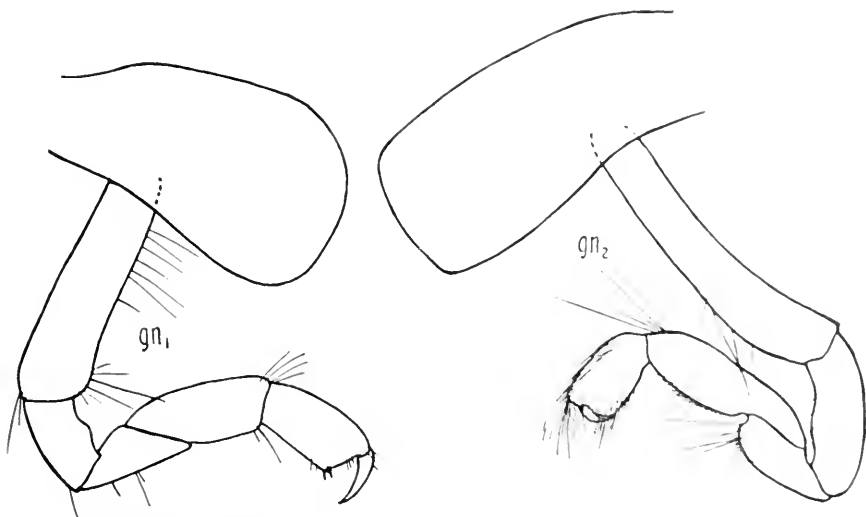

FIG. 8.—TRYPHIOSA COECA. *gn*<sub>1</sub>, FIRST GNATHOPOD; *gn*<sub>2</sub>, SECOND GNATHOPOD.

rounded elevation. First uropods with the rami nearly equal and slightly longer than the peduncle. Rami of second pair equal, armed with few spines, and not extending so far back as those of the first or third pairs. Third uropods with the rami equal, nearly twice the length of the peduncle, the terminal segment of the outer ramus about half the length of the basal one. Telson cleft to near the base, the cleft widening into a triangular form distally; tip of telson armed with a spine on either side and reaching the basal third of the rami of the third uropods.

*Length*.—8 mm.

*Locality*.—A single female specimen from Station 1549, Monterey Bay; 56-57 fathoms.

*Type*.—Cat. No. 38536, U.S.N.M.

Genus LAKOTA,<sup>a</sup> new.

Lateral angles of head prominent, antennæ of the usual form. Epistome not prominent. Upper lip projecting as a prominent rounded lamina far beyond the epistome. Mandible with well developed palp situated opposite the rather small pointed molar, which is nearer the distal than the proximal end. First maxillæ with the blunt end of the inner plate furnished with two plumose setæ; outer plate oblique distally where it is furnished with several spine teeth; palp two-jointed, the distal end widened and furnished with several teeth. Second maxillæ with the lobes rather broadly oblong, setose on the tip and inner margin; inner plate shorter than the outer. Maxillipeds with the inner plates short and broad; outer plates not extending beyond the second joint of the palp, the margin devoid of spines but furnished with small nodular denticles. Side plates deep. First gnathopods subchelate; carpus rather long; hand about as wide as carpus with a nearly transverse palm. Second gnathopods with the hand rather narrow, and not produced at the lower angle. Last two pereopods rather slender, of nearly equal length, with broad basal joints. Branchiæ simple. Infero-posterior angle of third abdominal segment produced. Terminal uropods projecting beyond the others, the rami subequal, flattened, lanceolate, furnished with lateral spines and setæ. Telson oblong, deeply cleft.

*Type of the genus.*—*L. carinata*, new species.

This genus is allied to *Tryphosa*, but differs in that the epistome is not projecting, and in having shorter inner and outer plates in the maxillipeds. From *Chironesimus*, which it resembles, among other things, in the character of the upper lip it differs in having a narrower hand in the second gnathopods which is not widened distally, and in having the carpus in the first gnathopods no wider than the hand.

## LAKOTA CARINATA, new species.

Eyes oblong, light brownish in alcohol. Anterior angle of head acute, about reaching the tip of the first joint of the first antennæ. First antennæ short, the secondary flagellum with four joints, of which the first is elongate. Second antennæ about a third the length of the body. Outer plate of first maxillæ with about ten spine teeth and a tuft of setæ at the inner end of the oblique distal margin; apical margin of palp with about eight short teeth. Inner plate of maxillipeds with several plumose setæ in inner margin; outer plate with few setæ.

First gnathopods with the side plates somewhat widened distally, hand as wide and nearly as long as the carpus, subrectangular, the

<sup>a</sup> No etymology.

nearly transverse palm with spines at the posterior angle. Hand of second gnathopods over half as long as the carpus, nearly rectangular; palm nearly transverse. Merus of first two pereopods wide and produced at the lower anterior angle; carpus about two-thirds as long as the propodus, which is nearly as long as the merus; dactyl about half as long as the preceding joint. Merus of third pereopods expanded, that of the fourth pair less so; while in the last pair the merus is scarcely wider than the carpus; dactyl about half the length of the propodus in the third pair and about one-third the length of the propodus in the last pair. Fifth pair of coxal plates a little broader than deep. Third abdominal segment with the infero-posterior angle produced into a rather short triangular tooth. Fourth segment with a dorsal sinus near the anterior end behind which is a

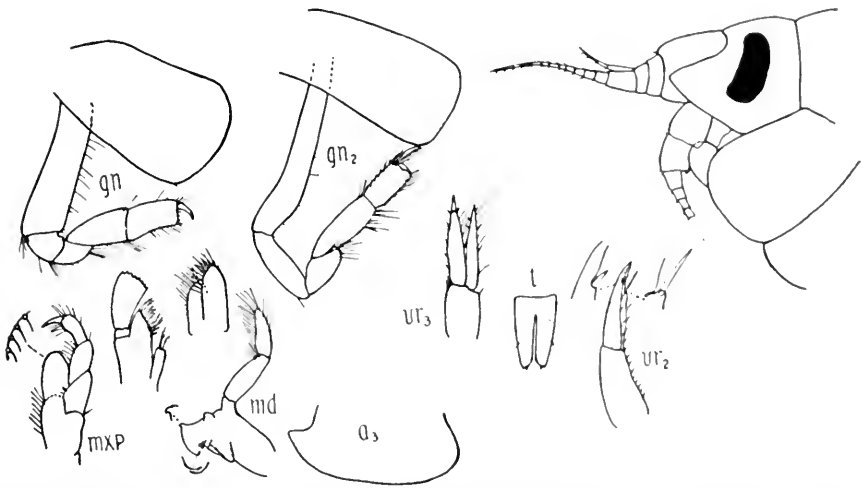

FIG. 9.—*LAKOTA CARINATA*. *a<sub>3</sub>*, THIRD ABDOMINAL SEGMENT; *gn<sub>1</sub>*, FIRST GNATHOPOD; *gn<sub>2</sub>*, SECOND GNATHOPOD; *md*, MANDIBLE; *mxp*, MAXILLIPED; *l*, TELSON; *ur<sub>2</sub>*, SECOND UROPOD; *ur<sub>3</sub>*, THIRD UROPOD.

gently arched carina. First uropods extending beyond the second but not the third pair; rami equal, about two-thirds as long as the peduncle, lanceolate, and armed with several spines. Rami of second pereopods about as long as the peduncle, armed with several spines, inner ramus slightly shorter than the outer with a constriction or incision at the posterior third, just in front of which is a prominence bearing a large spine; a smaller constriction beyond the last spine on the outer ramus. Third uropods with the inner ramus slightly shorter than the outer, but reaching beyond the first joint; terminal joint of outer ramus narrowly conical, inner margins of both rami with plumose setae; inner ramus with three spines on the inner and two on the outer margin; outer ramus with five spines or pairs of spines on the outer margin and none on the inner, except at the end of the first joint.

Telson with a short spine and a small seta at the end of each lobe and a single dorsal spine on either side.

*Length*.—10 mm.

*Locality*.—A single specimen from Station 4342, off South Coronado Island, 53–66 fathoms.

*Type*.—Cat. No. 38537, U.S.N.M.

SCOPELOCHEIRUS CÆCUS, new species.

Blind. Lateral corners of the head produced into a large acute lobe. Antennæ short; the first shorter than the second, the first joint very tumid, as thick as long; first joint of the flagellum a little longer than the five or six others combined; accessory flagellum a little longer than the first joint of the primary one, the elongate first joint followed by two small terminal ones. Second antennæ with the flagellum scarcely as long as the peduncle. A sinus between the

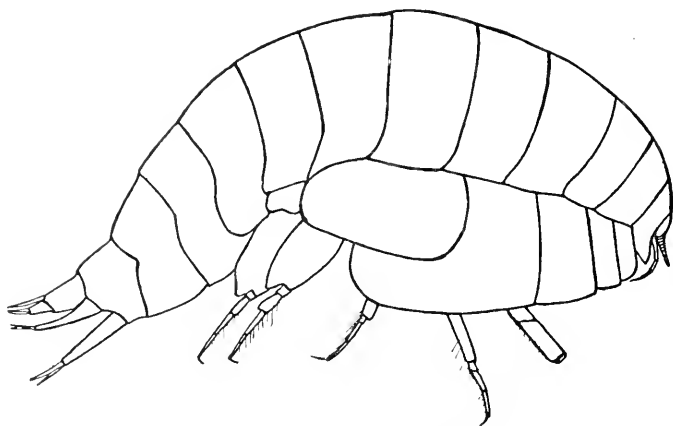

FIG. 10.—SCOPELOCHEIRUS CÆCUS.

epistome and the projecting upper lip. Mandibles with an elongated acute molar tubercle at the level of the palp. First maxillæ with the tapering inner plate nearly reaching tip of outer and furnished with twenty to twenty-five plumose setæ on inner margin; palp with seven spines on distal margins, the outer one single-pointed and finely setose, the others not setose, bifid, with the inner tooth situated farther down on the side as one passes toward the inner end of the row. Second maxillæ with inner plate nearly as long as outer. Outer plate of maxillipeds not quite reaching end of second joint of palp.

First gnathopods with the hand narrow, tapering, shorter than carpus; the small finger pointing toward proximal end of hand, furnished with dense rows of setæ on outer margin; a dense tuft of setæ on tip of hand behind dactyl. Second gnathopods with the

carpus wider than the hand and nearly twice as long; hand with the

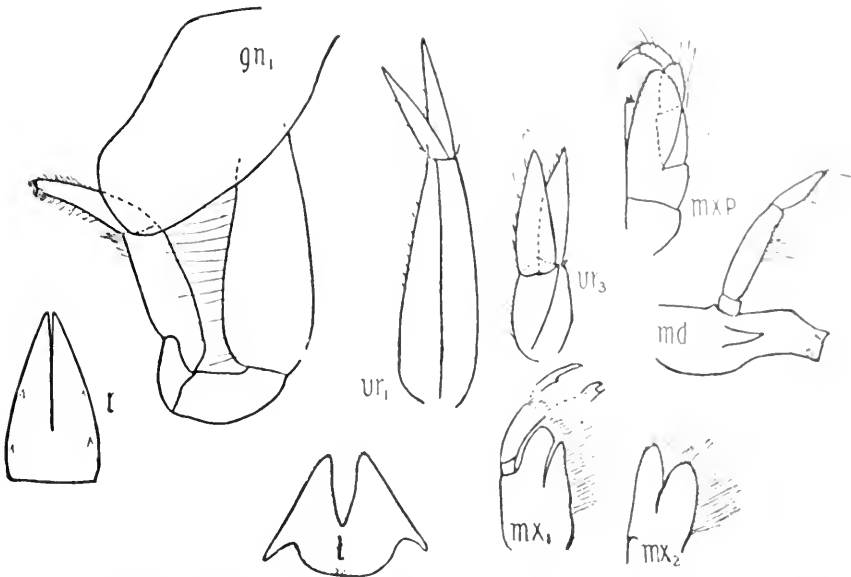

FIG. 11.—SCOPELOCHEIRUS CECUS. *gn*<sub>1</sub>, FIRST GNATHOPOD; *l*, LOWER LIP; *md*, MANDIBLE; *mx*<sub>1</sub>, FIRST MAXILLA; *mx*<sub>2</sub>, SECOND MAXILLA; *mxp*, MAXILLIPED; *t*, TELSON; *ur*<sub>1</sub>, FIRST UROPOD; *ur*<sub>3</sub>, THIRD UROPOD.

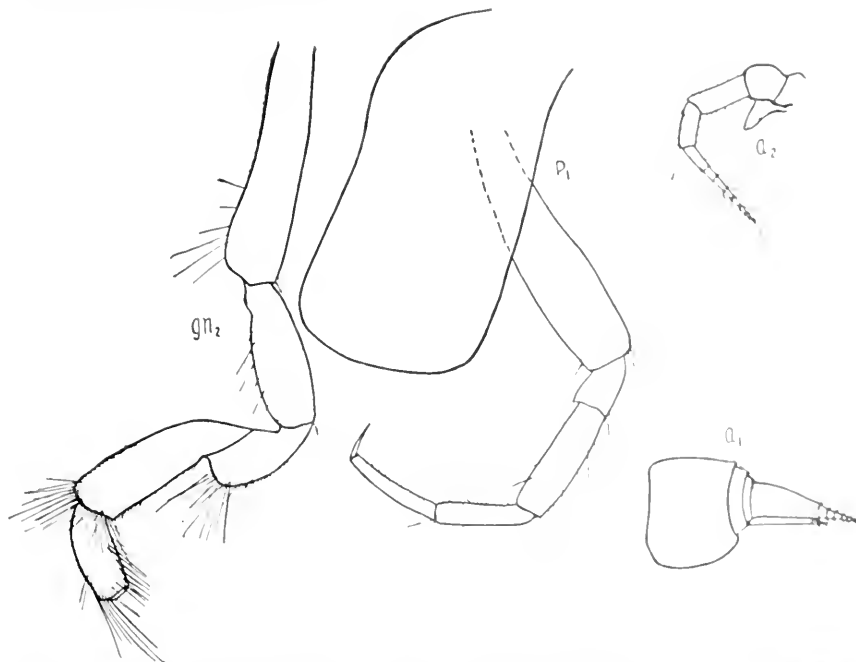

FIG. 12.—SCOPELOCHEIRUS CECUS. *a*<sub>1</sub>, FIRST ANTENNAL; *a*<sub>2</sub>, SECOND ANTENNAL; *gn*<sub>2</sub>, SECOND GNATHOPOD; *p*<sub>1</sub>, FIRST PEREPOD; *g*<sub>2</sub>, SECOND GILL.

palm nearly transverse. Last three pereopods with the large basal



joints strongly produced downward at the posterior angle; tarsi about a third the preceding joint.

Rami of third uropods longer than peduncle, the inner nearly as long as outer and furnished with several spines and setae on inner margin. Telson tapering to a narrow tip, with two dorsal pairs of spines, but no terminal ones.

*Length*.—20 mm.

*Locality*.—A single female specimen, Station 4405, off San Clemente Island, 654-704 fathoms.

*Type*.—Cat. No. 38538, U.S.N.M.

This species is larger than the two others assigned to this genus, of which the larger reaches a length of 9.5 mm. It is distinguished by being blind; or at least no trace of eyes could be discovered in the specimen examined, which was preserved in alcohol. The fourth abdominal segment is not indented above as in the other species of the genus; the outer plate of the maxillipeds is longer, the antennae, especially the second pair, are shorter, and the telson more pointed and devoid of apical spines.

#### Genus KOROGA,<sup>a</sup> new.

Epistome not very prominent. Upper lip projecting and clearly defined from the epistome by an incision. Antennae short. Mandible with molar small; palp behind molar, the terminal joint narrow and shorter than the preceding. Lower lip and first and second maxillae as in *Onisimus*. Maxillipeds with the outer plate extending beyond the second joint of the palp, furnished with low teeth, but no spines except one or more small ones at the apex; last joint of palp unguiform. Side plates deep, the anterior pair produced forward below. First gnathopods stout; the carpus very short; hand short and broad, but much longer than the carpus, subchelate with clearly defined palm. Second gnathopods with the hand oblong, narrower than the somewhat expanded carpus and not half as long, somewhat produced at the infero-posterior angle; the minute dactyl articulated behind the middle of the distal margin. Gills simple. Last three pairs of pereopods of nearly equal length with the basal joints expanded. Infero-posterior angle of the third abdominal segment not strongly produced. Terminal uropods with flattened lanceolate rami, the outer ramus with a short second joint. Telson not deeply cleft.

*Type of genus*.—*K. megalops*, new species.

This genus is closely allied to *Onisimus* and *Pseudalibrotus*. From both of these it differs in having a less developed molar on the mandible, in having the outer plate of the maxillipeds extend beyond the second joint of the palp, in having stouter first gnathopods with rela-

<sup>a</sup> No etymology.

tively much shorter carpus. It differs from *Ouisimus* also in not having the infero-posterior angle of the third abdominal segment produced into an acute tooth, and from *Pseudalibrotus* in its shorter antennae, in the position of the mandibular palp, and in having the upper lip clearly defined from the epistome. From *Lysianassa*, which it resembles, it differs in having two setae on the inner plate of the first maxillae, in having simple gills, and in having the first gnathopods subchelate. From *Aruga* it differs in the last named character and in the simple gills. From *Lysianopsis* it differs in the subchelate gnathopods and the terminal uropods.

KOROGA MEGALOPS, new species.

Lateral lobes of head broadly rounded. Eyes very large, elongated, nearly meeting above. First antennae with the flagellum about as long as the peduncle and composed of one elongated joint and about seven others; secondary flagellum about two-thirds as long as the primary and composed of four joints. Second antennae with the last basal joint a little shorter than the preceding one; flagellum shorter than the peduncle and composed of about twelve joints.

Epistome carinate in front, very slightly convex. Lower lip evenly rounded in front. Mandibles with the molar low, more or less pointed behind and covered with short setae. Distal margin of second expanded joint of the palp of the first maxillae furnished with seven spine-teeth external to which are a few small serrations. Inner plates of maxillipeds narrow, distally truncated, furnished with plumose setae on inner side; outer plate with about fourteen small denticulations and two very small spines on distal margin.

First gnathopods with the very short carpus furnished with a narrow posterior lobe closely applied to the base of the hand; hand quadrate, nearly as broad as long; palm transverse, about as long as the slightly concave posterior margin and armed with a spine at the end, evenly and gently convex and cut into several minute, sharp, irregular serrations. Second gnathopods with the lower posterior part of the elongated and distally widened carpus bulging and scabrous; hand twice as long as wide, slightly widening distally. First and second pereopods with the merus widened and produced at the antero-distal angle.

Infero-posterior angle of the third abdominal segment a right angle. The posterior extremity of the dorsal side of this segment curves abruptly downward and overhangs a dorsal depression on the fourth segment, which is followed by an elevation ending abruptly near the posterior margin. Third uropods extending farther back than the others, the rami a little longer than the peduncle, the outer ramus somewhat the longer. Telson tapering to a notched extremity

with a minute spine and seta on either side of the shallow emargination.

*Length*.—10 mm.

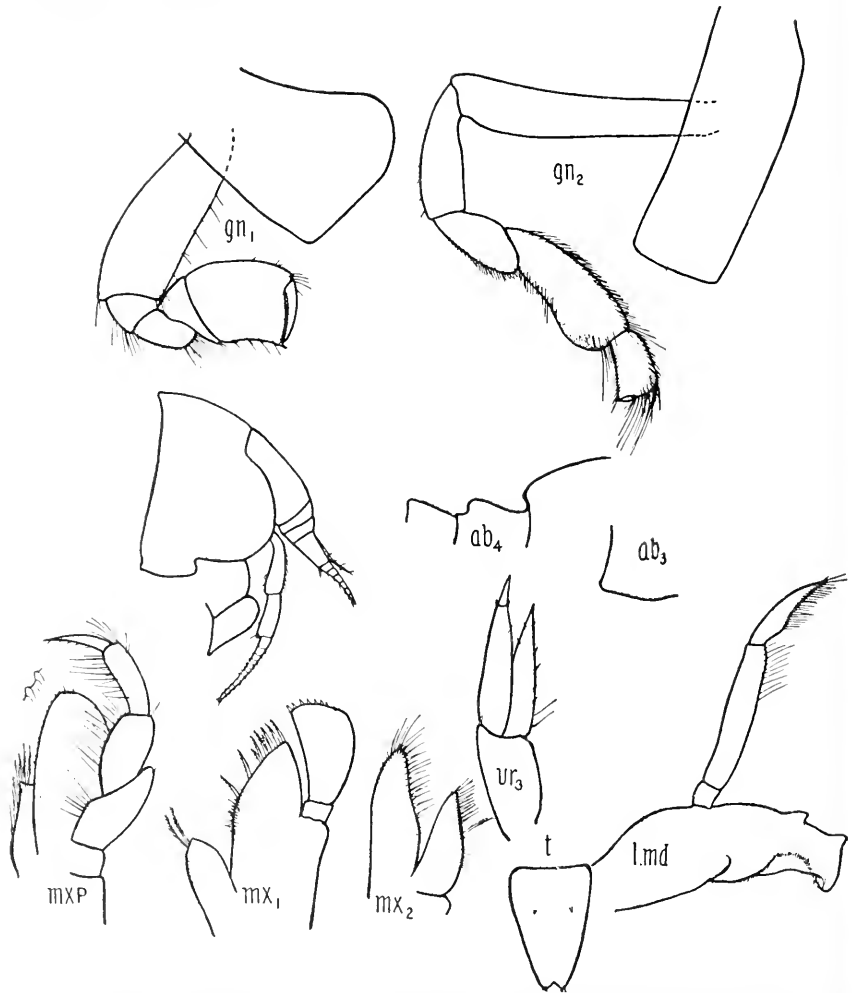

FIG. 13.—*KOROGA MEGALOPS*. *ab*<sub>3</sub>, THIRD SEGMENT OF THE ABDOMEN; *ab*<sub>4</sub>, FOURTH SEGMENT OF THE ABDOMEN; *lmd*, LEFT MANDIBLE; *gn*<sub>1</sub>, FIRST GNATHOPOD; *gn*<sub>2</sub>, SECOND GNATHOPOD; *mx*<sub>1</sub>, FIRST MAXILLA; *mx*<sub>2</sub>, SECOND MAXILLA; *mXP*, MAXILLIPED; *t*, TELSON; *ur*<sub>3</sub>, THIRD UROPOD.

*Locality*.—Described from a single female carrying ova; Station 4257, vicinity of Funder Bay, Lynn Canal, Alaska, 350 fathoms.

*Type*.—Cat. No. 38539, U.S.N.M.

Genus *ARUGA*,<sup>a</sup> new.

Side plates deep. Antenna short; secondary flagellum of first pair well developed; peduncle of second pair with none of the joints expanded. Upper lip produced forward into a rounded keel-like

<sup>a</sup> No etymology.

projection which is separated from the epistome by a narrow fissure. Mandibles rather narrow; palp slender and situated near the middle of the mandible; cutting edge rather narrow and edentate; molar small and situated nearer the distal end than the palp. First maxille with the inner plate devoid of terminal setae; palp two jointed, bent around the outer plate, the second joint crenulate to minutely dentate around the distal end. Plates of second maxille narrow, setose distally. Maxillipeds with the inner plate narrow, devoid of spines, and reaching the middle of the outer plate; outer plate devoid of spines, crenulate to minutely dentate on the margin; palp slender; dactyl spiniform. First gnathopods simple; second subchelate, to chelate. Peraeopods rather slender, the basal joints of the last three pairs widely expanded. Gills with plates on both sides. Uropods with styliiform rami, the last pair smaller than the others, with the rami subequal. Telson short, entire.

*Type of genus*.—*A. oculata*, new species.

This genus is allied to *Lysianella*, but differs in the absence of setae on the inner ramus of the first maxille and in the simple first gnathopods.

ARUGA OCULATA, new species.

Eyes large, oblong. Lateral angles of the head produced into an acute triangular lobe. First antennae with the second joint of the peduncle nearly as long as wide; third very short; first joint of flagellum elongated; secondary flagellum with about five joints. Second antennae about as long as the first, last two joints of peduncle of nearly equal length. Outer plate of maxillipeds devoid of setae and reaching end of second joint of palp. First gnathopods rather stout; side plate large and expanded below. Second gnathopods with very narrow basal joint; hand small, with the lower posterior angle produced so as to make it almost chelate. First and second peraeopods with the merus widened and produced into an acute lobe at the lower anterior angle. Third peraeopods short, the basal joint as wide as deep; merus dilated and produced at the infero-posterior angle. Fourth and fifth peraeopods more elongate, the broad basal joints serrated behind; merus slightly dilated in the fourth and not unusually so in the fifth; dactyls rather narrow and smooth. Third abdominal segment with a sinus above the not very prominent lateral angle. Fourth segment with a dorsal depression near the base. Uropods reaching back to about the same point; peduncles armed above with spines which are well developed in the first and second pairs but small in the third. Rami of first pair subequal, styliiform, shorter than the peduncle, and armed with few spines; in the second pair the rami are subequal and much longer than the peduncle; the outer ramus is styliiform and evenly tapering but the inner one is

furnished with a notch at about its posterior third just proximal to which is a small prominence bearing a large spine. Third uropods

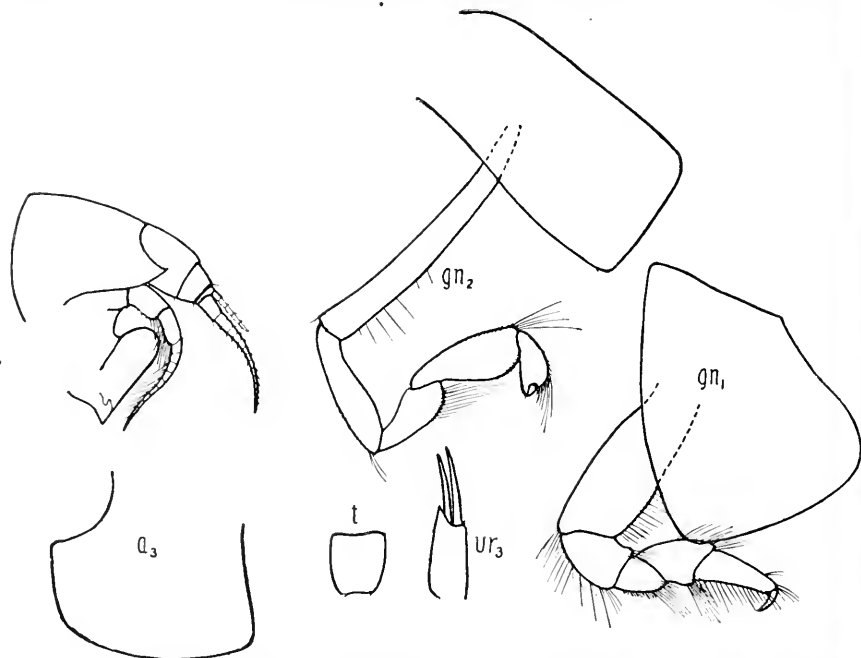

FIG. 14.—*ARUGA OCLATA*. *a*<sub>3</sub>, THIRD SEGMENT OF THE ABDOMEN; *gn*<sub>1</sub>, FIRST GNATHOPOD; *gn*<sub>2</sub>, SECOND GNATHOPOD; *t*, TELSON; *ur*<sub>3</sub>, THIRD UROPOD.

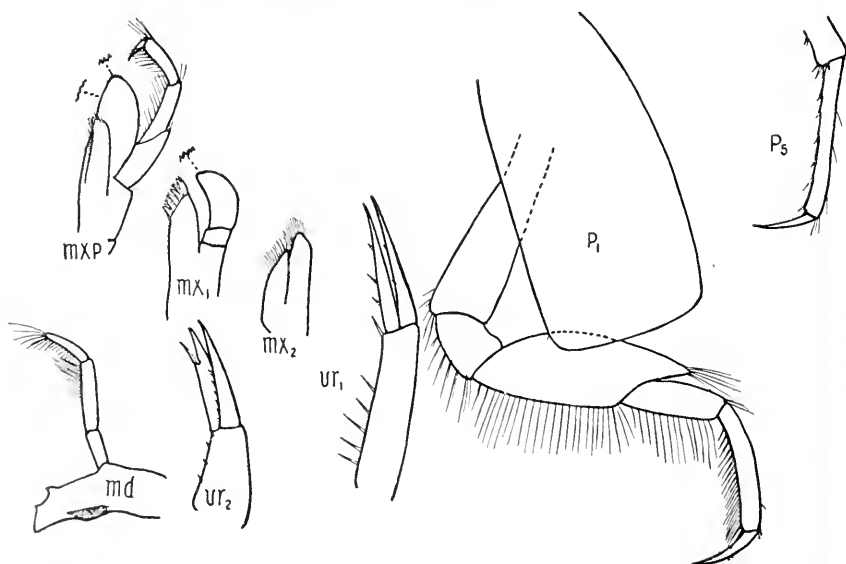

FIG. 15.—*ARUGA OCLATA*. *md*, MANDIBLE; *mx*<sub>1</sub>, FIRST MAXILLA; *mx*<sub>2</sub>, SECOND MAXILLA; *mxp*, MAXILLIPED; *p*<sub>1</sub>, FIRST PEREOPOD; *p*<sub>5</sub>, FIFTH PEREOPOD; *ur*<sub>1</sub>, FIRST UROPOD; *ur*<sub>2</sub>, SECOND UROPOD.

with the peduncle slightly longer than the rami and produced at the

upper posterior angle, rami narrow, equal and furnished with one or more minute spinules near the tip. Telson a little longer than wide, the posterior margin very slightly concave and furnished with a pair of very short setae on either side of the middle.

*Length*.—14 mm.

*Locality*.—A single female specimen from Station 4304, off Point Loma, 25 fathoms.

*Type*.—Cat. No. 38540, U.S.N.M.

### FAMILY AMPELISCIDÆ.

#### AMPELISCA CRISTATA, new species.

Eyes surrounded by red pigment. First antennae very short, the first joint a little over half length of second. Second antennae about

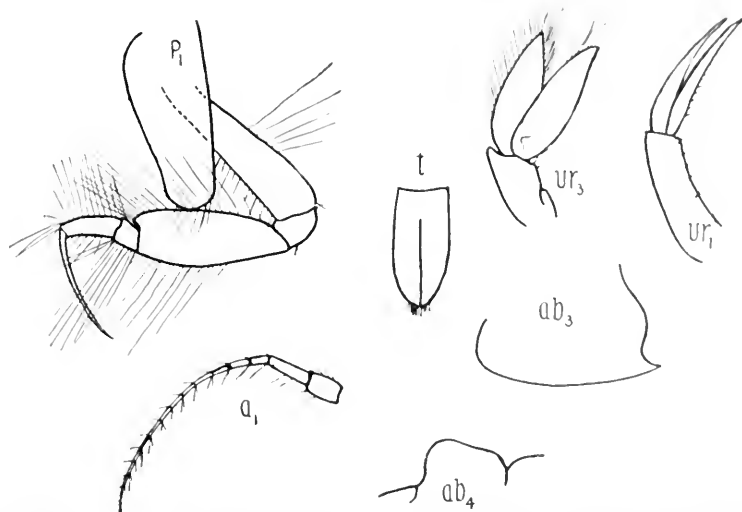

FIG. 16.—AMPELISCA CRISTATA, FEMALE. *a*<sub>1</sub>, FIRST ANTENNA; *ab*<sub>3</sub>, THIRD SEGMENT OF THE ABDOMEN; *ab*<sub>4</sub>, FOURTH SEGMENT OF THE ABDOMEN; *p*<sub>1</sub>, FIRST PEREPOD; *t*, TELSON; *ur*<sub>3</sub>, THIRD UROPOD; *ur*<sub>1</sub>, FIRST UROPOD.

the length of body; last basal joint about three-fifths length of preceding one. Hand of first gnathopod narrower than carpus and about two-thirds as long, almost simple. Hand of second gnathopods less than half length of propodus. Dactyl of first two pereopods larger than two preceding joints, merus of first produced to about middle of carpus in front. Fourth pereopods with anterior margin of basal joint produced and rounded where it is furnished with plumose setae; remaining joints armed in front with spines. Ischium of last pereopods much wider than long; basal lobe produced to beyond middle of merus, with the lower margin transverse; merus produced into a pointed lobe behind carpus nearly to its

middle; carpus longer than merus, produced behind a little more than in front; dactyl attenuate, shorter than propodus. Postero-inferior angle of third abdominal segment produced into an acute tooth, above which the margin is strongly bisinuate. Fourth abdominal segment with a rather prominent dorsal crest which is rounded behind.

First uropods reaching but slightly beyond peduncle of third pair, with equal rami about as long as the peduncle; outer ramus without spines; inner with several, mainly on basal half. Second uropods with equal rami about as long as peduncle, armed on one side with several spines, along subterminal spine on outer ramus. Rami of third pair broad, equal, furnished with long plumose setae, inner

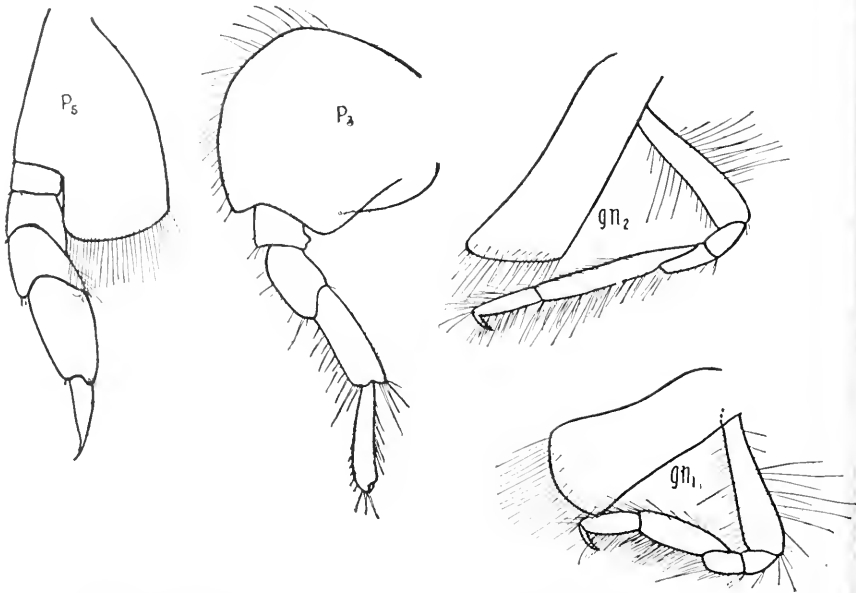

FIG. 17. AMPELISCA CRISTATA, FEMALE.  $gn_1$ , FIRST GNATHOPOD;  $gn_2$ , SECOND GNATHOPOD;  $p_3$ , THIRD PEREOPOD;  $p_5$ , FIFTH PEREOPOD.

with a prominence on lower side of base. Telson elongated, tip rounded and armed with several spinules.

*Length*.—14 mm.

*Locality*.—Station 4304, off Point Loma, 25 fathoms.

*Type*.—Cat. No. 38541, U.S.N.M.

*Additional locality*.—Station 4549, Monterey Bay, 56–57 fathoms.

This species is very closely allied to *A. macrocephala*, but differs in having a single well-developed crest on the dorsal side of the fourth abdominal segment instead of a depression followed by a small carina; the telson differs in having several spinules at the tip of each lobe instead of a single one; the rami of the terminal uropods are somewhat broader.

AMPELISCA PLUMOSA, new species.

*Female*.—Corneal lenses absent. Head about as long as the first three thoracic segments. First antenna about half the length of the second; second joint about twice length of first; flagellum three times length of peduncle. Second antennae as long as the body; a laminate process below base of peduncle divided into two lobes the posterior of which is acute; last joint of slender peduncle two-thirds length of preceding one; side plates with long plumose setae on lower margin; infero-posterior angle of first two pairs with a small tooth. Hand of first gnathopods about as long and broad as

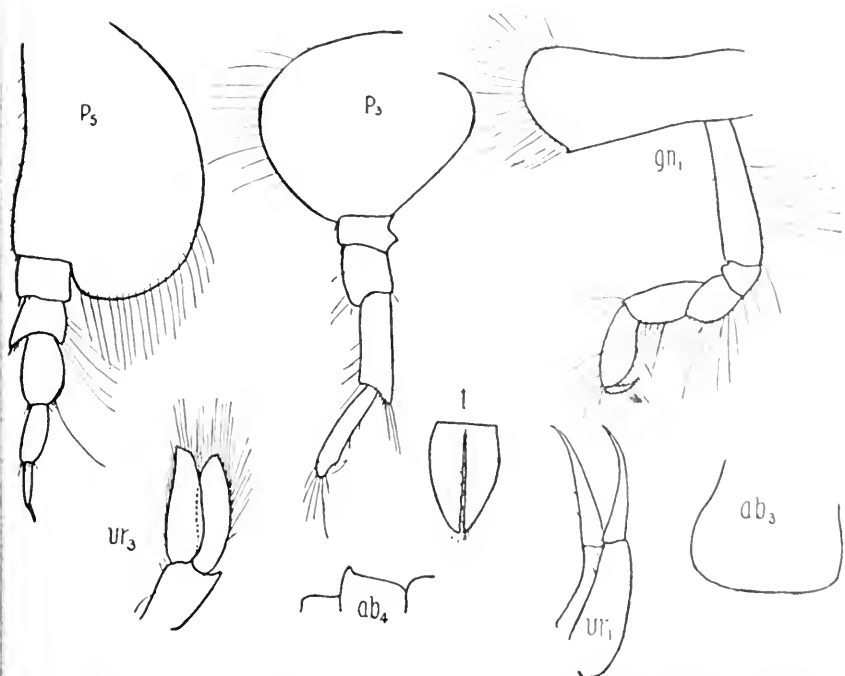

FIG. 18.—AMPELISCA PLUMOSA, FEMALE. *ab*<sub>3</sub>, THIRD SEGMENT OF THE ABDOMEN; *ab*<sub>4</sub>, FOURTH SEGMENT OF THE ABDOMEN; *gn*<sub>1</sub>, FIRST GNATHOPOD; *p*<sub>3</sub>, THIRD PEREOPOD; *p*<sub>5</sub>, FIFTH PEREOPOD; *t*, TELSON; *ur*<sub>1</sub>, FIRST UROPOD; *ur*<sub>3</sub>, THIRD UROPOD.

carpus; second gnathopods much longer than first, very slender, the carpus about twice the length of the narrow hand. Dactyl of the first two pereopods fully as long as the two preceding joints combined. Third and fourth pereopods with few setae and no spines except on distal end of carpus. Basal joint of last pereopods produced downward only to end of following joint; merus scarcely longer than ischium, and produced downward both in front and behind; the two following joints of subequal length and slightly longer than the straight dactyl.



Infero-lateral angle of third abdominal segment rounded. Fourth abdominal segment with a dorsal carina which increases in height toward the posterior end, where it is somewhat upturned. Rami of first uropods slender, about as long as peduncle; the outer one slightly narrower than the inner, but nearly as long and devoid of spines; inner ramus with two short spines. Rami of second uropods shorter than peduncle, much broader than those of first pair, nearly equal in length and armed with several short spines. Terminal uropods with flattened subequal rami furnished with long plumose setae; extremities blunt. Telson twice as long as broad, cleft to base, and tapering beyond middle.

*Length*.—13 mm.

*Locality*.—Station 4381, a single female specimen, off North Colorado Island, 618–667 fathoms.

*Type*.—Cat. No. 38542, U.S.N.M.

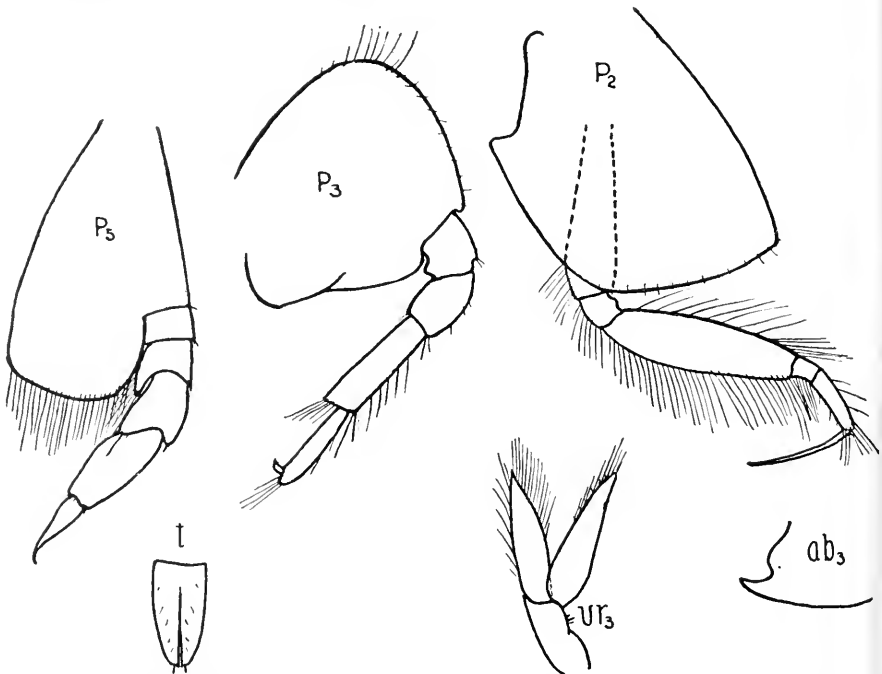

FIG. 19.—AMPELISCA MACROCEPHALA, FEMALE. *ab*<sub>3</sub>, THIRD SEGMENT OF THE ABDOMEN; *p*<sub>2</sub>, SECOND PEREPOD; *p*<sub>3</sub>, THIRD PEREPOD; *p*<sub>5</sub>, FIFTH PEREPOD; *t*, TELSON; *ur*<sub>3</sub>, THIRD UROPOD.

AMPELISCA MACROCEPHALA Lilljeborg.

*Localities*.—Station 4522, Monterey Bay, 130–149 fathoms, one specimen; Station 4549, Monterey Bay, 56–57 fathoms, two specimens; Station 4551, Monterey Bay, 46–56 fathoms, one specimen; Station 4555, Monterey Bay, 66–69 fathoms, one specimen.

## AMPELISCA PACIFICA, new species.

First antennæ very slender, scarcely one-fourth the length of the body, the tumid first joint about a third the length of the second and about equal to the third; flagellum longer than peduncle and composed of about ten or twelve narrow joints. Peduncle of second antennæ about as long as first pair, the last joint of the peduncle four-fifths the length of the preceding one. First gnathopods with hand shorter than carpus; hand of second gnathopods about half the length of carpus. Dactyl of first and second pereopods longer than the two preceding joints combined; merus of first pereopods produced in front

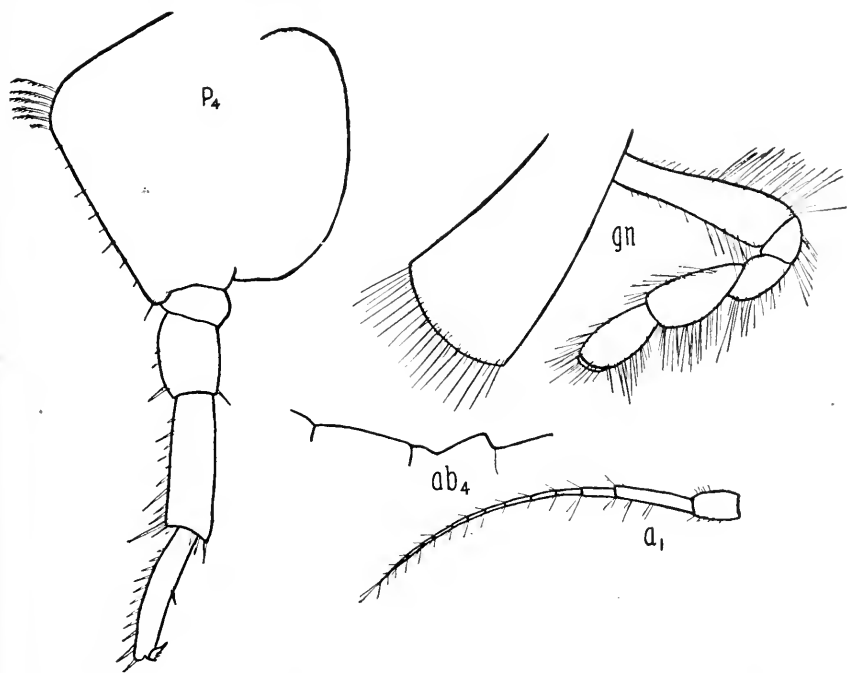

FIG. 20.—AMPELISCA PACIFICA, FEMALE.  $a_1$ , FIRST ANTENNA;  $ab_4$ , FOURTH ABDOMINAL SEGMENT;  $gn$ , GNATHOPOD;  $p_4$ , FOURTH PEREOPOD.

nearly to distal end of carpus; much less strongly produced in second pair. Fourth pereopods with spines on anterior margin of carpus and propodus. Tail of basal joint of last pereopods produced to middle of merus; ischium broader than long; merus produced downward posteriorly to beyond middle of carpus and bearing about six long plumose setæ on outer side of expansion, and a spine at the tip; carpus as long as merus on posterior side, armed with several spines at lower extremity, both in front of and behind propodus, and a single spine on anterior margin; dactyl attenuate at tip, shorter than propodus. Infero-posterior angle of third abdominal segment pro-

edged into a prominent acute tooth, above which the margin is sinuate. Dorsal side of fourth abdominal segment with a shallow

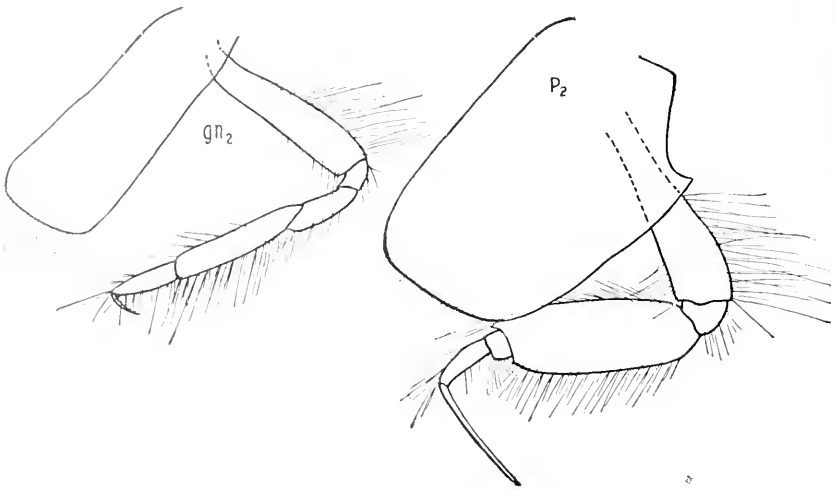

FIG. 21. AMPELISCA PACIFICA FEMALE.  $gn_2$ , SECOND GNATHOPOD;  $p_2$ , SECOND PEREOPOD.

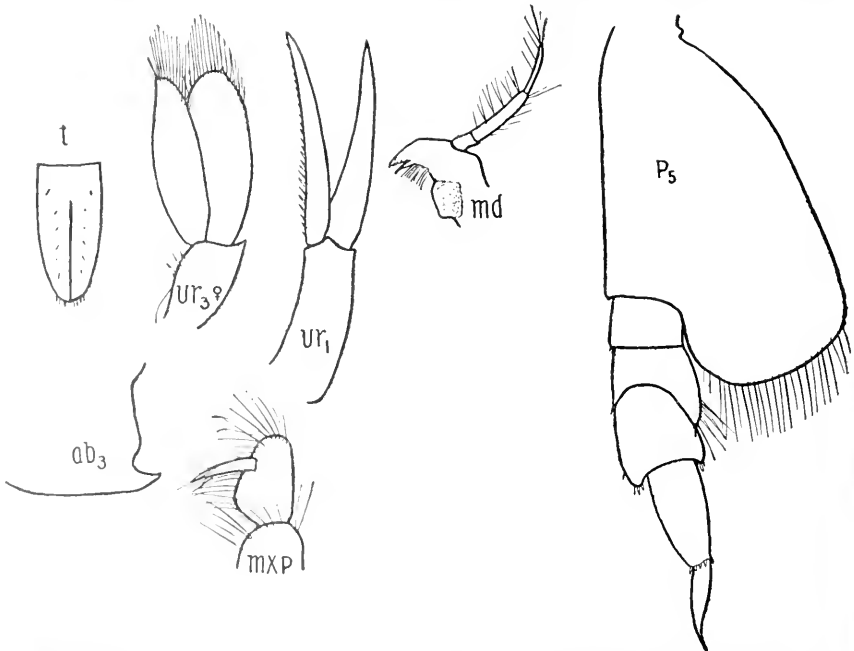

FIG. 22. AMPELISCA PACIFICA, FEMALE.  $ab_3$ , THIRD ABDOMINAL SEGMENT;  $md$ , MANDIBLE;  $mxp$ , TIP OF MAXILLIPED;  $p_5$ , FIFTH PEREOPOD;  $t$ , TELSON;  $ur_1$ , FIRST UROPOD;  $ur_2$ , SECOND UROPOD.

indivision near the middle, behind which it is somewhat elevated; the other segments smooth above.

Rami of first uropods longer than peduncle, subequal and reaching to middle of rami of third pair, outer ramus devoid of spines, inner with twenty to twenty-five on upper margin. Second uropods with rami equal, a little longer than peduncle, armed with several short spines on one edge, outer ramus with a very long spine near tip. Third uropods with broad, flat rami broadly rounded at tip except for a small cusp, and furnished distally with long plumose setae. Telson elongate and armed with about four short spines on either lobe.

*Length*.—12 mm.

*Locality*.—Station 4549, Monterey Bay, 56–57 fathoms, two females; Station 4556, Monterey Bay, 56–59 fathoms, one female, type.

*Type*.—Cat. No. 38543, U.S.N.M.

This species is readily distinguished from the others here described, as well as most others of the genus, by the wide rami of the terminal uropods with their broadly rounded extremities. The penultimate joint of the palp of the maxillipeds is peculiar in being produced beyond the articulation of the dactyl, so that the latter appears to arise from near the middle of the inner margin.

AMPELISCA CALIFORNICA, new species.

*Female*.—Head about as long as first three segments of thorax; lower pair of eyes on anterior margin of head. First antennae but slightly exceeding peduncle of second, the second joint three times length of first; flagellum over twice length of peduncle. Second antennae nearly as long as body; last joint of elongate peduncle a little shorter than preceding one; flagellum nearly twice the peduncle. First gnathopods with hand shorter than carpus; palm at angle of about  $45^{\circ}$  with posterior margin of hand. Second gnathopods considerably longer and more slender than the first; hand about half the length of the narrow carpus. First two pereopods with the dactyl over a half longer than the two preceding joints combined. Third and fourth pereopods with plumose setae around the prominent rounded anterior projections of the basal joints; anterior margin of propodus of fourth pereopod armed with long spines which are absent on corresponding joint of third pair. Last pair of pereopods with basal joint produced slightly beyond end of the ischium, which is nearly as long as broad; merus produced obliquely downward posteriorly into a large oblong lobe fringed with plumose setae; carpus produced downward in front into an acute triangular lobe whose lower margin is furnished with a few setae and three stout spines, each bearing a small cilium; anterior margin with a small prominence near the lower end bearing a short spine; dactyl shorter than propodus and attenuate and flexible at tip.

Infero-posterior angle of third abdominal segment produced into a tooth. Fourth abdominal segment with a dorsal crest, which bears

an elevation near the middle and a sharper one at posterior end. First uropods not nearly reaching the middle of the rami of second uropods, with equal and narrow rami, the inner one armed with about six spines; the outer one smooth. Second uropods with rami rather stout, subequal, about as long as peduncle and armed with numerous short spines in the margins, the outer ramus bearing also a very long slender spine near the tip. Third uropods with narrow subequal rami; outer one with plumose setae on inner margin; both rami devoid of spines, but a pair of spines on upper distal angle of peduncle. Telson narrow, inner sides of the two lobes produced into an acute point, between which and a smaller second point are about four small setae.

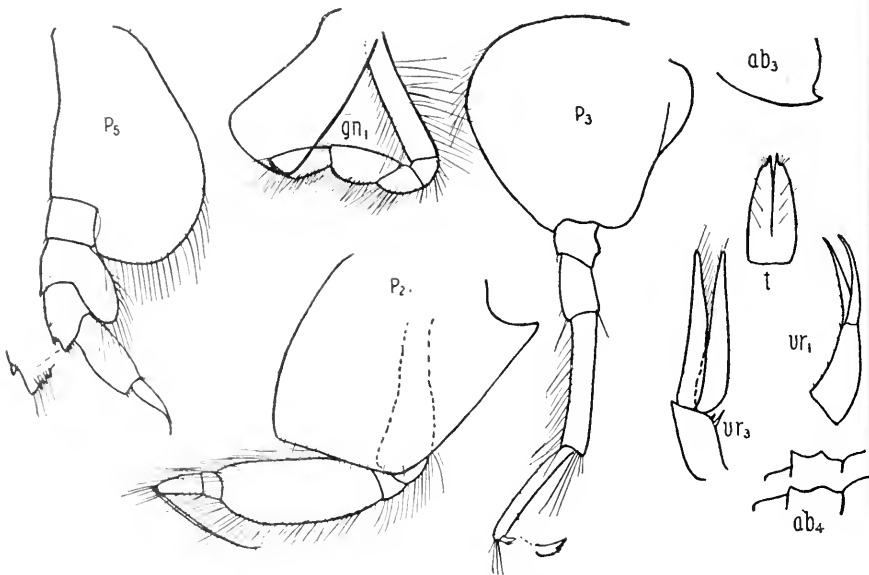

FIG. 23. AMPELISCA CALIFORNICA, FEMALE. THE UPPER FIGURE OVER  $ab_1$  IS FROM A MALE FROM STATION 4519.  $ab_3$ , THIRD SEGMENT OF THE ABDOMEN;  $ab_4$ , FOURTH SEGMENT OF THE ABDOMEN;  $gn_1$ , FIRST GNATHOPOD;  $p_2$ , SECOND PEREOPOD;  $p_3$ , THIRD PEREOPOD;  $p_5$ , FIFTH PEREOPOD;  $t$ , TELSON;  $ur_1$ , FIRST UROPOD;  $ur_3$ , THIRD UROPOD.

*Male*.—The first antennae may not reach beyond the end of the penultimate joint of the second pair, and the latter may be much longer than the body.

*Length*.—15 mm.

*Localities*.—Station 4342, off South Coronado Island, 53–66 fathoms; Station 1433, off Santa Rosa Island, 243–265 fathoms; Station 1436, off San Miguel Island, 264–271 fathoms; Station 4549, Monterey Bay, 56–57 fathoms.

*Type*.—Cat. No. 38544, U.S.N.M.

This species is allied to *A. brevicornis* (Costa), but the fourth joint of the first pereopods is not produced into a prominent distal lobe; the tooth at the infero-posterior angle of the third abdominal seg-

ment is not so prominent nor the margin above it so strongly sinuous; the dactyls of the first two pereopods are longer, and the telson has a very different extremity. It is distinguished from most species of the genus, except *brevicornis*, by the very large lobe on the posterior side of the merus of the last pereopods. In a male specimen from Station 4549 the anterior elevation on the dorsal side of the fourth abdominal segment was acute and the posterior one more prominent than in the other specimens examined. The terminal uropods are about the same in the two sexes, except that the rami are somewhat broader in the male. The species also resembles *A. pugetica* Stimpson, but the last three abdominal segments can scarcely be said to be "separated from the preceding ones by a deep notch."

AMPELISCA CECA, new species.

Eyes absent. First antennae but little longer than the peduncle of the second; the peduncle not reaching the middle of the antepenultimate

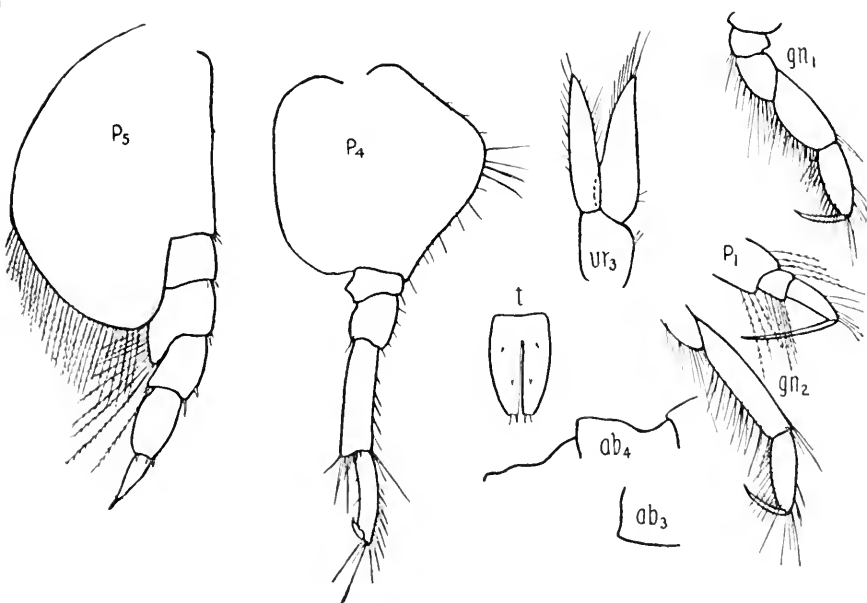

FIG. 24.—AMPELISCA CECA. *ab*<sub>3</sub>, THIRD SEGMENT OF THE ABDOMEN; *ab*<sub>4</sub>, FOURTH SEGMENT OF THE ABDOMEN; *gn*<sub>1</sub>, FIRST GNATHOPOD; *gn*<sub>2</sub>, SECOND GNATHOPOD; *p*<sub>1</sub>, FIRST PEREOPOD; *p*<sub>4</sub>, FOURTH PEREOPOD; *p*<sub>5</sub>, FIFTH PEREOPOD; *t*, TELSON; *ur*<sub>3</sub>, THIRD UROPOD.

timate joint of the peduncle of the second pair: first joint over half as thick as long and about half the length of the second; flagellum about eighteen-jointed. Second antennae about as long as the body; the last two joints of the slender elongated peduncle of subequal length.

First gnathopods with the hand narrowly oval with the palm and posterior margin forming an even regular curve. First and second pereopods with the dactyls slightly longer than the two preceding joints combined. Third pereopods with the basal joint broadly and evenly rounded in front with a few plumose setae near the middle of the anterior margin; posterior margin produced into a very prominent rounded lobe; carpus with two pairs of short spines near the anterior margin and a cluster at the lower margin; propodus with two spines on posterior margin and with several setae but no spines in the anterior one. Fourth pereopods with a few plumose setae near the middle of the rounded and projecting anterior margin; carpus with five or six spines on anterior margin and a cluster of several at the distal end; propodus with two spines on posterior margin and a row of eight or nine on the distal two thirds of the anterior margin. Basal joint of the last pereopods with the posterior expansion obliquely rounded off below; third joint about as long as the fourth, exclusive of the posterior lobe; fourth joint with a posterior lobe extending behind the following joint as far as its distal third or fourth and furnished with about nine long plumose setae on its posterior and distal margins; fifth joint about as long as the sixth; dactyl markedly shorter than the preceding joint.

Infero-posterior angle of the third abdominal segment almost a right angle and but very slightly produced. Fourth segment with a dorsal depression anteriorly, followed by crest whose posterior end is considerably above the following segment. Third uropods with rather broadly lanceolate rami, which are devoid of marginal spines but are furnished with setae on the distal portion of their opposed margins and along the outer side of the outer ramus. Telson twice as long as broad, armed with two pairs of dorsal spinules, and furnished with a spinule and a seta at the tip of each lobe.

*Length.* 42 mm.

*Locality.* A single specimen from Station 1115, off Santa Barbara Island, 302-638 fathoms, along with specimens of *Acanthoploceus annexus*.

*Type.* Cat. No. 38545, U.S.N.M.

This species resembles *A. odontoplar* Sars, but the head is not carinate dorsally; the first pairs of side plates are devoid of a tooth at the infero-posterior angle, the hand of the first gnathopods has the posterior margin more evenly curved, and the posterior expansion of the last pereopods is oblique instead of transversely truncated below. From *A. californica* it is readily distinguished by its absence of eyes, by the smaller posterior lobe of the merus of the posterior pereopods, by the broader terminal uropods, and by the extremity of the telson.

AMPELISCA LOBATA, new species.

Lower pair of eyes on the margin of the head. First antennae nearly half as long as the body, the first segment of the peduncle about as long as the second one, the third very short; flagellum over three times the length of the peduncle. Second antennae nearly as long as the body, the last joint of the peduncle nearly as long as the preceding.

First gnathopods with the hand narrowly oval, shorter and much narrower than the carpus, the palm and posterior margin forming an even curve. Hand of second gnathopod two-third the length of the carpus; dactyl about three-fourth the length of the hand.

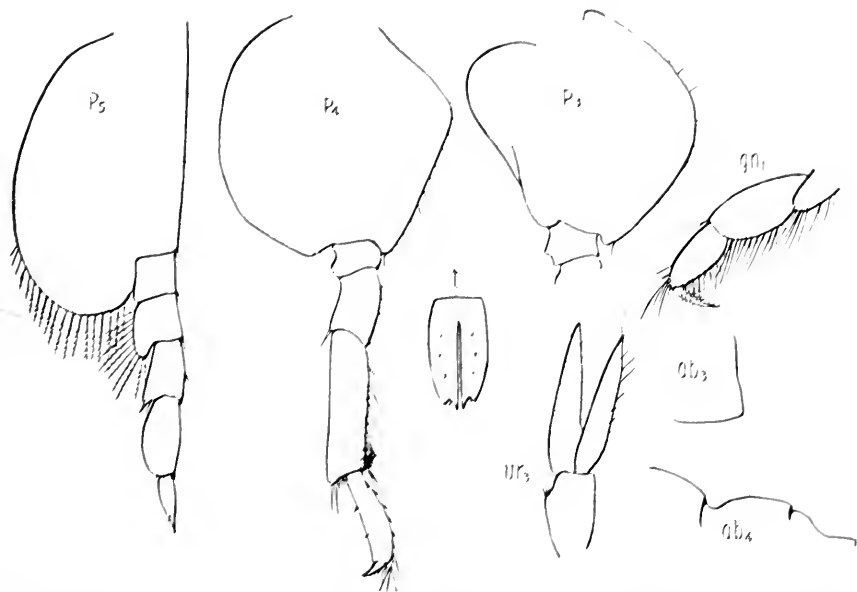

FIG. 25.—AMPELISCA LOBATA. *ab*<sub>3</sub>, THIRD SEGMENT OF THE ABDOMEN; *ab*<sub>4</sub>, FOURTH SEGMENT OF THE ABDOMEN; *gn*<sub>1</sub>, FIRST GNATHOPOD; *p*<sub>3</sub>, THIRD PEREOPOD; *p*<sub>4</sub>, FOURTH PEREOPOD; *p*<sub>5</sub>, FIFTH PEREOPOD; *t*, TELSON; *ur*<sub>3</sub>, THIRD UROPOD.

First and second pereopods with the dactyl about as long as the two preceding joints combined. Third pereopod with a very prominent lobe on the posterior side of the basal joint much as in *A. caeca*; carpus armed as in *caeca*. Fourth pereopod with the anterior margin furnished with several spines and projecting at the middle, but devoid of plumose setae; carpus with about five long and many more short spines on the anterior margin, and a cluster at the distal end; propodus with about six spines on the anterior margin. Last pereopods with the posterior expansion of the basal segment rather narrow, rounded below, and produced but slightly beyond the end of the ischium; merus with a posterior lobe which is produced



downward but not so far as the middle of the following joint and furnished with ten to twelve plumose setæ.

Infero-posterior angle of third abdominal segment nearly a right angle and not produced. Fourth segment with a dorsal depression followed by an elevation, which does not end posteriorly in a tooth. Third uropods with lanceolate flattened rami which are furnished with a few setæ; a few short spines on outer margin of the outer ramus. Telson twice as long as wide, with a notch at the tip of each lobe in which is situated a short spine; the inner side of the notch prolonged into an acute point.

*Length*.—9 mm.

*Locality*.—A single specimen from Station 4420, off San Nicolas Island, 32–33 fathoms.

*Type*.—Cat. No. 38546, U.S.N.M.

This species is unusual in having the peduncle of the first antennæ very short, with the first and second joints of nearly equal length. It resembles *A. caeca*, but differs from it, in addition to having well developed eyes, in having a narrower posterior lobe on the basal joint of the last pereopods which is not produced so far downward, in having the elevation on the fourth abdominal segment less high, in having the outer branch of the terminal uropods armed with short spines on the outer margin, and in the distal extremity of the telson.

HAPLOOPS TUBICOLA Lilljeborg.

A single specimen from Station 4454, Monterey Bay, 65–71 fathoms.

BYBLIS GAIMARDII Krøyer.

A single specimen each from Monterey Bay, Stations 4549, 56–57 fathoms, and 4551, 46–56 fathoms.

Family PHOXOCEPHALIDÆ.

PARAPHOXUS ROBUSTUS, new species.

Head nearly as long as the first three segments of the thorax, the hood evenly convex above and subacute at the tip. Eyes very large in the male, nearly meeting above, small and oblong in the female. First antennæ with the second joint nearly as long as the first; flagellum shorter than the peduncle; secondary flagellum over half the length of the primary. Second antennæ about the same in the two sexes, about as long as the first, the penultimate joint expanded, furnished laterally with a row of several spines, and with numerous long plumose setæ on the lower margin; last basal joint with two groups of lateral spines; flagellum seven-jointed and scarcely as long as the last two joints of the peduncle. Mandibles much as in *P. oculatus*. Maxillipeds with the outer plate reaching nearly to the

middle of the second joint of the palp, the inner margin armed with eight curved spines which increase rapidly in length toward the distal end.

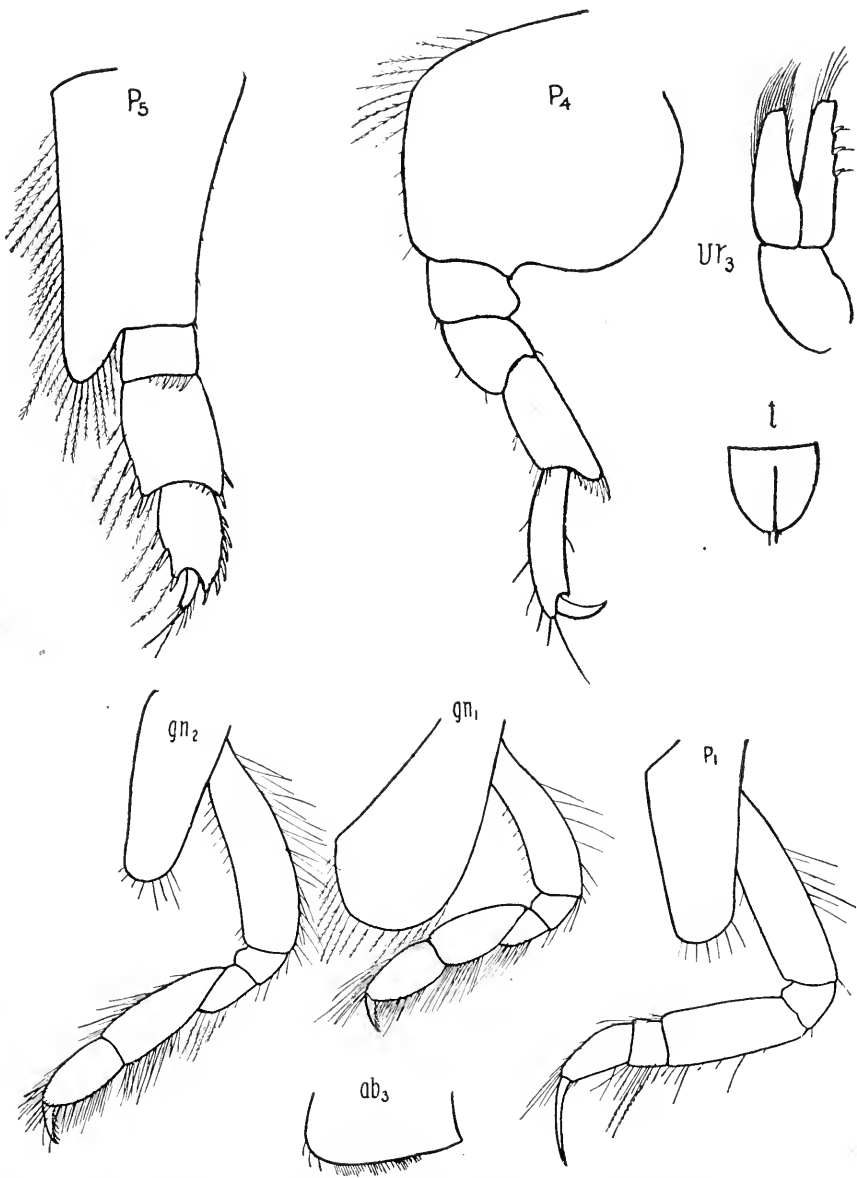

FIG. 26.—HAPLOOPS TUBICOLA. *ab*<sub>3</sub>, THIRD SEGMENT OF THE ABDOMEN; *gn*<sub>1</sub>, FIRST GNATHOPOD; *gn*<sub>2</sub>, SECOND GNATHOPOD; *p*<sub>1</sub>, FIRST PEREOPOD; *p*<sub>2</sub>, SECOND PEREOPOD; *p*<sub>3</sub>, THIRD PEREOPOD; *p*<sub>4</sub>, FOURTH PEREOPOD; *p*<sub>5</sub>, FIFTH PEREOPOD; *t*, TELSON; *ur*<sub>3</sub>, THIRD UROPOD.

Gnathopods similar in shape, the second slightly the larger, the hands rather narrower than in *oculatus*, and not widened distally. The side plate of the first pair bears about eighteen plumose setae in

the lower margin, that of the second pair about twelve. First and second pereopods with a very large spine at the distal end of the carpus, which extends as far as the tip of the propodus; dactyls curved and about two-thirds the length of the preceding joint. Fourth pereopods stouter than in *oculatus*, the entire anterior margin of the basal joint furnished with plumose setae and the lower portion of the anterior margin armed with short spines. Basal joint of last pereopods broadly oval in general outline, the posterior margin with about seven rather large serrations, the lower margin not serrate but furnished with about six very short setae.

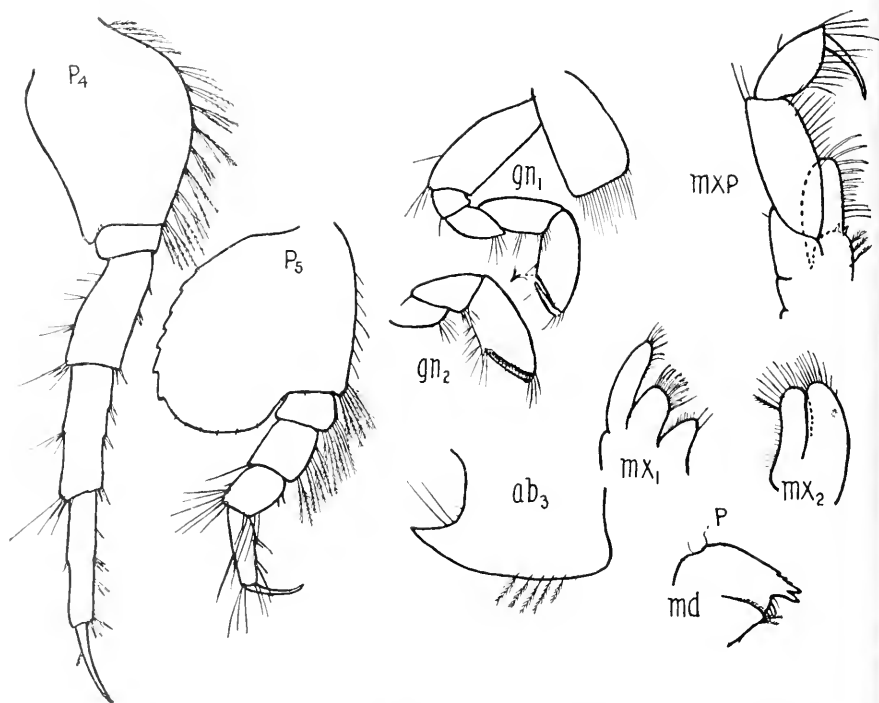

FIG. 27. *PARAPHOXUS ROBUSTUS*, FEMALE. *ab*<sub>3</sub>, THIRD SEGMENT OF THE ABDOMEN; *gn*<sub>1</sub>, FIRST GNATHOPOD; *gn*<sub>2</sub>, SECOND GNATHOPOD; *md*, MANDIBLE; *mx*<sub>1</sub>, FIRST MAXILLA; *mx*<sub>2</sub>, SECOND MAXILLA; *mxp*, MAXILLIPED; *p*, PALP OF MANDIBLE WHICH IS NOT SHOWN IN THE FIGURE; *p*<sub>1</sub>, FOURTH PEREOPOD; *p*<sub>5</sub>, FIFTH PEREOPOD.

Third abdominal segment with several plumose setae on the lower margin, infero-posterior angle produced into an acute lobe whose upper margin is furnished with setae. Third uropods with the inner ramus very short in the female; the rami nearly equal in the male and not fringed with plumose setae. Telson oblong, deeply cleft, the lobes with long terminal setae.

*Length*.—8 mm.

*Locality*.—A male and a female specimen from Station 4304, off Point Loma, 25 fathoms.

*Type*.—Cat. No. 38547, U.S.N.M.

This species may readily be distinguished from *P. ocellatus* by its stouter appendages, by its acute infero-posterior angle of the third abdominal segment, by its narrower hands, and by the larger number of setae on the lower margins of the anterior coxal plates. From *P. spinosus* it is readily distinguished by the much broader joints of the posterior pereopods and the larger serrations in the posterior margin of the basal joints of these appendages. The lack of fringes of plumose setae on the terminal uropods in the male distinguishes it from the other species of the genus.

HARPINIA OCULATA, new species.

Eyes rather small, oblong, oblique; postantennal corners of the head not prominent. Antennae short, subequal, the stout first joint

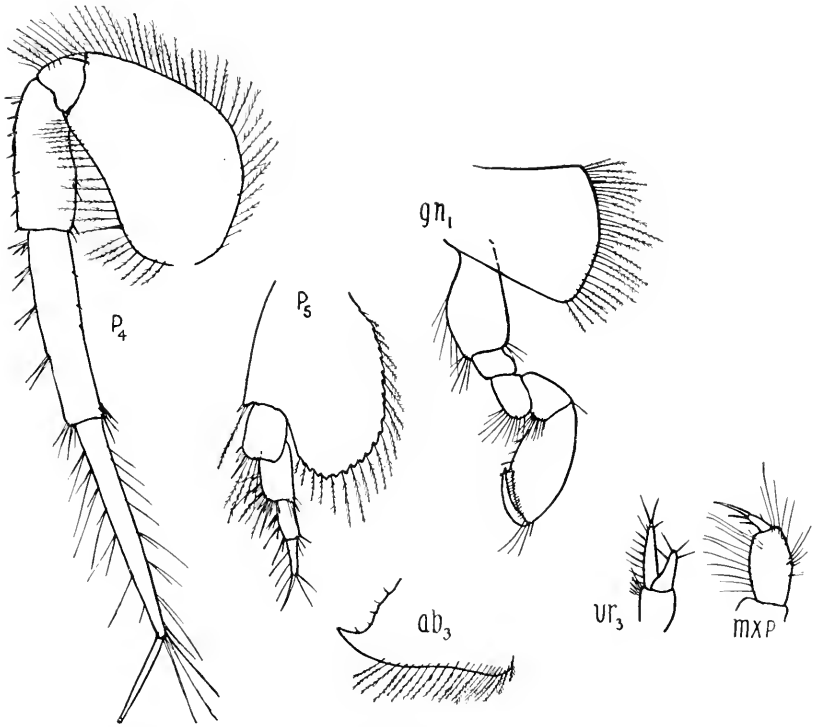

FIG. 28.—HARPINIA OCULATA, FEMALE. *ab<sub>3</sub>*, THIRD SEGMENT OF THE ABDOMEN; *gn<sub>1</sub>*, FIRST GNATHOPOD; *msp*, END OF PALP OF MAXILLIPED; *p<sub>4</sub>*, FOURTH PEREPOD; *p<sub>5</sub>*, FIFTH PEREPOD; *ur<sub>3</sub>*, THIRD UROPOD.

of the first antennae much longer than the next two, the distal part of the lower margin furnished with about twelve distally plumose setae, the second joint with about ten long setae on the distal half of the lower margin; flagellum with about nine joints; secondary flagellum about two-thirds the length of the primary, and composed of about seven joints. Second antennae with a very long narrow acute lobe

on the first basal joint; the expanded penultimate joint of the peduncle armed with nine spines and about ten plumose setae around the lower anterior angle; distal part of lower margin of last basal joint with about eight long plumose setae and a pair of long spines; flagellum with about nine joints. Mandibular palp very narrow, the last joint a little longer than the preceding and furnished with setae on its oblique tip and distal half. First maxillae with the small inner plate rounded and furnished with a large and a small seta; the joint between the first and second segments of the palp not so clearly marked as usual. Maxillipeds with the outer plate reaching about to the middle of the second joint of the palp; last joint of palp very small, furnished with a long curved spine at the tip and two smaller ones on the inner and a short seta on the outer margin.

First and second gnathopods of nearly the same size and shape; lower margin of coxa of first pair with over twenty-five plumose setae, those of the three following appendages with fifteen to seventeen setae. Penultimate pereopods long, basal joint with plumose setae along the whole of both margins, the hind margin with a convexity near the base which is not so prominent as in *H. affinis*; terminal joint styliform, nearly straight and about half as long as the preceding. Last pereopods very small, the basal joint with about twenty-five serrations on the posterior, lower, and a part of the anterior margin; from each notch between the serrations arises a long plumose seta; ischium with three spines and four plumose setae on prominent distal margin; merus with about seven spines on distal portion of anterior margin, many of them accompanied by long sparingly plumose setae; carpus with three pairs of setae on anterior margin; dactyl very slender and about as long as the propodus.

Third abdominal segment produced at the infero-posterior angle into an acute lobe, which is not strongly upturned; lower margin with about twenty-two plumose setae; margin above posterior angle ciliated and furnished with a few slender spines. Fourth abdominal segment gently concave above with no prominent elevation. Outer ramus of third uropods about twice as long as the peduncle, armed with about eight spines on outer margin; terminal segment very small, scarcely longer than broad and bearing a pair of long spines; inner ramus about three-fifths the length of the outer, narrowing distally from an expanded base, and armed with four spines; the distal margin of the peduncle is armed with about ten spines; apices of telson divergent and broadly rounded.

*Length*.—8 mm.

*Locality*.—Single female specimen from Station 4342, off South Coronado Island, 53–66 fathoms.

*Type*.—Cat. No. 38548 U.S.N.M.

This species is distinguished from the other species of the genus hitherto described in having fairly conspicuous eyes. In every other respect it agrees perfectly with the generic characters of *Harpinia* as given by Sars and Stebbing.

HARPINIA AFFINIS, new species.

*Female*.—Hood prominent, apex rounded; sides of head with a small angular projection. Antennae short, the peduncles scarcely

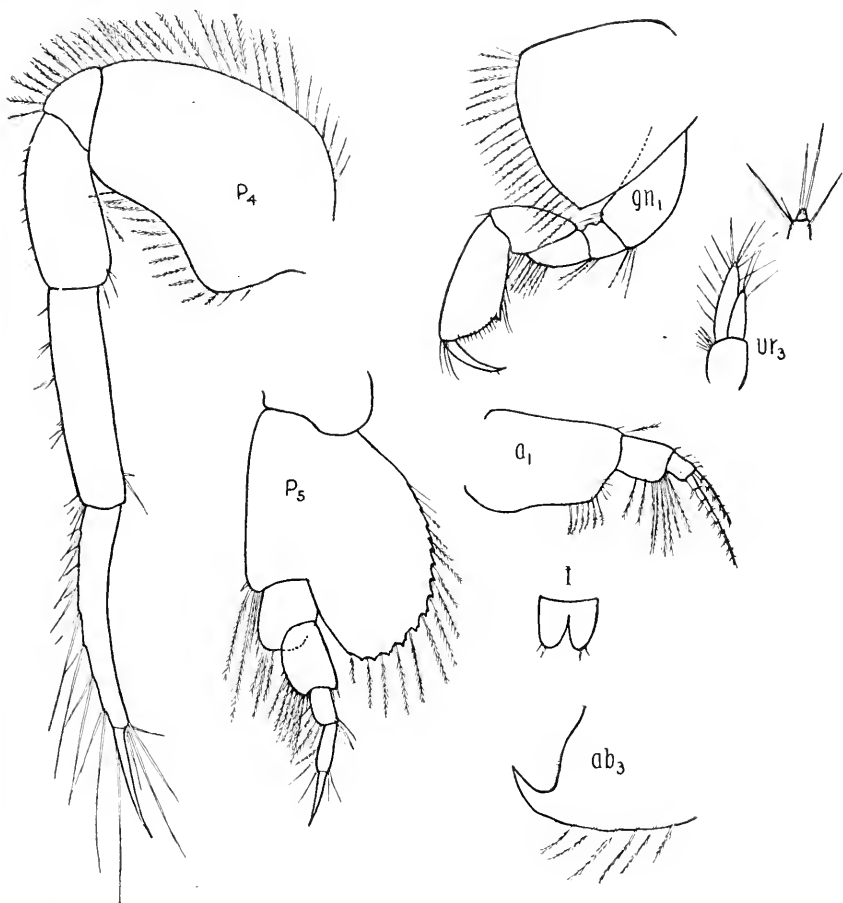

FIG. 29.—HARPINIA AFFINIS, FEMALE. *a*<sub>1</sub>, FIRST ANTENNA; *ab*<sub>3</sub>, THIRD SEGMENT OF THE ABDOMEN; *gn*<sub>1</sub>, FIRST GNATHOPOD; *p*<sub>4</sub>, FOURTH PEREOPOD; *p*<sub>5</sub>, FIFTH PEREOPOD; *t*, TELSON; *u*<sub>3</sub> THIRD UROPOD.

reaching tip of hood: first joint of first pair nearly equal to the rest of the appendage and furnished with about six plumose setae at lower anterior angle; second joint with about eight plumose setae on lower side; flagellum about nine-jointed; secondary flagellum over half the length of primary and consisting of about six joints. Second antenna about as long as primary; about six long spines and nine or ten long

plumose setae on expanded lower side of penultimate joint of peduncle; flagellum shorter than peduncle.

First gnathopods with about nineteen plumose setae on lower margin of side plate; hand with an oblique palm, which is shorter than the posterior margin and defined above by a triangular tooth with a strong spine at its base. Second gnathopods much like the first; side plate with about fourteen plumose setae. Fourth pereopod over half the length of the body, the basal joint with a prominent rounded lobe on upper half and bearing plumose setae on posterior as well as anterior margin. Fifth pereopod with the posterior lobe of the basal joint strongly produced downward and rounded, and furnished with serrations with plumose setae in the angles between them; the serrations increase in size around the postero-lateral angle where many of them become double pointed.

Third abdominal segment with plumose setae on lower margin, the posterior angle produced into a long, strongly upturned tooth. Third uropod with the outer ramus fully twice the length of the peduncle, the outer margin armed with six spines, the inner with two; terminal joint minute, about as broad as long and bearing two long spines. Inner ramus slightly over half the length of outer, with two terminal spines and one on inner margin. Telson about as broad as long, the lobes rounded.

*Length*.—9 mm.

*Locality*.—A single female specimen from Station 4554, Monterey Bay, 60–80 fathoms.

*Type*.—Cat. No. 38549, U.S.N.M.

This species is closely allied to *Harpinia plumosa* (Krøyer), but it differs from it in having a much larger number of setae on the lower margins of the side plates; in having rather more slender gnathopods; in having the posterior margin of the basal joint of the penultimate pereopods furnished with plumose setae and a prominent lobe; in having several well marked and regularly arranged teeth or serrations on the posterior margin of the basal joint of the last pereopods, in having the second joint of the outer branch of the terminal uropods minute, and in having the outer margin armed with a greater number of spines. From *H. neglecta* it differs in having much less prominent lateral angles of the head and in having a more strongly upturned tooth on the third abdominal segment.

### Family METOPIDÆ.

#### METOPA PACIFICA, new species.

*Male*.—First antennae almost as large as the second, which nearly equals the length of the body; flagellum shorter than the peduncle, which extends slightly beyond the penultimate joint of the peduncle of the second antennae. Peduncle of second antennae very elongate,

the last two joints subequal; flagellum shorter than last joint of peduncle. Maxillipeds slender, with very small outer plate. First

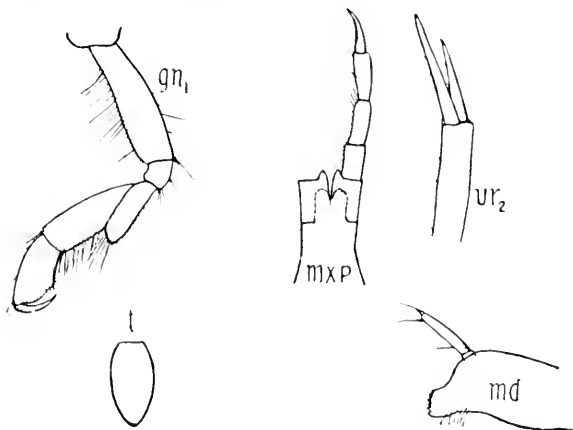

FIG. 30.—METOPA PACIFICA, MALE. THE MANDIBLE IS DRAWN TO A LARGER SCALE THAN THE OTHER FIGURES. *gn*<sub>1</sub>, FIRST GNATHOPOD; *md*, MANDIBLE; *mxp*, MAXILLIPED; *t*, TELSON; *ur*<sub>2</sub>, SECOND UROPOD.

gnathopods with carpus considerably longer than the hand, which is distinctly subchelate, widening distally; dactyl armed within with minute spinules. Second gnathopods large; a large tooth at distal

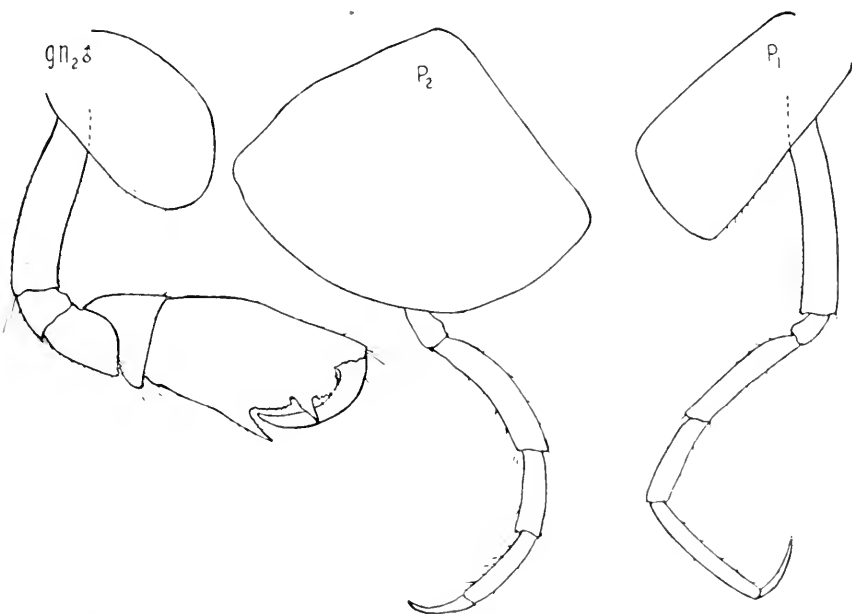

FIG. 31.—METOPA PACIFICA, MALE. *gn*<sub>2</sub>, SECOND GNATHOPOD; *p*<sub>1</sub>, FIRST PEREPOD; *p*<sub>2</sub>, SECOND PEREPOD.

end of palm, another near the middle, proximal to which is a rounded dentate lobe; margin between the middle and distal teeth produced



and armed with small rounded teeth. First two pereopods slender, the first more so than the second, with the dactyl about half the length of the propodus; dactyl of the second pair about two-thirds the length of the propodus; stouter and more curved than in the first. Last three pereopods with the merus not widely expanded and only moderately produced downward at the lower angle; dactyls half the length of the propodi. Ramus of third uropods slightly longer than the peduncle, the second joint slightly larger than the first. Telson oval, obtuse.

*Female*.—The female has the palm of the hand of the second gnathopods much more regular than in the male; there is a tooth and a pair of spines at the distal end of the palm, a smaller tooth near the middle, with some irregular teeth between it and the articulation of the dactyl; several small rounded teeth between the middle of the palm and the distal end. The same features occur as in the hand of the male, but they are much less pronounced.

*Length*.—6 mm.

*Locality*.—Station 4516, Monterey Bay, 718–756 fathoms.

*Type*.—Cat. No. 38550, U.S.N.M.

#### Family PARDALISCIDÆ.

NICIPPE TUMIDA Bruzelius.

A single female specimen from Station 4549, Monterey Bay, 56–57 fathoms.

#### Family LILJEBORGIDÆ.

LILJEBORGIA BREVICORNIS (Bruzelius).

A single specimen from Station 4430, of Santa Cruz Island, 197–281 fathoms.

#### Family CALLIOPIDÆ.

Genus GRACILIPES,<sup>a</sup> new.

Antennæ slender, elongated, with elongated peduncles, the first pair devoid of an accessory flagellum. Upper lip rounded, not bilobed. Mandibles with well-developed molar, dentate cutting-edge, and three-jointed palp. First maxillæ normal with rather slender two-jointed palp. Second maxillæ with oblong subequal lobes. Maxillipeds with enormously developed palp; outer plate devoid of marginal spines, and reaching but little beyond the first joint of the palp. Side plates very small; gnathopods similar, nearly equal in size, with large elongated hands, the palms of which include the larger part of the posterior margin. First two pairs of pereop-

<sup>a</sup> From the Latin words *gracilis*, slender, and *pes*, foot.

pods very slender, with straight dactyls. Last three pairs of pereopods greatly elongated; basal joints narrow, dactyls long and straight. Pleopods large. First two pairs of uropods with narrow attenuated rami; third pair with the rami broader and more flattened. Telson long, narrow, and emarginate.

*Type*.—*G. natator*, new species.

I have placed this genus in the family Calliopiidae, although it forms a somewhat aberrant member of that group. The peduncles of the antennae and the palps of the maxillipeds are much more elongated than in the other genera. The genus *Haliragoides* approaches it in having small side plates and long slender pereopods with very narrow dactyls, but in other respects it is quite different.

GRACILIPES NATATOR, new species.

Antennae very slender, about as long as the body, and of subequal length. Peduncle of first antennae elongate, about half the length

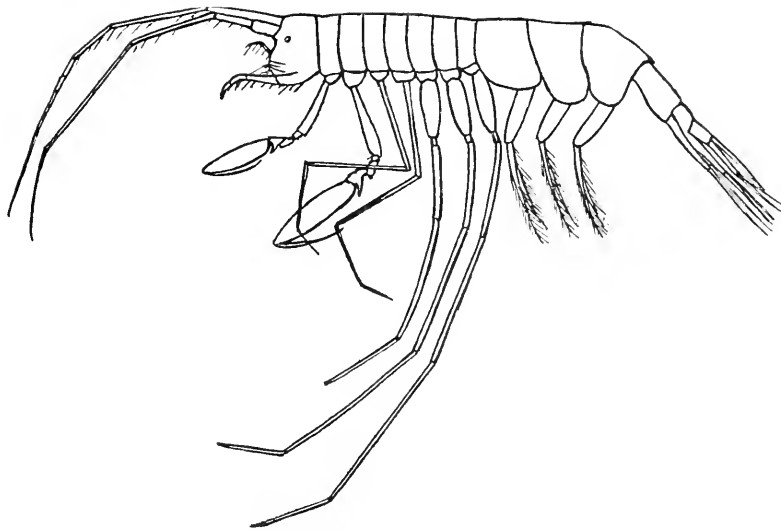

FIG. 32.—GRACILIPES NATATOR.

of the body, the second joint nearly a half longer than the first and over twice the length of the third; flagellum about equal to the peduncle, the elongate segments furnished with minute setae less than half the diameter of the segments in length. Second antennae with the peduncle exceeding that of the first, the last joint very slender and somewhat longer than the flagellum and markedly longer than the preceding joint. Along the lower and outer side of the first antennae, and to a greater extent along the upper side of the second pair, are numerous cup-like organs resembling calceolae both on the peduncles and the flagella.

Mandibles with well-developed molar, which is margined with slightly curved spines; spine row with four large setae on each mandible, with a small plumose seta at the base of each spine; secondary

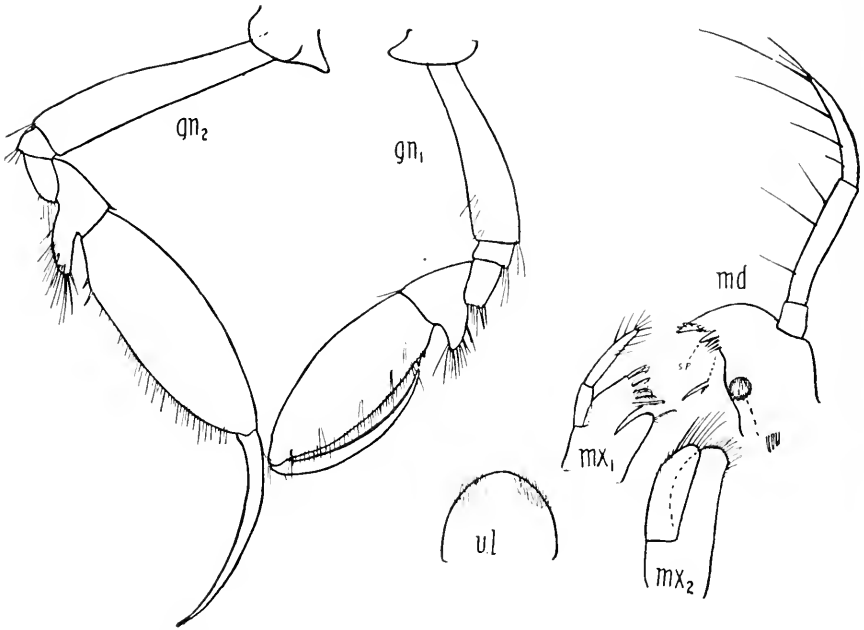

FIG. 33.—GRACILIPES NATATOR. *gn*<sub>1</sub>, FIRST GNATHOPOD; *gn*<sub>2</sub>, SECOND GNATHOPOD; *md*, MANDIBLE; *mx*<sub>1</sub>, FIRST MAXILLA; *mx*<sub>2</sub>, SECOND MAXILLA; *ul*, UPPER LIP.

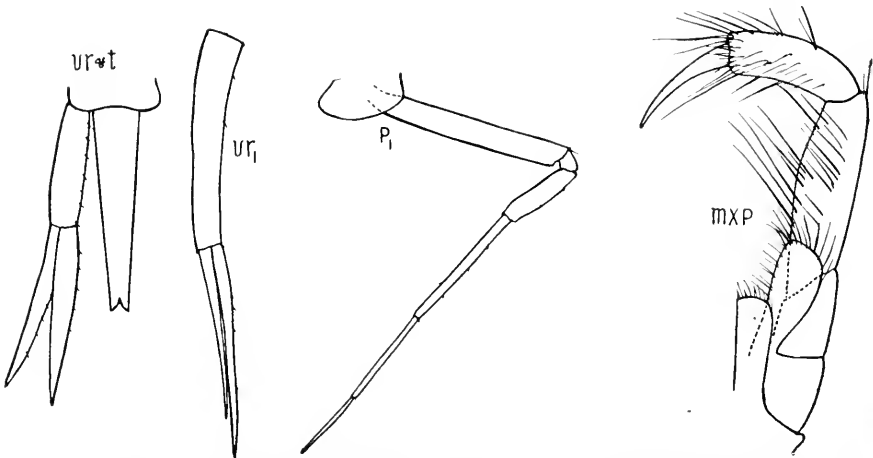

FIG. 34.—GRACILIPES NATATOR. *mxp*, MAXILLIPED; *p*<sub>1</sub>, FIRST PEREOPOD; *ur* AND *t*, UROPOD AND TELSON; *ur*<sub>1</sub>, FIRST UROPOD

plate well developed and dentate on left mandible, small and narrow on the right; last joint of palp curved, about three-fourths the length of preceding joint, and bearing a few large setae. Inner plate of

maxillæ, with a single seta near the tip and a second smaller seta near the first; outer plate with nine spines; first joint of palp about twice as long as wide; second twice the length of the first. Second maxillæ with large setæ only around the tips of the plates. Maxillipeds with two spines and a few stout setæ on end of inner plate; outer plate reaching beyond the first joint of the very large palp; claw of the palp long, narrow, and devoid of setæ.

Side plates very small, broader than deep, the first two produced at the antero-inferior angle. First gnathopods a little shorter than the second; carpus with a prominent posterior lobe; hand narrowly oval, palm extending over most of the posterior margin, defined above by a prominent spine, above which is a second smaller spine near which on the inner surface of the hand is a cluster of five or six spines. Second gnathopods with the posterior lobe of the carpus longer and more narrow than the first pair; hand much like that of the first, with two spines above the end of the palm, but having only two spines on the inner surface near the upper marginal spine.

First and second peræopods very slender, longer than the gnathopods, armed with but few minute spines; dactyls very slender and straight. Last three pairs of peræopods very long and slender, with narrow basal joints; dactyls very long, slender, straight.

Second and third abdominal segments with a dorsal carina, which ends posteriorly in a spine; fourth segment with a dorsal carina but no spine.

Uropods extending backward to nearly the same point; outer rami a little shorter than the inner; first and second uropods very sparsely armed with minute spinules, the rami very slender and attenuate; terminal uropods with lanceolate rami, which are broader and more flattened than in the preceding pairs, and armed with several short spines on the inner margin. Telson long and narrow, evenly tapering to the notched tip which reaches the middle of the rami of the posterior uropods.

*Length*.—11 mm.; length of posterior peræopods 11 mm.

*Locality*.—Station 4397, off Santa Catalina Islands, 2196–2228 fathoms, one female; Station 4427, of Santa Cruz Island, 417–510 fathoms, one female, type.

*Type*.—Cat. No. 38551, U.S.N.M.

GRACILIPES DISTINCTA, new species.

Blind. Rostrum small. First antennæ somewhat shorter than the second; the first joint of the elongate peduncle twice as thick as the second and nearly as long; third joint about two-thirds the length of the second; flagellum about two-thirds the length of the peduncle. Second antennæ with very long and slender peduncle, much exceeding that of the first pair; flagellum shorter than the peduncle. Both antennæ devoid of calceolæ.

Mandibles closely resembling those of the preceding species, but having the last joint of the palp longer than the two preceding ones combined. Inner lobes of lower lip small but distinct, and rounded in front like the outer ones; posterior angles moderately produced and rounded. First maxillæ resembling very closely those of the preceding species, the inner plate with a single large seta; outer plate with nine spines; palp with the first joint about twice as long as wide. Second maxillæ with the plates oblong, subequal, and setose only around the distal margin. Maxillipeds with the inner plates armed distally with three spines; outer plate relatively longer and more narrowed distally than in *natator*, and reaching the posterior third of the second joint of the very large palp.

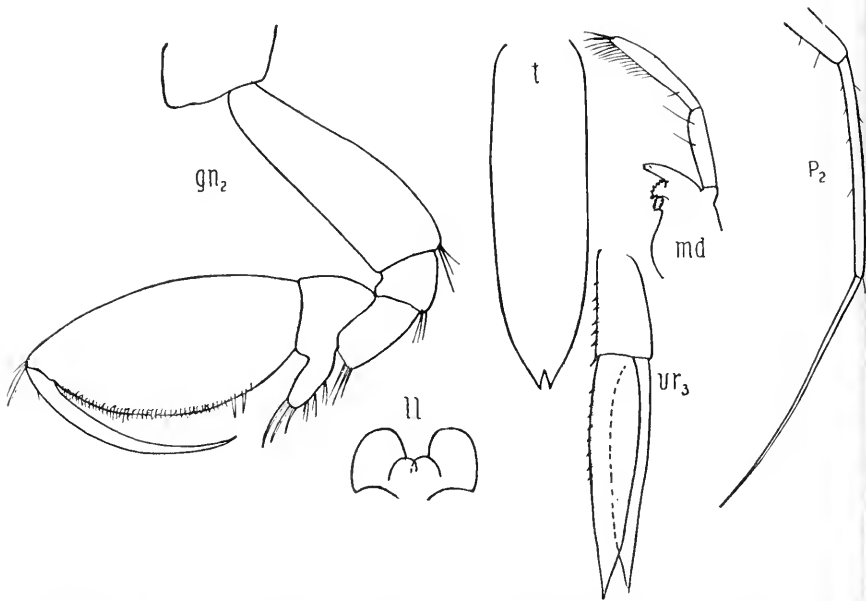

FIG. 35.—GRACILIPES DISTINCTA, FEMALE. *gn*<sub>2</sub>, SECOND GNATHOPOD; *ll*, LOWER LIP; *md*, MANDIBLE; *p*<sub>2</sub>, SECOND PEREOPOD; *t*, TELSON; *ur*<sub>3</sub>, THIRD UROPOD.

First gnathopods with the side plate rounded in front; basal joint with a prominence bearing several long setæ on the inner surface near the antero-inferior angle; carpus with a narrow setose posterior lobe; hand large, narrowly oval, palm extending over most of the posterior margin, furnished with stout setæ and having three spines above the upper end, which diminish in size toward the base of the hands; inner surface near these spines armed with a small group of spines. Second gnathopods a little larger than the first; side plate not produced anteriorly; basal joint with a setose prominence near the lower end, as in the first pair; carpus with a prominent posterior lobe which is longer and narrower than in the first gnathopods; hand

narrowly oval, palm relatively a little shorter than in the first pair, furnished with two marginal spines at the upper end, near which is a pair of stout spines on the inner surface.

Second pair of pereopods (the first pair broken in specimen) very long and slender, the basal joint armed behind with about ten spines; dactyl very slender, tapering, slightly curved and much elongated, exceeding the length of the propodus, which is also long. Basal joints of the posterior pairs of pereopods narrow; merus narrow and elongated. Marsupial lamellæ very large.

First three abdominal segments with a dorsal carina which ends posteriorly in a spine; infero-lateral angles of second and third segments broadly rounded. First uropods with flattened lanceolate rami, which are broader than in the preceding species and furnished like the somewhat longer peduncle with several spines; terminal uropods with flattened subequal lanceolate rami which are armed on the outer margin with several spines. Telson long, broader than in the preceding species, the sides nearly parallel up to the posterior third, whence they taper to the emarginate tip.

*Length*.—8 mm.

*Locality*.—A single female specimen from Station 4429, off Santa Cruz Island, 506–680 fathoms.

*Type*.—Cat. No. 38552, U.S.N.M.

In the single specimen of this species in the collection the last three pairs of pereopods were broken off at the end of the merus. The species closely resembles the preceding in many characters, but the maxillipeds have a longer and more pointed outer plate, the gnathopods have broader hands and the coxal plates not produced anteriorly, the second pereopods have a longer and more curved dactyl; the first and second uropods have broader rami armed with stouter spines, and the telson is broader and otherwise different in shape.

### Family PLEUSTIDÆ.

#### NEOPLEUSTES OCULATUS, new species.

Rostrum short; lateral lobe of head triangular, rounded at tip, lower angle of head produced into an acute, triangular lobe. Eyes fairly large. First antennæ over half the length of the body; first joint as long as the next two; third about half the length of second. Second antennæ about two-thirds the length of the first; last two joints of peduncle subequal.

Upper lip with unequal rounded lobes. Mandibles with rudimentary molar tubercle, cutting edge broad, with many teeth; accessory plate on one mandible broad and furnished with many teeth; third joint of palp armed with three or four spinelike bristles at tip and with about eight shorter ones on inner margin. First maxillæ

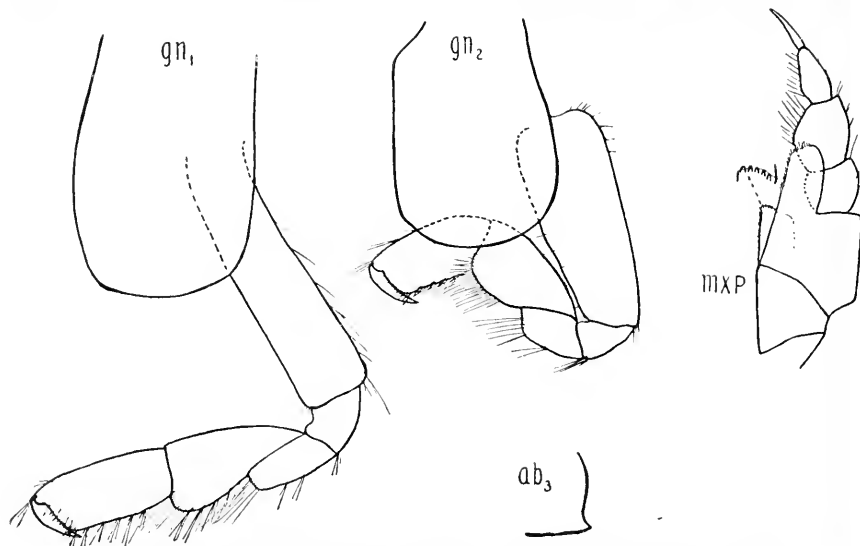

FIG. 36.—*NEOPLEUSTES OCLATUS*, FEMALE. *ab*<sub>3</sub>, THIRD SEGMENT OF THE ABDOMEN; *gn*<sub>1</sub>, FIRST GNATHOPOD; *gn*<sub>2</sub>, SECOND GNATHOPOD; *mxp*, MAXILLIPED.

with a minute seta on rudimentary inner lobe; palp with seven spines on distal margin. Lobes of second maxilla subequal, setose around rounded ends, a single long plumose seta on inner margin of inner plate. Outer plate of maxillipeds reaching but little beyond first joint of palp, armed with about eight slender spines on distal end and furnished with short setae, but no spines on inner margin.

Guathopods subequal, not strongly developed; hands more or less rectangular with slightly oblique palm. Segments of pleon as well as pereon smooth and devoid of spines or teeth. Uropods extending back to about the same distance, rami subequal in first pair; in the last two pairs the outer ramus is about two-thirds the length of the inner one. Telson oblong, rounded at tip, with a keel on ventral side at base.

*Length*.—11 mm.

*Locality*.—Station 4457, Monterey Bay, 40–46 fathoms, three specimens.

*Type*.—Cat. No. 38553, U.S.N.M.

FIG. 37.—*NEOPLEUSTES OCLATUS*, FEMALE. *t*, TELSON; *ur*<sub>1</sub>, FIRST UROPOD; *ur*<sub>3</sub>, THIRD UROPOD.

This species differs from most species of the genus in having no dorsal spines. From *N. brevicornis* (Sars) it differs in its longer antennae, more rectangular hands, and more oblong telson; from

*N. assimilis* (Sars) it differs in the more rectangular hands on the gnathopods; from *N. bairdi* (Boeck) it differs in the shape of the hands which are oval in that species as well as in the size of the hands which are relatively much smaller.

Genus ACANTHOPLEUSTES,<sup>a</sup> new.

Rostrum minute or absent. First antennæ elongate, with small accessory flagellum. Upper lip evenly rounded, entire. Mandibles with elongated, narrow three-jointed palp situated nearly opposite the well-developed molar tubercle; secondary plate on both mandibles. Lower lip with inner lobes fairly well developed. First maxillæ short, the inner plate broad, distally rounded and armed with a few plumose setæ; outer plate but little longer than the inner and armed with branched spines; palp two-jointed, the distal margin armed with stout spines. Second maxillæ with nearly equal oblong setose lobes. Maxillipeds with inner plates small, armed distally with three spine teeth; outer plates small, not reaching beyond middle of antepenultimate joint of palp, devoid of teeth, but furnished distally and along inner margin with long ciliated spine-like setæ; last joint of large palp a strong claw.

Gnathopods similar, fairly well developed, subchelate, side plates two to four pointed below. Last three pereopods rather long, with narrow basal joints. First three abdominal and some of the posterior thoracic segments produced posteriorly into teeth or spines. Rami of uropods lanceolate, those of the last pair broader than the others. Telson small, entire or slightly emarginate, and furnished with a prominent keel on the lower side.

*Type*.—*A. annectens*, new species.

This genus does not fall strictly within the limits of any of the families of Gammaridea, as they are defined by Sars or Stebbing. It is very close to the Paramphithoidæ as limited by Sars, but the antennæ have a secondary flagellum, and the upper lip is entire. Stebbing defines the Paramphithoidæ differently from Sars, including, besides the genus *Paramphithoe*, the genera which Sars places in the family Epimeridæ, and making out of several other genera which Sars placed in the family Paramphithoidæ, the new family Pleustidæ. It could be placed in the Calliopiidæ without doing violence to the definition of that family as given by Stebbing. Sars has commented on the resemblance of the Calliopiidæ and Paramphithoidæ and the present genus seems to occupy a position in some respects intermediate between these two families. The rudimentary rostrum, the presence of structures resembling calceolæ on the antennæ and the entire upper lip, are features more in accord with the Calliopiidæ, while the spiny dorsum, the pointed coxal plates, the ventrally keeled telson, the nar-

<sup>a</sup>From the Greek words ἄκανθα, spine, and Pleustes, a related genus of amphipods.



row basal joints of the pereopods, and the form of the maxillae and maxillipeds are more like those of the Paramphithoidae of Sars and the Pleustidae of Stebbing.

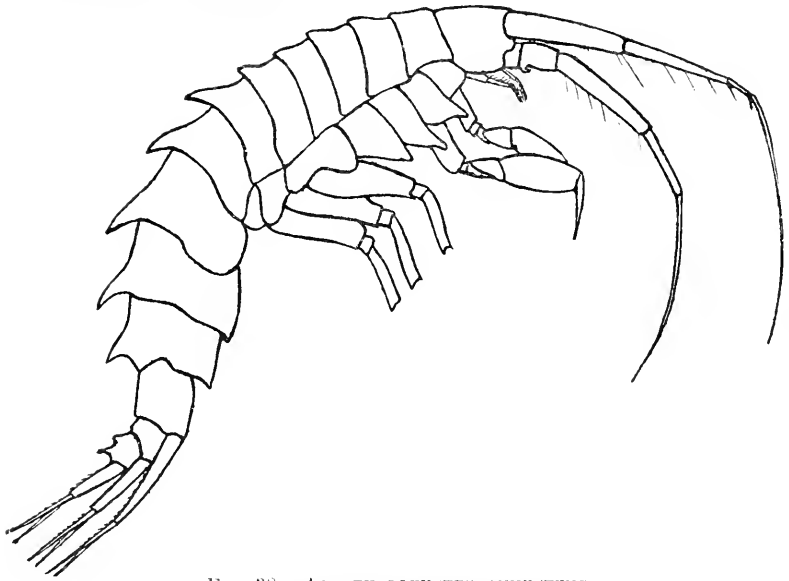

FIG. 38.—*ACANTHOPLEUSTES ANNECTENS*.

*ACANTHOPLEUSTES ANNECTENS*, new species.

Eyes absent. Lateral lobes of head truncated in front. First and second antennae subequal and over half the length of the body;

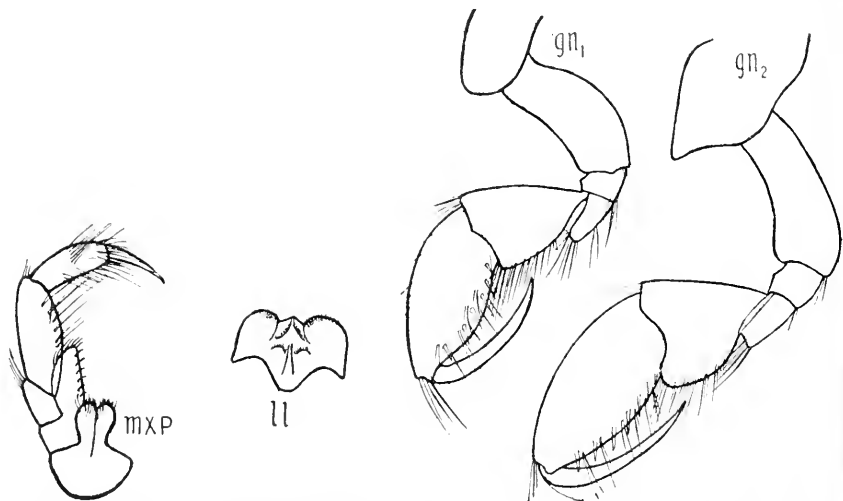

FIG. 39.—*ACANTHOPLEUSTES ANNECTENS*. *gn*<sub>1</sub>, FIRST GNATHOPOD; *gn*<sub>2</sub>, SECOND GNATHOPOD; *ll*, LOWER LIP; *mXP*, MAXILLIPED.

peduncles elongated and about equalling the flagelia, those of the first pair almost as long as those of the second and having the first

and second joints of subequal length and about four times as long as the third; secondary flagellum consisting of one elongate segment and furnished with a few spinules. Second antennæ with the last basal joint about two-thirds length of preceding one; flagella of both pairs with structures resembling calceola.

Last two thoracic segments produced posteriorly in the dorsal side into a large acute tooth similar to those on the first three segments of the abdomen. Last segment of the abdomen with a posterior acute tooth in front of which is a prominence of variable size. Infero-lateral angle of second and third abdominal segments acute. First pair of side plates broadly rounded below, the following three pairs with the infero-anterior angle produced and acute; the third pair longer and more narrowly produced than the others.

First and second gnathopods with narrowly ovate bands of similar form; dactyl long and closing against most of the length of the evenly curved posterior margins which is armed with a series of strong spines. Peraeopods of nearly equal length; basal joints narrow, dactyls rather long, half the length of the narrow propodi, smooth. Uropods reaching back to about the same point; peduncles of first and second pairs reaching

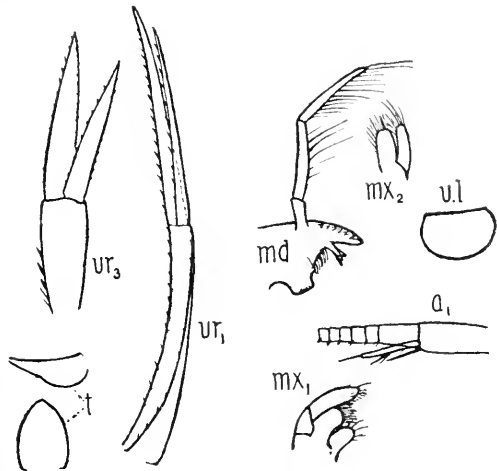

FIG. 40.—ACANTHOPLEUSTES ANNECTENS. *a<sub>1</sub>*, FIRST ANTENNA; *md*, MANDIBLE; *mx<sub>1</sub>*, FIRST MAXILLA; *mx<sub>2</sub>*, SECOND MAXILLA; *t*, TELSON; *ul*, UPPER LIP; *ur<sub>1</sub>*, FIRST UROPODA; *ur<sub>3</sub>*, THIRD UROPOD.

back to the same point, those of the third extending a little farther; rami slender, armed on both margins like the peduncles with numerous short spines, the outer ramus slightly shorter than the inner. Telson ovate, upper surface concave; a keel-like prominence on lower side of base.

*Length*.—14 mm.

*Localities*.—Station 4407, Santa Catalina Islands, 334-600 fathoms, type, 10 + specimens; station 4415, Santa Barbara Island, 302-638 fathoms.

*Type*.—Cat. No. 38554, U.S.N.M.

Family STILIPEDIDÆ, new.

Antennæ devoid of accessory flagellum. Mandible with three-jointed palp, molar tubercle small or absent. Lower lip with widely diverging lobes. First maxillæ with narrow inner plate; outer plate

very broad and armed distally with numerous spines; palp two-jointed, with widely expanded second joint. Maxillipeds with well-developed inner and outer plates, the latter widely separated and diverging distally; palp four-jointed and directed obliquely. First and second gnathopods simple or subchelate. Last pair of pereopods with a straight, elongated dactyl. Uropods biramous, with flattened, mostly lanceolate, rami. Telson short, entire or notched.

Genus *STILIPES*,<sup>a</sup> new.

Antennae with short peduncle and well developed flagellum. Mandibles with broad cutting edge. Second maxillae with broad rounded setose lobes. Maxillipeds devoid of prominent spines, joints of palp narrow, the terminal one unguiform. Anterior pairs of side plates large; the first three diminishing in width but subequal in length; fourth pair shorter than the third and more or less pointed below. Gnathopods moderately developed; carpus large; hands rather small, simple or more or less subchelate. First two pairs of pereopods subequal, with short, curved dactyls. Fourth pereopods with an elongated propodus and short styliiform dactyl. Last pereopods with the propodus relatively shorter and with the dactyl much larger. Rami of terminal uropods broader than in the others. Telson short and apically emarginate.

*Type*.—*S. distincta*, new species.

*STILIPES DISTINCTA*, new species.

Eyes absent, or at least not visible in alcoholic specimen. Rostrum short. First antennae with very short peduncle; flagellum rather stout with the joints on the proximal portion furnished below with numerous setae, which decrease in length and in number toward the more distal joints. Second antennae with the peduncle short, but much longer than in the first pair, and having its last joint a half longer than the preceding; flagellum nearly reaching the middle of the body and furnished only with very minute setae.

Mandibles stout, with broad cutting edge which is smooth on the right mandible but furnished with numerous regular, sharp, up-turned teeth on the left; molar not evident; third joint of palp about half the length of the second. Lower lip with widely separated acute lobes, and the posterior angles produced into a narrow acute lobe. First maxilla with the inner plate narrow and furnished with setae only around the distal end; the broad distal end of the outer plate is armed with about twenty-five uniform smooth spines which are curved at the distal end; the broadly expanded terminal joint of the palp is furnished on the distal margin with low, blunt teeth,

<sup>a</sup> From the Latin words *stilus*, style, and *pes*, foot.

which decrease in size toward the median edge, where there occurs a single small spine; the rounded outer angle is more or less serrate and furnished with slender spines. The plates of the second maxillae

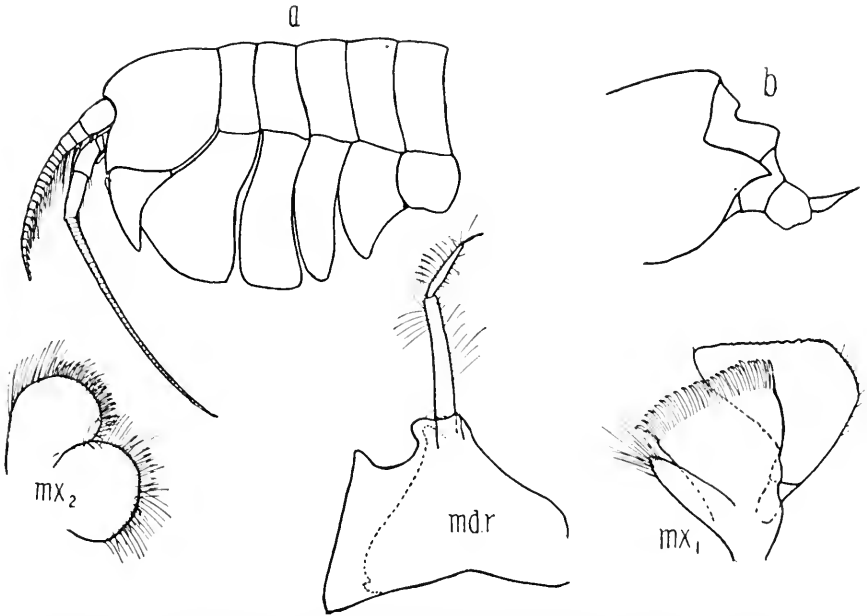

FIG. 41.—*STILIPES DISTINCTA*. *a*, ANTERIOR PART OF BODY; *b*, END OF ABDOMEN; *m.d.r.*, RIGHT MANDIBLE; *m.x.1*, FIRST MAXILLA; *m.x.2*, SECOND MAXILLA.

are nearly round, subequal in size, and furnished with numerous setae, among which are several strong, slightly curved spines. The maxillipeds have the inner plates nearly rectangular with the transverse distal margin setose; outer plates oval, setose, but devoid of spines; palp with the first and third joints of subequal length, and a little shorter than the second; fourth joint short and claw-like.

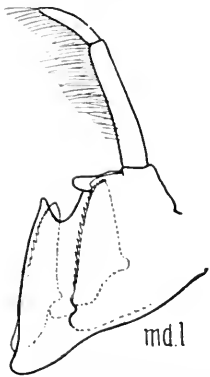

FIG. 42.—*STILIPES DISTINCTA*, LEFT MANDIBLE.

First gnathopods with the carpus longer and much broader than the hand, which is oblong, densely setose and simple, or very imperfectly subchelate. Second gnathopods longer than the first; carpus elongate, hand narrow, distally tapering, much longer than in the first pair and simple. First and second pereopods, with the exception of the coxal plates, similar in size and shape; posterior margins armed with numerous short stout spines, dactyls short and curved. The last pairs of pereopods are elongate, the basal joint is produced distally into a rounded lobe, the dactyls are straight: those of the last pair much elongate and armed with several spinules.

Fourth abdominal segment with a dorsal sinus behind which is a triangular prominence; infero-lateral angle of the second and third segments acute; pleopods long. Uropods extending back to nearly the same point, the first pair slightly exceeding the others, rami flattened, armed on both margins with numerous short spines, narrowly lanceolate in the first two pairs, broader in the third; nearly equal in the first and third pairs, but in the second the outer ramus is about one-fifth the shorter. Telson short, concave above, with a broad rounded emargination at the tip.

*Length*.—9 mm.

*Localities*.—Station 4423, off San Nicolas Island, 216-339 fathoms.

*Type*.—Cat. No. 38555, U.S.N.M.

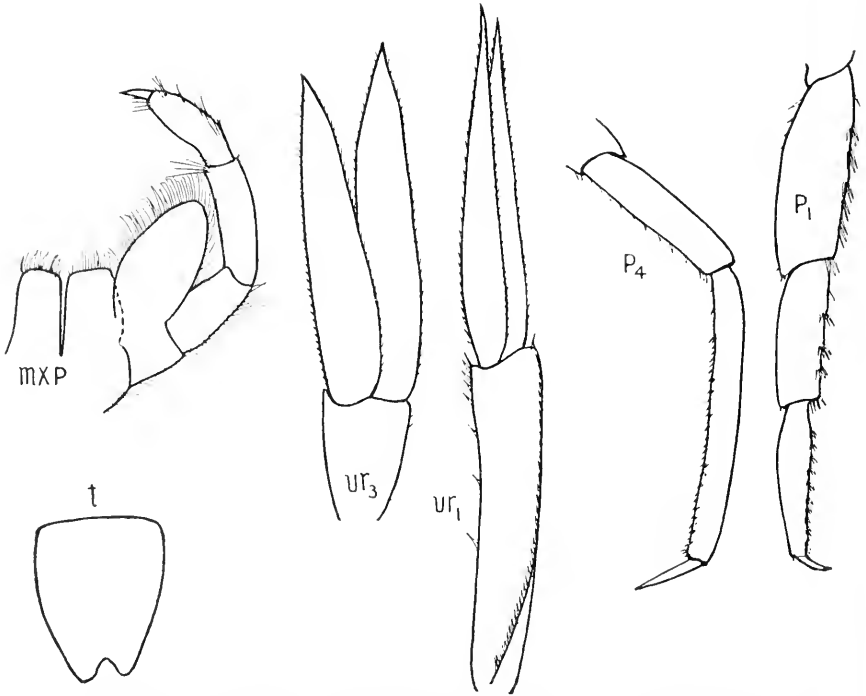

FIG. 43.—*STILIPES DISTINCTA*. *mXP*, MAXILLIPED; *p1*, FIRST PEREPOD; *p4*, FOURTH PEREPOD; *t*, TELSON; *ur1*, FIRST UROPOD; *ur3*, THIRD UROPOD.

I regret that but a single specimen of this species, and that a somewhat imperfect one, occurs in the collection. The ends of several of the legs were broken off and the lower lip was somewhat mutilated in removing it. The species is not closely allied to any of the recognized families of amphipods. The posterior pereopods resemble those of the *Cedicerotidae*, but the mouth parts are markedly different. The broad outer plate of the first maxillae with its large number of distal spines and the greatly expanded palp; the broad, rounded plates of the second maxillae; and the diverging outer plates and

palpi of the maxillipeds are characters seldom met with and never in combination in other groups. The mandibles also are unusual in having a very broad cutting edge and in having a number of small

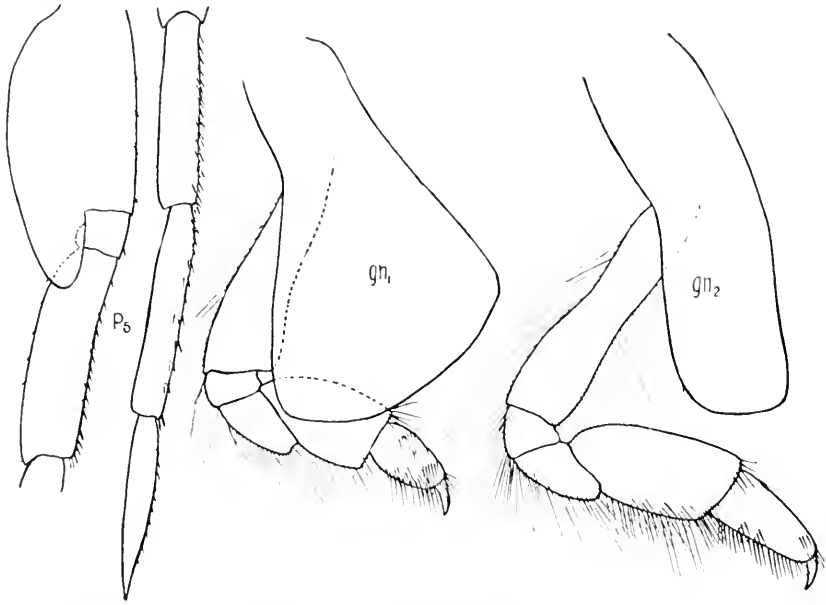

FIG. 41.—*STILIPES DISTINCTA*. *gn*<sub>1</sub>, FIRST GNATHOPOD; *gn*<sub>2</sub>, SECOND GNATHOPOD; *p*<sub>5</sub>, FIFTH PEREPOD.

acute teeth only on one side. Both of the first antennæ were broken off and the length of these appendages could not be determined.

### Family GAMMARIDÆ.

#### *MÆRA DUBIA* Calman.

A single specimen from Station 4523, Monterey Bay, 75-108 fathoms.

#### *MÆRA SPINICAUDA*, new species.

Eyes oval or round. First antennæ nearly half the length of the body, the first joint about three-fourths the length of the second; flagellum not as long as peduncle; secondary flagellum long, composed of eight to ten joints. Second antennæ about two-thirds as long as the first; last joint of the peduncle about two-thirds the length of the preceding one; flagellum about as long as the penultimate joint of the peduncle.

First four side plates about as deep as wide, the first produced forward into an acute angle. Second gnathopods large, unequal; the larger one with the carpus broader than long, with a narrow, setose

posterior lobe; hand longer than the preceding joints combined, oblong, the palm very oblique and extending beyond the middle of the posterior margin, defined above by a prominence bearing a pair of stout spines, and bearing below the middle two broad lobes armed with spines and separated by a narrow sinus; the stout curved finger bears a small rounded prominence near the base of the inner margin; the tip fits into a concavity at one side of the upper end of the palm; a couple of large spines on the edges of this concavity and a row of short spines extending distally from it along the inner surface of the hand. The smaller gnathopod has the carpus triangular, about as long as wide, with a broadly rounded posterior lobe; hand with

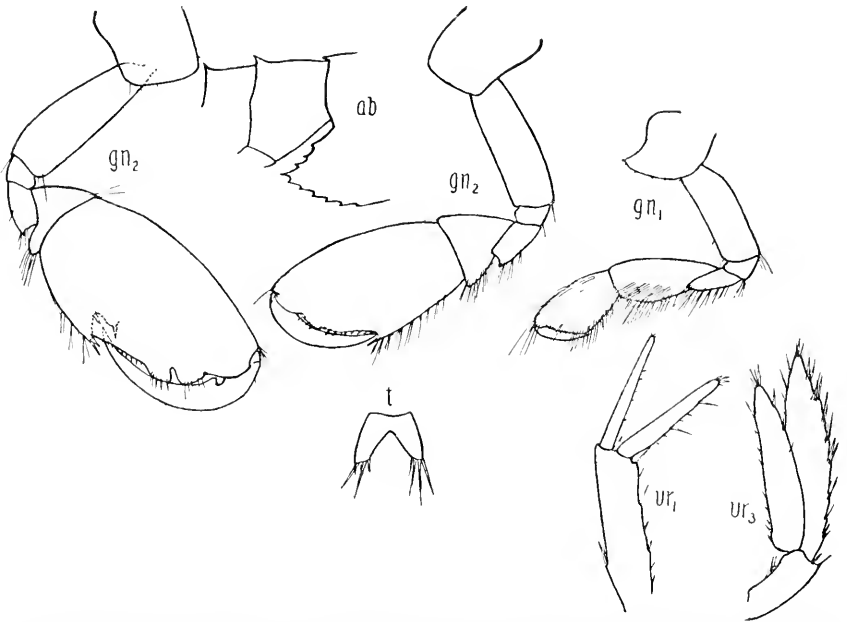

FIG. 45.—*MERA SPINICAUDA*. *ab*, SEGMENT OF THE ABDOMEN; *gn*<sub>1</sub>, FIRST GNATHOPOD; *gn*<sub>2</sub>, SECOND GNATHOPODS OF THE RIGHT AND LEFT SIDES; *t*, TELSON; *ur*<sub>1</sub>, FIRST UROPOD; *ur*<sub>3</sub>, THIRD UROPOD.

the palm less oblique and much less uneven than in the larger gnathopods, the lobes on the lower half being represented only by a slight prominence; the finger has a low prominence on the inner margin near the base, and the tip fits into a sinus near the spiniferous prominence at the upper end of the palm; this sinus is not nearly so large as in the larger hand but it is furnished with two large spines on its upper side on the inner surface of the hand.

First two pereopods slender, the dactyl about a third the length of the propodus. Basal joints of the last three pereopods about twice as long; merus expanded, especially in the last two pairs; dactyls about a third the length of the propodi. First five abdominal seg-

ments with a dorsal spine at the posterior end, those on the fourth and fifth segments larger and more upturned than the others. In-fero-lateral angles of first two abdominal segments with a small tooth, those of the third segment produced and armed with several teeth on the lower and posterior margins. Third uropods large, with broad flattened nearly equal rami, with spinose margins. Telson with a broadly triangular cleft, the lobes widely diverging, and armed with a cluster of four or five spines at the tip, some of which are very long.

*Length*.—12 mm.

*Locality*.—Station 4417, Santa Barbara Island, 29 fathoms; Station 4420, off San Nicolas Island, 32–33 fathoms, female type; Station 4431, off Santa Rosa Island, 38–45 fathoms.

*Type*.—Cat. No. 38556, U.S.N.M.

### Family PHOTIDÆ.

#### EURYSTHEUS DENTATUS, new species.

Eyes rather small, round, on the projecting lateral lobes of the head. First antennæ over half the length of the body and rather longer than the second; first joint of the peduncle nearly as long as the second; third joint about three-fifths the length of the second; flagellum a little shorter than the peduncle; secondary flagellum five-jointed. Second antennæ with the last two joints of the peduncle subequal; flagellum larger than the last basal joint but shorter than the last two.

Mandibles with the last joint of the palp nearly as long as the preceding and slightly wider and furnished distally with numerous very long setæ. Lower lip with acute narrow posterior lobes. First maxillæ with the inner plate broad, the narrow tip turned inward and furnished with four plumose setæ; outer margin with about fourteen plumose setæ; outer plate with ten spines; palp with about nine spines on distal margin of elongated second joint. Second maxillæ devoid of setæ on inner margin of inner plate, but having an oblique row of setæ extending across the surface from the base of the inner side. Maxillipeds with the terminal joint obtuse, about twice as long as wide and scarcely half the length of the preceding one.

First four pairs of side plates about as deep as broad, the first produced forward. First gnathopods rather stout, smaller than the second pair; hand about as long as carpus, about a half longer than broad; the palm at an angle of about 45° to long axis, slightly longer than the posterior margin, and having a stout spine at the end. In the second gnathopods the hand is relatively longer, considerably exceeding the carpus, the posterior margin longer than the palm, which has a large spine near the end. First and second pereopods



rather stout, second, fourth, and fifth joints rather broad, propodus and dactyl rather stout.

Infero-posterior angle of the third abdominal segment almost a right angle but produced into a small triangular tooth. Last three segments with a prominent dorsal tooth posteriorly on either side of the middle. First and second uropods extending back to about the same point but exceeding the third. Peduncle of first uropods somewhat shorter than the rami and having a large terminal spine, extending beneath the rami to about their posterior third. Peduncle

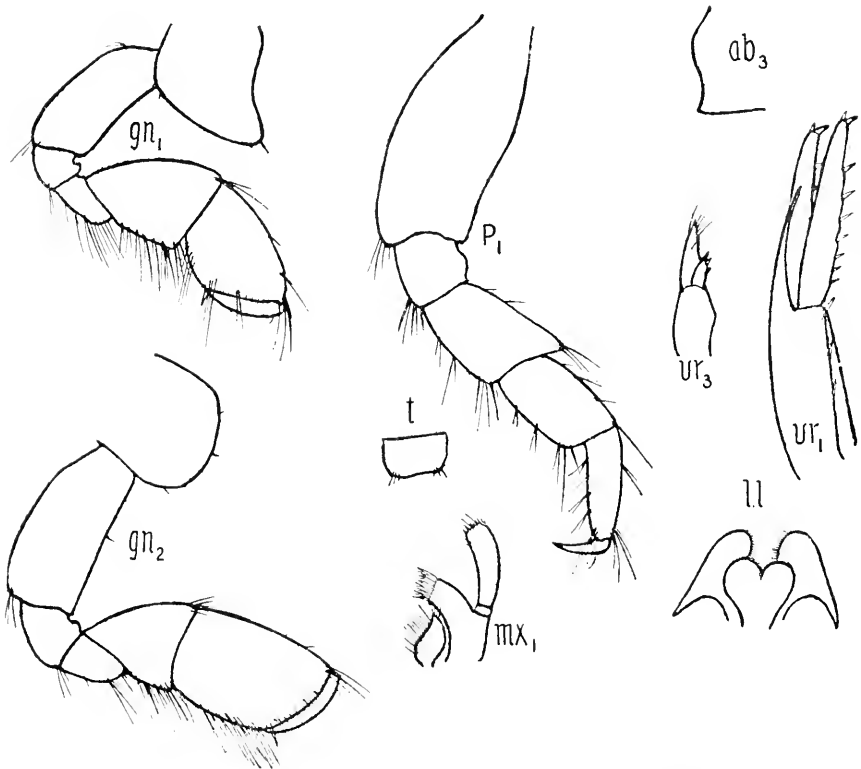

FIG. 46.—EURYSTHES DENTATUS. *ab*<sub>3</sub>, THIRD SEGMENT OF THE ABDOMEN; *gn*<sub>1</sub>, FIRST GNATHOPOD; *gn*<sub>2</sub>, SECOND GNATHOPOD; *ll*, LOWER LIP; *mx*<sub>1</sub>, FIRST MAXILLA; *p*<sub>1</sub>, FIRST PEREOPOD; *t*, TELSON; *ur*<sub>1</sub>, FIRST UROPOD; *ur*<sub>2</sub>, THIRD UROPOD.

of second uropods nearly as long as the rami and having no large terminal spine. In the small terminal uropods the inner ramus is about half the length of the outer which is nearly as long as the peduncle. Telson broader than long and distally truncated.

*Length*.—About 11 mm.

*Locality*.—A single female specimen from Station 4268, Afognak Bay, Afognak Island, Alaska, 16-17½ fathoms.

*Type*.—Cat. No. 38557, U.S.N.M.

PODOCEROPSIS NITIDA (Stimpson).

A single specimen from Station 1278, Alitak Bay, Kadiak Island, Alaska, 22-25 fathoms.

PHOTIS REINHARDI Krøyer.

Three specimens associated with *Caprella californica* from Station 4519, Monterey Bay, 27-35 fathoms.

Family COROPHIDÆ.

ERICHTHONIUS HUNTERI (Bate).

A specimen from Station 1302, off Shakan, Summer Strait, Alaska, 169-212 fathoms.

Legion CAPRELLIDEA.

Family CAPRELLIDÆ.

CAPRELLA CALIFORNICA Stimpson.

Numerous specimens from Station 4519, Monterey Bay, 27-35 fathoms.



NOTES ON THE MAMMALS AND COLD-BLOODED VERTEBRATES OF THE INDIANA UNIVERSITY FARM, MITCHELL, INDIANA.

By WALTER L. HAHN,

*Fellow in Zoology, Indiana University, Bloomington.*

INTRODUCTION.

Indiana University has come recently into possession of a tract of land in southern Indiana formerly known as the Donaldson Farm. This tract comprises nearly 180 acres. It is, for the most part, covered with a heavy growth of large oak and tulip trees, although a part of it was once cleared and is now partially overgrown with small bushes.

For many years this property was owned by a Scotchman named George Donaldson. At his death it escheated to the State and by special act of the legislature was placed in the custody of Indiana University.

The place is one of great natural beauty, which the former owner spared no pains to preserve. A subterranean stream traverses the property, coming to the surface at two places before finally emerging from the base of a cliff in one of the most picturesque cave entrances in America.

A fellowship in zoology was established on this "farm" with the incumbent as resident care-taker, and as the writer was the first to hold this fellowship it seemed desirable that a general survey of the local fauna be made as a basis for future work, and a part of his time was accordingly devoted to making a collection of the vertebrates and observing their habits. Birds have been quite thoroughly studied at various points in southern Indiana, and are therefore entirely omitted from this paper, which forms No. 93 of the contributions from the Zoological Laboratory of Indiana University.

The writer's incumbency began September 20, 1906, and terminated September 7, 1907. All dates mentioned in this paper are to be un-

derstood as falling within this period unless otherwise stated. While collecting was not limited strictly to the university's property, practically all of the data here presented were obtained within a radius of 1 mile of that place. A few mammals were trapped along White River, 3 miles away.

The site of the University Farm is 3 miles east of Mitchell, Lawrence County, Indiana, and about an equal distance south of the east fork of White River. The elevation varies but little over a hundred feet in the region considered, nevertheless the fauna is influenced in some degree by the physiographic features.

The soil is a thin, gravelly clay, underlaid by subcarboniferous (Mitchell) limestone, through which water percolates readily, making the drainage almost wholly subterranean.<sup>a</sup> For several miles to the south and southwest there are no surface streams at all, and this area consists of a series of larger or smaller sink holes. Many of the sink holes are filled with water, either permanently or during periods of heavy rainfall. While the absence of surface streams reduces the available habitat of the brook-dwelling fishes and amphibians, the numerous ponds, varying in size from a few square yards to an acre, afford homes to many aquatic animals and the individuals of some species are extremely abundant.

The rocky, brush-covered hillsides are inhabited by large numbers of reptiles and small mammals. The caves are entered by a number of species. Altogether, twenty-seven species of vertebrates were represented in these caves, either by living examples or identifiable remains. The large number is of interest in any discussion of the origin of a cave fauna because it shows that while many animals get into caves by accident or intent, only those especially adapted for cave-life survive. The list follows:

1. Blind fish, *Amblyopsis spelæus*.
2. Sun fish, *Apomotis cyanellus*.
3. Cut fish, *Ancistrus nectus*.
4. Miller's thumb, *Collus richardsonii*.
5. Minnow (*not identified*).
6. Cave salamander, *Speleperes maculicaudus*.
7. Ashy salamander, *Plethodon cinereus*.
8. Green frog, *Rana clamitans*.
9. Leopard frog, *Rana pipiens*.

<sup>a</sup>The principal caves are part of one underground water-course. At two places the roof has fallen and exposed the caves and the stream. The stream in the upper one of these breaks is known as Dalton's Spring, and the caves as the upper and lower Spring Caves. Water does not flow through the second break except after a heavy rain. Here the upper and lower openings are close together and are known as the Twin Caves. The exit of the stream is through a lofty opening into a short gorge. It is known as Donaldson's Cave or, more correctly, as Shawnee Cave.

10. Bull frog, *Rana catesbeiana*,
11. Water snake, *Natrix sipedon*,
12. Snapping turtle, *Chelydra serpentina*,
13. Box tortoise, *Terrapene carolina*,
14. Opossum, *Didelphis virginiana*,
15. Rabbit, *Sylvilagus floridanus macrasi*,
16. Pine mouse, *Microtus pinctorum auricularis*,
17. Prairie vole, *Microtus ochrogaster*,
18. White-footed mouse, *Peromyscus leucopus*,
19. Short-tailed shrew, *Blarina brevicauda*,
20. Big-eared bat, *Corynorhinus macrotis*,
21. Little brown bat, *Myotis lucifugus*,
22. Say bat, *Myotis subulatus*,
23. Large-winged bat, *Myotis velifer*,
24. Large brown bat, *Eptesicus fuscus*,
25. Georgian bat, *Pipistrellus subflatus*,
26. Red bat, *Lasiurus borealis*,
27. Hoary bat, *Lasiurus cinereus*,

Of the above list the fishes enter by following their natural instinct to ascend a stream, and once getting beyond daylight, are unable to get out. The salamanders are partially adapted to subterranean life, and the cave salamander obtains its food and breeds in the cave. Frogs enter in autumn, seeking warmth. Some are carried in by floods also. It is doubtful whether all are able to reach the surface again; none breed in the cave.

Of the reptiles, all get in by accident. The only snapping turtle had been carried in by a flood and died of starvation or injuries. The box tortoise was alive and had probably fallen into a sink-hole from which it had not been able to escape. The snake was found just within the limits of daylight on a cold day in late spring. It had doubtless gone in for warmth, being attracted by the warm outward current of air.

Among the mammals, bats alone are adapted to subterranean existence, and even they must leave the cave to secure food. Two kinds of mice were found alive, but they were few in numbers and had certainly never become established there.

It will be seen, therefore, that the cave fauna can be divided into three groups: (1) Those whose entire life cycle is spent in the cave, (2) Those that have homes in the cave but must go outside for food, (3) Those that are accidental visitors, unable either to obtain food in the cave or to go and come at will.

The third group is the largest in number of species. These animals can not adapt themselves to subterranean existence, and for them to enter the caves is death. The second group is represented by the largest number of individuals. The species belonging to this group may be incipiently subterranean, and any change of conditions which would furnish them with an adequate supply of food within the cave might lead them to take up a permanent residence there.

The first group, comprising the true cave fauna, contains but two species of vertebrates, the blind fish, *Amblyopsis spelaeus*, and the cave salamander, *Spelerpes maculicaudus*. The latter is not perfectly adapted to cave life and lives outside of caves in some localities.

The fauna of any restricted area can be divided into the same groups as those given above. Within the limits of distribution of a species, its local occurrence will be governed, in part, by the food supply. But a species is not found in every locality within its range where a sufficient amount of food can be obtained. Here the physical environment is the controlling factor, and the possibility of finding or constructing suitable dens, nests, runways, or other hiding places limits the local distribution of the species.

As far as the author is aware, the ecology of the land vertebrates has never been worked out in detail for such an area. The notes here given on the breeding habits, homes, and food of the various species were gathered for such a contribution, which, however, it has not been possible to complete.

A series from the specimens collected has been presented to the U. S. National Museum.

For providing the opportunity and necessary equipment for carrying on the work my thanks are due to Indiana University, and especially to Dr. C. H. Eigenmann, professor, and Dr. Charles Zeleny, associate professor, of zoology.

## THE COLD-BLOODED VERTEBRATES.

### FISHES.

The relation of the cave fauna to food-supply and to the local terranean fauna is best illustrated by the fishes. The subterranean streams contain a considerable number of small crustacea, plankton, and insect larvæ which constitute the food of the eyeless fish, *Amblyopsis spelaeus*. The surface streams contain a much larger quantity of the same kind of food, yet these cave fishes never take up their abode in the lighted portions of the stream. On the other hand, the common brook fishes seldom enter the subterranean portions of the streams and have never become established there.

The larger environment of White River and Mill Creek were not investigated, and, with the exception of one or two hauls of the seine in the latter stream, all of the fishes collected were taken from the small creek which flows from the Shawnee Cave. This part of the stream is less than 300 yards in length and contains no large pools and none more than  $2\frac{1}{2}$  feet deep. Thirteen species of fishes were taken in this stream in the course of a few hours.

The explored portion of the subterranean stream is at least 2 miles in length, and there are pools as large as any of those of the surface run that were seined. But in the 2 miles of underground stream only

the one species has its home and but four others have been observed as rare, accidental visitors.

Two causes combine to keep the other species from becoming established in the caves. First and most important is the dislike of most fishes for entering the dark and their inability to maintain themselves away from daylight. The one species which has become established in the cave is sightless, but the eyes were certainly degenerate before it adopted a subterranean habitat. This fact accounts for its presence in the cave rather than the reverse proposition that the eyes have degenerated because it lived in the dark.

A second factor is the small amount of food to be obtained in the cave. An amphipod and an isopod are permanent residents there. The larvæ of aquatic insects, together with other animal and vegetable matter, are washed into the cave with each heavy rain. Although limited, the supply of food would doubtless be sufficient for several additional species were they able to secure it.

#### LIST OF SPECIES.

1. *Ameiurus nebulosus* (Le Sueur), horned pout; bullhead. Taken in the small creek below the cave.

2. *Ameiurus nebulosus* (Rafinesque), black catfish. One was taken within the upper cave at a point where the light is very dim. There are specimens in the University Museum which were taken near the same spot. I am unable to say whether the fishes ascended the stream through the two lower caves or were washed down from some of the ponds which have been stocked with them, and which overflow through sink holes into the caves.

3. *Catostomus commersonii* (Lacépède), white sucker; common sucker.

4. *Minytrema melanops* (Rafinesque), winter sucker; spotted sucker.

5. *Placopharynx duquesnii* (Le Sueur).

6. *Hybognathus nuchalis* Agassiz.

7. *Pimephales notatus* (Rafinesque), blunt-nosed minnow.

8. *Cliola vigilax* (Baird and Girard).

9. *Notropis whipplei* (Girard), silver-fin.

10. *Rhinichthys atronasus* (Mitchell), black-nosed dace.

11. *Amblyopsis spelæus* De Kay, blind fish. Never seen outside the caves. One was seen in the cave with a minnow almost as large as itself half way down its throat.

12. *Apomotis cyanellus* (Rafinesque), blue sunfish. Has been taken 80 feet within the entrance of the upper cave, which it could have reached only by passing through one of the other caves. The specimens taken in the cave were starved and in very poor condition, and



it was only a matter of days before they would have passed out of the cave or starved to death.

13. *Etheostoma caeruleum* Storer, rainbow darter. Not abundant.

14. *Cottus richardsonii* Agassiz, miller's thumb. Abundant. Has been seen a short distance within the lower cave.

#### AMPHIBIANS.

Amphibians were abundant as individuals, although several species common in this region were not seen. The water dog (*Necturus maculosus*), the mud eel (*Siren lacertina*), and the hellbender (*Cryptobranchus alleghanicensis*) no doubt live along the river, but no collecting was done there, and none are found on the "farm."

The economic importance of the amphibians is a subject not often mentioned in the literature of this group. Nearly all frogs and salamanders are insectivorous during part or all of their existence. Where the individuals live in numbers as great as some species were found here they must exert a beneficial influence, not much less in importance than that of birds, in keeping down insect pests.

All that is necessary to set off the egg-laying impulse in some species of amphibians is the presence of water at the time the ova are ripe. In the spring of 1907 many eggs of both salamanders and frogs were laid immediately after the heavy rains which fell during the middle of March. At this time sink holes, roadside pools, and other low places were filled with water. The heavy precipitation ceased suddenly and the water evaporated and ran away. Many amphibian eggs which had been laid in these places were left on the ground to dry up without hatching, and many larvæ perished on account of the pools drying before they had reached adult life. I estimated that not less than one-half of the eggs laid at this time (and the number of these within a radius of 1 mile must have reached into the hundred thousands) were eliminated because they were deposited where the water supply was not permanent.

#### AMBYSTOMA JEFFERSONIANUM (Green).

##### JEFFERSON SALAMANDER.

The adults of this species were not taken, although evidently abundant. On February 28<sup>a</sup> eggs were found in a small pond. This little body of water is circular in shape and only about 25 feet in diameter, with a depth of not more than 18 inches. On the above-mentioned date it was free from ice and the water was very clear. The eggs were in small masses, not perfectly regular in outline nor absolutely uniform in shape, but nearly all had approxi-

<sup>a</sup> These eggs were in the late segmentation stages and had doubtless been laid some days. The species has been known to deposit eggs early in January.

mately the form of a sphere with each pole truncated. Most of the masses were pierced near the center by a weed, the petiole of a leaf, or a small stick. Often several masses were crowded upon the same stick, which was usually so placed that it formed some support to the eggs, although it did not always hold them free from the bottom. There were about 270 of these egg masses in the one small pond. The average number of eggs in each lot was not less than 20, and probably exceeded that number, the total number being, therefore, five or six thousand.

Some of the eggs were put in aquaria in the house. They began hatching March 12. Growth was slow, the young apparently feeding to some extent on the gelatinous substance which had enveloped the eggs. When first hatched the young were about 12 mm. in length. On March 30, eighteen days after hatching, a length of 15.5 mm. had been attained.

At this period the principal food of the larval salamanders seems to be the larvæ of aquatic diptera. These could not be obtained in large quantity, and the slow growth of the young salamanders may be accounted for by lack of sufficient food, although mosquito larvæ were supplied in small numbers and were greedily eaten when not too large and active. Young salamanders that were taken from the pond at this time (March 30) were much larger, being 20 to 25 mm. in length, with heavier bodies and broader heads. Their general color is greenish; blackish dots of pigment are scattered over the entire surface of the animal. On the body these are collected into bands extending across the back and down on the sides, the "fin" being also edged with the darker color. The number and size of the pigment specks do not increase with the growth of the animal, which, therefore, becomes lighter in color with increase in size, except the edge of the "fin," where the pigment accumulates and becomes more dense.

Young taken from the pond on May 2 measured from 30 to 37 mm. At this stage the dark cross bands of pigment have disappeared and the pigment was distributed in irregular blotches. There is an indistinct longitudinal line of pale, olive yellow about the level of the spinal column, and below this a line of denser pigment. Larvæ that had attained a length of 42 to 51 mm. on May 14 have a lateral row of pale, golden-yellow spots varying in number in different individuals.

On June 14 an individual was taken that was of the same length as those of a month previous, but which had a much greater bulk. At this stage the gills and "fin" have been largely resorbed and the animal voluntarily left the water when placed in a shallow aquarium, although it had been seined from the bottom of the pond. The

color is much darker than at any previous stage. The lateral row of yellow spots is indistinct and the pale stripe is also reduced. On the top of the head the pigment is spread in an apparently uniform sheet, the individual specks not being distinguishable; on the sides they can still be made out with a little magnification and the tail is still somewhat mottled, although the pale areas are reduced.

Owing to absence at this time, no completely transformed young from this pond were obtained, and those which had been kept in the house died. On July 10 none could be found either in the pond or under the logs and stones of the neighboring woods. Some larvæ were found, however, in another pond on August 1 and one of them was kept until a week later, when it had transformed. It died before adult coloration had been assumed. At this time the gill-slits are still open, but the external gills have disappeared, as has also the "fin" or keel of the tail. The color is about the same as in the last-mentioned specimen, but the pale spots of the sides are more distinct (probably an individual character) and the dark color extends entirely around the tail.

AMBYSTOMA PUNCTATUM (Linnæus).

SPOTTED SALAMANDER.

Quite common. It was taken only in the woods, either under logs or stones. Several were kept in captivity at different times. They ate earthworms greedily, but did not touch beetles or ants.

Measurements of an adult specimen: Length, 190 mm.; snout to axilla, 36; snout to groin, 83. Costal grooves, 11. Six spots on the head bright, deep orange. A row of about nine lemon-yellow spots on each side from head to base of tail, the spots on tail irregular and some of them from the two rows confluent; limbs also spotted. In all individuals of this species which were seen, the spots on the head were deep orange, but the number so colored varied from four to seven. An adult female taken on May 23 had the ovaries filled with quite large eggs.

AMBYSTOMA TIGRINUM (Green).

TIGER SALAMANDER.

A single specimen was caught in a mouse trap set at the entrance to a small sink hole early in December. Total length, 230 mm.; snout to axilla, 38; snout to groin, 87. Color (in life), glossy blue-black, with many small spots of lemon yellow on back; sides with the yellow predominating; belly, pale yellowish brown, spotted with lemon.

## PLETHODON GLUTINOSUS (Green).

## SLIMY SALAMANDER.

Not uncommon. Found under logs in the woods and once seen in a path, along which it was evidently fleeing to escape some enemy that had succeeded in getting most of the salamander's tail. This species is said to be nocturnal, but one was found which had been feeding in the early afternoon, for it had a beetle in the upper part of the throat.

On March 19 two were found together under an old log. One was very large and the body appeared to be distended by eggs. The two were placed alive in a glass jar and supplied with beetles and earthworms, but ate these sparingly if at all. No eggs were laid, although the larger one was kept for about three months.

Length of one specimen, 138 mm.: snout to axilla, 21; snout to groin, 51. Back irregularly marked with small spots of whitish, those on the head being very minute. On the lower part of the sides these spots become confluent, forming a band of irregular blotches. Tail and underside of body with few spots of white. Underside of head and throat with larger blotches; throat with a white band, crescentic in shape. Costal grooves, fourteen.

## PLETHODON CINEREUS (Green).

## ASHY SALAMANDER.

The most abundant Urodele, but not easily found at all times. During October it was to be found under almost every log in the woods and also under the rocks near the cave entrances. With the approach of winter it was seen less frequently. The extraordinarily warm weather in early January brought it out again and I saw numbers from the 6th to the 8th of that month. From that time till April none were taken above ground. Some were found in a small cave on March 26. Early in April, when the temperature was much lower than during part of March, these salamanders suddenly became very abundant. They were to be seen in almost any part of the woods, and were especially noticeable about the entrance to the Twin Cave. Here they seemed to be migrating from the vicinity of the cave into the woods. In a few moments I found eleven of the animals hiding under stones on the bank, all within an area of a few square yards. Ten days later diligent searching in the same place failed to discover a salamander. However, they remained fairly common under old logs in the woods throughout early spring. During the summer none were found nor were the eggs or young seen.

On several occasions I have heard salamanders of this species utter a faint squeak, not unlike that of a young mouse. They are often found with mutilated tails, doubtless escaping their enemies by

sacrificing that member. They can not endure dust and will die in three or four minutes if dropped on their backs on a dusty floor so that, in turning over, the entire body becomes coated with dust. Indeed, I have found this to be a quicker method of killing them than to drop them in formalin or alcohol.

The color of different individuals of this species varies greatly. None were noted, however, of the so-called *erythronotus* variety with the red of the back bordered by parallel lines, but the *dorsalis* variety with an irregular line of red along the back was almost as common as the ashy-colored individuals.

On March 26, eight specimens, from 40 to 90 mm. in length, were found in a small cave near the University's property. This cave goes down to a depth of 40 feet or more in an irregular spiral, with projecting benches, but no rooms or lateral passages of large size. It was inhabited by this species, by cave salamanders, and green frogs, as well as bats, earthworms, and insects. Some ashy salamanders were found about 25 feet below the surface, from which they were separated by smooth vertical walls, which would have to be sealed by the animals in escaping from the cave.

These animals show a wide variation in color which it may be worth while to describe in detail, as it seems probable that there they were actually blood relatives.

The largest specimen of the lot (90 mm. in length) is marked with a dorsal stripe of dull, dark orange, bordered by a line of dull brown which, in places, almost divides the stripe: the orange is diluted with indistinct flecks of gray, the stripe becoming indistinct on tail. Sides light brown, thickly dotted with minute spots of gray. Belly with ground color paler than sides and gray spots larger and more numerous. Head similar to sides, but slightly paler. Fore legs similar to head, dorsally; hind legs slightly darker. A second specimen is about equal to the first in length, but is more slender. The color is similar, but the dorsal stripe is forked at the occiput, the divisions becoming indistinct, passing through the eye and terminating on the snout. Posteriorly the stripe terminates indistinctly on the base of the tail, the distal portion of the latter being marked with gray. A third individual is more reddish on the back than on the sides, due, however, to a reduction of the gray dots rather than to an increase in the amount of red pigment and therefore not forming a clearly defined stripe. Dorsum of tail, except at tip, brighter than that of back. The smallest individual of this lot, and one of the smallest I have seen of the species (40 mm. in length), also has a dorsal stripe, poorly defined anteriorly, but quite distinct from the middle of the body to near the tip of the tail.

Four of the specimens from this lot have no dorsal stripe. Three of these have the sides and dorsum of the tail mottled with gray and

brown, caused by the segregation of the gray specks into certain areas. The fourth is almost uniformly colored on the back and sides. Several small individuals were found which had distinct bronzy reflections as described for *P. aneus*, but which otherwise agree with *P. cinereus*.

SPELERPES LONGICAUDUS (Green).

LONG-TAILED TRITON.

A single individual of this species was taken by Mr. Ferd Payne in the valley near the mouth of the Hamer Cave half a mile west of Shawnee Cave on May 25. In general appearance it differed little from specimens of the extremely variable cave salamander, abundant in the mouth of the cave not many yards away. However, there are differences in the details of color which, with the vomerine teeth, serve to identify the specimen. Ground color a rather pale orange. Black spots numerous and more often confluent than in *maculicaudus* and forming vertical bands on the tail. The lateral row of spots not very distinct.

Total length, 150 mm.; snout to axilla, 21; snout to groin, 53. Costal grooves, 13.

SPELERPES MACULICAUDUS (Cope).

CAVE SALAMANDER.

Numbers of individuals of this species were seen; but at times specimens were difficult to find. During the summer they were very abundant near the mouth of the Hamer Cave, where they were seen in small pockets or on ledges directly above deep and swift water. During the winter they were seen in the large room of the Shawnee Cave about half a mile from the entrance and also in a large chamber at the right of the lower entrance. In both of these places larvae were found later, but high water prevented entrance to these regions during much of the time from the middle of December until April. The eggs are probably laid during this season, but they have never been described, and the writer was not fortunate enough to secure them.

An account of the life history of this species has been published by Banta and McAttee,<sup>a</sup> but they failed to say anything about the nature of the food or the manner in which it is obtained. In this region the species is found chiefly in caves, but it is not fully adapted to cave life. It is usually seen near the entrances and probably reaches the inner chambers only by accident or for the purpose of breeding. Whether these salamanders obtain food away from daylight has not been certainly determined.

<sup>a</sup> Proc. U. S. Nat. Mus., XXX, 1906, pp. 67-83.

The single observation made on their feeding habits is of interest. Human feces near the mouth of the cave formed a favorite feeding place for these salamanders. Two were captured, and an examination of their stomachs showed that the animals had been feeding on small adult flies and dipterous larvæ, which were abundant in the refuse. At this point I could not see the animals without a light, even when they moved and after my eyes had been accustomed to the twilight. It would have been impossible for the human eye to distinguish flies in such a place. Others of the species taken in better light in the Hamer Cave had also been eating flies. The eyes do not appear to be in any measure degenerate.

An individual kept in captivity for some time refused to eat earthworms, myriapods, or small beetles placed in a glass jar with it.

A specimen taken from the Hamer Cave on July 22 differs somewhat in appearance from most individuals of this species that I have seen. The body is much distended with eggs. In life the ground color is a very deep orange with the black spots large, sharply defined and round; the tip of the tail is entirely black for about 10 mm.

Another specimen has the ground color similar to the above, but the back is marked with large irregular black blotches, indistinctly outlined and often confluent, so that the orange forms scarcely more than a reticulation. On the tail the black spots are smaller and they do not extend as far down the sides as in most individuals. Still another individual is pale yellow, with medium-sized black spots on the back, and the tail covered with many small black dots.

Total length, 153 mm.; snout to axilla, 24; snout to groin, 57. Costal grooves, 13.

*SPELERPES BISLINEATUS* (Green).

TWO-LINED TRITON.

Seen only along the stream leading from the Shawnee Cave, where it was abundant. Usually it was found hiding under submerged rocks, but once or twice was seen out of the water. Adults were to be seen there throughout the year, but no eggs or very young larvæ were found. Larvæ about 25 mm. in length were found in January in a little spring-fed tributary to this stream.

One of these young killed on March 12 is 29 mm. long and the gills are short, although the tail is still strongly keeled. The pigment spots have not yet segregated into unbroken bands, but form a row of small blotches along each side of the back. The median dark stripe is scarcely indicated. The sides are uniformly sprinkled with specks of brown pigment, as are the limbs and head. By March 25 one of the larvæ had transformed. An adult female taken on March 29 had the ovaries distended with eggs which appeared to be nearly ripe.

Amphipods were found in the stomach of an adult of this species, which was found on a rock at the edge of the stream where these crustaceans were abundant. Small diptera were also found in their stomachs. Amphipods and beetles placed in the aquaria were not eaten by either larvæ or adults which were kept in captivity.

Total length, 93 mm.; snout to axilla, 14; snout to groin, 38. Costal grooves, 14. The median dark spots form a narrow, somewhat broken line from the occiput to base of tail. Lateral dark stripes becoming diffused over lower part of sides.

DIEMICTYLUS VIRIDESCENS Rafinesque.

GREEN TRITON; NEWT.

Very abundant in all of the ponds. The eggs and young larvæ were not found, but young about 35 mm. long were taken on August 1. One of these transformed between the 18th and 21st of the same month. Young of the red, or so-called *minutus* form, were found under old logs in the woods on two occasions, and one was also found in the cave mentioned in the account of *P. cinereus*.

BUFO LENTIGINOSUS AMERICANUS<sup>a</sup> (Le Conte).

TOAD.

Very common. It was not seen until the last of April. At that time the adult toads gathered in considerable numbers about the ponds, and their high-pitched but musical note was heard every night from April till July. At this time no young toads were seen. About the 1st of July the tadpoles began to transform and the little toads became abundant everywhere. Individuals of small size, which had evidently transformed a year previous, were numerous during the summer, though none of these were seen early in the spring.

ACRIS GRYLLUS (Le Conte).

CRICKET FROG.

Perhaps the most abundant of the tailless amphibians. During the autumn it was seen everywhere, in the woods, the fields, and along the roads. While not uncommon near the ponds and creeks, it appeared to be equally at home at a distance from them. All colors, from bright green and rusty red to nearly black, were seen. The smooth-skinned variety (*A. gryllus gryllus*) was not observed.

In the spring the note of the cricket frog was not heard till later than that of the Pickering or chameleon tree-frog. The eggs were not certainly identified, but very small eggs were abundant in many of the ponds during the first two weeks of June. The cricket frog was abundant in the vicinity of these ponds, and no other frog which could possibly have laid the eggs was to be found at that time. The

<sup>a</sup> Toads from this region have recently been identified by Miss Mary C. Dickerson as *Bufo fowleri* Putnam.



eggs did not exceed 1 mm. in diameter. The gelatinous matter surrounding them was thin and transparent and appeared to be light enough to keep the eggs at the surface of the water, although they were never found entirely free from algae or other floating vegetation. The entire egg-mass was difficult to see because of the small size of the eggs, the transparency of their envelope, and their location.

The larvæ are said by Dr. O. P. Hay to transform late in August. I saw some leaving the water about the middle of July. These could not have hatched from the eggs above mentioned. They are more active than any other amphibian larvæ I have seen. They can run about, spring from object to object, and cling with their feet, while the tail is still as long as the body. In captivity I have seen the adults leap across an aquarium and catch a fly resting on the glass of the other side.

Width of head over tympanum, 9 mm.; tip of snout to anterior edge of tympanum, 8; length from tip of snout to vent, 27; vent to heel, 26; vent to tip of longest toe, 46.

CHOROPHILUS NIGRITUS FERIARUM (Baird).

STRIPED TREE-FROG.

The striped tree-frog was not positively identified at Mitchell. Late in the autumn a frog thought to be of this species was seined from a pond, but it escaped before it could be examined. I also thought I heard its note in the spring, but did not succeed in finding the animal. It is probable, however, that it occurs in certain localities near here, as it is common in southern Indiana. On June 1 it was abundant at West Baden, 25 miles southwest of Mitchell. Heavy rains had fallen, and the frogs were in small temporary ponds voicing their shrill, rapidly repeated whistle during the early afternoon. They were not easily disturbed, and several were caught as they sat on floating leaves. During the last week of June the newly transformed young were abundant in the cypress swamp on the Indiana side of the Wabash River opposite Mount Carmel, Illinois.

A specimen from West Baden has the median stripe entire except on head and rump, where it is broken; next two stripes slightly broken; lower stripes entire nearly to groin.

Width of head over tympanum, 10 mm.; length from tip of snout to anterior border of tympanum, 8; snout to vent, 29; vent to heel, 26; vent to tip of longest toe, 46.

Some newly transformed young, from the cypress swamp previously referred to, vary considerably in color and the distinctness of the markings. One is light gray, with all the bands, as well as the bars of the legs, obscure. Two others have the dorsal stripes faint and narrow but continuous, while on two others they are broad and well defined but broken.

## HYLA VERSICOLOR Le Conte.

## CHAMELEON TREE-FROG.

Very common, but not often seen. On October 26 two young frogs of this species were found near each other in the woods, where they seemed to be looking for winter quarters. Young were frequently seen during August.

This tree-frog became active about the same time as the toad, the last of April, and its note was frequently heard from then till August 1. Throughout May it gathered in numbers around the ponds every night, and at this season it could be found everywhere in abundance during the evening. It is not easily located by the note alone, as that is somewhat ventriloquistic and ceases at the slightest alarm and is not repeated for some time after the disturbance has ceased. Prof. W. P. Hay speaks of this note as a "short, loud, trilled rattle," but this scarcely describes the most common call of this frog, to my mind, as it always seems to me to be somewhat prolonged and mournful, not unlike that of the toad, but lower pitched and less musical.

It has, however, another and very different note which I heard it utter on a spring night as I watched it by the light of a lantern sitting at the water's edge. This is short, irregular, and repeated only three or four times in succession. It may be likened to that of a young chicken calling for its mother, and it also resembles the note of the striped tree-frog.

This frog is well protected by its changeable colors, which harmonize well with the bark of trees, foliage, or stones on which most of its time is spent. But it does not always select a place where it will be inconspicuous. On a cloudy morning I saw one sitting for several hours on the flat top of a gate post, where its form made it very conspicuous, even at a considerable distance.

## HYLA PICKERINGII (Storer).

## PICKERING TREE-FROG.

More abundant, but also more retiring, than the preceding species, except during the breeding season. Its characteristic shrill cry was heard during September and October, on warm, damp days in November and December, on January 5, 6, 7, and next on March 1. After that it was almost constantly heard till about the end of June. Doctor Hay, quoting from Cope, says that it is heard after "the rattling of *Acris gryllus* \* \* \* is fairly under way." The note of this frog has, however, been familiar to me in southern Indiana all of my life, and here it invariably begins calling earlier than any other frog. Some years I have noted it in February.

Usually they are more abundant in temporary ponds and marshy fields than about the larger bodies of water. At Mitchell I found them most abundant during March and April about a temporary pond not more than 60 feet in diameter. At this place the noise of their shrill cries was so deafening that it rang in the ears like the clatter of an iron foundry. One night I captured 40 of the frogs at this place in a short time, and after noting the position and abundance of the remainder rather carefully, I estimated that there were not less than 200 in the pond. Another pond frequented by them was not more than 200 yards away, and there were many others at short distances.

They sit about the edge of the water or on a stick or weed or a bit of bark and devote their whole energy to the love song. The gular sac is distended with all the power the frog can command until it almost equals the body of the animal in size. Then, the effort of the animal exhausted, it suddenly collapses, producing a shrill, ear-piercing whistle, which is repeated three or four times in succession as rapidly as the animal can gather the force of its muscles for the act. During this effort the frog seems oblivious to all else. You can throw the brilliant glare of an acetylene reflector upon him, and he does not even turn his head to stare at it. Approach closer and place your hand over him, yet he must give expression to that cry, even though he feels your hand inclosing him in its grasp.

During the breeding season the Pickering frogs may be heard at all hours of the day, although larger numbers join the chorus in the early evening. At this season they may also be seen during the day-time. Later in the summer I did not succeed in finding a single specimen, so thoroughly do they hide when the mating instinct is dormant.

They have many enemies, who are doubtless attracted, both by the volume of the chorus when the frogs gather in such numbers, and by its excellent carrying power. I found the tracks of opossums, raccoons, minks, and weasels about the pond above mentioned. Larger frogs and also snakes eat them.

It is difficult to understand how their eggs develop in the temporary puddles which they seem to frequent most. Small masses of eggs, presumably of this species, were found in the pond previously mentioned about the last of March. Some of these hatched, but two weeks later there was no water, and not even soft mud, in the pond, and the larvæ must have been dried up.

Width of head over tympanum of largest individuals, 10 mm.; tip of snout to anterior border of tympanum, 7; snout to vent, 28; vent to heel, 24; vent to tip of longest toe, 42.

## RANA PIPIENS (Schreber).

## LEOPARD FROG.

Not uncommon, yet far less abundant than in the Kankakee marshes or even the hilly southeastern part of Indiana. It is occasionally seen in the woods, but is most abundant in meadows and pastures. The young do not appear to stay near the water in the late summer. Newly transformed young were seen leaving the water during the last week in June and throughout July. This is one of the species which seems to hibernate in the caves to some extent. Leopard frogs were seen in some numbers not far within the mouth of the cave during March and they seemed to be moving toward the outside. This frog, also, was active in January. At this time high water overflowed the bottoms and drove many hibernating animals from their winter retreats. Leopard frogs, cricket frogs, and green frogs were among the species observed at this time.

Specimens from this locality should, perhaps, be referred to the form *sphenocephala*, although they partake of some of the characters of *pipiens* also, as the two varieties are defined by Cope. Spots scarcely, or not at all, bordered by pale color. Longitudinal band of femur usually represented by spots. Two phalanges of fourth toe free, the next usually with a very narrow web. Part or all of the tibial markings broken in the middle. External vocal vesicles present in male.

Width of head, 18 mm.; length of head, 18; tip of snout to vent, 66; vent to heel, 62; vent to tip of longest toe, 104.

## RANA CLAMITANS Latreille.

## GREEN FROG.

The relative numbers of this and the preceding species differ in this vicinity from most localities with which I am familiar, *R. clamitans* here being the more abundant. It is found along the creeks and about the ponds, as well as some distance from water. The species, at times, enters the caves where I have found the frogs at least half a mile from daylight.

Green frogs become active earlier in the spring than do the leopard frogs. Eggs were found on March 19, but the laying period seems to be somewhat extended, as ripe ova were found in a female more than a month later. The eggs were laid in large masses attached loosely to reeds and grass. The young appear to transform at any time between June and September.

Frogs of this species are very voracious, apparently eating anything of suitable size that moves within their range of vision. The contents of three stomachs examined on April 30 were as follows:

No. 1, 7 ants, 2 beetles, 1 myriapod, 1 mosquito; No. 2, 6 beetles, 10 mosquitoes, 1 fly; No. 3, 5 beetles, 4 mosquitoes, 1 snail. I have known them to eat tree-frogs, both *H. versicolor* and *H. pickeringi*. Digestion must be very slow, as the stomach of a frog which had been kept in captivity without a chance to secure food for forty-eight hours contained incompletely digested remains of a beetle and of a small frog.

The color and markings of specimens taken here vary greatly. A large breeding male is quite dusky all over the dorsal surface, but there are no distinct spots; dark bars of the legs indefinite. Another, also a breeding male, has numerous, fairly distinct, black spots all over the back; irregular bars run down on the sides, and the legs are marked with definite bars and spots. Another has dorsal spots equally definite, but smaller and less numerous. I noticed that green frogs taken from a pond in the woods in which the water was filled with decaying leaves appeared much darker than those taken from near-by fields, and immersion in alcohol for several weeks did not entirely remove the difference.

Width of head, 27 mm.; length of head, 30; snout to vent, 79; vent to heel, 72; vent to tip of longest toe, 120.

#### RANA CATESBEIANA Shaw.

##### BULL FROG.

Common about the larger ponds and several times seen in the caves, on one occasion at least half a mile from the entrance. High water carried a large bullfrog out of the lower end of the Shawnee Cave in midwinter.

In spite of the reputation of its voice, the cry of this frog is less noticeable than that of any other species about here. Its note is low-pitched and musical, carrying for a long distance, but not sounding loud. It was not heard before the middle of May nor after the middle of July. In the early summer these frogs were frequently seen floating on the water with their large eyes just above the surface. At such times they are not easily disturbed, and a stone or a shot may strike the water quite near them without causing them to sink. At night they are more wary and are secured less easily than some of the other species. Their cries always cease on the approach of a noise, and they will jump into the water at the slightest disturbance.

##### REPTILES.

The numerous thickets are well suited for hiding places for snakes, and they are abundant, both in number of species and individuals. On one occasion, in a walk of about a mile, eight trails were seen in the dust where snakes had crossed the road since the passing of the last vehicle, certainly less than half an hour earlier.

The list of turtles is for the vicinity of the University Farm only, and would be greatly increased had this group been collected along White River.

*SCELOPORUS UNDULATUS* (Latreille).

PINE-TREE LIZARD: RAIL-FENCE LIZARD.

Very abundant in the woods and along the fences. They came out of winter quarters early and a number were seen before the end of March. While very active at times, they are not timid. Once I saw a young lizard about 3 inches long following some persons along a path and keeping close to their feet. I have also touched and even picked up the adults as they lay basking in the sun, apparently wide awake. At other times they run away at the slightest disturbance, usually going up a tree if there is one near at hand.

*EUMECES FASCIATUS* (Linnaeus).

BLUE-TAILED SKINK.

A single immature specimen was seen, but not captured. It does not seem to be common in this vicinity but is abundant farther south, and a number were seen at New Harmony during the summer of 1907.

*CARPHOPHIS AMGENUS* (Say).

GROUND SNAKE.

Only two of these snakes were seen. The first was found under an old log on March 26. A female taken a little later contained six eggs. The eggs are subcylindrical and 11 mm. long. The stomach of the same animal contained remains of an earthworm and other unrecognizable material.

Scale rows, 12; color of ventral surface extending to middle of second row of scales; ventrals, 126; subcaudals, 23. Prefrontals absent. Length, 265 mm.

*VIRGINIA ELEGANS* Kennicott.

VIRGINIA SNAKE.

I am indebted to Mr. Ferd Payne for the first record of this comparatively rare snake from this locality. I took a second specimen in the edge of the woods near the house on August 30. The body was swollen to such an extent that the tail was sharply demarked. Dissection revealed six perfectly formed embryos, one of which was examined and found to be 95 mm. in length and similar in squamation and color to the adult except that it is slightly darker and the markings more obscure.

Color in life, brown above with a decided bluish tinge, the two or three lowest rows of scales paler than those above them; a faint pale

stripe, one entire scale and two half scales in width, down the middle of the back. On each side of this median stripe a somewhat irregular row of small black dots on the seventh row of scales, which is also darker than the other rows; another line of more scattered dots about the fifth row. Head with a number of very small dark blotches, larger and less clearly defined than those of the lateral rows. Below, sulphur yellow with a decided greenish reflection. Where the color of the sides and underparts meet there is a tinge of rosy. A bad odor, not unlike that of *Diadophis punctatus*, is very noticeable.

Scale rows, 17; ventral plates, 125; subcaudals, 34. Length, 264 mm.; tail, 38 mm.

DIADOPHIS PUNCTATUS (Linnæus).

RING-NECK SNAKE.

This species appears to be abundant here. It is generally found on the hillsides which are covered with loose rocks. It was first seen on March 31 near the Twin Cave and later was noted on all of the rocky hills in the vicinity. When captured it makes no attempt to bite, but the odor which it emits is very disagreeable, though not penetrating. It is sluggish and is said to be chiefly nocturnal in habit, but I have seen it moving about in the daytime.

Scales in 15 rows; ventrals, 146 to 148; subcaudals, 54 to 56. Color, glossy blue-black above, reddish orange below: ring of neck, lemon color, two scales in width. Length, 265 mm.

HETERODON PLATIRHINOS Latreille.

HOG-NOSE SNAKE; SPREADING ADDER.

Not uncommon. Also first seen March 31. None that I saw were of the very dark or very red colors sometimes seen in this species. This snake is much feared by most people, but is entirely harmless. I have thrust my finger against its nose and even into its mouth without being bitten. Apparently the instinct to frighten has been developed to such a degree that the habit of active defense has been lost.

I have seen a female of this species buried in the soft earth of a cornfield, apparently guarding her eggs, among which she was coiled.

PHYLLOPHILOPHIS ÆSTIVUS (Linnæus).

ROUGH GREEN SNAKE.

Not uncommon. One was rescued from a blue racer not much longer than its captive. The latter made haste to get away and did not appear to be injured, although its head and about one-fourth of the body had been swallowed.

Scale rows, 17; ventrals, 163; subcaudals, 127. Length, 875 mm.

## BASCANION CONSTRICTOR (Linnaeus).

## BLUE RACER; BLACK SNAKE.

Very abundant everywhere in the vicinity. This species has often been called bad tempered and vicious, but that is not my own experience with it. Usually these snakes will glide away with great swiftness at the sound of approaching steps. However, I have approached them quietly and stroked the neck and back with my hand without the reptile attempting either to escape or to bite. When captured they become angry and will bite at anything within reach. If kept in captivity they sometimes become docile and permit very rough handling. Probably there are great individual differences in this regard.

The blue racer has a habit of rapidly vibrating its tail when alarmed, and if a dry leaf happens to be in the way the effect is very much like the noise of a rattlesnake. It is probable that the motion of the tail is a sort of nervous impulse, due to excitement, and is not, strictly speaking, instinctive nor an adaptive mimicry of the venomous species. I have seen this vibratory motion when the snake was in a dusty road where no noise was produced.

## CALLOPELTIS OBSOLETUS (Say).

## ALLEGHENY BLACK SNAKE.

Nearly as abundant as the preceding species. It is a great destroyer of birds, climbing trees, if necessary, to reach the eggs and young. It also frequents barns, stables, and poultry yards. Only the typical form was seen about Mitchell. A more distinctly marked form, apparently *C. obsoletus confinis*, was noted in Knox County about 50 miles southwest.

## STORERIA OCCIPITO-MACULATA (Storer).

## STORER SNAKE.

Probably quite common. Two individuals were taken during the year. A female in the university collection, taken at the University Farm in August, 1906, contains ten embryos. They are about 85 mm. in length and resemble the mother in color. From their condition it is evident that the species is viviparous and not ovoviviparous, as Dr. O. P. Hay supposed.<sup>a</sup>

The female mentioned above is darker than the other specimens taken and has no distinct longitudinal stripes, although the pale spot on the occipital region is present. Another of these snakes has stripes so distinct as to bear a slight resemblance to a garter snake. The

<sup>a</sup>The Reptiles and Batrachians of Indiana, 17th Rept. Ind. State Geologist, p. 498.



belly in life was near salmon color, but in alcohol has faded to greenish yellow. A dark line runs along the ventral plates at the edge of the belly. This is followed by a pale stripe. The first row of scales form the second dark line, while the second, and most of the third rows are pale; fourth, fifth, and sixth rows are dark, while a light stripe nearly three scales wide forms the mid-dorsal line. The other specimen taken is intermediate in the distinctness of the markings.

Length of the last-mentioned specimen, 170 mm. Scale rows, 15; ventrals, 127; subcaudals, 48 pairs.

*NATRIX SIPEDON* (Linnaeus).

WATER SNAKE.

Common about the ponds. One was found some distance within a cave.

*THAMNOPHIS SIRTALIS* (Linnaeus).

GARTER SNAKE.

Only a few seen.

*LAMPROPELTIS DOLIATUS TRIANGULUS* (Boie).

MILK SNAKE; HOUSE SNAKE.

Not uncommon. Elsewhere I have generally seen this species in the vicinity of buildings, but here it was numerous in the woods. I have always found this to be an evil-tempered snake. When disturbed it neither attempts to escape or to coil, but raises the anterior half or more of the body clear of the ground, forming an irregular S, and it may remain on guard in this attitude for some time.

Scale rows, 19; ventrals, 198; subcaudals, 46. Loral present. Length, 785 mm. A dorsal series of 42 spots of bright, reddish-brown, surrounded by a distinct ring of black, one scale wide. The alternating spots sometimes confluent with dorsal series. Ventrals irregularly blotched with rectangular spots of black.

*AGKISTRODON CONTORTRIX* (Linnaeus).

COPPERHEAD.

Not rare. Two were seen during the summer of 1907 and several had been taken the previous year. Like the blue racer, it produces a rattling noise when the rapidly vibrating tail comes in contact with a dry leaf. It is probably less dangerous than most people suppose, because it is often very sluggish and does not strike till thoroughly aroused. No doubt there are great individual differences in this regard.

Scale rows, 23; ventrals, 156; subcaudals, 50; 20 "saddles" of dark color extending entirely across the back, with a single exception; the pale areas between, with a pair of dark spots. Length, 710 mm.

## TRIONYX SPINIFERUS Le Sueur.

## SPINY SOFT-SHELLED TURTLE.

Not seen alive but a small boy, familiar with the ponds of the neighborhood, informed me that the soft-shelled turtles were sometimes found in them. His statements were confirmed by finding the mangled remains of one in the road not far from a pond.

## CHELYDRA SERPENTINA (Linnæus).

## SNAPPING TURTLE.

Very common. In the spring they seem to wander a great deal, traveling from pond to pond. The remains of one was found in the cave some distance from the entrance. It had doubtless entered by accident and had been unable to sustain life there. A large one killed by a boy in the neighborhood measured 11 inches in a direct line from the nuchal to the caudal plate.

## TERRAPENE CAROLINA (Linnæus).

## BOX TORTOISE.

Very common; found living in the cave. A pair were seen mating on September 6. During the later part, at least, of the sexual congress the male assumes an erect position with the hinder edge of the carapace and hind feet on the ground, the tail hooked under the female, and the head and fore limbs in the air.

## CHRYSEMYS MARGINATA Agassiz.

## WESTERN PAINTED TORTOISE.

Very abundant in the ponds. On one occasion twenty-seven were counted on a single log. There were others in the same small pond, and four other ponds within a radius of 200 yards were inhabited by turtles at the same time.

## MAMMALS.

The physical characters of the region exert a noticeable influence upon the mammalian fauna. Bats are attracted in large numbers to the caves, in which they spend a considerable portion of their lives. The rocky hillsides and woods afford homes for the smaller carnivores as well as for the wood-dwelling rodents. An abundant supply of seeds of forest trees, shrubs, and vines furnish food for the latter class of animals.

On the other hand, there are no swamps or large tracts of grassy land in the immediate vicinity, and mammals living in such places

are either restricted in range or altogether absent. *Microtus pennsylvanicus* and *Peromyscus michiganensis*, both abundant at Bloomington, 35 miles north, were not found here at all. Two other grass-inhabiting voles, *M. ochrogaster* and *Synaptomys cooperi stouei* were fairly common, but only in certain localities.

Local migration of some of the small mammals was noted. During the autumn a large number of traps were placed at different times in a small, grass-grown area where the woods had once been cleared. Among other things, a single lemming vole (*S. c. stouei*) was captured, and it seemed to be the only representative of its kind in this area. No prairie voles (*M. ochrogaster*) were taken. During January and again in March, White River overflowed its banks and backwater extended up the creek valleys. In a little valley one-sixth of a mile from the clearing above mentioned these two voles had been abundant. The flood drove them away, probably drowning some, but they suddenly became abundant in the clearing, evidently having migrated there through the woods. Several species of mice and shrews were collected in large numbers on a railway embankment which was left as a narrow island during the flood. This island formed a retreat in time of high water and from this point the species afterward radiated outward to repossess the bottom lands from which they had been temporarily driven.

#### DIDELPHIS VIRGINIANA Kerr.

##### OPOSSUM.

The opossum is very abundant, finding a congenial home in the heavy forest and among the sink holes. Most often it seems to use a woodchuck hole for its home. All the specimens taken were immature and were caught in traps. The young of the previous summer were still immature late in January. The old animals are probably more wary and are not so easily trapped. All the stomachs examined contained remains of apples, which were abundant and easily obtained. Besides apples, two stomachs contained salamanders (*A. punctatum*), one a frog, one a snail, one a bird, and one a mammal.

I never saw tracks or other signs of the opossum in the caves, though a piece of a mandible with a single molar was found in the Shawnee Cave.

#### SCIURUS NIGER RUFIVENTER E. Geoffroy.

##### FOX SQUIRREL.

The woods of the University Farm consist principally of a heavy growth of large timber. In this large tract but one fox squirrel made its home during the winter, although there were many gray squirrels. On farms in the neighborhood, where there were more open groves, fox squirrels were common. Apparently they prefer the smaller and more open woods.

## SCIURUS CAROLINENSIS Gmelin.

## GRAY SQUIRREL.

The gray squirrel is very abundant on the University Farm, seeming to delight in using the large oaks and tulip-trees for homes. In the autumn of 1906 the crop of acorns was very large. I estimated that each of the large white oaks produced from two to eight thousand acorns during that season. Eighty acres are heavily wooded with white oaks and nearly a hundred acres more have a considerable growth of these trees. Before November 1 the immense crop of acorns had been so completely garnered by the squirrels that none were in sight on top of the leaves and only an occasional one could be found by the most careful search.

## SCIUROPTERUS VOLANS (Linnæus).

## FLYING SQUIRREL.

These squirrels were probably abundant, though not often seen. One was caught in a trap at the base of a hollow tree. During the summer, others were seen and heard in the evening, running about or sailing through the air among the trees near the house.

## TAMIAS STRIATUS (Linnæus).

## CHIPMUNK.

Not very abundant in the woods. During the autumn they were often heard giving their chipping call in the fields and open woods. The loud shrill whistle is most often heard in the spring, but I have never heard them chipping at that season.

## MARMOTA MONAX (Linnæus).

## WOODCHUCK; GROUND-HOG.

Very abundant both in the woods and fields. They were seen running about late in October, but probably were not active later than the end of that month.

They began to clean out and enlarge their holes during the last days of February. On March 5 there was a heavy snow storm late in the evening. Early next morning woodchuck tracks were numerous in the snow, showing where the animals had been running about and feeding.

When they venture out in such weather as this, it is difficult to see any adaptive necessity for their hibernation. At such times they eat ferns, shrubs, and the tender shoots of young trees. Indeed, their food is very similar at all times to that of the rabbit. The latter

animal fares well during the winter months and there is no reason why the woodchuck should not get along equally well. In this instance, and probably in many others, hibernation seems to be a sort of physiological rhythm, similar to sleep, but more prolonged.

SYNAPTOMYS COOPERI STONEI<sup>a</sup> Rhoads.

STONE LEMMING MOUSE.

This animal is restricted to fields in which a dense growth of grass is allowed to grow up and remain uncut. One was caught in a live trap on October 5. It was put in a roomy cage and given food and water, but died five days later.

The lemming mouse breeds as soon as the severe weather of winter is over. A large, round nest of moss and dry grass or sticks is made and the young, usually four or five in number, are brought forth in it. The first of these nests was found March 21. It contained four young, varying considerably in bulk and weight of body, but each having a total length of from 62 to 64 mm. The mother escaped and the young were taken to the house, kept in a room at even temperature and fed milk with a pipette. They seemed to thrive at first, but three days later all died within a few hours.

The female mates again very soon after giving birth to young. The period of gestation is probably three or four weeks, and if the process is kept up all summer, and it doubtless is, the number of young produced by a single female must be not less than twenty or thirty a year. The young of the earlier litters doubtless reproduce during their first year, and the rate of increase is therefore quite rapid.

An adult female taken October 5 is grizzled brownish on the back and sides, the hairs being plumbeous at the base and the short fur tipped with bright cinnamon, while the long hairs overlying it are black. Another female taken on March 12 differs from the first only in having grayer cheeks and flanks, and this second specimen is well matched by a male taken the following day. A male taken November 23 is much paler, the reddish tips of the hairs being near drab. The feet and sides are also paler. On the back and rump there is a new growth of short fur similar to the old. A female taken April 12 is similar, but the tail, feet, and sides are even paler than the last specimen and there is no new growth of fur concealed by the older hairs.

A male taken in December has shed the old coat except in the shoulder region and at the sides of the belly. The new growth is darker on account of a number of the hairs (in addition to the coarse overfur)

<sup>a</sup> Reasons are given elsewhere (Proc. U. S. Nat. Mus., XXXII, pp. 460-461) for adopting this name for the Indiana form of lemming vole. A comparison of the skulls will readily show that it is not *gossi*, as several mammalogists have suggested to the writer.

being dark throughout instead of having pale tips. The shoulder patches of old fur are paler, contrasting sharply with the new growth. The young are dark colored and the pale tips of the hairs are bulky instead of ferruginous or cinnamon.

Measurements: Average of ten individuals, total length, 113.2 mm.; tail, 18.5; hind foot, 17.1; ear, 9. Cranial measurements, greatest length, 26; basilar length, 22; palatilar length, 12; greatest width, 12; depth over bullae, 9.6; palatal width (outside of molars), 6; length of molar series, 6.8.

*MICROTUS OCHROGASTER* (Wagner).

PRAIRIE MEADOW MOUSE.

This is the most abundant vole and is found in the fields wherever there is a growth of grass dense enough to afford cover. Specimens caught November 22 and 23 were evidently not breeding, as the sexual organs were reduced. Of four pregnant females examined during the spring, two contained three embryos each and two contained four each. Some of the nursing females were pregnant, showing that they breed again soon after giving birth to young.

A nest was found under a railroad tie along an embankment on April 11. It contained three young apparently about a week old. The mother was not in the nest when it was found (about 4 p. m.), and the covering was replaced. Early next morning she was again absent, but about 10 o'clock she was in the nest nursing her young. When disturbed she started to run away with the young still clinging to her teats, but the whole family was captured. They were placed in a box and given plenty of fresh grass, as well as other food, and water. Nevertheless the old mouse ate her offspring during the first night and she, herself, survived only two days longer. She showed a surprising ability to climb, going up the vertical sides of the box and clinging to them while attempting to gnaw out, or running along the under surface of the screen wire which formed the top.

This species is diurnal in habits, though probably it is more or less active during the night, and it certainly is during early morning and late evening. It lives principally on grass, boring tunnels through the thickly matted growth and extending these or eating the tender shoots from along their sides as the needs require. Even in winter its food consists principally of grass, the dried blades being used to supplement the green shoots when enough of these can not be found beneath the snow and overgrowth. It does not refuse seeds, however, and is readily attracted by a bait of either cheese or oatmeal. During the early summer, when wheat is ripening, it will cut the stalks into little sections from 2 to 3 inches long, working to get the head low enough to reach and remove the grain. This work has generally

been attributed to *M. pennsylvanicus*, but I have positively traced it to *M. ochrogaster*, though the other species may have a similar habit.

The nest is generally placed underground, but sometimes an old log or board is the only covering. It is made of dry grass and bark. Two or more tunnels usually lead to it, for this species, like *M. pinetorum*, uses underground runways. Its fossorial habits lead it, doubtless accidentally, into caves. I found the skulls of two individuals in the Shawnee Cave and later trapped another there. It had been eating a pasteboard box, which was the only food at hand, and the lack of food would be a sufficient reason for preventing the species from becoming established in these caves.

The mice of this species collected at Mitchell are generally less gray than in northern Indiana. An adult male taken March 25 is still in winter pelage, the fur being long, dense, and soft. The color is dark, the black hairs preponderating, while the gray-tipped hairs are few in number. Others collected a little later have more gray hairs mixed with the black. A male taken on April 3 has very much more fulvous coloring than any other mice of this species that I have seen. The black hairs of the back are less numerous than is usual in the species, there are very few gray-tipped hairs, and all the hairs of the flanks, sides of the neck, and cheeks and lips are tipped with a broad band of fulvous. All the other specimens, collected chiefly in the early spring, are intermediate between those described.

Measurements, average of four males and four females: Total length, 144.2 mm.; tail, 36.4; hind foot, 19.6. Cranial measurements, average of six adults: Greatest length of skull, 26.6 mm.; basilar length, 23; palatilar length, 13; greatest width of braincase, 11.7; depth of brain case over bullae, 10.3; maxillary tooth row, 6.

MICROTUS PINETORUM AURICULARIS Bailey.

PINE VOLE; MOLE MOUSE.

This is an abundant vole, and is found in a great variety of locations. It lives on the rocky hills, about the caves, in the heavy woods where the carpet of dead leaves is several inches deep, and in the fields. Like the prairie vole, it is largely diurnal in habit and may often be seen scurrying back into its hole when one quietly approaches its feeding ground. It is a more omnivorous feeder than the other voles of this region. The contents of the stomachs I have examined is composed largely of seeds and roots, but I have found remains of insects in two. Sometimes grass is eaten, as well as the stems and leaves of other plants and the bark of shrubs and small trees. Where this species takes to the fields it appears to feed principally on grass.

It is not possible to say positively whether the pine vole of this locality is *auricularis* or *scalapsoides*, as the characters are interme-

diate. As the colors are quite dark and the ear large, it is thought best to adopt the former name.

Measurements, average of four: Total length, 122 mm.; tail, 19; hind foot, 16; ear from crown, 6. Cranial measurement of the same: Greatest length of skull, 25.8; basilar length, 21.2; palatilar length, 12.8; greatest width of braincase, 12.2; depth of braincase over bulke, 10.5; maxillary tooth row, 6.

PEROMYSCUS LEUCOPUS (Rafinesque).

WHITE-FOOTED MOUSE.

Here, as in many other places, this is the most abundant mammal, living in all kinds of places and eating all kinds of food. Several took up their residence under the house and in the wood pile just back of it. They were numerous under the corn shocks on the adjoining farm, and four were captured within the cave.

Some misapprehension has existed with regard to these cave mice, and it seems necessary to consider their status somewhat carefully. Prof. W. S. Blatchley says<sup>a</sup> of specimens taken in Marengo Cave: "They differed much in appearance from above-ground specimens, having larger external ears (13 mm. long by 11 mm. broad), longer whiskers (38 mm.), and more protruding eyes. \* \* \* The mice have been noted ever since the cave was discovered, but seem to keep close to the entrance, through which, however, no light passes." Dr. A. M. Banta, who has studied the fauna of the Mayfield Cave, in Monroe County, says<sup>b</sup> that the eyes of one which he captured in the cave became sore when left in the light. He does not state under what conditions it was kept, and as the species is chiefly nocturnal the same thing might occur if one of the mice which lived above ground were kept in intense light without any dark retreat. The measurements given by both Messrs. Banta and Blatchley are exceeded by many teranean specimens I have taken, and as the eyes are always strongly protuberant I doubt that any of the characters indicate even a limited amount of racial modification on account of cave life. Indeed, it is not certain that the species has ever become isolated in a cave.

A number of white-footed mice were kept in captivity at different times, but they could not be kept together. On one occasion six were caught under corn shocks and were divided equally between two cages. Next morning each cage contained two partially eaten carcasses, while of the survivors in each cage, one died within a few hours and the other a day later.

<sup>a</sup> 21st Ann. Rept. of the State Geologist of Indiana, 1896, p. 179.

<sup>b</sup> The Fauna of Mayfield's Cave. Pub. 67 of the Carnegie Institution, p. 19.



A male taken when half grown became so tame that it would eat from my hand. It remained under cover of its box during the day, but toward sunset would leave its retreat and begin to run about the cage looking for food and clambering about, often hanging downward from the roof of the cage. It would not allow me to pick it up, but would voluntarily come to my hand and nibble it or take food from it. Various kinds of food were given it; cheese and dry oatmeal were favorites. Among wild fruits none were eaten so greedily as the berries of the buck-bush (*Symphoricarpos symphoricarpos*). These berries are here the most important single item of diet for these mice in winter and also are eaten extensively by other mammals as well as birds. Acorns were also readily eaten. Seeds of the red bud (*Cercis*), the wahoo (*Euonymus*), and the bitter-sweet (*Celastrus*) were eaten only when the articles of food above mentioned were lacking. Seeds of the scarlet sumac (*Rhus glabra*) were rejected entirely.

A female with three young ate her offspring soon after being put in the cage, but the old one lived for several months. At one time, during my absence, she was without food, but ate the pasteboard box which served her for a home; she must have subsisted on this for at least a week.

Two were taken about an old pond shortly after a period of exceptionally heavy rainfall. At this time salamander eggs had been deposited in abundance around the edges of ponds and the receding water left many of them stranded on the bank. The stomachs of both of the white-footed mice taken at this place contained some gelatinous matter which I could not positively identify, but which resembled the coating of salamander eggs more closely than any other substance apt to be found in such a place.

Measurements, average of 10 adults: Total length, 160 mm.; tail, 70; hind foot, 19.5; ear from crown, 14. Cranial measurements of the same: Greatest length of skull, 25.5; basilar length, 19; palatilar length, 10.3; greatest width of braincase, 12; depth of braincase over bulge, 9.3; maxillary tooth row, 4.

SYLVILAGUS FLORIDANUS MEARNSI<sup>a</sup> (Allen).

#### PRAIRIE COTTONTAIL; RABBIT.

Very abundant; the sink holes and rocks afford homes and hiding places. Now and then rabbits wander into the caves and usually perish if they get away from the sink holes through which they enter the larger chambers. The remains of three were found in the caves, one of them comparatively fresh, the others quite old.

<sup>a</sup> Mr. E. W. Nelson has identified the rabbits collected at Mitchell as *S. f. mearnsi*.

During the summer I have often seen rabbits lie down on the ground where the soil was bare, smooth, and devoid of vegetation and gnaw the dirt. At one time, in a path near the house, a space of about a square yard had been gnawed away to a depth of from one-fourth to one-half an inch. This was not all done in one night, but it had been done between rains or within ten days.

During the winter I was at the University Farm the State forester complained vigorously of the damage done by rabbits to the young trees on the forest reservation about 50 miles farther south. Accordingly I paid close attention to their winter food in my locality. Comparatively little damage was done to the young hard-wood trees. The vegetation most often eaten was as follows: Wahoo, hydrangea, Christmas fern, sassafras, hepatica, red locust, and ironwood. The shellbark hickory, walnut, and sugar-maple shoots were eaten infrequently. I did not observe an oak, ash, or tulip-tree which had been injured by the rabbits, the abundance of more tender vegetation serving as an effective protection to the more valuable species.

*UROCYON CINEREOARGENTEUS* (Schreber).

**GRAY FOX.**

The gray fox is still common in this locality, although almost exterminated throughout the State. The first one I saw came up the path to within 30 yards of the house one morning. The hounds were bellowing in the distance and it stopped now and then to listen. Coming to a rail fence the animal sprang upon it and walked along the top rail for a few yards, but did not make a long leap to the side for the purpose of throwing the dogs off the trail, as the red fox is reputed to do.

Later I found a den in a secluded spot not more than 150 yards from a man's residence. When snow was on the ground the track of one of these foxes entered the Twin Cave nearly every night, for what purpose I can not say, as the cave contained no food, unless the fox was able to catch bats. A large male was caught in a steel trap set along the creek, but the skin was neglected and spoiled.

*VULPES FULVUS* (Desmarest).

**RED FOX.**

This fox was not seen or captured, but it is said to be quite as numerous as the other species. A small cave on top of the hill was inhabited by foxes, and I judged by the size of the track that it was the red rather than the gray species which lived in it.

## CANIS OCCIDENTALIS (Richardson).

## TIMBER WOLF.

It seems worth while to put on record what appears to be an authentic specimen of a wolf in this (Lawrence) county. The Indianapolis Star contained a somewhat sensational account of the capture of a wolf by a young girl at Springville, near Bedford. I wrote to the man on whose farm the animal was taken, and he replied that the story was substantially correct. The animal was first seen creeping under a deserted house, and some men were called who drove it out and shot it. The skin was disposed of and the carcass fell a prey to various carrion eaters, so that I was unable to see and verify the identification. Mr. Cobb, the farmer who furnished me with a crude description of the animal, says:

I noticed his tusks [canines] were fully  $1\frac{1}{2}$  inches long, and I think they had been broken at the tips [length doubtless overestimated]. The hide measured 6 feet from tip of nose to tip of tail, but when stretched on a 12-inch board the body part was not over  $3\frac{1}{2}$  or 4 feet long. The tail was long and bushy, something like a fox. The sides were gray, but the back was mixed gray and black, something like a rabbit. The tail was sort of yellowish gray. I suppose he would have been 2 feet in height.

Allowing for errors and exaggerations, this description does not seem to be applicable to a dog or fox. The only other possibility is the coyote. The timber wolf seems, however, to have survived the coyote in the hills of southern Indiana and has been reliably recorded from Brown, the adjoining county on the north, in recent years.

## MEPHITIS PUTIDA (Boitard).

## SKUNK.

Skunks seemed to be common in the region, but I did not succeed in locating a den on the university property, nor were their tracks often seen. Some skins in the possession of a fur buyer were examined, and they appeared to belong to this species.

## LUTREOLA VISON (Shreber).

## MINK.

Tracks were seen frequently: on one occasion they passed across the doorstep.

## PUTORIUS NOVEBORACENSIS Emmons.

## WEASEL.

Tracks of these animals were very numerous. A single one was trapped in a hole at the base of a tree.

## BLARINA BREVICAUDA CAROLINENSIS (Bachman).

## CAROLINA SHREW.

The form of the short-tailed shrew at this locality appears to be nearer *carolinensis* than *brevicauda*, although not typical. Specimens vary in total length from 95 to 105 mm.; hind foot, 11 to 14; tail, 19 to 24. All the specimens taken have a more or less distinct tinge of brownish.

This shrew is common, yet not nearly so abundant as at some other places I have collected. One day while collecting along the railway embankment I heard a loud squealing, and going to the spot I discovered a short-tailed shrew carrying away bodily a nearly grown *Microtus pinctorum*. The shrew became frightened at my approach and left its victim, which was about dead. The vole was the heavier of the two animals.

Measurements, average of five: Total length, 103 mm.; tail, 21.7; hind foot, 12.8. Cranial measurements, average of three: Greatest length of skull, 23; basilar length, 19.3; palatilar length, 10; greatest breadth of braincase, 11.6; depth of braincase over bullae, 7.3; upper tooth row, 10.

## BLARINA PARVA (Say).

## SMALL SHREW.

This shrew is almost as abundant as the larger species, but is not so generally distributed. The species seems to be partly or wholly diurnal in its movements. Its runways beneath the grass are so small as to be scarcely distinguishable. Most of the specimens obtained were taken in the vicinity of some small sink holes, which they evidently entered and in which their nests were probably made.

Measurements, average of six individuals: Total length, 74.8 mm.; tail, 16.6; hind foot, 10. Cranial measurements of the same: Greatest length of skull, 16.2; basilar length, 11; palatilar length, 7; greatest breadth of braincase, 8; depth, 5.4; upper tooth row, 7.

## CORYNORHINUS MACROTIS (Le Conte).

## BIG-EARED BAT.\*

This species, previously known from but one other locality in the State, proved to be common. Seven individuals were seen, but only two were secured. They were all found during the winter not far within the caves where both light and cold reached.

\*A detailed account of the habits of the bats of this locality, together with some experimental studies of their sensory adaptations, has been published by the author in the Biological Bulletin, XV, 1908, pp. 135-133.

Color of adult female taken in December: Back, very near the hair brown of Ridgway, the hairs banded with four distinct rings of color; the basal one-third clove brown followed by a band of brocoli brown; next a band of dark sepia, which is tipped by a narrow band of pale brown. The mingling of the outer bands gives the animal its characteristic color. Belly, pure white, with bases of hairs nearly black; breast and sides of throat with a tinge of the color of the back. An adult male, taken on May 5, has a somewhat darker color, due to the wearing away of the pale tips of the dorsal hairs.

Measurement of an adult female: Total length, 92 mm.; tail, 43; hind foot, 10; ear, 27; forearm, 43; longest finger, 78; expanse, 225. Cranial measurements: Greatest length of skull, 18 mm.; basilar length, 12; palatilar length, 6.5; breadth over audital bullæ, 10; depth from bullæ, 9; maxillary tooth row, 6.5; mandibular length, 10.5.

MYOTIS SUBULATUS (Say).

SAY BAT.

Common but less abundant than *M. lucifugus*. During the winter a few were found associated with the last-named species, the percentage, as nearly as it could be estimated, being 1 in 20. During the late summer they entered the cave in greater numbers and for several weeks, during July and August, the Say bat exceeded any other species in numbers.

This species exhibits a considerable variation both in color and proportions. In nine specimens collected between December 17 and April 9 the hairs of the ventral surface are tipped with pure white which glistens in life and makes the animals very conspicuous when seen by lantern light in the cave. The hair of the dorsal surface of the same individuals is paler than the average, being near the drab of Ridgway on the outer third, with clove brown at the base. The ears and membranes of these specimens are also pale, and the interfemoral membrane of some individuals is edged with a narrow pale stripe. Hair soft, close, and short.

An adult female taken on February 17 is more yellow, approaching the tawny olive of Ridgway, although not exactly matching it; underparts dirty yellowish white; membranes blackish. A male taken three weeks later is still darker, and it is almost exactly matched by a male taken August 11. Other August skins are in fresh pelage. A male killed on August 9 has very short, dense fur, mouse gray in color, but the hairs minutely tipped with cinnamon and but slightly darkened at the base. Another taken the same date is very much darker throughout. Fur on dorsal surfaces of both these bats tipped with cinnamon. A male taken August 2, also in fresh pelage, is simi-

lar, but the cinnamon tips are longer and brighter and the bases of the hairs darker.

The seasonal variation in color, in so far as it can be determined from this series of eighteen skins, may be summarized as follows: The old coat of hair is shed in July or August, while the new growth is still quite short. The new hairs are at first nearly unicolor, the tint being something near mouse gray. As the hairs lengthen, the basal part grows darker, finally becoming almost black in some individuals, while the tip assumes a reddish tinge which may vary from bright cinnamon to tawny olive or raw umber. After a time the reddish tinge fades in some individuals, leaving the animals drab or grayish in color, while others retain the reddish color throughout the year. The hairs of the underside are at first dark at the base and yellowish at the tips, but the yellow fades also, leaving the animals white beneath. The dark bases do not show on either the dorsal or ventral sides.

The ear varies more than any other structural character, the extremes being 11 and 16 mm. The forearm varies from 31 to 40 mm. and the tibia from 16 to 19 mm. Cranial variation is comparatively slight.

Average measurements (from the flesh) of eight males and two females: Total length, 87.9 mm.; tail vertebrae, 37.6; hind foot, 9.9; ear, from crown, 12.7; forearm, 37.8; tibia, 17.4. Cranial measurements: Greatest length of skull, 15.3 mm.; basilar length, 11.8; palatal length, 7.3; greatest width of braincase, 8.1; depth of braincase from adnital bullae, 7.4; maxillary tooth row, 7.3.

#### MYOTIS LUCIFUGUS (Le Conte).

#### LITTLE BROWN BAT.

This is by far the most abundant species of bat in this vicinity. Not less than four hundred passed the winter in the caves of the University property, and the number may have been much larger, as these animals sometimes creep away into the small crevices where they can not be seen. During the greater part of the year they are gregarious, cave-dwelling bats, but during the summer very few are found in the cave.

Color variations consist chiefly in a difference in intensity and apparently have no relation to season or sex. Some individuals are very near the typical color of *Eptesicus fuscus* (dark cinnamon), while others are very nearly tawny olive at the tips of the hairs. Still others are much darker, near Prout's brown. Molting seems to take place at any time during the summer. The darker basal part of the hairs is not so well concealed by the reddish tips, and the color is apt to be darker just after the molt. However, there are

exceptions to this rule, some of the bats with short summer fur being the lightest in color of any of this species that I have seen. The color of the underparts also varies considerably, but it always has a yellowish or reddish tinge and is never tipped with pure white, as in some specimens of *M. subulatus*.

Average measurement of six females and four males: Total length, 89.4 mm; tail, 38.7; hind foot, 9.9; ear, 11.1; forearm, 37.4; tibia, 16.6. Cranial measurements of the same specimens: Greatest length of skull, 15; basilar length, 11.5; palatilar length, 6.8; greatest width of braincase, 7.8; depth of braincase from bullae, 6.9; maxillary tooth row, 6.9.

MYOTIS VELIFER (J. A. Allen).

#### LARGE-WINGED BAT.

This species, with a habitat chiefly along the Mexican boundary region, had previously been reported from nowhere nearer than southwestern Missouri and Nick-a-Jack Cave, Tennessee. A single specimen was taken in the Twin Cave not far from the entrance on August 9. It is a female, which apparently had nursed during the present season, as there was a new growth of short, whitish hairs about the mammae. There are also white hairs along the middle line of the abdomen. Back light sepia, except some indistinct blotches on the shoulders, which are blackish.

Measurements: Total length, 97 mm.; tail, 40; hind foot, 10; ear, 12; forearm, 44; tibia, 20. Cranial measurements: Greatest length, 16 mm.; basilar length, 13; palatilar length, 8; depth of braincase over bullae, 7.5; width of braincase, 8.5; maxillary tooth row, 7.

PIPISTRELLUS SUBFLAVUS (F. Cuvier).

#### GEORGIAN BAT.

Next to *Myotis lucifugus*, this is the most abundant bat. It hibernated in the cave in considerable numbers and was seen flying about in the evenings throughout the summer. It is easily distinguished from the other bats of the vicinity by its uncertain, wavering flight, which resembles that of a butterfly. In the cave it was most often found on the sides of the high walls at some distance from the entrance.

Average measurements of five adult males and five females are as follows: Total length, 78.1 mm.; tail, 35.3; hind foot, 8.8; ear, 9.5; forearm, 33.8; longest finger, 58.6. Cranial measurements, average of five individuals: Greatest length of skull, 13.4 mm.; basilar length, 10; palatilar length, 5.5; greatest width, 7.2; greatest depth, 6.4; maxillary tooth row, 5.6.

## EPTESICUS FUSCUS (Beauvois).

## LARGE BROWN BAT.

Comparatively rare. But three specimens were taken, all of which were found in the cave near the entrance. Color of an adult male taken August 2, bright bistre above, broccoli brown below. A male taken in December is very near the raw umber of Ridgway in the color of the dorsal surface.

Measurements of an adult male: Total length, 100 mm.; tail, 40; hind foot, 11; ear, 11; forearm, 15; longest finger, 80; expanse, 295. Cranial measurements of the same individual: Greatest length, 20 mm.; basilar length, 15; palatilar length, 9; greatest width of braincase, 10; depth over bulke, 8; maxillary tooth row, 9; mandibular length, 15.1.

## LASIURUS BOREALIS (Müller).

## RED BAT.

No living specimens of this bat were seen in the caves, nor do I know that it has ever been taken alive in any of the caves of the Mississippi valley. A few individuals were seen flying about in the woods on summer evenings.

About two hundred skulls of this species were found in a large chamber of Shawnee Cave and a few in a chamber of Upper Spring Cave.<sup>a</sup> The skulls were scattered on the floor of the cavern in a way that indicated that the animals had died while hanging from the roof. Only about twenty skulls of all of the other species now abundant here, were found in the same place. Apparently the red bat has changed its habit from cave-dwelling to tree-dwelling within recent times.

## LASIURUS CINEREUS (Beauvois).

## HOARY BAT.

This species was not seen alive, but two skulls were found associated with those of the last species. The hoary bat is found in this region at the present time, but it is rare.

---

<sup>a</sup> A brief account of these skulls has been published in the Proceedings of the Indiana Academy of Science for 1906.





GENERIC NAMES APPLIED TO BIRDS DURING THE YEARS  
1901 TO 1905, INCLUSIVE, WITH FURTHER ADDITIONS TO  
WATERHOUSE'S "INDEX GENERUM AVIUM."

---

By CHARLES W. RICHMOND,

*Assistant Curator, Division of Birds, U. S. National Museum.*

---

The list presented herewith may be regarded as a continuation of the one published several years ago.<sup>a</sup> It consists of some 200 names introduced as new during the years 1901 to 1905, inclusive, with about 350 others of earlier date, the majority of which are not recorded by Waterhouse. Among the latter are a number of *nomina nuda*, and names of more or less uncertain status. Included in this category are the names given by F. O. Morris, in "a new system of nomenclature, illustrated by a list of British birds," published in Neville Wood's *Naturalist* (II, 1837, pp. 123-127). Every one of the thirty or more generic names proposed by him are identifiable with certainty, usually by means of the distinctive specific names of earlier authors, or by the citation of current and well-known vernacular appellations. There is no doubt, for example, what bird is intended by "*Probatheus roseus*," or "Rose-colored Pastor," when given in a list of British birds, yet Morris did not explain in so many words that his genus *Probatheus* was based on *Turdus roseus* Linnaeus. In these and similar cases I have indicated the absence of definite authority for the type species by giving the name in quotation marks and by the addition of the vernacular name. Thus, under *Ampelis* Morris, the type is given as "*Ampelis garrula*," or "Roller," not as "*Coracias garrulus* Linnaeus," which it undoubtedly is. This treatment of names will enable ornithologists to decide each case on its individual merits.

The ensuing list was compiled fully two years ago, but various causes have contributed to delay its publication until the present time. In its preparation I have been aided by several friends and correspondents, to whom my best acknowledgments are due: Mr. C. Davies

---

<sup>a</sup> List of generic terms proposed for birds during the years 1890 to 1900, inclusive, to which are added names omitted by Waterhouse in his "Index Generum Avium." *Proc. U. S. Nat. Mus.*, XXIV, No. 1267, 1902, pp. 663-729.

Sherborn sent references to the names given by Billberg; Miss M. J. Rathbun verified numerous references in the *Écho du Monde Savant* while in Paris; Mr. Witmer Stone supplied several names proposed by Dumont and permitted me to examine the late Professor Newton's copy of Billberg's "Synopsis" at the time it was in his hands; Dr. L. Stejneger and Messrs. Outram Bangs, S. A. Buturlin, and J. H. Riley have also aided me in various ways.

The derivations of generic names given in the following pages are of two classes, authentic and probable; those in the first category were furnished by the original authors, and are so indicated; the remainder were largely contributed by Mr. H. C. Oberholser, and the whole list was finally submitted to Dr. Theodore Gill for revision.

Fossil genera, as in the former list, are distinguished by a †; *nomina nuda*, and names of undecided status are preceded by an asterisk.

**Aaptus**<sup>a</sup> RICHMOND, Proc. Biol. Soc. Wash., XV, April 25, 1902, p. 85.

New name for *Aphobus* CABANIS, 1851, not *Aphobus* GISTEL, 1848. (Type, *Agelaius chopi* VIEILLOT.)-----[*Icteridæ*.]

<sup>1</sup>*Ααπτος*, unapproachable.

**Abalilus** CABANIS, Journ. für Orn., IX, July, 1861, p. 242.

Type, *Thamnophilus punctatus* CABANIS-----[*Formicariidæ*.]

"Von a privativum und βάλιός, scheckig, bunt." (Cabanis.)

\***Abernius** C. T. WOOD, Orn. Guide, Jan., 1837, p. 185 (see also p. 42, note).

Type, "Abernius albus, Wood," or "White Abern," or "Pere-noptère brun" [of his list of "Birds of Britain"]-.[*Falturnidæ*.]

**Ablas** BILLBERG, Synopsis Faunæ Scand., I, Pars 2, 1828, tab. A.

New name for *Capito* VIEILLOT-----[*Capitonidæ*.]

<sup>1</sup>*A*, very; βλάζω, I am foolish, silly.

\***Abuceros** BILLBERG, Synopsis Faunæ Scand., I, Pars 2, 1828, tab. A.

For part of the genus "*Buceros* Cuv."<sup>b</sup>-----[*Bucerotidæ*.]

<sup>1</sup>*A*, not; βούκερος, horned like an ox.

**Acanthis** BORKHAUSEN, Deutsche Fauna, I, 1797, p. 248.

Types, *Fringilla carduelis* LINNÆUS, *F. spinus* LINNÆUS, *F. cannabina* LINNÆUS, *F. linaria* LINNÆUS, *F. citrinella* LINNÆUS, *F. flavirostris* LINNÆUS, and *F. flamma* LINNÆUS.[*Fringillidæ*.]

<sup>1</sup>*Ακανθίς*, the goldfinch or the linnet.

<sup>a</sup>This name is preoccupied by *Aaptos* J. E. GRAY, 1867. It may be renamed *Cuorinopsar* (γυρόπιτος, well-known; ψάρ, starling).

<sup>b</sup>Cuvier divides the Hornbills into two groups, and *Abuceros* doubtless applies to the section "sans proéminences." The species of this group, as given by Cuvier, are: *Buceros javanicus* (= *B. undulatus* SHAW), *B. nasutus* LINNÆUS, *B. nasica* CUVIER (= *B. nasutus* LINNÆUS), *B. coronatus* (= *B. melanoleucus* LICHTENSTEIN), and *B. bengalensis* CUVIER (= *B. gingalensis* SHAW).

\***Acanthropterus**<sup>a</sup> BROOKES, Catal. Mus. Joshua Brookes, Pt. II, July, 1828, p. 100.

Type, "*Acanthropterus bilobus*," or "Two-lobed Spurrwing."

[*Charadriida*.]

"*Ἀκανθῶνα*, thorn, spine; *πτέρωον*, wing.

**Acanthura** GÜLDING, Zool. Journal, III, 1827, p. 407.

Type, "Mr. Stephens \* \* \* \* has separated, under the generic title of *Chactura*, a group of birds which I had named *Acanthura* in my cabinet. \* \* \* *H. acuta* of Stephens may stand as the type"

[*Micropodida*.]

"*Ἀκανθῶνα*, thorn, spine; *οὐρά*, tail.

**Acanthurus** BERTONI, Aves Nuevas del Paraguay, 1901, p. 72.

Type, *Acanthurus microrhynchus* BERTONI (= *Dendrocolaptes erithacus* LICHTENSTEIN).....

[*Dendrocolaptida*.]

"*Ἀκανθῶνα*, thorn, prickle; *οὐρά*, tail. (Bertoni.)

**Accentor**<sup>b</sup> BECHSTEIN, Getreue Abbild. Naturhist. Gegenstände, II, Heft 3, 1797 (Sept., or later), p. 47, pl. 30.

Type, *Accentor aquaticus* BECHSTEIN (= *Sturnus cinclus* LINNÆUS).....

[*Cinclida*.]

*Accentor*, one who sings with another.

**Acritillas** OBERHOLSER, Smithsonian Misc. Coll., Quarterly Issue, XLVIII, No. 2, July 1, 1905, p. 162.

Type, *Crimicor ictericus* STRICKLAND.....

[*Pycnonotida*.]

"*Ἀκριτοῦς*, confused; *ἄλλας*, a thrush. (Oberholser.)

**Acrochordopus** BERLEPSCH and HELLMAYR, Journ. für Orn., LIII, Jan., 1905, p. 26.

Type, *Phyllomyias subviridis* PELZELS.....

[*Tyrannida*.]

"*Ἀκροχορδῶν*, a wart; *ποῦς*, foot. (Berlepsch & Hellmayr.)

**Ægithalus** BILLBERG, Synopsis Fauna Scand., I, Pars 2, 1828, tab. A.

Type, "Les Moustaches Cuv." (= *Parusbiarmicus* LINNÆUS.)

[*Parida*.]

*Ἀγιθάλοϋς*, a titmouse.

**Ægithocichla** SHARPE, Hand-List Birds, IV, 1903, p. 134.

New name for *Cichlopasser* BONAPARTE, on grounds of purism.

[*Turdida*.]

*Ἀγιθῶϋς*, the hedge-sparrow; *κίχλη*, a thrush.

<sup>a</sup>"*Acanthropterus*, Leach" is cited by Gray, Catal. Gen. Birds, 1855, p. 111, as a synonym of *Hoplopterus* BONAPARTE.

<sup>b</sup>This name was later transferred to the Hedge-sparrows by the same author, who then adopted Borkhausen's term *Cinclus* for the Dipper. As *Cinclus* has priority, it follows that *Accentor* can not be used for either group. The earliest available name for the genus now called *Accentor* appears to be *Laiscopus* GLOGER, while that for the family is *Prunellida*.

- Aegithospiza** HELLMAYR, Journ. für Orn., XLIX, April, 1901, p. 171.  
Type, *Parus fringillarius* FISCHER & REICHENOW . . . [*Paridae*.]  
*ἄγυθος*, hedge-sparrow; *σπίζα*, finch.
- Ægypt** BILLBERG, Synopsis Faunæ Scand., I, Pats. 2, 1828, tab. A.  
Type, "*Temia* VAILLANT" (= *Corvus varians* LATHAM).  
(See also *Temia* OKEN.) [*Corvidæ*.]  
*ἄγυπιός*, a vulture.
- Aeronympha** OBERHOLSER, Proc. Biol. Soc. Wash., XVIII, June 29, 1905, p. 161.  
Type, *Aeronympha prosantis* OBERHOLSER . . . . . [*Trochilidæ*.]  
*ἄηρ*, air; *νύμφη*, a Nymph. (Oberholser.)
- Aëronis** BERTONI, Aves Nuevas del Paraguay, 1901, p. 66.  
Type, *Aëronis niveifrons* BERTONI (= *Chætura major* BERTONI, 1900 = *Cypselus senex* TEMMINCK) . . . . . [*Micropodidæ*.]  
*ἄηρ*, air; *ὄρνις*, bird. (Bertoni.)
- \* **Aesalon** MORRIS, in N. Wood's Naturalist, II, No. 9, June, 1837, p. 123.  
Type, "*Aesalon fringillarius*" or "Sparrow Hawk" [of his list of British birds] . . . . . [*Buteonidæ*.]  
*ἄισάλων*, a small hawk.
- Aethia** "MERR." DUMONT, Dict. Sci. Nat. (revised ed.), I, 1816, suppl., p. 71.  
Type, *Aethia cristatella* (= *Alca cristatella* PALLAS) . . [*Alcidæ*.]  
*ἄθουα*, a sea-bird of some kind.
- Aëthocorys** SHARPE, Bull. Brit. Orn. Club, XII, No. LXXXVIII, April 28, 1902, p. 62.  
Type, *Spizocorys personata* SHARPE . . . . . [*Alaudidæ*.]  
*ἄήθης*, unusual, strange; *κόρυς*, a lark.
- Aethostoma** SHARPE, Bull. Brit. Orn. Club, XII, No. LXXXVII, March 28, 1902, p. 54.  
New name for *Trichostoma* BLYTH, 1842, not *Trichostoma* PIC-  
TET, 1834 . . . . . [*Timaliidæ*.]  
*ἄήθης*, unusual, strange; *στόμα*, mouth.
- \* **Aëtus** MORRIS, in N. Wood's Naturalist, II, No. 9, June, 1837, p. 123.  
Types, "*Aëtus pygærgus*," or "Erne," and "*Aëtus aquila*," or  
"Golden Eagle" [of his list of British birds] . . . . . [*Buteonidæ*.]  
*ἄετός*, an eagle.
- Agami** [BLYTH?] in Partington's Brit. Cyclop. Nat. Hist., I, 1836, p. 46.  
New name for *Psophia* LINNÆUS (type, *P. eripitans*).  
[*Psophiidæ*.]

"Most of the ornithological items in this work are said to have been written by Mullie; a few, however, were from Blyth's pen (compare N. Wood's Orn. Text Book, 1836, p. 73).

- Agreutes** BILLBERG, Synopsis Fauna Scand., I, Pars 2, 1828, tab. A.  
 New name for *Duculo* LEACH. . . . . [*Alcedinidæ*.]  
 ἄγρευτός, a hunter, fisherman.
- \***Albellus** C. T. WOOD, Orn. Guide, Jan., 1837, p. 209.  
 Type, "Albellus maculosus, Wood," or "Pied Snew."  
 . . . . . [*Anatidæ*.]  
*Albellus* quasi-diminutive of *albus*, white.
- Aleyon** H. BOIE, Neues Staatsbürgerliches Magazin [Schleswig],<sup>a</sup> i.  
 Heft 2, 1832, p. 491.  
 Type, "Mein Genus Aleyon scheint mit Swainsons Haleyon  
 zusammen zu fallen, wenigstens zieht er collaris dahin."  
 . . . . . [*Alcedinidæ*.]  
 Ἀλευών, the kingfisher.
- \***Aleyon** HODGSON, in Gray's Zool. Misc., No. 3, 1844, p. 82.  
 Types, "Aleyon capensis? v. princeps, H. 221. A. smyrnensis,  
 590. A. calipyga, 769. A. guttata, 364. A. rudis, 365. A.  
 bengalensis, 606" . . . . . [*Alcedinidæ*.]
- Alector** SCHRANK, Fauna Boica, I, 1798, p. 135.  
 Type, *Phasianus gallus* LINNÆUS . . . . . [*Phasianidæ*.]  
 Ἀλέκτωρ, a cock.
- Alector** OKEN, Isis, I, 1817, p. 1184.  
 Based on "Les Alectors (Merrem)," Cuvier, Règne Animal  
 [I, 1817, p. 439 (type, *Circus alector* LINNÆUS)] . . . . . [*Circidæ*.]
- Alectryopelia** VAN DER HOEVEN, Handbuch der Zoologie, 2d. ed., II,  
 1852-1856, p. 449.  
 New name for *Terrulia* FLEMING (type, *Columba carunculata*  
 TEMMINCK) . . . . . [*Incertæ sedis*.]  
 (See *Columbigallina* OKEN.)  
 Ἀλεκτρυών, a cock; πέλεια, the wood pigeon.
- Allocotopterus** RIDGWAY, Proc. Biol. Soc. Wash., XVIII, Sept. 2,  
 1905, p. 209.  
 Type, *Pipra deliciosa* SCLATER . . . . . [*Pipridæ*.]  
 Ἀλλόκοτος, unusual; πτερόν, wing. (Ridgway.)
- <sup>a</sup>The several names quoted from this volume are extracted from a paper entitled:  
 "Briefe von Heinrich Boie geschrieben aus Ostindien und auf der Reise dahin," occu-  
 pying pages 126-218; 440-500; in all, 16 letters, with a prefatory note by F. Boie.  
 The paper exists also as a repaged brochure, and citations from it in ornithological  
 literature invariably bear the title "Briefe geschr. aus Ostindien," which, with the  
 altered pagination, effectually disguises it.
- It may be interesting to observe here that *Picus porphyrogaster*, the one species  
 always quoted from this paper, is a pure *nomen nudum*, and will have to be set  
 aside for *Picus melanogaster* HAY, 1845. (See also note under *Dendrochilidæ*.)

- Alopochelidon** RIDGWAY, Proc. Biol. Soc. Wash., XVI, Sept. 30, 1903, p. 106.  
 Type, *Hirundo fucata* TEMMINCK.....[*Hirundinidæ*.]  
 ἄλωπος, fox-colored; χελιδών, swallow. (Ridgway.)
- Amandava**<sup>a</sup> BLYTH, in White, Nat. Hist. Selborne, 1836, p. 44 (note).  
 Type, *Amandava punctata* BLYTH (= *Fringilla amandava* LINNÆUS).....[*Ploceidæ*.]  
 Name of the type-species, from the town of Ahmadabad, India.
- Amblyrhynchus** NUTTALL, Manual of Orn., Water Birds, 1834, p. 247.  
 Type, *Tringa glacialis* GMELIN (= *Tringa fulvicaria* LINNÆUS).  
 [Phalaropodidæ.]  
 ἄμβλυρός, blunt; ῥύγχος, bill, beak.
- †**Aminornis** AMEGHINO, Sinopsis geol.-paleon., Suplemento, 1899, p. 9.  
 Type, *Aminornis crecaratus* AMEGHINO.....[*Gruidæ*.]  
 ἄμεινων, better, superior; ὄρνις, bird. (Ameghino MS.)
- Ammomanoides** BIANCHI, Bull. Acad. Imp. Sci. St.-Petersb., 5th ser., XXI, No. 4, Nov., 1904, pp. 232, 241; Otto, Journ. für Orn., 1905, p. 612.  
 Type, *Mirafra phoenicuroides* BLYTH.....[*Alaudidæ*.]  
 (Proposed as a subgenus of *Ammomanes*.)  
*Ammomanes* (ἄμμος, sand; μαινόμεαι, I am mad, rage [with love]) + εἶδος, resemblance.
- Ammomanopsis** BIANCHI, Bull. Acad. Imp. Sci. St.-Petersb., 5th ser., XXI, No. 4, Nov., 1904, pp. 232, 241; Otto, Journ. für Orn., 1905, p. 611.  
 Type, *Alauda grayi* WAHLBERG.....[*Alaudidæ*.]  
 (Proposed as a subgenus of *Ammomanes*.)  
*Ammomanes* (ἄμμος, sand; μαινόμεαι, I am mad, rage [with love]) + ὄψις, appearance.
- Ampopasser**<sup>b</sup> ZARUDNY, Bull. Soc. Imp. Nat. Moscou, new ser., IV, No. 1, 1890, pp. 9, 20.  
 Type, *Passer ammodendri* SEVERTZOV.....[*Fringillidæ*.]  
 ἄμπος, sand; + *passer*, a sparrow.
- Ampospiza** OBERHOLSER, Smithsonian Misc. Coll., Quarterly Issue, XLVIII, No. 1, May 13, 1905, p. 68.  
 Type, *Oriolus caudatus* GMELIN.....[*Fringillidæ*.]  
 (See *Passer herbulus*.)  
 ἄμπος, sand; σπίζα, finch. (Oberholser.)
- \***Ampelis** MORRIS, in N. Wood's Naturalist, II, No. 9, June, 1837, p. 124.  
 Type, "*Ampelis garrula*" or "Roller" [of his list of British birds].....[*Coraciidæ*.]  
 ἄμπελλίς, a kind of singing bird.

<sup>a</sup>*Amandava* should replace *Sporogynthus* CABANIS, 1850.

<sup>b</sup>Not designated as new here, and probably used by some earlier writer.

- Anabathmis** REICHENOW, *Vögel Afrikas*, III, ii, Oct., 1905, p. 467.  
 Types, *Nectarinia thomensis* BOCAGE, *N. reichenbachii* HARTLAUB, *N. hartlaubi* HARTLAUB, and *Cinnyris newtoni* BOCAGE.  
 [Nectariniidæ.]  
 Ἄναβαθμίς, a step.
- Ancistroa** BILLBERG, *Synopsis Faunæ Scand.*, I, Pars 2, 1828, tab. A.  
 Type, *Columba curvirostra* GMELIN. . . . . [Trogonidæ.]  
 Ἄγκιστρον, a fish-hook.
- Anecorhamphus** BILLBERG, *Synopsis Faunæ Scand.*, I, Pars 2, 1828, tab. A.  
 New name for *Nirops* ILLIGER. . . . . [Furnariidæ.]  
 Ἄνῆκω, I reach up to; ῥάμφος, beak.
- \***Anerpous** TEMMINCK, *Trans. Linn. Soc. Lond.*, XIII, Pt. 1, 1824, p. 108.  
 Type, not designated; a *nomen nudum* here. . . . [Incertæ sedis.]
- Anisoramphæ** DUMONT, *Dict. Sci. Nat.*, IV, 1805, p. 173.  
 Possibly only a vernacular name for *Rynchops*; see note under *Psalidoramphos*. . . . . [Rynchopidæ.]  
 Ἄνισος, unequal; ῥάμφος, beak.
- Anomalospiza** SHELLEY, *Bull. Brit. Orn. Club*, XII, No. LXXXIII, Nov. 30, 1901, p. 30.  
 Type, *Scrinus vernalis* TRISTRAM. . . . . [Ploceidæ.]  
 Ἄνωμαλος, unusual; σπιζα, finch.
- Anseria** RAFINESQUE, *Principes Fond. Somiologie*, 1814, p. 27.  
 New name for *Anser* BRISSON. . . . . [Anatidæ.]  
 Ἄνσερ, the goose.
- Anteliocichla** OBERHOLSER, *Proc. U. S. Nat. Museum*, XXVIII, No. 1411, July 8, 1905, p. 901.  
 Type, *Acrocephalus bistrigiceps* SWINHOE. . . . . [Sylviidæ.]  
 Ἀντήλιος, eastern; κίχλη, thrush. (Oberholser.)
- Anthoscenus** RICHMOND, *Proc. Biol. Soc. Wash.*, XV, April 25, 1902, p. 85.  
 New name for *Floricola* ELLIOT, 1878, not *Floricola* GISTEL, 1848. (Type, *Trochilus longirostris* VIELLOT.) . . . . [Trochilidæ.]  
 Ἄνθος, a flower; σκήτρος, a hut, tent.
- †**Anthropornis** WIMAN, *Bull. Geol. Inst. Univ. Upsala*, VI, Pt. 2, 1905, p. 249.  
 Type, *Anthropornis nordenskjöldii* WIMAN. . . . . [Spheniscidæ.]  
 Ἀνθρωποσ, man; ὄρνις, bird.

a "Nouveau genre composé de trois espèces inédites."



**Antisianus**<sup>a</sup> FITZINGER, Sitz. k. Akad. Wiss. (Math.-Nat. Classe) [Wien], XXI, Heft 2, July, 1856, p. 294.

Type, *Trogon antisianus* D'ORBIGNY ..... [*Trogonidæ*.]  
Latinized from *Antis*, name of a Peruvian Indian tribe.

**Apatema** REICHENOW, Vögel Afrikas, III, ii, Oct., 1905, p. 523.

Type, *Parisoma olivascens* CASSIN ..... [*Muscicapidæ*.]  
<sup>γ</sup> *Ἀπάτημα*, deceit, cunning.

**Aphanotriccus** RIDGWAY, Proc. Biol. Soc. Wash., XVIII, Sept. 2, 1905, p. 207.

Type, *Myiobius capitalis* SALVIN ..... [*Tyrannidæ*.]  
<sup>γ</sup> *Ἀφανήης*, unseen, obscure; *τρίκκος*, a small bird. (Ridgway.)

**Aprunella** BIANCHI, Annuaire Mus. Zool. Acad. Imp. Sci. St.-Petersb., IX, No. 1-2, 1904, pp. 118, 154.

Type, *Accentor immaculatus* HODGSON ..... [*Prunellidæ*.]  
<sup>γ</sup> *Ἀ*, intensivum; + *Prunella*.

**Aptenodytes** MILLER, Various Subjects of Natural History, No. 4, 1778, pl. 23.<sup>b</sup>

Type, *Aptenodytes patagonica* MILLER ..... [*Spheniscidæ*.]  
<sup>γ</sup> *Ἀπτιήν*, wingless; *δύτης*, diver.

† **Apterodytes** AMEGHINO, Anales Soc. Cien. Argentina, LI, 1901, p. 81.

Type, *Apterodytes ictus* AMEGHINO ..... [*Spheniscidæ*.]  
(See *Palaeoapterodytes*.)

<sup>γ</sup> *Ἀπτερος*, without wings; *δύτης*, a diver.

**Aquilaster** C. L. BREHM, Allg. Deutsche Naturhist. Zeitung, Neue Folge, II, Heft 2, 1856, p. 53.

Type, *Falco bonelli* TEMMINCK ..... [*Buteonidæ*.]  
*Aquila*, the eagle; + *astur*, a hawk.

**Arachnothera** TEMMINCK, Planches Col., IV (Livr. 65), May, 1826, text to pl. 388, fig. 1.

Types, *Nectarinia chrysocephala*, *N. longirostra*, and *N. inornata* TEMMINCK<sup>c</sup> ..... [*Nectariniidæ*.]

<sup>γ</sup> *Ἀράχνη*, a spider; *θηράω*, I hunt, pursue.

† **Archæocygnus** DE VIS, Annals Queensl. Museum, No. 6, Sept. 30, 1905, p. 11.

Type, *Archæocygnus lacustris* DE VIS ..... [*Anatidæ*.]  
<sup>γ</sup> *Ἀρχαῖος*, ancient; *κύκνος*, a swan.

<sup>a</sup> *Antisianus* is quoted by Agassiz as dating from "D'Orb. Mag. de Zool. 1836," but the name really occurs in the volume for the following year (VII, 1837, Class ii, pl. 85), where it is used in a specific sense only, in the title of d'Orbigny's paper, thus:

"COUROUCOU. Trogon. *Linneæ*.  
*Antisien*. *Antisianus*. D'Orb."

On the plate accompanying the paper the name appears as "*Trogon antisianus*."

<sup>b</sup> The same plate occurs in Shaw and Miller's *Cimelia Physica*, 1796. (Compare RILEY, Auk, 1908, p. 269.)

<sup>c</sup> Boie, Isis, 1826, p. 974, gives *N. longirostra* as the type.

**Argaleocichla** OBERHOLSER, Smithsonian Misc. Coll., Quarterly Issue, XLVIII, No. 2, July 1, 1905, p. 160.

Type, *Trichophorus icterinus* BONAPARTE . . . [*Pycnonotida*.]  
 Ἀργαλέοσις, difficult; κίχλη, thrush. (Oberholser.)

**Argus**<sup>a</sup> TEMMINCK, Catal. Systemat., 1807, p. 149.

Type, *Argus giganteus* TEMMINCK (= *Phasianus argus* LINNEUS).  
 [Phasianida.]

*Argus*, the hundred-eyed guardian of Io.

†**Argyrodyptes** AMEGHINO, Anales Mus. Nac. Buenos Aires, 3d ser., VI, Nov. 30, 1905, p. 121.

Type, *Argyrodyptes microtarsus* AMEGHINO . . . [*Spheniscida*.]  
 Ἀργυροϋς, silver, *i. e.* La Plata; δὲπτης, a diver. (Ameghino, MS.)

**Arizelocichla** OBERHOLSER, Smithsonian Misc. Coll., Quarterly Issue, XLVIII, No. 2, July 1, 1905, p. 163.

Type, *Xenocichla nigricaps* SHELLEY . . . [*Pycnonotida*.]  
 Ἀρίζηλος, distinct; κίχλη, thrush. (Oberholser.)

**Arizelomyia** OBERHOLSER, Proc. U. S. Nat. Museum, XXVIII, No. 1411, July 8, 1905, p. 910.

Type, *Muscicapa latirostris* RAFFLES . . . [*Muscicapida*.]  
 Ἀρίζηλος, distinct; μύια, a fly. (Oberholser.)

**Arizelopsar** OBERHOLSER, Proc. U. S. Nat. Museum, XXVIII, No. 1411, July 8, 1905, p. 887.

Type, *Pholidopus fimoralis* RICHMOND . . . [*Sturnida*.]  
 Ἀρίζηλος, distinct; ψάρ, starling. (Oberholser.)

†**Arthrodytes** AMEGHINO, Anales Mus. Nac. Buenos Aires, 3d ser., VI, Nov. 30, 1905, p. 143.

Type, *Paraptydytes grandis* AMEGHINO . . . [*Spheniscida*.]  
 Ἀρθροϋν, a joint, limb; δὲπτης, a diver. (Ameghino, MS.)

\***Ascalaphus**<sup>b</sup> MORRIS, in N. Wood's Naturalist, II, No. 9, June, 1837, p. 123.

Types, "*Ascalaphus auritus*," or "Long-eared Owl," and "*Ascalaphus subauritus*," or "Short-eared Owl" [of his list of British birds] . . . [*Strigida*.]  
 Ἀσκάλαφος, a bird, supposed to be a kind of owl.

<sup>a</sup> *Argus* is preoccupied by *Argus* BOHAUSCH, 1761, and *Argus* SCOPOLI, 1777. *Argusianus* RAFFINESQUE, 1815, now employed for the Argus Pheasant, is a pure *nomen nudum* at that date, and as a valid generic name will have to be cited from Gray, Cat. Genera and Subgenera of Birds, 1855, p. 103. (See also, *Bremus*.)

<sup>b</sup> *Ascalaphia* of my earlier list requires correction as follows: Geoffroy mentions no type, but gives a diagnosis, viz.: "Ce genre a été établi par le professeur pour un oiseau à aigrettes dont les ailes sont courtes, mais construites sur le type aigu, et qui se trouve en Egypte et quelques autres parties de l'Afrique."

- \* *Asterias* MORRIS, in N. Wood's Naturalist, II, No. 9, June, 1837, p. 123.  
 Type, "*Asterias palumbarius*," or "Goshawk" [of his list of British birds] ..... [*Butoridæ*.]  
 Ἀστερίας, a kind of mottled falcon.
- Asturaëtos C. L. BREHM, Naumannia, 1855, Heft I, p. 26.  
 Types, "*Aquila Bonelli, limnaëtos* etc." ..... [*Butoridæ*.]  
 Ἀstur, a hawk; + ἄετός, an eagle.
- † *Asturaetus*<sup>a</sup> DE VIS, Annals Queensl. Museum, No. 6, Sept. 30, 1905, p. 6.  
 Type, *Asturactus furcillatus* DE VIS ..... [*Butoridæ*?]
- Atalotriccus RIDGWAY, Proc. Biol. Soc. Wash., XVIII, Sept. 2, 1905, p. 208.  
 Type, *Colaptes pilaris* CABANIS ..... [*Tyrannidæ*.]  
 Ἀταλός, delicate; τρῖκκος, a small bird. (Ridgway.)
- Atimastillas OBERHOLSER, Smithsonian Misc. Coll., Quarterly Issue, XLVIII, No. 2, July 1, 1905, p. 155.  
 Type, *Hæmatornis flavicollis* SWAINSON ..... [*Pyrenotidæ*.]  
 Ἀτίμαστος, neglected; ἄλλας, thrush. (Oberholser.)
- Attagen OKEN, Isis, I, 1817, p. 1184.  
 Based on "*Ganga ou d'Attagen*. (Pterocles. Tem.)" CUVIER, Règne Animal [I, 1817, 450 (type, *Tetrao alchata* LINNÆUS)].  
 [Pteroclidæ.]  
 Attagen, a bird living in marshes.
- † *Aucornis* AMEGHINO, Sinopsis geol.-paleon., Suplemento, 1899, p. 9.  
 Types, *Aucornis curyrhynchus* and *A. solidus* AMEGHINO.  
 [Stereornithes.]  
 Ἀῶξον, great, large; ὄρνις, bird. (Ameghino, MS.)
- Auga BILLBERG, Synopsis Faunæ Scand., I, Pars 2, 1828, tab. A.  
 New name for *Galbula* BRISSON ..... [*Galbulidæ*.]  
 Ἀυγέω, I shine, glitter.
- \* *Aurella* C. T. WOOD, Orn. Guide, Jan., 1837, p. 215.  
 Type, "*Aurella ciris*," or "Painted Nonparel" ..... [*Fringillidæ*.]  
*Aurella*, diminutive of *aura*, a bright light, a glitter.
- Autruchon TEMMINCK, Manuel d'Ornith., 2d ed., IV, 1840, p. 347.  
 Type, "Gralle bi-dactyle" of LEVAILLANT ..... [*Struthionæ*.]  
 Latinized from the French, *autruche*, an ostrich.
- \* *Bacha* JAMESON, Calcutta Journ. Nat. Hist., I, 1840, p. 320.  
 Type, not designated; a *nomen nudum* here ..... [*Butoridæ*.]  
 Name of a hawk (*Spilornis bacha*),<sup>b</sup> from Levaillant.

<sup>a</sup> *Asturactus* DE VIS is preoccupied by *Asturaëtos* BREHM. In a recent letter Mr. De Vis suggests as a substitute *Plioactus*, which I now formally adopt.

<sup>b</sup> J. R. Förster named this species *Falco bassus* (Naturgesch. African. Vögel, 1798, p. 55). The bird should therefore be called *Spilornis bassus*.

- \* **Balanephagus** MORRIS, in N. Wood's Naturalist, II, No. 9, June, 1837, p. 124.  
 Type, "*Balanephagus garrulus*," or "Jay" [of his list of British birds] . . . . . [*Corvidæ*.]  
*Βάλανος*, an acorn; *φαγεῖν*, to eat.
- Barbilanius** DUMONT, Diet. Sci. Nat., IV, 1805, p. 185.  
 Type, "Bec-de-fer" of LEVAILLANT (*Lanius superbus* SHAW; and genus *Sparactes* HILIGER, 1811) . . . . . [*Incerta sedis*.]  
*Barba*, a beard; *lanius*, a butcher.
- Barnesia** BERTONI, Aves Nuevas del Paraguay, 1901, p. 77.  
 Type, *Synallaxis curururi* BERTONI (= *S. ruficapilla* VIEILLOT).  
 (Proposed as a subgenus of *Synallaxis*) . . . . . [*Furnariidæ*.]  
 For Carlos St. Barnes. (Bertoni.)
- Basanistes** LICHTENSTEIN, Verz. Samml. Kaffernlande, 1842, p. 12.  
 Type, *Basanistes cissoides* LICHTENSTEIN . . . . . [*Laniidæ*.]  
*Βασανιστής*, an examiner, torturer.
- Bathmedonia** REICHENOW, Journ. für Orn., LH, Jan., 1904, p. 134.  
 New name for *Bathmocercus* REICHENOW, 1895, not *Bathmocercus* FITZINGER, 1863 . . . . . [*Timaliidæ*.]  
*Βαθμηδόν*, by steps.
- Bergia** BERTONI, Aves Nuevas del Paraguay, 1901, p. 86.  
 Type, *Bergia solanorum* BERTONI (= *Tamagra leucoccephala* VIEILLOT) . . . . . [*Tamagridæ*.]  
 For Dr. Carlos Berg. (Bertoni.)
- Berlepschia** BERTONI, Aves Nuevas del Paraguay, 1901, p. 114.  
 Type, *Berlepschia chrysoblephara* BERTONI (= *Tityra viridis* VIEILLOT)<sup>a</sup> . . . . . [*Cotingidæ*.]  
 For Hans, Graf von Berlepsch. (Bertoni.)
- Bernicla** OKEN, Isis, I, 1817, p. 1183.  
 Based on "Les Bernaches" CUVIER, Règne Animal [I, 1817, p. 531 (type, *Anas bernicla* LINNÆUS)]. . . . . [*Anatidæ*.]
- Biarmicus** C. L. BREHM, in Homeyer, Ornith. Briefe, 1881, p. 52.  
 Type, *Biarmicus russicus* (= *Mystacinus russicus* BREHM).  
 . . . . . [*Paridæ*.]  
 "*Biarmicus* = of Perm. in Eastern Russia." (B. O. U. list of British Birds, p. 25).
- Botha** SHELLEY, Birds of Africa, III, 1902, p. 104.  
 Type, *Botha djijicilis* SHELLEY . . . . . [*Alaudidæ*.]  
 (See *Directia*.)  
 For General Louis Botha.

<sup>a</sup>Compare ARRIBALZAGA, Anales Mus. Nac. Buenos Aires, VII, 1902, p. 389.

\* **Brachydactyla** BROOKES, Catal. Mus. Joshua Brookes, Pt. II, July, 1828, p. 84.

Type, "*Brachydactyla temminckii*," or "Temminck's Short-toe." (Belongs in the group "Sylviana" of Vigors.)

[*Incertæ sedis*.]

*Βραχύς*, short; *δάκτυλος*, a finger.

**Brachyrhamphus** BERTONI, Aves Nuevas del Paraguay, 1901, p. 46.

Type, *Brachyrhamphus elegans* BERTONI (= *Cissopis major* Cabanis) ----- [Tangaridae.]

*Βραχύς*, short; *ῥάμφος*, bill. (Bertoni.)

**Bremus**<sup>a</sup> BILLBERG, Synopsis Faune Scand., I, Pars 2, 1828, tab. A.

New name for *Argus* TEMMINCK ----- [Phasianidae.]

**Brevipes**, "P." [= S. PALMER]. Analyst, IV, No. XV, April 1, 1836, p. 101.

Alternative name for *Brachypus* MEYER ----- [Micropodidae.]

*Brevis*, short; *pes*, foot.

\* **Brevitarsus** JAMESON, Calcutta Journ. Nat. Hist., I, 1840, p. 320.

Type, not designated, a *nomen nudum* here ----- [Buteonidae.]

*Brevis*, short; *tarsus*, the tarsus.

**Budythanus** DAVID, Norv. Arch. du Mus., III, Fasc. 4 (Bull.), 1867, p. 33.

Type, *Budythanus torquatus* DAVID (= *Motacilla indica* GMELIN) ----- [Motacillidae.]

*Budytes* (*Βουθύτης*, supposed to be the wagtail), + *Anthus* (*ἄρθος* a small bird).

**Büttikoferia** MADARÁSZ, Bull. Brit. Orn. Club, XII, No. LXXXVI, Feb. 28, 1902, p. 49.

New name for *Mülleria* BÜTTIKOFER, 1895, preoccupied.

[*Timaliidae*.]

For Dr. John Büttikofer.

\* **Buteopernis** JAMESON, Calcutta Journ. Nat. Hist., I, 1840, p. 320.

Type, not designated, a *nomen nudum* here ----- [Buteonidae.]

*Buteo*, a kind of hawk; + *Pernis* (*πέρνης*, a bird of prey).

\* **Byas** MORRIS, in N. Wood's Naturalist, II, No. 9, June, 1837, p. 123.

Type, "*Byas nobilis*," or "Eagle Owl" [of his list of British birds] ----- [Strigidae.]

*Βιάς*, the owl.

<sup>a</sup> *Bremus* is preoccupied by *Bremus* JURINE, 1807, and *Bremus* PANZER, ——. It would otherwise replace *Argusianus* RAFINESQUE, 1815, since that is a pure *nomen nudum*, being simply a substitute name for "*Argus* R.," also a *nomen nudum*. As there is no other available name, we shall have to adopt *Argusianus* from Gray, 1855, who appears to have been the first to use it in an orthodox manner. (See *Argus*.)

- \***Byssura** MORRIS, in N. Wood's Naturalist, II, No. 9, June, 1837, p. 124.  
 Type, "*Byssura bohemicæ*," or "Silk-tail" [of his list of British birds].....[*Bombycillidæ*.]  
*Βύσσος*, fine flax, silk; *οὐρά*, tail.
- Calamornis** GOULD, Birds of Asia, III, Pt. XXVI, 1874, pp. 74, viii.  
 Type, *Paradorornis haulti* DAVID .....[*Paridæ*.]  
 (Proposed as a subgenus of *Paradorornis*.)  
*Κάλαμος*, a reed; *ὄρνις*, bird.
- Calandra** OKEN, Isis, I, 1817, p. 1184.  
 Based on "Les Calandres." CUVIER, Règne Animal [I, 1817, p. 378 (type, *Alauda calandra* LINNÆUS)].....[*Alaudidæ*.]  
 (See also: *Corydus* BILLBERG.)  
*Κάλανδρα*, a kind of lark.
- Calandrina** BLYTH, Journ. Asiatic Soc. Bengal, XXIV, 1855, p. 265 (note).  
 Type, *Melanocorypha torquata* BLYTH .....[*Alaudidæ*.]  
 Diminutive of *Calandra* (*Κάλανδρα*, a kind of lark).
- Calobates** TEMMINCK, Planches Col., III (Livr. 91), Dec., 1832, p. 538.  
 Type, *Calobates gallicus* TEMMINCK .....[*Cuculidæ*.]  
*Καλός*, beautiful; *βάτης*, one that treads or covers.
- Calyptocichla** OBERHOLSER, Smithsonian Misc. Coll., Quarterly Issue, XLVIII, No. 2, July 1, 1905, p. 165.  
 New name for *Trichites* HEINE, 1860, not *Trichites* LYCETT, 1850. (Type, *Crinifer serinus* VERREAUX).....[*Pycnonotidæ*.]  
*Καλυπτός*, covered, and thus hidden; *κίχλη*, a thrush. (Oberholser.)
- \* **Campylops**<sup>a</sup> LICHTENSTEIN, Verz. Samml. Kafferlande, 1842, p. 23.  
 • Type, *Campylops hamulus* LICHTENSTEIN, a *nomen nudum* here.....[*Cuculidæ*.]  
*Καμπύλος*, bent, curved; *ὄψις*, face, countenance.
- Campylorhamphus**<sup>b</sup> BERTONI, Aves Nuevas del Paraguay, 1901, p. 70.  
 Type, *Campylorhamphus longirostris* BERTONI (= *Dendrocolaptes procerus* TEMMINCK).....[*Dendrocolaptidæ*.]  
*Καμπύλος*, bent, curved; *ράμφος*, bill. (Bertoni.)
- Cannabia** BILLBERG, Synopsis Faune Scand., I, Pars 2, 1828, tab. A, and p. 31.  
 Types, *Cannabia propria* BILLBERG (= *Fringilla cannabina* LINNÆUS), and *Fringilla flavirostris* LINNÆUS.....[*Fringillidæ*.]  
 "Nomen gener. *ε* *Κάνναβιος*, qui de *Cannabi* civit, derivare nobis necesse fuit, quoniam hoc generis diversum videtur et denominatio *Curvici*, *cardualis*, (verbum adjectivum) ut nomen genericum inaptum est." (Billberg.)

<sup>a</sup>This name is mentioned by Gray (List Gen. Birds, 2d ed., p. 102) in 1841, and doubtless was used by Lichtenstein in some obscure catalogue of earlier date. Gray, in 1855, cites it as "Licht. 1837."

<sup>b</sup>This name antedates and should supersede *Xiphornis* OBERHOLSER. (See *Xiphornis*.)

- "**Capparis** ISERT," mentioned by Waterhouse (and also by Sherborn), is a plant. Sherborn records a species, "*erythrocarpus*," under this genus in his "Index Animalium."
- \* **Capricalea** "NILS." S. D. W., Analyst, III, No. XIV, Jan., 1836, p. 206.  
Type, "*Capricalea arborea*" (= "*Tetrao arborea*" of the same author) ..... [*Tetraonidae*.]  
Latinized from capereaille.
- \* **Carya** BILLBERG, Synopsis Faunæ Scand., I, Pars 2, 1828, tab. A.  
For one of Cuvier's groups of *Alcedo* (possibly intended to replace *Ceyx*, as he does not use that name) ..... [*Alcedinidae*.]  
*Καπύω*, I breathe, gasp.
- \* **Caricicola** C. L. BREHM, Isis, XXVIII, Heft 3, 1835, p. 245.  
For "die Riedgrassänger" (Type, *Sylvia paludicola* VIEILLOT<sup>a</sup>).  
[*Sylviidae*.]  
*Carix*, reed-grass, sedge; *colo*, I inhabit.
- Carites** BILLBERG, Synopsis Faunæ Scand., I, Pars 2, 1828, tab. A, and p. 143.  
New name for *Totanus*,<sup>b</sup> with the following species: *Scolopax fusca* LINNÆUS, 1766, not 1758 (= *S. erythropus* PALLAS, 1764), *S. calidris* LINNÆUS, *Totanus stagnatilis* BECHSTEIN, *Tringa ochropus* LINNÆUS, *T. glareola* LINNÆUS, and *T. hypoleucos* LINNÆUS. .... [*Scolopacidae*.]  
"Καριτης, eques; gallicum Chevalier." (Billberg.)
- Carpophaga**<sup>c</sup> BILLBERG, Synopsis Faunæ Scand., I, Pars 2, 1828, tab. A.  
New name for *Phenicophanus* VIEILLOT ..... [*Cuculidae*.]  
*Καρπός*, fruit; *φαγεῖν*, to eat.
- \* **Casmarhynchus**<sup>d</sup> REICHENBACH, Avium Syst. Nat., June 1, 1850, pl. LXXVIII (figure showing generic characters).  
Type, not named ..... [*Fringillidae*.]
- Cataractes** S. D. W., Analyst, IV, No. XVI, July, 1836, p. 296.  
Type, *Falco candicans* GMELIN ..... [*Falconidae*.]  
*καταρράκτης*, a bird of prey.
- \* **Cedola** BROOKES, Museum Brookesianum, Feb., 1830, p. 97.  
Type, "*Cedola senegalensis*" BROOKES, or "Senegal Cedola."  
[*Incertæ sedis*.]  
*Cedola*, anagram of *alcedo*.

<sup>a</sup> Compare Oberholser, Proc. U. S. Nat. Mus., XXVIII, 1905, pp. 898, 899.

<sup>b</sup> He writes: "*Totanus* auctorum recentiorum nomen est nec latinum nec græcum, unde rejiciendum."

<sup>c</sup> *Carpophaga* SELBY, 1835, is preoccupied by the above, as well as by *Carpophagus* MACLEAY, 1827. *Muscivora* GRAY (Catal. Gen. Birds, 1855, p. 98) seems to be the earliest available name to replace it.

<sup>d</sup> Not *Casmarhynchus* TEMMINCK, 1820, a member of the Cotingidae.

- Cela** OKEN, Lehrbuch der Naturgesch., III, Zool., 2 Abth., 1816, p. 646.  
 Type, *Struthio casuarius* LINNÆUS<sup>a</sup> [Casuariidae.]  
 Κέλυξ, a courser, race-horse.
- Cephus** WAGLER, Systema Avium, I, 1827, [p. 145].  
 Type, *Cephus scopus* WAGLER (= *Scopus umbretta* GMELIN). [Scopidae.]  
 Κέπφος, a light sea-bird; a booby.
- Ceraphanes** BERTONI, Aves Nuevas del Paraguay, 1901, p. 115.  
 Type, *Ceraphanes anomalus* BERTONI (= *Myiagrus lineatus* WIED) [Conopophagidae.]  
 Κεραψ, horn; φαίνω, I show, make known. (Bertoni.)
- \***Cerchne** MORRIS, in N. Wood's Naturalist, II, No. 9, June, 1837, p. 123.  
 Types, " *Cerchne pennipes*," or "Rough-legged Buzzard," and " *Cerchne buteo*," or "Buzzard" [of his list of British birds]. [Butoridae.]  
 Κέρχνη, a kind of hawk.
- Chaja** OKEN, Lehrbuch der Naturgesch., III, Zool., 2 Abth., 1816, p. 639.  
 Type, *Chaja torquata* OKEN<sup>b</sup> [Palamedidae.]  
 (Proposed as a subgenus of *Palamedea*.)  
*Chajá*, the native name quoted by Azara.
- Chamæbates** BERTONI, Aves Nuevas del Paraguay, 1901, p. 150.  
 Type, *Chamæbates rapiventris* BERTONI (= *Grallaria imperator* LAFRESNAYE) [Fornicariidae.]  
 Χαιβά, on the ground; βάτης, one that treads or covers. (Bertoni.)
- Charadriola** MADARÁSZ, Ann. Hist.-Nat. Mus. Nat. Hung., II, Pars 2, Nov. 30, 1904, p. 400.  
 Type, *Charadriola singularis* MADARÁSZ (= *Macronyx tenellus* CABANIS). (= *Tinctathylacus* CABANIS.) [Motacillidae.]  
 Diminutive of *Charadrius*, a plover.
- Charitillas** OBERHÖLSEK, Smithsonian Misc. Coll., Quarterly Issue, XLVIII, No. 2, July 1, 1905, p. 168.  
 Type, *Andropadus gracilis* CABANIS [Pycnonotidae.]  
 Χάρις, grace; ἄλλας, thrush. (Oberholser.)

<sup>a</sup>The emu is also included with a query. (See also, *Oryzopsis* and *Thrasys*.)

<sup>b</sup>The species generally known as *Chauna cristata* (SWAINSON), requires another name, since *Palamedea cristata* of Swainson is preoccupied by *Palamedea cristata* LINNÆUS. The species should stand as *Chauna torquata* (OKEN), as this name is long anterior to that proposed by Swainson.



**Charitospiza** OBERHOLSER, Smithsonian Misc. Coll., Quarterly Issue, XLVIII, No. 1, May 13, 1905, p. 67.

New name for *Tiaris* of authors, not of Swainson. (Type, *Charitospiza eucosma* OBERHOLSER = *Fringilla ornata* WIED, not VIEILLOT.) ----- [*Fringillidæ*.]

Χάρις, grace; σπιζα, a finch. (Oberholser.)

\* **Chelarga** BILLBERG, Synopsis Faunæ Scand., I, Pars 2, 1828, tab. A.

Type, *Casuarus novæ hollandiæ* LATHAM!<sup>a</sup> ----- [*Dromicidæ*.]  
Χηλαργός, with fleet hoofs.

**Chelido** BILLBERG, Synopsis Faunæ Scand., I, Pars 2, 1828, tab. A, and p. 193.

New name for *Sterna* LINNÆUS, with the following species: *Sterna caspia* PALLAS, *S. cantiaca* LINNÆUS, *S. dougalli* MONTAGU, *S. hirundo* LINNÆUS, *S. minuta* LINNÆUS, 1766 (= *S. albifrons* PALLAS, 1764) and *S. nigra* LINNÆUS ----- [*Laridæ*.]  
*Quum* nom. gener. *omni derivatione caret, nisi e nomine Succano formatum, græcum Χελιδών, Hirundo marina, conservavimus.*" (Billberg.)

**Chelidorhamphus** BERTONI, Aves Nuevas del Paraguay, 1901, p. 102.

Type, *Chelidorhamphus orhycterus* BERTONI (= *Tersina cærulea* VIEILLOT) ----- [*Procnitidæ*.]  
Χελιδών, a swallow; ράμφος, bill, beak. (Bertoni.)

\* **Chiasoramphe** DUMONT, Dict. Sci. Nat., IV, 1805, p. 177.

Possibly only a vermacular name for *Crucirostra*.<sup>b</sup>

[*Fringillidæ*.]

Χιάζω, I place crosswise; ράμφος, beak. (Dumont.)

**Chlorestrida** SHELLEY, Birds of Africa, IV, Pt. I, 1905, p. 176.

Type, *Pytelia ansorgei* HARTERT ----- [*Ploccidæ*.]  
Χλωρός, pale green; + *Estrilda*.

\* **Chloreus** MORRIS, in N. Wood's Naturalist, II, No. 9, June, 1837, p. 124.

Type, "*Chloreus oriolus*," or "Golden Oriole" [of his list of British birds] ----- [*Oriolidæ*.]

Χλωρεύς, a greenish or yellowish bird.

<sup>a</sup> Billberg writes simply: "3. *Thrasys* B. et 4. *Chelarga* B. (*Casuarus* Briss.)." As he refers in many cases to Cuvier, it is very probable that he here intended to name the two species in the "Règne Animal," restricting *Thrasys* to *Casuarus*, and *Chelarga* to *Casuarus novæ hollandiæ* LATHAM.

<sup>b</sup> "Si la dénomination de bec-croisé n'étoit pas consacrée par un ancien usage, et devenue en quelque sorte populaire, on auroit pu lui substituer celle de *chiasoramphe*, dérivée de χιάζω (*chiaso*), je croise, et de ράμφος (*rampfos*), bec; mais il auroit été difficile d'habituer les oreilles à ce changement, et l'on n'a appliqué des noms ainsi formés qu'à des oiseaux moins connus."

- Chlorion** TEMMINCK, Planches Col., I (Livr. —?), 1836?, (tabl. méth.), p. 40.  
Types, *Emberizoides melanotis* TEMMINCK, and *E. marginalis* TEMMINCK (= *Sylvia herbicola* VIEILLOT) . . . . . [Fringillida.]  
*Χλωρίων*, "nom grec de notre Bruant." (Temminck.)
- Chrysaëtus** SWEETING, in N. Wood's Naturalist, II, No. 12, Sept., 1837, p. 303.  
Type, *Chrysaëtus aquilinus* SWEETING (based on the "Golden Eagle, or *Aquila aura* of Willughby") . . . . . [Buteonida.]  
*Χρυσῶς*, gold; *ἀετός*, an eagle.
- Chrysocantor** MAYNARD, Warblers of New England, Pt. III, 1901, p. 58.  
Type, *Motacilla astiva* GIMELIN . . . . . [Motacillida.]  
*Chrysos* (χρυσῶς), gold; *cantor*, a singer.
- Chrysotilopicus** MALHERBE, Revue Zool., VIII, 1845, p. 403.  
Type, *Picus (Chrysotilopicus) smithii* MALHERBE . . . [Picida.]  
(Proposed as a subgenus of *Picus*.)  
*Χρυσῶς*, gold; *πίλον*, feather; + *Picus*.
- Cichlomyia** OBERHOLSER, Proc. U. S. Nat. Museum, XXVIII, No. 1411, July 8, 1905, p. 908.  
Type, *Butealis carolinensis* HARTLAUB . . . . . [Muscapida.]  
*Κίχλον*, thrush; *μύια*, a fly. (Oberholser.)
- † **Ciconiopsis** AMEGHINO, Sinopsis geol.-paleon., Suplemento, 1899, p. 8.  
Type, *Ciconiopsis antarctica* AMEGHINO . . . . . [Ciconiida.]  
*Ciconia*, a stork; + *ὄψις*, appearance.
- Cinclus** BORKHAUSEN, Deutsche Fauna, I, 1797, p. 300.  
Type, *Cinclus hydrophilus* BORKHAUSEN (= *Sturnus cinclus* LINNÆUS) . . . . . [Cinclida.]  
(See also *Accentor* BECHSTEIN.)  
*Κίγκλος*, a water-bird, a kind of wagtail.
- \* **Cinclus** RAFINESQUE, Analyse de la Nature, 1815, p. 67.  
Type, not designated; a *nomen nudum* here<sup>a</sup> . . . [Incerta sedis.]
- \* **Cinclus** RAFINESQUE, Analyse de la Nature, 1815, p. 68.  
Type, not designated; a *nomen nudum* here<sup>b</sup> . . . [Incerta sedis.]
- Cinclus** "MÖHR. (1752)" GRAY, List Genera Birds, 2d ed., 1841, p. 85.  
Type, *Tringa morinella* LINNÆUS . . . . . [Aphriza.]
- Cinerosa** MAYNARD, Warblers of New England, Pt. 54, 1904, p. 110.  
Type, *Sylvia philadelphia* WILSON . . . . . [Mniotiltida.]  
*Cinerosus*, full of ashes, i. e., ash-colored.

<sup>a</sup>One of his "Coraces," placed between "Carpocactus" and "Corvus."

<sup>b</sup>One of the "Sturniens" of Rafinesque, following "Xanthornus R."

**Cinnamopteryx** REICHENOW, Zool. Jahrb., I, Heft 1, April 1, 1886, p. 126.

Types, *Ploceus castaneofuscus* LESSON, *P. rubiginosus* RÜPPELL, *Hyphantornis tricolor* HARTLAUB, *H. badius* CASSIN, and *H. dimidiatus* SALVADORI and ANTINORI ..... [*Ploceidæ*.]

(Proposed as a subgenus of *Ploceus*.)

Κίνναμον, cinnamon; πτέρυξ, wing.

**Cladoscopus** CABANIS and HEINE, Mus. Heineanum, IV, Heft 2, 1863, p. 80.

New name for *Sphyrapicus* BAIRD, on grounds of purism (type, *Picus varius* LINNÆUS) ..... [*Picidæ*.]

“Κλάδος (Zweig): σκοπέω (spähen).” (Cabanis and Heine.)

**Clangula** OKEN, Isis, I, 1817, p. 1183.

Based on “Les Garrots” CUVIER, Règne Animal [I, 1817, p. 533 (type, *Anas clangula* LINNÆUS)] ..... [*Anatidæ*.]  
*Clangula*, quasi-diminutive of *clangor*, noise.

† **Climacarthrus** AMEGHINO, Sinopsis geol.-paleon., Suplemento, 1899, p. 8.

Type, *Climacarthrus incompletus* AMEGHINO ..... [*Falconidæ*.]  
Κλίμαξ, a ladder; ἄρθρον, a limb, joint. (Ameghino, MS.)

**Climacocercus** BERTONI, Aves Nuevas del Paraguay, 1901, p. 112.

Type, “*Thamniophilus cyanocephalus* VIEILLOT” (not of Vieillot) = *Platyhyuchus polychropterus* VIEILLOT ..... [*Cotingidæ*.]  
Κλίμαξ, a ladder; κέρκος, tail. (Bertoni.)

**Cnemarchus** RIDGWAY, Proc. Biol. Soc. Wash., XVIII, Sept. 2, 1905, p. 208.

Type, *Tenioptera erythropygia* SCLATER ..... [*Tyrannidæ*.]  
Κνημιός, slope of a mountain; ἀρχός, a leader, chief. (Ridgway.)

\* **Coccyx** MORRIS, in N. Wood's Naturalist, II, No. 9, June, 1837, p. 126.

Types, “*Coccyx americanus*,” or “American Cuckoo,” and “*Coccyx canorus*,” or “Cuckoo” [of his list of British birds].

[*Cuculidæ*.]

κόκκυξ, a cuckoo.

**Coleoramphus** DUMONT, Diet. Sci. Nat., X, 1818, p. 36.

Type, *Coleoramphus nivalis* DUMONT (= *Vaginalis alba* GMELIN).  
[*Chionididæ*.]

κολέος, a sheath; ῥάμφος, beak.

† **Colonosaurus** MARSH, Amer. Journ. Sci. and Arts, 3d ser. IV, No. 23, Nov., 1872, p. 406.

Type, *Colonosaurus mudgei* MARSH (= *Ichthyornis dispar* MARSH) ..... [*Ichthyornithidæ*.]

(Described as a reptile.)

κολωνός, a hill; σαύρος, a lizard.

**Colubris** HÜBNER, Samml. Vögel und Schmetterlinge, 1793, pp. 7, 9, pls. 15, 16, 39.

Types, *Colubris aurissa* (p. 7, pl. 15), *C. mellivorus* (p. 7, pl. 16), and *C. minimus* (p. 9, pl. 39)<sup>a</sup> ..... [*Trochilida*.]  
*Colubris*, Latinized from *colibri*, a barbarous word.

**Colubris** C. T. WOOD, Orn. Guide, Jan., 1837, p. 137.

Types, " Besides the old species of Colibree—the Rubythroated Colibree (*Colubris rubens*.) AUDUBON has discovered another—the Mango Colibree (*Colubris mango*)"<sup>b</sup> ..... [*Trochilida*.]

**Columbigallina** OKEN, Isis, I, 1817, p. 1184.

Based on " Les Columbi-Gallines, Vaill." CUVIER, Règne Animal [I, 1817, p. 455 (type, *Columba carunculata* TEMMINCK)].  
 [ *Incerta sedis*. ]

**Columbigallus** DES MURS, in CHEYR, Encyc. d'Hist. Nat. Ois., VI, 1854, p. 31.

Type, *Columbigallus francis* "(Lath., Chemu et O. Des Murs)."  
 [ *Trogonida*. ]

*Columba*, pigeon; *gallus*, a cock.

**Comeris** " KÜHL" CORNALIA, Vert. Mus. Mediolanense, 1849, p. 6.

A typographical error for *Comurus* KÜHL. .... [ *Psittacida*. ]

**Cometes** BILLBERG, Synopsis Faune Scand., I, Pars 2, 1828, tab. A.

New name for *Criniger* TEMMINCK ..... [ *Pygenotida*. ]  
*Κομήτης*, long-haired.

**Conopoderas**<sup>d</sup> BILLBERG, Synopsis Faune Scand., I, Pars 2, 1828, tab. A.

Type, *Turdus longirostris* Gmelin ..... [ *Sylviida*. ]  
*Κόνωδες*, a gnat; *δέρω* I flay, cudgel.

**Conopotheras** OBERHOLSER, Smithsonian Misc. Coll., Quarterly Issue, XLVIII, No. 1, May 13, 1905, p. 66.

New name for *Chenorhamphus* OUSTALET, 1878, not *Chenorhamphus* GRAY, 1848. (Type, *Chenorhamphus cyanopterus* OUSTALET = *Todopsis grayi* WALLACE) ..... [ *Muscicapida*. ]  
*Κωνωποθήρας*, a flycatcher. (Oberholser.)

\***Copsicus** MORRIS, in N. Wood's Naturalist, II, No. 9, June, 1837, p. 125.

Types, "*Copsicus merula*," or "Blackbird," and "*Copsicus torquata*," or "Ringneck" [of his list of British birds] . . . [ *Turdida*. ]  
*Κόψιχος*, a blackbird.

<sup>a</sup> No authorities are given for these names, and it is doubtful if the plates represent the Linnæan species usually associated with them.

<sup>b</sup> Mentioned in a review of Audubon's Ornithological Biography, vols. I-III.

<sup>c</sup> It is, however, adopted by Fitzinger, Sitz. k. Akad. Wiss. (Math.-Nat. Classe) [Wien], XXI, Heft II, July, 1856, p. 281, for "*Psittacus carolinensis*, Gmel.," but the name is preoccupied by *Comeris* HODGSON, 1841.

<sup>d</sup> This name has priority over *Tutare* LESSON, 1831.

**Corax** LEDRU, Voy. Ténériffe, II, 1810, p. 204.

Type, *Corax crucirostris* LEDRU (= *Corvus leucognaphalus* DAUDIN).....[*Corvidæ*.]

Κόραξ, a raven or crow.

\***Cormias** REICHENBACH, Avium Syst. Nat., March 1, 1850. pl. LIV (figure showing generic characters).

Type, not named .....[*Incertæ sedis*.]

Κορμῖος, trunk of a tree; +suffix ias.

\***Corone** MORRIS, in N. Wood's Naturalist, II, No. 9, June, 1837, p. 123.

Types, "Corone maxima," or "Raven," "Corone cornix," or "Crow," "Corone frugiliga," or "Rook," "Corone cinerea," or "Hooded Crow," and "Corone monedula," or "Jackdaw" [of his list of British birds] .....[*Corvidæ*.]

Κορῶνη, a sea-crow, crow, raven.

**Corvina** HAHN, Vogel aus Asien, Afrika, etc., I, Lief. XI, 1822, pl. 3, and text.

Emendation of *Coracina* VIEILLOT.....[*Cotingidæ*.]

Corvina, relating to a crow or raven.

**Corydalis** "TEM." F. BOIE, Isis, XIX, Heft X, 1826, p. 974.

Types, "*Alauda africana* Gm. Vaill. Afr. pl. 162 [=192]. 1. *bifasciata* Tem. u. v. a." .....[*Alaudidæ*.]

(See also *Pseudocorys*.)

Κορυδαλλίς, the crested lark.

\***Corydalis** MORRIS, in N. Wood's Naturalist, II, No. 9, June, 1837, p. 125.

Types, "*Corydalis arvensis*," or "Lavrock," and "*Corydalis nemorum*," or "Woodlark" [of his list of British birds].

[*Alaudidæ*.]

**Corydon** WAGLER, Abhandl. Akad. Wiss. [München], I, 1832, p. 504.

Type, *Psittacus galeatus* LATHAM.....[*Cacatuidæ*.]

Κορυδών, a shepherd's name.

\***Corydus** BILLBERG, Synopsis Faunæ Scand., I, Pars 2, 1828, tab. A.

Type, *Alauda calandra* LINNÆUS!<sup>a</sup> .....[*Alaudidæ*.]

Κορυδός, the crested lark.

**Corydus** DRESSER, Manual Palearctic Birds, Pt. I, 1902, p. 390.

New name for "*Galerita*," preoccupied .....[*Alaudidæ*.]

(= *Ptilocorys* Madarász.)

"*Corydus* (κόρυδος of Aristotle)." (Dresser.)

<sup>a</sup>Billberg has the following lark genera: "1. *Corydus* B. et 2. *Pseudocorys* B. (*Alauda* Cuv.), 3. *Alauda*." As he names several of the groups designated by Cuvier in the vernacular only; it was doubtless his intention here to name the three groups given in the Règne Animal (I, p. xxxiv), restricting *Alauda* to the "Alouettes proprement dites," *Corydus* to the "Cakandres," and *Pseudocorys* to the "Sirlis."

**Coua** OKEN, *Isis*, I, 1817, p. 1184.

Based on "Les Couas, Vaill." CUVIER, *Règne Animal* [I, 1817, p. 425 (type, *Cuculus madagascariensis* GMELIN—*Cuculus gigas* BODDAERT)] ..... [*Cuculidæ*.]

**Cractes** BILLBERG, *Synopsis Faunæ Scand.*, I, Pars 2, 1828, tab. A and p. 14.

New name for *Garrulus* BRISSON ..... [*Corvidæ*.]  
*Κράκτης*, a screamer, chatterer. (Billberg.)

**Craspedoprion** HARTERT, *Novitates Zoologicæ*, IX, No. 3, Dec. 16, 1902, p. 609.

Type, *Cyclorhynchus aquinoctialis* SCLATER ..... [*Tyrannidæ*.]  
*Κράσπεδον*, edge, border; *πίρων*, a saw.

\* **Craugus** BILLBERG, *Synopsis Faunæ Scand.*, I, Pars 2, 1828, tab. A.

Type, *Cuculus auratus* LINNÆUS ?<sup>a</sup> ..... [*Picidæ*.]  
*Κραυγός*, a woodpecker.

\* **Crecca** BROOKES, *Catal. Mus. Joshua Brookes*, Pt. II, July, 1828, p. 101.

Type, " *Crecca communis*," or "Common Teal" ..... [*Anatidæ*.]  
*Crecca*, probably an onomatopoeitic word.

**Crecca** "ANTIQ." S. D. W., *Analyst*, III, No. XIV, Jan., 1836, p. 209 (also Palmer, *Analyst*, IX, 1839, p. 306, note).

Types, " *Crecca palustris*," or "Common Teal," " *Crecca astiva*," or "Gargany Teal," and " *Crecca glaucitans*," or "Bimaculated Teal" ..... [*Anatidæ*.]

\* **Creurgus** MORRIS, in *N. Wood's Naturalist*, II, No. 9, June, 1837, p. 124.

Types, " *Creurgus excubitor*," or "Shrike," " *Creurgus lanius*," or "Flasher," and " *Creurgus rufus*," or "Woodchat" [of his list of British birds] ..... [*Laniidæ*.]  
*Κρεουργός*, a butcher, carver.

**Crocethia** BILLBERG, *Synopsis Faunæ Scand.*, I, Pars 2, 1828, tab. A and p. 132.

New name for *Calidris* ILLIGER, with the following species: *Tringa arenaria* LINNÆUS, 1766 (= *Tringa leucophaea* PALLAS, 1764) ..... [*Scolopacidæ*.]

" *Quum* Nom. genero *Arenaria* Bechst. generis *phythologicum* est et *Calidris* Ill. est nomen specificum alius generis aliud e *græcis vocis* *Κροκη λίτης* et *Ξειω κυρρο*, derivatum adoptarimus." (Billberg.)

<sup>a</sup>Billberg's woodpecker genera are "Craugus B. (*Picus Cur.*)," *Jynx*, and *Picus*. He includes *Picus tridactylus* under *Picus* (compare p. 126), thus eliminating *Picoides*. It is probable that he intended to bestow *Craugus* on the group of which Cuvier (*Règne Animal*, I, p. 423) wrote: "On peut également faire un sous-genre des espèces que leur bec, légèrement arqué, commence à rapprocher des coucous." As examples of this group Cuvier cited *Cuculus auratus* LINNÆUS, and *Picus cafer* GMELIN.

- † *Cruschedula* AMEGHINO, Sinopsis geol.-paleon., Suplemento, 1899, p. 9.  
 Type, *Cruschedula revola* AMEGHINO ..... [*Cladornithidæ*.<sup>a</sup>]  
*Crus*, leg; *schedula*, card. (Ameghino, MS.)
- Cryptoglaux** RICHMOND, Auk, XVIII, No. 2, April, 1901, p. 193.  
 New name for *Nyctala* BREHM, 1828, not *Nyctalus* BOWDICH, 1825. (Type, *Strix tengmalmi* GMELIN = *S. funerea* LINNÆUS.)  
 [*Strigidæ*.]
- (See also *Glaux* MORRIS.)  
*Κρυπτός*, hidden; *γλαυξ*, an owl. (Richmond.)
- \* **Culeus** BILLBERG, Synopsis Faunæ Scand., I, Pars 2, 1828, tab. A  
 Type, not designated<sup>b</sup> ..... [*Incertæ sedis*.]  
*Κουλέος*, sheath or scabbard of a sword.
- Cursor** J. R. FORSTER, Faunula Indica, 1795, p. 11.  
 Type, *Charadrius coromandelicus* GMELIN ..... [*Cursoridæ*.]  
*Cursor*, a runner.
- Cyano-sylvia** C. L. BREHM, Isis, XXI, Heft 8-9, 1828, p. 920.  
 Type, *Sylvia succica* (= *Motacilla succica* LINNÆUS) [*Turdidæ*.]  
*Cyanus*, blue; + *Sylvia* (*sylva*, forest).
- \* **Cygnus** " (BR.) " BROOKES, Catal. Mus. Joshua Brookes, Pt. II, July, 1828, p. 102.  
 Type, "*Cygnus ferus*," or "Northern Hooper" ..... [*Anatidæ*.]  
*Κύκνος*, a swan.
- † **Cyphornis** COPE, Journ. Acad. Nat. Sci. Phil., 2d ser., IX, 1894, p. 451.  
 Type, *Cyphornis magnus* COPE ..... [*Pelecanidæ*.]  
*Κυφός*, a hump; *ὄρνις*, bird.
- \* **Dagela** BROOKES, Museum Brookesianum, Feb., 1830, p. 93.  
 Type, "*Dagela hortensis*," or "Garden Warbler" ..... [*Sylviidæ*.]
- † **Delphinornis** WIMAN, Bull. Geol. Inst. Univ. Upsala, VI, Pt. 2, 1905, p. 250.  
 Type, *Delphinornis larsenii* WIMAN ..... [*Spheniscidæ*.]  
*Δελφίς* (*δελφίριος*), a dolphin; *ὄρνις*, bird.
- \* **Dendrobates** MORRIS, in N. Wood's Naturalist, II, No. 9, June, 1837, p. 124.  
 Type, "*Dendrobates familiaris*," or "Creeper" [of his list of British birds] ..... [*Certhiidæ*.]  
*Δένδρον*, a tree; *βάτης*, one that treads or covers, a climber.

<sup>a</sup>The genus *Cruschedula* is here made the type of a new family, Cruschedulidæ, but in a later paper the author transfers it to the family Cladornithidæ.

<sup>b</sup>*Culeus* is a member of the division "alis armatis" of Billberg's "Rallides," but there is no individual diagnosis for it here. The genera of this "division" are given in the following order: "1. Palamedes, 2. Parra, 3. Chauma III. 4. Culeus B."

<sup>c</sup>Not intended as an emendation, as *Cygnus* is used for another genus.

**Dendrochelidon** <sup>a</sup> H. BOIE, Neues Staatsbürgerliches Magazin [Schleswig], I. Heft 2, 1832, p. 492.

Types, "*longipennis*," and *Cypselus comatus* TEMMINCK.

[*Hemiprocniida*.]

*Δένδρορον*, tree; *χελιδών*, a swallow.

**Dendroœcia** BERTONI, Aves Nuevas del Paraguay, 1901, p. 138.

Type, *Dendroœcia erythroptera* BERTONI (= *Myiothra rufimarginata* TEMMINCK).....[*Fornicariida*.]

*Δένδρορον*, tree; *οἶκος*, a house. (Bertoni.)

**Dendrotreron** HODGSON, Journ. Asiatic Soc. Bengal, XII, Pt. 2, 1843, p. 337 (note).

Type, *Columba hodgsoni* VIGORS.....[*Columbida*.]

*Δένδρορον*, a tree; + *Τετρον* (τρήρων, a dove).

**Dentophorus** "VIEILLOT" F. BOIE, Isis, XXI, Heft 3-4, 1828, p. 326 (note).

Emendation of *Odontophorus* VIEILLOT.....[*Tetraonida*.]

*Δους*, a tooth; + *φορέω*, I bear, carry.

**Dewetia** BUTURLIN, Auk, XXI, No. 1, Jan., 1904, p. 80.

New name for *Botha* SHELLEY, 1902, not *Bothus* RAFINESQUE, 1810.....[*Maudida*.]

For General Christian De Wet. (Buturlin.)

\* **Diceratornis** BROOKES, Catal. Mus. Joshua Brookes, Pt. II, July, 1828, p. 94.

Type, "*Diceratornis satyrus*," or "Satyr *Diceratornis*."

[*Phasianida*.]

(See also *Satyra* BILLBERG.)

*Δίκερανος*, a double horn; *ὄρνις*, bird.

**Dicranura** VAN DER HOEVEN, Handbuch der Zoologie, 2d ed., II, 1852-1856, p. 498 (note).

A substitute name for *Phibalura* VIEILLOT, suggested, but not used here.....[*Cotingida*.]

(See also *Psalurus*.)

*Δίκρανος*, two-pointed; *οὐρά*, tail.

\* **Dilara** BROOKES, Museum Brookesianum, Feb., 1830, p. 95.

Type, "*Dilara locustella*," or "Grasshopper Warbler."

[*Sylviida*.]

**Dilophalius** COUES, Key N. A. Birds, 5th ed., II, Dec., 1903, p. 963.

Type, *Phalacrocorax dilophus* SWAINSON (= *Carbo auritus* LES-SON).....[*Phalacrocoracida*.]

*Δίλοφος*, with two crests; *ἀλιεύς*, one who has to do with the sea, a fisher.

<sup>a</sup>Gray (Appendix to List Genera Birds, 1842, p. 5) says: "M. [F.] Boie informs me that he had given to this genus the name of *Dendrochelidon*, in the year 1828; the latter name therefore should be employed." H. Boie's letter, containing this name, is dated "Buitenzorg den 4ten Juni," 1827. He died at Batavia just three months later.



**Dinopium** RAFINESQUE, Précis découvr. somnologiques, 1814, and Principes Fond. de Somnologie, 1814; name on original papers covers only.

Type, *Dinopium (Picoides) erythronotus*<sup>a</sup> RAFINESQUE (based on description in Bull. Sci. Soc. Philomath. Paris, III, 1803, No. 67, p. 146).....[*Picidae*?]

**Diplochelidon** RIDGWAY, Proc. Biol. Soc. Wash., XVI, Sept. 30, 1903, p. 106.

Type, *Hirundo melanoleuca* WIED. ....[*Hirundinidae*.]  
Διπλόχος, double; χελιδών, swallow. (Ridgway.)

**Diplochilus** BERTONI, Aves Nuevas del Paraguay, 1901, p. 88.

Type, *Diplochilus xanthochlorus* BERTONI (= *Piranga azaræ* d'ORBIGNY and LAFRESNAYE).....[*Tangaridae*.]  
Διπλόχος, double; χείλος, beak. (Bertoni.)

**Diplootocus** HARTERT, Novitates Zoologicae, IX, No. 2, July 25, 1902, p. 325.

Type, *Erithacus moussieri* OLPH-GALLIARD.....[*Turdidae*.]  
Διπλότῶς, double; ὠτόκος, laying eggs. (Hartert.)

**Dissemuropsis** DUBOIS, Synopsis Avium, I, Fasc. VIII, 1901, p. 532.

Substitute name for *Dissemuroides* HUME, on grounds of purism.....[*Dicruridae*.]  
*Dissemurus* (δίς, double; σῆμα, a mark, a character; οὐρά, tail); + ὄψις, aspect.

**Dissoura** CABANIS, Preuss. Staats-Anzeiger, Beilage, Sept. 1, 1850, p. 1484 (Compare CABANIS, in von der Decken's Reise, III, 1869, p. 48).

Type, *Ardea episcopus* BODDAERT.....[*Ciconiidae*.]  
Δισσόος, double, divided; οὐρά, tail.

†**Dolicopterus** AYMARD, Congrès Sci. de France, I, 1856, pp. 234, 267.

Type, *Dolicopterus viator* AYMARD.....[*Charadriiformes*.]  
Δολιχός, long; πτερόν, wing.

**Dromius** [BORKHAUSEN], Allg. Lit.-Zeitung, Jahre 1797, IV, No. 316, Oct. 4, 1797, p. 27.

Type, "Le Coure-vite" BUFFON (= *Charadrius gallicus* LINNÆUS).....[*Cursoriidae*.]  
Δρομεύς (δρομίας), a runner.

\***Dryocolaptes** MORRIS, in N. Wood's Naturalist, II, No. 9, June, 1837, p. 124.

Types, "Dryocolaptes martius," or "Hewhole," "Dryocolaptes viridis," or "Eele," "Dryocolaptes minor," or "Hickwall," and "Dryocolaptes major," or "Whitwall" [of his list of British birds].

Δρῶς, the oak, a timber tree; κολαπήξ, a chisel. [Picidae.]

<sup>a</sup> *Dinopium* of his "Analyse", 1815, p. 66, stands as a substitute name for "*Picoides* Lac." The specific name *erythronotus* occurs only in a list of Rafinesque's writings, printed on the original paper covers of the above works, and of the "Analyse."

**Dumetella** S. D. W., *Analyst*, V, No. XVIII, Jan., 1837, p. 206.

Type, *Dumetella felivora* [= *Turdus felivora* VIEILLLOT], "Cat Thrush" of Latham" ..... [*Mimida*.]

Related to *dumetum*, a thorn-hedge, thicket.

†**Dyspetornis** OBERHOLSER, *Smithsonian Misc. Coll.*, Quarterly Issue, XLVIII, No. 1, May 13, 1905, p. 61.

New name for *Hydroornis* MILNE-EDWARDS, 1867, not *Hydroornis* BLYTH, 1843. .... [*Incerta sedis*.]

Ἰδυσπετόρνις, difficult; ὄρνις, bird. (Oberholser.)

**Eafa** ROTHSCHILD and HARTERT, *Novitates Zoologicae*, X, No. 3, Dec. 20, 1903, p. 448.

Type, *Eafa maculata* ROTHSCHILD and HARTERT. . . [*Dicaeida*.<sup>b</sup>]

For the Eafa district, British New Guinea.

**Edolius**<sup>c</sup> LESSON, *Traité d'Orn.*, 1830, p. 147.

Types, *Cuculus glandarius* LINNAEUS, *Coccyzus leucillausti* SWAINSON, *Cuculus coromandus* LINNAEUS, and *Cuculus edolius* CUVIER (= *Cuculus serratus* SPARRMAN) ..... [*Cuculida*.]

**Egatheus** BILLBERG, *Synopsis Faunae Scand.*, I, Pars 2, 1828, tab. A and p. 158.

New name for *Ibis* LACÉPÈDE. (Used for *Tantalus fulvicaillus* on p. 158.)<sup>d</sup> ..... [*Ibidida*.]

Ἠγάθεος, hallowed, most holy. (Billberg.)

**Egretta** T. FORSTER, *Synop. Catal. Brit. Birds*, 1817, p. 59.

Type, *Ardea garzetta* LINNAEUS. .... [*Ardeida*.]

**Elainopsis** RIDGWAY, *Proc. Biol. Soc. Wash.*, XVIII, Sept. 2, 1905, p. 210.

Type, " *Elainia degans* PELZELN (= *Muscicapa gaimardi* D'ORBIGNY?)" ..... [*Cotingida*.]

*Elainia* (ελαίνεος, olive-colored); + ὄρνις, aspect. (Ridgway.)

**Empidornis** REICHENOW, *Journ. für Orn.*, XLIX, April, 1901, p. 285.

Type, *Muscicapa semipartita* RÜPPELL. .... [*Muscicapida*.]

Ἐμπίδρις (ἐμπίδρις), a gnat; ὄρνις, bird.

**Enodes** TEMMINCK, *Planches Col.*, I (Livr. 102?), 1839?, (tabl. méth.), p. 108.

Type, *Lamprotornis erythrophrys* TEMMINCK. .... [*Sturnida*.]

*Enodis*, smooth.

<sup>a</sup>Latham called it the "Cat Flycatcher."

<sup>b</sup>Compare SALVADORI, *Ibis*, 1904, p. 473. Originally placed in the family Meliphagidae.

<sup>c</sup>Not *Edolius* CUVIER, for a group of Drongos, which Lesson uses on p. 379 of the same work.

<sup>d</sup>"*Dissanctibus auctoribus, quantum esset Egyptiorum Ibis; hoc nomen avis in historia insignis justius ut specificum conservari credidimus, adeoque Egatheum a graeco Ἠγάθεος, saccr, pratulimus.*"

- \* **Entomophila** BROOKES, Museum Brookesianum, Feb., 1830, p. 90.  
Type, "*Entomophila australis*," or "Southern Insect Harrier."  
[*Alcedinidæ*?]  
"Εντομα, insects; φίλος, loving.
- Eopodoces** ZARUDNY and LOUDON, Ornith. Monatsb., X, No. 12, Dec., 1902, p. 185.  
Types, *Podoces biddulphi* HUME, and *P. hendersoni* HUME.  
[*Corvidæ*.]  
(Proposed as a subgenus of *Podoces*.)  
"Ἠώς, the east; + *Podoces* (ποδώκης, swift-footed).
- † **Eosphænisceus** WIMAN, Bull. Geol. Inst. Univ. Upsala, VI, Pt. 2, 1905, p. 250.  
Type, *Eosphænisceus gunnari* WIMAN ..... [ *Spheniscidæ*. ]  
"Ἠώς, dawn; + *Spheniscus* (σφηνίσκος, dim. of σφήν, a wedge).
- \* **Erops** MORRIS, in N. Wood's Naturalist, II, No. 9, June, 1837, p. 124.  
Type, "*Erops urupa*," or "Hoopoo" [of his list of British birds] ..... [ *Urupidæ*. ]  
"Εροφ, the hoopoo.
- † **Eremopezus** ANDREWS, Proc. Zool. Soc. Lond., 1904, I, Pt. 1, June, 1904, p. 168.  
Type, *Eremopezus coarctatus* ANDREWS ..... [ *Struthionæ*. ]  
"Ερημος, desert; πεζός, walking.
- Erionetta** COUES, Key N. A. Birds, 2d ed., 1884, p. 709.  
Type, *Anas spectabilis* LINNÆUS ..... [ *Anatidæ*. ]  
(Proposed as a subgenus of *Somateria*.)  
"Εριον, wool, down; νήττα, a duck.
- \* **Eriornis** BROOKES, Museum Brookesianum, Feb., 1830, p. 96.  
Type, "*Eriornis antarcticus*," or "Southern Eriornis."<sup>b</sup>  
[ *Incertæ sedis*. ]  
"Εριον, wool; ὄρνις, bird.
- \* **Erythropus** BLYTH, Analyst, V, No. XVII, Oct., 1836, p. 89.  
Type, "*Erythropus gallicus*," "Redfoot, or Red Partridge."  
[ *Tetraonidæ*. ]  
(See *Rupipes*.)  
"Ερυθρός, red; πούς, foot.
- "**Eubates** RIDGWAY," Zool. Record, XXX, for 1893, Aves, p. 49, index, p. 6; and Index Zool., 1902, p. 131. A misprint for *Eribates*.
- † **Eucallornis** AMEGHINO, Anales Soc. Cien. Argentina, LI, 1901, p. 78.  
New name for *Callornis* AMEGHINO, preoccupied.  
[ *Stereornithes*. ]  
"Εὖ, very; + *Callornis* (κάλλος, beauty; ὄρνις, bird).

<sup>a</sup> Compare also Horsfield, Zool. Researches in Java, No. 4, 1822, text to *Alcedo bira*.

<sup>b</sup> Possibly the "Mutton" bird, one of the Tubinares.

**Eudrepanis** SHARPE, in Shelley, Monogr. Nectariniidae, Pt. III, Feb., 1877, p. 83, pl. 28.

Type, *Ethopyga pulcherrima* SHARPE . . . . . [Nectariniidae.]  
E<sup>v</sup>, very much; + *Drepanis* (δρεπάνη, a sickle).

**Eugerygone** FINCH, Notes Leyden Museum, XXII, No. 3, March, 1901, p. 200.

Type, *Pseudogerygone rubra* SHARPE . . . . . [Musciapidae.]  
E<sup>v</sup>, very much; + *Gerygone* (γυργυρόνος, producing sound).

**Euplectes** SWAINSON, Zool. Illustrations, 2d ser., I, No. 8, 1829, text to pl. 37.

Type, *Loria orix* LINNÆUS . . . . . [Ploceidae.]  
E<sup>v</sup>, well; πλεκτός, plaited, woven.

**Eupoda** BRANDT, in Lehmann's Reise nach Buchara und Samarkand,<sup>a</sup> 1852, p. 323.<sup>b</sup>

Type, *Charadrius asiaticus* PALLAS . . . . . [Charadriidae.]  
(Proposed as a subgenus of *Charadrius*.)  
E<sup>v</sup>, well, much; πούς, foot.

**Euptilotis** GOULD, Monogr. Trogonidae, 2d ed., Pt. I, 1858, pl. 6, and text.

Type, *Trogon naevus* GOULD . . . . . [Trogonidae.]  
E<sup>v</sup>, well; πύλον, a feather; ὄς (ὄτος), ear.

\* **Eurhynchus** "GEOFFR." BILLBERG, Synopsis Faunæ Scand., I, Pars 2, 1828, tab. A.

Type [*Psittacus aterrimus* GMELIN!]<sup>c</sup> . . . . . [Cuculidae.]  
E<sup>v</sup>, well, much; ῥύγχος, beak.

**Falcator** TEMMINCK, Trans. Linn. Soc. Lond., XIII, Pt. I, May, 1821, p. 108.

Types, "*Certhia pacifica, obscura, coccinea, et falcata* de Linn. Gmel." . . . . . [Drepanididae.]  
*Falcatus*, sickle-shaped, curved.

\* **Fanissa** BROOKES, Museum Brookesianum, Feb., 1830, p. 96.

Type, "wood Fanissa (Wren, *Fanissa sylvicola*)" [Sylviidae<sup>d</sup>?]

**Finschia** HUTTON, Ibis, 8th ser., III, No. XI, July, 1903, p. 319.

Type, *Parus norve scandinav* GMELIN . . . . . [Paridae.]  
For Dr. Otto Finsch. (Hutton.)

<sup>a</sup>Or Bd. XVII of Baer and Helmersen's Beiträge zur Kenntniss des Russischen Reiches.

<sup>b</sup>Page 29 of the reprint of Brandt's "Anhang."

<sup>c</sup>No species is mentioned, but a diagnosis, "lingua extensibili" (as opposed to the "Psittacides") is given.

<sup>d</sup>*Troglodytes* is used for the "Common Wren."

**Francolinus** OKEN, *Isis*, I, 1817, p. 1184.

Based on "Les Francolins. Tem." CUVIER, *Règne Anima* [I, 1817, p. 450 (type, *Tetrao francolinus* LINNÆUS)]—[*Phasianidæ*.]  
*Francolinus*, Latinized from French *francolin*.

**Frugilegus** "LESS." GRAY, *Catal. Genera Birds*, 1855, p. 64.

Type, *Corvus frugilegus* LINNÆUS ..... [ *Corvidæ*. ]  
(See *Sitocorax* Bielz.)

*Frugilegus*, collecting fruit.

**Galbula** SCOPOLI, *Introd. Hist. Nat.*, 1777, p. 480.

Type, *Oriolus galbula* LINNÆUS ..... [ *Oriolidæ*. ]  
*Galbula*, a small bird.

**Gallophasis** HODGSON (1827?), *Journ. Asiatic Soc. Bengal*, VII, Pt. 2, Oct., 1838, p. 865.

Type, "between *Phasianus* and *Euplocamus*, vel *Nycthemerus*—a type which, by the bye, I characterized 11 years ago in the *Oriental Quarterly* under the style of *Gallophasis*, assigning the Kâlich of KIRKPATRICK'S *Nepal* as the icon" ..... [ *Phasianidæ*. ]  
*Gallus*, a cock; *Phasis*, the Phasian bird, pheasant.

\* **Gambo** S. D. W., *Analyst*, III, No. XIV, Jan., 1836, p. 214.

Type, " *Gambogalaria*," or "Spurwinged Gambo" ..... [ *Anatidæ*. ]  
*Gambosus*, with a swelling near the hoof.

**Gauria** BILLBERG, *Synopsis Faunæ Scand.*, I, Pars 2, 1828, tab. A.

New name for *Rhea* BRISSON ..... [ *Rheidæ*. ]  
*Γαυριάουρα*, I leap, spring.

**Gavia** OKEN, *Lehrbuch der Naturgesch.*, III, Zool., 2 Abth., 1816, p. 537.

Types, *Larus minutus* PALLAS, *L. canus* LINNÆUS, *L. ridibundus* LINNÆUS, and *L. rissa* BRÜNNICH. (Used as a subgenus of *Larus*.) ..... [ *Laridæ*. ]  
*Gavia*, a gull.

\* **Geo-Kichla** MACKLOT, *Bijdr. Natuurk. Wetensch.* [Amsterdam], V, St. I, 1830, p. 175.

Type, *Geo Kichla singularis* MACKLOT, a *nomen nudum* here. [ *Turdidæ*. ]

*Γῆ*, the earth, ground; *κίχλη*, thrush.

**Geokichla** "BOIE" S. MÜLLER, *Tijds. Natuurl. Gesch. Phys.*, II, St. III, 1835, p. 348.

Type, *Turdus citrinus* LATHAM ..... [ *Turdidæ*. ]

"**Geochelidon**, BREHM," cited by Waterhouse, occurs only as *Gelochelidon*.

\* **Geocichloides** SEEBOHM, *Monograph Turdidæ*, Pt. 2, 1898, p. 49.

Types, "species of *Geocichla* with white-tipped greater wing-coverts" ..... [ *Turdidæ*. ]

*Geocichla* (*γῆ*, earth; *κίχλη*, thrush), + *εἶδος*, resemblance.

"He says *Geocichla interpres* is a connecting link between "my subgeneric groups *Geocichla* and *Geocichloides*."

- Geocœcia** BERTONI. *Aves Nuevas del Paraguay*, 1901, p. 79.  
 Type, *Geocœcia orryctera* BERTONI (= *Myiothrua umbretta* LICHTENSTEIN) ..... [Furnariidæ.]  
*Γῆ*, ground, earth; *οἶκος*, a house. (Bertoni.)
- Geopega** BILLBERG. *Synopsis Faunæ Scand.*, I, Pars 2, 1828, tab. A.  
 Type, "Gorfou, Cuv." [= "Les Gorfous (Catarrhaetes Briss.)"  
 CUVIER, *Règne Animal*, I, 1817, p. 513]..... [Spheniscidæ.]  
*Γῆ*, earth; *πηγάζω*, I spring forth.
- Geophilus** BERTONI. *Aves Nuevas del Paraguay*, 1901, p. 43.  
 Type, *Geophilus jasijatore* BERTONI (= *Macropus phasianellus* SPIX) ..... [Cuculidæ.]  
*Γῆ*, ground, earth; *φίλος*, loving. (Bertoni.)
- \* **Gingala** RAFINESQUE. *Analyse de la Nature*, 1815, p. 67.  
 Type, not designated, a *nomen nudum* here .... [Bucrotidæ?]
- \* **Glaux** MORRIS. in *N. Wood's Naturalist*, II, No. 9, June, 1837, p. 123.  
 Types, "Glaux tengmalmi," or "Tengmalm's Owl," and "Glaux  
*nulipes*," or "Little Owl" [of his list of British birds].  
 [Strigidæ.]  
*Γλαύξ*, an owl.
- Goodfellowia** HARTERT. *Bull. Brit. Orn. Club*, XIV, No. C, Oct. 30,  
 1903, p. 11.  
 Type, *Goodfellowia miranda* HARTERT ..... [Sturnidæ.]  
 For Walter Goodfellow. (Hartert.)
- "**Gralla** J. P. EBELING" quoted by Sherborn, has no standing. Ebeling used "*Gralla Parra*" and "*Gralla Fulica*" as an equivalent of order Grallæ, genus *Parra*, and order Grallæ, genus *Fulica*. The names *parra* and *fulica* are indexed by Sherborn as species of the supposed genus "Gralla."
- Gryphus**<sup>b</sup> OKEN. *Lehrbuch der Naturgesch.*, Atlas, 1816, pl. xxxii fig.  
 Type, *Vultur gryphus* LINNÆUS ..... [Cathartidæ.]  
*Gryphus*, a fabulous bird, a griffin.
- Gryphus** ISID. GEOFFROY ST.-HILAIRE. *Essais de Zool. Générale* (Nouv. Suites à Buffon, Livr. 53<sup>e</sup>), 1841, p. 367 (note).  
 Type, *Vultur gryphus* LINNÆUS ..... [Cathartidæ.]
- Gupista** [N. WOOD], *Analyst*, VI, No. XIX, April, 1837, p. 71.  
 Type, "*Gupista barbata*," or "Bearded Lammer" (based on GOULD, *Birds of Europe*, Pt. V, pl. 1) ..... [Butoridæ?]  
*Γύψ*, a vulture; + ista.

<sup>a</sup> Placed in the subfamily "Acerampha," between "Les Bucériens" and "Momotus Lac.," and probably based on "Le Calao Gingala" of Levaillant (= *Buceros gingalensis* SHAW).

<sup>b</sup> Name on plate only. In the text (III, *Zool.*, 2 Abth., p. 489) it is called "F. [ultw] *Gryphus*, Greif, Kuntur."

\* **Gymnopus** "(Br.)" BROOKES, Catal. Mus. Joshua Brookes, Pt. II, July, 1828, p. 80.

Type, "*Gymnopus leschenaulti*," or "Leschenault's *Gymnopus*" ..... [*Strigidae*.]  
*Γυμνός*, naked; *πούς*, foot.

**Gypogeranus** [BORKHAUSEN], Allg. Lit.-Zeitung, Jahre 1797, IV, No. 316, Oct. 4, 1797, p. 25.

Types, *Palamedea cristata* LINNÆUS, and *Vultur serpentarius* LATHAM (= *Falco serpentarius* MILLER)<sup>a</sup> ..... [*Gypogeranidae*.]  
*Γύψ*, a vulture; *γέρανος*, a crane.

**Haemeria** ZANDER, Naturgesch. Vögel Mecklenburgs, Heft 2, 1838, pp. 123, 128.

Type, *Strix nireca* THUNBERG (= *Strix nyctea* LINNÆUS).  
[*Strigidae*.]  
*Αίμυρρός*, bloody, murderous.

\* **Halcyon** MORRIS, in N. Wood's Naturalist, II, No. 9, June, 1837, p. 124.

Type, "*Halcyon alcedo*," or "Kingfisher" [of his list of British birds] ..... [*Alcedinidae*.]  
*Ἁλκυών*, a kingfisher.

**Halohippus** BILLBERG, Synopsis Faunæ Scand., I, Pars 2, 1828, tab. A and p. 192.

Type, *Procellaria glacialis* LINNÆUS ..... [*Puffinidae*.]  
 "Nomen hujus generis opinione nostra vere distincti e verbis græcis ἄλς, mare, et ἵππος, equus; nomen ejus triviale Norregiæ." (Billberg.)

**Haplocichla** RIDGWAY, Proc. Biol. Soc. Wash., XVIII, Oct. 17, 1905, p. 212.

Type, *Turdus aurantius* GMELIN ..... [*Turdidae*.]  
*Ἁπλοΐς*, simple; *κίχλη*, thrush. (Ridgway.)

† **Hargeria** LUCAS, Proc. U. S. Nat. Mus., XXVI, No. 1320, Feb. 4, 1903, p. 552.

Type, *Hesperornis gracilis* MARSH ..... [*Hesperornithidae*.]  
 For Oscar Harger. (Lucas.)

\* **Harpaleus** CABANIS and HEINE, Mus. Heineanum, IV, i, 1863, p. 185 (note).

Type, not designated, but genus said to contain red-bellied species corresponding to the yellow-bellied ones of the genus *Aganus* of the same authors. .... [*Trogonidae*.]

**Heliolais** SHARPE, Hand-List Birds, IV, 1903, p. 193.

New name for *Dybowskia* OUSTALET, 1893, not *Dybowskia* DALL, 1876 ..... [*Sylviidae*.]  
*Ἡλιος*, the sun; *λάϊός*, a bird of the thrush kind.

<sup>a</sup> *Palamedea cristata* is the first species mentioned, but he knew it only from description; *Vultur serpentarius* is his prominent species.

- Helionympha** OBERHOLSER, Proc. U. S. Nat. Mus., XXVIII, No. 1411, July 8, 1905, p. 929.  
 Type, *Cinnyris nectarinioides* RICHMOND ..... [*Nectariniidæ*.]  
 "Ἡλιος, the sun; νύμφη, a Nymph. (Oberholser.)
- Heliophilus** DESCOURTILZ, Ornithologie Brésilienne, Pt. 2, 1854-56, p. 22, pl. 24, fig. 1.  
 Type, *Heliophilus tannaysii* DESCOURTILZ (= *Pardalotus pipra* LESSON) ..... [*Cotingidæ*.]  
 "Ἡλιος, the sun; φίλος, loving.
- Helminthophaga** BECHSTEIN, Ornith. Taschenbuch, Th. 2, 1803, p. 548.  
 Types, *Motacilla rubecula* LINNÆUS, *M. succica* LINNÆUS, *M. titys* LINNÆUS, *M. phanicurus* LINNÆUS, *M. modularis* LINNÆUS, *M. salicaria*, LINNÆUS, *Sylvia phragmitis* BECHSTEIN, *S. palustris* BECHSTEIN, *S. jitis* BECHSTEIN, *Motacilla rufa* LINNÆUS, *M. regulus* and *M. troglodytes* LINNÆUS ..... [*Turdida*!]  
 (Proposed as a subgenus of *Sylvia*.  
 "Ἐλμυρς (ἔλμυρθ-), a worm; φάγειν, to eat.
- Hemiprocne** NITZSCH, Observ. Avium Arteria Carot. Communi, 1829, p. 15.  
 Types, "Hemiprocnes genus, cui Cypselos, qui ill. Temminckio longipennis, comatus, fuciphagus, torquatus vocantur \* \* \* \* \*,"  
 ..... [*Hemiprocniidæ*.]  
 "Ἡμι-, half; + *Procne* (Ἠρόκνη, daughter of Pandion, transformed into a swallow).
- Heteroxenicus** SHARPE, Bull. Brit. Orn. Club, XII, No. LXXXVII, March 28, 1902, p. 55.  
 New name for *Drymochares* GOULD, 1868, not *Drymochares* Mulsant, 1847..... [*Timaliidæ*.]  
 "Ἐτερος, different; + *Xenicus* (ἔξενικός, foreign, strange).
- \* **Hexanemus** REICHENBACH, Avium Syst. Nat., June 1, 1850, pl. LXXXV (figure showing generic characters).  
 Type, not named<sup>a</sup> ..... [*Incerta sedis*.]  
 "Ἑξ, six; νῆμα, thread.
- \* **Hierax** MORRIS, in N. Wood's Naturalist, II, No. 9, June, 1837, p. 123.  
 Types, "Hierax islandicus," or "Jer," "Hierax peregrinus," or "Peregrine," "Hierax subbutco," or "Hobby," "Hierax rufipis," or "Orange-legged Hobby," "Hierax casius," or "Merlin," and "Hierax tinnunculus," or "Kestrel" [of his list of British birds] ..... [*Falconidæ*.]  
 "Ἱέραξ, a hawk.

<sup>a</sup>Avis composita? Compare GRAY, Hand-List, II, 1870, p. 21 (note).



**Hoerataria** OKEN, *Isis*, I, 1817, p. 1184.

Based on "Les Hoérotaires Vieillot," CUVIER, *Règne Animal* [I, 1817, p. 411 (type, *Certhia vestiaria* SHAW)] [*Drepanididæ*].

**Horizillas** OBERHOLSER, *Smithsonian Misc. Coll.*, Quarterly Issue, XLVIII, No. 1, May 13, 1905, p. 65.

New name for *Malacopteron* EYTON, 1839, not *Malacopterus* SERVILLE, 1833 ----- [*Timaliidæ*].  
 \* *Ὠπίζω*, I limit: ἰλλάς, a thrush. (Oberholser.)

**Hortulanus** VIEILLOT, *Hist. Nat. Oiseaux d'Amer. Sept.*, I, 1807, p. iii.

Types, "*Hortulanus erythrophthalmus*" (probably *Fringilla erythrophthalma* LINNÆUS), *Fringilla albicollis* GMELIN, and *Hortulanus nigricollis* VIEILLOT (= *Emberiza americana* GMELIN).  
 [*Fringillidæ*].

*Hortulanus*, a gardener.

\***Hortulanus** LEACH, *Syst. Catal.*, etc., 1816, p. 15.

Types, "*Hortulanus glacialis*" LEACH, or "Tawny Bunting," and "*Hortulanus montanus*" LEACH, or "Mountain Brambling."  
 (Both specific names are *nomen nudum* here)<sup>a</sup> ---- [*Fringillidæ*].

\***Huhus** RAFINESQUE, *Analyse de la Nature*, 1815, p. 65.

Type, not designated, a *nomen nudum* here<sup>b</sup> ---- [*Cuculidæ?*]  
 Latinized from the French (Buffon's) *houhou*, a species of cuckoo.

**Hydrichla** BILLBERG, *Synopsis Faunæ Scand.*, I, Pars 2, 1828, tab. A, and p. 75.

New name for "*Cinclus* Bechst." (type, *Sturnus cinclus* LINNÆUS) ----- [*Cinclidæ*].  
 " *Nomen Cincli speciei jam pridem ad genus Tringæ pertinenti impositum, ut genericum ineptum censuimus, unde novum necessum fuit, quod e vocis græcis ὕδωρ, aqua et ἕλην, Turdus, composuimus.*" (Billberg.)

**Hydrolegus** BERTONI, *Aves Nuevas del Paraguay*, 1901, p. 74.

Type, *Hydrolegus silvestrianus* BERTONI (= *Myiothera nematura* LICHTENSTEIN) ----- [*Furnariidæ*].  
 \* *Ἰδωρ* (ὑδρ-), water; λέγω, I choose. (Bertoni.)

**Hydropeleia** H. BOIE, *Neues Staatsbürgerliches Magazin* [Schleswig], I, Heft 1, 1832, p. 209.

Type, not named here<sup>c</sup> ----- [*Laridæ?*]  
 \* *Ἰδωρ* (ὑδρ-), water; πέλεια, the wood pigeon.

<sup>a</sup> Compare also FORSTER, *Synop. Catal. Brit. Birds*, 1817, pp. 11, 52.

<sup>b</sup> Placed near *Cuculus*, and probably based on "le Houhou" of Buffon (VI, p. 367 = *Cuculus ægyptius* GMELIN).

<sup>c</sup> An unnamed species, seen, but not obtained by Boie in the South African Seas. His description points to *Larus hartlaubii* or some related species, although he supposed his bird to be allied to *Procellaria capensis*, which he also includes in the new genus.

- Hylocentrites** BERTONI, *Aves Nuevas del Paraguay*, 1901, p. 126.  
 Type, *Hylocentrites ambulator* BERTONI (= *Myiothra calcitrata* WIED) ..... [*Conopophagida*.]  
 "Γλη, a wood, forest; + *Centrites* (κέντρον, a spur). (Bertoni.)
- Hylodes** "GOULD, (1841)" GRAY, *List Genera Birds*, 2d ed., 1841, p. 30.  
 Type, same as *Drymodes* GOULD<sup>a</sup> ..... [*Timaliida*.]  
 "Γλωδης, woody, bushy.
- Hylonax** RIDGWAY, *Proc. Biol. Soc. Wash.*, XVIII, Sept. 2, 1905, p. 210.  
 Type, *Myiarchus validus* CABANIS ..... [*Cotingida*.]  
 "Γλη, a wood; ἄναξ, king. (Ridgway.)
- Hypermegethes** REICHENOW, *Journ. für Orn.*, LI, Jan., 1903, p. 149.  
 Type, *Hyphantornis grandis* G. R. GRAY ..... [*Plociida*.]  
 (Proposed as a subgenus of *Ploceus*.)  
 "Γπερμεγέθης, exceedingly diligent.
- Hypocryptadius** HARTERT, *Bull. Brit. Orn. Club*, XIV, No. C, Oct. 30, 1903, p. 13.  
 Type, *Hypocryptadius cinnamomeus* HARTERT ..... [*Zosteropida*.]  
 "Γπό, under; κρυπτάδιος, secret, hidden.
- Ichla** BILLBERG, *Synopsis Fauna Scand.*, I, Pars 2, 1828, tab. A, and p. 75. New name for "*Pastor* Temm."  
 (Type, *Turdus roseus* LINNÆUS.) ..... [*Sturnida*.]  
 "Nom. gener. *D: i celeb. Temminck Pastor nobis minus idoneum videtur, unde hoc genuinum græcum e roce Ἰχλη, hujus Nationis adoptavimus.*" (Billberg.)
- \***Ichthyaëtus** SWEETING, in *N. Wood's Naturalist*, II, No. 12, Sept., 1837, p. 303.  
 Type, "*Ichthyaëtus piscivorus*," or "*Common Osprey*." ..... [*Pandionida*.]  
 "ἰχθύς, a fish; ἄετός, an eagle.
- †**Ichtyopteryx** WIMAN, *Bull. Geol. Inst. Univ. Upsala*, VI, Pt. 2, 1905, p. 251.  
 Type, *Ichtyopteryx gracilis* WIMAN ..... [*Spheniscida*.]  
 "ἰχθύς, a fish; πτέρυξ, wing.
- \***Ictinus** MORRIS, in *N. Wood's Naturalist*, II, No. 9, June, 1837, p. 123.  
 Type, "*Ictinus milvus*," or "*Kite*" [of his list of British birds] ..... [*Buteonida*.]  
 "ἰκτινος, a kite.
- Idiocichla** OBERHOLSER, *Smithsonian Misc. Coll.*, Quarterly Issue, XLVIII, No. 2, July 1, 1905, p. 153.  
 Type, *Trichophorus notatus* CASSIN ..... [*Pycnonotida*.]  
 "Ἰδοίς, distinct; κίχλη, a thrush. (Oberholser.)

<sup>a</sup>Cancelled on p. 101, Gould having meanwhile published the name as *Drymodes*.

- Idiococcyx** H. BOIE, Neues Staatsbürgerliches Magazin [Schleswig], I, Heft 2, 1832, p. 489.  
 Type, "Sähest Du schon Raffles Cuculus chlorocephalus von Cuvier (?) im Pariser Museum und von Tem. zu Phoenicophaus gebracht!—Er ist typus meines Genus Idiococcyx, wogegen gar nichts einzuwenden seyn wird" ..... [*Cuculidae*.]  
*"Ιδιος*, distinct; *κόκκυξ*, a cuckoo.
- Idiotriccus** RIDGWAY, Proc. Biol. Soc. Wash., XVIII, Sept. 2, 1905, p. 210.  
 Type, *Pogonotriccus zeledoni* LAWRENCE ..... [*Cotingidae*.]  
*"Ιδιος*, distinct; *τρίκκος*, a small bird. (Ridgway.)
- Iridophanes** RIDGWAY, Proc. Wash. Acad. Sci., III, April 15, 1901, p. 150.  
 Type, *Dacnis pulcherrima* SCLATER ..... [*Tangaridae*.]  
*ἶρις* (*ἶριδος*), the rainbow; *φαίνω*, I show, display.
- †**Isotremornis** AMEGHINO, Anales Mus. Nac. Buenos Aires, 3d ser., VI, Nov. 30, 1905, p. 134.  
 Type, *Isotremornis nordenskjöldi* AMEGHINO ..... [*Spheniscidae*.]  
*"Ισος*, like, equal; *τρήμα*, a hole; *ἴρις*, bird. (Ameghino, MS.)
- Ixobrychus** BILLBERG, Synopsis Faune Scand., I, Pars 2, 1828, tab. A. and p. 166.  
 Types, *Ardea minuta* LINNÆUS, and *A. stellaris* LINNÆUS. [*Ardeidae*.]  
 "N. gen. e grecis vocis Ἰξος arundo, et βρυχῶ fremo desuntum."  
 (Billberg.)
- Jacamerops** OKEN, Isis, I, 1817, p. 1184.  
 Based on "Les Jacamerops" CUVIER, Règne Animal [I, 1817, p. 420 (type, *Alcedo grandis* GMELIN = *Alcedo aurea* MÜLLER)]. [*Galbulidae*.]  
*Jacamar*, a native name; + *ῶψ*, face (or *Jac[amar]* + *merops*).
- \***Kasnakowia** BIANCHI, Annuaire Mus. Zool. Acad. Imp. Sci. St.-Petersb., VIII, No. 2, 1903, Compte rendu, p. 11.  
 Type, *Kasnakowia kaslowi* BIANCHI, a *nomen nudum* here. [*Timaliidae*.]  
 For A. N. Kasnakov.
- Kasnakowia** BIANCHI, Bul. Acad. Imp. Sci. St.-Petersb., 5th ser., XXIII, No. 1-2, 1905, p. 45.  
 Type, *Babur waddelli* DRESSER ..... [*Timaliidae*.]
- Kelea** MERREM, in Ersch and Gruber's Allg. Encyclop. Wissensch. und Künste, Sect. 1, I, 1818, p. 338.  
 New name for *Muscipeta* KOCH ..... [*Sylviidae*.]  
*Κηλέω*, I charm, bewitch.

- \***Kenopia** “Bl. 1855” GRAY, Hand-List Birds, I, 1869, p. 317.  
 Type, “leucostigma, Müll. striata, Bl.; maculatus, Eyton.”  
 [ *Timaliidæ*. ]  
 (Used as a subgenus of *Malacopteron*.)
- Koslowia** DRESSER, Ibis, 8th ser., V, No. XVIII, April, 1905, p. 154.  
 Type, *Leucosticte roborowskii* [PRIEVALSKY] . . . [ *Fringillidæ*. ]  
 For P. K. Kozlov.
- Krimnochelidon** TICKELL, in WALDEN, Ibis, 3d ser., VI, No. XXIII, July, 1876, p. 356.  
 Types, *Hirundo concolor* SYKES, and *H. rupestris* SCOPOLI.  
 [ *Hirundinidæ*. ]  
*Κρίμνον*, a kind of coarse meal; *χελιδών*, swallow.
- Lamprochelidon** RIDGWAY, Proc. Biol. Soc. Wash., XVI, Sept. 30, 1903, p. 106.  
 Type, *Hirundo euchrysa* GOSSE . . . . . [ *Hirundinidæ*. ]  
*Λαμπρός*, shining, bright; *χελιδών*, swallow. (Ridgway.)
- \***Lampronotus** BROOKES, Museum Brookesianum, Feb., 1830, p. 93.  
 Type, “*Lampronotus auratus*,” or “Gilded Lampronotus.”  
 [ *Lucerta sedis*. ]  
*Λαμπρός*, shining, bright; *νωτός*, the back.
- \***Lamprophonus** MORRIS, in N. Wood’s Naturalist, II, No. 9, June, 1837, p. 125.  
 Types, “*Lamprophonus musicus*,” or “Throstle,” “*Lamprophonus caricatus*,” or “White’s Thrush,” “*Lamprophonus ruscivorus*,” or “Shrite,” “*Lamprophonus pilaris*,” or “Field-fare,” and “*Lamprophonus turdus*,” or “Redwing” [of his list of British birds] . . . . . [ *Turdidæ*. ]  
*Λαμπρός*, clear, sonorous; *φωρέω*, I sing.
- Laniellus** “BLYTH” RENNIE, Field Naturalist, I, No. 2, Feb., 1833, p. 70.  
 Type, *Parus biarmicus* LINNÆUS . . . . . [ *Paridæ*. ]  
 Diminutive of *lanius*, a butcher.
- Leonardia** MEARNS, Proc. Biol. Soc. Wash., XVIII, Jan. 20, 1905, p. 1.  
 Type, *Leonardia woodi* MEARNS . . . . . [ *Timaliidæ*. ]  
 For Major-General Leonard Wood, U. S. A. (Mearns.)
- Leonardina** MEARNS, Proc. Biol. Soc. Wash., XVIII, Feb. 21, 1905, p. 88.  
 New name for *Leonardia* MEARNS, 1905, not *Leonardia* TAPPARONE-CANEFRI, 1890 . . . . . [ *Timaliidæ*. ]
- \***Leucophrya** REICHENBACH, Avium Syst. Nat., June 1, 1850, pl. LXXV (figure showing generic characters).  
 Type, not named <sup>a</sup> . . . . . [ *Fringillidæ*. ]  
*Λεύκος*, white; *οφρύς*, eye-brow.

<sup>a</sup> Not *Leucophrys* SWAINSON, 1837, a member of the family Ploceidæ.

- \***Limnophylax** H. BOIE, Neues Staatsbürgerliches Magazin [Schleswig] I, Heft 2, 1832, p. 489. A *nomen nudum* here.  
Type, *Limnophylax marmorata* H. BOIE, a *nomen nudum* here, but doubtless equivalent to *Nycticorax limnophylax* TEMMINCK (= *Ardea melanolopha* RAFFLES) ..... [*Ardeidae*.]  
*Λίμνη*, a pool, marsh; *φύλαξ*, a watcher, guard, sentinel.
- \***Linophaga** MORRIS, in N. Wood's Naturalist, II, No. 9, June, 1837, p. 125.  
Types, "*Linophaga linaria*," or "Linnet," "*Linophaga rubra*," or "Redpoll," "*Linophaga montium*," or "Twite," and "*Linophaga canescens*," or "Hoarypoll" [of his list of British birds].  
[*Fringillidae*.]  
*Λίνον*, flax; *φαγέειν*, to eat.
- †**Lithosteornis** GERVAIS, Remarques Oiseaux Fossiles, 1844, p. 7 (note).  
Alternative name for *Ostcornis* GERVAIS ..... [*Incertæ sedis*.]  
*Λίθος*, stone; + *Ostcornis* (*ὀσττέον*, bone; *ὄρνις*, bird).
- Loborhamphus** ROTHSCHILD, Bull. Brit. Orn. Club, XII, No. LXXXIV, Dec. 30, 1901, p. 34.  
Type, *Loborhamphus nobilis* ROTHSCHILD ..... [*Paradisidae*.]  
*Λοβός*, a lobe; *ὀψίς*, beak.
- † **Loneornis** AMEGHINO, Sinopsis geol.-paleon., Suplemento, 1899, p. 9.  
Type, *Loneornis erectus* AMEGHINO ..... [*Incertæ sedis*.]  
Latinized from *loneo*, Araucanian name of a hill, + *ὄρνις*, bird. (Ameghino, MS.)
- Longirostris** S. D. W., Analyst, IV, No. XV, April 1, 1836, p. 119.  
Substitute name for *Macrorhamphus* LEACH ..... [*Scelopacidae*.]  
*Longus*, long; *rostrum*, beak.
- \* **Loxorynchus** MORRIS, in N. Wood's Naturalist, II, No. 9, June, 1837, p. 124.  
Types, "*Loxorynchus curvirostra*," or "Crossbill," "*Loxorynchus crurivirostra*," or "Parrot Crossbill," and "*Loxorynchus albipennis*," or "White-winged Crossbill" [of his list of British birds] ..... [*Fringillidae*.]  
*Λοξός*, crosswise; *ὀψίς*, beak.
- Lucar** "BARTRAM" COUES, Proc. Acad. Nat. Sci. Phil., for 1875, Oct. 19, 1875, p. 349 (note).  
Type, *Muscicapa carolinensis* LINNÆUS ..... [*Mimidae*.]  
(See also *Dumetella*.)  
Etymology unknown. The identity with *lucar*, a forest tax, probably coincidental. (Gill.)

**Luscinia** T. FORSTER, Synop. Catal. Brit. Birds, 1817, p. 14.

Type, *Luscinia saxon* FORSTER (= *Sylvia luscinia* FORSTER (not of LINNÆUS) = *Luscinia megarhynchos* BREHM) [*Turdida*.]  
*Luscinia*, the nightingale.

\* **Macao**, S. D. W., Analyst, III, No. XIV, Jan., 1836, p. 212.

Type, "Macao splendilus" S. D. W., or "Blue Macaw."  
 [*Psittacida*.]

**Macrocephalon**<sup>a</sup> S. MÜLLER, Archiv für Naturgesch., 1846, I, p. 116.

Type, *Macrocephalon malco* S. MÜLLER . . . . . [*Meqapodida*.]  
*Μακρός*, long, large; *κεφάλῳ*, head.

**Macronectes** RICHMOND, Proc. Biol. Soc. Wash., XVIII, Feb., 21, 1905, p. 76.

New name for *Ossi-fraga* HOMBRON and JACQUINOT, 1844, not *Ossi-fraga* N. WOOD, 1835 . . . . . [*Puffinida*.]  
*Μακρός*, large; *νήκτις*, a swimmer. (Richmond.)

**Macropus** SPIX, Avium Species Novae, I, 1824, p. 53.

Types, *Macropus phasianellus* SPIX, and *M. calianus* SPIX.  
 [*Cuculida*.]

*Μακρός*, long; *πούς*, foot.

\* **Malacoedus** REICHENBACH, Avium Syst. Nat., March 1, 1850, pl. LVII (figure showing generic characters).

Type, not named . . . . . [*Incerta sedis*.]  
*Μαλακός*, mild, gentle; *ἡδός*, enjoyment, pleasure.

\* **Malacorhamphus** KITTLITZ, Denkw. Reise russischen Amerika, I, 1858, p. 124.

Type, *Malacorhamphus araucanus* KITTLITZ, a *nomen nudum* here . . . . . [*Incerta sedis*.]  
*Μαλακός*, soft; *ράμφος*, beak.

**Malacurus** GLOGER, Hand- und Hilfsbuch, 1842, p. 282.

Emendation of *Malurus* VIEILLOT . . . . . [*Sylviida*.]  
*Μαλακός*, soft; *οὐρά*, tail.

† **Mancalla** LUCAS, Proc. U. S. Nat. Mus., XXIV, No. 1245, Sept. 27, 1901, p. 133.

Type, *Mancalla californiensis*, LUCAS . . . . . [*Alcida*.]  
*Mancus*, imperfect; + *Alle* (alle, Swedish name of a kind of auk).

**Maria** GIULIANETTI, in Giglioli, Boll. Soc. Geogr. Ital., 3d ser., X, Fasc. I, 1897, p. 26.

Type, *Maria Mac Gregoria* GIULIANETTI . . . . . [*Paradisida*.]  
 For Lady Mc Gregor.

<sup>a</sup>This appears to be the earliest (albeit preoccupied) name for the genus, as well as the first reference to the specific name. It is true that Hartlaub mentioned the name *Macrocephalon malco* in 1844 (Verz. Ges. Mus. Bremen, p. 101), but only as a *nomen nudum*.

- \***Maridus** C. T. WOOD, Orn. Guide, Jan., 1837, p. 201.  
Types, "Maridus luteus, *Wood*," or "Common Nocturn," and  
"Maridus bahamensis, *Wood*," or "Yellow-headed Nocturn."  
[*Ardeidae*.]
- Marila** OKEN, Isis, I, 1817, p. 1183.  
Based on "Les Millouins" CUVIER, Règne Animal [I, 1817, p.  
534 (type, *Anas marila* LINNÆUS)] ..... [*Anatidae*.]  
*Μαρίλη*, embers of charcoal.
- Martula** C. T. WOOD, Orn. Guide, Jan., 1837, p. 183.  
Types<sup>a</sup> ..... [*Hirundinidae*.]
- Megacephalus** BERTONI, Aves Nuevas del Paraguay, 1901, p. 39.  
Type, *Megacephalus bitorquatus* BERTONI (= *Bucco swainsoni*  
GRAY) ..... [*Bucconidae*.]  
*Μέγας*, large; *κεφαλή*, head.
- \***Megalorhamphus** BROOKES, Catal. Mus. Joshua Brookes. Pt. II, July,  
1828, p. 97.  
Type, "Megalorhamphus asiaticus," or "Asiatic Argala."  
[*Ciconiidae*.]  
*Μέγας* (*μεγάλ*-), large; *ράμφος*, bill.
- Megaxenops** REISER, Anzeiger Akad. Wissensch. [Wien], XLII, No.  
XVIII, July, 1905, p. 322.  
Type, *Megaxenops paraguayae* REISER ..... [*Furnariidae*.]  
*Μέγας*, large; + *Xenops* (*ξένος*, strange; *ώψ*, face, appearance.)
- Melanhyphantes** SHARPE, in Jameson, Story of the Rear Column, 1890,  
p. 404.  
Type, *Malimbus nigricollis* VIEILLOT ..... [*Ploceidae*.]  
*Μέλας* (*μέλαν*-), black; + *Hyphantes* (*ὕφάντης*, a weaver).
- \***Melanoleuca** MORRIS, in N. Wood's Naturalist, II, No. 9, June, 1837,  
p. 124.  
Type, "*Melanoleuca pica*," or "Magpie" [of his list of British  
birds] ..... [*Corvidae*.]  
*Μέλας* (*μέλαν*-), black; *λευκός*, white.
- Melanonyx** BUTURLIN, Dukie icyu rossijski imperii ("Wild Geese of  
the Russian Empire"), 1901, p. 22.  
Type, *Anas segetum* GMELIN (= *A. fabalis* LATHAM).  
[*Anatidae*.]  
(Proposed as a subgenus of *Anser*.)  
*Μέλας* (*μέλαν*-), black; *ὄρνιξ*, nail, claw.

<sup>a</sup> "It was my intention to have separated the Eave Swallow, and the Bank Swallow of the following list from the genus Swallow (*Hirundo*.) under the names Eave Martlet (*Martula fenestra*.) and Bank Martlet, (*Martula riparia*.) but on further consideration it appeared to me, that the characters of the new genus were not yet sufficiently defined to warrant the innovation." In the "following list" he cites these species under the names "Eave Swallow," or "Hirundo fenestra, *Wood*," and "Bank Swallow," or "Hirundo riparia, *Aldr*."

**Melanopteryx** REICHENOW, Zool. Jahrb., I, Heft I, April 1, 1886, p. 125.

Type, *Ploceus nigerrimus* VIEILLOT.....[*Ploceidæ*.]  
(Proposed as a subgenus of *Ploceus*.)

Μέλας (μέλαν-), black; πτέρυξ, wing.

**Merion** SCHNIZ, in Cuvier, Thierreich, IV, 1825, p. 540.

Type, *Malurus galactotes* TEMMINCK.....[*Sylviidæ*.]

**Merula** KOCH,<sup>a</sup> Syst. Baierischen Zool., 1816, p. 242.

Type, *Turdus roseus* LINNÆUS.....[*Sturnidæ*.]

*Merula*, the blackbird.

†**Metancylornis** AMEGHINO, Anales Mus. Nac. Buenos Aires, 3d ser., VI, Nov. 30, 1905, p. 129.

Type, *Paraptonodytes curtus* AMEGHINO.....[*Spheniscidæ*.]

Μετά, in the midst of, between; ἄγκυλος, crooked, curved; ὄρνις, bird. (Ameghino, MS.)

**Micraëtus**<sup>b</sup> BERTONI, Aves Nuevas del Paraguay, 1901, p. 156.

Type, *Micraëtus holmbergianus* BERTONI (= *Falco capennensis* GMELIN).....[*Buteonidæ*.]

Μικρός, small; ἀετός, eagle. (Bertoni.)

**Microchelidon** SCLATER, Catal. Coll. Amer. Birds, 1862, p. 39.

Type, *Petrochelidon tibialis* CASSIN.....[*Merulinidæ*.]

Μικρός, small; χελιδών, swallow.

**Microgoura** ROTHSCHILD, Bull. Brit. Orn. Club, XIV, No. CVII, May 30, 1904, p. 77.

Type, *Microgoura meeki* ROTHSCHILD.....[*Microgouridæ*?]

Μικρός, small; + *Goura* (*goura*, a native? name for the crowned pigeon of New Guinea).

**Microlyssa** RILEY, Auk, XXI, No. 4, Oct., 1904, p. 485.

New name for *Bellona* MULSANT and VERREAUX, 1866, not *Bellona* REICHENBACH, 1852.....[*Trochilidæ*.]

Μικρός, small; λύσσα, rage, fury, frenzy.

<sup>a</sup>Koch's work was published before July (compare LICHTENSTEIN, Abh. k. Akad. Wiss. Berlin, 1816-1817 (1819), p. 144), thus antedating the use of *Merula* by Leach (the prefatory note of whose work is dated "August 30, 1816") for a thrush. The choice of a name for the group long called *Merula* seems to lie between *Hodoïporus* Reichenbach, 1850 (based on figures of generic outlines—no specific name mentioned) and *Planesticus* Bonaparte, 1854. (*Copsicus* MORRIS, 1837, is preoccupied by *Copsychus* WAGLER, 1827, and *Copsichus* KAUP, 1829.)

<sup>b</sup>*Odontriorechis* KAUP (Class. Säug. und Vögel, 1844, p. 124) appears to be the earliest available name for this genus, since *Leptodon* SUNDEVALL, 1836, is preoccupied by *Leptodon* RAFINESQUE, 1820. Those who regard *Falco uncinatus* TEMMINCK as a member of the same genus will have to use *Chondrohierax* LESSON, 1843 (type, *Dactolion erythrofrons* LESSON = *Falco uncinatus* TEMMINCK).



**Microparra** CABANIS, Ornith. Centralblatt, II, No. 12, June 15, 1877, p. 95.

Type, *Parra capensis* A. SMITH ..... [*Jacaniidæ*.]  
*Μικρός*, small; + *Parra*, a synonym of *Jacana*.

**Micropsites** "Is. GEOFF." BOURJOT St.-HILAIRE, Hist. Nat. Perroquets, 1837-1838 [pl. 100. and text].

Type, *Micropsites pygmaeus* "Is. Geoff." (= *Psittacus pygmaeus* QUOY and GAIMARD) ..... [*Psittacidæ*.]

**Microtriccus** RIDGWAY, Proc. Biol. Soc. Wash., XVIII, Sept. 2, 1905, p. 210.

Type, *Tyrannulus semijlarius* SCLATER and SALVIN. [*Cotingidæ*.]  
*Μικρός*, small; *τρικκος*, a small bird. (Ridgway.)

**Microtrogon** BERTONI, Aves Nuevas del Paraguay, 1901, p. 41.

Types, *Microtrogon fulvescens* BERTONI, (= *Bucco rubicula* SPIX), and *M. galbuloides* BERTONI (= ———?) ... [*Buconidæ*.]

*Μικρός*, small; + *Trogon* (*τρώγω*, I gnaw, I eat). (Bertoni.)

\***Misamichus** BROOKES, Catal. Mus. Joshua Brookes, Pt. II, July, 1828, p. 104.

Type, "*Misamichus pallasii*,"<sup>a</sup> a *nomen nudum* here. [*Laridæ*.]

†**Miserythrus** A. NEWTON, Encycl. Brit., 9th ed., III, 1875, p. 733.

Type, *Miserythrus leguati* = *Erythromachus leguati* MILNE-EDWARDS ..... [*Rallidæ*.]

*Μισέω*, I hate; *έρυθρη* [*θάλασσα*], the Erythraean Sea, Indian Ocean.

**Monadon**<sup>b</sup> "VIEILLOT" STEPHENS, General Zoology, IX, Pt. I, 1815 (1816?), p. 42.

Type, *Bucco cinereus* GMELIN ..... [*Buconidæ*.]  
*Μόνος*, single; *ὀδών*, a tooth. (Dr. Stejneger suggests *μοναδόν*, solitary wise.)

**Monias** OUSTALET and GRANDIDIER, Bull. Mus. d'Hist. Nat. [Paris], IX, No. 1, Feb. 17, 1903, p. 11.

Type, *Monias benschi* OUSTALET and GRANDIDIER ... [*Rallidæ*?]  
*Μονίας*, solitary.

\***Morphnaëtos** SEVERTZOV, Stray Feathers, III, No. 5, Nov., 1875, p. 422.

Types, *Aquila imperialis*, *A. adalberti*, *A. orientalis*, *A. bifasciata*, *A. glitschi*, *A. rapax*, *A. fulvescens*, *A. clanga*, and *A. naxia* [no authorities are cited for these names] .... [*Buconidæ*.]  
*Μόρφητος*, dusky, dark; *ἀετός*, eagle.

<sup>a</sup>STEPHENS (Gen. Zool., XIII, Pt. I, 1826, p. 185) cites this name as a doubtful synonym of *Larus ichthyatus* PALLAS.

<sup>b</sup>This is *Monasa* of VIEILLOT'S "Analyse." Possibly Vieillot substituted *Monasa* for *Monadon* after his manuscript was returned by the Linnaean Society of London, where Stephens probably saw it.

\***Moscha**<sup>a</sup> BROOKES, Catal. Mus. Joshua Brookes, Pt. II, July 1828, p. 102.  
 Type, "*Moscha carunculata*," or "Carunculated Musk-bird."  
 [Anatida.]

*Μόσχος*, musk.

\***Muscaccipiter** H. D. MINOR, Land-Birds and Game-Birds of New England, 1877, p. 291.  
 Type, described, but not named<sup>b</sup> ..... [Tyrannidae.]  
*Musca*, fly; *accipiter*, hawk.

**Muscadivores** "LESS." GRAY, Catal. Gen. Birds, 1855, p. 98.  
 Type, *Columba aca* LINNÆUS ..... [Tyrannidae.]  
 French *muscule*, a nutmeg; *devorer*, to devour.

\***Muscicula**<sup>c</sup> C. T. WOOD, Orn. Guide, Jan., 1837, p. 189.  
 Type, "*Muscicula luctuosa*, Wood," or "Pied Snapper."  
 [Muscicapidae.]  
*Muscicula*, Diminutive of *musca*, a fly.

**Musovora** BILLBERG, Synopsis Faune Scand., I, Pars 2, 1828, tab. A.  
 Emendation of *Musophaga* ISERR. .... [Musophagidae.]  
*Musa*, the plantain; *vorare*, I devour.

**Myiophthorus** BERTONI, Aves Nuevas del Paraguay, 1901, p. 128.  
 Type, *Myiophthorus morenoianus* BERTONI (= ———?)  
 [Tyrannidae?]  
*Μύια*, a fly; *φθορά*, destruction. (Bertoni.)

**Myiornis** BERTONI, Aves Nuevas del Paraguay, 1901, p. 129.  
 Type, *Euscarthmus minutus* BERTONI (= *Todus poliocephalus* WIED)  
 ..... [Tyrannidae.]  
 (Proposed as a subgenus of *Euscarthmus*.)  
*Μύια*, a fly; *ὄρνις*, bird.

\***Myiotheras** MORRIS, in N. Wood's Naturalist, II, No. 9, June, 1837, p. 125.  
 Types, "*Myiotheras luctuosus*," or "Pied Flycatcher," and "*Myiotheras griseus*," or "Spotted Flycatcher" [of his list of British birds]  
 ..... [Muscicapidae.]  
 (See also *Muscicula* and *Stoparola*.)  
*Μύια*, a fly; *θίψα*, the chase.

**Myiotriccus** RIDGWAY, Proc. Biol. Soc. Wash., XVIII, Sept. 2, 1905, p. 207.  
 Type, *Tyrannula phanicura* SCLATER ..... [Tyrannidae.]  
*Μύια*, a fly; *τρικκος*, a small bird. (Ridgway.)

<sup>a</sup> "*Moscha*, Leach MSS." is cited by Stephens, Gen. Zool., XII, Pt. II, 1824, p. 78, as a synonym of *Cairina*.

<sup>b</sup> Supposed to be a species of *Empidonax*.

<sup>c</sup> On page 184, he says "The Pied Flycatcher has been separated from the Gray Flycatcher, at Mr. BLYTH's suggestion." (Compare *Stoparola*.)

- Myopornis** REICHENOW, Journ. für Orn., XLIX, April, 1901, p. 285.  
 Type, *Bradyornis böhmii* REICHENOW. . . . . [*Muscicapidæ*.]  
*Μύωψ*, the horsefly; ὄρνις, bird.
- Nannorchilus** RIDGWAY, Proc. Biol. Soc. Wash., XVII, April 9, 1904,  
 p. 102.  
 New name for *Hemiuira* RIDGWAY, 1887, not *Hemiuirus* RUDOLPHI, 1809, etc. . . . . [*Troglodytidæ*.]  
*Νάννος*, a dwarf; ὄρχιλος, wren. (Ridgway.)
- Nannus**<sup>a</sup> BILLBERG, Synopsis Faune Scand., I, Pars 2, 1828, tab. A,  
 and p. 57.  
 New name for "*Troglodytes* Cuv.," which contains only "*le Troglodyte d'Europe*" (*Motacilla troglodytes* LINNÆUS).  
 . . . . . [*Troglodytidæ*.]  
*Νάννος*, a dwarf.
- \***Napothera** H. BOIE, Neues Staatsbürgerliches Magazin [Schleswig],  
 I, Heft 2, 1832, p. 488. A *nomen nudum* here.<sup>b</sup>  
 Type, "*Myothera lepidoccephala* Kuhl," a *nomen nudum* here.  
 . . . . . [*Timaliidæ*.]  
*Νάπος*, a woody dell; θηπέω, I hunt, seek.
- Napothera** "BOIE (1835)" GRAY, Appendix to List Gen. Birds, 1842,  
 p. 8.  
 Type, "*N. epilepidota* (Temm.), Boie. Pl. col. 448. f. 2."<sup>c</sup>  
 . . . . . [*Timaliidæ*.]
- Nea** BILLBERG, Synopsis Faune Scand., I, Pars 2, 1828, tab. A and  
 p. 155.  
 New name for "*Glottis* Nilss.," with the following species: *Scelopar semipalmata* GÜMELIN, and *S. glottis* LINNÆUS. [*Scelopacidæ*.]  
 "Hoc genus ut proprium et distinctum nobis arrisit; nomen vero Nilssonii, Glottis, quia apud grecos alia avis inter coturnices ita denominatur, in aliud a Νεω, rudo, derivatum, nobis potius mutandum." (Billberg.)
- †**Neculus** AMEGHINO, Anales Mus. Nac. Buenos Aires, 3d ser. VI, Nov.  
 30, 1905, p. 127.  
 Type, *Neculus rothi* AMEGHINO . . . . . [*Sphniscidæ*.]  
 Latinized from the Araucanian *neculú*, a runner. (Ameghino, MS.)

<sup>a</sup> This name should replace *Albiorchilus* OBERHOLSER.

<sup>b</sup> Other references are: *Napothera* MACKLOT, Bijdr. Natuurk. Wetensch., V, 1830, p. 175 (type, *N. brunisens* Macklot, a *nomen nudum* here); *Napothera* S. MÜLLER, Tijdsch. Naturf. Gesch. en Phys., II, 1835, p. 331 (type, *N. pyrroptera* "BOIE," a *nomen nudum* here). The name *Napothera* does not occur in "Isis, 1835," as often quoted.

<sup>c</sup> It is possible that *Napothera* may be available for the group we now know as *Turdinulus*, since *Myothera epilepidota* (from "les îles de Java et de Sumatra") appears to belong to this group. I have a memorandum to the effect that this species is discussed in the Bulletin of the Liverpool Museum, 1, p. 83, but can not verify the reference at present.

**Nemoricola** HODGSON, Journ. Asiatic Soc. Bengal, VI, Pt. 1, No. 66, June, 1837, p. 491.

Type, "I have set it down in my note book, as the type of a new genus or subgenus, under the style of *Nemoricola Nipalensis*, but I forbear, for the present, from so naming it". [*Scolopacida*.]

*Nemus*, a wood with open glades; *colo*, I inhabit.

**Nemoricola** "HODG. (1837)" GRAY, Appendix to List Genera Birds, 1842, p. 14.

Type, *Nemoricola nipalensis* HODGSON (= *Scolopax nemoricola* HODGSON) ..... [*Scolopacida*.]

**Nemoricola** BLYTH, Annals and Mag. Nat. Hist., XIV, No. 89, Aug., 1844, p. 114.

Type, *Motacilla indica* GMELIN ..... [*Motacillida*.]

**Neodendroica** MAYNARD, Warblers of New England, Pt. 4, 1901, p. 69.

Type, *Motacilla dominica* LINNÆUS ..... [*Mniotiltida*.]

*Νέος*, new; + *Dendroica* (δέρυδρον, a tree; οἰκέω, I inhabit).

**Neomenius** BILLBERG, Synopsis Faune Scand., I, Pars 2, 1828, tab. A, and p. 159.

Emendation of *Namenius* BRISSON ..... [*Scolopacida*.]

"Nomen hoc genericum a græco Νεομηνία, nova luna, ab formam rostri derivatum videtur; cunc autem Neomenius scribentur." (Billberg.)

**Neositta** HELLMAYR, Journ. für Orn., XLIX, April, 1901, p. 187.

New name for *Sittella* SWAINSON, 1837, not *Sittella* RAFINESQUE, 1815 ..... [*Sittida*.]

*Νέος*, new; + *Sitta* (σίτην, a nutbatch).

**Neospiza**<sup>a</sup> SALVADORI, Mem. R. Accad. Sci. [Torino], 2d ser., LIII, 1903, p. 26.

Type, *Amblyospiza concolor* BOCADE ..... [*Fringillida*.]

*Νέος*, new; *σπίζα*, a finch.

**Neothraupis**<sup>b</sup> BERLEPSCH, Ornith. Centralblatt, IV, No. 7, April 1, 1879, p. 55.

Type, *Piranga cyathicincta* VIEILLOT ..... [*Tangarida*.]

*Νέος*, new; + *Thraupis* (θηραυπίς, a small bird).

**Nesobates** SULARPE, Bull. Brit. Orn. Club, XII, No. LXXXVII, March 28, 1902, p. 54.

New name for *Oryglabes* SULARPE, 1870, not *Oryglabis* FORSTER, 1856 ..... [*Timaliida*.]

*Νήσος*, island; *βάτης*, one that treads or covers, a climber.

<sup>a</sup>"*Nesospiza*" REICHENOW, Vogel Afrikas, III, i, 1904, p. 278, not *Nesospiza* CABANIS!

<sup>b</sup>Name changed to *Callithraupis* on p. 63.

- Nesocharis** ALEXANDER, Bull. Brit. Orn. Club, XIII, No. XCV, Feb. 28, 1903, p. 48.  
Type, *Nesocharis shelleyi* ALEXANDER ..... [*Ploceidæ*.]  
Νῆσος, island; χάρις, grace.
- Notiocichla** OBERHOLSER, Proc. U. S. Nat. Museum, XXVIII, No. 1411, July 8, 1905, p. 900.  
Type, *Sylvia baticata* VIEILLOT ..... [*Sylviidæ*.]  
Λότιος, southern; κίχλη, thrush. (Oberholser.)
- Notospiza** OBERHOLSER, Smithsonian Misc. Coll., Quarterly Issue, XLVIII, No. 1, May 13, 1905, p. 64.  
New name for *Sharpia* BOCAGE, 1878, not *Sharpia* TOURNIER, 1873 ..... [*Ploceidæ*.]  
Λότιος, southern; σπιζα, a finch. (Oberholser.)
- Numida** LINNÆUS, Museum Adolphi Friderici, II, 1764, p. 27.  
Type, *Phasianus melagris* LINNÆUS ..... [*Phasianidæ*.]  
*Numida*, a Numidian.
- Numidica** OKEN, Isis, I, 1817, p. 1184.  
Based on "Les Numidiques" CUVIER, Règne Animal [I, 1817, p. 472 (type, "La Demoiselle de Numidie. (*Ardea virgo*. L.)"]<sup>a</sup>  
[*Gruidæ*.]  
*Numidicus*, Numidian.
- Nyctagreu**<sup>b</sup> NELSON, Proc. Biol. Soc. Wash., XIV, Sept. 25, 1901, p. 171.  
Type, *Caprimulgus yucatanensis* HARTERT. . . . [*Caprimulgidæ*.]  
Νύξ (νυκτός), night; ἀγρεύς, a hunter. (Nelson.)
- \* **Nyctimene** MORRIS, in N. Wood's Naturalist, II, No. 9, June, 1837, p. 123.  
Types, "*Nyctimene glauvula*," or "Gillihowlet," and "*Nyctimene stridula*," or "Brown Owl" [of his list of British birds].  
[*Aluconidæ*.]  
Νύξ (νυκτός), night; μένω, I remain, abide.
- Nyctornis** NITZSCH, Observ. Avium Arteria Carot. Communi, 1829, p. 15.  
Type, *Caprimulgus grandis* GMELIN ..... [*Caprimulgidæ*.]  
Νύξ (νυκτός), night; ὄρνις, bird.
- "**Nystactes** KAUP." cited by Waterhouse, is a mammal!
- † **Ocyplanus** DE VIS, Annals Queensl. Museum, No. 6, Sept. 30, 1905, p. 8.  
Type, *Ocyplanus proeses* DE VIS ..... [*Limicolæ*.]  
Ὀκυπλῆς, swift, fleet; πλάρος, a wandering about, roaming.

<sup>a</sup> Named *Grus numidica* by Bechstein, in 1792.

<sup>b</sup> Emended to "*Nyctagrius*" by Selater, Ibis, 1902, p. 345.

- Odontospiza** OBERHOLSER, Proc. U. S. Nat. Museum, XXVIII, No. 1411, July 8, 1905, p. 883.  
 Type, *Ptyelia caniceps* REICHENOW ..... [Ploceidæ.]  
 Ὀδοῦς (ὀδόντος), tooth; σπιζα, a finch. (Oberholser.)
- Olbiorchilus** OBERHOLSER, Auk, XIX, No. 2, April, 1902, p. 177.  
 Type, *Motacilla troglodytes* LINNÆUS ..... [Troglodytidae.]  
 (See *Xannus* BILLBERG.)  
 Ὀλβίος, happy; ὄρχιλος, wren. (Oberholser.)
- \* **Orchilus** MORRIS, in N. Wood's Naturalist, II, No. 9, June, 1837, p. 124.  
 Types, "Orchilus cristatus," or "Golderest," and "Orchilus ignicapillus," or "Firecrest" [of his list of British birds].  
 [Regulidæ.]  
 Ὀρχίλος, a wren.
- Oreias** TEMMINCK, Planches Col., I (Livr. 102<sup>l</sup>), 1839<sup>l</sup> (tabl. méth., p. 108).  
 Type, *Turdus azureus* TEMMINCK ..... [Turdidæ.]  
 Ὀρειάς, of or belonging to mountains.
- Oreomyias** REICHENOW, Journ. für Orn., I, April, 1902, p. 254.  
 Type, *Muscicapa viisi* HARTLAUB ..... [Muscicapidæ.]  
 Ὀρος (ὄρεος), mountain; μύια, a fly.
- Oreomystis** STEINER, Proc. Biol. Soc. Wash., XVI, Feb. 21, 1903, p. 11.  
 New name for *Oreomyza* STEINER, July, 1887, not *Oreomyza* POKORNY, Feb., 1887 ..... [Drepanididæ.]  
 (See *Petroreomyza*.)  
 Ὀρος (ὄρεος), mountain; μυστίς, one initiated.
- Oreoscopus** NORTH, Agric. Gazette N. S. Wales, XVI, Pt. 3, March 2, 1905, p. 247.  
 Type, *Sciricornis gutturalis* DE VIS ..... [Sylviidæ.]  
 Ὀρος (ὄρεος), mountain; σκοπός, one that watches, a spy, scout.
- Orites** "MEHR. (1752)" GRAY, List Genera Birds, 2d ed., 1841, p. 32.  
 Type, *Purus caudatus* LINNÆUS ..... [Paridæ.]  
 Ὀρειτης, a mountaineer.
- Orochelidon** RIDGWAY, Proc. Biol. Soc. Wash., XVI, Sept. 30, 1903, p. 106.  
 Type, "Petrochelidon naurina CASSIN (= *Hirundo cinerea* GME-LIN?)" ..... [Hirundinidæ.]  
 Ὀρος, mountain; χελιδών, swallow. (Ridgway.)
- Orodynastes** RIDGWAY, Proc. Biol. Soc. Wash., XVIII, Sept. 2, 1905, p. 208.  
 Type, *Taniptera striaticollis* SCLATER ..... [Tyrannidæ.]  
 Ὀρος, mountain; δυνάστης, a lord, master, ruler. (Ridgway.)

- Ortyx** <sup>a</sup> Oken. Lehrbuch der Naturgesch., III, Zool., 2 Abth., 1816, p. 611, viii.  
 Type, *Tetrao gibraltarius* GMELIN -----[*Turnicidæ*.]  
 "Ὀρτυξ, a quail.
- Ossifraga** N. Wood, Analyst, II, No. XI, June, 1835, p. 305 (III, 1836, p. 199; VI, 1837, p. 244; VII, 1837, p. 37).  
 Type, "White-tailed Ossifrage (*O. albicilla*)"<sup>b</sup> ---[*Buteonidæ*.]  
*Ossifraga*, the sea-eagle, osprey.
- Oticolus** HODGSON, Journ. Asiatic Soc. Bengal, XVI, Pt. II, 1847, p. 889.  
 Type, "This bird [*Otis bengalensis*] is congeneric with the Likh (Auritus) which Mr. Gray separates from Otis and places in Lesson's Genus Syphcotides, hodie Eupodotis. I had named the form, Oticolus" -----[*Otididæ*.]  
 Diminutive of *Otis*, a bustard.
- Otus** PENNANT, Indian Zoology, 1769, p. 3.  
 Type, *Otus bakkamoena* PENNANT -----[*Strigidæ*.]  
 "Ὀτος, the horned owl.
- † **Owenia** GRAY, Catal. Genera and Subgenera Birds, 1855, p. 152.  
 Type, *Dimornis struthioides* OWEN -----[*Dimornithidæ*.]  
 For Richard Owen.
- Oxyporus** BROOKES, Catal. Mus. Joshua Brookes, Pt. II, July, 1828, p. 95.  
 New name for "*Casuarus* Lin." (type, "*Casuarus galcatus*," or "Carunculated Cassowary") -----[*Casuariidæ*.]  
 (See also *Cela* and *Thrasys*.)  
 "Ὀξύρος, sharp; πῶρος, a node on the bones, a callus.
- † **Pachypteryx** WIMAN, Bull. Geol. Inst. Univ. Upsala, VI, Pt. 2, 1905, p. 250.  
 Type, *Pachypteryx grandis* WIMAN -----[*Spheniscidæ*.]  
 Παχύρως, thick; πτέρυξ, wing.
- Pachyrhynchus** <sup>c</sup> WAGLER, in Hahn, Vögel aus Asien, Afrika, etc., II, Lief. XIII, 1822, pl. 6 and text.  
 Type, *Pachyrhynchus melanocephalus* WAGLER (= *Lanius cayana* LINNÆUS) -----[*Cotingidæ*.]  
 Παχύρως, thick; ῥύγχος, beak.

<sup>a</sup> Intended as a substitute name for *Turnix*. On p. 611 he gives the generic heading thus: "Ortyx, Turnix, Tridactylus," and on p. viii it stands as "Ortyx (Turnix)."

<sup>b</sup> With references to GOULD, Birds of Europe, Pt. VII, pl. 19, and Pt. IX, pl. 5 (adult, and young of the first year).

<sup>c</sup> WAGLER, not Spix, is the authority for this name.

- † **Palaeoapterodytes** AMEGHINO, *Anales Mus. Nac. Buenos Aires*, 3d ser., VI, Nov. 30, 1905, p. 120.  
 New name for *Apterodytes* AMEGHINO, 1901, not *Apterodita* SCOPOLI, 1786. . . . . [*Spheniscida*.]  
*Παλαιότυς*, ancient; + *Apterodytes* (ἄπτερος, without wings; δύτης, a diver).
- † **Palæonornis** E. EMMONS, *Amer. Geology*, Pt. IV, 1857, p. 148, fig. 114.  
 Type, *Palæonornis struthionoides* EMMONS . . . [*Incerta sedis*.]  
*Παλαιότυς*, ancient; ὄρνις, bird.
- † **Paraspheniscus** AMEGHINO, *Anales Mus. Nac. Buenos Aires*, 3d ser., VI, Nov. 30, 1905, p. 115.  
 Type, *Palæospheniscus bergi* MORENO and MERCERAT. . . . . [*Spheniscida*.]  
*Παρά*, beside; + *Spheniscus* (σφηνίσκος, dim. of σφήν, a wedge).
- \* **Parcoræus**<sup>a</sup> BROOKES, *Catal. Mus. Joshua Brookes*, Pt. II, July, 1828, p. 84.  
 Type, "*Parcoræus narbonensis*," or "Languedoc Penduline". . . . . [*Parida*.]  
*Παρος*, a titmouse; + αἰωπέω, I hold in a pendulous position. (Suggested by Dr. Stejneger.)
- Parophasma** REICHENOW, *Vögel Afrikas*, III, ii, 1905, p. 743.  
 Type, *Parisoma galinieri* GUÉRIN . . . . . [*Muscicapida*.]  
*Παρος*, a titmouse; *phasma*, an apparition, phantom.
- Paroreomyza** PERKINS, *Ibis*, 8th ser., I, No. IV, Oct., 1901, p. 583.  
 Type, *Himatione maculata* CABANIS . . . . . [*Drepanidida*.]  
 (Proposed as a subgenus of *Oreomyza* = *Oreomyzitis*.)  
*Παρά*, beside; + *Oreomyza* (ὄρος, ὄρεος, mountain; πύζω, I suck).
- Passerherbulus**<sup>b</sup> MAYNARD, *Birds East. North Amer.*, 2d ed., Pt. 40, 1895, p. 707.  
 Type, *Emberiza leconteii* AUDUBON . . . . . [*Fringillida*.]  
*Passer*, a sparrow; *herbula*, a little herb.
- Paulomagus** HOWE, *Suppl. Birds of Rhode Island*, 1903, p. 22 (note).  
 Type, the "group including *aidon*" (= *Troglodytes aidon* VIEILLŒT) . . . . . [*Troglodytida*.]  
*Paulus*, little, small; *magus*, a magician.
- Pecula** C. T. WOOD, *Analyst*, IV, No. XVI, July, 1836, pp. 299, 300; V, 1837, p. 205.  
 Type, *Budytes neglectus* GOULD . . . . . [*Motacillida*.]
- \* **Pelargos** BROOKES, *Catal. Mus. Joshua Brookes*, Pt. II, July, 1828, p. 97.  
 Type, "*Pelargos niger*," or "Black Pelargos" . . . . . [*Ciconiida*.]  
*Πελαργός*, a stork.

<sup>a</sup> *Paracoræus* of BROOKES, *Mus. Brookesianum*, 1830, p. 95.<sup>b</sup> This name has priority over *Amospiza* OBERNOLSER, and should replace it.



"*Pelagias*" of my former list and "*Pelagie*" of Waterhouse's "Index" was used only in a vernacular sense by Geoffroy (Écho du Monde Savant, IV, No. 74, June 3, 1837, p. 84 [not "74"]), viz.: "*Pelagie*." Waterhouse took his reference from Gray, while I followed Lesson, who cited the wrong page. There is a possibility that the name may occur in a systematic sense in the "Cours d'Ornithologie" published in 1836-37 (see note under *Salangana*), but I have been unable, thus far, to find this work.

\* *Pelecyrhynchus* "(LEACH)" BROOKES, Catal. Mus. Joshua Brookes, Pt. II, July, 1828, p. 89.

Type, "*Pelecyrhynchus leucogaster*," or "White-bellied Hatchet-bill" ----- [*Bucerotidæ*.]

Πέλεκυς, an axe; ῥύγχος, beak.

*Pendulinus* "Cuv." C. L. BREHM, Isis, XXI, 1828, p. 1284; Handb. Vögel Deutschl., 1831, p. 475.

Types, *Pendulinus polonicus* BREHM, *P. medius* BREHM, and *P. macrourus* BREHM ----- [*Paridæ*.]

*Pendulus*, hanging.

\* *Pinguina* C. T. WOOD, Orn. Guide, Jan., 1837, p. 211.

Type, "*Pinguina arctica*, Wood," or "Arctic Penguin" [of his list of "Birds of Britain"] ----- [*Alcidæ*.]

*Pinguina*. Latinized from Penguin.

\* *Penthestes* REICHENBACH, Avium Syst. Nat., March 1, 1850, Pl. LXII (figure showing generic characters).

Type, not named ----- [*Paridæ*.]

Πένθος, grief, misfortune; ἐδυστής, an eater!

*Penthornis* HELLMAYR, Journ. für Orn., XLIX, April, 1901, p. 170.

Type, *Melaniparus semilarvatus* SALVADORI ----- [*Paridæ*.]

Πένθος, misfortune; ὄρνις, bird.

\* *Percnopterus* FLEMING, Philosophy of Zoology, II, 1822, p. 233.

Type, not specified; a generic diagnosis only is given.

[*Vulturidæ*.]

Περκνός, dark-colored, dusky; πτερόν, wing.

"*Percnopterus* RAFINESQUE" cited by Waterhouse, is a misprint for *Percnopterus*. It occurs only as "*Percnopterus*" in the "Analyse".

† *Perispheniscus* AMEGHINO, Anales Mus. Nac. Buenos Aires, 3d ser., VI, Nov. 30, 1905, p. 117.

Type, *Perispheniscus winmani* AMEGHINO ----- [*Spheniscidæ*.]

Περί, around; + *Spheniscus* (σφηνίσκος, dim. of σφήν, a wedge).

αCommonly identified as *Parus lugubris* TEMMICK.

**Perissotriccus** OBERHOLSER, Proc. U. S. Nat. Museum, XXV, No. 1276, Aug. 30, 1902, p. 64.

Type, *Tindirostrum caudatum* D'ORBIGNY and LAFRESNAYE.

[*Tyrannida*.]

Περισσόζ, wonderful; τρικκός, a small bird. (Oberholser.)

**Persa** BECHSTEIN, Gemein. Naturgesch. Deutschl., 2d ed., II, 1805, p. 238.

Type, *Persa turaco* BECHSTEIN (= *Cuculus persa* LINNÆUS).

[*Musophagidæ*.]

*Persa*, the daughter of Oceanus.

\* **Petacula** S. D. W., Analyst, III, No. XIV, Jan., 1836, p. 212.

Type, "Petacula canicularia," or "Bluecap Paroquet."

[*Psittacida*.]

Diminutive of *petar*, catching at, greedy for.

**Phæca** BILLBERG, Synopsis Faune Scand., I, Pars. 2, 1828, tab. A and p. 64.

New name for "*Ficedula* Bechst.," with the following species:

*Motacilla rubicula* LINNÆUS, *M. succica* LINNÆUS, *M. phanicurus* LINNÆUS, and *Phæca wilssoni* BILLBERG (= *Motacilla titys* LINNÆUS) . . . . . [*Turdida*.]

"Nomen genericum *Bechsteini*, *Ficedula*, ut specijicum alius generis, ineptum est, unde hocce grave Φαικος (agilis) designans." (Billberg.)

**Phænorhina** GRAY, Proc. Zool. Soc. Lond., Pt. XXVII, Aug., 1859, p. 165.

Type, *Carpophaga (Phænorhina) goliath* GRAY . . . [*Trogonida*.]

(Proposed as a subgenus of *Carpophaga*.)

Φαίρω, I display, exhibit; ῥίς (ῥινός), nose.

**Phæomyias** BERLEPSCH, Novitates Zoologicae, IX, No. 1, April 10, 1902, p. 41.

Types, *Elainca incompta* CABANIS and HEINE, *E. wogge* TACZANOWSKI, and *E. tumbesana* TACZANOWSKI . . . . . [*Tyrannida*.]

"Φαίος = fuscus, μνιάς = nomen propr." (Berlepsch.)

**Phæopharus**<sup>a</sup> MADARÁSZ, Magyarország Madarai, 1900, p. 139.

Type, *Parus palustris* LINNÆUS . . . . . [*Paridæ*.]

Φαίός, dusky; φάρος, a wide cloak or mantle. (Madarász.)

**Phæotriccus** RIDGWAY, Proc. Biol. Soc. Wash., XVIII, Sept. 2, 1905, p. 209.

Type, *Knipolegus hudsoni* SCLATER . . . . . [*Tyrannida*.]

Φαίός, dusky; τρικκός, a small bird. (Ridgway.)

**Phalænivora** BLYTH, Analyst, V, No. XVII, Oct., 1836, p. 79; in White, Nat. Hist. Selborne, 1836, pp. 49, 72 (note).

New name for *Caprimulgus* LINNÆUS . . . . . [*Caprimulgida*.]

*Phalæna* (φάλασσα, a devouring monster), a genus of moths; + *vor*, I devour.

<sup>a</sup>"*Phæoparus*" SCLATER, Ibis, 1903, p. 621.

- \* **Phasianlector** BROOKES, Museum Brookesianum, Feb., 1830, p. 93.  
Type, "*Phasianlector macartneyi*," or "Fire-backed Pheasant"  
..... [*Phasianidae*.]  
Φασιανός, a pheasant; ἀλέκτωρ, a cock.
- Philacantha** SWINHOE, Proc. Zool. Soc. Lond., for 1871, Pt. II, Oct.,  
1871, p. 355.  
Type, *Motacilla nisoria* BECHSTEIN ..... [*Sylviidae*.]  
Φιλέω, I love; ἄκανθα, a thorn, prickly plant.
- \* **Philydra** BILLBERG, Synopsis Faunæ Scand., I, Pars 2, 1828, tab. A.  
Based on "*Sylvia* Lath."<sup>a</sup> ..... [*Sylviidae*?]  
Φιλέω, I love; ἵδωρ, water.
- Phormoptectes** REICHENOW, Journ. für Orn., LI, Jan., 1903, p. 149.  
Type, *Sycobrotus insignis* SHARPE ..... [*Ploceidae*.]  
(Proposed as a subgenus of *Ploceus*.)  
Φορμός, a wicker-basket; πλεκτός, plaited, woven.
- \* **Phragmites** BLYTH, in Rennie's Field Naturalist, I, No. X, Oct., 1833,  
p. 425.  
Types, "*Phragmites arundinacea*," or "Reed Warbler,"  
"*Phragmites salicaria*," or "Sedge Warbler," and "*Phragmites*  
*locustella*," or "Grasshopper Warbler"<sup>b</sup> ..... [*Sylviidae*.]  
Φραγμαίτης, growing in hedges.
- \* **Phrygilus** MORRIS, in N. Wood's Naturalist, II, No. 9, June, 1837,  
p. 124.  
Types, "*Phrygilus vulgaris*," or "Bullfinch," and "*Phrygilus*  
*enucleator*," or "Pine Bullfinch" [of his list of British birds].  
[*Fringillidae*.]  
Φρυγίλος, a finch.
- Phyllobates** BERTONI, Aves Nuevas del Paraguay, 1901, p. 142.  
Type, *Phyllobates erythromotus* BERTONI (= *Myiothera maculata*  
WIED) ..... [*Formicariidae*.]  
Φύλλον, a leaf; βάτης, one that treads or covers, a climber. (Ber-  
toni.)
- Phylloœcia** BERTONI, Aves Nuevas del Paraguay, 1901, p. 120.  
Type, *Phylloœcia chlorolœuca* BERTONI (= *Leptotriccus sylvicolus*  
CABANIS and HEINE) ..... [*Tyrannidae*.]  
Φύλλον, a leaf; οἶκος, a house. (Bertoni.)
- Pinarocorys** SHELLEY, Birds of Africa, III, 1902, p. 71.  
Types, *Alauda nigricans* SUNDEVALL, and *A. erythropygia*  
STRICKLAND ..... [*Alaudidae*.]  
Πινάρός, dirty, squalid; κόρυς, a lark.

<sup>a</sup>That is, for part of the genus *Sylvia* of Latham, as he also recognizes the genus *Sylvia*. Evidently intended for a species or group not found in Scandinavia, as the name does not occur in the body of the work.

<sup>b</sup>On p. 439 he mentions the following as an extra-British species: "*Phragmites cetti*, *Sylvia cetti*, MARMORA."

\***Pintado** S. D. W., Analyst, III, No. XIII, Oct., 1835, p. 33.  
 Type, "*Pintado namibia*, Leach," or "Pearled Pintado."  
 [Phasianida.]

Spanish *pintado*, painted, mottled.

**Pipra** LINNÆUS, Museum Adolphi Friderici, II, 1764, p. 32.  
 Types, *Pipra auricola* LINNÆUS, *Pipra leucoccephala* LINNÆUS,  
*Pipra leucocilla* LINNÆUS, and *Motacilla minuta* LINNÆUS.  
 [Piprida.]

*Πίπρα*, a bird, probably a woodpecker.

**Pisobia** BILLBERG, Synopsis Faune Scand., I, Pars 2, 1828, tab. A,  
 and p. 136.  
 Types, *Tringa minuta* LEISLER, and *T. temminckii* LEISLER.  
 [Scelopacida.]

"Nom. gen. *e verbis græcis Πισοῦς, locus humidus, βιωῶ vivo derivatum est.*" (Billberg.)

**Placostomus** RIDGWAY, Proc. Biol. Soc. Wash., XVIII, Sept. 2, 1905,  
 p. 208.  
 Type, *Platyrhynchus superciliaris* LAWRENCE. . . [Tyrannida.]  
*Πλάξι* (*πλακός*), anything flat and broad; *στόμα*, the mouth.  
 (Ridgway.)

**Plancus**<sup>a</sup> REICHENBACH, Naturl. System, 1852, p. vi.  
 Type, *Plancus maior* REICHENBACH (= *Pelecanus bassanus*  
 LINNÆUS) . . . . . [Sulida.]  
*Plancus*, flat-footed.

\***Planorhampus** BILLBERG, Synopsis Faune Scand., I, Pars 2, 1828,  
 tab. A.  
 New name for "*Burchinus* III?" . . . . . [Elieniada.]  
*Πλάνωσ*, a wandering about, exploring; *ῥάμφος*, beak.

**Platyrhampus** BILLBERG, Synopsis Faune Scand., I, Pars 2, 1828,  
 tab. A and p. 172.  
 Type, *Numenius pusillus* BECHSTEIN<sup>b</sup> (Nat. Deutschl., IV, 1809,  
 p. 152) . . . . . [Scelopacida.]  
*Πλατύς*, broad, flat; *ῥάμφος*, beak. (Billberg.)

**Platytricus** RIDGWAY, Proc. Biol. Soc. Wash., XVIII, Oct. 17, 1905,  
 p. 211.  
 Type, *Platyrhynchus caneroma* SCLATER . . . . . [Tyrannida.]  
*Πλατύς*, broad; *τρίκκος*, a small bird. (Ridgway.)

<sup>a</sup> *Plancus* of Rafinesque, a *nomen nudum*, is one of "Les Rapaces" of that author, and placed in the "Sous-famille Ptiloderia. Les Nudicolles," near *Eudora*. GRAY (Catal. Birds Brit. Mus., XXVI, p. 423) synonymizes it with *Sula*!  
<sup>b</sup> *Limicola platyrhyncha* of Catal. Birds Brit. Mus., XXIV, p. 612.

**Plectrophanes** "LEACH," GRAY or GRIFFITH, in Cuvier, Animal Kingdom, VIII, 1829, p. 600.<sup>a</sup>

Type, *Anas gambensis* LINNÆUS ..... [*Anatidæ*.]  
*Πληκτροφον*, a spur; *φαίνω*, I show, exhibit.

\***Plotoides** BROOKES, Museum Brookesianum, Feb., 1830, p. 109.

Type, "*Plotoides surinamensis*," or "Surinam Plotoides."<sup>b</sup>  
 [ *Heliornithidæ*? ]  
*Plotus* (πλωτοῦς, sailing, floating); + εἶδος, resemblance.

**Poeciloides** BIANCHI, Annuaire Mus. Zool. Acad. Imp. Sci. St.-Pétersb., VII, No. 3, 1902, p. 241.

Type, *Poecile superciliosa* PRZEWAŁSKI ..... [*Paridæ*.]  
*Poecile* (ποικίλος, spotted, variegated); + εἶδος, resemblance.

**Pogoniulus** LAFRESNAYE, Dict. Univers. d'Hist. Nat., II, 1843, p. 463.

Type, "Le *Barbion* de Levaillant (*Bucco parvus* Gmel.)."<sup>c</sup>  
 [ *Cupitoidæ*. ]  
 Quasi-Latin diminutive of *Pogonia* (πωγωνίας, bearded).

**Pogonornis**<sup>d</sup> BILLBERG, Synopsis Faunæ Scand., I, Pars 2, 1828, tab. A.

New name for *Pogonias* ILLIGER ..... [*Cupitoidæ*.]  
*Πώγων*, a beard; ὄρνις, bird.

**Poliocichla** SHARPE, Hand-List Birds, IV, 1903, p. 175.

New name for *Emarginata* SHELLEY (because *Emarginata* is an adjective) ..... [*Turdidæ*.]  
*Πολιός*, gray; κίχλη, a thrush.

**Poliolais** ALEXANDER, Bull. Brit. Orn. Club, XIII, No. XCIV, Jan. 30, 1903, p. 36.

Type, *Poliolais helenoræ* ALEXANDER ..... [*Sylviidæ*.]  
*Πολιός*, gray; λάϊος, a bird of the thrush kind.

**Polyplectron** TEMMINCK, Catal. Systemat., 1807, p. 149.

Type, *Polyplectron argus* TEMMINCK (= *Paro bicaratus* LINNÆUS) ..... [*Phasianidæ*.]  
*Πολύς*, many; *πλήκτρον*, a cock's spur.

<sup>a</sup> "Some have the bend of the wing armed. They form the genus *Plectrophanes*, Leach, (not Meyer)." See also Brandt, Descr. et Icones Anim. Ross. Novorum, Aves, Fasc. I, 1836, p. 6.

<sup>b</sup> This is probably the "Surinam Darter" of Latham or "*Plotus surinamensis*" of Gmelin (= *Colymbus fulica* Boddaert).

<sup>c</sup> On p. 465 he gives as type "le Barbion de Levaillant, *Bucco parvus* des auteurs." *Pogoniulus* should replace *Xylobucco* of Mr. Oberholser's recent revision (Proc. U. S. Nat. Mus., XXVIII, 1905, p. 867).

<sup>d</sup> This name forbids the further use of *Pogonornis* (Gray, 1846) for the stitch-bird (*Meliphaga cincta* DUBUS). The latter may be renamed *Notiomystis*.

\* **Pomarinus** G. FISCHER, *Nationalmus. Naturgesch. zu Paris*, II, 1803, p. 185.

Type, *Pomarinus fuscus* G. FISCHER<sup>a</sup> ..... [*Stercorariidæ*.]  
*Πῶμα*, a lid, cover; *ῥίς* (*ῥινόξ*), nose.

**Poneropsar** OBERHOLSER, *Proc. U. S. Nat. Museum*, XXVIII, No. 1411, July 8, 1905, p. 888.

Type, *Spruo albicapillus* BLYTH ..... [*Sturnidæ*.]  
*Πονηρός*, difficult; *ψάρ*, starling. (Oberholser.)

**Potamolegus** BERTONI, *Aves Nuevas del Paraguay*, 1901, p. 158.

Types, "*Potamolegus superciliaris* (Vieill.)" BERTONI (= *Asturina nattereri* SCLATER and SALVIN), *P. s. magniplumis* BERTONI (= *Asturina nattereri*), and *P. s. ferricollis* BERTONI (= *Asturina pucherani* J. and E. VERREAUX) ..... [*Batoniidæ*.]  
*Ποταμός*, a river, stream; *λέγω*, I choose. (Bertoni.)

**Pratincola** J. R. FORSTER, *Faunula Indica*, 1795, p. 11.

Types, *Glarola maldivarum* FORSTER, *G. coromanda* FORSTER, and *G. madraspatana* FORSTER<sup>b</sup> ..... [*Cursoriidæ*.]  
*Pratum*, a meadow; *incola*, an inhabitant.

\*† **Preoneornis** AMEGHINO, *Anales Soc. Cien. Argentina*, LI, 1901, p. 78.

Type, *Preoneornis voridus* AMEGHINO, a *nomen nudum* here. [*Inseres*.]  
*Πρό*, before; + *Éoneornis* (*ἠώς*, dawn, *ρέος*, new; *ὄρνις*, bird). (Ameghino, MS.)

**Prionochilus** BERTONI, *Aves Nuevas del Paraguay*, 1901, p. 8.

Type, *Prionochilus brasiliensis* BERTONI (= *Mergus octosotaceus* VIEILLOT) ..... [*Anatidæ*.]  
*Πρίων*, a saw; *χέλος*, bill, beak.

<sup>a</sup>Fischer's description follows:  
 "Die Oeffnungen der Nasenlöcher unter einem Deckel gestellt; vier Zehen an jedem Fusse.  
 "Zwei Beispiele.  
 "Der braune, *Pomarin brun*, *P. fuscus*. Ein neues Geschlecht, welches Lacépède erst neuerlich aufgestellt hat. Es gleicht dem Sturmvogel sehr, ist aber von ihm durch die Gegenwart einer Zehe nach hinten und durch die besondere Oeffnung der Nasenlöcher verschieden, welche nicht, wie bei jenen, am Ende von länglichen Canälen stehen, sondern durch einen länglichen dünnen und platten Deckel geschlossen sind. Der Schnabel ist hakig."

*Pomarinus* follows "*Procellaria*" in Fischer's account of the birds in the Paris Museum.

<sup>b</sup>These names are equivalent to and antedate *Glarola orientalis* LEMM. For other references to *Pratincola* see PALLAS, *Reise Russ. Reichs*, I, 1771, p. 217; and *Pratincola* T. FORSTER, *Synop. Catal. Brit. Birds*, 1817, p. 17 (type, *Glarola austriaca* GMELIN = *Hirundo pratincola* LINNÆUS, 1766, p. 345 = *Tringa fusca* LINNÆUS, 1766, p. 252).

- \* **Probateus** MORRIS, in N. Wood's Naturalist, II, No. 9, June, 1837, p. 124.  
 Type, "*Probateus roseus*," or "Rose-coloured Pastor" [of his list of British birds] ..... [*Sturnidæ*.]  
*Προβατεύς*, a shepherd.
- Prodotes** NITZSCH, *Observ. Avium Arteria Carotide Communi*, 1829, p. 15.  
 New name for "*Indicator auctorum*" ..... [*Indicatoridæ*.]  
*Προδοτής*, a betrayer, traitor.
- Promepicus** LAFRESNAYE, *Diet. Univers. d'Hist. Nat.*, II, 1843, p. 463.  
 Type, "le Promépic," LEVAILLANT (= *Picus cafer* VIEILLOT = *Trachyphonus caillantii* RANZANI) ..... [*Capitonidæ*.]  
*Prome* [rops] + *Picus*.
- Proparoides** BIANCHI, *Bull. Brit. Orn. Club*, XII, No. LXXXVII, March 28, 1902, p. 55.  
 New name for *Sittiparus* OATES, 1889, not *Sittiparus* SELYS-LONGCHAMPS, 1884. (= *Semiparus* HELLMAYR, 1901, = *Pseudominla* OATES, 1894.) ..... [*Timaliidæ*.]  
*Proparus* (*pro*, before, in front of; *Parus*, a titmouse): + εἶδος, resemblance.
- Prosphorocichla** OBERHOLSER, *Smithsonian Misc. Coll.*, Quarterly Issue, XLVIII, No. 2, July 1, 1905, p. 156.  
 New name for *Pyrhurus* CASSIN, 1859, not *Pyrhura* BONAPARTE, 1856. (Type, *Phyllastrephus scandens* SWAINSON.) ..... [*Pycnonotidæ*.]  
*Πρόσφορος*, like, similar; κίχλη, thrush. (Oberholser.)
- Psalidoramphos**<sup>a</sup> DUMONT, *Diet. Sci. Nat.*, IV, 1805, p. 173.  
 Substitute name for *Rynchops* LINNÆUS ..... [*Rynchopidæ*.]  
*Ψαλίδς* (*ψαλίδος*), a pair of shears, a kind of razor; ῥάμφος, beak.
- Psaliurus** BERTONI, *Aves Nuevas del Paraguay*, 1901, p. 105.  
 Type, *Psaliurus accralianus* BERTONI (= *Phibalura flavirostris* VIEILLOT) ..... [*Cotingidæ*.]  
 (See also *Dieranura*.)  
*Ψαλίδς*, a pair of shears; οὐρά, tail. (Bertoni.)
- \* **Psar** MORRIS, in N. Wood's Naturalist, II, No. 9, June, 1837, p. 124.  
 Type, "*Psar variogatus*," or "Starling" [of his list of British birds] ..... [*Sturnidæ*.]  
*Ψάρ*, starling.

<sup>a</sup> "Le *rynchos* des Grecs est d'ailleurs un terme impropre pour désigner le bec des oiseaux, auquel le mot *ramphos* est spécialement consacré; et *psalidoramphos*, *psalidorampho*, exprimeroit plus exactement bec en rasoir. Si l'inégalité très-remarquable des mandibules paroissoit devoir être préférée à leur jeu, pour fournir le type du nom de l'oiseau, on pourroit aussi l'appeler *anisorampho*, et ce terme seroit moins dur à l'oreille."

- Pseudagelæus** RIDGWAY, Proc. Wash. Acad. Sci., III, April 15, 1901, p. 155.  
 Type, *Agelaius inthurni* SCLATER.....[*Icteriidæ.*]  
*Ψευδοήης*, false; + *Agelaius* (ἀγελαιῖος, gregarious).
- Pseudammomanes** BIANCHI, Bull. Acad. Imp. Sci. St.-Petersb., 5th ser., XXI, No. 4, Nov., 1904, pp. 231, 241; Otto, Journ. für Orn., LIII, Oct., 1905, p. 611.  
 Type, *Alauda ferruginea* SMITH.....[*Alaudidæ.*]  
 (Proposed as a subgenus of *Ammomanes*.)  
*Ψευδοήης*, false; + *Ammomanes* (ἀμμοσ, sand; μαινόμεαι, I am mad, rage [with love]).
- \* **Pseudocorys** BILLBERG, Synopsis Faunæ Scand., I, Pars 2, 1828, tab. A.  
 Type, probably *Alauda africana* GMELIN<sup>a</sup>.....[*Alaudidæ.*]  
*Ψευδοήης*, false; κόρυς, a lark.
- Pseudonigrita** REICHENOW, Journ. für Orn., LI, Jan., 1903, p. 149.  
 Type, *Nigrita arnaldi* BONAPARTE.....[*Ploceidæ.*]  
*Ψευδοήης*, false; + *Nigrita* (diminutive of *niger*, black).
- Pseudopodoces** ZARUDNY and LOUDON, Ornith. Monatsb., X, No. 12 Dec., 1902, p. 185.  
 Type, *Podoces humilis* HUME.....[*Corvidæ.*]  
 (Proposed as a subgenus of *Podoces*.)  
*Ψευδοήης*, false; + *Podoces* (ποδοκόκης, swift-footed).
- Pseudospermestes** DUBOIS, Annales Mus. Congo, Zool., 4th ser., I, Fasc. I, Nov., 1905, p. 16.  
 Type, *Pseudospermestes goossensii* DUBOIS.....[*Ploceidæ.*]  
*Ψευδοήης*, false; + *Spermestes* (σπέρματ, seed; ἐδέσταιής, an eater).
- † **Pseudosphenicus** AMEGHINO, Annales Mus. Nac. Buenos Aires, 3d ser., VI, Nov. 30, 1905, p. 123.  
 Type, *Pseudosphenicus interplanus* AMEGHINO. [*Spheniscidæ.*]  
*Ψευδοήης*, false; + *Spheniscus* (σφηνίσκος, dim. of σφήν, a wedge).
- Pseudotaon** BILLBERG, Synopsis Faunæ Scand., I, Pars 2, 1828, tabs. A, B, C, and p. 4.  
 New name for "*Melagris* Linné".....[*Phasianidæ.*]  
*Ψευδοήης*, false; ταῶς, ταῶν, peacock.
- Pseudoxenicus** FINSCH, Notes Leyden Mus., XXII, No. 3, March, 1901, p. 213.  
 Type, *Microrua superviliaris* BONAPARTE.....[*Timaliidæ.*]  
*Ψευδοήης*, false; + *Xenicus* (ξενικός, strange, foreign).
- Pseudozosterops** FINSCH, in Das Tierreich, Lief. 15, March, 1901, p. 46.  
 New name for *Helia* HARTLAUB, 1865, not *Helia* HÜBNER, 1816.....[*Zosteropidæ.*]  
*Ψευδοήης*, false; + *Zosterops* (ζωστήρ, a girdle; ὄψ, eye). (Finsch.)

<sup>a</sup> See *Corydalis* BOIE, and note under *Corydus* BILLBERG.



- Psittiparus HELLMAYR**, in *Das Tierreich*, Lief. 18, March, 1903, p. 163.  
New name for *Scæorhynchus* OATES, 1889, not *Scæorhynchus*  
E. B. WILSON, 1881 ..... [*Paridæ*.]  
*Psittacus*, a parrot; *parus*, a titmouse.
- Puffinus "WILL."** S. D. W., *Analyst*, III, no. XIV, Jan., 1836, p. 211  
(also Palmer, *Analyst*, IV, 1836, p. 97).  
Type, "*Puffinus flavirostris*,"<sup>a</sup> or "Common Puffin" - [*Aleidæ*.]  
Latinized from puffin.
- \* **Pyrgitina REICHENBACH**, *Avium Syst. Nat.*, June 1, 1850, pl. LXXV  
(figure showing generic characters).  
Type, not named. .... [*Fringillidæ*.]  
Diminutive of *Pyrgita* (*πυργίτης*, a sparrow).
- Pyrorhamphus BERTONI**, *Aves Nuevas del Paraguay*, 1901, p. 85.  
Type, *Pyrorhamphus berlepschianus* BERTONI (= *Loxia fuliginosa* DAUDIN) ..... [*Fringillidæ*.]  
*Ἡῶρ*, fire; *ῥάμφος*, beak. (Bertoni.)
- \* **Pyrrhacorax TUNSTALL**, *Ornith. Britannica*, 1771, p. 2.  
Type, "*Pyrrhacorax graculus*," or "Cornish Chongh or Daw." ..... [*Corvidæ*.]  
*Ἡυρρόος*, reddish; *κόραξ*, a raven.
- Querquedula OKEN**, *Isis*, I, 1817, p. 1183.  
Based on "Les Sarcelles" CUVIER, *Règne Animal* [I, 1817, p. 537 (type, *Anas querquedula* LINNÆUS)] ..... [*Anatidæ*.]
- \* **Ramphosteon RAFINESQUE**, *Amer. Monthly Magazine*, IV, No. 2, Dec., 1818, p. 106.  
Type, not designated; a *nomen nudum* here<sup>b</sup> ..... [*Mniotiltidæ*.]  
*ῥάμφος*, beak; *ὀστέον*, a bone.
- Reichenowia POCHE**, *Ornith. Monatsb.*, XII, No. 2, Feb., 1904, p. 26.  
New name for *Chlorura* REICHENBACH, 1863, not *Chlorura* SCLATER, 1862. (Type, *Chlorura hyperythra* REICHENBACH.) ..... [*Ploceidæ*.]  
For Dr. Anton Reichenow. (Poche.)
- Remiz DZIEDUSZYCKI**, *Muzeum imienia Dzieduszyckich we Lwowie*, 1880, p. 87.<sup>c</sup>  
Type, *Parus pendulinus* LINNÆUS ..... [*Paridæ*.]  
Remiz, Polish name of the species.
- Renggerornis BERTONI**, *Aves Nuevas del Paraguay*, 1901, p. 130.  
Type, *Renggerornis leucophthalmus* BERTONI (= *Muscicapa obsolleta* TEMMINCK) ..... [*Tyrannidæ*.]  
For Johann Rudolf Rengger: + *ὄρνις*, a bird. (Bertoni.)

<sup>a</sup> "*Puffinus flavirostris*" is *Alea arctica* LINNÆUS, according to Palmer.

<sup>b</sup> Doubtless equivalent to *Helmitheros* of his later paper.

<sup>c</sup> Also in German: Grfl. Dzieduszycki'sches Museum in Lemberg, I, Abth. Zool., II, Vögel, 1880, p. 85.

**Rhadina** BILLBERG, Synopsis Faune Scand., I, Pars 2, 1828, tab. A, and p. 54.

Types, *Motacilla sibilatrix* BECHSTEIN, *M. acridula* LINNÆUS, and *Sylvia rufa* LATHAM (= *Motacilla rufa* GMELIN) . . . [*Sylviida*.]  
 \*Ράδιωός, slender, slim, delicate. (Billberg.)

**Rhamphosynthlipsis** COUES, Key N. A. Birds, 5th ed., II, Dec., 1903, p. 1075.

Type, *Vireo wumizusame* TEMMINCK . . . . . [*Alcida*.]  
 (Proposed as a subgenus of *Synthliborhamphus*.)  
 \*Ράμφος, beak; σῦν, with; θλήψις, pressure.

**Rhipornis** BILLBERG, Synopsis Faune Scand., I, Pars 2, 1828, tab. A. New name for *Puffinus* BRISSON . . . . . [*Puffinida*.]

\*Ριπή, flight, sweep, swing; ὄρνις, bird.

**Rhondella** RENNIE, in White, Nat. Hist. Selborne, 1833, p. 62.

Type, *Motacilla phanicurus* LINNÆUS . . . . . [*Turdida*.]

**Rhopornis** RICHMOND, Proc. Biol. Soc. Wash., XV, March 5, 1902, p. 35.

New name for *Rhopocichla* ALLEN, 1891, not *Rhopocichla* OATES, 1889. . . . . [*Formicariida*.]  
 \*Ρώψ (ρόπος), bush; ὄρνις, bird.

† **Rhynchaëtes** WITTICH, Abhandl. Géol. Landesanstalt zu Darmstadt, III, Heft 3, 1898, p. 103, pl. 2.

Type, *Rhynchaëtes messelensis* WITTICH . . . . . [*Scolopacida*.]  
*Rhynchaeta* (ρήγχος, beak); + *ites*.

**Rhynchodon** NITZSCH, Observ. Avium Arteria Carotide Communi, 1829, p. 20.

Types, "(Falco auctt.)" peregrinus, Subbuteo, Aesalon, Tinunculus" . . . . . [*Falconida*.]  
 \*Ρήγχος, beak; ὀδών, tooth.

† **Riacama** AMEGHINO, Sinopsis geol.-paleon., Suplemento, 1899, p. 9.

Type, *Riacama caliginosa* AMEGHINO . . . . . [*Incerta sedis*.<sup>b</sup>]  
*Riacama*, anagram of *Cariama*. (Ameghino MS.)

**Ripæcola** RENNIE, in WHITE, Nat. Hist. Selborne, 1833, pp. 62, 441, 445.

Type, "Grasshopper lark" [of White], or "*Alauda trivialis* (*Ripæcola Locustella*)"<sup>c</sup> . . . . . [*Sylviida*.]  
*Ripa*, the bank (of a river); *colo*, I inhabit.

<sup>a</sup> Not a new name for *Falco*, as he employs that term for "Falco Albicilla, fulvus, lagopus, Buteo,—palumbarius, Nisus,—aeruginosus, Pygargus, cineraceus."

<sup>b</sup> *Riacama* is placed in the order Alektorides, and is compared with *Dicholophus*.

<sup>c</sup> An additional species, "The Sedge-bird (*Ripæcola salicaria*, RENNIE)," is mentioned on p. 441. See also RENNIE, Field Naturalist, I, 1833, p. 484, where "*Ripæcola arundinacea* RENNIE" is cited as a member of this genus. (Compare *Schaniia* HERBERT.)

**Ripidicala**<sup>a</sup> H. BOIE. Neues Staatsbürgerliches Magazin [Schleswig], I, Heft 2, 1832, p. 489.

Types, "Mein Genus *Ripidicala* (*ρῑπισ* Fächer) begreift die *Muscicapa flabellifera*, *javanica*, *phoenicea* Kuhl. *euryura* Kuhl. *perlata* in Sumatra, *leucogaster* Cuvier Mus. Pari. *pondiceriana* (Mus. Longier) *cochinchin.* Latham und noch mehrere andere."

[*Muscicapidae*.]

<sup>a</sup>*ῑπίς* (*ῑπίδος*) a fan; *καλή*, beautiful.

**Rubicilla** BONAPARTE and SCHLEGEL, Monogr. Loxiens, 1850, p. xiv.

Types *Loxia rubicilla* GÜLDENSTÄDT, *Pyrrhula rhodochlamys* BRANDT, *Carpodacus sophia* BONAPARTE and SCHLEGEL, and *Fringilla rosea* PALLAS ----- [Fringillidae.]

*Ruber*, redness; *cilla*, I move, i. e., the tail.

**Rubicapilla** S. D. W., Analyst, III, No. XIII, Oct., 1835, p. 32.

Type, "*Rubicapilla alnus*, W.," or "Catkin Redpoll." (Identified with *Linaria pusilla* BLYTH, on p. 204.)----- [Fringillidae.]  
*Ruber*, red; *capillus*, hair.

**Rufipes** "BLYTH" S. D. W., Analyst, III, No. XIII, Oct., 1835, p. 33.

Type, "*Rufipes vulgaris*," or "Common Red-leg."<sup>b</sup>

[*Tetraonidae*.]

(See *Erythropus* BLYTH.)

*Rufus*, red; *pes*, foot.

\***Rupicula** MACKLOT, Bijdr. Natuurk. Wetensch. [Amsterdam], V, St. I, 1830, p. 175.

Types, *Rupicula albobularis*, *R. ruficentris*, and *R. threnothorax*, all *nomina nuda* here ----- [Incertae sedis.]

*Rupicula*, diminutive of *rupes*, a rustic.

**Ruwenzornis** NEUMANN, Bull. Brit. Orn. Club, XIV, No. C, Oct. 30, 1903, p. 14.

Type, *Gallinax johnstoni* SHARPE ----- [Musophagidae.]

For Mount Ruwenzori; + *ῑπίς*, bird.

"**Saccharivora** M. J. BRISSON," cited by Sherborn, is not used in a generic sense.

"**Salangana**," cited by Waterhouse and adopted by me (Proc. U. S. Nat. Mus., XXV, 1902, p. 301) in place of *Collocalia*, proves to have been used in a vernacular sense only by Geoffroy St.-Hilaire.<sup>c</sup>

<sup>a</sup>Quoted as "*Rhipidicala*" by GRAY, Appendix List Genera Birds, 1842, p. 9, and as "*Rhipididura*, Boie, Oken's Isis" by GIEBEL, Thesaurus, III, 1877, p. 427.

<sup>b</sup>See also S. PALMER, Analyst, III, Jan., 1836, p. 272, where used for *Tetrao petrosus* GMELIN, and *Perdix savatilis* MEYER; PALMER, Analyst, IX, Jan., 1839, p. 307, for *Rufipes picta* PALMER (= *Perdix cuba* of GOULD, Birds of Europe, Part 17, pl. 1x).

<sup>c</sup>I was misled by Lesson's statements (Revue Zool., III, 1840, p. 145, and Écho du Monde Savant, July 20, 1843, p. 134) that *Salangana* was established by Geoffroy St.-Hilaire in 1837 (Écho du Monde Savant, IV, 1837, p. 84). Lesson adopts this name on both occasions, claiming priority for it over *Collocalia*, and accrediting the

**Sapayoa** HARTERT, *Novitates Zoologicae*, X, No. 1, April 20, 1903, p. 117.

Type, *Sapayoa aculeata* HARTERT. . . . . [*Pipridæ*.]

For the Rio Sapayo, Ecuador.

**Satyra** BILLBERG, *Synopsis Faunæ Scand.*, I, Pars 2, 1828, tab. A.

For part of the genus *Melcagris* LINNÆUS<sup>a</sup> (i. e., *Melcagris satyra*) . . . . . [*Phasianidæ*.]

Σάτυρος, a Satyr.

\* **Schœnia** W. HERBERT,<sup>b</sup> in WHITE, *Nat. Hist. Selborne*, 1833, p. 129 (note).

Type, "Sedge-birds," or "Aquatic Warblers". . . . . [*Sylviidæ*.]

Σχοινιά, a bunch of rushes.

**Scops** "Mœhr. (1752)" GRAY, *List Genera Birds*, 2d ed., 1841, p. 86.

Type, *Ardea virgo* LINNÆUS . . . . . [*Gruidæ*.]

Σκόψ, a kind of owl. [In this case, probably a contraction of σκοπέω, a watchman, etc.]

\* **Seiren** MORRIS, in N. Wood's *Naturalist*, II, No. 9, June, 1837, p. 125.

Types, "*Seiren rupestris*," or "Rock Pipit," "*Seiren pratensis*," or "Tit," "*Seiren arborea*," or "Tree Pipit," and "*Seiren ricardi*," or "Richard's Pipit" [of his list of British birds].

[*Motacillidæ*.]

Σειρήν, a Siren.

\* **Seisura** MORRIS, in N. Wood's *Naturalist*, II, No. 9, June, 1837, p. 125.

Types, "*Seisura flava*," or "Yellow Wagtail," "*Seisura neglecta*," or "Gould's Wagtail," "*Seisura cinerea*," or "Grey Wagtail," and "*Seisura maculata*," or "Pied Wagtail" [of his list of British birds]. . . . . [*Motacillidæ*.]

Σείω, I shake, move to and fro; οὐρά, tail.

name to "M. Isidore;" but Geoffroy, as it now appears, only used the vernacular form "Salanganes."

Bonaparte also claims this genus for Geoffroy St.-Hilaire in the following note: "Le genre a été fondé sous ce nom en 1836 par le professeur Geoffroy-Saint-Hilaire, et publié par M. Victor Meunier (qui a gardé l'anonyme) dans le résumé du cours d'ornithologie de notre illustre professeur, inséré dans une suite de numéros de l'*Écho du Monde Savant*, en 1836 et 1837, et dont il existe aussi un tirage à part in-8°. Voyez pages 75 et 76 de ce tirage à part." (See *Comptes Rendus*, XLI, 1855, p. 1112.)

It is not improbable that *Salangana* and several other names (*Halobana*, *Micropites*, *Paribis*, *Pelasgia*, etc.) attributed to the same author may occur in the tract mentioned by Bonaparte, but I am not able to consult the work at present.

<sup>a</sup>Billberg disposes of the Linnaean genus *Melcagris* as follows: "1. Pseudotaon B. (*Melcagris* Linné), 2. Penelope B. (*Penelope* Merrem), 3. Satyra B. (*Melcagris* L.)."

<sup>b</sup>See also BARRY, in Rennie's *Field Naturalist*, I, No. 7, July, 1833, p. 307. (Cf. *Ripicola* RENNIE.)

- Semiparus** HELLMAYR, Journ. für Orn., XLIX, April, 1901, p. 171.  
 New name for *Sittiparus*<sup>a</sup> OATES, preoccupied. . . [*Timaliidae*.]  
*Semi-*, half; *parus*, a titmouse.
- "**Serinus M. J. BRISSON**" (Sherborn). Not used in a generic sense by  
 Brisson.
- Sieberocitta** COUES, Key N. A. Birds, 5th ed., I, Dec., 1903, p. 499.  
 Type, *Cyanocitta ultramarina arizonae* RIDGWAY. . . [*Corvidae*.]  
 (Proposed as a subgenus of [*Phalacrocorax*].)  
 For [Franz Wilhelm?] Sieber: + κίττα, the jay.
- Silvestrius** BERTONI, Aves Nuevas del Paraguay, 1901, p. 136.  
 Type, *Thamnophilus (Silvestrius) flavescens* BERTONI (= *Myio-  
 othera mentalis* TEMMINCK) . . . [*Formicariidae*.]  
 (Proposed as a subgenus.)  
 For Dr. Felipe Silvestri. (Bertoni.)
- \* **Siolia** BROOKES, Catal. Mus. Joshua Brookes, Pt. II, July, 1828,  
 p. 84.  
 Type, "*Siolia spinicauda*," a *nomen nudum* here. (Referred to  
 the group "Sylviana" of Vigors) . . . [*Incertae sedis*.]
- Sitocorax** E. A. BIELZ, Verhandl. und Mittheil. siebenbürgischen  
 Verein [Hermannstadt], IV, No. 4, April, 1853, p. 55.  
 Type, *Corvus frugilegus* LINNÆUS. . . [*Corvidae*.]  
 Σίτος, wheat, corn, grain; κόραξ, a raven.
- Sittella** SWAINSON, Classif. Birds, II, July, 1837, p. 317.  
 Type, *Sitta chrysoptera* LATHAM. . . [*Sittidae*.]  
 Diminutive of *Sitta*, a nuthatch.
- † **Smiliornis** AMEGHINO, Sinopsis geol.-paleon., Suplemento, 1899, p. 9.  
 Type, *Smiliornis penetrans* AMEGHINO . . . [*Phororhacidae*.]  
 Σμίλον, a sharp cutting instrument, a chisel; ὄρνις, bird. (Ameg-  
 hino, MS.)
- Spermologa**<sup>b</sup> BILLBERG, Synopsis Faune Scand., I, Pars 2, 1828, tab.  
 A and p. 28.  
 Types, *Fringilla luleensis* LINNÆUS (= *F. montifringilla*  
 LINNÆUS.) *F. spinus* LINNÆUS, *F. carduelis* LINNÆUS, and *F.  
 linaria* LINNÆUS . . . [*Fringillidae*.]  
 Σπερμολόγος, picking up seeds. (Billberg.)
- Spizites** ILLIGER, Abhandl. K. Akad. Wiss. Berlin, for 1812-13, 1816,  
 p. 230.  
 Type, *Pipra punctata* LATHAM. . . [*Dicaeidae*.]  
 (= *Pardalotus* VIEILLOT, April, 1816.)  
 Σπιζίτης, a titmouse.

<sup>a</sup> See *Pseudomilta* OATES, 1894, and *Proparoidea* BIANCHI, 1902.

<sup>b</sup> "*Spermologa*" on table A, but *Spermologa* on p. 28, where the derivation is given as above.

\* **Steganura** REICHENBACH, Avium Syst. Nat., June 1, 1850, pl. LXXVI (figure showing generic characters).<sup>a</sup>

Type, not designated here ..... [*Ploceidæ*.]

Στεγανόρως, close, covered; οὐρά, tail.

**Stelgidocichla** OBERHOLSER, Smithsonian Misc. Coll., Quarterly Issue, XLVIII, No. 2, July 1, 1905, p. 168.

Type, *Andropodus latirostris* STRICKLAND ..... [*Pyrenotidæ*.]

Στεργίς (στεργίδος), a scraper; κίχλη, thrush. (Oberholser.)

**Stellerocitta** COUES, Key N. A. Birds, 5th ed., I, Dec., 1903, p. 495.

Type, *Corvus stelleri* GMELIN ..... [*Corvidæ*.]

(Proposed as a subgenus of *Cyanocitta*.)

For Georg Wilhelm Steller: + κίττα, the jay.

**Stictornis** RIDGWAY, Proc. Biol. Soc. Wash., XVIII, Sept. 2, 1905, p. 209.

Type, *Ampelis cinctus* TSCHUDI (not *Ampelis cinctus* KUMM., 1820) = *Cotinga tschudii* GRAY ..... [*Cotingidæ*.]

Στικτός, spotted; ὄρνις, bird. (Ridgway.)

**Stipituropis** BERTONI, Aves Nuevas del Paraguay, 1901, p. 141.

Type, *Formicivora archaralete* BERTONI (= *Formicivora genéi*

DE FILIPPI)<sup>b</sup> ..... [*Formicariidæ*.]

(Proposed as a subgenus of *Formicivora*.)

*Stipiturus (stipes (stipitis))*, a branch of a tree; οὐρά, tail); + ὄρνις, appearance.

**Stoparola** BLYTH, in WHITE, Nat. Hist. Selborne, 1836, p. 119 (note).

Type, "*Stoparola luctuosa*," or "the Pied Flycatcher, auct."

(= *Muscicapa atricapilla* LINNÆUS, 1766 = *Motacilla picadula* LINNÆUS, 1758) ..... [*Muscicapidæ*.]

**Struthus** BILLBERG, Synopsis Faune Scand., I, Pars 2, 1828, tab. A.

Type, "*Les Ramiéz Cur.*" (= *Parus pendulinus* LINNÆUS).

[*Paridæ*.]

(See also *Ramiéz*.)

Στρουθός, any small bird.

"**Strychnos BREHM**" of Waterhouse, is a plant!

**Sylosella** LESSON, Traité d'Orn., 1830, p. 314.

Type, "Nous l'avions nommé *sylosella*, lorsque le nom de M.

Swainson nous est revenu à la mémoire"<sup>c</sup> ..... [*Dendrocolaptidæ*.]

**Sylvicola** EYTON, Catal. Brit. Birds, 1836, p. 13.

Types, *Motacilla trochilus* LINNÆUS, *M. sibilatrix* BECHSTEIN,

and *M. rufa* GMELIN ..... [*Sylviidæ*.]

*Sylva*, a wood, forest; *colo*, I inhabit.

<sup>a</sup> *Steganura* REICHENBACH, Singvögel, 1862, p. 63 (types, *Emberiza paradisica* LINNÆUS, and *Steganura sphenura* BONAPARTE).

<sup>b</sup> Cf. ARRIBÁLAGA, Anales Mus. Nac. Buenos Aires, VII, 1902, pp. 369, 385.

<sup>c</sup> A substitute name for *Sittasomus* Swainson, mentioned, but not used here.

**Tachynantes** OBERHOLSER, Proc. U. S. Nat. Museum, XXVIII, No. 1411, July 8, 1905, p. 860.

New name for *Cypsiurus* LESSON, 1843, not *Cypsilurus* SWAINSON, 1838. (Type, *Cypselus parvus* LICHTENSTEIN.)

[*Micropodidæ*.]

*Ταχύς*, swift; *ναύτης*, a sailor. (Oberholser.)

**Tadorna** OKEN, Isis, I, 1817, p. 1183.

Based on "Les Tadornes" CUVIER, Règne Animal [I, 1817, p. 536 (type, *Anas tadorna* LINNÆUS)]. . . . . [*Anatidæ*.]

**Taeniotriccus** BERLEPSCH and HARTERT, Novitates Zoologicae, IX, No. 1, April 10, 1902, p. 38.

Type, *Taeniotriccus andrei* BERLEPSCH and HARTERT.

[*Tyrannidæ*.]

*Ταινία*, a band, ribbon; *τρικκος*, a small bird.

**Tanagra**<sup>a</sup> LINNÆUS, Museum Adolphi Friderici, II, 1764, p. 30.

Types, *Emberiza militaris* LINNÆUS, *Tanagra albirostris* LINNÆUS (= *Parus ecla* LINNÆUS,<sup>b</sup> 1758), and *Fringilla violacea* LINNÆUS. . . . . [*Tangaridæ*.]

Latinized from the native Brazilian word *tangara*.

**Tangara** BRISSON, Ornithologia, III, 1760, p. 3.

Type, thirty species are enumerated in this genus, of which the first (and type by tautonymy) is "Tangara" (= *Tanagra tatao* LINNÆUS, 1766) . . . . . [*Tangaridæ*.]

*Tangara*, a Brazilian word.

**Tapera** THUNBERG, Götheborgiska k. Vet. och Vitterhets Samhällets Nya Handl., 1819, p. —, plate. (See LÖNNBERG, *Ibis*, 1903, p. 239.)

Type, *Tapera brasiliensis* THUNBERG (= *Cuculus naxius* LINNÆUS) . . . . . [*Cuculidæ*.]

*Tapera*, a native Brazilian word for a species of martin.

<sup>a</sup>What is to become of the generic name *Tanagra* and family name *Tanagridæ*? The genus was established by Linnaeus in 1764, and at that date contained three species. The first of these is a *Leistes*, the second a *Cassicus*, and the third a *Euphonia*. The last named is therefore the sole original tanager in the genus. By taking the first species as type (probably also the type by elimination), *Tanagra* would become a member of the Icteridæ, equivalent to *Leistes* VIGORS. So far as I know the type of *Tanagra* at 1764 is yet to be fixed, and as "first reviser," under the rules of the new International Code, I will select *Fringilla violacea* LINNÆUS, 1758, as the type. This course will produce as little confusion as any other method, and will permit us to use **Tangaridæ** for the family, **Tangara** BRISSON, for the Callistes, *Euphonia* DESMAREST (*Tanagra* LINNÆUS, 1764, preoccupied by *Tangara* BRISSON) for the Euphonias, and *Thraupis* BOIE, for the "true" tanagers. Those who reject Brisson's names may use **Tanagridæ**, *Calospiza*, *Tanagra*, and *Thraupis* for the same groups.

<sup>b</sup> Cf. HELLMAYR, Novitates Zoologicae, XIII, 1906, p. 20.

† **Teleornis** AMEGHINO, Sinopsis geol.-paleon., Suplemento, 1899, p. 9.  
 Type, *Teleornis impressus* AMEGHINO. . . . . [*Anatida*.]  
*Τέλειος*, complete, perfect, full grown; ὄπρις, bird. (Ameghino, MS.)

**Temia** OKEN, Isis, I, 1817, p. 1184.

Based on "Les Temia, Vail." CUVIER, Règne Animal [I, 1817, p. 400 (type, "Les Temia" LEVAILLANT, Ois. d'Afr., pl. 56)].

[*Corvida*.]

(See also *Egyptus* BILLBERG.)

**Terenotriccus** RIDGWAY, Proc. Biol. Soc. Wash., XVIII, Sept. 2, 1905, p. 207.

Type, *Mniobius fulvigrularis* SALVIN and GODMAN. . . . . [*Tyrannida*.]  
*Τέρνερος*, soft, delicate; τρικκος, a small bird. (Ridgway.)

\* **Tetema** KÜHL and VAN HASSELT, Isis, XI, Heft VIII, 1822, p. 898.

Type, not indicated; a *nomen nudum* here. . . . . [*Incertæ sedis*.]

\* **Tetrix** MORRIS, in N. Wood's Naturalist, II, No. 9, June, 1837, p. 126.

Types, "Tetrix niger," or "Black Game," and "Tetrix sylvicola," or "Capercail" [of his list of British birds]. . . . . [*Tetraonida*.]  
*Τέτριξ*, a bird, supposed to be a grouse.

**Thapsinillas** OBERHOLSER, Smithsonian Misc. Coll., Quarterly Issue, XLVIII, No. 2, July 1, 1905, p. 161.

Type, *Criniger affinis* HOMBROX and JACQUINOT. . . . . [*Pycnonotida*.]  
*Θάψινος*, yellow; ἄλλας, thrush. (Oberholser.)

**Thaumasius** SCLATER, Proc. Zool. Soc. Lond., for 1879, Pt. I, June, 1879, p. 146.

Intended as an emendation of *Thaumatius* BONAPARTE. (Compare WHARTON, Ibis, 1879, p. 451) . . . . . [*Trochilida*.]

"Hoc nomen ex θαυμάσιος, admiratione dignus, derivatum. 'Thaumasius,' nec 'Thaumatius' melius scribatur." (Sclater.)

**Thescelocichla** OBERHOLSER, Smithsonian Misc. Coll., Quarterly Issue, XLVIII, No. 2, July 1, 1905, p. 154.

Type, *Phyllastrophus leucopleurus* CASSIN. . . . . [*Pycnonotida*.]  
*Θέσκελος*, marvelous; κίχλη, thrush. (Oberholser.)

**Thrasyacipiter** BERTONI, Aves Nuevas del Paraguay, 1901, p. 164.

Type, *Thrasyacipiter semiocturnis* BERTONI (= *Sparcius ruficollis* VIEILLOT) . . . . . [*Falconida*.]

Θρασύς, bold, spirited, resolute; + *Accipiter* (*accipiter*, a hawk). (Bertoni.)

<sup>a</sup>"Tetema" is Buffon's name for *Formicarius cayennensis* BODDAERT (compare BUFFON, Hist. Nat. Ois., IV, 475).



- \* **Thrasys** BILLBERG, Synopsis Faunæ Scand., I, Pars 2, 1828, tab. A.  
 New name for *Casuaris* BRISSON? ..... [*Casuariidæ*?]  
 (See also *Cela* OKEN, *Oeyporus* BROOKES, and note under  
*Chelarga*.)  
 Θρασύς, bold, spirited.
- Thyorchilus** OBERHOLSER, Proc. U. S. Nat. Museum, XXVII, No.  
 1354, Jan. 23, 1904, p. 198.  
 Type, *Troglodytes browni* BANGS ..... [*Troglodytidæ*.]  
 Θρόρον, a rush; ὀρχίλος, wren. (Oberholser.)
- † **Tiliornis** AMEGHINO, Sinopsis geol.-paleon., Suplemento, 1899, p. 9.  
 Type, *Tiliornis sener* AMEGHINO ..... [*Phanicopteridæ*.]  
 Τιλῆϊς, future of τιλλω, I pull, pluck out; ὄρνις, bird. (Ameghino,  
 MS.)
- \* **Tinamulus** MACKLOT, Bijdr. Natuurk. Wetensch. [Amsterdam], V,  
 St. I, 1830, p. 175.  
 Types, *Tinamulus virescens*, *T. paludum*, and *T. decoloratus*,  
 all *nomina nuda* here ..... [*Incertæ sedis*.]
- Titiza** BILLBERG, Synopsis Faunæ Scand., I, Pars 2, 1828, tab. A and  
 p. 58.  
 For "*Calamodyte* Mey.," with the following species: *Motacilla schanobæna* LINNÆUS, and *Titiza lightfooti* BILLBERG (= *Motacilla armulinacea* LIGHTFOOT) ..... [*Sylviidæ*.]  
 "N. gener. e roce græca Τιτίζειν titissare." (Billberg.)
- Todirhamphus** KAUP, Proc. Zool. Soc. Lond., 1851, Pt. XIX, Oct. 28,  
 1852, p. 52.  
 Types, *Todirhamphus pectoralis* KAUP, and *T. ruficeps* KAUP.  
 [Tyrannidæ.]  
 (Possibly a slip for *Todirostrum*.)  
*Todus*, a tody; + ῥάμφος, beak.
- Tolmarchus** RIDGWAY, Proc. Biol. Soc. Wash., XVIII, Sept. 2, 1905,  
 p. 209.  
 Type, *Pitangus taylori* SCLATER ..... [*Tyrannidæ*.]  
 Τόλμα, daring, boldness; αρχός, a leader, chief. (Ridgway.)
- Torgos**<sup>a</sup> KAUP, Isis, XXI, Heft XI, 1828, p. 1144.  
 Type, *Vultur auricularis* DAUDIN, 1800 (= *Vultur tracheliotus*  
 J. R. FORSTER, 1791) ..... [*Vulturidæ*.]  
 Τόργος, a vulture.
- Tragopan** "MEHR" GRAY, List Genera Birds, 2d ed., 1841, p. 65.  
 Type, *Buceros abyssinicus* GMELIN ..... [*Bucerotidæ*.]  
 Τράγος, a goat; Πάν, Pan, the god of woods and shepherds.

<sup>a</sup> *Torgos* is equivalent to and should replace *Otocoryps* GRAY, 1841.

- † **Treleudytes** AMEGHINO, *Anales Mus. Nac. Buenos Aires*, 3d ser., VI, Nov. 30, 1905, p. 156.  
Type, *Treleudytes crassa* AMEGHINO ..... [Spheniscidæ.]  
Trelew, a town in Patagonia; + δύτης; a diver. (Ameghino, MS.)
- \* **Trygonoides** BROOKES, *Catal. Mus. Joshua Brookes*, Pt. II, July, 1828, p. 93.  
Type, "*Trygonoides capensis*," or "Cape (long-tailed) Turtle-relle" ..... [Columbidæ?]  
Τρυγών, the turtle dove; εἶδος, resemblance.
- Tyrannopsis** RIDGWAY, *Proc. Biol. Soc. Wash.*, XVIII, Sept. 2, 1905, p. 209.  
Type, *Muscivora sulphurea* SPIX ..... [Tyrannidæ.]  
*Tyrannus* (τύραννος, a lord, master, tyrant); + ὄψις, aspect, appearance. (Ridgway.)
- Tyto** BILLBERG, *Synopsis Faune Scand.*, I, Pars 2, 1828, tab. A.  
New name for "*Strix* Savigny." (Type, *Strix plumbea* LINNÆUS, 1766 (not PONTOPIDAN, 1763)=*Strix alba* SCOROLL, 1769) ..... [Aucionidæ.]  
Τυτώ, the night owl.
- Urolais** ALEXANDER, *Bull. Brit. Orn. Club*, XIII, No. XCIV, Jan. 30, 1903, p. 35.  
Type, *Urolais marila* ALEXANDER ..... [Sylviidæ.]  
Ὠρόά, tail; λάρος, a bird of the thrush kind.
- Vanellochettusia**<sup>a</sup> BRANDT, in Lehmann's *Reise nach Buchara und Samarkand*,<sup>b</sup> 1852, p. 324.<sup>c</sup>  
Type, *Charadrius leucurus* LICHTENSTEIN ..... [Charadriidæ.]  
(Proposed as a subgenus of *Charadrius*.)
- Viguacarro** COUES, *Key N. A. Birds*, 5th ed., II, Dec., 1903, p. 965.  
Type, *Carbo mexicanus* BRANDT ..... [Phalacrocoracidæ.]  
(Proposed as a subgenus of *Phalacrocorax*.)  
Vigua, native Paraguayan name for a cormorant; + carbo, a coal.
- Viridibucco** OBERHOLSER, *Proc. U. S. Nat. Museum*, XXVIII, No. 1411, July 8, 1905, p. 865.  
Type, *Barbatula leucomystra* SHARPE ..... [Capitonidæ.]  
Viridis, green; + Bucco (*bucco*, a babbler, fool). (Oberholser.)
- Xanthopsar** RIDGWAY, *Proc. Wash. Acad. Sci.*, III, April 15, 1901, p. 155.  
Type, *Oriolus flavus* GMELIN ..... [Icteridæ.]  
Ξανθός, yellow; ψάρα, a starling.

<sup>a</sup>This name should replace *Zupterus* OBERHOLSER (in place of *Zuzypterus* and *Eulypus* SHARPE, preoccupied).

<sup>b</sup>Or Bd. XVII of Baer and Helmersen's *Beiträge zur Kenntniss des Russischen Reiches*.

<sup>c</sup>P. 30 of the reprint of Brandt's "Anhang."

†*Xenorhynchopsis* DE VIS, *Annals Queensl. Museum*, No. 6, Sept. 30, 1905, p. 9.

Types, *Xenorhynchopsis tibialis* DE VIS, and *X. minor* DE VIS. [Ciconiidae.]

*Xenorhynchus* (Ξένος, strange; ῥύγχος, beak); + ὄψις, aspect, appearance.

*Xenotreron* TWEEDDALE, *Proc. Zool. Soc. Lond.*, for 1877, Pt. IV, April, 1878, p. 832.

Type, *Ptilopus? incognita* TWEEDDALE ..... [Treronidae.]  
Ξένος, strange; + *Treron* (τρήρων, a dove).

*Xiphornis* OBERHOLSER, *Smithsonian Misc. Coll.*, Quarterly Issue, XLVIII, No. 1, May 13, 1905, p. 64.

New name for *Xiphorhynchus* of authors, not Swainson (type, *Dendrococcytes procurus* TEMMINCK ..... [Dendrococcyidae.]  
(See also *Campylorhamphus*.)

Ξίφος, a sword; ὄρνις, bird. (Oberholser.)

*Xylocota* "BONAP. (1839)" GRAY, *List Genera Birds*, 2d ed., 1841, p. 90.

Types, *Scolopax undulata* BODDAERT, and *S. sabinii* VIGORS. [Scolopacidae.]

Ξύλον, wood; κοτέω, to be angry at, to bear a grudge.

*Zalochelidon* BILLBERG, *Synopsis Faune Scand.*, I, Pars 2, 1828, tab. A and p. 133.

Type, *Procellaria pelagica* LINNÆUS, ..... [Procellariidae.]  
Ζάλη, a storm, hurricane; χελιδών, a swallow. (Billberg.)

\**Zelica* BROOKES, *Catal. Mus. Joshua Brookes*, Pt. II, July, 1828, p. 84.

Type, "*Zelica trochilus*," or "*Yellow Zelica*" ..... [Sylviidae.]

\**Zorca* "ANTIQU." S. D. W., *Analyst*, III, No. XIV, Jan., 1836, p. 200.

Type, "*Zorca arborea*" (*Scops zorca* of his earlier list).

[Strigidae.]

*Zorca*, the name applied to a species of owl in Sardinia.

#### CATALOGUE OF GENERA MENTIONED IN THE FOREGOING LIST, ARRANGED BY FAMILIES.

[Fossil genera are indicated by italics; *nomina nuda*, and names about the status of which there may be differences of opinion, are preceded by an asterisk.]

##### INCERTÆ SEDIS.

*Alectryopelia*.  
\**Anerpous*.  
*Barbilanius*.  
\**Brachydactyla*.  
\**Cedola*.  
\**Cinelus*.  
\**Cinelus*.  
*Columbigallina*.  
\**Cornuias*.

##### INCERTÆ SEDIS—Continued.

\**Culeus*.  
*D. spectornis*.  
\**Eriornis*.  
\**Hexanemus*.  
\**Lampronotus*.  
*Lithostecnis*.  
*Loucornis*.  
\**Malacoedus*.  
\**Malacorhamphus*.

## INCERFÆ SEDIS—Continued.

*Palaemonis.**Riagama.*\**Rupicula.*\**Siolia.*\**Tetema.*\**Tinamulus.*

## ACCENTORIDÆ.

(See Prunellidæ.)

## ALAUDIDÆ.

*Aëthocorys.**Ammonanoides.**Ammonanopsis.**Botha.**Calandra.**Calandrina.**Corydalis* BOIE.\**Corydalis* MORRIS.\**Corydus* BILLBERG.*Corydus* DRESSER.*Dewetia.**Pinarocorys.**Pseudammomanes.*\**Pseudocorys.*

## ALCEDINIDÆ.

*Agreutes.**Aleyon* BOIE.\**Aleyon* HODGSON.\**Capya.*\**Entomophila.*\**Haleyon.*

## ALCIDÆ.

*Aethia.**Mancalla.*\**Pinguina.**Putlinus.**Rhamphosynthlipsis.*

## ALUCONIDÆ.

\**Nyctimene.**Tyto.*

## AMPELIDÆ.

(See Bombycillidæ.)

## ANATIDÆ.

\**Abellus.**Anseria.**Archæocypenus.**Bernicla.**Clangula.*\**Crecca* BROOKES.*Crecca* S. D. W.\**Cyenus.**Erionetta.*\**Gambo.**Marila.*

## ANATIDÆ—Continued.

*Melanonyx.*\**Moscha.**Plectrophanes.*\**Pronomorus.**Prionochilus.**Querquedula.**Tadorna.**Telornis.*

## APURIZIDÆ.

*Cinclus.*

## ARDEIDÆ.

*Egretta.**Ixobrychus.*\**Limnophylax.*\**Maridus.*

## BOMBYCILLIDÆ.

\**Bysnra.*

## BUBONIDÆ.

(See Strigidæ.)

## BUCCONIDÆ.

*Megacephalus.**Microtrogon.**Monadon.*

## BUCEROTIDÆ.

\**Abuceros.*\**Gingala.*\**Pelecyrhynchus.**Tragopan.*

## BUTEONIDÆ.

\**Aesalon.*\**Aëtus.**Aquila-stur.*\**Asterias.**Asturæctos* BREHM.*Asturæctus* DE VIS.\**Bacha.*\**Brevitarsus.*\**Buteopernis.*\**Cerchne.**Chrysaëtus.**Guyista.*\**Ictinus.**Micraëtus.*\**Morphnaëtos.**Ossifraga.**Phiaëtus* (p. 592).*Potamolegus.*

## CACATUIDÆ.

*Corydon.*\**Eurhynchus.*

## CAPITONIDÆ.

*Abbas.**Pogoniulus.*

## CAPITONIDÆ—Continued.

Pogonornis.  
Promepicus.  
Viridibucco.

## CAPRIMULGIDÆ.

Nyctagrens.  
Nyctornis.  
Phalenixora.

## CASUARIIDÆ.

Cela.  
Oxyporus.  
\*Thrasys.

## CATHARTIDÆ.

Gryphus OKEN.  
Gryphus GEOFFROY. \*

## CERTHIDÆ.

\*Dendrobates.

## CHARADRIIDÆ.

\*Acanthropterus.  
Eupoda.  
Vanellouchettusia.

## CHARADRIIFORMES

*Bolicopterus.*

## CHIONIDIDÆ.

Coleoramphus.

## CICONIIDÆ.

*Ciconiopsis.*  
Dissoura.  
\*Megalorhamphus.  
\*Pelargos.  
*Xenorhynchopsis.*

## CINCLIDÆ.

Accentor.  
Cinclus.  
Hydrichla.

## CLADORNITHIDÆ.

*Cruschedula.*

## CEREBIDÆ.

\*Campylops.

## COLUMBIDÆ.

Dendrotreron.  
\*Trygonoides.

## CONOPOPHAGIDÆ.

Ceraphæes.  
Hylocentrites.

## CORACIDÆ.

\*Ampelis.

## CORVIDÆ.

Ægypt.  
\*Balanophagus.  
Crætes.  
Corax.  
\*Corone.

## CORVIDÆ—Continued.

Eopodoces.  
Frugilegus.  
\*Melanoleuca.  
Pseudopodoces.  
\*Pyrrhocorax.  
Sieberocitta.  
Sitocorax.  
Stellerocitta.  
Temia.

## COTINGIDÆ.

Berlepschia.  
Climacocercus.  
Corvina.  
Elainopsis.  
Heliophilus.  
Hylonax.  
Idiotriccus.  
Microtricus.  
Psaliurus.  
Stictornis.

## CRACIDÆ.

Alector.

## CUCULIDÆ.

Calobates.  
Carpophaga.  
\*Coccyx.  
Cona.  
Edolius.  
Geophilus.  
\*Hulus.  
Idiococcyx.  
Macropus.  
Tapera.

## CURSORIIDÆ.

Cursor.  
Dromius.  
Pratincola.

## DENDROCOLAPTIDÆ.

Acanthurus.  
Campylorhamphus.  
Sylosella.  
Xiphornis.

## DICEIDÆ.

Fafa.  
Spizites.

## DICRURIDÆ.

Dissemuropsis.

## DINORNITHIDÆ.

*Orcuia.*

## DREPANIDIDÆ.

Falcator.  
Hocrataria.

## DREPANIDIDÆ—Continued.

- Oreomystis.
- Paroreomyza.

## DROMICEIIDÆ.

- \*Chelarga.

## FALCONIDÆ.

- (See Buteonide, Pandionide.)

- Cataractes.

- Climacacanthrus*.

- \*Hierax.

- Rhynchodon.

- Thrasycapiter.

## FORMICARIIDÆ.

- Abalius.

- Chamebates.

- Dendroocia.

- Phyllobates.

- Rhopornis.

- Silvestrius.

- Stipituroopsis.

## FRINGILLIDÆ.

- Acanthis.

- Ammospiza.

- \*Aurella.

- Cannabia.

- \*Casmarrhynchus.

- Charitospiza.

- \*Chiasoramphus.

- Chlorion.

- Hortulanus VIEILLOT.

- \*Hortulanus LEACH.

- Koslowia.

- \*Lencophrya.

- \*Linophaga.

- \*Loxorhynchus.

- Neospiza.

- Passerherbulus.

- \*Phrygilus.

- \*Pyrgitina.

- Pyrohamphus.

- Rubicilla.

- Rubicapilla.

- Spermologa.

## FURNARIIDÆ.

- Ancorhamphus.

- Barnesia.

- Geococia.

- Hydrolegus.

- Megaxenops.

## GALBULIDÆ.

- Auga.

- Jacamerops.

## GOURIDÆ.

- (See Microgouride.)

## GRUIDÆ.

- Aminornis*.

- Numidica.

- Scops.

## GYPOGERANIDÆ.

- Gypogeranus.

## HELIORNITHIDÆ?

- \*Plotoides.

## HEMIPROCNIDÆ.

- Dendrochelidon.

- Hemiprocnus.

## HESPERORNITHIDÆ.

- Hargyia*.

## HIRUNDINIDÆ.

- Alpochelidon.

- Diplochelidon.

- Krimnochelidon.

- Lamprochelidon.

- Martula.

- Microchelidon.

- Orochelidon.

## IBIDIDÆ.

- Egathenus.

## ICHTHYORNITHIDÆ.

- Colomasaurus*.

## ICTERIDÆ.

- Aaptus.

- Gnorimopsar (p. 584).

- Pseudagelaius.

- Xanthopsar.

## INDICATORIDÆ.

- Prodotes.

## JACANIDÆ.

- Microparra.

## LANIIDÆ.

- Basamistes.

- \*Creurgus.

## LARIDÆ.

- Chelido.

- Gavia.

- Hydropeleia.

- \*Misamichus.

## LIMICOLÆ.

- Oenplamus*.

## MACROPTERYGIDÆ.

- (See Hemiprocnide.)

## MEGALOPODIDÆ.

- Macrocephalon.

## MELIPHAGIDÆ.

- Notiomystis (p. 634).

## MICROGOURIDÆ?

- Microgoura.

## MICROPODIDÆ.

Acanthura.  
 Acromis.  
 Brevipes.  
 Tachynautes.

## MIMIDÆ.

Dumetella.  
 Lucar.

## MNIOTILTIDÆ.

Chrysocantor.  
 Cinerosa.  
 Neodendroica.

\* Ramphosteon.

## MOTACILLIDÆ.

Budytanthus.  
 Charadriola.  
 Ncmoricola.  
 Pecula.

\* Sciren.

\* Scisura.

## MUSCICAPIDÆ.

Apatema.  
 Arizelomyia.  
 Cichlomyia.  
 Conopotheras.  
 Empidornis.  
 Eugerygone.

\* Muscicula.

\* Myiotheras.

Myopornis.  
 Oreomyias.  
 Parophasma.  
 Ripidicula.  
 Stoparola.

## MUSOPHAGIDÆ.

Museyora.  
 Persa.  
 Ruwenzornis.

## NECTARINIDÆ.

Anabathmis.  
 Arachnothera.  
 Endrepanis.  
 Helionympha.

## GEDIENIDÆ.

\* Planorhamphus.

## ORIOIDÆ.

\* Chloreus.  
 Galbula.

## OTIDIDÆ.

Oticulus.

## PALAMEDEIDÆ.

Chaja.

## PANDIONIDÆ.

\* Ichthyactus.

## PARADISÆIDÆ.

Loborhamphus.  
 Maria.

## PARIDÆ.

Ægithalus.  
 Aegithospiza.  
 Biarmicus.  
 Calamornis.  
 Finschia.  
 Laniellus.  
 Orites.

\* Parcoræus.

Pendulinus.

\* Penthestes.

Penthornis.  
 Phacopharus.  
 Poeciloides.  
 Psittiparus.  
 Remiz.  
 Struthus.

## PELECANIDÆ.

*Cyphornis.*

## PHALACROCORACIDÆ.

Dilophalicus.  
 Viguacarbo.

## PHALAROPODIDÆ.

Amblyrhynchus.

## PHASIANIDÆ.

Alector.  
 Argus.  
 Bremus.  
 \* Diceratornis.  
 Francolinus.  
 Gallophasis.  
 Numida.  
 \* Phasianlector.  
 \* Pintado.

Polyplectron.

Pseudotaon.

Satyra.

## PHENICOPTERIDÆ.

*Tiliornis.*

## PICIDÆ.

Chrysoptilopicus.  
 Cladoscopus.  
 \* Craugus.  
 Dinopium.  
 \* Dryocolaptes.

## PIPRIDÆ.

All cotopterus.  
 Pipra.  
 Sanayoa.

## PLOCEID.E.

Amandava.  
Anomalospiza.  
Chlorestrida.  
Cinnamopteryx.  
Enplectes.  
Hypermegethes.  
Melanhyphantes.  
Melanopteryx.  
Nesocharis.  
Notiospiza.  
Odontospiza.  
Phormoplectes.  
Pseudonigrita.  
Pseudospermestes.  
Reichenowia.  
\*Stegamura.

## PROCELLARIID.E.

Zalochelidon.

## PROCNATID.E.

Chelidorhamphus.

## PRUNELLID.E.

Aprunella.

## PSITTACID.E.

Comeris.  
\*Macao.  
Micropsites.  
\*Petacula.

## PTEROCLID.E.

Attagen.

## PUFFINID.E.

Halobippus.  
Macronectes.  
Rhipornis.

## PYCNONOTID.E.

Aeritillas.  
Argaleocichla.  
Arizelocichla.  
Atimastillas.  
Calyptocichla.  
Charitillas.  
Cometes.  
Idiocichla.  
Prosphorocichla.  
Stelgidocichla.  
Thapsinillas.  
Thescelocichla.

## RALLID.E.

*Miscoglytus*.  
Monias.

## REGULID.E.

\*Orchilus.

## RHEID.E.

Gauria.

## RYNCHOPID.E.

Anisoramphus.  
Psalidoramphus.

## SCOLOPACID.E.

Caribes.  
Crocethia.  
Longirostris.  
Nea.  
Neomenius.  
Pisobia.  
Platyrhamphus.  
*Rhynchacites*.  
Nylocota.

## SCOPID.E.

Cephus.

## SITTID.E.

Neositta.  
Sittella.

## SPHENISCID.E.

*Anthracornis*.  
Aptenodytes.  
*Apterodytes*.  
*Argyropytes*.  
*Arthrodytes*.  
*Delphinornis*.  
*Eospheniscus*.  
Geopega.  
*Ichthyophyrus*.  
*Isotremornis*.  
*Melanocornis*.  
*Neculus*.  
*Pachyphyrus*.  
*Palaeoapterodytes*.  
*Paraspheniscus*.  
*Perispheniscus*.  
*Pseudospheniscus*.  
*Trochodytes*.

## STERCORARIID.E?

\*Pomarinus.

## STEREORNITHES.

*Aucornis*.  
*Eucallornis*.  
*Suiliornis*.

## STRIGID.E.

For Strigidae of authors, see Alucoidae.)

\*Ascalaphus.

\*Byas.

Cryptoglaux.

\*Glaux.

\*Gymnopus.

Haemeria.

Otus.

\*Zorca.



## STRUTHIONES.

Antruchon.  
*Eremopezus.*

## STURNIDÆ.

Arizcopsar.  
 Enodes.  
 Goodfellowia.  
 Ichla.  
 Merula.  
 Poncropsar.  
 \*Probatens  
 \*Psar.

## SULIDÆ.

Plaucus.

## SYLVIIDÆ.

Anteliocichla.  
 \*Caricicola.  
 Conopoderas.  
 \*Dagela.  
 \*Dilara.  
 \*Fani-sa.  
 Heliolais.  
 Ke'ea.  
 Malacurus.  
 Merion.  
 Notiocichla.  
 Oreoscopus.  
 Philacantha.  
 \*Philydra.  
 \*Phragmites.  
 Poliolais.  
 Rhadina.  
 Ripaccola.  
 \*Schoenia.  
 Sylvicola.  
 Titiza.  
 Urolais.  
 \*Zelica.

## TANGARIDÆ.

Bergia.  
 Brachyrhamphus.  
 Diplochilus.  
 Iridophanes.  
 Neothraupis.  
 Tanagra.  
 Tangara.

## TETRAONIDÆ.

\*Capriceca.  
 Dentophorus.  
 \*Erythropus.  
 Rufipes.  
 \*Tetrix.

## TIMALIIDÆ.

Aethostoma.  
 Bathmedonia.  
 Buettikoferia.  
 Heteroxenicus.  
 Horizillas.  
 Hylodes.  
 \*Kasnakowia.  
 Kaznakowia.  
 \*Kenopia.  
 Leonardia.  
 Leonardina.  
 \*Napothera BOIE.  
 Napothera GRAY.  
 Nesobates.  
 Proparoides.  
 Pseudoxenicus.  
 Semiparus.

## TRERONIDÆ.

Ancistroa.  
 Columbigallus.  
 Muscadivores.  
 Phanorhina.  
 Xenotreron.

## TROCHILIDÆ.

Aeronympha.  
 Anthoscenus.  
 Colubris HÜBNER.  
 Colubris WOOD.  
 Microlyssa.  
 Thaumasinus.

## TROGLODYTIDÆ.

Nannorchilus.  
 Nannus.  
 Olbiorchilus.  
 Paulomagus.  
 Thyrochilus.

## TROGONIDÆ.

Antisianus.  
 Euptilotis.  
 \*Harpaleus.

## TURDIDÆ.

Ægithocichla.  
 \*Copsicus.  
 Cyano-sylvia.  
 Diplootoecus.  
 \*Geocichla MACKLOT.  
 Geocichla MÜLLER.  
 \*Geocichloides.  
 Haplocichla.  
 Helminthophaga.  
 \*Lamprophonus.  
 Luscinia

## TURDIDÆ—Continued.

Oreias.  
 Phæca.  
 Poliocichla.  
 Rhodella.

## TURNICIDÆ.

Ortyx.

## TYRANNIDÆ.

Aerochordopus.  
 Aphanotricus.  
 Atalotricus.  
 Cnemarchus.  
 Craspedoprion.  
 \*Muscacipiter.  
 Myiophthorus.  
 Myiornis.  
 Myiotricus.  
 Orodynastes.  
 Perissotricus.  
 Phaemyias.

## TYRANNIDÆ—Continued.

Phacotricus.  
 Phylloscia.  
 Placostomus.  
 Platytricus.  
 Renggerornis.  
 Taeniotricus.  
 Terenotricus.  
 Todirhamphus.  
 Tolmarchus.  
 Tyrannopsis.

## UPUPIDÆ.

\*Eups.

## VULTURIDÆ.

Abernus.  
 Perenopterus.  
 Torgos.

## ZOSTEROPIDÆ.

Hypocryptadius.  
 Pseudozosterops.



## A REVISION OF THE KINGFISHER GENUS RAMPHALCYON (PELARGOPSIS).

By HARRY C. OBERHOLSER,

*Assistant Ornithologist, Department of Agriculture.*

The many specimens of *Ramphaleyon* (= *Pelargopsis*) collected by Dr. W. L. Abbott during his various explorations in the East Indies include nearly all of these birds now in the United States National Museum. Mr. Robert Ridgway, the curator of birds, some time ago referred them to the writer for identification, which has led, almost unconsciously, into an investigation of all the forms of the genus. As the results may not be without interest for other workers in the same field, it seems well to publish them at the present time.

The genus *Ramphaleyon* is a well-defined group in the subfamily Alcedininae, and is naturally divisible, according to coloration, into three sections, which appear to represent three species, two of them separable into geographical races.

One of these sections comprises the brown-backed, brown-winged, red-billed *Ramphaleyon anauroptera*, which ranges from eastern India to the Malay Peninsula, without, however, any apparent modification into subspecies.

The second section is composed of *Ramphaleyon melanorhynchus* and its two conspecific forms, and is confined to Celebes and a few adjacent islands. This species has the bill partly or wholly black, and the back and wings brownish or dusky, with a greenish or bluish sheen.

The third section contains the remaining forms, all characterized by a red bill, and more or less greenish back and wings. This is a difficult group, particularly when studied with insufficient material, and is not at present in a satisfactory condition. The examination of altogether some 80 examples, mostly of recent collection, largely from new localities, and representing all but one of the forms,<sup>a</sup> indicates

<sup>a</sup> *Ramphaleyon capensis floresiana*.

almost conclusively that all, with the possible exception of *Ramphalecyon gigantea*, are best treated as subspecies of *Ramphalecyon capensis* (= *fraseri*).<sup>a</sup> It is true, of course, that birds like *Ramphalecyon javana* (= *leucocephala*) and *R. gouldi* are very different from *R. gurni* and *R. malaccensis*, but *R. intermedia* and *R. capensis* so completely bridge this gap that there is nothing to do but to call them all subspecies. As with some other kingfishers, altogether too little account has been taken of individual, of seasonal, age, and sexual variation, for some of the supposedly distinct species, even though separated by water, will be found on comparison of a sufficient series to differ by only average characters.

Individual variation, however, is not unusually great, except in a few of the races, such as *Ramphalecyon capensis capensis*, in which it produces birds both with or without a brown cap. The individual color variation affects principally the depth of shade on the pileum and lower surface, and the tint of back, scapulars, and wings. The effect of wear is most seen on the pileum, which often is thus made much paler; other parts are sometimes appreciably, but rarely much, altered by the same influence, the lower surface paling, the back and wings becoming more bluish.

The notable difference that exists between the sexes is one of the most interesting points brought out by the present investigation, for almost all writers unite in considering the male and female practically alike. As a matter of fact, however, the female is nearly always decidedly larger, and has back and wings, sometimes tail as well, duller and more brownish or greenish. These differences are very great and constant in some subspecies, much less and not trenchant in others, but the females are nearly always distinguishable by color, or at least by size.

Immature birds are duller, more brownish or greenish on the back and wings than adults, the males in this condition resembling adult females. Other indications of immaturity are broad buff or ochraceous edgings on the wing-coverts, and numerous conspicuous blackish margins on the feathers of the breast and jugulum. Neither of these, however, is an infallible criterion—although the latter commonly passes as such—for both appear sometimes on freshly molted birds that bear every other indication of maturity. It seems, however, that these edgings on both breast and wing-coverts are much less numerous and conspicuous on mature individuals, possibly are altogether absent on very old birds, and at any rate probably soon disappear under abrasion.

This species, *Ramphalecyon capensis*, has a wide range, for it extends from Ceylon, India, and Burma to Cochin China, the Philippine

<sup>a</sup> Cf. Hartert, Nov. Zool., IX, 1902, pp. 202-203.

Islands, Borneo, Flores, Java, and Sumatra with its western outlying islands. It is common and well distributed over this area, but separates into many local forms, of which at present fifteen seem to be recognizable. As is the case with many oriental and East Indian birds, the geographical distribution of these races presents several interesting anomalies. For instance, *Ramphalcyon c. intermedia*, of the Nicobar Islands, is most closely allied to the Bornean form, and separated from it by the totally dissimilar Malayan *Ramphalcyon c. malaccensis*. Again, *Ramphalcyon c. floresiana*, from Flores, is very much like *Ramphalcyon c. malaccensis*, and very different from the intervening Javan *Ramphalcyon c. capensis* and Bornean *R. c. javana*. Furthermore, both *Ramphalcyon c. gurali* and *R. c. burmanica* much more nearly resemble *Ramphalcyon c. simaluccensis*, from Simalur Island, and *Ramphalcyon c. isoptera*,<sup>a</sup> from the Pagi Islands, than they do either the Malayan *R. c. malaccensis* or *Ramphalcyon c. cyanopteryx*,<sup>b</sup> from northwestern Sumatra. Also the hereinafter described *Ramphalcyon c. hydrophila*,<sup>c</sup> from Singapore and Lingga Islands, is more like *Ramphalcyon c. sodalis*, from the Banjak Islands, off the northwestern coast of Sumatra, than like the mainland Sumatran *Ramphalcyon c. cyanopteryx*.<sup>b</sup> Other more local instances are given below under *Ramphalcyon c. nesocca*.<sup>d</sup>

The kingfishers of this group have for long passed under the generic name *Pelargopsis* Gloger; <sup>e</sup> but an examination of the original diagnosis shows this name to be clearly a *nomen nudum* there. It is proposed in the following fashion:

Mehrere andere würde man ebenfalls Storchschnäbler (*Pelargopsis*) nennen können. Denn sowohl ihre, noch grösseren und bedeutend stärkeren Schnäbel, die übrigens noch nirgends aufgetrieben erscheinen, wie ihre dickeren Köpfe, gleichen mehr jenen der Störche.

No species is mentioned, and even the common name "Storchschnäbler" is here used apparently for the first time, as by careful search in the literature no previous mention of these birds as "stork-bills," or "stork-billed kingfishers," has been brought to light. Furthermore, the diagnosis given by Gloger <sup>e</sup> is not certainly identifiable, for it is so brief and indefinite that it would just as well apply to *Ceryle*, or even *Dacelo*, as to the birds here under discussion; and we must therefore abandon *Pelargopsis* Gloger. The next available generic name for the stork-billed kingfishers is *Ramphalcyon* Reichenbach.<sup>f</sup>

The literature of this genus is not extensive, and consists chiefly of scattered references in faunal and systematic books and papers.

<sup>a</sup> See page 671.    <sup>b</sup> See page 676.    <sup>c</sup> See page 677.    <sup>d</sup> See page 674.

<sup>e</sup> Gem. Hand- und Hilfsb. Nat., I. 1842, p. 338.

<sup>f</sup> Handb. Spec. Orn., 1851, p. 16.

The most important reviews of the group, three in number, are by Dr. R. B. Sharpe.<sup>a</sup>

The material on which the present investigations rest consists of the collection of the United States National Museum, with the addition of a small number of specimens from the Academy of Natural Sciences of Philadelphia. For the privilege of making use of the latter the writer is indebted to the courtesy of Mr. Witmer Stone.

#### Genus RAMPHALCYON Reichenbach.

*Petargopsis* GLOGER, Gem. Hand- und Hilfsb. Nat., I, 1842, p. 338 (*nomen nudum*).

*Ramphalcyon* REICHENBACH, Handb. Spec. Orn., 1851, p. 16 (type,<sup>b</sup> *Alcedo capensis* LINNÆUS).

*Hyleaon* REICHENBACH, Handb. Spec. Orn., 1851, p. 18 (type, *Alcedo melanorhyncha* TEMMINCK).

*Petargopsis* CABANIS and HEINE, Mus. Hein., II, 1860, p. 156 (type, *Alcedo javana* BODDAERT).

*Generic characters*.—Similar to *Ceryle*, but bill relatively larger and heavier, especially broader; culmen decidedly flattened at base, instead of rounded; wing more rounded, the third and fourth<sup>c</sup> primaries, in place of the second and third,<sup>c</sup> longest, the outermost (first) at least 25 mm., instead of not over 17 mm., shorter than the longest; tail relatively longer; inner toe and claw falling far short of base of middle claw, instead of about reaching it, as in *Ceryle*.

*Type*.—*Alcedo capensis* LINNÆUS.

*Geographical distribution*.—Ceylon, India, and Burma, east to Siam, Cambodia, and the Philippine Islands; south to Celebes, Borneo, Flores, Java, and Sumatra with its outlying islands.

#### KEY TO THE SPECIES AND SUBSPECIES OF RAMPHALCYON.

- a. Back, wings, scapulars, and tail brown, without greenish or bluish tinge.  
*Ramphalcyon amauroptera*.
- a'. Back, wings, scapulars, and tail with more or less greenish or bluish tinge.
- b. Bill wholly or largely black.
- c. Bill entirely black.-----*Ramphalcyon melanorhyncha melanorhyncha*.
- c'. Bill with red spots at base.
- d. Red spots at base of bill small.  
*Ramphalcyon melanorhyncha culreptorhyncha*.
- d'. Red spots at base of bill large.  
*Ramphalcyon melanorhyncha dichrorhyncha*.
- b'. Bill red, except the dusky tip.
- c. Pileum not distinctly capped with brown.
- d. Head and under parts very pale buff or cream color.  
*Ramphalcyon capensis gigantea*.

<sup>a</sup> Proc. Zool. Soc. Lond., 1870, pp. 61-69; Monograph Alcedinidae, 1870, pp. 95-111, pls. xxix-xxxvi; Cat. Birds Brit. Mus., XVII, 1892, pp. 96-107.

<sup>b</sup> Fixed by Gray, in List Genera and Subgenera Birds, 1855, p. 16.

<sup>c</sup> Counting from the outermost.

- d'. Head and under parts deep ochraceous or tawny.
- e. Mantle much more greenish.....*Ramphalcyon capensis gouldi*
- e'. Mantle much more bluish.
- f. Pileum more mixed with brownish; mantle somewhat more greenish..... *Ramphalcyon capensis capensis.*
- f'. Pileum less mixed with brownish, often not at all; mantle somewhat more bluish.
- g. Larger; darker below, throat not whitish.  
*Ramphalcyon capensis intermedia.*
- g'. Smaller; lighter below, throat usually whitish.  
*Ramphalcyon capensis javana.*
- e'. Pileum distinctly capped with brown.
- d. Wing of female usually not less than 157 mm.
- e. Back, wings, and tail paler, duller, and more greenish.
- f. Pileum darker; lower parts much paler, the throat whitish.  
*Ramphalcyon capensis gural.*
- f'. Pileum lighter; lower parts much darker, the throat usually not whitish..... *Ramphalcyon capensis buranica.*
- e'. Back, wings, and tail darker, brighter, and more bluish.
- f. Pileum darker, and usually more mixed with ochraceous.  
*Ramphalcyon capensis cyanopteryx.*
- f'. Pileum paler, and usually less mixed with ochraceous.
- g. Lower surface darker and more uniform; back and wings somewhat more greenish .....*Ramphalcyon capensis sodalis.*
- g'. Lower surface lighter and less uniform; back and wings rather more bluish ... ..*Ramphalcyon capensis nesocca.*
- d'. Wing of female usually less than 157 mm.
- e. Back dull brownish green.
- f. Smaller; pileum more mixed with ochraceous; lower parts much darker..... *Ramphalcyon capensis simularcensis.*
- f'. Larger; pileum less mixed with ochraceous; lower parts much paler ..... *Ramphalcyon capensis isoptera.*
- e'. Back bright bluish green.
- f. Pileum paler, much varied with ochraceous.
- g. Smaller; pileum lighter, and with more ochraceous.  
*Ramphalcyon capensis capensis.*
- g'. Larger; pileum more deeply colored, and with less ochraceous.  
*Ramphalcyon capensis hydrophila.*
- f'. Pileum darker, varied with but little, if any, ochraceous.
- g. Top and sides of head but slightly, if at all, washed with greenish; lower surface darker.  
*Ramphalcyon capensis malaccensis.*
- g'. Top and sides of head strongly washed with greenish; lower surface lighter.....*Ramphalcyon capensis floresiana.*

RAMPHALCYON AMAUROPTERA (Pearson).

*Haleyon amauropterus* PEARSON, JOURNAL, ASIAT. SOC. BENGAL, X, 1841, p. 635 (Calcutta, India).

*Specific characters.*—Upper back, scapulars, wings, and tail seal brown, without any greenish tinge; head, neck, and under parts tawny ochraceous; rump and lower back light turquoise blue; bill red with dusky tip.



*Measurements.*—*Males:* Wing, 134–146.5 (average, 141.3); tail, 84–99 (average, 90.2); exposed culmen, 70–82.5 (average, 74.1); tarsus, 17–20.5 (average, 18.1). *Females:* Wing, 142–145 (average, 143.5); tail, 86–87.5 (average, 86.8); exposed culmen, 74; tarsus, 17.5–19 (average, 18.3) mm.

*Type-locality.*—Calcutta, India.

*Geographical distribution.*—Eastern Bengal, India, to Arakan, Tenasserim, and Lower Siam.

This very distinct species seems to be subject to little, if any, geographical variation in either size or color, for specimens from Lower Siam and the Mergui Archipelago are just like those from India. There appears to be little distinction of size and none of color between the sexes. Immature birds are distinguishable by dusky tips on the ochraceous feathers of neck and lower parts.

The following specimens of this species have been examined:

Museum and No.	Sex.	Locality.	Date.	Collector.
A. N. S. Phila. 21107.....	[♂]	India.....		
U.S.N.M. 173063.....	♂	Malium, Tenasserim.....	Mar. 18, 1900	Dr. W. L. Abbott.
U.S.N.M. 173064.....	♂	do.....	do.....	Do.
U.S.N.M. 173061.....	♂	Sullivan's Island, Mergui Archipelago.	Feb. 3, 1900	Do.
U.S.N.M. 173062.....	♂	Pulo Adang, Butang Islands.	Dec. 14, 1899	Do.
U.S.N.M. 153781.....	♂	Trong, Lower Siam.....	Mar. 17, 1896	Do.
U.S.N.M. 173779.....	♂	do.....	Mar. 8, 1896	Do.
U.S.N.M. 153780.....	♀	do.....	do.....	Do.

RAMPHALCYON MELANORHYNCHA MELANORHYNCHA (Temminck).

*Alcedo melanorhyncha* TEMMINCK, Planch. Col., IV, 1826, pl. cccxci (Celebes).

*Specific characters.*—Scapulars, middle of back, wings, and tail brown, tinged with greenish or bluish; rest of plumage cream color, becoming buff or ochraceous on the posterior lower surface, and dusky on the sides of head and forehead; bill wholly black.

*Measurements.*—Wing, 140–154 (average, 148.6); tail, 87–101 (average, 91.2); exposed culmen, 74–84 (average, 79); tarsus, 15–17 (average, 15.6) mm.

*Type-locality.*—Celebes.

*Geographical distribution.*—Togian Islands, Celebes, and the adjacent islands of Lembah, Banka, and Manado tua.

The bill in this form is nearly always entirely black, but sometimes in specimens from middle Celebes there appears a small red spot at its base.

This bird is found probably throughout Celebes, since it has been recorded from the northern, western, middle, and southeastern portions of the island.

Only one specimen has been examined, an adult male (A. N. S. Phila., No. 50028) collected by C. Hose on Mount Masarang, Celebes,

in November, 1895. The measurements above given are taken largely from Meyer and Wigglesworth<sup>a</sup> and from Sharpe.<sup>b</sup>

*RAMPHALCYON MELANORHYNCHA EUTREPTORHYNCHA* (Hartert).

*Pelargopsis melanorhyncha eutreptorhyncha* HARTERT, Nov. Zool., V, 1898, p. 128 (Sula Mangoli Island, Sula Islands).

*Subspecific characters*.—Similar to *Ramphalcyon melanorhyncha dichrorhyncha*, but the red on base of bill much reduced in extent.

*Measurements*.—Practically identical with those of *Ramphalcyon melanorhyncha dichrorhyncha*.

*Type-locality*.—Sula Mangoli Island, Sula Islands.

*Geographical distribution*.—Sula Islands, east of Celebes.

The bill at base has, almost always, at least small spots of red, though these are never so extensive as is usual in *Ramphalcyon melanorhyncha dichrorhyncha*. Curiously enough, *Ramphalcyon m. eutreptorhyncha* is intermediate in characters between *Ramphalcyon melanorhyncha melanorhyncha* and *R. m. dichrorhyncha*, though not so in geographical range.

*RAMPHALCYON MELANORHYNCHA DICHRORHYNCHA* (Meyer and Wigglesworth).

*Pelargopsis dichrorhyncha* MEYER and WIGGLESWORTH, Abh. k. Zool. und Anthrop. Mus. Dresden, 1896, No. 2, p. 12 (Peling and Banggai islands).

*Subspecific characters*.—Similar to *Ramphalcyon melanorhyncha melanorhyncha*, but basal half of bill extensively red.

*Measurements*.—Wing, 151–161; tail, 100; tarsus, 17 mm.

*Type-locality*.—Peling and Banggai islands, near the eastern coast of Celebes.

*Geographical distribution*.—Peling Islands and Banggai Island.

The red on the base of the bill varies much individually, being, on the maxilla, sometimes reduced to a spot, sometimes expanded to cover more than half its length; on the mandible extending over usually not less than one-half, in some cases fully three-fourths.

*RAMPHALCYON CAPENSIS CAPENSIS* (Linnæus).

*Alcedo capensis* LINNÆUS, Syst. Nat., 12th ed., I, 1766, p. 180 ("Cape of Good Hope;" locality erroneous; should be Java).

*Pelargopsis frasci* SHARPE, Proc. Zool. Soc. Lond., 1870, p. 65 (Java).

*Subspecific characters*.—Crown and occiput light brownish, but much mixed and overlaid with ochraceous; nape and lower surface deep ochraceous, excepting the throat, which is much paler—buff or cream color; mantle bluish green; size small.

<sup>a</sup> Birds Celebes, I, 1898, p. 270.

<sup>b</sup> Cat. Birds Brit. Mus., XVII, 1892, p. 97.

*Measurements.*—*Four males:* Wing, 137.5–141 (average, 139); tail, 86.5–92 (average, 88.9); exposed culmen, 70.5–76.5 (average, 73.5); tarsus, 16–17 (average, 16.6). *Three females:* Wing, 147.5–150.5 (average, 148.7); tail, 92–98.5 (average, 94.2); exposed culmen, 70–75.5 (average, 73); tarsus, 17.5–18.5 (average, 17.8) mm.

*Type-locality.*—Java.

*Geographical distribution.*—Java, Billiton Island, and southeastern Sumatra to the Indrigiri River.

This race has commonly no distinct cap of brown, but individuals occasionally occur which have a brown pileum, though in such cases the considerable admixture of ochraceous serves, as always, to distinguish this bird from the races to which it is otherwise most closely allied. Various intermediates in this respect occur also. Birds from Billiton Island and southeastern Sumatra are apparently not distinguishable from those taken in Java; at least, with the present limited series, no separation is possible. Northwestward along the eastern side of Sumatra, somewhere about the middle, *Ramphalcyon capensis capensis* passes into *Ramphalcyon capensis cyanopteryx*,<sup>a</sup> a new form from the northwestern end of this island, examples from the Indrigiri River being intermediate.

In *Ramphalcyon capensis capensis*, as in the other forms, there is a noticeable difference between the sexes, so that specimens of the same sex are necessary in making comparisons. This difference consists in the decidedly larger size of the female, as well as her duller, more brownish or greenish mantle.

Concerning the name to be used for the Javan bird, there has been considerable difference of opinion. Linnaeus founded his *Alcedo capensis*<sup>b</sup> solely on "Le Martin-pescheur du Cap de Bonne Espérance" (*Ispida capitis bona spei*) of Brisson,<sup>c</sup> and it therefore stands or falls by the identification of the latter, without regard to the determination of the "Martin Pêcheur du Cap de Bonne Espérance" of Daudenton,<sup>d</sup> which later formed the primary basis of Boddaert's *Alcedo capensis*.<sup>e</sup> There can be no doubt, after a careful examination of Brisson's detailed description,<sup>f</sup> that the *Alcedo capensis* of Linnaeus refers to one of the blue-backed forms of *Ramphalcyon*, and, such being the case, the name must stand for some one of them.

Brisson's plate is absolutely unidentifiable subspecifically, but his description<sup>f</sup> is a good one, and much better fits the bird from Java than any of the other forms. This was also the opinion of Dr. R. B.

<sup>a</sup> See page 676.

<sup>b</sup> Syst. Nat., 12th ed., 1, 1766, p. 180.

<sup>c</sup> Orn., IV, 1760, p. 488, pl. xxxvi, fig. 3.

<sup>d</sup> Tabl. Planch. Enl., 1783, p. 36.

<sup>e</sup> Planch. Enl., pl. 590.

<sup>f</sup> Orn., IV, 1760, pp. 488–489.

Sharpe, when, in 1870, he revised the species of the genus,<sup>a</sup> and his reasons for rejecting the name are merely trivial. He says:<sup>a</sup>

After carefully comparing a skin of the adult Javan bird with Brisson's elaborate description, I believe that his "*Ispida capitis bona spei*" was really taken from a Javan specimen. Consequently the species stands primarily as *Alcedo capensis*, Linn. But in the face of the manifest incongruity of such an appellation, I believe myself justified in proposing a new name for the bird, and I therefore take the opportunity of connecting with it the name of my friend Mr. W. T. Fraser. \* \* \*

The next year, in another place,<sup>b</sup> he makes the following remarks on the same subject:

\* \* \* I proposed the name of Mr. W. T. Fraser for the present species instead of retaining the one which seems by right to belong to the bird, viz., *Alcedo capensis* of Linnaeus, inasmuch as this name is founded on the "*Ispida capitis bona spei*" of Brisson, and if perpetuated could only lend additional confusion as to the correct locality of the species.

What Doctor Sharpe subsequently says<sup>c</sup> about the difficulty of identifying Daubenton's plate has no bearing on the question, for this plate does not enter into the equation at all, since Linnaeus did not mention it, although Doctor Sharpe, and some other writers as well, seem to be under the impression that he did. It appears, therefore, that *Alcedo capensis* Linnaeus has fully as clear a title as many of the names now in common use, and should stand for the Javan *Ramphalcyon*, since erroneous locality by no means debars a name. The Javan bird should consequently be called *Ramphalcyon capensis capensis* (Linnaeus).

The measurements above given were taken from the following specimens:

Museum and No.	Sex.	Locality.	Date.	Collector.
U.S.N.M. 17895.....	♂	Indrigiri River, Sumatra.....	Sept. 19, 1901	Dr. W. L. Abbott.
U.S.N.M. 178991.....	♂	.....do.....	Sept. 23, 1901	Do.
A. N. S. Phila. 39093.....	[♂]	Gocong Soegi, Lampong, Sumatra.	Oct.-Nov., 1901	Harrison and Hiller.
A. N. S. Phila. 39096.....	[♂]	.....do.....	.....do.....	Do.
A. N. S. Phila. 39094.....	♂	.....do.....	.....do.....	Do.
A. N. S. Phila. 39095.....	♂	.....do.....	.....do.....	Do.
U.S.N.M. 180516.....	♂	Tanjong Poetak, Billiton Island.	Aug. 13, 1904	Dr. W. L. Abbott.

*RAMPHALCYON CAPENSIS JAVANA* (Boddaert).

*Alcedo javana* BODDAERT, Tabl. Planch. Enl., 1783, p. 17 ("Java;" locality wrong; Borneo is doubtless its country of origin).

*Alcedo leucocephala* GMELIN, Syst. Nat., I, i, 1788, p. 156 ("Java").

*Alcedo javanica* SILLW., Gen. Zool., VIII, 1812, p. 67 ("Java").

*Subspecific characters*.—Similar to *Ramphalcyon capensis capensis*, but pileum clear ochraceous without admixture of brown; mantle less greenish blue.

<sup>a</sup> Proc. Zool. Soc. Lond., 1870, p. 66.

<sup>b</sup> Mon. Alcedinidae, 1871, pp. 103-104.

<sup>c</sup> Cat. Birds Brit. Mus., XVII, 1892, p. 106.

*Measurements.*—*One male:* Wing, 141; tail, 92; exposed culmen, 77; tarsus, 16.5. *Two females:* Wing, 150–152.5 (average, 151.3); tail, 93–98 (average, 95.5); exposed culmen, 73.5–75 (average, 74.3); tarsus, 17.5–18 (average, 17.8) mm.

*Type-locality.*—Borneo.

*Geographical distribution.*—Borneo.

There seems to be no doubt, as Doctor Hartert has already pointed out,<sup>a</sup> that the earliest name for this form is *Alcedo javana* Boddaert,<sup>b</sup> notwithstanding the supposition of Javan origin. Indeed, Doctor Sharpe himself is of the same opinion,<sup>c</sup> and rejects the name only on account of its erroneous implication. As there is, however, apparently no other reason for its rejection, it ought henceforth to be employed.

The measurements above summarized were taken from the subjoined specimens:

U.S.N.M. No.	Sex.	Locality.	Date.	Collector.
181377	♂	Mouth of Sempang River, West Borneo.	June 9, 1907	Dr. W. L. Abbott.
181376	♀	do.	do.	Do.
181375	♀	Sukadana, West Borneo.	June 6, 1907	Do.

RAMPHALCYON CAPENSIS INTERMEDIA (Hume).

*Ptergopsis intermedia* HUME, *Stray Feath.*, II, 1874, p. 166 (southern Nicobar Islands: Galatea Bay, Great Nicobar Island, may be considered the type-locality, as it is the first mentioned).

*Subspecific characters.*—Similar to *Ramphalecyon capensis gouldi*, but averaging larger; pileum and cervix lighter ochraceous; blue of back, rump, wings, and tail much less greenish.

*Measurements.*—*Five females:* Wing, 151–159 (average, 154.6); tail, 94–105 (average, 96.7); exposed culmen, 73–84 (average, 78.4); tarsus, 18–19 (average, 18.4) mm.

*Type-locality.*—Galatea Bay, Nicobar Island, Nicobar Islands.

*Geographical distribution.*—Nicobar Islands.

This race is very well differentiated from *Ramphalecyon c. gouldi*, but is very closely allied to *Ramphalecyon c. javana*, from which, however, it may be distinguished by its slightly larger size and darker, more uniform lower surface, the chin not decidedly paler than the posterior portion.

From *Ramphalecyon capensis gigantea* it differs so greatly by reason of its deeply colored lower surface, pileum, and cervix, and the much more bluish shade of back, wings, and tail, that no comparison is really necessary. Its larger size, less brownish pileum, less green-

<sup>a</sup> Nov. Zool., IX, 1902, pp. 202–203.

<sup>b</sup> Tabl. Planch. Enl., 1783, p. 47.

<sup>c</sup> Cat. Birds Brit. Mus., XVII, 1892, p. 98.

ish mantle, and less whitish chin and throat separate it readily from *Ramphalcyon c. capensis*.

As in *Ramphalcyon capensis gigantea*, *R. c. gouldi*, and *R. c. javana*, the pileum of *R. c. intermedia* reveals little or no brown when the plumage is unworn, for the broad ochraceous tips of the feathers obscure the brown bases; but when the plumage becomes abraded these brown bases are more or less visible on the forehead and crown, though they never produce the solidly brown effect seen in most of the other forms. Specimens of *Ramphalcyon c. intermedia* from Little Nicobar Island are apparently identical with those from Great Nicobar Island.

The following specimens furnished the above-given measurements:

U.S.N.M. No.	Sex.	Locality.	Date.	Collector.
178530.....	♂	Little Nicobar Island, Nicobar Is- lands.	Feb. 27, 1901	Dr. W. L. Abbott.
178529.....	♀	do.....	Mar. 3, 1901	Do.
178526.....	♀	Great Nicobar Island, Nicobar Is- lands.	Mar. 10, 1901	Do.
178527.....	♀	do.....	Mar. 11, 1901	Do.
178528.....	♀	do.....	Mar. 12, 1901	Do.

RAMPHALCYON CAPENSIS GOULDI (Sharpe).

*Pelargopsis gouldi* SHARPE, Ibis, 1870, p. 63 (Manila, Luzon, Philippine Islands).

*Subspecific characters*.—Similar to *Ramphalcyon capensis capensis*, but lower surface more uniform, the throat not much paler than the rest; pileum and cervix more deeply ochraceous, the former without so much mixture of brown; remainder of upper parts lighter and more greenish.

*Measurements*.—*Two males*: Wing, 139.5–141.5 (average, 140.5); tail, 82–84 (average, 83); exposed culmen, 80–82 (average, 81); tarsus, 17–18 (average, 17.5). *Two females*: Wing, 117.5–153 (average, 150.3); tail, 90.5–96.5 (average, 93.5); exposed culmen, 76–80.5 (average, 78.3); tarsus, 17–17.5 (average, 17.3) mm.

*Type locality*.—Manila, Luzon Island, Philippine Islands.

*Geographical distribution*.—Southwestern Philippines, on the islands of Luzon (Manila), Mindoro, Calamianes, Lubang, Palawan, and Balabac.

This form is in some respects nearer *Ramphalcyon capensis javana* than to *Ramphalcyon c. capensis*, but differs from the former in its more uniform lower surface and in the paler, much more greenish hue of back, wings, and tail. From *Ramphalcyon capensis gigantea* it is easily distinguished by its much more deeply colored lower parts, pileum, and cervix, by smaller size, and somewhat paler mantle. Both of these forms occur on Luzon, *Ramphalcyon c. gouldi* reaching the central part of this island by way of Palawan and Mindoro and

*Ramphaleyon c. gigantea* the southeastern portion through the Sulu Islands, Mindanao, and Leyte. That the two meet on Luzon is probable, and that they intergrade is indicated by the aberrant specimen of *R. c. gigantea* from Sorsogon mentioned under that form.

The above measurements came from the specimens listed below:

Museum and No.	Sex.	Locality.	Date.	Collector
U.S.N.M. 161211.....	♂	Mindoro Island, Philippine Islands.	June 2, 1888	Dr. F. S. Bourns.
A.N.S. Phila. 49602.....	♂	Pola, Mindoro, Philippine Islands.	Nov 20, 1903	Dr. E. H. Porter.
U.S.N.M. 161210.....	♀	Mindoro Island, Philippine Islands.	June 13, 1888	Dr. F. S. Bourns.
A.N.S. Phila. 49601.....	♀	Pola, Mindoro, Philippine Islands.	Oct. 21, 1903	Dr. E. H. Porter

RAMPHALCYON CAPENSIS GIGANTEA (Walden).

*Pelargopsis gigantea* WALDEN. Ann. and Mag. Nat. Hist., 4th ser., XIII, 1874, p. 123 (Salok Solo, Sulu Islands, Philippine Archipelago).

*Subspecific characters.*—Similar to *Ramphaleyon capensis javana*, but pileum, cervix, and entire lower surface very much paler, varying from deep buff to almost white, and the mantle much more greenish blue.

*Measurements.*—*Five males:* Wing, 148.5–152.5 (average, 150.8); tail, 89–94.5 (average, 91.3); exposed culmen, 74.5–78.5 (average, 76.7); tarsus, 16–17.5 (average, 16.8). *Two females:* Wing, 147–155 (average, 151); tail, 84–89.5 (average, 86.8); exposed culmen, 78–82.5 (average, 80.3); tarsus, 17.5–18.5 (average, 18) mm.

*Type-locality.*—Salok Solo, Sulu Islands, Philippine Islands.

*Geographical distribution.*—Southern and central parts of the Philippine Archipelago, on the islands of Sulu, Lapac, Tawi Tawi, Bongao, and Sibutu, in the Sulu group; Mindanao, Malanipa, Basilan, Leyte, Dinagat, Masbate, Negros, Panay, Gnimaras, Samar, Cebu, Tablas, Sibuyan, Ticao, and the far southeastern end of Luzon.

In its extreme manifestation this race is a very different bird from either *Ramphaleyon capensis capensis* or *Ramphaleyon capensis javana*, for its very pale head and under parts distinguish it at sight. It differs from the former in the same way as from the latter, and additionally in its decidedly larger size. Although *R. c. gigantea* thus appears to very distinct, the extreme individual variations of all these three birds approximate very closely the characters of each. The present race has previously never been recorded from Luzon, but its occurrence on this island, at least near the southeastern end, is attested by a specimen in the collection of the Philadelphia Academy of Sciences, obtained by Dr. E. H. Porter at Sorsogon. This example, while clearly referable to *Ramphaleyon c. gigantea*, shows a decided approach to *Ramphaleyon c. gouldi*, in the more deeply

ochraceous tint of the under surface and of the sides of head and neck. An immature bird from Mindanao is about as deeply colored below. Sexual differences are not so conspicuous in this race as in many of the others.

Measurements above recorded were furnished by the specimens below:

Museum and No.	Sex.	Locality.	Date.	Collector.
U.S.N.M. 19208.....	♂	Tubay River, Mindanao, Philippine Islands.	Apr. 24, 1901	Dr. E. A. Mearns.
U.S.N.M. 19001.....	♂	Makar, Mindanao, Philippine Islands.	Oct. 26, 1903	Do.
U.S.N.M. 191981.....	♂	Micas, Mindanao, Philippine Islands.	Feb. 15, 1904	Do.
U.S.N.M. 191455.....	♂	Pasonanca, Mindanao, Philippine Islands.	Dec. 21, 1902	M. L. Robb.
A.N.S. Phila. 49003.....	♂	Sorsogon, Luzon, Philippine Islands.	Mar. 16, 1903	Dr. E. H. Porter.
U.S.N.M. 19060.....	♂	Manay, Mindanao, Philippine Islands.	Oct. 23, 1904	Dr. E. A. Mearns.
U.S.N.M. 19080.....	♂	Micas, Mindanao, Philippine Islands.	Feb. 15, 1904	Do.

*RAMPHALCYON CAPENSIS GURIAL* (Pearson).

*Alcedo gural* PEARSON, Journ. Asiatic Soc. Bengal, X, 1844, p. 633 (Midnapore, Bengal, India).

*Aleyon capensis* vel *princeps* HODGSON, in Gray's Zool. Misc., 1844, p. 82 (Nepal).

*Haleyon bruniceps* JIMON, Madras Journ., XIII, 1844 (1845), p. 443 (Goornsoor, Malabar, and Travancore, India).

*Subspecific characters*.—Like *Ramphalcyon capensis burmanica*, but pileum darker; lower parts paler, the chin and throat more whitish and more contrasted with breast and abdomen.

*Measurements*.—*Three males*: Wing, 153–156 (average, 154.2); tail, 102; exposed culmen, 75.5–82.5 (average, 78.7); tarsus, 17–18.5 (average, 17.7). *One female*: Wing, 159; tail, 102.5; exposed culmen, 80; tarsus, 18.5 mm.

*Type locality*.—Midnapore, Bengal, India.

*Geographical distribution*.—Peninsula of India, excepting the northwestern part, south to Ceylon, north to Sikkim, and east to Assam and Manipur.

This race is most closely allied to *Ramphalcyon c. burmanica*, and like it is distinguished from the other above-described forms by its brown pileated head. From both *Ramphalcyon c. gouldi* and *Ramphalcyon c. intermedia* it differs in its paler chin and throat, more contrasted with the remaining lower parts, and in other characters as does *Ramphalcyon c. burmanica*. Examples from Assam and Manipur are said by Doctor Sharpe<sup>a</sup> to be intermediate between the present race and *Ramphalcyon capensis burmanica*. It is possible

<sup>a</sup>Cat. Birds Brit. Mus., XVII, 1892, p. 102.



that the birds from the southern part of the Indian peninsula will ultimately prove different from those of the north, in which case the *Halcyon bruniceps* of Jerdon<sup>a</sup> should be their name.

The measurements above given are from the following specimens:

Museum and No.	Sex.	Locality.	Date.	Collector.
U. S. N. M. 102004.....	[♂]	Sikkim, India.....		T. O. Russell.
A. N. S. Phila. 21114.....	♂	India.....		
A. N. S. Phila. 21113.....	[♂]	do.....		Doctor Hulinaga.
A. N. S. Phila. 50029.....	[♀]	do.....		

RAMPHALCYON CAPENSIS BURMANICA (Sharpe).

*Pelargopsis burmanica* SHARPE, Proc. Zool. Soc. Lond., 1870, p. 67 (Tonghoo, Burma).

*Subspecific characters.*—Resembling *Ramphalcyon capensis capensis*, but much larger; pileum conspicuously capped with dull brown, without admixture of ochraceous; back, wings, and tail lighter and decidedly more greenish.

*Measurements.*—*Three males:* Wing, 143–154.5 (average, 149.7); tail, 92.5–98 (average, 94.7); exposed culmen, 71–79.5 (average, 76.5); tarsus, 17–18 (average, 17.7). *One male:* Wing, 162; tail, —; exposed culmen, 77.5; tarsus, 19 mm.

*Type-locality.*—Tonghoo, Burma.

*Geographical distribution.*—Andaman Islands, Burma, and Tenasserim, east to Siam, Cambodia, and Cochin China.

The present race may be distinguished at a glance from *Ramphalcyon c. javana*, *R. c. gigantea*, *R. c. gouldi*, and *R. c. intermedia* by its very conspicuous brown cap, and from each of these by other characters as well. It has the pale and very greenish back, wings, and tail of *Ramphalcyon c. gouldi*, but even more strongly developed. There is considerable individual variation in *Ramphalcyon c. burmanica*, particularly in the color of the pileum. Young or immature birds, as in some of the other races, appear to be somewhat darker than adults. Specimens from Siam seem to be rather larger than those from Burma. Birds from the Andaman Islands are said to be still paler than those from the mainland, and may ultimately be found to represent an unnamed race.

The specimens supplying the above measurements are as follows:

Museum and No.	Sex.	Locality.	Date.	Collector.
U. S. N. M. 102003.....	[♂]	Siam.....		R. Schomburgk.
A. N. S. Phila. 21117.....	[♂]	do.....		Prince Monifanol.
A. N. S. Phila. 50011.....	♂	Thongyui, Burma.....	Feb. —, 1893	T. A. Huxwell.
A. N. S. Phila. 50032.....	[♀]	Burma.....		E. W. Oates.

<sup>a</sup> Madras Journ., XIII, 1841 (1845), p. 143.

*RAMPHALCYON CAPENSIS SIMALURENSIS* (Richmond).

*Pterargopsis simalurensis* RICHMOND, Proc. U. S. Nat. Mus., XXVI, 1903, p. 498 (Simalur Island, western coast of Sumatra).

*Subspecific characters*.—Similar to *Ramphalcyon capensis burmanica*, but smaller; back, wings, and tail darker, somewhat more bluish; pileum with more of an ochraceous tinge, and lower surface rather more deeply colored.

*Measurements*.—*Three males*: Wing, 139–141 (average, 140); tail, 89.5–93 (average, 91.5); exposed culmen, 78.5–79 (average, 78.7); tarsus, 16.5–17 (average, 16.8). *Three females*: Wing, 145–151 (average, 147.8); tail, 94–100 (average, 96.8); exposed culmen, 72–82.5 (average, 77.8); tarsus, 17.5–18.5 (average, 18) mm.

*Type locality*.—Simalur Island, western coast of Sumatra.

*Geographical distribution*.—Simalur Island, western coast of Sumatra.

This excellent form differs from *Ramphalcyon c. quial* about as from *R. c. burmanica*, and additionally in lacking the whitish chin and throat, these parts being ochraceous buff, and not so much paler than the remaining lower surface. It is of the same size as *Ramphalcyon capensis capensis*, but is readily separable by its distinctly brown-capped pileum, with but very little ochraceous tinge, duller, much more greenish back, wings, and tail, and more deeply colored, more uniform lower surface. So far as known, *Ramphalcyon capensis simalurensis* is confined to the island of Simalur, for the neighboring islands and the mainland of Sumatra are inhabited by different forms, as hereinafter described. It seems to be, however, certainly only a subspecies, connected by individual variations with the mainland race through the birds from Nias and the Batu Islands. The females of *Ramphalcyon capensis simalurensis* differ considerably from the males in larger size, duller wings and tail, and decidedly duller, more brownish back.

The following specimens have been examined:

U.S.N.M. No.	Sex.	Locality.	Date.	Collector
179205	♂	Simalur Island <sup>a</sup> .....	Nov. 29, 1901	Dr. W. L. Abbott.
179206	♂	do.....	Nov. 27, 1901	Do.
179743	♂	Sibobo Bay, Simalur Island.....	Oct. 23, 1902	Do.
179202	♀	Simalur Island.....	Nov. 29, 1901	Do.
179203	♀	do.....	Nov. 30, 1901	Do.
179204	♀	do.....	Nov. 27, 1901	Do.

<sup>a</sup> Type.

*RAMPHALCYON CAPENSIS ISOPTERA*, new subspecies.

*Subspecific characters*.—Similar to *Ramphalcyon capensis simalurensis*, but larger, the crown with less ochraceous, the lower back and rump more greenish, and the under surface decidedly paler.

*Description*.—Type, adult male, No. 179750, U.S.N.M.; Sikakap Strait, Pagi Islands, December 30, 1902; Dr. W. L. Abbott. Pileum and sides of head hair brown; upper back, superior tail-coverts and wing-coverts terre verte green; wing-quills and rectrices fuscous, their exposed surfaces when closed mostly bluish myrtle green; lower back and rump Nile blue; chin cream buff; throat, jugulum, and a cervical collar deep buff, shading into ochraceous on breast, abdomen, and lower tail-coverts; lining of wing ochraceous.

Measurements of the type series are as follows:

U.S.N.M. No.	Sex	Locality	Date	Total length, <sup>a</sup>	Wing	Tail	Ex-posed cul-men	Tar-sus
179750	♂	Sikakap Strait, Pagi Is-lands <sup>b</sup>	Dec. 30, 1902	378	152.5	95	81.5	17.5
179753	♂	Sikakap Strait, North Pagi Island	Nov. 11, 1902	370	145	94	82	17
179752	♂	North Pagi Island, Pagi Islands	Jan. 1, 1903	375	149	97.5	77	16
179747	♂	South Pagi Island, Pagi Islands	Dec. 3, 1902	370	150	94	73.5	17.5
179748	♂	do	Dec. 5, 1902	371	147	93	80	16.5
179749	♂	do	Dec. 10, 1902	355	149	90	78	16.5
Average of six males				369.8	148.8	93.9	78.7	16.8
179746	♀	South Pagi Island, Pagi Islands	Nov. 19, 1902	392	154	96	85	18
179751	♀	North Pagi Island, Pagi Islands	Nov. 20, 1902	380	148	92	79	18
Average of two females				386	151	94	82	18

<sup>a</sup> Measured in the flesh by the collector, Dr. W. L. Abbott.

<sup>b</sup> Type.

*Geographical distribution*.—North and South Pagi islands, western coast of Sumatra.

This new form differs noticeably from *Ramphaleyon capensis sodalis* in its smaller size and paler, less uniform lower surface. From *Ramphaleyon c. gurali* it may readily be distinguished by its smaller size, darker back and wings, paler pileum, and less whitish throat; from *R. c. burmanica* by smaller size, much paler, less uniform lower surface, darker back and wings; and from *Ramphaleyon capensis capensis* still more easily by reason of its larger size, much duller and greenish instead of bluish upper back, wings, and tail, lighter, more greenish lower back and rump, brown-capped pileum with little or no wash of ochraceous, and paler lower parts.

In geographical position this is the most southeastern of the races that have their home on the islands off the western coast of Sumatra, and it exhibits an interesting combination of characters. In size it is nearest *Ramphaleyon capensis cyanopteryx*, the mainland form from northwestern Sumatra above described; in the color of the lower surface it is almost exactly a counterpart of the bird from Nias, while in the shade of upper back, wings, and tail it is almost indistinguish-

able from *Ramphalcyon capensis simalurensis*. So far as known *Ramphalcyon c. isoptera* is confined to the Pagi Islands, though it may, perhaps, be found on the islands lying just to the northwest. The United States National Museum series of eight specimens is very uniform, showing no differences between birds from North Pagi Island and those from South Pagi Island, nor any very appreciable individual variations, except in some cases a lightening of the pileum or lower surface, due to wear of the plumage.

Except in size, there seems to be less contrast between the sexes than in some of the other subspecies, but the female is usually duller and more brownish on the upper back and wings than the male.

**RAMPHALCYON CAPENSIS SODALIS (Richmond).**

*Pelargopsis sodalis* RICHMOND, Proc. U. S. Nat. Mus., XXVI, 1903, p. 499  
(Pulo Tuangku, Banjak Islands, western coast of Sumatra).

*Subspecific characters*.—Similar to *Ramphalcyon capensis simalurensis*, but much larger; female with wings and tail more bluish, the back less brownish, and the pileum somewhat paler.

*Measurements*.—*Two females*: Wing, 158.5–161 (average, 159.8); tail, 102–104 (average, 103); exposed culmen, 84.5–85.5 (average, 85); tarsus, 19–21 (average, 20) mm.

*Type-locality*.—Pulo Tuangku, Banjak Islands, western coast of Sumatra.

*Geographical distribution*.—Pulo Tuangku and probably the remaining Banjak Islands, off the northwestern coast of Sumatra.

This race is, as would be expected from its geographical position, intermediate between *Ramphalcyon c. simalurensis* and *Ramphalcyon c. nesocca*, the form found on Nias. The females of *R. c. simalurensis* and *R. c. sodalis* differ as above mentioned, but the female of the latter is, except for its rather lighter pileum, practically identical in color with the male of *R. c. simalurensis*. The male of *R. c. sodalis* is unknown. This form is very similar to *Ramphalcyon c. burmanica*, being of the same size and same color below, but it is distinguishable by its paler pileum, darker back, and more bluish wings and tail. It is less like *Ramphalcyon c. gural*, differing from this as from *R. c. burmanica*, and additionally in its darker, more uniformly ochraceous lower surface. It is much larger than *Ramphalcyon capensis capensis*, with a much less ochraceous pileum, more greenish or brownish back, and less distinctly paler throat. From all the above-described forms without a brown cap it is, of course, readily separated.

A second specimen has the pileum much paler than the type, showing in this respect considerable individual variation, though part of this may be due in this instance to wear.

The two examples from which this race was described are the only ones that have been examined:

U.S.N.M. No.	Sex.	Locality.	Date.	Collector.
179208.....	♀	Pulo Tuanguku, Banjar Islands <sup>a</sup> ..	Jan. 25, 1902	Dr. W. L. Abbott.
179207.....	♀	do.....	Feb. 4, 1902	Do.

<sup>a</sup> Type.

**RAMPHALCYON CAPENSIS NESOECA, new subspecies.**

*Subspecific characters.*—Resembling *Ramphalcyon capensis isoptera*, but pileum paler; back, wings, and tail much brighter and more bluish.

*Description.*—Type, adult male, No. 180865 U.S.N.M.; Mojeia River, Nias Island, northwestern Sumatra, March 15, 1905; Dr. W. L. Abbott. Pileum and sides of head, including auriculars but not malar region, grayish hair brown, the feathers narrowly edged with buffy or cream color; cervix with a conspicuous ochraceous buff collar, continuous with lower parts; upper back, scapulars, superior tail-coverts, and wings myrtle green; the wing-quills and rectrices fuscous, their exposed surfaces when closed mostly bluish green; lower back and rump Nile blue; chin and throat buff, shading into ochraceous on the posterior lower surface; lining of wing ochraceous; “bill blood color, blackish at tip; feet coral red.”

Measurements of the type-series follow:

U.S.N.M. No.	Sex.	Locality.	Date.	Total length. ( <sup>a</sup> )	Wing.	Tail.	Ex-posed cul-men.	Tar-sus.
179757.....	♂	Nias Island.....	Mar. 13, 1903	360	144	92	81.5	16
180864.....	♂	Telok Bluku, Nias Is-land.	Mar. 2, 1905	375	148	93	83	18
180865.....	♂	Mojeia River, Nias Is-land. <sup>b</sup>	Mar. 15, 1905	375	147	91	76.5	17.5
179756.....	♂	Lafau, Nias Island.....	Mar. 22, 1903	360	148.5	90.5	78	17
179754.....	♂	do.....	do.....	365	143	92	82	16.5
179744.....	♂	Pulo Pinie, Batu Islands.	Mar. 6, 1903	377	151	90	80	18.5
Average of six males.....				368.6	146.9	91.4	80.2	17.3
179755.....	♀	Lafau, Nias Island.....	Mar. 23, 1903	385	161.5	102	80.5	17
179745.....	♀	Pulo Pinie, Batu Islands.	Mar. 6, 1903	395	160.5	95	86.5	18.5
Average of two females.....				390	161	98.5	83.5	17.8

<sup>a</sup> Measured in the flesh by the collector, Dr. W. L. Abbott.

<sup>b</sup> Type.

*Geographical distribution.*—Nias Island and the Batu Islands, western Sumatra.

This race differs very much from *Ramphalcyon capensis simularensis* in its larger size, paler pileum, brighter, more bluish upper back, wings, and tail, and lighter, less uniform lower surface. It seems to be most closely allied to *Ramphalcyon capensis sodalis*, but

as no one has yet obtained males of that form, final comparison is, of course, impossible; but so far as the females indicate, the principal differences lie in the lighter, less uniform lower surface, and rather more bluish back and wings of *Ramphalcyon c. nesocca*.

The most obvious distinctions between the present bird and *Ramphalcyon capensis capensis* are the former's much larger size, and its paler, brown-capped pileum, with little or no admixture of ochraceous; but, in addition, the chin and upper throat are usually less contrasted with the remainder of the lower surface. The more uniform under parts, the paler pileum, together with the much brighter, deeper, and more bluish back, wings, and tail, easily distinguish *Ramphalcyon c. nesocca* from *Ramphalcyon c. gurali*; while the darker, brighter, more bluish back, wings, and tail and somewhat paler ventral aspect separate it from *Ramphalcyon c. burmanica*.

Two specimens, male and female, from Pulo Pinie, Batu Islands, appear to belong to this form, although they are both rather less bluish above than Nias examples. This is possibly to be expected, as indicating a tendency toward intergradation with *Ramphalcyon c. isoptera* from the Pagi Islands; and the chain of evidence would probably be complete were specimens at hand from the intervening islands.

As is evident from the measurements above given, there is great difference of size between the sexes in the present race. The contrast in color is quite as marked, the female being very much duller and less bluish on upper back, wings, and tail. The divergence is confined to these parts, however, for, as in all the other forms, the color of the pileum and entire lower surface is apparently identical in male and female. The series examined is very uniform, but in some of the birds abrasion has somewhat lightened the tone of the lower parts, and made considerable similar change on the pileum, while the same influence has made the upper back, wings, and tail rather more bluish.

The four forms of *Ramphalcyon capensis* that inhabit the islands off the northwestern coast of Sumatra fall naturally into two divisions, according to the general tone of the posterior upper surface, but, strange to say, they do not in this respect correspond very well to geographical considerations, for *Ramphalcyon c. simalurensis* and *R. c. isoptera* from the Pagi Islands, which are the two most widely separated, have dull greenish back, wings, and tail; while the two other races, *R. c. nesocca*, from Nias Island, and *R. c. sodalis* (judging from its female) have a much brighter, more bluish shade on the same parts. In most other characters the differences, considered geographically, are nearly as peculiar.

## RAMPHALCYON CAPENSIS CYANOPTERYX, new subspecies.

*Subspecific characters*.—Similar to *Ramphaleyon capensis capensis*, from Java, but larger; pileum darker, less ochraceous, and distinctly brown-capped; upper back, wings, and tail more bluish.

*Description*.—Type, adult male, No. 179210, U.S.N.M.; Tapanuli Bay, northwestern Sumatra, March 22, 1902; Dr. W. L. Abbott. Pileum and sides of head bistre brown, much mixed with ochraceous, but forming a distinct cap; upper back, wing-coverts, and upper tail-coverts bluish myrtle green; wing-quills and rectrices sepia brown, their exposed surfaces when closed mostly greenish indigo blue; lower back and rump turquoise blue; chin cream buff; upper throat buff; remainder of lower surface, together with a broad cervical collar, rather light tawny ochraceous; lining of wing ochraceous buff.

Measurements are as follows:

U.S.N.M. No.	Sex.	Locality.	Date.	Total length. ( <i>a</i> )	Wing.	Tail.	Ex-posed culmen.	Tarsus.
179211.....	♂	Tapanuli Bay, west Sumatra.	Feb. 23, 1902	368	142.5	94.5	72.5	15.5
179210.....	♂	.....do. <i>b</i> .....	Mar. 22, 1902	355	146	93.5	72	16
180968.....	♂	Tarussan Bay, west Sumatra.	Jan. 15, 1905	362	145.5	85.5	73	16
181093.....	♂	Besitan River, east Sumatra.	Nov. 17, 1905	380	143.5	91	72.5	17
Average of four males.....				366.2	144.4	91.1	72.5	16.1
179212.....	♀	Tapanuli Bay, west Sumatra.	Mar. 26, 1902	381	163	99	75	20

<sup>a</sup> Measured in the flesh by the collector, Dr. W. L. Abbott.

<sup>b</sup> Type.

*Geographical distribution*.—Northwestern Sumatra, with Pulo Mansalar; northeastern Sumatra south at least to the Besitan River.

That the bird from northwestern Sumatra is so unlike that of the southeastern part of this island is an interesting discovery; and, curiously enough, this new form is more bluish on the back, wings, and tail than any of the races by which it is surrounded. It may be distinguished from *Ramphaleyon capensis malaccensis* by its paler pileum, with usually more admixture of ochraceous, more bluish upper back, wings, and tail, lighter lower parts, the chin and throat less uniform with the rest, and slightly greater average size. It resembles *Ramphaleyon capensis nesoecca*, but has the pileum darker and usually with more ochraceous, the back, wings, and tail much more bluish, and the lower parts more deeply colored. It differs greatly, however, from *Ramphaleyon capensis isoptera* in its darker, more ochraceous pileum, much brighter and more bluish back, wings, and tail, and more deeply colored lower parts.

It is smaller than *Ramphaleyon capensis sodalis*, has a darker pileum more mixed with ochraceous, and is more bluish on the back, wings, and tail. From *Ramphaleyon c. simalurensis* it differs still

more in its larger size, very much more bluish posterior upper parts, darker, more ochraceous pileum, and paler, less uniform lower parts. It is smaller than either *Ramphalcyon c. gurali* or *Ramphalcyon c. burmanica*, and, furthermore, departs so greatly from both in its more ochraceous pileum and much darker, brighter, more bluish back, wings, and tail that it is distinguishable at a glance. With the forms that have no brown cap it, of course, needs no special comparison.

The female of this race is very much larger than the male, and usually more greenish on upper back, scapulars, and wing-coverts, but there is not much other difference.

The single adult male from Tarussan Bay, western Sumatra, is like the type, though more worn. A bird from Pulo Mansalar, off the entrance to Tapanuli Bay, apparently belongs to this form: it is, according to the label, a female, and in color practically agrees with a female from Tapanuli Bay; but it is very small, about the size of males from the mainland; so that if it does not prove to belong to another subspecies, it is probably an immature male, notwithstanding its general appearance of maturity. In a few examples of the U. S. National Museum series the pileum has a noticeable wash of greenish, but this is not constant enough to be diagnostic.

***RAMPHALCYON CAPENSIS HYDROPHILA*, new subspecies.**

*Subspecific characters*.—Similar to *Ramphalcyon capensis capensis*, from Java, but larger; pileum with much less ochraceous, darker, and more distinctly capped with brown; lower surface averaging slightly darker and more uniform.

*Description*.—Type, adult male, No. 170447, U.S.N.M.; Singapore Island, May 27, 1899; Dr. W. L. Abbott. Pileum and sides of head hair brown, the feathers more or less margined with buff or cream color; upper back and superior tail-coverts bluish French green; wings and tail largely fuscous, but when closed their exposed surfaces bluish myrtle green; lower back and rump Nile blue; cervical collar ochraceous buff; chin buff, shading into the ochraceous of the remaining lower surface; lining of wing tawny ochraceous. Feet red, claws horn brown; eyelids red; iris dark brown; bill red, blackish at tip.

Measurements are as below:

U.S.N.M. No.	Sex	Locality	Date	Total length. ( <sup>a</sup> )	Wing.	Tail.	Ex- posed cul- men.	Tar- sus.
170447	♂	Singapore Island <sup>b</sup>	May 27, 1899	349	145.5	93.5	75	17.5
178996	♀	Lingga Island	Aug. 25, 1901	387	154	97	86	18
179484	♀	Pulo Bintang	Aug. 13, 1901	387	152	96.5	79.5	18
Average of two females				387	153	96.8	82.8	18

<sup>a</sup> Measured in the flesh by the collector, Dr. W. L. Abbott.

<sup>b</sup> Type.



*Geographical distribution.*—Islands of Singapore, Lingga, and Bintang, off the southern end of the Malay Peninsula.

Of the several forms of *Ramphaleyon capensis*, this new one seems to be most closely allied to *Ramphaleyon c. sodalis*, but differs by reason of its inferior size, and darker, more ochraceous pileum. It is larger, with a more ochraceous pileum, and much brighter, more bluish back, wings, and tail than *Ramphaleyon c. simalurensis*; while it differs so greatly from both *Ramphaleyon c. burmanica* and *R. c. gurial* in its smaller size, more ochraceous pileum, and much brighter, darker, more bluish back, wings, and tail, that it is separable at a glance. It is somewhat similar to *Ramphaleyon capensis cyanopteryx*, but has the back, wings, and tail much less bluish, and the pileum usually lighter; it differs from *Ramphaleyon capensis nesocca* in its smaller size, darker, more ochraceous pileum, more deeply and uniformly colored lower surface, and rather less bluish wings; and it is very unlike *Ramphaleyon capensis isoptera*, on account of its much brighter, more bluish back, wings, and tail, more ochraceous pileum, and darker, more uniform under parts.

It may seem unwise to describe another form of *Ramphaleyon capensis* from so near the type-locality of *Ramphaleyon c. malaccensis*, but the birds from Singapore, Lingga, and Bintang islands are clearly not *R. c. malaccensis*, of which the Museum has a good series from the Malay Peninsula, nor are they *R. c. capensis*; and although in fact somewhat intermediate between these two, are yet different enough to be worthy a name. So far as it is possible to tell from the limited series now at hand, the birds from all three of the above-mentioned islands are identical.

#### RAMPHALCYON CAPENSIS MALACCENSIS (Sharpe).

*Pterargopsis malaccensis* SHARPE, Proc. Zool. Soc. Lond., 1870, p. 67 (Malacca, Malay Peninsula).

*Subspecific characters.*—Similar to *Ramphaleyon capensis hydrophila*, but pileum much darker and much less mixed with ochraceous.

*Measurements.*—*Six males*: Wing, 137.5–146 (average, 141.5); tail, 86–94 (average, 89.9); exposed culmen, 68.5–75 (average, 71.2); tarsus, 16–18 (average, 16.8). *Three females*: Wing, 147–156 (average, 152.8); tail, 98–100 (average, 99.3); exposed culmen, 73–78.5 (average, 76.3); tarsus, 18.5–19 (average, 18.8) mm.

*Type-locality.*—Malacca, Malay Peninsula.

*Geographical distribution.*—Malay Peninsula south of Tenasserim.

This well-marked race may easily be distinguished from *Ramphaleyon capensis capensis* by its much darker, less ochraceous pileum, and more deeply colored, more uniform lower surface; from *Ram-*

*phaleyon c. burmanica* by smaller size, deeper brown pileum, and darker, brighter, more bluish back, wings, and tail; and still more readily from *R. c. gural* by far more deeply, more uniformly colored under parts, in addition to the same characters by which it is separated from *R. c. burmanica*. It differs much from both *Ramphaleyon c. simalurensis* and *Ramphaleyon c. isoptera* in its darker pileum, decidedly brighter, more bluish back and wings, and additionally from the latter in its darker, more uniform lower surface. It is more nearly like *Ramphaleyon c. sodalis* and *R. c. nesocca*, but is smaller, has a much more deeply colored pileum and usually darker ventral surface. With the several forms that have a plain ochraceous or buffy pileum no special comparison of *R. c. malaccensis* is needed, while the differences that separate it from *Ramphaleyon c. cyanopteryx* have already been fully discussed.<sup>a</sup>

There is rather more than usual purely individual variation in this race, affecting the depth of color on the pileum as well as the lower parts, but not so much the posterior upper surface. There is sometimes a slight gloss of greenish on the pileum. These variations may account for the supposed occurrence of *Ramphaleyon capensis capensis* (olim *fraseri*) within the territory of *R. c. malaccensis*; for since these two forms intergrade, and as they do not migrate, they, of course, nowhere live in the same locality. Sexual distinctions—the larger size, and duller, less bluish posterior upper parts of the female—are about as usual, but are rather less pronounced than in the forms from some of the islands off the western coast of Sumatra.

Measurements given above are from the subjoined specimens:

U.S.N.M. No.	Sex.	Locality.	Date.	Collector.
153787.....	♂	Trong, Lower Siam.....	July 6, 1896	Dr. W. L. Abbott.
153782.....	♂	do.....	May 10, 1896	Do.
153784.....	♂	do.....	June 27, 1896	Do.
175055.....	♂	Paeka, Tringanu, Malay Peninsula.....	Sept. 26, 1900	Do.
178951.....	♂	Jambu Luang, Johore, Malay Peninsula.....	Aug. 2, 1901	Do.
100235.....	[?]	[Malacca?].		
153786.....	♂	Trong, Lower Siam.....	July 4, 1896	Dr. W. L. Abbott.
153783.....	♂	do.....	May 22, 1896	Do.
153785.....	♂	do.....	June 27, 1896	Do.

**RAMPHALCYON CAPENSIS FLORESIANA** (Sharpe).

*Pelargopsis florisiana* SHARPE, Proc. Zool. Soc. Lond., 1870, p. 68 (Floris).

*Pelargopsis susak* VORDERMAN, Nat. Tijdschr. Ned. Ind., LIV, 1895, p. 334 (Laboean hadji, Lombok Island).

*Subspecific characters*.—Similar to *Ramphaleyon capensis malaccensis*, but top and sides of head strongly washed with green; lower parts paler ochraceous.

<sup>a</sup> See page 676.

*Measurements*.—Wing, 145; tail, 91; culmen, 81; tarsus, 11.5 mm.

*Type-locality*.—Island of Flores.

*Geographical distribution*.—The islands of Flores and Lombok.

No specimens have been examined, and this race is here recognized on the strength of Doctor Sharpe's descriptions,<sup>a</sup> by which its validity is indicated. The Lombok bird, too, described as *Pelargopsis sasak* by Vorderman,<sup>b</sup> is above synonymized on the authority of Doctor Sharpe.<sup>c</sup>

<sup>a</sup> Proc. Zool. Soc. Lond., 1870, p. 68; Cat. Birds Brit. Mus., XV11, 1892, p. 103.

<sup>b</sup> Nat. Tijdschr. Ned. Ind., LIV, 1895, p. 334.

<sup>c</sup> Hand-List Gen. and Spec. Birds, 11, 1900, p. 49.

## ALCYONARIA OF THE CALIFORNIAN COAST.

BY CHARLES C. NUTTING,

*Professor of Zoology, State University of Iowa, Iowa City.*

The collections upon which this report is based were obtained for the most part by the U. S. Fisheries steamer *Albatross* while on her cruise off the Californian coast during the year 1904. The collections of the University of California also furnished much interesting material. A few species were found in the collection of the Marine Biological Association of San Diego, and others were kindly placed at my disposal by Stanford University. The writer is under great obligation to the management of the Marine Biological Laboratory at La Jolla and the Hopkins Laboratory at Pacific Grove for laboratory facilities and other valued courtesies during the time he was at work on these collections.

Almost no work had been done on the Alcyonaria of the Californian coast previous to the summer of 1905, when the writer was commissioned by the Bureau of Fisheries to investigate the alcyonarian fauna of that region.

In 1863 Prof. W. M. Gabb published descriptions of a few species in the Proceedings of the California Academy of Natural Sciences.

From 1864 to 1868 Prof. A. E. Verrill published a number of papers containing descriptions of Alcyonaria of the Pacific coast, the most important being a Review of the Corals and Polyyps of the West Coast of America.<sup>a</sup> This is an exceedingly important paper, but deals almost exclusively with forms occurring south of the region at present under consideration, and includes descriptions of less than half a dozen species from north of Mexico.

In 1902 Dr. Th. Moroff published his Studien über Octocorallien, in which he describes three new species of pennatulids<sup>b</sup> from the Californian coast.

Aside from a few scattering references, the above are all of the papers that I have been able to find dealing with the Alcyonaria of

<sup>a</sup> Trans. Connecticut Acad. Arts and Sci., 1, Pl. 2.

<sup>b</sup> Zoologische Jahrbücher, Abtheilung für Systematik, Geographie, und Biologie der Thiere, XVII, 1902, p. 363.

the region under consideration. This scarcity of literature is probably due to the fact that the region is singularly barren of alcyonarian life so far as the shallow-water fauna is concerned. Quite the contrary is true of the deeper water off the Californian coast, and it remained for the Fisheries steamer *Albatross* to demonstrate this fact during the operations of that vessel in 1904, which yielded the greater part of the material upon which the present paper is based.

SYSTEMATIC LIST OF CALIFORNIAN ALCYONARIA IN THIS REPORT.

Order ALCYONACEA.

Family CORNULARIDÆ.

*Telesto rigida*.

*Telesto ambigua*.

*Symphodium armatum*.

Family ALCYONIDÆ.

*Anthomastus ritteri*.

Order PENNATULACEA.

Family PENNATULIDÆ.

*Pennatula aculeata*.

*Ptilosarcus quadrangularis*.

*Haliscyprum cystiferum*.

Family STYLATULIDÆ.

*Stylatula elongata*.

*Acanthoptilum gracile*.

*Acanthoptilum pourtalesii*.

*Acanthoptilum album*.

*Acanthoptilum scalpelliforme*.

*Acanthoptilum annulatum*.

Family VIRGULARIDÆ.

*Balticina pacifica*.

*Balticina funarctica*.

Family FUNICULINIDÆ.

*Funiculina armata*.

*Halipterus contorta*.

Family STACHYPTILIDÆ.

*Stachyptilum superbum*.

*Stachyptilum quadridentatum*.

Family ANTHOPTILIDÆ.

*Anthoptilum grandiflorum*.

Family UMBELLULIDÆ.

*Umbellula magniflora*.

*Umbellula huxleyi*.

*Umbellula loma*.

Family PROTOPTILIDÆ.

*Distichoptilum verrilli*.

Family RENILLIDÆ.

*Renilla amethystina*.

Order GORGONACEA.

Suborder HOLAXONIA.

Family PRAMNOIDE.

*Caligorgia sertosa.*  
*Plumarella longispina.*

Family MURICEIDE.

*Elasmogorgia filiformis.*  
*Muricella complanata.*  
*Eumuricea pusilla.*

Family PLEXAURIDE.

*Psammogorgia arbuscula.*  
*Psammogorgia simplex.*  
*Psammogorgia torreyi.*  
*Psammogorgia spauldingi.*

Family GORGONIDE.

*Leptogorgia flora.*  
*Leptogorgia purpurea.*  
*Leptogorgia caryi.*  
*Stenogorgia kojoidi.*

A glance at the foregoing list shows that the most striking feature of the collection is the number and variety of pennatulids, there being 20 of these beautiful forms out of a total of 38 alcyonarians.

Remembering the large number of Muricidæ and Plexauridæ described by Verrill from the west coast south of the United States, it is somewhat surprising that more numerous representatives of these groups are not included in the present list. This is probably due to the fact, before referred to, that Verrill's material was largely from shallow water, while the present collection was mostly from deep water.

The only alcyonarians that the writer saw in shallow water while working on that coast were *Stylatula gracilis* and *Rocella amethystina*, both pennatulids. So far as could be ascertained, no other alcyonarians had been collected from shallow water, either at La Jolla, where the laboratory of the Marine Biological Association of San Diego is located, or at Pacific Grove. The coast at both these places is rocky and furnishes many almost ideal habitats for alcyonarian life, and the reason for its almost entire absence is not evident, especially in view of its abundance along the Central American coast.

## Bathymetrical and geographical distribution of Californian Alcyonaria.

Name.	Depth.	Geographical distribution.						
		West coast of America.		West Pacific Ocean.	Atlantic Ocean.			
		California to Panama.	South America.		Coast of the United States.	West Indies.	Eastern Atlantic Ocean.	
	<i>Fathoms.</i>							
<i>Telostea rigida</i> .....	1,675							+
* <i>Telostea ambigua</i> .....	1,524							
<i>Symphodium armatum</i> .....	1,975						+	
* <i>Anthomastus ritteri</i> .....	231-638							
<i>Pennatula aculeata</i> .....	29-1,100					+		
<i>Philosereus quadrangularis</i> .....	31-200?							
* <i>Halijsceptrum cystiferum</i> .....	394-609							
<i>Stylatula elongata</i> .....	1-52							
? <i>Acanthoptilum gracile</i> .....	20-59							
<i>Acanthoptilum pourtalesii</i> .....	44						+	
* <i>Acanthoptilum album</i> .....	40-67							
<i>Acanthoptilum scalpelliforme</i> .....	30-140							
* <i>Acanthoptilum annulatum</i> .....	31-291							
* <i>Balticina pacifica</i> .....	243-1,083							
<i>Balticina himmarchica</i> .....	60-400					+		+
<i>Funiculina armata</i> .....	135-638						+	
* <i>Halipterus contorta</i> .....	478-600							
<i>Stachyptilum superbum</i> .....	26-524	+						
* <i>Stachyptilum quadridentatum</i> .....	108-145							
<i>Anthoptilum grandiflorum</i> .....	500-734					+	+	
<i>Umbellula magniflora</i> .....	334-1,600					+		
<i>Umbellula hurleyi</i> .....	500-565					+		
* <i>Umbellula loma</i> .....	330							
<i>Distichoptilum verrilli</i> .....	995-1,573	+						
<i>Rcanilla amythystina</i> .....	1-6	+	+					
<i>Caligorgia schous</i> .....	120-1,012					+		
<i>Plumatella longispina</i> .....	191					+		
<i>Elasmogorgia tiliformis</i> .....	28-423					+		
<i>Muriceella complanata</i> .....	285-345					+		
* <i>Eumuricea pusilla</i> .....	285							
<i>Psammogorgia arbuscula</i> .....	12-339	+						
* <i>Psammogorgia simplex</i> .....	447-448							
* <i>Psammogorgia torreyi</i> .....	26-197							
* <i>Psammogorgia spauldingi</i> .....	(?)							
<i>Lcptogorgia flava</i> .....	(?)—80	+						
<i>Lcptogorgia purpurea</i> .....	(?)—41		+			+	+	
<i>Lcptogorgia carp</i> .....	a(?)							
* <i>Stenogorgia coloidi</i> .....	60-74							

a Shallow water.

[The asterisk (\*) indicates a new species.]

The most important fact brought out by the foregoing list is the entire absence of forms known from the American coast north of California. Aside from this purely negative showing, the most striking feature of the list is the remarkable diversity of the derivation of this fauna, its relationships being almost exactly equal in respect to the faunas of the Pacific coast south of California, the Western Pacific, the eastern coast of the United States, and the West Indies.

Another interesting feature is that the relationship with the Atlantic and Pacific faunas is almost exactly equal.

The collection is hardly extensive enough to warrant any generalizations, and even if this were not so, this singular equivalence of relationship would signify little beyond the wide distribution of the Alcyonaria in comparatively deep water.

## SYSTEMATIC DISCUSSION AND DESCRIPTION OF SPECIES.

Order **ALCYONACEA.**

Fixed colonial forms without an axis cylinder.

Family **CORNULARIDÆ.**

Polyps with solenia; or branched and bearing lateral buds.

Genus **TELESTO.**

Axial polyps, from the walls of which lateral polyps bud forth. Walls containing spicules.

**TELESTO RIGIDA** Wright and Studer.*Telesto rigida* WRIGHT AND STUDER, Challenger Reports, the Alcyonaria, 1889, p. 261.

Base of attachment not present; colony, in typical specimen, 33 mm. high; longest branch, 30 mm.; average diameter of main stem, 2.5 mm., widening distally.

The main stem is the elongated body of the parent body wall, from which daughter polyps branch; these also give off buds, making three generations, as it were. The stem and calyces of the daughter polyps are rather faintly corrugated, the corrugations becoming almost obsolete on distal parts of calyces. Margins with 8 lobes and almost translucent.

The spicules are warty, short spindles, with a few crosses and slender spindles.

*Color.*—Almost white in specimens preserved in formalin.

*Locality.*—Station 4422, east point of San Nicholas Island bearing S. 6° W., 2.5 miles distant. Depth, 31 fathoms.

There were also two specimens in the collection of the University of California, labeled "Sta. XXI, haul 2, June 20, 1901," off Santa Catalina Island, 43 fathoms, and "Sta. LVII-H. L., 50 fathoms, July 17, 1903," from off San Diego.

These specimens agree in essential characters with the original description.

In some places the corrugations in the calyces are well marked, while in others they are almost obsolete, showing that their presence or absence can hardly be a good specific character.

The *Challenger* secured this species at Station 71, west of the Azores, at a depth of 1,675 fathoms.



## TELESTO AMBIGUA Nutting, new species.

Plate LXXXIV, figs. 1 and 2; Plate XC, fig. 1.

Colony growing from an expanded, more or less membranous base, and forming a tangled mass in which it is difficult to distinguish individual stems; longest stem attaining a height of 19 mm. The stem, or body of the mother polyp, gives off daughter calyces without any regularity whatever. In one case an individual attains a height of about 14 mm. Calycular wall with 8 longitudinal corrugations armed with spicules placed lengthwise, and ending at the margins in 8 rounded points. The corrugations are lighter in color than the intervening spaces, and somewhat broader, giving a decidedly striated appearance to the calycular walls.

The calyces enlarge slightly and gradually toward the margins; and are often curved, when long. In some cases there are calyces of the third generation.

The polyps are all so retracted that details of their structure can not be ascertained without sectioning.

The spicules are very slender spindles, almost needle like, with their outer surfaces rather closely beset with thorn-like processes. They are most numerous in the longitudinal rugosities on the calycular walls.

*Color*.—Pale yellowish brown, growing lighter distally; the intervals between the rugosities are greenish.

*Type-specimen*.—Cat. No. 25421, U.S.N.M.

*Locality*.—Station 4514, Monterey Bay, Point Pinos light-house bearing S. 39° E., 10.7 miles distant; 524 fathoms.

## Genus SYMPODIUM.

Polyps arising from a thin, leathery membrane, retractile. Spicules small and disk-shaped.

## SYMPODIUM ARMATUM Wright and Studer.

*Symphodium armatum* WRIGHT and STUDER. Challenger Report, Alcyonaria, 1889, p. 272.

Specimens which agree well with the original description were found at the following stations:

Station 4311, Point Loma light-house bearing N. 32° E., 8.5 miles distant; 110 fathoms.

Station 4515, Monterey Bay, Point Pinos light-house bearing S. 18° E., 8.1 miles distant; 495 fathoms.

Challenger Station 56, latitude 30° 08' 45" N., longitude 64° 59' 35" W.; 1,975 fathoms.

## Family ALCYONIDÆ.

## Genus ANTHOMASTUS.

Colony a fleshy rounded head supported by a short thick stem devoid of polyps; polyps large, scattered, and completely retractile; zooids present, scattered between the large polyps.

ANTHOMASTUS RITTERI Nutting, new species.

Plate LXXXIV, fig. 3; Plate XC, fig. 2.

Colony growing from a rounded, expanded, disk-shaped base; stem short and stout, devoid of polyps; head flattened, mushroom-shaped, kidney-shaped in longitudinal section. The stem is very rugose in specimens in formalin, livid whitish in color, 52 mm. long, 22 mm. in longest median diameter. The head is 72 mm. long, 57 mm. broad, and 26 mm. deep.

The large polyps are irregularly scattered over the entire head, without any well-marked bare areas, although they are rather sparsely distributed as a rule. The polyps have the body transversely and longitudinally wrinkled; 9 mm. to base of tentacles; tentacles 8 mm. long in specimens preserved in formalin. The polyps are completely retractile, but the verrucæ do not close over the retracted polyps, leaving sunken pits about 6 mm. in diameter. The younger polyps are interspersed among the older, but there seems to be no regular intergradation in size between old and young. In smaller specimens, however, this is not the case. The body cavities run down through the stem as in *Renilla*.

The zooids are distributed densely over the entire surface of the capitulum, covering it with their minute verrucæ, giving a distinctly granulated appearance to those portions not occupied by the polyps.

The spicules are of three types: 1. Needle-like forms imbedded in the surface of the capitulum. These are the most abundant. 2. Bar-like forms which are thickly crowded in the polyp walls. 3. Stars and double stars crowded on the surface of the capitulum between the siphonozooids. The zooids are surrounded by tufts of needle-like spicules.

The color of the polyps is deep crimson red, the lower part of the bodies lighter. The general surface of the capitulum is purplish pink. The stem is livid. One of the naturalists on the *Albatross* succinctly described the appearance of this species when he said that it resembled "an early rose potato stuck full of red cloves."

*Type-specimen.*—Cat. No. 25422, U.S.N.M., *Albatross* station 4415.

*Distribution.*—Station 4415, NE. point Santa Barbara Island N. 89° W. 4.7 miles, 438 fathoms; Station 4418, SW. rock, Santa Barbara Island, N. 8° E. 6.9 miles, 238 fathoms; Station 4423, E. Point San Nicholas Island S. 6° W. 2.5 miles, 216–389 fathoms;

Station 4429, Gull Island N.  $21^{\circ}$  W. 2.9 miles, 506-680 fathoms; Station 4461, Point Pinos light-house S.  $3^{\circ}$  E. 9.3 miles, 285-323 fathoms.

This striking species is named in honor of Prof. William E. Ritter, of the University of California.

### Order PENNATULACEA.

Colony free, consisting of a central stem, bearing polyps on its distal portion. Polyps either sessile, or borne on lateral leaves. A horny axis usually present. In addition to the polyps, zooids are usually found in this group.

#### Family PENNATULIDÆ.

Colony in the form of a true feather, leaves or pinnules large and evident.

#### Genus PENNATULA.

Zooids on the ventral side of the rachis only. Spicules scattered over the entire surface, not confined to the borders of the leaves.

#### PENNATULA ACULEATA Danielssen.

*Pennatula aculeata* DANIELSSEN, Forh. Vid.-Scl., Christiania, 1858, p. 25.

Numerous specimens collected by the Fisheries steamer *Albatross* seem to be of this exceedingly variable species. The following is a description of a typical colony:

Total length of colony 119 mm.; length of stem 45 mm. Stem distinctly swollen just below the rachis, the fleshy part abruptly pinching out about 7 mm. from the end, leaving bare the horny axis which expands into a terminal, transparent, greatly flattened knob or club. This is probably due to mutilation.

Leaves 23 pairs, the longest 17 mm. long by 3.5 broad, closely approximated.

There are about 10 calyces to each full grown leaf, their margins being surmounted by 8 slender acute points formed mainly by converging spicules.

Zooids densely crowded on the ventro-lateral surface, leaving a broad median band bare. Each zooid is guarded by a stockade of 5 to 10 spicules on its proximal side.

Spicules of the usual pennatulid type, the longest forming the calycular teeth and along the lower edges of the leaves, where they furnish a stiff support. They also form longitudinal bands between adjacent polyps, marking the surface of the leaf.

*Color.*—Zooids deep earmine red, pinnae yellow, streaked closely with crimson. Stem and bare portion of rachis dull brownish yellow. The general effect is a dull crimson for the colony as a whole.

*Distribution.*—Station 4378, Point Loma light-house bearing N.  $57^{\circ}$  E. 11 miles, 458–594 fathoms; Station 4417, SW. rock, Santa Barbara Island, bearing N.  $8^{\circ}$  W. 6.3 miles, 29 fathoms; Station 4425, E. point San Marcos Island bearing S.  $7^{\circ}$  E. 218 miles, 1,100 fathoms; Station 4432, Brockway's Point, Santa Rosa Island, bearing S. 8 miles, 275–270 fathoms; Station 4433, Brockway's Point, Santa Rosa Island, bearing S.  $10^{\circ}$  E. 7.5 miles, 265–243 fathoms; Station 4436, Harris Point, San Miguel Island, S.  $7^{\circ}$  E. 9.8 miles, 271–264 fathoms.

This species is abundant and widely distributed on our North Atlantic coast, according to Verrill. It is also a common species on the eastern shores of the Atlantic and in the North Sea.

Genus *PTILOSARCUS*.

Calyx with two teeth. Polyps without spicules.

*PTILOSARCUS QUADRANGULARIS* Moroff.

Plate LXXXIV, figs. 4–10; Plate LXXXV, figs. 1–11; Plate XCI, figs. 1–2.

*Ptilosarcus quadrangularis* MOROFF, Zool. Jahrb., Abth. Syst. Geog. und Biol. Thiere, XVII, 1902, p. 385.

A rather small specimen, in alcohol, measures 200 mm. in length. Stem much swollen and longitudinally wrinkled, 93 mm. long and 37 mm. in diameter at widest part, which is about 12 mm. below the rachis. Axis 150 mm. long.

Pinnæ 52 on each side, the largest being 32 mm. dorso-ventrally, and 25 mm. in greatest width from stem to margin. Polyps in transverse rows on edges of pinnæ, there being about three rows of 50 each on a medium-sized leaf. Calyces immersed to their margins, each with a distinctly bimucronate margin.

Zooids: The ventral surface of the rachis is covered with a dense mass of zooids divided by a clearly defined median band. The zooids extend around laterally to the bases of the very short peduncles on which the pinnæ are borne.

The spicules are of the regular pennatulid type, being long spindles or needles without verrucae. They occupy a band on the edges of the pinnæ about 2 to 3 mm. in width.

Color of the above-described specimen, a dull, brownish yellow. The color varies greatly, however, there being some specimens of a bright orange red, and others distinctly violet or even purple in color.

*Distribution.*—Station 4420, E. point San Nicholas Island S.  $77^{\circ}$  W. 5.7 miles, 33–32 fathoms; Station 4422, E. point San Nicholas Island S.  $6^{\circ}$  W. 2.5 miles, 31–32 fathoms; Station 4460, Monterey Bay, Point Pinos light S.  $12^{\circ}$  E. 10.8 miles, 52–67 fathoms.

Numerous specimens are also in the collection of the Hopkins Laboratory at Pacific Grove.

The abundance and excellent state of preservation of the material of this species in the collection of the Hopkins Laboratory at Pacific Grove, and the fact that this material was kindly placed at the disposition of the writer for study, and, so far as necessary, for dissection; together with the typical nature of this pennatulid and the apparent absence of any even fairly complete account of the anatomy of any member of the order published in English, have induced the writer to seize the opportunity to make a fairly exhaustive study of this species and a representation of its anatomy by the use of photography.

One of the first facts brought to light in the study of this material is the remarkable variation in size, color, and number of leaves, as is shown in the following table:

Number.	Length in inches.		Number of pairs of leaves.	Color.
	Stem.	Rachis.		
No. 1.....	10½	7½	50	Yellowish salmon.
No. 2.....	5½	5½	44	Purplish violet.
No. 3.....	7½	8½	57	Salmon.
No. 4.....	3.9	5.3	52	Violet wash over orange.
No. 5.....	11	7.5	48	Salmon yellow.
No. 6.....	22.5	7.5	52	Do.
No. 7.....	6.7	5	53	Do.
No. 8.....	5.7	6.4	58	Do.
No. 9.....	5.2	4.2	42	Do.
No. 10.....	5.4	5.3	39	Do.
No. 11.....	7	6.1	50	Violet wash over orange.
No. 12.....	5.8	6.5	42	Purplish violet.
No. 13.....	2.2	1.9	20	Dull yellow.
No. 14.....	.6	.7	17	Light corn yellow.

It is evident that the proportionate length of stem to rachis is exceedingly variable, one specimen having a stem 6 inches long and rachis 22.5 inches, while another (No. 7) has the rachis longer than the stem. This is doubtless due to the fact that the stem is composed largely of a tissue that is truly erectile,<sup>a</sup> so that the length of an individual stem will vary greatly at different times. The method of killing and the state of expansion at death will largely determine the length of the specimen.

The violet color seems, at first sight, to be due to sexual maturity; but there are in the collection of the University of California three specimens taken near Pacific Grove averaging only a little over 2 inches in length, which have but 16 pairs of leaves, and which I can not differentiate from this species. Their color is light-pinkish purple, the stem being a dull dark red, but yellow at the end. Two of these specimens are illustrated by fig. 9 on Plate LXXXIV.

There are two specimens showing irregularities or abnormalities.

No. 7 has a new leaf intercalated between two old ones, and a small leaf is growing directly from the upper flat surface of a fully-developed one.

<sup>a</sup> This fact is well known to the local Chinese fishermen, who secure this species on their trawl lines, and have a name for the species based on this character.

No. 11 has a number of more or less aborted leaves springing irregularly from the mass of zooids on the ventral side, as shown in Plate LXXXIV, fig. 8. The calyces on these aborted leaves appear to be quite normal. In one case there is a single calyx springing from the line of juncture of the leaf base and rachis on the ventral side. All of these abnormalities are on one side of the bare ventral space.

ANATOMICAL STUDY OF SPECIMEN NO. 1.

Stem flabby and much corrugated longitudinally, enlarging immediately below junction with rachis to a diameter of 1.9 inches and narrowing gradually to the proximal end. There is a distinct opening at the lower end.

Axis (dissected out from dorsal side), proximal end 6.7 inches from the proximal end of stem. Axis extends from this point to one 3.2 inches from distal end of feather. The axis is overlaid by a longitudinal membrane extending across the stem cavity and adherent below to the inner surface of a similar membranous septum on the ventral side. It is therefore situated in a separate chamber running lengthwise of the feather and adherent to the dorsal and ventral walls of this chamber, which it divides into two lateral halves. This, which I will call the "axial chamber," is quite small and inconspicuous, and might readily be overlooked in certain sections. There is a similar, but larger, longitudinal chamber between the axial chamber and the dorsal wall of the stem, and another which is ventral to the axis. There are thus four chambers in all: The right axial, left axial, dorsal, and ventral.

The dorsal chamber is much the largest, the ventral next in size, and the two axials much smaller. This is the condition in a section near the distal end of the axis. Farther down, where the leaves are best developed, the four chambers change their relative size. Here the dorsal is largest, the two axials next, and the ventral smallest, as shown in the lower section illustrated in fig. 2, Plate LXXXV.

The total length of the axis is 7.9 inches and its greatest diameter 0.14 inch. It is square in section, tapering gradually at each end.

A cross section of the stem just below the rachis, but not below the proximal end of the axis, is shown in the upper left-hand figure in fig. 2, Plate LXXXV. Here the four chambers are almost equal, the axis being approximately in the center.

A similar section taken through the stem below the axis cylinder and about 3.2 inches from the proximal end of the stem is nearly round and 1.3 inches in diameter. The wall is about 0.24 inch thick and is bounded by an outer and an inner membrane, as shown in the upper right-hand section in fig. 2, Plate LXXXV. Between these membranes is a vesiculated structure, well shown in the photograph. Here the stem cavity is divided by a longitudinal membranous par-

tion into two nearly equal chambers which are roughly half-moon shaped in section. This septum is not perforated, but the walls of the chambers which constitute the inner wall of the stem are marked by rather regularly distributed linear to ovate openings, the longest diameter of which is transverse to the long axis of the stem. These openings, on account of their function, may be called stomata. (Plate LXXXV, fig. 3.)

In other sections still nearer the proximal end of the stem it is seen that the membrane dividing the stem cavity into two chambers is really double, the two layers being divaricated at the ends of the partition, the spaces thus bounded by the split ends of the partition and the portion of the inner wall of the stem between them being the much-reduced right and left axial chambers.

A section taken across the rachis above the termination of the axis shows that the chambers are all much reduced in size, the partitions between them being thickened into fleshy masses of considerable consistence.

The canals entirely disappear near the end of the rachis, which terminates in a little rounded knob covered at its extremity with a mass of needle-like spicules.

#### THE LEAVES.

There are about nine pairs of rudimentary leaves below the first pair with developed polyps. The lowest of these is extremely minute and placed on a level with the lowest of the zooids on the dorso-lateral aspect of the rachis. They are edged with a single row of rounded papillæ, which are, in fact, rudimentary calyces.

The smallest papillæ are on the inner and the largest on the outer ends of the leaves. At the outer end there is a tendency toward a zigzag arrangement of these papillæ, indicating the incipency of the formation of two rows.

In the second pair this tendency is still more marked, there being two rather well-defined rows of papillæ extending nearly to the inner ends of the leaves, and at about the sixth pair the rows extend the entire length of the leaf border.

The third leaf has three rows of papillæ on its outer side, and these grow more and more complete in successive leaves until on the eighth leaf they extend along the entire border.

The bimucronation of the calyces appears on the outer part of the seventh leaf, while the tentacles of the polyps appear first on the outer polyps of the ninth pair of leaves. Here the polyps are rosette-shaped, when viewed from above, while on the tenth pair fully developed polyps with normal tentacles are seen.

This pair can thus be considered the first pair of functional leaves. There are about 30 polyps to the row, and the leaf is narrow and scalpelliform.

The twelfth leaf begins to show signs of the frilled border which is characteristic of the species. Beyond this, going upward, the leaves increase regularly in size and complexity of frilling, the largest being at about the middle of the rachis. (See Plate LXXXIV, figs. 7 and 8.)

A typical, full-sized leaf measures 4.2 inches around the sinuations of the polypiferous border, but is only 1.4 inches in greatest length, measured in a straight line, and has 75 polyps in the outer row, or about 275 to the entire leaf. The writer estimates that there are about 25,000 polyps to the entire colony.

Each leaf nearly meets its fellow on the dorsal side of the rachis, but not on the ventral, as shown in figs. 7 and 8, Plate LXXXIV. The leaves are very closely set and retain nearly their maximum size to near the distal end of the colony, where they diminish rapidly, forming a rosette-shaped mass at the apex of the colony, as illustrated in fig. 1, Plate LXXXV.

#### THE CALYCES.

The individual calyx is terete in form, about 3 mm. long, each coalescing with its neighbors on either side so that only the margins are exerted. The margin is ornamented with two rounded rather prominent teeth, which are opposite and situated in the upper and lower sides of the margin in the natural position of the leaf. This is well shown in fig. 5, Plate LXXXV, which is a photograph of the edge of a leaf in a vertical instead of a horizontal position, the camera being focussed on a single row of calyces, shown to the left of the figure.

Owing to the crowding of the calyces it is sometimes difficult to make out the number and position of the teeth, particularly when the polyps are expanded.

When the polyps are retracted, the teeth are more or less approximated, those from the opposite sides of the margin closing over the calycular opening. When the polyps are expanded, the teeth are widely divaricated.

A cross section of a leaf just below the calyces shows that the latter are continued downward by partitions that extend across the leaf, connecting its lower and upper surfaces. It thus comes about that these longitudinal chambers, which are continuous with the body cavities of the polyps, are uniserial, while the polyps on the border are in three and sometimes four series. This appears to be due to the crowding of the polyps which originally are in one row and are thrown into three rows by the fact that the edge of the leaf can not accommodate them in one row. A section taken across this polypiferous border at about the level of the œsophageal tubes of the polyps shows this very well as will be seen on consulting the upper section of fig. 8, Plate LXXXV. The middle and lower sections of the same figure show that the chambers which are continuations of the body cavities



are in one series, but much narrower than the body cavities shown in the upper section.

The leaf, then, below the polypiferous border, is divided into a great number of quadrangular but narrow chambers, which are parallel to each other and are separated from each other by septa which connect the upper with the lower surfaces of the leaf. The chambers extend from the body cavities of the polyps on the border of the leaf to a semicircular canal yet to be described at the base of the leaf. There is thus a chamber to each polyp, and a careful examination of the sections of the leaf which cut across these chambers will show that each of the four sides of the chamber bears the continuations of two mesenteries, each septum between chambers bearing four, or two on each side. As they approach the base of the leaf these chambers become narrower until they are almost linear, and the regularity of the arrangement of the mesenteries becomes deranged. But it is still usually possible to detect eight mesenteries to each chamber.

A section across a leaf of a sexually mature colony will reveal numerous ova or spermaries, all of which seem to be attached to the mesenteries which run down the sides of the partitions between the chambers, as is shown in fig. 9, Plate LXXXV.

The ova do not extend far below the bottoms of the œsophageal tubes, however, and a section near the basal part of a leaf will be devoid of them.

At the extreme base of each leaf these chambers open into a comparatively large canal that is inside of the leaf where it joins the rachis, and follows the curve of the line of junction of leaf and rachis for most of its length, but finally plunges into the mass of spongy tissue under the ventro-lateral aspect of the rachis and just beneath the mass of zooids. This canal terminates blindly at its other end in the basal portion of the leaf on the dorsal side of the rachis.

Fig. 6, Plate LXXXV, shows a magnified view of the side of a leaf, and the longitudinal markings made by the partitions between the chambers are plainly seen.

#### THE POLYPS.

These are of the regular aleyonarian type, with 8 fringed tentacles. They are white in color, and are expanded, in formalin specimens, about 4 mm. above the calycular walls. The polyp mouth is usually transverse to the polypiferous band of the leaf. Tentacles with about 20 papillæ on each side.

The mesenteries show plainly through the translucent walls of the polyps. Four of these bear ova and are disposed as described under the head of "Calyces."

There are no spicules, either in the tentacles or body walls of the polyps.

## THE ZOOIDS.

The two zooid bands extend the whole length of the rachis, being over 7 inches long and 0.6 broad at the widest part, narrowing gradually distally, and ending each in a somewhat curved lobe proximally. The mass is swollen and turgid to within about  $\frac{1}{2}$  inch of the proximal end, where it is suddenly contracted, the remainder being on a lower level, as seen from the ventral aspect. This proximal area on each band seems to be occupied by undeveloped zooids, as they are much smaller and less prominent than elsewhere.

The bare streak between the lateral bands of zooids is about half an inch broad at its widest part basally, and becomes almost obliterated distally. Its width and also the extent to which it is depressed between the lateral bands depends largely on the extent to which the rachis is inflated and the method of preparation of the specimen.

Both edges of the lateral bands are perfectly even, straight, and clearly defined. The bands do not reach the leaf bases laterally by about 0.16 of an inch.

The zooids are densely crowded together over the whole surface of the bands, and are greatly distorted by mutual pressure, so that their real shape is hard to ascertain, their outline being as varied as so many cobblestones in a pavement. (Fig. 10, Plate LXXXV.)

In general they present the appearance of conical or dome-shaped papillae, inclined somewhat toward the distal end of the colony and surrounded or partly surrounded by spicules. A terminal mouth is present, but closed so tightly that nothing but a slight depression can be seen. There are no true tentacles, although a scalloped appearance around the periphery of the zooid might suggest them.

Many minute zooids are crowded between the larger ones, as if there were a succession of these structures in various stages of growth; moreover, there are many deep infoldings and convolutions of the surface which bears the zooids, so that many of the latter are carried some distance below the surface, as is shown by transverse sections of the zooid bands. Such a section, taken across the rachis, shows that the zooids are simple, sac-like bodies with an elongated oval body cavity, the upper portion of the walls being beset with numerous spicules. The lower end of the body cavity is continued broadly into a canal which passes downward and opens into one of the numerous canals that are longitudinal to the rachis and form a series the openings of which, in such a section, are regularly disposed a short distance beneath the zooids. Below this zone of longitudinal canals are seen transverse sections of numerous complicated muscle bands which, like the canals, are disposed in a regular zone or layer running lengthwise of the rachis.

These muscle bands are the most striking feature of the section, and indicate the most powerful and highly specialized muscles of the

entire colony, their disposition indicating that they serve to powerfully contract and shorten the rachis. The bands are immersed in connective tissue which is more or less vesicular, containing numerous irregular lacunæ which may be a part of the water-vascular system. (Plate XCI, fig. 1.)

Intervening between the muscle bands and the lining of the rachis cavity is a mass of spongy tissue and a rather ill-defined layer of circular muscle bands.

To recapitulate. Passing from the surface of the rachis inward we encounter the following structures in regular order:

1. A superficial layer of zooids in longitudinal section, with the whole layer thrown into deep convolutions in places, and numerous spicules embedded in the upper parts of their walls.

2. A narrow zone of canals leading downward from the body cavities of the zooids.

3. A zone occupied by the cross sections of regularly arranged longitudinal canals, separated by partitions of connective tissue.

4. A very conspicuous zone of sections of powerful longitudinal muscles embedded in connective tissue and with numerous lacunæ.

5. A zone of loose, spongy tissue, doubtless part of the erectile tissue of the rachis.

6. An inconspicuous layer of circular muscles.

7. The lining of the cavity of the rachis.

A section taken parallel to the surface of the mass of zooids, but deep enough to include the upper part of the œsophageal tubes, shows very plainly the wall of the body cavity, the eight mesenteries in section, the endodermal lining of the œsophageal tubes and a transverse section of the conspicuous siphonoglyphs with a very unusual display of strong, lash-like cilia. For details of this interesting section see fig. 2, Plate XCI.

Below the œsophageal tubes the mesenteries are much reduced, and sometimes entirely wanting. Often one or two can be made out, but this arrangement does not seem to be constant.

#### THE CIRCULATORY SYSTEM.

The different parts of the water system have been mentioned in the above account, but not in such a manner as to show their anatomical relations as a whole.

It is possible for water to enter or leave the colony either through the opening at the distal end of the stem, the mouths of the polyps, or the mouths of the zooids. It seems likely that the extreme distension of the erectile tissue of the stem is effected by water entering the stem cavity by means of the opening at the end of the stem, and passing into the spongy erectile tissue of the stem walls by means of the "stomata" shown in fig. 3, Plate LXXXV. Probably this is the

main function of the water system in the stem. Water entering the mouths of the polyps would pass downward into the leaf chambers, which are continuous with the body cavities of the polyps, and thence into the semicircular canals at the bases of the leaves. These canals convey the water to the spongy tissue immediately under the zooid bands of the rachis. Water entering the mouths of the zooids would be conducted immediately to this spongy tissue of the rachis, which freely communicates with the spongy tissue of the stem. From here it could go into the stem chambers and out through the opening at the end of the stem.

It is quite likely that these currents may be reversed periodically, as is known to be the case in some other cœlenterates. The writer was told by one who had observed this species soon after it was taken and placed in a tank that the stem alternately expanded and contracted by inhaling and exhaling water through the opening at the end of the stem, and that the amount of expansion and contraction was very remarkable. That water is taken in through the mouths of the polyps seems very probable, from what is known of the manner of feeding of other polyps.

In most cases, however, where living polyps have been studied, water is both inhaled and exhaled through the polyp mouth.

There is doubtless some special and important function pertaining to the zooids in relation to the water system. The great size and number of the cilia in the siphonoglyphs, the regular series of longitudinal canals immediately beneath the zooid bands, together with the highly specialized longitudinal muscle bands in that region of the rachis, are highly significant of important service in the life of the colony.

The present writer has been unable to find a satisfactory explanation of these interesting structures, but hopes to renew his investigations with living material at no distant time.

It might be suggested that the contraction of the great longitudinal muscle bands would strongly compress the series of longitudinal water tubes by tending to shorten them, and that the water contained in the canals would find a direct outlet through the mouths of the zooids which would thus serve as excurrent orifices to the colony.

Jungerson, in his work on the structure and development of *Penntula phosphorea*, gives a view of the circulatory system which ascribes an excurrent function to the zooids, but believes that the water from the polyps passes exclusively to the dorsal canal in the stem cavity.<sup>a</sup> This latter statement will certainly not apply to *Ptilosarcus quadrangularis*.

<sup>a</sup> The present writer has not seen Jungerson's work, but finds it discussed in *Traité de Zoologie concrète*, Delage and Hérouard, II, p. 345.

## Genus HALISCEPTRUM.

Pennatulidæ in which the leaves are devoid of spicules.

## HALISCEPTRUM CYSTIFERUM, new species.

Plate LXXXVI, fig. 1.

Colony attaining a height of 120 mm. Length of stem to rudimentary leaves 65 mm. The terminal bulb takes the form of a remarkable bladderlike expansion, oval to round in shape, an average one measuring 9 mm. by 6 mm. The bladder is translucent, with fine annular markings produced by muscle bands in its walls. Above this bladderlike structure is another swelling of the stem, such as usually found in this group, about 30 mm. long.

The axis cylinder terminates at about the middle of this swelling, and protrudes considerably above the distal pinnae in all of the 13 specimens secured.

The ventral side of the stem has a distinct groove, and the bladder has an internal, longitudinal membranous septum which divides the stem cavity into two chambers, at least in its lower portion.

The pinnae are very short, and so closely set that the polyps appear at first sight to be attached to the stem direct. There are about 32 pairs, counting the rudimentary ones. The fully developed pinnae are nearly crescent-shaped, the concavity embracing the stem.

The polyps are 4 or 5 to each well-developed pinna, large in proportion to size of pinnae, apparently not completely retractile, ovate in vertical section.

The margins are somewhat inflected and ornamented with 8 lobes. Some of the calyces are much longer than others.

Zoooids do not seem to be present in this species.

Spicules are also apparently absent, or they are so small and scattered as to escape observation.

*Color.*—In alcohol, light buffy brown.

*Type-specimen.*—Cat. No. 25423, U.S.N.M., Albatross station 4541.

*Distribution.*—Station 4514, Point Pinos light-house S. 39° E. 10.7 miles, 394–524 fathoms; Station 4541, Point Pinos light-house S. 41° E. 9.3 miles, 609 fathoms.

The distinction between pinnae and sessile polyps here seems difficult. The pinnae might be regarded as groups of adherent, sessile polyps. In this case the species would have to go into another family, probably the Virgularidæ, which illustrates the distance which has yet to be traveled before we have a really natural classification of the pennatulids.

## Family STYLATULIDÆ.

Colony long and slender, with small pinnules which are supported beneath by a calcareous plate composed of fused radiating spicules.

Genus *STYLATULA* Verrill.

The plate of radiating spicules very large and conspicuous, the ends of the spicules often projecting beyond the borders of the leaves or pinnules.

*STYLATULA ELONGATA* (Gabb).

Plate LXXXVI. fig. 2.

*Virgularia elongata* GABB, Proc. California Acad. Nat. Sci., 11, 1863, p. 167.

Complete colony measuring about 30 cm. in length, terminating basally in a round or oval translucent bulb.

All but a small median ventral strip of the rachis is concealed by the modified leaves with their calyces. The whole colony is almost exactly round in cross section. The axis is central, hard and stony, about 2.5 mm. in diameter.

The modified leaves closely embrace the rachis to which they are extensively adherent by their inner edges, fitting around it like a collar, and overlapping somewhat on the dorsal side. There are 12-16 stiff calcareous raylike stays projecting directly outward from each leaf, and extending inward nearly to the axis. They lie on the lower surface of the leaves which they support, are transparent and thorn-like, and about 3 mm. in length.

There are about 10 pairs of leaves to the inch, and owing to their unusual position the polyps appear to be arranged in whorls around the rachis.

The polyps are naked, vertical in position, standing on the upper edges of the leaves. They are very closely crowded, so much so that they sometimes appear to be in two ranks. They are really in a single row, however, and there are from 20-24 in each row. The individual polyps are small, tapering considerably at distal end, greatly flattened below by mutual pressure, and about 2 mm. long.

The zooids are very numerous and papilliform, closely packed over the whole surface of the rachis between the unattached portions of the leaves and the rachis, but not visible without dissection, as they are covered by the closely crowded leaves.

The median ventral strip of the rachis is naked and distinctly grooved.

There are no spicules, unless the thorny stays of the leaves may be called highly modified spicules, which is doubtless the case.

*Color.*—In life, light grayish brown, the soft swelling above the end bulb salmon color, the polyps white. In alcohol the entire colony is a very light brown, almost white.

*Distribution.*—Station 4448, Point Pinos light-house S. 26° W. 3 miles, 46 fathoms; Station 4451, Point Pinos light-house S. 23° W. 3.2 miles, 52-54 fathoms; Station 4491, Santa Cruz light-house N. 51°

W. 5.8 miles, 20 fathoms; Station 4520, Point Pinos light-house S. 28° W. 11.2 miles, 44 fathoms; Station 4562, Santa Cruz light-house N. 72° W. 8.1 miles, 10 fathoms. All of these stations are in Monterey Bay.

Numerous specimens were found by collectors from the San Diego Marine Biological Association laboratory in Whalers Bight, San Diego Bay. They were growing deeply immersed in the mud. Verrill's specimens were from Panama and Cape St. Lucas.

Other specimens are from Sausalito, California.

Verrill regards this species of Gabb's as identical with his own *Stylatula elongata*; the priority, however, belongs to the species named by Gabb.

For the somewhat confusing synonymy of this species, see Verrill.<sup>a</sup>

#### Genus ACANTHOPTILUM Kölliker.

Colony very slender, with small, closely crowded leaves. Stem with an end bulb, and usually another swelling above this. A comparatively small plate of spicules under the base of each leaf. Spicules in calycular walls, with points projecting above the margin of calyces. Stem without radial canals.

#### ?ACANTHOPTILUM GRACILE (Gabb).

Plate LXXXVI, figs. 3 and 4.

*Virgularia gracilis* GABB, Proc. California Acad. Nat. Sci., II, 1863, p. 167.

Colony excessively slender, total length 67 cm. Stem to beginning of rudimentary pinnae 10 cm. Bulb not much swollen, passing almost insensibly into the swelling above, which is about 10 cm. long. A ventral median groove is often found passing along the whole rachis but this feature is not constant.

Pinnae excessively numerous and closely approximated, short the full-grown ones being 8 mm. long by 2½ mm. broad.

Calyces short, 8 or 9 to each fully-developed pinna, each surrounded by a border of 8 rather blunt points, oval in section, greater diameter transverse to the pinna owing to the crowding of the polyps.

The polyps are retractile, although most of them are partially expanded in alcoholic specimens.

Zooids in groups of 6 to 12 on lateral sides of rachis between adjacent pinnae. They are more prominent than usual, showing plainly the central depression surrounded by an elevated ring.

Spicules of the ordinary pennatulid type. They are mostly needle-like, practically colorless in alcoholic specimens, having but a slight yellowish tinge. There is a patch of comparatively large spicules supporting the base of each pinna on the under side. The spicules are very sparsely distributed or absent on the stem and rachis. There are 8 longitudinal bands of spicules in calycular walls.

<sup>a</sup>Trans. Connecticut Acad. Arts and Sci., I, Pt. 2, pp. 382-384.

*Color*.—In alcohol, a light tan brown. The swelling above the end bulb is dull purplish brown.

*Distribution*.—All in Bay of Monterey. Station 4464, Point Pinos light-house S.  $29^{\circ}$  W. 7.6 miles, 31–32 fathoms; Station 4492, Santa Cruz light-house N.  $54^{\circ}$  W. 7 miles, 26 fathoms; Station 4550, Point Pinos light-house S.  $6^{\circ}$  E. 4.6 miles, 50–57 fathoms; Station 4556, Point Pinos light-house S.  $7^{\circ}$  E. 3.7 miles, 56–59 fathoms; Station 4557, Point Pinos light-house S.  $25^{\circ}$  W. 3.1 miles, 53–54 fathoms; Station 4558, Point Pinos light-house S.  $79^{\circ}$  W. 2 miles, 28–40 fathoms.

The original specimens were from the Bay of Monterey, 20 fathoms.

In his discussion of this species, which he ascribes to the genus *Stylatula*, Verrill expresses a doubt as to its belonging to this genus at all.<sup>a</sup> The specimens collected by the Fisheries steamer *Albatross* agree quite well with the original description of *Virgularia gracilis* Gabb, and this, together with the fact that the locality is the same and the species evidently abundant at moderate depths in the Bay of Monterey, makes it quite likely that the species is correctly identified as *Virgularia gracilis* Gabb, which now goes into the genus *Acanthoptilum*.

? *ACANTHOPTILUM POURTALESII* Kölliker.

*Acanthoptilum pourtalesii* KÖLLIKER, Anat. Syst. Bes. Alcyonarien, Pt. 1, Die Pennatuliden, 1872, p. 231.

A specimen, without label, agrees closely with Kölliker's description, except that the spicules of the stem are not "biscuit-shaped" but of the usual rod-like type.

A very young specimen, apparently of this species, from the collection of the University of California from San Diego Bay, shallow water, has the leaves much more widely separated than the other.

The original specimens described by Kölliker were secured off the Florida reefs at depths of from 12 to 44 fathoms.

*ACANTHOPTILUM ALBUM*, new species.

Plate LXXXVI, figs. 5–8.

Colony very slender, attaining a height of about 225 mm. Stem to rudimentary leaves about 87 mm. Terminal bulb not well marked, and about an inch above it is a slight swelling.

Pinnae, including the rudimentary ones, about 75 pairs, 4 mm. long, regularly curving, without any twist.

Polyps apparently nonretractile, the lobular fringed tentacles being quite well expanded in alcoholic specimens, 4 or 5 to each pinna. The calyces are much reduced in size and quite soft, with an 8-lobed

<sup>a</sup>Trans. Connecticut Acad. Arts and Sci., 1, Pt. 2, p. 383.



margin that is not usually well defined. The distal calyx on each leaf is produced into a point extending beyond the expanded polyp.

Zooids apparently wanting on both dorsal and ventral surfaces of the rachis, and reduced to short rows of three each between adjacent pinnae. They are quite inconspicuous, and might readily be overlooked, being indicated in superficial view by nothing save the small groups of colorless spicules by which they are surrounded.

The spicules are colorless, of the ordinary pennatulid type, very sparsely distributed in calycular walls. There is a group of larger, spindle-shaped spicules beneath the origin of each pinna. Smaller, rod-like forms are distributed over the surface of the rachis and stem.

*Color.*—White, in preserved specimens, with the exception of a purple spot about 10 mm. long on the swelling above the terminal bulb.

*Type-specimen.*—Cat. No. 25424, U.S.N.M., Albatross Station 4473 (See below).

*Distribution.*—Station 4439, Point Pinos light-house S. 38° E. 6 miles, 42–40 fathoms; Station 4445, Point Pinos light-house S. 13° E. 6 miles, 66–60 fathoms; Station 4446, Point Pinos light-house S. 2° W. 5 miles, 59–52 fathoms; Station 4453, Point Pinos light-house S. 17° W. 2.3 miles, 49–51 fathoms; Station 4454, Point Pinos light-house S. 13° E. 8.3 miles, 71–65 fathoms; Station 4457, Point Pinos light-house S. 21° W. 6.1 miles, 46–40 fathoms; Station 4460, Point Pinos light-house S. 12° E. 10.8 miles, 55–67 fathoms; Station 4473, Point Pinos light-house S. 15° E. 2.8 miles, 59–65 fathoms; Station 4482, Santa Cruz light-house N. 39° W. 8.7 miles, 43–44 fathoms.

#### ACANTHOPTILUM SCALPELLIFORME Moroff.

Plate LXXXVI, figs. 9 and 10.

*Acanthoptilum scalpelliformis* MOROFF, Zool. Jahrb., Abth. Syst. Geog. und Biol. Thiere, XVII, 1902, p. 394.

An exceedingly attenuate form with true pinnae. Length 97.5 cm., length of stem to first rudimentary pinnae 262 mm. Pinnae very numerous, short, well separated, 3.5 mm. long by 1.5 mm. broad at the base.

Polyps 7 or 8 to each fully developed pinna, uniserial, the last or distal one on each pinna being widely separated from the next.

In the stem the bulb passes insensibly into the swelling, the two together being 135 mm. long.

The zooids are in lateral rows joining the bases of the pinnae, about 8 in a row. Sometimes the rows are partially double. The zooids are indicated by round white dots more or less completely surrounded by spicules.

The spicules are purplish pink in color, of two types: 1. Needle-shaped forms situated on the upper parts of the calycular walls on the side toward which the pinnae are directed. 2. Long, bar-shaped spicules on the lower calycular walls, sides of pinnae and on the rachis. They are often aggregated in lines on the pinnae, making radiating streaks. They also form patches on the under surfaces of the pinna bases.

*Color.*—In fresh specimens the pinnae are purplish; stem, upper part of bulb whitish; swelling pinkish shading to deep purple in the middle part. Ventral part of rachis nearly white.

*Locality.*—University of California Station 956, 30–140 fathoms, off La Jolla, California.

*ACANTHOPTILUM ANNULATUM*, new species.

Plate LXXXVI, figs. 11–13.

Colony very slender. Length about 156 mm.; stem 68 mm. There are about 170 pairs of pinnae, counting the rudimentary ones. Full grown pinnae 5 mm. long by 1.5 mm.

Polyps usually with 6 calyces to each well-developed pinna. Each calycular margin is armed with 8 moderately acute points, composed of coenenchyma reinforced by a few spicules. The longest (distal) polyps are about 2 mm. long to margin of calyx.

The zooids are in groups of 3 to 8, laterally placed, between adjacent pinnae. They are sometimes in a single row and sometimes in a double row.

The spicules are carmine pink in color, short rods with rounded ends, quite small. They are arranged in 8 longitudinal lines in the calycular walls, the lines ending in the points around the margin. These lines also extend downward between the extensions of the body cavities of the polyps, or on the lines which indicate the partitions between the latter, so as to constitute superficial markings on the surfaces of the leaves, these markings radiating from the base to the border of each leaf. The under part of each leaf is marked at its base by a distinct patch of densely aggregated spicules, bright carmine in color. These series of brightly colored spots, one on each side of the rachis, give an annulated appearance to the colony in side view and suggested the specific name "*annulatum*."

The spicules are generally distributed over the stem and rachis, but are less conspicuous on the former on account of the thickness of the ectodermal covering.

*Color.*—The general color of the colony is pink, owing to the combination of carmine spicules and white coenosarc. The middle part of the stem is purplish, the basal part being light pink, and the bulb whitish.

*Type-specimen.*—Cat. No. 25425, U.S.N.M.

*Distribution.*—Station 4420, E. point San Nicholas Island S.  $77^{\circ}$  W. 5.7 miles, 33–32 fathoms (type-locality); Station 4421, E. point San Nicholas Island N.  $26^{\circ}$  W. 3.8 miles, 291–229 fathoms; Station 4422, E. point San Nicholas Island S.  $6^{\circ}$  W. 2.5 miles, 31–32 fathoms.

#### Family VIRGULARIDÆ.

Colony long and slender; leaves short, sometimes reduced to a mere band of polyps, and without a plate of modified or aggregated spicules supporting their bases.

#### Genus BALTICINA.

Stem short and thick, rachis proportionately very long, pinnae reduced to band-like rows of calyces. There are spicules in the tentacles of the polyps.

#### BALTICINA PACIFICA, new species.

Plate LXXXVII, figs. 1 and 2.

A typical specimen measures 97.5 cm. in total length; the stem to the first rudimentary polyps 93 mm.; bulb 25 mm. long; swelling above bulb 75 mm. long.

The axis cylinder is very strong and hard, reaching to the end bulb. There are 114 rows of polyps, with 2 to 5 in each row, the polyps being closely appressed to each other. The rows are 5 to 8 mm. apart, measured on the dorso-lateral side.

The calyces decrease in size regularly from the first (ventral) to the last in each row. Each calyx has two broad conspicuous thorny spines on its lower margin, the outer spine being the larger. The first and largest calyx is 4 mm. high to tip of spine, and 2.5 mm. wide near the base.

The polyps appear to be nonretractile, and are of the usual alcyonarian type. The tentacles are long, and their outer surface is covered with spicules. There are also a few spicules on the body walls.

The zooids are in groups of 15 to 20 between the rows of polyps. These groups show a tendency in places to an arrangement in two or three rows. The zooids are unprotected by spicules, and appear as simple rounded granules. There are a few scattered zooids on the dorsal surface, usually continuous with the rows spoken of above.

The spicules are bar-shaped, and apparently confined to the calyces and polyps. They are most conspicuous in the calyces, where they converge to form the marginal spines. There are a few transverse rows on the polyp walls. They are diagonally arranged on tentacular bases and longitudinally disposed on the rest of the outer surfaces of the tentacles. The spicules are much more abundant on the sides of the polyps that are nearest the calycular spines.

The color of the polyps and calyces is chocolate brown, the swelling yellowish brown, and the end bulb dark reddish brown.

*Type-specimen*.—Cat. No. 25426, U.S.N.M.

*Distribution*.—Station 4326, Soledad Hill, Point La Jolla, S. 59° E. 5.6 miles, 280–243 fathoms; Station 4333, Point Loma light-house N. 27° E. 12.2 miles, 301 fathoms; Station 4433, Brockway Point, Santa Rosa Island, S. 10° E. 7.5 miles, 265–243 fathoms; Station 4513, Point Pinos light-house S. 31° E. 9.3 miles, 456–389 fathoms; Station 4516, Point Pinos light-house S. 49° E. 12.5 miles, 756 fathoms; Station 4537, Point Pinos light-house S. 71° E. 7.4 miles, 1,062 fathoms; Station 4538, Point Pinos light-house S. 85° E. 6.5 miles, 871–795 fathoms; Station 4547, Point Pinos light-house S. 82° E. 10.5 miles, 1,083 fathoms (type-locality).

Having examined a large number of specimens of this species from the Californian coast, and having found them constant in having not more than 5 polyps to each leaf (instead of from 8 to 15 as described by Kölliker),<sup>a</sup> I have concluded that the species is clearly distinct and given it the name *Balticina pacifica*.

*Paronaria californica* Moroff<sup>b</sup> is described as having polyps without spicules, while *P. doflini* Moroff has 11–14 polyps to the leaf, with no spicules in the tentacles.

BALTICINA FINMARCHICA (Sars).

*Vergularia finmarchica* Sars, Fauna Lit. Norvegie, II, 1856, p. 68.

In the collection at Stanford University there are a series of six specimens which were originally taken near Pacific Grove, California, by Chinese fishermen, who secured them on their trawls in deep water. These specimens apparently belong to this species. They are much macerated and their characters are difficult to make out with certainty. They differ from the preceding species, *Balticina pacifica*, in having 12–15 calyces to a row and in less prominent calyceular teeth.

The upper part of the rachis has anemones attached, each with a ring-like stolon clasping the rachis, exactly as described by Verrill.<sup>c</sup>

Two other specimens in the same collection which are labeled "*Verrillia blakei*, Barraeuda Inlet, British Columbia," do not seem to be fairly separable from this species. They are very large, one of them being 50 inches long; the stem to rudimentary leaves 12 inches long; terminal bulb 5 inches long. The calyces are in rows of 7 to 10. They are long, terete; margins with two low and incon-

<sup>a</sup> Anatomisch-Systematische Beschreibung der Alcyonarien. Pl. I. Die Pennatuliden, 1872, p. 239.

<sup>b</sup> Zool. Jahrb., Abth. Syst. Geog. und Biol. Thiere, XVII, 1902, p. 393.

<sup>c</sup> Bull. Mus. Comp. Zool., XI, No. 1, p. 5.

spicuous teeth. The zooids are in rows, usually of 3, on each side of the bare middle space on the dorsal side of the rachis. On the ventral side there are two lateral rows of zooids which are somewhat broken and irregular, there being a tendency toward the formation of double rows extending down the whole length of the rachis and stem to the end bulb.

These specimens are preserved in glycerin, and the spicules seem to have largely been dissolved.

The name *Verrillia* was proposed by Stearns as a subgeneric designation based on the species named originally *Pavonaria blakei* by the same author.<sup>a</sup> Later Verrill republished Stearns's original description, a very complete one, by the way, and adds, in a footnote: "A recent examination of a specimen convinces me that this species is most nearly allied to the *Halipterus christi*, and probably ought to be referred to this genus."<sup>b</sup>

The present writer having compared the careful description of Stearns with his own description of the specimens at Stanford University finds that the two agree quite closely. These specimens, however, can not be placed in Kölliker's genus *Halipterus* because the polyps are placed on rudimentary band-like pinnae, instead of being seated directly on the rachis as in the original description of the genus. They can be placed, however, in Kölliker's genus *Pavonaria*, which Verrill has shown to be a synonym of the genus *Balticina* Gray.<sup>c</sup> If the species under consideration is a valid one it should be called *Balticina blakei* (Stearns).

As indicated above, however, I am of the opinion that the Stanford specimens belong to the well-known species *Balticina finmarchica* (Sars).

#### Family FUNICULINIDÆ.

Polyps sessile, free, arranged in rows on sides of rachis and provided with calyces.

#### Genus FUNICULINA.

Calyces with 8 teeth and spicules in 8 vertical bands. Zooids dorsal.

#### FUNICULINA ARMATA Verrill.

*Funiculina armata* VERRILL, Amer. Journ. Sci. and Arts, XVII, 1879, p. 240.

Largest colony about 45 cm. long. The axis is distinctly quadrangular in section, and the end bulb is scarcely distinguished from the rest of the stem, the termination being curved and pointed.

<sup>a</sup> Proc. Cal. Acad. Sci., V, 1873, p. 147.

<sup>b</sup> Amer. Journ. Sci. and Arts, VII, 1874, p. 68.

<sup>c</sup> Bull. Mus. Comp. Zool., XI, no. 1, p. 4.

The calyces are as described by Verrill, irregularly distributed on the rachis, the rows or ranks being scarcely differentiated. The calyces are usually more expanded at the top than is indicated by Verrill's figure, but some of them have the same outline. The amount of expansion seems to depend on the stage of retraction of the polyp.

The zooids are relatively the most prominent that I have seen. They extend down on the dorsal side of the stem some distance below the rachis and within about 75 mm. of the end.

The spicules are long slender needles, forming 8 longitudinal ribs on the calycular walls and projecting decidedly from the marginal teeth. They are also thickly distributed lengthwise on the rachis, although they are sparse or wanting on the stem, where the spicules, when present, are more rod-like.

*Color.*—The polyps are dark brown, the stem and rachis being lighter.

*Distribution.*—Station 4400,  $30^{\circ} 50' 20''$  N.,  $118^{\circ} 03' 30''$  W., 500 fathoms; Station 4407, SE. point Santa Catalina Island N.  $19^{\circ} 30'$  E., 3.2 miles, 334–478 fathoms; Station 4415, NE. point Santa Catalina Island N.  $89^{\circ}$  W. 8.6 miles, 638 fathoms.

Also U. S. Fish Commission Stations 880 and 881, 262–325 fathoms; off Sable Island, Nova Scotia, 300–400 fathoms; *Blake* stations, off Santa Cruz, 135–500 fathoms; off Guadeloupe, 163 and 769 fathoms.

#### Genus HALIPTERIS.

Calyces with 2 to 4 teeth; zooids lateral.

##### HALIPTERIS CONTORTA, new species.

Plate LXXXVI, figs. 3 and 4.

Colony much distorted, about 75 mm. long; stem 12.5 mm., round. Bulb not distinct.

Polyps arranged in rows of 5 or 6, passing obliquely from ventral to dorsal surface on both sides, forming crescentic rows. The calyces decrease in size from lateral to dorsal, the mid-dorsal being the smallest and measuring but 1.5 mm. in height. The rows are closely crowded together, leaving no lateral or dorsal surface of rachis free, except where the calyces are disturbed.

Calyces with margins armed with 4 rather blunt teeth, 2 of which are much larger and more pointed than the others. The smaller teeth are often so inconspicuous that they might well be overlooked and the calyces be described as having but 2 teeth. On the lower part of the rachis there is a short row of rudimentary polyps or calyces on the dorsal side of the stem.

The polyps are entirely retractile, and their tentacles are without spicules.

Zooids are seen in a few lateral groups of 4 to 6 between the calyces. There are also a few scattered zooids on the dorsal surface.

The spicules are needle-like, small, colorless, and arranged longitudinally in calycular walls. Elsewhere they are variously distributed, sparsely scattered on the stem, and apparently absent from the dorsal band of the rachis.

*Type-specimen*.—Cat. No. 25427, U.S.N.M.

*Distribution*.—Station 4409, SE. Point Santa Catalina Island SW. 2.1 miles, 88-52 fathoms.

### Family STACHYPTILIDÆ.

Calyces present, free, zooids ventral.

### Genus STACHYPTILUM.

Polyps in rows of four on each side of the median dorsal line; calyces with broad vertical bands of spicules; zooids dorsal, ventral, and lateral.

#### STACHYPTILUM SUPERBUM Studer.

Plate XXXVII, figs. 5 and 6.

*Stachyptilum superbum* STUDER, Bull. Mus. Comp. Zool., XXV, No. 5, 1894, p. 56.

Length of colony 175 mm.; stem 31 mm. Terminal bulb soft, slender, wrinkled. There is a slight swelling above the bulb. The ventral surface of the rachis has a deep, even, undulating groove.

Polyps almost surrounding the rachis. Calyces in 4 rows forming oblique series. They are terete in form, rather slender, 3.5 to 5 mm. long by 1.25 mm. broad.

The outer side of calycular wall is much the longer, the inner being almost obliterated, owing to its adherence to the rachis. Margin armed with a varying number of jagged slender teeth, including spicules. Sometimes there are but two very conspicuous teeth, at others four, or even eight; but four is the most common number, two larger and two smaller.

The zooids appear as well-defined brownish dots, a row on either side of the ventral groove being particularly conspicuous on distal parts of the colony. In many places this row is reenforced by a patch of several rows of lateral zooids. The zooids are also rather numerous between the calyces on the dorsal side of the rachis.

The spicules are large and needle-like, placed longitudinally on the walls of the calyces, although they are often more or less oblique. The ventral furrow is devoid of spicules, in marked contrast to the rest of the rachis. Spicules are also apparently lacking in the stem.

*Color*.—In alcohol, dull brown, the stem and lower part of the rachis being light yellowish brown.

*Distribution.*—Station 4427, Point San Pedro, Santa Cruz Island, N.  $35^{\circ}$  E. 7 miles, 447 fathoms; Station 4432, Brockway Point, Santa Rosa Island, S. 8 miles, 372 fathoms; Station 4442, Point Pinos light-house S.  $67^{\circ}$  W. 4.6 miles, 26-31 fathoms; Station 4435, Harris Point, San Miguel Island, S.  $13^{\circ}$  W. 7.7 miles, 287-274 fathoms; Station 4514, Point Pinos light-house S.  $39^{\circ}$  E. 10.7 miles, 524 fathoms.

*Type-locality.*—Station 3389, latitude  $7^{\circ} 16' 45''$  N., longitude  $79^{\circ} 56' 30''$  W., 210 fathoms.

*STACHYPTILUM QUADRIDENTATUM*, new species.

Plate LXXXVII, figs. 7 and 8.

Total length of colony, 200 mm.; stem, 68 mm. Bulb and swelling almost continuous, and not much expanded. The swelling is quadrangular in section.

The polyps are irregularly placed on the dorsal surface of the rachis, with a tendency to an arrangement in transverse rows of three or four. The larger ones are usually laterally placed, and include the smaller ones between their bases, the smaller ones usually being inserted at a higher level than the larger. On the lower portion of the rachis there is a tendency to an arrangement in subopposite pairs; higher up the smaller one or two polyps appear between the larger, while nearer the distal end there are frequently three larger ones in the oblique series. Here, however, the polyps are so crowded that it is difficult to discern any regularity.

The calyces are rather long, narrowing above, with the margin bearing four very strong sharp teeth or spines, two larger and two shorter, on its outer side.

Length of calyces to end of longest spines, 3 mm.

The polyps are retractile, and when fully retracted the spines converge, forming a pointed calyx.

There are a few lateral zooids scattered along the sides of the rachis between the polyps, and others between polyps on the dorsal surface. The zooids vary considerably in size, the dorsal ones often being the larger.

The spicules are needle-like, arranged longitudinally in calycular walls, stem, and rachis.

*Color.*—Almost white, in alcoholic specimens.

*Type-specimen.*—Cat. No. 25428, U.S.N.M.

*Distribution.*—Station 4360, Point Loma light-house N.  $86^{\circ} 30'$  E. 9.4 miles, 108-92 fathoms (type-locality); Station 4371, Point Loma light-house N.  $84^{\circ}$  E. 9.5 miles, 145-89 fathoms.

In the collection of the University of California are several specimens apparently of this species labeled "Juneau, Alaska, dredged 20 fathoms."



## Family ANTHOPTILIDÆ.

Polyps free, sessile and without calyces.

## Genus ANTHOPTILUM.

Polyps in numerous short rows, large. No streak of undeveloped polyps at lower end of rachis. Zooids dorsal, ventral and lateral. Spicules absent, except at end of stalk.

## ANTHOPTILUM GRANDIFLORUM (Verrill).

*Anthoptilum grandiflorum* VERRILL. Amer. Journ. Sci. and Arts, XXIII, 1882, p. 312.

Length of longest specimen 80 cm. The sickle-shaped stem is bare of polyps, longitudinally corrugated, and with the end bulb and swelling about equal.

The polyps are in oblique rows, about 8 to a row, naked, transversely corrugated and about 10 mm. long.

The zooids are very numerous, covering all of the rachis but a narrow ventral groove.

*Color*.—In alcohol the color of the polyps is chocolate brown, while the short stem and bare part of the rachis is very light brown, almost white.

*Distribution*.—*Albatross* station 4400, 32° 51' 20" N., 118° 03' 30" W., 500 fathoms; *Challenger* station 320, off Buenos Ayres, 600 fathoms; *Blake*, off the coast of North Carolina, 603–647 fathoms; off Guadeloupe, 730 fathoms.

This magnificent pennatulid was first described by Verrill, under the name *Virgularia grandiflora*.<sup>a</sup> Afterwards it was described by Kölliker in his report on the Pennatulids of the *Challenger* expedition, under the name of *Anthoptilum thompsoni*.

Later Verrill put it in the genus *Anthoptilum* of Kölliker, when it became *Anthoptilum grandiflorum* (Verrill).

## Family UMBELLULIDÆ.

Polyps very large, naked, borne in a cluster at the end of a long slender stem.

## Genus UMBELLULA.

Being the only genus, its characters are the same as those of the family.

## UMBELLULA MAGNIFLORA Kölliker.

*Umbellula magniflora* KÖLLIKER, Report Pennatulida, Challenger Exp., 1880, p. 24.

A number of specimens apparently belonging to this widely distributed and variable species were dredged by the Fisheries steamer

<sup>a</sup> Amer. Journ. Sci. and Arts, March, 1879, p. 230.

*Albatross* off the coast of California. The variation in size of colonies and length and number of polyps is very great. The longest colony is nearly 2 feet in length, while one of the shorter ones is only 11 inches. This latter is in very good state of preservation and seems quite typical, except, perhaps, in length.

The bulb is 13 mm. long; while the swelling above it is 25 mm. long. The stem is quadrangular in section.

The polyps are 11 in number. The body to base of tentacles is 23 mm. long, cylindrical and tapering very gradually above. Greatest diameter 4 mm., least diameter 2.5 mm. Tentacles, in alcohol, 18 mm. long. The body walls are transversely rugose and longitudinally marked by the mesenteries.

The swelling of the rachis below the polyps tapers gradually until it merges with the stem 23 mm. below the polyps.

The zooids cover the entire surface of the rachis below the polyps, except on small V-shaped bare spaces below the polyp bases. There is also a definite patch of zooids in the center of the disk, encircled by the polyps. The zooids are provided with single, finger-like tentacles.

The spicules are apparently wanting.

*Color*.—The polyps are umber brown, the tentacles being more reddish. The stem is light brown, often darkening at the bulb and swelling.

*Distribution*.—Station 4399, 32° 44' 50" N., 117° 48' 45" W., 245 fathoms; Station 4407, SE. Point Santa Catalina Island N. 19° 30' E. 3.2 miles, 334 fathoms; Station 4415, NE. Point Santa Barbara Island N. 89° W. 4.7 miles, 438 fathoms; Station 4423, E. Point San Nicholas Island S. 7.6 miles, 339–216 fathoms.

Studer considers that this species is identical with *Umbellula euerinus* (Linnaeus), and if he is correct in following Grieg<sup>a</sup> in this matter<sup>b</sup> the distribution of the species should be extended to the North Atlantic, and should include Station 3410, latitude 0° 10' N., longitude 90° 34' W., 331 fathoms.

The type was secured by the *Challenger* from south of Tokyo, Japan, from a depth of 565 fathoms.

UMBELLULA HUXLEYI KÖLLIKER.

*Umbellula huxleyi* KÖLLIKER, Report Pennatulida, Challenger Exp., 1880, p. 21.

A specimen from Station 4400 agrees very well with Kölliker's description, except that the polyps are not distinctly corrugated, and that the tentacles of the zooids are well developed.

*Distribution*.—Station 4400, 32° 50' 20" N., 118° 03' 30" W., 500 fathoms.

<sup>a</sup> Oversigt over Norges pennatulider, Bergens Museum Aarsberetning, 1891, No. 1, p. 18.

<sup>b</sup> Bull. Mus. Comp. Zool., XXV, No. 5, 1894, p. 57.

The type was secured by the *Challenger*, Station 147, South Sea, east of Kerguelen Island, 1,000 fathoms.

UMBELLULA LOMA, new species.

Plate LXXXVII, fig. 9.

Total length of colony 20 cm. Terminal bulb and swelling confluent. Stem quadrangular in section, in places greatly flattened; greatest diameter, 2.5 mm. to 4 mm.; least diameter below rachis, 1 mm. The axis ends in the base of the central polyp. The stem passes insensibly into the rachis, and the latter gradually broadens from proximal to distal ends, where it is somewhat flattened.

Polyps, in full-grown specimens, 10 in number, the arrangement being such that 9 surround a central one. Polyp body 10 mm. long, tentacles 13 mm. The basal part of polyps is swollen, and its walls are both longitudinally and transversely corrugated.

The zooids cover the exposed portion of the rachis and are scattered over the stem as far as the proximal portion of the swelling, but with a tendency toward leaving a few bare longitudinal lined. The V-shaped bare spaces between the polyp bases, so characteristic of *Umbellula magniflora*, are not found in this species. The zooids are usually without tentacles, but a few at the bases of the polyps have a single tentacle, while a few others have two. A small patch of 5 zooids on the dorsal surface between the polyps are entirely without tentacles, as are those on the stem. The zooids also invade the ventral walls of the polyps.

There are a few very minute, irregular spicules on the end bulb, but they appear to be lacking elsewhere.

*Color*.—Fresh specimens; polyps deep umber brown, tentacles somewhat lighter; stem much lighter brown, but with dark spots on end bulb and swelling.

A cross section of the lower part of the rachis shows the central quadrangular axis and the four longitudinal canals, one being as large as all of the others put together. The canals are divided by longitudinal partitions, and the whole system is surrounded by a membranous envelope. Outside of this are a number of radiating partitions, passing to the outer covering of the stem, and also the tubelike bodies of the zooids, which are continuous with the external portion of the zooids. The mesenteries and mesenterial filaments can be plainly seen.

*Locality*.—Near San Clemente Island. Taken at a depth of 330 fathoms, by the *Loma*, a little vessel owned by the Marine Biological Association, of San Diego. The name is given in honor of this exceedingly efficient little craft, which has since been wrecked on the point which bears the same name.

This species is nearest *U. magniflora*, from which it differs greatly in size and in the character and disposition of the zooids.

*Type-specimen*.—In Museum of University of California.

#### Family PROTOPTILIDÆ.

Polyps with calyces, arranged on both sides of the rachis in a single series or in indistinct rows.

#### Genus DISTICHOPTILUM.

Slender forms with the axis extended throughout. Polyps uniserial, those on opposite sides alternating. Calyces bilobed, appressed. Zooids normally three to each polyp. Spicules numerous.

#### DISTICHOPTILUM VERRILLII Studer.

Plate LXXXVII, fig. 10.

*Distichoptilum verrillii* Studer, Bull. Mus. Comp. Zool., XXV, No. 5, 1891, p. 59.

Colony very slender, having a total length of 225 mm. The axis extends throughout the stem and rachis, ending below in a thin, curved, transparent bulb that resembles a maple seed in outline. Distal end of axis bare. Length of stem 50 mm. There is an enlargement about halfway up the stem.

The polyps are in opposite series, but are implanted toward the dorsal rather than the ventral side. Calyces adherent on their inner side, the outer side being straight and about 25 mm. long and passing insensibly into the rachis. The margin is without regular teeth, although the points of the spicules sometimes project, giving a jagged appearance. In places the polyps are nearly subopposite, and are well toward the dorsal aspect of the rachis. The pairs of calyces are adnate to each other by their inner surfaces, and the alternate pairs are rotated to the right and left so that the right-hand polyp of a lower pair is under the line separating the calyces of the pair immediately above.

The zooids are arranged in sets of three along the outer sides of the calyces, and one or two just above each calyx. They appear as mere openings, surrounded by a fence of spicules, and are entirely immersed.

The spicules are slender needles, covering the entire surface, excepting the central dorsal line of the rachis and small areas on the inner sides of calycular margins.

*Color*.—In alcohol very light pink, owing to the spicules. Rachis white, or nearly so. The bulb and swelling are pale yellow.

*Distribution*.—Station 4387, 32° 29' 30" N., 118° 05' W., 1,000 fathoms.

The types were taken from Station 3431, latitude 23° 59' N., longitude 108° 40' W., 995 fathoms, and Station 3398, latitude 1° 07' N., longitude 80° 02' W., 1,573 fathoms.

## Family RENILLIDÆ.

Rachis expanded into a flattened, heart-shaped form borne on a short smooth peduncle without axis, and with but two canals. Zooids numerous.

## Genus RENILLA.

The genus, being the only one, has the character of the family.

## RENILLA AMETHYSTINA Verrill.

Plate LXXXVII, fig. 11.

*Renilla amethystina* VERRILL, Bull. Mus. Comp. Zool., 1864, p. 29.

Numerous specimens of this beautiful species were found in shallow water in the bay of San Diego, and were kept alive in the laboratory at La Jolla.

The frond of the living colony has the power of considerable muscular contraction, giving an undulatory motion to the edges. Some of the fully expanded polyps were at least half an inch long. After they are once expanded they are quite sluggish, and will withstand handling without retracting.

Specimens left over night in small dishes of sea water were alive, and expanded readily upon the application of fresh sea water in the morning.

*Distribution*.—Bay of San Diego, shallow water; Panama, Pearl Islands, and the coast of Peru (Verrill).

## Order GORGONACEA.

Colonies fixed, with a more or less distinct axis cylinder around which the cortex is disposed. In branched forms the axis extends throughout the ramifications.

## Suborder HOLAŌXIA.

Axis cylinder well developed, and never consisting of fused spicules. It is composed of a horny substance more or less calcified, or of alternating horny and homogeneous calcareous matter.

## Family PRIMNOIDÆ.

Polyps with well-developed calyces, retractile tentacles, and an 8-parted operculum composed of modified spicules attached to the calyx. Root calcareous.

## Genus CALIGORGIA.

Calyces club-shaped, calyx scales ctenate with radiating ribs. Calyces regularly in whorls of more than three.

**CALIGORGIA SERTOSA** Wright and Studer.

*Caligorgia sertosa* WRIGHT and STUDER, Challenger Report, Alcyonaria, 1889, p. 77.

An incomplete colony is 260 mm. high, flabellate in form, consisting of a central geniculate stem giving off regularly alternate branches at the angles or geniculations. Some of the branches give off branchlets in the same manner.

The axis shows a distinct golden iridescence. The coenenchyma is thin.

The calyces are arranged in whorls of three to six, by far the most common number being four. In places there are simply two opposite or subopposite calyces.

They are about 2 mm. in length, and the space between whorls is about 1 mm. In form the calyces are curved spindles, curving from the base outward, upward, and inward so that their apertures are directed toward the stem or branch. The margins are composed of ctenate scales, inside of which are the bases of the 8 opercular scales which form a pyramidal operculum. The individual opercular scales are long triangles, somewhat twisted and bent, and overlapping at the tips when the polyp is fully retracted. The upper whorl of calycular scales are ctenate, with radiating striae, the others show these markings feebly if at all. There are six to nine whorls of scales in the calyces, the most common numbers being seven or eight.

The spicules are scale-like, flattened, sometimes oblong or fusiform on the stem and branches. They are imbricating and fan-shaped on the calycular walls.

*Color*.—In alcohol, light tan.

*Distribution*.—Station 4356, Point Loma light-house N.  $82^{\circ} 30'$  E. 5.9 miles, 120–131 fathoms; Station 4357, Point Loma light-house N.  $81^{\circ}$  E. 7.5 miles, 134 fathoms; Station 4358, Point Loma light-house N.  $82^{\circ} 30'$  E. 8.2 miles, 191 fathoms; Station 4386,  $30^{\circ} 30' 30''$  N.,  $118^{\circ} 06' 10''$  W., 1,012 fathoms; Station 4391,  $33^{\circ} 02' 15''$  N.,  $120^{\circ} 36' 30''$  W., 1,350 fathoms.

The type was secured by the *Challenger* at Station 192, off Kei Island, South Pacific, 140 fathoms.

Genus **PLUMARELLA**.

Colony flabellate; calyces small, cylindrical, alternate and opposite; usually somewhat distant. Calyx spicules scale-like, thin, cycloid.

## PLUMARELLA LONGISPINA Kinoshita.

Plate LXXXVIII, figs. 1 and 2; Plate XC, fig. 3.

*Plumarella longispina* KINOSHITA, Journ. Coll. Sci., Imp. Univ. Tōkyō, 1908, p. 14.

Colony, incomplete, flabellate in form, 106 mm. high, and 106 mm. broad. The main stem is somewhat flattened, giving forth alternate main branches at irregular distances, and between the main branches the stem gives forth regularly alternate branches that do not subdivide. The main branches subdivide as does the main stem. Calyces strictly alternate to strictly opposite in different parts of the colony, in two opposite series on stem and branches, the top of one ordinarily reaching to the base of the one next above. Aperture pointed upward and a little outward. Calycular walls armed with conspicuous flattened scale-like spicules which vary greatly in size and in form in different calyces; the typical arrangement being about four whorls, the two proximal whorls being composed of broad curved scales with their distal convex edges etenate, and the distal whorl bearing conspicuous thorn-like processes which extend beyond the end of the operculum. These spines are usually two to six in number, of which two are often distinctly longer than the others. Sometimes one or two spines are borne on the whorl of scales which lies just below the distal one.

The operculum is composed of eight irregularly shaped scale-like spicules, the points of which are often produced into spine-like processes. The side of the calycular wall next the branch is reduced to a narrow band, the antero-lateral processes from the proximal whorls of spicules being the only ones that meet to complete the whorl on the cauline side. Calyces about 1.5 mm. high to the summit of the operculum.

The spicules are of such varied forms as to defy description. They are all more or less flattened scales, however, the most characteristic being in the form of a flattened basal portion bearing on its distal edge the long thorn-like process that projects above the calycular margins. Many of the scales are ornamented with a convex etenate margin. Surfaces of scales ornamented with evenly and closely distributed granules.

The color of the colony as a whole is light grayish brown, the surfaces of the stem and branches being more distinctly gray.

*Locality*.—Station 4359, Point Loma light-house N. 85° E. 9 miles, 191 fathoms. The type was secured from Okinoce Bank, Sagami Sea, 330 fathoms.

## Family MURICEIDÆ.

Spicules usually projecting from the surfaces of the cœnenchyma. A collar of spindle-shaped spicules below the tentacular bases. An 8-rayed operculum formed by spicules on the tentacle bases.

## Genus ELASMOGORGIA.

Colonies with thin cœnenchyma, not profusely branched. Calyces verruciform, their margins infolded over the retracted tentacles, giving an appearance of invagination to the latter. Spicules spindle-shaped with verruciform projections.

## ELASMOGORGIA FILIFORMIS Wright and Studer.

*Elasmogorgia filiformis* WRIGHT and STUDER, Challenger Report, Alcyonaria, 1889, p. 133.

The single colony secured has a single whip-like stem with a branch arising near its base. Length 275 mm.

The calyces are very low broad domes or cones, rising but slightly above the general surface on all sides of the stem and branch, separated by about 3.5 mm., ovate in cross section, the longer diameter being parallel with the stem.

The spicules are heavy warty spindles, often one-sided and covered with very jagged verrucæ. There are also many smaller spicules, some of which are slender spindles, clubs, etc. The largest spicules seem to be on the stem between the calyces, although they often invade the walls of the latter, where they are usually of a distinctly more slender type and arranged transversely, forming annulations or oval markings around the margins when viewed from above.

The color of the colony is clear, light gray; axis dark brown.

*Distribution.* Station 4349, Point Loma light-house NE. 6.5 miles, 75-134 fathoms.

The type was taken by the *Challenger* at Station 188, Arafura Sea, south of Papua, 28 fathoms. Another specimen in University of California collection, taken off San Pedro, California.

The specimen agrees very well with the original description.

## Genus MURICELLA.

Colony branched; cœnenchyma thin. Calyces, short truncated cones projecting at right angles from the branches. Spicules large.

## MURICELLA COMPLANATA Wright and Studer.

*Muricella complanata* WRIGHT and STUDER, Challenger Report, Alcyonaria, 1889, p. 125.

Colony imperfectly flabellate in form, 15 cm. high by 23.7 cm. broad. The main stem gives off lateral branches and undivided branchlets, the former dividing once, twice, or three times in a pinnate manner.



The polyps are distributed on all sides of the stem and branches, but with a strong tendency to a bilateral arrangement, especially on the ultimate branchlets where they are arranged as in typical species of *Leptogorgia*. Polyps with a distinct colleret.

The calyces are short truncated cones usually less than 1 mm. high and 2 mm. broad at base, about 1.5 mm. apart and directed at a right angle from the stem.

The spicules are slender, often curved, pointed spindles covered with scattered spinules and nodules. There are a few short stout forms. The spicules of the colleret are conspicuous curved spindles. At the base of each tentacle a few spicules are arranged in chevrons, and beyond these the tentacular spicules are longitudinally disposed in two or more rows. In the calycular walls the general arrangement of spicules is longitudinal, although many are transverse or oblique, as they are on stem and branches.

The color of the colony is reddish brown, the spicules having a slight reddish tinge.

*Distribution*.—Station 4461, Point Loma light-house S. 3° E. 9.3 miles, 285 fathoms.

The type was secured by the *Challenger* at Station 232, off Japan, 345 fathoms.

The specimens taken by the Fisheries steamer *Albatross* differ slightly from the type, particularly in having a well-marked colleret and in the arrangement of the calycular spicules.

#### Genus EUMURICEA.

Colony branched; calyces verruciform or tubular, showing an 8-rayed figure in retraction. Spicules in the form of sharp pointed needles.

EUMURICEA PUSILLA, new species.

Plate LXXXVIII, figs. 3 and 4.

Colony branching in an irregular manner, a little over 37 mm. in height. The main stem gives forth roughly alternate branches at irregular intervals, the two longest being 13 mm. apart, the whole colony being roughly flabellate.

The calyces are on opposite sides of the stem and branches, alternate, 2.5 mm. from summit to summit, forming low rounded domes or cones, 8-rayed on the summits, about 1 mm. high by 2 mm. broad.

The calycular walls are covered with very hispid spicules, which have their edges somewhat overlapping and are, in general, disposed transversely rather than otherwise.

The polyps are completely retracted in the specimen secured. Dissection shows that they have the colleret characteristic of this family. The tentacles are heavily armed with large jagged spindle-shaped

spicules, longitudinally arranged, except under the tentacular bases, where they are in chevrons.

The spicules are exceedingly various in form, but of the usual muriceid type. There are many unsymmetrical spindles with irregular jagged edges and processes. Clubs of various patterns are fairly common, as are small scales with jagged edges, stars, and double stars. The general arrangement of spicules is longitudinal on the stem and branches.

The color of the colony is very light gray or brownish gray; axis horn-color lightening distally.

*Type-specimen*.—Cat. No. 25430, U.S.N.M.

*Locality*.—Station 4361, Point Loma light-house S. 3° E. 9.9 miles, 97 fathoms.

#### Family PLEXAURIDÆ.

Axis horny, or horny and calcareous, not jointed; cœnenchyma thick; calyces often included, placed on all sides of stem and branches; primary radial canals well defined.

#### Genus PSAMMOGORGIA Verrill.

Verrill's original description is as follows:

Corallum dichotomous or subpinnate, with round branches. Axis hornlike. Cœnenchyma moderately thick, the surface finely granulated with rough spicula. Cells scattered, somewhat flat, more frequently raised in the form of rounded verrucae.

Polyps with rather large, elongated, slender, warty spindles at the bases of the tentacles. Spicula of the cœnenchyma mostly short, thick, and very rough, warty spindles, and rough, warty clubs of moderate size."

#### ? PSAMMOGORGIA ARBUSCULA Verrill.

*Psammogorgia arbuscula* VERRILL, Amer. Journ. Sci., XIV, May, 1869, p. 414.

The largest colony measures 231 mm. long and is roughly flabellate in outline, dividing into two main branches about 37 mm. above the expanded base. These main branches again subdivide two or three times. The branches are of uniform diameter throughout.

The calyces are uniformly and thickly scattered throughout the cœnenchyma, but are seldom actually contiguous, and are in the form of low verrucae, about 1.5 mm. in diameter.

The polyps are fairly well expanded in specimens preserved in formalin, extending about 1.5 mm. above the calycular margin. There are numerous warty spicules on the lower part of the body wall, and a few are placed transversely below and over the tentacular bases. They are found sparsely on the tentacles.

"Trans. Connecticut Acad. Arts and Sci., 1, Pt. 2, 1867-1871, p. 414. Professor Verrill's description of the genus is here given entire. The genus is undoubtedly an aberrant one, and does not correspond to the family characters as given above, but the present writer is not prepared to attempt a reconstruction of the classification.

The spicules of the cœnenchyma are small warty spindles of various shapes, extremely verrucose. Many of them are double spindles characteristic of this genus.

The spicules on the tentacles and body walls of the polyps are more slender and less warty than the rest.

The color of the colony is bright coral red, probably owing to the color of the spicules. The polyps are white in alcohol or formalin, but may be yellow in life.

*Distribution*.—Station 4421, E. Point San Nicholas Island N. 20° W. 3.8 miles, 291 fathoms; Station 4423, E. Point San Nicholas Island S. 7.6 miles, 339 fathoms; Station 4441, Point Pinos light-house N. 87° W. 1.7 miles, 35 fathoms; Station 4451, Point Pinos light-house S. 23° W. 3.2 miles, 52 fathoms; Station 4543, Point Pinos light-house S. 25° E. 5.4 miles, 93 fathoms; Station 4550, Point Pinos light-house S. 6° E. 4.6 miles, 50 fathoms; Station 4555, Point Pinos light-house S. 63° E. 3.4 miles, 66 fathoms.

Professor Verrill reports this species from Panama and Pearl Islands, pools at extreme low-water mark, and from the Gulf of Nicoya, where it was taken by divers.

PSAMMOGORGIA SIMPLEX, new species.

Plate LXXXVIII, figs. 5 and 6; Plate XC, fig. 4.

Colony straggling, branched slightly or unbranched. Largest specimens 13 cm. long. Stem round, slender, of uniform thickness throughout.

Calyces uniformly distributed, not crowded, often as much as 2 mm. apart, tubular, small, about 1 mm. high, usually higher than broad.

The polyps have red spindle-shaped spicules in their walls and near and on the tentacular bases, where they are arranged more or less in chevrons. Otherwise they are longitudinally arranged. The cœnenchyma is thin for this genus.

The spicules are mainly of two sorts: 1. Small double spindles, rosettes, stars, and small clubs. These are found mostly in the superficial layer of the cœnenchyma, and are much less numerous than the second kind. 2. Larger spindles, slender, pointed, often somewhat curved, covered with regularly distributed verrucæ. The clubs are much less numerous than the other forms.

*Color*.—Coral red throughout.

*Type-specimen*.—Cat. No. 25431, U.S.N.M.

*Localities*.—Station 4416, SW. Rock, Santa Barbara Island, N. 49° W. 4.7 miles, 448 fathoms; Station 4427, Point San Pedro, Santa Cruz Island, N. 35° E. 7 miles, 447 fathoms (type-locality).

This species differs from its allies chiefly in the character of the spicules, the larger ones resembling those found in the genus *Muricea*.

*PSAMMOGORGIA TORREYI*, new species.

Plate LXXXIX, figs. 1 and 2; Plate XC, fig. 5.

Colony strictly flabelliform, the branches frequently anastomosing, 150 mm. high by 168 mm. broad. Main stem giving forth branches on opposite sides separated by about 7 mm. on the average. The whole forms a loose reticulation, almost exactly such as is found in the genus *Leptogorgia*.

The calyces are in the form of truncated cones about 1.5 mm. high, and the same in breadth at the base. They are distributed on all sides of the branches about 2.5 mm. apart. In front view they appear to have the arrangement found in the Gorgonidae—that is, two opposite rows of calyces—but a closer examination shows the arrangement described above.

The spicules are warty spindles, those on the stem and branches being smaller than those on the calyces and polyps. The largest appear to be the ones in the polyp walls and basal parts of the tentacles, where they are large, warty, and fusiform, sometimes curved, arranged longitudinally and extend downward in meridional bands to near the base of the polyps. Occasional club-shaped spicules are seen, but nearly all are of the warty fusiform type.

*Color.*—Dark, purplish red throughout. Many of them are almost black, in alcohol.

*Type-specimen.*—Cat. No. 25433, U.S.N.M.

*Distribution.* Station 4514, Point Pinos light-house S. 39° E. 10.7 miles, 524 fathoms; Station 4530, Point Pinos light-house S. 78° E. 6.8 miles, 26–28 fathoms (type-locality); Station 4537, Point Pinos light-house S. 74° E. 7.4 miles, 1062 fathoms; Station 4546, Point Pinos light-house S. 46° E. 8.4 miles, 849 fathoms. All of these stations are in Monterey Bay.

Named for Dr. Harry B. Torrey, University of California.

*PSAMMOGORGIA SPAULDINGI*, new species.

Plate LXXXVIII, figs. 3 and 4; Plate XC, fig. 7.

Colony flabellate in form; branches round in section. The manner of ramification is shown well in the photograph. (Plate LXXXVIII, fig. 3.)

Calyces scattered closely and evenly over the surface, in the form of very low verrucae which are scarcely raised above the general surface of the colony.

Polyps completely retractile, with but few spicules and these tending to a longitudinal arrangement in the body walls in eight rows. These rows sometimes extend part way up the outer sides of the tentacles.

The spicules are small, short warty spindles and double spindles. They are of small size and exceedingly warty. The spicules in the body walls of the polyps are somewhat longer, more slender spindles, with more delicate points and verrucæ.

The color of the colony is bright coral red. The polyps, in preserved specimens, are pure white.

Beautifully expanded colonies of this fine species are in the collection at the Hopkins Laboratory, Pacific Grove, California. They were secured in Monterey Bay, but the depth is not indicated.

*Type-specimen*.—Hopkins Laboratory, Pacific Grove, California.

Named for Mr. M. H. Spaulding, formerly of Stanford University.

#### Family GORGONIDÆ.

Colony branched, usually flabellate. Axis horny, or horny and calcareous. Polyps completely retractile and bilaterally disposed. Impressions of the canals evident on the surface of the stem and branches, and bilaterally disposed. Cœnenchyma smooth. Spicules small spindles, arranged in one layer.

Genus *LEPTOGORGIA* Milne Edwards, emended by Verrill.

Colony flabellate, with often more or less anastomosis of the branches. Calyces verruciform or included, not distributed evenly over the surface, but leaving a broad band on front of stem and branches bare.

#### ? *LEPTOGORGIA FLORÆ* Verrill.

*Leptogorgia flora* VERRILL, Trans. Connecticut Acad. Arts and Sci., I, Pt. 2, 1867 to 1871, p. 387.

A large dried specimen in the collection of the University of California is referred with some doubt to this species. It is very much larger than the type described by Verrill, which was about 6 inches high. The specimen before me is over 2 feet high. In detail, however, it agrees fairly well with the original description.

The locality is not stated on the label, which, however, gives the depth at 80 fathoms.

The type was secured by F. H. Bradley. The species is reported by Verrill as found at Panama and Pearl Islands.

#### *LEPTOGORGIA PURPUREA* (Pallas).

*Gorgonia purpurea* PALLAS, Elenchus Zoophytorum, 1767, p. 187.

Colony flabellate, 12.5 cm. high by 16.2 cm. broad. Stem irregularly sinuate, scarcely flattened, 3 mm. broad, giving off opposite branches at intervals of 3 to 13 mm. Some of the branches again divide once or twice. The terminal branchlets are somewhat flat-

tened, 14 to 25 mm. long, 1.5 mm. wide; somewhat widening at the terminations.

The calyces are arranged in two series on each side of the stem and larger branches and in one series on each side of the terminal branchlets. There are occasional calyces on the front and back of stem and branches. The calyces are in the form of low rounded verrucæ, closely crowded, about 1.5 mm. from summit to summit. Margins usually showing a tendency to a bilobed condition when the polyps are almost completely contracted. The calyces are about 2 mm. broad at base and 1 mm. or less high.

The polyps are small, with few spicules.

The spicules are of very uniform type, quite small stout double spindles with crowded verrucæ. They are often so stout as to be oval or even round in profile.

*Color*.—Uniformly purplish red.

*Distribution*.—Station 4431, Brockway Point, Santa Rosa Island, S. 43° W. 5.2 miles, 41 fathoms.

The locality given by Pallas is "Mare Americanus."

The *Challenger* took this species at Bahía, 10 to 20 fathoms, and at Station 310, Sarmiento Channel, depth 400 fathoms.

The specimens secured by the Fisheries steamer *Albatross* agree very well with the description and figures given by Wright and Studer.<sup>a</sup>

? *LEPTOGORGIA CARYI* Verrill.

*Leptogorgia caryi* VERRILL, Trans. Connecticut Acad. Arts and Sci., 1, Pt. 2, 1867 to 1871, p. 404.

A fragmentary specimen in the collection of the University of California is hardly sufficient for identification, and is referred to this species with much doubt. It is a single unbranched stem about 8 inches long, with two distant stubs indicating that it was sparsely branched. The verrucæ are almost entirely included and hardly evident.

The spicules are typical of this genus, those in the polyps walls being very small and sparse.

The specimen bears the label "L-II 3." It was probably secured off San Diego, California.

The type was collected near San Francisco by T. G. Cary.

Genus *STENOGORGIA* Verrill.

Colony branched; cœnenchyma thin. Polyps scattered, disposed in two rows, retractile and bent inward when at rest. Calyces exerted. Spicules small warty spindles and granules. There are spicules in the tentacles.

<sup>a</sup> Challenger Report, Alcyonaria, p. 150, pl. xxix, fig. 1.

## STENOGORGIA KOFOIDI, new species.

Plate LXXXIX, figs. 5 and 6; Plate XC, fig. 6.

Colony flabellate, 78 mm. by 78 mm.: 15 mm. from the base the main stem divides into three main branches, a center one ascending and almost unbranched, the two lateral ones at first widely divaricating, then ascending and giving forth pinnate branches which tend to be opposite, but are quite irregular. Branchlets about 6 mm. apart, where regular, and somewhat flattened.

The calyces are quite prominent, conical, with broad base, forming an irregular row on each side of front and back of branch, but more numerous in front than behind, their summits 3.5 mm. apart. The calyces are 1.5 mm. high and 1.5 broad at base. Margins with 8 scallops.

Polyps with the outer sides of the tentacles crowded with spicules.

The color of the colony, including the polyps, is deep coral red. The axis is dark greenish brown, lightening distally.

The spicules are almost exclusively small thorny slender spindles, the larger ones often curved. There are a few small double spindles, and part of the larger ones have the verrucæ common in the genus *Eunicea*.

*Type-specimen*.—Cat. No. 25432, U.S.N.M.

*Distribution*.—Station 4546; Station 4553, Point Pinos light-house, S. 67° E. 3.7 miles; 74 fathoms (type-locality); Station 4554, Point Pinos light-house S. 76° E. 3 miles, 60 fathoms.

This species seems to be a *Leptogorgia* in general form and arrangement of calyces; but the spicules are more like those characteristic of some of the Muricidæ.

Named in honor of Prof. C. A. Kofoid, of the University of California.

## LITERATURE CITED.

- DANIELSSEN, D. C. Forhandl. Vidensk.-Selsk., Christiania, 1858.
- DELAGE, YVES, AND HÉROUARD, EDGARD. *Traité de Zoologie Concrète*, II, Pt. 2.
- GABB, WILLIAM M. *Proceedings of the California Academy of Natural Sciences*, II, 1852.
- GRIEG, JAMES A. *Oversigt over Norges pennatuliden*, Bergens Museum aarsberetning, No. 1, 1891.
- KÖLLIKER, ALBERT VON. *Anatomisch-Systematische Beschreibung der Alcyonarien*, Erste Abtheilung, die Pennatuliden, 1872.
- Report on the Pennatulida dredged by H. M. S. Challenger during the years 1873-1876. *Challenger Reports, Zoology*, I, Pt. 2, 1880.
- MOROFF, TH. *Studien über Octocorallien*. *Zoologische Jahrbücher, Abtheilung für Systematik, Geographie und Biologie der Thiere*, XVII, 1902.
- PALLAS, P. S. *Elenchus Zoophytorum*, 1766.
- SARS, M. *Fauna littoralis Norvegiæ*, II, 1856.
- STEARNS, ROBERT E. C. Description of a new genus and species of Alcyonoid Polyp. *Proc. California Acad. Sci.*, August 18, 1873.
- *Verrillia blakei* or *Halipteris blakei*. *American Naturalist*, January, 1882, p. 55.

- STUDER, THÉOPHILE. Note préliminaire sur les Alcyonaires. Bulletin of the Museum of Comparative Zoology, XXV, No. 5, 1894.
- VERRILL, A. E. Revision of the Polyphi of the Eastern Coast of the United States. Memoirs Boston Soc. Nat. Hist., I, 1864.
- Review of the Corals and Polyphi of the West Coast of America. Trans. Connecticut Acad. Arts and Sci., I, Pt. 2, 1868.
- Note. Amer. Journ. Science and Arts, 3d ser., VII, 1871, p. 70.
- Brief contributions to Zoology from the Museum of Yale College, No. XL. Amer. Journ. Sci. and Arts, XVII, 1879.
- Brief contributions to Zoology from the Museum of Yale College, No. LI. Amer. Journ. Sci. and Arts, XXIII, 1882.
- Report on the Anthozoa. Bull. Mus. Comp. Zool., XI, No. 1, July, 1883.
- WRIGHT, E. PERCEVAL, AND STUDER, TH. Report on the Alcyonaria collected by H. M. S. Challenger during the years 1873-1876. Challenger Reports, Zoology, XXXI, No. 1, 1889.

## EXPLANATION OF PLATES.

The photographs were taken by the author. The drawings of the spicules and histological details were made under the camera lucida by Mr. Otto F. Kampmeier, of the Department of Zoology, State University of Iowa.

## PLATE LXXXIV.

- Fig. 1. *Tilesto ambigua*, new species. Somewhat reduced.
2. *Tilesto ambigua*. Portions of colonies,  $\times 6$ .
3. *Anthomastus ritleri*, new species. Colony, somewhat reduced.
4. *Ptilosarcus quadrangularis*. A young specimen, dorsal aspect.
5. *Ptilosarcus quadrangularis*. Ventral aspect of same specimen.
6. Part of ventral aspect of rachis of large specimen.
7. *Ptilosarcus quadrangularis*. Dorsal view of same.
8. *Ptilosarcus quadrangularis*. Ventral view of rachis, showing abnormal growth of rudimentary pinnae on zooid band to the left.
9. *Ptilosarcus quadrangularis*. Two small specimens with expanded polyphi.
10. *Ptilosarcus quadrangularis*. The smallest colony examined. Somewhat reduced.

## PLATE LXXXV.

- Fig. 1. *Ptilosarcus quadrangularis*. View of distal end of colony, showing the appearance of whorls of polyphi caused by crowding of pinnae.
2. *Ptilosarcus quadrangularis*. Upper left figure, cross section of stem and axis, showing septa, stem chambers, and spongy tissue. Upper right hand, section of stem taken below proximal end of axis. Lower figure, section across rachis with a pair of pinnae attached.
3. *Ptilosarcus quadrangularis*. To the left, surface of stem. To the right, inner surface of stem cavity showing stomata; also the spongy tissue of wall of stem.
4. *Ptilosarcus quadrangularis*. Two small pinnae, or leaves, showing polyp band.
5. *Ptilosarcus quadrangularis*. Edge of polyp band with polyphi retracted, showing binnueronate calyces.
6. *Ptilosarcus quadrangularis*. Portion of pinna, enlarged, showing expanded polyphi and the longitudinal chambers of the leaf.
7. *Ptilosarcus quadrangularis*. A few of the polyphi, magnified.
8. *Ptilosarcus quadrangularis*. Cross sections of leaf. Above, section just below polyp band, showing gullets and mesenteries of polyphi, and the arrangement of body cavities due to crowding. The middle and lower figures show sections taken below the gullets.



- Fig. 9. *Ptilosarcus quadrangularis*. Section of leaf to show ova and septa between leaf chambers.
10. *Ptilosarcus quadrangularis*. Surface view of portion of zooid band, enlarged.
11. *Ptilosarcus quadrangularis*. Cross section of rachis, showing zooids and muscle bands.

## PLATE LXXXVI.

- Fig. 1. *Halisceptrum cystiferum*, new species, somewhat reduced.
2. *Stylatula elongata*. Dorsal and ventral views of distal part of colony. Photographed from living specimens, slightly reduced.
3. *Acanthoptilum gracile*. Dorsal view of part of rachis, enlarged.
4. *Acanthoptilum gracile*. Ventral view of part of rachis, enlarged.
5. *Acanthoptilum album*, new species. Parts of colony, reduced.
6. *Acanthoptilum album*. Dorsal and ventral views of part of rachis, enlarged.
7. *Acanthoptilum album*. Lateral view of leaves.
8. *Acanthoptilum album*. Fragments, showing polyps.
9. *Acanthoptilum scalpelliforme*. Dorsal view, enlarged.
10. *Acanthoptilum scalpelliforme*. Ventral view, enlarged.
11. *Acanthoptilum annulatum*, new species. Part of colony, reduced.
12. *Acanthoptilum annulatum*. Ventral view of part of rachis, enlarged.
13. *Acanthoptilum annulatum*. Leaves, showing polyps, enlarged.

## PLATE LXXXVII.

- Fig. 1. *Balticina pacifica*, new species. Parts of colony, somewhat reduced.
2. *Balticina pacifica*. Part of rachis, showing polyps, enlarged.
3. *Halipterus contorta*, new species. Parts of colonies, slightly reduced.
4. *Halipterus contorta*. Part of colony, enlarged, showing calyces.
5. *Stachyptilum superbum*. Parts of rachis showing ventral and dorsal views, and of stem, about natural size.
6. *Stachyptilum superbum*. Ventral and dorsal views of part of rachis, enlarged.
7. *Stachyptilum quadridentatum*, new species. Part of rachis, somewhat reduced.
8. *Stachyptilum quadridentatum*. Part of rachis, ventral aspect, enlarged.
9. *Umbellula loma*, new species. Two views of rachis, and one of proximal part of stem, about natural size.
10. *Distichoptilum verrillii*. Portions of colony, somewhat reduced.
11. *Renilla amethystina*. Colony with expanded polyps, slightly reduced.

## PLATE LXXXVIII.

- Fig. 1. *Plumarella longispina*. Part of colony, somewhat reduced.
2. *Plumarella longispina*. Branches, enlarged.
3. *Eumuricca pusilla*, new species. Fragments, somewhat reduced.
4. *Eumuricca pusilla*. Parts of branches, enlarged.
5. *Psammogorgia simplex*, new species. Parts of colony, somewhat reduced.
6. *Psammogorgia simplex*. Parts of branches, enlarged.

## PLATE LXXXIX.

- Fig. 1. *Psammogorgia torreyi*, new species. Part of colony, somewhat reduced.
2. *Psammogorgia torreyi*. Ends of branchlets, enlarged.
3. *Psammogorgia spauldingi*, new species. Colony with expanded polyps, somewhat reduced.
4. *Psammogorgia spauldingi*, end of branch with expanded polyps, enlarged.
5. *Stenogorgia kofoidi*, new species. Colony, somewhat reduced.
6. *Stenogorgia kofoidi*. Portion of branch, enlarged.

PLATE XC.

- Fig. 1. Spicules of *Teleso ambigua*, new species.  
 2. Spicules of *Anthomastus ritleri*, new species.  
 3. Spicules of *Plumarella longispina*.  
 4. Spicules of *Psammogorgia simplex*, new species.  
 5. Spicules of *Psammogorgia torreyi*, new species.  
 6. Spicules of *Stenogorgia kofoidi*, new species.  
 7. Spicules of *Psammogorgia spauldingi*, new species.

PLATE XCI.

Structural and histological details of *Ptilosarcus quadrangularis*.

- Fig. 1. Cross section of wall of rachis, through the band of zooids.  
*c*, canal from gullet of zooid to large longitudinal canal of rachis.  
*c m*, circular muscles lining cavity of rachis.  
*ect*, ectodermal lining of oesophageal tube or gullet of zooid (siphonoglyph) showing long cilia.  
*end*, endodermal layer of gullet wall.  
*gul*, gullet of zooid in horizontal section taken across the siphonoglyph.  
*inv*, involution of surface of zooid band.  
*lc*, cavity of great longitudinal canals of rachis.  
*l m b*, longitudinal muscle bands, in section.  
*m*, mouth of zooid.  
*sp*, spicules, in cross section.  
*sp t*, spongy tissue below muscle bands.  
 2. Cross section of zooid, taken across gullet.  
*ect*, ectodermal lining of siphonoglyph.  
*end*, endodermal lining of intermesenterial chamber.  
*ic*, intermesenterial chamber.  
*m*, mesentery.  
*spgh*, cavity of siphonoglyph lined with long cilia.





ALCYONARIA OF THE CALIFORNIA COAST.

FOR EXPLANATION OF PLATE SEE PAGE 725.



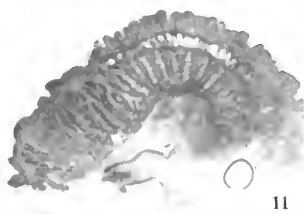
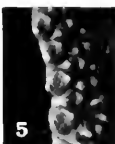
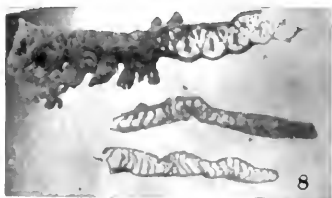
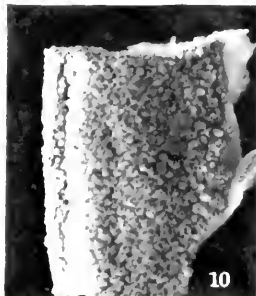
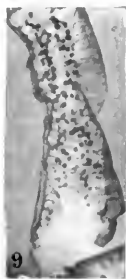
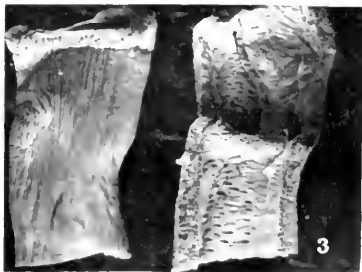
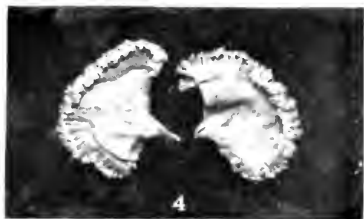
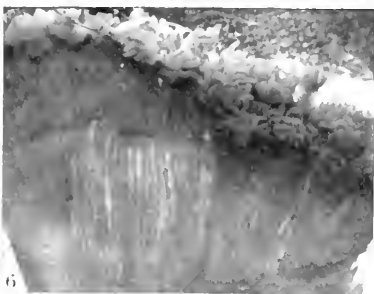
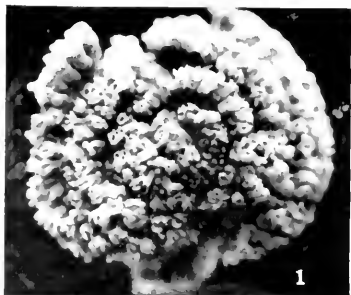

ALCYONARIA OF THE CALIFORNIA COAST.

FOR EXPLANATION OF PLATE SEE PAGES 725, 726.



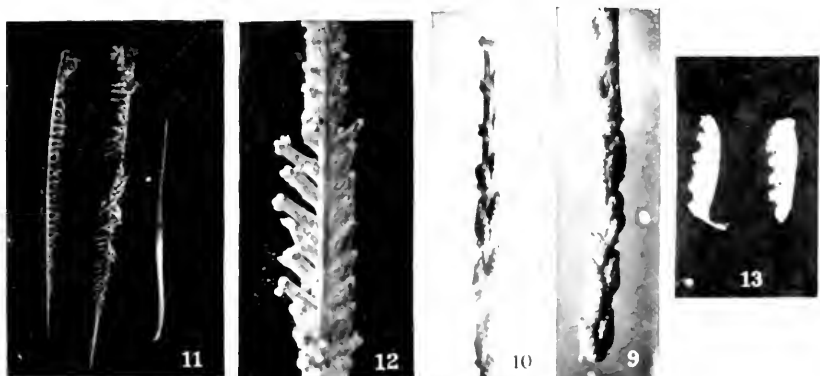
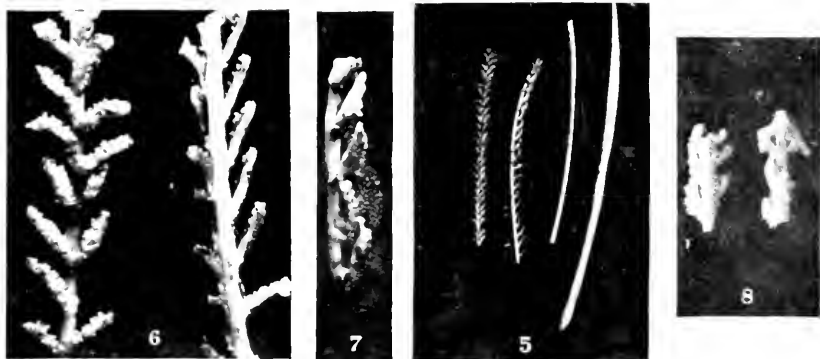
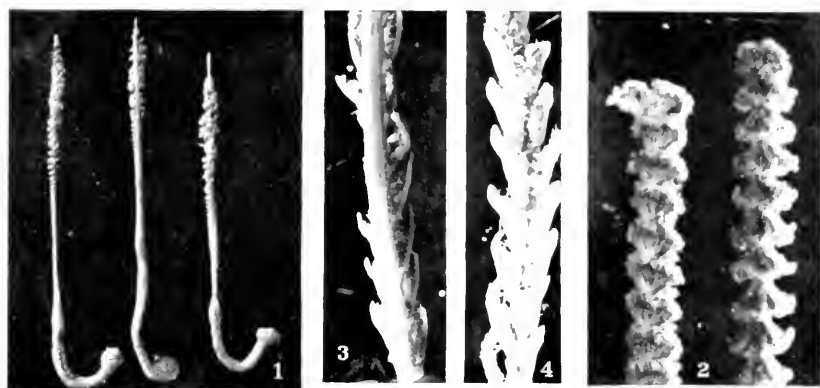

ALCYONARIA OF THE CALIFORNIA COAST.

FOR EXPLANATION OF PLATE SEE PAGE 725.







ALCYONARIA OF THE CALIFORNIA COAST

FOR EXPLANATION OF PLATE SEE PAGE 726.



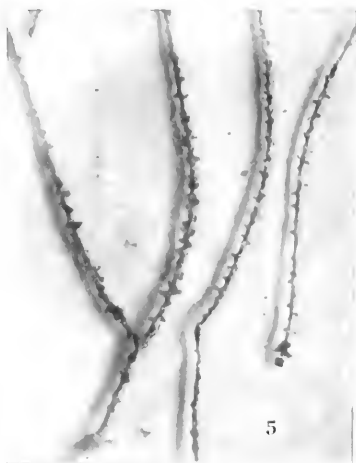
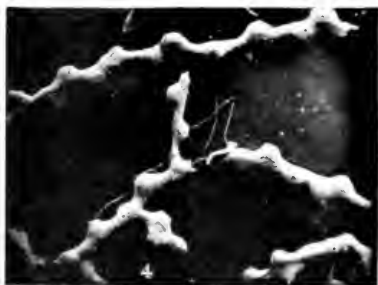
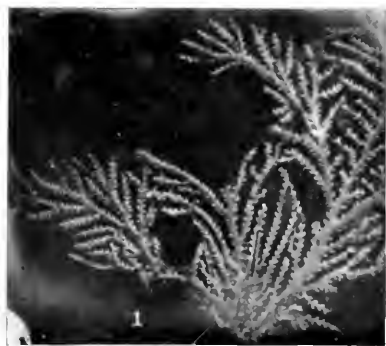

ALCYONARIA OF THE CALIFORNIA COAST.

FOR EXPLANATION OF PLATE SEE PAGE 726.



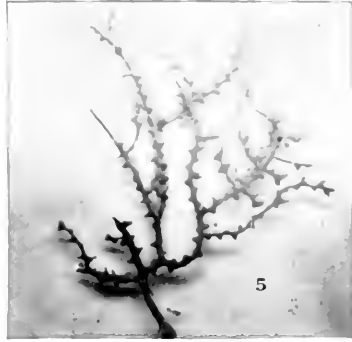

ALCYONARIA OF THE CALIFORNIA COAST.

FOR EXPLANATION OF PLATE SEE PAGE 726.



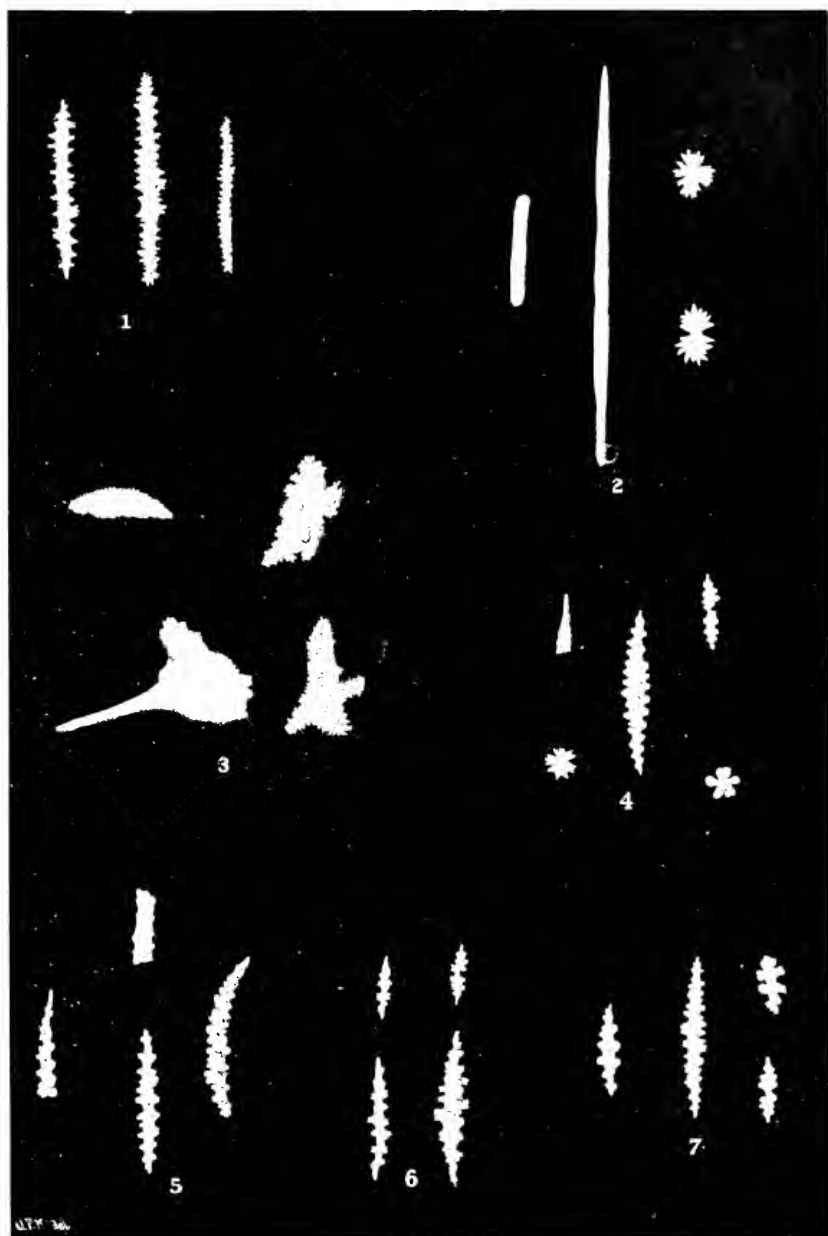

*Alnus Nana*, F. Tr. CALIFORNIA, C. C. B. S.

1. Male inflorescence. 2. Female inflorescence.

3. Male inflorescence. 4. Female inflorescence.

5. Male inflorescence. 6. Female inflorescence.

7. Male inflorescence. 8. Female inflorescence.





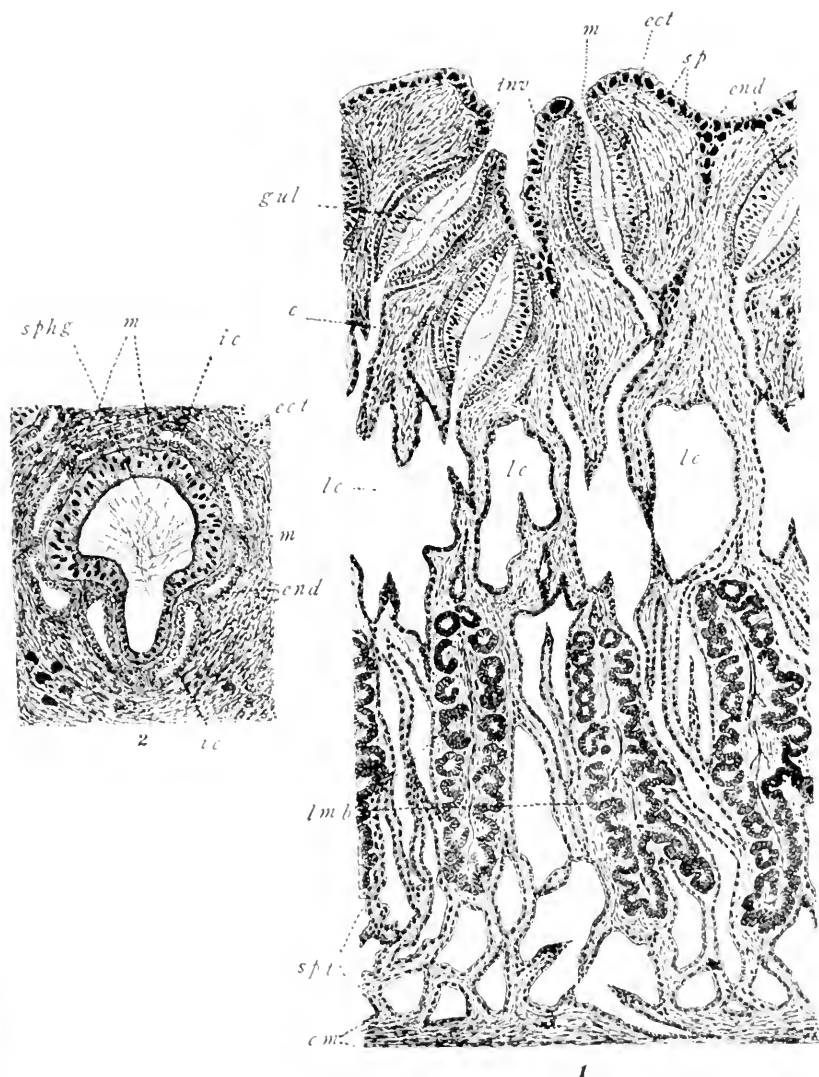

ALCYONARIA OF THE CALIFORNIA COAST.

FOR EXPLANATION OF PLATE SEE PAGE 727.



# INDEX.

	Page.		Page.
Aaptus.....	584	Aeronympha.....	586
Abalmus.....	584	prosantus.....	586
Abbott Collections. Vocabulary of Malay- sian Basketwork: A Study in the W. L., by Otis T. Mason.....	1	Aerornis.....	586
Abertius.....	584	niveifrons.....	586
Abbas.....	584	Aesalon.....	586
Abuceros.....	584	frugillarus.....	586
Acanthaspodia.....	72	Aethia.....	586
typhlops.....	72	cr. statella.....	586
Acanthis.....	584	Aethocorys.....	586
Acanthoplenestes.....	533	Aethopygia pulcherrima.....	609
annectens.....	516, 533, 534	Aethostoma.....	586
Acanthoptilum.....	700	Aetus.....	586
album.....	682, 684, 701	pygargus.....	586
annulatum.....	682, 684, 703	Agami.....	586
gracile.....	682, 684, 700	Agelaius chopi.....	584
poutrialesii.....	682, 684, 701	inthurus.....	637
scalpelliforme.....	682, 684, 702	Agkistrodon contortrix.....	566
Acanthropterus.....	585	Aglossa cestalis.....	369
bilobus.....	585	Agonopteryx.....	190, 198
Acanthura.....	585	amissella.....	199
Acanthurus.....	585	amyrisella.....	198
microrhynchus.....	585	arenella.....	199
Accentor.....	585, 590	argillacea.....	199
aquaticus.....	585	arnicella.....	198
immaculatus.....	590	atrodorsella.....	198
Aethonius.....	450	canadensis.....	199
oblongus.....	450	canella.....	198
Aeththeres coregoni.....	476	cimiflonella.....	198
Aerididae. Two New Species of Neotropical Orthoptera of the Family, by James A. G. Rehn.....	395	clemensella.....	198
Aeris gryllus.....	557, 559	curvilineiella.....	198
gryllus.....	557	flavicomella.....	199
Aeritillas.....	585	fulva.....	198
Aerocephalus bistrigiceps.....	580	gelidella.....	198
Aerochordopus.....	585	gracilis.....	198
Aetionometra.....	113	klamathiana.....	198
Additions to Waterhouse's "Index Generum Avium." Generic Names applied to Birds during the Years 1901 to 1905, inclusive, with further, by C. W. Richmond.....	583	leontella.....	199
Adelometra angustiradia.....	119	lythrella.....	199
Aedes aldrichi.....	57	muricorella.....	199
argentescens.....	55	nebulosa.....	198
atropalpus.....	54	nigrinotella.....	198
cuneatus.....	54	novimundi.....	198
compactus.....	53	nubilifera.....	199
haruspicus.....	56	ocellana.....	198
horridus.....	56	pallidella.....	199
idahomensis.....	57	plummerella.....	199
Aegithalus.....	585	posticella.....	199
Aegithochla.....	585	psorahella.....	198
Aegithospiza.....	586	pulvipennisella.....	198
Aegyptus.....	586	roliniella.....	199
		rosaciliella.....	198
		sabulella.....	199
		sanguinella.....	199
		scabella.....	198, 199
		thoracefasciella.....	198
		thoracemigracella.....	198
		umbaticostella.....	198

	Page.		Page.
<i>Agonopteryx walsinghamiella</i> .....	198	American Moths of the Family <i>Cecophoridae</i> , with Descriptions of New Species. A Gen- eric Revision of, by August Busek.....	187
<i>Agreutes</i> .....	587	American Paleozoic Ostracoda. Preliminary Revision of the <i>Beyrichiida</i> , with Descrip- tions of New Genera. New. By E. O. Ulrich and Ray S. Bassler.....	277
<i>Alauda africana</i> .....	602, 637	<i>Aminornis</i> .....	588
<i>bifasciata</i> .....	602	<i>excavatus</i> .....	588
<i>calandra</i> .....	595, 602	<i>Ammomanes</i> .....	588
<i>erythropygia</i> .....	632	<i>Ammomanoides</i> .....	588
<i>ferruginea</i> .....	637	<i>Ammomanopsis</i> .....	588
<i>grayi</i> .....	588	<i>Ammopasser</i> .....	588
<i>nigricans</i> .....	632	<i>Ammospiza</i> .....	588
<i>trivialis</i> .....	639	<i>Ampelis</i> .....	588
<i>Alaudidae</i> .....	586, 588, 593, 595, 602, 605, 632, 637	<i>cinctus</i> .....	643
<i>Albatross</i> off the West Coast of North Amer- ica, in 1903 and 1904, with Descriptions of a New Family and several New Genera and Species. The Amphipoda collected by the U. S. Bureau of Fisheries Steamer, by Samuel J. Holmes.....	489	<i>garrula</i> .....	583, 588
<i>Albellus</i> .....	587	<i>Ampelisea brevicornis</i> .....	514
<i>Albertosaurus</i> .....	357	<i>californica</i> .....	513, 516
<i>sarcophagus</i> .....	356, 357, 358, 365	<i>coeca</i> .....	515, 517, 518
<i>Alea cristatella</i> .....	586	<i>cristata</i> .....	507
<i>Aleodimida</i> .....	587, 596, 608, 612	<i>lobata</i> .....	517
<i>Aleedo aurea</i> .....	616	<i>macrocephala</i> .....	508, 510
<i>capensis</i> .....	660, 663, 664, 665	<i>odontoplax</i> .....	516
<i>grandis</i> .....	616	<i>pacifica</i> .....	511
<i>gurali</i> .....	669	<i>plumosa</i> .....	509
<i>javana</i> .....	660, 665, 666	<i>pugetica</i> .....	514
<i>leucocephala</i> .....	665	<i>Ampeliseidae</i> .....	507
<i>melanorhyncha</i> .....	660	<i>Amphioxus</i> .....	425
<i>Aleide</i> .....	586, 619, 630, 638, 639	<i>Amphipoda</i> collected by the U. S. Bureau of Fisheries Steamer "Albatross" off the West Coast of North America, in 1903 and 1904, with Descriptions of a New Family and several New Genera and Species, by Samuel J. Holmes.....	489
<i>Aleyon</i> .....	587	<i>Anabathmis</i> .....	589
<i>capensis vel princeps</i> .....	669	<i>Anarsia albafulvella</i> .....	191
<i>Aleyonacea</i> .....	685	<i>Anas bernicla</i> .....	593
<i>Aleyonaria</i> of the Californian Coast, by Charles C. Nutting.....	681	<i>clangula</i> .....	600
<i>Aleyonide</i> .....	682, 687	<i>fabalis</i> .....	620
<i>Alector</i> .....	587	<i>gambensis</i> .....	634
<i>Alectryopelia</i> .....	587	<i>marila</i> .....	620
Allegheny black snake.....	565	<i>querquedula</i> .....	638
<i>Allocotopterus</i> .....	587	<i>segetum</i> .....	620
<i>Allosaurus ferrox</i> .....	352	<i>spectabilis</i> .....	608
<i>fragilis</i> .....	352, 353, 354, 356	<i>tadorna</i> .....	644
Marsh and <i>Crocassurus</i> Marsh.....	353	<i>Anatidae</i> .....	587, 589, 590, 593, 600, 603, 604, 608, 610, 620, 623, 631, 635, 638, 644, 645
<i>medius</i> .....	353	<i>Anatina fryoniana</i> .....	339
<i>Alnus incana</i> .....	419	<i>Anceus</i> .....	483
<i>Altophelandon</i> .....	588	<i>bathybius</i> .....	483
<i>Altricus margaritarius</i> .....	106	<i>Anchorella uncinata</i> .....	475, 476
<i>novemmaculosus</i> .....	107	<i>Anastroa</i> .....	589
<i>Alucoidae</i> .....	626, 647	<i>Andropadus gracilis</i> .....	507
<i>Amandava</i> .....	588	<i>Aneceophamphus</i> .....	589
<i>punctata</i> .....	588	<i>Anerastia cestalis</i> .....	369
<i>Amblygobius naraharae</i> .....	101	<i>Anerpous</i> .....	589
<i>Amblyopsis speleus</i> .....	546, 548, 549	<i>Anesychia texanella</i> .....	206, 207
<i>Amblyospiza concolor</i> .....	625	<i>Anisoramphus</i> .....	589
<i>Amblyrhynchus</i> .....	588	<i>Anodonta coarctata</i> .....	180
<i>Ambystoma jeffersonianum</i> .....	550	<i>Anopheles</i> .....	53
<i>punctatum</i> .....	552	<i>cruxii</i> .....	53
<i>tigrinum</i> .....	552	<i>Anseres</i> .....	635
<i>Ameurus melas</i> .....	546, 549	<i>Anseria</i> .....	589
<i>nebulosus</i> .....	549	<i>Antedon</i> .....	113
America. Descriptions of some New Mos- quitoes from Tropical, by H. G. Dyar and Frederick Knab.....	53		
American Indian Skulls with Low Forehead. New Examples of, by Aleš Hrdlička.....	171		

	Page.		Page.
Antelocietula.....	589	Artaeolax + Bomolochus ardaeolax.....	433, 434, 476
Anthomastus.....	687	Arthrolytes.....	591
ritteri.....	682, 684, 687	Aruga.....	594
Anthoptilida.....	682, 710	oculata.....	595
Anthoptilum.....	710	Aseclaphus.....	591
grandiflorum.....	682, 684, 710	amitus.....	591
thompsoni.....	710	Aselloidea from the Atlantic Coast of North America. Some New Isopoda of the Superfamily, by Harriet Richardson.....	71
Anthoseenus.....	589	Asby salamander.....	553
Anthracia squamularis.....	253	Aspasma.....	184
nodularis.....	231	Aspiderotes granifer.....	198
Anthropornis.....	589	Asterias.....	592
nordenskjoldii.....	589	palumbarius.....	592
Antisiamus.....	590	Asterope.....	422
Antrodemus.....	353	oblonga.....	423
valens.....	353	Astrodapsis merriami.....	346
Aparchites.....	278	perrini.....	342
Apatema.....	590	Asturaeetus.....	592
Aphanotricus.....	590	fureillatus.....	592
Aphrizidae.....	590	Asturina mitterei.....	635
Apomotis cyanellus.....	546, 549	pucherani.....	635
Aprunella.....	590	Atalotricus.....	592
Aptenodytes.....	590	Athyris lamellosa.....	139
patagonica.....	590	Atimastillas.....	592
Apterydites.....	590, 629	Atlantic Coast of North America. Some New Isopoda of the Superfamily Aselloidea from the, by Harriet Richardson.....	71
Aquila adalberti.....	622	Atlantic Coast of North America. Some New Isopods of the Family Gnathilidae from the, by Harriet Richardson.....	483
aurea.....	599	Atrogen.....	592
bifasciata.....	622	Aublysodon.....	358
clanga.....	622	mirandus.....	359
fulvescens.....	622	Aucornis.....	592
glitsetii.....	622	euryrhynechus.....	592
imperialis.....	622	solidus.....	592
naevia.....	622	Auga.....	592
orientalis.....	622	Aurella.....	592
rapax.....	622	ciris.....	592
Aquidaster.....	590	Autruehon.....	592
Arachnothera.....	590	Avium. Generic Names applied to Birds during the Years 1901 to 1905, inclusive, with further Additions to Waterhouse's Index Generum, by C. W. Richmond.....	583
Arca trilineata.....	342, 344	Axial Canals of the recent Pentaerinitida, by A. H. Clark.....	87
vancouverensis.....	349	Babax waddelli.....	616
Archaeocyenus.....	540	Bacha.....	592
laenstra.....	590	Balanophagus.....	593
Archaeopus.....	346	garrulus.....	593
antennatus.....	341, 346, 347, 348	Balanus concavus.....	344
Ardea episcopus.....	606	Balticus.....	704
garzetta.....	607	blakei.....	706
melanolopha.....	618	himarchica.....	682, 684, 705, 706
numita.....	616	pacifica.....	682, 684, 704
stellaris.....	616	Barbatula leucomystax.....	647
virgo.....	626, 641	Barbilanius.....	593
Ardeida.....	607, 616, 618, 620	Barnesia.....	593
Argaleocietula.....	591	Basanistes.....	593
Argulidae.....	432	eissoides.....	593
Argulus niger.....	433	Basemanion constrictor.....	565
pugettensis.....	432	Basketwork: A Study in the W. L. Abbott Collections. Vocabulary of Malaysian, by Otis T. Mason.....	1
Argus.....	591		
giganteus.....	591		
Argyrolyptes.....	591		
microtarsus.....	591		
Aristotelia natalaba.....	194		
Arizelocietula.....	591		
Arizelomyia.....	591		
Arizelopsar.....	591		
Arm Joints and Arm Divisions in the recent Crinoids of the Families of the Comatulida and the Pentaerinitida. The Homologies of the, by A. H. Clark.....	113		
Artaeolax.....	433		

	Page.		Page.
Bassler, Ray S., and Edward O. Ulrich, New American Paleozoic Ostracoda. Preliminary Revision of the Beyrichiida: with Descriptions of New Genera.....	277	Beyrichia hastata .....	308
Bassler, Ray S. The Formation of Geodes with Remarks on the Silicification of Fossils.....	133	initialis.....	301
Bathmedonia.....	593	intermedia.....	301
Bathmoecerus.....	593	interrupta.....	285, 294
Bathynathia.....	483	jonesi.....	291, 299
curvirostris.....	483	jonesii.....	285, 293
Battus tuberculatus.....	283, 286	kloedeni.....	277,
Beds of Montana. Description of New Fossil Liverwort from the Fort Union, by F. H. Knowlton.....	157	283, 285, 287, 289, 290, 291, 292, 293	
Bergia.....	593	aeadica.....	285
Berlepschia.....	593	antiquata.....	285
chrysoblephara.....	593	bicuspis.....	285
Bernicla.....	593	granulata.....	285
Betula pumila.....	419	infecta.....	285
Beyrichia.....	277, 278, 284, 306, 308, 317, 324	intermedia.....	285
acuta.....	295, 296	subvar. sub-	
admixta.....	285	spissa.....	285
aequilatera.....	285	nuda.....	285
affinis.....	306	protuberans.....	285
antiqua.....	295, 296	var. scotica.....	302
aurita.....	286	subtorosa.....	285
barretti.....	301	torosa.....	285
baueri.....	285, 290	verruculosa.....	285
tripartita.....	285	kochii.....	281, 285, 287
beyrichioides.....	295	kolmodini.....	294
bohémica.....	306	kummeli.....	301
bolliana.....	285, 287	laculata.....	306
umbonata.....	286	lata.....	285, 292
bronnii.....	281, 285, 289	lauensis.....	285, 289
buchiana.....	285, 287, 288, 292, 293	lindstromi.....	285, 287
angustata.....	285	var. expansa.....	286
incisa.....	285	linnarssoni.....	293, 295, 296, 297, 298, 299
nutans.....	285	longispina.....	316
buchiano-tuberculata.....	289	lyoni.....	314
bussacensis.....	306	maccoyiana.....	281, 285, 286, 287, 298
carinata.....	306	sulcata.....	285
chambersi.....	278, 308	mamillosa.....	306
ciliata.....	278, 309, 310	marchica.....	306
clavata.....	281, 285, 291, 294, 299, 300	var. angustata.....	306
clavigera.....	281	lata.....	306
complicata.....	278, 306	montaguensis.....	301
var. decorata.....	306	moodeyi.....	285, 286, 287
concinna.....	301	muldensis.....	285
damesi.....	285, 299	multiloba.....	321
deckerensis.....	301	nearpassi.....	301
devonica.....	286	nodulosa.....	285
diffusa.....	285	expansa.....	286
digitata var. separata.....	306	noetlingi.....	286, 289, 290
dissecta.....	306	conjuncta.....	286
dubia.....	285	oculina.....	301
duryi.....	310	palmata.....	306
emaciata.....	316	parallela.....	319
erraticea.....	295, 296, 306	parasitica.....	301
fastigata.....	324	persulcata.....	288
grandis.....	215	plagosa.....	286
granulifera.....	294, 299, 300	plicata.....	286, 293
granulosa.....	285, 293	protuberans.....	291
guilleri.....	310	pustulosa.....	286, 289
haffi.....	319	quadrifida.....	308
hammeli.....	310	quadrifurcata.....	307
harpa.....	306	radians.....	307
		radiata.....	316, 320
		reticulata.....	286
		reuteri.....	286, 293
		ribeiriana.....	307
		richardsoni.....	278, 312
		salteriana.....	281, 286, 289, 293, 298, 299

	Page.		Page.
<i>Beyrichia scanensis</i> .....	286	<i>Bollia symmetrica</i> .....	319
<i>signata</i> .....	295, 296	<i>Bombycillide</i> .....	595
<i>simplex</i> .....	295	<i>Bomolochus</i> .....	433
<i>spinulosa</i> .....	286	<i>chatoessi</i> .....	433
<i>stenuloli</i> .....	286	<i>cornutus</i> .....	433
<i>sussexensis</i> .....	302	<i>hirsutus</i> .....	433
<i>trilobata</i> .....	286, 293	<i>scomberosus</i> .....	433
<i>trislucata</i> .....	318	<i>Borkhausenia</i> .....	190, 203
<i>tuberculata</i> .....	281, 286, 287, 289, 290, 291, 292, 293, 294, 302	<i>ascriptella</i> .....	204
<i>bigibbosa</i> .....	286	<i>conia</i> .....	204
<i>spicata</i> .....	286	<i>episcia</i> .....	204
<i>tuberculato-kochiana</i> .....	286, 287	<i>fasciata</i> .....	204
<i>tuberculospinosa</i> .....	321	<i>minutella</i> .....	204
<i>tumida</i> .....	292, 294, 311	<i>orites</i> .....	204
<i>umbonata</i> .....	286, 293, 294	<i>pseudo-pretella</i> .....	204
<i>ungula</i> .....	288	<i>Botha</i> .....	593, 605
<i>varicosa</i> .....	321	<i>ditlicilis</i> .....	593
<i>ventricornis</i> .....	322	<i>Box tortoise</i> .....	567
<i>v-scripta</i> .....	294, 300	<i>Brachiella anserina</i> .....	467, 477
<i>waldronensis</i> .....	286	<i>gracilis</i> .....	464
<i>wallpackensis</i> .....	302	<i>mallois</i> .....	461
<i>wilekensisiana</i> .....	277, 302	<i>Brachiopoda</i> .....	342
<i>plicata</i> .....	302	<i>Brachydaetyla</i> .....	594
<i>Beyrichiella</i> .....	278, 320, 322, 324	<i>temminckii</i> .....	594
<i>cristata</i> .....	322	<i>Brachypus</i> .....	591
<i>reticosa</i> .....	322	<i>Brachyrhamphus</i> .....	594
<i>Beyrichiidae</i> , with Descriptions of New Genera. New American Paleozoic Ostra- coda. Preliminary Revision of the, by E. O. Ulrich and Ray S. Bassler.....	277	<i>elegans</i> .....	591
<i>Beyrichiopsis</i> .....	320, 323	<i>Brachyscelus eruseculum</i> .....	490
<i>cornuta</i> .....	323	<i>Bradycinetus</i> .....	427
<i>limbriata</i> .....	323	<i>brenda</i> .....	428
<i>fortis</i> .....	323	<i>Bradyornis bohmi</i> .....	621
<i>granulata</i> .....	323, 324	<i>Branchiolambrus</i> .....	311
<i>simplex</i> .....	323, 324	<i>altus</i> .....	311, 315
<i>subdentata</i> .....	323	<i>Bremus</i> .....	591
<i>Biarmicus</i> .....	593	<i>Brevipes</i> .....	591
<i>russicus</i> .....	593	<i>Brevitarsus</i> .....	594
<i>Big-eared bat</i> .....	577	<i>Bucco cinereus</i> .....	622
<i>Birds during the Years 1901 to 1905, inclusive,</i> with further Additions to Waterhouse's "Index Generum Avium." Generic names applied to, by C. W. Richmond.....	583	<i>parvus</i> .....	634
<i>Black snake</i> .....	565	<i>rufecula</i> .....	622
<i>Blarina brevicauda</i> .....	517	<i>swainsoni</i> .....	620
<i>carolinensis</i> .....	577	<i>Buceonide</i> .....	620
<i>parva</i> .....	577	<i>Buceros</i> .....	584
<i>Blastobasis</i> .....	188	<i>abyssinus</i> .....	646
<i>Blennidae</i> .....	106	<i>Bucerotidae</i> .....	584, 611, 630, 646
<i>Blue racer</i> .....	565	<i>Budythanthus</i> .....	594
<i>Blue-tailed skink</i> .....	563	<i>torquatus</i> .....	594
<i>Boisduval</i> . A Revision of some Species of Noctuida: heretofore referred to the Genus Homoptera, by J. B. Smith.....	209	<i>Budytes</i> .....	594
<i>Bollia</i> .....	277, 309, 315, 317	<i>neglectus</i> .....	629
<i>auricularis</i> .....	297, 311	<i>Buettikoferia</i> .....	594
<i>halli</i> .....	319	<i>Bufo lentiginosus americanus</i> .....	557
<i>interrupta</i> .....	285, 291	<i>Bullfrog</i> .....	562
<i>kolmodini</i> .....	295	<i>Bureau of Fisheries Steamer "Albatross" off</i> <i>the West Coast of North America, in 1903</i> <i>and 1904, with Descriptions of a New Fam-</i> <i>ily and several New Genera and Species.</i> <i>The Amphipoda collected by the U. S.</i> <i>by Samuel J. Holmes</i> .....	489
<i>major</i> .....	310	<i>Busck, August, A Generic Revision of Ameri-</i> <i>can Moths of the Family Ctenophoridae, with</i> <i>Descriptions of New Species</i> .....	187
<i>minor</i> .....	297, 310	<i>Butalis caeruleescens</i> .....	599
<i>regularia</i> .....	288	<i>Buteonide</i> .....	586,
<i>regularis</i> .....	288, 319	590, 592, 594, 597, 599, 611, 615, 621, 622, 628, 635	635
		<i>Buteopernis</i> .....	594
		<i>Byas</i> .....	594



	Page.		Page.
<i>Byas nobilis</i> .....	594	Carnivorous Dinosaurs, with special Reference to <i>Ceratosaurs nasicornis</i> Marsh. On certain Genera and Species of, by Oliver P. Hay.....	351
<i>Byblis gaimardii</i> .....	518	Carolina shrew.....	577
<i>Byssura</i> .....	595	<i>Carpophis anomus</i> .....	563
<i>bohémica</i> .....	595	<i>Carpodacus sophia</i> .....	640
<i>Cacatuidæ</i> .....	602, 609	<i>Carpophaga</i> .....	596
<i>Cærebidae</i> .....	595	( <i>Phenorhina</i> ) <i>goliath</i> .....	631
<i>Calamornis</i> .....	595	<i>Casmarhynehus</i> .....	596
<i>Calandra</i> .....	595	<i>Castalia</i> .....	418
<i>Calandrina</i> .....	595	<i>Casuaridae</i> .....	597, 628, 646
<i>Calarina</i> .....	370	<i>Casuarus</i> .....	628
<i>Calidris</i> .....	603	<i>galeatus</i> .....	628
California. Descriptions of Fossil Crabs from, by M. J. Rathbun.....	341	<i>novæ hollandiæ</i> .....	598
California Fishes, <i>Rimicola eigenmanni</i> and <i>Plagiogrammus hopkinsi</i> . Notes on Two Rare, by John Otterbein Snyder.....	183	<i>Cataractes</i> .....	596
Californian Coast. <i>Aleyonaria</i> of the, by Charles C. Nutting.....	681	<i>Cathartide</i> .....	611
<i>Caligida</i> .....	439	<i>Catostomus commersonii</i> .....	549
<i>Caligorgia</i> .....	714	Cave salamander.....	555
<i>sertosa</i> .....	683, 684, 715	<i>Cecropina</i> .....	453
<i>Caligus gurnardi</i> .....	439, 476, 477	<i>Cecrops latreilii</i> .....	453, 477
<i>Calliopiidae</i> .....	526	<i>Cedola</i> .....	596
<i>Callopetis obsoletus</i> .....	565	<i>senegalensis</i> .....	596
<i>confinis</i> .....	565	<i>Cela</i> .....	597
<i>Callornis</i> .....	608	<i>Cephus</i> .....	597
<i>Calliodon elere</i> .....	99	<i>scorpus</i> .....	597
<i>lumula</i> .....	99	<i>Ceraphanes</i> .....	597
<i>Calobates</i> .....	595	<i>anomalus</i> .....	597
<i>radiceus</i> .....	595	<i>Ceratella</i> .....	308
<i>Calyptoecichla</i> .....	595	<i>Ceratopsis</i> .....	308
<i>Campylops</i> .....	595	<i>chambersi</i> .....	308
<i>hamulus</i> .....	595	<i>hastata</i> .....	308
<i>Campylorhamphus</i> .....	595	<i>intermedia</i> .....	308
<i>longirostris</i> .....	595	<i>oculifera</i> .....	308
Canals of the recent <i>Pentaerinitide</i> . The Axial, by A. H. Clark.....	87	<i>robusta</i> .....	308
Cancer.....	341	<i>Ceratops</i> .....	359
<i>fissus</i> .....	343	<i>Ceratops</i> <i>nasicornis</i> Marsh. On certain Genera and Species of Carnivorous Dinosaurs, with special Reference to, by Oliver P. Hay.....	351
<i>magister</i> .....	343, 344	<i>Cerchne</i> .....	597
Canceride.....	343	<i>buteo</i> .....	597
<i>Candona</i> .....	400, 401	<i>pennipes</i> .....	597
<i>euplectella</i> .....	402, 408	<i>Certhia coccinea</i> .....	609
<i>parallela</i> .....	400, 401	<i>falata</i> .....	609
<i>reticulata</i> .....	405	<i>obscura</i> .....	609
<i>Candonina</i> .....	400, 401	<i>pacifica</i> .....	609
<i>Canis occidentalis</i> .....	576	<i>vestiaria</i> .....	614
<i>Cannaba</i> .....	595	<i>Certhiide</i> .....	604
<i>propria</i> .....	595	<i>Ceryle</i> .....	659
<i>Capitonide</i> .....	584, 634, 636, 647	<i>Cha-tura major</i> .....	586
<i>Capparis</i> .....	596	<i>Chaja</i> .....	597
<i>Caprella californica</i> .....	543	<i>torquata</i> .....	597
<i>Caprellide</i> .....	543	<i>Chama pellucida</i> .....	342
<i>Caprellidea</i> .....	543	<i>Chamaebates</i> .....	597
<i>Capricalea</i> .....	596	<i>rufiventris</i> .....	597
<i>arboorea</i> .....	596	<i>Chamaelaphne calyculata</i> .....	419
<i>Caprimulgide</i> .....	626, 631	<i>Chambersia</i> .....	188
<i>Caprimulgus</i> .....	631	<i>Chameleon tree-frog</i> .....	559
<i>grandis</i> .....	626	<i>Chara</i> .....	418
<i>yucatanensis</i> .....	626	<i>Charadrius leucurus</i> .....	647
<i>Capya</i> .....	596	<i>Charadriide</i> .....	585, 609, 647
<i>Carbo auritus</i> .....	605	<i>Charadriiformes</i> .....	606
<i>mexicanus</i> .....	647	<i>Charadriola</i> .....	597
<i>Carex</i> .....	418	<i>singularis</i> .....	597
<i>Caricicola</i> .....	596	<i>Charadrius</i> .....	597
<i>Carites</i> .....	596		

	Page.		Page.
<i>Charadrius asiaticus</i> .....	609	<i>Cinnyris nectarinoides</i> .....	613
<i>gallieni</i> .....	606	<i>newtoni</i> .....	589
<i>Charitillus</i> .....	597	<i>Cimulia obliqua</i> .....	319
<i>Charitospiza</i> .....	598	<i>Cirripecta</i> .....	311
<i>eucosma</i> .....	598	<i>Cissopsis major</i> .....	594
<i>Chelarga</i> .....	598	<i>Citharethys</i> .....	476
<i>Chelido</i> .....	598	<i>Cladornithide</i> .....	604
<i>Chelidorhamphus</i> .....	598	<i>Cladosecopus</i> .....	600
<i>orhycterus</i> .....	598	<i>Clangula</i> .....	600
<i>Chelydra serpentina</i> .....	547, 567	Clark, Austin Hobart, The Axial Canals of the recent Pentaerini- tida.....	87
<i>Chenorhamphus</i> .....	601	The Homologies of the Arm Joints and Arm Divisions in the recent Crinoids of the Families of the Comatulida and Pentaeriniida.....	113
<i>cyanopectus</i> .....	601	<i>Clidiophora punctata</i> .....	311
<i>Chiasorampho</i> .....	598	<i>Climacanthus</i> .....	600
<i>Chilo comptulatalis</i> .....	393	<i>incompletus</i> .....	600
<i>densellus</i> .....	392	<i>Climacocerus</i> .....	600
<i>forbesellus</i> .....	393	<i>Chola vigilax</i> .....	549
<i>multipunctellus</i> .....	393	<i>Cnemarchus</i> .....	600
<i>placidellus</i> .....	392	Coast of North America, in 1903 and 1904, with Descriptions of a New Family and several New Genera and Species, The Amphipoda collected by the U. S. Bureau of Fisheries Steamer "Albatross" off the West, by Samuel J. Holmes.....	189
<i>plejadellus</i> .....	392	<i>Coccyx</i> .....	600
<i>puritellus</i> .....	393	<i>americanus</i> .....	600
<i>supramellus</i> .....	393	<i>canorus</i> .....	600
<i>Chimabache haustellata</i> .....	194	<i>Coccyzus leucillanthis</i> .....	607
<i>Chione tremlorensis</i> .....	346	<i>Coleocentrum</i> .....	177
<i>Chionidae</i> .....	600	<i>Crossostephanus palmeri</i> .....	177
<i>Chipmunk</i> .....	569	<i>palmeri</i> .....	177
<i>Chiron-simus</i> .....	498	Cold-blooded Vertebrates.....	548
<i>Chlamydotheca</i> .....	400	Cold-blooded Vertebrates of the Indiana University Farm, Mitchell, Indiana, Notes on the Mammals and, by Walter L. Hahn.....	545
<i>azteca</i> .....	400	<i>Coleoramphus</i> .....	600
<i>mexicana</i> .....	400	<i>nivalis</i> .....	600
<i>Chionostriada</i> .....	598	Collections, Vocabulary of Malaysian Bas- ketwork; A Study in the W. L. Abbott, by Otis T. Mason.....	1
<i>Chlorous</i> .....	598	<i>Collocalia</i> .....	640
<i>oriolus</i> .....	598	<i>Colonosaurus</i> .....	600
<i>Chlorion</i> .....	599	<i>mudgeli</i> .....	600
<i>Chlorura hyperythra</i> .....	638	<i>Colopterus pilaris</i> .....	592
<i>Chlorochilus trimaculella</i> .....	194	<i>Colubris</i> .....	601
<i>Chorodon</i> .....	156	<i>mango</i> .....	601
Chorodon in place of <i>Chlorops</i> for a Labroid Genus of Fishes, by Theodore Gill.....	155	<i>mellivorus</i> .....	601
<i>Chorodon macrodon</i> .....	156	<i>minimus</i> .....	601
<i>Chorops</i> .....	155, 156	<i>ourissa</i> .....	601
Chorops for a Labroid Genus of Fishes, Chorodon in place of, by Theodore Gill.....	155	<i>rubens</i> .....	601
<i>Chorops jordani</i> .....	98	<i>Columba aenea</i> .....	623
<i>macrodon</i> .....	155	<i>Columba carmelitana</i> .....	587, 601
<i>melagrades</i> .....	156	<i>curvirostris</i> .....	589
<i>Chondracanthidae</i> .....	431	<i>hodesoni</i> .....	605, 607
<i>Chondracanthus epachthes</i> .....	476	<i>Columbidae</i> .....	605, 607
<i>epachthes</i> .....	431	<i>Columbigallina</i> .....	587
<i>Chorophilus nigrilus feriarum</i> .....	558	<i>Columbigallus</i> .....	601
<i>Chrysaetus</i> .....	599		
<i>aquilinus</i> .....	599		
<i>Chryseus marginata</i> .....	567		
<i>Chrysoantor</i> .....	599		
<i>Chrysophilopicus</i> .....	599		
<i>Cichlomyia</i> .....	599		
<i>Cichlopasser</i> .....	585		
<i>Ciconia</i> .....	599		
<i>Ciconiidae</i> .....	599, 606, 620, 629, 648		
<i>Ciconiopsis</i> .....	599		
<i>antaretica</i> .....	599		
<i>Cinclida</i> .....	585, 599, 641		
<i>Cinclus</i> .....	599		
<i>hydrophilus</i> .....	599		
<i>Cinerosa</i> .....	599		
<i>Cinnamopteryx</i> .....	600		

	Page.		Page.
Columbigallus francie	601	Cossyphodes	155
Comaster	113, 123, 124	Cossyphus macrodon	155
borneensis	120, 123, 124	Cotinga tsehudii	643
coppingeri	120, 123, 124	Cotingidae	593,
discoidea	120, 123, 124	600, 602, 605, 607, 613, 615, 616, 622, 628, 636, 643	
limbriata	120, 123, 124	Cottus richardsoni	546, 550
iowensis	120, 123, 124	Cona	603
lineata	120, 123, 124	Crabs from California. Descriptions of Fossil,	
marie	120, 123, 124	by M. J. Rathbun	341
multiradiata	120, 123, 124	Cracida	587
sentosa	120, 123, 124	Cractes	603
Comatula	123, 124	Crambid Moths. Descriptions of New Species of North American, by W. D. Kearfott	367
distincta	124	Crambus bidens	381
multibrachiata	124	cockeellus	378
notata	124	dorsipunctellus	383
paucicirra	124	dumetellus	379
pectinata	124	intermedius	382, 383
solaris	124	nevadellus	384
Comatulida and the Pentaerinitidae. The Homologies of the Arm Joints and Arm Divisions in the recent Crinoids of the Families of the, by A. H. Clark	113	polingi	382
Comeris	601	simplicellus	384
Cometes	601	trichusalis	379
Conopoderas	601	youngellus	380
Conopophagidae	597, 615	Craspedopriion	603
Conopotheras	601	Craugus	603
Conurus	601	Crax alector	587
Conus	346	Crecca	603
Copepods: A List of those found upon the Fishes of the Pacific Coast, with Descriptions of New Genera and Species. North American Parasitic, by Charles Branch Wilson	431	communis	603
Copperhead	566	gloccitans	603
Copsicus	601	palustris	603
merula	601	Crenitabrus chabrolii	95
torquata	601	macrurus	95
Coracias garrulus	583	Creosaurus	353, 355
Coraciidae	588	atrox	354
Coracina	602	Creurgus	603
Corax	602	exultator	603
Coregonus	476	lanius	603
nelsonii	476	rufus	603
Cormias	602	Crieket frog	557
Cornularidae	685	Criniger affinis	645
Corone	602	ictericus	585
cinerea	602	serinus	595
cornix	602	Crinoids of the Families of the Comatulida and the Pentaerinitidae. The Homologies of the Arm Joints and Arm Divisions in the recent, by A. H. Clark	113
frugilega	602	Crocethia	603
maxima	602	Crossostephanus	177
monedula	602	Crucirostra	598
Corophiidae	543	Cruschedula	604
Corvida	586,	revola	604
593, 602, 603, 610, 620, 637, 638, 642, 643, 645		Cryptobranchus alleghaniensis	550
Corvina	602	Cryptoglaux	604
Corvus frugilegus	612	Cryptolechia	189
leucognaphalus	602	canariella	195
stelleri	643	ciliella	196
varians	586	concolorella	195
Corydalis	602	cretacea	194
arvensis	602	huachuella	195
nemorum	602	obscuromaculella	195
Corydon	602	sparsiciliella	201
Corydus	595, 602	stramineella	194
Corynorhinus macrofis	547, 577	tentoriferella	195
		Ctenobolbina	277, 278, 284, 309, 311, 315
		alata	310
		antepinosa	295

	Page		Page
<i>Ctenobolbina auricularia</i> .....	297	<i>Cylindroleberis oblonga</i> .....	401, 423
<i>auricularis</i> .....	297, 311	<i>Cynoscion nobilis</i> .....	441, 464, 476
<i>bispinosa</i> .....	310	<i>Cyphornis</i> .....	604
<i>cavimarginata</i> .....	295	<i>magnus</i> .....	601
<i>ciliata</i> .....	290, 296, 309, 311	<i>Cypria</i> .....	400, 408, 410
var. <i>curata</i> .....	310	<i>dentifera</i> .....	400, 405, 407, 410, 419
<i>crassa</i> .....	296, 310	<i>exsculpta</i> .....	400
<i>curta</i> .....	310	<i>obesa</i> .....	405
<i>durys</i> .....	310	<i>Cyprididae</i> .....	400, 401
<i>emaciata</i> .....	310	<i>Cypridina</i> .....	422, 426, 427
<i>fulerata</i> .....	296, 297, 310	<i>brenda</i> .....	428
<i>granosa</i> .....	310	<i>mariae</i> .....	423
<i>guilleri</i> .....	310	<i>oblonga</i> .....	423
<i>hammelli</i> .....	310	<i>Cypridinae</i> .....	400, 403
<i>impressa</i> .....	297, 310	<i>Cypridinidae</i> .....	401, 422
<i>informis</i> .....	295	<i>Cypridopsis</i> .....	400
<i>insolens</i> .....	295, 315	<i>vidua</i> .....	400, 405, 419
<i>loculata</i> .....	311	<i>Cypris</i> .....	400, 403, 408
<i>major</i> .....	310	<i>aurantia</i> .....	405
<i>minima</i> .....	311	<i>biplicata</i> .....	410
<i>minor</i> .....	310	<i>flava</i> .....	415
<i>obliqua</i> .....	310	<i>fusca</i> .....	404
<i>oblonga</i> .....	296, 310	<i>fusca</i> .....	400, 403, 404, 407, 419
<i>papillosa</i> .....	310	<i>gibba</i> .....	410
<i>punctata</i> .....	310	<i>hirsuta</i> .....	403
<i>spiculosa</i> .....	295	<i>incongruens</i> .....	400, 405
<i>spinosa</i> .....	295	<i>lavis</i> .....	408
<i>suberassa</i> .....	293, 296, 297, 309, 310, 317	<i>marginata</i> .....	415
<i>tumida</i> .....	290, 291, 294, 311	<i>monacha</i> .....	417
<i>umbonata</i> .....	296, 310	<i>pellucida</i> .....	400, 405
<i>Cuebidia</i> .....	535, 536, 600, 603, 607, 611, 614, 619, 644	<i>pubera</i> .....	400
<i>Cuerilea boversiana</i> .....	349	<i>reticulata</i> .....	400
<i>Cuculus coromandus</i> .....	607	<i>sinuata</i> .....	410
<i>edolius</i> .....	607	<i>virens</i> .....	409
<i>gigas</i> .....	603	<i>Cyprodopsinae</i> .....	400
<i>glanularius</i> .....	607	<i>Cyprois</i> .....	400, 414, 416
<i>madagascariensis</i> .....	603	<i>flavata</i> .....	415
<i>navis</i> .....	644	<i>marginata</i> .....	400, 405, 415
<i>persa</i> .....	631	<i>monacha</i> .....	407
<i>serratus</i> .....	607	<i>Cypris fuscata</i> .....	403
<i>Culex aikeni</i> .....	61	<i>Cypselus comatus</i> .....	605
<i>chrysonotum</i> .....	57	<i>parvus</i> .....	613
<i>consternator</i> .....	59	<i>senex</i> .....	586
<i>daurastocampa</i> .....	58	<i>Cystisoma spinosum</i> .....	490
<i>cumimetes</i> .....	61	<i>Cystisomidae</i> .....	490
<i>fu</i> .....	58	<i>Cythere</i> .....	400, 419
<i>regulator</i> .....	61	<i>americana</i> .....	400, 420, 422
<i>spissipes</i> .....	58	<i>papillosa</i> .....	400, 421
<i>stenolepis</i> .....	60	<i>Cythereis</i> .....	420
<i>stigmatosoma</i> .....	62	<i>Cytherida</i> .....	400, 419
<i>Cursor</i> .....	604	<i>Cytheridea</i> .....	420
<i>Cursoriidae</i> .....	604, 606, 635	<i>Daedala</i> .....	587, 659
<i>Cyanoceffa</i> .....	643	<i>Daenis pulcherrima</i> .....	616
<i>ultramarina arizonae</i> .....	642	<i>Dagda</i> .....	604
<i>Cyano-sylvia</i> .....	604	<i>hortensis</i> .....	604
<i>Cycloeypridinae</i> .....	400, 408	<i>Dall, William Healey, Descriptions and Figures of some Land and Fresh-water Shells from Mexico, believed to be New</i> .....	177
<i>Cycloeypris</i> .....	400, 408	<i>Decametrocrinus</i> .....	117
<i>forbesi</i> .....	409	<i>rucosus</i> .....	126
<i>lavis</i> .....	400, 405, 408	<i>Decantha</i> .....	190, 202
<i>Cyclorhynchus equinoctialis</i> .....	603	<i>bockhauseni</i> .....	202
<i>Cyrenus</i> .....	604	<i>Deinodon horrius</i> .....	376, 359
<i>ferus</i> .....	604	<i>Delphinorhis</i> .....	604
<i>Cyrenus</i> .....	604	<i>larsenii</i> .....	604
<i>Cylindroleberis</i> .....	400, 422	<i>Dendrium buxifolium</i> .....	370
<i>lobanici</i> .....	401, 424		
<i>marie</i> .....	423		

	Page.		Page.
Dendrobates.....	604	Dicaeidae.....	607, 642
<i>familiaris</i> .....	604	Diceratomis.....	605
Dendrochelidon.....	605	<i>satyrus</i> .....	605
Dendrocolaptes <i>erithacus</i> .....	585	Dichelestidae.....	453
<i>procurvus</i> .....	595, 648	Dicranella.....	279
Dendrocolaptidae.....	585, 595, 643, 648	Dicranura.....	605, 636
Dendrocoeca.....	605	Dicruridae.....	606
<i>erythroptera</i> .....	605	Didelphis <i>virginia</i> .....	568
Dendrotrogon.....	605	<i>virginiana</i> .....	547
Dentophorus.....	605	Dielis <i>tytus viridescens</i> .....	557
Depressaria.....	190, 260	Dikara.....	605
<i>alienella</i> .....	260	<i>locustella</i> .....	605
<i>apiella</i> .....	260	Dilobella.....	279, 311
<i>barbarella</i> .....	260	Dilophalieu.....	605
<i>betulella</i> .....	260	Dinopium.....	606
<i>cinereocostella</i> .....	260	( <i>Picoides</i> ) <i>erythronotus</i> .....	606
<i>groteella</i> .....	260	Dinornis <i>struthioides</i> .....	628
<i>heracliana</i> .....	260	Dinornithidae.....	628
<i>juliella</i> .....	260	Dinosaurs, with special Reference to Cerato-	
<i>maculata</i> .....	260	<i>saurus nasiceornis</i> Marsh. On certain Genera	
<i>togata</i> .....	260	and Species of Carnivorous, by Oliver P.	
Description of New Fossil Liverwort from the		Hay.....	351
Fort Union Beds of Montana, by F. H.		Diplochelidon.....	606
Knowlton.....	157	Diplochilus.....	606
Descriptions and Figures of some Land and		<i>xanthochlorus</i> .....	606
Fresh-water Shells from Mexico, believed to		Diplococus.....	362
be New, by W. H. Dall.....	177	Diplodon <i>websteri</i> .....	181
Descriptions of a New Family and several		Diplofonta <i>harfordi</i> .....	344
New Genera and Species. The Amphipoda, col-		Diplootocus.....	606
lected by the U. S. Bureau of Fisheries		Dissemturoides.....	606
Steamer Albatross off the West Coast of		Dissemturopsis.....	606
North America, in 1903 and 1904, with, by		Dissoura.....	606
Samuel J. Holmes.....	489	Distichoptilum.....	713
Descriptions of Eighteen New Species and		<i>verillii</i> .....	682, 684, 713
Two New Genera of Fishes from Japan and		Dolicopterus.....	606
the Kiu Kiu Islands, by John Otterbein		<i>viator</i> .....	606
Snyder.....	93	Dorosera <i>rotundifolia</i> .....	419
Descriptions of Five Species of North Amer-		Dorota <i>albastrigifolia</i> .....	191
ican Fossil Turtles, Four of which are New,		Doryptena.....	102
by Oliver P. Hay.....	161	<i>okinawae</i> .....	102, 103
Descriptions of Fossil Crabs from California,		<i>tanegasimae</i> .....	104
by M. J. Rathbun.....	341	Drasteria <i>horrida</i> .....	270
Descriptions of New Genera and Species.		Drepanella.....	289, 311
North American Parasitic Copepods: a List		<i>ampla</i> .....	312
of those found upon the Pacific Coast, with,		<i>bigeneris</i> .....	290, 312, 317
by Charles Branch Wilson.....	431	<i>bilateralis</i> .....	313, 314
Descriptions of New Genera. New American		<i>crassinoda</i> .....	290, 294, 312
Paleozoic Ostracoda. Preliminary Revi-		<i>nitida</i> .....	312
sion of the Beyrichiidae, with, by E. O.		<i>elongata</i> .....	312
Ulrich and Ray S. Bassler.....	277	<i>maera</i> .....	290, 294, 312
Descriptions of New Species. A Generic Re-		<i>nitida</i> .....	290
vision of American Moths of the Family		<i>richardsoni</i> .....	290, 291, 294
Geophoridae, with, by August Busck.....	187	<i>canadensis</i> .....	312
Descriptions of New Species of North Amer-		Drepanididae.....	609, 614, 627, 629
ican Crambid Moths, by W. D. Kearfott.....	367	Dromiceidae.....	538
Descriptions of some New Mosquitoes from		Dromius.....	603
Tropical America, by H. G. Dyar and Fred-		Drymocharis.....	613
erick Knab.....	53	Dryocolaptes.....	606
Desmosonidae.....	81	<i>major</i> .....	606
Dewetia.....	593, 605	<i>martini</i> .....	606
Diallophis <i>punctatus</i> .....	564	<i>minor</i> .....	606
Diatraea <i>alleni</i> .....	391	<i>viridis</i> .....	606
<i>differentialis</i> .....	391	Dryptosaurus <i>incrassatus</i> .....	356, 365
<i>idalis</i> .....	391	Dumetella.....	607, 618
<i>parallela</i> .....	391	<i>felviox</i> .....	607
<i>saccharalis</i> .....	392	Durrantia.....	197

	Page.		Page.
Durrantia obiterella.....	207	Eosphænicus gunnari.....	608
piperatella.....	197	Epelustia scabellæ.....	199
Dyar, Harrison G. and Frederick Knab. Descriptions of some New Mosquitoes from Tropical America.....	53	Epicallina.....	190, 201
Dybowskiæ.....	612	argenteinctella.....	201
Dyspetormis.....	607	coloradella.....	202
Eafa.....	607	dimidiella.....	202
maculata.....	607	edithella.....	201
Echinarachnitis gibbsii.....	342, 344	quadrimaculella.....	202
Echinolæa.....	342, 344, 346	Epops.....	608
Echmatemys rivalis.....	164	upupa.....	608
Echthrogalearis coleopratus.....	452	Eptesicus fuscus.....	547, 579, 581
torpedinis.....	451	Erebus edusa.....	225
Edolius.....	607	lunata.....	225
Egatheus.....	607	Eremopezus.....	608
Egretta.....	607	ocæemus.....	608
Ehretia elliptica.....	205	Ergasilidæ.....	433
Eido.....	189, 192	Erichthonius hunteri.....	543
albapalpella.....	192, 193	Eriocetta.....	608
albopalpella.....	193	Eriornis.....	608
Eigenmanni and Plagiogrammus hopkinsi. Notes on Two Rare California Fishes, Rimini-cola, by John Otterbein Snyder.....	183	antarcticus.....	608
Eighteen New Species and Two New Genera of Fishes from Japan and the Riu Kiu Islands. Descriptions of, by John Otterbein Snyder.....	93	Erithacus moussieri.....	606
Elainea elegans.....	607	Erpetocypris.....	413
incompta.....	631	Erythromachus leguati.....	622
tumbezana.....	631	Erythropus.....	608
waga.....	631	gallicus.....	608
Elainopsis.....	607	Etheostoma cæruleum.....	550
Elasmogorgia.....	717	Ethmia.....	190, 205
filiformis.....	683, 684, 717	albigrigella.....	206
Emarginata.....	634	albifogata.....	206
Emberiza lecontei.....	629	apicipunctella.....	206
militaris.....	644	areostaphylella.....	206
Emberizoides marginalis.....	599	aurifluella.....	206
melanotis.....	599	caliginosella.....	206
Empidonax.....	607	chambersella.....	207
Emys lativertebralis.....	166	confusella.....	206
Enchelyurus ater.....	111	coquilletella.....	206
flavipes.....	111	coranella.....	206
hepburni.....	110	discotrigella.....	206
Encrinurus caput-meduse.....	131	fuseipedella.....	206
paræ.....	131	hagenella.....	206
Endocœrinus.....	130, 131	josephinella.....	206
alternicœrinus.....	91, 131	lassenella.....	206
paræ.....	87, 88, 89, 91, 131	longinaculella.....	206
siboga.....	131	maceliosella.....	206
wyville-thomsoni.....	91, 131	marmorea.....	206
Endrosia.....	190, 203	mirusella.....	206
lacteella.....	203	monticola.....	206
Enodes.....	607	semilugens.....	206
Entomis.....	309	semiombra.....	206
impressa.....	297, 310	semitenebrella.....	206
obliqua.....	311	subcœrulea.....	206
oblonga.....	310	trifurcella.....	206
plicata.....	286, 293	obscurella.....	206
sigma.....	311	umbramarginella.....	206
umbonata.....	296, 310	zelleriella.....	206
Entomophila.....	608	Eubates.....	608
australis.....	608	Eucallornis.....	608
Eopodoces.....	608	Euclemensia.....	190, 202
Eosphænicus.....	608	bassettella.....	202
		schwarzella.....	202
		Endætylna uncinata.....	453, 476
		Endiocœrinus granulatus.....	117
		indivisus.....	113, 114, 117
		japonicus.....	113
		varians.....	113
		Eudrepanis.....	609

	Page.		Page.
Eufernaldia	385	Fishes, <i>Rimicola eigenmanni</i> and <i>Plagiogrammus hopkinsi</i> . Notes on Two Rare California, by John Otterbein Snyder	183
<i>argenteonervella</i>	385, 386	Five Species of North American Fossil Turtles, Four of which are New. Descriptions of, by Oliver P. Hay	161
Eugerygone	609	<i>Floricola</i>	589
Euglandina livida	180	Flying squirrel	509
<i>rosea</i>	180	Forehead. New Examples of American Indian Skulls with Low, by Aleš Hrdlička	171
Eugrotea	370	Formation of Geodes with Remarks on the Silicification of Fossils, by Ray S. Bassler	133
<i>yavapai</i>	377	<i>Formicariidae</i>	584, 597, 605, 632, 639, 642
Eumeces fasciatus	563	<i>Formicivora archavaletae</i>	643
Eumeyrickia	189, 191	<i>genei</i>	643
<i>trimaculella</i>	191	Fort Union Beds of Montana. Description of New Fossil Liverwort from the, by F. H. Knowlton	157
Eumuricea	718	Fossil Crabs from California. Descriptions of, by M. J. Rathbun	341
<i>pusilla</i>	683, 684, 718	Fossil Liverwort from the Fort Union Beds of Montana. Description of New, by F. H. Knowlton	157
Euplectes	609	Fossil Turtles, Four of which are New. Descriptions of Five Species of North American, by Oliver P. Hay	161
Eupoda	609	Fossils. The Formation of Geodes with Remarks on the Silicification of, by Ray S. Bassler	133
Eupilotis	609	Fox squirrel	568
Eurhynchus	609	<i>Francelinus</i>	610
Eurychilina	278, 298, 314	Fresh-water Shells from Mexico, believed to be New. Descriptions and Figures of some Land and, by W. H. Dall	177
Eurycope	84	<i>Fringilla albicollis</i>	614
<i>magnispinis</i>	84	<i>amandava</i>	588
<i>truncata</i>	81, 86	<i>cannabina</i>	595
Eurypylus	427	<i>carduelis</i>	584, 642
Eurystheus dentatus	541	<i>citrinella</i>	584
Examples of American Indian Skulls with Low Forehead. New, by Aleš Hrdlička	171	<i>erythrophthalma</i>	614
Eypathistoma	426	<i>flammea</i>	584
Fabiola	190, 202	<i>flavirostris</i>	584
<i>shalleriella</i>	202	<i>linaria</i>	584, 642
Falcator	609	<i>lulensis</i>	642
Falco bonnelli	590	<i>montifringilla</i>	642
<i>candicans</i>	596	<i>ornata</i>	598
<i>californensis</i>	621	<i>rosea</i>	640
<i>serpentarius</i>	612	<i>spinus</i>	584, 642
Falconidae	596, 600, 613, 639, 645	<i>violacea</i>	644
Families of the Comatulida and the Pentacrinutida. The Homologies of the Arm Joints and Arm Divisions in the recent Crinoids of the, by A. H. Clark	113	<i>Fringillidae</i>	584, 588, 592, 595, 596, 598, 599, 614, 617, 618, 625, 629, 632, 638, 642
Family and several New Genera and Species. The Amphipoda collected by the U. S. Bureau of Fisheries Steamer Albatross off the West Coast of North America, in 1903 and 1904, with Descriptions of a New, by Samuel J. Holmes	489	<i>Frugilegus</i>	610
Family Gnathiida from the Atlantic Coast of North America. Some New Isopods of the, by Harriet Richardson	483	<i>Funiculina</i>	706
Family Geophoridae, with Descriptions of New Species. A Generic Revision of American Moths of the, by August Busek	187	<i>armata</i>	682, 684, 706
Fanissa	609	<i>Funiculinidae</i>	682, 706
<i>sylicola</i>	609	<i>Furnariidae</i>	589, 593, 611, 614, 620
Figures of some Land and Fresh-water Shells from Mexico, believed to be New. Descriptions and, by W. H. Dall	177	Further Report on the Ostracoda of the United States National Museum, by R. W. Sharpe	399
Finschia	609	<i>Gadus macrocephalus</i>	440, 475, 476
Fishes. <i>Chorodon</i> in place of <i>Cherops</i> for a Labroid Genus of, by Theodore Gill	155	<i>Galbula</i>	592, 610
Fishes from Japan and the Rin Kiu Islands. Descriptions of Eighteen New Species and Two New Genera of, by John Otterbein Snyder	93	<i>Gallbulide</i>	592, 616
Fishes of the Pacific Coast, with Descriptions of New Genera and Species. North American Parasitic Copepods: a List of those found upon the, by Charles Branch Wilson	431	<i>Galeorhinus zyopterus</i>	453, 459, 476
		<i>Galerita</i>	602
		<i>Gallirex johnstoni</i>	640

	Page		Page
Gallophasis.....	610	Georgian bat.....	580
Gambo.....	610	Gerdana.....	189, 193
Gammaridae.....	539	<i>caritella</i> .....	193
Gammaridea.....	492	Gill, Theodore, Chorodon in place of Cho-	
Garter snake.....	566	rops for a Labroid Genus of Fishes.....	155
Gasteropoda.....	342, 344, 346, 349	Gingaba.....	611
Gauria.....	610	Glareola coromanda.....	635
Gavia.....	610	<i>madraspatana</i> .....	635
Gelochelidon.....	610	<i>maldivarum</i> .....	635
Genera and Species, North American Para-		Glaux.....	611
sitic Copepods: a List of those found upon		<i>nudipes</i> .....	611
the Fishes of the Pacific Coast, with Des-		<i>tengmalmi</i> .....	611
criptions of New, by Charles Branch		Glycymeris.....	341
Wilson.....	431	<i>veatchi</i> .....	349
Genera and Species of Carnivorous Dinosaurs,		Glyptops plicatulus.....	161
with special Reference to <i>Ceratopsus nasi-</i>		Gnathia.....	183, 485
<i>cornis</i> Marsh. On certain, by Oliver P.		<i>cristata</i> .....	486
Hay.....	351	<i>multispinis</i> .....	485
Genera and Species, The Amphipoda col-		<i>serrata</i> .....	487
lected by the U. S. Bureau of Fisheries		Gnathiidae.....	483
Steamer "Albatross" off the West Coast of		Gnathiidae from the Atlantic Coast of North	
North America, in 1903 and 1904, with Des-		America. Some New Isopods of the Fam-	
criptions of a New Family and several		ily, by Harriet Richardson.....	483
New, by Samuel J. Holmes.....	189	Gnatholepis sindonis.....	161
Genera <i>Deinodon</i> Leidy, <i>Dryptosaurus</i> Marsh,		Gobiesox eigenmanni.....	183
and <i>Albertosaurus</i> Osborn.....	356	<i>muscarum</i> .....	183, 184
Genera, New American Paleozoic Ostra-		Gobiidae.....	100
codæ. Preliminary Revision of the <i>Byr-</i>		Goodfellowia.....	611
<i>richiidae</i> , with Descriptions of New, By		<i>miranda</i> .....	611
E. O. Ulrich and Ray S. Bassler.....	277	Gorgonacea.....	683, 714
Genera of Fishes from Japan and the Riu Kiu		<i>Gorgonia purpurea</i> .....	722
Islands. Descriptions of Eighteen New		<i>Gorgonide</i> .....	683, 722
Species and Two New, by John Otterbein		Gracilipes.....	489, 526
Snyder.....	93	<i>distincta</i> .....	529
Generic Names applied to Birds during the		<i>natator</i> .....	527
Years 1901 to 1905, inclusive, with further		Gralla.....	611
Additions to Waterhouse's "Index <i>Generum</i>		<i>Grallaria imperator</i> .....	597
<i>Avium</i> ," by C. W. Richmond.....	583	Gray fox.....	575
Generic Revision of American Moths of the		squirrel.....	569
Family <i>Geophoridae</i> , with Descriptions of		Green frog.....	561
New Species, by August Busck.....	187	<i>tritron</i> .....	557
Generum <i>Avium</i> . Generic Names applied		Ground-hog.....	569
to Birds during the Years 1901 to 1905,		snake.....	563
inclusive, with further Additions to <i>Water-</i>		Group of <i>Beyrichia buchiana</i> .....	288
house's Index, by C. W. Richmond.....	583	<i>clavata</i> .....	293
Genus <i>Homoptera</i> Boisduval. A Revision of		<i>interrupta</i> .....	299
some Species of <i>Noctuidæ</i> heretofore re-		<i>klodeni</i> .....	287
ferred to the, by J. B. Smith.....	209	<i>linnarsoni</i> .....	295
Genus <i>Labrosaurus</i> Marsh and its species....	351	<i>salteriana</i> .....	292
Genus of Fishes. <i>Chorodon</i> in place of <i>Cho-</i>		<i>tuberculata</i> .....	289
<i>rops</i> for a Labroid, by Theodore Gill.....	155	<i>Ctenobolbina ciliata</i> .....	310
Genus <i>Ramphalecyon</i> (Pelargopsis). A Revi-		<i>subcrassa</i> .....	310
sion of the Kingfisher, by H. C. Oberholser..	657	Gruide.....	588, 626, 641
Gelochelidon.....	610	Gryphus.....	611
Geocichla.....	610, 611	Gupista.....	611
Geocichloides.....	610	<i>barbata</i> .....	611
Geodes with Remarks on the Silicification of		Gymnopus.....	612
Fossils. The Formation of, by Ray S.		<i>teschenaulti</i> .....	612
Bassler.....	133	Gymnothorax <i>chlamydatus</i> .....	91
Geo-Kichla.....	610	<i>odiosus</i> .....	94
<i>singularis</i> .....	610	Gypogeranidae.....	612
<i>Geosoria orryctera</i> .....	611	Gypogeraurus.....	612
Geopega.....	611	<i>Hæmatornis flavicollis</i> .....	592
Geophilus.....	611	Hæmeria.....	612
<i>jasijatere</i> .....	611	Hæmobaphes <i>cyclopterina</i> .....	458



	Page.		Page.
Hahn, Walter L. Notes on the Mammals and Cold-blooded Vertebrates of the Indiana University Farm, Mitchell, Indiana.....	545	Hierax subbuteo.....	613
Haleyon.....	612	tinnunculus.....	613
alcedo.....	612	Himatione maculata.....	629
amauropterus.....	661	Hirundinidae.....	588, 606, 617, 620, 621, 627
bruniceps.....	669, 670	Hirundo cinerea.....	627
Halipterus.....	707	ducata.....	588
christii.....	706	melanoleuca.....	606
contorta.....	682, 684, 707	Hoary bat.....	581
Haliptagoides.....	527	Hoerataria.....	614
Halisceptrum.....	698	Hog-nose snake.....	564
cystiferum.....	682, 684, 698	Holaxonia.....	683, 714
Haliptela.....	279	Hollina.....	309, 315
Halohippus.....	612	antespinosa.....	315
Haplocichla.....	612	armata.....	315
Haploniscus.....	75	cavimarginata.....	315
bicuspis.....	77	emacolata.....	316
excisus.....	75	granifera.....	315, 317
retrospinis.....	77	informis.....	315
Haploops tubicola.....	518	insolens.....	315
Hargeria.....	612	kolmodini.....	312, 315
Harpaleus.....	612	longispina.....	316, 321
Harpinia affinis.....	522, 523	radiata.....	315, 316, 317
oculata.....	521	spiculosa.....	315
plumosa.....	524	tricollina.....	315
Hatschekia hippoglossi.....	457	Holmes, Samuel J. The Amphipoda collected by the U. S. Bureau of Fisheries Steamer Albatross off the West Coast of North America in 1903 and 1904, with Descriptions of a New Family and several New Genera and Species.....	489
pinguis.....	455, 477	Homologies of the Arm Joints and Arm Divisions in the recent Crinoids of the Families of the Comatulida and the Pentacrinitidae, by A. H. Clark.....	113
Hay, Oliver P. Descriptions of Five Species of North American Fossil Turtles, Four of which are New.....	161	Homoptera albofasciata.....	238
On certain Genera and Species of Carnivorous Dinosaurs, with special Reference to Ceratosaurus nasicornis Marsh.....	351	atritincta.....	229
Heliolais.....	612	Homoptera Boisduval. A Revision of some Species of Noctuidae heretofore referred to the Genus, by J. B. Smith.....	209
Heliometra maxima.....	126	Homoptera calycanthata.....	236, 269, 270
tanneri.....	125	cinerea.....	271
Helionympha.....	613	cingulifera.....	261
Heliophilus.....	613	duplicata.....	258
taunaysii.....	613	edusa.....	225
Heliornithidae.....	634	edusina.....	229
Helminthophaga.....	613	exhausta.....	221
Hemiproctæ.....	613	fictilis.....	222
Hemiproctidae.....	605, 613	galbanata.....	243
Hemiura.....	624	guadalupeensis.....	222
Herpetocypridinae.....	400, 413	horrida.....	270
Herpetocypris.....	400, 413	intenta.....	261
Hesperornis gracilis.....	612	involuta.....	225
Hesperornithidae.....	612	lineosa.....	243
Heteroleotris arenarius.....	100	lunata.....	225
clara.....	101	minera.....	238
Heterodon platyrhinus.....	564	nigricans.....	231, 232
Heteromesus granulatus.....	82	obliqua.....	238
greeni.....	84	penna.....	241
spinescens.....	83	plenipennis.....	233
Heteroxenicus.....	613	putrescens.....	225, 272
Hexanemus.....	613	rosa.....	228
Hierax.....	613	rubi.....	266
caesius.....	613	salicis.....	228
islandicus.....	613	saundersii.....	225
peregrinus.....	613	sexplagiata.....	272
rufipes.....	613		

	Page.		Page.
<b>Homoptera umbripennis</b> .....	231	<b>Hyocypris gibba</b> .....	400, 410, 411, 412
<i>uniformia</i> .....	269	<b>Hyodromus</b> .....	400, 413
<i>unilineata</i> .....	245	<i>pectinatus</i> .....	400, 413
<i>viridans</i> .....	221	"Index Generum Avium." Generic Names	
<i>woodii</i> .....	261	applied to Birds during the Years 1901 to	
<b>Hopkinsi</b> . Notes on Two Rare California		1905, inclusive, with further Additions to	
Fishes, <i>Rimicola elgmanni</i> and <i>Plagio-</i>		Waterhouse's, by C. W. Richmond.....	583
<i>grammus</i> , by John Otterbein Snyder.....	183	<b>Indian Skulls with Low Forehead</b> . New Ex-	
<b>Hoplitica</b> .....	191	amples of American, by Ales Hrdlička.....	171
<b>Hoplochelys carinata</b> .....	163, 164	<b>Indiana University Farm</b> , Mitchell, Indi-	
<i>crassa</i> .....	161	ana. Notes on the Mammals and Cold-	
<b>Horizillas</b> .....	614	blooded Vertebrates of the, by Walter L.	
<b>Hortulanus</b> .....	614	Hahn.....	545
<i>erythrophthalmus</i> .....	614	<b>Indicaterode</b> .....	636
<i>montanus</i> .....	614	<b>Inga</b> .....	190, 200
<i>nigricollis</i> .....	614	<i>sparsicollis</i> .....	200, 201
<b>House snake</b> .....	506	<b>Inoceramus subundatus</b> .....	349
<b>Hrdlička, Ales</b> . New Examples of American		<b>Inusta</b> .....	395
Indian Skulls with Low Forehead.....	171	<i>antillarum</i> .....	395
<b>Huhus</b> .....	614	<b>Iolanthe acanthonotus</b> .....	73
<b>Hybognathus nuchalis</b> .....	549	<i>decorata</i> .....	73
<b>Hydrichla</b> .....	614	<b>Iolella</b> .....	71, 73
<b>Hydrolagus collicii</b> .....	434, 439, 476	<i>glabra</i> .....	71
<b>Hydrolegus</b> .....	614	<i>spinosa</i> .....	72
<i>silvestrianus</i> .....	614	<b>Iridophanes</b> .....	616
<b>Hydropeleia</b> .....	614	<b>Ischnomesus</b> .....	81
<b>Hydromis</b> .....	607	<b>Ischnosoma</b> .....	81
<b>Hyla pickeringii</b> .....	559, 562	<i>baeciloides</i> .....	81
<i>versicolor</i> .....	559, 562	<i>baecilus</i> .....	81
<b>Hylacon</b> .....	660	<i>bispinosum</i> .....	81
<b>Hylocentrites</b> .....	615	<i>greeni</i> .....	81
<i>ambulator</i> .....	615	<i>quadrispinosum</i> .....	81
<b>Hylodes</b> .....	615	<i>spinosum</i> .....	81
<b>Hylomax</b> .....	615	<i>thomsoni</i> .....	81
<b>Hypalocrinus</b> .....	129, 130	<b>Isoerinus</b> .....	115, 129
<i>naresianus</i> .....	131	<i>alternicornis</i> .....	126, 128, 129
<b>Hyperia medullarum</b> .....	490	<i>asteria</i> .....	127, 128, 129
<b>Hyperida</b> .....	490	<i>blakei</i> .....	127, 128
<b>Hypermegethes</b> .....	615	( <i>Isocornis</i> ) <i>asteria</i> .....	131
<b>Hypphantomis badius</b> .....	600	<i>decorus</i> .....	87, 88, 91, 127, 128, 129, 130
<i>dimidiatus</i> .....	600	( <i>Isocornis</i> ) <i>blakei</i> .....	131
<i>grandis</i> .....	615	<i>decorus</i> .....	131
<i>tricolor</i> .....	600	<i>naresianus</i> .....	126
<b>Hypocryptadius</b> .....	615	<i>parre</i> .....	126, 128, 129
<i>cinnamomeus</i> .....	615	<i>pendulus</i> .....	131
<b>Hypsigenys</b> .....	155	<i>silogae</i> .....	126, 128, 129
<b>Hypsypops rubicundus</b> .....	434, 476	<i>wyville-thomsoni</i> .....	126, 128, 129
<b>Ianthopsis bovallii</b> .....	73	<b>Isopoda of the Superfamily Aselloidea from</b>	
<b>Ibidide</b> .....	607	the Atlantic Coast of North America. Some	
<b>Ichla</b> .....	615	New, by Harriet Richardson.....	71
<b>Ichthyactis</b> .....	615	<b>Isopods of the Family Gnathiidae from the</b>	
<i>piscivorus</i> .....	615	Atlantic Coast of North America. Some	
<b>Ichthyornis dispar</b> .....	600	New, by Harriet Richardson.....	483
<b>Ichthyornithide</b> .....	600	<b>Isotremornis</b> .....	616
<b>Ichthyopteryx</b> .....	615	<i>nordenskjoldi</i> .....	616
<i>gracilis</i> .....	615	<b>Ixobrychus</b> .....	616
<b>Icteridae</b> .....	581, 637, 647	<b>Jacamerops</b> .....	616
<b>Ictinus</b> .....	615	<b>Jacamide</b> .....	622
<i>milvus</i> .....	615	<b>Janrella</b> .....	77
<b>Idiocichla</b> .....	615	<i>lobata</i> .....	78
<b>Idiococcyx</b> .....	616	<i>nanseni</i> .....	77, 79
<b>Idiotricicus</b> .....	616	<b>Januride</b> .....	71, 77
<b>Hyocypris</b> .....	400, 410	<b>Janthinosoma albipes</b> .....	57
<i>bradyi</i> .....	400, 410, 411	<i>litzii</i> .....	57

	Page.		Page.
Japan and the Riu Kiu Islands. Descriptions of Eighteen New Species and Two New Genera of Fishes from, by John Otterbein Snyder.....	93	Knipolegus hudsoni.....	631
Jefferson salamander.....	550	Knowlton, Frank Hall. Description of New Fossil Liverwort from the Fort Union Beds of Montana.....	157
Joints and Arm Divisions in the recent Crinoids of the Families of the Comatulida and the Pentaerinitidae. The Homologies of the Arm, by A. H. Clark.....	113	Koroga, megalops.....	502, 503
Jonesella.....	278	Koslowia.....	617
Jonesina.....	320, 324	Krimnochelidon.....	617
arenata.....	324	Kyammodos.....	320
bolliiformis.....	325	Labroid Genus of Fishes. Cherodon in place of Cherops for a, by Theodore Gill.....	155
bradyana.....	324	Labrosaurus.....	351
eraterigera.....	324, 325	ferox.....	352, 353
fastigiata.....	324	fragilis.....	352
foliata.....	324	lucaris.....	351, 352
Kasnakowia.....	616	suleatus.....	352, 353
koslowi.....	616	Labrus macrodonatus.....	155, 156
Kaznakowia.....	616	La-laps incrassatus.....	356
Kearfott, William Dunham. Descriptions of New Species of North American Crambid Moths.....	367	Lakota.....	498
Kelea.....	616	earinata.....	498
Kenopia.....	617	Lamprochelidon.....	617
Kermes.....	188	Lampronotus.....	617
Kingfisher Genus Ramphaleyon (Pelagopsis). A Revision of the, by H. C. Oberholser.....	657	auratus.....	617
Kirkbya annectens.....	322	Lampropeltis dolliatus triangulus.....	566
Kirkbyina.....	320, 322	Lamprophonus.....	617
Kloedenella.....	317	muscius.....	617
clarkii.....	319, 320	turdus.....	617
halli.....	319	variegatus.....	617
pennsylvanica.....	318, 319	viscicorus.....	617
Kloedenellina.....	317	Lamprotornis.....	607
Kluedenia.....	277, 312, 317	Lampsilis explicata.....	181
apiculata.....	301	(Proptera) salinasensis.....	181
centricornis.....	301	Land and Fresh-water Shells from Mexico, believed to be New. Descriptions and Figures of some, by W. H. Dall.....	177
concinna.....	301	Laniellus.....	617
fimbriata.....	301	Laniidae.....	503, 603
granulata.....	301	Lanius cayanus.....	628
initialis.....	301	superbus.....	593
intermedia.....	301	Large-winged bat.....	580
marginata.....	301	Laridae.....	598, 614, 622
jerseyensis.....	301	Larus canus.....	610
manliensis deckerensis.....	301	minutus.....	610
marginalis.....	301	ridibundus.....	610
montaguensis.....	301	rissa.....	610
nearpassi.....	301	Lasiurus borealis.....	547, 581
oculina.....	301	cinereus.....	547, 581
parasitica.....	301	Leonardia.....	617
praemunita.....	301	woodi.....	617
punctiflora.....	301	Leonardina.....	617
retifera.....	302	Leopard frog.....	561
scotica.....	302	Lepeoptheirus bifurcatus.....	440
simplex.....	302	brachyurus.....	441, 477
smocki.....	302	constrictus.....	443, 477
tuberculata.....	302	insignis.....	444
turgida.....	318	longipes.....	440, 477
wallpackensis.....	302	nordmannii.....	439, 477
wilckensiana.....	302	pacificus.....	440, 477
plicata.....	302	parviventris.....	476, 477
Knab, Frederick and Harrison G. Dyar. Descriptions of some New Mosquitoes from Tropical America.....	53	salmonis.....	440, 477
		thompsoni.....	441
		Leperditia.....	280
		Lepidaplois loxozonus.....	95
		macrurus.....	95
		mirabilis.....	96
		Lepidopsetta bilineata.....	476

	Page.		Page.
Leptocephalide.....	81	Macrocephalon.....	619
Leptocephalus flavirostris.....	93	maleo.....	619
Leptogorgia.....	721, 722, 724	Macronectes.....	619
caryi.....	683, 684, 723	Macronyx tenellus.....	597
florae.....	683, 684, 722	Macropus.....	619
purpurea.....	683, 684, 722	caixana.....	619
Leptotricus sylvius.....	632	phasanellus.....	611, 619
Lernaenicus mendisanus.....	458	Macrorhamphus.....	618
Lernaeopoda bearii.....	470, 477	Maetra stantoni.....	319
bicanaliculata.....	472, 477	Mera dubia.....	559
californiensis.....	475, 477	spiniacantha.....	559
extumescens.....	475, 476	Malacodius.....	619
falcinata.....	473, 477	Malacopterom.....	614
gibber.....	469, 471, 477	Malacoramphus.....	619
Lernaeopodida.....	464	araneanus.....	619
Lerneida.....	458	Malacurus.....	619
Lesticeompa schledocyclia.....	61	Malaysian Basketwork: A Study in the W. L. Abbott Collections. Vocabulary of, by Otis T. Mason.....	1
Leucophrya.....	617	Malunbus nigracollis.....	620
Leucosticta reborowskii.....	617	Malurus galactotes.....	621
Liljeborgia brevicornis.....	526	Mammals.....	567
Liljeborgiida.....	526	Mammals and Cold-blooded Vertebrates of the Indiana University Farm, Mitchell, Indiana. Notes on the, by Walter L. Hahn.....	545
Limicola.....	626	Mancalla.....	619
Limnophylax.....	618	californiensis.....	619
marmorata.....	618	Mangunhosia.....	53
Linaria pusilla.....	640	Marchantia pealei.....	157
Linophaga.....	618	polymorpha.....	157, 158, 159
canescens.....	618	sezannensis.....	158, 159
montium.....	618	Marchantites erectus.....	158
rubra.....	618	Margaritella.....	319
Lithosteorhis.....	618	Mara.....	619
Little brown bat.....	579, 581	MacGregoria.....	619
Liverwort from the Fort Union Beds of Montana. Description of New Fossil, by F. H. Knowlton.....	157	Maridus.....	619
Loborhamphus.....	618	Maria.....	619
nobilis.....	618	Marmota monax.....	569
Loncornis.....	618	Marsh, On certain Genera and Species of Carnivorous Dinosaurs, with special Reference to Ceratosaurus nasicornis, by Oliver P. Hay.....	351
erectus.....	618	Martula.....	619
Long-tailed triton.....	555	Martyringa.....	189, 190
Longrostris.....	618	latipennis.....	190
Low Forehead. New Examples of American Indian Skulls with, by Aleš Hrdlička.....	171	Mason, Otis T., Vocabulary of Malaysian Basketwork: A Study in the W. L. Abbott Collections.....	1
Loxia fuliginosa.....	638	Megacephalus.....	620
orix.....	609	bitorquatus.....	620
rubicilla.....	640	Megaloramphus.....	620
Loxorhynchus.....	341	asiaticus.....	620
grandis.....	341, 342, 343	Megapodid.....	619
Loxorynchus.....	618	Megaxenops.....	620
albipennis.....	618	Melanhyphantes.....	620
curvirostra.....	618	Melanoparus semilarvatus.....	630
grandis.....	342	Melanocorypha torquata.....	595
Lucar.....	618	Melanoleuca.....	620
Lunatia.....	349	pica.....	620
Lusemia.....	619	Melanonyx.....	620
adon.....	619	Melanopteryx.....	621
megarhynchus.....	619	Meleagris.....	637, 641
Lutroea vison.....	576	satyra.....	641
Lycodontis mordax.....	476	Menyanthes trifoliata.....	418
Lysianassa.....	503		
Lysianassidae.....	492		
Lysianella.....	505		
Macao.....	619		
splendidus.....	619		
Machimia.....	194		
Macoma nasuta.....	342		

	Page.		Page.
Mephitis putida.....	576	Mitchell, Indiana. Notes on the Mammals and Cold-blooded Vertebrates of the Indiana University Farm, by Walter L. Hahn.....	545
Mergus octosetaceus.....	635	Mniotiltidae.....	599, 625, 638
Merion.....	621	Mola mola.....	439, 444, 477
Merula.....	621	Mole mouse.....	572
Mesolia.....	370	Monadon.....	622
baboquivariella.....	374	Monias.....	622
huachucaella.....	374	benschi.....	622
oraucella.....	370, 373	Monoculus.....	416
Prionapteryx.....	375	fuscatus.....	403
Metacrinus.....	87, 114, 115, 128, 129, 130	Montana. Description of New Fossil Liver- wort from the Fort Union Beds of, by F. H. Knowlton.....	157
acutus.....	130	Morphnætos.....	622
angulatus.....	130	Moscha.....	623
cingulatus.....	130	carunculata.....	623
costatus.....	130	Mosquitoes from Tropical America. De- scriptions of some New, by H. G. Dyar and Frederick Knab.....	53
mosleyi.....	130	Motacilla aeredula.....	639
murrayi.....	170	arctica.....	599
var. nobilis.....	130	dominica.....	625
timorensis.....	130	ficedula.....	643
nodosus.....	130	indica.....	594, 625
rotundus.....	88, 89, 91, 130	minuta.....	633
var. interruptus.....	130	modularis.....	613
serratus.....	130	nisoria.....	632
stewarti.....	130	phoeniceus.....	613, 631, 639
sulnensis.....	130	regulus.....	613
superbus.....	130	rubecula.....	613, 631
var. tuberculatus.....	130	rufa.....	613, 643
tuberosus.....	130	salicaria.....	613
varians.....	130	schoenobaena.....	646
wyvillii.....	130	sibilatix.....	639, 643
Metancylornis.....	621	suecica.....	604, 613, 631
Metis.....	346	titys.....	613, 631
Metopa pacifica.....	524	trochilus.....	643
Metopidae.....	524	troglodytes.....	613, 624, 627
Mexico, believed to be New. Descriptions and Figures of some Land and Fresh-water Shells from, by W. H. Dall.....	177	Motacillidae.....	594, 597, 625, 629, 641
Micrætus.....	621	Moths. Descriptions of New Species of North American Crambid, by W. D. Kearfott.....	367
holmbergianus.....	621	Moths of the Family Cecophoridae, with De- scriptions of New Species. A Generic Re- vision of American, by August Busck.....	187
Micropodidae.....	585, 586, 594, 644	Mulinia densata.....	344
Microchelidon.....	621	Mulleria.....	594
Microgoura.....	621	Munna.....	79
meeki.....	621	fabricii.....	80, 81
Microgouridae.....	621	kroyeri.....	81
Microlyssa.....	621	truncata.....	79
Microparra.....	622	Munniidae.....	79
Micropsites.....	622	Munnopsidae.....	84
pygmaeus.....	622	Muraenidae.....	94
Microtricus.....	622	Muriceidae.....	683, 717
Microtrogon.....	622	Muricella.....	717
fulvescens.....	622	complanata.....	683, 684, 717
galbuloides.....	622	Muscaccipiter.....	623
Microtus ochrogaster.....	547, 568, 571, 572	Muscadivores.....	623
pennsylvanicus.....	568, 572	Muscicapa atricapilla.....	643
pinetorum.....	572, 577	carolinensis.....	618
auricularis.....	572	gaimardi.....	607
Microura supercilialis.....	637	latirostris.....	591
Milk snake.....	566	obsoleta.....	638
Mimide.....	607, 618	riisi.....	627
Mink.....	576	semipartita.....	607
Minytrema melanops.....	549		
Mirafra phoeniceuroides.....	588		
Misamichus.....	622		
pallasii.....	622		
Miserythrus.....	622		
leguati.....	622		
Missouri skull.....	173		

	Page.		Page.
<i>Muscicapa sulphurea</i> .....	647	<i>Nesocharis</i> .....	626
<i>Muscicapidae</i> .....	590,	<i>shelleyi</i> .....	626
591, 599, 601, 607, 609, 623, 624, 627, 629, 640, 643		<i>Neyerita reclusiana</i> .....	342
<i>Muscicula</i> .....	623	New American Paleozoic Ostracoda. Preliminary Revision of the Beyrichiidae, with Descriptions of New Genera, by E. O. Ulrich and Ray S. Bassler.....	277
<i>Muscipeta</i> .....	616	New Descriptions and Figures of some Land and Fresh-water Shells from Mexico, believed to be, by W. H. Dall.....	177
<i>Musophagidae</i> .....	623, 631, 640	New Descriptions of Five Species of North American Fossil Turtles, Four of which are, by Oliver P. Hay.....	164
<i>Musovora</i> .....	623	New Examples of American Indian Skulls with Low Forehead, by Aloš Hrdlička.....	171
<i>Myiagrus lineatus</i> .....	597	New Family and several New Genera and Species. The Amphipoda collected by the U. S. Bureau of Fisheries Steamer "Albatross," of the West Coast of North America, in 1903 and 1904, with Descriptions of a, by Samuel J. Holmes.....	489
<i>Myiarchus validus</i> .....	615	New Fossil Liverwort, from the Fort Union Beds of Montana. Description of, by F. H. Knowlton.....	157
<i>Myiobius capitalis</i> .....	590	New Genera and Species. North American Parasitic Copepods: a List of those found upon the Fishes of the Pacific Coast, with Descriptions of, by Charles Branch Wilson.....	431
<i>fulvicularis</i> .....	645	New Genera of Fishes from Japan and the Riu Kiu Islands. Descriptions of Eighteen New Species and Two, by John Otterbein Snyder.....	93
<i>Myiophthorus</i> .....	623	New Genera. New American Paleozoic Ostracoda. Preliminary Revision of the Beyrichiidae, with Descriptions of, by E. O. Ulrich and Ray S. Bassler.....	277
<i>morenoanus</i> .....	623	New Isopoda of the Superfamily Aselloidea from the Atlantic Coast of North America. Some, by Harriet Richardson.....	71
<i>Myiornis</i> .....	623	New Isopods of the Family Gnathiidae from the Atlantic Coast of North America, by Harriet Richardson.....	483
<i>Myiothera calcarata</i> .....	615	New Mosquitoes from Tropical America. Descriptions of some, by H. G. Dyar and Frederick Knab.....	53
<i>maculata</i> .....	632	New Species. A Generic Revision of American Moths of the Family Geophoridae, with Descriptions of, by August Busck.....	187
<i>nematura</i> .....	614	New Species and Two New Genera of Fishes from Japan and the Riu Kiu Islands. Descriptions of Eighteen, by John Otterbein Snyder.....	93
<i>rufimarginata</i> .....	605	New Species of Neotropical Orthoptera of the Family Acrididae. Two, by James A. G. Rehn.....	395
<i>umbretta</i> .....	611	New Species of North American Crambid Moths. Descriptions of, by W. D. Kearfoot.....	367
<i>Myiotheras</i> .....	623	<i>Newnhamia patagonica</i> .....	417
<i>griseus</i> .....	623	<i>Newt</i> .....	557
<i>luctuosus</i> .....	623	<i>Nieppo tumida</i> .....	526
<i>Myiotriccus</i> .....	623	<i>Nigrita arnaud</i> .....	637
<i>Myopornis</i> .....	624	<i>Noctua edusa</i> .....	225
<i>Myothera lepidoccephala</i> .....	624	<i>lunata</i> .....	225, 272
<i>Myotis lucifugus</i> .....	547, 578, 579, 580	<i>squamularis</i> .....	253
<i>subulatus</i> .....	578, 579	<i>undularis</i> .....	231
<i>velifer</i> .....	547, 580		
<i>Mystacinus russicus</i> .....	593		
<i>Myzomyia lutzii</i> .....	53		
<i>Myzorhynchella lutzii</i> .....	53		
<i>Nannobraconium leucopsarum</i> .....	458		
<i>Nannorellibus</i> .....	624		
<i>Nannus</i> .....	624		
<i>Napothera</i> .....	624		
<i>Nasicornis</i> Marsh. On certain Genera and Species of Carnivorous Dinosaurs, with special Reference to <i>Ceratops</i> , by Oliver P. Hay.....	351		
<i>Nassa californiana</i> .....	342, 344		
<i>Natrix sipedon</i> .....	547, 566		
<i>Nea</i> .....	624		
<i>Nectarinia chrysocephala</i> .....	590		
<i>hartlaubii</i> .....	589		
<i>thomensis</i> .....	589		
<i>Nectariniidae</i> .....	589, 590, 609, 613		
<i>Necturus maculosus</i> .....	559		
<i>Necurus</i> .....	624		
<i>rothi</i> .....	624		
<i>Nemorolea</i> .....	625		
<i>nipalensis</i> .....	625		
<i>Neodendroica</i> .....	625		
<i>Neoménis</i> .....	625		
<i>Neopleustes assimilis</i> .....	533		
<i>bairdi</i> .....	533		
<i>brevicornis</i> .....	532		
<i>oculatus</i> .....	531		
<i>Neositta</i> .....	625		
<i>Neospiza</i> .....	625		
<i>Neothraupis</i> .....	625		
Neotropical Orthoptera of the Family Acrididae. Two New Species of, by James A. G. Rehn.....	395		
<i>Nesippus borealis</i> .....	453		
<i>curticeaudis</i> .....	453		
<i>Nesobates</i> .....	625		

	Page.		Page.
Noctuidæ heretofore referred to the Genus		Odontospiza.....	627
Homoptera Boisduval. A Revision of		Œcophora.....	190
some Species of, by J. B. Smith.....	209	sulphurella.....	203
North America, in 1903 and 1904, with Descriptions of a New Family and several New Genera and Species. The Amphipoda collected by the U. S. Bureau of Fisheries Steamer "Albatross" off the West Coast of,		Œcophoridae, with Descriptions of New Species. A Generic Revision of American Moths of the Family, by August Busck.....	187
by Samuel J. Holmes.....	489	Œdiceriidae.....	633
North America. Some New Isopoda of the Superfamily Aselloidea from the Atlantic Coast of, by Harriet Richardson.....	71	Olbiorchilus.....	627
North America. Some New Isopods of the Family Gnathiidae from the Atlantic Coast of, by Harriet Richardson.....	483	On certain Genera and Species of Carnivorous Dinosaurs, with special Reference to <i>Ceratopsaurus nasicornis</i> Marsh, by Oliver P. Hay.....	351
North American Crambid Moths. Descriptions of New Species of, by W. D. Kearfott.....	367	Oncorhynchus gorbusha.....	441, 477
North American Fossil Turtles, Four of which are New. Descriptions of Five Species of, by Oliver P. Hay.....	161	kisutch.....	432
North American Parasitic Copepods: a List of those found upon the Fishes of the Pacific Coast, with Descriptions of New Genera and Species. By Charles Branch Wilson..	431	nerka.....	440, 473, 477
Note on <i>Antrodemus</i> Leidy.....	353	tshawytscha.....	439, 441, 470, 477
Notes on the Mammals and Cold-blooded Vertebrates of the Indiana University Farm, Mitchell, Indiana, by Walter L. Hahn.....	545	Onisimus.....	502
Notes on Two Rare California Fishes, <i>Rhinichthys eigenmanni</i> and <i>Plagiogrammus hopkinsi</i> , by John Otterbein Snyder.....	183	Opimia.....	459
Notiosichla.....	626	exilis.....	459
Notiospiza.....	626	gracilis.....	476
Notodromadinae.....	400, 414	Opossum.....	568
Notodromas.....	400, 414, 416	Orchilus.....	627
entzi.....	417	cristatus.....	627
fuscatus.....	417	Orchomenella affinis.....	492
madaraszii.....	417	groenlandica.....	494
monacha.....	400, 405, 417	minuta.....	494
oculatus.....	417	nanus.....	493
Notropis whipplei.....	549	pinguis.....	494
Nuclea truncata.....	349	Oregon skull.....	171
Numenius pusillus.....	633	Oreias.....	627
Numida.....	626	Oreomyias.....	627
Numidica.....	626	Oreomystis.....	627
Nutting, Charles C. Alcyonaria of the Californian Coast.....	681	Oreomyza.....	627
Nyctagrenus.....	626	Oreosecopus.....	627
Nyctala.....	604	Orientation of the valves.....	280
Nycteorax limnophylax.....	618	Orioliidae.....	598, 610
Nyctimene.....	626	Oriolus caudatus.....	588
flammula.....	626	flavus.....	647
stridula.....	626	galbula.....	610
Nyctornis.....	626	Ortes.....	627
Nymphæa.....	418	Ornithomimus velox.....	357
Nystactes.....	626	Orochelidon.....	627
Oberholser, Harry C. A Revision of the Kingfisher Genus <i>Ramphalcyon</i> ( <i>Pelagicopsis</i> ).....	657	Orodynastes.....	627
Observations on the Skull of <i>Ceratopsaurus nasicornis</i> Marsh.....	359	Orthoceras.....	134
Ocyplannus.....	626	Orthoptera of the Family Acrididae. Two New Species of Neotropical, by James A. G. Rehn.....	395
proeetus.....	626	Ortyx.....	628
Ocypodidae.....	346	Ossifraga.....	619, 628
Odontophorus.....	605	albicailla.....	628
		Osteornis.....	618
		Ostracoda of the United States National Museum. A further Report on the, by R. W. Sharpe.....	399
		Ostracoda. Preliminary Revision of the Beyrichiidae, with Descriptions of New Genera. New American Paleozoic. By E. O. Ulrich and Ray S. Bassler.....	277
		<i>Ostrea brewerii</i> .....	349
		Oticulus.....	628
		Otididae.....	628
		Otis bengalensis.....	628
		Otus.....	628
		bakkamoena.....	628
		Owenia.....	628
		Oxylabes.....	625

	Page.		Page.
Oxyporus.....	628	Pavonaria californica.....	705
Pachypteryx.....	628	Pecten andersoni.....	346
grandis.....	628	coalingensis.....	342
Pachyrhynchus.....	628	crassicaudo.....	346
melanocephalus.....	628	nutteri.....	342
Pacific Coast, with Descriptions of New Genera and Species. North American Parasitic Copepods: a List of those found upon the Fishes of the, by Charles Branch Wilson.....	431	Pecten.....	342
Palaeoapterodytes.....	500, 629	Pecten.....	629
Palaenornis.....	629	Pelargopsis: A Revision of the Kingfisher Genus Ramphaleyon, by H. C. Oberholser.....	657
Palaospheniscus bergi.....	629	Pelargopsis.....	659
Palamedea cristata.....	642	burmanica.....	670
Palamedeidae.....	597	dichrorhyncha.....	663
Paleozoic Ostracoda. Preliminary Revision of the Beyrichiidae, with Descriptions of New Genera. New American, by E. O. Ulrich and Ray S. Bassler.....	277	floresiana.....	679
Palius.....	348	fraseri.....	663
Pandarinæ.....	450	gigantea.....	668
Pandarus cranchii.....	453, 476	gouldi.....	667
Pandionidae.....	645	intermedia.....	666
Panopea concentrica.....	349	malaccensis.....	678
generosa.....	344	melanorhyncha eutreptorhyncha.....	663
Paracandona.....	400, 402	sasak.....	679, 680
(Candona) euplectella.....	402	simalurensis.....	671
euplectella.....	400, 402	Pelargos.....	629
Paradisæidae.....	618, 619	niger.....	629
Paradoxornis heudei.....	595	Pelagia.....	630
Paralabrax maculato-fasciatus.....	443, 477	Pelecanida.....	604
Paramphoe.....	533	Pelecanus bassianus.....	633
Paraphoxus oculatus.....	521	Pelecyopoda.....	342, 344, 346, 349
robustus.....	518	Pelecyrhynchus.....	630
spinosus.....	521	leucogaster.....	630
Paraptenodytes curtus.....	621	Pendulinus.....	630
grandis.....	591	polonicus.....	630
Parasitic Copepods: A List of those found upon the Fishes of the Pacific Coast, with De- scriptions of New Genera and Species. North American. By Charles Branch Wil- son.....	431	Penguinia.....	630
Paraspheniscus.....	629	Pennatula.....	688
Parcoræus.....	629	aculeata.....	682, 684, 688
narbonensis.....	629	Pennatulacea.....	682, 688
Pardaliscidae.....	526	Pennatulide.....	682, 688
Pardalotus pipra.....	613	Pentacrinutida: The Axial Canals of the recent, by A. H. Clark.....	87
Paridae.....	585, 586, 593, 595, 609, 627, 629, 631, 634, 638	The Homologies of the Arm Joints and Arm Divisions in the recent Crinoids of the Families of the Coma- tulida and the, by A. H. Clark.....	113
Parisoma galinieri.....	629	Pentacrinus maclearanus.....	131
olivascens.....	590	mulleri.....	87, 126, 131
Parophasma.....	629	naresianus.....	130
Paroromyza.....	629	Pentametrocrinida.....	117
Parra capensis.....	622	Penthestes.....	630
Parthenopidae.....	344	Penthornis.....	630
Parus aureola.....	633	Perenopterus.....	630
biarmicus.....	585, 617	Perenopterus.....	630
caulatus.....	627	Perophthalmus.....	104
cela.....	644	Perispheniscus.....	630
fringillarius.....	586	winami.....	630
novæ seelandiæ.....	609	Perissites warhi.....	158
palustris.....	631	Perissolax brevirostris.....	349
pencilinus.....	638, 653	Perissotruncus.....	631
Passer ammodendri.....	578	Peromyscus leucopus.....	547, 573
Passerherbulus.....	588, 629	michiganensis.....	568
Paulomagus.....	629	Persa.....	631
Pavo biclearatus.....	634	turaco.....	631
		Petaucula.....	631
		camularia.....	641
		Petrochelidon murina.....	627
		tibialis.....	621



	Page.		Page.
<i>Phacoides acutifineatus</i> .....	345	<i>Phanogenia duplex</i> .....	124
<i>Phaeca</i> .....	631	<i>echinoptera</i> .....	124
<i>nilssoni</i> .....	631	<i>elongata</i> .....	124
<i>Phaenorhina</i> .....	631	<i>gracilis</i> .....	124
<i>Phaeocyma æruginosa</i> .....	233, 272	<i>grandicalyx</i> .....	124
<i>albofasciata</i> .....	272	<i>japonica</i> .....	124
<i>atrifineta</i> .....	272	<i>littoralis</i> .....	124
<i>benesignata</i> .....	273	<i>macrobrachius</i> .....	124
<i>bethunei</i> .....	260, 273	<i>maculata</i> .....	124
<i>calycanthata</i> .....	269, 273	<i>magnifica</i> .....	124
<i>cinerea</i> .....	273	<i>meridionalis</i> .....	124
<i>cingulifera</i> .....	261, 273	<i>nobilis</i> .....	124
<i>colorado</i> .....	263, 273	<i>novæ-guineæ</i> .....	124
<i>eurema</i> .....	250, 273	<i>orientalis</i> .....	124
<i>duplicata</i> .....	258, 273	<i>parvicirra</i> .....	124
<i>edusa</i> .....	272	<i>peronii</i> .....	124
<i>edusina</i> .....	229, 272	<i>quadrata</i> .....	124
<i>exhausta</i> .....	221, 272	<i>regalis</i> .....	124
<i>fictilis</i> .....	222, 272	<i>robustipinna</i> .....	124
<i>galbanata</i> .....	273	<i>rotalaria</i> .....	124
<i>helata</i> .....	252, 273	<i>rubiginosa</i> .....	124
<i>horrida</i> .....	270, 273	<i>schlegelii</i> .....	124
<i>insuda</i> .....	234, 272	<i>serrata</i> .....	124
<i>intenta</i> .....	273	<i>stelligera</i> .....	124
<i>involuta</i> .....	272	<i>trichoptera</i> .....	124
<i>largera</i> .....	257, 273	<i>typica</i> .....	124
<i>lineosa</i> .....	243, 273	<i>valida</i> .....	124
<i>lunata</i> .....	225, 272	<i>variabilis</i> .....	124
<i>lunifera</i> .....	241, 243, 261, 272, 273	<i>Phasianalector</i> .....	632
<i>metata</i> .....	248, 273	<i>macartneyi</i> .....	632
<i>minerea</i> .....	238, 272	<i>Phasianidae</i> .....	587,
<i>nigricans</i> .....	272	591, 594, 605, 610, 632, 633, 634, 637, 641	
<i>norda</i> .....	236, 272	<i>Phasianus argus</i> .....	591
<i>obliqua</i> .....	247, 272, 273	<i>gallus</i> .....	587
<i>penna</i> .....	241, 272	<i>meleagris</i> .....	626
<i>plenipennis</i> .....	272	<i>Phibalura flavirostris</i> .....	636
<i>putrescens</i> .....	272	<i>Philomedes</i> .....	401, 427
<i>rosse</i> .....	272	<i>brenda</i> .....	401, 426
<i>rubi</i> .....	266, 273	<i>Philydra</i> .....	632
<i>rubrata</i> .....	265, 273	<i>Phœnicophaus</i> .....	596
<i>salicis</i> .....	228, 272	<i>Phœnicopteride</i> .....	646
<i>saundersii</i> .....	272	<i>Pholadomya subelongata</i> .....	349
<i>squamularis</i> .....	253, 273	<i>Pholidauges femoralis</i> .....	591
<i>undularis</i> .....	231, 272	<i>Phoniomyia</i> .....	69
<i>var. umbripennis</i> .....	272	<i>simmsi</i> .....	65
<i>uniformis</i> .....	273	<i>Phormoplectes</i> .....	632
<i>unilineata</i> .....	245, 273	<i>Phororhacidae</i> .....	642
<i>viridans</i> .....	224, 272	<i>Photidae</i> .....	541
<i>woodii</i> .....	273	<i>Photis reinhardi</i> .....	543
<i>yavapai</i> .....	267, 273	<i>Phoxocephalidae</i> .....	518
<i>Phaenomyias</i> .....	631	<i>Phragmites</i> .....	632
<i>Phaeopharus</i> .....	631	<i>arundinacea</i> .....	632
<i>Phaeotricus</i> .....	631	<i>locustella</i> .....	632
<i>Phalacrocoracidae</i> .....	605, 647	<i>salicaria</i> .....	632
<i>Phalacrocorax dilophus</i> .....	605	<i>Phrixocephalus</i> .....	461
<i>Phalacrocorax calycanthata</i> .....	269	<i>cincinatus</i> .....	461, 476
<i>Phalacrocorax</i> .....	631	<i>Phronima sedentaria</i> .....	490
<i>Phalaropodidae</i> .....	588	<i>Phronimidae</i> .....	490
<i>Phanogenia</i> .....	123	<i>Phrygillus</i> .....	632
<i>alata</i> .....	124, 126	<i>enucleator</i> .....	632
<i>alternans</i> .....	124	<i>vulgaris</i> .....	632
<i>belli</i> .....	124	<i>Phyllastrophus leucopurpureus</i> .....	645
<i>bennetti</i> .....	124	<i>scandens</i> .....	636
<i>briareus</i> .....	124	<i>Phyllobates</i> .....	632
<i>carpentieri</i> .....	124	<i>erythronotus</i> .....	632
<i>divaricata</i> .....	124	<i>Phyllomyias subviridis</i> .....	585

	Page.		Page.
Phyllocecia.....	632	Poecile superciliosa.....	634
chloroleuca.....	632	Poeciloides.....	634
Picidae.....	599, 603, 606	Pogoniulus.....	634
Pickering tree-frog.....	559	Pogonornis.....	634
Picus cafer.....	636	Pogonotriccus zeledoni.....	616
(Chrysophilopicus) smithii.....	599	Poliocichla.....	634
varius.....	600	Poliolais.....	634
Pimelometopon pulcher.....	441, 477	helenore.....	634
Pimophales notatus.....	549	Polyplectron.....	634
Pinarocorys.....	632	argus.....	634
Pine-tree lizard.....	563	Pomarinus.....	635
Pine vole.....	572	fuscus.....	635
Pinna calamitoides.....	359	Poneropsar.....	635
Pintado.....	633	Potamoeypris.....	400
numida.....	633	smaragdina.....	400
Pipistrellus subflavus.....	547, 580	Potamolegus.....	635
Pipra.....	633	superciliaris.....	635
deliciosa.....	587	furvicollis.....	635
leucocephala.....	633	magniplumis.....	635
leucocilla.....	633	Potentilla palustre.....	418
punctata.....	642	Prairie cottontail.....	574
Pipridae.....	587, 633, 641	meadow mouse.....	57
Piranga azara.....	606	Pratincola.....	635
cyanictera.....	625	Preliminary Revision of the Beyrichiidae, with Descriptions of New Genera. New American Paleozoic Ostracoda. By E. O. Ulrich and Ray S. Bassler.....	277
Pisania aff. fortis.....	344	Preconornis.....	635
Pisobia.....	633	roridus.....	635
Pitangus taylori.....	646	Primitia.....	277, 278, 313
Placentula.....	277	Primitiella.....	279
Placopharynx duquesnii.....	549	Primmoidae.....	683, 714
Placostomus.....	633	Pringa minuta.....	633
Plagiogrammus hopkinsi.....	183, 185	Prionapteryx.....	370
Plagiogrammus hopkinsi. Notes on Two Rare California Fishes, Rimicola eigen- manni and, by John Otterbein Snyder.....	183	baboquivariella.....	374
Plagiolophus vancoverensis.....	341, 346	nebulifera.....	370, 376
Planicus.....	633	serpentella.....	376
maior.....	633	stephens.....	369
Planorhampus.....	633	Prionochilus.....	635
Platyrrhampus.....	633	brasiliensis.....	635
Platyrhynchus caneroma.....	633	Probateus.....	636
polychropterus.....	60	roseus.....	583, 636
superciliaris.....	633	Procellaria glacialis.....	612
Platystrophia lynx.....	134	pelagica.....	648
Platytricus.....	633	Procellariidae.....	648
Plectrophanes.....	634	Proeniatiidae.....	598
Plethodon aneus.....	555	Proctolabus.....	396
cinereus.....	553, 555	bullatus.....	396
glutinosus.....	553	pulehripenis.....	396
Pleurogrammus monoptyerygius.....	439, 440, 447	Prodotes.....	636
Pleurota.....	189, 190	Promepicus.....	636
bicostella.....	191	Proparoides.....	636
Pleustidae.....	531	Prosporeoichla.....	636
Plexauridae.....	683, 719	Prosopolepis jocosus.....	64
Ploceidae.....	588, 589, 598, 600,	Protoptilidae.....	682, 713
609, 615, 621, 625, 626, 627, 632, 637, 638, 643		Prunellidae.....	590
Ploceus castaneofuscus.....	600	Psalidoramphos.....	589, 636
nigerrimus.....	621	Psaliurus.....	605, 636
rubiginosus.....	600	acevalianus.....	636
Plotoides.....	634	Psammogorgia.....	719
surinamensis.....	634	arbuscula.....	683, 684, 719
Plumarella.....	715	simplex.....	683, 684, 720
longispina.....	683, 684, 716	spauldingi.....	683, 684, 721
Podocerospis nitida.....	553	torreyi.....	683, 684, 721
Podoces biddulphi.....	608	Psar.....	636
hendersoni.....	608	variegatus.....	636
humilis.....	637		

	Page.		Page.
<i>Psettichthys melanostictus</i> .....	440, 477	<i>Ramphalcyon capensis gigantea</i> .....	660,
<i>Pseudageleus</i> .....	637	666, 667, 668, 670	
<i>Pseudalibrotus</i> .....	502	<i>gouldi</i> .....	661,
<i>Pseudammomanes</i> .....	637	666, 667, 668, 669, 670	
<i>Pseudanthracia squamularis</i> .....	253	<i>gurali</i> .....	659, 661, 669,
<i>Pseudemys rubriventris</i> .....	164	671, 672, 673, 675, 677, 679	
<i>Pseudochondracanthus</i> .....	436	<i>hydrophila</i> .....	659, 661, 677, 678
<i>dicraeus</i> .....	436, 477	<i>intermedia</i> .....	659,
<i>Pseudocorys</i> .....	602, 637	661, 666, 667, 669, 670	
<i>Pseudogerygone rubra</i> .....	609	<i>isoptera</i> .....	659, 661, 671,
<i>Pseudomigrita</i> .....	637	672, 674, 675, 676, 679	
<i>Pseudopodoecis</i> .....	637	<i>javana</i> .....	661, 666, 667, 668, 670
<i>Pseudospermestes</i> .....	637	<i>javanica</i> .....	659, 675
<i>goossensi</i> .....	637	<i>malaccensis</i> .....	659,
<i>Pseudospheniscus</i> .....	637	661, 676, 678, 679	
<i>interplanus</i> .....	637	<i>nesoea</i> .....	659,
<i>Pseudotaon</i> .....	637	661, 673, 674, 675, 676, 679	
<i>Pseudoxeniicus</i> .....	637	<i>simalurensis</i> .....	659, 661, 671,
<i>Pseudozosterops</i> .....	637	672, 673, 674, 676, 678, 679	
<i>Psilocorsis</i> .....	189, 196	<i>sodalis</i> .....	659, 661,
<i>cryptolechiella</i> .....	197	672, 673, 674, 676, 678, 679	
<i>dubitatella</i> .....	197	<i>gigantea</i> .....	658
<i>faginella</i> .....	197	<i>gouldi</i> .....	658
<i>obsoletella</i> .....	197	<i>gurali</i> .....	658
<i>quercicella</i> .....	196, 197	<i>intermedia</i> .....	658
<i>reflexella</i> .....	197	<i>javana</i> .....	658
<i>Psittacidae</i> .....	601, 619, 622, 631	<i>malaccensis</i> .....	658
<i>Psittacus atririmus</i> .....	609	<i>melanorhyncha dichorhyn-</i>	
<i>galeatus</i> .....	602	<i>cha</i> .....	660, 663
<i>pygmaeus</i> .....	622	<i>eutreptorhyn-</i>	
<i>Psittarrus</i> .....	638	<i>cha</i> .....	660, 663
<i>Psophia erepitanus</i> .....	586	<i>m e l a n o-</i>	
<i>Pteroclidæ</i> .....	592	<i>rhynga</i> .....	660,
<i>Ptilocorys</i> .....	602	661, 663	
<i>Ptilopus? incognita</i> .....	648	<i>melanorhynchus</i> .....	657
<i>Ptilosarcus</i> .....	689	<i>Ramphalcyon (Pelagopsis). A Revision of</i>	
<i>quadrangularis</i> .....	682, 684, 689	<i>the Kingfisher Genus, by H. C. Oberholser.</i>	657
<i>Puffinidae</i> .....	612, 619, 639	<i>Ramphosteon</i> .....	638
<i>Puffinus</i> .....	638	<i>Rana catesbeiana</i> .....	562
<i>flavirostris</i> .....	638	<i>catesbeiana</i> .....	547
<i>Putorius noveboracensis</i> .....	576	<i>clamitans</i> .....	546, 561
<i>Pyrenonotidae</i> .....	585,	<i>pipiens</i> .....	546, 561
591, 592, 595, 597, 601, 615, 636, 643, 645		<i>Rare California Fishes. Rimicola eigenmanni</i>	
<i>Pyrgitina</i> .....	638	<i>and Plagiogrammus hopkinsi. Notes on</i>	
<i>americana</i> .....	401, 426	<i>Two, by John Otterbein Snyder</i> .....	183
<i>Pyrocypris</i> .....	401, 426	<i>Rathbun, Mary J. Descriptions of Fossil</i>	
<i>Pyrorhamphus</i> .....	638	<i>Crabs from California</i> .....	341
<i>berlepschianus</i> .....	638	<i>Recent Pentacnemiidæ. The Axial Canals of</i>	
<i>Pyrrhocorax</i> .....	638	<i>the, by A. H. Clark</i> .....	87
<i>Pyrrhula rhodochlamys</i> .....	640	<i>Red bat</i> .....	581
<i>Pyrtelia ansorgei</i> .....	598	<i>fox</i> .....	575
<i>caniceps</i> .....	627	<i>Regulidæ</i> .....	627
<i>Querquedula</i> .....	638	<i>Rehn, James A. G. Two New Species of</i>	
<i>Rail-fence lizard</i> .....	563	<i>Neotropical Orthoptera of the Family</i>	
<i>Rallidæ</i> .....	622	<i>Acrididæ</i> .....	395
<i>Ramphalcyon</i> .....	657, 660,	<i>Reichenowia</i> .....	638
<i>amanoptera</i> .....	661, 669, 670, 671, 672,	<i>Remarks on the Silicification of Fossils. The</i>	
<i>capensis burmanica</i> .....	673, 675, 677, 678, 679	<i>Formation of Geodes, with, by Ray S.</i>	
<i>capensis</i> .....	658, 661, 663, 664,	<i>Bassler</i> .....	133
<i>capensis</i> .....	665, 667, 668, 670, 671, 672,	<i>Remiz</i> .....	638
<i>capensis</i> .....	673, 675, 676, 677, 678, 679	<i>Renggerornis</i> .....	638
<i>capensis</i> .....	659,	<i>leucophthalmus</i> .....	638
<i>floresi</i> .....	661, 664, 672, 676, 679	<i>Renilla</i> .....	587, 714
<i>floresiana</i> .....	657	<i>amethystina</i> .....	682, 684, 714
		<i>Renillidæ</i> .....	682, 714
		<i>Report on the Ostracoda of the United States</i>	
		<i>National Museum. A further, by R. W.</i>	
		<i>Sharpe</i> .....	399

	Page.		Page.
Reptiles, .....	562	Rubecula	640
Retropluma, .....	341	Rubricapilla	640
Revision of American Moths of the Family		albus, .....	640
(Ecophoridae, with Descriptions of New		Rufipes, .....	640
Species, A Generic, by August Busck ..	187	vulgans, .....	640
Revision of some Species of Noctuidæ here-		Rupicella	640
fore referred to the Genus Homoptera Bois-		albugularis	640
sduval, by E. B. Smith .....	269	rufiventris	640
Revision of the Beyrichiidae, with Descrip-		thronothorax ..	640
tions of New Genera, New American		Ruwenzoronia ..	640
Paleozoic Ostracoda—Preliminary, by E.		Rynchopide, .....	580, 636
O. Ulrich and Ray S. Bassler .....	277	Rynchops, .....	580
Revision of the Kingfisher Genus Ram-		Sabæthes longipes, ..	63
phalexon (Pelargopsis), by H. C. Ober-		schauis, .....	63
holser, .....	657	tar-opus, .....	62
Rhacura, .....	72	Saccharivora, .....	640
pulehera, .....	71	Salangana, .....	640
Rhachina, .....	639	Salaria bisernatus, ..	106, 107
Rhamphosynthlipsis, .....	639	muscarius, .....	109
Rheide, .....	610	sinuatus, .....	109
Rhinichthys atronastus, .....	519	undecimlatus, ..	110
Rhipornis, .....	639	Salyx, .....	418
Rhondella, .....	639	Salmo idens, .....	470
Rhopocichla, .....	639	Salvelinus malma, .....	441, 469, 470, 472, 477
Rhopornis, .....	639	Sapayoa, .....	641
Rhus glabra, .....	574	aenigma, .....	641
vernix, .....	419	Sarracenia purpurea, ..	419
Rhyncharites, .....	639	Satyra, .....	641
messelensis, .....	639	Saxidomus gracilis, .....	342
Rhynchodon, .....	639	Saxibat, .....	578
Rhynchotrema capax, .....	134	Scorihynchus, .....	638
Racema, .....	639	Scoride, .....	99
caliginea, .....	639	Sceloporus undulatus, ..	563
Richardson, Harriet—Some New Isopoda of		Scelma, .....	641
the Superfamily		Scina, .....	490
Aselloidea from the		Scinde, .....	490
Atlantic Coast of		Scirpus, .....	418
North America, ..	71	Scuropterus volans, ..	569
Some New Isopods of		Scurus carolinensis, ..	569
the Family Gnath-		niger rufiventris	568
idae from the At-		Scotfieldia, .....	314
lantic Coast of		bilateralis, .....	314
North America, ..	183	Scolopacidae, .....	596, 603, 618, 625, 633, 639, 648
Richmond, Charles W—Generic Names ap-		Scolopax erythropus, ..	596
plied to Birds		fusca, .....	596
during the Years		glottis, .....	624
1901 to 1905, in-		nemoricola, .....	625
clusive, with fur-		sabin	618
ther Additions		sempalmata, .....	624
to Waterhouse's		undulata, .....	618
"Index Gene-		Scopelocheirus coccois, ..	560
rum Avium"	583	Scopide, .....	597
Rimicola eigenmanni .....	183, 184, 185	Scops, .....	641
Rimicola eigenmanni and Flagigrammus		zorca, .....	648
hookersi—Notes on Two Rare California		Scorpus umbretta, .....	597
Fishes, by John Otterbein Snyder, ..	183	Scotelli breweriana, ..	342
Rimicola muscarum, .....	184	Sebastodes glatteus, .....	667, 477
Rin-neck snake, .....	564	rubrivinctus, .....	470, 477
Ripocola, .....	639	Seren, .....	641
locustella, .....	639	arborea, .....	641
Ripocula, .....	640	pratensis, .....	641
Riu Kiu Islands. Descriptions of Eighteen		ricardi, .....	641
New Species and Two		rupestris, .....	641
New Genera of Fishes		Sesura, .....	641
from Japan and the		inorea, .....	641
by John Otterbein		flava, .....	641
Snyder .....	94	maculata, .....	641

	Page.		Page
<i>Seisura neglecta</i> .....	641	<i>Spatula clypeata</i> .....	400, 411
<i>Semioscops</i> .....	190, 201	Species, A Generic Revision of American Moths of the Family <i>Cecophoridae</i> , with Descriptions of New, by August Busck.....	187
<i>alleneella</i> .....	201	Species and Two New Genera of Fishes from Japan and the Riu Kin Islands. Descriptions of Eighteen New, by John Otterbein Snyder.....	93
<i>aurorella</i> .....	201	Species, North American Parasitic Copepods: A List of those found upon the Fishes of the Pacific Coast, with Descriptions of New Genera and, by Charles Branch Wilson.....	431
<i>inornatella</i> .....	201	Species of Carnivorous Dinosaurs, with special Reference to <i>Ceratosaurus nasicornis</i> Marsh. On certain Genera and, by Oliver P. Hay.....	351
<i>meganierella</i> .....	201	Species of Neotropical Orthoptera of the Family <i>Acerididae</i> . Two New, by James A. G. Rehn.....	395
<i>merriecella</i> .....	201	Species of Noctuidae heretofore referred to the Genus <i>Homoptera</i> Boisduval. A Revision of some, by J. B. Smith.....	209
<i>packardella</i> .....	201	Species of North American Crambid Moths. Descriptions of New, by W. D. Kearfott.....	367
<i>steinkellneriana</i> .....	201	Species of North American Fossil Turtles. Four of which are New. Descriptions of Five, by Oliver P. Hay.....	161
<i>Semiparus</i> .....	642	Species, The Amphipoda collected by the U. S. Bureau of Fisheries Steamer Albatross of the West Coast of North America, in 1903 and 1901, with Descriptions of a New Family and several New Genera and, by Samuel J. Holmes.....	189
<i>Sericornis gutturalis</i> .....	627	<i>Spelerpes bislineatus</i> .....	536
<i>Serinus</i> .....	642	<i>longicaudus</i> .....	555
<i>rendalli</i> .....	589	<i>maulicandus</i> .....	546, 555, 548
Sharpe, Richard W. A further Report on the Ostracoda of the United States National Museum.....	399	Spermologia.....	642
Shells from Mexico, believed to be New. Descriptions and Figures of some Land and Fresh-water, by W. H. Dall.....	177	<i>Spheniscida</i> .....	589, 590, 591, 608, 611, 615, 616, 621, 624, 628, 629, 630, 637, 647
<i>Sieberscitta</i> .....	642	<i>Spilornis bacha</i> .....	592
Silification of Fossils. The Formation of Gooles, with Remarks on the, by Ray S. Bassler.....	133	Spiny soft-shelled turtle.....	567
<i>Silystrinus</i> .....	642	<i>Spirocypris</i> .....	400, 406
<i>Siola</i> .....	642	<i>passica</i> .....	400, 407
<i>spinicauda</i> .....	642	<i>tuberculata</i> .....	400, 405, 406
<i>Siphonalia</i> .....	346	<i>Spizites</i> .....	642
<i>Siron kaertma</i> .....	550	<i>Spizocorys personata</i> .....	586
<i>Sitella</i> .....	625, 642	Spotted salamander.....	552
<i>Sitocorax</i> .....	610, 642	Spreading adder.....	564
<i>Sitta chrysoptera</i> .....	642	<i>Spreo albicapillus</i> .....	635
<i>Sittidae</i> .....	625, 642	<i>Stachyptilidae</i> .....	682, 708
<i>Sittiparus</i> .....	636, 642	<i>Stachyptilum</i> .....	708
Skulls with Low Forehead. New Examples of American Indian, by Aloš Hrdlička.....	171	<i>quadridentatum</i> .....	682, 684, 709
Skunk.....	576	<i>superbum</i> .....	682, 684, 708
Slimy salamander.....	553	Steamer Albatross off the West Coast of North America, in 1903 and 1901, with Descriptions of a New Family and several New Genera and Species. The Amphipoda collected by the U. S. Bureau of Fisheries, by Samuel J. Holmes.....	189
Small shrew.....	577	<i>Steganura</i> .....	643
<i>Smilornis</i> .....	642	<i>Stelgidocichla</i> .....	643
<i>penetrans</i> .....	642	<i>Stellocitta</i> .....	643
Smith, John B. A Revision of some Species of Noctuidae heretofore referred to the Genus <i>Homoptera</i> Boisduval.....	209	<i>Stenogorgia</i> .....	723
Snapping turtle.....	567	<i>koloidi</i> .....	683, 684, 724
Snyder, John Otterbein. Descriptions of Eighteen New Species and Two New Genera of Fishes from Japan and the Riu Kin Islands.....	93	<i>Stereorariidae</i> .....	635
Notes on Two Rare California fishes, <i>Rimicola eigenmanni</i> and <i>Plagiograzamus hopkinsi</i> .....	183	<i>Stereolepis gigas</i> .....	440, 477
<i>Solenolambus</i> .....	346		
Some New Isopoda of the Superfamily <i>Ascolonida</i> from the Atlantic Coast of North America, by Harriet Richardson.....	71		
<i>Spirvius ruficollis</i> .....	645		

	Page.		Page.
Stercorornithes	592, 608	Sylvia rufa	639
Sterna	598	Sylvicola	643
albifrons	598	Sylvicola	589, 596, 601, 604, 607, 609, 612, 616, 619, 626, 627, 632, 634, 639, 646, 648
caerulescens	598	Sylvilagus floridanus leucurus	547, 574
caspia	598	Symphoricarpos symphoricarpos	574
dougalli	598	Symphodium	683
hirundo	598	armatum	682, 684, 686
minuta	598	Synallaxis curruvirens	593
nigra	598	rubicapilla	593
Stenelodia	289	Synalphe	278, 320, 322
Stictornis	643	Synaptomys cooperi stoner	568, 570
Stilpedidae	535	Tachynites	644
Stilpites	536	Tadorna	644
distincta	489, 536	Taeniotriccus	644
Stipitropis	643	andreae	644
stipiturus	643	Taeniopteryx thryops	600
Stone leaming mouse	570	straticollis	627
Stoperola	643	Tamias	190, 204
Storer snake	565	bairdii	205
Storeria occipito-maculata	565	delhiella	205
Streptostyla	178	mycosella	205
bartschii	178, 180	Tamias striatus	190, 204
nitidula	179	Tamphaleyon calypensis	658
toyneii	179, 180	Tanager	644
Streptula	277, 284	albirostris	644
lineata	296	leucocephala	593
limatifera	306	tatao	644
reticulata	297	Tangaridae	593, 594, 606, 616, 625, 644
simplex	277, 286	Tantalus fulvifemur	607
Strigidae	591, 594, 611, 612, 628, 648	Taperia	644
Striped tree-toad	558	brasilensis	644
Strix alba	647	Teleoceras fossiger	645
flaccinca	647	Teleornis	645
nivea	642	compressus	645
nyctea	642	Teleostoma	685
tongshanii	604	ambigua	682, 684, 686
Stroperola fluctuosa	643	rigida	682, 684, 685
Struthio casuarius	597	Tenna	645
Struthionidae	592, 608	Teprobata occidentalis	642
Struthus	643	Terenotriccus	645
Stychnos	643	Tepromide	631
Study in the W. L. Abbott Collections, Vocabulary of Malaysian Basketwork; by Ous T. Mason	1	Terrapene carolina	167, 168, 547, 567
Sturmdale	591, 607, 611, 621, 635, 636	longanulata	166, 168
Sturmia cinclus	585, 599, 614	ornata	167, 168
Stylatula	699, 701	Terstia carulea	598
elongata	682, 684, 699	Testudo orthopygia	106
Stylatulidae	682, 698	Tetema	645
Superfamily Aselloidea from the Atlantic Coast of North America. Some New Isopoda of the, by Harriet Richardson	71	Tetradella	277, 306, 313
Surattha	369, 370	altus	306
indentella	372	bohemiae	306
santella	371	bussacensis	306
Sycobotris insignis	632	carinata	306
Sylosella	643	complanata	306
Sylvia baccata	626	decorata	306
fitis	613	digitata	306
herbicola	599	erratica	306
luscina	619	harpori	306
paludicola	596	(Kusowia) dissecta	306
palustris	613	mamillosa	306
philadelphia	599	melans	307
phragmitis	613	lacunata	306
		limatifera	306
		marchena	306
		nigristata	306

	Page.		Page.
Tetraodon marchica laticauda.....	306	Trachyphonus vailantii.....	636
palmata.....	306	Tragopan.....	646
quadrilirata.....	307	Trebina.....	447
var. simplex.....	307	Trebinius tenuifurcatus.....	447
riberiana.....	307	Trelodytes.....	647
simplex.....	307	crassa.....	647
subquadrans.....	307	Treposella.....	292, 314
Tetraodon albiflatus.....	592	lyoni.....	292, 314, 315
arborea.....	596	Treronidae.....	589, 601, 623, 648
francoolinus.....	610	Triakis semifasciatus.....	450
gibraltariensis.....	628	Trichites.....	595
Tetraodonidae.....	596, 605, 608, 640, 645	Trichophorus icterinus.....	591
Tetrix.....	645	notatus.....	615
niger.....	645	Trichostoma.....	586
sylvicola.....	645	Triclonella.....	187, 190, 203
Thamnophilus cyanocephalus.....	600	determinatella.....	203
punctatus.....	584	pergandeella.....	203
(Silvestrius) flavescens.....	642	Trigonia evansiana.....	349
Thamnophilus sirtalis.....	566	leanta.....	349
Thapsimilas.....	645	Tringa arnularia.....	603
Thaumantias.....	645	fulvicaria.....	588
Thaumasius.....	645	glacialis.....	588
Thaumatoeremus.....	113, 128	glareola.....	596
Thaumatopeps atomosella.....	386, 388	hypoleucos.....	596
coloradella.....	386	leucophaea.....	603
crenulatella.....	386, 389	morinella.....	599
edonis.....	386	ochropus.....	596
fernaldella.....	386	temminckii.....	653
gibsonella.....	387	Trionyx spiniferus.....	567
magnifica.....	386	Trochilidae.....	586, 589, 601, 621, 635
nortella.....	386	Trochilus longirostris.....	589
pectinifer.....	386	Trogodytes.....	629
pexella.....	386, 391	ædon.....	629
repanda.....	386, 390	brownii.....	646
striatella.....	386	Trogodytidae.....	624, 627, 629, 646
Theropoda.....	362	Trogon antisthanus.....	590
Thescelocichla.....	645	neovenus.....	609
Thrasycaccipiter.....	645	Trogonidae.....	580, 609, 612
seminocornis.....	645	Tropical America. Descriptions of some New	
Thrasys.....	646	Mosquitoes from, by H. G. Dyar and Fred-	
Thryothorus.....	646	erick Knab.....	53
Thuris.....	598	Tropiometra.....	120
Tiger salamander.....	552	Trygonoides.....	647
Tiliornis.....	646	capensis.....	647
senex.....	646	Trypanidae.....	440
Timaliidae.....	586	Tryphosa.....	498
303, 394, 613, 614, 615, 616, 621, 625, 636, 637, 642		corca.....	496
Timber wolf.....	576	Turdidae.....	585, 601, 606, 610, 612, 617, 627, 631, 634
Tinamulus.....	646	Turdus aurantius.....	612
decoloratus.....	646	azureus.....	627
pallidum.....	646	citrinus.....	610
virescens.....	646	longirostris.....	601
Triton.....	646	rosens.....	583, 615, 621
lightfooti.....	646	Turnicidae.....	628
Pityra viridis.....	593	Turritella ooyama.....	346
Poed.....	557	pescaderoensis.....	346
Todirhamphus.....	646	Turtles, Four of which are New. Descriptions	
pectoralis.....	646	of Five Species of North American Fossil,	
ruficeps.....	646	by Oliver P. Hay.....	161
Todirostrum ocaudatum.....	631	Two-lined triton.....	356
Tolmarchus.....	646	Two New Genera of Fishes from Japan and	
Torgos.....	646	the Riu Kiu Islands. Descriptions of	
Totanus.....	596	Eighteen New Species and, by John Otter-	
stagnatilis.....	596	bein Snyder.....	93
Trachodon.....	357		

	Page		Page
Two New Species of Neotropical Orthoptera of the Family Acrididae, by E. A. G. Rehn, . . . . .	265	<i>Vulpes fulvus</i> , . . . . .	571
Two Rare California Fishes. Rinned <i>Coegen manni</i> and <i>Plagiogrammus hopkinsi</i> . Notes on, by John Otterbein Snyder, . . . . .	183	<i>Vultur auricularis</i> , . . . . .	536
Tyrannule, . . . . .	585, 590, 592, 600, 603, 623, 627, 631, 632, 633, 638, 644, 645, 647	<i>eryphus</i> , . . . . .	544
Tyrannopsis, . . . . .	647	<i>serpentarius</i> , . . . . .	612
Tyrannula phoenicea, . . . . .	623	<i>tracheoloti</i> , . . . . .	636
Tyrannulus semillavicus, . . . . .	622	Vulturidae, . . . . .	583, 623
Tyto, . . . . .	647	Waterhouse's "Index Generum Avium" Generic Names applied to Birds during the Years 1901 to 1905, inclusive, with further Additions to, by C. W. Richmond, . . . . .	8
Utaerimus, . . . . .	125	Weasel, . . . . .	57
Ulrich, Edward O., and Ray S. Bassler, New American Paleozoic Ostracoda. Pre- liminary Revision of the Beyrichiidae, with Descriptions of New Genera, . . . . .	277	West Coast of North America, in 1903 and 1904, with Descriptions of a New Family and several New Genera and Species. The Amphipoda collected by the U. S. Bureau of Fisheries, Steamer "Albatross" off the Coast of California, by S. J. H. Hobbins, . . . . .	383
Ulrichia, . . . . .	278, 316	Western painted tortoise, . . . . .	567
<i>confinis</i> , . . . . .	323	White-footed mouse, . . . . .	55
Umbellula, . . . . .	719	Wilson, Charles Branch, North American Parasitic Copepods: a List of those found upon the Fishes of the Pacific Coast, with Descriptions of New Genera and Species, . . . . .	569
<i>huxleyi</i> , . . . . .	682, 684, 711	Woodchuck, . . . . .	569
<i>loma</i> , . . . . .	682, 684, 712	<i>Waconya abascenta</i> , . . . . .	57
<i>magniflora</i> , . . . . .	682, 684, 719, 712, 713	<i>abehel</i> , . . . . .	57
Umbellulida, . . . . .	682, 710	<i>abul</i> , . . . . .	57
United States National Museum. A further Report on the Ostracoda of the Bay of Sharpe, . . . . .	99	<i>abules</i> , . . . . .	57
Upopodina, . . . . .	608	<i>abochra</i> , . . . . .	57
Uria lomizenus, . . . . .	639	<i>andropus</i> , . . . . .	58
Urocyon cinereoargenteus, . . . . .	575	<i>argyura</i> , . . . . .	57
Urolia, . . . . .	647	<i>baria</i> , . . . . .	59
<i>marina</i> , . . . . .	647	<i>clausolema</i> , . . . . .	58, 59
Urolophus halleri, . . . . .	447	<i>dymodora</i> , . . . . .	58
Urodys, . . . . .	367	<i>gynacopus</i> , . . . . .	56
<i>crustalis</i> , . . . . .	268, 369	<i>matata</i> , . . . . .	59
Utricularia, . . . . .	418	<i>megalodora</i> , . . . . .	57
Vaccinium corymbosum, . . . . .	419	<i>sororcula</i> , . . . . .	57
Vaginula alba, . . . . .	500	Xanthopsid, . . . . .	517
Valethiopsis, . . . . .	489, 494	Xenostomus, . . . . .	517
<i>dentatus</i> , . . . . .	495	<i>proterzoi</i> , . . . . .	517
Vanellochetrusia, . . . . .	647	Xenostobla microps, . . . . .	517
Venilia, . . . . .	192	Xenops, . . . . .	583
<i>albapalpella</i> , . . . . .	193	Xenonemichopsis, . . . . .	518
Vergia solanorum, . . . . .	593	<i>minor</i> , . . . . .	518
Vertebrates of the Indiana University Farm, Michell, Indiana. Notes on the Mammals and Cold-blooded, by Walter L. Hahn, . . . . .	545	<i>tibialis</i> , . . . . .	518
Vibilla californica, . . . . .	190	Xenotrichon, . . . . .	518
Vibillidae, . . . . .	190	Xyphora, . . . . .	618
Vignearbo, . . . . .	647	Xylocopa, . . . . .	618
Virginia elegans, . . . . .	563	Xylocorpuscula, . . . . .	618
<i>snake</i> , . . . . .	563	Xysopterygiosa, . . . . .	23
Virgularia elongata, . . . . .	699	<i>indularis</i> , . . . . .	23
<i>finmarchica</i> , . . . . .	705	Xysopterus trimauelellus, . . . . .	270
<i>gracilis</i> , . . . . .	700, 701	Zale horrida, . . . . .	622, 729
<i>grandiflora</i> , . . . . .	710	Zalochelidon, . . . . .	618
Virgulariidae, . . . . .	682, 704	Zelica, . . . . .	648
Viridibucco, . . . . .	647	<i>trochilis</i> , . . . . .	648
Vocabulary of Malaysian Basketwork: A Study in the W. L. Abbott Collections, by Otis T. Mason, . . . . .	1	Zonata, . . . . .	648
		<i>arhorea</i> , . . . . .	648
		Zosteropidae, . . . . .	617















SMITHSONIAN INSTITUTION LIBRARIES



3 9088 01420 9159