



Xantusia jaycolei Bezy, Bezy, and Bolles, 2008; Cole's Night Lizard. The population of night lizards at Desemboque del Río San Ignacio, Sonora, the principal town of the Seri (Comaaac people), was reported first by ethnozoologist Charles Malkin in 1962. Subsequent fieldwork by Richard Felger, also an ethnobiologist, revealed that the lizards are found almost exclusively within dead, rotting cardons, *Pachycereus pringlei* (Felger, 1965). Surveys of the region by Bezy in 1966 indicated that the population is restricted to the immediate vicinity of Desemboque, leading him to hypothesize that these small, secretive lizards might have been transported inadvertently in Seri boats across the Gulf of California from Baja California, an area from where night lizards are common. But, subsequent examination revealed that female night lizards in the Desemboque population lack femoral pores, a character they share with *Xantusia arizonae*, a species found in rock crevices in central Arizona. Later, analyses of DNA sequences (Sinclair et al., 2004) confirmed the distinctiveness of the Desemboque population and its sister relationship to *X. arizonae*, from which it differs in several morphological features other than femoral pores, resulting in its description as *X. jaycolei* by Bezy et al. (2008). The total known range of this Sonoran Desert coastal endemic is ca 20 km in length, extending from 6 km E of Desemboque del Río San Ignacio to Cerro Tepopa. This species received a highly vulnerable rating (EVS of 16) by Wilson et al. (2013a). Pictured here is an individual from Cerro Tepopa, Municipio de Pitiquito, Sonora, Mexico.  © Erik F. Enderson



Southern distributional limits of the Sonoran Desert herpetofauna along the mainland coast of northwestern Mexico

ROBERT L. BEZY¹, PHILIP C. ROSEN²,

THOMAS R. VAN DEVENDER³, AND ERIK F. ENDERSON⁴

¹*Natural History Museum of Los Angeles County, Los Angeles, California 90007, United States.*

E-mail: robertbezy@gmail.com

²*School of Natural Resources & the Environment, University of Arizona, Tucson, Arizona 85721, United States.*

E-mail: pcrosen@email.arizona.edu

³*GreaterGood.org, 6262 N. Swan Rd., Suite 150, Tucson, Arizona 85718, United States.*

E-mail: yecora4@comcast.net

⁴*Vail, Arizona 85641, United States.*

ABSTRACT: The Sonoran Desert is a well-recognized and widely studied zone of endemism with high landscape and herpetofaunal diversities, but its transitions with the core Neotropics remain understudied. Based on museum and literature records and our field experience, we identify and discuss the currently known southern distributional limits of species of amphibians and reptiles that occur extensively or exclusively in the Sonoran Desert, and that terminate on or within 50 km of the coasts of Sonora, Sinaloa, and Nayarit. Five focal areas are evident among the 60 species that terminate in this region. These foci are in areas in which marked transitions in vegetation and climate also are known. Three species reach their southern limits near the mouth of the Río Colorado. In the arid northern 400–500 km of our study region, we document a diffuse zone in which highly arid-associated species reach their southern, coastward distributional limits. To the south, nine species limits are clustered near the southern limit of the phytogeographically defined Sonoran Desert, but the herpetofauna retains a clear and strong Sonoran Desert character for an additional 200–350 km farther south, into the border region of Sonora and Sinaloa, where 13 species reach their known southern limits. The herpetofauna attains a demonstrably tropical character seen near Culiacán, Sinaloa. An additional 10 species, however, reach their southern limits, in southern Sinaloa and 10 in Nayarit, where the curtain falls on the Sonoran Desert herpetofauna along the coast of Mexico.

Key Words: Amphibians, anurans, biogeography, geographic distribution, lizards, Nayarit, reptiles, Sinaloa, snakes, Sonora, species terminations, turtles.

Resumen: El Desierto Sonorense es una zona de endemismo, con una alta diversidad de paisajes y herpetofauna, bien conocida y ampliamente estudiada, pero sus transiciones desde el núcleo del Neotrópico siguen siendo poco estudiadas. Con base en registros de museos y literatura y nuestra experiencia de campo, se identifican y discuten los límites sureños actualmente conocidos de las especies que terminan en o dentro de 50 km de las costas de Sonora, Sinaloa y Nayarit. Cinco regiones centrales de transición son evidentes en las 60 especies que terminan en esta región. Estos centros están en áreas en las que también se conocen marcadas transiciones en la vegetación y el clima. Cerca la boca del Río Colorado, tres especies

alcanzan sus límites de distribución más al sur. En los 400–500 km áridos al norte de nuestra región de estudio, documentamos una zona difusa en la que las especies altamente asociadas áridas alcanzan sus límites de distribución más al sur, hacia la costa. Al sur, los límites de ocho especies se agrupan cerca del límite actualmente reconocido del Desierto Sonorense, pero la herpetofauna conserva un carácter claro y fuerte del Desierto Sonorense por otros 200–350 km más al sur, en la región fronteriza entre Sonora y Sinaloa, donde 13 especies alcanzan sus límites meridionales conocidos, antes de alcanzar un carácter claramente tropical cerca de Culiacán, Sinaloa. Otras 10 especies alcanzan sus límites más sureños en el sur de Sinaloa y 10 en Nayarit, donde cae el telón sobre la herpetofauna del Desierto Sonorense.

Palabras Claves: Anfibios, anuros, biogeografía, distribución especies terminaciones geográfica, lagartijas, Nayarit, reptiles, serpientes, Sinaloa, Sonora, tortugas.

Citation: Bezy, Robert L., Philip C. Rosen, Thomas R. Van Devender, and Erik F. Enderson. 2017. Southern distributional limits of the Sonoran Desert herpetofauna along the mainland coast of northwestern Mexico. *Mesoamerican Herpetology* 4: 138–167.

Copyright: Bezy et al. 2017. This work is licensed under a Creative Commons Attribution-No Derivatives 4.0 International License.

Received: 16 December 2016; **Accepted:** 6 March 2017; **Published:** 30 March 2017.

DEDICATION



© Julia Coffman Rosen

We dedicate this paper to the memory of our mentor and friend Charles H. Lowe, who sparked our interest in the distribution of the herpetofauna of the Sonoran Desert. Some of his views on the topic were first expressed 60 years ago in seminal papers on species richness of the herpetofauna on the islands of the Gulf of California (Lowe, 1955a) and the eastern limits of the amphibians, reptiles, and vegetation of the Sonoran Desert (Lowe, 1955b).

In this photo, Lowe (far right) can be seen directing the progress of a 1992 venture into Sonora's Gran Desierto with Brent Martin (left) and Phil Rosen (middle). Additional information about Lowe's life and colorful personality and about the people he inspired can be found on a website dedicated to him (CharlesLowe.net), and in Rosen (2004).

INTRODUCTION

The Sonoran Desert is a well recognized and widely studied zone of endemism with diverse landscapes and herpetofauna (Brown and Lowe, 1980; Turner and Brown, 1982; Brown, 1994), but its transitions with the core Neotropics via thornscrub and tropical deciduous forest remain largely unexamined. These transitions occur primarily in northwestern Mexico, and are challenging to define due in large measure to the Sierra Madre Occidental paralleling the coast and its outlying Madrean Archipelago of mountains extending northward into southern Arizona and New Mexico (Gehlbach, 1981; DeBano et al., 1995). The cordillera and archipelago support a complex and species-rich mosaic involving both montane and lowland tropical biotas (e.g., Schwalbe and Lowe, 2000; Enderson et al., 2014; Bezy and Cole, 2014; Van Devender and Reina-Guerrero, 2016).

In this paper we step away from the topographic and biotic complexities of the sierra, and examine herpetofaunal transitions from Sonoran desertscrub to tropical deciduous forest in a simpler context, the mainland coast of the Gulf of California extending 1,500 km from extreme northwestern Sonora to Nayarit. Compared to the interior, the topography near the coast is far less rugged and presents a clearer vista from which to examine the desert-to-tropics transition of the herpetofauna. We use the available databases and published papers, supplemented by our field observations of the distribution of amphibians and reptiles, to estimate the southernmost occurrence of species along the coast of Sonora, Sinaloa, and Nayarit.

We pose two pivotal questions about the southern distribution limits of Sonoran Desert herpetofauna along the coast: (1) Are there focal areas for the southern terminations of species? and (2) How do the locations of these focal areas compare with the limits of recognized biotic communities and provinces? Ultimately, we hope to begin to clarify the nature of the herpetofaunal transition from Sonoran desertscrub to thornscrub and tropical deciduous forest, from which subtropical desertscrub largely has been derived (Van Devender, 2002). We ask: Do we find a more or less smooth gradient upon which defined biogeographic boundaries are artificially imposed, or is their clear evidence for herpetofaunal congruence with these defined boundaries that might represent transitions among centers of biodiversity generation and community organization within the tropics–subtropics transition?



Anaxyrus kelloggi (Taylor, 1938). The Little Mexican Toad ranges in the Sonoran Desert from near Santa Ana, Sonora, south along the coasts of Sonora and Sinaloa into tropical deciduous forest to near Acaponeta, Nayarit. Rated as highly vulnerable (EVS of 14) by Wilson et al. (2013b). Near Masiaca, Municipio de Navojoa, Sonora, Mexico.

© Erik F. Enderson

MATERIALS AND METHODS

The study includes native species that meet both of two criteria: (1) they are found extensively or exclusively in the Sonoran Desert, and (2) they reach a southern distribution limit within 50 km of the coast of Sonora, Sinaloa, or Nayarit (exclusive of islands). We focus on occurrences near the coast for two reasons: first, this is a tractable approach examining a relatively well-collected region, and second, it permits us to study the herpetofaunal transitions from hyperarid Sonoran desertscrub and, toward the south, to increasingly tropical desertscrub, thornscrub, and tropical deciduous forest biotic communities. We do not capitalize the common names of plants used in this paper, as we consider them to be informal names.

Species List

An initial species list of amphibians and reptiles known from Arizona, Sonora, and Sinaloa was compiled from Enderson et al. (2009) and Lemos-Espinal (2015). Locality data for the species were retrieved via queries of the Madrean Discovery Expedition (MDE; www.madrean.discovery.org; 2015–2016) database, which includes records from diverse sources, many from the large dataset pulled together by one of us (EFE) from major herpetological collections in the United States, VertNet, the published literature, and personal observations (EFE, PCR, TRV, and others). We performed additional data searches for all the species in January of 2016, using the EFE database VertNet (2016; www.vertnet.org), the Amphibian and Reptile Collection of the University of Arizona Museum of Natural History (<http://eebweb.arizona.edu/collections/herp/amphibian.htm>), and specimens cited by Hardy and McDiarmid (1969) and McDiarmid et al. (1976). The VertNet searches included Nayarit, Jalisco, and Colima, for species found to reach Sinaloa. We also consulted species lists in Serrano et al. (2014) for Sinaloa and Woolrich-Piña et al. (2016) for Nayarit.



Smilisca fodiens (Boulenger, 1882). The Lowland Burrowing Treefrog ranges from Sonoran desertscrub in southern Arizona, south along the coasts of Sonora, Sinaloa, and Nayarit into tropical semideciduous forest south to Colima. Pima County, Arizona, United States.

 © Erik F. Enderson

The criteria for inclusion include species ranging beyond the Sonoran Desert, but exclude species found only in the Sonoran Desert of southern California or the Baja California peninsula. We do not include Sonoran Desert species that occur essentially or only on the Baja California peninsula or on islands, due to the complexities introduced by these endemics that are not directly relevant to the questions we pose.

Our definition of “Sonoran Desert herpetofauna” includes species found extensively or exclusively in the Sonoran Desert as originally outlined by Shreve (1951), with the subsequent exclusion of the Foothills of Sonora by Brown and Lowe (1980). Not restricting our definition to those species found exclusively in the Sonoran Desert is important to our examination of the southern limits of species that might occur beyond the desert, as mapped strictly by vegetation. We consider the Sonoran Desert to be a geographic region roughly similar to the Sonoran Biotic Province of Dice (1939; figure 3 in Lowe and Brown, 1994). Most of the species included in this study occur extensively in the Sonoran desertscrub biotic community, although some are found primarily in riparian and aquatic biotic communities.

We included *Anaxyrus woodhousii*, *Sonora semiannulata*, and *Thamnophis marcianus*, as they occur widely in the Sonoran Desert biotic province, where they are restricted to major river corridors, despite not being fully aquatic or perennial-water obligate species. Three other species that are perennial-water aquatic (*Rana yavapaiensis*, *Kinosternon sonoriense*, and *Thamnophis eques*) were not included, as we have no verifiable records from within 50 km of the coast. We suspect they may have occurred near the Gulf on the Río Sonora delta west of Hermosillo, but were never recorded prior to agricultural development, the desiccation of riparian habitats, and the introduction of exotic species. Four species occurring extensively in or endemic to the Sonoran Desert (*Crotaphytus bicinctores*, *Cophosaurus texanus*, *Phrynosoma platyrhinos*, and *Aspidoscelis xanthonota*) also are not included, as they have not been reported within 50 km of the coast, although the endemic *A. xanthonota* probably occurs there.



Crotaphytus dickersonae Schmidt, 1922. Dickerson's Collard Lizard is a Sonoran Desert endemic found only on Isla Tiburón and the 150 km of Sonoran mainland coast from the Sierra El Julio south to Cerro Eucla near Bahía Kino. In the Sierra Libertad it basks on rocks in the only Sonoran stand of cirios (*Fouquieria columnaris*). Similar to strictly island species, it achieves dense populations and, compared to other mainland collard lizards, is relatively unwarry. Originally described as a separate species, it was long considered a subspecies of *C. collaris*, but its distinctive color, color pattern, scalation, skeleton, allozymes, and DNA sequences place it as sister to three species of collard lizards in Baja California. Near Bahía Kino, Municipio de Hermosillo, Sonora, Mexico.  © Erik F. Enderson

A number of other species significantly penetrate the margins of the Sonoran Desert, in canyons and riparian areas and in springs on the desert floor (e.g., *Hyla arenicolor*, *Elgaria kingii*, *Terrapene ornata*, *Aspidoscelis sonora*, *A. stictogramma*, *Plestiodon obsoletus*, *Sceloporus cowlesi*, and *Diadophis punctatus*). We exclude these as fundamentally non-desert species, and most do not approach the Gulf coast.

Species Terminations

For each species, we identified the southernmost record on or within 50 km from the coast of Sonora, Sinaloa, and Nayarit (excluding islands) from the locality data, and this comprised our initial estimate of its southern termination on the Gulf coast of mainland Mexico. For a few species, we rejected the initial estimate after finding convincing evidence that it was inaccurate in either species allocation or locality data. For example, for *Kinosternon alamosae*, the locality for LACM 105397 (Culiacán, Sinaloa) was considered by the original describers (Berry and Legler, 1980) to be in error, so we excluded it from consideration and used the next record to the north (UAZ 27956, 7.4 mi S Guasave) that was accepted by Berry and Legler. We consider that Taylor's (1936) La Posa, Sonora, record for *Thamnophis eques* (UIMNH 32968; now a skeleton; D. Wylie, pers. comm. 2016) likely is *T. cyrtopsis*, in view of the historical nomenclatural confusion of these species (Smith, 1951) and their documented ecological and geographic distributions (Webb, 1966; Rossman et al., 1996). We also did not accept any coastal records for *Kinosternon sonoriense* (e.g., O'Brien et al., 2006) considering the otherwise documented ecological and geographic distribution of the species (Iverson 1976, 1981; Legler and Vogt, 2013; and see above). Per our main criterion above, for species found farther south but > 50 km away from the coast, we used the record \leq 50 km of the coast.

Biogeographic Distribution

We used the map of Brown and Lowe (1980), as digitized by The Nature Conservancy (http://azconservation.org/download/s/biotic_communities_of_the_southwest_gis_data/), and that of Brown et al. (2007) to assign localities to the Lower Colorado River Valley (LCRV), Arizona Upland (AU), Plains of Sonora (POS), and Central Gulf Coast (CGC) subdivisions of the Sonoran Desert, as originally defined and outlined by Shreve (1951, 1964). We approximated the vegetation communities south of the desert using the maps of Brown et al. (1998, 2007).



Heloderma suspectum Cope, 1869. The Gila Monster occurs primarily in the Sonoran Desert and ranges from southern Nevada south along the coast of Sonora with an isolated record in thornscrub near El Dorado, Sinaloa. Rated as near threatened by IUCN and as highly vulnerable (EVS of 15) with a persecution score of 5 (killed on sight) by Wilson et al. (2013a). Sierra El Aguaje, Municipio de Guaymas, Sonora, Mexico. © Erik F. Enderson

We assigned each species to a biogeographic distribution class based on these vegetation maps, our field experiences, and the ranges depicted in Degenhardt et al. (1996), Grismer (2002), Stebbins (2003), Rosen (2007), Brennan and Holycross (2009), Jones and Lovich (2009), Stebbins and McGinnis (2012), Powell et al. (2016), and Rorabaugh and Lemos-Espinal (2016): (1) North American deserts, occurring in all three warm deserts (Sonoran, Chihuahuan, and Mohave); these species may extend more broadly across the continent; (2) Sonoran and Chihuahuan deserts; (3) Sonoran and Mohave deserts; these may extend into the colder Great Basin Desert; (4) Mohave and Lower Colorado River Valley subdivision of the Sonoran Desert; (5) Sonoran, centered in the Sonoran Desert; these may extend into thornscrub, tropical deciduous forest, or grasslands and woodlands of adjacent foothills and mountains (e.g., Mogollon Rim, Sierra Madre Occidental, and the Madrean Archipelago); (6) North American arid lands, Sonoran riparian; these species have wide distributions, but in the Sonoran Desert occur primarily in association with major riverine riparian corridors; and (7) Sonoran Desert-Madrean; these species occur widely in the Sonoran Desert, in riparian forests and on productive rock slopes, but are more widespread and abundant in Madrean woodlands.

We recognize that the categories are not discrete and use them primarily as a proxy to evaluate the relationship of biogeographic distribution patterns to species terminations of the herpetofauna in the Sonoran Desert. The categories reflect our understanding of the biogeographic distributional centers (principally in warm deserts) and salient macrohabitat features (riverine-riparian-aquatic versus desertscrub) of each species within the Sonoran Desert region.

Many core desert species also occur in grassland, woodland, and forest, but we did not include this in the categorization to avoid excessive multiplication of categories that might not be relevant to our focus on the subtropics–tropics transition. We included two species (*Sceloporus clarkii*, *Masticophis bilineatus*), however, which occur far more widely and abundantly in oak woodland than in desertscrub, in the Sonoran Desert–Madrean (category 7).



Dipsosaurus dorsalis (Baird and Girard, 1852). The Desert Iguana ranges from the northern Mohave Desert in California and Nevada south around the Gulf of California to Cabo San Lucas, Baja California Sur, and Topolobampo, Sinaloa. This highly thermophilous lizard represents an ancient lineage that diverged from other iguanids over 20 million years ago (Oligocene, Norell, 1989). In the Mohave and Sonoran deserts it is now closely associated with creosotebush (*Larrea divaricata*; Norris, 1953) which arrived in North America relatively recently (Pleistocene, Van Devender, 2007). Pima County, Arizona United States.  © Philip C. Rosen

RESULTS

Species Terminations

A total of 60 species of amphibians and reptiles included in the Sonoran Desert reach a southern limit on the coast of Sonora, Sinaloa, or Nayarit (Appendix 1, Fig. 1). Note that these terminations represent the most southern record on or near (= within 50 km of) the coast of these three states of Mexico, not necessarily the global southern limit of the species (see Materials and Methods). Here, we present a more or less north-to-south account highlighting the southern terminations for the Sonoran Desert herpetofauna.

Three species occur near the coast of Sonora only along the delta of the Hardy and Colorado rivers (Appendix 1, Fig. 1): *Anaxyrus woodhousii*, *Thamnophis marcianus*, and *Sonora semiannulata*. Essentially, these are riparian-aquatic species in much of the Sonoran Desert, and all three are widely distributed elsewhere in North America, with *S. semiannulata* ranging south on the Baja California peninsula to the cape region.

Phrynosoma mcallii and *Uma rufopunctata* are restricted primarily to the hyper-arid and sandy Gran Desierto del Altar. Four species that are characteristic of the arid LCRV and Mohave deserts reach their southern limits in this area: *Chionactis annulata* at Puerto Lobos; *Phrynosoma goodei* at Campo Dólar; *Urosaurus graciosus* at Bahía Kino; and *Crotalus cerastes* at Tastiota.

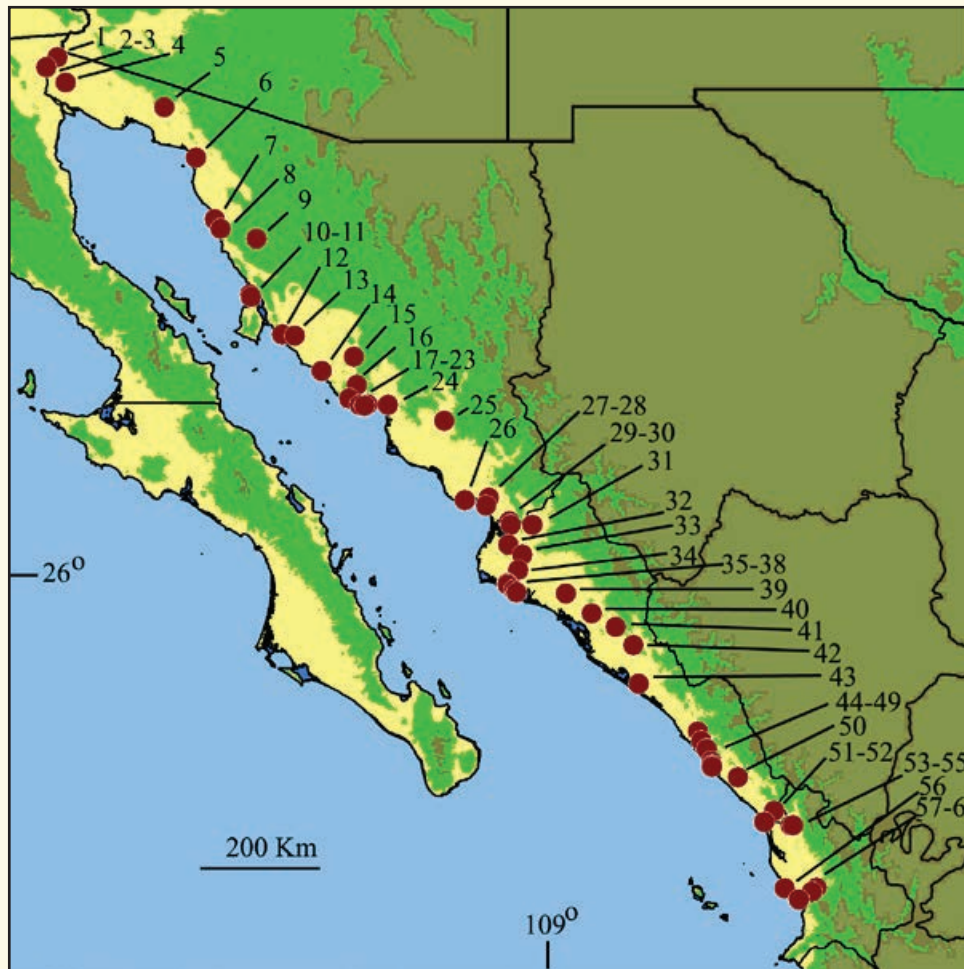



Fig. 1. The location of current estimates of the southern distributional limits along the coasts of Sonora, Sinaloa, and Nayarit for 60 species of amphibians and reptiles occurring exclusively or extensively in the Sonoran Desert (see data in Appendix 1). Yellow = elevations below 200 m; green = 200–1,000 m; and brown = above 1,000 m.



Sauromalus ater Dumeril, 1856. The Common Chuckwalla, a large herbivorous lizard, ranges in the Mohave and the Lower Colorado River Valley subdivision of the Sonoran deserts south to near Guaymas, Sonora. The species was eaten by native people, but was given a persecution score of 3 (generally ignored by humans) by Wilson et al. (2013a). Punta Sargento, Municipio de Hermosillo, Sonora, Mexico.

 © Erik F. Enderson

Xantusia vigilis, occurring in the Mohave Desert and in isolated mountain ranges of the arid LCRV Sonoran Desert, currently is known from only one locality in Sonora (25 mi S of San Luis). *Crotalus pyrrhus*, another species absent from most of the arborescent Arizona Upland Sonoran desertscrub, is documented in Sonora only in the Sierra Pinacate. Two Sonoran coastal endemics occur in this northern region of species terminations: *Xantusia jaycolei* has been recorded only from Desemboque del Río San Ignacio south to Cerro Tepopa; and *Crotaphytus dickersonae* from the Sierra Julio (EFE, pers. observ.) south to Bahía de Kino. Although these range terminations occur over a wide area, along 420 km (airline) of coast, and do not comprise a tight cluster (see next subsection), they share an underlying biogeographic association with great aridity.

Nine species reach their southern limits along the coast in a distinct cluster in the Guaymas region that encompasses an extent of 70 km (airline) from 32 km N (*Anaxyrus retiformis*) to 38 km SE of Guaymas (*Hypsiglena chlorophaea*). Farther south, 13 species terminations are clustered along the 150 km (airline) from Huatabampo, Sonora (*Uta stansburiana*), to just south of Topolobampo, Sinaloa (*Sceloporus magister*). Five species terminate in the 300 kms between the Topolobampo and Mazatlán regions (*Kinosternon alamosae*, *Phrynosoma solare*, *Ctenosaura macrolopha*, *Aspidoscelis tigris*, and *Heloderma suspectum*). The occurrence of *H. suspectum* at El Dorado, Sinaloa (Hardy and McDiarmid, 1969), 280 km south of the nearest records in southern Sonora, remains enigmatic (Campbell and Lamar, 2004; Beck, 2005). This specimen (AMNH R-90786) was collected by Dyfrigg McH. Forbes (D. Kizirian, pers. comm., 2016), who extensively vouchered the herpetofauna of the El Dorado area (Fugler and Dixon, 1961). We consider the record to be valid, but puzzling.

Another nine species terminate in a distinct cluster in southern Sinaloa, and 10 in Nayarit.

Focal Areas of Terminations

Five focal areas are discernable among the 60 species terminations of amphibians and reptiles along the coast of Sonora, Sinaloa, and Nayarit (Appendix 1, Figs. 1–7).

Río Colorado, Sonora (32.29°N). Three species (species 1–3; two anurans, one snake) occur in the study region only in riparian biotic communities near the delta of the Hardy and Colorado rivers.

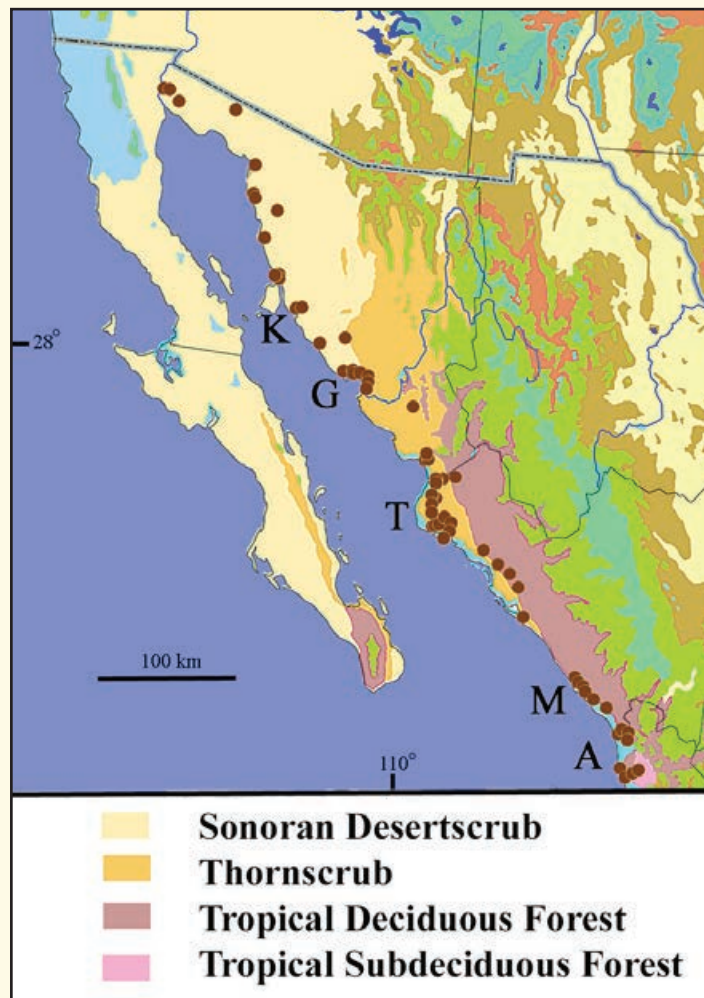

Fig. 2. The southern coastal terminations of 60 species of Sonoran Desert amphibians and reptiles plotted on a map of the biotic communities of northwestern Mexico. The map is derived from Brown and Lowe (1980), as extended by Brown et al. (1998, 2007). The letters represent five focal areas for terminations discussed in the text: C = Río Colorado, Sonora; K = Bahía Kino, Sonora; G = Guaymas, Sonora; T = Topolobampo, Sinaloa; M = Mazatlán, Sinaloa; and A = Acaponeta, Nayarit.

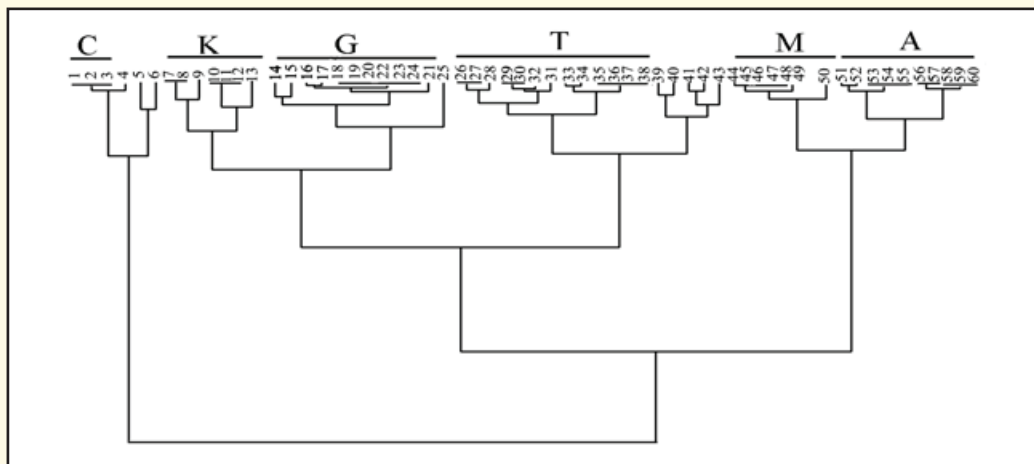

Fig. 3. The results of the cluster analysis (UPGMA, geographic distances) of coastal terminations for 60 species of Sonoran Desert amphibians and reptiles. The letters represent five focal areas for terminations discussed in the text: C = Río Colorado, Sonora; K = Bahía Kino, Sonora; G = Guaymas, Sonora; T = Topolobampo, Sinaloa; M = Mazatlán, Sinaloa; and A = Acaponeta, Nayarit.



Holbrookia elegans Bocourt, 1874. The Elegant Earless Lizard ranges in the Sonoran Desert from southern Arizona south along the coasts of Sonora and Sinaloa into semideciduous forest to near San Blas, Nayarit. Near Agua Prieta, Municipio de Agua Prieta, Sonora, Mexico.

© Erik F. Enderson

Bahía de Kino, Sonora (28.82°N). Seven species (7–13; five lizards, two snakes) reach their southern limit over a distance of 160 km (airline) between Puerto Lobos and Bahía de Kino. Of these, two are found only in the Sonoran Desert, four in the LCRV Sonoran and Mohave deserts, and one in all three warm North American deserts.

Guaymas, Sonora (27.92°N). Nine species (16–24; one anuran, four lizards, four snakes) terminate in the Guaymas area over a distance of 75 km. Six primarily are restricted to the Sonoran Desert, one to the Sonoran and Chihuahuan deserts, one to the LCRV Sonoran and Mohave deserts, and one widely in the North American deserts.

Topolobampo, Sinaloa (25.60°N). Thirteen species (26–38; two anurans, five lizards, five snakes, one turtle) terminate in this area over a distance of 150 km. Six occur primarily in the Sonoran Desert, two in the Sonoran and Chihuahuan deserts, two in the Sonoran and Mohave deserts, one in the LCRV Sonoran and Mohave deserts, and three widely in the North American deserts. Closely associated with this set of termini are five other species (39–43; four lizards, one turtle) known farther south in the northern coastal plain of Sinaloa, each from a single record. Three of these five are important Sonoran Desert species, as discussed below.

Mazatlán, Sinaloa (23.25°N). Seven species (44–50; one anuran, one lizard, five snakes) terminate in this area over a distance of 80 km. Two occur primarily in the Sonoran Desert, one in the Sonoran and Chihuahuan deserts, one in the Sonoran and Mohave deserts, one in the LCRV Sonoran and Mohave deserts, and three widely in North American deserts.

Acaponeta, Nayarit (22.50°N). Ten species (51–60; three anurans, four lizards, three snakes) terminate in the area over a distance of 134 km. Three occur primarily in the Sonoran Desert; one in the Sonoran and Mohave deserts, one in the Sonoran and Chihuahuan deserts, three widely in the North American deserts, and two in the Sonoran Desert and Madrean woodlands.

Whereas the range terminations of 13 species occur at various locations within the northern 420 km of Sonoran Desert, from the Gran Desierto and El Pinacate to Tastiota, a remaining 42 terminations occur within the summed total of 514 km in the five focal areas we identify, with only five terminations in the remaining 506 km (airline) of coast extending southward within our study region, demonstrating strong clustering rather than a gradual or random distribution of range terminations ($\chi^2 = 26$, $P < 0.0001$).

Taxonomic and Biogeographic Groups

For anurans, the species terminations tend to occur relatively far south, in the Topolobampo and Mazatlán and Acaponeta regions; for lizards, in the Topolobampo and Guaymas areas; and for snakes, in the Guaymas, Topolobampo, and Mazatlán areas (Fig. 4). Species found primarily in the LCRV Sonoran and Mohave deserts terminate almost exclusively in the Bahía Kino area; species found broadly in the three North American deserts have a higher percentage of their terminations in southern Sinaloa and Nayarit than species found only in the Sonoran Desert or only in the Sonoran and Mohave deserts (Fig. 5). We did not find these differences, however, to be statistically significant using ANOVA on either the untransformed, log-transformed, or ranked data, likely because of the difficulty of treating multi-modal distributions statistically; it appears that for snakes and anurans, widely distributed species tend to extend farther south into the tropical environments than lizards and desert-endemic species.

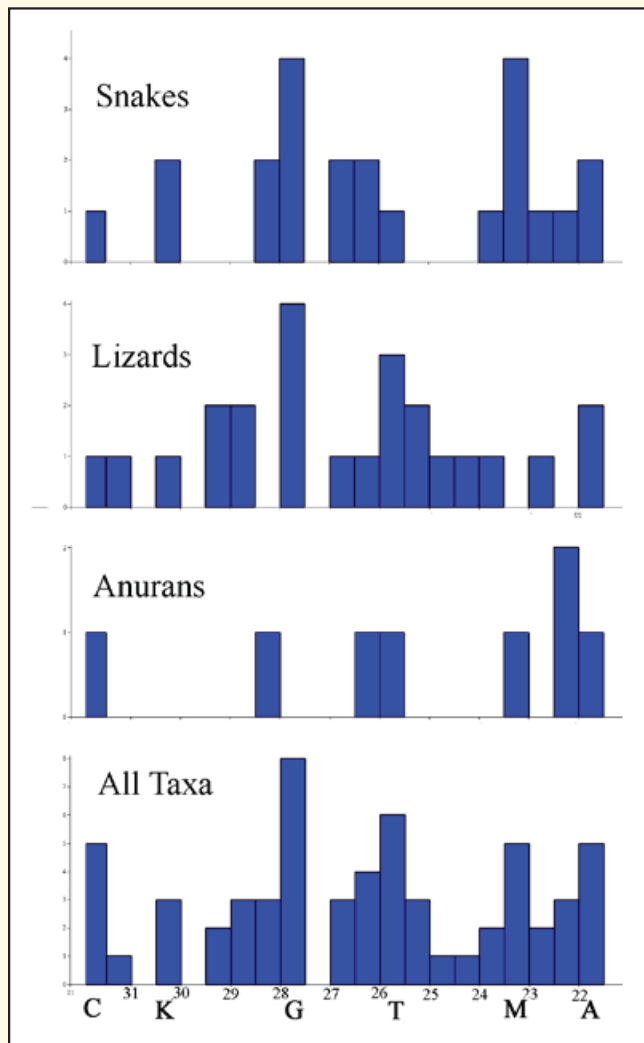

Fig. 4. Histograms of the number of southern terminations along the coast of northwest Mexico occurring at latitude intervals (30 minutes, ordered north to south) for all taxa, anurans, lizards, and snakes.

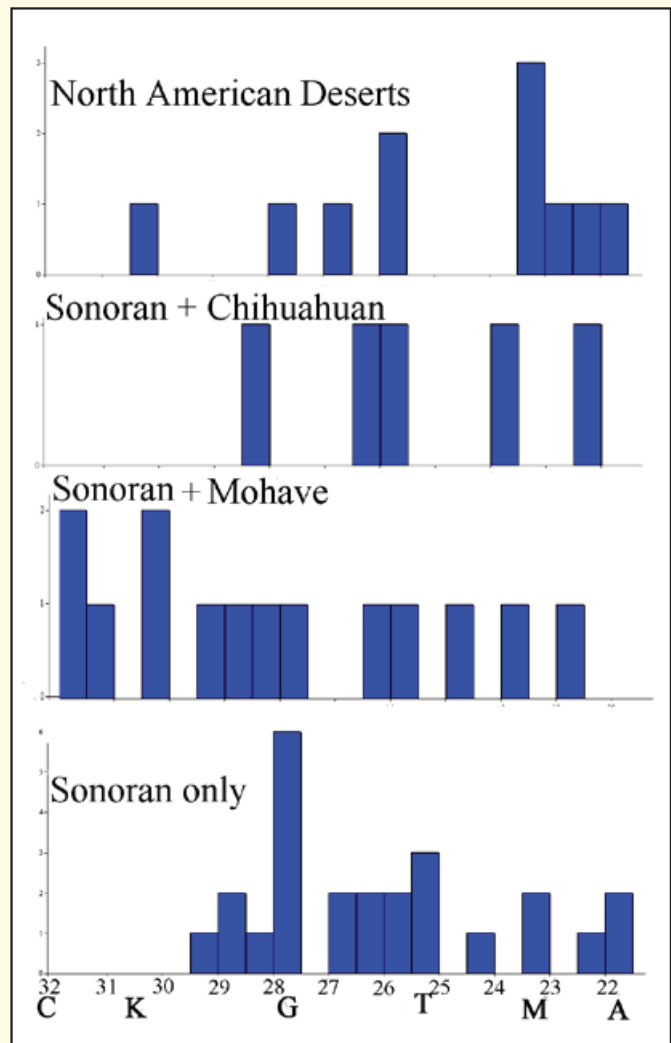

Fig. 5. Histograms of the number of southern terminations along the coast of northwest Mexico occurring at latitude intervals (30 minutes, ordered north to south) for four biogeographic distribution classes of amphibians and reptiles. The letters represent five focal areas for terminations discussed in the text: C = Río Colorado, Sonora; K = Bahía Kino, Sonora; G = Guaymas, Sonora; T = Topolobampo, Sinaloa; M = Mazatlán, Sinaloa; and A = Acaponeta, Nayarit.

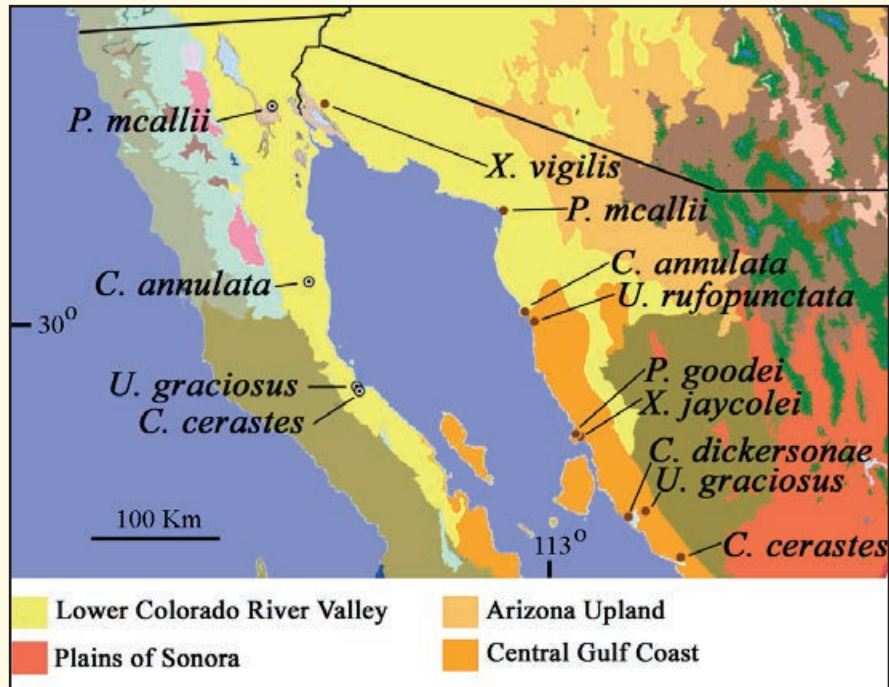

Fig. 6. Location of the southern terminations around the head of the Gulf of California for seven species of lizards (*Crotaphytus dickersonae*, *Phrynosoma goodei*, *Phrynosoma mcallii*, *Uma rufopunctata*, *Urosaurus graciosus*, *Xantusia jaycolei*, and *Xantusia vigilis*) and two snakes (*Chionactis annulata* and *Crotalus cerastes*). The map is based on Brown and Lowe (1980).

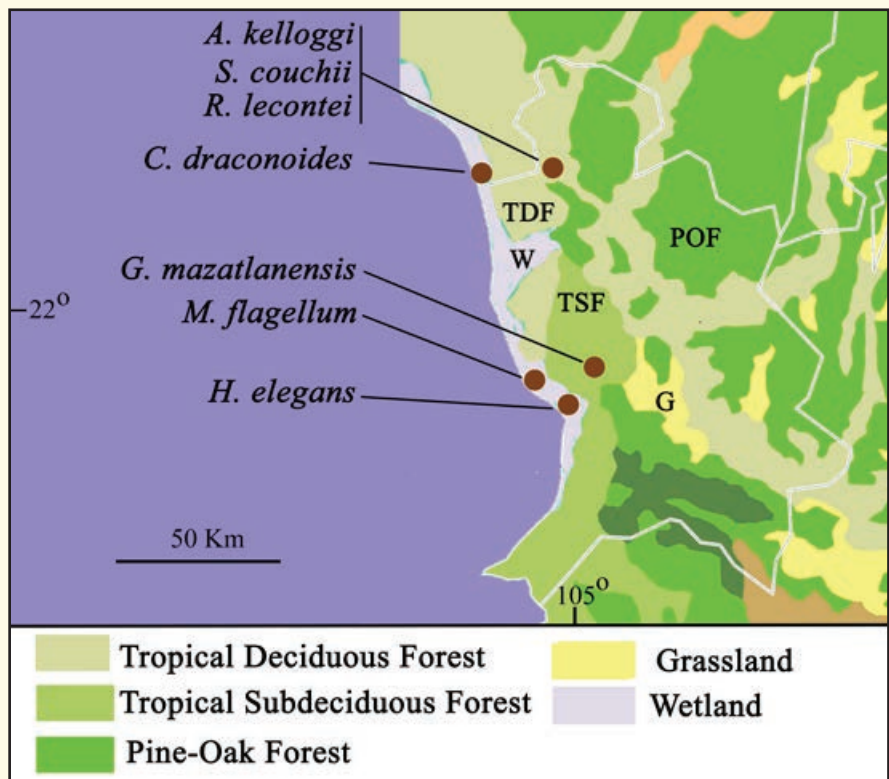

Fig. 7. Location of the southern terminations for seven species of amphibians and reptiles (*Anaxyrus kelloggi*, *Scaphiopus couchii*, *Rhinocheilus lecontei*, *Callisaurus draconoides*, *Gastrophryne mazatlanensis*, *Masticophis flagellum*, and *Holbrookia elegans*) in the complex vegetation mosaic of Nayarit and extreme southern Sinaloa. The map is based on Brown et al. (2007).

Conservation Status

None of the 60 species of amphibians and reptiles that reach southern limits along the northwestern coast of Mexico are listed as Threatened or Endangered under the U.S. Endangered Species Act (www.fws.gov/endangered/; accessed 10 December 2016). The IUCN Red List of Threatened Species (www.iucnredlist.org/search; accessed 10 December 2016) categorizes *Heloderma suspectum*, *Phrynosoma mcallii*, and *Uma rufopunctata* as Near Threatened. Eighteen species are listed as Subject to Special Protection (*Sujetos a Protección Especial*; Pr), and nine as Threatened (*Amenazadas*; A) under NOM 59 SEMARNAT 2010, the Mexican protected species law. Only one anuran (*Anaxyrus kelloggii*) received a high vulnerability score (EVS 14) by Wilson et al. (2013b), whereas two turtles, 11 lizards, and three snakes (Appendix 1) were scored as highly vulnerable (14–19) by Wilson et al. (2013a). Eight species of venomous reptiles received high persecution scores (5), as they were considered to be killed on sight, and *Gopherus morafkai* and *Ctenosaura macrolopha* were rated as 6, because they were exploited for meat and/or the pet trade.

On the basis of their limited geographic and ecological distribution, the most globally vulnerable species in the region may be five lizards, of which four are found near the head of the Gulf and one near Guaymas (listed in decreasing order): *Xantusia jaycolei*, *Uma rufopunctata*, *Phrynosoma mcallii*, *Crotaphytus dickersonae*, and *Aspidoscelis burti*.



Phrynosoma mcallii (Hallowell 1852). The Flat-tailed Horned Lizard ranges from extreme SE California and SW Arizona, south around the head of the Gulf of California into NE Baja California and NW Sonora, terminating near Bahía San Jorge. This arenicolous species is endemic to the periphery of the Gran Desierto and the adjacent sandy hyper-arid portions of the Sonoran Desert. It was listed as near threatened by IUCN and highly vulnerable (EVS of 15) by Wilson et al. (2013a). 30 km E San Luís Colorado, Yuma County, Arizona, United States.

 © Philip C. Rosen

DISCUSSION

Conservation

The five globally vulnerable lizard species, identified in the Results, occur on the northwestern coast of Sonora south to Guaymas, an area where threats from human impacts currently are minimal, but global warming and coastal developments for housing and energy production likely pose future threats. Although lizards generally are thermophilic, many, including common species, appear to be sensitive to the effects of global warming (Sinervo et al., 2010; Lara-Resendiz et al., 2015).



Uta stansburiana Baird and Girard, 1852. The Common Side-blotched Lizard is an abundant, widely distributed species in the North American deserts and ranges south along the coast of Sonora to near Huatabampo. Nacapule Canyon, Sierra el Aguaje, Municipio de Guaymas, Sonora, Mexico.  © Erik F. Enderson



Arizona elegans Kennicott, 1859. The Glossy Snake, widely distributed in the Chihuahuan, Mohave, and Sonoran deserts, ranges from southern Utah south along the coasts of Sonora and Sinaloa into tropical deciduous forest to near Mazatlán. Near Playa Mancha Blanca, Municipio de Pitiquito, Sonora, Mexico.  © Erik F. Enderson



Micruroides euryxanthus (Kennicott, 1860). The Sonoran Coral Snake, endemic to the Sonoran Desert, ranges from southern Arizona south along the coasts of Sonora and Sinaloa into Tropical Deciduous Forest to Jalisco (Cruz Sáenz et al., 2008). It was listed as highly vulnerable (EVS of 15) with a persecution score of 5 (killed on sight) by Wilson et al. (2013). Sierra El Aguaje, Municipio de Guaymas, Sonora, Mexico.

© Erik F. Enderson

For the populations of amphibians and reptiles in our study region, the greatest threat is the massive loss of natural or even modified flatland coastal plain habitat, including the deltas of Colorado, Sonora, Yaqui, and Mayo rivers, and the entire coastal plain of Sinaloa, from the Río Fuerte delta south to its terminus north of Mazatlán. In Sinaloa, the conversion of the river valley environs to agriculture already was well underway by the 1930s (Shreve, 1937) and, according to Brand (1936), already had been agricultural for centuries and, south of Culiacán, from pre-Columbian times. The remainder of the coastal plain was massively and almost uniformly converted to modern agriculture during the ensuing four decades (Fugler and Dixon, 1961; Rochin, 1985; Borlaug, 2007). Today, few areas retain even small isolated patches of intact or even modified wild habitat. Little information exists concerning natural environments or populations in this region. Species populations, habitat examples, scientific knowledge, and recreational amenities have been all but totally lost. The exceptions are in towns and villages, the immediate environs of major rivers, and local hills. Relatively more intact habitat may be surveyed, as the coast itself and its barrier islands are approached. Shreve (1937) noted that, “The vegetation of the hills which are scattered over the plain is commonly very similar to that of the plain” suggesting that important clues are to be found in these relict habitat patches, of which many still exist. We suggest that an inventory of these relict environments and their species populations, with a special focus on the aquatic species, is a key prelude to any future recovery of the resources lost, and will greatly assist interpretation of biogeographical transitions, to which we now turn our consideration.

Species Terminations

In northern Sonora, a 450 km-wide expanse of the Sonoran Desert lies between the Sierra Madre Occidental and the Río Colorado delta (Fig. 2). In Sinaloa, 600 km south of the desert, the coastal plain narrows to less than 100 km, and in Nayarit it disappears entirely as the sierra foothills meet the sea. This progressive southward convergence of the cordillera and the Gulf intensifies latitudinal climatic gradients, and has a significant impact on the biota as rainfall increases, winter freezes virtually cease to be part of the climate, and the environment becomes progressively more fully “tropical.” The northernmost thornscrub in Sonora is at 30.35°N near Arizpe in the Río Sonora Valley and 30.35°N at Presa Angostura on the Río Bavispe (Van Devender et al., 2013). Although the Tropic of Cancer lies at 23.43°N, just north of Mazatlán, Sinaloa, the northernmost tropical deciduous forest occurs in the Sierra San



Crotalus tigris Kennicott in Baird, 1859. The Tiger Rattlesnake occurs primary in the Sonoran Desert and ranges from southern Arizona south along the coast of Sonora to near Huatabampo. It was listed as highly vulnerable (EVS of 16), with a persecution rating of 5 (killed on sight) by Wilson et al. (2013a). Near Camahuiroa, Municipio de Huatabampo, Sonora, Mexico.  © Erik F. Enderson

Javier, Sonora (28.62°N), 680 km to the northwest. The Nayarit Peninsula is the wettest area on the west coast of Mexico (Van Devender et al., 2013). Thus, the southern coastal terminations of the herpetofauna examined in the study occur along a steep and complex gradient in climate and vegetation.

At the head of the Gulf lies the Gran Desierto del Altar (Fig. 6), the hottest and driest region in North America (Turner and Brown, 1982), equaled or surpassed only by local conditions in Death Valley and the Salton Depression of California, with some areas receiving less than 50 mm of rain per year. Its large sand sea originated from Colorado River sediments primarily in the Pleistocene, but lowered sea levels during the last glaciation also might have played a role, exposing an additional 50 km of sand below the present tides (Kresan, 2007). Evidence from packrat middens indicates that the vegetation near the Gulf might have been minimally impacted by ice age fluctuations, always retaining a Sonoran Desert character (Van Devender, 1990, 2007; Van Devender et al., 1990), although 100 km to the north, pinyon-juniper woodland was present in the Tinajas Altas Mountains in the late Pleistocene. Early Holocene (i.e., at the start of the present interglacial) vegetation in the Hornaday Mountains in the Pinacate region was a Sonoran desertscrub without junipers or other woodland plants. With Ice Age and early Holocene climates having greater winter rainfall, reduced summer rainfall, and cooler summers, the Central Gulf Coast subdivision of the Sonoran Desert probably was more like central Baja California, along a broader coastal area on the mainland (Van Devender et al., 1994). Nevertheless, fossil evidence suggests that Pleistocene fluctuations in climate and vegetation might not have greatly displaced vertebrate distributions in the Sonoran Desert (Van Devender and Mead, 1978). Thus, the herpetofaunal distributions examined here might have fluctuated to a relatively limited extent, compared to the large vegetational flux in the northern Sonoran Desert. A key unknown is whether reduced summer rainfall expanded the Sonoran Desert into thornscrub in southern Sonora during glacial periods.

Two endemic arenicolous lizards inhabit the extensive sand sheets surrounding the most barren dunes of the Grand Desierto sand sea (Figs. 8, 9) on both sides of the Gulf (Fig. 6), terminating near the southern edge of the LCRV (*Phrynosoma mcallii* and *Uma rufopunctata*). Four additional sand-associated species reach southern limits along the Gulf coast of northwestern Sonora (see Fig. 5), along with two arid-adapted rock-dwellers (*Crotalus*

pyrrhus and the locally endemic *Crotaphytus dickersonae*). All nine species that reach their range limits in the area have centers of abundance in, or even geographic distributions restricted to, the strongly arid LCRV Sonoran and Mohave deserts, or are endemic to the relatively arid Central Gulf Coast subprovince of the Sonoran Desert (Figs. 6, 9). Although this set of nine species clearly represents a well-defined ecological group, the relatively diffuse spread of their terminations points toward a complex ecological setting and transition within the northwestern Sonoran portion of the “true” or hyperarid desert of North America.





Fig. 8. The hot, hyper-arid Sierra Pinacate at the head of the Gulf of California, the southern limit of *Crotalus pyrrhus* near the coast of Sonora. Sonoran desertscrub is dominated by brittlebush (*Encelia farinosa*), creosotebush (*Larrea divaricata*), foothills paloverde (*Parkinsonia microphylla*), and desert ironwood (*Olneya tesota*). El Pinacate and Gran Desierto de Altar Biosphere Reserve, Municipio de Puerto Peñasco, Sonora, Mexico.  © Ana Lilia Reina-Guerrero



Fig. 9. Sand dunes of the Gran Desierto at the Central Gulf Coast subdivision of the Sonoran Desert near the southern limits of the arenicolous *Phrynosoma mcallii*, *Chionactis annulata*, and *Uma rufopunctata*. Coastal Sonoran desertscrub is dominated by cliff spurge (*Euphorbia misera*), elephant tree (*Bursera microphylla*), cardón (*Pachycereus pringlei*), and old man cactus (*Lophocereus schottii*). Near Libertad, Municipio de Pitiquito, Sonora, Mexico.  © Ana Lilia Reina-Guerrero

The first clearly, well-defined cluster south of the terminations of these several arid desert species occurs in the region of Guaymas, astride the mapped transition from Sonoran desertscrub to thornscrub (Figs. 2, 11), described in detail by Forrest Shreve 83 years ago (Shreve, 1934). He noted the southern limits of creosotebush east of Empalme (Cruz de Piedras, 27°57'N; near Guaymas), thus connoting the southern end of the phytogeographically defined Sonoran Desert as currently conceived (Brown and Lowe, 1980). Shreve noted that this was followed significantly farther south by the terminations of many other stalwarts of arborescent Sonoran desertscrub, such as desert ironwood (*Olneya tesota*, Teachive, 26°47'N) and saguaro (*Carnegiea gigantea*, Mesa Masiaca, 26°46'N) southeast of Navojoa, which reach their absolute limits in thornscrub considerably south of the desert itself (see also Turner and Brown, 1982; and Turner et al., 2005). Similar terminations of other highly characteristic Sonoran Desert plants (SEINet, 2016) also occur in the Guaymas region (foothill paloverde, *Parkinsonia microphylla*; ocotillo, *Fouquieria splendens*; triangle-leaf bursage, *Ambrosia deltoidea*) whereas many others, less arid-associated, similarly extend to the region near Masiaca and the Sinaloan border (blue paloverde, *Parkinsonia florida*; velvet mesquite, *Prosopis velutina*; desert hackberry, *Celtis pallida*; and brittlebush or incienso, *Encelia farinosa*), although isolated records for the latter two are available in Sinaloa). These two focal regions for range terminations of the dominant Sonoran Desert plants of southern Arizona (see Brown and Lowe, 1980) are broadly similar to the second and third focal areas we identified for the herpetofauna; however, we return to this issue below.



Fig. 10. The night lizard *Xantusia jaycolei* is endemic to the coast of Sonora and lives almost exclusively in fallen cardón (*Pachycereus pringlei*). Coastal Sonoran desertscrub is dominated by cardón, plus white bursage (*Ambrosia dumosa*), foothills paloverde (*Parkinsonia microphylla*), and teddybear cholla (*Cylindropuntia bigelovii*). Cerro Tepopa, Municipio de Pitiquito, Sonora, Mexico. 📷 © Erik F. Enderson



Fig. 11. Nine species of the Sonoran Desert herpetofauna reach their southern limits in the region just south of Guaymas, Sonora. The transition from desertscrub to thornscrub occurs in this area and was discussed 82 years ago by Shreve (1932). Data remain inadequate to examine the correspondence of the distributional limits of the plants, amphibians, and reptiles in this zone, and detailed studies are needed while the biotic communities remain somewhat intact. Coastal thornscrub is dominated by torote prieto (*Bursera laxiflora*), brazil (*Haematoxylum brasiletto*), palo brea (*Parkinsonia praecox*), sámota (*Coursetia glandulosa*), organ pipe cactus (*Stenocereus thurberi*), and the southernmost saguaros (*Carnegiea gigantea*). Masiaca Mesa, Municipio de Navojoa, Sonora, Mexico. 📷 © Thomas R. Van Devender

The confluence of 10 herpetofaunal range terminations near Guaymas supports the concept of a real biogeographic transition in this area (Figs. 2–5), although the species are an ecologically and biogeographically mixed assemblage, ranging from *Tantilla hobartsmithi* (primarily associated with semi-desert grassland and mesic desertscrub), *Aspidoscelis burti* (mesic desertscrub), *Chionactis palarostris* and *Lichanura trivirgata* (arid margin of arborescent Sonoran desertscrub), and *Sauromalus ater* (mostly in arid Sonoran and Mohave desertscrub). Most of these species are relatively arid-associated, but the change evident in this region does not appear to signify the principal transition from a Sonoran Desert herpetofauna to one of more tropical affiliation, thus differing from currently accepted phytogeographic categories that clearly place the terminus of the Sonoran Desert in the Guaymas region.

The 13 terminations clustered between Huatabampo, Sonora, and Topolobampo, Sinaloa, also appear to correlate with geographical changes in climate, and to a lesser extent with vegetation (Hardy and McDiarmid, 1969; Serrano et al., 2014). Annual precipitation at Empalme, Sonora, near the southern margin of the Sonoran Desert, is 196 mm (BWh, Köppen-Geiger “hot desert”); at Topolobampo (Figs. 12, 13), 300 km to the south, it is somewhat



Fig 12. Thirteen species of Sonoran Desert amphibians and reptiles reach their southern limits of distribution along the mainland coast of Mexico in the area of Topolobampo, Sinaloa. Fortunately large expanses of thornscrub and tropical deciduous forest remain intact in the region, and these deserve protection. Thornscrub in northwestern Sinaloa differs from coastal and foothills thornscrub in Sonora in dominance by ashy limberbush (*Jatropha cinerea*, as a small tree) in association with torote prieto (*Bursera laxiflora*) and organ pipe cactus (*Steinocereus thurberi*) on rocky slopes, and étcho (*Pachycereus pectin-aboriginum*), guayacán (*Guaiacum coulteri*), saituna (*Ziziphus amole*), and honey mesquite (*Prosopis glandulosa*) in flatter areas. Near Topolobampo, Municipio de Ahome, Sinaloa, Mexico.

© Philip C. Rosen

higher, 274 mm (BWh, “hot desert”); whereas at Culiacán, 400 km farther south, it is triple, 668 mm (BSh, “hot semi-arid”; <http://en.climate-data.org>). Plants widely distributed in the Sonoran Desert that reach their southern limits near Topolobampo, Sinaloa, include honey mesquite (*Prosopis glandulosa*) and organ pipe cactus (*Stenocereus thurberi*; Turner et al., 2005).



Fig. 13. In northern Sinaloa, thornscrub is replaced by tropical deciduous forest dominated by diverse 10–15 m tall trees. The understory in the rainy season is dense and humid, and reduced sunlight for basking limits the distribution of thermophilous, desert-adapted reptiles. The succulent in the foreground is the spiny bromeliad cuicuixtle (*Bromelia plumieri*). Near Pericos, Municipio de Mocorito, Sinaloa, Mexico.

© Philip C. Rosen

The 13 species in this cluster comprise a diverse assemblage, including some that are characteristic of the Sonoran Desert (*Chilomeniscus stramineus*, *Crotalus tigris*, *Incilius alvarius*) and other desert species that are conspicuously prominent in the Sonoran Desert (e.g., *Gopherus morafkai*, *Crotalus atrox*, *Dipsosaurus dorsalis*, *Sceloporus magister*, *Uta stansburiana*). Indeed, beyond this region the herpetofauna begins to lose much semblance of Sonoran Desert character.

The species turnover of the herpetofauna south of the Sonora–Sinaloa border was noted previously by Hardy and McDiarmid (1969). Just 75 km north of the border, Heringhi (1969) reported that Sonoran Desert species predominate (16 of 20 species) in [foothills] thornscrub along the road from Navajoa to 16 km west of Alamos, Sonora, to which may be added five additional Sonoran Desert species from 6.4 km north of Navajoa, for a total of 21 of 25 (84%) species that reach the Sonoran Desert of southern Arizona. Bogert and Oliver (1945) reported Sonoran Desert species to predominate (nine of 14, 64%) at Ahome, Sinaloa, 50 km south of the Sonora border. In contrast, in the Culiacán region the herpetofauna is distinctly and predominantly tropical in character: near El Dorado, Sinaloa (280 km south of the border) Fugler and Dixon (1961) identified 11 Sonoran Desert species among 32 amphibians and reptiles (32%); and near Costa Rica, Sinaloa (250 km south of the border), Smith and Van Gelder (1955) similarly reported six (32%) Sonoran Desert species among 19 total species reported.

These limited, old data on local species composition of the herpetofauna demonstrate support for the relatively abrupt species turnover indicated in our analysis of southern range terminations along the coast. Together, the species composition and range terminations indicate that the lowland herpetofauna of northwestern Mexico retains

a strongly Sonoran Desert character into the northern coastal region of Sinaloa. Thus, whereas thornscrub vegetation assumes predominance along the Sonoran coast in the Guaymas area (Brown, 1982; Martin et al., 1998), the Sonoran Desert herpetofauna retains its predominance at least another 200–350 km farther south.

The vegetation in this coastal region of Sinaloa has been variously characterized, mapped, and named. Shreve (1937), Goldman (1951), and Hardy and McDiarmid (1969) indicate that the vegetation is relatively uniform and extends throughout lowland Sinaloa to the middle of the state. Nonetheless, Shreve's (1934, p. 378) general statement that, "For 500 km. south of Navojoa ... the physiognomy of the vegetation is almost identical" is contradicted by his more specific statements, "Only in the northern part of the thorn-forest [= coastal thornscrub] are there large openings such as are thickly carpeted with ephemerals in the desert" (Shreve, 1937: 612), and "In certain situations, however, ... the open patches suggestive of desert spacing may still be seen as far south as the valley of Río Fuerte, in Sinaloa, with *Cercidium*, *Encelia* and *Opuntia fulgida* as their characteristic plants" (Shreve, 1934: 377; Fig. 12). Brown (1982) called the vegetation in the region Sinaloan thornscrub, lumping it with the distinctive foothills thornscrub. Búrquez et al. (1992, 1999) and Martin et al. (1998) identify it as coastal thornscrub, a unique vegetation type (Fig. 11). Creel (2010) included thornscrub from Sonora and northern Sinaloa as "*bosques secos transicionales de Sonora y Sinaloa*" (transitional dry forests of Sonora and Sinaloa) with southern limits similar to those we demonstrate here for the Sonoran Desert herpetofauna.

The southern limits of five species of reptiles are scattered between the Río Fuerte and Río Culiacán areas; two of these (*Heloderma suspectum*, *Phrynosoma solare*) are characteristic of and occur largely in the Sonoran Desert. The southernmost of these terminations, *H. suspectum* at 24°18'N, corresponds roughly with the southern coastal limit of thornscrub as mapped by Brown et al. (1998, 2007) at ca 24°N (Fig. 2). These herpetofaunal terminations are over 400 km south of the Sonoran Desert, as mapped on the basis of vegetation. The dominant perennial plants characteristic of tropical thornscrub in northwestern Mexico are, in varying degrees, controlled northward by exposure to freezing temperatures (Shreve, 1934; Felger et al., 2001), which they cannot avoid, whereas the herpetofauna likely is controlled by other factors, including precipitation and humidity, seasonal temperature means, and vegetation structure.



Fig. 14. Tropical deciduous forest has dense, slender trees with whitish bark in a large area in southern Sinaloa. Characteristic of tropical deciduous forest, the trees reach a greater height than the étcho columnar cactus (*Pachycereus pecten-aboriginum*). This habitat is most desert-like and open in the hot dry season, and the closed canopy in the wet season is limiting to desert-adapted species. Larger arroyos also provide open, sandy microhabitats. Meseta de Cacaxtla, Municipio de San Ignacio, Sinaloa, Mexico.  © Albert van der Heiden





Fig. 15. A coastal strand. Survival of such desert-adapted reptiles as sand lizards, *Callisaurus draconoides* and *Holbrookia elegans*, in tropical habitats is promoted by coastal dunes and wetlands where saline soils produce an edaphic desert. The trees in the background are mangroves. Las Labradas, Meseta de Cacaxtla, Municipio de San Ignacio, Sinaloa, Mexico.  © Albert van der Heiden



Fig. 16. Dense tall trees, a closed canopy, a shady moist understory, heavy rainfall, and a shortened dry season in tropical semideciduous forest bring down the curtain along the Pacific for all but three Sonoran Desert species of amphibians and reptiles. Cacti and agaves are replaced by bromeliads and orchids. The dominant tree is capomo (*Brosimum alicastrum*). La Guásima, Municipio de Concordia, Sinaloa, Mexico.  © Thomas R. Van Devender

Our finding that the terminus in northern Sinaloa of the Sonoran Desert herpetofauna as the predominating assemblage is consistent with a map presented by Lavín-Murcio and Lazcano (2010), and probably is not a sampling artifact related to agricultural development. Shreve (1937) reported that only the river floodplains proper in Sinaloa, comprising a small portion of the coastal plain, were extensively converted to agriculture; 25 years later Fugler and Dixon (1961) reported that their coastal plain study area south of Culiacán was completely converted to agriculture. Given the number of prior herpetological records in Sinaloa (e.g., records in Hardy and McDiarmid, 1969), however, the abundance and conspicuousness of many of the species involved, and the number of species sharing the terminus in the Topolobampo area (Appendix 1), it seems unlikely that the herpetofaunal termination patterns in northern and central Sinaloa are primarily artifacts of the impact of agriculture on sampling.

Details of how closely the herpetofaunal terminations correspond with the limits of species of Sonoran Desert and tropical plants and other organisms remain to be evaluated, both locally and regionally. We note that a strong and more varied perspective would likely emerge from an analysis similar to ours, but 50–200 km farther inland, and that a detailed study of distributional limits and abundance across the transitions from warm temperate to subtropical to tropical regions is of great and immediate interest, while at least remnants of natural vegetation exist in northwestern Mexico.

South of the thornscrub on the Sinaloa coast, amphibian and reptiles widespread in the Sonoran Desert gradually are closed out as the coastal plain narrows and the cordillera reaches the Pacific. Three species that are beyond the scope of this study (based on our criteria) continue along the coast south of the cordillera, terminating in Michoacán and Colima: *Smilisca fodiens* (Cox et al., 2012), *Rena humilis* (Hahn, 1979), and *Thamnophis cyrtopsis* (Webb, 1966). *Masticophis flagellum* (UMMZ 80186–89), listed for Colima by Duellman (1958), was identified as *M. mentovarius* by Johnson (1977). A few other species, such as *Sceloporus clarkii*, *Micruroides euryxanthus*, and *M. flagellum* abandon the coast, but extend inland in canyons (Webb, 1984; Cruz Sáenz et al., 2008).

Where the cordillera meets the Pacific in Nayarit is a complex mosaic of wetlands, tropical deciduous forest, tropical subdeciduous forest, and pine-oak forest (Fig. 7; Woolrich-Piña et al., 2016). The last appearance on the coast of three prominent Sonoran Desert species, *Callisaurus draconoides*, *Holbrookia elegans*, and *Masticophis flagellum*, is along a vast wetland, the Marismas Nacionales-San Blas, where saline soils give rise to a hot, open, sandy, dehydrating edaphic desert (Fig. 15). To the south, closed-canopy moist forests (Fig. 16) bring down the curtain along the Pacific for all but three species of Sonoran Desert amphibians and reptiles, a finality rivaling that of land's end at Cabo San Lucas on the Baja California peninsula, which now lies across the Gulf.

Acknowledgments.—We thank Richard Felger and Frank Reichenbacher for information on vegetation; David Kizirian (AMNH), Travis LaDuc (TNHC), Greg Schneider (UMMZ), and Dan Wylie (UIMNH) for information on museum specimens; Daniel Mulcahy (*Hypsiglena*) and Edward Myers (snakes) for information on systematics and distribution; Sky Jacobs for help with the production of maps; Kathryn Bolles, Albert van der Heiden, Mark Dimmitt, and Ana Lilia Reina-Guerrero for photographs; Kit Bolles Bezy and Kathryn Bolles for advice on illustrations; Ana Lilia Reina-Guerrero for the Resumen; and Kathryn Bolles, Louis Porras, Daniel Cruz Sáenz, and an anonymous reviewer for helpful suggestions on a previous draft of the manuscript.

LITERATURE CITED

- BECK, D. D. 2005. *Biology of Gila Monsters and Beaded Lizards*. University of California Press, Berkeley, California, United States.
- BERRY, J. F., AND J. M. LEGLER. 1980. A new turtle (genus *Kinosternon*) from northwestern Mexico. *Natural History Museum of Los Angeles County, Contributions in Science* 325: 1–25.
- BEZY, R. L., K. B. BEZY, AND K. BOLLES. 2008. Two new species of night lizards (*Xantusia*) from Mexico. *Journal of Herpetology* 42: 680–688.
- BEZY, R. L., AND C. J. COLE. 2014. Amphibians and reptiles of the Madrean Archipelago of Arizona and New Mexico. *American Museum Novitates* 3,810: 1–23.
- BOGERT, C. M., AND J. A. OLIVER. 1945. A preliminary analysis of the herpetofauna of Sonora. *Bulletin of the American Museum of Natural History* 83: 301–425.
- BORLAUG, N. E. 2007. Sixty-two years of fighting hunger: personal recollections. *Euphytica* 157: 287–297.
- BRAND, D. D. 1936. Notes to accompany a vegetation map of north-west Mexico. *University of New Mexico Biological Series* 280(4): 1–27.
- BRENNAN, T. C., AND A. T. HOLYCROSS. 2009. *A Field Guide to Amphibians and Reptiles in Arizona*. Arizona Game and Fish Department, Phoenix, Arizona, United States.

- BROWN, D. E. 1982. Sinaloa thronscrub. Pp. 101–105 *In* D. E. Brown (Ed.), *Desert Plants: Biotic Communities of the American Southwest—United States and Mexico*. Published by The University of Arizona for the Boyce Thompson Southwestern Arboretum, Superior Arizona, United States.
- BROWN, D. E. (ED.). 1994. *Biotic Communities: Southwestern United States and Northwestern Mexico*. University of Utah Press, Salt Lake City, Utah, United States.
- BROWN, D. E., AND C. H. LOWE. 1980. *Biotic Communities of the Southwest*. USDA Forest Service General Technical Report RM-78. U.S. Forest Service, Fort Collins, Colorado, United States.
- BROWN, D. E., F. W. REICHENBACHER, AND S. E. FRANSON. 1998. *A Classification System and Map of the Biotic Communities of North America*. University of Utah, Salt Lake City, Utah, United States.
- BROWN, D. E., P. J. UNMACK, AND T. C. BRENNAN. 2007. Digitized map of biotic communities for plotting and comparing distributions of North American animals. *Southwestern Naturalist* 52: 610–616.
- BÚRQUEZ, A., A. MARTÍNEZ-YRÍZAR, AND P. S. MARTIN. 1992. From the Sierra Madre to the coast: changes in vegetation along highway 16, Maycoba-Hermosillo. Pp. 239–252 *In* K. F. Clark, J. Roldán-Quintana, and R. Schmidt (Eds.), *Northern Sierra Madre Occidental Province, México*. Guidebook. El Paso Geological Society, El Paso, Texas, United States.
- BÚRQUEZ, A., A. MARTÍNEZ-Y., R. S. FELGER, AND D. YETMAN. 1999. Vegetation and habitat diversity at the southern edge of the Sonoran Desert. Pp. 36–67 *In* R. H. Robichaux (Ed.), *Ecology of Sonoran Desert Plants and Plant Communities*. University of Arizona, Tucson, Arizona, United States.
- CAMPBELL, J. A., AND W. W. LAMAR. 2004. *The Venomous Reptiles of the Western Hemisphere*. 2 Volumes. Comstock Publishing Associates, Cornell University Press, Ithaca, New York, United States.
- COX, C. L., J. W. STREICHER, C. M. SHEEHY III, J. A. CAMPBELL, AND P. T. CHIPPINDALE. 2012. Patterns of genetic differentiation among populations of *Smilisca fodiens*. *Herpetologica* 68: 226–235.
- CREEL, J. B. 2010. Las selvas secas del Pacífico Mexicano in perspectiva mundial. Pp. 21–40 *In* G. Ceballos, A. García, L. Martínez, E. Espinosa, J. Bezaury and R. Dirzo (Eds.), *Diversidad, Amenazas y Áreas Prioritarias para la Conservación de las Selvas Secas del Pacífico de México*. Comisión Nacional para el Conocimiento y Uso de la Biodiversidad, Comisión Nacional de Áreas Protegidas, and Universidad Nacional Autónoma de México, México, D.F., Mexico.
- CRUZ SAENZ, D., C. E. GUDIÑO LARIOS, C. D. JIMENO SEVILLA, R. LÓPEZ VELÁZQUEZ, AND J. CORTÉS AGUILAR. 2008. *Guía de Reptiles y Anfibios de Arcediano*. Gobierno de Jalisco, Mexico
- DEBANO, L. F., P. F. FOLLIOTT, A. ORTEGA-RUBIO, G. J. GOTTFRIED, R. H. HAMRE, AND C. B. EDMINSTER (TECHNICAL COORDINATORS). 1995. *Biodiversity and Management of the Madrean Archipelago: the Sky Islands of Southwestern United States and Northwestern Mexico*. General Technical Report RM-GTR-264. U.S.D.A. Forest Service, Fort Collins, Colorado, United States.
- DEGENHARDT, W. G., C. W. PAINTER, AND A. H. PRICE. 1996. *Amphibians and Reptiles of New Mexico*. University of New Mexico Press, Albuquerque, New Mexico, United States.
- DICE, L. R. 1939. The Sonoran biotic province. *Ecology* 20: 118–129.
- DUUELLMAN, W. E. 1958. A preliminary analysis of the herpetofauna of Colima, Mexico. *University of Michigan Publications in Zoology* 589: 1–22.
- ENDERSON, E. F., A. QUIJADA-MASCAREÑAS, D. S. TURNER, P. C. ROSEN, AND R. L. BEZY. 2009. The herpetofauna of Sonora, Mexico, with comparisons to adjoining states. *Checklist 5*: 632–672.
- ENDERSON, E. F., T. R. VAN DEVENDER, AND R. L. BEZY. 2014. Amphibians and reptiles of Yécora, Sonora and the Madrean Tropical Zone of the Sierra Madre Occidental in northwestern Mexico. *Checklist 10*: 913–926.
- FELGER, R. S. 1965. *Xantusia vigilis* and its habitat in Sonora, Mexico. *Herpetologica* 21: 146–147.
- FELGER, R. S., B. M. JOHNSON, AND M. F. WILSON. 2001. *The Trees of Sonora, Mexico*. Oxford University Press, New York, New York, United States.
- FUGLER, C. M., AND J. R. DIXON. 1961. Notes on the herpetofauna of the El Dorado area of Sinaloa, Mexico. *Publications of the Museum, Michigan State University, Biological Series* 2: 1–23.
- GEHLBACH, F. R. 1981. *Mountain Islands and Desert Seas: A Natural History of the U.S.-Mexican Borderlands*. Texas A&M University Press, College Station, Texas, United States.
- GOLDMAN, E. A. 1951. Biological investigations in Mexico. *Smithsonian Miscellaneous Collections* 115: *xiii* + 1–476.
- GRISMER, L. 2002. *Amphibians and Reptiles of Baja California Including its Pacific Islands and the Islands in the Sea of Cortes*. University of California Press, Berkeley, California, United States.
- HAHN, D. E. 1979. *Leptotyphlops humilis* (Baird and Girard). *Western Blind Snake Catalogue of American Amphibians and Reptiles* 232.1–232.4.
- HARDY, L. M., AND R. W. MCDIARMID. 1969. The amphibians and reptiles of Sinaloa, Mexico. *University of Kansas Publications of the Museum of Natural History* 18: 39–252.
- HERINGHI, H. L. 1969. *An Ecological Survey of the Herpetofauna of Álamos, Sonora, Mexico*. Unpublished MSc. thesis, Arizona State University, Tempe, Arizona, United States.
- IVERSON, J. B. 1976. *Kinosternon sonoriense*. *Sonora Mud Turtle. Catalogue of American Amphibians and Reptiles* 176.1–176.2.
- IVERSON, J. B. 1981. Biosystematics of the *Kinosternon hirtipes* species group (Testudines: Kinosternidae). *Tulane Studies in Zoology* 23: 174.
- JOHNSON, J. D. 1977. The taxonomy and distribution of the Neotropical whipsnake *Masticophis mentovarius* (Reptilia, Serpentes, Colubridae). *Journal of Herpetology* 11: 287–309.
- JONES, L. L. C., AND R. E. LOVICH (EDS.). 2009. *Lizards of the American Southwest: A Photographic Field Guide*. Rio Nuevo Publishers, Tucson, Arizona, United States.
- KRESAN, P. L. 2007. A geological tour of the dry borders region. Pp. 31–45 *In* R. S. Felger and B. Broyles (Eds.), *Dry Borders: Great Natural Reserves of the Sonoran Desert*. University of Utah Press, Salt Lake City, Utah, United States.
- LARA-RESENDIZ, R. A., T. JEZKOVA, P. C. ROSEN, AND F. R. MENDEZ-DE LA CRUZ. 2015. Thermoregulation during the summer season in the Goode's Horned Lizard *Phrynosoma goodei* (Iguania: Phrynosomatidae) in Sonoran Desert. *Amphibia-Reptilia*, 35: 161–172.

- LAVÍN-MUUCIO, P. A., AND D. LAZCANO. 2010. Geographic distribution and conservation of the herpetofauna of northern Mexico. Pp. 273–301 *In* L. D. Wilson, J. H. Townsend, and J. D. Johnson (Eds.), Conservation of Mesoamerican Amphibians and Reptiles. Eagle Mountain Publishing, LC, Eagle Mountain, Utah, United States.
- LEGLER, J. M., AND R. C. VOGT. 2013. The Turtles of Mexico: Land and Freshwater Forms. University of California Press, Berkeley, California, United States.
- LEMONS-ESPINAL, J. A. (ED.). 2015. Amphibians and Reptiles of the US–Mexico Border States / Anfíbios y Reptiles de los Estados de la Frontera México–Estados Unidos. Texas A&M University Press, College Station, Texas, United States.
- LOWE, C. H. 1955a. The eastern limit of the Sonoran Desert in the United States with additions to the known herpetofauna of New Mexico. *Ecology*, 36: 343–345.
- LOWE, C. H. 1955b. An evolutionary study of island faunas in the Gulf of California, Mexico, with a method for comparative analysis. *Evolution* 9: 339–344.
- LOWE, C. H., AND D. E. BROWN. 1994. Introduction. Pp. 8–16 *In* D. E. Brown (Ed.), Biotic Communities: Southwestern United States and Northwestern Mexico. University of Utah Press, Salt Lake City, Utah, United States.
- MALKIN, B. 1962. Seri ethnozoology. Occasional Papers of Idaho State College Museum 7: 1–59 (+8).
- MARTIN, P. S., D. A. YETMAN, M. FISHBEIN, P. JENKINS, T. R. VAN DEVENDER, AND R. K. WILSON (EDS.). 1998. Gentry's Río Mayo Plants: The Tropical Deciduous Forest and Environs of Northwest Mexico. University of Arizona Press, Tucson, Arizona, United States.
- MCDIARMID, R. W., J. F. COPP, AND D. E. BREEDLOVE. 1976. Notes on the herpetofauna of western México: new records from Sinaloa and the Tres Marias Islands. *Natural History Museum of Los Angeles County Contributions in Science* 275: 1–17.
- NORELL, M. A. 1989. Late Cenozoic lizards of the Anza Borrego Desert, California. *Natural History Museum of Los Angeles County, Contributions in Science* 414: 1–31.
- NORRIS, K. S. 1953. The ecology of the Desert Iguana *Dipsosaurus dorsalis*. *Ecology* 34: 265–287.
- O'BRIEN, C., A. D. FLESCHE, E. WALLACE, M. BOGAN, S. E. CARRILLO-PERCÁSTEGUI, S. JACOBS, AND C. VAN RIPER III. 2006. Biological Inventory of the Río Aros, Sonora, Mexico: A River Unknown. Final Report to T&E, Inc., University of Arizona and Sonoran Research Station, Tucson, Arizona, United States.
- POWELL, R., R. CONANT, AND J. T. COLLINS. 2016. Peterson Field Guide to Reptiles and Amphibians of Eastern and Central North America. 4th ed. Houghton Mifflin Harcourt, Boston, Massachusetts, United States.
- ROCHIN, R. I. 1985. Mexico's agriculture in crisis: a study of its northern states. *Mexican Studies/Estudios Mexicanos* 1: 255–275.
- RORABAUGH, J. C., AND J. A. LEMONS-ESPINAL. 2016. A Field Guide to the Amphibians and Reptiles of Sonora. ECO Herpetological Publishing, Rodeo, New Mexico, United States.
- ROSEN, P. C. 2004. Charles Herbert Lowe Jr. 1920–2002. *Copeia*, 2004: 961–972.
- ROSEN, P. C. 2007. The amphibians and reptiles of the dry borderlands of northwestern Sonora and southwestern Arizona. Pp. 310–337 *In* R. S. Felger and B. Broyles (Eds.), Dry Borders: Great Natural Reserves of the Sonoran Desert. University of Utah Press, Salt Lake City, Utah, United States.
- ROSSMAN, D. A., N. B. FORD, AND R. A. SEIGEL. 1996. The Garter Snakes: Evolution and Ecology. University of Oklahoma, Norman, Oklahoma, United States.
- SCHWALBE, C. R., AND C. H. LOWE. 2000. Amphibians and reptiles of the Sierra de Alamos. Pp. 172–199 *In* R. H. Robichaux and D. A. Yetman (Eds.), The Tropical Deciduous Forest of Alamos: Biodiversity of a Threatened Ecosystem in Mexico. University of Arizona Press, Tucson, Arizona, United States.
- SEINET (SOUTHWEST ENVIRONMENTAL INFORMATION NETWORK) – ARIZONA CHAPTER. 2016. (www.swbiodiversity.org/seinet/index.php; accessed 8 October 2016).
- SEMARNAT (SECRETARÍA DE MEDIO AMBIENTE Y RECURSOS NATURALES). 2010. Norma Oficial Mexicana NOM-059-SEMARNAT-2010, protección ambiental–especies nativas de México de flora y fauna Silvestre–categorías de riesgo y especificaciones para su inclusión, exclusión o cambio–lista de especies en riesgo. Diario Oficial de la Federación, México, D.F., Mexico.
- SERRANO, J. M., C. A. BERLANGA-ROBLES, AND A. RUIZ-LUNA. 2014. High amphibian diversity related to unexpected environmental values in a biogeographic transitional area in north-western Mexico. *Contributions to Zoology* 83: 151–166.
- SHREVE, F. 1934. Vegetation of the northwestern coast of Mexico. *Bulletin of the Torrey Botanical Club* 61: 373–380.
- SHREVE, F. 1937. Lowland vegetation of Sinaloa. *Bulletin of the Torrey Botanical Club* 64: 605–613.
- SHREVE, F. 1951. Vegetation of the Sonoran Desert. Carnegie Institution of Washington, Washington D.C., United States.
- SHREVE, F. 1964. Vegetation of the Sonoran Desert. Pp. 1–186 *In* F. Shreve and I. L. Wiggins, Vegetation and Flora of the Sonoran Desert. Volume 1. Stanford University Press, Palo Alto, California, United States.
- SINCLAIR, E. A., R. L. BEZY, K. BOLLES, K. A. CRANDALL, AND J. W. SITES, JR. 2004. Testing species boundaries in an ancient species complex with deep phylogeographic history: genus *Xantusia* (Squamata: Xantusiidae). *The American Naturalist* 164: 396–414.
- SINERVO, B., F. R. MÉNDEZ-DE LA CRUZ, D. B. MILES, B. HEULIN, E. BASTIAANS, M. VILLAGRAN-SANTA CRUZ, R. LARA-RESENDIZ, N. MARTÍNEZ-MÉNDEZ, M. L. CALDERÓN-ESPINOSA, R. N. MEZALÁZARO, H. GADSDEN, L. J. AVILA, M. MORANDO, I. J. DE LA RIVA, P. VICTORIANO SEPULVEDA, C. F. DUARTE ROCHA, N. IBARGÜENGOYTÍA, C. A. PUNTRIANO, M. MASSOT, V. LEPETZ, T. A. OKSANEN, D. G. CHAPPEL, A. M. BAUER, W. R. BRANCH, J. CLOBERT, AND J. W. SITES, JR. 2010. Erosion of lizard diversity by climate change and altered thermal niches. *Science* 324: 894–899.
- SMITH, H. M. 1951. The identity of the ophidian name *Coluber eques* Reuss. *Copeia* 1951: 138–140.
- SMITH, H. M., AND R. G. VAN GELDER. 1955. New and noteworthy amphibians and reptiles from Sinaloa and Puebla, Mexico. *Herpetologica* 11: 145–149.
- STEBBINS, R. C. 2003. A Field Guide to Western Reptiles and Amphibians. 3rd ed. Houghton Mifflin Company, Boston, Massachusetts, United States.

- STEBBINS, R., AND S. MCGINNIS. 2012. Field Guide to Amphibians and Reptiles of California. Revised Ed. University of California Press, Berkeley, California, United States.
- TAYLOR, E. H. 1936. Notes on the herpetological fauna of the Mexican state of Sonora. University of Kansas Science Bulletin 24: 475–503.
- TURNER, R. M., AND D. E. BROWN. 1982. Sonoran desert scrub. Pp. 181–221 In D. E. Brown (Ed.), Desert Plants: Biotic Communities of the American Southwest–United States and Mexico. Published by The University of Arizona for the Boyce Thompson Southwestern Arboretum, Superior Arizona, United States.
- TURNER, R. M., J. E. BOWERS, AND T. L. BURGESS. 2005. Sonoran Desert Plants: An Ecological Atlas. University of Arizona Press, Tucson, Arizona, United States.
- VAN DEVENDER, T. R. 1990. Late Quaternary vegetation and climate of the Sonoran Desert, United States and Mexico. Pp. 134–165 In J. L. Betancourt, T. R. Van Devender, and P. S. Martin (Eds.), Packrat Middens: The Last 40,000 Years of Biotic Change. University of Arizona Press, Tucson, Arizona, United States.
- VAN DEVENDER, T. R. 2002. Environmental history of the Sonoran Desert. Pp. 3–24 In T. H. Fleming and A. Valiente B. (Eds.) Evolution, Ecology and Conservation of Columnar Cacti and their Mutualists: Evolution, Ecology, and Conservation. University of Arizona Press, Tucson, Arizona, United States.
- VAN DEVENDER, T. R. 2007. Ice ages in the Sonoran Desert. Pp. 58–88 In R. S. Felger and B. Broyles (Eds.), Dry Borders: Great Natural Reserves of the Sonoran Desert. University of Utah Press, Salt Lake City, Utah, United States.
- VAN DEVENDER, T. R., T. L. BURGESS, J. C. PIPER, AND R. M. TURNER. 1994. Paleoclimatic implications of Holocene plant remains from the Sierra Bacha, Sonora, Mexico. Quaternary Research 41: 99–108.
- VAN DEVENDER, T. R., AND J. I. MEAD. 1978. Early Holocene and late Pleistocene amphibians and reptiles in Sonoran Desert. Copeia 1978: 464–475.
- VAN DEVENDER, T. R. AND A. L. REINA-GUERRERO. 2016. The tropical Madrean flora of Yécora, Sonora, Mexico. Phytoneuron 7: 1–23.
- VAN DEVENDER, T. R., G. YANES-ARVAYO, G., A. L. REINA-GUERRERO, M. VALENZUELA-YÁNEZ, M. P. MONTAÑEZ-ARMENTA, AND H. SILVA-KURUMIYA. 2013. Comparison of the tropical floras of the Sierra la Madera and the Sierra Madre Occidental, Sonora, Mexico. Pp. 240–242 In G. J. Gottfried, P. F. Ffolliott, B. S. Gebow, L. G. Eskew, and L. C. Collins (compilers), Biodiversity and Management of the Madrean Archipelago: The Sky Islands of Southwestern United States and Northwestern Mexico. General Technical Report, RM-GTR-264. U.S. Department of Agriculture, Forest Service, Fort Collins, Colorado, United States.
- WEBB, R. G. 1966. Resurrected names for Mexican populations of Black-necked Garter Snakes, *Thamnophis cyrtopsis* (Kennicott). Tulane Studies in Zoology 13: 55–70.
- WEBB, R. G. 1984. Herpetogeography in the Mazatlán-Durango region of the Sierra Madre Occidental, Mexico. Pp. 217–241 In R. A. Seigel, L. E. Hunt, J. L. Knight, L. Malaret, and N. L. Zuschlag (Eds.), Vertebrate Ecology and Systematics: A Tribute to Henry S. Fitch. Museum of Natural History, University of Kansas, Lawrence, Kansas, United States.
- WILSON, L. D., V. MATA-SILVA, AND J. D. JOHNSON. 2013a. A conservation reassessment of the reptiles of Mexico based on the EVS measure. Special Mexico Issue. Amphibian & Reptile Conservation 7: 1–47.
- WILSON, L. D., J. D. JOHNSON, AND V. MATA-SILVA. 2013b. A conservation reassessment of the amphibians of Mexico based on the EVS measure. Special Mexico Issue. Amphibian & Reptile Conservation 7: 97–127.
- WOOLRICH-PIÑA, G. A., P. PONCE CAMPOS, J. LOC-BARRAGÁN, J. P. RAMÍREZ-SILVA, V. MATA-SILVA, J. D. JOHNSON, E. GARCÍA PADILLA, AND L. D. WILSON. 2016. The herpetofauna of Nayarit, Mexico: composition, distribution, and conservation. Mesoamerican Herpetology 3: 376–448.

Appendix 1. The 60 species of Sonoran Desert amphibians and reptiles that reach their southern distributional limits on the coasts of Sonora, Sinaloa, and Nayarit, with their southern limit within 50 km of the coast; species number plotted in Fig. 1 (No); taxonomic group (G: A, anurans, L, lizards; S, snakes; T, turtles); latitude (Lat); longitude (Lon); museum or database identifier (Mus); state (State: Son, Sonora; Sin, Sinaloa; Nay, Nayarit); specific locality (Loc); listing by IUCN 2016-3 (ICN: NE, Not Examined; DD, Data Deficient; LC, Least Concern; NT, Near Threatened; VU, Vulnerable); listing by SEMARNAT 2010 NOM 59 (NOM: Pr, special protection; A, threatened); Environmental Vulnerability Score given by Wilson et al., 2013a,b (EVS: 14–16, highly vulnerable); and biogeographic distribution class assigned in this paper (Distr: Rip, riparian; LC, Lower Colorado River Valley of the Sonoran Desert; Moh, Mohave Desert; Son, Sonoran Desert; Chi, Chihuahuan Desert; NAD, North American deserts; and Mad, Madreatn).

Species	G	No	Lat	Lon	Mus	State	Loc	ICN	Nom	EVS	Distr
<i>Anaxyrus woodhousii</i>	A	1	32.4225	-114.8670	MVZ85240	Son	3 mi S San Luis	LC		10	Rip
<i>Sonora semiannulata</i>	S	2	32.2929	-115.0136	IBUNAM7761	Son	Colonia Nuevo León	LC		5	Rip
<i>Thamnophis marcianus</i>	S	3	32.2929	-115.0136	IBUNAM3007	Son	Colonia Nuevo León	NE	A	10	Rip
<i>Xantusia vigilis</i>	L	4	32.0916	-114.7624	CAS84144	Son	25 mi S San Luis	LC			LC-Moh
<i>Crotalus pyrrhus</i>	S	5	31.7756	-113.4916	IBUNAM1507	Son	Cerro El Pinacate, Valle Rojo	LC	Pr	12	LC-Moh
<i>Phrynosoma mcallii</i>	L	6	31.1216	-113.0787	CM49333	Son	E tip of Bahía San Jorge	NT	A	15	LC-Moh
<i>Chionactis annulata</i>	S	7	30.3215	-112.8341	UAZ 50629-PSV	Son	Vicinity of Puerto Lobos	?LC		12	LC-Moh
<i>Uma rufopunctata</i>	L	8	30.2015	-112.7625	CAS53373	Son	Tepoca Bay	NT	Pr	16	LC-Moh
<i>Crotalus scutulatus</i>	S	9	30.0735	-112.2953	UAZ 27799	Son	27.4 mi (rd) NE Puerto Libertad	LC	Pr	11	NAD
<i>Xantusia jaycolei</i>	L	10	29.3524	-112.3785	EFE	Son	Cerro Tepopa	NE		16	Son
<i>Phrynosoma goodiei</i>	L	11	29.3272	-112.3665	UAZ 13927	Son	Campo Dolar	NE		13	LC-Moh
<i>Crotaphytus dickersonae</i>	L	12	28.8413	-111.9638	UTEPI3778	Son	2 mi N Kino, Kino Bay	LC		16	Son
<i>Urosaurus graciosus</i>	L	13	28.8195	-111.8060	UABC1748	Son	12 km E of Bahía de Kino Viejo	LC		14	LC-Moh
<i>Crotalus cerastes</i>	S	14	28.3672	-111.4573	CAS-SU12778	Son	Tastiota	LC	Pr	16	LC-Moh
<i>Kinosternon arizonense</i>	T	15	28.5478	-111.0346	UF56575	Son	Hwy 15, 0.4 mi E Los Pocitos	LC		15	Son
<i>Anaxyrus retiformis</i>	A	16	28.1866	-110.9986	TNHC78248	Son	20 mi N Guaymas	LC	Pr	12	Son
<i>Tantilla hobartsmithi</i>	S	17	28.0092	-111.0976	UJMNH32968	Son	La Posa nr. Guaymas	LC		11	Son-Chi
<i>Aspidoscelis burti</i>	L	18	27.9389	-110.8639	UTEPI7613	Son	1 mi N Guaymas	LC		15	Son
<i>Crotaphytus nebrius</i>	L	19	27.9375	-110.8654	KUI176492	Son	6.4 km S Guaymas	LC		12	Son
<i>Crotalus molossus</i>	S	20	27.9291	-110.9582	CASSUR12784	Son	S slope Cerro Bocoobampo	LC	Pr	8	Son
<i>Sauromalus ater</i>	L	21	27.9183	-110.8995	UAZ 02234	Son	Guaymas, 5 ft	LC	Pr	13	LC-Moh
<i>Gambelia wislizenii</i>	L	22	27.9182	-110.8995	MVZ64653	Son	Guaymas	LC	Pr	13	NAD
<i>Chionactis palarostris</i>	S	23	27.9182	-110.8995	LACM51574	Son	Guaymas	LC		13	Son
<i>Lichanura trivirgata</i>	S	24	27.9264	-110.5980	UAZ 09368	Son	13 mi SE Empalme	LC	A	10	Son
<i>Hypsiglena chlorophaea</i>	S	25	27.7257	-109.8702	UAZ25038	Son	S end Presa Alvera Obregon	NE	Pr	8	Son
<i>Trimorphodon lambda</i>	S	26	26.7256	-109.2890	UAZ 39751	Son	20.6 mi S Navajoa	NE		13	Son
<i>Uta stansburiana</i>	L	27	26.6963	-109.6066	TCWC54607	Son	Huatabampo	LC		7	NAD

<i>Crotalus tigris</i>	S	28	26.6303	-109.3268	MABAson042	Son	Huatabampo, Las Bocas road	LC	Pr	16	Son
<i>Coleonyx variegatus</i>	L	29	26.4223	-109.0254	UAZ 09627	Son	Estacion Don	LC	Pr	11	Son-Moh
<i>Incilius abarivus</i>	A	30	26.3794	-109.0123	UAZ8386	Sin	1.3 mi S Sonora-Sinaloa border	LC		11	Son
<i>Chilomeniscus stramineus</i>	S	31	26.3771	-108.7283	LACM121310	Sin	2.7 mi W Miguel Hidalgo Dam	LC	Pr	8	Son
<i>Crotalus atrox</i>	S	32	26.1211	-109.0419	UAZ9376	Sin	2.9 mi (rd 15) N Cerro Prieto	LC	Pr	9	Son-Chi
<i>Anaxyrus cognatus</i>	A	33	25.9944	-108.8577	UAZ38720	Sin	9.2 mi W San Blas, W El Fuerte	LC		9	Son-Chi
<i>Lampropeltis californiae</i>	S	34	25.7916	-108.9108	LACM28715	Sin	6 km E Los Mochis Hwy 15	NE	A	10	NAD
<i>Dipsosaurus dorsalis</i>	L	35	25.6230	-109.0546	LACM95146	Sin	1.5 mi N Topolobampo	LC		11	LC-Moh
<i>Phyllodactylus homolepidurus</i>	L	36	25.6020	-109.0502	LACM93780	Sin	Topolobampo	LC	Pr	15	Son
<i>Gopherus morafkai</i>	T	37	25.5373	-108.9653	Edwards 2016	Sin	S Topolobampo	VU	A	15	Son
<i>Sceloporus magister</i>	L	38	25.5050	-108.9353	KU69926	Sin	16 km SE Topolobampo	LC		9	NAD
<i>Kinosternon alamosae</i>	T	39	25.4943	-108.2991	UAZ227956	Sin	7.4 mi S Guasvae, Hwy 15	DD	Pr	14	Son
<i>Phrynosoma solare</i>	L	40	25.2331	-107.9666	LACM6616	Sin	4 mi W Terreros	LC		14	Son
<i>Ctenosaura maculophaga</i>	L	41	25.0584	-107.6562	LACM94824	Sin	64 km SE Guamuchi Hwy 15	NE	Pr	19	Son
<i>Aspidoscelis tigris</i>	L	42	24.8249	-107.4217	KU48207	Sin	1 mi N Culiacan	LC		8	Son-Moh
<i>Heloderma suspectum</i>	L	43	24.3210	-107.3594	AMNH90786	Sin	Eldorado	NT	A	15	Son
<i>Urosaurus ornatus</i>	L	44	23.7125	-106.5894	UJMNH 40154	Sin	36 mi N Mazatlan	LC		10	Son-Chi
<i>Phyllorhynchus decurtatus</i>	S	45	23.5869	-106.5471	KU73609	Sin	26 mi N Mazatlan	LC		11	LC-Moh
<i>Micruroides euryxanthus</i>	S	46	23.4791	-106.4744	UMMZ114637	Sin	16.3 mi NW Mazatlan	LC	A	15	Son
<i>Phyllorhynchus browni</i>	S	47	23.3224	-106.4127	LACM53067	Sin	5.3 mi N Mazatlan	LC	Pr	13	Son
<i>Anaxyrus punctatus</i>	A	48	23.2782	-106.4125	FMNH102426	Sin	2 mi E Mazatlan	LC		5	NAD
<i>Arizona elegans</i>	S	49	23.2498	-106.4112	CAS93828	Sin	vic Mazatlan	LC		5	NAD
<i>Salvadora hexalepis</i>	S	50	23.1177	-106.0751	MCZ R61426	Sin	10 mi S Villa Union	LC		10	NAD
<i>Pituophis catenifer</i>	S	51	22.6832	-105.6008	CAS SU24021	Sin	16.1 mi S Escuinapa	LC		9	NAD
<i>Callisaurus draconoides</i>	L	52	22.5401	-105.7372	LACM6586	Sin	Teacapan	LC	A	12	Son-Moh
<i>Rhinocheilus lecontei</i>	S	53	22.4984	-105.3950	LACM136962	Nay	1 mi NW of Acaponeta	LC		8	NAD
<i>Anaxyrus kelloggi</i>	A	54	22.4960	-105.3629	USNM47865	Nay	Acaponeta	LC		14	Son
<i>Scaphiopus couchii</i>	A	55	22.4960	-105.3629	USNM47860	Nay	Acaponeta	LC		3	Son-Chi
<i>Masticophis flagellum</i>	L	56	21.6840	-105.4690	CM39470	Nay	Playa los Corchos	LC	A	8	NAD
<i>Masticophis bilineatus</i>	S	57	21.6916	-105.0549	CASSUR23958	Nay	0.4 mi W jet San Blas rd & Hwy 15	LC		11	Son-Mad
<i>Gastrophryne mazatlanensis</i>	A	58	21.6411	-105.1190	MVZ144017	Nay	Navarrete	NE	Pr	8	Son
<i>Sceloporus clarkii</i>	L	59	21.5413	-105.2847	MVZ 79381	Nay	Las Islas beach, San Blas	LC		10	Son-Mad
<i>Holbrookia elegans</i>	L	60	21.5413	-105.2847	LACM95207	Nay	San Blas	LC		13	Son

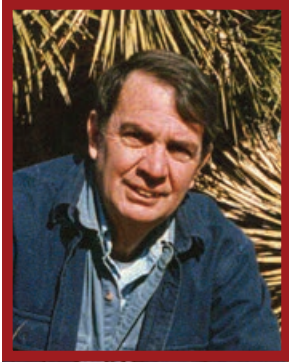

Robert L. Bezy is a native of Arizona and has been interested in the amphibians and reptiles of the Sonoran Desert since childhood. His herpetological development was greatly influenced by working with Charles Lowe as an undergraduate and a graduate student at the University of Arizona, where Bob received his Ph.D. in 1970. He served as a curator in the Section of Herpetology, Natural History Museum of Los Angeles County, for 27 years, before becoming emeritus in 1997 and moving back to Tucson, Arizona. His research on the systematics and distribution of xantusiid lizards has taken him throughout Mexico and Central America. In recent years he has enjoyed focusing on the biogeography of the amphibians and reptiles of Arizona and Sonora, including a paper with Charles Cole on the herpetofauna of the Madrean archipelago and one with Erik Enderson and Thomas Van Devender on the Yécora region of Sonora.



Philip C. Rosen followed a westerly trend from metro New York City, via Michigan to Arizona, arriving penniless in 1983. He has studied ecology, evolution, and herpetology continuously from an early age. Meeting Charles Lowe at Quitobaquito, in Organ Pipe Cactus National Monument in 1985 led to a dream job studying desert community ecology at the monument with Lowe as his Ph.D. mentor. Forbidden during that time from Sonora by Lowe (“You can’t keep ‘em down on the farm once they’ve been to gay Parie”), he completed his Ph.D. at the University of Arizona in 2000, and first visited Mexico professionally in 2005. He has remained at the University, specializing in desert, wetland, and urban herpetological ecology, conservation, and restoration. His love of Mexico and enjoyment of its people goes back, however, to vagabonding through in winter 1979–80, and now includes collaborations involving ecology and conservation of chelonians, lizards, and cacti.



Thomas R. Van Devender was born in Texas and collected his first Texas Horned Lizard eight years later in Roswell, New Mexico. His interest in amphibians, reptiles, the Sky Islands, and biogeography flourished when he went to graduate school at the University of Arizona in 1968 and met Charles Lowe. He finished his Ph.D. in 1973 before working as an Endangered Species Botanist with the Nature Conservancy, Senior Research Scientist at the Arizona-Sonora Desert Museum, Manager of the Madrean Archipelago Biodiversity Assessment program at Sky Island Alliance, and currently the Director of Biodiversity Programs at GreaterGood.org. His research interests have included a broad range of topics, natural history, paleoecology, desert grasslands, desert tortoise ecology, local floras, ethnobotany, herpetofaunas, and biodiversity. He is especially interested in the Sky Island mountain ranges, the Yécora area in the Sierra Madre Occidental, and tropical deciduous forest in the Álamos area, all in Sonora, Mexico.



Erik F. Enderson, despite his Los Angeles upbringing, developed a passion for the natural world at an early age. Egged on by his father’s stories of 10-foot rattlesnakes that wandered the nearby mountains of his southern California home, he began to take a particular interest in the region’s amphibians and reptiles. By his teens he had become fascinated with the area’s rapidly disappearing frog fauna and at 14 made his first of many excursions into the Sierra Nevada in search of the Golden Trout and the now-endangered state frog, *Rana draytonii* (California Red-legged Frog). A resident of southern Arizona since 1993, Erik has spent much of the last 20 years researching and photographing the herpetofauna of Sonora, Mexico.