

Panasonic®

Operating Instructions High Definition Video Camera

Model No. **HC-V130**

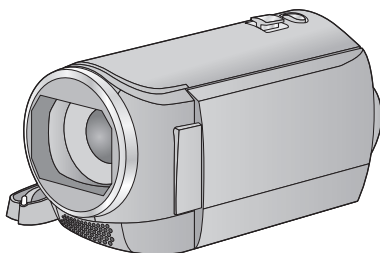

Please read these instructions carefully before using this product, and save this manual for future use.

AVCHD™

HDMI

SD™
XC

DOLBY
DIGITAL

SQT0053

Read this first

■ About the recording format for recording motion pictures

You can select from AVCHD, iFrame or MP4 recording formats to record motion pictures using this unit. (→ 41)

AVCHD:

It is suitable for viewing on a high-definition TV or for saving to disc.

iFrame:

This is a recording format suitable for playing back or editing on Mac (iMovie etc.).

- It is not compatible with motion pictures recorded in AVCHD format.

MP4:

This is a recording format suitable for playing back or editing on a PC.

- It is not compatible with motion pictures recorded in AVCHD format.

■ Indemnity about recorded content

Panasonic does not accept any responsibility for damages directly or indirectly due to any type of problems that result in loss of recording or edited content, and does not guarantee any content if recording or editing does not work properly. Likewise, the above also applies in a case where any type of repair is made to the unit.

■ About Condensation (When the lens or the LCD monitor is fogged up)

Condensation occurs when there is a change in temperature or humidity, such as when the unit is taken from outside or a cold room to a warm room. Please be careful, as it may cause the lens or LCD monitor to become soiled, moldy, or damaged.

When taking the unit to a place which has a different temperature, if the unit is accustomed to the room temperature of the destination for about one hour, condensation can be prevented. (When the difference in temperature is severe, place the unit in a plastic bag or the like, remove air from the bag, and seal the bag.) When condensation has occurred, remove the battery and/or the AC adapter and leave the unit like that for about one hour. When the unit becomes accustomed to the surrounding temperature, fogging will disappear naturally.

■ Cards that you can use with this unit

SD Memory Card, SDHC Memory Card and SDXC Memory Card

- 4 GB or more Memory Cards that do not have the SDHC logo or 48 GB or more Memory Cards that do not have the SDXC logo are not based on SD Memory Card Specifications.
- Refer to page 13 for more details on SD cards.

■ For the purposes of these operating instructions

- SD Memory Card, SDHC Memory Card and SDXC Memory Card are referred to as the "SD card".
- Functions that can be used for motion picture recording/motion picture playback are indicated by **VIDEO** in these operating instructions.
- Functions that can be used for still picture recording/still picture playback are indicated by **PHOTO** in these operating instructions.
- Scene(s) recorded in 1080/50i: "AVCHD scene(s)"
- Pages for reference are indicated by an arrow, for example: → 00

Contents

Read this first	2
-----------------------	---

Preparation

Names and Functions of Main Parts	6
Power supply	9
Inserting/removing the battery	9
Charging the battery	10
Charging and recording time	12
Recording to a card	13
Cards that you can use with this unit	13
Inserting/removing an SD card	14
Turning the unit on/off	15
Selecting a mode	16
Setting date and time	17

Basic

Before recording	18
Recording motion pictures	19
Recording still pictures	21
Intelligent Auto Mode	22
Motion picture/Still picture playback	24
Using the menu screen	26
Using the Setup Menu	27

Advanced (Recording)

Using the Zoom	35
Recording functions of operation icons	36
Operation icons	36
Recording functions of menus	39
Manual recording	47
White Balance	48
Manual shutter speed/Iris adjustment	49
Recording with Manual Focus	50

Advanced (Playback)

Playback Operations	51
Motion picture playback using operation icon	51
Creating still picture from motion picture	52
Repeat playback	52
Resuming the previous playback	52
Zooming in on a still picture during playback (Playback zoom)	53
Various playback functions	54
Playing back motion pictures/ still pictures by date	54
Changing the playback settings and playing back the slide show	55
Deleting scenes/still pictures	56
Dividing a scene (AVCHD)	58
Dividing a scene to partially delete (iFrame, MP4)	59
Protecting scenes/still pictures	60
Watching Video/Pictures on your TV	61
Connecting with a HDMI mini cable	63
Playback using VIERA Link	64

Copy/Dubbing

Dubbing with a Blu-ray disc recorder, video devices, etc.	66
Using the Eye-Fi™ card	70

With a PC

What you can do with a PC	73
End User License Agreement.....	75
Operating environment	77
Installation	80
Connecting to a PC	81
About the PC display	83
Starting HD Writer LE 2.1	84
Reading the operating instructions of the software applications	84
If using Mac	85

Others

Indications	86
Messages	88
About recovery	88
Troubleshooting	89
Cautions for use	93
About copyright	96
Recording modes/ approximate recordable time	97
Approximate number of recordable pictures	98
Optional accessories	99

Names and Functions of Main Parts

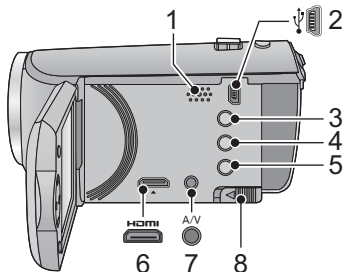

- 1 **Speaker**
- 2 **USB terminal** [] (→ 66, 81)
- 3 **Intelligent auto/Manual button** [i/MANUAL] (→ 22, 47)
- 4 **Delete button** [] (→ 56)
- 5 **Power button** [] (→ 15)
- 6 **HDMI mini connector** [HDMI] (→ 61)
- 7 **A/V connector** [A/V] (→ 61, 69)
- 8 **Battery release lever** [BATT] (→ 9)

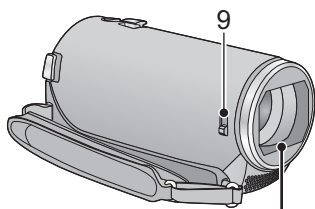

9 Lens cover opening/closing switch

When not using the unit, close the lens cover to protect the lens.

- Slide the opening/closing switch to open/close the cover.

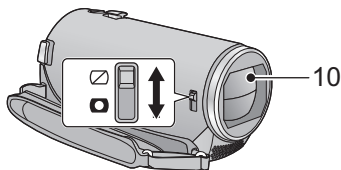
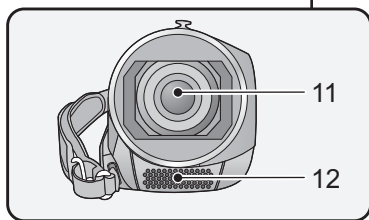

- 10 **Lens cover**
- 11 **Lens**
- 12 **Internal stereo microphones**

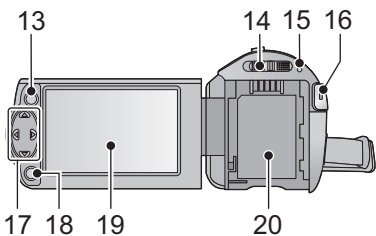

- 13 Menu button [MENU] (→ 26)**
- 14 Mode switch (→ 16)**
- 15 Status indicator (→ 15)**
- 16 Recording start/stop button (→ 19)**
- 17 Cursor button (→ 24, 26, 36)**

- Use the cursor button to select the recording functions and playback operations, and to operate the menu screen.
- In these operating instructions, the cursor button is denoted as shown below or as ▲/▼/◀/▶.

Example: For pressing the (down) button



or Press ▼

- 18 Enter button [ENTER] (→ 24, 26, 36)**
- 19 LCD monitor (→ 18)**



- It can open up to 90°.

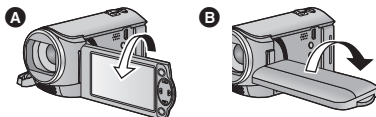



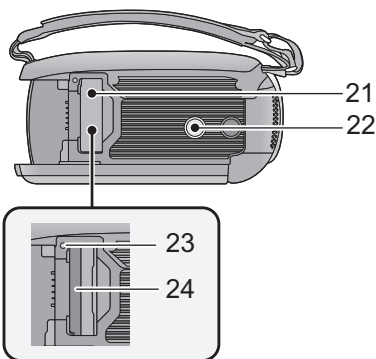

- It can rotate up to 180° **A** towards the lens or 90° **B** towards the opposite direction.

- 20 Battery holder (→ 9)**

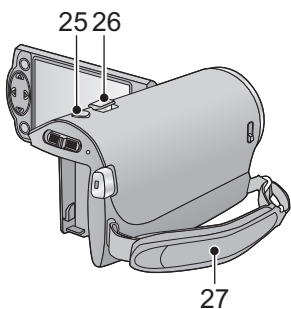

- 21 SD card cover (→ 14)**
- 22 Tripod receptacle**
 - Attaching a tripod with a screw length of 5.5 mm or more may damage the unit.
- 23 Access lamp [ACCESS] (→ 14)**
- 24 Card slot (→ 14)**



- 25** Photoshot button [] (→ 21)
- 26** Zoom lever [W/T] (In Recording Mode) (→ 35)
Thumbnail display switch [ / ]/
Volume lever [-VOL+] (In Playback Mode) (→ 25)
- 27** Grip belt

Adjust the length of the grip belt so that it fits your hand.

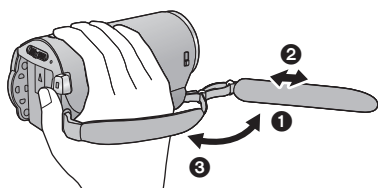

- 1** Flip the belt.
- 2** Adjust the length.
- 3** Replace the belt.

Power supply

■ About batteries that you can use with this unit

The battery that can be used with this unit is VW-VBY100/VW-VBT190/VW-VBT380.

It has been found that counterfeit battery packs which look very similar to the genuine product are made available to purchase in some markets. Some of these battery packs are not adequately protected with internal protection to meet the requirements of appropriate safety standards. There is a possibility that these battery packs may lead to fire or explosion. Please be advised that we are not liable for any accident or failure occurring as a result of use of a counterfeit battery pack. To ensure that safe products are used we would recommend that a genuine Panasonic battery pack is used.

Inserting/removing the battery

- Press the power button to turn off the unit. (→ 15)

Install the battery by inserting it in the direction shown in the figure.

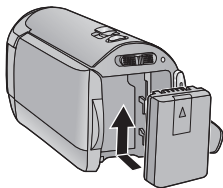

Insert the battery until it clicks and locks.

Removing the battery

Be sure to hold down the power button until the status indicator goes off. Then remove the battery while supporting the unit to prevent it from dropping.

Move the battery release lever in the direction indicated by the arrow and remove the battery when unlocked.

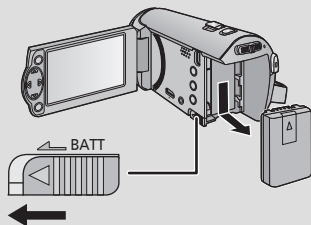

Charging the battery

When this unit is purchased, the battery is not charged. Charge the battery fully before using this unit for the first time.

■ Charging with an AC adaptor.

The unit is in the standby condition when the AC adaptor is connected. The primary circuit is always "live" as long as the AC adaptor is connected to an electrical outlet.

Important:

- The AC adaptor and USB cable are for use with this unit only. Do not use them with other equipment. Similarly, do not use AC adaptors and USB cables from other equipment with this unit.
- The battery cannot be charged when the power is on. Press the power button to turn off the power. (→ 15)
- It is recommended to charge the battery in a temperature between 10 °C and 30 °C. (The battery temperature should also be the same.)

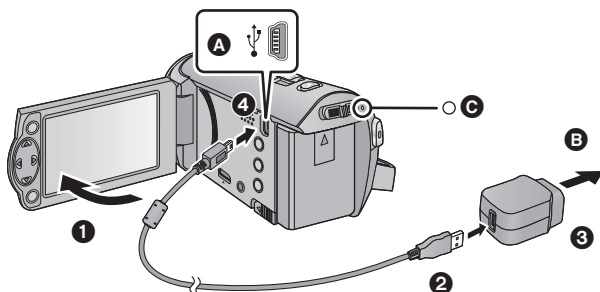

A USB terminal

B To the AC outlet

- Insert the plugs as far as they will go.

1 Open the LCD monitor.

2 Connect the USB cable to the AC adaptor.

- Check that the plug portion of the AC adaptor is not loose or misaligned.

3 Plug the AC adaptor into the AC outlet.

4 Connect the USB cable to the unit.

- The status indicator **C** will flash red with approx. 2 seconds period (off for approx. 1 second, on for approx. 1 second), indicating that charging has begun. It will turn off when the charging is completed.

■ Connecting to the AC outlet

If you turn on the unit while connecting with the AC adaptor, you can use the unit with power supplied from the outlet.

When recording for a long time, keep the AC adaptor connected and use it together with the battery. This allows you to continue the recording even if a power failure occurs or the AC adaptor is unplugged from the AC outlet by accident.

■ Connecting to a PC and charging.

Charge the unit if you do not have the AC adaptor handy.

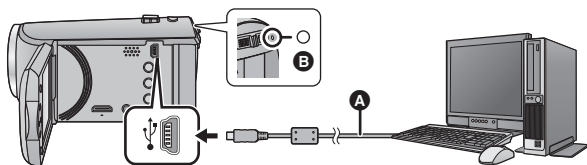

A USB cable (supplied)

- Insert the plugs as far as they will go.
- Press the power button and turn the unit off. (→ 15)

1 Turn the power of the PC on.

2 Connect the USB cable

- The status indicator **B** will flash red with approx. 2 seconds period (off for approx. 1 second, on for approx. 1 second), indicating that charging has begun.
It will turn off when the charging is completed.
 - Do not use any other USB cables except the supplied one. (Operation is not guaranteed with any other USB cables.)
 - Always connect directly to a PC.
 - You cannot charge when the status indicator flashes rapidly, or when it does not light at all.
Charge using the AC adaptor. (→ 10)
 - It will take 2 or 3 times longer to charge compared to when using the AC adaptor.
-
- If the status indicator flashes at a particularly fast or slow rate, refer to page 95.
 - We recommend using Panasonic batteries (→ 9).
 - If you use other batteries, we cannot guarantee the quality of this product.
 - Do not heat or expose to flame.
 - Do not leave the battery(ies) in a car exposed to direct sunlight for a long period of time with doors and windows closed.
 - If you do not intend to use the unit for an extended period, disconnect the USB cable from the unit for safety.
 - Charging may not be possible depending on the operating environment of the PC being used (such as custom-made PC).
 - Charging will stop when turning the power of the PC off or forcing it into sleep mode. Charging will start again when turning the power of the PC on again, or waking from sleep mode.
 - When connected to a PC, an error message may be displayed at the top of the PC screen. For more details, refer to page 91.
 - The unit will be charged if it is connected to a Panasonic Blu-ray disc recorder or DVD recorder with a USB cable, even if the unit is turned off.

Charging and recording time

■ Charging/Recording time







- Temperature: 25 °C/humidity: 60%RH
- Time in the parenthesis is charging time when this unit is connected to a PC, Panasonic Blu-ray disc recorder, or DVD recorder.

Battery model number [Voltage/Capacity (minimum)]	Charging time	Recording format	Recording mode	Maximum continuously recordable time	Actual recordable time
Supplied battery/VW- VBY100 (optional) [3.6 V/970 mAh]	2 h 20 min (3 h 10 min)	AVCHD	[HA], [HG], [HE]	1 h 15 min	40 min
		iFrame	-	1 h 25 min	50 min
		MP4	-	1 h 30 min	
VW-VBT190 (optional) [3.6 V/1940 mAh]	2 h 50 min (5 h 20 min)	AVCHD	[HA], [HG]	2 h 30 min	1 h 15 min
			[HE]	2 h 35 min	1 h 20 min
		iFrame	-	2 h 55 min	1 h 30 min
		MP4	-	3 h	1 h 35 min
VW-VBT380 (optional) [3.6 V/3880 mAh]	4 h 45 min (9 h 45 min)	AVCHD	[HA]	5 h 5 min	2 h 35 min
			[HG]		2 h 40 min
			[HE]	5 h 10 min	
		iFrame	-	6 h	3 h 5 min
		MP4	-	6 h 10 min	3 h 10 min

- These times are approximations.
- **The indicated charging time is for when the battery has been discharged completely. Charging time and recordable time vary depending on the usage conditions such as high/low temperature.**

- The actual recordable time refers to the recordable time when repeatedly starting/stopping recording, turning the unit on/off, moving the zoom lever etc.
- The batteries heat up after use or charging. This is not a malfunction.

Battery capacity indication

- The display changes as the battery capacity reduces.  →  →  →  → 
If the battery discharges, then  will flash red.

Recording to a card

The unit can record still pictures or motion pictures to an SD card. To record to an SD card, read the following.

Cards that you can use with this unit

Use SD cards conforming to Class 4 or higher of the SD Speed Class Rating* for motion picture recording.

Card type	Capacity
SD Memory Card	512 MB/1 GB/2 GB
SDHC Memory Card	4 GB/6 GB/8 GB/12 GB/16 GB/24 GB/32 GB
SDXC Memory Card	48 GB/64 GB

* SD Speed Class Rating is the speed standard regarding continuous writing. Check via the label on the card, etc.

e.g.:



- Please check the latest information on the support website below.

http://panasonic.jp/support/global/cs/e_cam

(This website is in English only.)

- **When using an SDHC Memory Card/SDXC Memory Card with other equipment, check the equipment is compatible with these Memory Cards.**
- An Eye-Fi X2 series SD card is required to use functions related to Eye-Fi. (→ 70)
- We do not guarantee the operation of SD cards other than the ones above. Further, SD cards with a capacity of less than 32 MB cannot be used for motion picture recording.
- 4 GB or more Memory Cards that do not have the SDHC logo or 48 GB or more Memory Cards that do not have the SDXC logo are not based on SD Memory Card Specifications.
- When the write-protect switch **A** on SD card is locked, no recording, deletion or editing will be possible on the card.
- Keep the Memory Card out of reach of children to prevent swallowing.

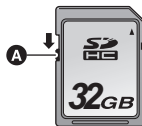

Inserting/removing an SD card

When using an SD card not from Panasonic, or one previously used on other equipment, for the first time on this unit, format the SD card. (→ 32) When the SD card is formatted, all of the recorded data is deleted. Once the data is deleted, it cannot be restored.

Caution:

Check that the access lamp has gone off.

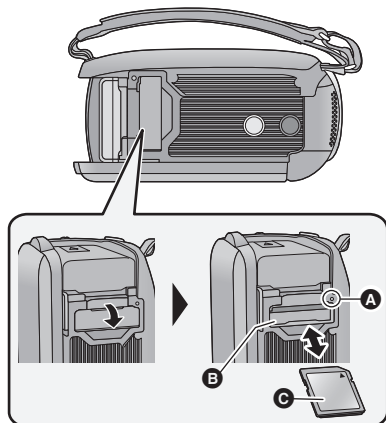

Access lamp [ACCESS] **A**

- When this unit is accessing the SD card, the access lamp lights up.

1 Open the SD card cover and insert (remove) the SD card into (from) the card slot **B**.

- Face the label side **C** in the direction shown in the illustration and press it straight in as far as it will go.
- Press the centre of the SD card and then pull it straight out.

2 Securely close the SD card cover.

- Securely close it until it clicks.

- Do not touch the terminals on the back of the SD card.
- Do not apply strong shocks, bend, or drop the SD card.
- Electrical noise, static electricity or the failure of this unit or the SD card may damage or erase the data stored on the SD card.
- When the card access lamp is lit, do not:
 - Remove the SD card
 - Turn the unit off
 - Insert and remove the USB cable
 - Expose the unit to vibrations or shockPerforming the above while the lamp is on may result in damage to data/SD card or this unit.
- Do not expose the terminals of the SD card to water, dirt or dust.
- Do not place SD cards in the following areas:
 - In direct sunlight
 - In very dusty or humid areas
 - Near a heater
 - Locations susceptible to significant difference in temperature (condensation can occur.)
 - Where static electricity or electromagnetic waves occur
- To protect SD cards, return them to their cases when you are not using them.
- About disposing of or giving away the SD card. (→ 95)

Turning the unit on/off

You can turn the unit on and off using the power button or by opening and closing the LCD monitor.

Turning the unit on and off with the power button

Open the LCD monitor and press the power button to turn on the unit.

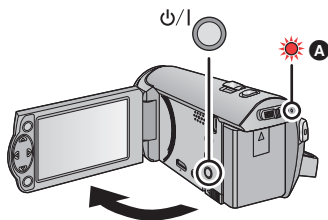

To turn off the unit

Hold down the power button until the status indicator goes off.

A The status indicator lights on.

Turning the unit on and off with the LCD monitor

Unit is turned on when the LCD monitor is opened, and unit is turned off when it is closed.



During normal use, opening and closing of the LCD monitor can be conveniently used to turn the unit on/off.

- The unit will not turn off while recording motion pictures even if the LCD monitor is closed.
- In the following cases, opening the LCD monitor does not turn on the unit. Press the power button to turn on the unit.
 - When the unit is originally purchased
 - When you have turned off the unit using the power button

Selecting a mode

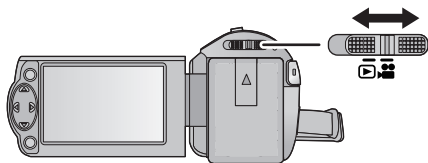
Operate the mode switch to change the mode to  or .



	Recording Mode (→ 19, 21)
	Playback Mode (→ 24, 51)





Setting date and time

The clock is not set at the time of purchase. Make sure to set the clock.

◇ Change the mode to  .

1 Select the menu. (→ 26)

MENU  : [SETUP] → [CLOCK SET]

2 Select the date or time using   and set the desired value using  / .

A Displaying the World time setting

(→ 27):

 [HOME] /  [DESTINATION]

- The year can be set between 2000 and 2039.

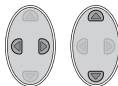

3 Press the ENTER button.

- A message prompting for World Time setting may be displayed. Perform the World Time setting by pressing the ENTER button. (→ 27)
- Press the MENU button to complete the setting.

- When the unit is turned on for the first time, a message asking you to set the date and time will appear. Select [YES] and perform Steps 2 to 3 to set the date and time.
- The date and time function is driven by a built-in lithium battery.
- If the time display becomes [- -], the built-in lithium battery needs to be charged. To recharge the built-in lithium battery, connect the AC adaptor or attach the battery to this unit. The battery is still being recharged even if the unit is off. Leave the unit as it is for approx. 24 hours and the battery will maintain the date and time for approx. 4 months.

Before recording

■ Basic camera positioning



- ❶ Hold the unit with both hands.
 - ❷ Put your hand through the grip belt.
- When recording, make sure your footing is stable and there is no danger of colliding with another person or object.
 - When you are outdoors, record pictures with the sunlight behind you. If the subject is backlit, it will become dark in the recording.
 - Keep your arms near your body and separate your legs for better balance.
 - Do not cover the microphones with your hand etc.

■ Basic motion picture recording

- The unit should normally be held steady when recording.
- If you move the unit when recording, do so slowly, maintaining a constant speed.
- The zoom operation is useful for recording subjects you cannot get close to, but overuse of zoom in and zoom out can make the resulting motion picture less enjoyable to watch.

■ Recording yourself

Rotate the LCD monitor towards the lens side.

- The image is horizontally flipped as if you see a mirror image.
(However, the image recorded is the same as a normal recording.)
- Only some indications will appear on the screen. When  appears, return the direction of the LCD monitor to normal position and check the warning/alarm indication.

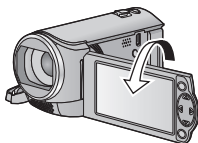



Recording motion pictures

- Open the lens cover before turning on the unit. (→ 6)

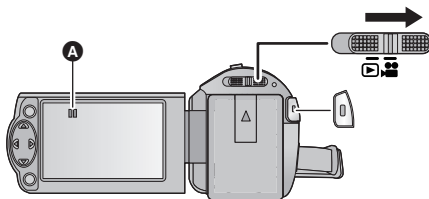
- 1 Change the mode to  and open the LCD monitor.
- 2 Press the recording start/stop button to start recording.



- A** When you begin recording,  changes to .

- 3 Press the recording start/stop button again to pause recording.

■ About the screen indications in the motion picture recording

	Recording format/Recording mode
R 1h20m	Approximate remaining recordable time <ul style="list-style-type: none"> • When the remaining time is less than 1 minute, R 0h00m flashes red.
0h00m00s	Recording time elapsed <ul style="list-style-type: none"> • “h” is an abbreviation for hour, “m” for minute and “s” for second. • Each time the unit is put into recording pause, the counter display will be reset to 0h00m00s.



- To change the recording format, change the [REC FORMAT] or [REC MODE]. (→ 40, 41)
- The images recorded between pressing the recording start/stop button to start recording and pressing it again to pause recording become one scene.
When you record with the [REC FORMAT] set to [iFrame] or [MP4], the scenes longer than approximately 20 minutes will be automatically divided. (Recording will continue.)
- (Maximum recordable scenes on a single SD card)

Recording formats	[AVCHD]	[iFrame]/[MP4]
Recordable scenes	Approx. 3900	Approx. 89100
Different dates (→ 54)	Approx. 900	Approx. 900

- Maximum number of recordable scenes and maximum number of different dates will be less than above table when there are iFrame or MP4 scenes and still pictures recorded on an SD card.
- While recording is in progress, the recording will not stop even if the LCD monitor is closed.
- Please refer to page 97 for details about approximate recordable time.

Recording still pictures

- Open the lens cover before turning on the unit. (→ 6)

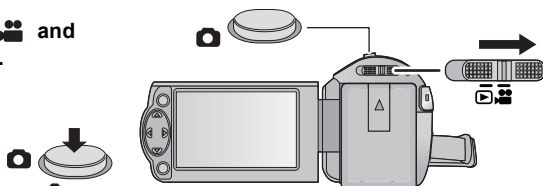

1 Change the mode to  and open the LCD monitor.

2 Press the  button.



- The still picture operating display () will turn red while recording still pictures.

■ About the screen indications in Still Picture Recording

	Size of still pictures (→ 46)
R3000	Remaining number of still pictures <ul style="list-style-type: none"> • Flashes in red when [0] appears.
	Still picture operation indicator (→ 87)





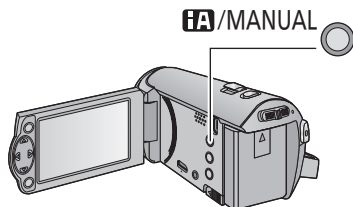

- During motion picture recording or when set to PRE-REC, you cannot record still pictures.
- Using a tripod is recommended when recording still pictures in dark places because the shutter speed becomes slow.
- The edges of still pictures recorded on this unit with a 16:9 aspect ratio may be cut at printing. Check the printer or photo studio before printing.
- Maximum number of recordable pictures that can be displayed is 9999. If the number of recordable pictures exceeds 9999, R 9999+ is displayed. The number will not change when the picture is taken until the number of recordable pictures is 9999 or less.
- The recording time may be long depending on the recording condition.

Intelligent Auto Mode

The following modes (appropriate for the condition) are set just by pointing the unit to what you want to record.



Intelligent auto/Manual button
Press this button to switch Intelligent Auto Mode/Manual Mode (→ 47).

Mode	Effect
 Portrait	Faces are detected and focused automatically, and the brightness is adjusted so it is recorded clearly.
 Scenery	The whole landscape will be recorded vividly without whiting out the background sky, which may be very bright.
 Spotlight	Very bright object is recorded clearly.
 Low light	It can record very clearly even in a dark room or twilight.
 Normal	In modes other than those described above, the contrast is adjusted to give a clear picture.

- Depending on the recording conditions, the unit may not enter the desired mode.
- In the Portrait, Spotlight and Low light mode, the face will be surrounded by white frame when detected. In the Portrait mode, a subject that is bigger and close to centre of the screen will be surrounded by an orange frame. (→ 45)
- Faces cannot be detected depending on the recording conditions, such as when faces are of certain sizes or at certain tilts or when digital zoom is used.

■ Intelligent Auto Mode

When switching to Intelligent Auto Mode, the Auto White Balance and Auto Focus operate and automatically adjust the colour balance and focusing.

Depending on the brightness of the subject, etc., the aperture and shutter speed are automatically adjusted for optimum brightness.

- Colour balance and focus may not be adjusted automatically depending on light sources or scenes. If so, manually adjust these settings. (→ 48, 50)

Automatic White Balance

The illustration shows the range over which Automatic White Balance functions.

- 1) The effective range of Automatic White Balance adjustment on this unit
- 2) Blue sky
- 3) Cloudy sky (rain)
- 4) Sunlight
- 5) White fluorescent lamp
- 6) Halogen light bulb
- 7) Incandescent light bulb
- 8) Sunrise or sunset
- 9) Candlelight

If the Automatic White Balance is not functioning normally, adjust the White Balance manually. (→ 48)

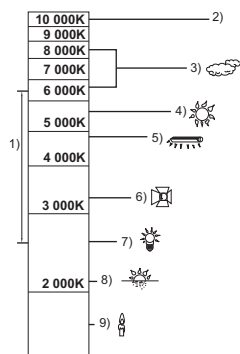



Auto Focus

The unit focuses automatically.

- Auto Focus does not work correctly in the following situations.
Record pictures in the Manual Focus Mode. (→ 50)
 - Recording distant and close-up objects at the same time
 - Recording a subject behind dirty or dusty window
 - Recording a subject that is surrounded by objects with glossy surfaces or by highly reflective objects

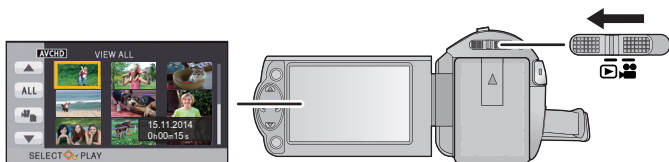
Motion picture/Still picture playback



1 Change the mode to .

2 Select the play mode select icon **A** using $\blacktriangle/\blacktriangledown/\blacktriangleleft$ and press the ENTER button.

- This can also be set from the menu.

[VIDEO SETUP] or [PHOTO SETUP] → [MEDIA, VIDEO/PICTURE]

3 Select still picture **B** or motion picture **C** to playback using $\blacktriangle/\blacktriangledown/\blacktriangleleft/\blacktriangleright$ and press the ENTER button.

- If you press the MENU button, or select motion picture/still picture and press the ENTER button, the setting is complete.
- When a motion picture item is selected, an icon will appear on the thumbnail display.
([AVCHD], [Frame], [MP4])



4 Select the scene or the still picture to be played back using $\blacktriangle/\blacktriangledown/\blacktriangleleft/\blacktriangleright$, then press the ENTER button.

- When you select $\blacktriangle/\blacktriangledown$ and press the ENTER button, the next (previous) page is displayed.



5 Select the operation icon using $\blacktriangle/\blacktriangledown/\blacktriangleleft/\blacktriangleright$.

D Operation icon



- Press the ENTER button to display/display the operation icon.



Motion picture playback	Still picture playback
<p>▶/II: Playback/Pause</p> <p>◀◀: Rewind playback*</p> <p>▶▶: Fast forward playback*</p> <p>■: Stops the playback and shows the thumbnails.</p>	<p>▶/II: Slide show (playback of the still pictures in numerical order) start/pause.</p> <p>◀II: Plays back the previous picture.</p> <p>II▶: Plays back the next picture.</p> <p>■: Stops the playback and shows the thumbnails.</p>

* When pressed two times, the fast forward/fast rewind speed increases. (The screen display changes ◀◀ / ▶▶ .)

Change the thumbnail display

While the thumbnail is displayed, the thumbnail display changes in the following order if the zoom lever is operated to  side or  side.
20 scenes ↔ 9 scenes ↔ 1 scene

- 9 scenes display returns if the unit is turned off or the mode is changed.

Speaker volume adjustment

Operate the volume lever to adjust the speaker volume during motion picture playback.

Towards "+":	Increases the volume
Towards "-":	Decreases the volume

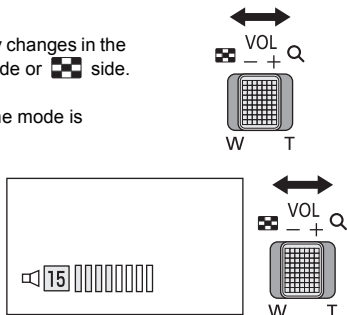

- Sound will be heard only during normal playback.
- If pause play is continued for 5 minutes, the screen returns to the thumbnails.
- The elapsed time for playback indication will be reset to 0h00m00s for each scene.

Motion picture compatibility

- This unit is based on AVCHD format/MPEG-4 AVC file format.
- Even if the devices used have compatible standards, when playback of motion pictures recorded using another device is performed using this unit, or when motion pictures recorded using this unit is played back in another device, playback may not proceed normally, or may not be possible. ( is displayed for motion pictures that cannot be played back with this unit)
Please check compatibility in the operating instruction of your device.
- MP4 motion pictures that can be played back on this unit are limited to those recorded using this unit.

Still picture compatibility

- This unit is compliant with the unified standard DCF (Design rule for Camera File system) established by JEITA (Japan Electronics and Information Technology Industries Association).
- The file format of still pictures supported by this unit is JPEG. (Not all JPEG formatted files will be played back.)
- This unit may degrade or not play back still pictures recorded or created on other products and other products may degrade or not play back still pictures recorded on this unit.

Using the menu screen

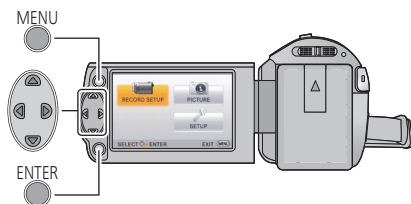

- 1 Press the **MENU** button.
- 2 Press **▲/▼/◀/▶** to select the top menu **A**, then press the **ENTER** button.



To get back to the previous screen
Press **◀** of the cursor button.

To exit the menu screen
Press the **MENU** button.

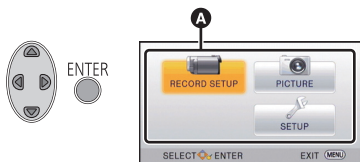

- 3 Select the submenu **B** using **▲/▼** and press **▶** or press the **ENTER** button.

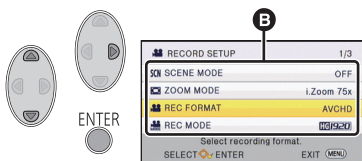

■ About the information display

Descriptions of the selected submenu and items displayed in Steps 3 and 4 are displayed.

■ About the operation icons



Select and press the **ENTER** button to switch page.



Select and press the **ENTER** button to return to previous screen.



- 4 Select the desired item using **▲/▼/◀/▶**, and press the **ENTER** button to set.



Using the Setup Menu

[DISPLAY]

Set the display method for the screen information display.

MENU : [SETUP] → [DISPLAY] → desired setting

[ON] (Display all information)/[OFF] (Display part of information)

[EXT. DISPLAY]

Please refer to page 62.

[CLOCK SET]

Please refer to page 17.

[SET WORLD TIME]

It is possible to display and record the time at the travel destination by selecting your home region and the travel destination.

- Change the mode to .

1 Select the menu.

MENU : [SETUP] → [SET WORLD TIME]

- If the clock is not set, adjust the clock to the current time. (→ 17)
- When the [HOME] (your home region) is not set, the message appears. Press the ENTER button and proceed to Step 3.

2 (Only when setting your home region)

Select [HOME] using ◀/▶ and press the ENTER button.

3 (Only when setting your home region)

Select your home region using ◀/▶ and press the ENTER button.

- Press ▲ to set daylight saving time.  is displayed and the summer time setting is turned on, the time difference between the current time and GMT will be set forward by 1 hour. Press ▲ again to return to the normal time setting.

If you set [Link Clock to Summertime] to [ON], the current time will also be set forward by 1 hour. (→ 28)



- A** The current time
- B** The time difference from GMT (Greenwich Mean Time)

4 (Only when setting the region of your travel destination)

Select [DESTINATION] using ◀/▶ and press the ENTER button.

- When the home region is set for the first time, the screen for selecting home/travel destination appears after setting the home region successively. If the home region has already been set once, execute the menu operation for Step 1.

5 (Only when setting the region of your travel destination)

Select your travel destination using ◀/▶ and press the ENTER button.



- Press ▲ to set daylight saving time.

 is displayed and the summer time setting is turned on, the time difference between the travel destination and the home region will be set forward by 1 hour. Press ▲ again to return to the normal time setting.

If you set [Link Clock to Summertime] to [ON], the time at the travel destination will also be set forward by 1 hour.

- Close the setting by pressing the MENU button.  appears and the time of the travel destination is indicated.

C The local time at the selected travel destination

D The time difference between the travel destination and the home region

To return the display to the home setting

Set the home region using Step 1 to 3, and close the setting by pressing the MENU button.

- If you cannot find your travel destination in the area shown on the screen, set it by using the time difference from your home region.

[Link Clock to Summertime]

If you set this function to [ON] and turn on the summer time setting in [SET WORLD TIME], the following times will be set forward by 1 hour:

- When setting your home region: The current time
- When setting the region of your travel destination: The local time at the selected travel destination

 : [SETUP] → [Link Clock to Summertime] → desired setting

[ON]: The times are adjusted when the summer time setting is turned on.

[OFF]: The times are not adjusted when the summer time setting is turned on.

[DATE/TIME]

It is possible to change the date and time display mode.

 : [SETUP] → [DATE/TIME] → desired setting

[DATE]/[D/T]/[OFF]

[DATE FORMAT]

It is possible to change the date format.

 : [SETUP] → [DATE FORMAT] → desired setting

[Y/M/D]/[M/D/Y]/[D/M/Y]

[ECONOMY (BATT)]

When about 5 minutes have passed without any operation, this unit automatically turns off to save battery life.

 : [SETUP] → [ECONOMY (BATT)] → [ON]

- This unit will not automatically turn off even if [ECONOMY (BATT)] is set to [ON] in following cases:
 - Using the AC adaptor*
 - Using the USB cable for PC etc.
 - PRE-REC is used
 - During playback of the slide show
- * When [ECONOMY (AC)] is activated, this unit automatically turns off.

[ECONOMY (AC)]

When about 30 minutes have passed without any operation while connecting the AC adaptor with this unit, the unit automatically turns off.

 : [SETUP] → [ECONOMY (AC)] → [ON]

- This unit will not automatically turn off even if the [ECONOMY (AC)] is set to [ON] in following cases:
 - PRE-REC is used
 - During playback of the slide show

[QUICK START]

This unit is put into recording pause approx. 0.6 seconds after the LCD monitor is reopened.

- When in Quick Start Standby Mode about 60% of the power used in recording pause mode is being consumed, so the recording time will be reduced.
- Quick Start will not work if there is no SD card inserted.
- Change the mode to .

1 Select the menu.

MENU : [SETUP] → [QUICK START] → [ON]

2 Close the LCD monitor.

The status indicator **A** flashes green and the unit goes into Quick Start Standby Mode.

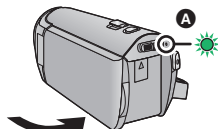

3 Open the LCD monitor.

The status indicator **A** lights red and the unit is put into recording pause.

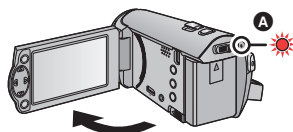

- Quick Start Standby Mode is cancelled if
 - about 5 minutes have elapsed
 - mode is set to 
- It may take some time for Automatic White Balance to adjust.
- In the Quick Start Mode, the zoom magnification becomes approx. 1×.
- When it has gone into Quick Start Standby Mode automatically with the [ECONOMY (BATT)] (→ 29)/[ECONOMY (AC)] (→ 29), close the LCD monitor once and open it again.
- Turn the unit off using the power button.

[ALERT SOUND]

Starting and stopping of recording and unit on/off can be confirmed with this sound.
When [OFF] is selected, the sound is not output at the start/end of recording, etc.

 : [SETUP] → [ALERT SOUND] → **desired setting**

 (Volume low)/  (Volume high)/[OFF]

2 Beeps for 4 times

When an error occurs. Check the sentence displayed on the screen.

[POWER LCD]

This makes it easier to view the LCD monitor in bright places including outdoors.

 : [SETUP] → [POWER LCD] → **desired setting**

* (Makes even brighter)/ * (Makes brighter)/ * (Normal)/ * (Makes less bright)

- These settings will not affect the images actually recorded.
- When the AC adaptor is in use, the LCD monitor is set to * automatically.
- When the LCD monitor is bright, the recordable time with the battery will be shorter.

[LCD SET]

It adjusts brightness and colour density on the LCD monitor.

- These settings will not affect the images actually recorded.

1 Select the menu.

 : [SETUP] → [LCD SET] → **desired setting**

[BRIGHTNESS]: Brightness of the LCD monitor

[COLOUR]: Colour level of the LCD monitor

2 Press / to adjust, and press the ENTER button.

- Press the MENU button to exit the menu screen.

[HDMI RESOLUTION]

Please refer to page 63.

[VIERA Link]

Please refer to page 64.

[TV ASPECT]

Please refer to page 62.

[INITIAL SET]

Set to [YES] for changing the menu settings back to the default condition.
(Only when the mode is at the  position)

 : [SETUP] → [INITIAL SET]

- Settings for [CLOCK SET] and [LANGUAGE] will not change.

[NUMBER RESET]

Set the file number of the iFrame/MP4 and still picture recorded next to 0001.

 : [SETUP] → [NUMBER RESET]

- Folder number is updated and file number will start from 0001. (→ 83)
- To reset the folder number, format the SD card, and then perform [NUMBER RESET].

[FORMAT MEDIA]

Please be aware that if a medium is formatted, then all the data recorded on the medium will erase and cannot be restored. Back up important data on a PC, disc, etc. (→ 73)

 : [SETUP] → [FORMAT MEDIA]

- When formatting is complete, press MENU button to exit the message screen.
 - Perform a physical formatting of the SD card when the SD card is to be disposed/ transferred. (→ 95)
-
- Do not turn this unit off or remove the SD card while formatting. Do not expose the unit to vibrations or shock.

Use this unit to format media.

Do not format an SD card using any other equipment such as a PC. The card may not be used on this unit

[MEDIA STATUS]

The used space and remaining recordable time of the SD card can be checked.

 : [SETUP] → [MEDIA STATUS]

- When the mode switch is set to  , remaining recordable time for the selected recording format or recording mode is displayed.
 - Press the MENU button to close the indication.
-
- The SD card requires some space to store information and manage system files, so the actual usable space is slightly less than the indicated value. The usable SD card space is generally calculated as 1 GB=1,000,000,000 bytes. The capacities of this unit, PCs and software are expressed as 1 GB=1,024×1,024×1,024=1,073,741,824 bytes. Therefore, the indicated value of the capacity appears to be smaller.

[Version Disp.]

The firmware version of this unit is displayed.
(Only when the mode is at the  position)

 : [SETUP] → [Version Disp.]

[Version Up]

You can update the firmware version of this unit.
(Only when the mode is at the  position)

 : [SETUP] → [Version Up]

For the latest update information, check the support website below. (As of December 2013)
http://panasonic.jp/support/global/cs/e_cam (This Site is English only)

[DEMO MODE]

This item is used to start the unit demonstration.
(Only when the mode is at the  position)

 : [SETUP] → [DEMO MODE] → [ON]

- If [DEMO MODE] is switched to [ON] and you press the MENU button when there is no SD card inserted and while this unit is connected to the AC adaptor, the demonstration automatically starts.
If any operation takes place, the demonstration is cancelled. However if no operations take place for approx. 10 minutes, the demonstration automatically starts again. To stop the demonstration, set [DEMO MODE] to [OFF] or insert an SD card.

[Eye-Fi TRANSFER]

This item is displayed only when an Eye-Fi card is inserted.
Please refer to page 70.

[Eye-Fi DIRECT]

This item is displayed only when an Eye-Fi card is inserted.
Please refer to page 71.

[LANGUAGE]

You can select the language on the screen display and the menu screen.

 : [SETUP] → [LANGUAGE] → desired setting

Using the Zoom

- ◇ Change the mode to .

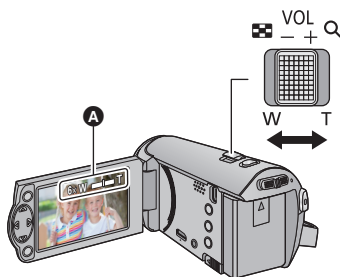

Zoom lever

T side:

Close-up recording (zoom in)

W side:

Wide-angle recording (zoom out)

A Zoom bar

- The zoom speed varies depending on the range over which the zoom lever is moved.
- Maximum zoom magnification can be set with [ZOOM MODE]. (→ 40)

■ About Zoom bar

Zoom bar is displayed during the zoom operation.

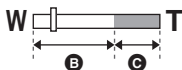

B i.Zoom OFF

C i.Zoom/Digital zoom (Blue)

- If you take your finger off the zoom lever during zoom operation, the operation sound may be recorded. When returning the zoom lever to the original position, move it quietly.
- When the zoom magnification is 50×, the subjects are focused at about 1.6 m or more.
- When the zoom magnification is 1×, this unit can focus on a subject approx. 3 cm away from the lens.

Recording functions of operation icons

Select the operation icons to add different effects to the images to be recorded.

◇ **Change the mode to**  .

1 Press the **ENTER** button to display the operation icons on the screen.









- The indication changes each time you press ▼ of the cursor button.
- Press the ENTER button to display/not-display the operation icon.

2 (e.g. Backlight Compensation)
Select an operation icon.



- Select the operation icon again to cancel the function.
- Refer to the respective pages for cancelling the following functions.
 - Help Mode (→ 37)
 - Guidelines (→ 37)
- The icon is displayed when the operation icon is set.

Operation icons

	Fade
	Backlight Compensation
	Help Mode ^{*1}
	Guidelines
P.REC	PRE-REC ^{*1}
	Colour Night View ^{*1,2}
	Intelligent Contrast Control ^{*2}

*1 It is not displayed during recording.

*2 It is not displayed in the Intelligent Auto Mode.

- If you turn off the unit or change the mode to  , Backlight Compensation, PRE-REC and Colour Night View functions are cancelled.
- If you turn off the unit, the Fade function is cancelled.
- It is possible to set from the menu.
(Except for the Help Mode)



Fade

VIDEO

When you start recording, the image/audio gradually appears. (Fade in)

When you pause recording, the image/audio gradually disappears. (Fade out)

- The Fade setting is cancelled when the recording stops.

■ To select the colour for Fade in/out

MENU : [RECORD SETUP] → [FADE COLOUR] →
[WHITE] or [BLACK]

(Fade in)



(Fade out)



- The thumbnails of scenes recorded using fade in become black (or white).



Backlight Compensation

VIDEO

PHOTO

This makes the image brighter to prevent darkening of a backlit subject.



Help Mode

VIDEO

PHOTO

Select the desired icon using the cursor button to display an explanation on the screen.



To exit the Help Mode

Press the MENU button or select [END].

- You cannot record or set functions while in Help Mode.



Guidelines

VIDEO

PHOTO

You can check if the image is level while recording. The function can also be used to estimate the balance of the composition.

It will switch every time the icon is selected.

→ → → Setting cancelled

- The guidelines do not appear on the images actually recorded.

P.REC

PRE-REC

This prevents you from missing a shot.

VIDEO

This allows recording of the pictures and sound to start approximately 3 seconds before the recording start/stop button is pressed.

-  appears on the screen.
-

- **Aim the unit at the subject beforehand.**
 - There is no beep sound.
 - PRE-REC is cancelled in the following cases.
 - If you change the mode
 - If you remove the SD card
 - If you press the MENU button
 - If you turn the unit off
 - If you start recording
 - After 3 hours have passed
 - After setting PRE-REC, if recording starts in less than 3 seconds, motion pictures taken 3 seconds before pressing the recording start/stop button cannot be recorded.
 - Images displayed on the thumbnail in Playback Mode will differ from the motion pictures displayed at the start of playback.
-



Colour Night View

VIDEO

PHOTO

This function allows you to record colour images in very low light situations. (Minimum required illumination: approx. 1 lx)

- **Recorded scene is seen as if frames were missed.**
 - If set in a bright place, the screen may become washed out for a while.
 - Bright dots that are usually invisible may be seen, but this is not a malfunction.
 - Using a tripod is recommended.
 - In darker areas, Auto Focus may focus a bit slower. This is normal.
-



Intelligent Contrast Control

VIDEO

PHOTO

This brightens parts that are in shadow and difficult to see and suppresses white saturation in bright parts at the same time. Both bright and dark parts can be recorded clearly.

- If there are extremely dark or bright parts or the brightness is insufficient, the effect may not be clear.

Recording functions of menus

- Change the mode to  .











[SCENE MODE]

VIDEO

PHOTO

When you record images in different situations, this mode automatically sets optimum shutter speeds and apertures.

 : [RECORD SETUP] → [SCENE MODE] → desired setting

[OFF]:	Cancel the setting
 Sports:	To make fast moving scenes less shaky with slow playback and pause of playback
 Portrait:	To make people stand out against the background
 Soft Skin:	To makes skin colours appear softer for a more attractive appearance
 Spotlight:	Improved quality when subject is brightly illuminated.
 Snow:	Improved image quality when shooting in snowy locations.
 Beach:	To make blue in the sea or sky vibrant
 Sunset:	To make red in the sunrise or sunset vibrant
 Scenery:	For spatial scenery
 Fireworks:	To capture the fireworks in the night sky beautifully
 Night scenery:	To capture the evening or night scenery beautifully.
 Low light:	For dark scenes, such as at dusk

- **(Sunset/Low light)**
 - The shutter speed is 1/25 or more.
- **(Sunset/Scenery/Fireworks/Night scenery)**
 - Image may get blurry when close object is recorded.
- **(Sports)**
 - During normal playback, the image movement may not look smooth.
 - Colour and screen brightness may change under indoor lighting.
 - If the brightness is insufficient, the Sports Mode does not function. The  display flashes.
- **(Portrait)**
 - Colour and screen brightness may change under indoor lighting.
- **(Soft Skin)**
 - If the background or anything else in the scene has colours similar to the skin colour, they will also be smoothed.
 - If the brightness is insufficient, the effect may not be clear.
 - If you record a person in the distance, the face may not be recorded clearly. In this case, cancel Soft Skin Mode or zoom in on the face (close-up) to record.

- **(Fireworks)**
 - The shutter speed is 1/25.
 - Image may get washed out when recorded in bright surrounding.
- **(Night scenery)**
 - Using a tripod is recommended.

[ZOOM MODE]

VIDEO

PHOTO

Set the maximum zoom ratio.



: [RECORD SETUP] → [ZOOM MODE] → desired setting

[i.Zoom OFF]:	Up to 50×
[i.Zoom 75×]:	This zoom function allows you to maintain high-definition picture quality. (Up to 75×)
[D.Zoom 100×]:	Digital zoom (Up to 100×)
[D.Zoom 2500×]:	Digital zoom (Up to 2500×)

- The larger the digital zoom magnification, the more the image quality is degraded.

[REC FORMAT]

VIDEO

Switches the recording format of the motion picture.



: [RECORD SETUP] → [REC FORMAT] → desired setting

[AVCHD]/[iFrame]^{*1}/[MP4]^{*2}

*1 [iFrame] is a format suitable for Mac (iMovie etc.). It is recommended when using a Mac.

*2 [MP4] is a recording format suitable for playing back or editing on a PC.

- This function's default setting is [AVCHD] mode.

[REC MODE]

VIDEO

Switch the quality and recording format of the motion picture to record in AVCHD.

- Set [REC FORMAT] to [AVCHD].

MENU



: [RECORD SETUP] → [REC MODE] → desired setting

[HA]/[HG]/[HE]:

Set the recording mode to 1080/50i.



- A** Favours image quality
- B** Favours recording time

- **Recordable time using the battery (→ 12)**
- This function's default setting is [HG] mode.
- Please refer to page 97 about approximate recordable time.
- When the unit is moved a lot or moved quickly, or when a fast-moving subject is recorded (Especially when recording in recording format [MP4] or recording mode [HE]), mosaic-type noise may appear at playback.

[E.I.S.]

VIDEO



PHOTO

Use the image stabilizer to reduce the effects of shake during recording.

MENU







: [RECORD SETUP] → [E.I.S.] → [ON]

-  appears on the screen.
- When recording with a tripod, we recommend that you set [OFF].
- When the Colour Night View function is used or the shutter speed is slower than 1/50 depending on the surrounding darkness, the electrical image stabilizer function does not work and the  indication flashes.
- Stabilization may not be possible under strong camera shaking conditions.

You can record motion pictures with added effects.

MENU : [RECORD SETUP] → [Creative Control]

Press ▲/▼ to select the desired Creative Control Mode, and press the ENTER button.

Mode		Effect
 [Miniature Effect]		You can record motion pictures with a diorama effect like recording a miniature by intentionally creating focused area and out of focused area in the peripheral of the image and recording motion picture with an interval. ● Motion pictures recorded with this function will look as if the frame rate is low.
 [8mm movie]		You can record motion pictures with a faded retro effect. (→ 43)
 [Silent movie]		You can record motion pictures that are similar to black-and-white silent films by lowering the amount of incoming light. (→ 44)
 [Time Lapse Rec]		You can record a scene that moves slowly over a long period of time as a short time motion picture by recording one frame at each set time lapse. (→ 44)

- Still pictures cannot be taken.

 [Miniature Effect]

1 Press ▲ to select .



2 Press ▲/▼ to adjust the horizontal position of the in-focus portion.

- If the unit is not operated for approximately 1 second, operation icons will be displayed. You can change the position of the in-focus portion again by pressing ▲/▼.
- If you press ► and select [RESET], the in-focus portion will return to the default position.



3 Press ◀ to select [I], and change the size of the in-focus portion.

- Each time you press ◀, the size of the in-focus portion will change.

Medium size → Large size → Small size

- If you press ▲/▼, you can adjust the horizontal position of the in-focus portion.
- If you press ▶ and select [RESET], the in-focus portion will return to the default position, and will also be resized to the medium size.



4 Press the ENTER button.

5 (When adjusting the brightness)

Press ◀ to select [☀], and adjust the setting.

- Each time you press ◀, the brightness setting will change.

[☀]₀ (Standard) → [☀]₊₁ (Bright) → [☀]₋₁ (Dark)



6 (When adjusting the vividness)

Press ▶ to select [■], and adjust the setting.

- Each time you press ▶, the vividness setting will change.

[■]₀ (Standard) → [■]₊₁ (Vivid) → [■]₊₂ (Most vivid)

7 Start recording.

- It will record with an interval. 1 second will be recorded for approximately every 6 seconds of recording.

-
- To make the Miniature Effect easier to gain, record objects incorporating a distant view or those that can provide depth or a skewed perspective. Also, use a tripod and avoid zooming.
 - Audio cannot be recorded.
 - You may see a lot of noise in the in-focus portion when recording dark subjects such as night scenes.
 - [REC MODE] is set to [HA].
 - The maximum recordable time is 12 hours.
 - Motion pictures recorded with this function will look as if the frame rate is low.

8mm [8mm movie]

1 (When adjusting the brightness)

Press ◀ to select [☀], and adjust the setting.

- Each time you press ◀, the brightness setting will change.

[☀]₀ (Standard) → [☀]₊₁ (Bright) → [☀]₋₁ (Dark)

2 (When adjusting the colour balance)

Press ▶ to select [■], and adjust the setting.

- Each time you press ▶, the colour balance setting will change.

[■]₆ (Blue) → [■]₃ (Red) → [■]₄ (Yellow)

3 Start recording.



-
- The sound is monaural.

SILN [Silent movie]

- (When adjusting the brightness)
Press **◀** to select **+**, and adjust the setting.
 - Each time you press **◀**, the brightness setting will change.
+₀ (Standard) → **+**₊₁ (Bright) → **+**₋₁ (Dark)
- Start recording.



- Audio cannot be recorded.

INTV [Time Lapse Rec]

Press **▲/▼/◀/▶** to select the desired setup time, and press the **ENTER** button.

[1 SECOND]/[10 SECONDS]/[30 SECONDS]/[1 MINUTE]/[2 MINUTES]

- A frame is recorded with a set recording interval. 25 frames will make up motion picture of 1 second.

Setup example	Setup time (recording interval)	Recording time	Recorded time
Sunset	1 s	Approx. 1 h	Approx. 2 min
Blooming	30 s	Approx. 3 h	Approx. 12 s

- Maximum recordable time is 12 hours.

- Audio cannot be recorded.
- [REC MODE] is set to [HA].
- The shortest motion picture recording time is 1 second.
- The colour balance and focus may not be adjusted automatically depending on the light source or scene. If so, manually adjust those settings. (→ 48, 50)
- When recording for a long time, we recommend recording with the AC adaptor connected.

[FACE FRAMING]

VIDEO

PHOTO

Detected faces appear with frames.



: [RECORD SETUP] → [FACE FRAMING] → desired setting

[PRIMARY]:

Only the prioritised face framing is displayed.

[ALL]:

All face detection framings are displayed.

[OFF]:

Cancel the setting.



- Up to 15 frames are indicated. Larger faces and faces nearer to the centre of the screen take preference over others.

■ Prioritised face framing

Prioritised face framing is displayed as orange frames. Focus and adjustment of brightness will be performed against the prioritised face framing.

- The prioritised face frame is displayed only with Portrait Mode in the Intelligent Auto Mode.
- The white frame is for face detection only.

[AUTO SLOW SHTR]

VIDEO

PHOTO

You can record bright pictures even in dark places by slowing the shutter speed.

- **Switch to Manual Mode.** (→ 47)



: [RECORD SETUP] → [AUTO SLOW SHTR] → [ON]

- The shutter speed is set to 1/25 or more depending on the surrounding brightness.
- When the shutter speed becomes 1/25, the screen may be seen as if frames are missed and afterimages may appear.

[WIND CUT]

VIDEO

This is for reducing the wind noise coming into the built-in microphones.

- **Switch to Manual Mode.** (→ 47)



: [RECORD SETUP] → [WIND CUT] → [ON]



- This function's default setting is [ON].
- When switching to Intelligent Auto Mode, [WIND CUT] is set to [ON], and the setting cannot be changed.
- You may not see the full effect depending on the recording conditions.

[PICTURE SIZE]

PHOTO

The higher the number of pixels, the higher the clarity of the picture when printing.

 : [PICTURE] → [PICTURE SIZE] → **desired setting**

Picture size		Aspect ratio
 8.9M	3968×2232	16:9
 2.1M	1920×1080	

- This function's default settings is  8.9M.
- The recording will become longer depending on the recording pixels.
- Please refer to page 98 for details about the number of recordable pictures.

[SHTR SOUND]

PHOTO

You can add a shutter sound when recording still pictures.

 : [PICTURE] → [SHTR SOUND] → **desired setting**

 : Volume low

 : Volume high

[OFF]: Cancel the setting.

Manual recording

- ◇ Change the mode to  .

Press the Intelligent auto/Manual button to switch to Manual Mode.

- **MNL** appears on the screen.

IA/MANUAL

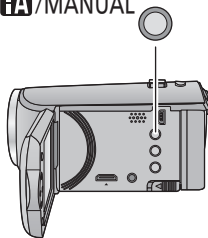

- WB** White Balance (→ 48)
- SHTR** Manual Shutter Speed (→ 49)
- IRIS** Iris Adjustment (→ 49)
- MF** Focus (→ 50)

- Press the ENTER button to display/not display the manual icon.
- The page changes with each press of ▼.

White Balance

Automatic White Balance function may not reproduce natural colours depending on the scenes or lighting conditions. If so, you can adjust the White Balance manually.

- Press the Intelligent auto/Manual button to switch to **Manual Mode**.

- 1 Select [WB] using the cursor button.
- 2 Press ◀/▶ to select White Balance Mode.





Icon	Mode/Recording conditions
	Auto White Balance adjustment
	Sunny mode: Outdoors under a clear sky
	Cloudy mode: Outdoors under cloudy sky
	Indoor mode 1: Incandescent light, video lights like in the studio, etc.
	Indoor mode 2: Colour fluorescent lamps, sodium lamps in gymnasiums, etc.
	Manual adjustment mode: <ul style="list-style-type: none">● Mercury-vapor lamps, sodium lamps, some fluorescent lights● Lights used for wedding receptions at hotels, stage spotlights in theaters● Sunrise, sunset, etc.

- To return to auto setting, select **AWB** or press the Intelligent auto/Manual button.

■ To set the White Balance manually

- 1 Press ◀/▶ to select , and fill the screen with a white subject.
- 2 Press ▲ to set.

- When the screen turns black instantly and the  display stops flashing and then lights constantly, the setting is complete.
- If the  display continues flashing, the White Balance cannot be set. In this case, use other White Balance Modes.

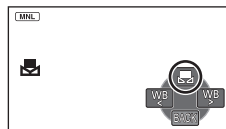

- If you turn on the unit with the lens cover closed, the Auto White Balance will not be performed correctly. Always open the lens cover before turning on the unit.
- When the  display flashes, the Manual White Balance previously adjusted is stored. Whenever recording conditions change, re-set the White Balance.
- When setting both the White Balance and the iris/gain, set the White Balance first.
- **AWB** is not displayed on the screen when **AWB** is being set.

Manual shutter speed/Iris adjustment

Shutter Speed:

Adjust it when recording fast-moving subjects.

Iris:

Adjust it when the screen is too bright or too dark.

- Press the Intelligent auto/Manual button to switch to Manual Mode. (→ 47)

1 Select [SHTR] or [IRIS] using the cursor button.

2 Press ◀/▶ to adjust settings.

A SHTR : Shutter speed:

1/50 to 1/8000

- If [AUTO SLOW SHTR] is set to [ON], the shutter speed will be set between 1/25 and 1/8000.
- The shutter speed closer to 1/8000 is faster.



B IRIS : Iris/Gain value:

CLOSE ↔ (F16 to F2.0) ↔ OPEN ↔ (0dB to 18dB)

- Value closer to CLOSE darkens the image.
- Value closer to 18dB brightens the image.
- When the iris value is adjusted to brighter than OPEN, it changes to the gain value.
- To return to auto setting, press the Intelligent auto/Manual button.

-
- When setting both the shutter speed and the iris/gain value, set the shutter speed and then set the iris/gain value.

Manual shutter speed adjustment

- You may see a band of light around an object that is shining very bright, or highly reflective.
- During normal playback, image movement may not look smooth.
- If you record an extremely bright object or record under indoor lighting, colour and screen brightness may change or a horizontal line may appear on the screen. In this case, record in the Intelligent Auto Mode or set the shutter speed to 1/100 in areas where the power supply frequency is 50 Hz, or 1/125 in areas of 60 Hz.

Manual iris/gain adjustment

- If the gain value is increased, the noise on the screen increases.
- Depending on the zoom magnification, there are iris values that are not displayed.

Recording with Manual Focus

If auto focusing is difficult due to the conditions, then use Manual Focus.

- Press the Intelligent auto/Manual button to switch to Manual Mode. (→ 47)

1 (When MF assist function is used)

Select the menu.

MENU : [RECORD SETUP] → [MF ASSIST] → [ON]

- Display the operation icon by pressing the ENTER button, and switch to manual icon by pressing ▼.

2 Select [MF] using the cursor button to change to Manual Focus.

- MF appears on the screen.

3 Press ◀/▶ to adjust the focus.

MF + : To focus on a close subject
MF - : To focus on a faraway subject



The in-focus area is displayed in blue. The normal screen returns approximately 2 seconds after you finish bringing the subject into focus.

- When [MF ASSIST] is [OFF], the blue area is not displayed.
- To restore Auto Focus, select [AF] or press the Intelligent auto/Manual button.

-
- The blue display does not appear on the images actually recorded.

Playback Operations

Motion picture playback using operation icon

VIDEO

For details on the basic playback operations, refer to page 24.

Playback operation	Cursor button/Playback display	Operating steps
Slow-motion playback	<p>During Pause</p> 	<p>With the playback paused, press and hold ► of the cursor button. (Press and hold ◀ for slow rewind playback) Slow-motion playback will continue over the period that the button is pressed.</p> <ul style="list-style-type: none"> • Normal playback is restored when you press ▲. • When Slow-motion pictures are played back in reverse, they will be shown continuously at approximately 2/3rd the speed of normal playback (intervals of 0.5 seconds). • Slow-motion playback for iFrame or MP4 scenes will be in 1 second intervals.
Frame-by-frame playback		<p>With the playback paused, press ► of the cursor button. (Press ◀ to advance the frames one at a time in the reverse direction.)</p> <ul style="list-style-type: none"> • Normal playback is restored when you press ▲. • When the frames are advanced one at a time in the reverse direction, they will be shown in intervals of 0.5 seconds. • Frame-by-frame playback for iFrame or MP4 scenes will be in 1 second intervals.

Creating still picture from motion picture

VIDEO

A single frame from the recorded motion picture can be saved as a still picture.

[2.1M] (1920×1080) still pictures will be recorded for the AVCHD scenes and iFrame scenes, and

[0.2M] (640×360) still pictures will be recorded for the MP4 scenes.

Press the  button at the location to be saved as a still picture during the playback.

- It is convenient to use Pause, Slow-motion Playback and Frame-by-frame Playback.
- The date the motion picture was recorded will be registered as date of the still picture.
- Quality will be different from the normal still picture.

Repeat playback

VIDEO

Playback of the first scene starts after playback of the last scene finishes.

MENU  : [VIDEO SETUP] → [REPEAT PLAY] → [ON]

The  indication appears on the full screen views.

- All the scenes are played back repeatedly. (When playing back motion pictures by date, all the scenes on the selected date are played back repeatedly.)

Resuming the previous playback

VIDEO

If playback of a scene was stopped halfway, the playback can be resumed from where it was stopped.

MENU  : [VIDEO SETUP] → [RESUME PLAY] → [ON]

If playback of a motion picture is stopped,  appears on the thumbnail view of the stopped scene.

- The memorised resume position is cleared if you turn off the unit or change the mode. (The setting of [RESUME PLAY] does not change.)

Zooming in on a still picture during playback (Playback zoom)

PHOTO

You can zoom in on still pictures during playback.

1 Move the zoom lever to side.

- You can zoom to a maximum of 4×. (1× → 2× → 4×)

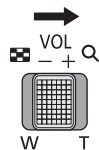

2 Shift the position of the zoomed portion using the cursor button.

- The location of the zoom displays for about 1 second when zooming in (zooming out) or moving the displayed location.



- **A** Displayed location of the zoom

Zooming out from the zoomed still picture

Move the zoom lever to  side to zoom out. (4× → 2× → 1×)

- The more a picture is enlarged, the more its quality deteriorates.

Various playback functions

Playing back motion pictures/still pictures by date

VIDEO PHOTO

The scenes or the still pictures recorded on the same day can be played back in succession.

- 1 Select the date select icon using the cursor button, then press the ENTER button.**

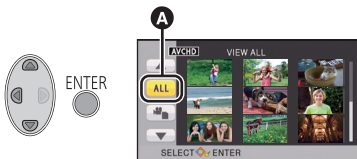

A Date select icon

- 2 Select the playback date, then press the ENTER button.**

The scenes or the still pictures recorded on the date selected are displayed as thumbnails.

- 3 Select the scene or the still picture to be played back, then press the ENTER button.**

-
- Playing back of all the scenes or the still pictures returns if the unit is turned off or the mode is changed.
 - Even if the scenes have been recorded on the same day, they will be displayed separately in the following cases. -1, -2 ... are added after the date displayed on the list by date.
 - When the number of scenes exceeds 99
 - When recorded in Creative Control Mode
 - When [NUMBER RESET] is performed
 - [] is displayed after the date in the list by date for the still pictures created from the motion picture. (→ 52)

Changing the playback settings and playing back the slide show

PHOTO

- 1** Select  using the cursor button, then press the ENTER button.

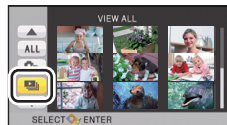

- 2** (Only when you would like to change the settings)
Select the item to change and press the ENTER button.

[DATE SETUP]: Select the date to be played back.

[SLIDES INTERVAL]: Selects the interval between still pictures at playback.

[MUSIC SELECT]: Select the music to be played on playback.

- 3** (When [DATE SETUP] is selected)
Select the playback date, then press the ENTER button.

(When [SLIDES INTERVAL] is selected)

Select the interval of playback for the slide show and press the ENTER button.

[SHORT]: Approx. 1 second

[NORMAL]: Approx. 5 seconds

[LONG]: Approx. 15 seconds

(When [MUSIC SELECT] is selected)

Select the desired sound and press the ENTER button.

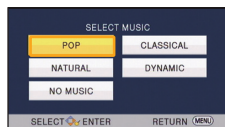

- 4** Select [START] and press the ENTER button.

- 5** Select the playback operation. (→ 24)

- When the playback is finished or stopped, the screen to select [REPLAY], [SELECT AGAIN] or [EXIT] is displayed. Select the desired item and press the ENTER button.

Deleting scenes/still pictures

Deleted scenes/still pictures cannot be restored, so perform appropriate confirmation of the contents before proceeding with deletion.

◇ Change the mode to  .

■ To delete the scene or still picture being played back

Press the Delete button while scenes or still pictures to be deleted are being played back.

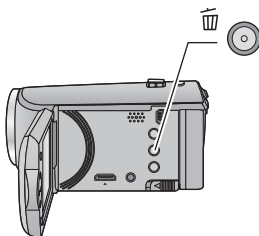

■ To delete scenes or still pictures from the thumbnail display

● Switch to the thumbnail display of the scenes or still pictures to delete. (→ 24)

1 Press the Delete button while the thumbnail view screen is displayed.

● When the thumbnail display is 1 scene display, the scene or still picture being displayed is deleted.

2 Select [ALL SCENES], [MULTI] or [SINGLE] using the cursor button, then press the ENTER button.

● All the scenes or still pictures displayed as thumbnails will be deleted by selecting [ALL SCENES].

(In case of playing back scenes or still pictures by date, all the scenes or still pictures on the selected date will be deleted.)

● Protected scenes/still pictures cannot be deleted.

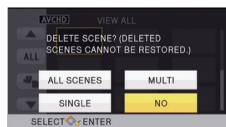

3 (When [MULTI] is selected in Step 2)

Select the scene/still picture to be deleted, then press the ENTER button.

- The scene/still picture is selected and the  indication appears on the thumbnail. Press the ENTER button again to cancel the operation.
- Up to 99 scenes can be selected to be deleted.

(When [SINGLE] is selected in Step 2)

Select the scene/still picture to be deleted, then press the ENTER button.

4 (When [MULTI] is selected in Step 2)

Select [Delete], and press the ENTER button, or the Delete button.

- To continuously delete other scenes/still pictures, repeat Steps 3-4.

When you stop deleting halfway

Press the MENU button while deleting.

- The scenes or still pictures that have already been deleted when the deletion is cancelled cannot be restored.

To complete editing

Press the MENU button.

-
- You can also delete scenes by pressing the MENU button, selecting [EDIT SCENE] → [DELETE] → [ALL SCENES], [MULTI] or [SINGLE].
 - You can also delete still pictures by pressing the MENU button, selecting [PHOTO SETUP] → [DELETE] → [ALL SCENES], [MULTI] or [SINGLE].
 - Scenes which cannot be played back (the thumbnails are displayed as ) cannot be deleted.
 - In case of [ALL SCENES], the deletion may take time if there are many scenes or still pictures.
 - If you delete scenes recorded on other products or still pictures conforming to DCF standard with this unit, all the data related to the scenes/still pictures may be deleted.
 - When still pictures recorded on an SD card by other products are deleted, a still picture (other than JPEG) that cannot be played back on this unit may be erased.

Dividing a scene (AVCHD)

VIDEO

It is possible to divide an AVCHD scene. Any unwanted parts in the scene can be deleted after dividing.

- Set the mode switch to , select the play mode selection icon, and select the AVCHD scene. (→ 24)

1 Select the menu.

 : [EDIT SCENE] → [DIVIDE] → [SET]

2 Select the scene you wish to divide using the cursor button and press the ENTER button.

3 Select to set the dividing point.

- It is convenient to use Slow-motion Playback and Frame-by-frame Playback. (→ 51)
- Select [YES] to continue dividing the same scene. To continue dividing other scenes, select [NO] and repeat Steps 2-3.



4 Press the MENU button to complete dividing.

- Unwanted parts can be deleted. (→ 56)

To delete all the divided points

 : [EDIT SCENE] → [DIVIDE] → [CANCEL ALL]

- The scenes that were deleted after division cannot be recovered.
- You cannot divide a scene if the number of scenes of a given date would exceed 99 scenes.
- It may not be possible to divide scenes with a short recording time.
- Data that has been recorded or edited on another device cannot be divided and the divided points cannot be deleted.

Dividing a scene to partially delete (iFrame, MP4)

VIDEO

Divide the iFrame or MP4 scene, and delete unnecessary parts.

This divides the recorded scenes in two and deletes the front half or back half.

The scenes that were deleted after division cannot be recovered.

- Set the mode switch to  , select the play mode selection icon, and set to [iFrame] or [MP4]. (→ 24)

1 Select the menu.

MENU : [EDIT SCENE] → [SPLIT&DELETE]

2 Select the scene you wish to divide using the cursor button and press the ENTER button.

3 Select  to set the dividing point.

- It is convenient to use Slow-motion Playback and Frame-by-frame Playback. (→ 51)
- Set to at least 2 seconds for the portions to be deleted and at least 3 seconds for the portion that is to remain.



4 Select the part for deletion, then press the ENTER button.

5 Select [YES] and press the ENTER button to confirm (play back) the part for deletion.

- A confirmation message appears when [NO] is selected. Proceed to Step 7.

6 Stop the playback.

- A confirmation message appears.

7 Select [YES] and press the ENTER button.

- To continue dividing and deleting other scenes, repeat Steps 2-7.

To complete dividing

- Press the MENU button.

-
- It may not be possible to divide scenes with a short recording time.
 - The actual division may slightly slip off the previously designated dividing point.

Protecting scenes/still pictures

VIDEO PHOTO

Scenes/still pictures can be protected so that they are not deleted by mistake.

(Even if you protect some scenes/still pictures, formatting the media will delete them.)

- Change the mode to  .

1 Select the menu.

MENU : [VIDEO SETUP] or [PHOTO SETUP] → [SCENE PROTECT]*

* [TRANSFER/PROTECT] is displayed when using the Eye-Fi card that is set as the selected transfer setting device in advance on the computer.

2 Select the scene/still picture to be protected using the cursor button, then press the ENTER button.

- The scene/still picture is selected and the  indication appears on the thumbnail. Press the ENTER button again to cancel the operation.
- Press the MENU button to complete the settings.

Watching Video/Pictures on your TV

Confirm the terminals on your TV and use a cable compatible with the terminals. Image quality may vary with the connected terminals.

- A** High quality
- 1** HDMI terminal
- 2** Video terminal

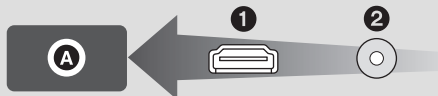

- HDMI is the interface for digital devices. If you connect this unit to an HDMI compatible high-definition TV and then play back the recorded high-definition images, you can enjoy them in high resolution with high quality sound.

1 Connect this unit to a TV.

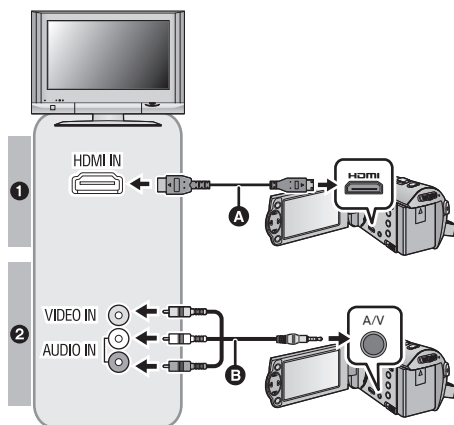

- A** HDMI mini cable (supplied or optional)^{*1}
- Be sure to connect to the HDMI terminal.
- Connecting with a HDMI mini cable (→ 63)
- Playback using VIERA Link (→ 64)
- B** AV cable (supplied or commercially-available)^{*2}

Picture quality

- 1** High-definition images when connecting to HDMI terminal
- 2** Standard images when connecting to video terminal

*1 Use the HDMI mini cable that comes with this unit if supplied. If it does not come with a HDMI mini-cable, use a genuine Panasonic HDMI mini cable (RP-CDHM15, RP-CDHM30: optional). Check the accessories in the basic operating instructions.

*2 Use the AV cable that comes with this unit if supplied. Check the accessories in the basic operating instructions.

- Check that the plugs are inserted as far as they can go.

2 Select the video input on the TV.

- Example:
 - Select the [HDMI] channel with a HDMI mini cable.
 - Select the [Video 2] channel with an AV cable.
 - (The name of the channel may differ depending on the connected TV.)
- Check the input setting (input switch) and the audio input setting on the TV. (For more information, please read the operating instructions for the TV.)

3 Change the mode to to play back.

- When connecting the device to a television, the television image will not be displayed in the following cases. Use the device's LCD monitor.
 - Recording video
 - When setting PRE-REC



■ To watch images on a regular TV (4:3) or when both sides of the images do not appear on the screen

Change the menu setting to display the images correctly. (Check the TV setting.)



- If you set the option to [4:3] and connect this unit and the TV with the AV cable, images or menu screens may be displayed in a reduced size.

Example of images with a [16:9] aspect ratio on a regular TV (4:3)

[TV ASPECT] setting	
[16:9]	[4:3]
	

- If a wide-screen TV is connected, adjust the aspect setting on the TV. (Refer to the operating instructions of the TV for details.)

■ To display the on-screen information on the TV

When the menu setting is changed, the information displayed on the screen (operation icon and time code etc.) can be displayed/not displayed on the TV.

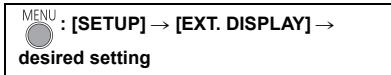

[SIMPLE]*:	Information partially displayed
[DETAIL]:	All information displayed
[OFF]:	Not displayed

* This setting is only available in recording mode.

Refer to the following support site for information about the Panasonic TVs that you can directly insert an SD card into the SD card slot on the TV and then play it back.

<http://panasonic.net/>

- It may not be possible to play back scenes on the TV depending on the [REC FORMAT] and [REC MODE].
- For details on how to play back, please read the operating instructions for the TV.

Connecting with a HDMI mini cable

Select the desired method of HDMI output.

MENU



: [SETUP] → [HDMI RESOLUTION] → [AUTO]/[1080i]/[576p]

- [AUTO] determines the output resolution automatically based on information from the connected TV.
If the images are not output on the TV when the setting is [AUTO], switch to the method [1080i] or [576p] which enables the images to be displayed on your TV. (Please read the operating instructions for the TV.)
- Images may not be displayed on the television for several seconds in some cases, such as when changing between scenes.

Playback using VIERA Link

What is the VIERA Link (HDAVI Control™)?

- This function allows you to use your remote control for Panasonic TV for easy operations when this unit has been connected to a VIERA Link compatible device using an HDMI mini cable (supplied or optional)* for automatic linked operations. (Not all operations are possible.)
 - VIERA Link is a unique Panasonic function built on an HDMI control function using the standard HDMI CEC (Consumer Electronics Control) specification. Linked operations with HDMI CEC compatible devices made by other companies are not guaranteed. When using devices made by other companies that are compatible with VIERA Link, refer to the operating instructions for the respective devices.
 - This unit supports "VIERA Link Ver.5" function. "VIERA Link Ver.5" is the standard for Panasonic's VIERA Link compatible equipment. This standard is compatible with Panasonic's conventional VIERA Link equipment.
- * Use the HDMI mini cable that comes with this unit if supplied. If it does not come with a HDMI mini-cable, use a genuine Panasonic HDMI mini cable (RP-CDHM15, RP-CDHM30: optional). Check the accessories in the basic operating instructions.

◇ Change the mode to  .

1 Select the menu.

 : [SETUP] → [VIERA Link] → [ON]

- If you are not using VIERA Link, set to [OFF].

2 Connect this unit to a Panasonic TV compatible with VIERA Link with a HDMI mini cable. (→ 61)

- It is recommended to connect this unit to an HDMI terminal other than the HDMI1 if there are 2 or more HDMI input terminals on the TV.
- VIERA Link must be activated on the connected TV. (Read the operating instructions of the TV for how to set, etc.)

3 Operate with the remote control for the TV.

- You can select the scene or picture you want to play back by pressing the button up, down, left or right, and then the button in the centre.

(When selecting scenes)

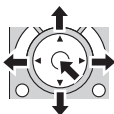

(When playing back)

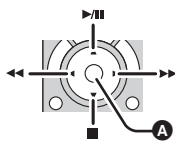

A Display/Cancel operation icons

- The following operations are available by pressing the colour buttons on the remote control.

Green	<ul style="list-style-type: none">• Switching the number of scenes/still pictures in thumbnail display (9 thumbnails → 20 thumbnails → 9 thumbnails...)• Zoom in on still picture
Yellow	<ul style="list-style-type: none">• Deleting scenes/still pictures
Red	<ul style="list-style-type: none">• Zoom out from still picture

■ Other linked operations

Turning the unit off:

If you use the remote control for the TV to turn off the power, this unit also turns off.

Automatic input switching:



If you connect with an HDMI mini cable and then turn on this unit, the input channel on the TV automatically switches to this unit's screen. If the TV's power is in standby status, it will turn on automatically (if [Set] has been selected for the TV's [Power on link] setting).

- Depending on the HDMI terminal on the TV, the input channel may not switch automatically. In this case, use the remote control for the TV to switch the input channel.
-
- If you are unsure whether or not the TV and AV amplifier you are using are compatible with VIERA Link, read the operating instructions for the devices.
 - Available linked operations between this unit and a Panasonic TV is different depending on the types of Panasonic TVs even if they are compatible with VIERA Link. Refer to the operating instructions of the TV for the operations that support on the TV.
 - Operation is not possible with a cable that is not based on the HDMI standard.

Dubbing with a Blu-ray disc recorder, video devices, etc.

■ Check before dubbing

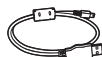
Check the equipment used for dubbing.

Equipment used for dubbing	Dubbing picture quality	To dub
Equipment with SD card slot	High-definition picture quality*	Insert the SD card directly (→ 67) 
Equipment with USB terminal	High-definition picture quality*	Connect with supplied USB cable (→ 67) 
Equipment without SD card slot or USB terminal	Standard picture quality This can be played back on equipment incompatible with high-definition (AVCHD), so it is convenient if you are dubbing for distribution.	Connect with AV cable (→ 69) 

* Some equipment may not be compatible with high-definition (AVCHD) picture quality. In such a case, connect with the AV cable and dub with standard picture quality. (→ 69)

- For the positions of the SD card slot, USB terminal, or terminal for connecting the AV cable, refer to the operating instructions of the equipment used.
- The iFrame and MP4 scenes cannot be dubbed by inserting the SD cards or by connecting with the USB cable. To dub iFrame and MP4 scenes, refer to page 69.

You can dub using a Panasonic Blu-ray disc recorder or high-definition (AVCHD) compatible DVD recorder.

- Depending on the recorders or the media to be copied to, you may not be able to copy in high-definition (AVCHD) picture quality. For further details, see the operating instructions of your recorder.
- Note that the equipment described may not be available in certain countries and regions.

Dubbing in high-definition picture quality

VIDEO PHOTO

■ To dub using equipment with an SD card slot

You can dub by directly inserting an SD card.

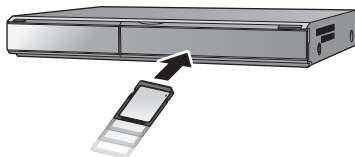

■ To dub using equipment with a USB terminal

You can dub by connecting a USB cable.

- When the USB cable is connected to other equipment, the AC adaptor cannot be used. Please ensure that the battery is sufficiently charged.
- Turn on the unit.

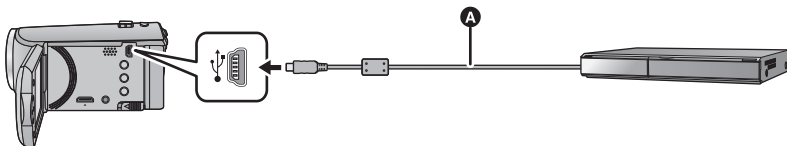

A USB cable (supplied)

- Insert the plugs as far as they will go.

1 Connect the unit to the Blu-ray disc recorder or high-definition (AVCHD) compatible DVD recorder.

- The USB function selection screen will appear on the screen of the unit.

2 Select [RECORDER] using the cursor button on the unit and press the ENTER button.

- When you select an option other than [RECORDER], reconnect the USB cable.
- When using the battery, the LCD monitor turns off after about 5 seconds. Press the cursor button to turn the LCD monitor on.

About the screen indication of the unit

- When the unit is accessing the SD card, card access icon () appears on the unit screen or the access lamp is on.
- Be careful not to disconnect the USB cable, AC adaptor or battery while the unit is accessing media, as this may result in the loss of recorded content.

3 Dub through operations on the Blu-ray disc recorder or high-definition (AVCHD) compatible DVD recorder.

- Do not use any other USB cables except the supplied one. (Operation is not guaranteed with any other USB cables.)
- When this unit is connected to a Panasonic Blu-ray disc recorder or a DVD recorder using a USB cable while the unit is turned on, power is also supplied from the connected equipment to this unit.
- For details on dubbing and playback methods, read the operating instructions of the Blu-ray disc recorder or DVD recorder.
- When you connect the unit to a Blu-ray disc recorder, a dubbing operations screen may appear on the television connected to the Blu-ray disc recorder. In this case as well, perform the operations of Steps 1 to 3.
- You cannot change the mode of the unit or turn off the unit while it is connected to a Blu-ray disc recorder or DVD recorder. Disconnect the USB cable before performing either of these operations.
- If the battery runs down during dubbing, a message will appear. Operate the Blu-ray disc recorder to cancel the dubbing.

■ Dubbing using equipment without an SD card slot or a USB terminal, or using a video device

You can dub by connecting an AV cable.

- **Images are dubbed in standard quality.**
- Use the AC adaptor to free you from worrying about the battery running down.

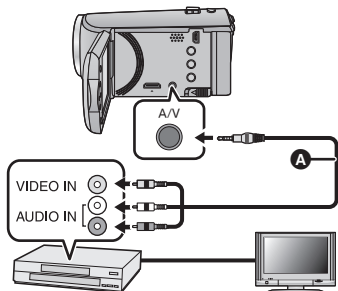

Change the video input on the video device and TV that this unit is connected to.

- The channel set will differ depending on the terminal to which the unit is connected.
- See the operating instructions of the video device for details.
- Insert the plugs as far as they will go.
- **A** AV cable (supplied or commercially-available)*
- * Use the AV cable that comes with this unit if supplied. Check the accessories in the basic operating instructions.

- Change the mode to  .

1 Connect this unit to a video device and start playback on this unit.

2 Start recording on the connected device.

- To stop recording (dubbing), stop playback on this unit after stopping recording on the recorder.
-
- If the date and time display and function indication are not wanted, cancel them before dubbing. (→ 27, 62)
 - Turn off the operation icon by pressing the ENTER button when dubbing (→ 24).

If the dubbed images are played back on a wide-screen TV, the images may be stretched vertically.

In this case, refer to the operating instruction of the device you are connecting to or read the operating instructions of the wide-screen TV and set the aspect ratio to 16:9.

Using the Eye-Fi™ card

Using an Eye-Fi card (commercially-available), you can record motion pictures and still pictures on the card, and save them on a PC or upload them on a file-sharing website via a wireless network.



- The functions of the Eye-Fi card (including wireless transmission) are not guaranteed to work on this product. In the case of a malfunction of the card, please contact the card manufacturer.
- To use the Eye-Fi transfer feature, a broadband wireless LAN environment is required.
- To use the Eye-Fi card, permission from the national or regional government is required. Do not use if you have not obtained permission. If you are unsure as to whether use is permitted, please check with the card manufacturer.
- To prevent the interception of communications, misuses, identity thefts, etc., we strongly recommend you configure the appropriate security settings (encryption settings). For details, refer to the manuals of your Eye-Fi card and access point.
- **Install the software supplied with the Eye-Fi card in advance on your PC, and configure the Eye-Fi settings. (For settings methods etc., please read the card operating instructions or consult the card manufacturer)**

- **Inserting an Eye-Fi card (commercially available) to the unit.**

Select the menu.

MENU : [SETUP] → [Eye-Fi TRANSFER] → [ON]

- When [Eye-Fi TRANSFER] is set to [ON], the transferrable files will be transferred automatically.
- To cancel the transferring of a file, turn off the unit or set [Eye-Fi TRANSFER] to [OFF].
- The setting at the time of purchase is [OFF]. Every time the Eye-Fi card is removed from the unit, this setting is set to [OFF].
- Eye-Fi transfers are not available during motion picture recording.
- You can check the file transfer status on the thumbnail screen.

	File has been transferred
	File waiting for transfer
	File cannot be transferred

■ Using Eye-Fi direct mode

The files can be transferred directly from the Eye-Fi card to a smartphone or tablet without going through the access point when necessary setting is performed in a PC in advance.

- **Install the software supplied with the Eye-Fi card on your PC, and configure the Eye-Fi direct mode settings.**
 - **Inserting an Eye-Fi card (commercially available) to the unit**
- Select the menu.

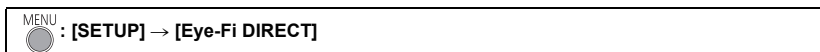

- This mode is displayed only when [Eye-Fi TRANSFER] is set to [ON].
- The mode will be cancelled using the following steps.
 - When the unit is turned off
 - If you start recording motion pictureIn addition to the steps above, the mode may also be cancelled by the Eye-Fi card.
- When connected via Eye-Fi direct mode, [ECONOMY (BATT)]/[ECONOMY (AC)] are disabled.

■ Selecting files to transfer

If you perform the required settings in advance on your PC, you can transfer selected files alone. For settings methods etc., please read the card operating instructions or consult the card manufacturer.

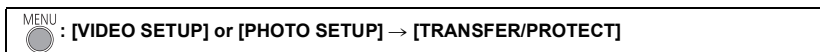

- **Install the software supplied with the Eye-Fi card on your PC, and configure the selection transfer settings.**
- **Inserting an Eye-Fi card (commercially available) to the unit**
- **Set the mode switch to , select the playback mode selection icon, and set the video/still picture to [iFrame], [MP4], or [PICTURE] (→ 24)**

Select the menu.



- The settings method is the same as that for the [SCENE PROTECT] settings. (→ 60)
- If the selected transfer setting is not configured on the computer, [SCENE PROTECT] is displayed and the selected transfer setting cannot be configured.
- When the write protect switch on the Eye-Fi card is on the LOCK side, [SCENE PROTECT] is displayed and selected transfer setting is disabled. Please unlock the write protect switch.
- The protect setting is also applied to the files for which [TRANSFER/PROTECT] is set. To delete a file, first cancel [TRANSFER/PROTECT] and then perform the operation.
- AVCHD scenes cannot be used as the selected transfer setting.

- The Eye-Fi menu only appears when an Eye-Fi card is used.
- The Eye-Fi transfer feature cannot be guaranteed to continue to operate in the future due to changes to the card specification etc.
- Update the firmware of the Eye-Fi card to the latest one using the software supplied with the Eye-Fi card before use.
- When the endless memory function of the Eye-Fi card is set to on, the files transferred from the card may be deleted automatically.
- The Eye-Fi card may heat up as a result of the files being transferred. Note that the use of an Eye-Fi card accelerates the battery drain, so we recommend you use the card in Playback Mode.
- Setting of the Eye-Fi can be confirmed while pausing the recording.

	[Eye-Fi TRANSFER] is set to [ON] (Transferring in Eye-Fi direct mode)
	[Eye-Fi TRANSFER] is set to [ON]
	[Eye-Fi TRANSFER] is set to [OFF]

- If the Eye-Fi card is removed and then reinserted into the unit, set functions related to Eye-Fi again from the menu.
- When using the Eye-Fi card, please be sure to unlock the write-protect switch. (→ 13)
- Before deleting the files, please confirm they have been transferred to your PC and uploaded to the sharing site.
- Do not use the Eye-Fi card in locations where the use of wireless devices is forbidden, such as inside aircraft etc.
- Depending on network conditions, the transfer may take some time. Also, if network conditions deteriorate, the transfer may be suspended.
- Files over 2 GB in size cannot be transferred. Such files should first be split to reduce the file size. (→ 58)

What you can do with a PC

HD Writer LE 2.1

You can copy the motion/still picture data to the HDD of PCs or write to media like Blu-ray discs, DVD discs or SD cards using HD Writer LE 2.1, the software installed in the supplied CD-ROM. Refer to the operating instructions of HD Writer LE 2.1 (PDF file) for details on how to use it.

■ Smart wizard

The Smart wizard screen is automatically displayed when you connect this unit to a PC with HD Writer LE 2.1 installed. (→ 81)



Copy to PC:

You can copy motion/still picture data to the HDD of PCs.

Copy to disc:

You can copy to disc in high-definition picture quality.

- Select the function you wish to use and follow the on-screen instructions for easy copying.

What can be done with the HD Writer LE 2.1	Data type
Copying data to a PC	Motion picture and still picture
Copying in Blu-ray disc/AVCHD format: <ul style="list-style-type: none"> • The scenes in iFrame or MP4 cannot be copied to Blu-ray disc or in AVCHD format. 	
Editing: Editing motion picture data copied on an HDD of a PC <ul style="list-style-type: none"> • Dividing, Trimming, Still picture, Title, Effect, Transition, BGM, Delete partially • Converting part of motion picture into still picture 	Motion picture
Online sharing: You can upload motion pictures on the Internet and share them with your family and friends.	
Playing back on a PC: Play back the motion picture data in high-definition picture quality on a PC.	Motion picture and still picture
Formatting discs: Depending on the type of disc that you use, formatting is necessary.	Motion picture

- It is possible to play back on a PC using an image viewer standard to Windows or commercially available image browsing software, and copy pictures to a PC using Windows Explorer.
- Please refer to page 85 for details about using a Mac.

Important Notice

- When using an SDXC Memory Card, check the following support site.
<http://panasonic.net/avc/sdcard/information/SDXC.html>
- Do not insert a disc recorded in AVCHD format with HD Writer LE 2.1 in a device that does not support the AVCHD format. In some cases the disc may get stuck in the device.
- When inserting a disc containing recorded motion pictures into other devices, a message prompting you to format the disc may be displayed. Do not format the disc, since deleted data cannot be restored later.

-
- Data cannot be written from a PC to the unit.
 - Motion pictures that have been recorded on another device cannot be written to the software supplied with this unit. To write motion picture data recorded with the Panasonic High Definition Video Camera sold previously, use the HD Writer supplied with the unit.
 - When motion picture data is written to and read from the SD card, correct operation of the unit cannot be guaranteed if software other than that supplied with the unit is used.
 - Do not start the software supplied with this unit and other software at the same time.

End User License Agreement

Before opening the CD-ROM package, please read the following.

You ("Licensee") are granted a license for the Software defined in this End User License Agreement ("Agreement") on condition that you agree to the terms and conditions of this Agreement.

Article 1 License

Licensee is granted the right to use the software, including the information recorded or described on the CD-ROM, instruction manuals, and any other media provided to Licensee (collectively "Software"), but all applicable rights to patents, copyrights, trademarks and trade secrets in the Software are not transferred to Licensee.

Article 2 Use by a Third Party

Licensee may not use, copy, modify, transfer, rent, lease, lend or allow any third party, whether free of charge or not, to use, copy or modify the Software, except as expressly provided for in this Agreement.

Article 3 Restrictions on Copying the Software

Licensee may make a single copy of the Software in whole or a part solely for back-up purpose.

Article 4 Computer

Licensee may use the Software only on one computer, and may not use it on more than one computer. Further, Licensee may not use the Software for commercial software hosting services.

Article 5 Reverse Engineering, Decompiling or Disassembly

Licensee may not reverse engineer, decompile, or disassemble the Software, except to the extent either of them is permitted under law or regulation of the country where Licensee resides. Panasonic, or its distributors will not be responsible for any defects in the Software or damage to Licensee caused by Licensee's reverse engineering, decompiling, or disassembly of the Software.

Article 6 Indemnification

The Software is provided "AS-IS" without warranty of any kind, either expressed or implied, including, but not limited to, warranties of non-infringement, merchantability and/or fitness for a particular purpose. Further, Panasonic does not warrant that the operation of the Software will be uninterrupted or error free. Panasonic or any of its distributors will not be liable for any damage suffered by Licensee arising from or in connection with Licensee's use of the Software.

Article 7 Export Control

Licensee agrees not to export or re-export to any country the Software in any form without the appropriate export licenses under regulations of the country where Licensee resides, if necessary.

Article 8 Termination of License

The right granted to Licensee hereunder will be automatically terminated if Licensee contravenes any of the terms and conditions of this Agreement. In this event, Licensee must destroy the Software and related documentation together with all the copies thereof at Licensee's own expense.

Article 9 With regard to MICROSOFT SQL SERVER COMPACT 3.5 produced by Microsoft Corporation

(1) Licensee shall use the MICROSOFT SQL SERVER COMPACT 3.5 only when included in the Software, and shall not use the MICROSOFT SQL SERVER COMPACT 3.5 in any other configuration or method. Licensee shall not publish the MICROSOFT SQL SERVER COMPACT 3.5 or work around any technical limitations in the MICROSOFT SQL SERVER COMPACT 3.5.

(2) Licensee shall not use, copy, distribute, regrant for use or otherwise handle the Software in any way beyond the range of use granted under Article 9 (1), and shall not conduct operations such as reverse engineering, decompilation, disassembling, etc. of the MICROSOFT SQL SERVER COMPACT 3.5.

(3) All rights, including copyright, patent rights etc. relating to the MICROSOFT SQL SERVER COMPACT 3.5 shall belong to Microsoft Corporation. Licensee shall not claim any rights related to the MICROSOFT SQL SERVER COMPACT 3.5 whatsoever.

Operating environment

- Even if the system requirements mentioned in these operating instructions are fulfilled, some PCs cannot be used.
- A CD-ROM drive is necessary to install the supplied software applications. (A compatible Blu-ray disc/DVD writer drive and media are necessary for writing to a Blu-ray disc/DVD.)
- Operation is not guaranteed in the following cases.
 - When 2 or more USB devices are connected to a PC, or when devices are connected through USB hubs or by using extension cables.
 - Operation on an upgraded OS.
 - Operation on an OS other than the one pre-installed.

■ Operating environment for HD Writer LE 2.1

OS	Windows 8/Windows 8.1 (32 bit/64 bit) Windows 7 (32 bit/64 bit) SP1 Windows Vista (32 bit) SP2 Windows XP (32 bit) SP3
CPU	Intel Pentium 4 2.8 GHz or higher (including compatible CPU) <ul style="list-style-type: none"> ● Intel Core 2 Duo 2.16 GHz or higher or AMD Athlon 64 X2 Dual-Core 5200+ or higher is recommended when using playback function. ● Intel Core 2 Quad 2.6 GHz or higher is recommended when using the editing function.
RAM	Windows 7/Windows 8/Windows 8.1: 2 GB or more (64 bit)/1 GB or more (32 bit) Windows Vista: 1 GB or more Windows XP: 512 MB or more (1 GB or more recommended)
Display	High Colour (16 bit) or more (32 bit or more recommended) Desktop resolution of 1024×768 pixels or more (1920×1080 pixels or more recommended) Windows Vista/Windows 7/Windows 8/Windows 8.1: DirectX 9.0c compatible video card (DirectX 10 recommended) Windows XP: DirectX 9.0c compatible video card Compatible with DirectDraw overlay PCI Express™ × 16 compatible recommended Video memory of 256 MB or more recommended

Free hard disk drive space	Ultra DMA — 100 or more 450 MB or more (for installing the software) <ul style="list-style-type: none"> When writing to a DVD/Blu-ray disc/SD, the twice amount of free space as the disc is necessary.
Sound	DirectSound Support
Interface	USB port [Hi-Speed USB (USB 2.0)]
Other requirements	Mouse or equivalent pointing device Internet connection

- Supplied CD-ROM is available for Windows only.
- Input is not supported in languages other than English, German, French, Simplified Chinese and Russian.
- Operation cannot be guaranteed on all Blu-ray disc/DVD drives.
- Operation is not guaranteed on Windows XP Media Center Edition, Tablet PC Edition, Windows Vista Enterprise, Windows 7 Enterprise, Windows 8 Enterprise, Windows 8.1 Enterprise or Windows RT.
- It will only operate as a desktop application with the Windows 8/Windows 8.1.
- This software is not compatible with a multi-boot environment.
- This software is not compatible with a multi-monitor environment.
- If using Windows XP, an administrative account user only can use this software. If using Windows Vista/Windows 7/Windows 8/Windows 8.1, administrative account and standard account users only can use this software. (An administrative account user should install and uninstall this software.)

■ To use the HD Writer LE 2.1

You will need a high performance PC depending on the functions to be used. It may not properly play back or properly operate depending on the environment of the PC used. Refer to the operating environment and notes.

- Operation during the playback may become slow if the CPU or memory is not fulfilling the requirements of the operating environment.
- Always use the most current driver for the video card.
- Always make sure there is enough capacity on the HDD in the PC. It may become inoperable or the operation may stop suddenly if the capacity gets low.

■ Operating environment for the card reader function (mass storage)

OS	Windows 8/Windows 8.1 (32 bit/64 bit) Windows 7 (32 bit/64 bit) or SP1 Windows Vista (32 bit) SP2
CPU	1 GHz or higher 32-bit (×86) or 64-bit (×64) processor (including compatible CPU)
RAM	Windows 7/Windows 8/Windows 8.1: 2 GB or more (64 bit)/1 GB or more (32 bit) Windows Vista Home Basic: 512 MB or more Windows Vista Home Premium/Business/Ultimate/Enterprise: 1 GB or more
Interface	USB port
Other requirements	Mouse or equivalent pointing device

- Incorporation of data on the Microsoft Windows XP is guaranteed. But, other functions are not guaranteed.
- The USB equipment operates with the driver installed as standard in the OS.

Installation

When installing the software, log on to your computer as the Administrator or with a user name with equivalent authorisation. (If you do not have authorisation to do this, consult your manager.)

- Before starting the installation, close all applications that are running.
- Do not perform any other operations on your PC while the software is being installed.
- Explanation of operations is based on Windows 7.

1 Insert the CD-ROM into the PC.

- The autoplay screen is displayed automatically. Click [Run setup.exe] → [Yes].
- If the autoplay screen is not displayed automatically, select [Start] → [Computer] (or double-click on [Computer] on the desktop), and then double-click [Panasonic].

2 Click [Yes].

3 Click [Next].

- Operate following the instruction on the screen.
- If the country or region cannot be selected, select [PAL Area].

The PC must be rebooted for the application to work.

■ Uninstalling HD Writer LE 2.1

Follow the steps below to uninstall any software applications that you no longer require.

1 Select [Start] → [Control Panel] → [Uninstall a program].

2 Select [HD Writer LE 2.1], then click [Uninstall].

- Proceed with the uninstallation by following the on-screen instructions.
- After uninstalling the software, be sure to reboot the PC.

Connecting to a PC

- Connect this unit to the PC after the software applications are installed.
- Remove the supplied CD-ROM from your PC.

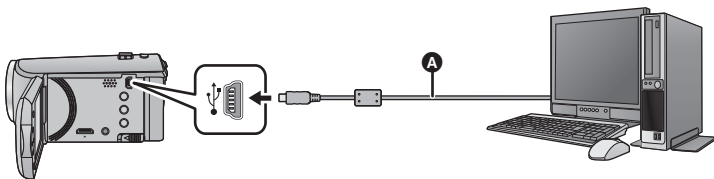

- A** USB cable (supplied)
- Insert the plugs as far as they will go.
- When the USB cable is connected to other equipment, the AC adaptor cannot be used. Please ensure that the battery is sufficiently charged.
- **Turn on the unit.**

1 Connect this unit to a PC.

- The USB function selection screen will appear.

2 Select [PC] using the cursor button on the unit and press the ENTER button.

- The Smart wizard screen is automatically displayed when HD Writer LE 2.1 is installed.
- This unit is automatically recognised as an external drive of the PC. (→ 83)
- When you select an option other than [PC], reconnect the USB cable.
- When using the battery, the LCD monitor turns off after about 5 seconds. Press the cursor button to turn the LCD monitor on.

-
- Do not use any other USB cables except the supplied one. (Operation is not guaranteed with any other USB cables.)
 - When this unit is connected to a PC using a USB cable while the unit is turned on, power is also supplied from the PC to this unit.
 - When performing reading/writing between a PC and an SD card, be aware that some SD card slots built into PCs and some SD card readers are not compatible with the SDHC Memory Card or SDXC Memory Card.
 - When using an SDXC Memory Card, check the following support site.
<http://panasonic.net/avc/sdcard/information/SDXC.html>

■ To disconnect USB cable safely

Select the  icon in task tray displayed on the PC, and then click [Eject Panasonic Video Camera].

- Depending on your PC's settings, this icon may not be displayed.

About the screen indication of the unit

- Do not disconnect the USB cable or the battery, while the access lamp is on or card access icon () appears on the unit screen.
- If the screen does not change when the unit is operated while connected to a PC, disconnect the battery, wait approximately 1 minute, reconnect the battery, wait approximately 1 minute again, and then turn the unit back on. (Data may be destroyed when above operation is performed while accessing the SD card.)

About the PC display

When the unit is connected to a PC, it is recognised as an external drive.

- Removable disk (Example:  CAM_SD (F:)) is displayed in [Computer].

We recommend using HD Writer LE 2.1 to copy motion picture data.

Using Windows Explorer or other programmes on the PC to copy, move or rename files and folders recorded with this unit will result in them being unusable with HD Writer LE 2.1.

It is impossible to write data to the SD card on the unit from a PC.

■ Copying your still pictures to your PC

Card reader function (mass storage)

Still pictures recorded with this unit can be copied to the PC with Explorer or other programmes.

- 1 **Double-click the folder that contains the still pictures. ([DCIM] → [100CDPFQ] etc.)**
- 2 **Drag and drop the still pictures onto the destination folder (on the PC's HDD).**

Example folder structure of an SD card:

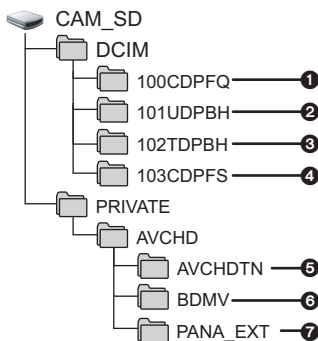

The following data will be recorded.

- 1 **Up to 999 still pictures in JPEG format ([S1000001.JPG] etc.)**
- 2 **iFrame format motion picture files ([S1000001.MP4] etc.)**
- 3 **MP4 format motion picture files ([S1000001.MP4] etc.)**
- 4 **JPEG format still pictures created from the motion picture**
- 5 **The motion picture thumbnails**
- 6 **AVCHD format motion picture files ([00000.MTS] etc.)**
- 7 **For management**

- Do not delete the SD card's folders. Doing so may make the SD card unusable in this unit.
- When data not supported by this unit has been recorded on a PC, it will not be recognised by this unit.
- Always use this unit to format SD cards.

Starting HD Writer LE 2.1

- To use the software, log on as an Administrator or as user name for standard user account (only for Windows Vista/Windows 7/Windows 8/Windows 8.1).
The software cannot be used with the user name for a guest account.

(On the PC)

Select [Start] → [All Programs] → [Panasonic] → [HD Writer LE 2.1] → [HD Writer LE 2.1].

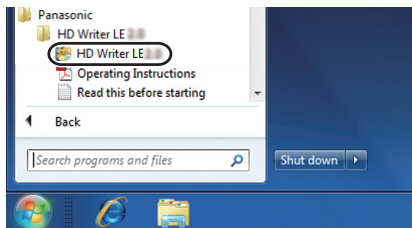

- For details on how to use the software applications, read the PDF operating instructions of the software.

Reading the operating instructions of the software applications

- You will need Adobe Acrobat Reader 5.0 or later or Adobe Reader 7.0 or later to read the PDF operating instructions.

Select [Start] → [All Programs] → [Panasonic] → [HD Writer LE 2.1] → [Operating Instructions].

If using Mac

- HD Writer LE 2.1 is not available for Mac.
- iMovie supported. For details about iMovie, please contact Apple Inc.

■ Operating environment

PC	Mac
OS	OS X v10.9
CPU	Intel Core 2 Duo or better
RAM	4 GB or more
Interface	USB port
Other requirements	Mouse or equivalent pointing device

- Even if the system requirements mentioned in these operating instructions are fulfilled, some computers cannot be used.
- The USB equipment operates with the driver installed as standard in the OS.
- Supplied CD-ROM is available for Windows only.

■ Copying still pictures on a Mac

1 Connect this unit to a Mac via the supplied USB cable.

- The USB function selection screen will appear.

2 Select [PC] using the cursor button on the unit and press the ENTER button.

- This unit is automatically recognised as an external drive of Mac.
- When you select an option other than [PC], reconnect the USB cable.
- When using the battery, the LCD monitor turns off after about 5 seconds. Press the cursor button to turn the LCD monitor on.

3 Double-click [CAM_SD] displayed on the desktop.

- Files are stored in [100CDPFQ] folder etc. in the [DCIM] folder.

4 Using a drag-and-drop operation, move the pictures you want to acquire or the folder storing those pictures to any different folder on the Mac.

■ To disconnect USB cable safely

Drag [CAM_SD] disk icon to the [Trash], and then disconnect the USB cable.

-
- Do not use any other USB cables except the supplied one. (Operation is not guaranteed with any other USB cables.)

Indications

Recording indications

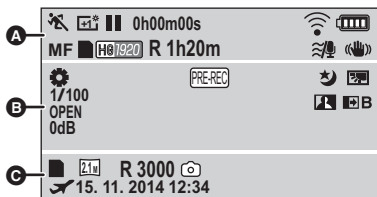

A



Intelligent Auto Mode (→ 22)



Manual Mode (→ 47)



Scene Mode (→ 39)



Creative Control Mode (→ 42)



Power LCD (→ 31)

●/II (Red) Recording

II (Green) Recording pause

0h00m00s Elapsed recording time (→ 19)

("h" is an abbreviation for hour, "m" for minute and "s" for second.)



Eye-Fi setting (→ 70)

Remaining battery power
(→ 12)

MF Manual Focus (→ 50)

(White) Card recording possible status (motion picture)

(Green) Recognising the card (motion picture)

HA1920 / H01920 / HE1920 / Frame / 360/25p

Recording Format/Recording Mode (→ 40, 41)

R 1h20m Remaining time for motion picture recording (→ 19)

Wind cut (→ 45)

Image Stabilizer (→ 41)

B



White Balance (→ 48)

1/100 Shutter Speed (→ 49)

OPEN/F2.0 Iris value (→ 49)

0dB Gain value (→ 49)

PRE-REC (→ 38)

Time Lapse Recording (→ 44)

Colour Night View function (→ 38)

Intelligent Contrast Control (→ 38)

Backlight Compensation (→ 37)

Fade (White), Fade (Black) (→ 37)

Brightness Adjustment (Miniature Effect/8mm movie/Silent movie) (→ 42, 43, 44)

Vividness Adjustment (Miniature Effect) (→ 42)

Color balance Adjustment (8mm movie) (→ 43)

 **(White)** Card recording possible status (still picture)

 **(Green)** Recognising the card (still picture)

 Number of recording pixels for still pictures (→ 21, 46, 52)

In Playback Mode, the picture size is not displayed for still pictures recorded with other products that have different picture sizes from the sizes shown above.

R3000 Remaining number of still pictures (→ 21)

 **(White)** Still picture recording icon

 **(Red)** Recording still picture

 World time setting (→ 27)

15. 11. 2014 Date indication (→ 17)

12:34 Time indication (→ 17)

■ Playback indications



Display during playback (→ 24, 51)

0h00m00s Playback Time (→ 24)

No.10 Scene Number

 Repeat Playback (→ 52)

 Resume Playback (→ 52)

100-0001 Still picture folder/file name

 Transfer/Protected motion pictures/still pictures (→ 60, 71)



Play mode selection display (→ 24)

MINI Miniature-recorded scene (→ 42)

 Time lapse-recorded scene (→ 44)

 Eye-Fi transfer status (→ 71)

■ Indication of connection to other devices

 Accessing the card (→ 67, 82)

■ Confirmatory indications

-- (Time display) The built-in battery is low. (→ 17)

 Warning for recording yourself (→ 18)

 SD card is not inserted or is incompatible.

Messages

Major confirmation/error messages to be indicated on the screen in text.

CHECK CARD.

This card is not compatible or it cannot be recognised by the unit.

If this message appears even though motion pictures and still pictures are recorded on an SD card, the card may be unstable. Reinsert the SD card, then turn the unit off and then on again.

About recovery

If faulty management information is found, the messages may appear and a repair is performed. (Repairing may take time depending on the error.)

-  is displayed when abnormal management information is detected when the scenes are displayed in thumbnail.
- Use a sufficiently charged battery or the AC adaptor.
- Depending on the condition of the data, it may not be possible to completely repair the data.
- If recovery fails, it will not be possible to play back scenes recorded before the unit turned off.
- When data recorded on another device is recovered, it may not be possible to play back the data on this unit or the other device.
- If recovery fails, turn the unit off and on again after waiting a while. If recovery fails repeatedly, format a media on the unit. Please be aware that if a media is formatted, then all the data recorded on the media will be erased.
- If the thumbnail information is recovered, displaying the thumbnails may become slower.

Troubleshooting

■ It is not a malfunction in the following cases

A clicking sound is heard when the unit is shaken.	<ul style="list-style-type: none"> This is the sound of the lens moving and is not a defect. This sound will no longer be heard when the unit is turned on and change the mode to  .
Object seems to be warped.	<ul style="list-style-type: none"> Object seems to be warped slightly when the object moves across the image very fast, but this is because the unit is using MOS for the image sensor. This is not a malfunction.
The lens or LCD monitor fog up.	<ul style="list-style-type: none"> This is due to condensation. It is not a malfunction. Please refer to page 2.



Power

Problem	Check points
<p>This unit cannot be turned on.</p> <p>This unit does not stay on long enough.</p> <p>Battery runs down quickly.</p>	<ul style="list-style-type: none"> Charge the battery again to ensure it is sufficiently charged. (→ 10) In cold places, the battery using time becomes shorter. The battery has a limited life. If the operating time is still too short even after the battery is fully charged, the battery has worn out and needs to be replaced.
This unit is turned off automatically.	<ul style="list-style-type: none"> If the unit turns off when you turn off the power to the TV using the TV remote control, the VIERA Link is at work. If you are not using the VIERA Link, set [VIERA Link] to [OFF]. (→ 64)
<p>This unit cannot be operated though it is turned on.</p> <p>This unit does not operate normally.</p>	<ul style="list-style-type: none"> Remove the battery or AC adaptor, wait about 1 minute and then reconnect the battery or AC adaptor. Then about 1 minute later, turn on the unit again. (Conducting the above operation while the media is being accessed may damage the data on the media.) If normal operation is still not restored, detach the power connected, and consult the dealer who you purchased this unit from.
“ERROR OCCURRED. PLEASE TURN UNIT OFF, THEN TURN ON AGAIN.” is displayed.	<ul style="list-style-type: none"> The unit has automatically detected an error. Restart the unit by turning the unit off and on. The unit will be turned off in about 1 minute if the unit is not turned off and on. Repair is needed if it is repeatedly displayed even if it is restarted. Detach the power connected, and consult the dealer who you purchased this unit from. Do not attempt to repair the unit by yourself.



Indication

Problem	Check points
The remaining time indication or the elapsed time indication is not shown.	<ul style="list-style-type: none"> • [DISPLAY] of the [SETUP] is [OFF]. (→ 27)

Recording

Problem	Check points
The unit arbitrarily stops recording.	<ul style="list-style-type: none"> • Use an SD card that can be used for motion picture recording. (→ 13) • The recordable time may have shortened due to the deterioration of the data writing speed or repeated recording and deletion. Using the unit, format the SD card. (→ 32)
Auto Focus function does not work.	<ul style="list-style-type: none"> • Switch to Intelligent Auto Mode. • If you are trying to record a scene that is hard to bring into focus in Auto Focus Mode, use the Manual Focus Mode to adjust the focus. (→ 23, 50)
“CONDITION TOO DARK, OR OPEN LENS COVER.” is displayed.	<ul style="list-style-type: none"> • Before turning on the unit, open the lens cover. • This message may also be displayed when recording in a very dark location.
Colour balance of images is strange when recording in a place such as a gymnasium.	<ul style="list-style-type: none"> • In a place with multiple light sources, such as a gymnasium or a hall, set the White Balance setting to  (Indoor mode 2). If you cannot record clearly with the  (Indoor mode 2), set it to  (Manual adjustment mode). (→ 48)
Colour or brightness of the image changes, or you may see horizontal bars in the image.	<ul style="list-style-type: none"> • Colour or brightness of the image may change, or you may see horizontal bars in the image when the object is recorded under fluorescent light, mercury light or sodium light, etc., but this is not a malfunction. • Record in Intelligent Auto Mode or set the shutter speed to 1/100 in areas where the power supply frequency is 50 Hz, or 1/125 in areas of 60 Hz.
The LCD monitor flickers indoors.	

Playback

Problem	Check points
Scenes/still pictures cannot be played back.	<ul style="list-style-type: none"> • Any scenes/still pictures where the thumbnails are displayed as  cannot be played back. • Motion pictures recorded with other devices may not be possible to play back on this unit. ( is displayed.)
Scenes cannot be deleted.	<ul style="list-style-type: none"> • Release the protect setting. (→ 60, 71) • Any scenes/still pictures where the thumbnails are displayed as  cannot be deleted. If the scenes/still pictures are unnecessary, format the media to erase the data. (→ 32) Please be aware that if a media is formatted then all the data recorded on the media is erased and cannot be recovered. Back up important data on a PC, disc etc.

With other products

Problem	Check points
<p>Although this unit is correctly connected to a TV, images cannot be seen.</p> <p>The images are squeezed horizontally.</p>	<ul style="list-style-type: none"> ● Please read the operating instructions of your TV and select the channel that matches the input used for the connection. ● Change the [TV ASPECT] setting to match the aspect ratio of the TV. (→ 62) ● When connecting the device to a television, the television image will not be displayed in the following cases. Use the device's LCD monitor. <ul style="list-style-type: none"> – Recording video – When setting PRE-REC
<p>If the SD card is inserted in another device, it is not recognised.</p>	<ul style="list-style-type: none"> ● Check that the device is compatible with the capacity or type of SD card (SD Memory Card/SDHC Memory Card/SDXC Memory Card) that you inserted. Refer to the operating instructions of the device for details.
<p>VIERA Link does not work.</p>	<p>(Setting on this unit)</p> <ul style="list-style-type: none"> ● Connect with a HDMI mini cable. (supplied or optional)* (→ 61) ● Set [VIERA Link] to [ON]. (→ 64) ● Turn the unit off and then back on again. <p>* Use the HDMI mini cable that comes with this unit if supplied. If it does not come with a HDMI mini cable, use a genuine Panasonic HDMI mini cable (RP-CDHM15, RP-CDHM30: optional). Check the accessories in the basic operating instructions.</p> <p>(Setting on other devices)</p> <ul style="list-style-type: none"> ● If the TV input does not switch automatically, switch the input using the TV remote control. ● Check the VIERA Link setting on the connected device. ● Please refer to the operating instructions of the connected device.
<p>Cannot copy scenes on the SD card by connecting to other equipment with the USB cable.</p>	<ul style="list-style-type: none"> ● Other equipment might have not recognised the SD card. Unplug the USB cable once, and reconnect it.

With a PC

Problem	Check points
<p>When connected by the USB cable and charging the battery, an error message will appear on the PC.</p>	<ul style="list-style-type: none"> ● After removing the USB cable, turn the unit on and connect the cable again. The unit will be recognised by the PC. To charge the battery, after safely removing the USB cable, turn the unit off and connect the USB cable again.

With a PC	
Problem	Check points
When connected by the USB cable, this unit is not detected by the PC.	<ul style="list-style-type: none"> • After re-inserting the SD card into the unit, reconnect the supplied USB cable. • Select another USB terminal on the PC. • Check the operating environment. (→ 77, 85) • Connect the supplied USB cable again after restarting the PC and turning on this unit again.
When the USB cable is disconnected, an error message will appear on the PC.	<ul style="list-style-type: none"> • To disconnect the USB cable safely, double-click the  icon in the task tray and follow the instructions on the screen.
Cannot see the PDF operating instructions for HD Writer LE 2.1.	<ul style="list-style-type: none"> • You will need Adobe Acrobat Reader 5.0 or later or Adobe Reader 7.0 or later to read the PDF operating instructions for HD Writer LE 2.1.

Others	
Problem	Check points
If the SD card is inserted in this unit, it is not recognised.	<ul style="list-style-type: none"> • If the SD card is formatted on a PC, it may not be recognised by this unit. Use this unit to format SD cards. (→ 32)

■ If AVCHD scenes do not change smoothly when played back on another device

The images may be still for several seconds at the joins between the scenes if the following operations are performed when multiple scenes have been continuously played back using another unit.

- Just how smoothly the scenes will be played back depends on the playback unit. Depending on the unit used, the images may stop moving and become still for a moment even when none of the following conditions are applicable.
- A continuous recording of motion picture data that exceeds 4 GB may momentarily stop at every 4 GB of data when played back with another device.
- It may not play back smoothly when the editing of scenes was done with the HD Writer LE 2.1, but it will play back smoothly if you set the seamless settings in the HD Writer LE 2.1. Refer to the operating instructions for the HD Writer LE 2.1.

Principal reasons for not playing back smoothly
• When the scenes were recorded on different dates
• When scenes lasting under 3 seconds have been recorded
• When PRE-REC was used for recording
• When the Miniature Effect recording is used
• When the Time Lapse Recording is used
• When deleting scenes
• When scenes recorded more than 99 scenes on the same date

Cautions for use

About this unit

The unit and the SD card become warm during use. This is not a malfunction.

Keep this unit as far away as possible from electromagnetic equipment (such as microwave ovens, TVs, video games etc.).

- If you use this unit on top of or near a TV, the pictures and/or sound on this unit may be disrupted by electromagnetic wave radiation.
- Do not use this unit near cell phones because doing so may result in noise adversely affecting the pictures and/or sound.
- Recorded data may be damaged, or pictures may be distorted, by strong magnetic fields created by speakers or large motors.
- Electromagnetic wave radiation generated by microprocessors may adversely affect this unit, disturbing the pictures and/or sound.
- If this unit is adversely affected by electromagnetic equipment and stops functioning properly, turn this unit off and remove the battery or disconnect AC adaptor. Then reinsert the battery or reconnect AC adaptor and turn this unit on.

Do not use this unit near radio transmitters or high-voltage lines.

- If you record near radio transmitters or high-voltage lines, the recorded pictures and/or sound may be adversely affected.

Make sure to use the supplied cords and cables. If you use optional accessories, use the cords and the cables supplied with them.

Do not extend the cords and the cables.

Do not spray insecticides or volatile chemicals onto the unit.

- If the unit is sprayed with such chemicals, its body may be marred and the surface finish may peel off.
- Do not leave rubber or plastic products in contact with the unit for a long time.

When you use the unit in a sandy or dusty place such as a beach, do not let sand or fine dust get into the body and terminals of the unit.

Also, keep the unit away from sea water.

- Sand or dust may damage the unit. (Care should be taken when inserting and removing a card.)
- If sea water splashes onto the unit, wipe off the water with a well wrung cloth. Then wipe the unit again with a dry cloth.

When carrying the unit, do not drop or bump it.

- A strong impact can break the unit's casing, causing it to malfunction.

Cleaning

- Before cleaning, detach the battery or pull the AC adaptor from the AC outlet, and then wipe the unit with a soft, dry cloth.
- If the unit is very dirty, dip a cloth in water and squeeze firmly, and then wipe the unit with the damp cloth. Next, dry the unit with a dry cloth.
- Use of benzine, paint thinner, alcohol, or dishwashing liquid may alter the camera body or peel the surface finish. Do not use these solvents.
- When using a chemical dust cloth, follow the instructions that came with the cloth.

Do not use the unit for surveillance purposes or other business uses.

- This unit was designed for consumer intermittent use. It was not intended for continuous use, or for any industrial or commercial application resulting in prolonged use.
- In certain situations, continuous use could cause the unit to overheat and cause a malfunction. Such use is strongly discouraged.

When you are not going to use the unit for an extended time

- When storing the unit in a cupboard or cabinet, it is recommended that you place a desiccant (silica gel) in with it.

About the battery

The battery used in this unit is a rechargeable lithium-ion battery. It is susceptible to humidity and temperature and the effect increases the more the temperature rises or falls. In cold areas, the full charge indication may not appear or the low battery indication may appear about 5 minutes after starting use. At high temperatures, the protection function may be triggered, making it impossible to use the unit.

Be sure to detach the battery after use.

- If the battery is left attached, a minute amount of current continues to flow even if the unit is off. Keeping the unit in this state may result in over discharge of the battery. This may result in you not being able to use the battery even after it is charged.
- The battery should be stored in the vinyl bag so metal does not come into contact with the terminals.
- The battery should be stored in a cool place free from humidity, with as constant temperature as possible. (Recommended temperature: 15 °C to 25 °C, Recommended humidity: 40%RH to 60%RH)
- Extremely high temperatures or low temperatures will shorten the life of the battery.
- If the battery is kept in high-temperature, high-humidity, or oily-smoky places, the terminals may rust and cause malfunctions.

- To store the battery for a long period of time, we recommend that you charge it once every year and store it again after you have completely used up the charged capacity.
- Dust and other matter attached to the battery terminals should be removed.

Prepare spare batteries when going out for recording.

- Prepare batteries enough to last for 3 to 4 times the period you are planning to record for. Cold places such as a ski resort can shorten recording time.

If you drop the battery accidentally, check to see if the terminals are damaged.

- Inserting a battery with damaged terminals can damage the unit.

Do not throw old battery into fire.

- Heating a battery or throwing it into a fire may result in an explosion.

If the operating time is very short even after the battery has been recharged, the battery has worn out. Please purchase a new battery.

About the AC adaptor

- If the temperature of the battery is extremely high or extremely low, charging may take time or the battery may not be charged.
- If you use the AC adaptor near a radio, radio reception may be disturbed. Keep the AC adaptor 1 m or more away from the radio.
- When using the AC adaptor, it may generate whirring sounds. However, this is normal.
- After use, be sure to disconnect the AC adaptor. (If it is left connected, a minute amount of current is consumed.)
- Always keep the electrodes of the AC adaptor and battery clean.

About status indicator during charging

When the status indicator is flashing at a particularly fast or slow rate, the following should be considered.

Flashing with approx. 4 second period (off for approx. 2 seconds, on for approx. 2 seconds):

- When the battery is over discharged or the temperature of the battery is too high or low. It can be charged, but it may take a few hours to complete the charging normally.
- It will flash in approx. 2 second intervals when normal charging resumes. Even in such cases, it may start flashing in approx. 4 second intervals until charging is completed depending on the conditions of use.

Flashing with approx. 0.5 second period (off for approx. 0.25 second, on for approx. 0.25 second):

- The battery is not charged. Remove the battery from the unit, and try charging again.
- Check that the terminals of the unit or battery are not dirty or covered with a foreign object, and connect the battery correctly once again. If a foreign object or dirt is present, turn off the unit before removing.
- The battery or environment is at an extremely high or low temperature. Wait until the temperature has returned to an appropriate level and try charging again. If you are still unable to charge, there may be a fault in the unit, battery or AC adaptor.

Off:

- Charging has finished.
- If the status indicator stays off despite the charging being unfinished, there may be a fault in the unit, battery or AC adaptor. Refer to page 94 for details on the battery.

About the SD card

When disposing of or giving away the SD card, note that:

- Formatting and deletion of this unit or computer only changes the file management information and does not completely delete the data in the SD card.
- It is recommended that the SD card is physically destroyed or the SD card is physically formatted using this unit when disposing of or giving away the SD card. For the physical format, connect the unit to the AC adaptor, select [SETUP] → [FORMAT MEDIA] → [YES] from the menus, and then press and hold down the Recording start/stop button for approximately 3 seconds on the screen below. When the SD card data deletion screen appears, select [YES], and then follow the on-screen instructions.



LCD monitor

- When the LCD screen is dirty or condensation has occurred, please wipe it using a soft cloth such as eyeglass cleaner.
- When the unit has become very cold, for example due to storage in a cold area, its LCD monitor will be slightly darker than usual immediately after the unit is turned on. The normal brightness will be restored when the unit's internal temperature rises.

Extremely high precision technology is employed to produce the LCD Monitor screen. The result is more than 99.99% effective dots with a mere 0.01% of the dots inactive or always lit. However, this is not a malfunction and does not affect the recorded picture.

About copyright

■ Carefully observe copyright laws

Recording of pre-recorded tapes or discs or other published or broadcast material for purposes other than your own private use may infringe copyright laws. Even for the purpose of private use, recording of certain material may be restricted.

■ Licenses

- SDXC Logo is a trademark of SD-3C, LLC.
- "AVCHD" and the "AVCHD" logo are trademarks of Panasonic Corporation and Sony Corporation.
- Manufactured under license from Dolby Laboratories.
Dolby and the double-D symbol are trademarks of Dolby Laboratories.
- HDMI, the HDMI Logo, and High-Definition Multimedia Interface are trademarks or registered trademarks of HDMI Licensing LLC in the United States and other countries.
- HDAVI Control™ is a trademark of Panasonic Corporation.
- Microsoft®, Windows® and Windows Vista® are either registered trademarks or trademarks of Microsoft Corporation in the United States and/or other countries.
- Microsoft product screen shot(s) reprinted with permission from Microsoft Corporation.
- IBM and PC/AT are registered trademarks of International Business Machines Corporation of the U.S.
- Intel®, Pentium®, Celeron® and Intel®Core™ are trademarks of Intel Corporation in the U.S. and/or other countries.
- AMD Athlon™ is a trademark of Advanced Micro Devices, Inc.
- iMovie, Mac and Mac OS are trademarks of Apple Inc. registered in the U.S. and other countries.
- "Eye-Fi" is a trademark of Eye-Fi, Inc.

- Other names of systems and products mentioned in these instructions are usually the registered trademarks or trademarks of the manufacturers who developed the system or product concerned.

This product is licensed under the AVC patent portfolio license for the personal and non-commercial use of a consumer to (i) encode video in compliance with the AVC Standard ("AVC Video") and/or (ii) decode AVC Video that was encoded by a consumer engaged in a personal and non-commercial activity and/or was obtained from a video provider licensed to provide AVC Video. No license is granted or shall be implied for any other use. Additional information may be obtained from MPEG LA, LLC. See <http://www.mpegla.com>.

Recording modes/approximate recordable time

- SD cards are only mentioned with their main memory size. The stated times are the approximate recordable times for continuous recording.

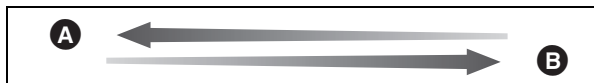

Recording format		[AVCHD]		
Recording mode		[HA]	[HG]	[HE]
Picture size/frame rate		1920×1080/50i	1920×1080/50i	1920×1080/50i
SD card	4 GB	30 min	40 min	1 h 30 min
	16 GB	2 h	2 h 40 min	6 h 40 min
	64 GB	8 h 30 min	11 h	27 h 30 min

- A** Favours image quality
- B** Favours recording time

Recording format		[iFrame]	[MP4]
Picture size/frame rate		960×540/25p	640×360/25p
SD card	4 GB	19 min	5 h
	16 GB	1 h 20 min	21 h
	64 GB	5 h 20 min	84 h

- If recording for long periods, prepare batteries for 3 or 4 times the period you wish to record for. (→ 12)
- The setting at the time of purchase for [REC FORMAT] is set to [AVCHD] and the [REC MODE] is set to [HG].
- Maximum continuously recordable time for one scene: 6 hours
- The recording is paused once when the recording time for one scene exceeds 6 hours, and the recording will automatically resume after a few seconds.
- The recordable time may be reduced if recording with a lot of action is recorded or recording of short scene is repeated.
- Use time in the row of 4 GB in above table as a guideline for the time that can be copied onto one DVD disc (4.7 GB).

Approximate number of recordable pictures

- SD cards are only mentioned with their main memory size. The stated number is the approximate number of recordable pictures.

Picture size		8.9M 3968×2232	2.1M 1920×1080
Aspect ratio		16:9	
SD card	4 GB	800	3200
	16 GB	3200	12500
	64 GB	13000	52000

- The number of recordable pictures depends on the subject being recorded.**
- Maximum number of recordable pictures that can be displayed is 9999. If the number of recordable pictures exceeds 9999, R 9999+ is displayed. The number will not change when the picture is taken until the number of recordable pictures is 9999 or less.
- The memory capacity indicated on the label of an SD card is the total of the capacity for copyright protection and management and the capacity which can be used on the unit, a PC etc.

Optional accessories

Some optional accessories may not be available in some countries.

About the Suction Cup Mount/ the Video Camera Mount (For Handlebar)

You can attach the Suction Cup Mount (VW-SCA100) as follows.

- For information on how to mount the Video Camera Mount (For Handlebar) RP-CMC10E, refer to the operating instructions for it.

■ When attaching the Suction Cup Mount

- Align tripod receptacle **A** of this unit with camera screw **B** of the suction cup mount.

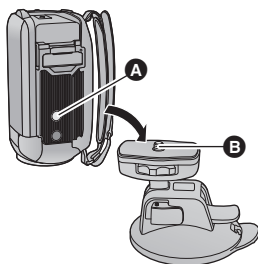

- Turn camera lock dial **C** of the Suction Cup Mount in the direction of the arrow (the LOCK side) to lock it.

- Hold this unit with your fingers to prevent it from turning with the dial.

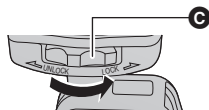

■ When removing the Suction Cup Mount

To remove the suction cup mount, perform the steps for mounting it in reverse order.

- The screen may shake during recording. We recommend that you record an image as follows:
 - Close the LCD monitor during recording (The recording will continue)
 - Set the zoom magnification to $\times 1$
 - [E.I.S.] is set to [ON] (→ 41)
- Depending on recording conditions, even if you record the image as described above, the screen may shake.
- If you experience fatigue, a feeling of discomfort or other symptoms when playing back a scene recorded with the Suction Cup Mount/Video Camera Mount (For Handlebar), stop the playback.

Panasonic Corporation
Web site: <http://panasonic.net>