



E. Weber & Cie AG
Zürich

Hauptkatalog

ab 2018 · www.webstar.ch



REINIGUNG

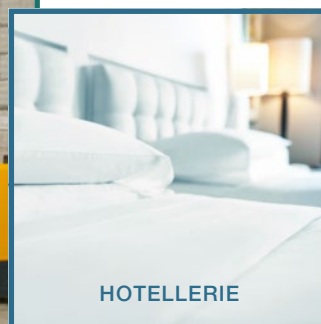

HOTELLERIE



RESTAURANT



EINWEGHANDSCHUHE



WASCHRAUM



ENTSÖRGUNG



KÜCHE

E. Weber & Cie AG Zürich



Industriestrasse 28
CH-8157 Dielsdorf
Tel. 044 870 87 00
Fax 044 870 87 20

Worbstrasse 97
CH-3074 Muri bei Bern
Tel. 031 950 20 80
Fax 031 950 20 88

Wildenerstrasse 5
CH-7270 Davos Platz
Tel. 081 410 61 40
Fax 081 410 61 41



Inhaltsverzeichnis

1	Tabletop	3
2	Gläser	55
3	Küche	67
4	Hotelkosmetik	89
5	Reception, Administration, Verpackung	125
6	Waschraumhygiene	133
7	Entsorgung	223
8	Wisch- und Reinigungstücher	241
9	Reinigungszubehör	273
10	Reinigungschemie	309
11	Werbeartikel	387

Tabletop



Servietten Zellstoff	4
Servietten Airlaid	13
Dispo-Servietten	17
Serviettendispenser	19
Tischset	21
Servietten- und Bestecktaschen	24
Tischtuchrollen	26
Tischdecken in Formate	30
Platten- und Spitzenpapiere	31
Tassen- und Tellerunterlagen	34
Tisch- und Servicezubehör	36
Kerzen	42
Rechaudzubehör	46
Diverses für den Service	47
Bar	51

Servietten Zellstoff | Starline

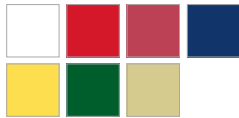

Starline Servietten Brunch Starline

33 x 33 cm, 2-lagig, 1/8 Kopffalzung

Artikel-Nr.	Produktinfo	Inhalt /VE	Preis /VE	ab 5 VE 10%
4030.2	weiss	(Pal. 30) 2000	64.70	58.25
4031.2	rot	(Pal. 30) 2000	89.85	80.85
4032.2	bordeaux	(Pal. 30) 2000	89.85	80.85
4034.2	dunkelblau	(Pal. 30) 2000	89.85	80.85
4037.2	gelb	(Pal. 30) 2000	89.85	80.85
4035.2	tannengrün	(Pal. 30) 2000	89.85	80.85
4043.1	champagner	(Pal. 30) 2000	89.85	80.85



Starline Servietten Lunch Starline

39 x 39 cm, 2-lagig, 1/8 Buchfalzung

Artikel-Nr.	Produktinfo	Inhalt /VE	Preis /VE	ab 5 VE 10%
4050.2	weiss	(Pal. 28) 1800	86.00	77.40
4051.2	rot	(Pal. 28) 1800	125.45	112.90
4052.2	bordeaux	(Pal. 28) 1800	125.45	112.90
4054.2	blau	(Pal. 28) 1800	125.45	112.90
4057.2	gelb	(Pal. 28) 1800	125.45	112.90
4055.2	tannengrün	(Pal. 28) 1800	125.45	112.90
4062.2	champagner	(Pal. 28) 1800	125.45	112.90



Starline Servietten Dinner Starline

39 x 39 cm, 3-lagig, 1/8 Buchfalzung

Artikel-Nr.	Produktinfo	Inhalt /VE	Preis /VE	ab 5 VE 10%
4070.2	weiss	(Pal. 28) 1200	76.90	69.20
4071.2	rot	(Pal. 28) 1200	116.55	104.90
4072.2	bordeaux	(Pal. 28) 1200	116.55	104.90
4074.2	dunkelblau	(Pal. 28) 1200	116.55	104.90
4077.2	gelb	(Pal. 28) 1200	116.55	104.90
4075.2	tannengrün	(Pal. 28) 1200	116.55	104.90
4082.2	champagner	(Pal. 28) 1200	116.55	104.90



Starline Servietten Dinner Starline

39 x 39 cm, 3-lagig, 1/4 Falzung

Artikel-Nr.	Produktinfo	Inhalt /VE	Preis /VE	ab 5 VE 10%
7370.2	weiss	(Pal. 28) 1200	76.90	69.20
7371.2	rot	(Pal. 28) 1200	116.55	104.90
7372.2	bordeaux	(Pal. 28) 1200	116.55	104.90
7374.2	dunkelblau	(Pal. 28) 1200	116.55	104.90
7377.2	gelb	(Pal. 28) 1200	116.55	104.90
7375.2	tannengrün	(Pal. 28) 1200	116.55	104.90
7383.2	champagner	(Pal. 28) 1200	116.55	104.90

Servietten Zellstoff | Tela

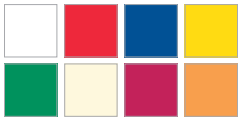

tela **Servietten Brunch Tela**

33 x 33 cm, 2-lagig, 1/8 Falzung



Artikel-Nr.	Produktinfo	Inhalt /VE	Preis /VE	Preis ab 20 VE
5030	weiss	(Pal. 42) 1200	38.15	34.55
5031	rot	(Pal. 42) 1200	57.15	49.35
5034	dunkelblau	(Pal. 42) 1200	57.15	49.35
5037	gelb	(Pal. 42) 1200	57.15	49.35
5035	dunkelgrün	(Pal. 42) 1200	57.15	49.35
5042	crème / panna	(Pal. 42) 1200	57.15	49.35
5032	bordeaux	(Pal. 42) 1200	57.15	49.35
14656	orange	(Pal. 42) 1200	57.15	49.35



tela **Servietten Lunch Tela**

40 x 40 cm, 2-lagig, 1/8 Falzung



Artikel-Nr.	Produktinfo	Inhalt /VE	Preis /VE	Preis ab 20 VE
5050	weiss	(Pal. 70) 600	25.30	22.85

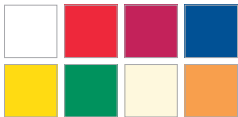

tela **Servietten Dinner Tela**

40 x 40 cm, 3-lagig, 1/8 Falzung



Artikel-Nr.	Produktinfo	Inhalt /VE	Preis /VE	Preis ab 20 VE
5070	weiss	(Pal. 70) 400	22.85	20.65
5071	rot	(Pal. 70) 400	35.55	30.45
5072	bordeaux	(Pal. 70) 400	35.55	30.45
5074	dunkelblau	(Pal. 70) 400	35.55	30.45
5077	gelb	(Pal. 70) 400	35.55	30.45
5075	dunkelgrün	(Pal. 70) 400	35.55	30.45
7082	crème / panna	(Pal. 70) 400	35.55	30.45
14579	orange	(Pal. 70) 400	35.55	30.45



tela **Servietten Quick Seide Tela**

33 x 33 cm, 1-lagig, 1/8 Falzung

Artikel-Nr.	Produktinfo	Inhalt /VE	Preis /VE	Preis ab 20 VE
5001	weiss	(Pal. 25) 2700	54.65	48.95



tela **Servietten Quick Seide Tela**

33 x 33 cm, 1-lagig, 1/4 Falzung

Artikel-Nr.	Produktinfo	Inhalt /VE	Preis /VE	Preis ab 20 VE
5002	weiss	(Pal. 20) 3200	62.90	51.20



tela **Servietten Krepp Tela**

40 x 40 cm, 1-lagig, 1/4 Falzung

Artikel-Nr.	Produktinfo	Inhalt /VE	Preis /VE	Preis ab 20 VE
5003.1	weiss	(Pal. 56) 1100	66.75	58.65



tela **Servietten Tela Careline**

33 x 33 cm, 3-lagig, 1/4 Falzung, nassreissfest

Artikel-Nr.	Produktinfo	Inhalt /VE	Preis /VE	Preis VE /Pal.
4386	weiss	(Pal. 40) 800	53.60	49.40

Servietten Zellstoff | Tork



TORK Servietten Tork Universal

33 x 33 cm, 1-lagig, 1/4 Falzung

Artikel-Nr.	Produktinfo	Inhalt /VE	Preis /VE	ab 5 VE 10%
7520.1	weiss	(Pal. 20) 5000	88.45	79.60



TORK Servietten Tork Advanced

33 x 33 cm, 2-lagig, 1/4 Falzung

Artikel-Nr.	Produktinfo	Inhalt /VE	Preis /VE	ab 5 VE 10%
11496.1	weiss	(Pal. 30) 2000	111.50	100.35



TORK Servietten Tork Advanced

33 x 33 cm, 2-lagig, 1/8 Kopffalzung

Artikel-Nr.	Produktinfo	Inhalt /VE	Preis /VE	ab 5 VE 10%
7510.1	weiss	(Pal. 30) 2000	86.65	77.95



TORK Servietten Tork Advanced

33 x 33 cm, 3-lagig, 1/8 Kopffalzung

Artikel-Nr.	Produktinfo	Inhalt /VE	Preis /VE	ab 5 VE 10%
16846	weiss	(Pal. 30) 1500	86.80	78.15



TORK Servietten Tork Advanced

33 x 33 cm, 3-lagig, 1/4 Falzung

Artikel-Nr.	Produktinfo	Inhalt /VE	Preis /VE	ab 5 VE 10%
5021.1	weiss	(Pal. 30) 1500	103.70	93.30



TORK Servietten Tork Advanced

39 x 39 cm, 2-lagig, 1/4 Falzung

Artikel-Nr.	Produktinfo	Inhalt /VE	Preis /VE	ab 5 VE 10%
7530.1	weiss	(Pal. 28) 1800	115.50	103.95



TORK Servietten Tork Advanced

39 x 39 cm, 2-lagig, 1/8 Buchfalzung

Artikel-Nr.	Produktinfo	Inhalt /VE	Preis /VE	ab 5 VE 10%
7540.1	weiss	(Pal. 16) 1800	121.45	109.30



TORK Servietten Tork Advanced

39 x 39 cm, 3-lagig, 1/4 Falzung

Artikel-Nr.	Produktinfo	Inhalt /VE	Preis /VE	ab 5 VE 10%
5025.1	weiss	(Pal. 28) 1200	93.25	83.95



TORK Servietten Tork Advanced

39 x 39 cm, 3-lagig, 1/8 Buchfalzung

Artikel-Nr.	Produktinfo	Inhalt /VE	Preis /VE	ab 5 VE 10%
7523.1	weiss	(Pal. 16) 1200	125.90	113.30



TORK Servietten Tork Universal

33 x 32 cm, 1-lagig, 1/8 Buchfalzung

Artikel-Nr.	Produktinfo	Inhalt /VE	Preis /VE	ab 5 VE 10%
18540.1	weiss	(Pal. 24) 4500	112.05	100.85

Servietten Zellstoff | Duni

Zelltuch-Servietten

33 x 33 cm, 2-lagig, 1/8 Falzung



Artikel-Nr.	Produktinfo	Inhalt /VE	Preis /VE	
6089	weiss	(Pal. 24) 1200	47.70	netto



Zelltuch-Servietten

33 x 33 cm, 3-lagig, 1/8 Falzung



Artikel-Nr.	Produktinfo	Inhalt /VE	Preis /VE	
6116	weiss	(Pal. 26) 1000	61.30	netto
6153	champagner	(Pal. 28) 1000	81.40	netto

weitere Farben auf Anfrage.

Zelltuch-Servietten

40 x 40 cm, 2-lagig, 1/8 Falzung



Artikel-Nr.	Produktinfo	Inhalt /VE	Preis /VE	
6087	weiss	(Pal. 18) 1200	65.50	netto

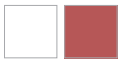

Zelltuch-Servietten

40 x 40 cm, 3-lagig, 1/8 Falzung



Artikel-Nr.	Produktinfo	Inhalt /VE	Preis /VE	
6084	weiss	(Pal. 24) 1000	74.00	netto
6080*	bordeaux	(Pal. 24) 1000	101.00	netto

weitere Farben auf Anfrage.

Zelltuch-Servietten

33 x 33 cm, 2-lagig, 1/4 Falzung



Artikel-Nr.	Produktinfo	Inhalt /VE	Preis /VE	
6111	weiss	(Pal. 24) 1200	47.70	netto



Zelltuch-Servietten

33 x 33 cm, 3-lagig, 1/4 Falzung



Artikel-Nr.	Produktinfo	Inhalt /VE	Preis /VE	
14082	schwarz	(Pal. 28) 1000	81.40	netto
21727*	champagner	(Pal. 28) 1000	81.40	netto

weitere Farben auf Anfrage.

Zelltuch-Servietten

40 x 40 cm, 2-lagig, 1/4 Falzung



Artikel-Nr.	Produktinfo	Inhalt /VE	Preis /VE	
6086*	weiss	(Pal. 18) 1200	65.50	netto

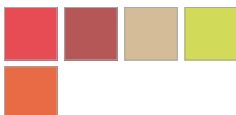

Zelltuch-Servietten

40 x 40 cm, 3-lagig, 1/4 Falzung



Artikel-Nr.	Produktinfo	Inhalt /VE	Preis /VE	
6007*	rot	(Pal. 18) 1000	101.00	netto
6068*	bordeaux	(Pal. 18) 1000	101.00	netto
13528	champagner	(Pal. 18) 1000	101.00	netto
21992*	kiwi	(Pal. 18) 1000	101.00	netto
21991*	mandarin	(Pal. 18) 1000	101.00	netto

weitere Farben auf Anfrage.

* auf Bestellung

Servietten Zellstoff | Duni



Servietten Klassik Duni

40 x 40 cm, 4-lagig, 1/4 Falzung



Artikel-Nr.	Produktinfo	Inhalt /VE	Preis /VE	
6100	bordeaux	(Pal. 42) 300	64.30	netto
12687*	kiwi	(Pal. 42) 300	64.30	netto
16671*	champagner	(Pal. 42) 300	64.30	netto
4727*	dunkelblau	(Pal. 42) 300	64.30	netto
4728*	weiss	(Pal. 42) 300	54.70	netto
18198	jägergrün	(Pal. 42) 300	64.30	netto
26082*	gelb	(Pal. 42) 300	64.30	netto

weitere Farben auf Anfrage.

Servietten Zellstoff | Bulkysoft



Servietten Bulkysoft

33 x 33 cm, 1-lagig, 1/4 Falzung



Artikel-Nr.	Produktinfo	Inhalt /VE	Preis /VE	ab 5 VE 10%
25859	weiss	(Pal. 15) 4000	51.10	46.00



Servietten Bulkysoft

33 x 33 cm, 2-lagig, 1/4 Falzung



Artikel-Nr.	Produktinfo	Inhalt /VE	Preis /VE	ab 5 VE 10%
21699	weiss	(Pal. 30) 2000	45.50	40.95
26824	champagner	(Pal. 24) 1200	45.15	40.65
21700	gelb	(Pal. 24) 1200	45.15	40.65
21702	rot	(Pal. 40) 1200	45.15	40.65
21703	bordeaux	(Pal. 40) 1200	45.15	40.65
21704	blau	(Pal. 40) 1200	45.15	40.65
26833	tannengrün	(Pal. 40) 1200	45.15	40.65
26838	schwarz	(Pal. 40) 1200	45.15	40.65
26825	zitrone	(Pal. 24) 1200	45.15	40.65
26826	rosa	(Pal. 40) 1200	45.15	40.65
21701	orange	(Pal. 40) 1200	45.15	40.65
26827	lachs	(Pal. 40) 1200	45.15	40.65
26829	fuchsia	(Pal. 40) 1200	45.15	40.65
26831	lila	(Pal. 40) 1200	45.15	40.65
26832	hellblau	(Pal. 40) 1200	45.15	40.65
26834	kiwi	(Pal. 24) 1200	45.15	40.65
26835	grau	(Pal. 40) 1200	45.15	40.65
26837	braun	(Pal. 40) 1200	45.15	40.65



Servietten Bulkysoft

33 x 33 cm, 2-lagig, 1/8 Kopffalzung



Artikel-Nr.	Produktinfo	Inhalt /VE	Preis /VE	ab 5 VE 10%
21790	weiss	(Pal. 30) 2000	47.95	43.15
21791	champagner	(Pal. 30) 2000	66.05	59.45
21792	gelb	(Pal. 30) 2000	81.85	73.70
21793	rot	(Pal. 30) 2000	81.85	73.70
21794	bordeaux	(Pal. 30) 2000	81.85	73.70
21795	blau	(Pal. 30) 2000	81.85	73.70
21796	tannengrün	(Pal. 30) 2000	81.85	73.70
26841	schwarz	(Pal. 30) 2000	81.85	73.70
26839	rosa	(Pal. 30) 2000	81.85	73.70
26840	hellblau	(Pal. 30) 2000	81.85	73.70

Servietten Zellstoff | Bulkysoft

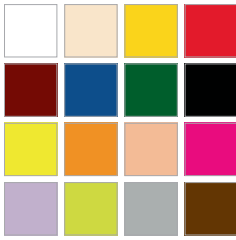

Servietten Lunch Bulkysoft

38 x 38 cm, 2-lagig, 1/4 Falzung



Artikel-Nr.	Produktinfo	Inhalt /VE	Preis /VE	ab 5 VE 10%
25865	weiss	(Pal. 24) 2000	59.95	53.95
25866	champagner	(Pal. 24) 2000	80.00	72.00
25872	gelb	(Pal. 24) 2000	97.50	87.75
25870	rot	(Pal. 24) 2000	97.50	87.75
25867	bordeaux	(Pal. 24) 2000	97.50	87.75
25869	blau	(Pal. 24) 2000	97.50	87.75
25871	tannengrün	(Pal. 24) 2000	97.50	87.75
26853	schwarz	(Pal. 24) 2000	97.50	87.75
26842	zitrone	(Pal. 24) 2000	97.50	87.75
26845	orange	(Pal. 24) 2000	97.50	87.75
26846	lachs	(Pal. 24) 2000	97.50	87.75
26847	fuchsia	(Pal. 24) 2000	97.50	87.75
26849	lila	(Pal. 24) 2000	97.50	87.75
26850	kiwi	(Pal. 24) 2000	97.50	87.75
26851	grau	(Pal. 24) 2000	97.50	87.75
26852	braun	(Pal. 24) 2000	97.50	87.75



Servietten Lunch Bulkysoft

38 x 38 cm, 2-lagig, 1/8 Kopffalzung



Artikel-Nr.	Produktinfo	Inhalt /VE	Preis /VE	ab 5 VE 10%
25873	weiss	(Pal. 24) 2000	63.20	56.90
25874	champagner	(Pal. 24) 2000	86.05	77.45
25875	gelb	(Pal. 24) 2000	104.95	94.45
25876	rot	(Pal. 24) 2000	104.95	94.45
25877	bordeaux	(Pal. 24) 2000	104.95	94.45
25878	blau	(Pal. 24) 2000	104.95	94.45
25879	tannengrün	(Pal. 24) 2000	104.95	94.45
26856	schwarz	(Pal. 24) 2000	104.95	94.45
26854	rosa	(Pal. 24) 2000	104.95	94.45
26855	hellblau	(Pal. 24) 2000	104.95	94.45



Servietten Punta-Punta Bulkysoft

38 x 38 cm, 2-lagig, 1/4 Falzung, vollflächige Punktprägung



Artikel-Nr.	Produktinfo	Inhalt /VE	Preis /VE	ab 5 VE 10%
21798	weiss	(Pal. 16) 1680	54.20	48.80
21800	champagner	(Pal. 16) 1440	62.60	56.35
21801	gelb	(Pal. 16) 1440	75.30	67.75
21802	orange	(Pal. 16) 1440	75.30	67.75
21803	rot	(Pal. 16) 1440	75.30	67.75
21804	bordeaux	(Pal. 16) 1440	75.30	67.75
21805	blau	(Pal. 16) 1440	75.30	67.75
21806	tannengrün	(Pal. 16) 1440	75.30	67.75
21807	braun	(Pal. 16) 1440	75.30	67.75
21808	schwarz	(Pal. 16) 1440	75.30	67.75



DIE SERVIETTEN, DIE IHREN TISCH SCHMÜCKEN!

Große Auswahl an
Farben und
Formaten



Servietten Zellstoff | Bulkysoft



Servietten Lunch Punta-Punta Bulkysoft

38 x 38 cm, 2-lagig, 1/8 Kopffalzung, vollflächige Punktprägung



Artikel-Nr.	Produktinfo	Inhalt /VE	Preis /VE	ab 5 VE 10%
25984	weiss	(Pal. 28) 800	28.35	25.50
25985	champagner	(Pal. 28) 800	37.45	33.70
25986	gelb	(Pal. 28) 800	45.00	40.50
25987	orange	(Pal. 28) 800	45.00	40.50
25988	rot	(Pal. 28) 800	45.00	40.50
25989	bordeaux	(Pal. 21) 800	45.00	40.50
25991	blau	(Pal. 28) 800	45.00	40.50
25990	tannengrün	(Pal. 28) 800	45.00	40.50
25992	braun	(Pal. 28) 800	45.00	40.50
25993	schwarz	(Pal. 28) 800	45.00	40.50

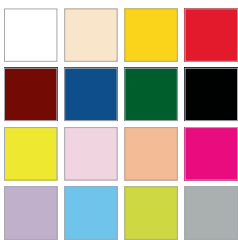

Servietten Bulkysoft

40 x 40 cm, 3-lagig, 1/4 Falzung



Artikel-Nr.	Produktinfo	Inhalt /VE	Preis /VE	ab 5 VE 10%
21810	weiss	(Pal. 32) 1000	50.85	45.75
21811	champagner	(Pal. 32) 1000	66.85	60.15
21812	gelb	(Pal. 32) 1000	81.30	73.20
21813	rot	(Pal. 32) 1000	81.30	73.20
21814	bordeaux	(Pal. 32) 1000	81.30	73.20
21815	blau	(Pal. 32) 1000	81.30	73.20
21816	tannengrün	(Pal. 32) 1000	81.30	73.20
26866	schwarz	(Pal. 32) 1000	81.30	netto
26857	zitrone	(Pal. 32) 1000	81.30	netto
26858	rosa	(Pal. 32) 1000	81.30	netto
26859	lachs	(Pal. 32) 1000	81.30	netto
26860	fuchsia	(Pal. 32) 1000	81.30	netto
26861	lila	(Pal. 32) 1000	81.30	netto
26862	hellblau	(Pal. 32) 1000	81.30	netto
26864	kiwi	(Pal. 32) 1000	81.30	netto
26865	grau	(Pal. 32) 1000	81.30	netto



Servietten Bulkysoft

40 x 40 cm, 2-lagig, 1/8 Kopffalzung

Artikel-Nr.	Produktinfo	Inhalt /VE	Preis /VE	ab 5 VE 10%
21809	weiss	(Pal. 24) 2000	61.05	54.95
26265	crème	(Pal. 24) 2000	75.85	netto
26266	rot	(Pal. 24) 2000	92.45	netto
23074	bordeaux	(Pal. 30) 2000	92.45	netto

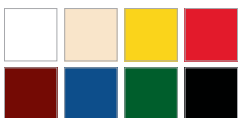

Servietten Dinner Bulkysoft

40 x 40 cm, 3-lagig, 1/8 Kopffalzung

Artikel-Nr.	Produktinfo	Inhalt /VE	Preis /VE	ab 5 VE 10%
21818	weiss	(Pal. 32) 1000	55.60	50.05
25843	champagner	(Pal. 32) 1000	63.45	57.10
25846	gelb	(Pal. 32) 1000	77.20	69.50
25844	rot	(Pal. 32) 1000	77.20	69.50
25845	bordeaux	(Pal. 32) 1000	77.20	69.50
25848	blau	(Pal. 32) 1000	77.20	69.50
25851	tannengrün	(Pal. 32) 1000	77.20	69.50
26867	schwarz	(Pal. 32) 1000	77.20	69.50

Servietten Zellstoff | Diverse



Servietten Guten Morgen «Katze»

33 x 33 cm, 2-lagig, 1/4 Falzung

Artikel-Nr.	Produktinfo	Inhalt /VE	Preis /VE	ab 5 VE 10%
5008	weiss	(Pal. 20) 2400	154.60	139.10



Servietten Karo

33 x 33 cm, 1-lagig, 1/4 Falzung

Artikel-Nr.	Produktinfo	Inhalt /VE	Preis /VE	ab 5 VE 10%
7514	rot/weiss	(Pal. 12) 6000	236.55	212.90



Servietten Tissue

40 x 40 cm, 2-lagig, 1/8 Kopffalzung

Artikel-Nr.	Produktinfo	Inhalt /VE	Preis /VE	ab 5 VE 10%
13957	champagner	(Pal. 20) 2100	114.60	netto
20580	weiss	(Pal. 20) 2100	125.00	112.50



Servietten Tissue

33 x 33 cm, 3-lagig, 1/4 Falzung

Artikel-Nr.	Produktinfo	Inhalt /VE	Preis /VE	ab 5 VE 10%
20902	weiss	(Pal. 20) 2000	147.45	132.70

Servietten Tissue

48 x 48 cm, 4-lagig, 1/4 Falzung

Artikel-Nr.	Produktinfo	Inhalt /VE	Preis /VE	ab 5 VE 10%
13744	weiss	(Pal. 36) 400	75.20	67.65

Servietten Zellstoff | Cocktailservietten



TORK Cocktail-Servietten Tork Advanced

24 x 24 cm, 3-lagig, 1/4 Falzung



Artikel-Nr.	Produktinfo	Inhalt /VE	Preis /VE	ab 5 VE 10%
5020	weiss	(Pal. 28) 3000	162.10	145.85



TORK Cocktail-Servietten Tork Advanced

24 x 24 cm, 2-lagig, 1/4 Falzung



Artikel-Nr.	Produktinfo	Inhalt /VE	Preis /VE	ab 5 VE 10%
7489	sonnengelb	(Pal. 50) 2400	105.30	94.80
7477.1	rot	(Pal. 50) 2400	109.20	98.30
7487	bordeaux	(Pal. 50) 2400	109.20	98.30
7531.1	weiss	(Pal. 50) 2400	75.60	68.00
7479	elfenbein	(Pal. 48) 2400	105.30	94.80
7475	dunkelblau	(Pal. 50) 2400	109.20	98.30
27037	schwarz	(Pal. 50) 2400	105.30	94.80
7476	dunkelgrün	(Pal. 50) 2400	109.20	98.30

Duni Zelltuch-Servietten

24 x 24 cm, 2-lagig, 1/4 Falzung



Artikel-Nr.	Produktinfo	Inhalt /VE	Preis /VE	ab 5 VE 10%
6088	weiss	(Pal. 30) 2400	72.00	netto

Servietten Zellstoff | Cocktailservietten



Zelltuch-Servietten

24 x 24 cm, 3-lagig, 1/4 Falzung



Artikel-Nr.	Produktinfo	Inhalt /VE	Preis /VE	
6115	bordeaux	(Pal. 30) 2000	118.50	netto
14024	weiss	(Pal. 30) 2000	99.00	netto
12842	schwarz	(Pal. 30) 2000	118.50	netto
6121	champagner	(Pal. 30) 2000	118.50	netto

weitere Farben auf Anfrage.



Servietten Bulkysoft

24 x 24 cm, 2-lagig, 1/4 Falzung



Artikel-Nr.	Produktinfo	Inhalt /VE	Preis /VE	ab 5 VE 10%
21692	weiss	(Pal. 42) 3000	53.50	48.15
21693	champagner	(Pal. 42) 3000	62.15	55.95
21694	gelb	(Pal. 42) 3000	66.25	59.65
21695	orange	(Pal. 42) 3000	66.25	59.65
21696	rot	(Pal. 42) 3000	66.25	59.65
21697	bordeaux	(Pal. 42) 3000	66.25	59.65
21698	blau	(Pal. 42) 3000	66.25	59.65
21788	tannengrün	(Pal. 42) 3000	66.25	59.65
21789	schwarz	(Pal. 42) 3000	66.25	59.65



Servietten Airlaid Mank

25 x 25 cm, 1/4 Falzung



Artikel-Nr.	Produktinfo	Inhalt /VE	Preis /VE	
22988	weiss	(Pal. 48) 1500	83.80	netto
17024*	creme	(Pal. 48) 1000	78.75	netto
17025	braun	(Pal. 48) 1000	82.60	netto
22987	beton	(Pal. 48) 1000	82.60	netto
13767	schwarz	(Pal. 48) 1000	82.60	netto

weitere Farben auf Anfrage.

Servietten Airlaid | Duni



Servietten Dunilin

40 x 40 cm, 70 g/m², 1/4 Falzung



Artikel-Nr.	Produktinfo	Inhalt /VE	Preis /VE	
6101	weiss	(Pal. 15) 600	196.50	netto
6104	dunkelblau	(Pal. 15) 600	217.50	netto
6107	bordeaux	(Pal. 15) 600	217.50	netto
6108*	rot	(Pal. 15) 600	217.50	netto
6105	champagner	(Pal. 15) 600	217.50	netto
25766	chestnut	(Pal. 15) 600	217.50	netto
23684	kiwi	(Pal. 15) 600	217.50	netto
14359	schwarz	(Pal. 15) 600	217.50	netto
21140	mandarin	(Pal. 30) 600	217.50	netto

weitere Farben und Motive auf Anfrage.



Servietten Dunilin

40 x 40 cm, 70 g/m², 1/4 Falzung



Artikel-Nr.	Produktinfo	Inhalt /VE	Preis /VE	
21147*	Motiv «Suisse»	(Pal. 15) 600	210.70	netto

weitere Farben und Motive auf Anfrage.



*„Individuality and diversity is
the key to success...“*

Linclass®

by *Mank®*



Servietten Airlaid | Duni



Servietten Dunisoft

40 x 40 cm, 1/8 Buchfaltung



Artikel-Nr.	Produktinfo	Inhalt /VE	Preis /VE	
19987	weiss	(Pal. 15) 720	185.40	netto

Servietten Airlaid | Mank



Servietten Airlaid Mank

40 x 40 cm, 1/8 Falzung



Artikel-Nr.	Produktinfo	Inhalt /VE	Preis /VE	
17005	weiss	(Pal. 30) 600	84.30	netto

weitere Farben auf Anfrage.



Servietten Airlaid Mank

33 x 33 cm, 1/4 Falzung



Artikel-Nr.	Produktinfo	Inhalt /VE	Preis /VE	
6870	weiss	(Pal. 30) 1000	84.55	netto



Servietten Linclass Light Mank

40 x 40 cm, 55 g/m², 1/4 Falzung



Artikel-Nr.	Produktinfo	Inhalt /VE	Preis /VE	
5019	weiss	(Pal. 30) 600	81.85	netto
11015	creme	(Pal. 30) 600	120.30	netto
17013	kiwi	(Pal. 30) 600	120.30	netto
16996	rot	(Pal. 30) 600	120.30	netto
16995	bordeaux	(Pal. 30) 600	120.30	netto
17019	braun	(Pal. 30) 600	120.30	netto
16998	schwarz	(Pal. 30) 600	120.30	netto
17653	royalblau	(Pal. 30) 600	120.30	netto



Servietten Linclass Mank

40 x 40 cm, 65 g/m², 1/4 Falzung

Artikel-Nr.	Produktinfo	Inhalt /VE	Preis /VE	
28983	beton	(Pal. 30) 600	128.70	netto
28985	aubergine	(Pal. 30) 600	129.00	netto
28988	aqua blau	(Pal. 30) 600	129.00	netto
28989	terrakotta	(Pal. 30) 600	129.00	netto
28996	gelb	(Pal. 30) 600	129.00	netto

weitere Farben auf Anfrage.

Servietten Airlaid | Tork



TORK Servietten Tork LinStyle Premium

39 x 39 cm, 1/4 Falzung, Vlies



Artikel-Nr.	Produktinfo	Inhalt /VE	Preis /VE	ab 5 VE 10%
21168	weiss	(Pal. 20) 600	145.95	131.35
21169	creme	(Pal. 20) 600	224.95	202.45
21170	champagner	(Pal. 20) 600	224.95	202.45
21171	bordeaux	(Pal. 20) 600	224.95	202.45
21172	rot	(Pal. 20) 600	224.95	202.45
21173	kakao	(Pal. 20) 600	224.95	202.45
21174	schwarz	(Pal. 20) 600	224.95	202.45
21175	grau	(Pal. 20) 600	224.95	202.45
21176	mitternachtsblau	(Pal. 20) 600	224.95	202.45
21179	orange	(Pal. 20) 600	224.95	202.45
21180	pistazie	(Pal. 20) 600	224.95	202.45
21181	biscuit	(Pal. 20) 600	224.95	202.45
28358	minze	(Pal. 20) 600	224.95	202.45
28357	koralle	(Pal. 20) 600	224.95	202.45



TORK Servietten Tork LinStyle Premium

39 x 39 cm, 1/8 Buchfalzung, Vlies



Artikel-Nr.	Produktinfo	Inhalt /VE	Preis /VE	ab 5 VE 10%
21569	weiss	(Pal. 20) 600	145.95	131.35
21570*	creme	(Pal. 20) 600	224.95	202.45
21571*	champagner	(Pal. 20) 600	224.95	202.45
21572	bordeaux	(Pal. 20) 600	224.95	202.45
21573	rot	(Pal. 20) 600	224.95	202.45
21574	kakao	(Pal. 20) 600	224.95	netto
21575	schwarz	(Pal. 20) 600	224.95	202.45

Servietten Airlaid | Diverse



Servietten Airlaid

40 x 40 cm, 1/4 Falzung

Artikel-Nr.	Produktinfo	Inhalt /VE	Preis /VE	ab 5 VE 10%
5090	weiss	(Pal. 32) 800	171.00	153.90
5005	tannengrün	(Pal. 32) 800	253.00	227.70
5006	gelb	(Pal. 32) 800	253.00	227.70
5094	dunkelblau	(Pal. 32) 800	253.00	227.70
5091	rot	(Pal. 32) 800	253.00	227.70
27152	aqua	(Pal. 32) 800	253.00	227.70
27150	avocado	(Pal. 32) 800	253.00	227.70
27157	bernstein	(Pal. 32) 800	253.00	227.70
27160	fuchsia	(Pal. 32) 800	253.00	227.70
27155	grau	(Pal. 32) 800	253.00	227.70
27156	kreide	(Pal. 32) 800	253.00	227.70
27161	lila	(Pal. 32) 800	253.00	227.70
27154	meeresblau	(Pal. 32) 800	253.00	227.70
27158	orange	(Pal. 32) 800	253.00	227.70
27151	salbei	(Pal. 32) 800	253.00	227.70
27159	violett	(Pal. 32) 800	253.00	227.70
5092	bordeaux	(Pal. 32) 800	253.00	227.70
16389	braun	(Pal. 32) 800	253.00	227.70
16390	schwarz	(Pal. 32) 800	253.00	227.70
27153	türkis	(Pal. 32) 800	253.00	227.70

Servietten Airlaid | Diverse



Starline Servietten Airlaid Starline

40 x 40 cm, 1/4 Falzung, 50g/m²

Artikel-Nr.	Produktinfo	Inhalt /VE	Preis /VE	ab 5 VE 10%
5058	champagner	(Pal. 32) 800	253.00	227.70



tela Servietten Premium Tela Airlaid

40 x 40 cm, 1-lagig, 1/4 Falzung



Artikel-Nr.	Produktinfo	Inhalt /VE	Preis /VE	ab 5 VE 10%
14659	weiss	(Pal. 30) 800	237.60	213.85
14660*	rot	(Pal. 30) 800	237.60	213.85
14661*	gelb	(Pal. 30) 800	237.60	213.85
7086*	bordeaux	(Pal. 30) 800	237.60	213.85
7087*	blau	(Pal. 30) 800	237.60	213.85
7096*	butter / panna	(Pal. 30) 800	237.60	213.85
14664*	kiwi	(Pal. 30) 800	237.60	213.85
14663*	aubergine	(Pal. 30) 800	237.60	201.40



Servietten The Napkins Deluxe

40 x 40 cm, 1/4 Falzung, sehr stoffähnlich

Artikel-Nr.	Produktinfo	Inhalt /VE	Preis /VE	ab 5 VE 10%
22430	polarweiss	(Pal. 40) 600	220.70	198.65
22431	bordeaux	(Pal. 40) 600	220.70	198.65
22433	lavendel	(Pal. 40) 600	220.70	198.65
22434*	türkisblau	(Pal. 40) 600	220.70	198.65
22435	blau	(Pal. 40) 600	220.70	198.65
22436*	hellblau	(Pal. 40) 600	220.70	198.65
22437*	apfelgrün	(Pal. 40) 600	220.70	198.65
22438	kiwi	(Pal. 40) 600	220.70	198.65
22439*	dunkelgelb	(Pal. 40) 600	220.70	198.65
22440	lachsrot	(Pal. 40) 600	220.70	198.65
22441	cacao	(Pal. 40) 600	220.70	198.65
22442	taupe	(Pal. 40) 600	220.70	198.65
22443	oker	(Pal. 40) 600	220.70	198.65
22444	champagner	(Pal. 40) 600	220.70	198.65
22428	dunkelgrau	(Pal. 40) 600	220.70	198.65
22429	silbergrau	(Pal. 40) 600	220.70	198.65
25913	grey floral line	(Pal. 40) 600	220.70	198.65

Servietten Airlaid | Cocktailservietten



TORK Cocktail-Servietten Tork LinStyle Premium

23 x 23 cm, 1/4 Falzung, Vlies



Artikel-Nr.	Produktinfo	Inhalt /VE	Preis /VE	ab 5 VE 10%
26878	weiss	(Pal. 24) 1500	200.70	180.65
26883	schwarz	(Pal. 24) 1500	295.00	265.50
26881	kakao	(Pal. 24) 1500	295.00	265.50

Dispo-Servietten



TORK Spenderservietten Tork Counterfold - N1 System

30 x 33 cm, 1-lagig



Artikel-Nr.	Produktinfo	Inhalt /VE	Preis /VE	ab 5 VE 10%
7511	weiss	(Pal. 30) 4000	129.20	116.25

Dispo-Servietten



TORK Dispo-Servietten Tork Counterfold - N1 System

33 x 32 cm, 2-lagig

Artikel-Nr.	Produktinfo	Inhalt /VE	Preis /VE	ab 5 VE 10%
10048	weiss	(Pal. 28) 3000	99.15	89.20



TORK Spenderservietten Tork Fastfold - N2 System

25 x 30 cm, 1-lagig



Artikel-Nr.	Produktinfo	Inhalt /VE	Preis /VE	ab 5 VE 10%
7501	weiss	(Pal. 20) 9000	204.85	184.35



TORK Spenderservietten Tork Xpressnap - N4 System

21.6 x 33 cm, 1-lagig



Artikel-Nr.	Produktinfo	Inhalt /VE	Preis /VE	Preis VE /Pal.
13433	weiss	(Pal. 20) 9000	207.75	177.10



TORK Spenderservietten Tork Xpressnap Extrasoft - N4 System

21.6 x 33 cm, 2-lagig



Artikel-Nr.	Produktinfo	Inhalt /VE	Preis /VE	Preis VE /Pal.
13573.1	weiss	(Pal. 20) 4000	144.20	122.95



TORK Spenderservietten Tork Xpressnap Extrasoft - N4 System

21.6 x 16.5 cm, 2-lagig



Artikel-Nr.	Produktinfo	Inhalt /VE	Preis /VE	Preis VE /Pal.
13572.1	weiss	(Pal. 20) 8000	203.15	173.20



TORK Spenderservietten Tork Xpressnap Extrasoft - N4 System

21.6 x 33 cm, 2-lagig



Artikel-Nr.	Produktinfo	Inhalt /VE	Preis /VE	ab 5 VE 10%
23963	weiss, mit Blätterdesign	(Pal. 20) 4000	156.50	140.85



TORK Spenderservietten - N7 System

31 x 41 cm, 1-lagig

Artikel-Nr.	Produktinfo	Inhalt /VE	Preis /VE	ab 5 VE 10%
7504	weiss	(Pal. 24) 5400	220.25	198.20



BulkySoft Servietten Bulkysoft System One

19 x 14.5 cm, 2-lagig, 1/2 Falzung, für Spender Art. 21821 + 21822



Artikel-Nr.	Produktinfo	Inhalt /VE	Preis /VE	ab 5 VE 10%
21820	weiss, Micro-Prägung	(Pal. 48) 4800	51.05	45.95



BulkySoft Servietten Bulkysoft System One

21.5 x 16 cm, 2-lagig, 1/2 Falzung, für Spender Art. 21821 + 21822



Artikel-Nr.	Produktinfo	Inhalt /VE	Preis /VE	ab 5 VE 10%
21819	weiss, Micro-Prägung	(Pal. 35) 4000	53.25	47.90



BulkySoft Servietten Bulkysoft System One

21.5 x 16 cm, 3-lagig, 1/2 Falzung, für Spender Art. 21821 + 21822



Artikel-Nr.	Produktinfo	Inhalt /VE	Preis /VE	ab 5 VE 10%
26264	weiss, Micro-Prägung	(Pal. 35) 4000	79.85	71.85

Dispo-Servietten



Spenderservietten Duni

33 x 33 cm, 1-lagig, 1/8 Falzung



Artikel-Nr.	Produktinfo	Inhalt /VE	Preis /VE	
7903	weiss	(Pal. 36) 4500	70.90	netto
7913*	dunkelblau	(Pal. 18) 4500	120.50	netto
7908	gelb	(Pal. 18) 4500	120.50	netto

weitere Farben auf Anfrage.

Spenderservietten Duni

33 x 33 cm, 2-lagig, 1/8 Falzung



Artikel-Nr.	Produktinfo	Inhalt /VE	Preis /VE	
7904	weiss	(Pal. 24) 1200	40.20	netto

Serviettendispenser



Serviettenspender Tork Counterfold - N1 System

H: 107 B: 189 T: 356 mm

Artikel-Nr.	Produktinfo	Inhalt /VE	Preis /VE	
7536	für ca. 300 Servietten, grau	(Pal. 192) 1	99.75	netto



Tisch-Serviettenspender Tork Fastfold - N2 System

H: 131 B: 101 T: 147 mm, beidseitig bedienbar

Artikel-Nr.	Produktinfo	Inhalt /VE	Preis /VE	
7502	für ca. 90 Servietten, grau	(Pal. 580) 1	37.35	netto



Serviettenspender Tork Fastfold - N2 System

H: 134 B: 105 T: 311 mm

Artikel-Nr.	Produktinfo	Inhalt /VE	Preis /VE	
7503.1*	für ca. 275 Servietten, grau	(Pal. 272) 1	80.85	netto



Tisch-Serviettenspender Tork Xpressnap - N4 System

H: 155 B: 201 T: 150 mm

Artikel-Nr.	Produktinfo	Inhalt /VE	Preis /VE	
22627	für ca. 275 Servietten, schwarz	(Pal. 216) 1	52.10	netto
22628	für ca. 275 Servietten, rot	(Pal. 216) 1	52.10	netto
22629	für ca. 275 Servietten, hellgrau	(Pal. 216) 1	52.10	netto

Erhältlich mit Leihspendervertrag (es können Servicegebühren anfallen)



Thekenspender Tork Xpressnap - N4 System

H: 145 B: 191 T: 307 mm

Artikel-Nr.	Produktinfo	Inhalt /VE	Preis /VE	
22630	für ca. 550 Servietten, schwarz	(Pal. 168) 1	85.20	netto
22631	für ca. 550 Servietten, rot	(Pal. 168) 1	85.20	netto
22632	für ca. 550 Servietten, hellgrau	(Pal. 168) 1	85.20	netto

Erhältlich mit Leihspendervertrag (es können Servicegebühren anfallen)

Serviettendispenser



TORK Stehspender Tork Xpressnap - N4 System

H: 622 B: 235 T: 235 mm

Artikel-Nr.	Produktinfo	Inhalt /VE	Preis /VE	
22633	für ca. 1100 Servietten, schwarz	(Pal. 35) 1	113.00	netto
22634	für ca. 1100 Servietten, rot	(Pal. 35) 1	113.00	netto
22635	für ca. 1100 Servietten, hellgrau	(Pal. 35) 1	113.00	netto

Erhältlich mit Leihspendervertrag (es können Servicegebühren anfallen)



TORK Serviettenspender Tork Xpressnap - N4 System

H: 178 B: 209 T: 150 mm

Artikel-Nr.	Produktinfo	Inhalt /VE	Preis /VE	ab 5 VE 10%
23961*	für ca. 150 Servietten, Aluminium	(Pal. 168) 1	106.45	95.80



TORK Serviettenspender Tork Xpressnap - N4 System

H: 203 B: 193 T: 136 mm

Artikel-Nr.	Produktinfo	Inhalt /VE	Preis /VE	ab 5 VE 10%
23959	für ca. 150 Servietten, Walnussholz	(Pal. 152) 1	114.80	103.30



TORK Serviettenspender - N7 System

H: 140 B: 190 T: 300 mm

Artikel-Nr.	Produktinfo	Inhalt /VE	Preis /VE	
7509*	für ca. 300 Servietten, schwarz	1	117.55	netto



TORK Serviettenspender Tork Xpressnap Snack - N10 System

H: 157 B: 149 T: 149 mm

Artikel-Nr.	Produktinfo	Inhalt /VE	Preis /VE	ab 5 VE 10%
24653	für ca. 225 Servietten, schwarz	1	32.35	29.10

Erhältlich mit Leihspendervertrag (es können Servicegebühren anfallen)



TORK Serviettenspender Tork Xpressnap Snack - N10 System

H: 121 B: 138 T: 144 mm

Artikel-Nr.	Produktinfo	Inhalt /VE	Preis /VE	ab 5 VE 10%
23962	für ca. 75 Servietten, Aluminium	(Pal. 240) 1	62.60	56.35



TORK Serviettenspender Tork Xpressnap Snack - N10 System

H: 146 B: 116 T: 136 mm

Artikel-Nr.	Produktinfo	Inhalt /VE	Preis /VE	ab 5 VE 10%
23960	für ca. 75 Servietten, Walnussholz	(Pal. 288) 1	74.35	66.90



BulkySoft Serviettenspender System One Bulkysoft

H: 148 B: 188 T: 130 mm, für Art. 21819 / 21820 / 26264

Artikel-Nr.	Produktinfo	Inhalt /VE	Preis /VE	
21821	transparent / grau, ABS Kunststoff	(Pal. 96) 1	31.70	netto



BulkySoft Serviettenspender System One Bulkysoft

H: 445 B: 200 T: 310 mm, für Art. 21819 / 21820 / 26264

Artikel-Nr.	Produktinfo	Inhalt /VE	Preis /VE	
21822	transparent / grau, ABS Kunststoff	(Pal. 50) 1	52.30	netto

Serviettendispenser



Serviettenspender

aus Draht, verchromt

Artikel-Nr.	Produktinfo	Inhalt /VE	Preis /VE	
14372	für 1/8 Kopffalzung, 40 x 40 cm	1	20.50	netto
14373	für 1/8 Kopffalzung, 33 x 33 cm	1	19.45	netto
14371	für 1/8 Buchfalzung, 40 x 40 cm	1	20.50	netto

Tischset | Starline



Starline Tischset Starline - Shetland-Prägung

29 x 39 cm, 1-lagig

Artikel-Nr.	Produktinfo	Inhalt /VE	Preis /VE	ab 5 VE 10%
7155.1	weiss	(Pal. 40) 2500	120.45	108.40
7156.1	rot	(Pal. 40) 2500	149.00	134.10
7157.1	bordeaux	(Pal. 40) 2500	149.00	134.10
7158.1	schwarz	(Pal. 40) 2500	148.95	134.05
7159.1	blau	(Pal. 40) 2500	149.00	134.10
7160.1	tannengrün	(Pal. 40) 2500	149.00	134.10
7162.1	gelb	(Pal. 40) 2500	149.00	134.10
14945.1	orange	(Pal. 40) 2500	149.00	134.10
7168.1	champagner	(Pal. 40) 2500	148.95	134.05

Tischset | Tela

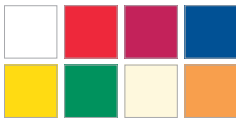

tela Tischset Tela

39 x 29 cm, 3-lagig

Artikel-Nr.	Produktinfo	Inhalt /VE	Preis /VE	Preis ab 8 VE
5220	weiss	(Pal. 16) 2000	204.80	173.65
5221	rot	(Pal. 16) 2000	244.85	203.50
5222	bordeaux	(Pal. 16) 2000	244.85	203.50
5224	dunkelblau	(Pal. 16) 2000	244.85	203.50
5227	gelb	(Pal. 16) 2000	244.85	203.50
5225	dunkelgrün	(Pal. 16) 2000	244.85	203.50
5232	crème / panna	(Pal. 16) 2000	244.85	203.50
14666	orange	(Pal. 16) 2000	244.85	203.50

Tischset | Duni



Duni Tischset Dunicel

mit Linnea-Rand, 30 x 40 cm



Artikel-Nr.	Produktinfo	Inhalt /VE	Preis /VE	
17977	weiss	(Pal. 30) 500	142.60	netto
10372*	gelb	(Pal. 30) 500	152.50	netto
6093*	mandarin	(Pal. 30) 500	152.50	netto
11300	dunkelblau	(Pal. 30) 500	152.50	netto
6148.1	bordeaux	(Pal. 30) 500	152.50	netto
6152.1	champagner	(Pal. 30) 500	152.50	netto
12689	kiwi	(Pal. 30) 500	152.50	netto

weitere Farben auf Anfrage.



SUPPLIER OF GOODFOODMOOD®

Amici

www.duni.com

NAPKINS

Tischset | Duni



Tischset Papier

29 x 39 cm

Artikel-Nr.	Produktinfo	Inhalt /VE	Preis /VE	
6044*	dunkelblau	(Pal. 24) 2500	165.00	netto
6039*	jägergrün	(Pal. 24) 2500	165.00	netto
6042*	gelb	(Pal. 24) 2500	165.00	netto
14731*	mandarin	(Pal. 24) 2500	165.00	netto
17218*	rot	(Pal. 24) 2500	165.00	netto
27870*	aubergine	(Pal. 24) 2500	165.00	netto
23948*	granite grey	(Pal. 30) 2500	165.00	netto

weitere Farben auf Anfrage.

Tischset | Mank



Mank Tischset Vlies Mank

30 x 40 cm, 40 g/m2



Artikel-Nr.	Produktinfo	Inhalt /VE	Preis /VE	
12503	WEBKANTE, bordeaux	(Pal. 36) 1000	162.35	netto
12607	WEBKANTE, creme	(Pal. 30) 1000	162.35	netto

weitere Farben auf Anfrage.



Mank Tischset Airlaid Mank

30 x 40 cm



Artikel-Nr.	Produktinfo	Inhalt /VE	Preis /VE	
18334*	schwarz	(Pal. 30) 600	111.35	netto
18341	bordeaux	(Pal. 30) 600	111.35	netto
18340	kiwi	(Pal. 30) 600	111.35	netto
18344	terrakotta	(Pal. 30) 600	111.35	netto

weitere Farben auf Anfrage.

Tischset | Diverse



Tischset Airlaid

29 x 39 cm, 1-lagig

Artikel-Nr.	Produktinfo	Inhalt /VE	Preis /VE	ab 5 VE 10%
16391	weiss	(Pal. 24) 1000	145.45	130.90
16392	blau	(Pal. 24) 1000	199.95	179.95
16393	bordeaux	(Pal. 24) 1000	199.95	179.95
16394	gelb	(Pal. 24) 1000	199.95	179.95
16395	rot	(Pal. 24) 1000	199.95	179.95
16396	tannengrün	(Pal. 24) 1000	199.95	179.95
16397	champagner	(Pal. 24) 1000	199.95	179.95
16398	braun	(Pal. 24) 1000	199.95	179.95
16399	schwarz	(Pal. 24) 1000	199.95	179.95



Tischset - Ecosais

28 x 39 cm

Artikel-Nr.	Inhalt /VE	Preis /VE	ab 5 VE 10%
5205	(Pal. 120) 500	48.20	43.35



Tischset - Good-Morning Sonne

28 x 39 cm

Artikel-Nr.	Inhalt /VE	Preis /VE	ab 5 VE 10%
5208	(Pal. 120) 500	48.20	43.35

Tischset | Diverse



Tischset Fantasy Désalpe

28 x 40 cm

Artikel-Nr.	Inhalt /VE	Preis /VE	ab 5 VE 10%
10978	500	67.30	60.55



Tischset

29.4 x 43 cm, 10 kg

Artikel-Nr.	Produktinfo	Inhalt /VE	Preis /VE	ab 5 VE 10%
6544.1	Strohpapier	(Pal. 54) 800	59.00	53.10



Tischset

28 x 38 cm

Artikel-Nr.	Produktinfo	Inhalt /VE	Preis /VE	ab 5 VE 10%
5270	weiss, Kroko, glatter Rand	2000	112.90	101.60
5268	weiss, Kroko, gezackter Rand	500	37.75	33.95



Tischset, Shetland

30 x 40 cm

Artikel-Nr.	Produktinfo	Inhalt /VE	Preis /VE	ab 5 VE 10%
10702	dunkelblau	500	45.10	40.60
10711	grün	500	45.10	40.60
10713	weiss	(Pal. 36) 1250	53.30	47.95



Tischset Deluxe line

30 x 40 cm

Artikel-Nr.	Produktinfo	Inhalt /VE	Preis /VE	ab 5 VE 10%
22646	polarweiss	(Pal. 30) 500	201.15	181.05
22647*	silbergrau	500	201.15	181.05
22648	dunkelgrau	(Pal. 30) 500	201.15	181.05
22649	champagner	500	201.15	181.05
22650	cacao	500	201.15	181.05



Tischset Fiesta

30 x 43 cm

Artikel-Nr.	Produktinfo	Inhalt /VE	Preis /VE	
28494	passion yellow	(Pal. 36) 1500	120.85	netto
28495	orange	(Pal. 36) 1500	120.85	netto
28496	framboise	(Pal. 36) 1500	120.85	netto
28497	warm red	(Pal. 36) 1500	120.85	netto
28498	green tea	(Pal. 36) 1500	120.85	netto
28499	azur	(Pal. 36) 1500	120.85	netto

Servietten- und Bestecktaschen | Duni



Servietten-Taschen «Sacchetto»

19 x 8.5 cm, 5 x 100 Stück, mit Zelltuch-Serviette



Artikel-Nr.	Produktinfo	Inhalt /VE	Preis /VE	
4802*	bordeaux, mit champagner Serviette	(Pal. 25) 500	122.50	netto
4803*	blau, mit dunkelblauer Serviette	(Pal. 25) 500	122.50	netto
23671*	champagner, mit bordeaux Serviette	(Pal. 25) 500	122.50	netto

weitere Farben auf Anfrage.

Servietten- und Bestecktaschen | Duni



Servietten-Taschen «Sacchetto» Dunisoft

23 x 11.5 cm, 4 x 60 Stück



Artikel-Nr.	Produktinfo	Inhalt /VE	Preis /VE	
21223*	champagner	(Pal. 28) 240	89.00	netto

weitere Farben auf Anfrage.

Servietten- und Bestecktaschen | Mank



Pocket Napkins Airlaid Mank

40 x 40 cm, 1/8 Falzung



Artikel-Nr.	Produktinfo	Inhalt /VE	Preis /VE	
14820	weiss	(Pal. 15) 1200	163.70	netto
17001	creme	(Pal. 30) 600	129.00	netto
17015	kiwi	(Pal. 30) 600	129.00	netto
17003	rot	(Pal. 30) 600	129.00	netto
17002	bordeaux	(Pal. 30) 600	129.00	netto
17428	schwarz	(Pal. 30) 600	129.00	netto
19776	pflaume	(Pal. 30) 600	129.00	netto



Pocket Napkins XL Airlaid Mank

48 x 40 cm, 70 g/m², 1/8 Falzung



Artikel-Nr.	Produktinfo	Inhalt /VE	Preis /VE	
21897	weiss	(Pal. 24) 600	148.30	netto

Servietten- und Bestecktaschen | Tork



Bestecktaschen Airlaid, Tork Premium

40 x 40 cm, 1-lagig

Artikel-Nr.	Produktinfo	Inhalt /VE	Preis /VE	ab 5 VE 10%
12898*	weiss	(Pal. 24) 1200	358.00	322.20



Bestecktaschen «Bon appétit» Tissue, Tork Advanced

40 x 40 cm, 3-lagig

Artikel-Nr.	Produktinfo	Inhalt /VE	Preis /VE	ab 5 VE 10%
12897	weiss	(Pal. 24) 1200	157.00	141.30

Servietten- und Bestecktaschen | Diverse



Besteckbeutel

80 x 245 + 40 mm, PE-LD

Artikel-Nr.	Produktinfo	Inhalt /VE	Preis /VE	ab 5 VE 10%
7731	transparent	(Pal. 48) 10000	263.75	237.40



Servietten-Taschen

12 x 27 cm, aus Karton

Artikel-Nr.	Produktinfo	Inhalt /VE	Preis /VE	ab 5 VE 10%
4934	Leinenprägung	(Pal. 108) 200	69.75	62.75

Tischläufer und Skirtings | Starline



Starline Tischläufer Airlaid Starline
40 cm x 1.10 m

Artikel-Nr.	Produktinfo	Inhalt /VE	Preis /VE	
5047	champagner	(Pal. 32) 300	152.10	netto

Tischläufer und Skirtings | Duni



Duni Tischläufer tête-à-tête Dunicel
40 x 120 cm, Rolle à 20 Abschnitte



Artikel-Nr.	Produktinfo	Inhalt /VE	Preis /VE	
4779*	weiss	(Pal. 36) 6	135.25	netto
4786*	rot	(Pal. 36) 6	135.25	netto
4784*	jägergrün	(Pal. 36) 6	135.25	netto
4787*	bordeaux	(Pal. 36) 6	135.25	netto
4783*	dunkelblau	(Pal. 36) 6	135.25	netto
12690*	kiwi	(Pal. 36) 6	135.25	netto
24640	granite grey	(Pal. 36) 6	135.25	netto
23680*	schwarz	(Pal. 36) 6	135.25	netto

weitere Farben auf Anfrage.



Duni Table-Skirtings Dunicel
72 cm x 4 m, selbstklebend

Artikel-Nr.	Produktinfo	Inhalt /VE	Preis /VE	
16799	weiss	(Pal. 40) 5	171.50	netto
18012*	champagner	(Pal. 40) 5	188.00	netto
22387*	bordeaux	(Pal. 40) 5	188.00	netto
23692*	schwarz	(Pal. 40) 5	188.00	netto

weitere Farben auf Anfrage.

Tischläufer und Skirtings | Mank

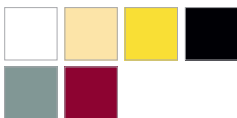

Mank Tischläufer Airlaid Mank
40 cm x 24 m, perforiert, Rolle à 20 Abschnitte



Artikel-Nr.	Produktinfo	Inhalt /VE	Preis /VE	
12652	weiss	(Pal. 50) 4	65.90	netto
17718	creme	(Pal. 50) 4	74.85	netto
17697	gelb	(Pal. 50) 4	74.85	netto
17700	schwarz	(Pal. 50) 4	74.85	netto
21368	beton	(Pal. 50) 4	74.85	netto
18643	bordeaux	(Pal. 50) 4	74.85	netto

weitere Farben auf Anfrage.

Tischtuchrollen | Tela

Papier



tela Tischtuchrolle Hostess Tela
100 cm x 45 m, 3-lagig, Krepp-Papier

Artikel-Nr.	Produktinfo	Inhalt /VE	Preis /VE	Preis ab 8 VE
5314	rot	(Pal. 72) 1	43.20	36.20
5313	bordeaux	(Pal. 72) 1	43.20	36.20
5311	dunkelblau	(Pal. 72) 1	43.20	36.20
5315	gelb	(Pal. 72) 1	43.20	36.20
5312	dunkelgrün	(Pal. 72) 1	43.20	36.20
14704	orange	(Pal. 72) 1	43.20	36.20

Tischtuchrollen | Tela

Papier



tela Tischtuchrolle Table Top Tela

120 cm x 25 m, Unterbeschichtung, wasserundurchlässig

Artikel-Nr.	Produktinfo	Inhalt /VE	Preis /VE	Preis ab 8 VE
14698	dunkelblau	(Pal. 54) 1	80.95	68.30
14692	weiss	(Pal. 54) 1	74.20	62.70
14696	bordeaux	(Pal. 54) 1	80.95	68.30
14699	rot	(Pal. 54) 1	80.95	68.30
14700	butter / panna	(Pal. 54) 1	80.95	68.30



tela Tischtuchrolle Tweed Tela

100 cm x 45 m, 1-lagig, Krepp-Papier

Artikel-Nr.	Produktinfo	Inhalt /VE	Preis /VE	Preis ab 20 VE
7581	weiss	(Pal. 72) 1	26.90	22.45



tela Tischtuchrolle Trianon Tela

100 cm x 100 m, 1-lagig, Krepp-Papier

Artikel-Nr.	Produktinfo	Inhalt /VE	Preis /VE	Preis ab 20 VE
7582	weiss	(Pal. 48) 1	62.20	52.20

Vlies



tela Tischtuchrolle Tela

120 cm x 35 m, Vlies

Artikel-Nr.	Produktinfo	Inhalt /VE	Preis /VE	Preis ab 8 VE
14686	gelb	(Pal. 54) 1	85.55	72.20
14677	weiss	(Pal. 54) 1	77.15	66.00
14679	rot	(Pal. 54) 1	85.55	72.20
14680	bordeaux	(Pal. 54) 1	85.55	72.20
14681	dunkelblau	(Pal. 54) 1	85.55	72.20
14689	grün	(Pal. 54) 1	85.55	72.20
14682	orange	(Pal. 54) 1	85.55	72.20
14687	butter / panna	(Pal. 54) 1	85.55	72.20

Tischtuchrollen | Duni



Duni Tischtuchrolle Dunicel

125 cm x 40 m, 140 g/m²



Artikel-Nr.	Produktinfo	Inhalt /VE	Preis /VE	
10756	weiss	(Pal. 35) 1	105.00	netto
10932*	champagner	(Pal. 35) 1	111.00	netto
10931*	gelb	(Pal. 35) 1	111.40	netto
10930	bordeaux	(Pal. 35) 1	111.00	netto

weitere Farben auf Anfrage.

Tischtuchrollen | Duni



Tischtuchrolle Dunicel

125 cm x 25 m, 140 g/m²



Artikel-Nr.	Produktinfo	Inhalt /VE	Preis /VE	
6113	weiss	(Pal. 35) 2	139.00	netto
6123*	gelb	(Pal. 35) 2	149.50	netto
6142*	jägergrün	(Pal. 35) 2	149.50	netto
6117*	rot	(Pal. 35) 2	149.50	netto
6149	dunkelblau	(Pal. 35) 2	149.50	netto
6120	bordeaux	(Pal. 35) 2	149.50	netto
6144*	champagner	(Pal. 35) 2	149.50	netto
24497*	fuchsia	(Pal. 35) 2	149.50	netto
23689	kiwi	(Pal. 35) 2	149.50	netto
23687*	herbal green	(Pal. 35) 2	149.50	netto
20463	schwarz	(Pal. 35) 2	149.50	netto

weitere Farben auf Anfrage.



Tischtuchrolle Dunicel

120 cm x 25 m, beschichtet



Artikel-Nr.	Produktinfo	Inhalt /VE	Preis /VE	
23670	weiss	(Pal. 44) 2	149.50	netto
17208*	champagner	(Pal. 44) 2	149.50	netto

weitere Farben auf Anfrage.

Tischtuchrollen | Mank



Tischtuchrolle Airlaid Mank

120 cm x 40 m



Artikel-Nr.	Produktinfo	Inhalt /VE	Preis /VE	
17267	weiss	(Pal. 40) 1	48.60	netto
18067	schwarz	(Pal. 40) 1	74.15	netto
21227	braun	(Pal. 40) 1	74.15	netto
18026	creme	(Pal. 40) 1	74.15	netto
19795	rot	(Pal. 40) 1	74.15	netto

weitere Farben auf Anfrage.

Tischtuchrollen | Tork



Tischtuchrolle Damast Tork

100 cm x 50 m, 1-lagig, Papier

Artikel-Nr.	Produktinfo	Inhalt /VE	Preis /VE	ab 5 VE 10%
7580	weiss	(Pal. 72) 1	28.75	25.85

Tischtuchrollen | Bulkysoft



Tischtuchrolle Damast Bulkysoft

100 cm x 50 m, Papier

Artikel-Nr.	Produktinfo	Inhalt /VE	Preis /VE	ab 5 VE 10%
21705	weiss	(Pal. 36) 6	113.20	101.90
21706	rot	(Pal. 36) 6	130.60	117.55
21707	gelb	(Pal. 36) 6	130.60	117.55
21708	blau	(Pal. 36) 6	130.60	117.55
25854	tannengrün	(Pal. 36) 6	130.60	117.55

Tischtuchrollen | Diverse

Tischtuchrolle Raute Damast

100 cm x 50 m, 1-lagig, Papier

Artikel-Nr.	Produktinfo	Inhalt /VE	Preis /VE	ab 5 VE 10%
1950	blau / weiss	(Pal. 132) 1	35.15	31.65

Tischtuchrolle Shetland-Prägung

100 cm x 50 m, Papier

Artikel-Nr.	Produktinfo	Inhalt /VE	Preis /VE	ab 5 VE 10%
5186	weiss	(Pal. 15) 6	100.80	netto

Tischtuchrolle Shetland-Prägung

100 cm x 100 m, Papier

Artikel-Nr.	Produktinfo	Inhalt /VE	Preis /VE	ab 5 VE 10%
10683	weiss	1	41.00	36.90

Tischtuchrolle Folie

100 cm x 50 m, 1-lagig, Polyethylen

Artikel-Nr.	Produktinfo	Inhalt /VE	Preis /VE	ab 5 VE 10%
7585	weiss	(Pal. 91) 1	52.25	47.00

Tischtuchrolle Airlaid

120 cm x 50 m

Artikel-Nr.	Produktinfo	Inhalt /VE	Preis /VE	ab 5 VE 10%
5190	weiss	(Pal. 50) 1	82.05	73.85
5191	rot	(Pal. 50) 1	121.70	109.55
5192	bordeaux	(Pal. 50) 1	121.70	109.55
5194	blau	(Pal. 50) 1	121.70	109.55
5195	tannengrün	(Pal. 50) 1	121.70	109.55
5196	gelb	(Pal. 50) 1	121.70	109.55

Messer elektrisch für Tischtuchrollen

weiss

Artikel-Nr.	Inhalt /VE	Preis /VE	ab 5 VE 10%
11102	(Pal. 2300) 1	18.80	netto

Tischdecken in Formate | Diverse



Tischdeckpapier Shetland-Prägung

1-lagig, weiss

Artikel-Nr.	Produktinfo	Inhalt /VE	Preis /VE	ab 5 VE 10%
10680	35 x 50 cm	1000	57.40	51.65
10684	40 x 60 cm	1000	117.25	105.50
5307	50 x 100 cm	(Pal. 10) 250	75.40	67.85
10679	55 x 70 cm	(Pal. 10) 500	62.50	56.25
5301	60 x 80 cm	(Pal. 20) 500	134.95	121.45
5318	60 x 100 cm	(Pal. 20) 250	67.75	netto
5302	64.5 x 69.5 cm	(Pal. 10) 500	126.15	113.55
21209	65 x 65 cm	(Pal. 10) 500	135.00	121.50
5300	65 x 100 cm	(Pal. 30) 250	92.45	83.20
5310	65 x 75 cm	(Pal. 10) 500	149.05	134.15
5306	70 x 70 cm	(Pal. 10) 500	145.40	130.85
10677	70 x 80 cm	(Pal. 10) 500	87.10	78.40
5303	70 x 100 cm	(Pal. 10) 250	93.60	84.25
10673	70 x 110 cm	(Pal. 10) 250	60.50	54.45
10681	70 x 120 cm	250	65.10	58.55
5305	80 x 80 cm	(Pal. 10) 500	193.45	174.10
7603*	80 x 110 cm	250	82.50	netto
5309	80 x 120 cm	(Pal. 20) 250	137.10	123.40
10696	80 x 130 cm	(Pal. 20) 250	145.10	130.60
5308	90 x 90 cm	(Pal. 10) 500	223.85	201.45
5350	100 x 100 cm	(Pal. 10) 250	153.70	138.35
5304	100 x 120 cm	(Pal. 10) 250	170.05	153.05



Tischdeckpapier Shetland-Prägung

80 x 120 cm

Artikel-Nr.	Produktinfo	Inhalt /VE	Preis /VE	ab 5 VE 10%
10691	bordeaux	(Pal. 20) 250	172.20	155.00



Tischdeckpapier Brasserie-Prägung

weiss

Artikel-Nr.	Produktinfo	Inhalt /VE	Preis /VE	ab 5 VE 10%
7600.1	60 x 70 cm	(Pal. 40) 250	31.55	netto
7596	63 x 75 cm	(Pal. 20) 250	53.45	48.10
26938	64 x 67 cm	(Pal. 20) 250	50.30	netto
7597	70 x 70 cm	(Pal. 20) 250	52.05	46.85
7598	70 x 80 cm	(Pal. 20) 250	60.10	54.10



Napperon Kroko-Prägung

glatter Rand, weiss

Artikel-Nr.	Produktinfo	Inhalt /VE	Preis /VE	ab 5 VE 10%
5280	21 x 27 cm	250	10.15	9.15
5281	25 x 35 cm	500	26.65	24.00
5277	28 x 48 cm	250	24.00	21.60
5276	30 x 45 cm	250	24.25	21.80
17821	32 x 46 cm	500	35.15	netto
5283	33.5 x 48.5 cm	500	53.35	48.00
5284	35 x 50 cm	500	56.20	50.55
5285	36 x 46 cm	500	53.35	48.00
5287	40 x 55 cm	500	70.70	63.60
5288	45 x 60 cm	500	86.45	77.80

Tischdecken in Formate | Diverse

Tischdecken Airlaid Mank



weiss

Artikel-Nr.	Produktinfo	Inhalt /VE	Preis /VE	
23141*	80 x 80 cm, 1/4 Falzung	(Pal. 60) 50	41.20	netto
20178	100 x 100 cm	(Pal. 30) 60	94.30	netto

weitere Farben auf Anfrage.



Mitteldecken Evolin



weiss, wasserabweisend, fällt wie Stoff

Artikel-Nr.	Produktinfo	Inhalt /VE	Preis /VE	
25338*	110 x 110 cm	(Pal. 20) 50	87.50	netto
25339	127 x 127 cm	(Pal. 20) 50	98.00	netto
25340*	127 x 180 cm	(Pal. 24) 25	72.00	netto
25341	127 x 220 cm	(Pal. 24) 25	87.50	netto

weitere Farben auf Anfrage.

Plattenpapiere | Rund



Plattenpapier rund

Kroko-Prägung, gezackter Rand, weiss

Artikel-Nr.	Produktinfo	Inhalt /VE	Preis /VE	ab 5 VE 10%
5339	12 cm	500	8.20	7.35
5340	14 cm	500	9.20	8.25
5341	16 cm	500	11.15	10.05
5342	18 cm	500	12.70	11.45
5343	19 cm	500	13.35	12.00
5344	21 cm	500	14.55	13.10
5345	23 cm	500	16.95	15.25
5346	25 cm	500	19.80	17.80
5347	27 cm	500	22.60	20.30
5348	30 cm	500	26.30	23.65
5349	33 cm	500	33.20	29.90



Plattenpapier rund

Raisin-Prägung, weiss

Artikel-Nr.	Produktinfo	Inhalt /VE	Preis /VE	ab 5 VE 10%
5340.1	15 cm	1000	15.75	14.15
5341.1	17 cm	1000	20.20	18.15
5343.1	19 cm	1000	22.20	20.00
5344.1	21 cm	1000	28.95	26.05
5347.1	28 cm	1000	53.25	47.95

Plattenpapiere | Oval



Plattenpapier oval

Kroko-Prägung, gezackter Rand, weiss

Artikel-Nr.	Produktinfo	Inhalt /VE	Preis /VE	ab 5 VE 10%
5355	14 x 21 cm	500	10.90	9.80
5356	16 x 24 cm	500	12.40	11.15
5357	18 x 27 cm	500	13.75	12.40
5358	19 x 29 cm	500	15.15	13.60
5359	21 x 32 cm	500	16.85	15.15
5360	23 x 35 cm	500	21.90	19.70
5361	26 x 38 cm	500	26.05	23.45
5362	26 x 40 cm	500	29.05	26.15
5363	28 x 46 cm	500	33.15	29.85
5364	32 x 48 cm	500	37.50	33.75
5365	36 x 56 cm	500	63.45	57.10



Plattenpapier oval

Raisin-Prägung, weiss

Artikel-Nr.	Produktinfo	Inhalt /VE	Preis /VE	ab 5 VE 10%
5355.1	20 x 14 cm	1000	17.35	15.60
5356.1	24 x 16 cm	1000	23.90	21.55
5359.1	32 x 21 cm	1000	39.35	35.40

Spitzenpapiere | Rund



Spitzenpapier rund

Rosenmuster, weiss

Artikel-Nr.	Produktinfo	Inhalt /VE	Preis /VE	ab 5 VE 10%
5441	9 cm	(Pal. 1350) 500	19.75	17.80
5377	10 cm	(Pal. 2160) 250	6.90	6.20
5380	12 cm	(Pal. 2376) 250	7.50	6.75
5381	14 cm	(Pal. 1496) 250	8.15	7.35
5403	15 cm	(Pal. 288) 500	24.70	22.20
5392	16 cm	(Pal. 1152) 250	9.30	8.35
5404	17 cm	(Pal. 1152) 250	13.70	12.35
5382	18 cm	(Pal. 1152) 250	10.70	9.60
5383	20 cm	(Pal. 600) 250	11.40	10.30
5384	22 cm	(Pal. 600) 250	12.70	11.45
5385	24 cm	(Pal. 576) 250	14.75	13.25
5394	26 cm	(Pal. 576) 250	15.80	14.20
5386	28 cm	(Pal. 288) 250	16.75	15.10
5387	30 cm	(Pal. 288) 250	19.95	17.95
12514	32 cm	(Pal. 240) 250	11.80	10.60
5388	33 cm	(Pal. 240) 250	25.90	23.30
12512	34 cm	(Pal. 240) 250	16.65	15.00
5389	36 cm	(Pal. 288) 250	29.75	26.75
5395	38 cm	(Pal. 240) 250	34.55	31.10
5390	40 cm	(Pal. 288) 250	43.85	39.45

Spitzenpapiere | Rechteckig und oval



Spitzenpapier rechteckig

Blütenmuster, weiss

Artikel-Nr.	Produktinfo	Inhalt /VE	Preis /VE	ab 5 VE 10%
5424	18 x 30 cm	(Pal. 576) 250	29.80	26.80
5425	30 x 25 cm	(Pal. 288) 250	33.15	29.85
12511	30 x 40 cm	(Pal. 288) 250	15.35	13.80
5422	34 x 26 cm	(Pal. 384) 250	20.05	18.05
5426	36 x 46 cm	(Pal. 192) 250	65.85	59.25
5427	40 x 50 cm	(Pal. 160) 250	85.15	76.65



Spitzenpapier oval

Rosenmuster, weiss

Artikel-Nr.	Produktinfo	Inhalt /VE	Preis /VE	ab 5 VE 10%
5455	15 x 22 cm	(Pal. 200) 500	19.50	17.55
5456	18 x 26 cm	(Pal. 160) 500	24.10	21.65
5428	22 x 32 cm	(Pal. 800) 100	12.95	11.65



Spitzenpapier oval

Barockmuster, weiss

Artikel-Nr.	Produktinfo	Inhalt /VE	Preis /VE	ab 5 VE 10%
10839	27 x 17 cm	(Pal. 1440) 100	13.40	12.05



Spitzenpapier oval

Blütenmuster, weiss

Artikel-Nr.	Produktinfo	Inhalt /VE	Preis /VE	ab 5 VE 10%
5420	50 x 30 cm	(Pal. 192) 250	52.20	47.00



Spitzenpapier rechteckig Gastronorm

Blütenmuster, weiss

Artikel-Nr.	Produktinfo	Inhalt /VE	Preis /VE	
5430.1	47 x 31 cm, fett dicht	100	15.50	netto
5429	53 x 32.5 cm	2000	394.00	354.60

Spitzen-Decoretten



Spitzen-Decoretten rund

Rosenmuster, weiss

Artikel-Nr.	Produktinfo	Inhalt /VE	Preis /VE	ab 5 VE 10%
5446	18 cm	(Pal. 500) 500	37.50	33.75



Spitzen-Decoretten rund

Barockmuster, weiss

Artikel-Nr.	Produktinfo	Inhalt /VE	Preis /VE	ab 5 VE 10%
5439	13 cm	(Pal. 1200) 500	26.05	23.45

Tellerunterlagen



Tellerunterlagen viereckig

16 x 16 cm, gezackter Rand, weiss, leichte Qualität

Artikel-Nr.	Produktinfo	Inhalt /VE	Preis /VE	ab 5 VE 10%
5101	Waffel	(Pal. 400) 1000	9.10	8.15
5116	Strahlen blau	(Pal. 400) 1000	13.10	11.75
5115	Strahlen gelb	(Pal. 400) 1000	13.10	11.75
5118	Strahlen grün	(Pal. 400) 1000	13.10	11.75
5110	Strahlen orange	(Pal. 400) 1000	13.10	11.75
5119	Strahlen rot	(Pal. 400) 1000	13.10	11.75
27290	Strahlen schwarz	(Pal. 400) 1000	13.10	11.75



Tellerunterlagen viereckig

gezackter Rand, Kroko-Prägung, weiss, 40 g/m²

Artikel-Nr.	Produktinfo	Inhalt /VE	Preis /VE	ab 5 VE 10%
5370	12 x 12 cm	(Pal. 120) 5000	56.80	51.10
7590	15 x 15 cm	(Pal. 60) 6000	81.10	73.00
7591	16 x 16 cm	(Pal. 50) 6000	94.40	85.00
5104	18 x 18 cm	(Pal. 32) 6000	119.50	107.55



Tellerunterlagen viereckig

Raisin-Prägung, weiss

Artikel-Nr.	Produktinfo	Inhalt /VE	Preis /VE	ab 5 VE 10%
5370.1	12 x 12 cm	1000	12.55	11.30
7590.1	15.5 x 15.5 cm	1000	19.15	17.25
7591.1	17 x 17 cm	1000	19.55	17.60

Tassen- und Gläserunterlagen | Tela



Gläserunterlagen Tela rund

8.5 cm, 6-lagig

Artikel-Nr.	Produktinfo	Inhalt /VE	Preis /VE	Preis ab 8 VE
14672	weiss	(Pal. 128) 1600	125.60	109.25
14674	bordeaux	(Pal. 128) 1600	125.60	109.25
14675	dunkelblau	(Pal. 128) 1600	125.60	109.25
14676	gelb	(Pal. 128) 1600	125.60	109.25

Tassen- und Gläserunterlagen | Papier



Gläserunterlagen, rund

8.5 cm, Papier, 1-lagig

Artikel-Nr.	Produktinfo	Inhalt /VE	Preis /VE	
5479	weiss, Krepp-Prägung	1000	12.70	netto



Gläserunterlagen rund

Papier, 1-lagig, Kroko-Prägung, weiss

Artikel-Nr.	Produktinfo	Inhalt /VE	Preis /VE	ab 5 VE 10%
5480	8.5 cm	(Pal. 2200) 500	4.55	4.10
5482.2	9.5 cm	500	4.95	4.45



Gläserunterlagen rund

9 cm, Papier, 1-lagig

Artikel-Nr.	Produktinfo	Inhalt /VE	Preis /VE	ab 5 VE 10%
7592	weiss, Nadel-Prägung	(Pal. 960) 1000	7.65	6.90
5483	Rote Rose	(Pal. 960) 1000	9.85	8.85



Tassen- und Gläserunterlagen | Papier



Gläserunterlagen rund

9,5 cm

Artikel-Nr.	Produktinfo	Inhalt /VE	Preis /VE	ab 5 VE 10%
5482.1	weiss, Raisin-Prägung	1000	10.20	9.20

Tassen- und Gläserunterlagen | Zellstoff



Gläserunterlagen rund

9 cm, 7-lagig, Papier

Artikel-Nr.	Produktinfo	Inhalt /VE	Preis /VE	ab 5 VE 10%
4490.1	weiss, Sterne-Punkte-Prägung	(Pal. 80) 1500	22.15	19.90



Gläserunterlagen rund

9 cm, 7-lagig, Zellstoffwatte



Artikel-Nr.	Produktinfo	Inhalt /VE	Preis /VE	ab 5 VE 10%
5490.1	weiss, Blumenprägung	250	12.60	11.35



Gläserunterlagen eckig

9,5 x 9,5 cm, 9-lagig, Zellstoffwatte



Artikel-Nr.	Produktinfo	Inhalt /VE	Preis /VE	ab 5 VE 10%
22996	schwarz	(Pal. 192) 1000	37.80	netto



Gläserunterlagen rund

9 cm, 7-lagig, Zellstoffwatte



Artikel-Nr.	Produktinfo	Inhalt /VE	Preis /VE	ab 5 VE 10%
4492	weiss, Rand olivgrün	250	13.85	12.45
4493	weiss, Rand bordeaux	250	13.85	12.45



Gläserunterlagen rund

9 cm, 8-lagig, Zellstoffwatte



Artikel-Nr.	Produktinfo	Inhalt /VE	Preis /VE	ab 5 VE 10%
14418	weiss	(Pal. 160) 1500	23.65	netto

Kannenhalter / Eierwärmer



Kannenhalter

9-lagig, weiss, Zellstoffwatte



Artikel-Nr.	Produktinfo	Inhalt /VE	Preis /VE	ab 5 VE 10%
5501	5 x 8,5 cm, mit Blumenprägung	500	76.00	68.40
5508	6,5 x 10 cm, mit Blumenprägung	500	112.15	100.95
5507	5,5 x 9,5 cm, Randprägung	(Pal. 10) 600	114.00	102.60



Eierwärmer

9-lagig, weiss, Zellstoffwatte



Artikel-Nr.	Produktinfo	Inhalt /VE	Preis /VE	ab 5 VE 10%
5510	10,5 x 8,2 cm, Waffelprägung	(Pal. 24) 600	143.65	129.30

Tisch- und Servicezubehör | Zahnstocher



Starline Zahnstocher Starline

aus Holz, in Plastikhülle

Artikel-Nr.	Produktinfo	Inhalt /VE	Preis /VE	ab 5 VE 10%
7385	6.5 cm	5000	52.45	47.20



Starline Zahnstocher Starline

aus Holz, in Papierhülle

Artikel-Nr.	Produktinfo	Inhalt /VE	Preis /VE	ab 5 VE 10%
7387	6.5 cm	5000	52.45	47.20



Zahnstocher Kiel

aus Kunststoff, in Papierhülle

Artikel-Nr.	Produktinfo	Inhalt /VE	Preis /VE	
7382.1	4.5 cm	1000	19.75	netto

Tisch- und Servicezubehör | Salz- und Pfeffermühlen



Peugeot Pfeffermühle Nancy

Acrylglas, transparent

Artikel-Nr.	Produktinfo	Inhalt /VE	Preis /VE	
24238	12 cm	1	35.20	netto
24240	18 cm	1	38.55	netto



Peugeot Salzmühle Nancy

Acrylglas, transparent

Artikel-Nr.	Produktinfo	Inhalt /VE	Preis /VE	
24239	12 cm	1	35.20	netto
24241	18 cm	1	38.55	netto



Peugeot Pfeffermühle Paris

Buche gebeizt, chocolate

Artikel-Nr.	Produktinfo	Inhalt /VE	Preis /VE	
24232	12 cm	1	28.80	netto
24233	18 cm	1	33.80	netto
24234	22 cm	1	38.25	netto
24236	30 cm	1	52.50	netto
24237	40 cm	1	74.25	netto

Tisch- und Servicezubehör | Süsse Gästepräsente



Bonbons

3 kg, farbig assortiert

Artikel-Nr.	Inhalt /VE	Preis /VE	ab 5 VE 10%
6085	1	55.10	49.55



Bonbons Halsfeger

5 kg

Artikel-Nr.	Produktinfo	Inhalt /VE	Preis /VE	
26488	ca. 1380 Stück à 3.6 g	1	59.90	netto

Tisch- und Servicezubehör | Süsse Gästepräsente

Bonbons Cola Fröschli

5 kg

Artikel-Nr.	Produktinfo	Inhalt /VE	Preis /VE	
26487	ca. 830 Stück à 6 g	1	59.90	netto

Mentos Choco Caramel - Kaffeebeilage

2 kg

Artikel-Nr.	Inhalt /VE	Preis /VE	
28027	(Pal. 144) 476	28.80	netto

Tisch- und Servicezubehör | Flaschenrosetten

Starline Flaschen-Rosetten Starline

mit Beschriftungsfeld

Artikel-Nr.	Produktinfo	Inhalt /VE	Preis /VE	ab 5 VE 10%
5696	gold	100	18.90	17.00
5697	grün	(Pal. 160) 100	17.50	15.75
5699	rosa / gold	100	13.70	12.30

Tisch- und Servicezubehör | Für die jungen Gäste

Kindermalsets

100 Bestecktaschen, 100 Tischsets & 6 Farbstifte

Artikel-Nr.	Inhalt /VE	Preis /VE	
27882	(Pal. 40) 100	99.80	netto

Malstifte

8.5 cm, 6 Farben im Karton

Artikel-Nr.	Inhalt /VE	Preis /VE	
10360	10	16.00	netto

Hochstuhl Babyminder

H: 710 B: 490 T: 490 mm, 6 kg, stapelbar

Artikel-Nr.	Produktinfo	Inhalt /VE	Preis /VE	
24804	Kautschukholz natur	(Pal. 25) 1	108.65	netto
24805	Kautschukholz Nuss	(Pal. 25) 1	108.65	netto

Holz-Hochstuhl Traveller

Mit gepolstertem Sitz, beschichtetem und abwischbarem Stoffbezug, extragrosses Ess- und Spielbrett, Buchenholz.

Artikel-Nr.	Produktinfo	Inhalt /VE	Preis /VE	
13862	H: 87 B: 51 T: 63 cm, Sitzhöhe 55 cm	1	204.00	netto

Wickeltisch Trixi

Klappbar, gepolsterter Seitenschutz und Wickelfläche, aus massivem Buchenholz.

Artikel-Nr.	Produktinfo	Inhalt /VE	Preis /VE	
21586	H: 97 B: 56 T: 70 cm, Arbeitshöhe 91 cm	1	163.00	netto

Kinderüberraschung

assortiert

Artikel-Nr.	Produktinfo	Inhalt /VE	Preis /VE	
21634	Animal Island	100	26.00	netto
21649	Zug	100	26.00	netto



E. Weber & Cie AG
Zürich



Produktkatalog 18/19
catalogue des produits 18/19



**Wir führen eine grosse
Auswahl an Speisekarten.
Verlangen Sie unseren
Speisekarten-Katalog.**



Seite 3 / page 3



Seite 9 / page 9



Seite 17 / page 17



Seite 22 / page 22



Seite 25 / page 25



Seite 27 / page 27



Seite 30 / page 30

E . W e b e r & C i e A G Z ü r i c h



Industriestrasse 28
CH-8157 Dielsdorf
Tel. 044 870 87 00
Fax 044 870 87 20

Worbstrasse 97
CH-3074 Muri bei Bern
Tel. 031 950 20 80
Fax 031 950 20 88

Wildenerstrasse 5
CH-7270 Davos Platz
Tel. 081 410 61 40
Fax 081 410 61 41



Tisch- und Servicezubehör | Tischsteller



Kreidetafel

aus Holz Teak

Artikel-Nr.	Produktinfo	Inhalt /VE	Preis /VE	
21505	A4, 275 x 320 x 70 mm	1	24.85	netto
21504	A5, 200 x 230 x 60 mm	1	20.70	netto



Tischsteller ETOILE

aus Hartfolie, transparent

Artikel-Nr.	Produktinfo	Inhalt /VE	Preis /VE	
11544	A5, 148 x 210 x 0.8 mm	1	10.25	netto
13794	A6, 105 x 148 x 0.8 mm	1	8.20	netto



Tischsteller ACRYL

aus Acrylglas, transparent, beidseitig verwendbar

Artikel-Nr.	Produktinfo	Inhalt /VE	Preis /VE	
21515	A4, 210 x 297 x 2 mm	1	18.45	netto
13795	A5, 148 x 210 x 2 mm	1	17.45	netto
7312	A6, 105 x 148 x 2 mm	1	11.30	netto



Tischsteller ACRYL

Acrylglas, transparent

Artikel-Nr.	Produktinfo	Inhalt /VE	Preis /VE	
13792	A4, 210 x 297 x 2.5 mm	1	17.45	netto
13793	A5, 140 x 210 x 2 mm	1	12.30	netto
13798	A6, 105 x 148 x 2 mm	1	8.20	netto



Tischsteller ECO

Hartfolie, farblos, glanz

Artikel-Nr.	Produktinfo	Inhalt /VE	Preis /VE	
13502	2 x A6, 148 x 105 x 0.5 mm	1	4.00	netto
7313	2 x A7, 105 x 74 x 0.5 mm	1	2.55	netto



Kartenhalter

sehr robust, Drahtstärke 5 mm, Bodenplatte 100 x 100 mm und 6 mm Dicke, max. Fassungsvermögen 20 mm

Artikel-Nr.	Produktinfo	Inhalt /VE	Preis /VE	
13836	silber	1	28.00	netto
13837	schwarz	1	25.00	netto

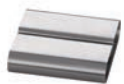

Kartenhalter

Edelstahl satiniert, max. Fassungsvermögen 2 - 3 mm

Artikel-Nr.	Produktinfo	Inhalt /VE	Preis /VE	
21517	80 x 78 x 18 mm	1	7.00	netto



Kreidemarker

weiss

Artikel-Nr.	Produktinfo	Inhalt /VE	Preis /VE	
21510	2 - 6 mm	1	5.20	netto
21512	7 - 15 mm	1	9.30	netto



Kreidemarker

farbig assortiert

Artikel-Nr.	Produktinfo	Inhalt /VE	Preis /VE	
21509	2 - 6 mm, Set à 8 Stück	1	36.25	netto
21511	7 - 15 mm, Set à 8 Stück	1	70.40	netto

Tisch- und Servicezubehör | Tischreiter



Tischreiter

Edelstahl satiniert mit Drucktext «Reserviert»

Artikel-Nr.	Produktinfo	Inhalt /VE	Preis /VE	
21531	120 x 40 x 1.5 mm	1	19.00	netto

Weitere Tischreiter auf Anfrage.



Tischreiter

silber eloxiert, mit Zifferngravur

Artikel-Nr.	Produktinfo	Inhalt /VE	Preis /VE	
21525*	60 x 60 mm	1	15.00	netto

Weitere Tischreiter auf Anfrage.



Tischreiter

gold eloxiert, mit Zifferngravur

Artikel-Nr.	Produktinfo	Inhalt /VE	Preis /VE	
21526*	60 x 60 mm	1	15.00	netto

Weitere Tischreiter auf Anfrage.

Tisch- und Servicezubehör | Esstätze



Latz Vlies Mank

neutral, weiss



Artikel-Nr.	Produktinfo	Inhalt /VE	Preis /VE	
11093	42 x 60 cm, 40 g/m ²	(Pal. 50) 100	39.45	netto



Latz Vlies Mank

neutral, weiss, zum Binden



Artikel-Nr.	Produktinfo	Inhalt /VE	Preis /VE	
16121	41.5 x 50 cm, 40 g/m ²	(Pal. 50) 100	39.45	netto



Latz Vlies Mank

42 x 60 cm, 40 g/m²



Artikel-Nr.	Produktinfo	Inhalt /VE	Preis /VE	
11090	Hummer, weiss	(Pal. 50) 200	78.95	netto
17704	Italia	(Pal. 50) 200	78.95	netto



Latz Dunicel

Marienkäfer

Artikel-Nr.	Produktinfo	Inhalt /VE	Preis /VE	
10754	40 x 60 cm	(Pal. 15) 400	261.60	netto

Tisch- und Servicezubehör | Diverses



Rondellen für Buttertöpfe

60 mm, weiss

Artikel-Nr.	Inhalt /VE	Preis /VE	ab 5 VE 10%
5916	500	18.30	16.45



Tischabfallbehälter

10.5 x 13.2 cm, weiss, ohne Deckel

Artikel-Nr.	Inhalt /VE	Preis /VE	ab 5 VE 10%
5145	1	9.00	8.10

Tisch- und Servicezubehör | Diverses

Einlagebeutel für Tischabfallbehälter

weiss, Polyethylen

Artikel-Nr.	Produktinfo	Inhalt /VE	Preis /VE	ab 5 VE 10%
5142	20 x 22 cm, 0.025 mm	2000	114.90	103.45

Tischabfallbehälter

matt steel

Artikel-Nr.	Produktinfo	Inhalt /VE	Preis /VE	
12852*	1 Liter, 14 x 16.5 cm	(Pal. 72) 4	119.60	netto

T-Pic Schale für Teebeutel

53 / 42 x 18 mm, transparent

Artikel-Nr.	Inhalt /VE	Preis /VE	ab 5 VE 10%
5132	(Pal. 50) 1000	93.90	84.50

Eierlöffel

13.5 cm, weiss, Plastik fest

Artikel-Nr.	Inhalt /VE	Preis /VE	ab 5 VE 10%
5133	50	41.20	37.10

Zitronennetzchen

Baumwolle

Artikel-Nr.	Inhalt /VE	Preis /VE	ab 5 VE 10%
5134	100	24.85	22.35

Citro-Feuchtservietten Starline

6 x 8 cm, weiss, im Sachtet

Artikel-Nr.	Inhalt /VE	Preis /VE	ab 5 VE 10%
7864	(Pal. 56) 1000	103.80	93.40

Gläserdeckel CAPS Mattkarton

250 g/m2, weiss



Artikel-Nr.	Produktinfo	Inhalt /VE	Preis /VE	
6016	Ø 6.9 cm	(Pal. 30) 1000	73.90	netto
17643	Ø 7.5 cm	(Pal. 30) 1000	73.90	netto
6835	Ø 8 cm	(Pal. 30) 1000	82.60	netto

weitere Grössen auf Anfrage.

Weinkühler

Acrylglas, für 500 ml Flaschen

Artikel-Nr.	Produktinfo	Inhalt /VE	Preis /VE	ab 5 VE 10%
5537	13 cm hoch, Ø 14 cm oben, Ø 9 cm unten	6	38.50	34.65

Weintropfenfänger Drop Stop

lose im Beutel

Artikel-Nr.	Inhalt /VE	Preis /VE	
7801	10	21.60	netto

Tisch- und Servicezubehör | Diverses



Aschenbecher

10 x 10 x 20 cm, silber, Aluminium

Artikel-Nr.	Produktinfo	Inhalt /VE	Preis /VE	ab 5 VE 10%
602	viereckig	(Pal. 162) 100	53.50	48.15



Aschenbecher

9 x 10 cm, gold / silber, Aluminium

Artikel-Nr.	Produktinfo	Inhalt /VE	Preis /VE	
600	rund	500	144.20	netto



Rindenscheibe

Erlenholz, lackiert und geschrumpft

Artikel-Nr.	Produktinfo	Inhalt /VE	Preis /VE	
26166	45 - 50 x 2 cm	1	23.15	netto
26167	50 - 60 x 2 cm	1	32.20	netto

Kerzen | Spitzkerzen



Spitzkerzen

23 x 245 mm, Brenndauer ca. 8 Stunden

Artikel-Nr.	Produktinfo	Inhalt /VE	Preis /VE	ab 5 VE 10%
5578	weiss	(Pal. 64) 100	57.60	51.85
5570	altrosa	(Pal. 64) 100	57.60	51.85
5571	bordeaux	(Pal. 64) 100	57.60	51.85
5573	champagner	(Pal. 64) 100	57.60	51.85
5577	rot	(Pal. 64) 100	57.60	51.85
5569	dunkelblau	(Pal. 64) 100	57.60	51.85
5582*	gelb	(Pal. 64) 100	57.60	51.85
5574	dunkelgrün	(Pal. 64) 100	57.60	51.85
5572*	apricot	(Pal. 64) 100	57.60	51.85
5579	terrakotta	(Pal. 64) 100	57.60	51.85

Spezialfarben auf Anfrage

Kerzen | Stumpenkerzen



Stumpenkerzen

58 x 100 mm

Artikel-Nr.	Produktinfo	Inhalt /VE	Preis /VE	ab 5 VE 10%
17815	champagner	(Pal. 266) 6	10.30	9.25
11364*	rot	(Pal. 266) 6	9.50	8.55
17816	weiss	(Pal. 266) 6	10.30	9.25

weitere Farben auf Anfrage.



Stumpenkerzen

58 x 130 mm

Artikel-Nr.	Produktinfo	Inhalt /VE	Preis /VE	ab 5 VE 10%
11283	weiss	(Pal. 288) 6	14.00	12.60

weitere Farben auf Anfrage.



Stumpenkerzen

68 x 150 mm

Artikel-Nr.	Produktinfo	Inhalt /VE	Preis /VE	ab 5 VE 10%
20296	champagner	(Pal. 190) 6	17.95	16.15

weitere Farben auf Anfrage.

Kerzen | Stumpenkerzen



Stumpenkerzen

68 x 200 mm

Artikel-Nr.	Produktinfo	Inhalt /VE	Preis /VE	ab 5 VE 10%
6470	weiss	(Pal. 160) 4	19.85	17.85
22960*	bordeaux	(Pal. 160) 4	19.85	17.85
18173	champagner	(Pal. 160) 4	19.85	17.85

weitere Farben auf Anfrage.



Stumpenkerzen

78 x 120 mm

Artikel-Nr.	Produktinfo	Inhalt /VE	Preis /VE	ab 5 VE 10%
13000	champagner	(Pal. 168) 4	14.00	12.60

weitere Farben auf Anfrage.



Stumpenkerzen

78 x 180 mm

Artikel-Nr.	Produktinfo	Inhalt /VE	Preis /VE	ab 5 VE 10%
18128	champagner	(Pal. 84) 6	32.75	29.45

weitere Farben auf Anfrage.



Stumpenkerzen

100 x 300 mm

Artikel-Nr.	Produktinfo	Inhalt /VE	Preis /VE	ab 5 VE 10%
29101	creme	(Pal. 45) 4	66.20	netto



Stumpenkerzen

80 x 200 mm

Artikel-Nr.	Produktinfo	Inhalt /VE	Preis /VE	ab 5 VE 10%
29100	creme	(Pal. 40) 12	72.45	netto



Stumpenkerzen

80 x 250 mm

Artikel-Nr.	Produktinfo	Inhalt /VE	Preis /VE	ab 5 VE 10%
6485	champagner	(Pal. 63) 6	46.90	42.20
6478	weiss	(Pal. 63) 6	46.90	42.20
22414*	rot	(Pal. 63) 6	46.90	42.20

weitere Farben auf Anfrage.



Stumpenkerzen

88 x 300 mm

Artikel-Nr.	Produktinfo	Inhalt /VE	Preis /VE	ab 5 VE 10%
18062	elfenbeinfarben	(Pal. 96) 3	34.35	30.90

weitere Farben auf Anfrage.



Stumpenkerzen ProfilLine

60 x 130 mm

Artikel-Nr.	Produktinfo	Inhalt /VE	Preis /VE	ab 5 VE 10%
24422	weiss	(Pal. 42) 6	14.00	12.60

* auf Bestellung

Kerzen | Rechaudkerzen



Rechaudkerzen

mit Alu-Hülse

Artikel-Nr.	Produktinfo	Inhalt /VE	Preis /VE	
5620	15 x 38 mm, Kerzen, Brenndauer ca. 4 Stunden	(Pal. 112) 180	28.65	netto
5621	13 x 38 mm, Kerzen, Brenndauer ca. 4 Stunden	(Pal. 24) 800	127.00	114.30
5674	20 x 38 mm, Brenndauer ca. 6 Stunden	(Pal. 24) 640	122.60	110.35
25717	24 x 38 mm, Brenndauer ca. 8 Stunden	(Pal. 32) 400	105.00	94.50

Rechaudkerzen «Maxi»

mit Alu-Hülse



Artikel-Nr.	Produktinfo	Inhalt /VE	Preis /VE	ab 5 VE 10%
5623	24 x 58 mm, Brenndauer ca. 10 Stunden	(Pal. 66) 100	59.50	53.55

Rechaudkerzen Profiline

mit Alu-Hülse



Artikel-Nr.	Produktinfo	Inhalt /VE	Preis /VE	ab 5 VE 10%
24966	20 x 38 mm, Brenndauer ca. 6 Stunden	(Pal. 60) 320	45.90	41.30

Rechaudkerzen Master-Lights

mit Alu-Hülse, mit blauem Docht



Artikel-Nr.	Produktinfo	Inhalt /VE	Preis /VE	ab 5 VE 10%
28801	28 x 46 mm, Brenndauer ca. 12 Stunden	(Pal. 60) 140	63.70	57.35

Kerzen | Diverse Kerzen

Partylichter



Partylichter

100 x 100 mm

Artikel-Nr.	Produktinfo	Inhalt /VE	Preis /VE	ab 5 VE 10%
5627	milchig	(Pal. 42) 10	55.20	49.70
5629	rot	(Pal. 42) 12	66.25	59.60



Partylichter

128 x 97 mm, Glas

Artikel-Nr.	Produktinfo	Inhalt /VE	Preis /VE	
16644	mit weissem Wachs	(Pal. 36) 12	44.90	netto
20256*	mit gelbem Wachs	(Pal. 36) 12	44.90	netto
20257*	mit orangem Wachs	(Pal. 36) 12	44.90	netto
20258	mit rotem Wachs	(Pal. 36) 12	44.90	netto

Geburtstagskerzen



Geburtstagskerzen

8 x 75 mm

Artikel-Nr.	Produktinfo	Inhalt /VE	Preis /VE	ab 5 VE 10%
27954	weiss	50	5.90	5.30



Tortenkerzenhalter

120 x 130 mm, Kunststoff

Artikel-Nr.	Produktinfo	Inhalt /VE	Preis /VE	
27955	weiss, für Art. 27954	100	2.70	netto

Kerzen | Diverse Kerzen

Geburtstagskerzen



Eisfontäne / Zaubersterne

rauchlos, mit Silbereffekten

Artikel-Nr.	Produktinfo	Inhalt /VE	Preis /VE	
3747.1	Brenndauer ca. 80 Sekunden	4	9.50	netto

Schwimmkerzen



Schwimmkerzen

50 mm

Artikel-Nr.	Produktinfo	Inhalt /VE	Preis /VE	ab 5 VE 10%
6493	weiss	60	45.70	41.10
17155*	orange	60	45.70	41.10
17156	rot	60	45.70	41.10

weitere Farben auf Anfrage.

Stabkerzen



Stabkerzen

22 x 200 mm

Artikel-Nr.	Produktinfo	Inhalt /VE	Preis /VE	
6492	rohweiss	200	84.50	netto

Tafelkerzen

21.5 x 180 mm



Artikel-Nr.	Produktinfo	Inhalt /VE	Preis /VE	ab 5 VE 10%
14918*	weiss	(Pal. 56) 120	64.20	57.80

LED-Kerzen



Duni LED Kerzenset Warm White

70 x 40 mm, aufladbar

Artikel-Nr.	Produktinfo	Inhalt /VE	Preis /VE	
23066*	12 weisse LEDs	1	120.00	netto



Duni LED Kerzenset Multicolour

70 x 40 mm, aufladbar

Artikel-Nr.	Produktinfo	Inhalt /VE	Preis /VE	
25376	12 LEDs in optionalen Farben	1	120.00	netto
27100	4 LEDs in optionalen Farben	1	60.00	netto



Duni LED Ersatzset Warm White

aufladbar

Artikel-Nr.	Produktinfo	Inhalt /VE	Preis /VE	
23067*	6 weisse LEDs	6	60.00	netto



Duni Kerzenhalter

140 x 75 mm, Metall, passend für LED-Kerzen

Artikel-Nr.	Produktinfo	Inhalt /VE	Preis /VE	
25377	schwarz	(Pal. 144) 4	24.00	netto
26052	weiss	(Pal. 144) 4	24.00	netto

* auf Bestellung

Kerzen | Kerzenzubehör

Manschetten



Kerzenmanschetten

100 mm

Artikel-Nr.	Produktinfo	Inhalt /VE	Preis /VE	ab 5 VE 10%
5640	weiss	(Pal. 200) 100	14.85	13.40



Kerzenmanschetten

100 mm, rund

Artikel-Nr.	Produktinfo	Inhalt /VE	Preis /VE	ab 5 VE 10%
10838	weiss	100	39.45	35.50

Lampenöl



Lampenöl für Leuchten

12 x 1 Liter

Artikel-Nr.	Inhalt /VE	Preis /VE	ab 5 VE 10%
5648	12	149.45	134.50

Rechazubehör | Brennpasten



Brennpaste Pyrogel

Dose à 95 ml

Artikel-Nr.	Inhalt /VE	Preis /VE	ab 5 VE 10%
5645	(Pal. 144) 30	44.35	39.90



Brennpaste Pyrogel

Dose à 200 g

Artikel-Nr.	Inhalt /VE	Preis /VE	ab 5 VE 10%
5646	(Pal. 54) 48	76.20	68.60



Brennpaste Pyrogel

5 kg Kanister

Artikel-Nr.	Inhalt /VE	Preis /VE	ab 5 VE 10%
5643	(Pal. 90) 1	24.10	21.70



Brennpaste Pyrogel

5 Liter Eimer

Artikel-Nr.	Inhalt /VE	Preis /VE	ab 5 VE 10%
5649	(Pal. 90) 1	24.10	21.70



Brennpaste Pyrogel

Flasche à 1 Liter

Artikel-Nr.	Inhalt /VE	Preis /VE	ab 5 VE 10%
5666	(Pal. 48) 12	69.35	62.40



Brennpaste Powerflame

Bio-Ethanol, flüssig, für Kamin

Artikel-Nr.	Produktinfo	Inhalt /VE	Preis /VE	ab 5 VE 10%
11683	10 Liter Kanister	1	57.00	51.30

Rechaudzubehör | Brennpastenzubehör

Alubecher leer



Artikel-Nr.	Inhalt /VE	Preis /VE	ab 5 VE 10%
5647	100	32.20	28.95

Rechaudzubehör | Hot & Safe



Brenn-Flüssigkeit - Hot & Safe

Brenndauer pro Füllung à 200 ml: 2 - 2.5 Stunden

Artikel-Nr.	Produktinfo	Inhalt /VE	Preis /VE	ab 5 VE 10%
5160	1 Liter	(Pal. 60) 12	103.00	92.70

Brenner mit Einsatz - Hot & Safe



Artikel-Nr.	Inhalt /VE	Preis /VE	ab 5 VE 10%
5161	1	14.90	netto

Fondue-Brenner - Hot & Safe



Artikel-Nr.	Inhalt /VE	Preis /VE	ab 5 VE 10%
5164	1	11.95	netto

Chafing Dish Set - Hot & Safe



Gestell und Deckel 18/0 und Einsätze 18/8 Chromnickelstahl, inkl. 1 Stück GN 1/1 Einsatz, 2 Stück GN 1/2 Einsätze, Wasserbadbehälter, 2 Brenner und 1 Flasche Brennflüssigkeit gratis!

Artikel-Nr.	Inhalt /VE	Preis /VE	ab 5 VE 10%
5165	1	128.50	netto

Diverses für den Service | Serviceblöcke



Service-Block Duplikat

50 x 2 Blatt

Artikel-Nr.	Produktinfo	Inhalt /VE	Preis /VE	ab 5 VE 10%
5702	weiss mit schwarzem Text	(Pal. 125) 40	73.95	66.55



Service-Block Triplikat

50 x 3 Blatt

Artikel-Nr.	Produktinfo	Inhalt /VE	Preis /VE	ab 5 VE 10%
5705	weiss mit schwarzem Text	(Pal. 100) 40	103.65	93.30



Blockhalter

115 x 175 mm, klein, mit Klemme

Artikel-Nr.	Produktinfo	Inhalt /VE	Preis /VE	ab 5 VE 10%
5708	schwarz	1	19.75	netto



Service-Block Triplikat

100 x 145 mm

Artikel-Nr.	Produktinfo	Inhalt /VE	Preis /VE	ab 5 VE 10%
11030	weiss	1	3.35	3.05
11049	grün	1	3.35	3.05
11050	blau	1	3.35	3.05
11051	rosa	1	3.35	3.05

Diverses für den Service | Serviceblöcke



Service-Block Duplikat

100 x 145 mm

Artikel-Nr.	Produktinfo	Inhalt /VE	Preis /VE	ab 5 VE 10%
11018	weiss	1	2.45	2.20
11019	blau	1	2.45	2.20
11020	rosa	1	2.45	2.20
11017	grün	1	2.45	2.20



Kassa-Block Duplikat

A6, 50 Blatt

Artikel-Nr.	Produktinfo	Inhalt /VE	Preis /VE	
24455	weiss	1	3.10	netto

Diverses für den Service | Bonblöcke / Couponblöcke / Gutscheine



Service-Laufbonblöcke 4-teilig

90 x 124 mm, 100 Blatt, perforiert

Artikel-Nr.	Produktinfo	Inhalt /VE	Preis /VE	ab 5 VE 10%
4350	weiss, Druck: Suppe - I. Gang - II. Gang - Dessert	10	64.55	58.10
4353	grün, Druck: Suppe - I. Gang - II. Gang - Dessert	10	64.55	58.10



Bonbücher Duplikat 4-teilig

92 mm, 300 Bons

Artikel-Nr.	Produktinfo	Inhalt /VE	Preis /VE	ab 5 VE 10%
5715	weiss	10	68.55	61.70
5710	blau	10	68.55	61.70
5711*	grün	10	68.55	61.70
5712	gelb	10	68.55	61.70
5714.1	rot	10	68.55	61.70



Couponblöcke Duplikat

Artikel-Nr.	Produktinfo	Inhalt /VE	Preis /VE	ab 5 VE 10%
5739	weiss	20	136.40	122.75



Geschenkgutschein

285 x 210 mm, mit Tischgedeck

Artikel-Nr.	Produktinfo	Inhalt /VE	Preis /VE	
21603	deutsch	25	35.00	netto
21604	französisch	25	35.00	netto



Geschenkgutschein

285 x 210 mm, mit Blumen

Artikel-Nr.	Produktinfo	Inhalt /VE	Preis /VE	
21605	deutsch	25	35.00	netto
21606	französisch	25	35.00	netto

Diverses für den Service | Service-Handschuhe



HYGOSTAR Baumwollhandschuhe

weiss

Artikel-Nr.	Produktinfo	Inhalt /VE	Preis /VE	ab 5 VE 10%
7980	Grösse M	(Pal. 750) 12	31.95	28.75
7980.1	Grösse L	(Pal. 450) 12	31.95	28.75

Diverses für den Service | Servietücher



Servietücher

47 x 60 cm, Halbleinen

Artikel-Nr.	Produktinfo	Inhalt /VE	Preis /VE	ab 5 VE 10%
4507	weiss mit roten Streifen	6	32.70	29.45
4508	weiss mit blauen Streifen	6	32.70	29.45



Servietücher Ecoline

47 x 90 cm, Halbleinen

Artikel-Nr.	Produktinfo	Inhalt /VE	Preis /VE	ab 5 VE 10%
4503	blau, kariert	6	44.85	40.35



Servietücher Picco

50 x 85 cm, Baumwolle, Waffelstruktur

Artikel-Nr.	Produktinfo	Inhalt /VE	Preis /VE	ab 5 VE 10%
4520	weiss	3	16.85	15.15

Diverses für den Service | Portemonnaies, Geldschein-Prüfer/-Zähler



Service-Abrechnungstasche

Skai-Leder

Artikel-Nr.	Produktinfo	Inhalt /VE	Preis /VE	
14657	25 x 18 cm, schwarz	1	9.55	netto



Serviceportemonnaie

Leder, mit Münzfach, 5 Scheinfächern, 1 Fach mit Reisverschluss, 1 Scheinfach separat und Öse für Kette

Artikel-Nr.	Produktinfo	Inhalt /VE	Preis /VE	
21535	10 x 17.5 cm, schwarz	1	63.00	netto



Serviceportemonnaie

Leder, mit Münzfach, 5 Scheinfächern und 1 Fach mit Reisverschluss

Artikel-Nr.	Produktinfo	Inhalt /VE	Preis /VE	
21534	9 x 17.5 cm, schwarz	1	49.00	netto

Weitere Portemonnaies finden Sie in unserem Hotwag-Katalog.



Serviertasche

Leder, 3 Fächer

Artikel-Nr.	Produktinfo	Inhalt /VE	Preis /VE	
21536	schwarz	1	29.00	netto



Rechnungsetui für Kreditkarten

Kunstleder

Artikel-Nr.	Produktinfo	Inhalt /VE	Preis /VE	
21500	13 x 23 cm, schwarz genarbt	1	12.00	netto



Rollmatic Schlüsselkette

51 cm

Artikel-Nr.	Inhalt /VE	Preis /VE	
13852	2	22.00	netto

Diverses für den Service | Portemonnaies, Geldschein-Prüfer/-Zähler



Safescan Münzzähler

220 Münzen pro Minute, mit Bündelfunktion

Artikel-Nr.	Produktinfo	Inhalt /VE	Preis /VE	
22754	für CHF	1	308.00	netto



Safescan Geldschein Prüfer

in 0.5 Sekunden Echtheit geprüft

Artikel-Nr.	Produktinfo	Inhalt /VE	Preis /VE	
22752	für CHF, EUR, GBP	1	153.00	netto



Safescan Banknoten Zähler

zählt 1000 Scheine pro Minute, mit Warmmeldung

Artikel-Nr.	Produktinfo	Inhalt /VE	Preis /VE	
22753	geeignet für alle Währungen	1	328.00	netto



Geldkassette

Stahlblech, versenkter Traggriff, herausnehmbarer Münzeinsatz, 2 Schlüssel

Artikel-Nr.	Produktinfo	Inhalt /VE	Preis /VE	
24178	262 x 195 x 82 mm, rot	(Pal. 200) 1	33.90	netto



Geldzählkassette

Stahl, versenkter Traggriff, herausnehmbarer Münz-Zähleinsatz, mit Füllmengenskala, 3-teiliges Notenfach, 2 Schlüssel

Artikel-Nr.	Produktinfo	Inhalt /VE	Preis /VE	
24179	300 x 242 x 106 mm, silbergrau	(Pal. 100) 1	144.00	netto



Geldzählkassette

ergonomischer Griff, herausnehmbarer Münzeinsatz, mit Mengenskala, 3-teiliges Notenfach

Artikel-Nr.	Produktinfo	Inhalt /VE	Preis /VE	
24180	300 x 242 x 102 mm, silbergrau	(Pal. 100) 1	213.00	netto

Diverses für den Service | Kassa- und Thermo-Rollen



Thermorolle

Ø 80 mm, 12.7 mm Kern, 80 mm Breite, 80 m Länge

Artikel-Nr.	Produktinfo	Inhalt /VE	Preis /VE	
4751.3	weiss	(Pal. 72) 30	142.20	netto



Kassenrolle

Ø 69 mm, 12.7 mm Kern, 76 mm Breite, 40 m Länge

Artikel-Nr.	Produktinfo	Inhalt /VE	Preis /VE	
4766	weiss	(Pal. 48) 50	105.55	netto



Kassenrolle

Ø 80 mm, 17 mm Kern, 76 mm Breite, 49 m Länge

Artikel-Nr.	Produktinfo	Inhalt /VE	Preis /VE	
21594*	weiss	50	74.60	netto

Diverses für den Service | Kassa- und Thermo-Rollen



Thermorolle

Ø 30 mm, 7.9 mm Kern, 57 mm Breite, 10 m Länge

Artikel-Nr.	Produktinfo	Inhalt /VE	Preis /VE	
20243	weiss	(Pal. 150) 24	28.15	netto



Thermorolle

Ø 40 mm, 7.5 mm Kern, 56.7 mm Breite, 19 m Länge

Artikel-Nr.	Produktinfo	Inhalt /VE	Preis /VE	ab 5 VE 10%
18725	weiss	(Pal. 150) 20	39.70	35.75



Thermorolle

Ø 45 mm, 12.7 mm Kern, 57 mm Breite, 24 m Länge

Artikel-Nr.	Produktinfo	Inhalt /VE	Preis /VE	ab 5 VE 10%
17972	weiss	(Pal. 190) 20	31.30	28.20



Thermorolle

Ø 60 mm, 12.7 mm Kern, 58 mm Breite, 44 m Länge

Artikel-Nr.	Produktinfo	Inhalt /VE	Preis /VE	
22120*	weiss	50	97.65	netto



Thermorolle

Ø 70 mm, 12.7 mm Kern, 79 mm Breite, 58 m Länge

Artikel-Nr.	Produktinfo	Inhalt /VE	Preis /VE	ab 5 VE 10%
17985*	weiss	(Pal. 36) 50	273.25	245.90



Thermorolle

Ø 74 mm, 12.7 mm Kern, 57 mm Breite, 70 m Länge

Artikel-Nr.	Produktinfo	Inhalt /VE	Preis /VE	ab 5 VE 10%
17984*	weiss	(Pal. 36) 50	193.55	174.20

Bar | Trinkhalme

Ungehülst



Trinkhalme Jumbo, ungehülst

schwarz

Artikel-Nr.	Produktinfo	Inhalt /VE	Preis /VE	
7627	150 x 8 mm	(Pal. 100) 1000	10.50	netto
7623	200 x 8 mm	(Pal. 80) 1000	11.30	netto
7631	250 x 8 mm	(Pal. 80) 1000	12.30	netto



Trinkhalme Jumbo, ungehülst

assortiert

Artikel-Nr.	Produktinfo	Inhalt /VE	Preis /VE	ab 5 VE 10%
7630	230 x 6 mm	1000	19.55	17.60
7633	250 x 8 mm	(Pal. 80) 1000	24.70	22.20



Trinkhalme Jumbo, ungehülst

250 x 8 mm, rot

Artikel-Nr.	Inhalt /VE	Preis /VE	ab 5 VE 10%
11036	150	4.20	3.80

* auf Bestellung

Bar | Trinkhalm

Ungehülst



Trinkhalm, ungehülst

240 x 5 mm, schwarz, flexibel

Artikel-Nr.	Inhalt /VE	Preis /VE	ab 5 VE 10%
7618	1000	22.70	20.40



Trinkhalm, ungehülst

210 x 5 mm, assortiert, flexibel

Artikel-Nr.	Inhalt /VE	Preis /VE	ab 5 VE 10%
7620	1000	22.70	20.40



Trinkhalm, ungehülst

240 x 5 mm, transparent gestreift, flexibel

Artikel-Nr.	Inhalt /VE	Preis /VE	ab 5 VE 10%
22284	1000	22.70	netto



Trinkhalm Mini, ungehülst

125 x 5 mm, assortiert

Artikel-Nr.	Inhalt /VE	Preis /VE	ab 5 VE 10%
7626	1000	22.50	20.25



Trinkhalm Ballermann, ungehülst

750 mm, pink oder gelb

Artikel-Nr.	Inhalt /VE	Preis /VE	ab 5 VE 10%
7628.1	(Pal. 360) 100	28.55	netto



Trinkhalm, ungehülst

220 x 4 mm, mit Löffel

Artikel-Nr.	Inhalt /VE	Preis /VE	ab 5 VE 10%
7617	50	12.90	netto

Einzel gehülst



Trinkhalm, einzeln gehülst

210 x 5 mm, weiss, flexibel

Artikel-Nr.	Inhalt /VE	Preis /VE	ab 5 VE 10%
7621	(Pal. 80) 1000	22.70	20.40



Trinkhalm, einzeln gehülst

240 x 5 mm, weiss gestreift, flexibel

Artikel-Nr.	Inhalt /VE	Preis /VE	ab 5 VE 10%
7622	1000	22.70	20.40



Trinkhalm, einzeln gehülst

220 x 3.3 mm, weiss

Artikel-Nr.	Inhalt /VE	Preis /VE	ab 5 VE 10%
7624	(Pal. 224) 1000	14.55	13.10

Bar | Cocktail - Stirrer und Sticks



Cocktail-Sticks

Allespicker «Bohne», 90 mm, bunt

Artikel-Nr.	Inhalt /VE	Preis /VE	ab 5 VE 10%
5515	1000	17.25	15.55



Cocktail-Sticks

Party-Frills, Holzspiessli mit farbigen Fransen, 70 mm, bunt

Artikel-Nr.	Inhalt /VE	Preis /VE	ab 5 VE 10%
5517	1000	10.90	9.80



Cocktail-Sticks

Prisma, 88 mm, schwarz

Artikel-Nr.	Inhalt /VE	Preis /VE	
23431	(Pal. 192) 1000	61.45	netto



Cocktail-Sticks

Prisma, transparent

Artikel-Nr.	Produktinfo	Inhalt /VE	Preis /VE	
24214	90 mm	1000	12.00	netto
24213	115 mm	1000	14.50	netto



Cocktail-Stirrer

Pfeil, 150 mm, Farben assortiert

Artikel-Nr.	Inhalt /VE	Preis /VE	ab 5 VE 10%
5541	1000	35.00	31.50



Cocktail-Stirrer

Apéro, 150 mm, rauchtropas

Artikel-Nr.	Inhalt /VE	Preis /VE	ab 5 VE 10%
5542	500	39.10	35.20



Cocktail-Stirrer

Longdrink, 220 mm, schwarz

Artikel-Nr.	Inhalt /VE	Preis /VE	
5548	500	32.25	netto



Cocktail-Stirrer

Schwert, 120 mm, Silber

Artikel-Nr.	Inhalt /VE	Preis /VE	ab 5 VE 10%
10990	100	18.85	16.95



Starline Cocktail-Stirrer Starline

Apéro, mit Stern, 170 mm, glasklar

Artikel-Nr.	Inhalt /VE	Preis /VE	ab 5 VE 10%
5558	500	73.45	66.10



Cocktail-Stirrer

Prisma, 190 mm, transparent

Artikel-Nr.	Produktinfo	Inhalt /VE	Preis /VE	ab 5 VE 10%
24203	190 mm	100	9.90	8.90

Bar | Coupefiguren



Coupefigur

Japan-Schirmchen, Farben assortiert

Artikel-Nr.	Produktinfo	Inhalt /VE	Preis /VE	
1603	9 cm	144	12.10	netto



Coupefigur

Folienpalme, Farben assortiert

Artikel-Nr.	Produktinfo	Inhalt /VE	Preis /VE	
1602	17/10 cm	100	12.60	netto



Coupefigur

Windrädchen, bunt

Artikel-Nr.	Produktinfo	Inhalt /VE	Preis /VE	
1618	22/6 cm	100	15.70	netto



Schweizerfähnchen am Zahnstocher

rot / weiss

Artikel-Nr.	Produktinfo	Inhalt /VE	Preis /VE	ab 5 VE 10%
1601	ca. 25 x 38 mm	100	2.35	2.10

Gläser



Kelch-Gläser	56
Becher	59
Dekanter, Wein- und Wasserkrüge	63
Dessert- und Coupes-Gläser	64
Einmachgläser	65
Vasen	66
Ascher	66

Kelch-Gläser | DOC (Kristall)



Weinkelch DOC

182 / 79 mm



Artikel-Nr.	Produktinfo	Inhalt /VE	Preis /VE	Preis ab 10 VE
13100*	41 cl	24	144.40	130.00
21222*	41 cl, 1dl geeicht	24	150.25	135.20



Weinkelch DOC

174 / 73 mm



Artikel-Nr.	Produktinfo	Inhalt /VE	Preis /VE	Preis ab 10 VE
13101*	31 cl	24	113.55	102.20
13102*	31 cl, 1 dl geeicht	24	129.00	116.10
13103	31 cl, 2 dl geeicht	24	129.00	116.10



Weinkelch DOC

155 / 65 mm



Artikel-Nr.	Produktinfo	Inhalt /VE	Preis /VE	Preis ab 10 VE
13104*	21.5 cl	24	95.35	85.80
13105*	21.5 cl, 1 dl geeicht, Sommelier	24	113.55	102.20
13106*	21.5 cl, 2 + 4 cl geeicht, Sommelier	24	114.95	103.50



Weinkelch DOC

136 / 54 mm



Artikel-Nr.	Produktinfo	Inhalt /VE	Preis /VE	Preis ab 10 VE
13107*	12 cl	24	92.55	83.30
13108*	12 cl, 1 dl geeicht	24	107.95	97.15
13109*	12 cl, Filet weiss 2 + 4 cl	24	127.60	114.85

Kelch-Gläser | Viticole



Weinkelch Viticole

175 / 72 mm



Artikel-Nr.	Produktinfo	Inhalt /VE	Preis /VE	Preis ab 10 VE
13062	31 cl	6	20.20	18.20
13063	31 cl, 1 dl geeicht	6	23.85	21.50



Weinkelch Viticole

155 / 65 mm



Artikel-Nr.	Produktinfo	Inhalt /VE	Preis /VE	Preis ab 10 VE
13064	21.5 cl	6	16.15	14.55
13065	21.5 cl, 1 dl geeicht	6	19.45	17.55
13066*	21.5 cl, Filet weiss 2 + 4 cl	6	25.35	22.80



Weinkelch Viticole

131 / 53 mm



Artikel-Nr.	Produktinfo	Inhalt /VE	Preis /VE	Preis ab 10 VE
13067	12 cl	24	61.70	55.55
13068	12 cl, 1 dl geeicht	24	77.85	70.05
13069*	12 cl, Filet weiss 2 + 4 cl	24	98.15	88.35

Kelch-Gläser | Weinland



Weinkelch Weinland

171 / 68 mm



Artikel-Nr.	Produktinfo	Inhalt /VE	Preis /VE	Preis ab 10 VE
17899*	23 cl	6	17.95	16.20

Kelch-Gläser | Weinland



Weinkelch Weinland

190 / 75 mm



Artikel-Nr.	Produktinfo	Inhalt /VE	Preis /VE	Preis ab 10 VE
17898*	29 cl	6	19.85	17.90



Weinkelch Weinland

195 / 79 mm



Artikel-Nr.	Produktinfo	Inhalt /VE	Preis /VE	Preis ab 10 VE
17897*	35 cl	6	22.25	20.00



Weinkelch Weinland

205 / 85 mm



Artikel-Nr.	Produktinfo	Inhalt /VE	Preis /VE	Preis ab 10 VE
17896	45 cl	6	24.10	21.70

Kelch-Gläser | Magnifique



Weinkelch Magnifique

210 / 90 mm



Artikel-Nr.	Produktinfo	Inhalt /VE	Preis /VE	Preis ab 10 VE
28831*	35 cl	24	66.75	60.05



Weinkelch Magnifique

227 / 97 mm



Artikel-Nr.	Produktinfo	Inhalt /VE	Preis /VE	Preis ab 10 VE
28830*	45 cl	24	66.75	60.05



Weinkelch Magnifique

224 / 104 mm



Artikel-Nr.	Produktinfo	Inhalt /VE	Preis /VE	Preis ab 10 VE
28829	55 cl	24	70.20	63.20

Kelch-Gläser | Amelia



Kelch Amelia

100 / 68 mm, stapelbar



Artikel-Nr.	Produktinfo	Inhalt /VE	Preis /VE	Preis ab 10 VE
13117*	16 cl	48	170.40	153.35



Kelch Amelia

105 / 72 mm, stapelbar



Artikel-Nr.	Produktinfo	Inhalt /VE	Preis /VE	Preis ab 10 VE
13116*	19 cl	48	176.25	158.65



Kelch Amelia

115 / 78 mm, stapelbar



Artikel-Nr.	Produktinfo	Inhalt /VE	Preis /VE	Preis ab 10 VE
13115*	25 cl	48	190.95	171.85

Kelch-Gläser | Napoli



Weinkelch Napoli

151 / 79 mm



Artikel-Nr.	Produktinfo	Inhalt /VE	Preis /VE	Preis ab 10 VE
13070*	30 cl	12	37.85	34.05



Weinkelch Napoli

140 / 70 mm



Artikel-Nr.	Produktinfo	Inhalt /VE	Preis /VE	Preis ab 10 VE
13071	24 cl	12	34.35	30.90
13072*	24 cl, 2 dl geeicht	12	36.45	32.80



Weinkelch Napoli

125 / 66 mm



Artikel-Nr.	Produktinfo	Inhalt /VE	Preis /VE	Preis ab 10 VE
13073	18 cl	12	31.55	28.40



Weinkelch Napoli

112 / 58 mm



Artikel-Nr.	Produktinfo	Inhalt /VE	Preis /VE	Preis ab 10 VE
13074	12 cl	12	30.15	27.15
13075*	12 cl, 1 dl geeicht	12	34.35	30.90



Likörkelch Napoli

88 / 47 mm



Artikel-Nr.	Produktinfo	Inhalt /VE	Preis /VE	Preis ab 10 VE
13076*	5 cl, Filet weiss 2 + 4 cl	12	42.10	37.90

Kelch-Gläser | Flûtes



Flûte Napoli

167 / 59 mm



Artikel-Nr.	Produktinfo	Inhalt /VE	Preis /VE	Preis ab 10 VE
13077*	17 cl	12	36.45	32.80



Flûte Napoli

157 / 56 mm



Artikel-Nr.	Produktinfo	Inhalt /VE	Preis /VE	Preis ab 10 VE
13078*	15 cl	12	36.45	32.80
13079*	15 cl, 1 dl geeicht	12	38.55	34.70



Flûte Elegance

180 / 48 mm



Artikel-Nr.	Produktinfo	Inhalt /VE	Preis /VE	Preis ab 10 VE
13178*	13 cl, 1 dl geeicht	48	202.70	182.45



Flûte Professional

178 / 50 mm



Artikel-Nr.	Produktinfo	Inhalt /VE	Preis /VE	Preis ab 10 VE
19082*	14 cl, 1 dl geeicht	6	15.10	13.60

Kelch-Gläser | Flûtes



Flûte Vinya 7

225 / 70 mm



Artikel-Nr.	Produktinfo	Inhalt /VE	Preis /VE	Preis ab 10 VE
16080	23 cl, 1 dl geeicht	6	55.25	49.70



Flûte Reims

157 / 55 mm



Artikel-Nr.	Produktinfo	Inhalt /VE	Preis /VE	Preis ab 10 VE
25447*	14.5 cl	12	20.05	18.05



Flûte Versailles

230 / 44 mm



Artikel-Nr.	Produktinfo	Inhalt /VE	Preis /VE	Preis ab 10 VE
17685*	16 cl	24	74.95	67.45

Becher | Granity



Becher Granity

175 / 95 mm



Artikel-Nr.	Produktinfo	Inhalt /VE	Preis /VE	Preis ab 10 VE
13125*	65 cl, 5 dl geeicht	6	30.85	27.75



Becher Granity

158 / 87 mm



Artikel-Nr.	Produktinfo	Inhalt /VE	Preis /VE	Preis ab 10 VE
13126*	46 cl, 4 dl geeicht	6	23.70	21.30



Longdrinkbecher Granity

140 / 73 mm



Artikel-Nr.	Produktinfo	Inhalt /VE	Preis /VE	Preis ab 10 VE
13127*	31 cl	6	13.20	11.90
13128*	31 cl, 2.5 dl geeicht	6	16.55	14.90



Longdrinkbecher Granity

120 / 83 mm



Artikel-Nr.	Produktinfo	Inhalt /VE	Preis /VE	Preis ab 10 VE
13129*	35 cl	6	27.15	24.45
13130	35 cl, 3 dl geeicht	6	16.15	14.55



Whiskybecher Granity

90 / 78 mm



Artikel-Nr.	Produktinfo	Inhalt /VE	Preis /VE	Preis ab 10 VE
16130*	27 cl	6	14.05	12.65
13131	27 cl, 2 dl geeicht	6	14.70	13.25



Becher Granity

75 / 68 mm



Artikel-Nr.	Produktinfo	Inhalt /VE	Preis /VE	Preis ab 10 VE
16131	16 cl	6	10.30	9.25
13132	16 cl, 1 dl geeicht	6	11.75	10.60

* auf Bestellung

Becher | Granity



Stamper Granity

58 / 48 mm



Artikel-Nr.	Produktinfo	Inhalt /VE	Preis /VE	Preis ab 10 VE
13133*	4.5 cl	48	64.65	58.15

Becher | Islande



Becher Islande fh

170 / 60 mm



Artikel-Nr.	Produktinfo	Inhalt /VE	Preis /VE	Preis ab 10 VE
13134*	36 cl	24	39.65	35.70
13135*	36 cl, Filet weiss 4 cl	24	77.85	70.05



Longdrinkbecher Islande fh

156 / 59 mm



Artikel-Nr.	Produktinfo	Inhalt /VE	Preis /VE	Preis ab 10 VE
13136*	33 cl, Filet weiss 4 cl	6	18.35	16.50



Becher Islande tubo fh

152 / 50 mm



Artikel-Nr.	Produktinfo	Inhalt /VE	Preis /VE	Preis ab 10 VE
13137*	22 cl, Filet weiss 4 cl	6	16.90	15.20
13138*	22 cl, Filet weiss 2 + 4 cl geeicht	6	16.90	15.20



Becher Islande fh

144 / 58 mm



Artikel-Nr.	Produktinfo	Inhalt /VE	Preis /VE	Preis ab 10 VE
13139*	29 cl, Filet weiss 4 cl	48	146.90	132.20



Stamper Islande

105 / 38 mm



Artikel-Nr.	Produktinfo	Inhalt /VE	Preis /VE	Preis ab 10 VE
13140*	6 cl	72	66.10	59.50
13141*	6 cl, Filet weiss 2 cl, 4 cl geeicht	72	171.85	154.70



Whiskybecher Islande

93 / 75 mm



Artikel-Nr.	Produktinfo	Inhalt /VE	Preis /VE	Preis ab 10 VE
17636*	30 cl	24	49.00	44.10
13142*	30 cl, Filet weiss 4 cl	24	79.30	71.40

Becher | Granada



Longdrinkbecher Granada

135 / 75 mm



Artikel-Nr.	Produktinfo	Inhalt /VE	Preis /VE	Preis ab 10 VE
28832*	34 cl	24	30.50	27.45



Becher Granada

108 / 75 mm



Artikel-Nr.	Produktinfo	Inhalt /VE	Preis /VE	Preis ab 10 VE
28833*	29 cl	24	29.65	26.70

Becher | Bowling



Apérobecher Bowling

147 / 66 mm



Artikel-Nr.	Produktinfo	Inhalt /VE	Preis /VE	Preis ab 10 VE
13080	35 cl, 3 dl geeicht	6	17.20	15.45
13081*	35 cl, Filet weiss 4 cl	6	22.45	20.20
13082*	35 cl, Filet weiss 2 + 4 cl geeicht	6	22.45	20.20



Becher Bowling

114 / 65 mm



Artikel-Nr.	Produktinfo	Inhalt /VE	Preis /VE	Preis ab 10 VE
13083	26 cl, 2 dl geeicht	6	17.20	15.45



Whiskybecher Bowling

92 / 73 mm



Artikel-Nr.	Produktinfo	Inhalt /VE	Preis /VE	Preis ab 10 VE
13085*	25 cl	6	15.10	13.60
13086*	25 cl, Filet weiss 4 cl	6	22.45	20.20

Becher | Nordland



Becher Nordland

134 / 62 mm



Artikel-Nr.	Produktinfo	Inhalt /VE	Preis /VE	Preis ab 10 VE
17688	28.5 cl, 2 dl geeicht	12	10.90	9.80



Becher Nordland

150 / 68 mm



Artikel-Nr.	Produktinfo	Inhalt /VE	Preis /VE	Preis ab 10 VE
17687	37.5 cl, 3 dl geeicht	12	16.20	14.60

Becher | Dayton



Bierbecher Dayton

153 / 51 mm



Artikel-Nr.	Produktinfo	Inhalt /VE	Preis /VE	Preis ab 10 VE
26986*	2 dl geeicht	6	13.85	12.45



Bierbecher Dayton

161 / 54 mm



Artikel-Nr.	Produktinfo	Inhalt /VE	Preis /VE	Preis ab 10 VE
26985*	2.5 dl geeicht	6	15.30	13.80



Bierbecher Dayton

170 / 57 mm



Artikel-Nr.	Produktinfo	Inhalt /VE	Preis /VE	Preis ab 10 VE
26984*	3 dl geeicht	6	14.30	12.85



Bierbecher Dayton

206 / 67 mm



Artikel-Nr.	Produktinfo	Inhalt /VE	Preis /VE	Preis ab 10 VE
26983*	5 dl geeicht	6	16.40	14.80

* auf Bestellung

Becher | Diverse



Becher Conique

124 / 77 mm



Artikel-Nr.	Produktinfo	Inhalt /VE	Preis /VE	Preis ab 10 VE
25442*	33 cl	48	90.00	81.00
27819*	33 cl, 3 dl geeicht	48	111.25	100.15



Longdrinkebecher Paneled

137 / 79 mm



Artikel-Nr.	Produktinfo	Inhalt /VE	Preis /VE	Preis ab 10 VE
17755*	35.5 cl	36	92.70	83.45



Becher Paneled

103 / 75 mm



Artikel-Nr.	Produktinfo	Inhalt /VE	Preis /VE	Preis ab 10 VE
17756*	26.5 cl	36	76.35	68.70

Becher | Heissgetränke-Gläser



Kafiflas Pilatus

140 / 66 mm



Artikel-Nr.	Produktinfo	Inhalt /VE	Preis /VE	Preis ab 10 VE
13149*	20 cl	12	33.05	29.75



Kaffeeglas Original

144 / 66 mm



Artikel-Nr.	Produktinfo	Inhalt /VE	Preis /VE	Preis ab 10 VE
16132*	20 cl	12	30.70	27.65



Becher Acapulco «Latte Macchiato»

150 / 78 mm



Artikel-Nr.	Produktinfo	Inhalt /VE	Preis /VE	Preis ab 10 VE
16133	28 cl	12	34.05	30.65



Teebecher mit Henkel

104 / 74 mm



Artikel-Nr.	Produktinfo	Inhalt /VE	Preis /VE	Preis ab 10 VE
13151	23 cl	6	13.60	12.25



Teebecher mit Henkel

90 / 72 mm



Artikel-Nr.	Produktinfo	Inhalt /VE	Preis /VE	Preis ab 10 VE
18331*	25 cl	36	75.50	67.95



Teetasse Casablanca

105 / 86 mm



Artikel-Nr.	Produktinfo	Inhalt /VE	Preis /VE	Preis ab 10 VE
26994*	27 cl	12	21.85	19.70

Becher | Heissgetränke-Gläser



Becher Latte Macchiato Casablanca

160 / 80 mm



Artikel-Nr.	Produktinfo	Inhalt /VE	Preis /VE	Preis ab 10 VE
25935*	35 cl	24	49.75	44.80

Dekanter, Wein- und Wasserkrüge



Budelle (R)



Artikel-Nr.	Produktinfo	Inhalt /VE	Preis /VE	Preis ab 10 VE
13156*	1 dl geeicht, 159 / 48 mm	6	94.85	85.35
13155*	2 dl geeicht, 193 / 59 mm	6	112.50	101.25
13154*	3 dl geeicht, 234 / 62 mm	6	131.70	118.50
13153*	5 dl geeicht, 272 / 78 mm	6	154.70	139.25



Budelle (F)



Artikel-Nr.	Produktinfo	Inhalt /VE	Preis /VE	Preis ab 10 VE
17037	1 dl geeicht, 155 / 46 mm	6	94.45	85.00
17033	2 dl geeicht, 185 / 60 mm	6	47.75	42.95
17034*	3 dl geeicht, 210 / 65 mm	6	58.10	52.30
18430	5 dl geeicht, 240 / 80 mm	6	90.55	81.50



Italienische Massflasche



Artikel-Nr.	Produktinfo	Inhalt /VE	Preis /VE	Preis ab 10 VE
13159*	2.5 dl geeicht, 190 / 68 mm	12	31.55	28.40
13158*	5 dl geeicht, 235 / 84 mm	12	41.40	37.25
13157	1 Liter geeicht, 262 / 108 mm	6	32.60	29.35



Karaffe Pisa



Artikel-Nr.	Produktinfo	Inhalt /VE	Preis /VE	Preis ab 10 VE
16136*	1 dl geeicht, 130 / 77 mm	12	67.40	60.70
16137*	2 dl geeicht, 163 / 93 mm	12	75.20	67.65
17236	3 dl geeicht, 70 / 96 mm	12	78.75	70.90
16138*	5 dl geeicht, 206 / 118 mm	6	49.20	44.30
16139*	1 Liter geeicht, 249 / 142 mm	6	72.80	65.50



Krug Aspen

225 / 130 mm



Artikel-Nr.	Produktinfo	Inhalt /VE	Preis /VE	Preis ab 10 VE
13161	1.3 Liter	6	34.90	31.40



Krug Tivoli

257 / 187 mm



Artikel-Nr.	Produktinfo	Inhalt /VE	Preis /VE	Preis ab 10 VE
16134	2.3 Liter	6	50.55	45.50

Dekanter, Wein- und Wasserkrüge

Weinkrug Ideal



Artikel-Nr.	Produktinfo	Inhalt /VE	Preis /VE	Preis ab 10 VE
22330*	1 dl geeicht, 96 / 65 mm	6	103.20	92.90
22331*	2 dl geeicht, 110 / 85 mm	6	108.60	97.75
22332*	3 dl geeicht, 128 / 85 mm	6	116.15	104.55
22333*	5 dl geeicht, 150 / 105 mm	6	131.35	118.25

Karaffe Atelier



Artikel-Nr.	Produktinfo	Inhalt /VE	Preis /VE	Preis ab 10 VE
20200*	1 dl geeicht, 133 / 56 mm	12	54.10	48.70
20199*	2 dl + 3 dl geeicht, 174 / 73 mm	12	61.80	55.60
20198*	5 dl geeicht, 225 / 90 mm	6	40.00	36.00
20197*	1 Liter geeicht, 280 / 108 mm	6	60.15	54.10

Karaffe Ypsilon



Artikel-Nr.	Produktinfo	Inhalt /VE	Preis /VE	Preis ab 10 VE
25924*	25 cl, 1 & 2 dl geeicht, 165 / 68 mm	12	73.05	65.75
25923*	55 cl, 3 & 5 dl geeicht, 204 / 84 mm	6	45.00	40.50
25922*	1 Liter, 1 Liter geeicht, 255 / 104 mm	6	56.90	51.20

Krug Acapulco

250 / 150 mm



Artikel-Nr.	Produktinfo	Inhalt /VE	Preis /VE	Preis ab 10 VE
26189*	1.9 Liter	8	126.55	113.90

Krug Ipanema

300 / 135 mm



Artikel-Nr.	Produktinfo	Inhalt /VE	Preis /VE	Preis ab 10 VE
26188*	2 Liter	8	143.65	129.30

Dessert- und Coupes-Gläser

Coupekelch Rock Bar

182 / 85 mm



Artikel-Nr.	Produktinfo	Inhalt /VE	Preis /VE	Preis ab 10 VE
22356*	38 cl	6	27.55	24.80

Coupekelch Sorbet



Artikel-Nr.	Produktinfo	Inhalt /VE	Preis /VE	Preis ab 10 VE
24108	21 cl, 71 / 99 mm	6	24.25	21.85
24113	38 cl, 95 / 117 mm	6	28.45	25.60

Coupekelch Caprice

145 / 129 mm



Artikel-Nr.	Produktinfo	Inhalt /VE	Preis /VE	Preis ab 10 VE
24230*	24 cl	12	56.25	50.60

Dessert- und Coupes-Gläser



Coupekelch Circée

hoch



Artikel-Nr.	Produktinfo	Inhalt /VE	Preis /VE	Preis ab 10 VE
24229*	27 cl, 169 / 110 mm	6	44.60	40.15



Coupekelch Circée

tief



Artikel-Nr.	Produktinfo	Inhalt /VE	Preis /VE	Preis ab 10 VE
24228*	25 cl, 107 / 141 mm	6	40.40	36.35



Coupekelch Elite Marguerita

144 / 116 mm



Artikel-Nr.	Produktinfo	Inhalt /VE	Preis /VE	Preis ab 10 VE
25445*	27 cl	6	35.40	31.90



Coupekelch Palmier

200 / 118 mm



Artikel-Nr.	Produktinfo	Inhalt /VE	Preis /VE	Preis ab 10 VE
26195*	37 cl	24	195.25	175.70



Coupekelch Primavera

140 / 135 mm



Artikel-Nr.	Produktinfo	Inhalt /VE	Preis /VE	Preis ab 10 VE
20356*	22 cl	6	28.35	25.55



Coupekelch Acapulco



Artikel-Nr.	Produktinfo	Inhalt /VE	Preis /VE	Preis ab 10 VE
26192*	30 cl, 125 / 116 mm	6	25.35	22.80
26191*	17.5 cl, 105 / 94 mm	6	20.70	18.60



Cocktailbecher Hurricane



Artikel-Nr.	Produktinfo	Inhalt /VE	Preis /VE	Preis ab 10 VE
25914*	44 cl, 210 / 77 mm	12	54.70	49.25
26194*	25 cl, 195 / 71 mm	24	117.15	105.40

Einmachgläser



Einmachglas Fido



Artikel-Nr.	Produktinfo	Inhalt /VE	Preis /VE	Preis ab 10 VE
13119*	20 cl, Höhe 85 mm, ø 85 mm	6	19.05	17.15
19084*	50 cl, Höhe 105 mm, ø 107 mm	6	20.05	18.05
23920*	100 cl, Höhe 153 mm, ø 110 mm	6	24.25	21.85
29041*	150 cl, Höhe 193 mm, ø 100 mm	6	28.75	25.85
29040*	300 cl, Höhe 242 mm, ø 140 mm	6	43.30	39.00

Vasen



Vase Ambiente

255 mm, zylindrisch

Artikel-Nr.	Inhalt /VE	Preis /VE	Preis ab 10 VE
14172*	8	96.00	86.40

Ascher



Ascher

rund, hell, transparent

Artikel-Nr.	Produktinfo	Inhalt /VE	Preis /VE	Preis ab 10 VE
13162	85 mm	24	38.45	34.60
13163	107 mm	24	49.65	44.70

Küche



Kapseln	68
Allzweckhandschuhe	69
Einweghandschuhe	70
Kochmützen	72
Schürzen	73
Diverses	73
Kaffeefilter	77
Pergament / Pergamin / Dauerfrischpapier	78
Backpapier	78
Folien	80
Beutel	84
Erste Hilfe	88

Kapseln | Praline- und Patisseriekapseln



Patisserie- und Pralinekapseln

braun, Pergamin



Artikel-Nr.	Produktinfo	Inhalt /VE	Preis /VE	ab 5 VE 10%
5830	24 x 16 mm	1000	10.70	9.60



Patisserie- und Pralinekapseln

braun, Pergamentersatz



Artikel-Nr.	Produktinfo	Inhalt /VE	Preis /VE	ab 5 VE 10%
16402*	45 x 25 mm	1000	15.60	netto



Patisserie- und Pralinekapseln

weiss, Pergamin



Artikel-Nr.	Produktinfo	Inhalt /VE	Preis /VE	ab 5 VE 10%
5829	24 x 16 mm	1000	11.00	9.90



Patisserie- und Pralinekapseln

weiss, Pergamentersatz



Artikel-Nr.	Produktinfo	Inhalt /VE	Preis /VE	ab 5 VE 10%
5836	28 x 16 mm	1000	14.05	12.65
5839	50 x 25 mm	(Pal. 200) 1000	19.80	17.85
5838	45 x 25 mm	1000	18.55	16.70
5841	60 x 27 mm	(Pal. 240) 1000	23.60	21.20



Patisseriekapseln

weiss, Pergamin, oval



Artikel-Nr.	Produktinfo	Inhalt /VE	Preis /VE	ab 5 VE 10%
5840	30 x 80 x 23 mm	1000	86.65	78.00



Savarinkapseln

transparent, PS



Artikel-Nr.	Produktinfo	Inhalt /VE	Preis /VE	ab 5 VE 10%
7666	90 x 76 x 25 mm	1000	98.65	88.80

Kapseln | Diplomat-Kapseln



Diplomat-Kapseln

weiss, A-PET, Dessert



Artikel-Nr.	Produktinfo	Inhalt /VE	Preis /VE	ab 5 VE 10%
5850	52 x 72 x 44 mm	(Pal. 42) 1000	145.75	131.20



Diplomat-Kapseln

weiss, A-PET «Diplast»



Artikel-Nr.	Produktinfo	Inhalt /VE	Preis /VE	ab 5 VE 10%
5849	38 x 56 x 30 mm	1000	64.35	57.90



Diplomat-Kapseln / Saucen- / Degustationsschale

weiss, aus PS, unzerbrechlich, Deckel: Art. 801



Artikel-Nr.	Produktinfo	Inhalt /VE	Preis /VE	ab 5 VE 10%
7667	57 x 33 mm, 57 ml	(Pal. 104) 1000	60.30	54.25

Kapseln | Diplomat-Kapseln



Flachdeckel zu Art. 7667

glasklar, aus PET



Artikel-Nr.	Produktinfo	Inhalt /VE	Preis /VE	
801	Ø 66 mm	(Pal. 40) 1000	80.15	netto



Diplomat-Kapseln

weiss, A-PET «Diplast»



Artikel-Nr.	Produktinfo	Inhalt /VE	Preis /VE	
10753	56 x 43.5 x 35 mm	1000	61.65	netto
5844	Ø 60 mm, Höhe: 44 mm	2000	155.45	netto

Allzweckhandschuhe



Allzweck-Handschuh Latex ECO 59

gelb



Artikel-Nr.	Produktinfo	Inhalt /VE	Preis /VE	
9725.1*	Grösse S	10	14.15	netto
9725*	Grösse M	(Pal. 240) 10	14.15	netto
9721	Grösse L	(Pal. 240) 10	13.50	netto
9721.1*	Grösse XL	10	14.15	netto



Allzweck-Handschuh Naturlatex Vileda Contract

gelb



Artikel-Nr.	Produktinfo	Inhalt /VE	Preis /VE	
8896	Grösse S (6.5-7)	(Pal. 2400) 1	1.75	netto
8898	Grösse M (7.5-8)	(Pal. 2400) 1	1.75	netto
8899	Grösse L (8.5-9)	(Pal. 2400) 1	1.75	netto
12241*	Grösse XL (9.5-10)	(Pal. 2400) 50	88.50	netto



HYGO STAR Allzweck-Handschuh Latex Bettina

gelb



Artikel-Nr.	Produktinfo	Inhalt /VE	Preis /VE	ab 5 VE 10%
7985	Grösse S	(Pal. 504) 12	24.85	22.35
7986	Grösse M	(Pal. 480) 12	24.85	22.35
7987	Grösse L	(Pal. 504) 12	24.85	22.35
7989	Grösse XL	(Pal. 504) 12	24.85	22.35



HYGO STAR Allzweck-Handschuh Latex Bettina

pink



Artikel-Nr.	Produktinfo	Inhalt /VE	Preis /VE	ab 5 VE 10%
5985	Grösse S	(Pal. 504) 12	21.80	19.65
5986	Grösse M	(Pal. 504) 12	21.80	19.65
5987	Grösse L	(Pal. 504) 12	21.80	19.65
5989	Grösse XL	(Pal. 504) 12	21.80	19.65



HYGO STAR Allzweck-Handschuh Latex Bettina

blau



Artikel-Nr.	Produktinfo	Inhalt /VE	Preis /VE	ab 5 VE 10%
16973	Grösse S	(Pal. 504) 12	21.80	19.65
16974	Grösse M	(Pal. 504) 12	21.80	19.65
16975	Grösse L	(Pal. 504) 12	21.80	19.65
16976	Grösse XL	(Pal. 504) 12	21.80	19.65

* auf Bestellung

Einweghandschuhe | Nitril gepudert



HYGOSTAR Nitril-Handschuhe CONTROL

blau, gepudert



Artikel-Nr.	Produktinfo	Inhalt /VE	Preis /VE	ab 5 VE 10%
7392	Grösse S	(Pal. 840) 100	9.60	8.65
7393	Grösse M	(Pal. 840) 100	9.60	8.65
7394	Grösse L	(Pal. 840) 100	9.60	8.65
7395	Grösse XL	(Pal. 840) 100	9.60	8.65

Einweghandschuhe | Nitril ungedudert



Nitril-Handschuhe Kolibri Premium

blau, puderfrei



Artikel-Nr.	Produktinfo	Inhalt /VE	Preis /VE	ab 5 VE 10%
21669	Grösse S	(Pal. 600) 100	9.10	8.20
21670	Grösse M	(Pal. 600) 100	9.10	8.20
21671	Grösse L	(Pal. 600) 100	9.10	8.20
21672	Grösse XL	(Pal. 600) 100	9.10	8.20



Nitril-Handschuhe Kolibri Sensitive

weiss, puderfrei



Artikel-Nr.	Produktinfo	Inhalt /VE	Preis /VE	ab 5 VE 10%
23990	Grösse S	(Pal. 540) 200	9.90	8.90
23991	Grösse M	(Pal. 540) 200	9.90	8.90
23992	Grösse L	(Pal. 540) 200	9.90	8.90
23993	Grösse XL	(Pal. 540) 180	9.90	8.90



Nitril-Handschuhe Semperguard Style

schwarz, puderfrei



Artikel-Nr.	Produktinfo	Inhalt /VE	Preis /VE	
23994	Grösse S	(Pal. 600) 100	9.90	netto
23995	Grösse M	(Pal. 600) 100	9.90	netto
23996	Grösse L	(Pal. 600) 100	9.90	netto
23997	Grösse XL	(Pal. 600) 90	9.90	netto



HYGOSTAR Nitril-Handschuhe SAFE LIGHT

blau, puderfrei



Artikel-Nr.	Produktinfo	Inhalt /VE	Preis /VE	ab 5 VE 10%
7396	Grösse S	(Pal. 840) 100	9.60	8.65
7397	Grösse M	(Pal. 840) 100	9.60	8.65
7398	Grösse L	(Pal. 840) 100	9.60	8.65
7399	Grösse XL	(Pal. 840) 100	9.60	8.65

Einweghandschuhe | Latex gepudert



Latex-Handschuhe Kolibri

weiss, gepudert



Artikel-Nr.	Produktinfo	Inhalt /VE	Preis /VE	ab 5 VE 10%
8646	Grösse S	(Pal. 660) 100	9.50	8.55
8637	Grösse M	(Pal. 660) 100	9.50	8.55
8639	Grösse L	(Pal. 600) 100	9.50	8.55
21666	Grösse XL	(Pal. 660) 100	9.50	8.55

Einweghandschuhe | Latex gepudert



HYGO STAR Latex-Handschuhe SKIN

weiss, gepudert



Artikel-Nr.	Produktinfo	Inhalt /VE	Preis /VE	ab 5 VE 10%
7958	Grösse S	(Pal. 480) 100	10.50	9.45
7938	Grösse M	(Pal. 630) 100	10.50	9.45
7939	Grösse L	(Pal. 630) 100	10.50	9.45
7964	Grösse XL	100	10.50	9.45

Einweghandschuhe | Latex ungepudert



Latex-Handschuhe Kolibri Premium

weiss, puderfrei



Artikel-Nr.	Produktinfo	Inhalt /VE	Preis /VE	ab 5 VE 10%
8634	Grösse S	(Pal. 600) 100	12.00	10.80
8633	Grösse M	(Pal. 600) 100	12.00	10.80
8635	Grösse L	(Pal. 600) 100	12.00	10.80
6929	Grösse XL	(Pal. 600) 100	12.00	10.80



HYGO STAR Latex-Handschuhe GRIP

weiss, puderfrei



Artikel-Nr.	Produktinfo	Inhalt /VE	Preis /VE	ab 5 VE 10%
7957.2	Grösse S	(Pal. 540) 100	13.50	12.15
7957	Grösse M	(Pal. 540) 100	13.50	12.15
7957.1	Grösse L	(Pal. 540) 100	13.50	12.15
7964.1	Grösse XL	(Pal. 540) 100	13.50	12.15



HYGO STAR Latex-Handschuhe DIABLO

schwarz, puderfrei



Artikel-Nr.	Produktinfo	Inhalt /VE	Preis /VE	ab 5 VE 10%
16714	Grösse S	100	14.50	13.05
16715	Grösse M	100	14.50	13.05
16716	Grösse L	100	14.50	13.05
16717	Grösse XL	100	14.50	13.05

Einweghandschuhe | Vinyl gepudert



Vinyl-Handschuhe Semperguard

weiss, gepudert



Artikel-Nr.	Produktinfo	Inhalt /VE	Preis /VE	ab 5 VE 10%
27587	Grösse S	100	10.50	netto
27588	Grösse M	100	10.50	netto
27589	Grösse L	100	10.50	netto
27590	Grösse XL	100	10.50	netto



HYGO STAR Vinyl-Handschuhe CLASSIC

weiss, gepudert



Artikel-Nr.	Produktinfo	Inhalt /VE	Preis /VE	ab 5 VE 10%
5936.1	Grösse S	(Pal. 480) 100	9.50	8.55
5938.1	Grösse M	(Pal. 480) 100	9.50	8.55
5939.1	Grösse L	100	9.50	8.55
7906.1	Grösse XL	(Pal. 480) 100	9.50	8.55

Einweghandschuhe | Vinyl ungepudert



Vinyl-Handschuhe Semperguard

transparent, puderfrei



Artikel-Nr.	Produktinfo	Inhalt /VE	Preis /VE	ab 5 VE 10%
27583	Grösse S	100	12.00	10.80
27584	Grösse M	100	12.00	10.80
27585	Grösse L	100	11.00	9.90
27586	Grösse XL	100	11.00	9.90



HYGOSTAR Vinyl-Handschuhe IDEAL

weiss, puderfrei



Artikel-Nr.	Produktinfo	Inhalt /VE	Preis /VE	ab 5 VE 10%
7356	Grösse S	100	9.00	8.10
7357	Grösse M	(Pal. 720) 100	9.00	8.10
7358	Grösse L	100	9.00	8.10
7359	Grösse XL	100	9.00	8.10

Einweghandschuhe | Polyethylen



Einweghandschuhe - Damengrösse

transparent, LD-PE, 0.018 mm, für einmaligen Gebrauch



Artikel-Nr.	Produktinfo	Inhalt /VE	Preis /VE	Preis ab 6 VE
7506	Grösse M	(Pal. 5000) 100	2.60	2.35



Einweghandschuhe - Herrengrösse

transparent, LD-PE, 0.018 mm, für einmaligen Gebrauch



Artikel-Nr.	Produktinfo	Inhalt /VE	Preis /VE	Preis ab 6 VE
7508	Grösse L	(Pal. 5000) 100	2.60	2.35

Kochmützen



HYGOSTAR HYGOSTAR Kochmützen Toque «Excellent»

Krepp-Papier, plissiert, verstellbar

Artikel-Nr.	Produktinfo	Inhalt /VE	Preis /VE	ab 5 VE 10%
5930	weiss, Höhe: 23 cm	(Pal. 64) 50	76.60	68.95



HYGOSTAR HYGOSTAR Kochmütze Toque «Standard»

Vliesstoff, offengelegt, verstellbar

Artikel-Nr.	Produktinfo	Inhalt /VE	Preis /VE	ab 5 VE 10%
5931	weiss	(Pal. 30) 50	80.40	72.35



HYGOSTAR HYGOSTAR Kochmütze «Europa» Standard

Saugstoffpapier, offengelegt

Artikel-Nr.	Produktinfo	Inhalt /VE	Preis /VE	ab 5 VE 10%
7862	weiss, Höhe: 20.5 cm	(Pal. 40) 250	276.60	248.95



HYGOSTAR HYGOSTAR Kochmütze «Europa» Extra

Viskose-Vlies, offengelegt

Artikel-Nr.	Produktinfo	Inhalt /VE	Preis /VE	ab 5 VE 10%
17289	weiss, Höhe: 22 cm	250	370.50	333.45

Kochmützen



HYGOSTAR HYGOSTAR Kochmütze Toque «Variabel»

Krepp-Papier, offengelegt, verstellbar

Artikel-Nr.	Produktinfo	Inhalt /VE	Preis /VE	ab 5 VE 10%
7940	weiss, Höhe 22 cm	(Pal. 30) 300	294.05	264.65



HYGOSTAR HYGOSTAR Kochmütze «Grand Chef»

Vliesstoff



Artikel-Nr.	Produktinfo	Inhalt /VE	Preis /VE	
7861	weiss, Höhe: 25 cm	(Pal. 84) 50	142.00	netto



HYGOSTAR HYGOSTAR Kochmütze mit Schweißband

Papier, luftdurchlässig, saugfähig

Artikel-Nr.	Produktinfo	Inhalt /VE	Preis /VE	ab 5 VE 10%
23536	schwarz, Höhe: 22 cm	250	281.25	253.10



HYGOSTAR HYGOSTAR Schiffchenmütze

Papier, perforiert, oben geschlossen

Artikel-Nr.	Produktinfo	Inhalt /VE	Preis /VE	netto
11100	weiss mit blauem Rand	(Pal. 760) 25	8.50	netto



HYGOSTAR HYGOSTAR Schiffchenmütze mit Schweißband

Papier, geprägt, oben geschlossen

Artikel-Nr.	Produktinfo	Inhalt /VE	Preis /VE	ab 5 VE 10%
20984	schwarz	(Pal. 78) 500	169.50	152.55

Schürzen



Latzschürzen

100% Baumwolle, 95 x 90 cm mit Latz

Artikel-Nr.	Produktinfo	Inhalt /VE	Preis /VE	ab 5 VE 10%
4510	weiss	2	45.10	40.60



Chefschürze

aus Baumwolle, 90 x 70 cm

Artikel-Nr.	Produktinfo	Inhalt /VE	Preis /VE	ab 5 VE 10%
4514	weiss	2	32.70	29.45



HYGOSTAR HYGOSTAR Latzschürze mit Bändern

LD-PE, zum einmaligen Gebrauch, weiss



Artikel-Nr.	Produktinfo	Inhalt /VE	Preis /VE	Preis ab 6 VE
5934	150 x 75 cm, 0.025 mm	50	21.55	19.40
5935	125 x 70 cm, 0.025 mm	(Pal. 360) 100	41.60	37.45

Diverses | Küchenschnüre



Traiteurschnur

für Poulet, Rollbraten und Spargel, weiss



Artikel-Nr.	Produktinfo	Inhalt /VE	Preis /VE	ab 5 VE 10%
5680	Knäuel à ca. 160 m, ca. 100 g	10	64.20	57.75

Diverses | Küchen- und Geschirrtücher



Geschirrtücher

45 x 85 cm, 185 g/m², Halbleinen

Artikel-Nr.	Produktinfo	Inhalt /VE	Preis /VE	ab 5 VE 10%
4504.1	blau / weiss	6	36.40	32.75
4504	rot / weiss	6	36.40	32.75
4504.2	grün / weiss	6	36.40	32.75



Geschirrtücher Top Line

45 x 90 cm, 215 g/m², 2-seitig gesäumt

Artikel-Nr.	Produktinfo	Inhalt /VE	Preis /VE	
16442	rot / weiss	6	43.60	netto
16443	blau / weiss	6	43.60	netto
16444	grün / weiss	6	43.60	netto
16218	gelb / weiss	6	43.60	netto



Geschirrtuch

40 x 60 cm, Mikrofaser

Artikel-Nr.	Produktinfo	Inhalt /VE	Preis /VE	
16409	blau / weiss	3	19.40	netto



Küchentorchon

45 x 85 cm, 290 g/m², 100 % Baumwollzwirn

Artikel-Nr.	Inhalt /VE	Preis /VE	ab 5 VE 10%
4501	6	49.65	44.70

Diverses | Dressiersäcke



HYGOSTAR HYGOSTAR Dressiersäcke

transparent, Kunststoff



Artikel-Nr.	Produktinfo	Inhalt /VE	Preis /VE	ab 5 VE 10%
5854	280 x 540 mm, 0.08 mm, Rolle à 100 Beutel	(Pal. 480) 1	76.85	69.20



HYGOSTAR HYGOSTAR Dressiersäcke HOT

rot, PE, 3-lagig



Artikel-Nr.	Produktinfo	Inhalt /VE	Preis /VE	ab 5 VE 10%
22167	280 x 590 mm, 0.12 mm, Rolle à 74 Beutel	5	183.45	165.10

Diverses | Manschetten



HYGOSTAR Manschetten für Geflügel



Artikel-Nr.	Produktinfo	Inhalt /VE	Preis /VE	ab 5 VE 10%
5691	9 mm	100	25.65	23.10
5692	14 mm	100	28.45	25.60
5693	16 mm	100	32.80	29.50
5694	25 mm	50	40.85	36.75

Diverses | Lebensmitteltücher



Lebensmitteltuch Gourmenta

weiss, 1-lagig



Artikel-Nr.	Produktinfo	Inhalt /VE	Preis /VE	Preis VE /Pal.
7883	79 x 59 cm, 10 kg	(Pal. 30) 1	62.95	58.15
7884	58 x 38 cm, 10 kg	(Pal. 36) 1	65.85	59.45
7885	58 x 38 cm, 18 kg	(Pal. 16) 1	118.45	106.95



Lebensmitteltuch Alimenta

weiss, 1-lagig, 100 % Zellstoff



Artikel-Nr.	Produktinfo	Inhalt /VE	Preis /VE	Preis VE /Pal.
4891	38 x 58 cm, 18 kg	(Pal. 32) 1	111.90	101.00
4892	59 x 79 cm, 10 kg	(Pal. 40) 1	61.15	55.20



Tork Lebensmitteltücher - W4 System

weiss, 2-lagig, Hybrid-Qualität, Einzeltücher



Artikel-Nr.	Produktinfo	Inhalt /VE	Preis /VE	Preis VE /Pal.
5898	28.5 x 32.5 cm, 200 Blatt	(Pal. 32) 1000	99.30	76.10

Diverses | Spiesse



Holzspiesse

10 cm / 2 mm



Artikel-Nr.	Inhalt /VE	Preis /VE	ab 5 VE 10%
5525	1000	11.30	10.15



Holzspiesse

12 cm / 3.8 mm



Artikel-Nr.	Inhalt /VE	Preis /VE	ab 5 VE 10%
5526	(Pal. 128) 1000	24.70	netto



Holzspiesse

20 cm / 3 mm



Artikel-Nr.	Inhalt /VE	Preis /VE	ab 5 VE 10%
5530	1000	21.65	19.50



Bambusspiesse

25 cm / 3 mm



Artikel-Nr.	Inhalt /VE	Preis /VE	ab 5 VE 10%
5531	(Pal. 3900) 100	2.30	2.10



Schaschlikspiesse

20 cm / 3 mm



Artikel-Nr.	Inhalt /VE	Preis /VE	ab 5 VE 10%
5529	1000	22.00	netto



Schaschlikspiesse

30 cm / 3 mm



Artikel-Nr.	Inhalt /VE	Preis /VE	ab 5 VE 10%
5524.1	200	8.05	7.25

Diverses | Spiesse



Zahnstocher

6.5 cm, Holz, rund, ungehült



Artikel-Nr.	Inhalt /VE	Preis /VE	ab 5 VE 10%
5512	5000	19.30	17.40



Stick Saigon

Apérospiess aus Bambus, gedreht, nature



Artikel-Nr.	Produktinfo	Inhalt /VE	Preis /VE	
24206*	60 mm	250	24.80	netto
24207	90 mm	250	24.80	netto
18532	105 mm	250	24.80	netto
24208*	120 mm	250	24.80	netto
24209*	150 mm	250	24.80	netto
24210*	180 mm	250	24.80	netto



Stick Tokyo

Apérospiess aus Bambus, nature



Artikel-Nr.	Produktinfo	Inhalt /VE	Preis /VE	
26547	120 mm	250	13.75	netto
26548*	140 mm	250	13.75	netto
27393*	180 mm	250	18.95	netto



Stick Saigon Twisted

Apérospiess aus Bambus, gedreht, nature / schwarz



Artikel-Nr.	Produktinfo	Inhalt /VE	Preis /VE	
26899*	120 mm	250	24.50	netto



Stick Mumbai

Apérospiess aus Bambus, gedreht, nature / schwarz



Artikel-Nr.	Produktinfo	Inhalt /VE	Preis /VE	
26900*	120 mm	250	24.50	netto



Stick Atami

Apérospiess aus Bambus, nature / schwarz / rot



Artikel-Nr.	Produktinfo	Inhalt /VE	Preis /VE	
28341	90 mm	250	15.55	netto



Stick Kyoto

Apérospiess aus Bambus, nature / rot



Artikel-Nr.	Produktinfo	Inhalt /VE	Preis /VE	
28342	90 mm	250	15.55	netto



Bambusspiesse «Fingerfood»

nature



Artikel-Nr.	Produktinfo	Inhalt /VE	Preis /VE	
66.1	120 mm	250	8.50	netto
28689	150 mm	250	10.15	netto
3752	180 mm	250	16.05	14.45
28692	200 mm	250	14.85	netto

Diverses | Diverses



Bäckerpinsel

3 cm



Artikel-Nr.	Inhalt /VE	Preis /VE	
5852	1	2.35	netto



HYGO STAR Passiertuch

75 x 75 cm, Vliesstoff



Artikel-Nr.	Inhalt /VE	Preis /VE	ab 5 VE 10%
4500	(Pal. 56) 100	230.55	207.50



Regeneriersalz Reosal Tabletten

25 kg

Artikel-Nr.	Inhalt /VE	Preis /VE	
8954	(Pal. 40) 1	36.90	netto



Regeneriersalz Reosal fein

Artikel-Nr.	Produktinfo	Inhalt /VE	Preis /VE	
10284	1 kg	(Pal. 80) 10	23.60	netto



Dispenser aus Kunststoff

transparent, H: 24 cm, Ø 7 cm



Artikel-Nr.	Produktinfo	Inhalt /VE	Preis /VE	
26544	708 ml	(Pal. 504) 6	24.00	netto



Aluminiumkapseln

silber



Artikel-Nr.	Produktinfo	Inhalt /VE	Preis /VE	ab 5 VE 10%
23666	35 x 80 mm	(Pal. 135) 180	39.55	35.60

Kaffee | Filter



Kaffee-Filtertüten Melitta



Artikel-Nr.	Produktinfo	Inhalt /VE	Preis /VE	ab 5 VE 10%
5655	Pa-Ho 220	100	63.75	57.35
5653.1	Pa-Ho 202/s	(Pal. 540) 100	14.85	13.35
5651.1	Pa-Ho 1 x 4	80	6.60	5.95
5654	Pa-Ho 206	200	130.65	117.60



Kaffee-Korbfilter Perrondo Sombrero

90 mm



Artikel-Nr.	Produktinfo	Inhalt /VE	Preis /VE	ab 5 VE 10%
5660	Pa 250	1000	91.05	81.95

weitere Größen auf Anfrage.

Kaffee | Reinigung



Reinigungstabletten für Kaffeemaschinen

Artikel-Nr.	Inhalt /VE	Preis /VE	
5236	100	24.00	netto

Kaffee | Reinigung



Ceragol Premium - Entkalkungsmittel für Kaffeemaschinen

Artikel-Nr.	Produktinfo	Inhalt /VE	Preis /VE	
12666	500 ml	(Pal. 60) 20	115.45	netto

Pergament / Pergamin / Dauerfrischpapier | Pergamentersatz



Pergamentersatz

weiss



Artikel-Nr.	Produktinfo	Inhalt /VE	Preis /VE	ab 5 VE 10%
5912	18 x 25 cm, 50 g/m2, 5,5 kg, ca. 2500 Blatt	(Pal. 50) 2500	41.65	37.50

Pergament / Pergamin / Dauerfrischpapier | Pergamin



Pergamin

gebleicht



Artikel-Nr.	Produktinfo	Inhalt /VE	Preis /VE	ab 5 VE 10%
5922	50 x 75 cm, 40 g/m2, ca. 600 Blatt	1	132.20	119.00



Pergamin

feinweiss gebleicht



Artikel-Nr.	Produktinfo	Inhalt /VE	Preis /VE	ab 5 VE 10%
11865	75 x 100 cm, 40 g/m2, ca. 500 Blatt	1	176.45	158.80

Pergament / Pergamin / Dauerfrischpapier | Diverse



Fleischwickler-Rolle

rosa



Artikel-Nr.	Produktinfo	Inhalt /VE	Preis /VE	
10766	50 cm x 400 m, 12,5 kg	1	92.30	netto

Backpapier | aus Silikon



Backpapier aus Silikon

weiss, Cutterbox



Artikel-Nr.	Produktinfo	Inhalt /VE	Preis /VE	ab 5 VE 10%
7916	50 cm x 200 m, 41 g/m2	(Pal. 96) 1	73.75	66.40



Backpapier aus Silikon



Artikel-Nr.	Produktinfo	Inhalt /VE	Preis /VE	ab 5 VE 10%
5918.1	50 x 75 cm, 8 kg, ca. 500 Blatt	500	116.20	104.55



Baktrennpapier silikonisiert

weiss



Artikel-Nr.	Produktinfo	Inhalt /VE	Preis /VE	
12971.1	60 x 40 cm, 5 kg, 41 g/m2, ca. 500 Blatt	1	55.30	netto

Backpapier | aus Silikon



Backpapier aus Silikon

Bogen



Artikel-Nr.	Produktinfo	Inhalt /VE	Preis /VE	ab 5 VE 10%
10686*	57 x 78 cm, 41 g/m ²	500	113.05	101.75



Backpapier aus Silikon

weiss, Cutterbox



Artikel-Nr.	Produktinfo	Inhalt /VE	Preis /VE	ab 5 VE 10%
5917	45 cm x 100 m, 41 g/m ²	(Pal. 120) 1	38.65	34.80



Backpapier aus Silikon, Backstar

braun, Cutterbox



Artikel-Nr.	Produktinfo	Inhalt /VE	Preis /VE	ab 5 VE 10%
5917.1	50 cm x 100 m, 41 g/m ²	(Pal. 168) 1	29.80	26.80



Backpapier aus Silikon

weiss



Artikel-Nr.	Produktinfo	Inhalt /VE	Preis /VE	ab 5 VE 10%
5919	45 x 65 cm, 41 g/m ² , 800 Blatt	1	265.95	239.35



Backpapier Backstar Profi Gastronorm 1/1

53 x 32.5 cm, 41 g/m²



Artikel-Nr.	Produktinfo	Inhalt /VE	Preis /VE	ab 5 VE 10%
12919	weiss	(Pal. 128) 300	48.05	43.25
17045	braun	(Pal. 128) 300	48.05	43.25



Backpapier Backstar Profi Gastronorm 2/1

braun



Artikel-Nr.	Produktinfo	Inhalt /VE	Preis /VE	ab 5 VE 10%
12920	64 x 52 cm, 41 g/m ²	(Pal. 52) 250	73.55	66.20



Backpapier Backstar ungebleicht



Artikel-Nr.	Produktinfo	Inhalt /VE	Preis /VE	ab 5 VE 10%
16839	39 cm x 8 m, 41 g/m ²	(Pal. 72) 24	85.70	77.15



Backpapier Bogen Bäckernorm

weiss



Artikel-Nr.	Produktinfo	Inhalt /VE	Preis /VE	ab 5 VE 10%
16459	40 x 60 cm, 41 g/m ²	500	80.65	72.60



Backpapier Backstar aus Silikon

braun



Artikel-Nr.	Produktinfo	Inhalt /VE	Preis /VE	ab 5 VE 10%
21865	33 x 42 cm, 41 g/m ² , 25 Bogen	(Pal. 180) 10	44.05	39.65

Folien | Aluminium



Aluminiumfolie

stark, in Rollen-Abreisskarton



Artikel-Nr.	Produktinfo	Inhalt /VE	Preis /VE	ab 5 VE 10%
27467	29.5 cm x 30 m, 0.012 mm	(Pal. 60) 30	235.10	211.55



Aluminiumfolie Alustar

in Rollen-Abreisskarton



Artikel-Nr.	Produktinfo	Inhalt /VE	Preis /VE	ab 5 VE 10%
17876	29 cm x 20 m, 0.0115 mm	(Pal. 150) 10	66.75	60.10



Aluminiumfolie Alustar

extrastark, in Rollen-Abreisskarton



Artikel-Nr.	Produktinfo	Inhalt /VE	Preis /VE	ab 5 VE 10%
7774	45 cm x 15 m, 0.018 mm	(Pal. 60) 10	81.20	73.10



Aluminiumfolie

stark, in Rollen-Abreisskarton



Artikel-Nr.	Produktinfo	Inhalt /VE	Preis /VE	ab 5 VE 10%
7777	29.5 cm x 150 m, 0.012 mm	(Pal. 48) 6	232.80	209.55
7777.9	29.5 cm x 150 m, 0.012 mm	1	38.80	netto



Aluminiumfolie

extrastark, in Rollen-Abreisskarton



Artikel-Nr.	Produktinfo	Inhalt /VE	Preis /VE	ab 5 VE 10%
7778	44 cm x 150 m, 0.018 mm	(Pal. 30) 6	392.50	353.25
7778.9	44 cm x 150 m, 0.018 mm	1	65.40	netto



Aluminiumfolie

in Rollen-Abreisskarton



Artikel-Nr.	Produktinfo	Inhalt /VE	Preis /VE	ab 5 VE 10%
25864	45 cm x 150 m, 0.012 mm	(Pal. 48) 6	132.45	119.20



Aluminiumfolie

ohne Cutterbox



Artikel-Nr.	Produktinfo	Inhalt /VE	Preis /VE	ab 5 VE 10%
7778.2	45 cm x 150 m, 0.012 mm	(Pal. 44) 3	99.75	89.75



Aluminiumfolie Alustar économique

extrastark, in Rollen-Abreisskarton



Artikel-Nr.	Produktinfo	Inhalt /VE	Preis /VE	ab 5 VE 10%
7779	44 cm x 45 m, 0.018 mm	(Pal. 30) 8	163.50	147.15



Aluminiumfolien-Zuschnitte für Baked Potatoes

silber, Dispenserkarton



Artikel-Nr.	Produktinfo	Inhalt /VE	Preis /VE	ab 5 VE 10%
7721	23 x 27 cm, 90 Blatt	(Pal. 968) 60	8.15	7.35

Folien | Aluminium



Aluminiumfolien-Zuschnitte für Baked Potatoes

gold, Dispenserkarton



Artikel-Nr.	Produktinfo	Inhalt /VE	Preis /VE	
7721.1	23 x 27 cm, 200 Blatt	(Pal. 378) 200	27.25	netto



Aluminiumfolie Alustar Gastronom

stark, in Rollen-Abreisskarton



Artikel-Nr.	Produktinfo	Inhalt /VE	Preis /VE	
28969	30 cm x 150 m, 0.013 mm	(Pal. 154) 1	24.80	netto



Aluminiumfolien Alustar

in Rollen-Abreisskarton



Artikel-Nr.	Produktinfo	Inhalt /VE	Preis /VE	ab 5 VE 10%
27879	45 cm x 150 m, 0.015 mm	(Pal. 112) 1	44.25	39.85



Backofeneinlagen Alustar

5 Folien



Artikel-Nr.	Produktinfo	Inhalt /VE	Preis /VE	ab 5 VE 10%
20948*	41 x 46 cm, 0.05 mm	(Pal. 99) 10	108.45	97.60

Folien | Frischhaltefolien

Perforiert



Frischhaltefolie perforiert

ca. 500 m, für Spender Art. 7741



Artikel-Nr.	Produktinfo	Inhalt /VE	Preis /VE	ab 5 VE 10%
7725	25 x 25 cm	(Pal. 72) 4	96.45	86.80
7730	30 x 30 cm	(Pal. 72) 3	86.80	78.10
7740	40 x 40 cm	(Pal. 72) 3	106.95	96.25
7745	45 x 45 cm	(Pal. 72) 3	118.60	106.75

Nicht-perforiert



Frischhaltefolie PVC

nicht perforiert



Artikel-Nr.	Produktinfo	Inhalt /VE	Preis /VE	ab 5 VE 10%
7748.1	29 cm x 30 m, 0.008 mm	(Pal. 96) 24	74.30	66.85



Frischhaltefolie

nicht perforiert, inkl. Einwegdispenser mit Zahnleiste



Artikel-Nr.	Produktinfo	Inhalt /VE	Preis /VE	ab 5 VE 10%
7750	30 cm x 300 m, 0.01 mm	(Pal. 240) 1	15.75	14.15
7755	45 cm x 300 m, 0.01 mm	(Pal. 288) 1	21.20	19.10



Frischhaltefolie PVC

nicht perforiert, für Wand-/Tischdispenser



Artikel-Nr.	Produktinfo	Inhalt /VE	Preis /VE	ab 5 VE 10%
7760	30 cm x 300 m, 0.01 mm, für Spender Art. 7761	(Pal. 108) 4	54.35	48.90
7765	45 cm x 300 m, 0.01 mm, für Spender Art. 7766	(Pal. 80) 4	76.80	69.10
7767	60 cm x 1500 m, 0.008 mm	(Pal. 35) 1	213.70	192.35

* auf Bestellung

Folien | Spender



Dispenser aus Metall

für alle perforierten Folien-Rollen

Artikel-Nr.	Produktinfo	Inhalt /VE	Preis /VE	
7741	grau	1	39.90	netto



Dispenser aus Metall

für 2 Rollen, 30 cm

Artikel-Nr.	Inhalt /VE	Preis /VE	
7771	1	35.45	netto



Dispenser aus Metall

für 2 Rollen, 45 cm

Artikel-Nr.	Inhalt /VE	Preis /VE	
7806*	1	66.75	netto



Dispenser aus Metall

für 29 cm breite Rollen, für Art. 7760

Artikel-Nr.	Inhalt /VE	Preis /VE	
7761	(Pal. 120) 1	29.25	netto



Dispenser aus Metall

für 45 cm breite Rollen, für Art. 7765

Artikel-Nr.	Inhalt /VE	Preis /VE	
7766	(Pal. 80) 1	58.65	netto

Folien | Jet-Cut System



Freshstar Jet-Cut Frischhaltefolie Nachfüllrolle PVC swiss made

für Spender Art. 17887



Artikel-Nr.	Produktinfo	Inhalt /VE	Preis /VE	
17888	30 cm x 500 m	(Pal. 30) 4	94.50	netto



Freshstar Jet-Cut Frischhaltefolie Nachfüllrolle PVC swiss made

für Spender Art. 17891



Artikel-Nr.	Produktinfo	Inhalt /VE	Preis /VE	
17892	45 cm x 500 m	(Pal. 42) 4	123.65	netto



Freshstar Jet-Cut Frischhaltefolie PVS swiss made



Artikel-Nr.	Produktinfo	Inhalt /VE	Preis /VE	
19346	30 cm x 40 m	(Pal. 120) 10	50.30	ab 5 VE 10% 45.30



Freshstar Jet-Cut Inox Dispenser

für Art. 17888



Artikel-Nr.	Produktinfo	Inhalt /VE	Preis /VE	
17887	inkl. 1 Rolle PVC-Folie, 30 cm x 500 m	(Pal. 192) 1	84.20	netto

Folien | Jet-Cut System



Freshstar Jet-Cut Inox Dispenser

für Art. 17892



Artikel-Nr.	Produktinfo	Inhalt /VE	Preis /VE	
17891	inkl. 1 Rolle PVC-Folie, 45 cm x 500 m	(Pal. 128) 1	97.55	netto

Folien | Wrapmaster System



Dispenser für Frischhaltefolien Wrapmaster

Artikel-Nr.	Produktinfo	Inhalt /VE	Preis /VE	
7786	30 cm, für Art. 7781	1	75.90	netto
7789	45 cm, für Art. 7782	1	81.35	netto



Frischhaltefolie für Wrapmaster



Artikel-Nr.	Produktinfo	Inhalt /VE	Preis /VE	
7781	30 cm x 300 m, für Spender Art. 7786	(Pal. 108) 3	55.40	netto
7782	45 cm x 300 m, für Spender Art. 7789	(Pal. 72) 3	75.80	netto

Folien | Cello-Folien



Cello-Folien für Fruchtekorb

transparent, Rolle



Artikel-Nr.	Produktinfo	Inhalt /VE	Preis /VE	ab 5 VE 10%
5777	100 cm x 50 m	1	119.15	107.25

Beutel | Vakuumbbeutel



Vakuumbbeutel

PA/PE 20/70, bis 90°C kochfest



Artikel-Nr.	Produktinfo	Inhalt /VE	Preis /VE	ab 5 VE 10%
4254	120 x 160 mm, 0.09 mm	1000	54.90	49.40
12464*	130 x 280 mm, 0.09 mm	1000	74.00	66.60
5810.2	140 x 200 mm, 0.09 mm	1000	85.30	76.75
4233	140 x 235 mm, 0.09 mm	1000	93.70	84.30
4242	145 x 200 mm, 0.09 mm	(Pal. 147) 1000	83.85	75.45
5822	150 x 200 mm, 0.09 mm	(Pal. 64) 1000	149.10	netto
16280	150 x 230 mm, 0.09 mm	(Pal. 80) 1000	105.00	94.50
4234	150 x 250 mm, 0.09 mm	1000	137.50	123.75
4236	150 x 300 mm, 0.09 mm	1000	171.90	154.70
11027	150 x 260 mm, 0.09 mm	1000	80.50	72.45
4240	155 x 175 mm, 0.09 mm	1000	84.60	76.15
4237	160 x 250 mm, 0.09 mm	(Pal. 80) 1000	150.00	135.00
5811	180 x 270 mm, 0.09 mm	1000	154.60	139.15
4239	200 x 250 mm, 0.09 mm	1000	157.75	141.95
5812	200 x 300 mm, 0.09 mm	(Pal. 54) 1000	189.00	170.10
4253	200 x 400 mm, 0.09 mm	1000	238.35	214.50
10720	250 x 300 mm, 0.09 mm	1000	170.75	153.70
4244	250 x 350 mm, 0.09 mm	(Pal. 54) 1000	275.00	247.50
4245	250 x 400 mm, 0.09 mm	1000	314.00	282.60
10721	260 x 360 mm, 0.09 mm	1000	206.60	185.95
5815	300 x 300 mm, 0.09 mm	1000	289.60	260.65
5814	300 x 400 mm, 0.09 mm	1000	396.75	357.10
4248	300 x 500 mm, 0.09 mm	500	235.95	212.35
10722	300 x 600 mm, 0.09 mm	500	185.35	166.85
5816	350 x 350 mm, 0.09 mm	(Pal. 78) 500	214.80	193.30
10723	350 x 400 mm, 0.09 mm	500	148.35	133.50
12425	350 x 500 mm, 0.09 mm	500	269.40	242.45
5858	400 x 500 mm, 0.09 mm	500	231.90	208.75
5817	400 x 600 mm, 0.09 mm	500	378.05	340.25
5824	400 x 400 mm, 0.09 mm	500	256.90	231.20
4824	400 x 700 mm, 0.09 mm	250	220.35	198.30
11281	500 x 600 mm, 0.09 mm	250	117.30	netto

weitere Größen auf Anfrage



Vakuumbbeutel

PA/PE 20/70, bis 115°C kochfest



Artikel-Nr.	Produktinfo	Inhalt /VE	Preis /VE	ab 5 VE 10%
29023	150 x 200 mm, 0.09 mm	1000	157.00	141.30
11314	200 x 300 mm, 0.09 mm	1000	285.45	256.90
11315	250 x 350 mm, 0.09 mm	1000	416.35	374.70
11316	300 x 400 mm, 0.09 mm	600	342.55	308.30
11317*	400 x 600 mm, 0.09 mm	600	482.80	434.50

weitere Größen auf Anfrage

Beutel | Kochbeutel



Kochbeutel

transparent, OPA/PP 15/75, bis 121°C kochfest



Artikel-Nr.	Produktinfo	Inhalt /VE	Preis /VE	ab 5 VE 10%
26677*	160 x 200 mm, 0.09 mm	1000	137.10	123.40
22406*	180 x 250 mm, 0.09 mm	1000	220.70	198.65

weitere Größen auf Anfrage

Beutel | Gefrierbeutel



Gefrierbeutel

transparent, mit Beschriftungsfeld + Verschlussstäbchen



Artikel-Nr.	Produktinfo	Inhalt /VE	Preis /VE	ab 5 VE 10%
5732	3 Liter, 24 x 36 cm, 0.032 mm, Rolle à 40 Beutel	(Pal. 72) 30	71.30	64.15
5733	4 Liter, 27 x 40 cm, 0.032 mm, Rolle à 40 Beutel	(Pal. 72) 30	91.15	82.05



Eiskugelbeutel

50 x 20 Beutel



Artikel-Nr.	Inhalt /VE	Preis /VE	
12086	(Pal. 170) 1000	80.95	netto

Beutel | Frischhaltebeutel



Frischhaltebeutel

HD-PE



Artikel-Nr.	Produktinfo	Inhalt /VE	Preis /VE	ab 5 VE 10%
5800	15 x 25 cm, 20 x 100 Beutel	2000	34.65	31.20
5801	20 x 30 cm, 25 x 100 Beutel	(Pal. 100) 2500	62.15	55.90

Beutel | Cellobbeutel



Cellobbeutel mit Kreuzboden

transparent



Artikel-Nr.	Produktinfo	Inhalt /VE	Preis /VE	ab 5 VE 10%
5755	80 x 130 mm	100	14.00	12.60
5756	85 x 170 mm	100	14.85	13.35
11799	95 x 155 mm	100	12.40	netto
5758	95 x 190 mm	100	14.25	netto
5757	105 x 170 mm	100	19.05	17.15
5759	115 x 185 mm	100	17.00	15.30
5760	115 x 230 mm	100	17.70	15.90
11800	125 x 200 mm	100	17.50	netto
5761	125 x 250 mm	100	21.05	18.95
11801	145 x 230 mm	100	19.45	netto
5763	145 x 300 mm	100	25.35	22.85
11803	165 x 265 mm	100	21.95	netto
5764	210 x 300 mm	100	33.90	30.50

Weitere Größen auf Anfrage.

Beutel | Seitenfaltbeutel

Papier



Wegglibeutel

weiss, Seitenfaltung



Artikel-Nr.	Produktinfo	Inhalt /VE	Preis /VE	ab 5 VE 10%
5787	Nr. 1: 5 x 23 cm + 12 cm, 40 g/m ²	(Pal. 72) 1000	57.05	51.35
5788	Nr. 2: 6 x 32 cm + 13 cm, 40 g/m ²	(Pal. 57) 1000	81.50	73.35
5789	Nr. 3: 7 x 36 cm + 16 cm, 40 g/m ²	(Pal. 36) 1000	97.05	87.35
5790	Nr. 4: 9 x 40 cm + 18 cm, 40 g/m ²	(Pal. 70) 500	62.95	56.65



Brotbeutel

weiss, Seitenfaltung



Artikel-Nr.	Produktinfo	Inhalt /VE	Preis /VE	ab 5 VE 10%
4535	8 x 28 cm + 18 cm, 500 g, rund	(Pal. 60) 1000	68.85	61.95
4537.1	11 x 42 cm + 25 cm, 1 kg, rund	(Pal. 50) 500	52.50	47.25
4536.1	7 x 52 cm + 20 cm, 1 kg, lang	(Pal. 42) 500	57.80	52.00

Beutel | Seitenfaltbeutel

Papier



Brotbeutel Baguette

weiss, Seitenfaltung



Artikel-Nr.	Produktinfo	Inhalt /VE	Preis /VE	netto
5791	7 x 48 cm + 10 cm	1000	51.80	



Sichtstreifenbeutel Baguette

weiss, Seitenfaltung



Artikel-Nr.	Produktinfo	Inhalt /VE	Preis /VE	ab 5 VE 10%
4549.1	5.5 x 52 cm + 12 cm	(Pal. 32) 1000	136.40	122.80



Sichtstreifenbeutel

weiss, Seitenfaltung, rund



Artikel-Nr.	Produktinfo	Inhalt /VE	Preis /VE	ab 5 VE 10%
4548.1	10 x 33 cm + 21 cm	(Pal. 40) 1000	145.20	130.65



Seitenfaltenbeutel Nr. 1

braun



Artikel-Nr.	Produktinfo	Inhalt /VE	Preis /VE	netto
4712	5 x 21 + 12 cm, 35 g/m2	(Pal. 88) 1000	34.80	



Seitenfaltenbeutel Nr. 2

braun



Artikel-Nr.	Produktinfo	Inhalt /VE	Preis /VE	netto
12456	6 x 30 cm + 14 cm, 35 g/m2	(Pal. 57) 1000	58.40	



Wegglibeutel Nr. 5

braun, aus Kraftpapier, Seitenfaltung



Artikel-Nr.	Produktinfo	Inhalt /VE	Preis /VE	ab 5 VE 10%
25121	9 x 47 cm + 20 cm, 40 g/m2	500	72.30	65.10

Pergamin



Pergaminbeutel

weiss, Seitenfaltung



Artikel-Nr.	Produktinfo	Inhalt /VE	Preis /VE	ab 5 VE 10%
4551	Nr. 1: 5 x 23 cm + 12 cm	(Pal. 100) 1000	70.60	63.55
4552	Nr. 2: 6 x 32 cm + 13.5 cm	(Pal. 64) 1000	89.70	80.75

Beutel | Brötchenbeutel PP



Brötchenbeutel

transparent, aus PP, mit Nadelperforation



Artikel-Nr.	Produktinfo	Inhalt /VE	Preis /VE	ab 5 VE 10%
5766	16 x 20 cm	(Pal. 84) 600	57.75	52.00
5773	18 x 35 cm	(Pal. 42) 2000	227.55	204.80
5767.1	20 x 29 cm	100	10.60	9.55
5769	24 x 35 cm	(Pal. 40) 500	70.50	63.45

Beutel | Brötchenbeutel PP



Brötchenbeutel, nicht geblockt

transparent, aus PP, mit Nadelperforation



Artikel-Nr.	Produktinfo	Inhalt /VE	Preis /VE	ab 5 VE 10%
14572	13 x 28 cm	(Pal. 96) 2400	74.15	66.75
12970	12 x 35 cm	2000	66.40	59.75

Beutel | Sandwichbeutel



Sandwichbeutel

transparent, aus PP, mit Nadelperforation



Artikel-Nr.	Produktinfo	Inhalt /VE	Preis /VE	ab 5 VE 10%
5754	12 x 28 cm	(Pal. 56) 600	46.50	41.85



Sandwichbeutel

ohne Aufdruck, aus Pergamin, Seitenfaltung



Artikel-Nr.	Produktinfo	Inhalt /VE	Preis /VE	ab 5 VE 10%
5768	4 x 26 cm + 9 cm	1000	66.20	netto



Sandwichbeutel Half & Half

weiss, mit Sichtfenster



Artikel-Nr.	Produktinfo	Inhalt /VE	Preis /VE	ab 5 VE 10%
14018	6 x 30.5 cm + 9 cm	(Pal. 30) 1000	94.05	netto



Sandwichbeutel

aus Pergamin, Seitenfaltung, 4 x 28 cm + 8 cm



Artikel-Nr.	Produktinfo	Inhalt /VE	Preis /VE	ab 5 VE 10%
10719	rot bedruckt	1000	45.00	40.50
10718	blau bedruckt	1000	45.00	40.50



Sandwichbeutel

natur, bedruckt, HD-PE, ohne Seitenfaltung



Artikel-Nr.	Produktinfo	Inhalt /VE	Preis /VE	ab 5 VE 10%
7680	12.5 x 29 cm + 2.5 cm	(Pal. 240) 500	21.05	18.95

Beutel | Diverses



Harassenbeutel

PE-lightplus, natur, mit Seitenfaltung

Artikel-Nr.	Produktinfo	Inhalt /VE	Preis /VE	Preis ab 6 VE
7709	60 / 40 x 70 cm cm, 0.011 mm	(Pal. 62) 500	60.05	56.95



Harassenbeutel

LD-PE, transparent

Artikel-Nr.	Produktinfo	Inhalt /VE	Preis /VE	ab 5 VE 10%
7556	100 x 75 cm, 0.03 mm	(Pal. 60) 250	103.45	93.10



Abdeckhauben für Trolleys

transparent

Artikel-Nr.	Produktinfo	Inhalt /VE	Preis /VE	ab 5 VE 10%
7389	37.5 x 19 cm + 77 cm	(Pal. 49) 100	76.25	netto

Erste Hilfe



Snögg Soft NEXT Pflasterrolle

Klebstoffreies Pflaster. Haftet nur an sich selbst. Latexfrei. Weich und elastisch. Absorbierend. Stoppt Blutungen. Haftet im Wasser. Atmungsaktiv.

Artikel-Nr.	Produktinfo	Inhalt /VE	Preis /VE	
25361	blau, 6 cm x 4.5 m	(Pal. 1536) 1	19.90	netto



Snögg Pflasterspender

inkl. 1 Rolle Snögg Soft NEXT blau

Artikel-Nr.	Produktinfo	Inhalt /VE	Preis /VE	
23481	16 x 9 x 16 cm	(Pal. 144) 1	59.00	netto



Snögg Burnshield Hydrogel

Absorbiert und leitet Wärme ab - minimiert Verbrennungsschäden. Kühlen - Schmerzlinderung und Schockreduktion. Nichthaftend - bleibt nicht an der Wunde kleben. Natürlich antibakteriell - reduziert Infektionsgefahr. Elastisch, dehn- und biegsam.

Artikel-Nr.	Produktinfo	Inhalt /VE	Preis /VE	
27897	125 ml	(Pal. 3072) 1	13.90	netto

Hotelkosmetik



Hotelkosmetik Starline	90
Hotelkosmetik und Accessoires ADA	92
Zimmerartikel Diverse	114
Kosmetiktücher	119
Seifen / Spender	122

Hotelkosmetik Starline | Shampoo / Bodylotion / Duschgel



Starline Shampoo Hair & Body Starline

300 ml, press + wash

Artikel-Nr.	Inhalt /VE	Preis /VE	
14532	(Pal. 42) 30	141.00	netto



Starline Shampoo Hair & Body Starline

40 ml, transparent, Flacon

Artikel-Nr.	Inhalt /VE	Preis /VE	ab 5 VE 10%
6146	(Pal. 136) 88	45.75	41.20



Starline Bath & Shower Gel Starline

30 ml, gelb-transparent, Flacon

Artikel-Nr.	Inhalt /VE	Preis /VE	ab 5 VE 10%
6126	(Pal. 120) 140	65.40	58.85



Starline Shampoo Hair & Body Starline

30 ml, transparent, Flacon

Artikel-Nr.	Inhalt /VE	Preis /VE	ab 5 VE 10%
25967	(Pal. 120) 140	80.85	72.75



Starline Bodylotion Starline

30 ml, transparent, Flacon

Artikel-Nr.	Inhalt /VE	Preis /VE	ab 5 VE 10%
6147	(Pal. 120) 140	82.00	73.80



Starline Shampoo Hair & Body Starline

10 ml, im Beutel

Artikel-Nr.	Inhalt /VE	Preis /VE	ab 5 VE 10%
6130	(Pal. 40) 600	97.50	87.75

Hotelkosmetik Starline | Seife



Starline Liquid Cream Soap Starline

300 ml, press + wash

Artikel-Nr.	Inhalt /VE	Preis /VE	
14533	(Pal. 42) 30	141.00	netto



Starline Seife Starline

20 g, weiss, im Plissé-Papier

Artikel-Nr.	Inhalt /VE	Preis /VE	ab 5 VE 10%
6125	(Pal. 72) 280	100.55	90.50



Starline Seife Starline

15 g, weiss, im Flowpack

Artikel-Nr.	Inhalt /VE	Preis /VE	ab 5 VE 10%
6110	(Pal. 40) 300	53.70	48.35

Hotelkosmetik Starline | Seife



Starline Seife Starline

20 g, weiss, in Kartonbox

Artikel-Nr.	Inhalt /VE	Preis /VE	
6118	(Pal. 45) 420	102.95	netto

Hotelkosmetik Starline | Accessoires



Starline Zahnbürsten-Set Starline

27 x 20 x 175 mm, weiss, in Kartonbox

Artikel-Nr.	Inhalt /VE	Preis /VE	ab 5 VE 10%
6193	(Pal. 36) 220	326.55	293.90



Starline Rasierset Starline

50 x 25 x 110 mm, weiss, in Kartonbox

Artikel-Nr.	Inhalt /VE	Preis /VE	ab 5 VE 10%
6194	(Pal. 42) 114	163.50	147.15



Starline Duschhaube Starline

im Plastikbeutel

Artikel-Nr.	Inhalt /VE	Preis /VE	ab 5 VE 10%
6150	(Pal. 125) 200	50.55	45.50



Starline Nähertui Starline

75 x 5 x 65 mm, in Kartonbox

Artikel-Nr.	Inhalt /VE	Preis /VE	ab 5 VE 10%
6181	(Pal. 72) 500	250.40	225.35



Starline Wattestäbchen Starline

4 Stück, Kartonbox

Artikel-Nr.	Inhalt /VE	Preis /VE	ab 5 VE 10%
6155	(Pal. 200) 100	33.85	30.45



Starline Nagelfeile Starline

Plastiketui

Artikel-Nr.	Inhalt /VE	Preis /VE	ab 5 VE 10%
6185	100	38.85	34.95



Starline Kamm Plastik Starline

160 mm, weiss

Artikel-Nr.	Inhalt /VE	Preis /VE	ab 5 VE 10%
6173	100	37.05	33.35



Starline Schuhputztuch Starline

im Sacht

Artikel-Nr.	Inhalt /VE	Preis /VE	ab 5 VE 10%
6172	(Pal. 60) 500	97.15	87.45

Hotelkosmetik Starline | Accessoires



Starline Schuh-Pflegeschwamm Starline

rund, Plastikdose

Artikel-Nr.	Inhalt /VE	Preis /VE	ab 5 VE 10%
6170	100	60.55	54.50



Starline Schuhlöffel Starline

200 mm, weiss

Artikel-Nr.	Inhalt /VE	Preis /VE	ab 5 VE 10%
6174	100	57.90	52.15



Starline Wäschebeutel Starline

400 x 530 mm, weiss, mit Kordel

Artikel-Nr.	Inhalt /VE	Preis /VE	ab 5 VE 10%
6161	(Pal. 40) 500	170.95	153.85



Starline Zündhölzer Starline

56 x 24 x 8 mm, Box weiss / gold

Artikel-Nr.	Produktinfo	Inhalt /VE	Preis /VE	ab 5 VE 10%
6158	Box à 11 Zündhölzer	100	18.05	16.25



Starline Kugelschreiber Starline

weiss / gold, Mine blau

Artikel-Nr.	Inhalt /VE	Preis /VE	ab 5 VE 10%
6159	50	37.95	34.15



Starline Flaschenöffner Starline

45 x 85 mm, transparent, Öffner silber, aus Plexi

Artikel-Nr.	Inhalt /VE	Preis /VE	ab 5 VE 10%
6157	(Pal. 140) 50	122.80	netto



Schuhputzhandschuh

weiss, Vlies



Artikel-Nr.	Inhalt /VE	Preis /VE	ab 5 VE 10%
6168	500	161.00	144.90

Hotelkosmetik und Accessoires ADA | wellness for body & mind

Pure Herbs



Liquid Soap PURE HERBS

300 ml, press + wash

Artikel-Nr.	Inhalt /VE	Preis /VE	ab 5 VE 10%
10057	(Pal. 42) 30	175.50	netto



Shampoo Hair & Body PURE HERBS

300 ml, press + wash

Artikel-Nr.	Inhalt /VE	Preis /VE	ab 5 VE 10%
10058	(Pal. 42) 30	175.50	netto

Hotelkosmetik und Accessoires ADA | wellness for body & mind

Pure Herbs



Liquid Soap PURE HERBS

300 ml, Smart Care System

Artikel-Nr.	Inhalt /VE	Preis /VE	
21446	(Pal. 48) 30	192.60	netto



Shampoo Hair & Body PURE HERBS

300 ml, Smart Care System

Artikel-Nr.	Inhalt /VE	Preis /VE	
21447	(Pal. 48) 30	192.60	netto



Shower Gel PURE HERBS

60 ml, Flacon

Artikel-Nr.	Inhalt /VE	Preis /VE	
6297	(Pal. 45) 160	108.80	netto



Shampoo PURE HERBS

60 ml, Flacon

Artikel-Nr.	Inhalt /VE	Preis /VE	
6299	(Pal. 45) 160	108.80	netto



Conditioner PURE HERBS

60 ml, Flacon

Artikel-Nr.	Inhalt /VE	Preis /VE	
6373*	(Pal. 45) 160	115.20	netto



Body Lotion PURE HERBS

60 ml, Flacon

Artikel-Nr.	Inhalt /VE	Preis /VE	
6338	(Pal. 45) 160	120.00	netto



Shower Gel PURE HERBS

35 ml, Flacon

Artikel-Nr.	Inhalt /VE	Preis /VE	
12939	(Pal. 63) 220	118.80	netto



Shampoo PURE HERBS

35 ml, Flacon

Artikel-Nr.	Inhalt /VE	Preis /VE	
12940	(Pal. 63) 220	118.80	netto



Conditioner PURE HERBS

35 ml, Flacon

Artikel-Nr.	Inhalt /VE	Preis /VE	
13088*	(Pal. 63) 220	123.20	netto

Hotelkosmetik und Accessoires ADA | wellness for body & mind

Pure Herbs



Body Lotion PURE HERBS

35 ml, Flacon

Artikel-Nr.	Inhalt /VE	Preis /VE	
13346	(Pal. 63) 220	127.60	netto



Shower Gel PURE HERBS

250 ml, Flacon

Artikel-Nr.	Inhalt /VE	Preis /VE	
12032	(Pal. 282) 6	26.70	netto



Shampoo PURE HERBS

250 ml, Flacon

Artikel-Nr.	Inhalt /VE	Preis /VE	
12033	(Pal. 282) 6	26.70	netto



Pflanzenseife PURE HERBS

50 g, weiss, im Soft Bag

Artikel-Nr.	Inhalt /VE	Preis /VE	
6339*	(Pal. 63) 150	120.00	netto



Pflanzenseife PURE HERBS

30 g, weiss, im Soft Bag

Artikel-Nr.	Inhalt /VE	Preis /VE	
14084	(Pal. 63) 200	100.00	netto



Pflanzenseife PURE HERBS

15 g, weiss, im Soft Bag

Artikel-Nr.	Inhalt /VE	Preis /VE	
13358	(Pal. 63) 500	105.00	netto



Badekristalle mit Kräutern PURE HERBS

50 g, weiss / grün, in Kartonbox

Artikel-Nr.	Inhalt /VE	Preis /VE	
6374	(Pal. 63) 122	191.55	netto



Bade-Teebeutel PURE HERBS

7 g, weiss / grün, im Sachet

Artikel-Nr.	Inhalt /VE	Preis /VE	
17384*	(Pal. 120) 100	114.00	netto



Vanity Set PURE HERBS

weiss / grün, in Kartonbox

Artikel-Nr.	Inhalt /VE	Preis /VE	
6347	(Pal. 36) 200	114.00	netto

Hotelkosmetik und Accessoires ADA | wellness for body & mind

Pure Herbs



Duschhaube PURE HERBS

weiss / grün, in Kartonbox

Artikel-Nr.	Inhalt /VE	Preis /VE	
6346	(Pal. 50) 250	82.50	netto



3-Flächen Polierfeile PURE HERBS

weiss / grün, in Kartonbox

Artikel-Nr.	Inhalt /VE	Preis /VE	
11521	(Pal. 81) 400	256.00	netto



Nähetui PURE HERBS

weiss / grün, in Kartonbox

Artikel-Nr.	Inhalt /VE	Preis /VE	
13010	(Pal. 70) 250	82.50	netto



Schuhputzschwamm PURE HERBS

weiss / grün, in Kartonbox

Artikel-Nr.	Inhalt /VE	Preis /VE	
14085*	(Pal. 63) 200	84.00	netto



Rasierset PURE HERBS

weiss / grün, in Kartonbox

Artikel-Nr.	Inhalt /VE	Preis /VE	
14087	(Pal. 70) 100	138.00	netto



Mundpflegeset PURE HERBS

weiss / grün, in Kartonbox

Artikel-Nr.	Inhalt /VE	Preis /VE	
14086	(Pal. 80) 100	130.00	netto



Wellness Set PURE HERBS «Saunakübel»

60 ml Energizing Shower Gel, 60 ml Vitalizing Shampoo, 60 ml Soothing Body Lotion, 1 Peeling-schwamm, 1 Bimsstein, 1 Massageschwamm, 1 Massageroller

Artikel-Nr.	Inhalt /VE	Preis /VE	
6953	(Pal. 66) 5	63.55	netto



Shampoo Hair & Body PURE HERBS

1 Liter-Nachfüllflasche

Artikel-Nr.	Inhalt /VE	Preis /VE	
12750	(Pal. 36) 9	85.40	netto



Gentle Liquid Soap PURE HERBS

1 Liter-Nachfüllflasche

Artikel-Nr.	Inhalt /VE	Preis /VE	
13022	(Pal. 36) 9	85.40	netto

Hotelkosmetik und Accessoires ADA | wellness for body & mind

Pure Herbs



Liquid Soap PURE HERBS

300 ml, Pumpspender

Artikel-Nr.	Inhalt /VE	Preis /VE	
16833	(Pal. 63) 24	124.55	netto



Hand & Body Lotion PURE HERBS

300 ml, Pumpspender

Artikel-Nr.	Inhalt /VE	Preis /VE	
17431*	(Pal. 63) 24	159.10	netto

Hydro Basics



Liquid Soap HYDRO Basics

300 ml, press + wash

Artikel-Nr.	Inhalt /VE	Preis /VE	
6355	(Pal. 42) 30	175.50	netto



Shampoo Hair & Body HYDRO Basics

300 ml, press + wash

Artikel-Nr.	Inhalt /VE	Preis /VE	
6354	(Pal. 42) 30	175.50	netto



Liquid Soap HYDRO Basics

300 ml, Smart Care System

Artikel-Nr.	Inhalt /VE	Preis /VE	
3798*	(Pal. 48) 30	192.60	netto



Liquid Soap HYDRO Basics

300 ml, mit Sichtstreifen, Smart Care System

Artikel-Nr.	Inhalt /VE	Preis /VE	
21444	(Pal. 48) 30	192.60	netto



Shampoo Hair & Body HYDRO Basics

300 ml, Smart Care System

Artikel-Nr.	Inhalt /VE	Preis /VE	
3797	(Pal. 48) 30	192.60	netto



Shampoo Hair & Body HYDRO Basics

300 ml, mit Sichtstreifen, Smart Care System

Artikel-Nr.	Inhalt /VE	Preis /VE	
21445	(Pal. 48) 30	192.60	netto



Shampoo Hair & Body HYDRO Basics

30 ml, Flacon

Artikel-Nr.	Inhalt /VE	Preis /VE	
6356	(Pal. 112) 99	53.45	netto

Hotelkosmetik und Accessoires ADA | wellness for body & mind

Hydro Basics



Bath & Shower Gel HYDRO Basics

30 ml, Flacon

Artikel-Nr.	Inhalt /VE	Preis /VE	
6357	(Pal. 112) 99	53.45	netto



Shampoo HYDRO Basics

30 ml, Flacon

Artikel-Nr.	Inhalt /VE	Preis /VE	
6736	(Pal. 112) 99	53.45	netto



Conditioner HYDRO Basics

30 ml, Flacon

Artikel-Nr.	Inhalt /VE	Preis /VE	
11500	(Pal. 112) 99	55.45	netto



Body Lotion HYDRO Basics

30 ml, Flacon

Artikel-Nr.	Inhalt /VE	Preis /VE	
6358	(Pal. 112) 99	58.40	netto



Pflanzenseife HYDRO Basics

20 g, blau, in Plissée-Papier

Artikel-Nr.	Inhalt /VE	Preis /VE	
6359	(Pal. 72) 360	126.00	netto



Pflanzenseife HYDRO Basics

50 g, blau, in Stretchfolie

Artikel-Nr.	Inhalt /VE	Preis /VE	
6366*	(Pal. 63) 200	162.00	netto



Mundpflegeset HYDRO Basics

weiss, in Kartonbox

Artikel-Nr.	Inhalt /VE	Preis /VE	
6729	(Pal. 48) 100	133.00	netto



Rasierset HYDRO Basics

weiss, in Kartonbox

Artikel-Nr.	Inhalt /VE	Preis /VE	
6730	(Pal. 30) 100	141.00	netto



Vanity Set HYDRO Basics

weiss, in Kartonbox

Artikel-Nr.	Inhalt /VE	Preis /VE	
6369	(Pal. 40) 200	116.00	netto

Hotelkosmetik und Accessoires ADA | wellness for body & mind

Hydro Basics



Duschhaube HYDRO Basics

weiss, in Kartonbox

Artikel-Nr.	Inhalt /VE	Preis /VE	
6367	(Pal. 40) 200	66.00	netto



Nähetui HYDRO Basics

weiss, in Kartonbox

Artikel-Nr.	Inhalt /VE	Preis /VE	
6368	(Pal. 126) 250	82.50	netto



Schuhputzschwamm HYDRO Basics

weiss, in Kartonbox

Artikel-Nr.	Inhalt /VE	Preis /VE	
6370	(Pal. 40) 200	84.00	netto



Nagelfeile 3-flächig HYDRO Basics

weiss, in Kartonbox

Artikel-Nr.	Inhalt /VE	Preis /VE	
6467	(Pal. 60) 400	256.00	netto



Liquid Soap HYDRO Basics

1 Liter-Nachfüllflasche

Artikel-Nr.	Inhalt /VE	Preis /VE	
6887*	(Pal. 63) 9	87.10	netto



Shampoo Hair & Body HYDRO Basics

1 Liter-Nachfüllflasche

Artikel-Nr.	Inhalt /VE	Preis /VE	
6886*	(Pal. 63) 9	87.10	netto



Conditioner HYDRO Basics

1 Liter-Nachfüllflasche

Artikel-Nr.	Inhalt /VE	Preis /VE	
22783*	(Pal. 63) 9	106.10	netto



Bodylotion HYDRO Basics

1 Liter-Nachfüllflasche

Artikel-Nr.	Inhalt /VE	Preis /VE	
22859*	(Pal. 63) 9	97.40	netto



Liquid Soap HYDRO Basics

5 Liter-Nachfüllbidon

Artikel-Nr.	Inhalt /VE	Preis /VE	
3774	(Pal. 120) 1	45.05	netto

Hotelkosmetik und Accessoires ADA | wellness for body & mind

Hydro Basics



Shampoo Hair & Body HYDRO Basics

5 Liter-Nachfüllbidon

Artikel-Nr.	Inhalt /VE	Preis /VE	
12439	(Pal. 120) 1	45.05	netto



Liquid Soap HYDRO Basics

300 ml, Pumpspender

Artikel-Nr.	Inhalt /VE	Preis /VE	
14952	(Pal. 63) 24	124.55	netto



Hand & Body Lotion HYDRO Basics

290 ml, Pumpspender

Artikel-Nr.	Inhalt /VE	Preis /VE	
17430*	(Pal. 63) 24	159.10	netto

Hotelkosmetik und Accessoires ADA | essentials with style

Classic



Liquid Cream Soap CLASSIC

300 ml, press + wash

Artikel-Nr.	Inhalt /VE	Preis /VE	
6227	(Pal. 42) 30	150.60	netto



Shampoo Hair & Body CLASSIC

300 ml, press + wash

Artikel-Nr.	Inhalt /VE	Preis /VE	
6218	(Pal. 42) 30	150.60	netto



Bath & Shower Gel CLASSIC

40 ml, Flacon

Artikel-Nr.	Inhalt /VE	Preis /VE	
6238	(Pal. 136) 88	31.70	netto



Shampoo Hair & Body CLASSIC

40 ml, Flacon

Artikel-Nr.	Inhalt /VE	Preis /VE	
6239	(Pal. 136) 88	31.70	netto



Bodylotion CLASSIC

40 ml, Flacon

Artikel-Nr.	Inhalt /VE	Preis /VE	
6253	(Pal. 136) 88	36.95	netto



Shampoo Hair & Body CLASSIC

10 ml, weiss, Sachet

Artikel-Nr.	Inhalt /VE	Preis /VE	
6235	(Pal. 63) 500	65.00	netto

* auf Bestellung

Hotelkosmetik und Accessoires ADA | essentials with style

Classic



Cremeseife CLASSIC

15 ml, weiss, Sachet

Artikel-Nr.	Inhalt /VE	Preis /VE	
6236	(Pal. 63) 500	70.00	netto



Cremeseife CLASSIC

20 ml, weiss, in Plissé-Papier

Artikel-Nr.	Inhalt /VE	Preis /VE	
6237	(Pal. 49) 400	92.00	netto

DermaCare



Hand, Hair & Body Wash dermaCARE

300 ml, press + wash



Artikel-Nr.	Inhalt /VE	Preis /VE	
22601*	(Pal. 42) 30	163.80	netto



Hand, Hair & Body Wash dermaCARE

300 ml, Smart Care System



Artikel-Nr.	Inhalt /VE	Preis /VE	
22602*	(Pal. 48) 30	178.50	netto



Cleansing Body Wash dermaCARE

30 ml, Flacon



Artikel-Nr.	Inhalt /VE	Preis /VE	
22603*	(Pal. 120) 140	56.00	netto



Shampoo Hair & Body dermaCARE

30 ml, Flacon



Artikel-Nr.	Inhalt /VE	Preis /VE	
22604	(Pal. 120) 140	56.00	netto



Soothing Body Milk dermaCARE

30 ml, Flacon



Artikel-Nr.	Inhalt /VE	Preis /VE	
22605	(Pal. 120) 140	60.20	netto



Cleansing Body Wash dermaCARE

150 ml, Flacon



Artikel-Nr.	Inhalt /VE	Preis /VE	
28917*	(Pal. 266) 8	36.70	netto



Soothing Body Milk dermaCARE

150 ml, Flacon



Artikel-Nr.	Inhalt /VE	Preis /VE	
28918*	(Pal. 266) 8	40.15	netto

Hotelkosmetik und Accessoires ADA | essentials with style

DermaCare



Shampoo Hair & Body dermaCARE

10 ml, Sachet



Artikel-Nr.	Inhalt /VE	Preis /VE	
23326*	(Pal. 63) 500	80.00	netto



Cremeseife dermaCARE

15 g, im Flowpack



Artikel-Nr.	Inhalt /VE	Preis /VE	
22606*	(Pal. 63) 500	90.00	netto



Geschenkset dermaCARE

je 1 Flacon Body Wash, Shampoo Hair & Body & Body Milk & 15 g Seife



Artikel-Nr.	Inhalt /VE	Preis /VE	
22607*	(Pal. 105) 14	46.50	netto

Be different



All in One: Hair, Hand & Body BE DIFFERENT

330 ml, press + wash

Artikel-Nr.	Inhalt /VE	Preis /VE	
24668*	(Pal. 42) 30	130.20	netto



All in One: Hair, Hand & Body BE DIFFERENT

300 ml, Smart Care System

Artikel-Nr.	Inhalt /VE	Preis /VE	
24695	(Pal. 48) 30	150.60	netto



Seife BE DIFFERENT

12 g, im Flowpack

Artikel-Nr.	Inhalt /VE	Preis /VE	
24708*	(Pal. 50) 600	78.00	netto



Seife BE DIFFERENT

20 g, im Papierwickel

Artikel-Nr.	Inhalt /VE	Preis /VE	
24709	400	80.00	netto



Shampoo BE DIFFERENT

25 ml, Tube

Artikel-Nr.	Inhalt /VE	Preis /VE	
24697*	(Pal. 60) 210	71.40	netto



Shampoo Hair & Body BE DIFFERENT

25 ml, Tube

Artikel-Nr.	Inhalt /VE	Preis /VE	
24698*	(Pal. 60) 210	71.40	netto

Hotelkosmetik und Accessoires ADA | essentials with style

Be different



Bath & Shower Gel BE DIFFERENT

25 ml, Tube

Artikel-Nr.	Inhalt /VE	Preis /VE	
24696	(Pal. 60) 210	71.40	netto



Body Lotion BE DIFFERENT

25 ml, Tube

Artikel-Nr.	Inhalt /VE	Preis /VE	
24700*	(Pal. 60) 210	81.90	netto



Hair Conditioner BE DIFFERENT

25 ml, Tube

Artikel-Nr.	Inhalt /VE	Preis /VE	
24699*	(Pal. 60) 210	86.10	netto



Bath & Shower Gel BE DIFFERENT

150 ml, Tube

Artikel-Nr.	Inhalt /VE	Preis /VE	
29026*	(Pal. 112) 24	65.30	netto



Shampoo Hair & Body BE DIFFERENT

150 ml, Tube

Artikel-Nr.	Inhalt /VE	Preis /VE	
29027*	(Pal. 112) 24	65.30	netto



Hair Conditioner BE DIFFERENT

150 ml, Tube

Artikel-Nr.	Inhalt /VE	Preis /VE	
29028*	(Pal. 112) 24	73.45	netto



Body Lotion BE DIFFERENT

150 ml, Tube

Artikel-Nr.	Inhalt /VE	Preis /VE	
29029*	(Pal. 112) 24	73.45	netto



Erfrischungstuch BE DIFFERENT

in Dose

Artikel-Nr.	Inhalt /VE	Preis /VE	
29030*	(Pal. 440) 60	68.40	netto



Geschenkset BE DIFFERENT

je 1 Tube Bath & Shower Gel, Hair Conditioner, Body Lotion & 20 g Seife

Artikel-Nr.	Inhalt /VE	Preis /VE	
24711*	(Pal. 42) 30	125.10	netto

Hotelkosmetik und Accessoires ADA | essentials with style

Jungle Kids



Jungle Kids Rucksackset mit Waschhandschuh «Tigerform»

Kuscheltier Tiger, Handtuch, 30ml Tube Shampoo Hair & Body, 30 ml Tube Bodylotion, 25 g Seife Krokodil

Artikel-Nr.	Inhalt /VE	Preis /VE	
17368	(Pal. 36) 8	137.05	netto



Pantoffeln Frotté

weiss, 22 cm, für Kinder, Kunststoffsohle

Artikel-Nr.	Produktinfo	Inhalt /VE	Preis /VE	
11543	Einheitsform, offen	(Pal. 6) 150	364.50	netto



Jungle Kids Beutelset

Waschhandschuh in Tigerform, 30 ml Tube Shampoo Hair & Body, 25 g Seife Krokodil im Softbag

Artikel-Nr.	Inhalt /VE	Preis /VE	
17369	(Pal. 40) 20	112.20	netto



Jungle Kids Malset

6 Buntstifte & 3 Postkarten, in Kartonbox

Artikel-Nr.	Inhalt /VE	Preis /VE	
17370	(Pal. 42) 20	71.20	netto

Hotelkosmetik und Accessoires ADA | responsible living

Green Culture



Liquid Soap ECO by GREEN CULTURE

300 ml, press + wash



Artikel-Nr.	Inhalt /VE	Preis /VE	
14835	(Pal. 42) 30	171.90	netto



Shampoo Hair & Body ECO by GREEN CULTURE

300 ml, press + wash



Artikel-Nr.	Inhalt /VE	Preis /VE	
14834	(Pal. 42) 30	171.90	netto



Liquid Soap ECO by GREEN CULTURE

300 ml, Smart Care System



Artikel-Nr.	Inhalt /VE	Preis /VE	
21438	(Pal. 48) 30	189.00	netto



Shampoo Hair & Body ECO by GREEN CULTURE

300 ml, Smart Care System



Artikel-Nr.	Inhalt /VE	Preis /VE	
13479	(Pal. 48) 30	189.00	netto



Hair & Body Wash ECO by GREEN CULTURE

30 ml, Tube



Artikel-Nr.	Inhalt /VE	Preis /VE	
23304	(Pal. 45) 210	115.50	netto



ADA
INTERNATIONAL

Hotelkosmetik und Accessoires ADA | responsible living

Green Culture



Body Lotion ECO by GREEN CULTURE

30 ml, Tube



Artikel-Nr.	Inhalt /VE	Preis /VE	
23306	(Pal. 45) 210	123.90	netto



Hair & Body Wash ECO by GREEN CULTURE

30 ml, Flacon



Artikel-Nr.	Inhalt /VE	Preis /VE	
17433*	(Pal. 96) 168	92.40	netto



Body Lotion ECO by GREEN CULTURE

30 ml, Flacon



Artikel-Nr.	Inhalt /VE	Preis /VE	
17435*	(Pal. 96) 168	99.10	netto



Pflanzenseife ECO by GREEN CULTURE

20 g, in Kartonbox



Artikel-Nr.	Inhalt /VE	Preis /VE	
17436	(Pal. 49) 420	151.20	netto

Naturals



Liquid Soap NATURALS

300 ml, press + wash



Artikel-Nr.	Inhalt /VE	Preis /VE	
16292	(Pal. 42) 30	180.00	netto



Shampoo Hair & Body NATURALS

300 ml, press + wash



Artikel-Nr.	Inhalt /VE	Preis /VE	
13411	(Pal. 42) 30	180.00	netto



Liquid Soap NATURALS

300 ml, Smart Care System



Artikel-Nr.	Inhalt /VE	Preis /VE	
21436	(Pal. 48) 30	192.60	netto



Shampoo Hair & Body NATURALS

300 ml, Smart Care System



Artikel-Nr.	Inhalt /VE	Preis /VE	
21437	(Pal. 48) 30	192.60	netto



Refreshing Shower Gel NATURALS

30 ml, Flacon



Artikel-Nr.	Inhalt /VE	Preis /VE	
17268	(Pal. 63) 240	122.40	netto

Hotelkosmetik und Accessoires ADA | responsible living

Naturals



Aromatic Shampoo NATURALS

30 ml, Flacon



Artikel-Nr.	Inhalt /VE	Preis /VE	netto
13423	(Pal. 63) 240	122.40	netto



Caring Body Lotion NATURALS

30 ml, Flacon



Artikel-Nr.	Inhalt /VE	Preis /VE	netto
17269	(Pal. 63) 240	132.00	netto



Softening Conditioner NATURALS

30 ml, Flacon



Artikel-Nr.	Inhalt /VE	Preis /VE	netto
13434*	(Pal. 63) 240	132.00	netto



Badesalz NATURALS

50 g Dose mit Aludeckel



Artikel-Nr.	Inhalt /VE	Preis /VE	netto
18701*	(Pal. 72) 120	237.60	netto



Pflanzenseife NATURALS

15 g, im Papierwickel



Artikel-Nr.	Inhalt /VE	Preis /VE	netto
17270	(Pal. 85) 500	125.00	netto



Nähetui NATURALS

weiss, im Briefumschlag

Artikel-Nr.	Inhalt /VE	Preis /VE	netto
21283*	(Pal. 32) 250	82.50	netto



Duschhaube NATURALS

weiss, im Briefumschlag

Artikel-Nr.	Inhalt /VE	Preis /VE	netto
21284*	(Pal. 45) 250	82.50	netto



Vanity Set NATURALS

weiss, im Briefumschlag

Artikel-Nr.	Inhalt /VE	Preis /VE	netto
21286*	(Pal. 30) 200	114.00	netto



Nagelfeile NATURALS

weiss, im Briefumschlag

Artikel-Nr.	Inhalt /VE	Preis /VE	netto
21287*	(Pal. 120) 400	100.00	netto

Hotelkosmetik und Accessoires ADA | responsible living

Floraluxe



Liquid Soap FLORALUXE

300 ml, press + wash



Artikel-Nr.	Inhalt /VE	Preis /VE	
17408*	(Pal. 42) 30	210.30	netto



Shampoo Hair & Body FLORALUXE

300 ml, press + wash



Artikel-Nr.	Inhalt /VE	Preis /VE	
17409*	(Pal. 42) 30	210.30	netto



Liquid Soap FLORALUXE

300 ml, Smart Care System



Artikel-Nr.	Inhalt /VE	Preis /VE	
21434*	(Pal. 48) 30	231.00	netto



Shampoo Hair & Body FLORALUXE

300 ml, Smart Care System



Artikel-Nr.	Inhalt /VE	Preis /VE	
21435*	(Pal. 48) 30	231.00	netto



Gentle Shower Cream FLORALUXE

30 ml, Flacon



Artikel-Nr.	Inhalt /VE	Preis /VE	
17402*	(Pal. 120) 140	93.80	netto



Pure Shampoo FLORALUXE

30 ml, Flacon



Artikel-Nr.	Inhalt /VE	Preis /VE	
17403*	(Pal. 120) 140	93.80	netto



Active Body Lotion FLORALUXE

30 ml, Flacon



Artikel-Nr.	Inhalt /VE	Preis /VE	
17405*	(Pal. 120) 140	110.60	netto



Natural Cream Soap FLORALUXE

15 g, im Flowpack



Artikel-Nr.	Inhalt /VE	Preis /VE	
17407*	(Pal. 36) 500	190.00	netto

Fair Cosmethics



Liquid Soap FAIR COSMETHICS

300 ml, Smart Care System

Artikel-Nr.	Inhalt /VE	Preis /VE	
21427	(Pal. 48) 30	220.50	netto

Hotelkosmetik und Accessoires ADA | responsible living

Fair Cosmetics



Shampoo Hair & Body FAIR COSMETHICS

300 ml, Smart Care System

Artikel-Nr.	Inhalt /VE	Preis /VE	
21428	(Pal. 48) 30	220.50	netto



Liquid Cream Soap FAIR COSMETHICS

300 ml, Pumpspender

Artikel-Nr.	Inhalt /VE	Preis /VE	
25981*	(Pal. 63) 24	140.65	netto



Body Cleanser, FAIR COSMETHICS

30 ml, Tube

Artikel-Nr.	Inhalt /VE	Preis /VE	
21429*	(Pal. 60) 143	92.95	netto



Hair Shampoo FAIR COSMETHICS

30 ml, Tube

Artikel-Nr.	Inhalt /VE	Preis /VE	
21430*	(Pal. 60) 143	92.95	netto



Hair Conditioner FAIR COSMETHICS

30 ml, Tube

Artikel-Nr.	Inhalt /VE	Preis /VE	
21431*	(Pal. 60) 143	97.25	netto



Body Lotion FAIR COSMETHICS

30 ml, Tube

Artikel-Nr.	Inhalt /VE	Preis /VE	
21432*	(Pal. 60) 143	97.25	netto



Cream Soap FAIR COSMETHICS

15 g, im Papierwickel

Artikel-Nr.	Inhalt /VE	Preis /VE	
21433*	(Pal. 75) 500	145.00	netto



Accessoires Set FAIR COSMETHICS

Duschhaube, Nähetui, Vanity-Set & Nagelfeile

Artikel-Nr.	Inhalt /VE	Preis /VE	
22560*	(Pal. 72) 50	58.50	netto

Accessoires Green



Duschhaube GREEN

braun, in Kartonbox, 100% Recycling-Papier

Artikel-Nr.	Inhalt /VE	Preis /VE	
17437*	(Pal. 40) 250	82.50	netto

Hotelkosmetik und Accessoires ADA | responsible living

Accessoires Green



Vanity-Set GREEN

braun, in Kartonbox, 100% Recycling-Papier

Artikel-Nr.	Inhalt /VE	Preis /VE	
17438	(Pal. 48) 200	116.00	netto



Nähetui GREEN

braun, in Kartonbox, 100% Recycling-Papier

Artikel-Nr.	Inhalt /VE	Preis /VE	
17439*	(Pal. 72) 250	82.50	netto



Nagelfeile GREEN

braun, in Kartonbox, 100% Recycling-Papier

Artikel-Nr.	Inhalt /VE	Preis /VE	
17440*	(Pal. 48) 500	135.00	netto



Schuhputzschwamm GREEN

braun, in Kartonbox, 100% Recycling-Papier

Artikel-Nr.	Inhalt /VE	Preis /VE	
21442*	(Pal. 48) 210	86.10	netto



Holzkamm GREEN

braun, in Kartonbox, 100% Recycling-Papier

Artikel-Nr.	Inhalt /VE	Preis /VE	
21443*	(Pal. 36) 500	425.00	netto



Rasierset GREEN

braun, in Kartonbox, 100% Recycling-Papier

Artikel-Nr.	Inhalt /VE	Preis /VE	
12603*	(Pal. 36) 100	141.00	netto



Mundpflegeset GREEN

braun, in Kartonbox, 100% Recycling-Papier

Artikel-Nr.	Inhalt /VE	Preis /VE	
12602*	100	133.00	netto

Accessoires White & Black



Duschhaube White & Black

weiss / schwarz, in Kuvert-Kartonage

Artikel-Nr.	Inhalt /VE	Preis /VE	
29203*	200	66.00	netto



Nähetui White & Black

weiss / schwarz, in Kuvert-Kartonage

Artikel-Nr.	Inhalt /VE	Preis /VE	
29204*	200	68.00	netto

Hotelkosmetik und Accessoires ADA | responsible living

Accessoires White & Black



Vanity-Set White & Black

weiss / schwarz, in Kuvert-Kartonage

Artikel-Nr.	Inhalt /VE	Preis /VE	
29205*	200	102.00	netto



Nagelpflegeset White & Black

weiss / schwarz, in Kuvert-Kartonage

Artikel-Nr.	Inhalt /VE	Preis /VE	
29206*	200	120.00	netto



Mundpflegeset White & Black

weiss / schwarz, in Kuvert-Kartonage, mit Colgate Zahnpasta

Artikel-Nr.	Inhalt /VE	Preis /VE	
29207*	100	196.00	netto



Rasieret White & Black

weiss / schwarz, in Kuvert-Kartonage

Artikel-Nr.	Inhalt /VE	Preis /VE	
29208*	250	490.00	netto

Hotelkosmetik und Accessoires ADA | Complementary Products

WHITE



Duschhaube WHITE

40 x 40 x 40 mm, weiss / silber, in Kartonbox

Artikel-Nr.	Inhalt /VE	Preis /VE	
6873	(Pal. 64) 250	77.50	netto



Duschhaube WHITE

weiss, in PE-Beutel

Artikel-Nr.	Inhalt /VE	Preis /VE	
14712	(Pal. 96) 200	26.00	netto



Vanity-Set WHITE (Wattestabchen & Pads)

70 x 20 x 85 mm, weiss / silber, in Kartonbox

Artikel-Nr.	Inhalt /VE	Preis /VE	
6872	(Pal. 38) 200	112.00	netto



Nagelfeile WHITE

20 x 155 mm, weiss / silber, in Kartonbox

Artikel-Nr.	Inhalt /VE	Preis /VE	
10697	(Pal. 84) 500	140.00	netto



Nahetui WHITE

75 x 5 x 65 mm, weiss / silber, in Kartonbox

Artikel-Nr.	Inhalt /VE	Preis /VE	
6709	(Pal. 140) 250	75.00	netto

Hotelkosmetik und Accessoires ADA | Complementary Products

WHITE



Kamm WHITE

160 mm, weiss, in Polybag

Artikel-Nr.	Inhalt /VE	Preis /VE	
6866	(Pal. 182) 250	90.00	netto



Haarbürste WHITE

45 x 25 x 115 mm, weiss / silber, mit Spiegel, in Kartonbox

Artikel-Nr.	Inhalt /VE	Preis /VE	
6865	(Pal. 96) 50	57.00	netto



Rasierset WHITE

50 x 25 x 110 mm, weiss / silber, in Kartonbox

Artikel-Nr.	Inhalt /VE	Preis /VE	
6727	(Pal. 48) 100	129.00	netto



Mundpflegeset WHITE

27 x 20 x 175 mm, weiss / silber, in Kartonbox

Artikel-Nr.	Inhalt /VE	Preis /VE	
6726	(Pal. 80) 100	122.00	netto



Damen-Set WHITE

75 x 30 x 105 mm, weiss / silber, in Kartonbox

Artikel-Nr.	Produktinfo	Inhalt /VE	Preis /VE	
10274	Inhalt: 1 Tampon, 1 Damenbinde, 3 Slipeinlagen	(Pal. 56) 50	67.00	netto



Schuhlöffel WHITE

200 mm, weiss

Artikel-Nr.	Inhalt /VE	Preis /VE	
6869	(Pal. 72) 250	137.50	netto



Schuhputzschwamm WHITE

60 x 25 x 45 mm, weiss / silber, in Kartonbox

Artikel-Nr.	Inhalt /VE	Preis /VE	
6876	(Pal. 42) 210	69.30	netto



Wäschebeutel WHITE

42 x 58 cm, weiss, mit Kordel

Artikel-Nr.	Inhalt /VE	Preis /VE	ab 5 VE 10%
25968	(Pal. 44) 500	155.80	140.25

Trendline



Nähetui Trendline

transparent, im Flowpack

Artikel-Nr.	Inhalt /VE	Preis /VE	
21304	(Pal. 36) 250	57.50	netto

Hotelkosmetik und Accessoires ADA | Complementary Products

Trendline



Schuhputzhandschuh Trendline

transparent, im Flowpack

Artikel-Nr.	Inhalt /VE	Preis /VE	
21305	(Pal. 36) 250	57.50	netto



Nagelfeile Trendline

transparent, im Flowpack

Artikel-Nr.	Inhalt /VE	Preis /VE	
21307	(Pal. 36) 250	47.50	netto



Rasierer Trendline

transparent, im Flowpack

Artikel-Nr.	Inhalt /VE	Preis /VE	
21310	(Pal. 48) 100	84.00	netto



Mundpflegeset Trendline

transparent, im Flowpack

Artikel-Nr.	Inhalt /VE	Preis /VE	
21309	(Pal. 36) 100	84.00	netto



Vanity Set Trendline

transparent, im Flowpack

Artikel-Nr.	Inhalt /VE	Preis /VE	
21306	(Pal. 36) 250	105.00	netto

Cocooning Line



Duschhaube Cocooning Line

weiss, in Kartonbox

Artikel-Nr.	Inhalt /VE	Preis /VE	
22588	(Pal. 48) 250	82.50	netto



Schuhputzschwamm Cocooning Line

weiss, in Kartonbox

Artikel-Nr.	Inhalt /VE	Preis /VE	
22589*	200	84.00	netto



Polierfeile Cocooning Line

weiss, in Kartonbox

Artikel-Nr.	Inhalt /VE	Preis /VE	
22591*	400	256.00	netto



Nähetui Cocooning Line

weiss, in Kartonbox

Artikel-Nr.	Inhalt /VE	Preis /VE	
22590*	250	142.50	netto

Hotelkosmetik und Accessoires ADA | Complementary Products

Cocooning Line



Mundpflegeset Cocooning Line

weiss, in Kartonbox

Artikel-Nr.	Inhalt /VE	Preis /VE	
23333	100	130.00	netto



Rasierset Cocooning Line

weiss, in Kartonbox

Artikel-Nr.	Inhalt /VE	Preis /VE	
23334*	100	130.00	netto



Vanity Set Cocooning Line

weiss, in Kartonbox

Artikel-Nr.	Inhalt /VE	Preis /VE	
22587	(Pal. 36) 200	114.00	netto

Hotelkosmetik und Accessoires ADA | Halterungen und Zubehör



Halterung press+wash

weiss

Artikel-Nr.	Produktinfo	Inhalt /VE	Preis /VE	
6294	zum Schrauben	(Pal. 99) 10	0.00	netto



Halterung press+wash

chrom glänzend

Artikel-Nr.	Produktinfo	Inhalt /VE	Preis /VE	
10267	zum Schrauben	(Pal. 99) 10	0.00	netto



Halterung press+wash

weiss

Artikel-Nr.	Produktinfo	Inhalt /VE	Preis /VE	
6871	selbstklebend	(Pal. 108) 10	0.00	netto



Halterung press+wash

chrom glänzend

Artikel-Nr.	Produktinfo	Inhalt /VE	Preis /VE	
6901	zum Kleben	(Pal. 108) 10	0.00	netto



Hülse zu Press+Wash

transparent

Artikel-Nr.	Inhalt /VE	Preis /VE	
6295	(Pal. 304) 20	0.00	netto



Halterung Smart Care System

weiss

Artikel-Nr.	Produktinfo	Inhalt /VE	Preis /VE	
3799	zum Schrauben	(Pal. 345) 10	0.00	netto
20791	selbstklebend	(Pal. 345) 10	0.00	netto

Hotelkosmetik und Accessoires ADA | Halterungen und Zubehör



Halterung Smart Care System

chrom

Artikel-Nr.	Produktinfo	Inhalt /VE	Preis /VE	
13487	zum Schrauben	(Pal. 345) 10	0.00	netto
20790	selbstklebend	(Pal. 345) 10	0.00	netto



Doppel-Halterung Smart Care System

zum Schrauben & selbstklebend

Artikel-Nr.	Produktinfo	Inhalt /VE	Preis /VE	
29005*	Aluminium-Optik	10	255.00	netto
29004*	weiss	10	136.00	netto

Hotelkosmetik und Accessoires ADA | Diverse



All in One: Hair, Hand & Body AQUA SENSES

330 ml, press + wash

Artikel-Nr.	Inhalt /VE	Preis /VE	
6375	(Pal. 42) 30	124.80	netto



Hair, Hand & Body Wash AQUA SENSES

5 Liter-Nachfüllpackung

Artikel-Nr.	Inhalt /VE	Preis /VE	
6289	(Pal. 120) 1	27.20	netto

Zimmerartikel Diverse | Slippers, Bitte nicht stören etc.



Starline Pantoffeln Frotté Starline

weiss, mit Kunststoffsohle

Artikel-Nr.	Produktinfo	Inhalt /VE	Preis /VE	ab 5 VE 10%
6165	Einheitsform	(Pal. 48) 25	63.65	57.30



Pantoffeln Frotté TORNADO

weiss, 30cm, für Zimmerbereich, mit Vlies-Sohle

Artikel-Nr.	Produktinfo	Inhalt /VE	Preis /VE	
6708	Einheitform, offen	(Pal. 16) 100	100.00	netto



Pantoffeln Frotté TORNADO

weiss, 30 cm, für Zimmerbereich, Vlies-Sohle

Artikel-Nr.	Produktinfo	Inhalt /VE	Preis /VE	
18061*	Einheitsform, geschlossen	(Pal. 10) 100	119.00	netto



Pantoffeln Frotté Tornado EVA

weiss, 30 cm, EVA Sohle 4 mm

Artikel-Nr.	Produktinfo	Inhalt /VE	Preis /VE	ab 5 VE 10%
25969	Einheitsform, offen	(Pal. 10) 100	232.00	208.80



Pantoffeln Frotté SCIROCCO

weiss, 30 cm, EVA-Sohle 5 mm

Artikel-Nr.	Produktinfo	Inhalt /VE	Preis /VE	
12071	Fussform, offen	(Pal. 10) 100	243.00	netto

Zimmerartikel Diverse | Slippers, Bitte nicht stören etc.



Pantoffeln Frotté

weiss, 22 cm, für Kinder, Kunststoffsohle

Artikel-Nr.	Produktinfo	Inhalt /VE	Preis /VE	
11543	Einheitsform, offen	(Pal. 6) 150	364.50	netto



Pantoffeln Frotté Tornado EVA

weiss, 30 cm, EVA Sohle 4mm

Artikel-Nr.	Produktinfo	Inhalt /VE	Preis /VE	
12242	Einheitsform, geschlossen	(Pal. 16) 100	177.00	netto



Wellness-Slippers Frotté SPA Terry

weiss, 30 cm, rutschhemmende Noppensohle

Artikel-Nr.	Inhalt /VE	Preis /VE	
17426*	(Pal. 8) 100	298.00	netto



Pantoffeln Frottée SPA-SLIPPER

weiss, 30 cm, rutschhemmende Noppensohle

Artikel-Nr.	Produktinfo	Inhalt /VE	Preis /VE	
17519	Einheitsform, offen	(Pal. 10) 100	254.00	netto



Schilder «Bitte nicht stören»

Vorderseite rot: «Bitte nicht stören» / Rückseite grün: «Bitte Zimmer aufräumen»

Artikel-Nr.	Produktinfo	Inhalt /VE	Preis /VE	ab 5 VE 10%
6019	Kunststoff, 4-sprachig	100	83.00	74.70



Schilder «Bitte nicht stören» - schwarz

Vorderseite rot: «Bitte nicht stören» / Rückseite grün: «Bitte Zimmer aufräumen»

Artikel-Nr.	Produktinfo	Inhalt /VE	Preis /VE	ab 5 VE 10%
6020	Karton, 4-sprachig	100	50.25	45.20

Zimmerartikel Diverse | Badezimmer



Zahnbürste mit Zahnpasta eingepägt

einzelnd verpackt in Plastik

Artikel-Nr.	Inhalt /VE	Preis /VE	ab 5 VE 10%
6199	(Pal. 350) 100	47.85	43.05



Zahnglasbeutel

150 x 250 mm, 0.04 mm, LD-PE



Artikel-Nr.	Inhalt /VE	Preis /VE	ab 5 VE 10%
6195	3000	117.05	105.35



Zahnbecher

2 dl-PP, transparent, einzeln verpackt

Artikel-Nr.	Produktinfo	Inhalt /VE	Preis /VE	
6198	unzerbrechlich, solid	(Pal. 12) 1050	176.90	netto

Zimmerartikel Diverse | Badezimmer



Abfallbehälter

weiss, Kunststoff, schwer entflammbar

Artikel-Nr.	Produktinfo	Inhalt /VE	Preis /VE	
6000	6 Liter, 20 x 25 cm, für Art. 7708	(Pal. 12) 1	21.10	netto



Badezimmer-Spiegel

190 mm, gold, rund, mit Vergrößerung

Artikel-Nr.	Inhalt /VE	Preis /VE	
6208	1	49.90	netto



Badematte

55 x 55 cm, Bionic clear «Spirella», PVC

Artikel-Nr.	Produktinfo	Inhalt /VE	Preis /VE	
6204	30° waschbar	1	29.90	netto



Badematte

71 x 36 cm, Bionic clear «Spirella», PVC

Artikel-Nr.	Produktinfo	Inhalt /VE	Preis /VE	
6205	30° waschbar	1	29.90	netto



Manki Badvorleger Your Bath / Shower Mat

60 x 42 cm, 40 g, weiss, Vlies

Artikel-Nr.	Inhalt /VE	Preis /VE	
16474	1000	250.30	netto



Haartrockner Solis Comfort Line Typ 430

Wandmodell

Artikel-Nr.	Produktinfo	Inhalt /VE	Preis /VE	
6214	weiss, 1200 Watt	1	49.00	netto



Haartrockner Solis Compact Dryer Typ 379

zusammenklappbar, 2 Gebläse- und 2 Temperaturstufen

Artikel-Nr.	Produktinfo	Inhalt /VE	Preis /VE	
26023	silber, 1600 Watt	1	39.90	netto



Haartrockner Solis Swiss Perfection Typ 440

mit Kaltlufttaste und Spiralkabel, mehrere Gebläse- und Heizstufen, Überhitzungsschutz

Artikel-Nr.	Produktinfo	Inhalt /VE	Preis /VE	
20227	schwarz, 2300 Watt	1	99.90	netto

Zimmerartikel Diverse | Plateau / Körbchen / Kosmetiktaschen

Körbchen

220 x 130 x 45 mm, weiss, Plastik



Artikel-Nr.	Inhalt /VE	Preis /VE	
6096	1	3.05	netto

Zimmerartikel Diverse | Plateau / Körbchen / Kosmetiktaschen



Porzellantablett für Gästepräsente

288 x 80 x 23 mm, weiss

Artikel-Nr.	Inhalt /VE	Preis /VE	
12964*	(Pal. 144) 6	62.80	netto



Acryltablett für Gästepräsente

243 x 107 x 10 mm, weiss

Artikel-Nr.	Inhalt /VE	Preis /VE	
17422*	(Pal. 360) 5	26.40	netto



Acryltablett für Gästepräsente

243 x 107 x 10 mm, schwarz

Artikel-Nr.	Inhalt /VE	Preis /VE	
17423*	(Pal. 360) 5	26.40	netto



Kosmetiktasche CARLA

190 x 40 x 110 mm, transparent, weisser Rand

Artikel-Nr.	Inhalt /VE	Preis /VE	
6731*	(Pal. 4) 200	754.00	netto



Kosmetiktasche JULIA

170 x 60 x 175 mm, transparent-gefrostet

Artikel-Nr.	Inhalt /VE	Preis /VE	
14718	(Pal. 192) 50	75.50	netto



Reise-Kosmetiktasche AMELIA

200 x 40 x 160 cm, transparent-weiss

Artikel-Nr.	Inhalt /VE	Preis /VE	
29073*	(Pal. 6) 200	714.00	netto

Zimmerartikel Diverse | Zimmermappen / Dachsteller



Reparaturschild «Reparaturwünsche»

Artikel-Nr.	Inhalt /VE	Preis /VE	ab 5 VE 10%
6021	100	27.50	24.75



Dachsteller «Der Umwelt zuliebe»

aus Kunststoff, 4-sprachig, 75 x 137 mm

Artikel-Nr.	Inhalt /VE	Preis /VE	ab 5 VE 10%
6022	20	35.80	32.25



Kleber «Der Umwelt zuliebe»

4-sprachig, 100 x 100 mm

Artikel-Nr.	Inhalt /VE	Preis /VE	ab 5 VE 10%
6013	20	23.05	20.75

Zimmerartikel Diverse | Kleiderbügel



Hosenspanner aus Buchenholz

25 cm, hell, mit Filzeinlage weiss



Artikel-Nr.	Inhalt /VE	Preis /VE	Preis ab 500 VE
6244	1	2.45	2.15



Garderobenbügel aus Holz

hell, Buchenholz, lackiert



Artikel-Nr.	Inhalt /VE	Preis /VE	Preis ab 500 VE
6241	1	4.40	3.85



Formbügel aus Holz

44 cm, beige hell, Haken chrom

Artikel-Nr.	Produktinfo	Inhalt /VE	Preis /VE	Preis ab 500 VE
6246	mit rutschfestem beigem Steg und Kerben	1	2.70	2.45



Formbügel aus Holz

44 cm, dunkel, Haken gold

Artikel-Nr.	Produktinfo	Inhalt /VE	Preis /VE	Preis ab 500 VE
6247	mit rutschfestem schwarzem Steg und Kerben	1	2.70	2.45



Formbügel aus Holz

44 cm, mahagoni, Haken gold

Artikel-Nr.	Produktinfo	Inhalt /VE	Preis /VE	Preis ab 500 VE
6245	mit rutschfestem schwarzem Steg und Kerben	1	2.70	2.45



Formbügel Holz

schwarz, Haken gold

Artikel-Nr.	Produktinfo	Inhalt /VE	Preis /VE	Preis ab 500 VE
4795	rutschfester Steg, diebstahlsicher, inkl. Montagering	1	2.90	2.65



Formbügel Holz

beige, Haken chrom

Artikel-Nr.	Produktinfo	Inhalt /VE	Preis /VE	Preis ab 500 VE
4794	rutschfester Steg, diebstahlsicher, inkl. Montagering	1	2.90	2.65



Kleiderbügel aus Plastik, flach

44 cm, schwarz

Artikel-Nr.	Inhalt /VE	Preis /VE	Preis ab 500 VE
22320	(Pal. 4200) 1	1.40	1.10



Kleiderbügel aus Plastik, geschweift

45 cm, schwarz

Artikel-Nr.	Inhalt /VE	Preis /VE	Preis ab 500 VE
22321	(Pal. 840) 1	2.00	1.85

Zimmerartikel Diverse | Diverses



Frischwäschebeutel

transparent

Artikel-Nr.	Produktinfo	Inhalt /VE	Preis /VE	Preis ab 6 VE
7805	35 x 50 cm, 0.03 mm	(Pal. 60) 500	106.30	95.65



Papierkorb

schwarz, aus Kunststoff mit Kunstlederüberzug

Artikel-Nr.	Produktinfo	Inhalt /VE	Preis /VE	
12902	250 x 290 mm	1	22.50	netto



Papierkorb

braun, aus Kunststoff mit Vinylüberzug

Artikel-Nr.	Produktinfo	Inhalt /VE	Preis /VE	
6634	250 x 290 mm	1	22.50	netto



Papierkorb

bordeaux, aus Kunststoff mit Vinylüberzug

Artikel-Nr.	Produktinfo	Inhalt /VE	Preis /VE	
6635	250 x 290 mm	1	22.50	netto



Kofferständer

chrom, aus Metall, Gurte schwarz

Artikel-Nr.	Produktinfo	Inhalt /VE	Preis /VE	
13208	56 x 38 x 44 cm	1	75.00	netto



Wasserkocher Aquamat Typ 554

Expresswasserkocher aus Edelstahl, Inhalt: 1 Liter

Artikel-Nr.	Produktinfo	Inhalt /VE	Preis /VE	
18354*	2000 Watt	1	89.90	netto

Kosmetiktücher | Starline



Starline Kosmetiktücher Starline

weiss, 2-lagig, 100 % Zellstoff, samtweich

Artikel-Nr.	Produktinfo	Inhalt /VE	Preis /VE	Preis ab 10 VE
6030	Box à 100 Tücher, Schachtel marmoriert	(Pal. 28) 40	59.75	54.10



Kosmetiktuch neutral

weiss, 2-lagig, 100 % Zellstoff, samtweich

Artikel-Nr.	Produktinfo	Inhalt /VE	Preis /VE	Preis ab 10 VE
7863	Box à 100 Tücher, Schachtel neutral	(Pal. 28) 40	53.35	48.10
6032	Box à 150 Tücher, Schachtel neutral	(Pal. 28) 25	51.00	42.70

Kosmetiktücher | Tork



TORK Kosmetiktuch Premium

hochweiss, 2-lagig, extraweich

Artikel-Nr.	Produktinfo	Inhalt /VE	Preis /VE	ab 5 VE 10%
11885	Box à 100 Tücher, Würfel 12 x 12 x 11 cm	(Pal. 24) 30	111.05	99.95



Kosmetiktücher | Tork



Tork Kosmetiktuch Premium - F1 System

hochweiss, 2-lagig, extraweich, 20 x 20.8 cm



Artikel-Nr.	Produktinfo	Inhalt /VE	Preis /VE	Preis ab 10 VE
6034.1	Box à 100 Tücher	(Pal. 35) 30	49.30	44.40

Kosmetiktücher | Kimberly Clark



Kimberly-Clark Kosmetiktuch Tela

weiss, 2-lagig, extraweich, 21 x 20.5 cm

Artikel-Nr.	Produktinfo	Inhalt /VE	Preis /VE	Preis VE /Pal.
6029	Box à 100 Tücher, für Spender Art. 10278	(Pal. 30) 30	60.25	55.60



Kimberly-Clark Kosmetiktuch Tela Supersoft

weiss, 2-lagig, extraweich, 21 x 20.5 cm

Artikel-Nr.	Produktinfo	Inhalt /VE	Preis /VE	Preis VE /Pal.
6033	Box à 150 Tücher	(Pal. 24) 30	73.25	67.60



Kimberly-Clark Kosmetiktuch Tela

weiss, 2-lagig, extraweich, 21 x 20.5 cm

Artikel-Nr.	Produktinfo	Inhalt /VE	Preis /VE	Preis VE /Pal.
6028	Box à 100 Tücher, für Spender Art. 10278	(Pal. 24) 30	60.85	56.10



Kimberly-Clark Kosmetiktuch Kleenex

weiss, 2-lagig, 20.1 x 21 cm



Artikel-Nr.	Produktinfo	Inhalt /VE	Preis /VE	Preis ab 8 VE
6024	Box à 90 Tücher, Würfel	(Pal. 84) 12	58.45	50.60



Kimberly-Clark Kosmetiktuch Kleenex

weiss, 2-lagig, 19 x 22 cm



Artikel-Nr.	Produktinfo	Inhalt /VE	Preis /VE	ab 5 VE 10%
14906	Box à 100 Tücher, für Spender Art. 10278	(Pal. 45) 21	49.05	44.15



Kimberly-Clark Kosmetiktücher Scott Standard

weiss, 2-lagig, 19 x 22 cm, 100 % Recycling



Artikel-Nr.	Produktinfo	Inhalt /VE	Preis /VE	ab 5 VE 10%
18837	Box à 100 Tücher, für Spender Art. 10278	(Pal. 45) 21	36.95	33.25



Kimberly-Clark Kosmetiktuch Kleenex Standard

weiss, 3-lagig, 20 x 20 cm



Artikel-Nr.	Produktinfo	Inhalt /VE	Preis /VE	ab 5 VE 10%
22348	Box à 72 Tücher, für Spender Art. 10278	(Pal. 100) 12	19.90	17.90



Kimberly-Clark Kosmetiktuch Kleenex Collection

weiss, 3-lagig, 20.7 x 20.4 cm



Artikel-Nr.	Produktinfo	Inhalt /VE	Preis /VE	
14141	Box à 48 Tücher, Würfel	(Pal. 48) 12	23.80	netto

Kosmetiktücher | Kimberly Clark



Kimberly-Clark Kosmetiktuch Kleenex Balsam

weiss, 3-lagig, 20 x 20 cm



Artikel-Nr.	Produktinfo	Inhalt /VE	Preis /VE	ab 5 VE 10%
24520	Box à 56 Tücher, Würfel	(Pal. 84) 12	33.20	29.90

Kosmetiktücher | Bulkysoft



Kosmetiktuch Bulkysoft

weiss, 2-lagig, 21 x 21 cm, 100 % Zellstoff



Artikel-Nr.	Produktinfo	Inhalt /VE	Preis /VE	ab 5 VE 10%
27840	Box à 150 Tücher	(Pal. 28) 25	34.05	30.65



Bulkysoft Kosmetiktuch Classic

weiss, 2-lagig, 21 x 21 cm, Zellstoff, glatt



Artikel-Nr.	Produktinfo	Inhalt /VE	Preis /VE	ab 5 VE 10%
26253	Box à 100 Tücher	(Pal. 28) 40	46.35	41.75



Bulkysoft Kosmetiktuch

weiss, 2-lagig, 20.5 x 20.5 cm, Zellstoff



Artikel-Nr.	Produktinfo	Inhalt /VE	Preis /VE	ab 5 VE 10%
26251	Box à 90 Tücher, Würfel	(Pal. 42) 24	42.90	38.60



Bulkysoft Kosmetiktuch

weiss, 3-lagig, 21 x 21 cm, Zellstoff, glatt

Artikel-Nr.	Produktinfo	Inhalt /VE	Preis /VE	ab 5 VE 10%
26252	Box à 60 Tücher, Würfel	(Pal. 32) 30	37.10	netto

Kosmetiktücher | Spender



Kosmetiktuchspender

transparent, Acryl

Artikel-Nr.	Produktinfo	Inhalt /VE	Preis /VE	ab 5 VE 10%
6035	Wandmodell, mit Klebeband	2	32.75	netto



Kosmetiktuchspender

weiss, Kunststoff, H: 70 B: 270 T: 140 mm

Artikel-Nr.	Produktinfo	Inhalt /VE	Preis /VE	ab 5 VE 10%
6037	Wand- und Standmodell	(Pal. 20) 1	21.60	netto



Kosmetiktuchspender

verchromt, H: 70 B: 270 T: 140 mm

Artikel-Nr.	Produktinfo	Inhalt /VE	Preis /VE	ab 5 VE 10%
6038	Wand- und Standmodell	(Pal. 20) 1	30.80	netto



Kimberly-Clark Kosmetiktuchspender

aus Kunststoff, verchromt, 145 x 269 x 60 mm

Artikel-Nr.	Produktinfo	Inhalt /VE	Preis /VE	ab 5 VE 10%
10278	für Art. 6029 / 6028 / 14906 / 18837 / 22348	(Pal. 280) 1	37.40	netto

Kosmetiktücher | Spender



BulkySoft Bulkysoft Kosmetiktuchspender

weiss, ABS Kunststoff, H: 135 B: 250 T: 55 mm

Artikel-Nr.	Produktinfo	Inhalt /VE	Preis /VE	
26275	für Art. 26253	(Pal. 546) 1	14.55	netto



TORK Tork Kosmetiktuchspender - F1 System

gebürsteter Edelstahl

Artikel-Nr.	Produktinfo	Inhalt /VE	Preis /VE	
25169	67 x 256 x 136 mm	(Pal. 360) 1	62.55	netto

Kosmetiktücher | Papiertaschentücher



Starline Starline Taschentücher

weiss, 4-lagig, Zellstoff, weich

Artikel-Nr.	Produktinfo	Inhalt /VE	Preis /VE	Preis ab 10 VE
4905	24 x 10 Packungen à 10 Tücher	(Pal. 42) 2400	58.20	34.55



Kleenex Kimberly-Clark Taschentücher Balsam Kleenex

weiss, 4-lagig



Artikel-Nr.	Produktinfo	Inhalt /VE	Preis /VE	
18593*	16 x 12 Packungen à 9 Tücher	(Pal. 30) 1728	56.10	netto

Seifen / Spender | Shampoo / Badegel / Body Lotion



Starline Shampoo Hair & Body Basic, Starline

lachs mit Perlglanz

Artikel-Nr.	Produktinfo	Inhalt /VE	Preis /VE	ab 5 VE 10%
6306	1 Liter	(Pal. 400) 1	10.50	9.45
6307	10 Liter Bidon	(Pal. 60) 1	103.85	93.45



Starline Shampoo Hair & Body Classic Starline, Charles Grivet

blau

Artikel-Nr.	Produktinfo	Inhalt /VE	Preis /VE	ab 5 VE 10%
6312	1 Liter	1	7.55	6.80
6313	10 Liter Bidon	(Pal. 60) 1	73.70	66.30



KATRIN Katrin Duschgel mild

parfümiert, blau, für Spender Art. 28392 / 28393



Artikel-Nr.	Produktinfo	Inhalt /VE	Preis /VE	ab 5 VE 10%
28420	1000 ml	(Pal. 95) 6	68.05	61.25



KATRIN Katrin Duschgel mild

parfümiert, blau, für Spender Art. 28390 / 28391



Artikel-Nr.	Produktinfo	Inhalt /VE	Preis /VE	ab 5 VE 10%
28422	500 ml	(Pal. 70) 12	93.20	83.85

Seifen / Spender | Shampoo / Badegel / Body Lotion

Spender



KATRIN Katrin Inclusive Spender

weiss, H: 291 B: 100 T: 130 mm, 1000 ml, für Art. 28423 / 28419 / 28420

Artikel-Nr.	Inhalt /VE	Preis /VE	
28392	(Pal. 189) 1	47.10	netto

Kostenlos erhältlich mit Leihspendervertrag



KATRIN Katrin Inclusive Spender

schwarz, H: 291 B: 100 T: 130 mm, 1000 ml, für Art. 28423 / 28419 / 28420

Artikel-Nr.	Inhalt /VE	Preis /VE	
28393	(Pal. 189) 1	47.10	netto

Kostenlos erhältlich mit Leihspendervertrag



KATRIN Katrin Inclusive Spender

weiss, H: 204 B: 100 T: 125 mm, 500 ml

Artikel-Nr.	Produktinfo	Inhalt /VE	Preis /VE	
28390	für Art. 28424 / 28421 / 28422 / 28425	(Pal. 315) 1	36.65	netto

Kostenlos erhältlich mit Leihspendervertrag



KATRIN Katrin Inclusive Spender

schwarz, H: 204 B: 100 T: 125 mm, 500 ml

Artikel-Nr.	Produktinfo	Inhalt /VE	Preis /VE	
28391	für Art. 28424 / 28421 / 28422 / 28425	(Pal. 315) 1	36.65	netto

Kostenlos erhältlich mit Leihspendervertrag

Seifen / Spender | Handseife



Starline Flüssigseife Cream Soap Basic Starline

mint mit Perlglanz

Artikel-Nr.	Produktinfo	Inhalt /VE	Preis /VE	ab 5 VE 10%
6309	1 Liter	(Pal. 400) 1	6.60	5.95
6310	10 Liter	(Pal. 60) 1	64.65	58.20



Starline Flüssigseife Cream Soap Premium Starline

weiss mit Perlglanz, parfümiert

Artikel-Nr.	Produktinfo	Inhalt /VE	Preis /VE	ab 5 VE 10%
6303	1 Liter	1	6.30	5.70
6304	10 Liter	(Pal. 60) 1	60.80	54.70



Starline Flüssigseife Cream Soap Classic Starline

hellgelb

Artikel-Nr.	Produktinfo	Inhalt /VE	Preis /VE	ab 5 VE 10%
6315	1 Liter	(Pal. 400) 1	5.55	5.00
6316	10 Liter	(Pal. 40) 1	54.15	48.75



Starline Flüssigseife Starline

perlmutterweiss, pH-neutral

Artikel-Nr.	Produktinfo	Inhalt /VE	Preis /VE	
16814	500 ml	(Pal. 72) 12	34.65	netto

Seifen / Spender | Handseife



Leere Flasche

Artikel-Nr.	Produktinfo	Inhalt /VE	Preis /VE	
6327	1 Liter	1	2.75	netto



Hahnen

für 10 und 5 Liter Gebinde

Artikel-Nr.	Inhalt /VE	Preis /VE	
6328	1	9.75	netto

Seifen / Spender | Cosi - Spender



Seifenspender Cosi

weiss / transparent

Artikel-Nr.	Produktinfo	Inhalt /VE	Preis /VE	
6127	170 ml, H: 150 B: 55 T: 75 mm	(Pal. 50) 1	23.80	netto
6344	350 ml, H: 160 B: 95 T: 95 mm	(Pal. 50) 1	49.35	netto
6340	800 ml, H: 250 B: 95 T: 95 mm	(Pal. 50) 1	59.40	netto
6342	1100 ml, H: 220 B: 115 T: 130 mm	(Pal. 50) 1	66.25	netto



Seifenspender Cosi

chrom / transparent

Artikel-Nr.	Produktinfo	Inhalt /VE	Preis /VE	
6228	170 ml, H: 150 B: 55 T: 75 mm	(Pal. 50) 1	29.10	netto
6345	350 ml, H: 160 B: 95 T: 95 mm	(Pal. 12) 1	58.65	netto
6341	800 ml, H: 250 B: 95 T: 95 mm	(Pal. 50) 1	68.70	netto
6343	1100 ml, H: 220 B: 115 T: 130 mm	(Pal. 6) 1	77.05	netto

Seifen / Spender | Spirit



Spirit Pure Nature Hair & Body Shampoo

orange

Artikel-Nr.	Produktinfo	Inhalt /VE	Preis /VE	ab 5 VE 10%
8064	10 Liter Bidon	(Pal. 60) 1	57.75	51.95

Reception , Administration , Verpackung



Hotelhalle / Reception	126
Administration	128
Verpackung	130

Hotelhalle / Reception | Informationstafeln



Strassenständer Teak

witterungsbeständig

Artikel-Nr.	Produktinfo	Inhalt /VE	Preis /VE	
21508	70 x 120 cm, 18 kg, Sandwich	1	237.00	netto
21507	55 x 85 cm, 8 kg, Duplo	1	185.25	netto



Strassenständer

Aluminium, witterungsbeständig

Artikel-Nr.	Produktinfo	Inhalt /VE	Preis /VE	
13782	A1, 60 x 85 cm, 9 kg netto	1	204.00	netto



Infotafel SWING

Mit Klapprahmen aus Aluminium, Standsockel: 33 x 30 x 3 cm, Höhe Standrohr: 98.5 cm

Artikel-Nr.	Produktinfo	Inhalt /VE	Preis /VE	
13791	A4, 3.35 kg	(Pal. 40) 1	139.00	netto
13790	A3, 3.65 kg	(Pal. 40) 1	149.00	netto

Hotelhalle / Reception | LED Boards



LED Informationsvitrine

99 x 52 cm, 19 kg, Edelstahl, für 6 x A4, 16 Farben (inkl. Fernsteuerung)

Artikel-Nr.	Produktinfo	Inhalt /VE	Preis /VE	
21418*	transportierbar, kann mit Batterien angetrieben werden, mit oder ohne Stange, Kabel und Sockel erhältlich	1	690.00	netto

Batterie für LED-Informationsvitrine

12 x 7 cm, Laufzeit von 8 bis 10 Stunden



Artikel-Nr.	Produktinfo	Inhalt /VE	Preis /VE	
21419*	für Art. 21418	1	95.00	netto

Stange zu LED-Informationsvitrine

Edelstahl, chrom poliert



Artikel-Nr.	Produktinfo	Inhalt /VE	Preis /VE	
21420*	für Art. 21418	1	149.00	netto

Sockel zu LED-Informationsvitrine

Edelstahl, chrom poliert



Artikel-Nr.	Produktinfo	Inhalt /VE	Preis /VE	
21421*	für Art. 21418	1	75.00	netto

Hotelhalle / Reception | Menurahmen



Forex-Tafel

schwarz, 5 mm Dicke

Artikel-Nr.	Produktinfo	Inhalt /VE	Preis /VE	
13774	60 x 90 cm	1	73.00	netto
13773	50 x 70 cm	1	56.00	netto
14325	50 x 100 cm	1	71.00	netto
18167*	60 x 120 cm	1	85.00	netto



Kreidetafel mit Holzrahmen

aus Holz Teak

Artikel-Nr.	Produktinfo	Inhalt /VE	Preis /VE	
21506	60 x 80 cm	1	92.10	netto

Hotelhalle / Reception | Menurahmen



Klapprahmen

silber eloxiert, Aluminium, aufklappbar

Artikel-Nr.	Produktinfo	Inhalt /VE	Preis /VE	
13760*	A1, 60 x 90 cm	1	87.00	netto
25182	A3	1	56.00	netto
21513	A4	1	37.00	netto
21514	A5	1	34.00	netto



Kreidetischtafel

aus Holz Teak

Artikel-Nr.	Produktinfo	Inhalt /VE	Preis /VE	
21505	A4, 275 x 320 x 70 mm	1	24.85	netto
21504	A5, 200 x 230 x 60 mm	1	20.70	netto

Kreidemarker

weiss



Artikel-Nr.	Produktinfo	Inhalt /VE	Preis /VE	
21510	2 - 6 mm	1	5.20	netto
21512	7 - 15 mm	1	9.30	netto



Kreidemarker

farbig assortiert

Artikel-Nr.	Produktinfo	Inhalt /VE	Preis /VE	
21509	2 - 6 mm, Set à 8 Stück	1	36.25	netto
21511	7 - 15 mm, Set à 8 Stück	1	70.40	netto

Hotelhalle / Reception | Leitsysteme



Leitpfosten-Wandsystem

Gebürsteter Edelstahl, Bandlänge: 2.1 m

Artikel-Nr.	Produktinfo	Inhalt /VE	Preis /VE	
17346	grau	1	92.10	netto
17347*	rot	1	92.10	netto



Ausziehbares Leitpfostensystem

gebürstetes Chromstahl, sehr stabil (schwerer Fuss), Bandlänge 2.1 m, geeignet für Innen- oder Aussenbereich, wetterbeständig

Artikel-Nr.	Produktinfo	Inhalt /VE	Preis /VE	
17344	grau	1	164.55	netto
17345	rot	1	164.55	netto



Absperpfosten

Fuss von 12 kg, sehr stabil, geeignet für den Innen- oder Aussenbereich, wetterbeständig, Wandhalterung optional erhältlich

Artikel-Nr.	Produktinfo	Inhalt /VE	Preis /VE	
13252	chrom, flacher Kopf	1	112.80	netto
13251	gold, runder Kopf	1	112.80	netto



Trennungskordel mit Halterung aus Edelstahl

Durchmesser: 38 mm, Länge: 150 cm

Artikel-Nr.	Produktinfo	Inhalt /VE	Preis /VE	
13253	bronzene Kordel aus geflochtenem Satinseil, chrom Halterungen	1	71.40	netto
13259	rote Kordel aus Samt, chrom Halterungen	1	71.40	netto
13269	blaue Kordel aus geflochtenem Satinseil, chrom Halterungen	1	71.40	netto
19845*	schwarze Kordel aus Samt, chrom Halterungen	1	71.40	netto

Hotelhalle / Reception | Schlüsselanhänger und -aufbewahrung



Schlüsseldepot für bis zu 7 Schlüssel

Metallguss-Legierung, robust, 4-stelliges, verstellbares Zahlenschloss

Artikel-Nr.	Produktinfo	Inhalt /VE	Preis /VE	
24184	65 x 100 x 35 mm, schwarz	(Pal. 200) 1	47.00	netto



Schlüsseldepot für Schlüsselbunde, Magnetkarten und Batch-Anhänger

Metallguss-Legierung, robust, 4-stelliges, verstellbares Zahlenschloss

Artikel-Nr.	Produktinfo	Inhalt /VE	Preis /VE	
24186	80 x 190 x 50 mm, schwarz	(Pal. 200) 1	62.00	netto



Schlüsselkasten mit 20 Haken

Stahlblech, fixe Hakenleiste, mit Hakennummerierung, 2 Schlüssel

Artikel-Nr.	Produktinfo	Inhalt /VE	Preis /VE	
24182	200 x 160 x 80 mm	(Pal. 100) 1	39.50	netto



Schlüsselkasten mit 42 Haken

Stahlblech, verstellbare Hakenleiste, 2 Schlüssel, ohne Anhänger

Artikel-Nr.	Produktinfo	Inhalt /VE	Preis /VE	
24181	350 x 270 x 80 mm	(Pal. 75) 1	99.00	netto

Weitere Schlüsselanhänger finden Sie in unserem Hotwag-Katalog.

Hotelhalle / Reception | Rezeptionsglocke



Rezeptionsglocke

Ø 95 mm, Höhe: 90 mm, chrom, Messing

Artikel-Nr.	Inhalt /VE	Preis /VE	
21533	1	64.00	netto



Rezeptionsglocke

Ø 95 mm, Höhe: 90 mm, gold, Messing

Artikel-Nr.	Inhalt /VE	Preis /VE	
21532	1	64.00	netto

Administration | Officepapier



Kopierpapier A4 Symbio

weiss, 80 g/m²

Artikel-Nr.	Produktinfo	Inhalt /VE	Preis /VE	Preis ab 10 VE
7264	5 x 500 Blatt	(Pal. 40) 2500	40.60	24.70



Kopierpapier Bio Top 3 A4

weiss, 80 g/m²

Artikel-Nr.	Produktinfo	Inhalt /VE	Preis /VE	ab 5 VE 10%
7257	5 x 500 Blatt	(Pal. 40) 2500	62.50	56.25



Kopierpapier Pioneer A4

hochweiss, 80 g/m²

Artikel-Nr.	Produktinfo	Inhalt /VE	Preis /VE	ab 5 VE 10%
25326	5 x 500 Blatt	2500	70.50	63.45

Administration | Officepapier



Kopierpapier Image Recycled A4

hochweiss, 80 g/m²

Artikel-Nr.	Produktinfo	Inhalt /VE	Preis /VE	Preis ab 10 VE
19978	5 x 500 Blatt	(Pal. 40) 2500	50.85	33.95



Kopierpapier IQ Economy A3

weiss, 80 g/m²

Artikel-Nr.	Produktinfo	Inhalt /VE	Preis /VE	Preis VE /Pal.
7274.1	5 x 500 Blatt	(Pal. 20) 2500	76.10	70.70



Kopierpapier A4 Yes Bronze

weiss, 80g/m²

Artikel-Nr.	Produktinfo	Inhalt /VE	Preis /VE	Preis ab 10 VE
28125	5 x 500 Blatt	(Pal. 40) 2500	40.60	23.95

Administration | Anmeldeblöcke



Meldescheingarnitur

148 x 105 mm, 2-fach selbstdurchschreibend

Artikel-Nr.	Produktinfo	Inhalt /VE	Preis /VE	ab 5 VE 10%
10972.1	A6 quer	500	64.05	57.65

Administration | Diverses



Visitenkartenhalter Taymar

93 x 18 x 50 mm, transparent, Polystyrol

Artikel-Nr.	Inhalt /VE	Preis /VE	netto
21591	1	5.00	netto



Klick Fix Pen

Kugelschreiber mit Teleschnur zur Befestigung (selbstklebend) an Kasse, Telefon, in der Küche etc.

Artikel-Nr.	Inhalt /VE	Preis /VE	netto
21588	1	9.45	netto



Duracell Industrial Batterien

AAA LR03-Alkaline, 1.5 V

Artikel-Nr.	Inhalt /VE	Preis /VE	ab 5 VE 10%
28298	10	9.90	8.90



Duracell Industrial Batterien

AA LR06-Alkaline, 1.5 V

Artikel-Nr.	Inhalt /VE	Preis /VE	ab 5 VE 10%
28300	10	10.90	9.80



Duracell Industrial Batterien

C/LR14-Alkaline, 1.5 V

Artikel-Nr.	Inhalt /VE	Preis /VE	ab 5 VE 10%
28326	10	29.90	26.90

Administration | Diverses



Duracell Industrial Batterien

D/LR20-Alkaline, 1.5 V

Artikel-Nr.	Inhalt /VE	Preis /VE	ab 5 VE 10%
28324	10	36.50	32.85



Duracell Industrial Batterien

6LF22-Alkaline, 9 V

Artikel-Nr.	Inhalt /VE	Preis /VE	ab 5 VE 10%
28333	10	32.00	28.80



Sicherheitsbox für Aufbewahrung

Einwandig, Elektronikschloss mit mech. Notöffnungsschloss, 2 Schlüssel

Artikel-Nr.	Produktinfo	Inhalt /VE	Preis /VE	
24183	35 x 25 x 25 cm, schwarz	1	79.00	netto

Verpackung | Polygripverschlussbeutel



Polygrip-Verschlussbeutel

LD-PE, transparent, mit Druckverschluss, 0.05 mm

Artikel-Nr.	Produktinfo	Inhalt /VE	Preis /VE	Preis ab 6 VE
7640	40 x 60 mm	1000	15.35	13.85
7642	50 x 75 mm	1000	24.25	21.85
7641	75 x 90 mm	1000	26.90	24.25
7643	90 x 110 mm	1000	30.90	27.80
7644	115 x 155 mm	1000	52.65	47.35
7645	160 x 220 mm	1000	108.15	97.35
7646	200 x 250 mm	1000	124.00	111.60
7647	220 x 310 mm	1000	173.55	156.20
7563	280 x 350 mm	1000	157.20	141.50

weitere Größen auf Anfrage



Polygrip-Verschlussbeutel mit Beschriftungsfeld

LD-PE, transparent, mit Druckverschluss, 0.05 mm

Artikel-Nr.	Produktinfo	Inhalt /VE	Preis /VE	Preis ab 6 VE
7650	75 x 90 mm	1000	35.95	32.35
7651	90 x 110 mm	1000	45.85	41.30
11581	100 x 125 mm	1000	52.00	46.80
7652	115 x 155 mm	1000	53.90	48.55
7653	160 x 220 mm	1000	121.30	109.20

weitere Größen auf Anfrage



Polygrip-Verschlussbeutel

LD-PE, transparent, mit Druckverschluss, 0.075 mm

Artikel-Nr.	Produktinfo	Inhalt /VE	Preis /VE	Preis ab 6 VE
7642.1	50 x 75 mm	1000	34.35	30.95
7641.1	75 x 90 mm	1000	46.70	42.05
12509	100 x 125 mm	1000	59.25	53.35
7644.1	115 x 155 mm	1000	87.40	78.65
7645.1	160 x 220 mm	1000	115.95	netto
13402	240 x 300 mm	1000	129.10	netto
7563.1	280 x 350 mm	1000	207.50	netto
11598	360 x 450 mm	1000	249.00	netto

weitere Größen auf Anfrage

Verpackung | Polygripverschlussbeutel



Polygrip-Verschlussbeutel mit Beschriftungsfeld

LD-PE, transparent, mit Druckverschluss, 0.075 mm

Artikel-Nr.	Produktinfo	Inhalt /VE	Preis /VE	
12984	90 x 110 mm	1000	68.80	netto

weitere Grössen auf Anfrage

Verpackung | Packseidenpapier



Seidenpapier

weisslich

Artikel-Nr.	Produktinfo	Inhalt /VE	Preis /VE	ab 5 VE 10%
5926	50 x 75 cm, 22 g/m2, 5 kg , ca. 123 Blatt/kg	(Pal. 100) 1	31.55	28.40



Packseidenpapier

weisslich

Artikel-Nr.	Produktinfo	Inhalt /VE	Preis /VE	Preis ab 4 VE
7283	50 x 75 cm, 12.5 kg	(Pal. 32) 1	54.95	46.35

Verpackung | Schnüre



Packschnur

450 m, 2.5 mm Durchmesser, farbig

Artikel-Nr.	Produktinfo	Inhalt /VE	Preis /VE	ab 5 VE 10%
5687	500 g	1	14.05	12.65



Packschnur

440 m, farbig

Artikel-Nr.	Produktinfo	Inhalt /VE	Preis /VE	ab 5 VE 10%
5688	2.2 kg	(Pal. 189) 1	43.10	38.75



Packschnur

ca. 300 m

Artikel-Nr.	Produktinfo	Inhalt /VE	Preis /VE	
9025	ca. 500 g	(Pal. 360) 1	6.25	netto

Verpackung | Diverses



Druckausschuss

weisslich, maschinenglatt

Artikel-Nr.	Produktinfo	Inhalt /VE	Preis /VE	
11765	37 x 57 cm, 50 g/m2, 12.5 kg	(Pal. 40) 1	28.15	netto
11752	64 x 52 cm, 50 g/m2, 12.5 kg	(Pal. 40) 1	28.15	netto

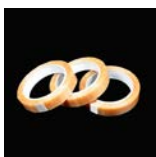

Klebeband

transparent

Artikel-Nr.	Produktinfo	Inhalt /VE	Preis /VE	
9021	38 mm	(Pal. 72) 8	20.80	netto



Handstretchfolie

nicht für Lebensmittel geeignet

Artikel-Nr.	Produktinfo	Inhalt /VE	Preis /VE	
7728	50 x 300 cm, 0.02 mm	(Pal. 33) 6	126.80	netto

Verpackung | Diverses



Luftpolsterfolie

0.08 mm

Artikel-Nr.	Produktinfo	Inhalt /VE	Preis /VE	ab 5 VE 10%
7291	120 cm x 100 m	1	111.45	100.30
7290	100 cm x 100 m	1	109.25	98.35

Waschraumhygiene



Toilettenpapier Kleinrollen	134
Toilettenpapier Einzelblatt	142
Toilettenpapier Grossrollen und Systemrollen	144
Feuchte Toilettenpapiere	154
Falhandtücher	154
Rollenhandtücher	174
Seifen	183
Desinfektion	199
WC-Garnituren und WC-Besen	206
Hygienebeutel	208
Sitzreiniger	211
Diverse Toilettenartikel	212
Lufterfrischer	214

Toilettenpapier Kleinrollen | Tork

Recycling | 2-lagig



TORK Toilettenpapier Tork Universal - T4 System

9.5 x 13 cm, 2-lagig, Recycling, Trilliumprägung

Artikel-Nr.	Produktinfo	Inhalt /VE	Preis /VE	Preis ab 10 VE
4870.2	weiss, Rolle à 400 Blatt	(Pal. 40) 30	32.50	29.25
7858.2	weiss, Rolle à 250 Blatt	(Pal. 18) 60	49.15	44.25



TORK Toilettenpapier Tork Advanced - T4 System

9.5 x 12 cm, 2-lagig, Recycling, weich, Daunenfederprägung

Artikel-Nr.	Produktinfo	Inhalt /VE	Preis /VE	ab 5 VE 10%
7994.2	weiss, Rolle à 400 Blatt	(Pal. 40) 30	47.30	42.55
27223	weiss, Rolle à 250 Blatt	(Pal. 27) 64	66.00	59.40

Recycling | 3-lagig



TORK Toilettenpapier Tork Advanced - T4 System

9.5 x 12 cm, 3-lagig, Recycling, extra weich, Daunenfederprägung

Artikel-Nr.	Produktinfo	Inhalt /VE	Preis /VE	ab 5 VE 10%
4826.2	weiss, Rolle à 250 Blatt	(Pal. 40) 30	39.10	35.15



TORK Toilettenpapier Tork Advanced - T4 System

9.5 x 13 cm, 3-lagig, Recycling, extra weich, Daunenfederprägung

Artikel-Nr.	Produktinfo	Inhalt /VE	Preis /VE	Preis ab 10 VE
4860.3	weiss, Rolle à 150 Blatt	(Pal. 18) 60	53.40	48.05

Zellstoff | 2-lagig



TORK Toilettenpapier Tork Premium - T4 System

9.4 x 11 cm, 2-lagig, Zellstoff, extra weich, Daunenfederprägung



Artikel-Nr.	Produktinfo	Inhalt /VE	Preis /VE	ab 5 VE 10%
29119	hochweiss, Rolle à 600 Blatt	(Pal. 22) 48	79.70	71.70

Zellstoff | 3-lagig



TORK Toilettenpapier Tork Premium - T4 System

9.4 x 11.8 cm, 3-lagig, Zellstoff, extra weich, Dekorprägung



Artikel-Nr.	Produktinfo	Inhalt /VE	Preis /VE	Preis ab 10 VE
4860.1	hochweiss, Rolle à 250 Blatt	(Pal. 18) 72	83.05	74.75
4860.2	hochweiss, Rolle à 250 Blatt	(Pal. 100) 16	18.45	16.60

Zellstoff | 4-lagig



TORK Toilettenpapier Tork Premium - T4 System

10 x 13 cm, 4-lagig, Zellstoff, extra weich, Dekorprägung



Artikel-Nr.	Produktinfo	Inhalt /VE	Preis /VE	Preis ab 10 VE
4859	hochweiss, Rolle à 150 Blatt	(Pal. 40) 42	65.80	59.20

Toilettenpapier Kleinrollen | Tork

Kleinrollenspender



TORK Tork Elevation Spender für 2 Kleinrollen - T4 System

weiss, Kunststoff, H: 158 B: 286 T: 153 mm

Artikel-Nr.	Produktinfo	Inhalt /VE	Preis /VE	
7153	mit Vorratsanzeige	(Pal. 160) 1	69.95	netto



TORK Tork Elevation Spender für 2 Kleinrollen - T4 System

schwarz, Kunststoff, H: 158 B: 286 T: 153 mm

Artikel-Nr.	Produktinfo	Inhalt /VE	Preis /VE	
13558	mit Vorratsanzeige	(Pal. 160) 1	69.95	netto

Toilettenpapier Kleinrollen | Kimberly-Clark

Recycling | 2-lagig



Toilettenpapier

9.5 x 12 cm, 2-lagig, Recycling



Artikel-Nr.	Produktinfo	Inhalt /VE	Preis /VE	Preis VE /Pal.
18221	weiss, Rolle à 400 Blatt, 6 x 6 Rollen	(Pal. 27) 36	37.30	28.65



Toilettenpapier

9.5 x 12 cm, 2-lagig, Recycling, schnellauflösend im Wasser



Artikel-Nr.	Produktinfo	Inhalt /VE	Preis /VE	Preis VE /Pal.
18102	weiss, Rolle à 250 Blatt, 8 x 8 Rollen	(Pal. 27) 64	49.80	38.20



Kimberly-Clark PROFESSIONAL Toilettenpapier Kimberly-Clark Kleenex

9.5 x 12.5 cm, 2-lagig, Recycling



Artikel-Nr.	Produktinfo	Inhalt /VE	Preis /VE	Preis VE /Pal.
18441	weiss, Rolle à 600 Blatt, 6 x 6 Rollen	(Pal. 27) 36	64.15	49.20

Recycling | 3-lagig



Kimberly-Clark PROFESSIONAL Toilettenpapier Kimberly-Clark Scott Premier

9.5 x 12.5 cm, 3-lagig, Recycling



Artikel-Nr.	Produktinfo	Inhalt /VE	Preis /VE	Preis VE /Pal.
18518	weiss, Rolle à 350 Blatt, 6 x 6 Rollen	(Pal. 27) 36	54.90	42.05



Hakle Toilettenpapier Hakle Natürliche Sauberkeit

9.8 x 12 cm, 3-lagig, 100 % Recycling



Artikel-Nr.	Produktinfo	Inhalt /VE	Preis /VE	
17794	weiss, Rolle à 150 Blatt, 4 x 9 Rollen, Swiss Made	(Pal. 36) 36	54.10	netto



Hakle Toilettenpapier Hakle Klassische Sauberkeit

9.8 x 12 cm, 3-lagig, Zellstoff-Recycling-Mix



Artikel-Nr.	Produktinfo	Inhalt /VE	Preis /VE	
14553*	orange, Rolle à 150 Blatt, 4 x 9 Rollen, Swiss Made	(Pal. 36) 36	54.10	netto

* auf Bestellung

Toilettenpapier Kleinrollen | Kimberly-Clark

Recycling | 3-lagig



Toilettenpapier Hakle Professionelle Sauberkeit

9.5 x 12 cm, 3-lagig, Recycling



Artikel-Nr.	Produktinfo	Inhalt /VE	Preis /VE	
24810	weiss, Rolle à 140 Blatt, 6 x 10 Rollen, Swiss Made	(Pal. 21) 60	29.20	netto

Recycling | 4-lagig



Toilettenpapier Hakle Pflegende Sauberkeit

9.8 x 12 cm, 4-lagig, Zellstoff-Recycling-Mix, bedruckt, Kamille



Artikel-Nr.	Produktinfo	Inhalt /VE	Preis /VE	
25599*	weiss, Rolle à 135 Blatt, 4 x 9 Rollen, Swiss Made	(Pal. 36) 36	32.50	netto
26715*	weiss, Rolle à 135 Blatt, 3 x 16 Rollen, Swiss Made	(Pal. 24) 48	43.20	netto
26716*	weiss, Rolle à 135 Blatt, 48 x 24 Rollen, Swiss Made	(Pal. 1) 1152	1'037.70	netto

Zellstoff | 2-lagig



Toilettenpapier Kimberly-Clark Kleenex

9.5 x 12.5 cm, 2-lagig, Zellstoff



Artikel-Nr.	Produktinfo	Inhalt /VE	Preis /VE	Preis VE /Pal.
18442	weiss, Rolle à 350 Blatt, 8 x 8 Rollen	(Pal. 27) 64	84.25	64.55



Toilettenpapier Kimberly-Clark Scott

9.5 x 12.5 cm, 2-lagig, Zellstoff



Artikel-Nr.	Produktinfo	Inhalt /VE	Preis /VE	Preis VE /Pal.
18519	weiss, Rolle à 350 Blatt, 8 x 8 Rollen	(Pal. 27) 64	53.30	40.90

Zellstoff | 3-lagig



Toilettenpapier Kimberly-Clark Kleenex Profi Line Top

10 x 13.5 cm, 3-lagig, Zellstoff

Artikel-Nr.	Produktinfo	Inhalt /VE	Preis /VE	Preis VE /Pal.
18454	weiss, Rolle à 180 Blatt, 4 x 9 Rollen	(Pal. 36) 36	47.65	36.55



Toilettenpapier Hakle Klassische Sauberkeit

9.9 x 12 cm, 3-lagig, Zellstoff



Artikel-Nr.	Produktinfo	Inhalt /VE	Preis /VE	Preis VE /Pal.
7893	weiss bedruckt, Rolle à 150 Blatt, 4 x 9 Rollen, Swiss Made	(Pal. 36) 36	41.75	31.85



Toilettenpapier Kimberly-Clark Kleenex Premier

9.5 x 12.5 cm, 3-lagig, Zellstoff



Artikel-Nr.	Produktinfo	Inhalt /VE	Preis /VE	Preis VE /Pal.
18440	weiss, Rolle à 350 Blatt, 6 x 6 Rollen	(Pal. 27) 36	72.60	55.65

Toilettenpapier Kleinrollen | Kimberly-Clark

Zellstoff | 4-lagig



Toilettenpapier Hakle Verwöhnende Sauberkeit

9.5 x 12 cm, 4-lagig, Zellstoff

Artikel-Nr.	Produktinfo	Inhalt /VE	Preis /VE	
11992.1	weiss, Rolle à 140 Blatt, 4 x 9 Rollen, Swiss Made	(Pal. 36) 36	33.20	netto
12085.1	weiss, Rolle à 140 Blatt, 10 x 2 Rollen, Swiss Made	(Pal. 63) 20	25.50	netto



Toilettenpapier Kimberly-Clark Kleenex Premium

12 x 9.8 cm, 4-lagig, Zellstoff

Artikel-Nr.	Produktinfo	Inhalt /VE	Preis /VE	ab 5 VE 10%
21640.1	weiss, Rolle à 160 Blatt, 6 x 4 Rollen	(Pal. 54) 24	33.00	29.70



Kleinrollenspender



Doppelrollen-Spender Kimberly-Clark Aquarius

weiss, Kunststoff, mit Sichtfenster, H: 180 B: 298 T: 130 mm

Artikel-Nr.	Inhalt /VE	Preis /VE	ab 5 VE 10%
20793	(Pal. 120) 1	89.15	80.25

Kostenlos erhältlich mit Spenderleihvertrag (ab 10 Kimberly Clark-Spender)



Doppelrollen-Spender Kimberly-Clark Aquarius

schwarz, Kunststoff, mit Sichtfenster, H: 180 B: 298 T: 130 mm

Artikel-Nr.	Inhalt /VE	Preis /VE	ab 5 VE 10%
26923	(Pal. 120) 1	89.15	80.25

Kostenlos erhältlich mit Spenderleihvertrag (ab 10 Kimberly Clark-Spender)

Toilettenpapier Kleinrollen | Bulkysoft

2-lagig



Toilettenpapier Classic Bulkysoft

10 x 10.5 cm, 2-lagig, 100 % Zellstoff

Artikel-Nr.	Produktinfo	Inhalt /VE	Preis /VE	ab 5 VE 10%
26875	weiss, Rolle à 500 Blatt	(Pal. 40) 40	26.40	23.75



3-lagig



Toilettenpapier Excellence Bulkysoft

9.5 x 11.5 cm, 3-lagig, 100 % Zellstoff

Artikel-Nr.	Produktinfo	Inhalt /VE	Preis /VE	ab 5 VE 10%
28838	weiss, Rolle à 120 Blatt	(Pal. 18) 96	31.45	28.30



Toilettenpapier Excellence Bulkysoft

10 x 13.5 cm, 3-lagig, 100 % Zellstoff

Artikel-Nr.	Produktinfo	Inhalt /VE	Preis /VE	ab 5 VE 10%
26219	weiss, Rolle à 250 Blatt	(Pal. 15) 72	50.25	45.20

Toilettenpapier Kleinrollen | Bulkysoft

4-lagig



BulkySoft Toilettenpapier Excellence Bulkysoft

10 x 13.5 cm, 4-lagig, 100 % Zellstoff



Artikel-Nr.	Produktinfo	Inhalt /VE	Preis /VE	ab 5 VE 10%
26217	weiss, Rolle à 150 Blatt	(Pal. 24) 60	33.50	30.15

Toilettenpapier Kleinrollen | Diverse

Recycling | 2-lagig



Toilettenpapier

9.5 x 11.5 cm, 2-lagig, Recycling

Artikel-Nr.	Produktinfo	Inhalt /VE	Preis /VE	Preis ab 10 VE
4858.2	naturweiss, Rolle à 250 Blatt	(Pal. 27) 64	31.45	28.35



Toilettenpapier Satino Comfort

12.1 x 9.6 cm, 2-lagig, Recycling



Artikel-Nr.	Produktinfo	Inhalt /VE	Preis /VE	Preis VE /PaL.
7315	nature, Rolle à 400 Blatt	(Pal. 28) 60	55.35	42.30



Toilettenpapier Satino Premium

12.1 x 9.6 cm, 2-lagig, Recycling



Artikel-Nr.	Produktinfo	Inhalt /VE	Preis /VE	ab 5 VE 10%
10806	hochweiss, Rolle à 400 Blatt	(Pal. 40) 40	29.50	26.55



Toilettenpapier Eco Natural

9.6 x 11 cm, 2-lagig, Recycling



Artikel-Nr.	Produktinfo	Inhalt /VE	Preis /VE	ab 5 VE 10%
19332	nature, Rolle à 400 Blatt	(Pal. 42) 30	19.05	17.15



Toilettenpapier

9.5 x 11.5 cm, 2-lagig, Recycling

Artikel-Nr.	Produktinfo	Inhalt /VE	Preis /VE	Preis ab 10 VE
27221	weiss, Rolle à 400 Blatt	(Pal. 40) 30	29.40	26.45



Toilettenpapier Smart

9.5 x 11 cm, 2-lagig, Recycling



Artikel-Nr.	Produktinfo	Inhalt /VE	Preis /VE	ab 5 VE 10%
25078	weiss, Rolle à 250 Blatt	(Pal. 33) 64	31.65	28.50



Toilettenpapier Smart

9.5 x 11 cm, 2-lagig, Recycling



Artikel-Nr.	Produktinfo	Inhalt /VE	Preis /VE	ab 5 VE 10%
25080	weiss, Rolle à 400 Blatt	(Pal. 33) 48	42.45	38.20

Toilettenpapier Kleinrollen | Diverse

Recycling | 3-lagig



Toilettenpapier Webstar Oekostar

9.8 x 13.5 cm, 3-lagig, Recycling



Artikel-Nr.	Produktinfo	Inhalt /VE	Preis /VE	Preis ab 10 VE
4863	nature, Rolle à 250 Blatt	(Pal. 20) 60	53.60	48.20



Toilettenpapier Premium

9.8 x 11.5 cm, 3-lagig, Recycling



Artikel-Nr.	Produktinfo	Inhalt /VE	Preis /VE	Preis ab 10 VE
7311.1	hell, Rolle à 250 Blatt	(Pal. 18) 72	40.65	36.60



Toilettenpapier

9.8 x 11.5 cm, 3-lagig, 100 % Recycling

Artikel-Nr.	Produktinfo	Inhalt /VE	Preis /VE	Preis ab 10 VE
4878	weiss, Rolle à 200 Blatt	(Pal. 27) 64	43.20	38.40



Toilettenpapier ToPa

9.4 x 13.5 cm, 3-lagig, 100 % Recycling



Artikel-Nr.	Produktinfo	Inhalt /VE	Preis /VE	Preis VE /Pal.
18098	weiss, Rolle à 200 Blatt	(Pal. 36) 36	29.90	25.15



Toilettenpapier Eco Natural

9.6 x 11 cm, 3-lagig, Recycling



Artikel-Nr.	Produktinfo	Inhalt /VE	Preis /VE	ab 5 VE 10%
18273	nature, Rolle à 250 Blatt	(Pal. 42) 30	20.00	18.00



Toilettenpapier Comfort

9.5 x 12 cm, 3-lagig, Recycling



Artikel-Nr.	Produktinfo	Inhalt /VE	Preis /VE	ab 5 VE 10%
25077	hochweiss, Rolle à 250 Blatt	(Pal. 18) 72	59.95	53.95



Toilettenpapier Smart

9.5 x 11 cm, 3-lagig, Recycling



Artikel-Nr.	Produktinfo	Inhalt /VE	Preis /VE	ab 5 VE 10%
25083	hochweiss, Rolle à 250 Blatt	(Pal. 33) 64	55.70	50.10



Toilettenpapier Oeco Swiss Classic

9.5 x 12.5 cm, 3-lagig, 100% Recycling



Artikel-Nr.	Produktinfo	Inhalt /VE	Preis /VE	ab 5 VE 10%
28803	weiss, Rolle à 250 Blatt	(Pal. 168) 8	5.90	5.30



Toilettenpapier Oeco Swiss Plus

9.5 x 12.5 cm, 3-lagig, 100% Recycling



Artikel-Nr.	Produktinfo	Inhalt /VE	Preis /VE	ab 5 VE 10%
28802	hochweiss, Rolle à 250 Blatt	(Pal. 168) 8	6.35	5.75

Toilettenpapier Kleinrollen | Diverse

Zellstoff | 2-lagig



Starline Toilettenpapier Premium neutral

Kurzblatt: 9.6 x 11.5 cm, 2-lagig, Zellstoff

Artikel-Nr.	Produktinfo	Inhalt /VE	Preis /VE	Preis ab 10 VE
7894	weiss, Rolle à 300 Blatt	(Pal. 24) 72	55.40	49.85



KATRIN Toilettenpapier Katrin Care

11.5 x 14 cm, 2-lagig, Zellstoff



Artikel-Nr.	Produktinfo	Inhalt /VE	Preis /VE	Preis ab 10 VE
7871	hochweiss, Rolle à 280 Blatt	(Pal. 36) 40	56.90	51.20



Toilettenpapier neutral

9.6 x 11.5 cm, 2-lagig, 100 % Zellstoff, Softprägung

Artikel-Nr.	Produktinfo	Inhalt /VE	Preis /VE	Preis ab 10 VE
7848	weiss, Rolle à 250 Blatt	(Pal. 24) 72	31.50	28.35



Toilettenpapier Superior Bio-Tech

9.5 x 11 cm, 2-lagig, Zellstoff, schnellauflösend. Verringert das Verstopfungsrisiko und trägt zur Instandhaltung von Rohrleitungen und Abwassersystemen bei.



Artikel-Nr.	Produktinfo	Inhalt /VE	Preis /VE	ab 5 VE 10%
4588	weiss, Rolle à 250 Blatt	(Pal. 24) 96	93.40	84.05

Zellstoff | 3-lagig



Toilettenpapier Premium

Langblatt: 9.5 x 13 cm, 3-lagig, 100 % Zellstoff

Artikel-Nr.	Produktinfo	Inhalt /VE	Preis /VE	Preis ab 10 VE
4886	weiss, Rolle à 250 Blatt	(Pal. 28) 60	60.10	47.40



Toilettenpapier neutral

9.6 x 11.5 cm, 3-lagig, Zellstoff

Artikel-Nr.	Produktinfo	Inhalt /VE	Preis /VE	Preis ab 10 VE
12886	weiss, Rolle à 350 Blatt	(Pal. 40) 40	39.25	35.00



Toilettenpapier neutral

10 x 13.5 cm, 3-lagig, 100 % Zellstoff

Artikel-Nr.	Produktinfo	Inhalt /VE	Preis /VE	Preis ab 10 VE
4886.2	weiss, Rolle à 250 Blatt	(Pal. 18) 72	70.45	55.55



Toilettenpapier Premium

9.6 x 11.5 cm, 3-lagig, 100 % Zellstoff

Artikel-Nr.	Produktinfo	Inhalt /VE	Preis /VE	Preis ab 10 VE
7897.2	weiss, Rolle à 250 Blatt	(Pal. 18) 72	58.30	46.00

Toilettenpapier Kleinrollen | Diverse

Zellstoff | 3-lagig



KATRIN Toilettenpapier Katrin Plus Toilet 210

11.5 x 14 cm, 3-lagig, Zellstoff



Artikel-Nr.	Produktinfo	Inhalt /VE	Preis /VE	Preis ab 10 VE
18315	hochweiss, Rolle à 210 Blatt	(Pal. 36) 40	51.75	46.55



Starline Toilettenpapier Starline

9.6 x 11.5 cm, 3-lagig, 100 % Zellstoff, Softprägung

Artikel-Nr.	Produktinfo	Inhalt /VE	Preis /VE	Preis ab 10 VE
7826	weiss, Rolle à 200 Blatt	(Pal. 24) 72	55.05	42.55



Toilettenpapier «SAMPA violett»

9.8 x 11 cm, 3-lagig, 100 % Zellstoff

Artikel-Nr.	Produktinfo	Inhalt /VE	Preis /VE	ab 5 VE 10%
25193	weiss, Rolle à 250 Blatt	(Pal. 30) 56	60.95	54.85



Toilettenpapier Superior Bio-Tech

9.5 x 11 cm, 3-lagig, Zellstoff, schnellauflösend. Verringert das Verstopfungsrisiko und trägt zur Instandhaltung von Rohrleitungen und Abwassersystemen bei.



Artikel-Nr.	Produktinfo	Inhalt /VE	Preis /VE	ab 5 VE 10%
25997	weiss, Rolle à 250 Blatt	(Pal. 18) 72	75.00	67.50



Toilettenpapier

9.8 x 11.5 cm, 3-lagig, 100 % Zellstoff, Softprägung

Artikel-Nr.	Produktinfo	Inhalt /VE	Preis /VE	ab 5 VE 10%
11914	weiss, Rolle à 300 Blatt	(Pal. 28) 60	44.55	40.10



Toilettenpapier neutral

9.3 x 11 cm, 3-lagig, Zellstoff

Artikel-Nr.	Produktinfo	Inhalt /VE	Preis /VE	Preis ab 10 VE
22019	weiss, Rolle à 250 Blatt	(Pal. 24) 72	62.00	48.90



Toilettenpapier Supersoft neutral

9.5 x 11 cm, 3-lagig, 100 % Zellstoff



Artikel-Nr.	Produktinfo	Inhalt /VE	Preis /VE	ab 5 VE 10%
26931	hochweiss, Rolle à 250 Blatt	(Pal. 33) 64	69.65	62.70



Toilettenpapier Superflausch neutral

9.5 x 13.8 cm, 3-lagig, 100 % Zellstoff



Artikel-Nr.	Produktinfo	Inhalt /VE	Preis /VE	ab 5 VE 10%
25081	hochweiss, Rolle à 250 Blatt	(Pal. 18) 72	86.40	77.80

Toilettenpapier Kleinrollen | Diverse

Zellstoff | 4-lagig



KATRIN Toilettenpapier Katrin 150 Plus

9.5 x 13 cm, 4-lagig, Zellstoff



Artikel-Nr.	Produktinfo	Inhalt /VE	Preis /VE	Preis ab 10 VE
4893	weiss, Rolle à 150 Blatt	(Pal. 33) 48	57.00	51.30



Toilettenpapier PRO 104 Clean&Clever

9.7 x 12.5 cm, 4-lagig, 100 % Zellstoff



Artikel-Nr.	Produktinfo	Inhalt /VE	Preis /VE	Preis ab 10 VE
14600	hochweiss, Rolle à 150 Blatt	(Pal. 18) 72	61.60	55.40



Toilettenpapier neutral

9.8 x 13.5 cm, 4-lagig, 100 % Zellstoff

Artikel-Nr.	Produktinfo	Inhalt /VE	Preis /VE	Preis ab 10 VE
3778	weiss, Rolle à 150 Blatt	(Pal. 24) 60	59.30	53.35



Toilettenpapier neutral

9.5 x 13.8 cm, 4-lagig, 100 % Zellstoff



Artikel-Nr.	Produktinfo	Inhalt /VE	Preis /VE	Preis ab 10 VE
14600.1	hochweiss, Rolle à 150 Blatt	(Pal. 21) 72	60.10	54.05



Toilettenpapier Prestige

9.5 x 13 cm, 4-lagig, 100 % Zellstoff



Artikel-Nr.	Produktinfo	Inhalt /VE	Preis /VE	ab 5 VE 10%
25093	hochweiss, Rolle à 150 Blatt	(Pal. 21) 72	76.05	68.45

Kleinrollenspender



Doppelrollenspender für 2 Rollen Toilettenpapier

weiss / transparent, Kunststoff, H: 260 B: 165 T: 165 mm

Artikel-Nr.	Produktinfo	Inhalt /VE	Preis /VE	
7830	abschliessbar	(Pal. 6) 1	40.50	netto



Spender für Toilettenpapier

Edelstahl, matt, H: 383 B: 140 T: 155 mm

Artikel-Nr.	Inhalt /VE	Preis /VE	
14022*	2	79.80	netto

Toilettenpapier Einzelblatt | Tork

Toilettenpapier Einzelblatt



TORK Toilettenpapier Einzelblatt Tork Premium - T3 System

11 x 19 cm, 2-lagig, extra weich



Artikel-Nr.	Produktinfo	Inhalt /VE	Preis /VE	ab 5 VE 10%
4889	weiss, 30 x 252 Blatt	(Pal. 42) 7560	93.25	83.90

Toilettenpapier Einzelblatt | Tork

Einzelblattspender



TORK Tork Elevation Spender für Toilettenpapier Einzelblatt - T3 System

weiss, Kunststoff, H: 270 B: 160 T: 130 mm

Artikel-Nr.	Produktinfo	Inhalt /VE	Preis /VE	
7174.3	mit Vorratsanzeige	(Pal. 216) 1	45.65	netto

Erhältlich mit Leihspendervertrag (es können Servicegebühren anfallen)



TORK Tork Elevation Spender für Toilettenpapier Einzelblatt - T3 System

schwarz, Kunststoff, H: 270 B: 160 T: 130 mm

Artikel-Nr.	Produktinfo	Inhalt /VE	Preis /VE	
7176*	mit Vorratsanzeige	(Pal. 216) 1	45.65	netto

Erhältlich mit Leihspendervertrag (es können Servicegebühren anfallen)

Toilettenpapier Einzelblatt | Kimberly-Clark

Toilettenpapier Einzelblatt



Kimberly-Clark PROFESSIONAL Toilettenpapier Einzelblatt Kimberly-Clark Scott

11.7 x 18.6 cm, 2-lagig, Tissue, Mikroprägung, Interfold-Falzung



Artikel-Nr.	Produktinfo	Inhalt /VE	Preis /VE	Preis VE /Pal.
18509	weiss, 36 x 220 Blatt	(Pal. 40) 36	60.90	46.75



Kimberly-Clark PROFESSIONAL Toilettenpapier Einzelblatt Kimberly-Clark Kleenex Ultra

12.5 x 18.6 cm, 2-lagig, Tissue, Mikroprägung, Interfold-Falzung



Artikel-Nr.	Produktinfo	Inhalt /VE	Preis /VE	Preis VE /Pal.
13045	weiss, 36 x 200 Blatt	(Pal. 32) 36	72.60	55.00



Kimberly-Clark PROFESSIONAL Toilettenpapier Einzelblatt Kimberly-Clark Scott

11.7 x 18.6 cm, 2-lagig, Tissue, Mikroprägung, Interfold-Falzung



Artikel-Nr.	Produktinfo	Inhalt /VE	Preis /VE	ab 5 VE 10%
18508	weiss, 36 x 250 Blatt	(Pal. 40) 36	86.25	77.65



Kimberly-Clark PROFESSIONAL Toilettenpapier Einzelblatt Kimberly-Clark Kleenex Premier

12.5 x 18.6 cm, 2-lagig, Tissue, Mikroprägung, Interfold-Falzung



Artikel-Nr.	Produktinfo	Inhalt /VE	Preis /VE	ab 5 VE 10%
13289	weiss, 24 x 200 Blatt	(Pal. 56) 24	63.35	57.05

Einzelblattspender



Kimberly-Clark PROFESSIONAL Spender für Toilettenpapier Einzelblatt Kimberly-Clark Aquarius

weiss, Kunststoff, H: 338 B: 169 T: 120 mm, mit Sichtfenster

Artikel-Nr.	Inhalt /VE	Preis /VE	ab 5 VE 10%
20001	(Pal. 126) 1	54.75	49.25

Kostenlos erhältlich mit Spenderleihvertrag (ab 10 Kimberly Clark-Spender)

* auf Bestellung

Toilettenpapier Einzelblatt | Kimberly-Clark

Einzelblattspender



Spender für Toilettenpapier Einzelblatt Kimberly-Clark Aquarius

schwarz, Kunststoff, H: 338 B: 169 T: 120 mm, mit Sichtfenster

Artikel-Nr.	Inhalt /VE	Preis /VE	ab 5 VE 10%
26919	(Pal. 126) 1	54.75	49.25

Kostenlos erhältlich mit Spenderleihvertrag (ab 10 Kimberly Clark-Spender)



Spender für Toilettenpapier Einzelblatt Kimberly-Clark

Edelstahl, H: 319 B: 143 T: 100 mm

Artikel-Nr.	Inhalt /VE	Preis /VE	ab 5 VE 10%
22323	(Pal. 126) 1	150.45	135.40

Toilettenpapier Einzelblatt | Bulkysoft

Toilettenpapier Einzelblatt



Toilettenpapier Bulkysoft

11 x 19 cm, 2-lagig, 100 % Zellstoff



Artikel-Nr.	Produktinfo	Inhalt /VE	Preis /VE	ab 5 VE 10%
26220	weiss, 250 Blatt, für Spender Art. 26271	(Pal. 40) 36	41.00	36.90

Einzelblattspender



Spender für Toilettenpapier Einzelblatt Bulkysoft

weiss / transparent, ABS Kunststoff, H: 275 B: 135 T: 121 mm

Artikel-Nr.	Produktinfo	Inhalt /VE	Preis /VE	ab 5 VE 10%
26271	abschliessbar, für Art. 26220	(Pal. 288) 1	24.20	netto

Toilettenpapier Grossrollen und Systemrollen | Tork

1-lagig



Toilettenpapier Mini Jumbo Tork Advanced - T2 System

9.5 x 14 cm, 1-lagig



Artikel-Nr.	Produktinfo	Inhalt /VE	Preis /VE	ab 5 VE 10%
7561	weiss, Rolle à 240 lfm	(Pal. 36) 12	94.75	85.25

2-lagig



Toilettenpapier Jumbo Tork Advanced - T1 System

9.5 x 35 cm, 2-lagig, Dekorprägung



Artikel-Nr.	Produktinfo	Inhalt /VE	Preis /VE	ab 5 VE 10%
25047	weiss, Rolle à 380 lfm, 1900 Blatt	(Pal. 24) 6	86.45	77.80



Toilettenpapier Jumbo Tork Advanced - T1 System

10 x 20 cm, 2-lagig, Dekorprägung



Artikel-Nr.	Produktinfo	Inhalt /VE	Preis /VE	Preis VE /Pal.
7849	hochweiss, Rolle à 360 lfm, ca. 1800 Blatt	(Pal. 36) 6	72.55	54.40

Toilettenpapier Grossrollen und Systemrollen | Tork

2-lagig



TORK Toilettenpapier Jumbo Tork Premium - T1 System

Ø 26 cm, 10 x 20 cm, 2-lagig, Dekorprägung



Artikel-Nr.	Produktinfo	Inhalt /VE	Preis /VE	Preis VE /Pal.
7854	hochweiss, Rolle à 360 lfm, ca. 1800 Blatt	(Pal. 36) 6	96.70	72.55



TORK Toilettenpapier Mini Jumbo Tork Advanced - T2 System

10 x 20 cm, 2-lagig, Dekorprägung



Artikel-Nr.	Produktinfo	Inhalt /VE	Preis /VE	Preis VE /Pal.
7856	weiss, Rolle à 170 lfm, ca. 1213 Blatt	(Pal. 36) 12	71.70	53.80



TORK Toilettenpapier Mini Jumbo Tork Premium - T2 System

Ø 18 cm, 10 x 14 cm, 2-lagig, Dekorprägung



Artikel-Nr.	Produktinfo	Inhalt /VE	Preis /VE	Preis VE /Pal.
7973	hochweiss, Rolle à 170 lfm, ca. 1214 Blatt	(Pal. 36) 12	112.15	84.10



TORK Toilettenpapier Midi Tork Advanced - T7 System

9.3 x 12.5 cm, 2-lagig, hülsenlos, Lotusblumen-Prägung



Artikel-Nr.	Produktinfo	Inhalt /VE	Preis /VE	Preis ab 10 VE
11286	weiss, Rolle à 112.5 lfm, ca. 900 Blatt	(Pal. 33) 36	130.90	117.80



TORK Toilettenpapier Midi Tork Premium - T7 System

9.3 x 12.5 cm, 2-lagig, weich, hülsenlos, Lotusblumen-Prägung



Artikel-Nr.	Produktinfo	Inhalt /VE	Preis /VE	Preis ab 10 VE
14615	weiss, Rolle à 100 lfm, ca. 800 Blatt	(Pal. 33) 36	130.90	117.80



TORK Toilettenpapier SmartOne Tork Advanced - T8 System

18 x 13.4 cm, 2-lagig



Artikel-Nr.	Produktinfo	Inhalt /VE	Preis /VE	Preis ab 10 VE
14618	weiss, Rolle à 207 lfm, ca. 1150 Blatt	(Pal. 64) 6	54.60	49.15



TORK Toilettenpapier SmartOne Mini Tork Advanced - T9 System

18 x 13.4 cm, 2-lagig



Artikel-Nr.	Produktinfo	Inhalt /VE	Preis /VE	ab 5 VE 10%
18231	weiss, Rolle à 112 lfm, ca. 620 Blatt	(Pal. 48) 12	83.10	74.80

3-lagig



TORK Toilettenpapier Mini Jumbo Tork Premium - T2 System

10 x 20 cm, 3-lagig, extra weich, Dekorprägung

Artikel-Nr.	Produktinfo	Inhalt /VE	Preis /VE	Preis VE /Pal.
13006.1	weiss, Rolle à 120 lfm, ca. 600 Blatt	(Pal. 36) 12	100.95	75.70



TORK Toilettenpapier Midi Tork Premium - T7 System

9.3 x 12.5 cm, weiss, 3-lagig, extra weich, hülsenlos



Artikel-Nr.	Produktinfo	Inhalt /VE	Preis /VE	Preis ab 10 VE
18080	weiss, Rolle 69 lfm, ca. 550 Blatt	(Pal. 66) 18	58.65	52.80

Machen Sie Ihren Waschraum zu etwas Besonderem



Mit unserer neuen Spenderlinie setzen Sie ein Statement für Ihr Image

Gebürsteter Edelstahl, feine Linienführung und sanfte Kurven – die Tork Image Design™ Linie spricht eine diskrete aber dennoch ausdrucksstarke Designsprache. Durch eine Mischung aus Form und Funktionalität verschafft Sie Ihrem Waschraum einen Gesamteindruck, der Ihren Gästen positiv im Gedächtnis bleibt.



25161



25162



25164



25165

Besuchen Sie den Image Design™ Showroom:
www.torkimagedesign.com



Toilettenpapier Grossrollen und Systemrollen | Tork

Grossrollen- und Systemspender



TORK Tork Elevation Spender für Toilettenpapier Jumbo - T1 System

weiss, Kunststoff, H: 437 B: 360 T: 133 mm

Artikel-Nr.	Inhalt /VE	Preis /VE	
7118.4	(Pal. 65) 1	86.50	netto



TORK Tork Elevation Spender für Toilettenpapier Jumbo - T1 System

schwarz, Kunststoff, H: 440 B: 360 T: 130 mm

Artikel-Nr.	Inhalt /VE	Preis /VE	
13559*	(Pal. 65) 1	86.50	netto



TORK Tork Spender für Toilettenpapier Jumbo - T1 System

weiss, Metall, H: 316 B: 322 T: 117 mm

Artikel-Nr.	Inhalt /VE	Preis /VE	
13282*	(Pal. 105) 1	118.60	netto



TORK Tork Elevation Spender für Toilettenpapier Mini Jumbo - T2 System

weiss, Kunststoff, H: 256 B: 432 T: 146 mm

Artikel-Nr.	Produktinfo	Inhalt /VE	Preis /VE	
12120	mit Sichtfenster, eine Spenderbefüllung entspricht ca. 16 Kleinrollen	(Pal. 84) 1	195.80	netto

Erhältlich mit Leihspendervertrag (es können Servicegebühren anfallen)



TORK Tork Elevation Spender für Toilettenpapier Mini Jumbo - T2 System

schwarz, Kunststoff, H: 256 B: 432 T: 146 mm

Artikel-Nr.	Produktinfo	Inhalt /VE	Preis /VE	
12122	mit Sichtfenster, eine Spenderbefüllung entspricht ca. 16 Kleinrollen	(Pal. 92) 1	195.80	netto

Erhältlich mit Leihspendervertrag (es können Servicegebühren anfallen)



TORK Tork Elevation Spender für Toilettenpapier Mini Jumbo - T2 System

weiss, Kunststoff, H:275 B:345 T:132 mm, abschliessbar, mit Sichtfenster

Artikel-Nr.	Inhalt /VE	Preis /VE	
7119	(Pal. 108) 1	55.05	netto

Erhältlich mit Leihspendervertrag (es können Servicegebühren anfallen)



TORK Tork Elevation Spender für Toilettenpapier Mini Jumbo - T2 System

schwarz, Kunststoff, H:275 B:345 T:132 mm, abschliessbar, mit Sichtfenster

Artikel-Nr.	Inhalt /VE	Preis /VE	
13560	(Pal. 108) 1	55.05	netto

Erhältlich mit Leihspendervertrag (es können Servicegebühren anfallen)



TORK Tork Spender für Toilettenpapier Mini Jumbo - T2 System

gebürsteter Edelstahl / Kunststoff, H: 254 B: 355 T: 133 mm

Artikel-Nr.	Inhalt /VE	Preis /VE	
25164	(Pal. 88) 1	87.60	netto

* auf Bestellung

Toilettenpapier Grossrollen und Systemrollen | Tork

Grossrollen- und Systemspender



TORK Tork Spender für hülsenloses Midi Toilettenpapier - T7 System

Edelstahl, H: 120 B: 140 T: 140 mm

Artikel-Nr.	Inhalt /VE	Preis /VE	
19695	(Pal. 288) 1	87.60	netto



TORK Tork Doppelrollenspender für hülsenloses Toilettenpapier Midi - T7 System

Edelstahl, H: 150 B: 320 T: 150 mm

Artikel-Nr.	Inhalt /VE	Preis /VE	
11287	(Pal. 136) 1	88.70	netto



TORK Tork Elevation Doppelrollenspender für hülsenloses Midi Toilettenpapier - T7 System

weiss, Kunststoff, H: 207 B: 360 T: 130 mm

Artikel-Nr.	Inhalt /VE	Preis /VE	
28999	(Pal. 140) 1	48.80	netto

Erhältlich mit Leihspendervertrag (es können Servicegebühren anfallen)



TORK Tork Elevation Doppelrollenspender für hülsenloses Midi Toilettenpapier - T7 System

schwarz, Kunststoff, H: 207 B: 360 T: 130 mm

Artikel-Nr.	Inhalt /VE	Preis /VE	
29000	(Pal. 140) 1	48.80	netto

Erhältlich mit Leihspendervertrag (es können Servicegebühren anfallen)



TORK Tork SmartOne Elevation Spender für Toilettenpapier - T8 System

weiss, Kunststoff, H: 269 B: 269 T: 156 mm

Artikel-Nr.	Inhalt /VE	Preis /VE	
26024	(Pal. 114) 1	48.80	netto

Erhältlich mit Leihspendervertrag (es können Servicegebühren anfallen)



TORK Tork SmartOne Elevation Spender für Toilettenpapier - T8 System

schwarz, Kunststoff, H: 269 B: 269 T: 156 mm

Artikel-Nr.	Inhalt /VE	Preis /VE	
26025	(Pal. 114) 1	48.80	netto

Erhältlich mit Leihspendervertrag (es können Servicegebühren anfallen)



TORK Tork SmartOne Wave Spender für Toilettenpapier - T8 System

blau, Kunststoff, H: 270 B: 270 T: 170 mm

Artikel-Nr.	Inhalt /VE	Preis /VE	
14610	(Pal. 128) 1	48.80	netto

Erhältlich mit Leihspendervertrag (es können Servicegebühren anfallen)



TORK Tork SmartOne Spender für Toilettenpapier - T8 System

Edelstahl, H: 270 B: 270 T: 170 mm

Artikel-Nr.	Inhalt /VE	Preis /VE	
14617	(Pal. 68) 1	88.70	netto

Toilettenpapier Grossrollen und Systemrollen | Tork

Grossrollen- und Systemspender



TORK Tork SmartOne Wave Mini Spender für Toilettenpapier - T9 System

blau, Kunststoff, H: 225 B: 225 T: 108 mm

Artikel-Nr.	Inhalt /VE	Preis /VE	
18232	(Pal. 189) 1	48.80	netto

Erhältlich mit Leihspendervertrag (es können Servicegebühren anfallen)



TORK Tork SmartOne Elevation Mini Spender für Toilettenpapier - T9 System

weiss, Kunststoff, H: 219 B: 219 T: 156 mm

Artikel-Nr.	Inhalt /VE	Preis /VE	
26026	(Pal. 176) 1	48.80	netto

Erhältlich mit Leihspendervertrag (es können Servicegebühren anfallen)



TORK Tork SmartOne Elevation Mini Spender für Toilettenpapier - T9 System

schwarz, Kunststoff, H: 219 B: 219 T: 156 mm

Artikel-Nr.	Inhalt /VE	Preis /VE	
26027	(Pal. 176) 1	48.80	netto

Erhältlich mit Leihspendervertrag (es können Servicegebühren anfallen)



TORK Tork SmartOne Wave Mini Doppelrollenspender für Toilettenpapier - T9 System

blau, Kunststoff, H: 400 B: 230 T: 180 mm

Artikel-Nr.	Inhalt /VE	Preis /VE	
18234	(Pal. 108) 1	77.10	netto

Erhältlich mit Leihspendervertrag (es können Servicegebühren anfallen)



TORK Tork SmartOne Elevation Mini Doppelrollenspender für Toilettenpapier - T9 System

weiss, Kunststoff, H: 221 B: 398 T: 156 mm

Artikel-Nr.	Inhalt /VE	Preis /VE	
26028	(Pal. 96) 1	77.10	netto

Erhältlich mit Leihspendervertrag (es können Servicegebühren anfallen)



TORK Tork SmartOne Elevation Mini Doppelrollenspender für Toilettenpapier - T9 System

schwarz, Kunststoff, H: 221 B: 398 T: 156 mm

Artikel-Nr.	Inhalt /VE	Preis /VE	
26029	(Pal. 96) 1	77.10	netto

Erhältlich mit Leihspendervertrag (es können Servicegebühren anfallen)

Tork T6 System



TORK Toilettenpapier Tork Advanced - T6 System

9.9 cm x 110 lfm, 2-lagig, unperforiert, Dekorprägung



Artikel-Nr.	Produktinfo	Inhalt /VE	Preis /VE	ab 5 VE 10%
14234	hochweiss	(Pal. 30) 27	96.75	87.05

Toilettenpapier Grossrollen und Systemrollen | Tork

Tork T6 System



TORK Toilettenpapier Tork Premium - T6 System

10 cm x 70 lfm, 3-lagig, unperforiert, extra weich, Dekorprägung



Artikel-Nr.	Produktinfo	Inhalt /VE	Preis /VE	ab 5 VE 10%
17720	hochweiss	(Pal. 30) 27	81.25	73.15



TORK Tork Elevation Spender für Toilettenpapier - T6 System

weiss, Kunststoff, H: 184 B: 344 T: 140 mm

Artikel-Nr.	Produktinfo	Inhalt /VE	Preis /VE	
13413	abschliessbar, mit Vorratsanzeige	(Pal. 120) 1	81.70	netto

Erhältlich mit Leihspendervertrag (es können Servicegebühren anfallen)



TORK Tork Elevation Spender für Toilettenpapier - T6 System

schwarz, Kunststoff, H: 184 B: 344 T: 140 mm

Artikel-Nr.	Produktinfo	Inhalt /VE	Preis /VE	
13567	abschliessbar, mit Vorratsanzeige	(Pal. 120) 1	81.70	netto

Erhältlich mit Leihspendervertrag (es können Servicegebühren anfallen)

Toilettenpapier Grossrollen und Systemrollen | Kimberly-Clark

2-lagig



Kimberly-Clark PROFESSIONAL Toilettenpapier Maxi Jumbo Kimberly-Clark Scott Performance

2-lagig, unperforiert



Artikel-Nr.	Produktinfo	Inhalt /VE	Preis /VE	Preis VE /Pal.
8511	weiss, Rolle à 380 lfm	(Pal. 42) 6	83.85	64.30



Kimberly-Clark PROFESSIONAL Toilettenpapier Midi Jumbo Kimberly-Clark Kleenex

9.4 x 40 cm, 2-lagig



Artikel-Nr.	Produktinfo	Inhalt /VE	Preis /VE	ab 5 VE 10%
8515	weiss, Rolle à 250 lfm, 625 Blatt	(Pal. 42) 6	56.40	50.75

Grossrollen- und Systemspender



Kimberly-Clark PROFESSIONAL Spender für Toilettenpapier Mini-Jumbo Kimberly-Clark Aquarius

weiss, Kunststoff, H: 312 B: 250 T: 145 mm

Artikel-Nr.	Produktinfo	Inhalt /VE	Preis /VE	ab 5 VE 10%
28243*	mit Sichtfenster	(Pal. 110) 1	76.85	69.15

Kostenlos erhältlich mit Spenderleihvertrag (ab 10 Kimberly Clark-Spender)



Kimberly-Clark PROFESSIONAL Spender für Toilettenpapier Midi-Jumbo Kimberly-Clark Aquarius

weiss, Kunststoff, H: 382 B: 446 T: 130 mm

Artikel-Nr.	Produktinfo	Inhalt /VE	Preis /VE	ab 5 VE 10%
21953*	mit Sichtfenster, für Art. 8511 / 8515	(Pal. 48) 1	99.50	89.55

Kostenlos erhältlich mit Spenderleihvertrag (ab 10 Kimberly Clark-Spender)



Kimberly-Clark PROFESSIONAL Spender für Toilettenpapier Midi-Jumbo Kimberly-Clark Aquarius

schwarz, Kunststoff, H: 382 B: 446 T: 130 mm

Artikel-Nr.	Produktinfo	Inhalt /VE	Preis /VE	ab 5 VE 10%
26921	mit Sichtfenster, für Art. 8511 / 8515	(Pal. 32) 1	99.50	89.55

Kostenlos erhältlich mit Spenderleihvertrag (ab 10 Kimberly Clark-Spender)

Toilettenpapier Grossrollen | Bulkysoft

1-lagig



BulkySoft Toilettenpapier Classic Bulkysoft Mini Jumbo

9 cm x 300 m, 1-lagig, 100 % Zellstoff, Mikroprägung



Artikel-Nr.	Produktinfo	Inhalt /VE	Preis /VE	ab 5 VE 10%
26215	weiss, unperforiert	(Pal. 40) 12	38.85	34.95

2-lagig



BulkySoft Toilettenpapier Premium Bulkysoft Mini Jumbo

9 cm x 145 m, 2-lagig, Zellstoff, Mikroprägung

Artikel-Nr.	Produktinfo	Inhalt /VE	Preis /VE	ab 5 VE 10%
26200	weiss, unperforiert	(Pal. 48) 12	28.15	25.35



BulkySoft Toilettenpapier Premium Bulkysoft Mini Jumbo

170 m, 2-lagig, 100 % Zellstoff



Artikel-Nr.	Produktinfo	Inhalt /VE	Preis /VE	ab 5 VE 10%
26144	weiss, Rolle à 485 Blatt	(Pal. 40) 12	23.80	21.40



BulkySoft Toilettenpapier Premium Bulkysoft Maxi Jumbo

9 x 35 cm, 2-lagig, 100 % Zellstoff



Artikel-Nr.	Produktinfo	Inhalt /VE	Preis /VE	ab 5 VE 10%
26216	weiss, Rolle à 915 Blatt	(Pal. 49) 6	21.05	18.95

Grossrollenspender



BulkySoft Spender Bulkysoft für Toilettenpapier Mini Jumbo

weiss / transparent, ABS Kunststoff, H: 284 B: 265 T: 127 mm

Artikel-Nr.	Produktinfo	Inhalt /VE	Preis /VE	
26269	abschliessbar	(Pal. 192) 1	32.85	netto



BulkySoft Spender Bulkysoft für Toilettenpapier Maxi Jumbo

weiss / transparent, ABS Kunststoff, H: 358 B: 331 T: 127 mm

Artikel-Nr.	Produktinfo	Inhalt /VE	Preis /VE	
26267		(Pal. 108) 1	40.15	netto

Toilettenpapier Systemrollen | Hagleitner

2-lagig



hagleitner XIBU multiROLL W2 Toilettenpapier

9.8 x 12 cm, 2-lagig, Recycling, Spotprägung

Artikel-Nr.	Produktinfo	Inhalt /VE	Preis /VE	ab 5 VE 10%
24916	weiss, Rolle à 950 Blatt, für Spender Art. 24912	(Pal. 20) 42	158.35	142.50

3-lagig



hagleitner XIBU multiROLL V3 Toilettenpapier

9.8 x 12 cm, 3-lagig, Recycling, Mikroprägung

Artikel-Nr.	Produktinfo	Inhalt /VE	Preis /VE	ab 5 VE 10%
24905	weiss, Rolle à 560 Blatt, für Spender Art. 24912	(Pal. 24) 32	127.70	114.95

Toilettenpapier Systemrollen | Hagleitner

4-lagig



hagleitner XIBU multiROLL Z4 Toilettenpapier

9.5 x 12 cm, 4-lagig, Zellstoff, Mikroprägung

Artikel-Nr.	Produktinfo	Inhalt /VE	Preis /VE	ab 5 VE 10%
24953	weiss, Rolle à 425 Blatt, für Spender Art. 24912	(Pal. 24) 32	133.05	119.75

Systemspender



hagleitner XIBU TISSUEPAPER Spender für zwei Rollen Toilettenpapier

weiss, ABS Kunststoff, H: 323 B: 170 T: 170 mm

Artikel-Nr.	Produktinfo	Inhalt /VE	Preis /VE	ab 5 VE 10%
24912	abschliessbar, für Art. 24916 / 24905 / 24953	(Pal. 8) 1	95.00	85.50

Toilettenpapier Systemrollen | Katrin

2-lagig



KATRIN Toilettenpapier Katrin Classic

10 x 12.5 cm, 2-lagig, Mischqualität



Artikel-Nr.	Produktinfo	Inhalt /VE	Preis /VE	ab 5 VE 10%
25629	weiss, Rolle à 800 Blatt, für Spender Art. 28386 / 28387 / 28388 / 28389	(Pal. 30) 36	104.20	93.75

Systemspender



KATRIN Katrin Inclusive Toilettenpapierspender

Kunststoff, H: 313 B: 154 T: 174 mm, für Art. 25629

Artikel-Nr.	Produktinfo	Inhalt /VE	Preis /VE	
28386	weiss	(Pal. 102) 1	51.30	netto
28387	schwarz	(Pal. 102) 1	51.30	netto

Kostenlos erhältlich mit Leihspendervertrag



KATRIN Katrin Inclusive Toilettenpapierspender

Kunststoff, H: 402 B: 154 T: 174 mm, mit Hülsenfänger, für Art. 25629

Artikel-Nr.	Produktinfo	Inhalt /VE	Preis /VE	
28388	weiss	(Pal. 72) 1	51.30	netto
28389	schwarz	(Pal. 72) 1	51.30	netto

Kostenlos erhältlich mit Leihspendervertrag

Toilettenpapier Grossrollen und Systemrollen | Diverse

2-lagig



Toilettenpapier Mini Jumbo

Ø 22 cm, 10 x 19 cm, 2-lagig, Zellstoff

Artikel-Nr.	Produktinfo	Inhalt /VE	Preis /VE	Preis ab 10 VE
4873	Rolle à 1160 Blatt, ca. 220 lfm, für Spender Art. 7859	(Pal. 36) 12	50.20	45.20

Toilettenpapier Grossrollen und Systemrollen | Diverse

2-lagig



Toilettenpapier Jumbo

Ø 26 cm, 10 x 19 cm, 2-lagig, 100 % Zellstoff

Artikel-Nr.	Produktinfo	Inhalt /VE	Preis /VE	Preis ab 10 VE
7853	Rolle à 1900 Blatt, ca. 360 lfm, für Spender Art. 7855	(Pal. 36) 6	43.85	39.65



Toilettenpapier Jumbo Eco Natural

8.9 x 24 cm, 2-lagig, Recycling



Artikel-Nr.	Produktinfo	Inhalt /VE	Preis /VE	ab 5 VE 10%
19331	nature, Rolle à 1458 Blatt, 350 lfm	(Pal. 48) 6	25.50	22.95



KATRIN Toilettenpapier Jumbo Classic Gigant M2

10 x 12.5 cm, 2-lagig, Fasermischung



Artikel-Nr.	Produktinfo	Inhalt /VE	Preis /VE	ab 5 VE 10%
14334	weiss, Rolle à 2720 Blatt, 340 lfm	(Pal. 42) 6	34.90	31.40



Toilettenpapier Mini Jumbo Comfort

9.2 x 25 cm, 2-lagig, Recycling



Artikel-Nr.	Produktinfo	Inhalt /VE	Preis /VE	Preis VE /Pal.
27526	hochweiss, Rolle à 700 Blatt	(Pal. 44) 12	72.45	54.35

Toilettenpapier COSMOS

9.8 x 11 cm, 2-lagig, Zellstoff



Artikel-Nr.	Produktinfo	Inhalt /VE	Preis /VE	ab 5 VE 10%
25040	100 lfm, für Spender Art. 25052 / 25059	(Pal. 34) 32	85.60	77.05

3-lagig

Toilettenpapier COSMOS

9.8 x 11 cm, 3-lagig, Zellstoff



Artikel-Nr.	Produktinfo	Inhalt /VE	Preis /VE	ab 5 VE 10%
25039	65 lfm, für Spender Art. 25052 / 25059	(Pal. 24) 32	90.35	81.30

Systemspender



COSMOS Toilettenpapierspender

ABS-Kunststoff, H: 325 B: 155 T: 175 mm, abschliessbar, abnehmbare Wandhalterung, Bremsfunktion

Artikel-Nr.	Produktinfo	Inhalt /VE	Preis /VE	ab 5 VE 10%
25052	weiss	(Pal. 155) 1	61.95	55.75
25059	weiss / schwarz	(Pal. 155) 1	61.95	55.75

Grossrollenspender



Spender für Toilettenpapier Jumbo

weiss / transparent, Kunststoff, H: 400 B: 370 T: 125 mm

Artikel-Nr.	Produktinfo	Inhalt /VE	Preis /VE	
7855	abschliessbar, für Art. 7853	(Pal. 50) 1	39.45	netto

Toilettenpapier Grossrollen und Systemrollen | Diverse

Grossrollenspender



KATRIN Spender Gigant für Toilettenpapier Jumbo

weiss, Metall, H: 330 B: 310 T: 129 mm

Artikel-Nr.	Produktinfo	Inhalt /VE	Preis /VE	
4872	abschliessbar, mit Sichtfenster	(Pal. 57) 1	45.50	netto



Spender für Toilettenpapier Mini Jumbo

weiss / transparent, ABS Kunststoff, Ø: 260 T: 130 mm

Artikel-Nr.	Produktinfo	Inhalt /VE	Preis /VE	
7859	abschliessbar	(Pal. 6) 1	31.25	netto



Spender für Toilettenpapier Jumbo

Edelstahl, Ø: 310 T: 120 mm

Artikel-Nr.	Produktinfo	Inhalt /VE	Preis /VE	
21744	abschliessbar, mit Sichtfenster	1	92.70	netto

Feuchte Toilettenpapiere



Hakle Feuchtes Toilettenpapier Hakle

Box à 42 Tücher, mit Aloe Vera und Kamille



Artikel-Nr.	Inhalt /VE	Preis /VE	Preis VE /Pal.
13460.1	(Pal. 96) 1	4.50	4.15



Hakle Nachfüllpackung feuchtes Toilettenpapier Hakle

42 Tücher, mit Aloe Vera und Kamille



Artikel-Nr.	Produktinfo	Inhalt /VE	Preis /VE	
7926	Nachfüllpackung für Art. 13460.1	(Pal. 184) 12	54.00	netto



Hakle Feuchtes Toilettenpapier Mini Hakle

12 Tücher, mit Aloe Vera und Kamille



Artikel-Nr.	Inhalt /VE	Preis /VE	
18384	(Pal. 300) 18	34.20	netto

Falhandtücher | Tork

Falhandtücher - Premium



TORK Handtuch Tork Premium - H2 System

21 x 34 cm, 2-lagig, TAD-Qualität, extra weich, Multifold-Falzung (W-Falzung), Tiefe gefaltet: 8.5 cm



Artikel-Nr.	Produktinfo	Inhalt /VE	Preis /VE	Preis ab 10 VE
4932	hochweiss, Dekorprägung, 100 Tücher	(Pal. 32) 2100	92.40	83.15



TORK Handtuch Tork Premium - H2 System

21 x 34 cm, 2-lagig, TAD-Qualität, Multifold-Falzung (W-Falzung), Tiefe gefaltet: 8.5 cm



Artikel-Nr.	Produktinfo	Inhalt /VE	Preis /VE	Preis ab 10 VE
4989	hochweiss, Dekorprägung, 110 Tücher	(Pal. 32) 2310	96.95	87.25

Falhandtücher | Tork

Falhandtücher - Premium



Handtuch Tork Premium - H3 System

23 x 23 cm, 2-lagig, TAD-Qualität, V-Falzung (ZickZack-Falzung), Tiefe gefaltet: 11.5 cm



Artikel-Nr.	Produktinfo	Inhalt /VE	Preis /VE	Preis ab 10 VE
4937.1	hochweiss, Dekorprägung, 200 Tücher	(Pal. 28) 3000	110.15	99.15

Falhandtücher - Advanced



Handtuch Tork Advanced - H2 System

21 x 34 cm, 2-lagig, Hybrid-Qualität (TAD & Tissue), Multifold-Falzung (W-Falzung), Tiefe gefaltet: 8.5 cm



Artikel-Nr.	Produktinfo	Inhalt /VE	Preis /VE	Preis ab 10 VE
4988	hochweiss, Dekorprägung, 136 Tücher	(Pal. 32) 2856	98.40	88.60



Handtuch Tork Advanced - H2 System

21 x 26 cm, 2-lagig, Hybrid Qualität (TAD & Tissue), Multifold-Falzung (Z-Falzung), Tiefe gefaltet: 8.5 cm



Artikel-Nr.	Produktinfo	Inhalt /VE	Preis /VE	Preis ab 10 VE
12976	weiss, Dekorprägung, 180 Tücher	(Pal. 32) 3780	111.35	100.20



Handtuch Tork Xpress Advanced - H2 System

21 x 23 cm, 2-lagig, Multifold-Falzung (Z-Falzung), Tiefe gefaltet: 7.8 cm



Artikel-Nr.	Produktinfo	Inhalt /VE	Preis /VE	Preis ab 10 VE
14627	weiss, 190 Tücher	(Pal. 20) 3800	67.25	60.55



Handtuch Tork Advanced - H2 System

21.2 x 25.5 cm, 2-lagig, Multifold-Falzung (Z-Falzung), schnellauflösend, Tiefe gefaltet: 8.9 cm



Artikel-Nr.	Produktinfo	Inhalt /VE	Preis /VE	ab 5 VE 10%
26936	weiss, Dekorprägung, 200 Tücher	(Pal. 32) 4200	135.25	121.70



Handtuch Tork Advanced - H3 System

25 x 31 cm, 2-lagig, C-Falzung, Tiefe gefaltet: 9.6 cm



Artikel-Nr.	Produktinfo	Inhalt /VE	Preis /VE	Preis ab 10 VE
10398	naturweiss, 96 Tücher	(Pal. 28) 2400	111.60	98.25
10386	grün, 96 Tücher	(Pal. 28) 2400	84.20	75.80



Handtuch Tork Advanced - H3 System

25 x 41 cm, 2-lagig, C-Falzung, Tiefe gefaltet: 9.6 cm



Artikel-Nr.	Produktinfo	Inhalt /VE	Preis /VE	ab 5 VE 10%
16264	hochweiss, 84 Tücher	(Pal. 28) 1680	89.85	80.85
12977	grün, 84 Tücher	(Pal. 28) 1680	87.10	78.40



Handtuch Tork Advanced - H3 System

25 x 23 cm, 2-lagig, V-Falzung (ZickZack-Falzung), Tiefe gefaltet: 11.5 cm



Artikel-Nr.	Produktinfo	Inhalt /VE	Preis /VE	Preis ab 10 VE
14719	weiss, 200 Tücher	(Pal. 32) 4000	129.65	116.65

Falhandtücher | Tork

Falhandtücher - Advanced



Handtuch Tork Advanced - H3 System

25 x 23 cm, 2-lagig, V-Falzung (ZickZack-Falzung), Tiefe gefaltet: 11.5 cm



Artikel-Nr.	Produktinfo	Inhalt /VE	Preis /VE	Preis ab 10 VE
4997.1	weiss, Dekorprägung, 250 Tücher	(Pal. 28) 3750	121.95	109.75



Handtuch Tork Advanced - H3 System

25 x 23 cm, 2-lagig, V-Falzung (ZickZack-Falzung), Tiefe gefaltet: 11.5 cm



Artikel-Nr.	Produktinfo	Inhalt /VE	Preis /VE	Preis ab 10 VE
4809.1	grün, Dekorprägung, 250 Tücher	(Pal. 28) 3750	86.90	78.25



Handtuch Tork Advanced - H3 System

23 x 23 cm, 2-lagig, V-Falzung, schnellauflösend, Tiefe gefaltet: 11.5 cm



Artikel-Nr.	Produktinfo	Inhalt /VE	Preis /VE	Preis ab 10 VE
10378.1	weiss, 250 Tücher	(Pal. 28) 3750	142.80	128.50

Falhandtücher - Universal



Handtuch Tork Universal - H2 System

21 x 23.5 cm, 2-lagig, Tissue, Multifold-Falzung (Z-Falzung), Tiefe gefaltet: 7.8 cm



Artikel-Nr.	Produktinfo	Inhalt /VE	Preis /VE	Preis ab 10 VE
12811.1	hochweiss, 237 Tücher	(Pal. 32) 4740	135.15	121.65



Handtuch Tork Xpress Universal - H2 System

19.6 x 25.5 cm, 1-lagig, Multifold-Falzung, Tiefe gefaltet: 8.5 cm



Artikel-Nr.	Produktinfo	Inhalt /VE	Preis /VE	ab 5 VE 10%
29120	weiss, 230 Tücher	(Pal. 32) 4830	104.50	94.05



Handtuch Tork Xpress Universal - H2 System

21 x 23 cm, 1-lagig, Multifold-Falzung (Z-Falzung), Tiefe gefaltet: 7.8 cm



Artikel-Nr.	Produktinfo	Inhalt /VE	Preis /VE	Preis ab 10 VE
11284	weiss, 250 Tücher	(Pal. 36) 5000	69.95	62.95



Handtuch Tork Universal - H3 System

25 x 31 cm, 1-lagig, Krepp-Papier, C-Falzung, Tiefe gefaltet: 9.6 cm



Artikel-Nr.	Produktinfo	Inhalt /VE	Preis /VE	Preis ab 10 VE
4987.1	weiss, 192 Tücher	(Pal. 28) 4608	72.90	64.20



Handtuch Tork Universal - H3 System

23 x 23 cm, 1-lagig, 100 % Zellstoff, V-Falzung (ZickZack-Falzung), Tiefe gefaltet: 11.5 cm



Artikel-Nr.	Produktinfo	Inhalt /VE	Preis /VE	Preis ab 10 VE
8662.1	weiss, 300 Tücher	(Pal. 28) 4500	113.25	101.90

Falhandtücher | Tork

Falhandtücher - Universal



Handtuch Tork Universal - H3 System

25 x 23 cm, 1-lagig, Krepp-Papier, V-Falzung (ZickZack-Falzung), Tiefe gefaltet: 11.5 cm



Artikel-Nr.	Produktinfo	Inhalt /VE	Preis /VE	Preis ab 10 VE
4844	grün, 200 Tücher	(Pal. 28) 4000	79.90	71.95



Endlos Handtuch Tork PeakServe Universal - H5 System

20 x 22.5 cm, 1-lagig

Artikel-Nr.	Produktinfo	Inhalt /VE	Preis /VE	ab 5 VE 10%
28871	weiss, 410 Tücher	(Pal. 45) 4920	115.80	104.25

Spender



Tork Xpress Spender für Multifold Handtücher - H2 System

weiss, Kunststoff, H: 444 B: 302 T: 102 mm

Artikel-Nr.	Produktinfo	Inhalt /VE	Preis /VE	
7060	abschliessbar, mit Sichtfenster	(Pal. 75) 1	103.30	netto

Erhältlich mit Leihspendervertrag (es können Servicegebühren anfallen)



Tork Xpress Spender für Multifold Handtücher - H2 System

schwarz, Kunststoff, H: 444 B: 302 T: 102 mm

Artikel-Nr.	Produktinfo	Inhalt /VE	Preis /VE	
13562	abschliessbar, mit Sichtfenster	(Pal. 100) 1	102.05	netto

Erhältlich mit Leihspendervertrag (es können Servicegebühren anfallen)



Tork Xpress Spender für Multifold Handtücher - H2 System

gebürsteter Edelstahl / Kunststoff, H: 468 B: 317 T: 101 mm

Artikel-Nr.	Inhalt /VE	Preis /VE	
25162	(Pal. 56) 1	110.75	netto



Tork Xpress Mini Spender für Multifold Handtücher - H2 System

weiss, Kunststoff, H: 295 B: 302 T: 101 mm

Artikel-Nr.	Produktinfo	Inhalt /VE	Preis /VE	
7056	abschliessbar, mit Sichtfenster	(Pal. 150) 1	88.85	netto

Erhältlich mit Leihspendervertrag (es können Servicegebühren anfallen)



Tork Xpress Mini Spender für Multifold Handtücher - H2 System

schwarz, Kunststoff, H: 295 B: 302 T: 101 mm

Artikel-Nr.	Produktinfo	Inhalt /VE	Preis /VE	
7058	abschliessbar, mit Sichtfenster	(Pal. 150) 1	88.85	netto

Erhältlich mit Leihspendervertrag (es können Servicegebühren anfallen)



Tork Xpress Tischspender für Multifold Handtücher - H2 System

weiss, Kunststoff, H: 218 B: 323 T: 116 mm

Artikel-Nr.	Inhalt /VE	Preis /VE	
21922	(Pal. 84) 1	66.95	netto

Falthandtücher | Tork

Spender



TORK Tork Xpress Tischspender für Multifold Handtücher - H2 System

schwarz, Kunststoff, H: 218 B: 323 T: 116 mm

Artikel-Nr.	Inhalt /VE	Preis /VE	
21923	(Pal. 84) 1	66.95	netto



TORK Tork Xpress Tischspender für Multifold Handtücher - H2 System

gebürsteter Edelstahl / Kunststoff, H: 218 B: 323 T: 116 mm

Artikel-Nr.	Inhalt /VE	Preis /VE	
25163	(Pal. 84) 1	90.35	netto



TORK Tork Spender für Zickzack und Lagenfalz Handtücher (C- und V-Falzung) - H3 System

weiss, Kunststoff, H: 439 B: 333 T: 136 mm

Artikel-Nr.	Produktinfo	Inhalt /VE	Preis /VE	
7018.3	abschliessbar, mit Sichtfenster	(Pal. 72) 1	101.65	netto



TORK Tork Spender für Zickzack und Lagenfalz Handtücher (C- und V-Falzung) - H3 System

schwarz, Kunststoff, H: 439 B: 333 T: 136 mm

Artikel-Nr.	Produktinfo	Inhalt /VE	Preis /VE	
13563	abschliessbar, mit Sichtfenster	(Pal. 72) 1	101.65	netto



TORK Tork Mini Spender für Zickzack und Lagenfalz Handtücher (C- und V-Falzung) - H3 System

weiss, Kunststoff, H: 291 B: 332 T: 135 mm

Artikel-Nr.	Inhalt /VE	Preis /VE	
8665.3	(Pal. 108) 1	65.75	netto



TORK Tork Mini Spender für Zickzack und Lagenfalz Handtücher (C- und V-Falzung) - H3 System

schwarz, Kunststoff, H: 291 B: 332 T: 135 mm

Artikel-Nr.	Inhalt /VE	Preis /VE	
13564	(Pal. 108) 1	65.75	netto



TORK Tork PeakServe Spender für Endlos-Handtücher - H5 System

weiss, Kunststoff, H: 730 B: 370 T: 101 mm

Artikel-Nr.	Inhalt /VE	Preis /VE	
28872	(Pal. 45) 1	80.00	netto

Erhältlich mit Leihspendervertrag (es können Servicegebühren anfallen)



TORK Tork PeakServe Spender für Endlos-Handtücher - H5 System

schwarz, Kunststoff, H: 730 B: 370 T: 101 mm

Artikel-Nr.	Inhalt /VE	Preis /VE	
28873	(Pal. 45) 1	80.00	netto

Erhältlich mit Leihspendervertrag (es können Servicegebühren anfallen)

Falthandtücher | Kimberly-Clark

Recycling | 1-lagig



Handtuch Kimberly-Clark Hostess Telafold

24 x 24 cm, 1-lagig, Recycling, Multifold-Falzung (Z-Falzung), Tiefe gefaltet: 8.8 cm



Artikel-Nr.	Produktinfo	Inhalt /VE	Preis /VE	Preis VE /Pal.
14501	natur, 24 x 224 Tücher	(Pal. 28) 5376	97.60	80.45



Handtuch Kimberly-Clark Hostess Telafold

24 x 24 cm, 1-lagig, Multifold-Falzung (Z-Falzung)



Artikel-Nr.	Produktinfo	Inhalt /VE	Preis /VE	Preis VE /Pal.
14431	hellgrün, 24 x 224 Tücher, Tiefe gefaltet: 9.1 cm	(Pal. 28) 5376	91.55	73.30
14502	gräulich, 24 x 224 Tücher, Tiefe gefaltet: 9.5 cm	(Pal. 28) 5376	87.30	66.30



Handtuch Kimberly-Clark Hostess

22.5 x 33 cm, 1-lagig, Recycling, C-Falzung, Tiefe gefaltet: 9.4 cm

Artikel-Nr.	Produktinfo	Inhalt /VE	Preis /VE	Preis VE /Pal.
7400	weiss, 16 x 208 Tücher	(Pal. 20) 3328	58.85	45.10



Handtuch Kimberly-Clark

25 x 33 cm, 1-lagig, Recycling, C-Falzung, Tiefe gefaltet: 9.4 cm

Artikel-Nr.	Produktinfo	Inhalt /VE	Preis /VE	Preis VE /Pal.
7407	grün, 20 x 180 Tücher	(Pal. 28) 3600	61.35	46.45

Recycling | 2-lagig



Handtuch Kimberly-Clark Scott Natura

25 x 33 cm, 2-lagig, Recycling, C-Falzung, Tiefe gefaltet: 9.4 cm



Artikel-Nr.	Produktinfo	Inhalt /VE	Preis /VE	Preis VE /Pal.
7405	weiss, 20 x 140 Tücher	(Pal. 28) 2800	105.40	80.80



Handtuch Kimberly-Clark Scott Excellent

25 x 33 cm, 2-lagig, 100 % Recycling, C-Falzung, Tiefe gefaltet: 9.4 cm



Artikel-Nr.	Produktinfo	Inhalt /VE	Preis /VE	ab 5 VE 10%
7404	weiss, 20 x 140 Tücher	(Pal. 28) 2800	146.30	131.65

Airflex | 1-lagig



Handtuch Kimberly-Clark Scott Performance

21.5 x 31.5 cm, 1-lagig, Airflex, Interfold-Falzung (W-Falzung), Tiefe gefaltet: 10.5 cm



Artikel-Nr.	Produktinfo	Inhalt /VE	Preis /VE	Preis VE /Pal.
7412	weiss, 15 x 212 Tücher	(Pal. 32) 3180	78.95	59.85
7413	blau, 15 x 212 Tücher	(Pal. 32) 3180	91.40	69.30



Handtuch Kimberly-Clark Scott Xtra

20 x 31.5 cm, 1-lagig, Airflex, Interfold-Falzung (W-Falzung), Tiefe gefaltet: 10.5 cm



Artikel-Nr.	Produktinfo	Inhalt /VE	Preis /VE	Preis VE /Pal.
12847	weiss, 15 x 240 Tücher	(Pal. 36) 3600	85.15	65.30

Faltheadtücher | Kimberly-Clark

Airflex | 1-lagig



Handtuch Kimberly-Clark Kleenex Ultra Soft Pop Up

22.5 x 26 cm, 1-lagig, Zellstoff-Latex-Mix, Interfold-Falzung

Artikel-Nr.	Produktinfo	Inhalt /VE	Preis /VE	ab 5 VE 10%
16652	weiss, 18 x Zupfbox à 70 Tücher	(Pal. 16) 1260	143.40	129.05



Handtuch Kimberly-Clark Kleenex

23.5 x 24 cm, 1-lagig, Airflex, Multifold-Falzung (Z-Falzung), Tiefe gefaltet: 8.1 cm

Artikel-Nr.	Produktinfo	Inhalt /VE	Preis /VE	ab 5 VE 10%
24618	weiss, 16 x 150 Tücher	(Pal. 28) 2400	38.00	34.20



Handtuch Kimberly-Clark Kleenex Scott

20 x 24 cm, 1-lagig, Airflex, Multifold-Falzung (Z-Falzung), Tiefe gefaltet: 8.1 cm

Artikel-Nr.	Produktinfo	Inhalt /VE	Preis /VE	ab 5 VE 10%
24621	weiss, 16 x 250 Tücher	(Pal. 32) 4000	44.25	39.85



Handtuch Kimberly-Clark Kleenex Scott

23.5 x 24 cm, 1-lagig, Airflex, Multifold-Falzung (Z-Falzung), Tiefe gefaltet: 8.1 cm

Artikel-Nr.	Produktinfo	Inhalt /VE	Preis /VE	ab 5 VE 10%
24619	weiss, 16 x 250 Tücher	(Pal. 28) 4000	52.75	47.50



Handtuch Kimberly-Clark Kleenex Scott

23.5 x 24 cm, 1-lagig, Airflex, Multifold-Falzung (Z-Falzung), schnellauflösend, Tiefe gefaltet: 8.1 cm

Artikel-Nr.	Produktinfo	Inhalt /VE	Preis /VE	ab 5 VE 10%
24620	weiss, 16 x 250 Tücher	(Pal. 28) 4000	63.50	57.15



Handtuch Kimberly-Clark Scott Scottfold

20 x 31.5 cm, 1-lagig, Airflex, Multifold-Falzung, Tiefe gefaltet: 7.9 cm

Artikel-Nr.	Produktinfo	Inhalt /VE	Preis /VE	Preis VE /Pal.
13474	weiss, 25 x 175 Tücher	(Pal. 21) 4375	94.35	72.35



Handtuch Kimberly-Clark Scott Slimfold

19 x 29.5 cm, 1-lagig, Airflex, Multifold-Falzung, Tiefe gefaltet: 5 cm

Artikel-Nr.	Produktinfo	Inhalt /VE	Preis /VE	ab 5 VE 10%
15856	weiss, 16 x 110 Tücher	(Pal. 56) 1760	46.45	41.80



Handtuch Kimberly-Clark Scott

25 x 33 cm, 1-lagig, Airflex, C-Falzung, Tiefe gefaltet: 9.7 cm

Artikel-Nr.	Produktinfo	Inhalt /VE	Preis /VE	Preis VE /Pal.
7306	weiss, 20 x 140 Tücher	(Pal. 28) 2800	69.05	52.95



Handtuch Kimberly-Clark Scott Xtra

20 x 21 cm, 1-lagig, Airflex, V-Falzung, Tiefe gefaltet: 10.5 cm

Artikel-Nr.	Produktinfo	Inhalt /VE	Preis /VE	Preis VE /Pal.
12755	weiss, 15 x 320 Tücher	(Pal. 36) 4800	80.05	61.40



Faltheadtücher | Kimberly-Clark

Airflex | 1-lagig



Handtuch Kimberly-Clark Scott Plus

24.7 x 23 cm, 1-lagig, Airflex, V-Falzung, Tiefe gefaltet: 11.5 cm



Artikel-Nr.	Produktinfo	Inhalt /VE	Preis /VE	Preis VE /Pal.
7305*	weiss, 20 x 180 Tücher	(Pal. 28) 3600	104.00	79.70



Handtuch Kimberly-Clark Scott

23.8 x 21.2 cm, 1-lagig, Airflex, V-Falzung, Tiefe gefaltet: 10.5 cm



Artikel-Nr.	Produktinfo	Inhalt /VE	Preis /VE	Preis VE /Pal.
7307.1	weiss, 15 x 320 Tücher	(Pal. 28) 4800	83.45	63.95

Airflex | 2-lagig



Handtuch Kimberly-Clark Kleenex Ultra

21.5 x 31.5 cm, 2-lagig, Airflex, Interfold-Falzung (W-Falzung), Tiefe gefaltet: 10.5 cm



Artikel-Nr.	Produktinfo	Inhalt /VE	Preis /VE	Preis VE /Pal.
7408	weiss, 30 x 124 Tücher	(Pal. 16) 3720	139.90	106.40
7402	weiss, 15 x 124 Tücher	(Pal. 32) 1860	65.40	49.70



Handtuch Kimberly-Clark Kleenex Ultra

21.5 x 41.5 cm, 2-lagig, Airflex, Interfold-Falzung (W-Falzung), Tiefe gefaltet: 10.5 cm



Artikel-Nr.	Produktinfo	Inhalt /VE	Preis /VE	Preis VE /Pal.
7409	weiss, 30 x 94 Tücher	(Pal. 16) 2820	190.80	144.55



Handtuch Kimberly-Clark Kleenex Ultra

20.3 x 23.8 cm, 2-lagig, Airflex, Multifold-Falzung (Z-Falzung), Tiefe gefaltet: 8 cm



Artikel-Nr.	Produktinfo	Inhalt /VE	Preis /VE	ab 5 VE 10%
26925	weiss, 16 x 150 Tücher	(Pal. 32) 2400	40.70	36.60



Handtuch Kimberly-Clark Scott Excellent Plus

25 x 33 cm, 2-lagig, Airflex, C-Falzung, Tiefe gefaltet: 9.4 cm



Artikel-Nr.	Produktinfo	Inhalt /VE	Preis /VE	Preis VE /Pal.
7300	weiss, 20 x 110 Tücher	(Pal. 28) 2200	111.20	85.25



Handtuch Kimberly-Clark Scott Excellent Plus

24.7 x 23 cm, 2-lagig, Airflex, V-Falzung, Tiefe gefaltet: 11.5 cm



Artikel-Nr.	Produktinfo	Inhalt /VE	Preis /VE	Preis VE /Pal.
7301	weiss, 20 x 180 Tücher	(Pal. 28) 3600	153.00	117.25



Handtuch Kimberly-Clark Kleenex Ultra

21.5 x 21 cm, 2-lagig, Airflex, V-Falzung, Tiefe gefaltet: 10.5 cm



Artikel-Nr.	Produktinfo	Inhalt /VE	Preis /VE	Preis VE /Pal.
7416	weiss, 15 x 186 Tücher	(Pal. 32) 2790	56.00	42.95

Falorthandtücher | Kimberly-Clark

Airflex | 3-lagig



Handtuch Kimberly-Clark Kleenex Ultra Super Soft

21.5 x 31.5 cm, 3-lagig, Airflex, Interfold-Falzung (W-Falzung), Tiefe gefaltet: 10.5 cm



Artikel-Nr.	Produktinfo	Inhalt /VE	Preis /VE	Preis VE /Pal.
7410	weiss, 30 x 96 Tücher	(Pal. 16) 2880	149.05	112.95



Handtuch Kimberly-Clark Kleenex Premier

21.5 x 31.5 cm, 3-lagig, Airflex, Interfold-Falzung (W-Falzung), Tiefe gefaltet: 10.5 cm



Artikel-Nr.	Produktinfo	Inhalt /VE	Preis /VE	ab 5 VE 10%
27536	weiss, 15 x 72 Tücher	(Pal. 32) 1080	122.60	110.35



Handtuch Kimberly-Clark Kleenex Ultra Super Soft

21.5 x 41.5 cm, 3-lagig, Airflex, Interfold-Falzung (W-Falzung), Tiefe gefaltet: 10.5 cm



Artikel-Nr.	Produktinfo	Inhalt /VE	Preis /VE	Preis VE /Pal.
7411	weiss, 30 x 72 Tücher	(Pal. 16) 2160	175.80	133.15

Spender



Handtuchspender Standard Kimberly-Clark Aquarius

Kunststoff, H: 407 B: 317 T: 150 mm, für alle C- und V-Handtücher

Artikel-Nr.	Produktinfo	Inhalt /VE	Preis /VE	ab 5 VE 10%
20565	weiss, mit Sichtfenster	(Pal. 48) 1	110.05	99.05

Kostenlos erhältlich mit Spenderleihvertrag (ab 10 Kimberly Clark-Spender)



Handtuchspender klein Kimberly-Clark Aquarius

weiss, Kunststoff, H: 159 B: 287 T: 140 mm, für alle C- und V-Handtücher (mit Adapter Art. 7420 auch Interfold möglich)

Artikel-Nr.	Produktinfo	Inhalt /VE	Preis /VE	ab 5 VE 10%
4595	mit Sichtfenster	(Pal. 132) 1	37.85	34.05

Kostenlos erhältlich mit Spenderleihvertrag (ab 10 Kimberly Clark-Spender)



Handtuchspender Kimberly-Clark Aquarius

weiss, Kunststoff, H: 399 B: 265 T: 140 mm, für Interfold-Handtücher, passende Handtücher Art. 13474 / 18226 / 7412 / 7413 / 12847 / 12755 / 7410 / 16772 / 7411 / 7408 / 7402 / 7416

Artikel-Nr.	Produktinfo	Inhalt /VE	Preis /VE	ab 5 VE 10%
19999	mit Sichtfenster	(Pal. 52) 1	110.80	99.70

Kostenlos erhältlich mit Spenderleihvertrag (ab 10 Kimberly Clark-Spender)



Handtuchspender Kimberly-Clark Aquarius

schwarz, Kunststoff, H: 399 B: 265 T: 140 mm, für Interfold-Handtücher, passende Handtücher Art. 13474 / 18226 / 7412 / 7413 / 12847 / 12755 / 7410 / 16772 / 7411 / 7408 / 7402 / 7416

Artikel-Nr.	Produktinfo	Inhalt /VE	Preis /VE	ab 5 VE 10%
26918	mit Sichtfenster	(Pal. 52) 1	104.65	94.20

Kostenlos erhältlich mit Spenderleihvertrag (ab 10 Kimberly Clark-Spender)



Handtuchspender Kimberly-Clark

Edelstahl, H: 349 B: 237 T: 120 mm, für Interfold-Handtücher

Artikel-Nr.	Produktinfo	Inhalt /VE	Preis /VE	ab 5 VE 10%
22324		(Pal. 72) 1	179.95	161.95

Falhandtücher | Kimberly-Clark

Spender



Handtuchspender Kimberly-Clark Aquarius

weiss, Kunststoff, H: 451 B: 294 T: 120 mm, für Multifold-Handtücher, passende Handtücher Art. 24618 / 24619 / 24620 / 24621 / 26925

Artikel-Nr.	Produktinfo	Inhalt /VE	Preis /VE	ab 5 VE 10%
25454	mit Sichtfenster	(Pal 54) 1	94.70	85.25

Kostenlos erhältlich mit Spenderleihvertrag (ab 10 Kimberly Clark-Spender)



Handtuchspender Slimfold Kimberly-Clark Aquarius

weiss, Kunststoff, H: 380 B: 239 T: 81 mm, für Slimfold-Handtücher, passende Handtücher Art. 15856

Artikel-Nr.	Produktinfo	Inhalt /VE	Preis /VE	ab 5 VE 10%
25769*	mit Sichtfenster	(Pal 126) 1	103.55	93.20

Kostenlos erhältlich mit Spenderleihvertrag (ab 10 Kimberly Clark-Spender)

Falhandtücher | Bulkysoft

Classic



Handtuch Classic Bulkysoft

23 x 31 cm, 1-lagig, Zellstoff, C-Falzung, Micro-Prägung, Tiefe gefaltet: 8.9 cm



Artikel-Nr.	Produktinfo	Inhalt /VE	Preis /VE	ab 5 VE 10%
26134	weiss, 153 Tücher	(Pal 40) 3060	35.20	netto



Handtuch Classic Bulkysoft

23 x 31 cm, 2-lagig, Zellstoff, C-Falzung, Micro-Prägung, Tiefe gefaltet: 8.9 cm



Artikel-Nr.	Produktinfo	Inhalt /VE	Preis /VE	ab 5 VE 10%
26232	weiss, 153 Tücher	(Pal 28) 3060	38.00	34.20



Handtuch Classic Bulkysoft

23 x 31 cm, 2-lagig, Zellstoff, C-Falzung, Diamond-Prägung, Tiefe gefaltet: 8.9 cm



Artikel-Nr.	Produktinfo	Inhalt /VE	Preis /VE	ab 5 VE 10%
26231	weiss, 144 Tücher	(Pal 28) 2880	46.50	41.85



Handtuch Classic Bulkysoft

21.5 x 20.5 cm, 2-lagig, Zellstoff, V-Falzung, Micro-Prägung, Tiefe gefaltet: 10.5 cm



Artikel-Nr.	Produktinfo	Inhalt /VE	Preis /VE	ab 5 VE 10%
26228	weiss, 200 Tücher	(Pal 32) 4000	33.90	30.50



Handtuch Classic Bulkysoft

24 x 21.5 cm, 2-lagig, Zellstoff, V-Falzung, Micro-Prägung, Tiefe gefaltet: 10.5 cm



Artikel-Nr.	Produktinfo	Inhalt /VE	Preis /VE	ab 5 VE 10%
26229	weiss, 200 Tücher	(Pal 28) 3000	28.95	26.05



Handtuch Classic Bulkysoft

24 x 21 cm, 2-lagig, Zellstoff, V-Falzung, Micro-Prägung, schnellauflösend im Wasser, Tiefe gefaltet: 10.5 cm



Artikel-Nr.	Produktinfo	Inhalt /VE	Preis /VE	ab 5 VE 10%
26230	weiss, 150 Tücher	(Pal 28) 3000	32.95	29.65

Falthandtücher | Bulkysoft

Classic



BulkySoft Handtuch Classic Bulkysoft

24 x 21.5 cm, 2-lagig, Zellstoff, V-Falzung, Plus-Prägung, Tiefe gefaltet: 10.5 cm



Artikel-Nr.	Produktinfo	Inhalt /VE	Preis /VE	ab 5 VE 10%
26037	weiss, 200 Tücher	(Pal. 28) 4000	36.65	32.95

Premium



BulkySoft Handtuch Premium Bulkysoft

32 x 21.5 cm, 2-lagig, Zellstoff, Interfold-Falzung (M-Falzung), K-Prägung, Tiefe gefaltet: 7.9 cm



Artikel-Nr.	Produktinfo	Inhalt /VE	Preis /VE	ab 5 VE 10%
26222	weiss, 125 Tücher	(Pal. 40) 3125	39.65	35.65



BulkySoft Handtuch Premium Bulkysoft

32 x 21.5 cm, 3-lagig, Zellstoff, Interfold-Falzung (M-Falzung), K-Prägung, Tiefe gefaltet: 7.9 cm



Artikel-Nr.	Produktinfo	Inhalt /VE	Preis /VE	ab 5 VE 10%
26221	weiss, 100 Tücher	(Pal. 32) 2500	47.80	43.05



BulkySoft Handtuch Premium Bulkysoft

24 x 23 cm, 2-lagig, Zellstoff, Interfold-Falzung (Z-Falzung), Micro-Prägung, Tiefe gefaltet: 7.9 cm



Artikel-Nr.	Produktinfo	Inhalt /VE	Preis /VE	ab 5 VE 10%
26225	weiss, 144 Tücher	(Pal. 28) 4032	45.75	41.15



BulkySoft Handtuch Premium Bulkysoft

24 x 21.5 cm, 2-lagig, Zellstoff, Interfold-Falzung (Z-Falzung), K-Prägung, Tiefe gefaltet: 7.9 cm



Artikel-Nr.	Produktinfo	Inhalt /VE	Preis /VE	ab 5 VE 10%
26038	weiss, 150 Tücher	(Pal. 32) 3750	33.50	30.15

Membrane Plus



BulkySoft Handtuch Membrane Plus Bulkysoft

21.5 x 32 cm, 3-lagig, Zellstoff, Interfold-Falzung (M-Falzung), Bulkysoft-Prägung, Tiefe gefaltet: 7.9 cm



Artikel-Nr.	Produktinfo	Inhalt /VE	Preis /VE	ab 5 VE 10%
26223	weiss, 120 Tücher	(Pal. 36) 2520	68.50	61.65



BulkySoft Handtuch Membrane Plus Bulkysoft

20.5 x 42 cm, 3-lagig, Zellstoff, Interfold-Falzung (W-Falzung), Bulkysoft-Prägung, Tiefe gefaltet: 10.5 cm



Artikel-Nr.	Produktinfo	Inhalt /VE	Preis /VE	ab 5 VE 10%
26227	weiss, 75 Tücher	(Pal. 36) 1500	51.00	45.90



BulkySoft Handtuch Membrane Plus Bulkysoft

21.5 x 24 cm, 3-lagig, Zellstoff, Interfold-Falzung (Z-Falzung), Bulkysoft-Prägung, Tiefe gefaltet: 7.9 cm



Artikel-Nr.	Produktinfo	Inhalt /VE	Preis /VE	Preis VE /Pal.
26224	weiss, 140 Tücher	(Pal. 36) 2940	59.95	51.15

Falhandtücher | Bulkysoft

Membrane Plus



BulkySoft Handtuch Membrane Plus Bulkysoft

20.5 x 21 cm, 3-lagig, Zellstoff, V-Falzung, Bulkysoft-Prägung, Tiefe gefaltet: 10.5 cm



Artikel-Nr.	Produktinfo	Inhalt /VE	Preis /VE	ab 5 VE 10%
26226	weiss, 180 Tücher	(Pal. 36) 3600	61.15	55.05

Spender



BulkySoft Handtuchspender Bulkysoft

weiss / transparent, ABS Kunststoff, H: 374 B: 275 T: 106 mm

Artikel-Nr.	Produktinfo	Inhalt /VE	Preis /VE	
26043	abschliessbar, für C- und Interfold-Handtücher (max. 8.5 x 25 cm)	(Pal. 120) 1	33.50	netto



BulkySoft Handtuchspender Bulkysoft

weiss / transparent, ABS Kunststoff, H: 375 B: 275 T: 140 mm

Artikel-Nr.	Produktinfo	Inhalt /VE	Preis /VE	
26042	abschliessbar, für V-Handtücher (max. 12 x 25 cm)	(Pal. 120) 1	35.75	netto

Falhandtücher | Hagleitner

Spender



hagleitner XIBU touchMULTIFOLD Falhandtuchspender

weiss, Kunststoff, H: 395 B: 336 T: 148 mm

Artikel-Nr.	Produktinfo	Inhalt /VE	Preis /VE	ab 5 VE 10%
25432	mit Sichtfenster, für alle gängigen Falhandtuchgrössen, in 7 Farben erhältlich	(Pal. 96) 1	85.50	76.95

Falhandtücher | Katrin

1-lagig



KATRIN Handtuch Katrin Basic Non Stop

23.5 x 24 cm, 1-lagig, Recycling, Interfold-Falzung (Z-Falzung), Tiefe gefaltet: 8 cm

Artikel-Nr.	Produktinfo	Inhalt /VE	Preis /VE	Preis ab 10 VE
4920	natur, 250 Tücher, für Spender Art. 28382 / 28383	(Pal. 24) 4500	75.35	66.35

2-lagig



KATRIN Handtuch Katrin Plus One Stop L2

23.5 x 34 cm, 2-lagig, Zellstoff, Interfold-Falzung, Tiefe gefaltet: 8.5 cm



Artikel-Nr.	Produktinfo	Inhalt /VE	Preis /VE	ab 5 VE 10%
28400	weiss, 110 Tücher, für Spender Art. 28382 / 28383	(Pal. 32) 2310	64.30	57.85



KATRIN Handtuch Katrin Classic One Stop L2

23.5 x 34 cm, 2-lagig, Mischqualität, Interfold-Falzung, Tiefe gefaltet: 8.5 cm



Artikel-Nr.	Produktinfo	Inhalt /VE	Preis /VE	Preis ab 10 VE
20161	weiss, 110 Tücher, für Spender Art. 28382 / 28383	(Pal. 32) 2310	66.95	58.95

**WEIL HYGIENE
KEINE UNWICHTIGE
NEBENSACHE IST:
KATRIN.**

KATRIN®



Katrin ist der Spezialist für Frische, Wohlbefinden und Funktionalität in großen und kleinen Waschräumen. Erste Wahl für besonders hoch frequentierte Waschräume sind die Katrin Inclusive Systemspender, die eine hygienische Anwendung und hohe Kapazität gewährleisten.



Wirtschaftliche Hygiene für Ihren Waschraum

Mit dem komplett durchdachten Katrin System-Sortiment an funktionalen und robusten Spendern, dazu passenden Handtuch- und Toilettenpapieren sowie milden und feuchtigkeitsspendenden Seifen optimieren Sie Ihr Hygieneangebot und minimieren zusätzlich Verbrauch und Kosten. Das bedeutet: weniger Nachfüllaufwand, weniger Abfallentsorgung und geringere Einkaufs- und Lagerungskosten!

Die Katrin Inclusive System Handtuchrollenspendern geben die Handtücher stets hygienisch sauber und unberührt aus

(„Touch free“). Sie besitzen die richtige Blattgröße und sind enorm saugfähig. Die perfekte Ergänzung sind der praktische Katrin Inclusive Seifenspender und der Katrin Inclusive System Toilettenpapierspender für zwei Rollen, erhältlich in zwei Varianten mit oder ohne Hülsenfänger. Die zweite Rolle fällt automatisch nach, sobald die erste aufgebraucht ist; so ist immer ausreichend Papier vorhanden.

Handhygiene mit nachhaltigem Nutzen
www.katrin.com



Falhandtücher | Katrin

2-lagig



KATRIN Handtuch Katrin Plus One Stop M2

23.5 x 25.5 cm, 2-lagig, Zellstoff, Interfold-Falzung (W-Falzung), Tiefe gefaltet: 8.5 cm



Artikel-Nr.	Produktinfo	Inhalt /VE	Preis /VE	ab 5 VE 10%
28402	weiss, 144 Tücher, für Spender Art. 28382 / 28383	(Pal. 32) 3024	68.30	61.50



KATRIN Handtuch Katrin Classic One Stop M2

23.5 x 25 cm, 2-lagig, Recycling, Interfold-Falzung (W-Falzung), Tiefe gefaltet: 8.5 cm



Artikel-Nr.	Produktinfo	Inhalt /VE	Preis /VE	Preis ab 10 VE
4918.1	weiss, 144 Tücher, für Spender Art. 28382 / 28383	(Pal. 32) 3024	65.50	57.65



KATRIN Handtuch Katrin Classic One Stop M2

20.6 x 25.5 cm, 2-lagig, Mischqualität, Interfold-Falzung (W-Falzung), Tiefe gefaltet: 8.5 cm



Artikel-Nr.	Produktinfo	Inhalt /VE	Preis /VE	ab 5 VE 10%
28403	weiss, 144 Tücher, für Spender Art. 28382 / 28383 / 28384 / 28385	(Pal. 36) 3024	49.40	44.45



KATRIN Handtuch Katrin Plus Non Stop 2

23.5 x 24 cm, 2-lagig, Zellstoff, Interfold-Falzung (Z-Falzung), Tiefe gefaltet: 8 cm



Artikel-Nr.	Produktinfo	Inhalt /VE	Preis /VE	Preis ab 10 VE
18382	hochweiss, 150 Tücher, für Spender Art. 28382 / 28383	(Pal. 32) 2100	49.85	43.90



KATRIN Handtuch Katrin Plus C-fold 2

24 x 33 cm, 2-lagig, Zellstoff, C-Falzung, LimTech-Prägung, Tiefe gefaltet: 9.1 cm



Artikel-Nr.	Produktinfo	Inhalt /VE	Preis /VE	Preis ab 10 VE
11771	hochweiss, 125 Tücher, für Spender Art. 28382 / 28383	(Pal. 24) 3000	91.30	80.35

3-lagig



KATRIN Handtuch Katrin Plus One Stop L3

23.5 x 34 cm, 3-lagig, Zellstoff, Interfold-Falzung, Tiefe gefaltet: 8.5 cm



Artikel-Nr.	Produktinfo	Inhalt /VE	Preis /VE	ab 5 VE 10%
28398	weiss, 90 Tücher, für Spender Art. 28382 / 28383	(Pal. 32) 1890	80.65	72.55

Spender



KATRIN Katrin Inclusive Falhandtuchspender M

Kunststoff, H: 450 B: 301 T: 146 mm, für alle Katrin-Falhandtücher

Artikel-Nr.	Produktinfo	Inhalt /VE	Preis /VE	
28382	weiss	(Pal. 35) 1	68.05	netto
28383	schwarz	(Pal. 35) 1	68.05	netto

Kostenlos erhältlich mit Leihspendervertrag

Falhandtücher | Katrin

Spender



KATRIN Katrin Inclusive Falhandtuchspender mini

Kunststoff, H: 350 B: 248 T: 114 mm, für Handtuch Art. 28403

Artikel-Nr.	Produktinfo	Inhalt /VE	Preis /VE	
28384	weiss	(Pal. 81) 1	57.60	netto
28385	schwarz	(Pal. 81) 1	57.60	netto

Kostenlos erhältlich mit Leihspendervertrag

Falhandtücher | Diverse

Recycling | 1-lagig



Handtuch Non Stop

25 x 23 cm, 1-lagig, Recycling, Interfold-Falzung (Z-Falzung), Tiefe gefaltet: 7.6 cm

Artikel-Nr.	Produktinfo	Inhalt /VE	Preis /VE	ab 5 VE 10%
24906	naturweiss, 300 Tücher	(Pal. 42) 3000	58.45	52.60



Handtuch Jolly

25 x 33 cm, 1-lagig, Recycling, C-Falzung, Tiefe gefaltet: 9.6 cm

Artikel-Nr.	Produktinfo	Inhalt /VE	Preis /VE	Preis ab 10 VE
4913	grün, 144 Tücher	(Pal. 28) 3456	38.30	34.35



Handtuch Jolly

25 x 33 cm, 1-lagig, Recycling, C-Falzung, Tiefe gefaltet: 9.6 cm

Artikel-Nr.	Produktinfo	Inhalt /VE	Preis /VE	Preis ab 10 VE
4917	grau, 144 Tücher	(Pal. 32) 3456	36.80	33.05



Handtuch Oeco Swiss Plus

24.5 x 33 cm, 1-lagig, Recycling, C-Falzung, Tiefe gefaltet: 9.5 cm



Artikel-Nr.	Produktinfo	Inhalt /VE	Preis /VE	ab 5 VE 10%
23387	weisslich, 152 Tücher	(Pal. 24) 3648	37.65	33.90



Handtuch

25 x 31 cm, 1-lagig, Recycling, C-Falzung, Tiefe gefaltet: 9.6 cm



Artikel-Nr.	Produktinfo	Inhalt /VE	Preis /VE	Preis ab 10 VE
8661.1	natur, 192 Tücher	(Pal. 28) 4608	52.65	47.25



Handtuch Satino Basic

25 x 33 cm, 1-lagig, Krepp-Papier, CZ-Falzung, Tiefe gefaltet: 9.6 cm



Artikel-Nr.	Produktinfo	Inhalt /VE	Preis /VE	Preis ab 10 VE
4896.1	naturweiss, 180 Tücher	(Pal. 32) 3600	39.60	35.55



Handtuch Claire

25 x 19 cm, 1-lagig, Recycling, V-Falzung, Tiefe gefaltet: 9.6 cm

Artikel-Nr.	Produktinfo	Inhalt /VE	Preis /VE	Preis ab 10 VE
4970	grau, 250 Tücher	(Pal. 28) 6000	46.70	42.00

Faltheadtücher | Diverse

Recycling | 1-lagig



Handtuch

25 x 23 cm, 1-lagig, Krepp, V-Falzung, Tiefe gefaltet: 11.5 cm



Artikel-Nr.	Produktinfo	Inhalt /VE	Preis /VE	ab 5 VE 10%
4998	naturweiss, 250 Tücher	(Pal. 28) 5000	71.40	64.25

Recycling | 2-lagig



Handtuch

21 x 24 cm, 2-lagig, Recycling, Interfold-Falzung (Z-Falzung), Tiefe gefaltet: 8 cm



Artikel-Nr.	Produktinfo	Inhalt /VE	Preis /VE	Preis ab 10 VE
12992.1	hochweiss, 150 Tücher	(Pal. 48) 2250	35.25	31.65



Handtuch Eco Natural

22.5 x 24 cm, 2-lagig, Recycling, Interfold-Falzung (Z-Falzung), Tiefe gefaltet: 8 cm



Artikel-Nr.	Produktinfo	Inhalt /VE	Preis /VE	ab 5 VE 10%
19330	natur, 200 Tücher	(Pal. 36) 3000	38.05	34.25



Handtuch Eco Natural

23 x 23.5 cm, 2-lagig, Recycling, Interfold-Falzung (Z-Falzung), Tiefe gefaltet: 9.1 cm



Artikel-Nr.	Produktinfo	Inhalt /VE	Preis /VE	ab 5 VE 10%
19329	natur, 220 Tücher	(Pal. 16) 3960	47.25	42.50



Handtuch

23.5 x 24 cm, 2-lagig, Recycling, Interfold-Falzung (Z-Falzung), Tiefe gefaltet: 8 cm



Artikel-Nr.	Produktinfo	Inhalt /VE	Preis /VE	Preis ab 10 VE
12992	hochweiss, 150 Tücher	(Pal. 36) 3000	49.05	44.05



Handtuch Comfort

24 x 24 cm, 2-lagig, Recycling, Interfold-Falzung (Z-Falzung), Tiefe gefaltet: 7.8 cm



Artikel-Nr.	Produktinfo	Inhalt /VE	Preis /VE	ab 5 VE 10%
25088	weiss, 150 Tücher	(Pal. 32) 3750	93.55	84.20



Handtuch Oeco Swiss Plus

24.5 x 33 cm, 2-lagig, Recycling, C-Falzung, Tiefe gefaltet: 9.4 cm



Artikel-Nr.	Produktinfo	Inhalt /VE	Preis /VE	ab 5 VE 10%
23386	weiss, 128 Tücher	(Pal. 28) 3072	57.75	51.95



Handtuch

25 x 31 cm, 2-lagig, C-Falzung, Tiefe gefaltet: 9.6 cm

Artikel-Nr.	Produktinfo	Inhalt /VE	Preis /VE	ab 5 VE 10%
4839	grau, 120 Tücher	(Pal. 28) 2400	100.85	90.75



Handtuch

25.3 x 21 cm, 2-lagig, Recycling, V-Falzung, Tiefe gefaltet: 10.5 cm



Artikel-Nr.	Produktinfo	Inhalt /VE	Preis /VE	ab 5 VE 10%
27520	weiss, 190 Tücher	(Pal. 32) 3800	100.00	90.00

Falhandtücher | Diverse

Recycling | 2-lagig



Handtuch

25 x 22 cm, 2-lagig, Recycling, V-Falzung, Tiefe gefaltet: 11 cm

Artikel-Nr.	Produktinfo	Inhalt /VE	Preis /VE	ab 5 VE 10%
24908	weiss / grün, 210 Tücher	(Pal. 36) 3150	41.40	37.25



Handtuch

25 x 23 cm, 2-lagig, extra weich, V-Falzung, Tiefe gefaltet: 11.5 cm



Artikel-Nr.	Produktinfo	Inhalt /VE	Preis /VE	ab 5 VE 10%
10478.1	naturweiss, 250 Tücher	(Pal. 28) 3750	102.40	92.15

Zellstoff | 1-lagig



Handtuch Jolly

25 x 33 cm, 1-lagig, Zellstoff, C-Falzung, Tiefe gefaltet: 9.6 cm

Artikel-Nr.	Produktinfo	Inhalt /VE	Preis /VE	Preis ab 10 VE
4914	weiss, 144 Tücher	(Pal. 28) 3456	80.25	72.30

Zellstoff | 2-lagig



Starline Handtuch Starline de Luxe

25 x 38 cm, 2-lagig, Zellstoff, Interfold-Falzung (W-Falzung), Tiefe gefaltet: 9.5 cm

Artikel-Nr.	Produktinfo	Inhalt /VE	Preis /VE	Preis ab 10 VE
4976	weiss, 110 Tücher	(Pal. 28) 2640	82.85	74.60



Handtuch Super Soft

20.6 x 32 cm, 2-lagig, Zellstoff, Interfold-Falzung (W-Falzung), Tiefe gefaltet: 7.9 cm



Artikel-Nr.	Produktinfo	Inhalt /VE	Preis /VE	ab 5 VE 10%
25089	hochweiss, 120 Tücher	(Pal. 36) 3000	59.40	53.45



Handtuch Prestige

24 x 32 cm, 2-lagig, Zellstoff, Interfold-Falzung (W-Falzung), Tiefe gefaltet: 7.9 cm



Artikel-Nr.	Produktinfo	Inhalt /VE	Preis /VE	ab 5 VE 10%
24806	hochweiss, 120 Tücher	(Pal. 32) 3000	45.95	41.35



Handtuch Non Stop Interfold

22 x 32 cm, 2-lagig, Zellstoff, Interfold-Falzung (W-Falzung), Tiefe gefaltet: 10.4 cm

Artikel-Nr.	Produktinfo	Inhalt /VE	Preis /VE	ab 5 VE 10%
24909	reinweiss, 160 Tücher	(Pal. 40) 3200	102.25	92.00



Handtuch ZZ-Premium

24 x 23.5 cm, 2-lagig, 100 % Zellstoff, Interfold-Falzung (Z-Falzung), Tiefe gefaltet: 7.8 cm

Artikel-Nr.	Produktinfo	Inhalt /VE	Preis /VE	Preis ab 10 VE
4829	weiss, 150 Tücher	(Pal. 28) 3750	52.90	47.60



Handtuch ZZ-Premium

24 x 22.5 cm, 2-lagig, 100 % Zellstoff, Interfold-Falzung (Z-Falzung), Tiefe gefaltet: 8 cm



Artikel-Nr.	Produktinfo	Inhalt /VE	Preis /VE	ab 5 VE 10%
4829.2	weiss, 200 Tücher	(Pal. 36) 4000	56.15	50.55

Falthandtücher | Diverse

Zellstoff | 2-lagig



Handtuch DryTech

20.3 x 24 cm, 2-lagig, Zellstoff, Interfold-Falzung (Z-Falzung), Tiefe gefaltet: 8 cm

Artikel-Nr.	Produktinfo	Inhalt /VE	Preis /VE	ab 5 VE 10%
22015	weiss, 130 Tücher	(Pal. 40) 2600	58.60	52.75



Handtuch

23.5 x 24 cm, 2-lagig, Zellstoff, Interfold-Falzung (Z-Falzung), Tiefe gefaltet: 7.8 cm

Artikel-Nr.	Produktinfo	Inhalt /VE	Preis /VE	Preis ab 10 VE
22862	weiss, 150 Tücher	(Pal. 32) 3750	35.50	31.95



Handtuch

22.5 x 24 cm, 2-lagig, Zellstoff, Interfold-Falzung (Z-Falzung), Tiefe gefaltet: 7.8 cm



Artikel-Nr.	Produktinfo	Inhalt /VE	Preis /VE	ab 5 VE 10%
25588	weiss, 200 Tücher	(Pal. 48) 3000	39.50	35.55



Handtuch Soft

23 x 30.7 cm, 2-lagig, 100 % Zellstoff, C-Falzung, Tiefe gefaltet: 9 cm

Artikel-Nr.	Produktinfo	Inhalt /VE	Preis /VE	Preis ab 10 VE
10100	weiss, 153 Tücher	(Pal. 28) 3060	68.50	53.10



Handtuch Jolly de Luxe

25 x 33 cm, 2-lagig, Zellstoff, C-Falzung, Tiefe gefaltet: 9 cm

Artikel-Nr.	Produktinfo	Inhalt /VE	Preis /VE	Preis ab 10 VE
4904	weiss, 144 Tücher	(Pal. 28) 3456	87.65	78.70



Handtuch Special

23 x 32 cm, 2-lagig, Zellstoff, C-Falzung, Tiefe gefaltet: 9.4 cm



Artikel-Nr.	Produktinfo	Inhalt /VE	Preis /VE	ab 5 VE 10%
4904.3	weiss, 144 Tücher	(Pal. 36) 2880	87.30	78.55



Handtuch Comfort

25 x 33 cm, 2-lagig, Recycling, C-Falzung, Tiefe gefaltet: 9.4 cm



Artikel-Nr.	Produktinfo	Inhalt /VE	Preis /VE	ab 5 VE 10%
25086	hochweiss, 128 Tücher	(Pal. 32) 3072	77.65	69.85



Handtuch Clean & Clever

25 x 33 cm, 2-lagig, 100 % Recycling, C-Falzung, Tiefe gefaltet: 9.6 cm

Artikel-Nr.	Produktinfo	Inhalt /VE	Preis /VE	Preis ab 10 VE
4904.1	weiss, 20 x 140 Tücher	(Pal. 28) 2800	82.35	73.95



Handtuch

20.6 x 21.5 cm, 2-lagig, 100 % Zellstoff, V-Falzung, Tiefe gefaltet: 10.8 cm

Artikel-Nr.	Produktinfo	Inhalt /VE	Preis /VE	Preis ab 10 VE
4830	weiss, 200 Tücher	(Pal. 32) 4000	48.60	43.75

Faltheadtücher | Diverse

Zellstoff | 2-lagig



Handtuch Claire de Luxe

25 x 19 cm, 2-lagig, Zellstoff, V-Falzung, Tiefe gefaltet: 9.7 cm

Artikel-Nr.	Produktinfo	Inhalt /VE	Preis /VE	Preis ab 10 VE
4973	weiss, 220 Tücher	(Pal. 28) 5280	82.85	77.30



Handtuch Ultra

24 x 21.5 cm, 2-lagig, 100 % Zellstoff, V-Falzung, Tiefe gefaltet: 10.5 cm

Artikel-Nr.	Produktinfo	Inhalt /VE	Preis /VE	Preis ab 10 VE
4828	weiss, 200 Tücher	(Pal. 28) 4000	48.60	43.75



Handtuch

24 x 21.5 cm, 2-lagig, 100 % Zellstoff, V-Falzung, Tiefe gefaltet: 10.5 cm

Artikel-Nr.	Produktinfo	Inhalt /VE	Preis /VE	ab 5 VE 10%
4828.1	weiss, 266 Tücher	(Pal. 28) 3990	48.85	43.95



Handtuch Bio-Tech

22 x 21 cm, 2-lagig, Zellstoff, V-Falzung, Tiefe gefaltet: 10.5 cm. Verringert das Verstopfungsrisiko und trägt zur Instandhaltung von Rohrleitungen und Abwassersystemen bei.



Artikel-Nr.	Produktinfo	Inhalt /VE	Preis /VE	ab 5 VE 10%
24652	weiss, 210 Tücher	(Pal. 40) 3150	71.30	64.15



Handtuch

21 x 25.3 cm, 2-lagig, Zellstoff, V-Falzung, Tiefe gefaltet: 10.5 cm



Artikel-Nr.	Produktinfo	Inhalt /VE	Preis /VE	ab 5 VE 10%
27521	weiss, 190 Tücher	(Pal. 32) 3800	107.50	96.75



Handtuch

24 x 20.8 cm, 2-lagig, Zellstoff, V-Falzung, Tiefe gefaltet: 10.5 cm

Artikel-Nr.	Produktinfo	Inhalt /VE	Preis /VE	ab 5 VE 10%
24922	hochweiss, 200 Tücher	(Pal. 36) 4000	77.70	69.90



Handtuch High Grade

21.5 x 24 cm, 2-lagig, 100 % Zellstoff, V-Falzung, Tiefe gefaltet: 10.5 cm

Artikel-Nr.	Produktinfo	Inhalt /VE	Preis /VE	Preis ab 10 VE
23133	weiss, 200 Tücher	(Pal. 28) 4000	43.80	39.40



Handtuch Prestige

25 x 23 cm, 2-lagig, Zellstoff, V-Falzung, Tiefe gefaltet: 11.2 cm



Artikel-Nr.	Produktinfo	Inhalt /VE	Preis /VE	ab 5 VE 10%
25087	hochweiss, 150 Tücher	(Pal. 32) 3000	59.10	53.20

Zellstoff | 3-lagig



Handtuch Quattro Plus

32 x 20.2 cm, 3-lagig, 100 % Zellstoff, Interfold-Falzung (W-Falzung), profundeur pliée: 8 cm

Artikel-Nr.	Produktinfo	Inhalt /VE	Preis /VE	Preis ab 10 VE
14944	weiss, 125 Tücher	(Pal. 54) 1875	50.00	45.00

Falhandtücher | Diverse

Zellstoff | 3-lagig



Handtuch ZZ-Premium

23.5 x 24 cm, 3-lagig, 100 % Zellstoff, Interfold-Falzung (Z-Falzung), Tiefe gefaltet: 8 cm

Artikel-Nr.	Produktinfo	Inhalt /VE	Preis /VE	Preis ab 10 VE
14567	weiss, 125 Tücher	(Pal. 36) 3125	57.35	51.60



Handtuch Jolly Exclusive

25 x 33 cm, 3-lagig, Zellstoff, C-Falzung, Tiefe gefaltet: 9.7 cm

Artikel-Nr.	Produktinfo	Inhalt /VE	Preis /VE	Preis ab 10 VE
4939	weiss, 120 Tücher	(Pal. 28) 2880	121.55	109.10



Handtuch Oeco Swiss Comfort

24.5 x 33 cm, 3-lagig, Zellstoff, C-Falzung, Tiefe gefaltet: 9.5 cm



Artikel-Nr.	Produktinfo	Inhalt /VE	Preis /VE	ab 5 VE 10%
24397	weiss, 96 Tücher	(Pal. 28) 2304	73.55	66.20



Handtuch Ultra Forte

21.5 x 20.6 cm, 3-lagig, 100 % Zellstoff, V-Falzung, Tiefe gefaltet: 10.7 cm

Artikel-Nr.	Produktinfo	Inhalt /VE	Preis /VE	Preis ab 10 VE
14592	weiss, 150 Tücher	(Pal. 32) 3000	42.25	38.00

Spender



Handtuchspender gross, für C-, V- und Interfold-Falzung

weiss / transparent, Kunststoff, H: 400 B: 280 T: 130 mm

Artikel-Nr.	Produktinfo	Inhalt /VE	Preis /VE	
7836	abschliessbar, für 400 Tücher	(Pal. 50) 1	50.60	netto



Handtuchspender klein, für C-, V- und Interfold-Falzung

weiss / transparent, Kunststoff, H: 300 B: 290 T: 115 mm

Artikel-Nr.	Produktinfo	Inhalt /VE	Preis /VE	
7832	abschliessbar, für 400 Tücher	(Pal. 50) 1	41.90	netto



Drahthalter für Handtücher

verchromt, H: 269 B: 110 T: 258 mm

Artikel-Nr.	Produktinfo	Inhalt /VE	Preis /VE	
6001	für ca. 180 Tücher	1	25.75	netto



Handtuchspender für C-, V-, Interfold-Falzung

weiss, Kunststoff, H: 365 B: 276 T: 130 mm

Artikel-Nr.	Produktinfo	Inhalt /VE	Preis /VE	
14542	abschliessbar	(Pal. 144) 1	26.00	netto



Handtuchspender Maxi für C-, V- und Interfold-Falzung

Edelstahl, H: 380 B: 270 T: 120 mm

Artikel-Nr.	Inhalt /VE	Preis /VE	
21742	1	109.70	netto

Rollenhandtücher | Tork

1-lagig



TORK Handtuchrolle Tork Matic Universal - H1 System

21 x 24.5 cm, 1-lagig, TAD-Qualität



Artikel-Nr.	Produktinfo	Inhalt /VE	Preis /VE	ab 5 VE 10%
21139	weiss, 280 lfm, Rolle à 1143 Blatt	(Pal. 28) 6	194.05	174.65

2-lagig



TORK Handtuchrolle Tork Matic Advanced - H1 System

21 x 24.5 cm, 2-lagig, Tissue



Artikel-Nr.	Produktinfo	Inhalt /VE	Preis /VE	Preis VE /Pal.
4954	grün, Dekorprägung, 150 lfm, Rolle à 612 Blatt	(Pal. 28) 6	129.25	110.20



TORK Handtuchrolle Tork Matic Advanced - H1 System

21 x 24.5 cm, 2-lagig, Hybrid-Qualität



Artikel-Nr.	Produktinfo	Inhalt /VE	Preis /VE	Preis VE /Pal.
4953	hochweiss, Dekorprägung, 150 lfm, Rolle à 612 Blatt	(Pal. 28) 6	148.45	126.55



TORK Handtuchrolle Tork Matic Advanced - H1 System

21 x 24.5 cm, 2-lagig, Hybrid-Qualität



Artikel-Nr.	Produktinfo	Inhalt /VE	Preis /VE	Preis VE /Pal.
11305	blau, Dekorprägung, 150 lfm, Rolle à 612 Blatt	(Pal. 28) 6	167.40	142.75



TORK Handtuchrolle Tork Matic Premium - H1 System

21 x 24.5 cm, 2-lagig, TAD-Qualität



Artikel-Nr.	Produktinfo	Inhalt /VE	Preis /VE	Preis VE /Pal.
4921	hochweiss, Dekorprägung, 100 lfm, Rolle à 408 Blatt	(Pal. 28) 6	102.80	87.65



TORK Handtuchrolle Tork Advanced für Sensorspender - H12 System

19.5 x 25 cm, 2-lagig, Tissue



Artikel-Nr.	Produktinfo	Inhalt /VE	Preis /VE	Preis VE /Pal.
14629	weiss, 143 lfm, Rolle à 572 Blatt	(Pal. 40) 6	113.90	97.10



TORK Handtuchrolle Tork Advanced für Sensorspender - H13 System

24.7 x 20 cm, 2-lagig, HydraTek Tissue



Artikel-Nr.	Produktinfo	Inhalt /VE	Preis /VE	Preis VE /Pal.
14614	weiss, 143 lfm, Rolle à 715 Blatt	(Pal. 32) 6	144.30	123.05



TORK Handtuchrolle Tork Advanced - H14 System

19.5 x 25 cm, 2-lagig



Artikel-Nr.	Produktinfo	Inhalt /VE	Preis /VE	Preis VE /Pal.
16266	weiss, 160 lfm, Rolle à 640 Blatt	(Pal. 24) 6	118.20	100.80

Rollenhandtücher | Tork

Rollenspender



Tork Matic Elevation Spender für Rollenhandtücher - H1 System

weiss, Kunststoff, H: 372 B: 337 T: 203 mm

Artikel-Nr.	Produktinfo	Inhalt /VE	Preis /VE	
7069	mit Sichtfenster	(Pal. 48) 1	48.00	netto

Nur erhältlich mit Leihspendervertrag (es können Servicegebühren anfallen)



Tork Matic Elevation Spender für Rollenhandtücher - H1 System

schwarz, Kunststoff, H: 372 B: 337 T: 203 mm

Artikel-Nr.	Produktinfo	Inhalt /VE	Preis /VE	
13561	mit Sichtfenster	(Pal. 44) 1	48.00	netto

Nur erhältlich mit Leihspendervertrag (es können Servicegebühren anfallen)



Tork Matic Elevation Sensorspender für Rollenhandtücher - H1 System

weiss, Kunststoff, H: 368 B: 331 T: 206 mm

Artikel-Nr.	Produktinfo	Inhalt /VE	Preis /VE	
18644	LED-Füllstandsanzeige	(Pal. 24) 1	120.00	netto

Nur erhältlich mit Leihspendervertrag (es können Servicegebühren anfallen)



Tork Matic Elevation Sensorspender für Rollenhandtücher - H1 System

schwarz, Kunststoff, H: 368 B: 331 T: 206 mm

Artikel-Nr.	Produktinfo	Inhalt /VE	Preis /VE	
18645	LED-Füllstandsanzeige	(Pal. 24) 1	120.00	netto

Nur erhältlich mit Leihspendervertrag (es können Servicegebühren anfallen)



Tork Matic Sensorspender für Rollenhandtücher - H1 System

gebürsteter Edelstahl / Kunststoff, H: 373 B: 345 T: 204 mm

Artikel-Nr.	Produktinfo	Inhalt /VE	Preis /VE	
25161		(Pal. 40) 1	452.10	netto

Rollenhandtücher | Kimberly-Clark

1-lagig



Handtuchrolle Kimberly-Clark Standard

20 cm x 190 lfm, 1-lagig, 100 % Recycling



Artikel-Nr.	Produktinfo	Inhalt /VE	Preis /VE	Preis VE /Pal.
7415	grau, für Spender Art. 8872	(Pal. 36) 6	72.80	55.15



Handtuchrolle Kimberly-Clark Scott

20 cm x 304 lfm, 1-lagig, Airflex



Artikel-Nr.	Produktinfo	Inhalt /VE	Preis /VE	Preis VE /Pal.
7401	weiss, für Spender Art. 16406 / 20324 / 20527	(Pal. 36) 6	173.75	133.20

Spendersysteme für mehr Komfort & Hygiene im Waschraum

 Kimberly-Clark
PROFESSIONAL*



AQUARIUS* Rollenhandtuchsysteme

Aquarius



Art.-Nr. 28230

Art.-Nr. 28231

- ✓ Hygienischster Spender im Wettbewerbsvergleich¹
- ✓ Verbesserte Restrollenfunktion sorgt für kontinuierliche Bevorratung
- ✓ Auch im schlanken Slimrollformat erhältlich, passend für jeden Waschraum

SCOTT® Rollenhandtücher

- ✓ Rollenhandtücher für hervorragende Effizienz
- ✓ 1.400 Tücher pro Rolle - ideal für stark frequentierte Bereiche
- ✓ Weiches und hoch saugfähiges AIRFLEX* Material



Art.-Nr. 24635

SCOTT® Schaumseifen



Scott

Art.-Nr. 26920 (schwarz)
Art.-Nr. 18609 (weiß)

- ✓ Hochwertiger Seifenschaum dank speziellem Pumpsystem
- ✓ Hohe Kapazität mit 2.500 Portionen pro Kartusche
- ✓ Spender einfach zu reinigen und schnell zu befüllen²

¹ Ergebnisse einer Studie der MGS Laboratories anhand von Abstrichen an Handtuchspendern, Januar 2017

² Passend für alle Waschlotionen und Schaumseifen von Kimberly-Clark Professional*

Rollenhandtücher | Kimberly-Clark

1-lagig



Handtuchrolle Kimberly-Clark Scott Performance

20 cm x 200 lfm, 1-lagig, Airflex



Artikel-Nr.	Produktinfo	Inhalt /VE	Preis /VE	Preis VE /Pal.
6665	weiss, für Spender Art. 16406 / 20324 / 20527	(Pal. 36) 6	138.35	101.10



Handtuchrolle Kimberly-Clark Scott

20 cm x 304 lfm, 1-lagig, Airflex



Artikel-Nr.	Produktinfo	Inhalt /VE	Preis /VE	ab 5 VE 10%
6668	blau, für Spender Art. 16406 / 20324 / 20527	(Pal. 36) 6	179.70	161.70



Handtuchrolle Kimberly-Clark Scott Slimroll

20 cm x 165 lfm, 1-lagig, Airflex



Artikel-Nr.	Produktinfo	Inhalt /VE	Preis /VE	ab 5 VE 10%
7463	weiss, für Spender Art. 4597 / 26922	(Pal. 54) 6	94.25	84.85



Handtuchrolle Kimberly-Clark Scott XL Slimroll

20 cm x 190 lfm, 1-lagig, Airflex



Artikel-Nr.	Produktinfo	Inhalt /VE	Preis /VE	ab 5 VE 10%
22831	weiss, für Spender Art. 4597 / 26922	(Pal. 54) 6	90.30	81.25



Handtuchrolle Kimberly-Clark Slimroll

20 cm x 100 lfm, 1-lagig, Airflex



Artikel-Nr.	Produktinfo	Inhalt /VE	Preis /VE	ab 5 VE 10%
23223*	weiss, für Spender Art. 4597 / 26922	(Pal. 54) 6	81.80	73.65



Handtuchrolle Kimberly-Clark Scott Control Slimroll

19.8 cm x 150 lfm, 1-lagig, Airflex



Artikel-Nr.	Produktinfo	Inhalt /VE	Preis /VE	ab 5 VE 10%
28235	weiss, für Spender Art. 28228 / 28229	(Pal. 54) 6	49.95	44.95



Handtuchrolle Kimberly-Clark Scott Essential Slimroll

19.8 cm x 190 lfm, 1-lagig, Airflex, für Spender Art. 28228 / 28229



Artikel-Nr.	Produktinfo	Inhalt /VE	Preis /VE	ab 5 VE 10%
28236	weiss	(Pal. 54) 6	61.05	54.95
28237	blau	(Pal. 54) 6	61.05	54.95



Handtuchrolle Kimberly-Clark Scott Control

19.8 cm x 250 lfm, 1-lagig, Airflex



Artikel-Nr.	Produktinfo	Inhalt /VE	Preis /VE	ab 5 VE 10%
28232	weiss, für Spender Art. 28230 / 28231	(Pal. 36) 6	83.40	75.05



Handtuchrolle Kimberly-Clark Scott Essential

19.8 cm x 350 lfm, 1-lagig, Airflex, für Spender Art. 28230 / 28231



Artikel-Nr.	Produktinfo	Inhalt /VE	Preis /VE	ab 5 VE 10%
24635	weiss	(Pal. 36) 6	176.60	158.95
24638	blau	(Pal. 36) 6	176.60	158.95

* auf Bestellung

Rollenhandtücher | Kimberly-Clark

1-lagig



Handtuchrolle Kimberly-Clark Scott XL

19.8 cm x 354 lfm, 1-lagig, Airflex



Artikel-Nr.	Produktinfo	Inhalt /VE	Preis /VE	ab 5 VE 10%
10666	weiss, für Spender Art. 20324	(Pal. 36) 6	178.10	160.30

2-lagig



Handtuchrolle Kimberly-Clark Kleenex Ultra

20 cm x 130 lfm, 2-lagig, Airflex



Artikel-Nr.	Produktinfo	Inhalt /VE	Preis /VE	Preis VE /Pal.
6765	weiss, für Spender Art. 16406 / 20324 / 20527	(Pal. 36) 6	122.25	93.70



Handtuchrolle Kimberly-Clark Hostess Natur

20 cm x 140 lfm, 2-lagig, 100 % Recycling

Artikel-Nr.	Produktinfo	Inhalt /VE	Preis /VE	Preis VE /Pal.
7414	weiss, für Spender Art. 20324	(Pal. 36) 6	93.45	70.80



Handtuchrolle Kimberly-Clark Ultra Slimroll

19.8 cm x 100 m, 2-lagig, Airflex



Artikel-Nr.	Produktinfo	Inhalt /VE	Preis /VE	ab 5 VE 10%
28233	weiss, für Spender Art. 28228 / 28229	(Pal. 54) 6	52.50	47.25



Handtuchrolle Kimberly-Clark Kleenex Ultra

19.8 cm x 150 lfm, 2-lagig, Airflex



Artikel-Nr.	Produktinfo	Inhalt /VE	Preis /VE	ab 5 VE 10%
27183	weiss, für Spender Art. 28230 / 28231	(Pal. 36) 6	97.65	87.85

Rollenspender



Elektronischer Spender für Handtuchrollen Kimberly-Clark

weiss, Kunststoff, H: 410 B: 320 T: 260 mm

Artikel-Nr.	Produktinfo	Inhalt /VE	Preis /VE	ab 5 VE 10%
16406*	berührungslos, mit Batterien, für Art. 7401 / 6665 / 6668 / 6765 / 10666	(Pal. 24) 1	240.90	216.85

Ab 10 Kimberly Clark-Spender mit Spenderleihvertrag erhältlich (Servicegebühr: CHF 20.00 / Stk.)



Spender für Handtuchrollen No-Touch Kimberly-Clark Aquarius

weiss, Kunststoff, H: 430 B: 326 T: 240 mm

Artikel-Nr.	Produktinfo	Inhalt /VE	Preis /VE	ab 5 VE 10%
20324	für Art. 7401 / 7463 / 6665 / 6668 / 6765 / 10666	(Pal. 20) 1	163.30	146.95

Kostenlos erhältlich mit Spenderleihvertrag (ab 10 Kimberly Clark-Spender)



Spender für Handtuchrollen Kimberly-Clark

Edelstahl, H: 435 B: 303 T: 230 mm

Artikel-Nr.	Produktinfo	Inhalt /VE	Preis /VE	ab 5 VE 10%
20527	für Art. 7401 / 6665 / 6668 / 6765 / 10666	(Pal. 20) 1	467.90	421.10

Rollenhandtücher | Kimberly-Clark

Rollenspender



Spender für Handtuchrollen Slimroll Kimberly-Clark Aquarius

Kunststoff, H: 343 B: 318 T: 191 mm, abschliessbar, mit Sichtfenster, für Art. 7463 / 18063 / 22831 / 23223

Artikel-Nr.	Produktinfo	Inhalt /VE	Preis /VE	ab 5 VE 10%
4597*	weiss	(Pal. 36) 1	114.10	102.70
26922	schwarz	(Pal. 36) 1	107.80	97.00

Kostenlos erhältlich mit Spenderleihvertrag (ab 10 Kimberly Clark-Spender)



Spender für Handtuchrollen Slimroll Kimberly-Clark Aquarius

Kunststoff, H: 324 B: 297 T: 192 mm, für Art. 28233 / 28235 / 28236 / 28237

Artikel-Nr.	Produktinfo	Inhalt /VE	Preis /VE	ab 5 VE 10%
28228	weiss	(Pal. 40) 1	57.50	51.75
28229	schwarz	(Pal. 40) 1	57.50	51.75

Kostenlos erhältlich mit Spenderleihvertrag (ab 10 Kimberly Clark-Spender)



Spender für Handtuchrollen Kimberly-Clark Aquarius

Kunststoff, H: 374 B: 297 T: 248 mm, für Art. 28232 / 27183 / 24635 / 24638

Artikel-Nr.	Produktinfo	Inhalt /VE	Preis /VE	ab 5 VE 10%
28230	weiss	(Pal. 24) 1	63.95	57.55
28231	schwarz	(Pal. 24) 1	63.95	57.55

Kostenlos erhältlich mit Spenderleihvertrag (ab 10 Kimberly Clark-Spender)

Rollenhandtücher | BulkySoft

2-lagig



Handtuchrolle BulkySoft Classic

20 cm x 250 lfm, 2-lagig, Zellstoff, Mikro-Prägung, ohne Kunststoffkern



Artikel-Nr.	Produktinfo	Inhalt /VE	Preis /VE	ab 5 VE 10%
26241	weiss	(Pal. 36) 6	45.95	41.35



Handtuchrolle BulkySoft Premium

20 cm x 150 lfm, 2-lagig, Zellstoff, Mikro-Prägung, ohne Kunststoffkern



Artikel-Nr.	Produktinfo	Inhalt /VE	Preis /VE	ab 5 VE 10%
26239	weiss	(Pal. 36) 6	35.55	32.00



Handtuchrolle BulkySoft Premium

19 x 38 cm, 150 lfm, 2-lagig, Zellstoff, Mikro-Prägung



Artikel-Nr.	Produktinfo	Inhalt /VE	Preis /VE	ab 5 VE 10%
26137	weiss, Rolle à 396 Blatt	(Pal. 48) 6	29.85	netto



Handtuchrolle BulkySoft Autocut

21 cm x 150 lfm, 2-lagig, Zellstoff, Mikro-Prägung



Artikel-Nr.	Produktinfo	Inhalt /VE	Preis /VE	Preis VE /Pal.
20454	weiss, für Spender Art. 20455	(Pal. 32) 6	51.90	44.25

Rollenhandtücher | Bulkysoft

3-lagig



BulkySoft Handtuchrolle Bulkysoft Autocut Membrane Plus

19.5 cm x 150 lfm, 3-lagig, Zellstoff, Mikro-Prägung



Artikel-Nr.	Produktinfo	Inhalt /VE	Preis /VE	Preis VE /Pal.
26234	weiss, für Spender Art. 26270	(Pal. 36) 6	62.75	53.50



BulkySoft Handtuchrolle Bulkysoft Autocut Membrane Plus Light

19.5 cm x 150 lfm, 3-lagig, Zellstoff, Mikro-Prägung



Artikel-Nr.	Produktinfo	Inhalt /VE	Preis /VE	ab 5 VE 10%
27192	weiss, für Spender Art. 26270	(Pal. 36) 6	61.50	55.35



BulkySoft Handtuchrolle Bulkysoft Autocut

21 cm x 100 lfm, 3-lagig, Zellstoff, Mikro-Prägung



Artikel-Nr.	Produktinfo	Inhalt /VE	Preis /VE	Preis VE /Pal.
26233	weiss, für Spender Art. 20455	(Pal. 32) 6	44.80	38.20



BulkySoft Handtuchrolle Bulkysoft Autocut Membrane Plus XL

21 cm x 150 lfm, 3-lagig, Zellstoff, Mikro-Prägung



Artikel-Nr.	Produktinfo	Inhalt /VE	Preis /VE	ab 5 VE 10%
27191	weiss, für Spender Art. 20455	(Pal. 36) 6	67.70	60.90

Rollenspender



BulkySoft Handtuchspender Bulkysoft Autocut

weiss / transparent, ABS Kunststoff, H: 347 B: 298 T: 248 mm

Artikel-Nr.	Produktinfo	Inhalt /VE	Preis /VE	
26270	abschliessbar, für Art. 26234 / 27192	(Pal. 144) 1	90.80	netto



BulkySoft Handtuchspender Bulkysoft Autocut

weiss, ABS Kunststoff, H: 365 B: 250 T: 230 mm

Artikel-Nr.	Produktinfo	Inhalt /VE	Preis /VE	
20455	für Art. 26233 / 20454 / 27191	(Pal. 48) 1	0.00	netto

Rollenhandtücher | Hagleitner

1-lagig



hagleitner XIBU multiRoll X1 Handtuchrolle

21 cm x 205 lfm, 1-lagig, 100 % Recycling, Mikro-Prägung

Artikel-Nr.	Produktinfo	Inhalt /VE	Preis /VE	ab 5 VE 10%
25010	weiss, für Spender Art. 24928 / 25433	(Pal. 40) 5	95.00	85.50

2-lagig



hagleitner XIBU multiROLL X2 Handtuchrolle

21 cm x 160 lfm, 2-lagig, 100 % Recycling, Mikro-Prägung

Artikel-Nr.	Produktinfo	Inhalt /VE	Preis /VE	ab 5 VE 10%
24913	weiss, für Spender Art. 24928 / 25433	(Pal. 40) 5	100.35	90.30

Rollenhandtücher | Hagleitner

Rollenspender



hagleitner XIBU touchTOWEL Handtuchspender manuell

weiss, ABS Kunststoff, H: 432 B: 331 T: 228 mm

Artikel-Nr.	Produktinfo	Inhalt /VE	Preis /VE	ab 5 VE 10%
25433	abschliessbar, mit 2 Rollensystemen, in 7 Farben erhältlich, für Art. 25010 / 24913	1	227.05	204.35



hagleitner XIBU senseTOWEL Handtuchspender Sensor

weiss, ABS Kunststoff, H: 432 B: 331 T: 228 mm

Artikel-Nr.	Produktinfo	Inhalt /VE	Preis /VE	ab 5 VE 10%
24928	abschliessbar, berührungslos, mit 2 Rollensystemen, in 7 Farben erhältlich, für Art. 25010 / 24913, Batterien Art. 24919	(Pal. 22) 1	337.85	304.05

Rollenhandtücher | Katrin

1-lagig



KATRIN Handtuchrolle Katrin Basic M

21 cm x 180 lfm, 1-lagig, Recycling, unperforiert



Artikel-Nr.	Produktinfo	Inhalt /VE	Preis /VE	ab 5 VE 10%
25628	naturweiss, für Spender Art. 28375 / 28377 / 28378 / 28379	(Pal. 36) 6	94.75	85.25



KATRIN Handtuchrolle Katrin Plus M

20.5 cm x 280 lfm, 1-lagig, Zellstoff, Innenabrollung, unperforiert



Artikel-Nr.	Produktinfo	Inhalt /VE	Preis /VE	ab 5 VE 10%
24249	hochweiss	(Pal. 36) 6	84.60	76.15

2-lagig



KATRIN Handtuchrolle Katrin Classic M2

21 cm x 160 lfm, 2-lagig, Mischqualität, unperforiert



Artikel-Nr.	Produktinfo	Inhalt /VE	Preis /VE	ab 5 VE 10%
21073	weiss, für Spender Art. 28375 / 28377 / 28378 / 28379	(Pal. 36) 6	94.75	85.25



KATRIN Handtuchrolle Katrin Classic M2

20 x 37 cm, 148 lfm, 2-lagig, Mischqualität



Artikel-Nr.	Produktinfo	Inhalt /VE	Preis /VE	ab 5 VE 10%
3742	blau, Rolle à 400 Blatt	(Pal. 40) 6	64.45	58.00

Rollenspender



KATRIN Katrin Inclusive Spender für Rollenhandtücher

weiss, Kunststoff, H: 403 B: 335 T: 216 mm, für Art. 25628 / 21073

Artikel-Nr.	Inhalt /VE	Preis /VE	ab 5 VE 10%
28375	(Pal. 24) 1	103.65	netto

Kostenlos erhältlich mit Leihspendervertrag

Rollenhandtücher | Katrin

Rollenspender



KATRIN Katrin Inclusive Spender für Rollenhandtücher

schwarz, Kunststoff, H: 403 B: 335 T: 216 mm, für Art. 25628 / 21073

Artikel-Nr.	Inhalt /VE	Preis /VE	
28377	(Pal. 24) 1	103.65	netto

Kostenlos erhältlich mit Leihspendervertrag



KATRIN Katrin elektronischer Spender für Rollenhandtücher

weiss, Kunststoff, H: 434 B: 299 T: 234 mm, für Art. 25628 / 21073

Artikel-Nr.	Inhalt /VE	Preis /VE	
28378	(Pal. 72) 1	153.90	netto

Kostenlos erhältlich mit Leihspendervertrag



KATRIN Katrin elektronischer Spender für Rollenhandtücher

schwarz, Kunststoff, H: 434 B: 299 T: 234 mm, für Art. 25628 / 21073

Artikel-Nr.	Inhalt /VE	Preis /VE	
28379	(Pal. 72) 1	153.90	netto

Kostenlos erhältlich mit Leihspendervertrag

Rollenhandtücher | Diverse

1-lagig



Handtuchrolle COSMOS

20 cm x 230 lfm, 1-lagig, 100 % Zellstoff, Kern: 40 mm

Artikel-Nr.	Produktinfo	Inhalt /VE	Preis /VE	ab 5 VE 10%
25038	weiss, für Spender Art. 25032 / 25061 / 25049 / 25057 / 25042	(Pal. 34) 6	79.20	71.30



Handtuchrolle TAD

20 cm x 250 lfm, 1-lagig, Zellstoff, Kern: 40 mm

Artikel-Nr.	Produktinfo	Inhalt /VE	Preis /VE	ab 5 VE 10%
25060	weiss	(Pal. 40) 6	92.45	83.20

2-lagig



Handtuchrolle neutral

20 cm x 150 lfm, 2-lagig, Tissue

Artikel-Nr.	Produktinfo	Inhalt /VE	Preis /VE	Preis ab 10 VE
5887	weiss, für Spender Art. 6963	(Pal. 45) 6	41.75	36.30



Handtuchrolle COSMOS

20 cm x 140 lfm, 2-lagig, Zellstoff

Artikel-Nr.	Produktinfo	Inhalt /VE	Preis /VE	ab 5 VE 10%
25033	weiss, für Spender Art. 25032 / 25061 / 25049 / 25057 / 25042	(Pal. 34) 6	55.40	49.85



Handtuchrolle COSMOS TAD

20 cm x 100 lfm, 2-lagig, Zellstoff, Kern: 40 mm

Artikel-Nr.	Produktinfo	Inhalt /VE	Preis /VE	ab 5 VE 10%
25037	weiss, für Spender Art. 25032 / 25061 / 25049 / 25057 / 25042	(Pal. 34) 6	58.35	52.50

Rollenhandtücher | Diverse

2-lagig



Handtuchrolle

21 cm x 140 lfm, 2-lagig, 100 % Zellstoff, Kern: 39 mm

Artikel-Nr.	Produktinfo	Inhalt /VE	Preis /VE	ab 5 VE 10%
25034	weiss	(Pal. 32) 6	57.75	51.95



Handtuchrolle

21 cm x 140 lfm, 2-lagig, Zellstoff geklebt, Kern: 39 mm

Artikel-Nr.	Produktinfo	Inhalt /VE	Preis /VE	ab 5 VE 10%
25035	weiss	(Pal. 45) 6	46.05	41.45



Handtuchrolle

21.5 cm x 140 lfm, 2-lagig, 100 % Zellstoff, Kern: 50 mm

Artikel-Nr.	Produktinfo	Inhalt /VE	Preis /VE	ab 5 VE 10%
25036	weiss	(Pal. 45) 6	47.75	42.95



Handtuchrolle TAD

21 cm x 100 lfm, 2-lagig, Zellstoff

Artikel-Nr.	Produktinfo	Inhalt /VE	Preis /VE	ab 5 VE 10%
25041	weiss	(Pal. 34) 6	54.15	48.75

3-lagig



Starline Handtuchrolle Starline

20 x 140 lfm, 3-lagig, Zellstoff, unperforiert

Artikel-Nr.	Produktinfo	Inhalt /VE	Preis /VE	ab 5 VE 10%
5731	weiss, für Spender Art. 16406	(Pal. 36) 6	49.50	44.55

Rollenspender



COSMOS Handtuchspender Autocut

ABS-Kunststoff, H: 430 B: 320 T: 210 mm, abschliessbar, für Art. 25033 / 25037 / 25038

Artikel-Nr.	Produktinfo	Inhalt /VE	Preis /VE	ab 5 VE 10%
25032	weiss	(Pal. 50) 1	127.90	115.10
25061	schwarz	(Pal. 50) 1	104.55	94.10
25049	weiss / schwarz	(Pal. 50) 1	127.90	115.10



COSMOS Handtuchspender Sensor

ABS-Kunststoff, H: 430 B: 320 T: 210 mm, abschliessbar, für Art. 25033 / 25037 / 25038

Artikel-Nr.	Produktinfo	Inhalt /VE	Preis /VE	ab 5 VE 10%
25057	weiss	(Pal. 50) 1	184.50	166.05
25042	weiss / schwarz	(Pal. 50) 1	184.50	166.05

Seifen | Seifencreme / Waschlotion

Starline



Starline Flüssigseife Cream Soap Basic Starline

mint mit Perlglanz

Artikel-Nr.	Produktinfo	Inhalt /VE	Preis /VE	ab 5 VE 10%
6309	1 Liter	(Pal. 400) 1	6.60	5.95
6310	10 Liter	(Pal. 60) 1	64.65	58.20

Seifen | Seifencreme / Waschlotion

Starline



Starline Flüssigseife Cream Soap Premium Starline

weiss mit Perlglanz, parfümiert

Artikel-Nr.	Produktinfo	Inhalt /VE	Preis /VE	ab 5 VE 10%
6303	1 Liter	1	6.30	5.70
6304	10 Liter	(Pal. 60) 1	60.80	54.70



Starline Flüssigseife Cream Soap Classic Starline

hellgelb

Artikel-Nr.	Produktinfo	Inhalt /VE	Preis /VE	ab 5 VE 10%
6315	1 Liter	(Pal. 400) 1	5.55	5.00
6316	10 Liter	(Pal. 40) 1	54.15	48.75



Starline Flüssigseife Starline

perlmutterweiss, pH-neutral

Artikel-Nr.	Produktinfo	Inhalt /VE	Preis /VE	
16814	500 ml	(Pal. 72) 12	34.65	netto

Leere Flasche



Artikel-Nr.	Produktinfo	Inhalt /VE	Preis /VE	
6327	1 Liter	1	2.75	netto

Hahnen

für 10 und 5 Liter Gebinde



Artikel-Nr.	Inhalt /VE	Preis /VE	
6328	1	9.75	netto

Spender - Cosi

Seifenspender Cosi

weiss / transparent



Artikel-Nr.	Produktinfo	Inhalt /VE	Preis /VE	
6127	170 ml, H: 150 B: 55 T: 75 mm	(Pal. 50) 1	23.80	netto
6344	350 ml, H: 160 B: 95 T: 95 mm	(Pal. 50) 1	49.35	netto
6340	800 ml, H: 250 B: 95 T: 95 mm	(Pal. 50) 1	59.40	netto
6342	1100 ml, H: 220 B: 115 T: 130 mm	(Pal. 50) 1	66.25	netto

Seifenspender Cosi

chrom / transparent



Artikel-Nr.	Produktinfo	Inhalt /VE	Preis /VE	
6228	170 ml, H: 150 B: 55 T: 75 mm	(Pal. 50) 1	29.10	netto
6345	350 ml, H: 160 B: 95 T: 95 mm	(Pal. 12) 1	58.65	netto
6341	800 ml, H: 250 B: 95 T: 95 mm	(Pal. 50) 1	68.70	netto
6343	1100 ml, H: 220 B: 115 T: 130 mm	(Pal. 6) 1	77.05	netto

Tork



TORK Flüssigseife mild Tork Premium - S1 System

1000 ml, perlmutt



Artikel-Nr.	Produktinfo	Inhalt /VE	Preis /VE	ab 5 VE 10%
7134	leicht parfümiert	(Pal. 80) 6	89.00	80.10

Seifen | Seifencreme / Waschlotion

Tork



Flüssigseife mild Tork Premium - S1 System

1000 ml, weiss



Artikel-Nr.	Produktinfo	Inhalt /VE	Preis /VE	ab 5 VE 10%
7137	unparfümiert	(Pal. 80) 6	91.90	82.70



Flüssigseife Luxus Tork Premium - S1 System

1000 ml, seide



Artikel-Nr.	Produktinfo	Inhalt /VE	Preis /VE	ab 5 VE 10%
7079	parfümiert, dermatologisch getestet	(Pal. 80) 6	97.20	87.50



Flüssigseife Industrie Tork Premium - S1 System

1000 ml, farblos



Artikel-Nr.	Produktinfo	Inhalt /VE	Preis /VE	ab 5 VE 10%
7139	unparfümiert	(Pal. 80) 6	89.60	80.60



Flüssigseife Hair & Body Shampoo Tork Premium - S1 System

1000 ml, blau



Artikel-Nr.	Produktinfo	Inhalt /VE	Preis /VE	ab 5 VE 10%
7183	parfümiert	(Pal. 80) 6	81.20	73.10



Händedesinfektionsgel Tork Premium - S1 System

1000 ml, farblos

Artikel-Nr.	Produktinfo	Inhalt /VE	Preis /VE	ab 5 VE 10%
16051	dermatologisch getestet	(Pal. 64) 6	160.35	144.30



Flüssigseife zur Händedekontamination Tork Premium - S1 System

1000 ml, transparent

Artikel-Nr.	Produktinfo	Inhalt /VE	Preis /VE	ab 5 VE 10%
28191	unparfümiert	(Pal. 80) 6	108.35	97.55



Flüssigseife Mini mild Tork Premium - S2 System

475 ml, perlmutt



Artikel-Nr.	Produktinfo	Inhalt /VE	Preis /VE	ab 5 VE 10%
7135	leicht parfümiert, dermatologisch getestet	(Pal. 96) 8	65.15	58.60



Lotion Hand & Body Tork Premium - S2 System

475 ml, weiss



Artikel-Nr.	Produktinfo	Inhalt /VE	Preis /VE	ab 5 VE 10%
7182	unparfümiert	(Pal. 96) 8	114.90	103.45



Flüssigseife Hair & Body Shampoo Tork Premium - S2 System

475 ml, blau



Artikel-Nr.	Produktinfo	Inhalt /VE	Preis /VE	ab 5 VE 10%
11243	parfümiert	(Pal. 96) 8	60.05	54.05

Seifen | Seifencreme / Waschlotion

Tork



TORK Flüssigseife Hair & Body Luxus Tork Premium - S2 System

475 ml, lindgrün



Artikel-Nr.	Produktinfo	Inhalt /VE	Preis /VE	ab 5 VE 10%
16049	parfümiert	(Pal. 96) 8	70.65	63.60



TORK Sprayseife Tork Universal - S35 System

800 ml, pink

Artikel-Nr.	Produktinfo	Inhalt /VE	Preis /VE	ab 5 VE 10%
14622	parfümiert	(Pal. 182) 6	84.65	76.20

Tork - Spender



TORK Tork Elevation Spender für Flüssigseifen - S1 System

weiss, Kunststoff, H: 291 B: 112 T: 114 mm

Artikel-Nr.	Produktinfo	Inhalt /VE	Preis /VE	
7121	mit Sichtfenster, abschliessbar	(Pal. 324) 1	60.65	netto

Erhältlich mit Leihspendervertrag (es können Servicegebühren anfallen)



TORK Tork Elevation Spender für Flüssigseifen - S1 System

schwarz, Kunststoff, H: 291 B: 112 T: 114 mm

Artikel-Nr.	Produktinfo	Inhalt /VE	Preis /VE	
7123	mit Sichtfenster, abschliessbar	(Pal. 324) 1	60.65	netto

Erhältlich mit Leihspendervertrag (es können Servicegebühren anfallen)



TORK Tork Spender für Flüssigseifen - S1 System

weiss, Metall, H: 291 B: 112 T: 114 mm

Artikel-Nr.	Inhalt /VE	Preis /VE	
16247	(Pal. 360) 1	115.20	netto



TORK Tork Elevation Spender für Flüssigseifen - S1 System

weiss, Kunststoff, H: 291 B: 112 T: 114 mm

Artikel-Nr.	Produktinfo	Inhalt /VE	Preis /VE	
7136	mit Sichtfenster, abschliessbar, mit Armbedienung	(Pal. 324) 1	85.60	netto

Erhältlich mit Leihspendervertrag (es können Servicegebühren anfallen)



TORK Tork Elevation Spender für Flüssigseifen - S1 System

schwarz, Kunststoff, H: 291 B: 112 T: 114 mm

Artikel-Nr.	Produktinfo	Inhalt /VE	Preis /VE	
19301	mit Sichtfenster, abschliessbar, mit Armbedienung	(Pal. 192) 1	85.60	netto

Erhältlich mit Leihspendervertrag (es können Servicegebühren anfallen)



TORK Tork Mini Spender für Flüssigseifen - S2 System

weiss, Kunststoff, H: 206 B: 112 T: 114 mm

Artikel-Nr.	Produktinfo	Inhalt /VE	Preis /VE	
7171	mit Sichtfenster, abschliessbar	(Pal. 432) 1	57.70	netto

Erhältlich mit Leihspendervertrag (es können Servicegebühren anfallen)

Seifen | Seifencreme / Waschlotion

Tork - Spender



TORK Tork Elevation Spender für Flüssigseifen - S2 System

schwarz, Kunststoff, H: 206 B: 112 T: 114 mm

Artikel-Nr.	Produktinfo	Inhalt /VE	Preis /VE	
7173	mit Sichtfenster, abschliessbar	(Pal. 432) 1	57.70	netto

Erhältlich mit Leihspendervertrag (es können Servicegebühren anfallen)



TORK Tork Desinfektionsstation - ohne Spender

schwarz, Edelstahl, für S1 / S2 / S4 / F1 System

Artikel-Nr.	Inhalt /VE	Preis /VE	
29116	(Pal. 8) 1	247.80	netto

Kimberly-Clark



Kimberly-Clark PROFESSIONAL Flüssigseife Kimberly-Clark Kleenex Ultra

1000 ml, caramelfarben

Artikel-Nr.	Produktinfo	Inhalt /VE	Preis /VE	
7490	parfümiert	(Pal. 96) 6	121.25	netto



Kimberly-Clark PROFESSIONAL Sanfte Flüssigseife Kimberly-Clark Kleenex

1000 ml, transparent

Artikel-Nr.	Produktinfo	Inhalt /VE	Preis /VE	
7491	unparfümiert	(Pal. 96) 6	93.25	netto



Kimberly-Clark PROFESSIONAL Normale Flüssigseife Kimberly-Clark Kleenex

1000 ml, rosa

Artikel-Nr.	Produktinfo	Inhalt /VE	Preis /VE	
7493	parfümiert	(Pal. 96) 6	66.30	netto



Kimberly-Clark PROFESSIONAL Haar- und Körpershampoo Kimberly-Clark Kleenex

1000 ml, weiss

Artikel-Nr.	Produktinfo	Inhalt /VE	Preis /VE	
7494	parfümiert	(Pal. 96) 6	146.90	netto

Kimberly-Clark - Spender



Kimberly-Clark PROFESSIONAL Spender für Handreiniger Kimberly-Clark Aquarius

weiss, Kunststoff, H: 237 B: 115 T: 250 mm

Artikel-Nr.	Produktinfo	Inhalt /VE	Preis /VE	ab 5 VE 10%
21138	mit Armhebel, für alle KC 1000 ml-Kassetten	(Pal. 270) 1	40.85	36.75

Kostenlos erhältlich mit Spenderleihvertrag (ab 10 Kimberly Clark-Spender)



Kimberly-Clark PROFESSIONAL Spender für Handreiniger Kimberly-Clark Aquarius

weiss, Kunststoff, H: 235 B: 116 T: 114 mm

Artikel-Nr.	Produktinfo	Inhalt /VE	Preis /VE	ab 5 VE 10%
18609	für alle KC 1000 ml-Kassetten	(Pal. 270) 1	35.45	31.90

Kostenlos erhältlich mit Spenderleihvertrag (ab 10 Kimberly Clark-Spender)

Seifen | Seifencreme / Waschlotion

Kimberly-Clark - Spender



Spender für Handreiniger Kimberly-Clark Aquarius

schwarz, Kunststoff, H: 235 B: 116 T: 114 mm

Artikel-Nr.	Produktinfo	Inhalt /VE	Preis /VE	ab 5 VE 10%
26920	für alle KC 1000 ml-Kassetten	(Pal. 270) 1	33.50	30.15

Kostenlos erhältlich mit Spenderleihvertrag (ab 10 Kimberly Clark-Spender)



Spender für Handreiniger Kimberly-Clark

Edelstahl, H: 231 B: 107 T: 120 mm

Artikel-Nr.	Produktinfo	Inhalt /VE	Preis /VE	ab 5 VE 10%
20528	für alle KC 1000 ml-Kassetten	(Pal. 216) 1	172.00	154.80

Gojo - NXT-System (manuell)



GOJO Spender NXT

weiss, manuell

Artikel-Nr.	Produktinfo	Inhalt /VE	Preis /VE	
14711	für 1000 ml-Flaschen	(Pal. 294) 1	0.00	netto

Kostenlos bei Bezug von Gojo-Seifen



GOJO Flüssigseife Deluxe NXT

mit Feuchtigkeitscreme, parfümiert

Artikel-Nr.	Produktinfo	Inhalt /VE	Preis /VE	
16900	1000 ml	(Pal. 60) 8	128.60	netto



GOJO Spa Bath Duschbad und Shampoo NXT

Körper- und Haarpflege

Artikel-Nr.	Produktinfo	Inhalt /VE	Preis /VE	
16901	1000 ml	(Pal. 60) 8	165.20	netto

Bulkysoft



Flüssigseife Bulkysoft

750 ml, pink

Artikel-Nr.	Produktinfo	Inhalt /VE	Preis /VE	ab 5 VE 10%
26950	für Spender Art. 26273	(Pal. 63) 12	63.00	56.70



Flüssigseife Bulkysoft

1000 ml, transparent, antibakteriell

Artikel-Nr.	Produktinfo	Inhalt /VE	Preis /VE	ab 5 VE 10%
26320	für Spender Art. 26273	(Pal. 45) 12	106.40	95.75

Bulkysoft - Spender



Spender für Seife in Kartuschen Bulkysoft

weiss, ABS Kunststoff, H: 270 B: 125 T: 118 mm

Artikel-Nr.	Produktinfo	Inhalt /VE	Preis /VE	
26273	für Art. 26950 / 26320	(Pal. 384) 1	27.30	netto

Seifen | Seifencreme / Waschlotion

Katrin



KATRIN Katrin Flüssigseife mild

1000 ml, pink



Artikel-Nr.	Produktinfo	Inhalt /VE	Preis /VE	ab 5 VE 10%
28419	parfümiert, für Spender Art. 28392 / 28393	(Pal. 95) 6	68.05	61.25



KATRIN Katrin Flüssigseife mild

500 ml, pink



Artikel-Nr.	Produktinfo	Inhalt /VE	Preis /VE	ab 5 VE 10%
28421	parfümiert, für Spender Art. 28390 / 28391	(Pal. 70) 12	93.20	83.85

Katrin - Spender



KATRIN Katrin Inclusive Spender

weiss, H: 291 B: 100 T: 130 mm, 1000 ml, für Art. 28423 / 28419 / 28420

Artikel-Nr.	Inhalt /VE	Preis /VE	
28392	(Pal. 189) 1	47.10	netto

Kostenlos erhältlich mit Leihspendervertrag



KATRIN Katrin Inclusive Spender

schwarz, H: 291 B: 100 T: 130 mm, 1000 ml, für Art. 28423 / 28419 / 28420

Artikel-Nr.	Inhalt /VE	Preis /VE	
28393	(Pal. 189) 1	47.10	netto

Kostenlos erhältlich mit Leihspendervertrag



KATRIN Katrin Inclusive Spender

weiss, H: 204 B: 100 T: 125 mm, 500 ml

Artikel-Nr.	Produktinfo	Inhalt /VE	Preis /VE	
28390	für Art. 28424 / 28421 / 28422 / 28425	(Pal. 315) 1	36.65	netto

Kostenlos erhältlich mit Leihspendervertrag



KATRIN Katrin Inclusive Spender

schwarz, H: 204 B: 100 T: 125 mm, 500 ml

Artikel-Nr.	Produktinfo	Inhalt /VE	Preis /VE	
28391	für Art. 28424 / 28421 / 28422 / 28425	(Pal. 315) 1	36.65	netto

Kostenlos erhältlich mit Leihspendervertrag

Diverse



SMA91-1 Flüssigseife

500 ml, rosa

Artikel-Nr.	Inhalt /VE	Preis /VE	ab 5 VE 10%
9305	(Pal. 98) 12	61.70	55.50



SMA 91-2 Flüssigseife

950 ml, rosa

Artikel-Nr.	Inhalt /VE	Preis /VE	ab 5 VE 10%
9306	(Pal. 126) 6	41.75	37.55

Seifen | Seifencreme / Waschlotion

Diverse



SMA 91-8 Clean & Clever Flüssigseife

5 Liter, rosa

Artikel-Nr.	Inhalt /VE	Preis /VE	ab 5 VE 10%
9307	(Pal. 96) 1	21.40	19.30



SMA91-10 Clean & Clever Flüssigseife

10 Liter, rosa

Artikel-Nr.	Inhalt /VE	Preis /VE	ab 5 VE 10%
9308	(Pal. 60) 1	30.30	27.25



Flüssigseife

rosa

Artikel-Nr.	Produktinfo	Inhalt /VE	Preis /VE	ab 5 VE 10%
5993	500 ml, für Spender Art. 5995	(Pal. 75) 12	61.65	55.50
5991	950 ml, für Spender Art. 5996	(Pal. 648) 1	6.95	6.25



Starline Flüssigseife Starline

rosa

Artikel-Nr.	Produktinfo	Inhalt /VE	Preis /VE	ab 5 VE 10%
5992	5 Liter	(Pal. 96) 1	21.40	19.25
5997	10 Liter	(Pal. 60) 1	30.00	27.00



Flüssigseife

5 Liter, blau

Artikel-Nr.	Inhalt /VE	Preis /VE	ab 5 VE 10%
7993	(Pal. 90) 1	37.50	33.75



Lola Lotion

Milde Waschlotion für die Hände, parfümiert, rosa

Artikel-Nr.	Produktinfo	Inhalt /VE	Preis /VE	ab 5 VE 10%
24783	5 Liter	(Pal. 32) 4	45.60	41.05



Lunea Lotion

Milde, hypoallergene Waschlotion für Haut und Hände, mit angenehmem Duft.

Artikel-Nr.	Produktinfo	Inhalt /VE	Preis /VE	ab 5 VE 10%
24772*	5 Liter	(Pal. 32) 4	88.10	79.30



Clin'Skin Classic

Milde Lotion für Haut und Hände, mit blumigem Duft.

Artikel-Nr.	Produktinfo	Inhalt /VE	Preis /VE	ab 5 VE 10%
24771*	5 Liter	(Pal. 32) 4	66.35	59.75



GOJO Milde Flüssigseife

unparfümiert

Artikel-Nr.	Produktinfo	Inhalt /VE	Preis /VE	ab 5 VE 10%
22089	118 ml	(Pal. 92) 48	72.10	netto

Seifen | Seifencreme / Waschlotion

Diverse - Spender



Seifenspender

Edelstahl, H: 265 B: 120 T: 120 mm

Artikel-Nr.	Produktinfo	Inhalt /VE	Preis /VE	
21746	750 ml	1	96.20	netto

Seifen | Schaumseife

Tork



Schaumseife Luxus Tork Premium - S3 System

800 ml, farblos

Artikel-Nr.	Produktinfo	Inhalt /VE	Preis /VE	ab 5 VE 10%
11777	dermatologisch getestet	(Pal. 192) 4	96.05	86.45



Schaumseife mild Tork Premium - S4 System

1000 ml, 2500 Dosierungen, farblos



Artikel-Nr.	Produktinfo	Inhalt /VE	Preis /VE	ab 5 VE 10%
18131	leicht parfümiert, dermatologisch getestet	(Pal. 80) 6	124.30	111.85



Schaumseife extra mild Tork Premium - S4 System

1000 ml, 2500 Dosierungen, farblos



Artikel-Nr.	Produktinfo	Inhalt /VE	Preis /VE	ab 5 VE 10%
18132	unparfümiert, dermatologische getestet	(Pal. 80) 6	137.80	124.05



Schaumseife für die Händedekontamination Tork Premium - S4 System

1000 ml, 2500 Dosierungen, farblos

Artikel-Nr.	Produktinfo	Inhalt /VE	Preis /VE	ab 5 VE 10%
18133	unparfümiert, dermatologisch getestet, bakterizide und fungizide Wirkung	(Pal. 80) 6	194.20	174.75



Schaum für die Händehygiene Tork Premium - S4 System

950 ml, 2375 Dosierungen, farblos

Artikel-Nr.	Produktinfo	Inhalt /VE	Preis /VE	ab 5 VE 10%
26951	unparfümiert, hydroalkoholisch	(Pal. 80) 6	197.65	177.85



Schaumseife Tork Premium - S34 System

800 ml, pink

Artikel-Nr.	Produktinfo	Inhalt /VE	Preis /VE	ab 5 VE 10%
11288	parfümiert	(Pal. 147) 6	73.40	66.05

Tork - Schaumseifenspender



Tork Elevation Spender für Schaumseife - S4 System

weiss, Kunststoff, H: 286 B: 113 T: 105 mm

Artikel-Nr.	Produktinfo	Inhalt /VE	Preis /VE	
18116	mit Sichtfenster, abschliessbar	(Pal. 324) 1	74.70	netto

Erhältlich mit Leihspendervertrag (es können Servicegebühren anfallen)

Seifen | Schaumseife

Tork - Schaumseifenspender



TORK Tork Elevation Spender für Schaumseife - S4 System

schwarz, Kunststoff, H: 286 B: 113 T: 105 mm

Artikel-Nr.	Produktinfo	Inhalt /VE	Preis /VE	
18117	mit Sichtfenster, abschliessbar	(Pal. 324) 1	74.70	netto

Erhältlich mit Leihspendervertrag (es können Servicegebühren anfallen)



TORK Tork Elevation Spender für Schaumseife - S4 System

weiss, Kunststoff, H: 278 B: 113 T: 130 mm

Artikel-Nr.	Produktinfo	Inhalt /VE	Preis /VE	
20991	mit Sensor	(Pal. 180) 1	139.50	netto

Erhältlich mit Leihspendervertrag (es können Servicegebühren anfallen)



TORK Tork Elevation Spender für Schaumseife - S4 System

schwarz, Kunststoff, H: 278 B: 130 T: 113 mm

Artikel-Nr.	Produktinfo	Inhalt /VE	Preis /VE	
20992	mit Sensor	(Pal. 180) 1	139.50	netto

Erhältlich mit Leihspendervertrag (es können Servicegebühren anfallen)



TORK Tork Spender für Schaumseife - S4 System

gebürsteter Edelstahl / Kunststoff, H: 289 B: 106 T: 107 mm

Artikel-Nr.	Produktinfo	Inhalt /VE	Preis /VE	
25166		(Pal. 300) 1	110.75	netto



TORK Tork Spender für Schaumseife - S4 System

gebürsteter Edelstahl / Kunststoff, H: 278 B: 116 T: 130 mm

Artikel-Nr.	Produktinfo	Inhalt /VE	Preis /VE	
25165	mit Sensor	(Pal. 280) 1	167.80	netto



TORK Tork Wave Spender für Schaumseife - S34 System

blau, Kunststoff, H: 260 B: 130 T: 120 mm

Artikel-Nr.	Produktinfo	Inhalt /VE	Preis /VE	
14608		(Pal. 420) 1	74.70	netto

Erhältlich mit Leihspendervertrag (es können Servicegebühren anfallen)



TORK Tork Desinfektionsstation - ohne Spender

schwarz, Edelstahl, für S1 / S2 / S4 / F1 System

Artikel-Nr.	Produktinfo	Inhalt /VE	Preis /VE	
29116		(Pal. 8) 1	247.80	netto

Kimberly-Clark



Kimberly-Clark Luxuriöse Schaumseife Kimberly-Clark Scott Essential

200 ml, rosa, tägliche Verwendung

Artikel-Nr.	Produktinfo	Inhalt /VE	Preis /VE	
18813	parfümiert, für Spender Art. 18812	(Pal. 115) 12	60.80	netto

Seifen | Schaumseife

Kimberly-Clark



Luxuriöse Schaumseife Kimberly-Clark Scott Control

1000 ml, transparent, häufige Verwendung



Artikel-Nr.	Produktinfo	Inhalt /VE	Preis /VE	ab 5 VE 10%
7578	unparfümiert, sanft	(Pal. 96) 6	104.25	93.80



Luxuriöse Schaumseife Kimberly-Clark Scott Essential

1000 ml, rosa, tägliche Verwendung

Artikel-Nr.	Produktinfo	Inhalt /VE	Preis /VE	ab 5 VE 10%
7576	parfümiert	(Pal. 96) 6	76.85	69.20



Schaumseife Kimberly-Clark Kleenex Energy

1000 ml, gelb



Artikel-Nr.	Produktinfo	Inhalt /VE	Preis /VE	ab 5 VE 10%
26624	parfümiert	(Pal. 96) 6	84.15	75.75



Schaumseife Kimberly-Clark Kleenex Fresh

1000 ml, grün



Artikel-Nr.	Produktinfo	Inhalt /VE	Preis /VE	ab 5 VE 10%
26626	parfümiert	(Pal. 96) 6	84.15	75.75



Schaumseife Kimberly-Clark Kleenex Joy

1000 ml, rosa



Artikel-Nr.	Produktinfo	Inhalt /VE	Preis /VE	ab 5 VE 10%
26627	parfümiert	(Pal. 96) 6	84.15	75.75



Luxuriöse Schaumseife Kimberly-Clark Scott Control

1200 ml, transparent, häufige Verwendung



Artikel-Nr.	Produktinfo	Inhalt /VE	Preis /VE	ab 5 VE 10%
16410.1*	unparfümiert, für Spender Art. 16408 / 18999	(Pal. 68) 4	101.10	91.00

Kimberly-Clark - Schaumseifenspender



Elektronischer Spender für Schaumseife und Händedesinfektion Kimberly-Clark

weiss, Kunststoff, H: 290 B: 183 T: 100 mm

Artikel-Nr.	Produktinfo	Inhalt /VE	Preis /VE	ab 5 VE 10%
16408	berührungslos, für Art. 16410.1 / 24649	(Pal. 99) 1	146.65	132.00

Ab 10 Kimberly Clark-Spender mit Spenderleihvertrag erhältlich (Servicegebühr: CHF 20.00 / Stk.)



Elektronischer Spender für Schaumseife und Händedesinfektion Kimberly-Clark

verchromt, Kunststoff, H: 290 B: 183 T: 100 mm

Artikel-Nr.	Produktinfo	Inhalt /VE	Preis /VE	ab 5 VE 10%
18999	berührungslos, Desinfektionsmittel Art. 24649, Schaumseife Art. 16410.1, Ständer Art. 19000	1	171.45	154.30

Ab 10 Kimberly Clark-Spender mit Spenderleihvertrag erhältlich (Servicegebühr: CHF 30.00 / Stk.)

Seifen | Schaumseife

Kimberly-Clark - Schaumseifenspender



Ständer für elektrischen Schaumseifenspender Kimberly-Clark

schwarz, aus Stahl, H: 146 B: 45 T: 45 cm

Artikel-Nr.	Produktinfo	Inhalt /VE	Preis /VE	ab 5 VE 10%
19000	für Art. 18999	(Pal. 28) 1	186.10	167.50

Ab 10 Kimberly Clark-Spender mit Spenderleihvertrag erhältlich (Servicegebühr: CHF 30.00 / Stk.)



Spender für Handreiniger Kimberly-Clark Aquarius

weiss, Kunststoff, H: 235 B: 116 T: 114 mm

Artikel-Nr.	Produktinfo	Inhalt /VE	Preis /VE	ab 5 VE 10%
18609	für alle KC 1000 ml-Kassetten	(Pal. 270) 1	35.45	31.90

Kostenlos erhältlich mit Spenderleihvertrag (ab 10 Kimberly Clark-Spender)



Spender für Handreiniger Kimberly-Clark Aquarius

schwarz, Kunststoff, H: 235 B: 116 T: 114 mm

Artikel-Nr.	Produktinfo	Inhalt /VE	Preis /VE	ab 5 VE 10%
26920	für alle KC 1000 ml-Kassetten	(Pal. 270) 1	33.50	30.15

Kostenlos erhältlich mit Spenderleihvertrag (ab 10 Kimberly Clark-Spender)



Spender für Handreiniger Kimberly-Clark

Edelstahl, H: 231 B: 107 T: 120 mm

Artikel-Nr.	Produktinfo	Inhalt /VE	Preis /VE	ab 5 VE 10%
20528	für alle KC 1000 ml-Kassetten	(Pal. 216) 1	172.00	154.80



Spender für Handreiniger Slim Kimberly-Clark

weiss, Kunststoff, H: 190 B: 65 T: 85 mm

Artikel-Nr.	Produktinfo	Inhalt /VE	Preis /VE	ab 5 VE 10%
18812	für Art. 18813	(Pal. 1050) 1	47.10	netto

Gojo | LTX-System (mit Sensor)



GOJO Spender LTX-7

automatisch, für 700 ml-Flaschen Art. 14512 / 14513 / 27644

Artikel-Nr.	Produktinfo	Inhalt /VE	Preis /VE	ab 5 VE 10%
14427	grau / weiss	(Pal. 192) 1	33.70	netto
14429	chrom / schwarz	(Pal. 192) 1	33.70	netto



Shield Tropfenfänger LTX

weiss

Artikel-Nr.	Produktinfo	Inhalt /VE	Preis /VE	ab 5 VE 10%
14588	für Spender Art. 14427 / 14416 / 26240 / 26236	(Pal. 2400) 1	0.00	netto



Shield Tropfenfänger LTX

schwarz

Artikel-Nr.	Produktinfo	Inhalt /VE	Preis /VE	ab 5 VE 10%
14577	für Spender Art. 14429 / 14425 / 26242 / 26238	(Pal. 2400) 1	0.00	netto

Seifen | Schaumseife

Gojo | LTX-System (mit Sensor)



GOJO Schaumseife LTX-7

700 ml, für Art. 14427 / 14429



Artikel-Nr.	Produktinfo	Inhalt /VE	Preis /VE	
14513	blau, Freshberry	(Pal. 140) 3	68.75	netto
14512	unparfümiert, ultramild	(Pal. 140) 3	68.75	netto
27644	transparent, antibakteriell	(Pal. 140) 3	75.65	netto



GOJO Spender LTX-12

automatisch, für 1200 ml-Flaschen Art. 26243 / 26244 / 27643

Artikel-Nr.	Produktinfo	Inhalt /VE	Preis /VE	
26240	grau / weiss	(Pal. 288) 1	33.70	netto
26242	chrom / schwarz	(Pal. 288) 1	33.70	netto



GOJO Schaumseife LTX-12

1200 ml, für Art. 26240 / 26242



Artikel-Nr.	Produktinfo	Inhalt /VE	Preis /VE	
26244	blau, freshberry	(Pal. 215) 2	68.35	netto
26243	unparfümiert, ultramild	(Pal. 215) 2	68.35	netto
27643*	transparent, antibakteriell	(Pal. 215) 2	73.85	netto

Gojo | TFX-System (mit Sensor)



GOJO Spender TFX

automatisch, für 1200 ml-Flaschen

Artikel-Nr.	Produktinfo	Inhalt /VE	Preis /VE	
17202	weiss	(Pal. 192) 1	25.30	netto
18955	Metalleffekt	(Pal. 192) 1	25.30	netto



GOJO Schaumseife TFX

1200 ml



Artikel-Nr.	Produktinfo	Inhalt /VE	Preis /VE	
16574	premium, blau, parfümiert	(Pal. 216) 2	65.55	netto
16959	ultrasanft, unparfümiert	(Pal. 216) 2	65.55	netto
27647	antibakteriell, unparfümiert	(Pal. 210) 2	74.95	netto

Gojo | ADX-System (manuell)



GOJO Spender ADX-7

manuell, für 700 ml-ADX-Flaschen

Artikel-Nr.	Produktinfo	Inhalt /VE	Preis /VE	
24433	grau / weiss	(Pal. 360) 1	0.00	netto
24434	chrom / schwarz	(Pal. 360) 1	0.00	netto

Kostenlos bei Bezug von Gojo-Seifen



GOJO Schaumseife ADX-7

700 ml

Artikel-Nr.	Produktinfo	Inhalt /VE	Preis /VE	
24441	freshberry	(Pal. 144) 4	58.60	netto
24439	unparfümiert, extra mild	(Pal. 144) 4	58.60	netto
27646	antibakteriell	(Pal. 120) 4	64.50	netto
24445	luxury hair, body and hand	(Pal. 144) 4	58.60	netto

* auf Bestellung

Seifen | Schaumseife

Gojo | ADX-System (manuell)



GOJO Spender ADX-12

manuell, für 1250 ml-ADX-Flaschen

Artikel-Nr.	Produktinfo	Inhalt /VE	Preis /VE	
24435	grau / weiss	(Pal. 288) 1	0.00	netto
24436	chrom / schwarz	(Pal. 288) 1	0.00	netto

Kostenlos bei Bezug von Gojo-Seifen



GOJO Schaumseife ADX-12

1250 ml



Artikel-Nr.	Produktinfo	Inhalt /VE	Preis /VE	
24442	forestberry	(Pal. 130) 3	68.35	netto
24440	unparfümiert, extra mild	(Pal. 130) 3	68.35	netto
27645*	antibakteriell	(Pal. 130) 3	74.90	netto
24446*	luxury hair, body and hand	(Pal. 130) 3	68.35	netto



GOJO Spender ADX-7 HAND MEDIC

manuell, für 700 ml-ADX-Flaschen

Artikel-Nr.	Produktinfo	Inhalt /VE	Preis /VE	
24177	grau / weiss	1	0.00	netto
24438	chrom / schwarz	(Pal. 360) 1	0.00	netto

Kostenlos bei Bezug von Gojo Hand Medic (Art. 24174)



GOJO HAND MEDIC ADX-7

700 ml

Artikel-Nr.	Produktinfo	Inhalt /VE	Preis /VE	
24174	professionelle Hautpflege	(Pal. 150) 4	65.65	netto

Gojo | FMX-System (manuell)



GOJO Spender FMX

manuell, für 1250 ml-Flaschen

Artikel-Nr.	Produktinfo	Inhalt /VE	Preis /VE	
14790	weiss	1	0.00	netto

Kostenlos bei Bezug von Gojo-Seifen



GOJO Schaumseife FMX

1250 ml



Artikel-Nr.	Produktinfo	Inhalt /VE	Preis /VE	
14792	freshberry, blau, parfümiert	(Pal. 132) 3	68.15	netto
16178	unparfümiert, ultrasanft	(Pal. 132) 3	69.45	netto
27648	antibakteriell, unparfümiert	(Pal. 126) 3	78.65	netto



GOJO Luxury Schaum-Duschgel für Körper und Haare FMX

1250 ml



Artikel-Nr.	Produktinfo	Inhalt /VE	Preis /VE	
22410*	parfümiert, Gurke und Melone, 59% der Zutaten sind auf pflanzlicher Basis	(Pal. 132) 3	80.35	netto

Seifen | Schaumseife

Bulkysoft



Schaumseife Bulkysoft

1000 ml, pink

Artikel-Nr.	Produktinfo	Inhalt /VE	Preis /VE	ab 5 VE 10%
26321	für Spender Art. 26272	(Pal. 250) 6	79.70	71.75

Bulkysoft - Schaumseifenspender



Spender für Schaumseife in Kartuschen Bulkysoft

weiss, ABS Kunststoff, H: 270 B: 125 T: 118 mm

Artikel-Nr.	Produktinfo	Inhalt /VE	Preis /VE	
26272	für Art. 26321	(Pal. 140) 1	27.30	netto

Katrin



Katrin Schaumseife mild

1000 ml



Artikel-Nr.	Produktinfo	Inhalt /VE	Preis /VE	ab 5 VE 10%
28423	parfümiert, für Spender Art. 28392 / 28393	(Pal. 95) 6	94.95	85.45



Katrin Schaumseife mild

500 ml



Artikel-Nr.	Produktinfo	Inhalt /VE	Preis /VE	ab 5 VE 10%
28424	parfümiert, für Spender Art. 28390 / 28391	(Pal. 70) 12	120.30	108.25

Katrin - Schaumseifenspender



Katrin Inclusive Spender

weiss, H: 291 B: 100 T: 130 mm, 1000 ml, für Art. 28423 / 28419 / 28420

Artikel-Nr.	Inhalt /VE	Preis /VE	
28392	(Pal. 189) 1	47.10	netto

Kostenlos erhältlich mit Leihspendervertrag



Katrin Inclusive Spender

schwarz, H: 291 B: 100 T: 130 mm, 1000 ml, für Art. 28423 / 28419 / 28420

Artikel-Nr.	Inhalt /VE	Preis /VE	
28393	(Pal. 189) 1	47.10	netto

Kostenlos erhältlich mit Leihspendervertrag



Katrin Inclusive Spender

weiss, H: 204 B: 100 T: 125 mm, 500 ml

Artikel-Nr.	Produktinfo	Inhalt /VE	Preis /VE	
28390	für Art. 28424 / 28421 / 28422 / 28425	(Pal. 315) 1	36.65	netto

Kostenlos erhältlich mit Leihspendervertrag



Katrin Inclusive Spender

schwarz, H: 204 B: 100 T: 125 mm, 500 ml

Artikel-Nr.	Produktinfo	Inhalt /VE	Preis /VE	
28391	für Art. 28424 / 28421 / 28422 / 28425	(Pal. 315) 1	36.65	netto

Kostenlos erhältlich mit Leihspendervertrag

Seifen | Schaumseife

Hagleitner



XIBU foamSOAP Schaumseife cremig

600 ml, für saubere und samtweiche Hände

Artikel-Nr.	Produktinfo	Inhalt /VE	Preis /VE	ab 5 VE 10%
24918	für Spender Art. 24930 / 24962	(Pal. 85) 6	68.70	61.80



XIBU septDES FOAM Desinfizierende Schaumseife

600 ml, für eine schonende Desinfektion und Reinigung der Hände

Artikel-Nr.	Produktinfo	Inhalt /VE	Preis /VE	ab 5 VE 10%
28797	für Spender Art. 24930 / 24962	6	143.50	129.15

Hagleitner - Schaumseifenspender



XIBU touchFOAM Schaumseifenspender manuell

weiss, ABS Kunststoff, H: 300 B: 133 T: 119 mm, in 7 Farben erhältlich

Artikel-Nr.	Produktinfo	Inhalt /VE	Preis /VE	ab 5 VE 10%
24962	einstellbare Abgabemenge, für Art. 24918 / 28797	(Pal. 15) 1	105.60	95.00



XIBU senseFOAM Schaumseifenspender Sensor

weiss, ABS Kunststoff, H: 277 B: 135 T: 108 mm, in 7 Farben erhältlich

Artikel-Nr.	Produktinfo	Inhalt /VE	Preis /VE	ab 5 VE 10%
24930	berührungslos, einstellbare Abgabemenge, Batterien Art. 25422, für Seifen Art. 24918 / 28797	(Pal. 15) 1	216.50	194.85

Diverse



Schaumseifenkonzentrat

400 ml

Artikel-Nr.	Produktinfo	Inhalt /VE	Preis /VE	ab 5 VE 10%
8979	parfümiert, Zitrone, für Spender Art. 7050	(Pal. 70) 12	71.40	64.25



Schaumseifenkonzentrat BestFoam

500 ml, cremefarben

Artikel-Nr.	Produktinfo	Inhalt /VE	Preis /VE	ab 5 VE 10%
17314	mild	(Pal. 72) 12	112.95	netto



Schaumseife

5 Liter, gelb

Artikel-Nr.	Produktinfo	Inhalt /VE	Preis /VE	ab 5 VE 10%
24432	parfümiert, Zitrus	(Pal. 96) 1	25.10	22.60



Schaumseifenkartuschen für Seifenspender COSMOS

1000 ml

Artikel-Nr.	Produktinfo	Inhalt /VE	Preis /VE	ab 5 VE 10%
25053	parfümiert, Grapefruit	(Pal. 60) 6	50.90	45.85

Seifen | Schaumseife

Diverse - Schaumseifenspender



Spender für Schaumseife

Artikel-Nr.	Produktinfo	Inhalt /VE	Preis /VE	
7050	für Art. 8979	1	87.15	netto



COSMOS Schaumseifenspender

H: 240 B: 105 T: 120 mm, ABS Kunststoff, abschliessbar, abnehmbare Wandhalterung

Artikel-Nr.	Produktinfo	Inhalt /VE	Preis /VE	ab 5 VE 10%
25044	weiss	(Pal. 480) 1	47.45	42.70
25046	weiss / schwarz	(Pal. 480) 1	47.45	42.70
25062*	schwarz	(Pal. 480) 1	47.45	42.70

Desinfektion | Purell

LTX-System (mit Sensor)



PURELL Spender LTX-7

automatisch, für 700 ml-Flasche Art. 14516

Artikel-Nr.	Produktinfo	Inhalt /VE	Preis /VE	
14416	weiss	(Pal. 192) 1	33.70	netto
14425	chrom / schwarz	(Pal. 192) 1	33.70	netto



PURELL Advanced Händedesinfektionsgel LTX-7

700 ml

Artikel-Nr.	Produktinfo	Inhalt /VE	Preis /VE	
14516	hydroalkoholisch, für Art. 14416 / 14425	(Pal. 140) 3	76.25	netto



PURELL Spender LTX-12

automatisch, für 1200 ml-Flasche Art. 26246

Artikel-Nr.	Produktinfo	Inhalt /VE	Preis /VE	
26236	weiss	(Pal. 288) 1	33.70	netto
26238	chrom / schwarz	(Pal. 288) 1	33.70	netto



PURELL Advanced Händedesinfektionsgel LTX-12

1200 ml

Artikel-Nr.	Produktinfo	Inhalt /VE	Preis /VE	
26246	hydroalkoholisch, für Art. 26236 / 26238	(Pal. 215) 2	74.55	netto



GOJO Shield Tropfenfänger LTX

weiss

Artikel-Nr.	Produktinfo	Inhalt /VE	Preis /VE	
14588	für Spender Art. 14427 / 14416 / 26240 / 26236	(Pal. 2400) 1	0.00	netto



GOJO Shield Tropfenfänger LTX

schwarz

Artikel-Nr.	Produktinfo	Inhalt /VE	Preis /VE	
14577	für Spender Art. 14429 / 14425 / 26242 / 26238	(Pal. 2400) 1	0.00	netto

GOJO® & PURELL® LÖSUNGEN FÜR HAUTHYGIENE UND DESINFEKTION VON OBERFLÄCHEN



REINIGUNG

GOJO bietet eine komplette Palette von sanften, duftenden und antimikrobiellen Handreinigungsprodukten, die die Bedürfnisse unserer Kunden zugeschnitten sind und die Haut gesund erhalten.



DESINFEKTION

Die Händedesinfektionsprodukte PURELL haben eine außergewöhnliche antimikrobielle Wirksamkeit und gewährleisten einen verlängerten Schutz gegen die Ausbreitung der Keime. Sie halten die Haut gesund, was sogar klinisch bewiesen wurde.



OBERFLÄCHEN

Nach vielen Jahren wissenschaftlicher Erfahrung bietet Ihnen die Marke PURELL jetzt eine Auswahl an Tüchern und Sprays für die Desinfektion von Oberflächen.



<http://www.gojo.com>

Desinfektion | Purell

TFX-System (mit Sensor)



Purell PURELL Spender TFX

automatisch, für 1200 ml-Flaschen

Artikel-Nr.	Produktinfo	Inhalt /VE	Preis /VE	
14475	weiss	(Pal. 192) 1	25.30	netto
18956	Metalleffekt	(Pal. 192) 1	25.30	netto



Purell PURELL Tropfenfänger zu Spender TFX

weiss, Kunststoff

Artikel-Nr.	Inhalt /VE	Preis /VE	
16173	1	0.00	netto



Purell PURELL VF 481 Händedesinfektionsgel TFX

1200 ml

Artikel-Nr.	Produktinfo	Inhalt /VE	Preis /VE	
14482	antiseptisch	(Pal. 96) 4	146.00	netto



Purell PURELL Advanced Händedesinfektionsgel TFX

1200 ml

Artikel-Nr.	Produktinfo	Inhalt /VE	Preis /VE	
27849	hydroalkoholisch	(Pal. 210) 2	65.70	netto



Purell PURELL Advanced Händedesinfektionsschaum TFX

1200 ml

Artikel-Nr.	Produktinfo	Inhalt /VE	Preis /VE	
18541	hydroalkoholisch	(Pal. 225) 2	100.05	netto

ADX-System (manuell)



Purell PURELL Spender ADX-7

manuell, für 700 ml-ADX-Flaschen

Artikel-Nr.	Produktinfo	Inhalt /VE	Preis /VE	
24548	weiss	(Pal. 360) 1	0.00	netto
24549	chrom / schwarz	(Pal. 360) 1	0.00	netto

Kostenlos bei Bezug von Purell-Desinfektionsmittel



Purell PURELL Advanced Händedesinfektionsgel ADX-7

700 ml

Artikel-Nr.	Produktinfo	Inhalt /VE	Preis /VE	
24546	hydroalkoholisch	(Pal. 144) 4	73.85	netto



Purell PURELL Spender ADX-12

manuell, für 1200 ml-ADX-Flaschen

Artikel-Nr.	Produktinfo	Inhalt /VE	Preis /VE	
24437	grau / weiss	(Pal. 288) 1	0.00	netto
24547	chrom / schwarz	(Pal. 288) 1	0.00	netto

Kostenlos bei Bezug von Purell-Desinfektionsmittel

Desinfektion | Purell

ADX-System (manuell)



PURELL Advanced Händedesinfektionsgel ADX-12

1200 ml

Artikel-Nr.	Produktinfo	Inhalt /VE	Preis /VE	
24447	hydroalkoholisch	(Pal. 170) 3	82.80	netto

FMX-System (manuell)



PURELL Spender FMX

manuell, für 1200 ml-Flaschen

Artikel-Nr.	Produktinfo	Inhalt /VE	Preis /VE	
17206*	weiss	(Pal. 240) 1	0.00	netto

Kostenlos bei Bezug von Purell-Desinfektionsmittel



PURELL VF 481 Händedesinfektionsgel FMX

1200 ml

Artikel-Nr.	Produktinfo	Inhalt /VE	Preis /VE	
16179	antiseptisch	(Pal. 144) 3	76.00	netto



PURELL Advanced Milder Händedesinfektionsschaum FMX

1200 ml

Artikel-Nr.	Produktinfo	Inhalt /VE	Preis /VE	
18542*	hydroalkoholisch	(Pal. 132) 3	104.95	netto

NXT-System (manuell)



PURELL Spender NXT

manuell, für 1000 ml-Flaschen

Artikel-Nr.	Produktinfo	Inhalt /VE	Preis /VE	
17207	weiss	(Pal. 294) 1	0.00	netto

Kostenlos bei Bezug von Purell-Desinfektionsmittel



PURELL Advanced Händedesinfektionsgel NXT

1000 ml

Artikel-Nr.	Produktinfo	Inhalt /VE	Preis /VE	
16898	hydroalkoholisch	(Pal. 60) 8	138.90	netto

ES-System (manuell)



PURELL Starterset ES

Spender + 450 ml Nachfüllpackung

Artikel-Nr.	Inhalt /VE	Preis /VE	
26556	(Pal. 72) 8	224.95	netto



PURELL Advanced Händedesinfektionsgel ES

450 ml

Artikel-Nr.	Produktinfo	Inhalt /VE	Preis /VE	
26557	hydroalkoholisch, für Spender Art. 26556	(Pal. 168) 6	102.45	netto

Desinfektion | Purell

ES-System (manuell)



Purell PURELL Ständer für Spender ES

weiss

Artikel-Nr.	Produktinfo	Inhalt /VE	Preis /VE	
26558	für Spender Art. 26556	(Pal. 2080) 1	15.45	netto



Purell PURELL Ständer Tischmontage für Spender ES

schwarz

Artikel-Nr.	Produktinfo	Inhalt /VE	Preis /VE	
26559	für Spender Art. 26556	(Pal. 2000) 1	18.40	netto



Purell PURELL Tropfenfänger für Spender ES

weiss

Artikel-Nr.	Produktinfo	Inhalt /VE	Preis /VE	
26560	für Spender Art. 26556	(Pal. 4128) 1	7.35	netto

Flaschen & Halterungen



Purell PURELL Desinfektionsstation

ohne Spender, Höhe 130 cm

Artikel-Nr.	Produktinfo	Inhalt /VE	Preis /VE	
14768	Metall	(Pal. 30) 1	203.05	netto
14477	grau	(Pal. 30) 1	126.20	netto



Purell PURELL Ausziehbarer Anhänge-Clip

einfach an die Kleidung anzuheften, eignet sich für eine 60 ml-Flasche von Purell

Artikel-Nr.	Produktinfo	Inhalt /VE	Preis /VE	
14481	Purell-Flaschen werden separat verkauft	(Pal. 13056) 1	0.00	netto



Purell PURELL VF 481 Händedesinfektionsgel

60 ml-Flasche

Artikel-Nr.	Produktinfo	Inhalt /VE	Preis /VE	
14484	antiseptisch	(Pal. 300) 24	63.80	netto



Purell PURELL Advanced Händedesinfektionsgel

60 ml-Pumpflasche

Artikel-Nr.	Produktinfo	Inhalt /VE	Preis /VE	
20887	hydroalkoholisch	(Pal. 260) 24	63.80	netto



Purell PURELL Advanced Händedesinfektionsgel

100 ml-Flasche

Artikel-Nr.	Produktinfo	Inhalt /VE	Preis /VE	
26647	hydroalkoholisch	(Pal. 220) 24	60.60	netto



Purell PURELL VF 481 Händedesinfektionsgel

350 ml-Pumpflasche

Artikel-Nr.	Produktinfo	Inhalt /VE	Preis /VE	
14483	antiseptisch, Wandhalterung Art. 14479, Hook-On-Halter Art. 14480	(Pal. 154) 12	111.00	netto

Desinfektion | Purell

Flaschen & Halterungen



Purell PURELL Advanced Händedesinfektionsgel

300 ml-Pumpflasche (3 ml-Pumpe)

Artikel-Nr.	Produktinfo	Inhalt /VE	Preis /VE	
26645	hydroalkoholisch, Wandhalterung Art. 27894	(Pal. 147) 12	99.75	netto

Oberflächendesinfektion



Purell PURELL Surface Tücher für Oberflächendesinfektion

Tuchgröße 130 x 210 mm



Artikel-Nr.	Produktinfo	Inhalt /VE	Preis /VE	
29009*	Dose à 100 Tücher	12	63.95	netto



Purell PURELL Surface Tücher für Oberflächendesinfektion

Tuchgröße 185 x 215 mm



Artikel-Nr.	Produktinfo	Inhalt /VE	Preis /VE	
29010*	Dose à 200 Tücher	6	63.80	netto



Purell PURELL Surface Spray für Oberflächendesinfektion

750 ml



Artikel-Nr.	Inhalt /VE	Preis /VE	
29011*	6	43.05	netto

Desinfektion | Kimberly-Clark



Kimberly-Clark Feuchtigkeitspendendes Händedesinfektionsgel Kimberly-Clark

Kleenex

100 ml-Flasche, ohne Farb- und Duftstoffe, transparent, hydroalkoholisch

Artikel-Nr.	Inhalt /VE	Preis /VE	
24646	(Pal. 180) 24	108.75	netto



Kimberly-Clark Feuchtigkeitspendendes Händedesinfektionsgel Kimberly-Clark

Kleenex

480 ml-Pumpflasche, ohne Farb- und Duftstoffe, transparent, hydroalkoholisch

Artikel-Nr.	Inhalt /VE	Preis /VE	
24647	(Pal. 84) 12	96.60	netto



Kimberly-Clark Feuchtigkeitspendendes Händedesinfektionsgel Kimberly-Clark

Kleenex

1000 ml, ohne Farb- und Duftstoffe, transparent, hydroalkoholisch

Artikel-Nr.	Produktinfo	Inhalt /VE	Preis /VE	
24648	für Spender Art. 18609 + 21138	(Pal. 96) 6	87.55	netto



Kimberly-Clark Feuchtigkeitspendendes Händedesinfektionsgel Kimberly-Clark

Kleenex

1200 ml, ohne Farb- und Duftstoffe, transparent, hydroalkoholisch

Artikel-Nr.	Produktinfo	Inhalt /VE	Preis /VE	
24649	für Spender Art. 16408 + 18999	(Pal. 68) 4	93.60	netto

Desinfektion | Kimberly-Clark



Elektronischer Spender für Schaumseife und Händedesinfektion
Kimberly-Clark

weiss, Kunststoff, H: 290 B: 183 T: 100 mm

Artikel-Nr.	Produktinfo	Inhalt /VE	Preis /VE	ab 5 VE 10%
16408	berührungslos, für Art. 16410.1 / 24649	(Pal. 99) 1	146.65	132.00

Ab 10 Kimberly Clark-Spender mit Spenderleihvertrag erhältlich (Servicegebühr: CHF 20.00 / Stk.)



Elektronischer Spender für Schaumseife und Händedesinfektion
Kimberly-Clark

verchromt, Kunststoff, H: 290 B: 183 T: 100 mm

Artikel-Nr.	Produktinfo	Inhalt /VE	Preis /VE	ab 5 VE 10%
18999	berührungslos, Desinfektionsmittel Art. 24649, Schaumseife Art. 16410.1, Ständer Art. 19000	1	171.45	154.30

Ab 10 Kimberly Clark-Spender mit Spenderleihvertrag erhältlich (Servicegebühr: CHF 30.00 / Stk.)



Ständer für elektrischen Schaumseifenspender Kimberly-Clark

schwarz, aus Stahl, H: 146 B: 45 T: 45 cm

Artikel-Nr.	Produktinfo	Inhalt /VE	Preis /VE	ab 5 VE 10%
19000	für Art. 18999	(Pal. 28) 1	186.10	167.50

Ab 10 Kimberly Clark-Spender mit Spenderleihvertrag erhältlich (Servicegebühr: CHF 30.00 / Stk.)

Desinfektion | Haglertner



XIBU septLIQUID SENSITIVE Händedesinfektion

besonders hautverträgliche und pflegende, alkoholische Lösung. Auch für chirurgische Händedesinfektion.

Artikel-Nr.	Produktinfo	Inhalt /VE	Preis /VE	ab 5 VE 10%
25407	700 ml, für Spender Art. 25407	6	79.25	71.30



XIBU senseDISINFECT Desinfektionsspender Sensor

weiss, Kunststoff, H: 277 B: 135 T: 108 mm, in 7 Farben erhältlich

Artikel-Nr.	Produktinfo	Inhalt /VE	Preis /VE	ab 5 VE 10%
24950	berührungslos, einstellbare Abgabemenge, Batterien Art. 25422, für Art. 25407	(Pal. 15) 1	202.45	182.20



XIBU disinfectFLOOR

Bodenstandfuss zur mobilen Aufstellung von Spendern.

Artikel-Nr.	Produktinfo	Inhalt /VE	Preis /VE	ab 5 VE 10%
25425	H: 895 B: 395 T: 385 mm, für Spender Art. 24950, Art. 25426 erforderlich	1	158.35	142.50



XIBU disinfectTABLE

Tischstandfuss für den Tisch oder für den Boden Standfuss zur mobilen Aufstellung mit Tropfschale.

Artikel-Nr.	Produktinfo	Inhalt /VE	Preis /VE	ab 5 VE 10%
25426	H: 445 B: 155 T: 215 mm, für Spender Art. 24950	1	123.20	110.90



XIBU disinfectWALL

Tropfschale für Wandmontage.

Artikel-Nr.	Produktinfo	Inhalt /VE	Preis /VE	ab 5 VE 10%
25427	H: 196 B: 108 T: 123 mm, für Spender Art. 24950	1	44.10	39.65

Desinfektion | Hagleitner



XIBU disinfect Tafel

2-sprachig: Deutsch / Englisch

Artikel-Nr.	Produktinfo	Inhalt /VE	Preis /VE	ab 5 VE 10%
29188	für Spender Art. 24950	1	13.20	11.90

WC-Garnituren und WC-Besen



WC-Garnitur ohne Randreiniger

chrom, 6,5 cm

Artikel-Nr.	Inhalt /VE	Preis /VE	ab 5 VE 10%
4312	1	38.40	34.55



WC-Besen ohne Randreiniger

Kugelform, mit Chromstahlgriff

Artikel-Nr.	Produktinfo	Inhalt /VE	Preis /VE	
27284*	für Art. 4312	10	62.20	netto



WC-Garnitur ohne Randreiniger

weiss

Artikel-Nr.	Inhalt /VE	Preis /VE	ab 5 VE 10%
4292	1	8.55	7.70



Brabantia WC-Garnitur ohne Randreiniger

chrom / brillant steel

Artikel-Nr.	Inhalt /VE	Preis /VE	
5412*	(Pal. 234) 2	69.80	netto



Brabantia WC-Garnitur ohne Randreiniger

matt steel, mit Wandbefestigungsmaterial

Artikel-Nr.	Inhalt /VE	Preis /VE	
16262*	(Pal. 84) 2	129.80	netto



Brabantia WC-Ersatzbesen

schwarz

Artikel-Nr.	Produktinfo	Inhalt /VE	Preis /VE	
28491*	für WC-Garnitur Art. 16262	6	89.40	netto



LooBlade WC-Garnitur ohne Randreiniger

Besen mit Silikonblätter

Artikel-Nr.	Produktinfo	Inhalt /VE	Preis /VE	
27042	weiss / grau	(Pal. 16) 10	325.00	netto
27042.9	weiss / grau	(Pal. 160) 1	35.50	netto
27862	türkis	(Pal. 16) 10	325.00	netto
27862.9	türkis	(Pal. 160) 1	35.50	netto
27055	weiss / grau	(Pal. 16) 20	650.00	netto
27055.9	weiss / grau	(Pal. 320) 1	35.50	netto



WC-Garnitur mit Randreiniger

weiss, 7,5 cm

Artikel-Nr.	Inhalt /VE	Preis /VE	ab 5 VE 10%
4314	1	10.75	9.70

WC-Garnituren und WC-Besen



WC-Garnitur mit Randreiniger

weiss

Artikel-Nr.	Inhalt /VE	Preis /VE	ab 5 VE 10%
4368	1	8.80	7.95



Haug WC-Garnitur

weiss

Artikel-Nr.	Inhalt /VE	Preis /VE	
11594	(Pal. 200) 1	7.05	netto



Haug WC-Ersatzbesen

weiss

Artikel-Nr.	Produktinfo	Inhalt /VE	Preis /VE	
11595	für Art. 11594	1	4.75	netto



Haug - WC-Garnitur «Zwiebel»

weiss, mit Randreiniger

Artikel-Nr.	Inhalt /VE	Preis /VE	
8678	1	12.50	netto



Haug WC-Wandgarnitur mit Besen

weiss, rund, 11.5 x 10 x 41 cm

Artikel-Nr.	Inhalt /VE	Preis /VE	
10087	1	5.55	netto



WC-Besen ohne Randreiniger

weiss, Kugelform, 6.7 cm

Artikel-Nr.	Produktinfo	Inhalt /VE	Preis /VE	ab 5 VE 10%
4316	3-er Pack	3	10.65	9.60



WC-Besen ohne Randreiniger

weiss, Kugelform, 7.5 cm

Artikel-Nr.	Produktinfo	Inhalt /VE	Preis /VE	ab 5 VE 10%
4319	3-er Pack	3	10.65	9.60



WC-Besen ohne Randreiniger

weiss, rund, aus PP, 7.5 cm

Artikel-Nr.	Inhalt /VE	Preis /VE	
16238	(Pal. 1260) 1	2.70	netto



WC-Besen ohne Randreiniger

rund, 6.7 cm

Artikel-Nr.	Produktinfo	Inhalt /VE	Preis /VE	ab 5 VE 10%
11513	weiss	(Pal. 2000) 1	3.65	3.30
24591*	schwarz	1	3.00	2.70



WC-Ersatzbesen ohne Randreiniger

weiss, Kugelform, 8.2 cm

Artikel-Nr.	Produktinfo	Inhalt /VE	Preis /VE	ab 5 VE 10%
23537	für Art. 16261	3	10.65	9.60

* auf Bestellung

WC-Garnituren und WC-Besen



WC-Besen mit Randreiniger

weiss, 7,5 cm

Artikel-Nr.	Produktinfo	Inhalt /VE	Preis /VE	ab 5 VE 10%
4315	3er-Pack	3	12.60	11.35



Haug WC-Besen mit Randreiniger

schwarz, 7,5 cm

Artikel-Nr.	Inhalt /VE	Preis /VE	ab 5 VE 10%
4317	1	4.90	netto



WC-Besen mit Doppelrandreiniger

blau / weiss

Artikel-Nr.	Inhalt /VE	Preis /VE	ab 5 VE 10%
14053	1	4.40	4.00



WC-Besen mit Randreiniger

weiss, Polypropylen

Artikel-Nr.	Inhalt /VE	Preis /VE	ab 5 VE 10%
9699	1	2.45	netto



WC-Besen mit Randreiniger

weiss, 7,5 cm

Artikel-Nr.	Inhalt /VE	Preis /VE	ab 5 VE 10%
16090	(Pal. 1536) 1	3.05	2.75



WC Bürste Flex mit Randreiniger

weiss, 8 cm

Artikel-Nr.	Inhalt /VE	Preis /VE	ab 5 VE 10%
26564	4	15.50	netto

Hygienebeutel | Plastik



Starline Hygienebeutel Starline

weiss / gold, Kunststoff

Artikel-Nr.	Produktinfo	Inhalt /VE	Preis /VE	ab 5 VE 10%
6049	18.5 x 32 cm, Abreissblock à 50 Beutel	(Pal. 250) 1000	28.90	26.05



Starline Hygienebeutel Starline

weiss, Kunststoff

Artikel-Nr.	Produktinfo	Inhalt /VE	Preis /VE	ab 5 VE 10%
6041	11 x 13 cm, Box à 50 Beutel	100	402.65	362.40



Hygienebeutel in Austauschboxen «Le Prestige»

weiss

Artikel-Nr.	Produktinfo	Inhalt /VE	Preis /VE	ab 5 VE 10%
6045	8.8 x 12.8 cm, Box à 30 Beutel	(Pal. 72) 50	98.05	88.25

Hygienebeutel | Plastik



Hygienebeutel

rosa, HD-PE

Artikel-Nr.	Produktinfo	Inhalt /VE	Preis /VE	ab 5 VE 10%
7729	19 x 33 cm + 25 mm, geblockt	(Pal. 121) 2000	53.90	48.50



Hygienebeutel für Wallbox

blau

Artikel-Nr.	Produktinfo	Inhalt /VE	Preis /VE	
19060	19 / 12 x 38 cm, 0.015 mm, Rolle à 50 Beutel	(Pal. 294) 5	21.10	netto

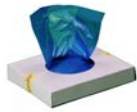

Hygienebeutel zu Hygobag

blau

Artikel-Nr.	Produktinfo	Inhalt /VE	Preis /VE	
13462	Box à 25 Beutel, für Spender Art. 16638 / 22137	(Pal. 180) 500	39.60	netto



Hygienebeutel

PE

Artikel-Nr.	Produktinfo	Inhalt /VE	Preis /VE	ab 5 VE 10%
25402	für Spender Art. 25405	20	96.50	86.85



Hygienebeutel Tork - B5 System

weiss

Artikel-Nr.	Produktinfo	Inhalt /VE	Preis /VE	ab 5 VE 10%
12105	12.7 x 8.7 x 1.5 cm, 25 Beutel	(Pal. 108) 48	119.45	107.50

Hygienebeutel | Papier



Hygienebeutel Starline

weiss / gold, Papier

Artikel-Nr.	Produktinfo	Inhalt /VE	Preis /VE	ab 5 VE 10%
7857	17 x 27.5 cm	(Pal. 100) 1000	56.40	50.75



Hygienebeutel Bulkysoft

weiss, Papier

Artikel-Nr.	Produktinfo	Inhalt /VE	Preis /VE	ab 5 VE 10%
26312	4.5 x 28 + 12 cm, für Spender Art. 26276	(Pal. 300) 1000	27.55	24.80

Hygienebeutel | Spender + Entsorgung



Hygienebeutelspender

weiss

Artikel-Nr.	Produktinfo	Inhalt /VE	Preis /VE	
6047	für Art. 6041	2	13.60	netto



Hygienebeutelspender «Le Prestige»

10 x 14 x 2.7 cm, mit Klebeband, für Art. 6045

Artikel-Nr.	Produktinfo	Inhalt /VE	Preis /VE	
7846	weiss	(Pal. 1000) 1	12.45	netto
7847	chrom	(Pal. 1000) 1	15.15	netto

Hygienebeutel | Spender + Entsorgung



Hygienebeutelspender

Draht, plastifiziert

Artikel-Nr.	Produktinfo	Inhalt /VE	Preis /VE	
6055	weiss, für Art. 7857	1	9.95	netto



Hygobag Whiteline Hygienebeutelspender

12 x 18.5 x 28 cm, Kunststoff

Artikel-Nr.	Produktinfo	Inhalt /VE	Preis /VE	
22137	weiss, für Beutel Art. 13462	1	19.90	netto



Hygobag Hygienebeutelspender Chromeline

12 x 16.7 x 26 cm, Chrom

Artikel-Nr.	Produktinfo	Inhalt /VE	Preis /VE	
16638*	für Beutel Art. 13462	1	102.20	netto



Wallbox All-In-One für Damenhygiene

21 x 28.5 x 10.5 cm

Artikel-Nr.	Produktinfo	Inhalt /VE	Preis /VE	
23098	weiss	1	170.40	netto



Wallbox All-In-One für Damenhygiene

20.5 x 28.5 x 10 cm, Chromnickelstahl

Artikel-Nr.		Inhalt /VE	Preis /VE	
23084*		1	222.00	netto



Wallbox Chromeline für Damenhygiene

21 x 2.85 x 10.5 cm, Chromnickelstahl

Artikel-Nr.		Inhalt /VE	Preis /VE	
19441*		1	191.00	netto



Wallbox Whiteline Wandabfallbehälter Zincor

20.5 x 28.5 x 10 cm

Artikel-Nr.	Produktinfo	Inhalt /VE	Preis /VE	
22136	weiss	1	139.40	netto



hagleitner XIBU sanitaryBAG Hygienebeutelspender

10.9 x 13.7 x 6.6 cm, Einhandbedienung, auch in schwarz erhältlich

Artikel-Nr.	Produktinfo	Inhalt /VE	Preis /VE	ab 5 VE 10%
25405	weiss, für Art. 25402	1	15.90	14.30



BulkySoft Hygienebeutelspender Bulkysoft

28.5 x 4.5 x 13.5 cm, ABS Kunststoff

Artikel-Nr.	Produktinfo	Inhalt /VE	Preis /VE	
26276	weiss, für Beutel Art. 26312	(Pal. 600) 1	15.15	netto



TORK Tork Hygienebeutelspender - B5 System

weiss, 13.5 x 9.5 x 3.2 cm

Artikel-Nr.		Inhalt /VE	Preis /VE	ab 5 VE 10%
12093		(Pal. 3456) 1	10.40	9.40

Hygienebeutel | Spender + Entsorgung



TORK Tork Hygienebeutelspender - B5 System

schwarz, 13.5 x 9.5 x 3.2 cm

Artikel-Nr.	Inhalt /VE	Preis /VE	ab 5 VE 10%
22680	(Pal. 1768) 1	10.40	9.40

Sitzreiniger



hagleitner XIBU wcDESINFECT Desinfektion für WC-Sitze

300 ml, Desinfektionsmittel ohne Alkohol, trocknet rasch, gibt keine Hautreizungen oder Rückstände

Artikel-Nr.	Produktinfo	Inhalt /VE	Preis /VE	ab 5 VE 10%
25411	für Spender Art. 25537 / 25535	6	81.30	73.15



hagleitner XIBU touchSEAT-CLEANER WC-Sitzreiniger manuell

weiss, 250 x 128 x 107 mm, Desinfektion, einstellbare Abgabemenge

Artikel-Nr.	Produktinfo	Inhalt /VE	Preis /VE	ab 5 VE 10%
25535	in 7 Farben erhältlich, für Art. 25411	(Pal. 90) 1	53.80	48.45



hagleitner XIBU senseSEAT-CLEANER WC-Sitzreiniger Sensor

weiss, 230 x 128 x 107 mm, Desinfektion, einstellbare Abgabemenge, berührungslos

Artikel-Nr.	Produktinfo	Inhalt /VE	Preis /VE	ab 5 VE 10%
25537	in 7 Farben erhältlich, Batterien Art. 27098, für Art. 25411	(Pal. 90) 1	192.45	173.20

Nachfüllbeutel für WC-Sitzreiniger

400 ml, ca. 2000 Dosierungen



Artikel-Nr.	Produktinfo	Inhalt /VE	Preis /VE	ab 5 VE 10%
6010	für Spender Art. 6009	(Pal. 150) 12	181.70	163.55

Spender für WC-Sitzreiniger

weiss / blau



Artikel-Nr.	Produktinfo	Inhalt /VE	Preis /VE	ab 5 VE 10%
6009	für Art. 6010	(Pal. 432) 1	39.10	netto

TORK WC-Sitzreiniger Tork Premium - S2 System

475 ml, transparent, für 600 Reinigungen



Artikel-Nr.	Produktinfo	Inhalt /VE	Preis /VE	ab 5 VE 10%
16050	dermatologisch getestet, für Spender Art. 7171 / 7173	(Pal. 96) 8	86.20	77.55

TORK Tork Mini Spender für Flüssigseifen - S2 System

weiss, Kunststoff, H: 206 B: 112 T: 114 mm



Artikel-Nr.	Produktinfo	Inhalt /VE	Preis /VE	ab 5 VE 10%
7171	mit Sichtfenster, abschliessbar	(Pal. 432) 1	57.70	netto

Erhältlich mit Leihspendervertrag (es können Servicegebühren anfallen)

TORK Tork Elevation Spender für Flüssigseifen - S2 System

schwarz, Kunststoff, H: 206 B: 112 T: 114 mm



Artikel-Nr.	Produktinfo	Inhalt /VE	Preis /VE	ab 5 VE 10%
7173	mit Sichtfenster, abschliessbar	(Pal. 432) 1	57.70	netto

Erhältlich mit Leihspendervertrag (es können Servicegebühren anfallen)

Sitzreiniger



Scott WC-Sitzreiniger Kimberly-Clark

400 ml, transparent

Artikel-Nr.	Produktinfo	Inhalt /VE	Preis /VE	ab 5 VE 10%
22240	für Spender Art. 22241	(Pal. 128) 6	46.40	41.75



Spender für WC-Sitzreiniger Kimberly-Clark

weiss, Kunststoff, H: 200 B: 90 T: 100 mm

Artikel-Nr.	Produktinfo	Inhalt /VE	Preis /VE	ab 5 VE 10%
22241	für WC-Sitzreiniger Art. 22240	(Pal. 456) 1	26.20	23.55

Kostenlos erhältlich mit Spenderleihvertrag (ab 10 Kimberly Clark-Spender)



Katrin Toilet Seat Sanitizer

500 ml, Reinigungsschaum



Artikel-Nr.	Produktinfo	Inhalt /VE	Preis /VE	ab 5 VE 10%
28425	für Spender Art. 28390 / 28391	(Pal. 70) 12	148.45	133.60



Katrin Inclusive Spender

weiss, H: 204 B: 100 T: 125 mm, 500 ml

Artikel-Nr.	Produktinfo	Inhalt /VE	Preis /VE	ab 5 VE 10%
28390	für Art. 28424 / 28421 / 28422 / 28425	(Pal. 315) 1	36.65	netto

Kostenlos erhältlich mit Leihspendervertrag



Katrin Inclusive Spender

schwarz, H: 204 B: 100 T: 125 mm, 500 ml

Artikel-Nr.	Produktinfo	Inhalt /VE	Preis /VE	ab 5 VE 10%
28391	für Art. 28424 / 28421 / 28422 / 28425	(Pal. 315) 1	36.65	netto

Kostenlos erhältlich mit Leihspendervertrag

Diverse Toilettenartikel



Toilettenstreifen «Dieser Sitz wurde gereinigt und desinfiziert»

7 x 61 cm, mit 4-sprachigem Text

Artikel-Nr.	Inhalt /VE	Preis /VE	ab 5 VE 10%
5998	1000	56.60	50.95



Pissoir-Sieb

Metall, oval, TYP 0

Artikel-Nr.	Inhalt /VE	Preis /VE	ab 5 VE 10%
4222	1	33.75	30.40



Pissoir-Sieb

Metallwelle

Artikel-Nr.	Inhalt /VE	Preis /VE	ab 5 VE 10%
4223	1	33.75	30.40



Pissoirsteine lose im Eimer

orange, 40 Stück, 2.5 kg

Artikel-Nr.	Inhalt /VE	Preis /VE	ab 5 VE 10%
4224	40	153.80	138.40

Diverse Toilettenartikel



WC-Duftspüler Citro

lemon

Artikel-Nr.	Inhalt /VE	Preis /VE	
27463	4	11.45	netto



whiteMARINES Pissoirsteine

0.7 kg, Reinigung und Beduftung von Pissoirs, verhindert die Entstehung von Kalkansätzen, erzeugt einen blumigen Frischduft

Artikel-Nr.	Inhalt /VE	Preis /VE	ab 5 VE 10%
25424	(Pal. 48) 6	236.80	213.10



Urinalsieb FrePro Wave

blau, mit Duft

Artikel-Nr.	Inhalt /VE	Preis /VE	
25147	1	9.50	netto



Urinalsieb V-Screen

178 x 178 mm

Artikel-Nr.	Produktinfo	Inhalt /VE	Preis /VE	ab 5 VE 10%
24799	Apple Orchard	12	30.65	27.60
24800	Citrus / Mango	12	30.65	27.60
24801	Cool Mint	12	30.65	27.60
24802	Gurke / Melone	12	30.65	27.60
24803	Ocean Spray	12	30.65	27.60



Nu-Bio Block Biotechnologischer Urinalstein

zur Beseitigung schlechter Gerüche und Ablagerungen in Pissoirs und Abwasserrohren



Artikel-Nr.	Inhalt /VE	Preis /VE	
9635	1	39.90	netto



Plakathalter

mit 4 Klebenocken

Artikel-Nr.	Produktinfo	Inhalt /VE	Preis /VE	
14940	A4	1	21.00	netto
14842	A5	1	13.85	netto



Tork Elevation Abfallbehälter für Damenhygiene - B3 System

Kunststoff, 5 Liter, H: 380 B: 190 T: 160 mm

Artikel-Nr.	Produktinfo	Inhalt /VE	Preis /VE	
17505	weiss	(Pal. 140) 1	55.35	netto
17506	schwarz	(Pal. 140) 1	55.35	netto



Abfallsack Tork - B3 System

5 Liter, schwarz, 0.025 mm

Artikel-Nr.	Produktinfo	Inhalt /VE	Preis /VE	ab 5 VE 10%
17590	40 x 33 cm, Rolle à 50 Säcke, für Art. 17505 / 17506	(Pal. 64) 20	83.15	74.85



Abfallsack Tork - B3 System

5 Liter, grau, mit Tork-Logo

Artikel-Nr.	Produktinfo	Inhalt /VE	Preis /VE	ab 5 VE 10%
17591	37 x 25 cm, 50 Säcke mit Zugband, für Art. 17505 / 17506	(Pal. 540) 50	37.80	34.05

Diverse Toilettenartikel



hagleitner XIBU careMOUSSE Mousse zum befeuchten des WC-Papiers

300 ml, mit Aloe Vera, geeignet für eine gute Intimhygiene

Artikel-Nr.	Produktinfo	Inhalt /VE	Preis /VE	ab 5 VE 10%
26727	für Spender Art. 26726	6	49.50	44.55



hagleitner XIBU senseMOISTCARE Schaumspender für feuchtes WC-Papier

weiss, 230 x 128 x 107 mm, einstellbare Abgabemenge, berührungslos

Artikel-Nr.	Produktinfo	Inhalt /VE	Preis /VE	ab 5 VE 10%
26726	in 7 Farben erhältlich, Batterien Art. 27098, für Art. 26727	1	130.40	117.35



hyShell Türmuschel

weiss, PP Copolymer

Artikel-Nr.	Produktinfo	Inhalt /VE	Preis /VE	
27184	170 x 170 x 123 mm	1	159.00	netto



Wickeltisch Babyminder vertikal

H: 899 B: 560 T: 117 / 903 mm

Artikel-Nr.	Produktinfo	Inhalt /VE	Preis /VE	
24807	weiss, LD-PE	(Pal. 22) 1	325.95	netto



Wickeltisch Babyminder horizontal

H: 510 B: 872 T: 102 / 513 mm

Artikel-Nr.	Produktinfo	Inhalt /VE	Preis /VE	
24808	weiss, LD-PE	(Pal. 24) 1	254.20	netto



BulkySoft Toilettensitzauflagen Bulkysoft

weiss, Papier

Artikel-Nr.	Produktinfo	Inhalt /VE	Preis /VE	ab 5 VE 10%
26313	Box à 200 Beutel, für Spender Art. 26277	(Pal. 300) 2000	73.45	66.10



BulkySoft Toilettensitzauflagen-Spender Bulkysoft

weiss, ABS Kunststoff, H: 285 B: 210 T: 60 mm

Artikel-Nr.	Produktinfo	Inhalt /VE	Preis /VE	
26277	für Art. 26313	(Pal. 500) 1	27.45	netto

Luftfrischer | Systeme

Kimberly Clark



Kimberly-Clark PROFESSIONAL Spender für Luftfrischer Kimberly-Clark Aquarius

weiss, Kunststoff, H: 212 B: 125 T: 87 mm

Artikel-Nr.	Produktinfo	Inhalt /VE	Preis /VE	ab 5 VE 10%
22763	für Art. 22757 / 22758 / 22759 / 22760 / 22761 / 22762	(Pal. 305) 1	109.65	98.70

Ab 10 Kimberly Clark-Spender mit Spenderleihvertrag erhältlich (Servicegebühr: CHF 20.00 / Stk.)

Luftfrischer | Systeme

Kimberly Clark



Luftfrischer Kimberly-Clark

300 ml, für Spender Art. 22763

Artikel-Nr.	Produktinfo	Inhalt /VE	Preis /VE	ab 5 VE 10%
22757	Harmony	(Pal. 160) 6	136.55	122.90
22758	Energy	(Pal. 160) 6	136.55	122.90
22759	Joy	(Pal. 160) 6	136.55	122.90
22760	Fresh	(Pal. 160) 6	136.55	122.90
22761	Zen	(Pal. 160) 6	136.55	122.90



Luftfrischer Kimberly-Clark

300 ml, Mix

Artikel-Nr.	Produktinfo	Inhalt /VE	Preis /VE	ab 5 VE 10%
22762	für Spender Art. 22763	(Pal. 160) 5	124.80	112.35

Tork



Tork Airfresh Spender für Luftfrischer - A1 System

weiss, H: 170 B: 85 T: 67 mm

Artikel-Nr.	Produktinfo	Inhalt /VE	Preis /VE	
7152	ohne Batterien, automatisches Luftfrischungs- und Geruchskontrollsystem	(Pal. 810) 1	155.10	netto

Erhältlich mit Leihspendervertrag (es können Servicegebühren anfallen)



Tork Airfresh Spender für Luftfrischer - A1 System

grau, H: 168 B: 84 T: 66 mm

Artikel-Nr.	Produktinfo	Inhalt /VE	Preis /VE	
23774	ohne Batterien, automatisches Luftfrischungs- und Geruchskontrollsystem	1	155.10	netto

Erhältlich mit Leihspendervertrag (es können Servicegebühren anfallen)



Tork Premium Duftpatrone für Luftfrischer - A1 System

Patrone à 75 ml, zu Art. 7152

Artikel-Nr.	Produktinfo	Inhalt /VE	Preis /VE	ab 5 VE 10%
7147	Mix Pack: 4x Citrus / Frucht / Floral	(Pal. 240) 12	208.70	187.85
7142	Citrus	(Pal. 240) 12	208.70	187.85
7143	Frucht	(Pal. 240) 12	208.70	187.85
7144	Floral	(Pal. 240) 12	208.70	187.85



Tork Halter für Luftfrischer - A2 System

weiss, Kunststoff, H: 70 B: 80 T: 20 mm

Artikel-Nr.	Inhalt /VE	Preis /VE	
17785	(Pal. 380) 4	12.10	netto



Tork Universal Luftfrischer Anhänger - A2 System

20 Anhänger

Artikel-Nr.	Produktinfo	Inhalt /VE	Preis /VE	ab 5 VE 10%
12837	Zitrus	(Pal. 135) 4	270.40	243.40
12838	Apfel	(Pal. 135) 4	270.40	243.40
17757*	Floral	(Pal. 135) 4	270.40	243.40

* auf Bestellung



24912



24928
26086



24933



24930



HAGLEITNER
senseMANAGEMENT

Ihr Waschraum
wird digital. (Zusatzoption)

Füllstände, Abgabemengen und Besucherzahlen
sind überall abrufbar – dank WLAN und
Daten-Cloud.



intelligent **b**alanced **u**nique

Das intelligente
Spendersystem

Passend für
jeden Waschraum.

- Schönes Design
- Wirtschaftlich und sparsam
- Niemals leer
- Einfache Bedienung
- Österreichisches Qualitätsprodukt
- In sieben Dekoren erhältlich

Luftfrischer | Systeme

Bulkysoft



Spender für Luftfrischer Bulkysoft

weiss, H: 175 B: 85 T: 64 mm

Artikel-Nr.	Produktinfo	Inhalt /VE	Preis /VE	
26274	für Art. 26314 / 26315 / 26316 / 26317 / 26318	(Pal. 500) 1	61.00	netto



Luftfrischer Bulkysoft

100 ml, passender Spender: Art. 26274

Artikel-Nr.	Produktinfo	Inhalt /VE	Preis /VE	ab 5 VE 10%
26318	gemischte Düfte	(Pal. 500) 12	98.80	88.90
26314	Blumenduft	(Pal. 500) 12	98.80	88.90
26315	Citrusduft	(Pal. 500) 12	98.80	88.90
26316	Apfelduft	(Pal. 500) 12	98.80	88.90
26317	exotische Früchte	(Pal. 500) 12	98.80	88.90

Hagleitner



Luftfrischer MAGICUS

für einen gleichmässigen und anregenden Raumduft

Artikel-Nr.	Produktinfo	Inhalt /VE	Preis /VE	
28441*	hellblau / weiss, 890 x 270 x 270 mm	(Pal. 12) 1	1'014.75	netto



Luftfrischer MAGICUS

2.5 Liter

Artikel-Nr.	Produktinfo	Inhalt /VE	Preis /VE	
28443*	greenTEA - Erfrischender Duft nach grünem Tee	1	204.00	netto
28444*	whiteMUSK - Warmer Duft nach Moschus	1	204.00	netto



XIBU senseFRESHAIR Spender für Luftfrischer Freshair für 300 ml

Flaschen

weiss, 219 x 135 x 92 mm, individuell programmierbar, Parfumabgabe mit Zeitintervall und / oder Bewegungsmelder

Artikel-Nr.	Produktinfo	Inhalt /VE	Preis /VE	ab 5 VE 10%
24933	in 7 Farben erhältlich, Batterien Art. 24919, für Art. 24995 / 24956 / 24969 / 24952 / 24994 / 24947 / 24942 / 27219 / 27218 / 24955	(Pal. 12) 1	158.35	142.50



XIBU airFRESH green

aufregender Duft nach Frühling

Artikel-Nr.	Produktinfo	Inhalt /VE	Preis /VE	ab 5 VE 10%
24969	300 ml, für Spender Art. 24933	8	123.50	111.15



XIBU airFRESH yellow

lebendiger Duft nach Sommer mit fruchtigem Geschmack

Artikel-Nr.	Produktinfo	Inhalt /VE	Preis /VE	ab 5 VE 10%
24994	300 ml, für Spender Art. 24933	8	123.50	111.15



XIBU airFRESH red

beruhigender Duft nach Herbst-Ernte mit reifen Früchten

Artikel-Nr.	Produktinfo	Inhalt /VE	Preis /VE	ab 5 VE 10%
24955	300 ml, für Spender Art. 24933	8	123.50	111.15

* auf Bestellung

Lufterfrischer | Systeme

Hagleitner



XIBU airFRESH blue

erfrischender Duft nach Winter

Artikel-Nr.	Produktinfo	Inhalt /VE	Preis /VE	ab 5 VE 10%
24995	300 ml, für Spender Art. 24933	8	123.50	111.15



XIBU airFRESH spice

frischer und entspannender Duft nach Kräutergarten

Artikel-Nr.	Produktinfo	Inhalt /VE	Preis /VE	ab 5 VE 10%
24952	300 ml, für Spender Art. 24933	8	133.05	119.75



XIBU airFRESH fireside

warme Komposition aus Orangen und Zimt

Artikel-Nr.	Produktinfo	Inhalt /VE	Preis /VE	ab 5 VE 10%
24956	300 ml, für Spender Art. 24933	8	133.05	119.75



XIBU airFRESH whiteMUSK

warmer, edler Duft nach Moschus; blumige, orientalische Note

Artikel-Nr.	Produktinfo	Inhalt /VE	Preis /VE	ab 5 VE 10%
27219	300 ml, für Spender Art. 24933	8	123.50	111.15



XIBU airFRESH greenTEA

frischer, blumiger Duft für ein Gefühl von Ordnung und Sicherheit

Artikel-Nr.	Produktinfo	Inhalt /VE	Preis /VE	ab 5 VE 10%
27218	300 ml, für Spender Art. 24933	8	123.50	111.15



XIBU airFRESH 4 Jahreszeiten

Mix Pack aus Frühling, Sommer Herbst und Winter

Artikel-Nr.	Produktinfo	Inhalt /VE	Preis /VE	ab 5 VE 10%
24942	300 ml, für Spender Art. 24933	8	128.85	115.95



XIBU airFRESH Wellness

Mix Pack aus Spice, GreenTea, WhiteMusk und Fireside

Artikel-Nr.	Produktinfo	Inhalt /VE	Preis /VE	ab 5 VE 10%
24947	300 ml, für Spender Art. 24933	8	142.60	128.30

Basic



BASIC Spender für Lufterfrischer

weiss

Artikel-Nr.	Produktinfo	Inhalt /VE	Preis /VE	ab 5 VE 10%
7044	280 x 100 x 85 mm	1	99.85	netto

Luftfrischer | Systeme

Basic



Luftfrischer

400 ml, für Art. 7044

Artikel-Nr.	Produktinfo	Inhalt /VE	Preis /VE	
7070	Hermano	12	246.00	netto
7071	Note Verte	12	246.00	netto
7072	Essentielle	6	123.00	netto
7073	Carissima	12	246.00	netto
24398	Luxor	12	246.00	netto
24399	Nocturne	12	246.00	netto

Good Sense (Diversey)



Good Sense Spender für Luftfrischer

kompaktes und einfach nachzufüllendes Gerät mit einstellbarem Sprühintervall

Artikel-Nr.	Produktinfo	Inhalt /VE	Preis /VE	
11694	ohne Luftfrischerpatrone, inkl. 2 AA/LR6 Batterien	(Pal. 240) 1	70.40	netto



Good Sense Refill Summer Festival

Sommer-Luftfrischerpatronen mit O.N.T.

Artikel-Nr.	Produktinfo	Inhalt /VE	Preis /VE	
11454	20 ml	(Pal. 737) 12	101.80	netto



Good Sense Refill Vert

Apfel-Luftfrischerpatronen mit O.N.T.

Artikel-Nr.	Produktinfo	Inhalt /VE	Preis /VE	
11695	20 ml	(Pal. 737) 12	101.80	netto



Good Sense Refill Magnolia & Mimosa

Blüten-Luftfrischerpatronen mit O.N.T.

Artikel-Nr.	Produktinfo	Inhalt /VE	Preis /VE	
11696	20 ml	(Pal. 737) 12	101.80	netto

Rubbermaid



Aerosol Spender für Luftfrischer LED Standard

weiss

Artikel-Nr.	Produktinfo	Inhalt /VE	Preis /VE	
28553*	für Art. 28541 / 19488 / 16272 / 16274 / 28539 / 19489 / 25157 / 19487 / 16273 / 28540	1	99.90	netto

* auf Bestellung

Lufterfrischer | Systeme

Rubbermaid



Lufterfrischer Aerosol

243 ml, für Art. 28553

Artikel-Nr.	Produktinfo	Inhalt /VE	Preis /VE	Preis ab 2 VE
28541*	Island Cocktail	12	214.80	193.30
19488*	Impressions	12	214.80	193.30
16272*	Anticipation	12	214.80	193.30
16274*	Expressions	12	214.80	193.30
28539*	Inspirations	12	214.80	193.30
19489*	Sensations	12	214.80	193.30
25157*	Odour Neutraliser	12	214.80	193.30
19487*	Radiant Sense	12	214.80	193.30
16273*	Vibrant Sense	12	214.80	193.30
28540*	Clean Sense	12	214.80	193.30

My Senso



My Senso Raumduft

100 ml, mit Rattanstäbchen

Artikel-Nr.	Produktinfo	Inhalt /VE	Preis /VE	
14963	Green Tea	6	116.85	netto
14962	Lemongrass	6	116.85	netto
23858	Musc Cassis	6	116.85	netto
23859	Orange	6	116.85	netto



My Senso Raumduft

240 ml, mit Rattanstäbchen

Artikel-Nr.	Produktinfo	Inhalt /VE	Preis /VE	
23854	Musc Cassis	6	196.80	netto
23855	Lemongrass	6	196.80	netto
23856	Green Tea	6	196.80	netto
23857	Orange	6	196.80	netto



My Senso Raumduft

Nachfüllflasche à 240 ml

Artikel-Nr.	Produktinfo	Inhalt /VE	Preis /VE	
23860	Musc Cassis	6	110.70	netto
23861	Lemongrass	6	110.70	netto
23862	Green Tea	6	110.70	netto
23863	Orange	6	110.70	netto



My Senso Raumduft

Nachfüllflasche à 2000 ml

Artikel-Nr.	Produktinfo	Inhalt /VE	Preis /VE	
22127	Green Tea	1	157.85	netto
22128	Lemongrass	1	157.85	netto
23853	Musc Cassis	1	157.85	netto
23852	Orange	1	157.85	netto

bacteriaStop ad1 air



bacteriaStop ad1 air Wandspender für Lufterfrischer

mechanisch, einfach zu bedienen, hygienisch

Artikel-Nr.	Produktinfo	Inhalt /VE	Preis /VE	
25335	für Art. 25336 / 25337	1	19.90	netto

Luftfrischer | Systeme

bacteriaStop ad1 air



bacteriaStop ad1 air Luftfrischer Strips

15 Streifen, für den Einsatz in Sanitärräumen, Fluren, Büros etc.

Artikel-Nr.	Produktinfo	Inhalt /VE	Preis /VE	
25336	Oriental Flower	15	35.00	netto
25337	Pacific Blue	15	35.00	netto

GreenAir



Spender für Luftfrischer GreenAir

weiss, 138 x 60 x 60 mm

Artikel-Nr.	Produktinfo	Inhalt /VE	Preis /VE	ab 5 VE 10%
27043	ohne Batterien	1	9.55	8.60



Kartusche für GreenAir Luftfrischer

104 x 54 mm

Artikel-Nr.	Produktinfo	Inhalt /VE	Preis /VE	ab 5 VE 10%
27045	Apple Orchard	6	59.35	53.40
27046	Citrus / Mango	6	59.35	53.40
27047	Gurke / Melone	6	59.35	53.40
27048	Cool Mint	6	59.35	53.40
27049	Ocean Spray	6	59.35	53.40

Luftfrischer | Diverses



Luftfrischer V-Fresh

100 x 77 mm

Artikel-Nr.	Produktinfo	Inhalt /VE	Preis /VE	
26608	Apple Orchard	12	38.75	netto
26609	Cool Mint	12	38.75	netto
26610	Gurke / Melone	12	38.75	netto
26611	Ocean Spray	12	38.75	netto
26612	Citrus / Mango	12	38.75	netto



Fresh Wave IAQ Luftfrischer Spray

eliminiert Gerüche ohne Duftstoffe oder Chemikalien

Artikel-Nr.	Produktinfo	Inhalt /VE	Preis /VE	
21915	100 ml Spray	(Pal. 2268) 1	6.40	netto
23663	250 ml Spray	(Pal. 1050) 1	10.70	netto
23528	5 Liter Refill	(Pal. 72) 1	95.90	netto



Fresh Wave IAQ Luftfrischer Gel

eliminiert Gerüche ohne Duftstoffe oder Chemikalien

Artikel-Nr.	Produktinfo	Inhalt /VE	Preis /VE	
21916	250 g Gel	(Pal. 1536) 1	9.50	netto
22569	10 kg Gel	(Pal. 24) 1	163.50	netto



Airclean Luftfrischer

200 ml, Luftfrischer mit Sprühkopf. Beseitigt unangenehme Gerüche.

Artikel-Nr.	Produktinfo	Inhalt /VE	Preis /VE	
17557	Citro	8	56.80	netto
22118	Fleur	8	56.80	netto

Luftfrischer | Diverses



Luftfrischer-Spraydose

300 ml

Artikel-Nr.	Produktinfo	Inhalt /VE	Preis /VE	ab 5 VE 10%
10887	Lavendelduft	1	3.75	3.35
10884.1	Sea Breeze	1	3.75	3.35



Stromboli Luftfrischer

500 ml

Artikel-Nr.	Produktinfo	Inhalt /VE	Preis /VE	
13492	Verveine Eucalyptus	12	218.65	netto
14557*	Zimt / Orange	12	218.65	netto



WC-Luftfrischer Fenjal

500 ml Spritzflasche

Artikel-Nr.	Inhalt /VE	Preis /VE	
7033	1	11.35	netto



WC-Luftfrischer Fenjal

5 Liter Nachfüllbidon

Artikel-Nr.	Inhalt /VE	Preis /VE	
7032	1	79.55	netto



Luftfrischer-Flasche

52 g

Artikel-Nr.	Produktinfo	Inhalt /VE	Preis /VE	
7039	zum Aufstellen	10	104.10	netto



Luftfrischer Automat Airokit

50 x 100 mm

Artikel-Nr.	Inhalt /VE	Preis /VE	
7022	1	19.15	netto



Luftfrischer Ersatzplatten

für Art. 7022

Artikel-Nr.	Produktinfo	Inhalt /VE	Preis /VE	ab 5 VE 10%
7023	Lemon	1	6.65	6.00
7024	Grapefruit	1	6.65	6.00



Luftfrischer Aria di Casa

140 g

Artikel-Nr.	Produktinfo	Inhalt /VE	Preis /VE	ab 5 VE 10%
10895	Classico	2	4.30	3.90
10893	Lavendelduft	2	4.30	3.90

Entsorgung



Kehrichtsäcke	224
Containersäcke	230
Papiersäcke	231
Eimereinlagen / Einlagebeutel	231
Abfallkörbe	234
Diverses	240

Kehrriechsäcke | Normal

mit Verschlussband



Kehrriechsäcke

35 Liter, HD/LLDPE, schwarz, mit Verschlussband

Artikel-Nr.	Produktinfo	Inhalt /VE	Preis /VE	Preis ab 6 VE
7688	280 / 275 x 700 mm, 0.023 mm, Rolle à 20 Säcke	(Pal. 70) 25	60.55	57.50



Kehrriechsäcke

60 Liter, HD/LLD-PE, schwarz, mit Verschlussband

Artikel-Nr.	Produktinfo	Inhalt /VE	Preis /VE	Preis ab 6 VE
7689	280 / 270 x 960 mm, 0.024 mm, Rolle à 10 Säcke	(Pal. 70) 30	61.45	58.35



Kehrriechsäcke

110 Liter, HD/LLD-PE, schwarz, mit Verschlussband

Artikel-Nr.	Produktinfo	Inhalt /VE	Preis /VE	Preis ab 6 VE
7690	355 / 345 x 1100 mm, 0.026 mm, Rolle à 10 Säcke	(Pal. 77) 20	49.65	47.15



Kehrriechsäcke Profitbag Solo

35 Liter, HD-PE, schwarz, mit Verschlussband

Artikel-Nr.	Produktinfo	Inhalt /VE	Preis /VE	Preis ab 6 VE
23799	279 / 276 x 700 mm, 0.02 mm, Rolle à 20 Säcke	(Pal. 72) 20	48.45	46.00



Kehrriechsäcke Profitbag Solo

60 Liter, HD-PE, schwarz, mit Verschlussband

Artikel-Nr.	Produktinfo	Inhalt /VE	Preis /VE	Preis ab 6 VE
23820	279 / 276 x 920 mm, 0.022 mm, Rolle à 10 Säcke	(Pal. 90) 20	49.15	46.65



Kehrriechsäcke Profitbag Solo

110 Liter, HD-PE, schwarz, mit Verschlussband

Artikel-Nr.	Produktinfo	Inhalt /VE	Preis /VE	Preis ab 6 VE
23821	355 / 345 x 1100 mm, 0.024 mm, Rolle à 10 Säcke	(Pal. 77) 20	49.65	47.15



Kehrriechsäcke BUDGET

35 Liter, LD-PE, schwarz, mit Verschlussband

Artikel-Nr.	Produktinfo	Inhalt /VE	Preis /VE	Preis ab 6 VE
23275	280 / 275 x 700 mm, 0.034 mm, Rolle à 20 Säcke	(Pal. 56) 20	43.60	41.40



Kehrriechsäcke BUDGET

60 Liter, LD-PE, schwarz, mit Verschlussband

Artikel-Nr.	Produktinfo	Inhalt /VE	Preis /VE	Preis ab 6 VE
23276	280 / 270 x 960 mm, 0.034 mm, Rolle à 10 Säcke	(Pal. 56) 30	55.30	52.50



Kehrriechsäcke BUDGET

110 Liter, LD-PE, schwarz, mit Verschlussband

Artikel-Nr.	Produktinfo	Inhalt /VE	Preis /VE	Preis ab 6 VE
23277	355 / 345 x 1100 mm, 0.038 mm, Rolle à 10 Säcke	(Pal. 48) 25	55.85	53.05

Kehrichtsäcke | Normal

mit Verschlussband



Kehrichtsäcke

75 Liter, LD-PE, schwarz, mit Verschlussband

Artikel-Nr.	Produktinfo	Inhalt /VE	Preis /VE	ab 5 VE 10%
10708	300 / 280 x 980 mm, 0.04 mm, Rolle à 10 Säcke	(Pal. 48) 20	86.05	77.45



Kehrichtsäcke

110 Liter, LD-PE, transparent, mit Verschlussband

Artikel-Nr.	Produktinfo	Inhalt /VE	Preis /VE	Preis ab 6 VE
7675.1	350 / 350 x 1100 mm, 0.032 mm, Rolle à 10 Säcke	(Pal. 70) 20	70.70	67.15



Kehrichtsäcke

130 Liter, LD-PE, schwarz, mit Verschlussband

Artikel-Nr.	Produktinfo	Inhalt /VE	Preis /VE	ab 5 VE 10%
7611	400 / 400 x 1150 mm, 0.075 mm, Rolle à 10 Säcke	(Pal. 32) 10	105.35	94.85



Kehrichtsäcke

200 Liter, LD-PE, schwarz, mit Verschlussband

Artikel-Nr.	Produktinfo	Inhalt /VE	Preis /VE	ab 5 VE 10%
7770.1	510 / 440 x 1300 mm, 0.07 mm	(Pal. 48) 50	91.20	82.05



Kehrichtsäcke

200 Liter, LD-PE, opak grau, mit Verschlussband

Artikel-Nr.	Produktinfo	Inhalt /VE	Preis /VE	ab 5 VE 10%
7612	520 / 470 x 1200 mm, 0.075 mm	(Pal. 60) 50	92.80	83.50



Kehrichtsäcke

270 Liter, LD-PE, schwarz, mit Verschlussband

Artikel-Nr.	Produktinfo	Inhalt /VE	Preis /VE	ab 5 VE 10%
11904	650 / 550 x 1500 mm, 0.07 mm	(Pal. 36) 50	83.65	75.30



Kehrichtsäcke Ecofine

60 Liter, LD-PE, transparent, mit Verschlussband

Artikel-Nr.	Produktinfo	Inhalt /VE	Preis /VE	ab 5 VE 10%
23766	575 x 1000 mm, 0.025 mm, Rolle à 10 Säcke	(Pal. 56) 10	44.55	40.10



Kehrichtsäcke Ecofine

110 Liter, LD-PE, transparent, mit Verschlussband

Artikel-Nr.	Produktinfo	Inhalt /VE	Preis /VE	ab 5 VE 10%
23208	700 x 1100 mm, 0.025 mm, Rolle à 25 Säcke	(Pal. 40) 10	68.75	61.85



Kehrichtsäcke Premium

130 Liter, LD-PE, transparent, mit Verschlussband

Artikel-Nr.	Produktinfo	Inhalt /VE	Preis /VE	ab 5 VE 10%
23767	800 x 1000 mm, 0.05 mm, Rolle à 25 Säcke	(Pal. 24) 10	131.00	117.90

Kehrichtsäcke | Normal

mit Verschlussband



Kehrichtsäcke

110 Liter, LD-PE, schwarz, mit Verschlussband

Artikel-Nr.	Produktinfo	Inhalt /VE	Preis /VE	Preis ab 6 VE
26141	360 / 360 x 1100 mm, 0.04 mm, Rolle à 10 Säcke	(Pal. 45) 20	64.45	61.20

ohne Verschlussband



Kehrichtsäcke

120 Liter, HD-PE, 700 x 1100 mm, Rolle à 50 Säcke

Artikel-Nr.	Produktinfo	Inhalt /VE	Preis /VE	ab 5 VE 10%
12299	blau, 0.014 mm	(Pal. 40) 10	95.85	86.25
12301	transparent, 0.02 mm	(Pal. 48) 10	95.85	86.25
12302	grün, 0.016 mm	(Pal. 48) 10	95.85	86.25
12305	grau, 0.02 mm	(Pal. 42) 10	95.85	86.25



Kehrichtsäcke Premium

200 Liter, LD-PE, transparent

Artikel-Nr.	Produktinfo	Inhalt /VE	Preis /VE	ab 5 VE 10%
23768	700 / 250 x 1200 mm, 0.05 mm	(Pal. 24) 200	185.70	167.15



Kehrichtsäcke

120 Liter, HD-PE, blau

Artikel-Nr.	Produktinfo	Inhalt /VE	Preis /VE	Preis ab 6 VE
7772	700 x 1100 mm, 0.023 mm, Rolle à 50 Säcke	(Pal. 30) 10	111.20	105.55



Kehrichtsäcke Premium

140 Liter, LD-PE, blau

Artikel-Nr.	Produktinfo	Inhalt /VE	Preis /VE	ab 5 VE 10%
12119	600 / 260 x 1100 mm, 0.06 mm, Rolle à 25 Säcke	(Pal. 20) 10	135.85	122.30



Kehrichtsäcke

240 Liter, LD-PE, blau

Artikel-Nr.	Produktinfo	Inhalt /VE	Preis /VE	netto
12307	800 / 400 x 1200 mm, 0.05 mm	(Pal. 18) 200	135.60	netto



Kehrichtsäcke Premium

120 Liter, LD-PE, blau

Artikel-Nr.	Produktinfo	Inhalt /VE	Preis /VE	netto
8932	800 x 1000 mm, 0.04 mm, Rolle à 25 Säcke	(Pal. 30) 10	89.90	netto



Kehrichtsäcke

120 Liter, LD-PE, opak grau

Artikel-Nr.	Produktinfo	Inhalt /VE	Preis /VE	ab 5 VE 10%
7668	900 x 1200 mm, 0.07 mm	(Pal. 30) 100	159.85	143.85



Kehrichtsäcke

270 Liter, LD-PE, schwarz

Artikel-Nr.	Produktinfo	Inhalt /VE	Preis /VE	Preis ab 6 VE
7574	670 / 600 x 1500 mm, 0.07 mm	(Pal. 30) 50	148.25	140.75

Kehrriechtsäcke | Normal

Mit Zugband



Kehrriechtsäcke Quickbag

35 Liter, LD-PE, schwarz, mit Zugband

Artikel-Nr.	Produktinfo	Inhalt /VE	Preis /VE	Preis ab 6 VE
7718	60 / 580 x 600 mm, 0.035 mm, Rolle à 20 Säcke	(Pal. 42) 25	81.30	77.20



Kehrriechtsäcke Quickbag

60 Liter, LD-PE, schwarz, mit Zugband

Artikel-Nr.	Produktinfo	Inhalt /VE	Preis /VE	Preis ab 6 VE
7716	60 / 580 x 890 mm, 0.043 mm, Rolle à 10 Säcke	(Pal. 54) 25	73.65	70.00



Kehrriechtsäcke Quickbag

110 Liter, LD-PE, schwarz, mit Zugband

Artikel-Nr.	Produktinfo	Inhalt /VE	Preis /VE	Preis ab 6 VE
7714	60 / 700 x 1040 mm, 0.05 mm, Rolle à 10 Säcke	(Pal. 50) 15	57.70	54.75



Kehrriechtsäcke Quickbag Solo

35 Liter, LD-PE, schwarz, mit Zugband

Artikel-Nr.	Produktinfo	Inhalt /VE	Preis /VE	Preis ab 6 VE
27213	60 / 555 x 600 mm, 0.023 mm, Rolle à 20 Säcke	(Pal. 40) 20	63.10	59.95



Kehrriechtsäcke Quickbag Solo

60 Liter, LD-PE, schwarz, mit Zugband

Artikel-Nr.	Produktinfo	Inhalt /VE	Preis /VE	Preis ab 6 VE
27214	60 / 555 x 860 mm, 0.026 mm, Rolle à 10 Säcke	(Pal. 60) 20	57.10	54.30



Kehrriechtsäcke Quickbag Solo

110 Liter, LD-PE, schwarz, mit Zugband

Artikel-Nr.	Produktinfo	Inhalt /VE	Preis /VE	Preis ab 6 VE
27215	60 / 700 x 1030 mm, 0.03 mm, Rolle à 10 Säcke	(Pal. 40) 20	74.60	70.80



Kehrriechtsäcke Quickbag

35 Liter, LD-PE, Oeko-Light, schwarz, mit Zugband

Artikel-Nr.	Produktinfo	Inhalt /VE	Preis /VE	Preis ab 6 VE
23660	570 x 600 mm, 0.03 mm, Rolle à 20 Säcke	(Pal. 54) 25	73.15	69.50



Kehrriechtsäcke Quickbag

60 Liter, LD-PE, Oeko-Light, schwarz, mit Zugband

Artikel-Nr.	Produktinfo	Inhalt /VE	Preis /VE	Preis ab 6 VE
23661	570 x 860 mm, 0.03 mm, Rolle à 10 Säcke	(Pal. 54) 30	79.55	75.60



Kehrriechtsäcke Quickbag

110 Liter, LD-PE, Oeko-Light, schwarz, mit Zugband

Artikel-Nr.	Produktinfo	Inhalt /VE	Preis /VE	Preis ab 6 VE
23662	720 x 1020 mm, 0.03 mm, Rolle à 10 Säcke	(Pal. 50) 20	69.25	65.70

Kehrriechtsäcke | Normal

Twin-Tie



Kehrriechtsäcke Twin-Tie

35 Liter, HD-LLDPE, grau

Artikel-Nr.	Produktinfo	Inhalt /VE	Preis /VE	Preis ab 6 VE
7734	360 / 200 x 880 mm, 0.03 mm, Rolle à 20 Säcke	(Pal. 68) 25	99.05	94.05



Kehrriechtsäcke Twin-Tie

60 Liter, HD-LLDPE, grau

Artikel-Nr.	Produktinfo	Inhalt /VE	Preis /VE	Preis ab 6 VE
7735	360 / 200 x 1130 mm, 0.025 mm, Rolle à 10 Säcke	(Pal. 77) 30	123.30	117.05



Kehrriechtsäcke Twin-Tie

110 Liter, HD-LLDPE, grau

Artikel-Nr.	Produktinfo	Inhalt /VE	Preis /VE	Preis ab 6 VE
7736	360 / 350 x 1300 mm, 0.036 mm, Rolle à 10 Säcke	(Pal. 66) 20	101.75	96.60

Kehrriechtsäcke | OKS

Mit Verschlussband



Kehrriechtsäcke OKS

35 Liter, LD-PE, schwarz, mit Verschlussband

Artikel-Nr.	Produktinfo	Inhalt /VE	Preis /VE	Preis ab 6 VE
7705.1	555 x 700 mm, 0.04 mm, Rolle à 20 Säcke	(Pal. 64) 20	70.70	67.05



Kehrriechtsäcke OKS

60 Liter, LD-PE, schwarz, mit Verschlussband

Artikel-Nr.	Produktinfo	Inhalt /VE	Preis /VE	Preis ab 6 VE
7706.1	555 x 970 mm, 0.04 mm, Rolle à 10 Säcke	(Pal. 64) 22	66.10	62.80



Kehrriechtsäcke OKS

110 Liter, LD-PE, schwarz, mit Verschlussband

Artikel-Nr.	Produktinfo	Inhalt /VE	Preis /VE	Preis ab 6 VE
7707.1	700 x 1100 mm, 0.05 mm, Rolle à 10 Säcke	(Pal. 70) 15	61.70	58.60



Kehrriechtsäcke OKS

110 Liter, LD-PE, grau, mit Verschlussband

Artikel-Nr.	Produktinfo	Inhalt /VE	Preis /VE	Preis ab 6 VE
7702	350 / 350 x 1100 mm, 0.065 mm, Rolle à 10 Säcke	(Pal. 54) 12	80.30	76.25



Kehrriechtsäcke OKS

110 Liter, LD-PE, braun, mit Verschlussband

Artikel-Nr.	Produktinfo	Inhalt /VE	Preis /VE	Preis ab 6 VE
7703	350 / 350 x 1100 mm, 0.05 mm, Rolle à 10 Säcke	(Pal. 63) 15	59.60	56.50

Kehrichtsäcke | OKS

Mit Zugband



Kehrichtsäcke Quickbag OKS

17 Liter, LD-PE, schwarz, mit Zugband

Artikel-Nr.	Produktinfo	Inhalt /VE	Preis /VE	Preis ab 6 VE
7744	430 x 500 x 60 mm, 0.045 mm, Rolle à 20 Säcke	(Pal. 48) 20	70.55	66.90



Kehrichtsäcke Quickbag OKS

35 Liter, LD-PE, schwarz, mit Zugband

Artikel-Nr.	Produktinfo	Inhalt /VE	Preis /VE	Preis ab 6 VE
7719	555 x 600 mm, 0.03 mm, Rolle à 20 Säcke	(Pal. 48) 20	75.75	71.85



Kehrichtsäcke Quickbag OKS

60 Liter, LD-PE, schwarz, mit Zugband

Artikel-Nr.	Produktinfo	Inhalt /VE	Preis /VE	Preis ab 6 VE
7717	555 x 860 mm, 0.04 mm, Rolle à 10 Säcke	(Pal. 55) 20	71.30	67.75



Kehrichtsäcke Quickbag OKS

110 Liter, LD-PE, schwarz, mit Zugband

Artikel-Nr.	Produktinfo	Inhalt /VE	Preis /VE	Preis ab 6 VE
7715	700 x 1030 mm, 0.045 mm, Rolle à 10 Säcke	(Pal. 32) 20	86.85	82.45



Kehrichtsäcke Quickbag OKS

35 Liter, LD-PE, schwarz, mit Zugband

Artikel-Nr.	Produktinfo	Inhalt /VE	Preis /VE	Preis ab 6 VE
7719.1	50 / 560 x 600 mm, 0.04 mm, Rolle à 20 Säcke	(Pal. 54) 20	75.75	71.85



Kehrichtsäcke Quickbag OKS

60 Liter, LD-PE, schwarz, mit Zugband

Artikel-Nr.	Produktinfo	Inhalt /VE	Preis /VE	Preis ab 6 VE
7717.1	50 / 580 x 860 mm, 0.045 mm, Rolle à 10 Säcke	(Pal. 54) 25	89.10	84.65



Kehrichtsäcke Quickbag OKS

110 Liter, LD-PE, schwarz, mit Zugband

Artikel-Nr.	Produktinfo	Inhalt /VE	Preis /VE	Preis ab 6 VE
7715.1	50 / 720 x 1030 mm, 0.05 mm, Rolle à 10 Säcke	(Pal. 50) 15	65.10	61.85

Twin-Tie / Quicktie



Kehrichtsäcke Twin-Tie OKS

35 Liter, LD-PE, grau

Artikel-Nr.	Produktinfo	Inhalt /VE	Preis /VE	Preis ab 6 VE
7737.1	360 / 200 x 880 mm, 0.045 mm, Rolle à 20 Säcke	(Pal. 56) 20	76.20	72.30



Kehrichtsäcke Twin-Tie OKS

60 Liter, LD-PE, grau

Artikel-Nr.	Produktinfo	Inhalt /VE	Preis /VE	Preis ab 6 VE
7738.1	355 / 200 x 1050 mm, 0.04 mm, Rolle à 10 Säcke	(Pal. 77) 20	69.90	66.45

Kehrichtsäcke | OKS

Twin-Tie / Quicktie



Kehrichtsäcke Twin-Tie OKS

110 Liter, LD, grau

Artikel-Nr.	Produktinfo	Inhalt /VE	Preis /VE	Preis ab 6 VE
7739.1	360 / 340 x 1280 mm, 0.04 mm, Rolle à 10 Säcke	(Pal. 60) 15	75.65	71.80

Kehrichtsäcke | Spezialsäcke



Verbandwagen-Beutel

7 Liter, HD-PE, opakgrau

Artikel-Nr.	Produktinfo	Inhalt /VE	Preis /VE	
7763	180 / 120 x 350 mm, 0.01 mm, Rolle à 50 Säcke	(Pal. 128) 30	53.80	netto

Verbandwagen- und Hygienebeutel

10 Liter, HD-PE, schwarz



Artikel-Nr.	Produktinfo	Inhalt /VE	Preis /VE	ab 5 VE 10%
7722	180 / 120 x 380 mm, 0.008 mm, Rolle à 50 Säcke	(Pal. 100) 20	49.30	44.40

Verbandwagen-Beutel

15 Liter, HD-PE, schwarz



Artikel-Nr.	Produktinfo	Inhalt /VE	Preis /VE	ab 5 VE 10%
7708	250 / 140 x 520 mm, 0.012 mm, Rolle à 50 Säcke	(Pal. 72) 30	78.30	70.45
23631	200 / 190 x 500 mm, 0.008 mm, Rolle à 50 Säcke	(Pal. 70) 30	50.30	45.25

Containersäcke

Containersäcke

240 Liter, HD-PE, transparent



Artikel-Nr.	Produktinfo	Inhalt /VE	Preis /VE	ab 5 VE 10%
10833	800 / 360 x 1350 mm, 0.018 mm	(Pal. 54) 100	87.05	78.35

Containersäcke

360 Liter, LD-PE, transparent



Artikel-Nr.	Produktinfo	Inhalt /VE	Preis /VE	ab 5 VE 10%
19853	820 x 650 x 1600 mm, 0.025 mm	(Pal. 48) 50	53.05	47.75

Containersäcke

360 Liter, HD-PE, transparent



Artikel-Nr.	Produktinfo	Inhalt /VE	Preis /VE	ab 5 VE 10%
12174	810 / 680 x 1940 mm, 0.03 mm	(Pal. 50) 50	99.30	89.35

Containersäcke

800 Liter, LD-PE, grau



Artikel-Nr.	Produktinfo	Inhalt /VE	Preis /VE	Preis ab 6 VE
7691	1150 / 710 x 1500 mm, 0.023 mm	(Pal. 84) 50	62.30	59.20
15644	1150 / 710 x 1500 mm, 0.032 mm	(Pal. 56) 50	48.40	43.60

Containersäcke

800 Liter, LD-PE, schwarz



Artikel-Nr.	Produktinfo	Inhalt /VE	Preis /VE	
18476	1150 / 710 x 1500 mm, 0.05 mm	(Pal. 21) 50	87.40	netto

Containersäcke

Containersäcke

800 Liter, LD-PE, transparent



Artikel-Nr.	Produktinfo	Inhalt /VE	Preis /VE	Preis ab 6 VE
7681	1150 / 730 x 1500 mm, 0.023 mm	(Pal. 48) 50	63.75	60.55

Containersäcke

800 Liter, LD-PE, transparent, Spenderverpackung



Artikel-Nr.	Produktinfo	Inhalt /VE	Preis /VE	Preis ab 6 VE
7669	1150 / 750 x 1500 mm, 0.023 mm	(Pal. 72) 50	100.30	95.30

Containersäcke

800 Liter, PE light extra, transparent



Artikel-Nr.	Produktinfo	Inhalt /VE	Preis /VE	Preis ab 6 VE
7607	1260 / 620 x 1530 mm, 0.03 mm	(Pal. 54) 50	81.45	77.35

Containersäcke

800 Liter, LD-PE, transparent



Artikel-Nr.	Produktinfo	Inhalt /VE	Preis /VE	Preis ab 6 VE
18605	1150 / 730 x 1500 mm, 0.05 mm	(Pal. 30) 50	83.45	netto

Papiersäcke

Schwergut-Säcke

aus Papier, 3-fach, braun



Artikel-Nr.	Produktinfo	Inhalt /VE	Preis /VE	ab 5 VE 10%
11900	60 x 103 / 10 cm	(Pal. 167) 15	34.30	30.90

Kehrichtsäcke

aus Papier, beige



Artikel-Nr.	Produktinfo	Inhalt /VE	Preis /VE	Preis ab 6 VE
18239	60 Liter	(Pal. 40) 50	107.65	netto
7180	110 Liter	(Pal. 60) 25	105.40	94.85

Eimereinlagen / Einlagebeutel | Transparent, normal

mit Verschlussband

Einlagebeutel, Z-Faltung

PE light plus, transparent, 0.006 mm, mit Verschlussband



Artikel-Nr.	Produktinfo	Inhalt /VE	Preis /VE	Preis ab 6 VE
7692	18 - 20 Liter, 500 x 550 mm, Rolle à 40 Säcke	(Pal. 231) 20	42.65	40.45
7693	28 - 35 Liter, 540 x 590 mm, Rolle à 30 Säcke	(Pal. 286) 20	38.85	36.80
7694	55 Liter, 200 / 400 x 770 mm, Rolle à 20 Säcke	(Pal. 260) 20	46.30	43.90
5806	70 Liter, 200 / 400 x 920 mm, Rolle à 25 Säcke	(Pal. 200) 20	62.85	59.60

Einlagebeutel PROFITbag

HD-PE, transparent, 0.007 mm, mit Verschlussband



Artikel-Nr.	Produktinfo	Inhalt /VE	Preis /VE	Preis ab 6 VE
22491	22 Liter, 250 / 250 x 560 mm, Rolle à 40 Säcke	(Pal. 96) 30	45.25	40.75
22492	33 Liter, 270 / 270 x 600 mm, Rolle à 30 Säcke	(Pal. 96) 30	41.50	37.35
22493	55 Liter, 300 / 300 x 770 mm, Rolle à 20 Säcke	(Pal. 90) 30	39.60	35.65
22494	77 Liter, 330 / 330 x 920 mm, Rolle à 20 Säcke	(Pal. 72) 30	49.05	44.15

Eimereinlagen / Einlagebeutel | Transparent, normal

mit Verschlussband



Einlagebeutel

HD-PE, transparent, 0.008 mm, mit Verschlussband

Artikel-Nr.	Produktinfo	Inhalt /VE	Preis /VE	Preis ab 6 VE
7711	22 Liter, 250 / 250 x 560 mm, Rolle à 40 Säcke	(Pal. 100) 30	62.45	56.20
7713	33 Liter, 270 / 270 x 600 mm, Rolle à 30 Säcke	(Pal. 143) 30	58.25	52.45
7723	55 Liter, 300 / 300 x 770 mm, Rolle à 20 Säcke	(Pal. 132) 30	63.75	57.40
7704	77 Liter, 330 / 330 x 920 mm, Rolle à 20 Säcke	(Pal. 81) 30	93.35	84.00

Einlagebeutel

70 Liter, PE light plus, natur



Artikel-Nr.	Produktinfo	Inhalt /VE	Preis /VE	Preis ab 6 VE
5809	350 / 260 x 930 mm, 0.012 mm	(Pal. 336) 100	11.40	netto

Einlagebeutel, Z-Faltung

80 Liter, PE light plus, transparent



Artikel-Nr.	Produktinfo	Inhalt /VE	Preis /VE	Preis ab 6 VE
7638	360 / 340 x 880 mm, 0.012 mm, Rolle à 20 Säcke	(Pal. 72) 20	49.10	44.25

Einlagebeutel

LD-PE, transparent, 0.02 mm, mit Verschlussband



Artikel-Nr.	Produktinfo	Inhalt /VE	Preis /VE	Preis ab 6 VE
14936	33 Liter, 280 / 270 x 600 mm, Rolle à 30 Säcke	(Pal. 96) 20	104.80	94.30
14668	55 Liter, 300 / 300 x 770 mm, Rolle à 20 Säcke	(Pal. 80) 20	72.95	65.65

Einlagebeutel

110 Liter, HD-PE, transparent, mit Verschlussband



Artikel-Nr.	Produktinfo	Inhalt /VE	Preis /VE	ab 5 VE 10%
10454	350 / 350 x 1100 mm, 0.024 mm, Rolle à 10 Säcke	(Pal. 77) 20	55.35	49.85

Einlagebeutel

110 - 130 Liter, LD-PE, transparent, mit Verschlussband



Artikel-Nr.	Produktinfo	Inhalt /VE	Preis /VE	ab 5 VE 10%
4792	440 / 420 x 1090 mm, 0.03 mm, Rolle à 10 Säcke	(Pal. 66) 12	52.60	47.35

Mit Zugband

Einlagebeutel

22 Liter, HD-PE, natur, mit Zugband



Artikel-Nr.	Produktinfo	Inhalt /VE	Preis /VE	Preis ab 6 VE
7660.1	50 / 560 x 560 mm, 0.014 mm, Beutel à 20 Säcke	(Pal. 77) 30	87.85	79.10

Einlagebeutel

33 Liter, HD-PE, transparent, mit Zugband



Artikel-Nr.	Produktinfo	Inhalt /VE	Preis /VE	Preis ab 6 VE
7769.1	50 / 560 x 560 mm, 0.013 mm, Beutel à 20 Säcke	(Pal. 77) 30	103.65	93.25

Einlagebeutel

55 Liter, HD-PE, natur, mit Zugband



Artikel-Nr.	Produktinfo	Inhalt /VE	Preis /VE	Preis ab 6 VE
28869	740 / 575 x 690 mm, 0.017 mm, Beutel à 20 Säcke	20	99.35	89.40



Eimereinlagen / Einlagebeutel | Transparent, normal

ohne Band



Einlagebeutel Quicktie

PE light plus, natur, Knotenverschluss

Artikel-Nr.	Produktinfo	Inhalt /VE	Preis /VE	Preis ab 6 VE
7662	20 Liter, 460 x 660 mm, 0.009 mm, Rolle à 30 Säcke	(Pal. 120) 30	57.25	51.50
7663	30 Liter, 520 x 700 mm, 0.009 mm, Rolle à 20 Säcke	(Pal. 160) 30	48.40	45.85
7664	50 Liter, 560 x 860 mm, 0.01 mm, Rolle à 15 Säcke	(Pal. 146) 30	52.85	50.10

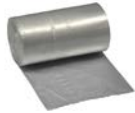

Einlagebeutel Universal

16 - 20 Liter, HD-PE, transparent

Artikel-Nr.	Produktinfo	Inhalt /VE	Preis /VE	Preis ab 6 VE
8694	450 x 540 mm, 0.006 mm, Rolle à 50 Säcke	(Pal. 100) 40	46.85	netto

Eimereinlagen / Einlagebeutel | Allzweckbeutel (ohne Seitenfalz)



Allzweckbeutel

LD-PE, transparent



Artikel-Nr.	Produktinfo	Inhalt /VE	Preis /VE	Preis ab 3 VE
7809	15 x 25 cm, 0.04 mm	(Pal. 60) 3000	283.00	226.40
7811	20 x 30 cm, 0.04 mm	(Pal. 56) 2000	269.45	215.55
7812	24 x 36 cm, 0.04 mm	(Pal. 56) 1500	257.25	205.80
7813	27 x 40 cm, 0.04 mm	(Pal. 24) 1500	309.95	248.00
7814	30 x 50 cm, 0.04 mm	(Pal. 48) 1000	269.45	215.55
7815	35 x 50 cm, 0.04 mm	(Pal. 60) 700	251.50	201.20
7816	40 x 60 cm, 0.04 mm	(Pal. 48) 500	188.60	150.90
7817	48 x 70 cm, 0.04 mm	(Pal. 48) 400	215.60	172.45
7818*	50 x 80 cm, 0.06 mm, mit Bodennaht	(Pal. 28) 250	278.40	222.75
7819	55 x 100 cm, 0.06 mm, mit Bodennaht	(Pal. 77) 50	74.10	59.30
7819.1	55 x 100 cm, 0.1 mm, mit Seitennaht	(Pal. 90) 50	70.70	56.60
7820	70 x 120 cm, 0.08 mm	(Pal. 77) 40	96.45	77.20
7821	80 x 140 cm, 0.08 mm, mit Bodennaht	(Pal. 24) 100	316.20	260.85
7822*	100 x 180 cm, 0.09 mm, mit Bodennaht	(Pal. 21) 50	305.40	251.95



Allzweckbeutel

LD-PE, weiss, 0.035 mm



Artikel-Nr.	Produktinfo	Inhalt /VE	Preis /VE	ab 5 VE 10%
7292	20 x 34 cm	3000	652.10	586.90
7293	26 x 38 cm	(Pal. 28) 2000	526.90	474.25

Eimereinlagen / Einlagebeutel | Einlagebeutel, gross



Einlagebeutel Opak

110 Liter, LD-PE, schwarz, mit Bodennaht

Artikel-Nr.	Produktinfo	Inhalt /VE	Preis /VE	ab 5 VE 10%
7695	600 x 1180 mm, 0.06 mm	(Pal. 30) 200	175.60	158.05



Einlagebeutel

110 - 130 Liter, LD-PE, transparent

Artikel-Nr.	Produktinfo	Inhalt /VE	Preis /VE	Preis ab 6 VE
7636	860 x 1100 mm, 0.045 mm	(Pal. 42) 150	108.95	103.30

Eimereinlagen / Einlagebeutel | Einlagebeutel, gross



Einlagebeutel

180 Liter, LD-PE, opak-schwarz, mit Verschlussband

Artikel-Nr.	Produktinfo	Inhalt /VE	Preis /VE	ab 5 VE 10%
11905	600 / 400 x 1200 mm, 0.045 mm	(Pal. 32) 100	56.10	50.50



Einlagebeutel

150 Liter, LD-PE, transparent

Artikel-Nr.	Produktinfo	Inhalt /VE	Preis /VE	Preis ab 6 VE
7639	800 x 1200 mm, 0.035 mm	(Pal. 33) 200	161.10	152.95



Paletteinlagebeutel

PE light extra, transparent

Artikel-Nr.	Produktinfo	Inhalt /VE	Preis /VE	Preis ab 6 VE
7670.1	1200 / 800 x 1600 mm, 0.025 mm, lose verpackt	(Pal. 64) 50	72.35	68.65

Eimereinlagen / Einlagebeutel | Kompostierbare Säcke



Compobag

kompostierbar, grün, Knotenverschluss

Artikel-Nr.	Produktinfo	Inhalt /VE	Preis /VE	Preis ab 6 VE
7654	5 Liter, 220 / 180 x 450 mm, 0.018 mm, Rolle à 10 Säcke	(Pal. 96) 24	121.50	103.90
7655	9 Liter, 220 / 180 x 550 mm, 0.020 mm, Rolle à 10 Säcke	(Pal. 96) 24	145.05	123.45
7656	16 Liter, 240 / 220 x 600 mm, 0.028 mm, Rolle à 10 Säcke	(Pal. 64) 24	164.60	141.10
7658	240 Liter, 1200 x 1400 mm, 0.025 mm, Beutel à 5 Säcke	(Pal. 48) 100	298.55	254.45



Compobag

kompostierbar, weiss

Artikel-Nr.	Produktinfo	Inhalt /VE	Preis /VE	Preis ab 6 VE
7659	800 Liter, 1150 x 1500 mm, Beutel à 5 Säcke	100	566.20	482.60

Abfallkörbe | Plastik / Draht



Abfallbehälter

weiss mit rotem Deckel, Kunststoff

Artikel-Nr.	Produktinfo	Inhalt /VE	Preis /VE	
6003	36 Liter, 360 x 500 mm	1	58.45	netto



Abfallbehälter

weiss, Kunststoff, robuste Ausführung

Artikel-Nr.	Produktinfo	Inhalt /VE	Preis /VE	
5977	35 Liter, 500 x 300 x 270 mm	(Pal. 50) 1	18.55	netto



Abfallbehälter Wandmodell

weiss, Kunststoff

Artikel-Nr.	Produktinfo	Inhalt /VE	Preis /VE	
10099	8 Liter, 280 x 240 x 170 mm	(Pal. 50) 1	48.75	netto



Abfallbehälter Tork Mini - B2 System

weiss, Kunststoff

Artikel-Nr.	Produktinfo	Inhalt /VE	Preis /VE	
7179	20 Liter, 430 x 320 x 210 mm	(Pal. 48) 1	55.20	netto

Abfallkörbe | Plastik / Draht



TORK Abfallbehälter Tork Mini - B2 System

weiss, Drahtgitter

Artikel-Nr.	Produktinfo	Inhalt /VE	Preis /VE	
7170	20 Liter, 350 x 320 x 220 mm	(Pal. 175) 1	41.75	netto

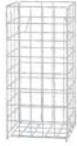

TORK Abfallbehälter Tork - B1 System

weiss, Drahtgitter

Artikel-Nr.	Produktinfo	Inhalt /VE	Preis /VE	
7169	60 Liter, 720 x 330 x 250 mm	(Pal. 160) 1	70.95	netto



TORK Abfallbehälter Tork Elevation - B1 System

weiss, Kunststoff

Artikel-Nr.	Produktinfo	Inhalt /VE	Preis /VE	
13565	50 Liter, 629 x 389 x 289 mm	(Pal. 18) 1	104.10	netto



TORK Deckel zu Art. 13565 - B1 System

weiss, Kunststoff

Artikel-Nr.	Produktinfo	Inhalt /VE	Preis /VE	
13565.5	310 x 240 mm	(Pal. 154) 1	32.20	netto



TORK Abfallbehälter Tork Elevation - B1 System

schwarz, Kunststoff

Artikel-Nr.	Produktinfo	Inhalt /VE	Preis /VE	
13566	50 Liter, 629 x 389 x 289 mm	(Pal. 18) 1	104.10	netto



TORK Deckel zu Art. 13566 - B1 System

schwarz, Kunststoff

Artikel-Nr.	Produktinfo	Inhalt /VE	Preis /VE	
13566.5*	310 x 240 mm	(Pal. 154) 1	32.20	netto



Kimberly-Clark PROFESSIONAL Kimberly-Clark Aquarius Abfallbehälter Medium

weiss, ABS Kunststoff

Artikel-Nr.	Produktinfo	Inhalt /VE	Preis /VE	ab 5 VE 10%
20969	43 Liter, 569 x 422 x 287 mm, 2 Stück	(Pal. 12) 2	98.25	88.40

Ab 10 Kimberly Clark-Spender mit Spenderleihvertrag erhältlich (Servicegebühr: CHF 30.00 / Stk.)



BulkySoft Abfallbehälter mit Schwenckdeckel Bulkysoft

weiss / grau, ABS Kunststoff, passender Beutel: Art. 7713

Artikel-Nr.	Produktinfo	Inhalt /VE	Preis /VE	
26278	30 Liter, 610 x 350 x 285 mm	(Pal. 50) 1	25.40	netto



haglertner XIBU touchPaperbox Abfallbehälter

weiss, Kunststoff, auch in schwarz erhältlich

Artikel-Nr.	Produktinfo	Inhalt /VE	Preis /VE	ab 5 VE 10%
26084	45 Liter, 340 x 700 x 237 mm	1	114.15	102.70

Abfallkörbe | Plastik / Draht



XIBU sensePaperbox Abfallbehälter

weiss, schlagfester Polyethylen-Kunststoff, auch in schwarz erhältlich

Artikel-Nr.	Produktinfo	Inhalt /VE	Preis /VE	ab 5 VE 10%
26086	45 Liter, 340 x 701 x 237 mm	1	259.05	233.15



Helit Abfallbehälter

lichtgrau, Kunststoff

Artikel-Nr.	Produktinfo	Inhalt /VE	Preis /VE	
20581*	18 Liter	1	9.95	netto
22690*	30 Liter	1	35.00	netto



Abfallbehälter mit Schwenkdeckel

weiss, rund, Kunststoff

Artikel-Nr.	Produktinfo	Inhalt /VE	Preis /VE	
28401	7 Liter, Ø 20 cm	1	5.60	netto

Abfallkörbe | Metall



Abfallbehälter «Touch Bin»

brilliant steel, mit Kunststoff-Inneneimer

Artikel-Nr.	Produktinfo	Inhalt /VE	Preis /VE	
7026*	30 Liter, Kehrichtsack Code G, 720 x 300 mm	(Pal. 12) 1	139.90	netto



Abfallbehälter «Conical»

matt steel

Artikel-Nr.	Produktinfo	Inhalt /VE	Preis /VE	
14206*	5 Liter, Kehrichtsack Code B, 238 x 216 mm	(Pal. 28) 4	119.60	netto
12660*	11 Liter, Kehrichtsack Code C, 309 x 262 mm	(Pal. 30) 2	79.80	netto



Abfallbehälter

matt steel

Artikel-Nr.	Produktinfo	Inhalt /VE	Preis /VE	
12575*	7 Liter, Kehrichtsack Code C, 235 x 213 mm	(Pal. 21) 4	119.60	netto



Abfallbehälter

brilliant steel

Artikel-Nr.	Produktinfo	Inhalt /VE	Preis /VE	
12863	15 Liter, Kehrichtsack Code D, 320 x 262 mm	(Pal. 24) 2	69.80	netto



Tischabfallbehälter

matt steel

Artikel-Nr.	Produktinfo	Inhalt /VE	Preis /VE	
12852*	1 Liter, 14 x 16.5 cm	(Pal. 72) 4	119.60	netto



Treteimer Newlcon

weiss, Kunststoff-Inneneimer

Artikel-Nr.	Produktinfo	Inhalt /VE	Preis /VE	
27066	3 Liter, Kehrichtsack Code A, 250 x 170 mm	(Pal. 120) 1	29.90	netto

Abfallkörbe | Metall



brabantia Treteimer Newlcon

metallic grey, Kunststoff-Inneneimer

Artikel-Nr.	Produktinfo	Inhalt /VE	Preis /VE	
27069*	3 Liter, Kehrichtsack Code A, 250 x 170 mm	(Pal. 126) 1	31.90	netto



brabantia Treteimer Newlcon

brilliant steel, Kunststoff-Inneneimer

Artikel-Nr.	Produktinfo	Inhalt /VE	Preis /VE	
27064	3 Liter, Kehrichtsack Code A, 250 x 170 mm	(Pal. 120) 1	29.90	netto



brabantia Treteimer Newlcon

weiss, Kunststoff-Inneneimer

Artikel-Nr.	Produktinfo	Inhalt /VE	Preis /VE	
27058	5 Liter, Kehrichtsack Code B, 280 x 205 mm	(Pal. 75) 1	39.90	netto



brabantia Treteimer Newlcon

matt steel, Kunststoff-Inneneimer

Artikel-Nr.	Produktinfo	Inhalt /VE	Preis /VE	
27057	5 Liter, Kehrichtsack Code B, 280 x 205 mm	(Pal. 75) 1	39.90	netto



brabantia Treteimer Newlcon

brilliant steel, Kunststoff-Inneneimer

Artikel-Nr.	Produktinfo	Inhalt /VE	Preis /VE	
27060	5 Liter, Kehrichtsack Code B, 280 x 205 mm	1	39.90	netto



brabantia Treteimer Newlcon

weiss, Kunststoff-Inneneimer

Artikel-Nr.	Produktinfo	Inhalt /VE	Preis /VE	
27061	12 Liter, Kehrichtsack Code C, 400 x 250 mm	(Pal. 30) 1	54.90	netto



brabantia Treteimer Newlcon

metallic grey, Kunststoff-Inneneimer

Artikel-Nr.	Produktinfo	Inhalt /VE	Preis /VE	
27070*	12 Liter, Kehrichtsack Code C, 400 x 250 mm	(Pal. 30) 1	54.90	netto



brabantia Treteimer Newlcon

matt steel, Kunststoff-Inneneimer

Artikel-Nr.	Produktinfo	Inhalt /VE	Preis /VE	
27072*	12 Liter, Kehrichtsack Code C, 400 x 250 mm	(Pal. 30) 1	69.90	netto



brabantia Treteimer Newlcon

brilliant steel, Kunststoff-Inneneimer

Artikel-Nr.	Produktinfo	Inhalt /VE	Preis /VE	
27059*	12 Liter, Kehrichtsack Code C, 400 x 250 mm	(Pal. 30) 1	54.90	netto



brabantia Treteimer Newlcon

weiss, Kunststoff-Inneneimer

Artikel-Nr.	Produktinfo	Inhalt /VE	Preis /VE	
27067	20 Liter, Kehrichtsack Code D, 467 x 290 mm	(Pal. 18) 1	79.90	netto

* auf Bestellung

Abfallkörbe | Metall

 **Treteimer Newlcon**

brilliant steel, Kunststoff-Inneneimer

Artikel-Nr.	Produktinfo	Inhalt /VE	Preis /VE	
27073*	20 Liter, Kehrichtsack Code D, 467 x 290 mm	(Pal. 18) 1	79.90	netto

 **Treteimer Newlcon**

weiss, Kunststoff-Inneneimer

Artikel-Nr.	Produktinfo	Inhalt /VE	Preis /VE	
27068*	30 Liter, Kehrichtsack Code G, 679 x 293 mm	(Pal. 12) 1	89.90	netto

 **Treteimer Newlcon**

metallic grey, Kunststoff-Inneneimer

Artikel-Nr.	Produktinfo	Inhalt /VE	Preis /VE	
27071*	30 Liter, Kehrichtsack Code G, 679 x 293 mm	(Pal. 12) 1	89.90	netto

 **Abfallbehälter Tork - B1 System**

gebürsteter Edelstahl / Kunststoff

Artikel-Nr.	Produktinfo	Inhalt /VE	Preis /VE	
25167	50 Liter, 614 x 253 x 395 mm	(Pal. 16) 1	179.65	netto

 **Deckel Tork für Abfallbehälter - B1 System**

Kunststoff

Artikel-Nr.	Produktinfo	Inhalt /VE	Preis /VE	
25168*	38 x 345 x 224 mm, für Art. 25167	1	32.20	netto

 **Abfallbehälter Tork - B1 System**

weiss, aus Metall

Artikel-Nr.	Produktinfo	Inhalt /VE	Preis /VE	
7178	50 Liter, 710 x 340 x 260 mm	(Pal. 30) 1	230.70	netto

 **Abfallbehälter Kimberly-Clark**

aus Edelstahl

Artikel-Nr.	Produktinfo	Inhalt /VE	Preis /VE	ab 5 VE 10%
22326	50 Liter, 649 x 350 x 240 mm	(Pal. 12) 1	357.05	321.35

**Abfallbehälter IRIS**

Metalloberfläche, ohne Trichterdeckel

Artikel-Nr.	Produktinfo	Inhalt /VE	Preis /VE	
17895*	50 Liter, 380 x 150 mm	4	566.45	netto

**Trichterdeckel IRIS zu Art. 17895**

schwarz, Kunststoff

Artikel-Nr.	Produktinfo	Inhalt /VE	Preis /VE	
22533*	38 x 15 cm	4	162.50	netto

Abfallkörbe | Kehrachtsack für Abfallkörbe



brabantia Kehrachtsäcke Code A

3 Liter, HD-PE

Artikel-Nr.	Produktinfo	Inhalt /VE	Preis /VE	
7360	290 x 270 mm, Rolle à 20 Säcke	12	37.80	netto



brabantia Kehrachtsäcke Code B

5 Liter, HD-PE

Artikel-Nr.	Produktinfo	Inhalt /VE	Preis /VE	
7361	340 x 330 mm, Rolle à 20 Säcke	12	37.80	netto



brabantia Kehrachtsäcke Code C

12 Liter, HD-PE

Artikel-Nr.	Produktinfo	Inhalt /VE	Preis /VE	
7362	490 x 385 mm, Rolle à 20 Säcke	12	39.60	netto



brabantia Kehrachtsäcke Code F

20 Liter, HD-PE

Artikel-Nr.	Produktinfo	Inhalt /VE	Preis /VE	
7363	760 x 370 mm, Rolle à 20 Säcke	(Pal. 120) 12	61.80	netto



brabantia Kehrachtsäcke Code G

30 Liter, HD-PE

Artikel-Nr.	Produktinfo	Inhalt /VE	Preis /VE	
7364	760 x 412 mm, Rolle à 20 Säcke	12	75.60	netto



brabantia Kehrachtsäcke Code H

50 Liter, HD-PE

Artikel-Nr.	Produktinfo	Inhalt /VE	Preis /VE	
7365*	820 x 600 mm, Rolle à 10 Säcke	12	63.60	netto



TORK Abfallsäcke Tork - B1 System

50 Liter, LD-PE, transparent

Artikel-Nr.	Produktinfo	Inhalt /VE	Preis /VE	ab 5 VE 10%
17594	61 x 90 cm, 0.035 mm, Rolle à 25 Säcke	(Pal. 56) 10	129.75	116.80



TORK Abfallsäcke Tork Mini - B2 System

20 Liter, LD-PE, weiss

Artikel-Nr.	Produktinfo	Inhalt /VE	Preis /VE	ab 5 VE 10%
17595	520 x 580 mm, 0.02 mm, Rolle à 100 Säcke	(Pal. 50) 10	161.90	145.70



TORK Kehrachtsäcke Tork - B2 System

25 Liter, LD-PE, transparent

Artikel-Nr.	Produktinfo	Inhalt /VE	Preis /VE	ab 5 VE 10%
18081*	63 x 61 cm, 0.025 mm, Rolle à 50 Säcke	(Pal. 120) 5	59.35	53.40



hagleitner Kehrachtsäcke XIBU

45 Liter, LD-PE, weiss, mit Zugband

Artikel-Nr.	Produktinfo	Inhalt /VE	Preis /VE	ab 5 VE 10%
26088	500 x 740 mm, 0.045 mm, Rolle à 25 Säcke	6	31.60	28.45

* auf Bestellung

Diverses



Abfallsackbehälter

anthrazit, aus Polycarbonat, ohne Deckel

Artikel-Nr.	Produktinfo	Inhalt /VE	Preis /VE	
14546	120 Liter	1	77.25	netto



Standaschenbecher «Smokers Pole»

aus gebürstetem Edelstahl, wetterresistent

Artikel-Nr.	Produktinfo	Inhalt /VE	Preis /VE	
14176	100 cm	1	174.90	netto

Wisch- und Reinigungstücher



Küchenrollen	242
Starline - Wischtücher	243
Tork - Wisch- und Reinigungstücher	245
Kimberly Clark - Wisch- und Reinigungstücher	255
Bulkysoft - Wischtücher	263
Chicopee - Reinigungstücher	265
Diverse Hersteller - Wisch- und Reinigungstücher	266
Putzlappen aus Textil	267
Putzfäden, Faservlies, Polyspüntücher	271

Küchenrollen | Starline



Starline Küchenrollen Starline

22 x 25.2 cm, 3-lagig, 100% Zellstoff



Artikel-Nr.	Produktinfo	Inhalt /VE	Preis /VE	Preis ab 10 VE
5952	weiss, Rolle à 60 Blatt	(Pal. 14) 40	53.30	46.85

Küchenrollen | Tork



TORK Küchenrollen Tork Premium Kitchen Plus

26 x 25 cm, 3-lagig



Artikel-Nr.	Produktinfo	Inhalt /VE	Preis /VE	Preis ab 10 VE
4992	hochweiss, Rolle à 51 Blatt	(Pal. 14) 48	98.05	86.25



TORK Küchenrollen Tork Premium Tissue

23 x 24 cm, 2-lagig, perforiert



Artikel-Nr.	Produktinfo	Inhalt /VE	Preis /VE	Preis ab 10 VE
13123	hochweiss, Rolle à 64 Blatt	(Pal. 32) 24	39.25	34.50

Küchenrollen | Kimberly-Clark



Kimberly-Clark PROFESSIONAL Küchenrollen Kimerly-Clark Scott Exquisita

27 x 23 cm, 2-lagig



Artikel-Nr.	Produktinfo	Inhalt /VE	Preis /VE	Preis VE /Pal.
4907	weiss, Rolle à 150 Blatt	(Pal. 18) 28	103.85	90.55



Kimberly-Clark PROFESSIONAL Küchenrollen Kimerly-Clark Scott Comfort

27 x 23 cm, 2-lagig



Artikel-Nr.	Produktinfo	Inhalt /VE	Preis /VE	Preis VE /Pal.
5950	weiss, Rolle à 150 Blatt	(Pal. 18) 28	101.60	77.05



tela Küchenrollen Tela tipptopp

23.5 x 24.9 cm, 2-lagig, 100 % Zellstoff



Artikel-Nr.	Produktinfo	Inhalt /VE	Preis /VE	
25919	weiss, Rolle à 50 Blatt	(Pal. 15) 32	29.80	netto
25920*	weiss, Rolle à 50 Blatt	(Pal. 48) 12	8.40	netto

Küchenrollen | Diverse



Küchenrollen neutral

22 x 25,2cm, 3-lagig, 100% Zellstoff



Artikel-Nr.	Produktinfo	Inhalt /VE	Preis /VE	Preis ab 10 VE
5900	weiss, Rolle à 120 Blatt	(Pal. 28) 20	56.40	49.05



KATRIN Küchenrollen Katrin Classic

26 cm x 22 cm, 2-lagig



Artikel-Nr.	Produktinfo	Inhalt /VE	Preis /VE	Preis ab 10 VE
4832	weiss, Rolle à 50 Blatt	(Pal. 24) 28	29.00	25.55

Küchenrollen | Diverse



Küchenrollen

26 x 24 cm, 2-lagig, Tissue



Artikel-Nr.	Produktinfo	Inhalt /VE	Preis /VE	Preis ab 10 VE
4995	hochweiss, Rolle à 64 Blatt	(Pal. 14) 48	75.00	65.95



Küchenrollen Eco Natural

22.8 x 22 cm, 2-lagig, Recycling



Artikel-Nr.	Produktinfo	Inhalt /VE	Preis /VE	ab 5 VE 10%
19334	nature, Rolle à 150 Blatt	(Pal. 20) 24	42.05	37.85



Küchenrollen Comfort

22 x 26 cm, 2-lagig, Recycling



Artikel-Nr.	Produktinfo	Inhalt /VE	Preis /VE	ab 5 VE 10%
25092	weiss, Rolle à 64 Blatt	(Pal. 21) 32	28.65	25.80



Küchenrollen Prestige

23 x 26 cm, 3-lagig, 100% Zellstoff



Artikel-Nr.	Produktinfo	Inhalt /VE	Preis /VE	ab 5 VE 10%
25091	weiss, Rolle à 51 Blatt	(Pal. 21) 32	34.55	31.10

Küchenrollen | Rollenhalter



Rollenhalter

Kunststoff, 23 - 29 cm Breite, mit Klebeband

Artikel-Nr.	Produktinfo	Inhalt /VE	Preis /VE	
7288	weiss	1	12.75	netto

Starline | Wischtücher



Starline Papierwischtücher Mini Starline

weiss, 1-lagig, 100% Zellstoff, Innen- / Aussenabwicklung

Artikel-Nr.	Produktinfo	Inhalt /VE	Preis /VE	Preis ab 10 VE
5948	Ø 13.5 cm, 38 x 20 cm, 315 Blatt = 120 lfm	(Pal. 36) 15	76.80	72.55



Starline Papierwischtücher Midi Starline

weiss, 1-lagig, 100% Zellstoff, Innenabwicklung

Artikel-Nr.	Produktinfo	Inhalt /VE	Preis /VE	Preis ab 10 VE
10226	Ø 18.5 cm, 22 x 38 cm, 763 Blatt = 290 lfm	(Pal. 40) 6	56.70	51.25



Starline Papierwischtücher Midi/Standard Starline

weiss, 1-lagig, 100% Zellstoff, Innen- / Aussenabwicklung

Artikel-Nr.	Produktinfo	Inhalt /VE	Preis /VE	Preis ab 10 VE
5949	Ø 19.5 cm, 38 x 24 cm, 842 Blatt = 320 lfm	(Pal. 32) 6	74.65	70.40



Starline Papierwischtücher Maxi Starline

weiss, 1-lagig, 100% Zellstoff, Innen- / Aussenabwicklung

Artikel-Nr.	Produktinfo	Inhalt /VE	Preis /VE	Preis ab 10 VE
7881	Ø 28.5 cm, 38 x 28 cm, 1710 Blatt = 650 lfm	(Pal. 36) 2	66.90	63.20

Starline | Wischtücher



Starline Papierwischtücher Mini Starline

weiss, 1-lagig, Recycling, Innen- / Aussenabwicklung

Artikel-Nr.	Produktinfo	Inhalt /VE	Preis /VE	Preis ab 10 VE
7876	Ø 13.5 cm, 38 x 20 cm, 315 Blatt = 120 lfm	(Pal. 36) 15	64.95	58.65



Starline Papierwischtücher Midi Starline

natur, 1-lagig, 100% Recycling, Innen- / Aussenabwicklung

Artikel-Nr.	Produktinfo	Inhalt /VE	Preis /VE	Preis ab 10 VE
7878	Ø 18 cm, 22 cm breite, 290 lfm	(Pal. 32) 6	53.35	48.25



Starline Papierwischtücher Mini-Soft Starline

weiss, 2-lagig, 100% Zellstoff, Innen- / Aussenabwicklung

Artikel-Nr.	Produktinfo	Inhalt /VE	Preis /VE	Preis ab 10 VE
5750	Ø 13 cm, 20 x 20 cm, 285 Blatt = 57 lfm	(Pal. 36) 15	69.20	57.35



Starline Papierwischtücher Midi Starline

weiss, 2-lagig, 100% Zellstoff, Innen- / Aussenabwicklung

Artikel-Nr.	Produktinfo	Inhalt /VE	Preis /VE	Preis ab 10 VE
5967	Ø 19.5 cm, 36 x 24 cm, 450 Blatt = 162 lfm	(Pal. 32) 6	57.00	48.30



Starline Papierwischtücher Tira Starline

weiss, 2-lagig, 100% Zellstoff, Innen- / Aussenabwicklung

Artikel-Nr.	Produktinfo	Inhalt /VE	Preis /VE	Preis ab 10 VE
7887	Ø 14.5 cm, 18 x 22 cm, 500 Blatt = 90 lfm, für Spender Art. 7888	(Pal. 32) 12	60.95	54.60



Starline Papierwischtücher Maxi Starline

weiss, 2-lagig, 100% Zellulose, Innen- / Aussenabwicklung

Artikel-Nr.	Produktinfo	Inhalt /VE	Preis /VE	Preis ab 10 VE
5966	Ø 29 cm, 36 x 29 cm, 903 Blatt = 325 lfm	(Pal. 36) 2	48.00	40.85



Papierwischtücher Blue Maxi Starline

blau, 2-lagig, 100% Zellstoff

Artikel-Nr.	Produktinfo	Inhalt /VE	Preis /VE	ab 5 VE 10%
7488	Ø 24.5 cm, 36 x 38 cm, 500 Blatt = 190 lfm	(Pal. 30) 2	49.10	44.20



Starline Papierwischtücher Blue Power Extra Starline

blau, 2-lagig, 100% Zellulose, Innen- / Aussenabwicklung

Artikel-Nr.	Produktinfo	Inhalt /VE	Preis /VE	Preis ab 10 VE
7970	Ø 37 cm, 36 x 26 cm, 1750 Blatt = 630 lfm	(Pal. 42) 1	37.15	31.60



Starline Papierwischtücher Blue Power Maxi Starline

blau, 3-lagig, 100% Zellulose, Innen- / Aussenabwicklung

Artikel-Nr.	Produktinfo	Inhalt /VE	Preis /VE	Preis ab 10 VE
7845	Ø 25.5 cm, 36 x 29 cm, 500 Blatt = 180 lfm	(Pal. 36) 2	38.25	32.55



Starline Papierwischtücher Blue Power Jumbo-Maxi Starline

blau, 3-lagig, 100% Zellulose, Aussenabwicklung

Artikel-Nr.	Produktinfo	Inhalt /VE	Preis /VE	Preis ab 10 VE
7844	Ø 37 cm, 36 x 34 cm, 1100 Blatt = 396 lfm	(Pal. 30) 1	50.15	42.70

Starline | Wischtücher



Papierwischtücher Blue Power Starline

blau, 3-lagig, Zellstoff

Artikel-Nr.	Produktinfo	Inhalt /VE	Preis /VE	Preis ab 10 VE
7972	Ø 30 cm, 36 x 38 cm, 500 Blatt = 190 lfm	(Pal 30) 2	45.90	39.10

Starline | Spender für Wischtücher



Starline Spender Starline für Papierwischtücher MINI ROLL-BOX

Kunststoff, weiss-transparent, Innenabwicklung, abschliessbar

Artikel-Nr.	Produktinfo	Inhalt /VE	Preis /VE	Preis ab 10 VE
5946	14.5 x 27 cm	(Pal 50) 1	44.85	netto



Starline Spender Starline für Papierwischtücher MIDI ROLL-BOX

Kunststoff, weiss-transparent, Innenabwicklung, abschliessbar

Artikel-Nr.	Produktinfo	Inhalt /VE	Preis /VE	Preis ab 10 VE
5945	25 x 35 cm	(Pal 50) 1	58.55	netto



Starline Spender Starline für Papierwischtücher MAXI ROLL-BOX

Kunststoff, weiss-transparent, Innenabwicklung, abschliessbar

Artikel-Nr.	Produktinfo	Inhalt /VE	Preis /VE	Preis ab 10 VE
5947	33 x 42 cm	(Pal 1) 1	88.05	netto



Bodenständer für Papierwischtücher

aus Metall, lackiert, Aussenabwicklung, passend für alle Grössen

Artikel-Nr.	Produktinfo	Inhalt /VE	Preis /VE	Preis ab 10 VE
5973	95 x 48 x 45 cm	(Pal 4) 1	35.70	netto

Tork - Wisch- und Reinigungstücher | Wischen



TORK Standard Papierwischtücher - M1 System

weiss, 1-lagig, unperforiert, Mini Innenabrollung



Artikel-Nr.	Produktinfo	Inhalt /VE	Preis /VE	Preis VE /Pal.
8656	21.5 cm x 120 lfm	(Pal 32) 11	66.45	50.95



TORK Mehrzweck Papierwischtücher - M1 System

weiss, 1-lagig, unperforiert, Innenabrollung Mini



Artikel-Nr.	Produktinfo	Inhalt /VE	Preis /VE	Preis VE /Pal.
4991	21.5 cm x 120 lfm	(Pal 32) 11	108.30	83.00



TORK Starke Mehrzweck Papierwischtücher - M1 System

weiss, 2-lagig, perforiert, Mini Innenabrollung



Artikel-Nr.	Produktinfo	Inhalt /VE	Preis /VE	Preis VE /Pal.
5944	21.5 x 35 cm, 214 Blatt = 75 lfm	(Pal 32) 11	122.70	94.05



TORK Standard Papierwischtücher - M2 System

weiss, 1-lagig, unperforiert, Innenabrollung



Artikel-Nr.	Produktinfo	Inhalt /VE	Preis /VE	Preis VE /Pal.
5689	20 cm x 300 lfm	(Pal 36) 6	77.65	59.55



Produkte für mehr Effizienz und Sauberkeit.

Unsere Wisch- und Reinigungstücher für die Industrie erfüllen eine Vielzahl von Aufgaben – von der Vorbereitung der Teile und der Reinigung vor dem Lackieren über die Instandhaltung und Qualitätskontrolle bis hin zum Aufwischen von ausgelaufenem Öl oder anderen Schmierstoffen. Für jede dieser Aufgaben hält unser Sortiment die passende Lösung bereit. Wir bei Tork legen Wert auf jedes noch so kleine Detail, damit Sie Ihre Arbeiten noch effizienter erledigen können.



Tork - Wisch- und Reinigungstücher | Wischen



TORK Tork Standard Papierwischtücher - M2 System

weiss, 2-lagig, perforiert, Innenabrollung,



Artikel-Nr.	Produktinfo	Inhalt /VE	Preis /VE	Preis VE /Pal.
4772	20 x 35 cm, 457 Blatt = 160 lfm	(Pal. 32) 6	82.00	62.90



TORK Tork Mehrzweck Papierwischtücher - M2 System

weiss, 1-lagig, Innenabrollung



Artikel-Nr.	Produktinfo	Inhalt /VE	Preis /VE	Preis VE /Pal.
12098	19.5 x 35 cm, 471 Blatt = 165 lfm	(Pal. 32) 6	71.10	54.50



TORK Tork Mehrzweck Papierwischtücher - M2 System

weiss, 1-lagig, unperforiert, Innenabrollung



Artikel-Nr.	Produktinfo	Inhalt /VE	Preis /VE	Preis VE /Pal.
4966	21.5 cm x 275 lfm	(Pal. 32) 6	108.35	83.10



TORK Tork Starke Mehrzweck Papierwischtücher - M2 System

weiss, 2-lagig, Innenabrollung, perforiert



Artikel-Nr.	Produktinfo	Inhalt /VE	Preis /VE	Preis VE /Pal.
5943	21.5 x 35 cm, 457 Blatt = 160 lfm	(Pal. 32) 6	97.75	74.95



TORK Tork Starke Mehrzweck Papierwischtücher - M2 System

weiss, 2-lagig, Innenabrollung



Artikel-Nr.	Produktinfo	Inhalt /VE	Preis /VE	ab 5 VE 10%
5884	23.5 x 34 cm, 368 Blatt = 125 lfm	(Pal. 32) 6	101.85	91.65



TORK Tork Mehrzweck Papierwischtücher Reflex - M3 System

weiss, 1-lagig, Mini Innenabrollung



Artikel-Nr.	Produktinfo	Inhalt /VE	Preis /VE	Preis VE /Pal.
16074	19.8 x 35 cm, 343 Blatt = 120 lfm	(Pal. 40) 12	67.90	52.05



TORK Tork Starke Mehrzweck Papierwischtücher Reflex - M3 System

weiss, 2-lagig, Mini Innenabrollung



Artikel-Nr.	Produktinfo	Inhalt /VE	Preis /VE	Preis VE /Pal.
16289	19.4 x 33.5 cm, 200 Blatt = 67 lfm	(Pal. 36) 9	62.90	48.25



TORK Tork Mehrzweck Papierwischtücher Reflex - M4 System

weiss, 1-lagig, Innenabrollung



Artikel-Nr.	Produktinfo	Inhalt /VE	Preis /VE	ab 5 VE 10%
18075	19.8 x 35 cm, 857 Blatt = 300 lfm	(Pal. 40) 6	64.75	58.25
14619	19.4 x 33.5 cm, 340 Blatt = 114 lfm	(Pal. 24) 6	73.45	56.30



TORK Tork Starke Mehrzweck Papierwischtücher Reflex - M4 System

blau, 2-lagig, Innenabrollung



Artikel-Nr.	Produktinfo	Inhalt /VE	Preis /VE	ab 5 VE 10%
19703	19.4 x 33.5 cm, 450 Blatt = 150 lfm	(Pal. 24) 6	104.75	94.30

Tork - Wisch- und Reinigungstücher | Wischen



TORK Tork Starke Mehrzweck Papierwischtücher Reflex - M4 System

weiss, 2-lagig, Innenabrollung



Artikel-Nr.	Produktinfo	Inhalt /VE	Preis /VE	Preis VE /Pal.
17041	19.4 x 33.5 cm, 450 Blatt = 150 lfm	(Pal. 24) 6	78.20	59.95



TORK Tork Standard Papierwischtücher - W1 System

blau, 2-lagig, perforiert



Artikel-Nr.	Produktinfo	Inhalt /VE	Preis /VE	ab 5 VE 10%
22571	34 x 37 cm, 1000 Blatt = 340 lfm	(Pal. 30) 2	102.50	92.25



TORK Tork Standard Papierwischtücher - W1 System

weiss, 2-lagig



Artikel-Nr.	Produktinfo	Inhalt /VE	Preis /VE	ab 5 VE 10%
17341	34 x 37 cm, 2000 Blatt = 680 lfm	(Pal. 30) 1	82.45	74.20



TORK Tork Mehrzweck Papierwischtücher - W1 System

weiss, 1-lagig, unperforiert



Artikel-Nr.	Produktinfo	Inhalt /VE	Preis /VE	Preis VE /Pal.
4967	24.5 cm x 1000 lfm	(Pal. 42) 1	93.25	71.50



TORK Tork Starke Mehrzweck Papierwischtücher - W1 System

weiss, 2-lagig



Artikel-Nr.	Produktinfo	Inhalt /VE	Preis /VE	Preis VE /Pal.
13335	37 x 34 cm, 1500 Blatt = 510 lfm	(Pal. 30) 1	100.25	76.85
4730.1	23.5 x 34 cm, 1500 Blatt = 510 lfm	(Pal. 48) 1	66.10	50.70



TORK Tork Starke Mehrzweck Papierwischtücher - W1 System

blau, 2-lagig



Artikel-Nr.	Produktinfo	Inhalt /VE	Preis /VE	Preis VE /Pal.
8663	37 x 34 cm, 1500 Blatt = 510 lfm	(Pal. 30) 1	76.85	58.90



TORK Tork Extra Starke Mehrzweck Papierwischtücher - W1 System

blau, 2-lagig



Artikel-Nr.	Produktinfo	Inhalt /VE	Preis /VE	Preis VE /Pal.
10984	37 x 34 cm, 1000 Blatt = 340 lfm	(Pal. 30) 1	77.40	59.35



TORK Tork Extra Starke Industrie Papierwischtücher - W1 System

blau, 3-lagig, geprägt



Artikel-Nr.	Produktinfo	Inhalt /VE	Preis /VE	Preis VE /Pal.
11886	37 x 34 cm, 750 Blatt = 255 lfm	(Pal. 30) 1	99.35	76.20



TORK Tork Standard Papierwischtücher - W1 System

weiss, 2-lagig, geprägt



Artikel-Nr.	Produktinfo	Inhalt /VE	Preis /VE	ab 5 VE 10%
23132	23.5 x 34 cm, 1500 Blatt = 510 lfm	(Pal. 32) 2	85.30	76.75

Tork - Wisch- und Reinigungstücher | Wischen



TORK Tork Industrie Papierwischtücher - W1 System

blau, 3-lagig



Artikel-Nr.	Produktinfo	Inhalt /VE	Preis /VE	ab 5 VE 10%
17694	34 x 37 cm, 1000 Blatt = 340 lfm	(Pal. 30) 1	71.35	64.20



TORK Tork Standard Papierwischtücher - W1/W2 System

weiss, 2-lagig, Kombirolle



Artikel-Nr.	Produktinfo	Inhalt /VE	Preis /VE	Preis VE /Pa.
7181	23.5 x 34 cm, 1000 Blatt = 340 lfm	(Pal. 48) 2	68.10	52.20



TORK Tork Mehrzweck Papierwischtücher - W1/W2 System

weiss, 1-lagig, Kombirolle



Artikel-Nr.	Produktinfo	Inhalt /VE	Preis /VE	Preis VE /Pa.
4979	24.5 x 40 cm, 1150 Blatt = 460 lfm	(Pal. 42) 2	85.15	65.30



TORK Tork Starke Mehrzweck Papierwischtücher - W1/W2 System

weiss, 2-lagig, Kombirolle



Artikel-Nr.	Produktinfo	Inhalt /VE	Preis /VE	Preis VE /Pa.
4982.1	23.5 x 34 cm, 750 Blatt = 255 lfm	(Pal. 48) 2	56.40	43.25



TORK Tork Starke Mehrzweck Papierwischtücher - W1/W2 System

blau, 2-lagig, Kombirolle



Artikel-Nr.	Produktinfo	Inhalt /VE	Preis /VE	ab 5 VE 10%
16156	23.5 x 34 cm, 750 Blatt = 255 lfm	(Pal. 48) 2	51.80	46.65



TORK Tork Extra Starke Mehrzweck Papierwischtücher - W1/W2 System

weiss, 2-lagig, Kombirolle



Artikel-Nr.	Produktinfo	Inhalt /VE	Preis /VE	Preis VE /Pa.
4985.1	23.5 x 34 cm, 500 Blatt = 170 lfm	(Pal. 48) 2	53.75	41.20



TORK Tork Extra Starke Industrie Papierwischtücher - W1/W2 System

blau, 3-lagig, Kombirolle



Artikel-Nr.	Produktinfo	Inhalt /VE	Preis /VE	Preis VE /Pa.
4986	23.5 x 34 cm, 700 Blatt = 199 lfm	(Pal. 48) 2	62.45	47.90



TORK Tork Starke Mehrzweck Papierwischtücher - W1/W2/W3 System

weiss, 2-lagig, Kombirolle im Karton



Artikel-Nr.	Produktinfo	Inhalt /VE	Preis /VE	ab 5 VE 10%
5885	26 x 34 cm, 750 Blatt = 255 lfm	(Pal. 72) 1	34.20	30.75



TORK Tork Extra Starke Industrie Papierwischtücher - W4 System

blau, 3-lagig, Einzeltücher



Artikel-Nr.	Produktinfo	Inhalt /VE	Preis /VE	Preis VE /Pa.
4993	38.5 x 34 cm, 100 Blatt	(Pal. 32) 500	92.85	71.20



TORK Tork Lebensmitteltücher - W4 System

weiss, 2-lagig, Hybrid-Qualität, Einzeltücher



Artikel-Nr.	Produktinfo	Inhalt /VE	Preis /VE	Preis VE /Pa.
5898	28.5 x 32.5 cm, 200 Blatt	(Pal. 32) 1000	99.30	76.10

Tork - Wisch- und Reinigungstücher | Wischen



TORK Tork Standard Papierwischtücher - W5 System

weiss, 2-lagig, Kleinrolle

Artikel-Nr.	Produktinfo	Inhalt /VE	Preis /VE	Preis VE /Pal.
11603	23 x 27.5 cm, 200 Blatt = 55 lfm	(Pal. 28) 10	71.55	54.85



TORK Tork Extra Starke Industrie Papierwischtücher - W7 System

blau, 3-lagig, Handy Box



Artikel-Nr.	Produktinfo	Inhalt /VE	Preis /VE	Preis VE /Pal.
4959.1	38.5 x 32.5 cm, 200 Blatt	(Pal. 70) 200	37.25	28.55

Tork - Wisch- und Reinigungstücher | Reinigen



TORK Tork Reinigungstücher - W1 System

weiss, 1-lagig, Vliesstoff, weich und flexibel



Artikel-Nr.	Produktinfo	Inhalt /VE	Preis /VE	Preis VE /Pal.
4962	43 x 38 cm, 1000 Blatt = 380 lfm	(Pal. 30) 1	214.30	164.30



TORK Tork Reinigungstücher - W1 System

blau, 1-lagig, Vliesstoff, weich und flexibel



Artikel-Nr.	Produktinfo	Inhalt /VE	Preis /VE	Preis VE /Pal.
13059	43 x 38 cm, 1000 Blatt = 380 lfm	(Pal. 30) 1	214.30	164.30



TORK Tork Extra Starke Reinigungstücher - W1 System

weiss, 1-lagig, Vliesstoff, weich und flexibel



Artikel-Nr.	Produktinfo	Inhalt /VE	Preis /VE	ab 5 VE 10%
13440	32 x 43 cm, 710 Blatt = 270 lfm	(Pal. 30) 1	229.50	206.55



TORK Tork Industrie Reinigungstücher - W1 System

grau, 1-lagig, Vliesstoff, weich und flexibel



Artikel-Nr.	Produktinfo	Inhalt /VE	Preis /VE	Preis VE /Pal.
4965	43 x 38 cm, 950 Blatt = 361 lfm	(Pal. 30) 1	213.90	164.00



TORK Tork Reinigungstücher - W1/W2/W3 System

weiss, Kombirolle im Karton, 1-lagig, Vliesstoff, weich und flexibel



Artikel-Nr.	Produktinfo	Inhalt /VE	Preis /VE	Preis VE /Pal.
4964	32 x 38 cm, 400 Blatt = 152 lfm	(Pal. 72) 1	66.40	50.95



TORK Tork Reinigungstücher - W1/W2/W3 System

blau, Kombirolle im Karton, 1-lagig, Vliesstoff, weich und flexibel



Artikel-Nr.	Produktinfo	Inhalt /VE	Preis /VE	Preis VE /Pal.
13021	32 x 38 cm, 400 Blatt = 152 lfm	(Pal. 72) 1	65.75	50.45



TORK Tork Extra Starke Reinigungstücher - W1/W2/W3 System

weiss, Kombirolle im Karton, 1-lagig, Vliesstoff, weich und flexibel



Artikel-Nr.	Produktinfo	Inhalt /VE	Preis /VE	Preis VE /Pal.
4902	32 x 38 cm, 280 Blatt = 106 lfm	(Pal. 72) 1	69.30	53.15

Tork - Wisch- und Reinigungstücher | Reinigen



TORK Tork Langlebige Reinigungstücher - W1/W2/W3 System

weiss, Kombirolle im Karton, Vliesstoff, weich und flexibel



Artikel-Nr.	Produktinfo	Inhalt /VE	Preis /VE	Preis VE /Pal.
10268	32 x 38 cm, 300 Blatt = 114 lfm	(Pal. 72) 1	84.75	65.00



TORK Tork Industrie Reinigungstücher - W1/W2/W3 System

grau, Kombirolle im Karton, 1-lagig, Vliesstoff, weich und flexibel



Artikel-Nr.	Produktinfo	Inhalt /VE	Preis /VE	Preis VE /Pal.
4978	32 x 38 cm, 390 Blatt = 148 lfm	(Pal. 72) 1	83.00	63.65



TORK Tork Reinigungstücher - W4 System

weiss, Einzeltücher, 1-lagig, Vliesstoff, weich und flexibel

Artikel-Nr.	Produktinfo	Inhalt /VE	Preis /VE	Preis VE /Pal.
4958.2	35.5 x 43 cm, 150 Blatt	(Pal. 48) 650	142.45	109.20



TORK Tork Extra Starke Reinigungstücher - W4 System

weiss, Einzeltücher, 1-lagig, Vliesstoff, weich und flexibel

Artikel-Nr.	Produktinfo	Inhalt /VE	Preis /VE	ab 5 VE 10%
14130.2	35.5 x 64 cm, 60 Blatt	(Pal. 48) 300	147.70	132.95
4983.2	35.5 x 43 cm, 100 Blatt	(Pal. 48) 500	161.30	123.70



TORK Tork Extra Starke Reinigungstücher - W4 System

blau, Einzeltücher, Vliesstoff, weich und flexibel

Artikel-Nr.	Produktinfo	Inhalt /VE	Preis /VE	Preis VE /Pal.
4996.2	35.5 x 43 cm, 100 Blatt	(Pal. 48) 500	161.30	123.70



TORK Tork Langlebige Reinigungstücher - W4 System

weiss, Einzeltücher, Vliesstoff, weich und flexibel

Artikel-Nr.	Produktinfo	Inhalt /VE	Preis /VE	Preis VE /Pal.
4994.2	35.5 x 43 cm, 90 Blatt	(Pal. 48) 450	146.95	112.65



TORK Tork Industrie Reinigungstücher - W4 System

grau, Einzeltücher, 1-lagig, Vliesstoff, weich und flexibel



Artikel-Nr.	Produktinfo	Inhalt /VE	Preis /VE	Preis VE /Pal.
4968.2	35.5 x 43 cm, 140 Blatt	(Pal. 48) 600	167.55	128.45



TORK Tork Extra Starke Industrie Reinigungstücher - W4 System

weiss, Einzeltücher, 1-lagig, Vliesstoff, weich und flexibel



Artikel-Nr.	Produktinfo	Inhalt /VE	Preis /VE	ab 5 VE 10%
16433.2	38.5 x 43 cm, 65 Blatt	(Pal. 48) 325	122.75	110.50



TORK Tork Küchen Reinigungstücher - W4 System

weiss, Einzeltücher, 1-lagig, Vliesstoff, weich und flexibel

Artikel-Nr.	Produktinfo	Inhalt /VE	Preis /VE	ab 5 VE 10%
24617.2	43 x 35.5 cm, 80 Blatt	(Pal. 48) 400	125.05	112.55

Tork - Wisch- und Reinigungstücher | Reinigen



TORK Tork Reinigungstücher - W7 System

Handy Box, 1-lagig, 35,5 x 43 cm, 300 Blatt, Vliesstoff, weich und flexibel

Artikel-Nr.	Produktinfo	Inhalt /VE	Preis /VE	ab 5 VE 10%
16263.2	weiss	(Pal. 80) 300	65.55	59.00
16436.2*	blau	(Pal. 80) 300	65.55	59.00



TORK Tork Extra Starke Reinigungstücher - W7 System

weiss, Handy Box, 1-lagig, Vliesstoff, weich und flexibel

Artikel-Nr.	Produktinfo	Inhalt /VE	Preis /VE	Preis VE /Pal.
4990.2	35,5 x 43 cm, 200 Blatt	(Pal. 90) 200	64.55	49.50
13360.2	35,5 x 64 cm, 120 Blatt	(Pal. 90) 120	59.30	53.35



TORK Tork Industrie Reinigungstücher - W7 System

grau, Handy Box, 1-lagig, Vliesstoff, weich und flexibel

Artikel-Nr.	Produktinfo	Inhalt /VE	Preis /VE	Preis VE /Pal.
4963.2	35,5 x 43 cm, 280 Blatt	(Pal. 80) 280	78.25	60.00



TORK Tork Reinigungstücher - W8 System

weiss, Small Pack, 1-lagig, Vliesstoff, weich und flexibel



Artikel-Nr.	Produktinfo	Inhalt /VE	Preis /VE	Preis VE /Pal.
12835	38,5 x 32 cm, 55 Blatt	(Pal. 60) 440	127.75	97.95



TORK Tork Extra Starke Reinigungstücher - W8 System

weiss, Small Pack, 1-lagig, Vliesstoff, weich und flexibel



Artikel-Nr.	Produktinfo	Inhalt /VE	Preis /VE	Preis VE /Pal.
12836	38,5 x 32 cm, 45 Blatt	(Pal. 60) 360	105.70	81.05



TORK Tork Langlebige Farbige Reinigungstücher - W8 System

Small Pack, 38 x 30 cm, 40 Blatt, 1-lagig, Vliesstoff, weich und flexibel



Artikel-Nr.	Produktinfo	Inhalt /VE	Preis /VE	Preis VE /Pal.
12781*	blau	(Pal. 66) 320	146.10	112.05
12779	grün	(Pal. 66) 320	146.10	112.05
12782	gelb	(Pal. 66) 320	146.10	112.00
12780	rot	(Pal. 66) 320	146.10	112.05



TORK Tork Fusselarme Reinigungstücher - W10 System

türkis, Nachfüllrolle, Vliesstoff, weich und flexibel



Artikel-Nr.	Produktinfo	Inhalt /VE	Preis /VE	ab 5 VE 10%
27224*	16,5 x 30 cm, 200 Blatt = 60 lfm	(Pal. 70) 4	219.60	197.65



TORK Tork Fusselarme Reinigungstücher - W10 System

türkis, Rolle im Spenderimer, Vliesstoff, weich und flexibel



Artikel-Nr.	Produktinfo	Inhalt /VE	Preis /VE	ab 5 VE 10%
18568*	16,5 x 30 cm, 200 Blatt = 60 lfm	(Pal. 28) 4	246.55	221.90



TORK Tork Feuchte Oberflächenreinigungstücher - W14 System

weiss, im Spenderimer, 1-lagig, Vliesstoff, weich und flexibel

Artikel-Nr.	Produktinfo	Inhalt /VE	Preis /VE	ab 5 VE 10%
18394	27 x 27 cm, 58 Blatt = 15 lfm	(Pal. 30) 4	140.35	126.30

Tork - Wisch- und Reinigungstücher | Reinigen



TORK Handreinigungstücher Tork Premium - W14 System

Spenderimer, vorgetränkt, 1-lagig, perforiert, Vliesstoff, weich und flexibel

Artikel-Nr.	Produktinfo	Inhalt /VE	Preis /VE	ab 5 VE 10%
17283*	27 x 27 cm, 58 Blatt	(Pal. 30) 4	140.35	126.30

Tork - Wisch- und Reinigungstücher | Polieren



TORK Tork Poliertücher - W1/W2/W3 System

weiss, Kombirolle im Karton, 1-lagig, Vliesstoff, weich und flexibel

Artikel-Nr.	Produktinfo	Inhalt /VE	Preis /VE	ab 5 VE 10%
4956	32 x 38 cm, 450 Blatt = 171 lfm	(Pal. 72) 1	124.65	112.20



TORK Tork Poliertücher - W4 System

weiss, Einzeltücher, 1-lagig, Vliesstoff, weich und flexibel

Artikel-Nr.	Produktinfo	Inhalt /VE	Preis /VE	Preis VE /Pal.
4960.2	35,5 x 43 cm, 125 Blatt	(Pal. 48) 625	231.40	177.40

Tork - Wisch- und Reinigungstücher | Spender



TORK Tork Performance Mini Innenabrollungsspender - M1 System

türkis / weiss

Artikel-Nr.	Produktinfo	Inhalt /VE	Preis /VE	
16455	Kunststoff, H: 333 B: 193 T: 172 mm	(Pal. 120) 1	75.90	netto



TORK Tork Performance Mini Innenabrollungsspender - M1 System

schwarz / rot

Artikel-Nr.	Produktinfo	Inhalt /VE	Preis /VE	
16456*	Kunststoff, H: 333 B: 193 T: 172 mm	(Pal. 120) 1	75.90	netto



TORK Tork Elevation Mini Innenabrollungsspender - M1 System

weiss

Artikel-Nr.	Produktinfo	Inhalt /VE	Preis /VE	
7154.3	Kunststoff, H: 321 B: 174 T: 165 mm	(Pal. 120) 1	80.75	netto



TORK Tork Elevation Mini Innenabrollungsspender - M1 System

schwarz

Artikel-Nr.	Produktinfo	Inhalt /VE	Preis /VE	
12925	Kunststoff, H: 321 B: 174 T: 165 mm	(Pal. 120) 1	80.75	netto



TORK Tork Performance Innenabrollungsspender - M2 System

türkis / weiss

Artikel-Nr.	Produktinfo	Inhalt /VE	Preis /VE	
16457	Kunststoff, H: 356 B: 248 T: 232 mm	(Pal. 75) 1	98.60	netto



TORK Tork Performance Innenabrollungsspender - M2 System

schwarz / rot

Artikel-Nr.	Produktinfo	Inhalt /VE	Preis /VE	
16458	Kunststoff, H: 356 B: 248 T: 232 mm	(Pal. 75) 1	98.60	netto

Tork - Wisch- und Reinigungstücher | Spender



TORK Tork Elevation Innenabrollungsspender - M2 System

weiss

Artikel-Nr.	Produktinfo	Inhalt /VE	Preis /VE	
7138.3	Kunststoff, H: 360 B: 239 T: 227 mm	(Pal. 75) 1	118.20	netto



TORK Tork Elevation Innenabrollungsspender - M2 System

schwarz

Artikel-Nr.	Produktinfo	Inhalt /VE	Preis /VE	
10194	Kunststoff, H: 360 B: 239 T: 227 mm	(Pal. 75) 1	118.20	netto



TORK Tork Wave Reflex Einzelblatt Mini Innenabrollungsspender - M3 System

Kunststoff, H: 210 B: 182 T: 297 mm

Artikel-Nr.	Produktinfo	Inhalt /VE	Preis /VE	
16288	blau	(Pal. 140) 1	46.20	netto

Erhältlich mit Leihspendervertrag (es können Servicegebühren anfallen)



TORK Tork Wave Reflex Einzelblatt Innenabrollungsspender - M4 System

blau

Artikel-Nr.	Produktinfo	Inhalt /VE	Preis /VE	
14611	Kunststoff, H: 318 B: 236 T: 265 mm	(Pal. 80) 1	55.95	netto

Erhältlich mit Leihspendervertrag (es können Servicegebühren anfallen)



TORK Tork Wave Reflex Einzelblatt Innenabrollungsspender - M4 System

weiss

Artikel-Nr.	Produktinfo	Inhalt /VE	Preis /VE	
22399	Kunststoff, H: 318 B: 236 T: 265 mm	(Pal. 80) 1	55.95	netto

Erhältlich mit Leihspendervertrag (es können Servicegebühren anfallen)



TORK Tork Performance Bodenspender - W1 System

türkis / weiss

Artikel-Nr.	Produktinfo	Inhalt /VE	Preis /VE	
16355	Kunststoff / Metall, H: 1006 B: 646 T: 530 mm	(Pal. 7) 1	173.80	netto



TORK Tork Performance Bodenspender - W1 System

schwarz / rot

Artikel-Nr.	Produktinfo	Inhalt /VE	Preis /VE	
16356	Kunststoff / Metall, H: 1006 B: 646 T: 530 mm	(Pal. 7) 1	173.80	netto



TORK Tork Performance Wandhalter - W1 System

türkis / weiss

Artikel-Nr.	Produktinfo	Inhalt /VE	Preis /VE	
16451	Kunststoff / Metall, H: 463 B: 646 T: 274 mm	(Pal. 23) 1	119.80	netto



TORK Tork Performance Wandhalter - W1 System

schwarz / rot

Artikel-Nr.	Produktinfo	Inhalt /VE	Preis /VE	
16452	Kunststoff / Metall, H: 463 B: 646 T: 274 mm	(Pal. 23) 1	119.80	netto

Tork - Wisch- und Reinigungstücher | Spender



TORK Tork Performance Maxi Innenabrollungsspender - W2 System

türkis / weiss

Artikel-Nr.	Produktinfo	Inhalt /VE	Preis /VE	
16453	Kunststoff, H: 447 B: 328 T: 302 mm	(Pal. 20) 1	126.30	netto



TORK Tork Performance Maxi Innenabrollungsspender - W2 System

schwarz / rot

Artikel-Nr.	Produktinfo	Inhalt /VE	Preis /VE	
16454	Kunststoff, H: 447 B: 328 T: 302 mm	(Pal. 20) 1	126.30	netto



TORK Tork Performance Einzeltuchspender - W4 System

türkis / weiss

Artikel-Nr.	Produktinfo	Inhalt /VE	Preis /VE	
16357	Kunststoff, H: 394 B: 427 T: 206 mm	(Pal. 52) 1	72.30	netto

Erhältlich mit Leihspendervertrag (es können Servicegebühren anfallen)



TORK Tork Performance Einzeltuchspender - W4 System

schwarz / rot

Artikel-Nr.	Produktinfo	Inhalt /VE	Preis /VE	
16358	Kunststoff, H: 394 B: 427 T: 206 mm	(Pal. 52) 1	72.30	netto

Erhältlich mit Leihspendervertrag (es können Servicegebühren anfallen)



TORK Tork Spender Small Pack - System W8

Kunststoff, H: 210 B: 150 T: 110 mm

Artikel-Nr.	Produktinfo	Inhalt /VE	Preis /VE	
28264	weiss	(Pal. 308) 1	9.10	netto

Kimberly Clark - Wisch- und Reinigungstücher | Kimberly-Clark Spender



Kimberly-Clark PROFESSIONAL Fahrbarer Bodenständiger Kimberly-Clark für Wypall X & Wypall L Grossrollen

Metall, H: 1090 B: 500 T: 740 mm

Artikel-Nr.	Produktinfo	Inhalt /VE	Preis /VE	
7433	blau	(Pal. 12) 1	111.30	netto

Kostenlos erhältlich mit Spenderleihvertrag (ab 10 Kimberly Clark-Spender)



Kimberly-Clark PROFESSIONAL Wandspender Kimberly-Clark für Wypall X & Wypall L Grossrollen

Metall, H: 328 B: 515 T: 300 mm

Artikel-Nr.	Produktinfo	Inhalt /VE	Preis /VE	
7866	blau	(Pal. 44) 1	89.90	netto

Kostenlos erhältlich mit Spenderleihvertrag (ab 10 Kimberly Clark-Spender)



Kimberly-Clark PROFESSIONAL Bodenständiger Kimberly-Clark für Wypall X & Wypall L Grossrollen

Metall, H: 960 B: 515 T: 550 mm

Artikel-Nr.	Produktinfo	Inhalt /VE	Preis /VE	
8872	blau	(Pal. 51) 1	82.00	netto

Kostenlos erhältlich mit Spenderleihvertrag (ab 10 Kimberly Clark-Spender)

Kimberly Clark - Wisch- und Reinigungstücher | Kimberly-Clark Spender



Zentralentnahme-Spender Kimberly-Clark

Kunststoff, H: 315 B: 170 T: 170 mm

Artikel-Nr.	Produktinfo	Inhalt /VE	Preis /VE	
8863*	schwarz, für Art. 8831.1 / 8824.1 / 8861 / 8860 / 17767 / 23336	(Pal. 119) 1	79.85	netto

Kostenlos erhältlich mit Spenderleihvertrag (ab 10 Kimberly Clark-Spender)



Spender Kimberly-Clark für Wypall X & Wypall L Zentralentnahme-Rollen

Kunststoff, H: 370 B: 260 T: 260 mm

Artikel-Nr.	Produktinfo	Inhalt /VE	Preis /VE	
8869	schwarz, für Art. 8830	(Pal. 32) 1	86.75	netto

Kostenlos erhältlich mit Spenderleihvertrag (ab 10 Kimberly Clark-Spender)



Aquarius Spender Kimberly-Clark für Roll Control System (RCS)

Kunststoff, H: 278 B: 276 T: 226 mm

Artikel-Nr.	Produktinfo	Inhalt /VE	Preis /VE	ab 5 VE 10%
22047	weiss, für Art. 8816.1 / 8817.1 / 8815.1 / 19763 / 27092	(Pal. 52) 1	61.50	55.35

Kostenlos erhältlich mit Spenderleihvertrag (ab 10 Kimberly Clark-Spender)



Spender Kimberly-Clark für Wypall-Reinigungstücher mit 1/4 Falzung

Kunststoff, H: 196 B: 223 T: 223 mm

Artikel-Nr.	Produktinfo	Inhalt /VE	Preis /VE	ab 5 VE 10%
24637	grau / blau-transparent, für Art. 26158 / 26159 / 26161 / 26162	(Pal. 75) 1	47.35	42.60



Kimberly Clark - Wisch- und Reinigungstücher | Wypall*X Wischtücher - Wiederverwendbar

X80



Reinigungstücher Kimberly-Clark Wypall - X80

stahlblau, Hydroknit, Grossrolle

Artikel-Nr.	Produktinfo	Inhalt /VE	Preis /VE	Preis VE /Pal.
8374	42 x 38 cm, 475 Blatt, für Spender Art. 7866 / 8872 / 7433	(Pal. 32) 1	186.35	142.85



Reinigungstücher Kimberly-Clark Wypall - X80

weiss, Hydroknit, Grossrolle

Artikel-Nr.	Produktinfo	Inhalt /VE	Preis /VE	Preis VE /Pal.
8377	31.5 x 34 cm, 475 Blatt, für Spender Art. 7866 / 8872 / 7433	(Pal. 55) 1	118.95	91.20



Reinigungstücher Kimberly-Clark Wypall Brag Box - X80

stahlblau, Hydroknit, Interfold-Falzung, Brag Box

Artikel-Nr.	Produktinfo	Inhalt /VE	Preis /VE	Preis VE /Pal.
8373	31.8 x 42.7 cm, 160 Blatt	(Pal. 70) 160	67.20	51.55



Reinigungstücher Kimberly-Clark Wypall Brag Box - X80

weiss, Hydroknit, Interfold-Falzung, Brag Box

Artikel-Nr.	Produktinfo	Inhalt /VE	Preis /VE	ab 5 VE 10%
18379	31.8 x 42.7 cm, 160 Blatt	(Pal. 50) 1	64.85	58.35



Kimberly Clark - Wisch- und Reinigungstücher | Wypall*X Wischtücher - Wiederverwendbar

X80



Reinigungstücher Kimberly-Clark Wypall - X80

stahlblau, Hydroknit, Interfold-Falzung, Zupfbox

Artikel-Nr.	Produktinfo	Inhalt /VE	Preis /VE	Preis VE /Pal.
8375	23.1 x 42.6 cm, 80 Blatt	(Pal. 42) 400	148.55	113.85



Reinigungstücher Kimberly-Clark Wypall - X80

weiss, Hydroknit, 1/4 Falzung



Artikel-Nr.	Produktinfo	Inhalt /VE	Preis /VE	ab 5 VE 10%
14083	32 x 31 cm, 50 Blatt, für Spender Art. 24637	(Pal. 90) 200	55.15	49.65



Reinigungstücher Kimberly-Clark Wypall - X80

Hydroknit, Interfold-Falzung, 34.4 x 41.6 cm, 25 Blatt



Artikel-Nr.	Produktinfo	Inhalt /VE	Preis /VE	Preis VE /Pal.
8400	blau	(Pal. 66) 250	150.40	115.25
8402	gelb	(Pal. 66) 250	150.40	115.25
8404	rot	(Pal. 66) 250	150.40	115.25
12972*	grün	(Pal. 66) 250	150.40	115.25



Reinigungstücher Kimberly-Clark Wypall - X80 Plus

Hydroknit, 1/4 Falzung, 34 x 35 cm, 30 Blatt



Artikel-Nr.	Produktinfo	Inhalt /VE	Preis /VE	ab 5 VE 10%
26158	rot	(Pal. 40) 240	113.00	101.70
26159	blau	(Pal. 40) 240	113.00	101.70
26161	grün	(Pal. 40) 240	113.00	101.70
26162	gelb	(Pal. 40) 240	113.00	101.70

X70



Reinigungstücher Kimberly-Clark Wypall - X70

weiss, Hydroknit, Grossrolle



Artikel-Nr.	Produktinfo	Inhalt /VE	Preis /VE	Preis VE /Pal.
8384	41 x 38 cm, 500 Blatt, für Spender Art. 7866 / 8872 / 7433	(Pal. 32) 1	177.80	136.30



Reinigungstücher Kimberly-Clark Wypall - X70

weiss, Hydroknit, 1/4 Falzung



Artikel-Nr.	Produktinfo	Inhalt /VE	Preis /VE	Preis VE /Pal.
14167	31 x 32 cm, 76 Blatt	(Pal. 30) 912	216.80	173.85



Reinigungstücher Kimberly-Clark Wypall Brag Box - X70

weiss, Hydroknit, Interfold-Falzung, Brag Box



Artikel-Nr.	Produktinfo	Inhalt /VE	Preis /VE	Preis VE /Pal.
8383	31.8 x 42.7 cm, 152 Blatt	(Pal. 70) 1	57.00	43.75



Reinigungstücher Kimberly-Clark Wypall - X70

weiss, Hydroknit, Interfold-Falzung, Proman



Artikel-Nr.	Produktinfo	Inhalt /VE	Preis /VE	Preis VE /Pal.
7449	42 x 38 cm, 70 Blatt	(Pal. 30) 420	151.95	115.10

Kimberly Clark - Wisch- und Reinigungstücher | Wypall*X Wischtücher - Wiederverwendbar

X60



Reinigungstücher Kimberly-Clark Wypall Brag Box - X60

blau, Hydroknit, Interfold-Falzung, Brag Box



Artikel-Nr.	Produktinfo	Inhalt /VE	Preis /VE	Preis VE /Pal.
8370	31.7 x 42.6 cm, 200 Blatt	(Pal. 70) 1	65.45	50.15



Reinigungstücher Kimberly-Clark Wypall - X60

weiss, Hydroknit, Zupfbox



Artikel-Nr.	Produktinfo	Inhalt /VE	Preis /VE	Preis VE /Pal.
8376*	42.6 x 23.1 cm, 10 x 126 Blatt	(Pal. 18) 1260	218.30	netto



Reinigungstücher Kimberly-Clark Wypall - X60

weiss, Hydroknit, Grossrolle



Artikel-Nr.	Produktinfo	Inhalt /VE	Preis /VE	Preis VE /Pal.
8407	42 x 38 cm, 750 Blatt, für Spender Art. 7866 / 8872 / 7433	(Pal. 32) 1	199.10	152.70



Reinigungstücher Kimberly-Clark Wypall - X60

weiss, Hydroknit, 1/4-Falzung, in Kartonbox



Artikel-Nr.	Produktinfo	Inhalt /VE	Preis /VE	Preis VE /Pal.
8405	31 x 32 cm, 76 Blatt	(Pal. 30) 912	183.15	140.45



Reinigungstücher Kimberly-Clark Wypall - X60

weiss, Hydroknit, Interfold-Falzung, Brag Box



Artikel-Nr.	Produktinfo	Inhalt /VE	Preis /VE	Preis VE /Pal.
8406	31.7 x 42.6 cm, 200 Blatt	(Pal. 70) 1	58.50	44.85



Reinigungstücher Kimberly-Clark Wypall - X60

blau, Hydroknit, Multibox



Artikel-Nr.	Produktinfo	Inhalt /VE	Preis /VE	ab 5 VE 10%
8380	24.5 x 42 cm, 150 Blatt	(Pal. 112) 1	25.75	23.20

X50



Reinigungstücher Kimberly-Clark Wypall - X50

Hydroknit, Interfold-Falzung, 24.5 x 41.6 cm, 50 Tücher, für Spender Art. 20565



Artikel-Nr.	Produktinfo	Inhalt /VE	Preis /VE	Preis VE /Pal.
7441	blau	(Pal. 112) 300	73.05	55.30
7442	grün	(Pal. 112) 300	73.05	55.30
7443	gelb	(Pal. 112) 300	73.05	55.30
7444*	rot	(Pal. 112) 300	73.05	55.30

Kimberly Clark - Wisch- und Reinigungstücher | Wypall*L Wischtücher

L40



Papierwischtücher Kimberly-Clark Wypall - L40

weiss, 1-lagig, Zellstoff-Latex-Gemisch, Grossrolle

Artikel-Nr.	Produktinfo	Inhalt /VE	Preis /VE	Preis VE /Pal.
8801	32 x 34 cm, 750 Blatt, für Spender Art. 7866 / 8872 / 7433	(Pal. 30) 1	176.05	135.05
12107	31.5 x 34 cm, 950 Blatt, für Spender Art. 7866 / 8872 / 7433	(Pal. 30) 1	141.05	108.20

Kimberly Clark - Wisch- und Reinigungstücher | Wypall*L Wischtücher

L40



Papierwischtücher Kimberly-Clark Wypall - L40

weiss, 1-lagig, Zellstoff-Latex-Gemisch, 1/4-Falzung, Karton

Artikel-Nr.	Produktinfo	Inhalt /VE	Preis /VE	Preis VE /Pal.
8800	31.8 x 30.5 cm, 56 Blatt	(Pal. 18) 1008	201.60	154.55

L30



Papierwischtücher Kimberly-Clark Wypall - L30 Ultra+

blau, 3-lagig, Airflex, Grossrolle



Artikel-Nr.	Produktinfo	Inhalt /VE	Preis /VE	Preis VE /Pal.
8803	33 x 38 cm, 750 Blatt, für Spender Art. 7866 / 8872 / 7433	(Pal. 30) 1	77.55	59.50



Papierwischtücher Kimberly-Clark Wypall - L30 Ultra

weiss, 3-lagig, Airflex, Grossrolle



Artikel-Nr.	Produktinfo	Inhalt /VE	Preis /VE	ab 5 VE 10%
8826	37 x 38 cm, 1000 Blatt, für Spender Art. 7866 / 8872 / 7433	(Pal. 30) 1	104.00	93.60



Papierwischtücher Kimberly-Clark Wypall - L30 Ultra+

blau, 3-lagig, Airflex, Grossrolle



Artikel-Nr.	Produktinfo	Inhalt /VE	Preis /VE	Preis VE /Pal.
8804	23.5 x 38 cm, 750 Blatt, für Spender Art. 7866 / 8872 / 7433	(Pal. 42) 1	55.20	42.35



Papierwischtücher Kimberly-Clark Wypall - L30 Ultra

blau, 3-lagig, LDC, Grossrolle



Artikel-Nr.	Produktinfo	Inhalt /VE	Preis /VE	ab 5 VE 10%
28366*	35 x 38 cm, 1000 Blatt	(Pal. 30) 1	32.10	28.90

L20



Papierwischtücher Kimberly-Clark Wypall - L20 Extra+

blau, 2-lagig, Airflex, Grossrolle



Artikel-Nr.	Produktinfo	Inhalt /VE	Preis /VE	Preis VE /Pal.
8809	33 x 38 cm, 500 Blatt, für Spender Art. 7866 / 8872 / 7433	(Pal. 65) 1	27.15	20.80
8810	23.5 x 38 cm, 500 Blatt, für Spender Art. 7866 / 8872 / 7433	(Pal. 91) 1	19.45	14.95



Papierwischtücher Kimberly-Clark Wypall Brag Box - L20 Extra

blau, 2-lagig, Airflex, Interfold Falzung, Brag Box



Artikel-Nr.	Produktinfo	Inhalt /VE	Preis /VE	Preis VE /Pal.
8802	33 x 42 cm, 280 Blatt	(Pal. 55) 1	42.20	32.40



Papierwischtücher Kimberly-Clark Wypall - L20 Extra

weiss, 2-lagig, Airflex, Zentralentnahme



Artikel-Nr.	Produktinfo	Inhalt /VE	Preis /VE	Preis VE /Pal.
8830	18.5 x 42.5 cm, 300 Blatt, für Spender Art. 8869	(Pal. 32) 6	105.30	80.75

Kimberly Clark - Wisch- und Reinigungstücher | Wypall*L Wischtücher

L20



Papierwischtücher Kimberly-Clark Wypall - L20 Extra

blau, 2-lagig, Airflex, Grossrolle, verleimt



Artikel-Nr.	Produktinfo	Inhalt /VE	Preis /VE	ab 5 VE 10%
7346	23.5 x 38 cm, 1000 Blatt, für Spender Art. 7866 / 8872 / 7433	(Pal. 56) 1	36.20	32.55



Papierwischtücher Kimberly-Clark Wypall - L20 Extra+

blau, 2-lagig, Airflex, Kleinrolle



Artikel-Nr.	Produktinfo	Inhalt /VE	Preis /VE	ab 5 VE 10%
8833*	24 x 38 cm, 100 Blatt	(Pal. 12) 24	228.20	205.35



Papierwischtücher Kimberly-Clark Wypall - L20 Extra

blau, 2-lagig, Airflex, Grossrolle, verleimt



Artikel-Nr.	Produktinfo	Inhalt /VE	Preis /VE	ab 5 VE 10%
7347	33 x 38 cm, 1000 Blatt, für Spender Art. 7866 / 8872 / 7433	(Pal. 40) 1	46.55	41.90



Papierwischtücher Kimberly-Clark Wypall - L20 Extra

weiss, 2-lagig, Airflex, Grossrolle



Artikel-Nr.	Produktinfo	Inhalt /VE	Preis /VE	Preis VE /Pal.
10281	32.5 x 38.5 cm, 1000 Blatt, für Spender Art. 7866 / 8872 / 7433	(Pal. 40) 1	46.30	35.50



Papierwischtücher Kimberly-Clark Wypall - L20

weiss, 2-lagig, LDC, Grossrolle



Artikel-Nr.	Produktinfo	Inhalt /VE	Preis /VE	Preis VE /Pal.
14732	23 x 38 cm, 1500 Blatt	(Pal. 20) 2	85.40	65.50

L10



Papierwischtücher Kimberly-Clark Wypall - L10 Extra+

weiss, 1-lagig, Airflex, Zentralentnahme



Artikel-Nr.	Produktinfo	Inhalt /VE	Preis /VE	Preis VE /Pal.
8827	18.5 x 38 cm, 400 Blatt, für Spender Art. 22417	(Pal. 36) 6	58.65	45.00



Papierwischtücher Kimberly-Clark Wypall - L10 Extra+

weiss, 1-lagig, Airflex, Grossrolle



Artikel-Nr.	Produktinfo	Inhalt /VE	Preis /VE	Preis VE /Pal.
8811	32.5 x 38.5 cm, 1000 Blatt, für Spender Art. 7866 / 8872 / 7433	(Pal. 40) 1	41.20	31.60



Papierwischtücher Kimberly-Clark Wypall - L10 Extra+

blau, 1-lagig, Airflex, Grossrolle



Artikel-Nr.	Produktinfo	Inhalt /VE	Preis /VE	Preis VE /Pal.
8835	32.5 x 38.5 cm, 1000 Blatt, für Spender Art. 7866 / 8872 / 7433	(Pal. 40) 1	42.45	32.60



Papierwischtücher Kimberly-Clark Wypall - L10 Extra+

weiss, 1-lagig, Airflex, Grossrolle



Artikel-Nr.	Produktinfo	Inhalt /VE	Preis /VE	Preis VE /Pal.
8820	23.5 x 38 cm, 1000 Blatt, für Spender Art. 7866 / 8872 / 7433	(Pal. 56) 1	29.30	22.40

Kimberly Clark - Wisch- und Reinigungstücher | Wypall*L Wischtücher

L10



Papierwischtücher Kimberly-Clark Wypall - L10 Extra+

weiss, 1-lagig, Airflex, Zentralentnahme RCS



Artikel-Nr.	Produktinfo	Inhalt /VE	Preis /VE	Preis VE /Pal.
8816.1	18.5 x 38 cm, 400 Blatt, für Spender Art. 22047	(Pal. 36) 6	62.75	48.10



Papierwischtücher Kimberly-Clark Wypall - L10 Extra+

blau, 1-lagig, Airflex, Zentralentnahme RCS



Artikel-Nr.	Produktinfo	Inhalt /VE	Preis /VE	Preis VE /Pal.
8817.1	18.5 x 38 cm, 400 Blatt, für Spender Art. 22047	(Pal. 36) 6	56.35	43.20



Papierwischtücher Kimberly-Clark Wypall - L10 Extra

weiss, 1-lagig, Airflex, Grossrolle



Artikel-Nr.	Produktinfo	Inhalt /VE	Preis /VE	Preis VE /Pal.
8829	23.5 x 38 cm, 1500 Blatt, für Spender Art. 7866 / 8872 / 7433	(Pal. 56) 1	32.45	24.85



Papierwischtücher Kimberly-Clark Wypall - L10 Extra

weiss, 1-lagig, Airflex, Zentralentnahme



Artikel-Nr.	Produktinfo	Inhalt /VE	Preis /VE	Preis VE /Pal.
8831.1	18.5 x 38 cm, 200 Blatt, für Spender Art. 8863	(Pal. 36) 12	63.45	48.65
8824.1	18.5 x 38 cm, 250 Blatt, für Spender Art. 8863	(Pal. 54) 9	48.85	37.45
8818.1	18.5 x 38 cm, 630 Blatt, für Spender Art. 22417 / 8869	(Pal. 36) 6	62.35	47.80



Papierwischtücher Kimberly-Clark Wypall - L10 Extra

weiss, 1-lagig, Airflex, Zentralentnahme RCS



Artikel-Nr.	Produktinfo	Inhalt /VE	Preis /VE	Preis VE /Pal.
8815.1	18.5 x 38 cm, 630 Blatt, für Spender Art. 22047	(Pal. 36) 6	82.40	63.15



Papierwischtücher Kimberly-Clark Wypall - L10 Extra

blau, 1-lagig, Airflex, Zentralentnahme RCS



Artikel-Nr.	Produktinfo	Inhalt /VE	Preis /VE	ab 5 VE 10%
19763*	18.5 x 38 cm, 525 Blatt, für Spender Art. 22047	(Pal. 36) 6	51.40	46.30



Papierwischtücher Kimberly-Clark Wypall - L10 Essential

weiss, 1-lagig, unperforiert, Zentralentnahme



Artikel-Nr.	Produktinfo	Inhalt /VE	Preis /VE	ab 5 VE 10%
26955*	19.5 cm x 300 m, für Spender Art. 22417	(Pal. 32) 6	70.65	63.60



Papierwischtücher Kimberly-Clark Wypall - L10 Extra

weiss, 1-lagig, Airflex, Zentralentnahme RCS



Artikel-Nr.	Produktinfo	Inhalt /VE	Preis /VE	ab 5 VE 10%
27092*	18.5 x 38 cm, 525 Blatt, für Spender Art. 22047	(Pal. 36) 6	48.55	43.70

Kimberly Clark - Wisch- und Reinigungstücher | Wypall*Reinigungstücher



Reinigungstücher Kimberly-Clark Wypall

grün, feucht

Artikel-Nr.	Produktinfo	Inhalt /VE	Preis /VE	Preis VE /Pal.
7452	27 x 27 cm, 300 Blatt, Spenderbox	(Pal. 66) 6	165.60	125.45
8864	27 x 27 cm, 540 Blatt, Spendereimer	(Pal. 24) 6	281.45	215.80

* auf Bestellung

Kimberly Clark - Wisch- und Reinigungstücher | Kimtech Pure*Wischtücher



Papierwischtücher Kimberly-Clark Kimtech Pure

weiss, 1-lagig, Polypropylen, 1/4-Falzung

Artikel-Nr.	Produktinfo	Inhalt /VE	Preis /VE	Preis VE /Pal.
8844*	35.1 x 38.5 cm, 420 Blatt	(Pal. 36) 420	163.25	125.15



Papierwischtücher Kimberly-Clark Kimtech Pure - W4

weiss, 1-lagig, Polypropylen, 1/4-Falzung

Artikel-Nr.	Produktinfo	Inhalt /VE	Preis /VE	ab 5 VE 10%
14647*	30.4 x 30.4 cm, 100 Blatt	(Pal. 18) 500	414.85	373.35
28448*	22.8 x 22.8 cm, 100 Blatt	(Pal. 45) 500	80.45	72.40

Kimberly Clark - Wisch- und Reinigungstücher | Kimtech Science*Labor- und Präzisionstücher



Labortücher Kimberly-Clark Kimtech Science

weiss, 2-lagig, Interfold-Falzung

Artikel-Nr.	Produktinfo	Inhalt /VE	Preis /VE	Preis VE /Pal.
7437	20 x 21 cm, 100 Blatt	(Pal. 50) 2400	78.70	59.60
14304*	20 x 20.5 cm, 200 Blatt	(Pal. 50) 3000	82.15	73.95



Präzisionstücher Kimberly-Clark Kimtech Science

weiss, 1-lagig, Interfold Falzung

Artikel-Nr.	Produktinfo	Inhalt /VE	Preis /VE	Preis VE /Pal.
7438	30 x 30 cm, 196 Blatt	(Pal. 25) 2940	304.75	230.85
7439	11.4 x 21.3 cm, 280 Blatt	(Pal. 42) 8400	225.15	172.65

Kimberly Clark - Wisch- und Reinigungstücher | Kimtech*Prozesswischtücher



Prozesswischtücher Kimberly-Clark Kimtech Science

blau, 1-lagig, Polypropylen, Grossrolle

Artikel-Nr.	Produktinfo	Inhalt /VE	Preis /VE	Preis VE /Pal.
8840	34 x 38 cm, 500 Blatt, für Spender Art. 7866 / 8872 / 7433	(Pal. 30) 1	228.50	175.25



Prozesswischtücher Kimberly-Clark Kimtech Science

blau, 1-lagig, Polypropylen, 1/4-Falzung

Artikel-Nr.	Produktinfo	Inhalt /VE	Preis /VE	Preis VE /Pal.
8841	49 x 38.1 cm, 35 Blatt	(Pal. 24) 420	238.90	183.30



Prozesswischtücher Kimberly-Clark Kimtech Science

blau, Polypropylen, Interfold-Falzung, Brag Box

Artikel-Nr.	Produktinfo	Inhalt /VE	Preis /VE	Preis VE /Pal.
8842	42.6 x 30.7 cm, 160 Blatt	(Pal. 70) 1	73.80	56.60

Kimberly Clark - Wisch- und Reinigungstücher | Kimtech*Poliertücher



Poliertücher Kimberly-Clark Kimtech Science

weiss, 1-lagig, Viskose-/Polyester-Spinnvlies, Grossrolle, Zentralentnahme

Artikel-Nr.	Produktinfo	Inhalt /VE	Preis /VE	Preis VE /Pal.
8850	39 x 60 cm, 300 Blatt	(Pal. 48) 1	213.65	163.75

Kimberly Clark - Wisch- und Reinigungstücher | Kimtech*Wettask - Nachfüllbares Reinigungssystem



Spendereimer Kimberly-Clark Kimtech Wettask DS

weiss, PE, nachfüllbar

Artikel-Nr.	Produktinfo	Inhalt /VE	Preis /VE	ab 5 VE 10%
14548	3 Liter, 20 x 17.8 cm, für Art. 8861 / 8860 / 17767 / 23336	(Pal. 55) 6	74.50	67.05



Papierwischtücher Kimberly-Clark Kimtech Wettask SXX

weiss, feucht, Nachfüllung

Artikel-Nr.	Produktinfo	Inhalt /VE	Preis /VE	Preis VE /Pal.
8860	31 x 32 cm, 60 Blatt, für Spender Art. 22287 / 14548 / 8863	(Pal. 50) 6	172.70	132.40



Papierwischtücher Kimberly-Clark Kimtech Wettask DS

weiss, feucht, Polypropylen

Artikel-Nr.	Produktinfo	Inhalt /VE	Preis /VE	ab 5 VE 10%
17767	30.5 x 31.8 cm, 90 Blatt, für Spender Art. 22287 / 14548 / 8863	(Pal. 54) 6	94.10	84.70



Rollspendereimer Kimberly-Clark Kimtech Wettask

blau, HDPE, mit selbstschliessbarem Deckel

Artikel-Nr.	Produktinfo	Inhalt /VE	Preis /VE	ab 5 VE 10%
22287	4.5 Liter, 22 x 23.5 cm, für Art. 8861 / 8860 / 17767 / 23336	(Pal. 21) 4	168.20	151.40

Kimberly Clark - Wisch- und Reinigungstücher | Kimtech*Diverse Produkte



Reinigungstücher Kimberly-Clark Professional

weiss, 1-lagig, Hydroknit, Grossrolle

Artikel-Nr.	Produktinfo	Inhalt /VE	Preis /VE	ab 5 VE 10%
28372	31 x 34 cm, 540 Blatt	(Pal. 24) 1	101.25	91.10



Universalreinigungstücher Kimberly-Clark Professional

weiss, 1-lagig, Hydroknit, Grossrolle

Artikel-Nr.	Produktinfo	Inhalt /VE	Preis /VE	ab 5 VE 10%
28373*	31 x 34 cm, 900 Blatt	(Pal. 18) 1	97.75	87.95

Bulkysoft | Wischtücher Mini / Midi



Papierwischtücher Mini Bulkysoft Classic

weiss, 1-lagig, 100 % Zellstoff, Innenabwicklung

Artikel-Nr.	Produktinfo	Inhalt /VE	Preis /VE	ab 5 VE 10%
26256	Ø 12.5 cm, 20 cm x 120 lfm, unperforiert, für Spender Art. 26281	(Pal. 45) 12	49.05	44.15



Papierwischtücher Mini Bulkysoft Premium

weiss, 2-lagig, 100 % Zellstoff, Innenabwicklung, Micro-Prägung

Artikel-Nr.	Produktinfo	Inhalt /VE	Preis /VE	ab 5 VE 10%
26255	Ø 12.5 cm, 22 x 30 cm, 200 Blatt = 60 lfm, für Spender Art. 26281	(Pal. 40) 12	41.60	37.45



Papierwischtücher Midi Bulkysoft Premium

weiss, 2-lagig, 100 % Zellstoff, Innenabwicklung, Micro-Prägung

Artikel-Nr.	Produktinfo	Inhalt /VE	Preis /VE	ab 5 VE 10%
26254	Ø 19 cm, 22 x 38 cm, 421 Blatt = 160 lfm, für Spender Art. 26279	(Pal. 32) 6	40.35	36.35



BulkySoft | Wischtücher Mini / Midi



BulkySoft Papierwischtücher Midi BulkySoft Classic

weiss, 1-lagig, 100 % Zellstoff, Innenabwicklung



Artikel-Nr.	Produktinfo	Inhalt /VE	Preis /VE	ab 5 VE 10%
26257	Ø 19 cm, 22 x 35 cm, 857 Blatt = 300 lfm, für Spender Art. 26279	(Pal. 40) 6	48.15	43.30

BulkySoft | Spender für Wischtücher Mini / Midi



BulkySoft Spender für Papierwischtücher Mini BulkySoft

ABS Kunststoff, H: 345 B: 180 T: 172 mm, Innenabwicklung, abschliessbar

Artikel-Nr.	Produktinfo	Inhalt /VE	Preis /VE	
26281	weiss / transparent	(Pal. 120) 1	37.90	netto



BulkySoft Spender für Papierwischtücher Midi BulkySoft

ABS Kunststoff, H: 365 B: 250 T: 230 mm, Innenabwicklung, abschliessbar

Artikel-Nr.	Produktinfo	Inhalt /VE	Preis /VE	
26279	weiss / transparent	(Pal. 72) 1	48.60	netto

BulkySoft | Wischtücher Maxi



BulkySoft Papierwischtücher Maxi BulkySoft Premium

blau, 2-lagig, 100 % Zellstoff, Aussenabwicklung, Micro-Prägung



Artikel-Nr.	Produktinfo	Inhalt /VE	Preis /VE	ab 5 VE 10%
26262	Ø 27 cm, 38 x 26 cm, 800 Blatt = 304 lfm, für Spender Art. 26282 / 26284 / 26285	(Pal. 49) 2	32.00	28.80



BulkySoft Papierwischtücher Maxi BulkySoft Premium

blau, 2-lagig, 100 % Zellstoff, Aussenabwicklung, Evolution-Prägung



Artikel-Nr.	Produktinfo	Inhalt /VE	Preis /VE	ab 5 VE 10%
26263	Ø 28 cm, 38 x 36 cm, 1000 Blatt = 380 lfm, für Spender Art. 26285	(Pal. 30) 2	54.20	48.75



BulkySoft Papierwischtücher Maxi BulkySoft Excellence

blau, 3-lagig, 100 % Zellstoff, Aussenabwicklung, Micro-Prägung



Artikel-Nr.	Produktinfo	Inhalt /VE	Preis /VE	ab 5 VE 10%
26261	Ø 29 cm, 38 x 36 cm, 500 Blatt = 190 lfm, für Spender Art. 26285	(Pal. 30) 2	41.80	37.65



BulkySoft Papierwischtücher Maxi BulkySoft Excellence

weiss, 3-lagig, 100 % Zellstoff, Innenabwicklung, Evolution-Prägung



Artikel-Nr.	Produktinfo	Inhalt /VE	Preis /VE	ab 5 VE 10%
26258	Ø 26 cm, 26 x 30 cm, 500 Blatt = 150 lfm, für Spender Art. 26282 / 26284 / 26285	(Pal. 49) 2	21.40	19.25



BulkySoft Papierwischtücher Maxi BulkySoft Classic

weiss, 2-lagig, 100 % Zellstoff, Aussenabwicklung, Evolution-Prägung

Artikel-Nr.	Produktinfo	Inhalt /VE	Preis /VE	
26136	Ø 25 cm, 26 x 34 cm, 800 Blatt = 272 lfm, für Spender Art. 26282 / 26284 / 26285	(Pal. 56) 2	21.30	netto



BulkySoft Papierwischtücher Maxi BulkySoft Excellence

blau, 3-lagig, 100 % Zellstoff, Aussenabwicklung, Evolution-Prägung



Artikel-Nr.	Produktinfo	Inhalt /VE	Preis /VE	ab 5 VE 10%
26259	Ø 26 cm, 26 x 30 cm, 500 Blatt = 150 lfm, für Spender Art. 26282 / 26284 / 26285	(Pal. 49) 2	23.75	21.40

Bulkysoft | Wischtücher Maxi



Bulkysoft Papierwischtücher Maxi Bulkysoft Excellence

blau, 3-lagig, 100 % Zellstoff, Aussenabwicklung, Micro-Prägung



Artikel-Nr.	Produktinfo	Inhalt /VE	Preis /VE	ab 5 VE 10%
26260	Ø 38 cm, 36 x 38 cm, 1000 Blatt = 380 lfm, für Spender Art. 26285	(Pal. 30) 1	41.80	37.65

Bulkysoft | Spender für Wischtücher Maxi



Bulkysoft Bodenständer für Papierwischtücher Maxi Bulkysoft

Kunststoff, H: 900 B: 480 T: 460 mm

Artikel-Nr.	Produktinfo	Inhalt /VE	Preis /VE	
26285	chrom, für Rollenbreite 370 / 380 mm	(Pal. 30) 1	35.50	netto



Bulkysoft Spender für Papierwischtücher Maxi Bulkysoft

Kunststoff, H: 410 B: 350 T: 345 mm, abschliessbar

Artikel-Nr.	Produktinfo	Inhalt /VE	Preis /VE	
26282	weiss / blau, für Rollenbreite max. 260 mm	(Pal. 30) 1	72.65	netto



Bulkysoft Wandhalterung für Papierwischtücher Maxi Bulkysoft

Kunststoff, H: 380 B: 320 T: 240 mm

Artikel-Nr.	Produktinfo	Inhalt /VE	Preis /VE	
26284	weiss / chrom, für Rollenbreite max. 320 mm	(Pal. 200) 1	44.00	netto

Chicopee - Reinigungstücher



Chicopee Reinigungstücher J-CLOTH PLUS, WIPE

36 x 61 cm



Artikel-Nr.	Produktinfo	Inhalt /VE	Preis /VE	Preis ab 10 VE
6450	weiss	(Pal. 300) 50	25.15	13.10
6451	grün	(Pal. 300) 50	25.15	13.10
6452	blau	(Pal. 300) 50	25.15	13.10
6453	gelb	(Pal. 300) 50	25.15	13.10
6454	rot	(Pal. 300) 50	25.15	13.10



Chicopee Reinigungstücher LAVETTE SUPER, WIPE

51 x 36 cm, besonders voluminös, reissfest und geschmeidig, waschbar und wiederverwendbar



Artikel-Nr.	Produktinfo	Inhalt /VE	Preis /VE	Preis ab 10 VE
6441	grün	(Pal. 36) 150	108.90	84.80
6442	blau	(Pal. 36) 150	108.90	84.80
6443	gelb	(Pal. 36) 150	108.90	84.80
6444	rot	(Pal. 36) 150	108.90	84.80



Chicopee Reinigungstücher MULTIPURPOSE SUPER, ROLL

weiss

Artikel-Nr.	Produktinfo	Inhalt /VE	Preis /VE	Preis ab 10 VE
12645	40 x 32 cm, 500 Blatt	(Pal. 30) 1	236.60	189.30

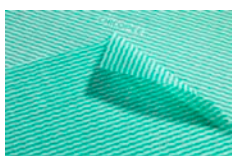

Reinigungstücher Econoline

grün, perfekte Schmutzaufnahme, einfach auszuspülen, wirtschaftlich im Gebrauch



Artikel-Nr.	Produktinfo	Inhalt /VE	Preis /VE	Preis ab 10 VE
6446	61 x 53 cm	(Pal. 40) 250	101.50	80.80

Chicopee - Reinigungstücher



Reinigungstücher Veraclean Polish Plus Wipe

weiss

Artikel-Nr.	Produktinfo	Inhalt /VE	Preis /VE	ab 5 VE 10%
6461	34 x 32 cm	(Pal. 24) 800	193.00	173.70



Reinigungstücher Veraclean Soft Plus Wipe

weiss

Artikel-Nr.	Produktinfo	Inhalt /VE	Preis /VE	
12139	43 x 50 cm	(Pal. 35) 400	132.25	netto

Diverse Hersteller | Wisch- und Reinigungstücher



Reinigungstücher

weiss, Vlies

Artikel-Nr.	Produktinfo	Inhalt /VE	Preis /VE	ab 5 VE 10%
7890	40 x 40 cm	(Pal. 30) 550	112.70	101.45



Reinigungstücher Sontara HDH

türkis, perforiert, reissfest, lösungsmittelbeständig, fusselfarm

Artikel-Nr.	Produktinfo	Inhalt /VE	Preis /VE	
20367	32 x 38 cm, Rolle à 500 Blatt	(Pal. 60) 1	97.20	netto



Reinigungstücher Sontara HDH

türkis, Z-Falzung, reissfest, lösungsmittelbeständig, fusselfarm

Artikel-Nr.	Produktinfo	Inhalt /VE	Preis /VE	
12291*	32 x 38 cm, Pack à 60 Blatt	(Pal. 32) 720	179.00	netto



Reinigungstücher Sontara HDS

türkis, Z-Falzung, reissfest, lösungsmittelbeständig, fusselfarm

Artikel-Nr.	Produktinfo	Inhalt /VE	Preis /VE	ab 5 VE 10%
14564	33.5 x 38 cm	(Pal. 42) 270	78.00	70.20



Reinigungstücher Wipex-Star

blau

Artikel-Nr.	Produktinfo	Inhalt /VE	Preis /VE	
4690	40 x 38 cm	(Pal. 30) 420	108.75	netto



KATRIN Reinigungstücher Katrin Plus Poly Roll Box

hochweiss, 1-lagig, Vlies

Artikel-Nr.	Produktinfo	Inhalt /VE	Preis /VE	ab 5 VE 10%
13342	32.5 x 36.5 cm, 800 Blatt = 292 lfm	(Pal. 24) 1	229.25	206.30



Papierwischtücher Midi ohne Kartonkern

weiss, 100% Zellstoff, 2-lagig

Artikel-Nr.	Produktinfo	Inhalt /VE	Preis /VE	
27516	20 x 36 cm, 450 Blatt = 162 lfm	(Pal. 40) 6	57.90	netto

Diverse Hersteller | Wisch- und Reinigungstücher



Papierwischtücher Midi

weiss, 2-lagig, 100% Zellstoff, Innen- / Aussenabwicklung

Artikel-Nr.	Produktinfo	Inhalt /VE	Preis /VE	Preis ab 10 VE
23518	Ø 20 cm, 24 x 36 cm, 450 Blatt = 162 lfm	(Pal. 32) 6	65.45	61.75



Papierwischtücher Mini

weiss, 2-lagig, 100% Zellstoff, geprägt, Innen- / Aussenabwicklung

Artikel-Nr.	Produktinfo	Inhalt /VE	Preis /VE	ab 5 VE 10%
25114	Ø 12.5 cm, 20 x 36 cm, 195 Blatt = 75 lfm	(Pal. 32) 12	45.85	41.25



Papierwischtücher Mini Premium

weiss, 1-lagig, 100% Zellstoff, geprägt, Innen- / Aussenabwicklung, unperforiert

Artikel-Nr.	Produktinfo	Inhalt /VE	Preis /VE	ab 5 VE 10%
25115	Ø 12.5 cm, 20 cm x 120 lfm	(Pal. 45) 12	41.50	37.35



Papierwischtücher Midi Comfort

weiss, 1-lagig, 100% Recycling, geprägt, Innen- / Aussenabwicklung, unperforiert

Artikel-Nr.	Produktinfo	Inhalt /VE	Preis /VE	ab 5 VE 10%
25109	Ø 20 cm, 22 cm x 320 lfm	(Pal. 32) 6	50.40	45.35



Papierwischtücher Midi Premium

weiss, 2-lagig, 100% Zellstoff, geprägt, Innen- / Aussenabwicklung

Artikel-Nr.	Produktinfo	Inhalt /VE	Preis /VE	ab 5 VE 10%
25108	Ø 19.5 cm, 22 x 36 cm, 438 Blatt = 158 lfm	(Pal. 40) 6	50.40	45.35



Papierwischtücher Midi Premium

weiss, 1-lagig, 100% Zellstoff, ungeprägt, Innen- / Aussenabwicklung, unperforiert

Artikel-Nr.	Produktinfo	Inhalt /VE	Preis /VE	ab 5 VE 10%
25110	Ø 19 cm, 22 cm x 320 lfm	(Pal. 40) 6	60.45	54.40



Papierwischtücher Maxi Premium

weiss, 2-lagig, 100% Zellstoff, geprägt, Innen- / Aussenabwicklung

Artikel-Nr.	Produktinfo	Inhalt /VE	Preis /VE	ab 5 VE 10%
25107	Ø 27.5 cm, 29 x 35 cm, 1000 Blatt = 350 lfm	(Pal. 36) 2	48.25	43.40



Papierwischtücher neutral Midi

weiss, 1-lagig, unperforiert, Innenabwicklung

Artikel-Nr.	Produktinfo	Inhalt /VE	Preis /VE	ab 5 VE 10%
12061	20 cm x 300 lfm	(Pal. 36) 6	63.70	57.35
16259	20 cm x 350 lfm	(Pal. 36) 6	64.30	49.30

Putzlappen aus Textil - Trikot



Putzlappen Trikot bunt

100% Baumwolle, sehr saugfähig, reissfest, weich und fusselfarm. Geeignet für Werkstätte, Elektroindustrie, Garagen, Carosseriebau, Metallbau, Druckerei, Eisen- und Luftseilbahnen, Bau, Reinigungsarbeiten, Dienstleistungsbetriebe usw.

Artikel-Nr.	Produktinfo	Inhalt /VE	Preis /VE	ab 5 VE 10%
27336	5 kg	(Pal. 120) 1	12.75	11.45
27338	10 kg	(Pal. 36) 1	26.90	24.20
27337	5 x 5 = 25 kg	(Pal. 24) 1	72.50	65.25

Putzlappen aus Textil - Trikot



Putzlappen Trikot bunt

Artikel-Nr.	Produktinfo	Inhalt /VE	Preis /VE	ab 5 VE 10%
13383	5 kg	(Pal. 100) 1	14.15	12.75
8995	5 x 5 = 25 kg	(Pal. 20) 1	74.50	67.05



Putzlappen Trikot bunt

Artikel-Nr.	Produktinfo	Inhalt /VE	Preis /VE	ab 5 VE 10%
13459	5 kg	(Pal. 100) 1	14.25	12.85



Putzlappen Trikot bunt mit Henkel

Artikel-Nr.	Produktinfo	Inhalt /VE	Preis /VE	ab 5 VE 10%
8995.1	5 x 5 = 25 kg	(Pal. 20) 1	75.00	67.50



Putzlappen Trikot dunkelbunt

Artikel-Nr.	Produktinfo	Inhalt /VE	Preis /VE	ab 5 VE 10%
25200	5 x 5 = 25 kg	(Pal. 24) 1	75.50	67.95



Putzlappen Trikot bunt I

Artikel-Nr.	Produktinfo	Inhalt /VE	Preis /VE	ab 5 VE 10%
8996	5 x 5 = 25 kg	(Pal. 20) 1	76.50	68.85



Putzlappen Trikot hell

Artikel-Nr.	Produktinfo	Inhalt /VE	Preis /VE	ab 5 VE 10%
27342	5 kg	(Pal. 72) 1	15.50	13.95
27344	10 kg	(Pal. 30) 1	28.00	25.20
27343	5 x 5 = 25 kg	(Pal. 24) 1	77.50	69.75



Putzlappen Trikot hell

Artikel-Nr.	Produktinfo	Inhalt /VE	Preis /VE	ab 5 VE 10%
13382	5 kg	(Pal. 100) 1	16.50	14.85
8991	5 x 5 = 25 kg	(Pal. 20) 1	80.00	72.00



Putzlappen Trikot hell, Kleinstücke

Artikel-Nr.	Produktinfo	Inhalt /VE	Preis /VE	ab 5 VE 10%
13394	5 kg	(Pal. 100) 1	18.45	16.60



Putzlappen Trikot weiss II

Artikel-Nr.	Produktinfo	Inhalt /VE	Preis /VE	ab 5 VE 10%
27390	10 kg	(Pal. 30) 1	39.50	35.55
27389	5 x 5 = 25 kg	(Pal. 24) 1	112.50	101.25

Putzlappen aus Textil - Trikot



Putzlappen Trikot weiss I

Artikel-Nr.	Produktinfo	Inhalt /VE	Preis /VE	ab 5 VE 10%
27351	5 kg	(Pal. 72) 1	20.00	18.00
27353	10 kg	(Pal. 30) 1	42.50	38.25
27352	5 x 5 = 25 kg	(Pal. 24) 1	119.50	107.55



Putzlappen Trikot weiss I

Artikel-Nr.	Produktinfo	Inhalt /VE	Preis /VE	ab 5 VE 10%
19063	5 kg	(Pal. 100) 1	22.00	19.80
8993	5 x 5 = 25 kg	(Pal. 20) 1	130.00	117.00



Putzlappen Trikot weiss I

Artikel-Nr.	Produktinfo	Inhalt /VE	Preis /VE	ab 5 VE 10%
25198	5 x 5 = 25 kg	(Pal. 24) 1	130.00	117.00



Putzlappen Trikot weiss, dünn

Artikel-Nr.	Produktinfo	Inhalt /VE	Preis /VE	ab 5 VE 10%
25196	5 x 5 kg	(Pal. 24) 1	116.60	104.95

Putzlappen aus Textil - Polo



Putzlappen Trikot bunt LP

100% feines Baumwollgewebe aus Polo-Shirts, sehr saugfähig, weich und fusselarm. Für die einfache Reinigung mit Wasser und Ölen, Dienstleistungsbetriebe, Industrie, Druckerei, Feinmechanik, Carosseriebau, usw.

Artikel-Nr.	Produktinfo	Inhalt /VE	Preis /VE	ab 5 VE 10%
27339	5 kg	(Pal. 120) 1	16.50	14.85
27341	10 kg	(Pal. 36) 1	28.50	25.65
27340	5 x 5 = 25 kg	(Pal. 24) 1	80.00	72.00



Putzlappen Trikot bunt Polo

Artikel-Nr.	Produktinfo	Inhalt /VE	Preis /VE	ab 5 VE 10%
25477	5 kg	(Pal. 120) 1	17.50	15.75
25195	10 kg	(Pal. 60) 1	29.50	26.55
25194	5 x 5 = 25 kg	(Pal. 24) 1	82.00	73.80



Putzlappen Trikot hell LP

Artikel-Nr.	Produktinfo	Inhalt /VE	Preis /VE	ab 5 VE 10%
27345	5 kg	(Pal. 72) 1	18.00	16.20
27347	10 kg	(Pal. 30) 1	31.00	27.90
27346	5 x 5 = 25 kg	(Pal. 24) 1	85.00	76.50



Putzlappen Trikot hell UNI LP

Artikel-Nr.	Produktinfo	Inhalt /VE	Preis /VE	ab 5 VE 10%
27350	10 kg	(Pal. 60) 1	35.50	31.95
27349	5 x 5 = 25 kg	(Pal. 24) 1	92.50	83.25

Putzlappen aus Textil - Polo



Putzlappen Trikot weiss LP

Artikel-Nr.	Produktinfo	Inhalt /VE	Preis /VE	ab 5 VE 10%
27356	10 kg	(Pal. 30) 1	39.00	35.10
27355	5 x 5 = 25 kg	(Pal. 24) 1	140.00	126.00

Putzlappen aus Textil - Standard



Putzlappen bunt

Gemischte Sortierung mit bedingter Saugfähigkeit, robust und fest. Geeignet für Metallindustrie, Bauunternehmen, Schreinereien, Tankstellen, Schlosserei usw. Putzarbeiten, die keine hohe Saugkraft, jedoch festes Gewebe erfordern.

Artikel-Nr.	Produktinfo	Inhalt /VE	Preis /VE	ab 5 VE 10%
27359	10 kg	(Pal. 30) 1	25.00	22.50
27358	5 x 5 = 25 kg	(Pal. 24) 1	68.75	61.85



Putzlappen bunt

Artikel-Nr.	Produktinfo	Inhalt /VE	Preis /VE	ab 5 VE 10%
8990	5 x 5 = 25 kg	(Pal. 20) 1	71.00	63.90



Putzlappen hell

Artikel-Nr.	Produktinfo	Inhalt /VE	Preis /VE	ab 5 VE 10%
27360	5 kg	(Pal. 72) 1	14.50	13.05
27362	10 kg	(Pal. 30) 1	27.00	24.30
27361	5 x 5 = 25 kg	(Pal. 24) 1	75.00	67.50



Putzlappen hell

Artikel-Nr.	Produktinfo	Inhalt /VE	Preis /VE	ab 5 VE 10%
8994	5 x 5 = 25 kg	(Pal. 20) 1	79.00	71.10



Putzlappen weiss

Artikel-Nr.	Produktinfo	Inhalt /VE	Preis /VE	ab 5 VE 10%
27365	10 kg	(Pal. 36) 1	36.50	32.85
27364	5 x 5 = 25 kg	(Pal. 24) 1	102.50	92.25



Putzlappen weiss

Artikel-Nr.	Produktinfo	Inhalt /VE	Preis /VE	ab 5 VE 10%
8992	5 x 5 = 25 kg	(Pal. 20) 1	105.00	94.50

Putzlappen aus Textil - Frotté



Putzlappen Frotté bunt

Frottélappen sind aus Frottiertücher, Bademäntel, Waschtücher und sind sehr saugfähig, weich, robust und fest. Geeignet für die Aufnahme von grossen Mengen Öl sowie Schmier- und Grobverschmutzungen wie zum Beispiel bei Tankreinigungsarbeiten.

Artikel-Nr.	Produktinfo	Inhalt /VE	Preis /VE	ab 5 VE 10%
27374	10 kg	(Pal. 30) 1	29.00	26.10
27373	5 x 5 = 25 kg	(Pal. 24) 1	72.50	65.25

Putzlappen aus Textil - Frotté



Putzlappen Frotté bunt I

Artikel-Nr.	Produktinfo	Inhalt /VE	Preis /VE	ab 5 VE 10%
27371	10 kg	(Pal. 36) 1	35.00	31.50
27370	5 x 5 = 25 kg	(Pal. 24) 1	99.50	89.55



Putzlappen Frotté hell

Artikel-Nr.	Produktinfo	Inhalt /VE	Preis /VE	ab 5 VE 10%
13421	5 kg	(Pal. 100) 1	20.45	18.40

Putzlappen aus Textil - Flanell



Putzlappen Flanell bunt

Flanell ist dicht gewebter Baumwollstoff, weich und fusselfrei, robust und leicht. Geeignet für Druckereien, Feinmechanik, Carrossierarbeiten usw. Auch zum Polieren geeignet.

Artikel-Nr.	Produktinfo	Inhalt /VE	Preis /VE	ab 5 VE 10%
27380	5 x 5 = 25 kg	(Pal. 24) 1	125.05	112.55



Putzlappen Flanell weiss

Artikel-Nr.	Produktinfo	Inhalt /VE	Preis /VE	ab 5 VE 10%
27383	10 kg	(Pal. 30) 1	55.00	49.50



Putzlappen Flanell Spezial hell

Artikel-Nr.	Produktinfo	Inhalt /VE	Preis /VE	ab 5 VE 10%
8999	38 x 38 cm, 160 Tücher	(Pal. 42) 160	37.50	33.75

Putzlappen aus Textil - Bettwäsche



Putzlappen Bettwäsche weiss

100% Baumwolle aus Bettwäsche, nahtlos, fusselfrei, für sehr feine und anspruchsvolle Reinigung, geeignet für Labor, Fensterreinigung, Optik, Goldschmied, usw.

Artikel-Nr.	Produktinfo	Inhalt /VE	Preis /VE	ab 5 VE 10%
27368	10 kg	(Pal. 36) 1	50.00	45.00
27367	5 x 5 = 25 kg	(Pal. 24) 1	132.50	119.25
27384	30 kg, gerollt	(Pal. 20) 1	149.00	134.10



Putzlappen Bettwäsche weiss

Artikel-Nr.	Produktinfo	Inhalt /VE	Preis /VE	ab 5 VE 10%
8997	5 x 5 = 25 kg	(Pal. 20) 1	139.00	125.10

Putzfäden, Faservlies, Polypunttücher



Putzfäden bunt

aus Baumwolle, weich und saugstark, aus ungebrauchten Spinnerei- und Webereiabfällen, kurz und lang. Zum Reinigen överschmutzter Maschinen und Fahrzeuge, Aufnahme von Öllächen etc.

Artikel-Nr.	Produktinfo	Inhalt /VE	Preis /VE	ab 5 VE 10%
23202	10 kg	(Pal. 30) 1	32.25	29.00
27379	25 kg	(Pal. 30) 1	99.20	89.30

Putzfäden, Faservlies, Polspunttücher



Polierfäden weiss

aus Baumwolle, weich und saugstark, aus ungebrauchten Spinnerei- und Webereiabfällen, kurz und lang. Zum Behandeln und Polieren von empfindlichen Oberflächen.

Artikel-Nr.	Produktinfo	Inhalt /VE	Preis /VE	ab 5 VE 10%
27377	10 x 1 kg	(Pal. 30) 10	49.00	44.10
27376	10 kg	(Pal. 30) 1	42.50	38.25
27375	25 kg	(Pal. 30) 1	115.00	103.50



Textile Faservliestücher hell

textiles Nadelvlies, saugstark, weiches Material, ca. 37 x 40 cm. Universeller Einsatz, auch als Unterlage oder zum Aufsaugen von Öl gut geeignet.

Artikel-Nr.	Produktinfo	Inhalt /VE	Preis /VE	ab 5 VE 10%
27488	10 kg	1	59.05	53.15



Polspunttücher

38 x 40 cm

Artikel-Nr.	Produktinfo	Inhalt /VE	Preis /VE	ab 5 VE 10%
27490	3 kg	(Pal. 48) 275	64.00	57.60

Reinigungszubehör

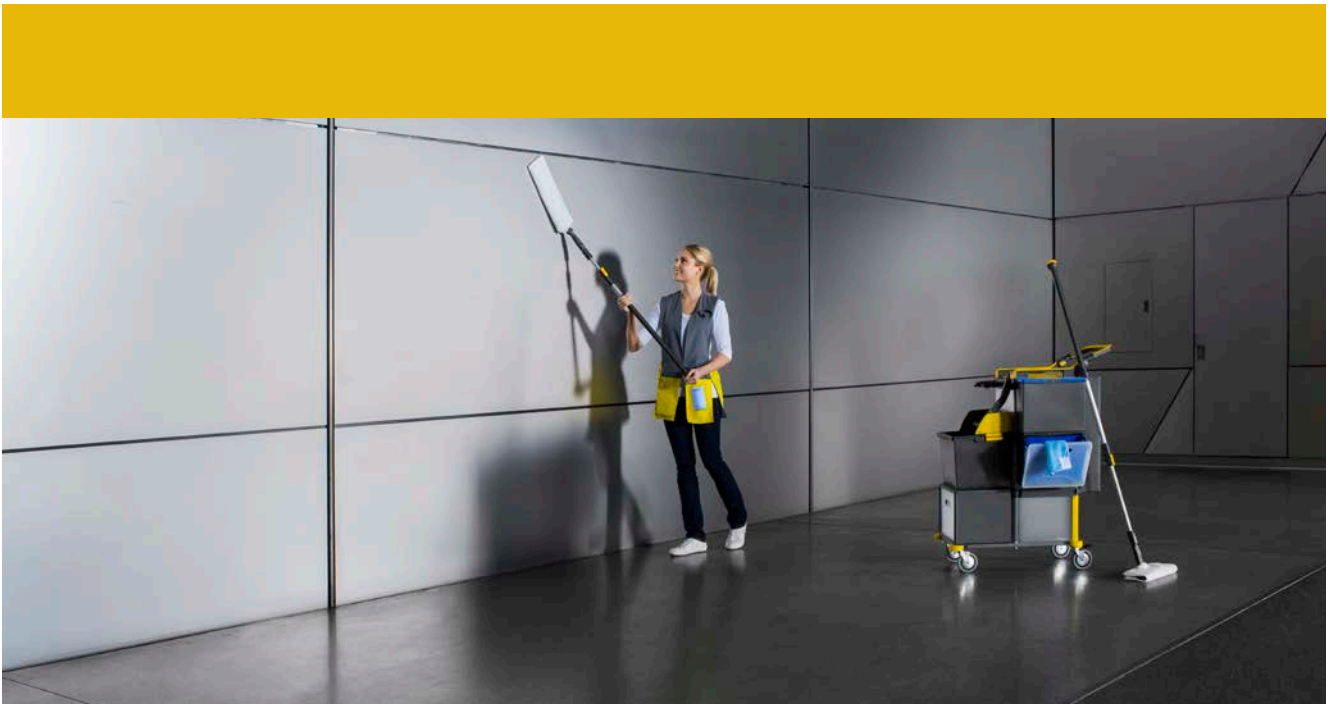

Microfaser- und Nasswischtücher	274
Schwämme	276
Pads	278
Besen und Schrubber	281
Kehrgarnitur	285
Warnschilder	287
Diverse Kleinartikel	288
Fensterreinigung	294
Reinigung - Vermop	294
Reinigung - Vikan	297
Reinigung - Unger	301
Reinigung - Ecolab	305
Reinigung - Diversey	306
Wäschereiartikel	306

Reinigungsgeräte und Utensilien | Allgemein

Microfaser- und Nasswischtücher



Starline Microfasertuch Starline

40 x 40 cm, 200 g/m², 87 % Polyester, 13% Polyamide

Artikel-Nr.	Produktinfo	Inhalt /VE	Preis /VE	ab 5 VE 10%
12773	blau	5	17.90	16.10
12774	grün	5	17.90	16.10
12775	rosa	5	17.90	16.10
12776	gelb	5	17.90	16.10



Microfasertuch Professional

40 x 40 cm, ca. 310 g/m²

Artikel-Nr.	Produktinfo	Inhalt /VE	Preis /VE	
21001	blau	(Pal. 768) 10	24.00	netto
21001.1	rosa	(Pal. 768) 10	24.00	netto
21001.2	gelb	(Pal. 768) 10	24.00	netto
21001.3	grün	(Pal. 768) 10	24.00	netto



Microfasertuch ECO62 - CLEAN & CLEVER

40 x 40 cm

Artikel-Nr.	Produktinfo	Inhalt /VE	Preis /VE	
27527	blau	(Pal. 192) 25	25.50	netto
27527.1	rosa	25	25.50	netto
27527.2	gelb	25	25.50	netto
27527.3	grün	25	25.50	netto



Microfasertuch für Glas und Geschirr

50 x 65 cm, ca. 360 g/m²

Artikel-Nr.	Produktinfo	Inhalt /VE	Preis /VE	
24396	blau	(Pal. 420) 4	30.00	netto



Microfasertuch PVAmicro Vileda

38 x 35 cm

Artikel-Nr.	Produktinfo	Inhalt /VE	Preis /VE	
22236	blau	5	21.95	netto
22236.1	rot	5	21.95	netto
22236.2*	grün	5	21.95	netto
22236.3	gelb	5	21.95	netto



Microfasertuch für Geschirr

45 x 80 cm, 300 g/m², 71 % Polyester, 29 % Polyamid

Artikel-Nr.	Produktinfo	Inhalt /VE	Preis /VE	ab 5 VE 10%
15624	blau	(Pal. 400) 5	57.60	51.85



Microfasertuch Kimberly-Clark Wypall

40 x 40 cm, 1/4 Falzung

Artikel-Nr.	Produktinfo	Inhalt /VE	Preis /VE	Preis VE /Pal.
12848	gelb	(Pal. 90) 24	80.60	61.80
12849	blau	(Pal. 90) 24	80.60	61.80
12850	grün	(Pal. 180) 24	80.60	61.80
12851	rot	(Pal. 90) 24	80.60	61.80

Reinigungsgeräte und Utensilien | Allgemein

Microfaser- und Nasswischtücher



Allzwecktuch ECO63 - CLEAN & CLEVER

38 x 40 cm, Vlies

Artikel-Nr.	Produktinfo	Inhalt /VE	Preis /VE	
12225	rosa	(Pal. 40) 200	62.45	netto
12225.1	gelb	(Pal. 40) 200	62.45	netto
12225.2	blau	(Pal. 40) 200	62.45	netto
12225.3	grün	(Pal. 40) 200	62.45	netto



Nasswisch Tuch

40 x 38 cm, 145 g/m², bis 95°C waschbar, Vlies

Artikel-Nr.	Produktinfo	Inhalt /VE	Preis /VE	ab 5 VE 10%
7865	Farben assortiert	(Pal. 200) 45	28.25	25.45
7865.1	gelb	(Pal. 200) 45	28.25	25.45
7865.2	blau	(Pal. 200) 45	28.25	25.45
7865.3	rosa	(Pal. 200) 45	28.25	25.45
7865.4	grün	(Pal. 200) 45	28.25	25.45



Lochtuch Vileda PRO 63, Gebäudereinigungstuch

35 x 40 cm

Artikel-Nr.	Produktinfo	Inhalt /VE	Preis /VE	
8629*	natur	(Pal. 640) 5	24.45	netto



Lochtuch Vileda

35 x 40 cm

Artikel-Nr.	Produktinfo	Inhalt /VE	Preis /VE	
8523	natur	(Pal. 320) 10	54.25	netto



Staubbindetuch Vileda 101

24 x 60 cm, imprägniert, High Performance

Artikel-Nr.	Produktinfo	Inhalt /VE	Preis /VE	
8531	gelb	(Pal. 200) 50	14.70	netto



Staubbindetuch Vileda

24 x 60 cm, Pflegeöl imprägniert

Artikel-Nr.	Produktinfo	Inhalt /VE	Preis /VE	
8573	rosa	50	5.55	netto



Feuchtwischtuch

24 x 63 cm, 22 g/m², Polypropylen, medizinalölprägniert

Artikel-Nr.	Produktinfo	Inhalt /VE	Preis /VE	ab 5 VE 10%
16163	weiss	(Pal. 800) 50	8.95	8.05



Feuchtwischtuch TASKI florzip Refill 65

weiss, 100% Polypropylene, getränkt mit white oil

Artikel-Nr.	Produktinfo	Inhalt /VE	Preis /VE	
8291	25 x 65 cm, Rolle à 150 Blatt	(Pal. 504) 1	24.65	netto

Reinigungsgeräte und Utensilien | Allgemein

Microfaser- und Nasswischtücher



Staubbindetuch Witex

weiss, 40 g/m², 100 % Viscose

Artikel-Nr.	Produktinfo	Inhalt /VE	Preis /VE	ab 5 VE 10%
23976	22 x 60 cm, Rolle à 50 Blatt	20	336.00	302.40



Bodentuch Vileda

59 x 50 cm

Artikel-Nr.	Produktinfo	Inhalt /VE	Preis /VE	
5979	blau	5	23.50	netto



Scheuertuch Exakt

50 x 70 cm, Vlies

Artikel-Nr.	Produktinfo	Inhalt /VE	Preis /VE	ab 5 VE 10%
10120	weiss	(Pal. 48) 50	61.55	55.40

Schwämme

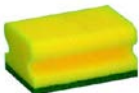

Scheuerschwamm ECO 60, klein

7 x 9.5 cm

Artikel-Nr.	Produktinfo	Inhalt /VE	Preis /VE	
9565	gelb/grün	(Pal. 840) 6	2.60	netto



Scheuerschwamm PRO60

7 x 15 cm

Artikel-Nr.	Produktinfo	Inhalt /VE	Preis /VE	
8580	gelb / grün	6	7.50	netto



Schwamm PRO61-1

7 x 15 cm

Artikel-Nr.	Produktinfo	Inhalt /VE	Preis /VE	
8544	rot / weiss	(Pal. 576) 6	6.30	netto
10063	gelb / weiss	(Pal. 576) 6	6.30	netto
8545	blau / weiss	(Pal. 240) 6	6.30	netto
8915	grün / weiss	(Pal. 576) 6	6.30	netto



Schwamm

15 x 9.3 x 5 cm, Scheuserseite fein

Artikel-Nr.	Produktinfo	Inhalt /VE	Preis /VE	ab 5 VE 10%
5970	gelb / weiss	(Pal. 200) 10	21.70	19.50



3M Schwamm Scotch-Brite

7 x 13 cm

Artikel-Nr.	Produktinfo	Inhalt /VE	Preis /VE	
8628	gelb / weiss	10	22.75	netto
8614	blau / weiss	10	22.75	netto
8615	rot / weiss	10	22.75	netto

Reinigungsgeräte und Utensilien | Allgemein

Schwämme



3M Schwamm Scotch-Brite 13-21

15,4 x 8 x 4,8 cm

Artikel-Nr.	Produktinfo	Inhalt /VE	Preis /VE	
4419	beige / weiss	10	22.50	netto
4420	grün / weiss	10	22.50	netto



3M Pflegeschwamm Scotch-Brite 2276

7 x 15 cm

Artikel-Nr.	Produktinfo	Inhalt /VE	Preis /VE	
12214	blau / weiss	6	28.25	netto



Schwamm Vileda

7 x 15 cm, kratzfrei

Artikel-Nr.	Produktinfo	Inhalt /VE	Preis /VE	
8630	grün / weiss	(Pal. 160) 10	18.95	netto
8538	rot / weiss	(Pal. 160) 10	18.95	netto
8532	blau / weiss	(Pal. 160) 10	18.95	netto
8547	gelb / weiss	10	18.95	netto



universalSCHWAMM blau Hagleitner

für Reinigung im Housekeepingbereich

Artikel-Nr.	Produktinfo	Inhalt /VE	Preis /VE	ab 5 VE 10%
26735	blau / weiss	(Pal. 300) 10	10.80	9.75

Schwamm

15 x 9,3 x 5 cm, Scheuserseite mittel



Artikel-Nr.	Produktinfo	Inhalt /VE	Preis /VE	ab 5 VE 10%
5971	gelb / grün	(Pal. 200) 10	21.70	19.50



3M Scheuerschwamm Scotch-Brite 2286

7 x 15 cm

Artikel-Nr.	Produktinfo	Inhalt /VE	Preis /VE	
12215	grün / gelb	6	28.25	netto



Schwamm Vileda PUR Active

6,3 x 14 cm, eckig

Artikel-Nr.	Produktinfo	Inhalt /VE	Preis /VE	
8530*	grün	10	19.00	netto
8552*	rot	10	19.00	netto
8543*	blau	10	19.00	netto
8550	gelb	10	19.00	netto



Scheuerschwamm Vileda

7 x 15 cm

Artikel-Nr.	Produktinfo	Inhalt /VE	Preis /VE	
8560	gelb / grün	(Pal. 160) 10	19.35	netto



Pad-Schwamm

14 x 6,5 cm, Scheuserseite mittel

Artikel-Nr.	Produktinfo	Inhalt /VE	Preis /VE	ab 5 VE 10%
5971.1	gelb / grün	10	18.20	16.40

* auf Bestellung

Reinigungsgeräte und Utensilien | Allgemein

Schwämme



abwaschSCHWAMM grün Hagleitner

für den Abwasch und Reinigung im Küchenbereich

Artikel-Nr.	Produktinfo	Inhalt /VE	Preis /VE	ab 5 VE 10%
26732	grün	(Pal. 240) 10	10.80	9.75



3M Reinigungsschwamm Scotch-Brite

8 x 15.4 x 4.8 cm

Artikel-Nr.	Produktinfo	Inhalt /VE	Preis /VE	
10965	gelb / blau	10	23.80	netto
5679	rot / blau	10	23.80	netto
10964	blau / blau	10	23.80	netto



sanitärSCHWAMM gelb Hagleitner

für Reinigung im Sanitärbereich

Artikel-Nr.	Produktinfo	Inhalt /VE	Preis /VE	ab 5 VE 10%
26734	gelb / blau	(Pal. 300) 10	10.80	9.75



toilettenSCHWAMM rot Hagleitner

für Reinigung von Toiletten

Artikel-Nr.	Produktinfo	Inhalt /VE	Preis /VE	ab 5 VE 10%
26731	rot / blau	(Pal. 240) 10	10.80	9.75



Pad-Schwamm

17 x 11 x 7 cm, Polyester, grobporig

Artikel-Nr.	Produktinfo	Inhalt /VE	Preis /VE	
5706	gelb	(Pal. 1000) 1	3.60	netto



Zelluloseschwamm

16 x 12 x 4 cm, grobporig

Artikel-Nr.	Produktinfo	Inhalt /VE	Preis /VE	
5837	gelb	10	40.50	netto

Pads



Topfreiniger

23 x 15 x 0.7 cm, fein

Artikel-Nr.	Produktinfo	Inhalt /VE	Preis /VE	ab 5 VE 10%
5975	weiss	(Pal. 200) 10	19.40	17.45



Topfreiniger

23 x 15 x 0.7 cm, mittel

Artikel-Nr.	Produktinfo	Inhalt /VE	Preis /VE	ab 5 VE 10%
5976	grün	(Pal. 400) 10	19.40	17.45



Topfreiniger

15 x 10 x 2 cm, extra-grob

Artikel-Nr.	Produktinfo	Inhalt /VE	Preis /VE	ab 5 VE 10%
5978	schwarz	10	30.65	27.60

Reinigungsgeräte und Utensilien | Allgemein

Pads



3M Maxi-Pads Doodlebug Scotch-Brite

117 x 254 mm

Artikel-Nr.	Produktinfo	Inhalt /VE	Preis /VE	
10370	blau	10	76.80	netto
4745	braun	10	76.80	netto
10122	weiss	10	64.80	netto
22568	rot	10	71.00	netto



3M Handpad Scotch-Brite SB86 grob

15.8 x 22.4 cm

Artikel-Nr.	Produktinfo	Inhalt /VE	Preis /VE	
12325	grün	30	86.90	netto



3M Handpad Scotch-Brite SB98

15.8 x 22.4 cm

Artikel-Nr.	Produktinfo	Inhalt /VE	Preis /VE	
8609	weiss	20	44.60	netto



3M Handpad-Rolle Scotch-Brite SB640

20 x 10 cm, perforiert

Artikel-Nr.	Produktinfo	Inhalt /VE	Preis /VE	
11048*	grün, Rolle à 40 Pads	6	210.00	netto



3M Handpad Scotch-Brite SB96 mittel

158 x 224 x 7 mm

Artikel-Nr.	Produktinfo	Inhalt /VE	Preis /VE	
8626	grün	20	35.00	netto



3M Flecken-Radierer Scotch Brite

110 x 70 x 30 mm

Artikel-Nr.	Produktinfo	Inhalt /VE	Preis /VE	
10002	weiss	6	7.60	netto



Handpad Vileda Super

12 x 26 cm

Artikel-Nr.	Produktinfo	Inhalt /VE	Preis /VE	
8562*	weiss	5	23.00	netto
8578	grün	(Pal 120) 5	21.65	netto



Handpad

220 x 150 x 80 mm

Artikel-Nr.	Produktinfo	Inhalt /VE	Preis /VE	ab 5 VE 10%
28158	weiss	(Pal 450) 10	19.85	17.85



Miracleclean Radierer Vileda

10 x 3 x 6 cm, zur Schmutzentfernung

Artikel-Nr.	Produktinfo	Inhalt /VE	Preis /VE	
7342	weiss	12	16.15	netto

* auf Bestellung

Reinigungsgeräte und Utensilien | Allgemein

Pads



Fleckenradierer

110 x 70 x 30 mm, Melaminharz aus Basotect

Artikel-Nr.	Produktinfo	Inhalt /VE	Preis /VE	ab 5 VE 10%
28188	weiss	(Pal. 504) 10	10.15	9.15

Floorpads



Superpad DynaCross Vileda

Ø 430 mm

Artikel-Nr.	Produktinfo	Inhalt /VE	Preis /VE	
8565*	schwarz	5	88.75	netto
8565.1	blau	5	88.75	netto
8913*	rot	5	88.75	netto
8631*	beige	5	88.75	netto
8632*	grün	5	88.75	netto
8916*	grau	5	97.65	netto

3M Superpad Scotch-Brite

Ø 432 mm, Polyester



Artikel-Nr.	Produktinfo	Inhalt /VE	Preis /VE	
8616	rot	(Pal. 26) 5	117.00	netto
8608	blau	5	117.00	netto
8613*	braun	5	117.00	netto
8611	weiss	5	117.00	netto

3M Superpad Scotch-Brite

Ø 432 mm, Nylon



Artikel-Nr.	Produktinfo	Inhalt /VE	Preis /VE	
16969*	grün	5	120.00	netto
16962*	schwarz	5	122.50	netto

3M Superpad Scotch-Brite

Ø 355 mm, Polyester



Artikel-Nr.	Produktinfo	Inhalt /VE	Preis /VE	
8618.1*	rot	5	90.00	netto

Stahlschwämme



Stahlschwamm

aus rostfreiem Edelstahl, kratzfrei

Artikel-Nr.	Produktinfo	Inhalt /VE	Preis /VE	ab 5 VE 10%
5960	60 g	10	29.50	26.55
5961	90 g	10	44.00	39.60

Kupferlappen



Stahlwatte mit Seife

Artikel-Nr.	Produktinfo	Inhalt /VE	Preis /VE	ab 5 VE 10%
5965	15 Beutel à 20 Stück	300	62.60	56.35
5965.9	1 Beutel à 20 Stück	20	4.90	netto

Reinigungsgeräte und Utensilien | Allgemein

Kupferlappen



Kupferlappen

25 x 25 cm

Artikel-Nr.	Inhalt /VE	Preis /VE	
5974	10	31.80	netto

Bodenlappen



Bodenlappen

aus Baumwolle, Waffelmuster, 140 g/m²

Artikel-Nr.	Produktinfo	Inhalt /VE	Preis /VE	ab 5 VE 10%
5964	40 x 60 cm	(Pal. 1) 25	49.50	44.55

Besen und Schrubber



Piassavabesen

2-Band mit Holzstiel

Artikel-Nr.	Inhalt /VE	Preis /VE	ab 5 VE 10%
4300	(Pal. 400) 1	15.65	14.10



Reisbesen

4-Band mit Buchenholzstiel

Artikel-Nr.	Produktinfo	Inhalt /VE	Preis /VE	Preis VE /Pal.
4144	schwere Ausführung, 900 g/Stück	(Pal. 25) 10	71.35	64.20



Reisbesen

5-Band mit Buchenholzstiel

Artikel-Nr.	Produktinfo	Inhalt /VE	Preis /VE	Preis VE /Pal.
4194	schwere Ausführung, 950 g/Stück	(Pal. 25) 10	74.50	67.05



Reisbesen

8-Band mit Buchenholzstiel

Artikel-Nr.	Produktinfo	Inhalt /VE	Preis /VE	Preis VE /Pal.
4151	1100 g/Stück	(Pal. 25) 10	75.40	67.90



Reisbesen 4+1

5-Band mit lackiertem Buchenholzstiel, mit roter Kapsel

Artikel-Nr.	Inhalt /VE	Preis /VE	
10273	(Pal. 25) 10	98.90	netto



Reisbesen

5-Band mit Buchenholzstiel, mit roter Kapsel

Artikel-Nr.	Produktinfo	Inhalt /VE	Preis /VE	Preis VE /Pal.
4195	1150 g/Stück	(Pal. 25) 10	90.80	81.70



Bambusbesen

schwere Ausführung

Artikel-Nr.	Produktinfo	Inhalt /VE	Preis /VE	Preis VE /Pal.
4197	mit dickem Stiel	(Pal. 25) 10	54.65	49.20

Reinigungsgeräte und Utensilien | Allgemein

Besen und Schrubber



Aussenbesen «il verde»

grüne Borsten, Metallstiel, schrägschnitt

Artikel-Nr.	Produktinfo	Inhalt /VE	Preis /VE	
14650	130 cm Wischbreite	1	15.95	netto



Hausplatzbesen „Rapido V4“

Kunststoff, extrahart, Stiel aus Buchenholz

Artikel-Nr.	Inhalt /VE	Preis /VE	
29056*	1	24.25	netto



Bodenwischer ohne Stiel

Rosshaar, mit Metall-Gewinde, zu Art. 4261.2



Artikel-Nr.	Produktinfo	Inhalt /VE	Preis /VE	
4199	30 cm	1	11.05	netto
4149	35 cm	1	12.65	netto
4185	40 cm	1	15.60	netto



Bodenwischer Kokosfaser

Holzkörper mit Metall-Gewinde, für Art. 4261.2



Artikel-Nr.	Produktinfo	Inhalt /VE	Preis /VE	
4166	40 cm	1	12.40	netto



Bodenwischer

Rosshaarmischung, Polyester PBT, mit Dual Effekt, Stiel: Art. 4261.2

Artikel-Nr.	Produktinfo	Inhalt /VE	Preis /VE	ab 5 VE 10%
27570	30 cm, schwarz / rot	1	16.30	14.65
27308	40 cm, schwarz / rot	1	25.10	netto



Stiel für Bodenwischer

Holz roh, mit Gewinde, mit drehbarem Aufhänger



Artikel-Nr.	Produktinfo	Inhalt /VE	Preis /VE	ab 5 VE 10%
4261.2	150 cm	1	7.05	6.35



Bodenwischer ohne Stiel

Rosshaar, mit Flügelschraube, für CH-Stielhalter (Art. 28901)

Artikel-Nr.	Produktinfo	Inhalt /VE	Preis /VE	
4184	50 cm	1	19.35	netto
4198	60 cm	1	26.00	netto
4159	80 cm	1	46.70	netto



Bodenwischer Kokosfaser

Holzkörper flach, mit Flügelschraube, ohne Stielhalter, für Art. 28901

Artikel-Nr.	Produktinfo	Inhalt /VE	Preis /VE	ab 5 VE 10%
4155	60 cm	1	19.70	17.75



Stiel für Bodenwischer

150 cm, Holz roh, mit CH-Stielhalter und Aufhänger



Artikel-Nr.	Produktinfo	Inhalt /VE	Preis /VE	ab 5 VE 10%
28901	natur	1	9.60	8.65

Reinigungsgeräte und Utensilien | Allgemein

Besen und Schrubber



Schrubber mit Stiel

metalleingepresst, Union

Artikel-Nr.	Produktinfo	Inhalt /VE	Preis /VE	ab 5 VE 10%
4290	23 cm, schwarz	1	16.90	15.20



Ersatzschrubber ohne Stielhalter

metalleingepresst, Union

Artikel-Nr.	Inhalt /VE	Preis /VE	ab 5 VE 10%
4291	1	9.25	8.30



Hygiene Schrubber

Körper und Besatz hitzebeständig bis 125°C, lebensmittelecht und cadmiumfrei. 30 cm, ohne Stiel, Polyester 0.50

Artikel-Nr.	Produktinfo	Inhalt /VE	Preis /VE	ab 5 VE 10%
4330	weiss	1	14.30	12.85
4330.1*	blau	1	14.30	12.85
4330.2*	rot	1	14.30	12.85
4330.3*	grün	1	14.30	12.85
4330.4*	gelb	1	14.30	12.85



Hygiene Schrubber

Körper und Besatz hitzebeständig bis 125°C, lebensmittelecht und cadmiumfrei. 40 cm, ohne Stiel, Polyester 0.50

Artikel-Nr.	Produktinfo	Inhalt /VE	Preis /VE	ab 5 VE 10%
4331	weiss	1	22.20	20.00
4331.1*	blau	1	22.20	20.00
4331.2*	rot	1	22.20	20.00
4331.3*	grün	1	22.20	20.00
4331.4*	gelb	1	22.20	20.00



Hygienebesen

Körper und Besatz hitzebeständig bis 125°C, lebensmittelecht und cadmiumfrei. 30 cm, ohne Stiel, soft Polyester

Artikel-Nr.	Produktinfo	Inhalt /VE	Preis /VE	ab 5 VE 10%
4332.1*	weiss	1	25.70	23.10
4332	blau	1	25.65	23.10
4332.2*	rot	1	25.65	23.10
4332.3*	grün	1	25.65	23.10
4332.4*	gelb	1	25.65	23.10



Hygienebesen soft

Körper und Besatz hitzebeständig bis 125°C, lebensmittelecht und cadmiumfrei. 40 cm, ohne Stiel, Polyester 0.25

Artikel-Nr.	Produktinfo	Inhalt /VE	Preis /VE	ab 5 VE 10%
4333.1*	weiss	1	36.80	33.10
4333	blau	1	36.80	33.10
4333.2*	rot	1	36.80	33.10
4333.3*	grün	1	36.80	33.10
4333.4*	gelb	1	36.80	33.10

Reinigungsgeräte und Utensilien | Allgemein

Besen und Schrubber



Hygienebesen hart

Körper und Besatz hitzebeständig bis 125°C, lebensmittelecht und cadmiumfrei. 60 cm, ohne Stiel, Polyester 0.25

Artikel-Nr.	Produktinfo	Inhalt /VE	Preis /VE	ab 5 VE 10%
4628.1*	weiss	1	40.90	36.80
4628	blau	1	40.90	36.80
4628.2*	rot	1	40.90	36.80
4628.3*	grün	1	40.90	36.80
4628.4*	gelb	1	40.90	36.80



Fugenbürste

Körper und Besatz hitzebeständig bis 125°C, lebensmittelecht und cadmiumfrei, aus PP mit Gelenk, Polyester 0.25, Stiel: Art. 4341 + 4342

Artikel-Nr.	Produktinfo	Inhalt /VE	Preis /VE	ab 5 VE 10%
4639	blaue Borsten	1	16.30	14.65

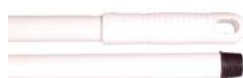

Hygiene Glasfaserstiel

150 cm, weiss

Artikel-Nr.	Produktinfo	Inhalt /VE	Preis /VE	ab 5 VE 10%
4341.1*	Griff weiss	(Pal. 850) 1	23.95	21.55
4341	Griff blau	(Pal. 850) 1	23.95	21.55
4341.2*	Griff rot	(Pal. 850) 1	23.95	21.55
4341.3*	Griff grün	(Pal. 850) 1	23.95	21.55
4341.4*	Griff gelb	(Pal. 850) 1	23.95	21.55



Teleskopstiel

Alu, eloxiert

Artikel-Nr.	Produktinfo	Inhalt /VE	Preis /VE	ab 5 VE 10%
4342	80 - 150 cm	(Pal. 1260) 1	18.30	16.50



Gumminoppenbesen

mit Wasserabziehlippe, ohne Stiel, Stiel: Art. 4341 + 4342

Artikel-Nr.	Produktinfo	Inhalt /VE	Preis /VE	
4299*	30 cm, blau	1	18.55	netto



Wasserschieber

weiss, ohne Stiel, für Art. 4341 / 4342

Artikel-Nr.	Produktinfo	Inhalt /VE	Preis /VE	ab 5 VE 10%
4340	55 cm	(Pal. 550) 1	18.05	16.25
16151	43 cm	1	11.00	9.90



Wasserschieber

mit Holzstiel



Artikel-Nr.	Produktinfo	Inhalt /VE	Preis /VE	
4624*	60 cm	5	63.85	netto



Pudelmop Baumwolle

250 g, mit italienischem Gewinde, 65% Baumwolle, 35% Mischfasern

Artikel-Nr.	Produktinfo	Inhalt /VE	Preis /VE	ab 5 VE 10%
14683*	weiss, Stiel: Art. 14684	1	4.60	4.15

Reinigungsgeräte und Utensilien | Allgemein

Besen und Schrubber



Metallstiel

mit italienischem Gewinde

Artikel-Nr.	Produktinfo	Inhalt /VE	Preis /VE	ab 5 VE 10%
14684*	140 cm, blau, für Art. 14683	1	3.60	3.25



Bodengerät «Micro Clean»

mit Teleskopstiel und Microfaserbezug

Artikel-Nr.	Produktinfo	Inhalt /VE	Preis /VE	ab 5 VE 10%
28353*	40 cm, Stiel: 80 - 140 cm	1	27.05	24.35



Universaltuch Microfaser «Micro Clean»

40 cm, 100% Polyester

Artikel-Nr.	Produktinfo	Inhalt /VE	Preis /VE	ab 5 VE 10%
28354*	Für Art. 28353	1	7.80	7.05



Trapezwischer Vileda

ohne Stiel, Stiel: Art. 10184

Artikel-Nr.	Produktinfo	Inhalt /VE	Preis /VE	
8897*	blau	1	60.10	netto



Teleskopstiel Vileda

100 - 180 cm, für Art. 8897

Artikel-Nr.	Produktinfo	Inhalt /VE	Preis /VE	
10184	blau	1	31.50	netto



Staubbindetuch Vileda 101

24 x 60 cm, imprägniert, High Performance

Artikel-Nr.	Produktinfo	Inhalt /VE	Preis /VE	
8531	gelb	(Pal. 200) 50	14.70	netto



Staubbindetuch Vileda

24 x 60 cm, Pflegeöl imprägniert

Artikel-Nr.	Produktinfo	Inhalt /VE	Preis /VE	
8573	rosa	50	5.55	netto

Kehrgarnitur



Kehrgarnitur mit Lippe

blau, Kunststoff, Rosshaar

Artikel-Nr.	Inhalt /VE	Preis /VE	ab 5 VE 10%
4276	(Pal. 300) 1	7.20	6.45



Kehrgarnitur mit Lippe

rot, Kunststoff, Rosshaar

Artikel-Nr.	Inhalt /VE	Preis /VE	ab 5 VE 10%
4277	(Pal. 300) 1	7.20	6.45

* auf Bestellung

Reinigungsgeräte und Utensilien | Allgemein

Kehrgarnitur



Kehrgarnitur Smart mit Lippe

gelb, Kunststoff, Rosshaar

Artikel-Nr.	Inhalt /VE	Preis /VE	ab 5 VE 10%
4623	1	7.20	6.45



Kehrgarnitur Smart mit Lippe

grün, Kunststoff, Rosshaar

Artikel-Nr.	Inhalt /VE	Preis /VE	ab 5 VE 10%
4622*	1	7.20	6.45



Kehrgarnitur Smart mit Lippe

blau, Kunststoff, Rosshaar

Artikel-Nr.	Inhalt /VE	Preis /VE	ab 5 VE 10%
4621	1	6.85	6.15



Kehrgarnitur

Körper und Besatz hitzebeständig bis 125°C, lebensmittelecht und cadmiumfrei, Polyester 0.25

Artikel-Nr.	Produktinfo	Inhalt /VE	Preis /VE	ab 5 VE 10%
4334	weiss mit blauen Borsten	1	15.50	13.95



Kehrgarnitur Hygo

Kunststoff, mit Gummilippe

Artikel-Nr.	Produktinfo	Inhalt /VE	Preis /VE	ab 5 VE 10%
22691	weiss / blau	1	12.40	netto



Kehrgarnitur

Rosshaarmischung, mit Dual Effekt, Polyester PBT 0.50

Artikel-Nr.	Produktinfo	Inhalt /VE	Preis /VE	ab 5 VE 10%
27481	34 x 22.5 cm, schwarz / rot	1	13.20	11.90



Kehrgarnitur light mit Lippe

Kunststoff, mit weissen Borsten

Artikel-Nr.	Produktinfo	Inhalt /VE	Preis /VE	ab 5 VE 10%
16084	rot	1	3.35	3.00



Handwischer

Rosshaarmischung

Artikel-Nr.	Produktinfo	Inhalt /VE	Preis /VE	ab 5 VE 10%
4270	28 cm, blau	1	4.00	3.60



Handwischer

Holz roh, Rosshaar

Artikel-Nr.	Produktinfo	Inhalt /VE	Preis /VE	Preis ab 50 VE
4268	32 cm	(Pal. 100) 1	7.10	4.75



Reinigungsgeräte und Utensilien | Allgemein

Kehrgarnitur



Handwischer

Holz roh, Kokosfasern



Artikel-Nr.	Produktinfo	Inhalt /VE	Preis /VE	ab 5 VE 10%
4269	32 cm	(Pal. 100) 1	6.20	3.70



Kehrschaufel ohne Lippen

Metall

Artikel-Nr.	Produktinfo	Inhalt /VE	Preis /VE	ab 5 VE 10%
4282	schwarz	1	11.75	6.60



Langstiel-Kehrgarnitur mit Bodenwischer «Butler»

Artikel-Nr.	Inhalt /VE	Preis /VE	ab 5 VE 10%
4288	(Pal. 96) 1	30.10	27.10



Kehrgarnitur Futura Haug

mit langem Stahlstiel

Artikel-Nr.	Produktinfo	Inhalt /VE	Preis /VE	ab 5 VE 10%
9579	24 x 98 cm, schwarz	1	19.90	netto



Langstiel-Kehrgarnitur Profi

mit gelben Borsten, mit Teleskopstiel

Artikel-Nr.	Produktinfo	Inhalt /VE	Preis /VE	ab 5 VE 10%
14697	schwarz	1	40.00	36.00



Kehrschaufel Jumbo

grosse Schmutzmulde

Artikel-Nr.	Produktinfo	Inhalt /VE	Preis /VE	ab 5 VE 10%
14649*	35 x 35 x 22.5 cm, blau	1	31.00	netto

Warnschilder



Warnschild Ecolab

Artikel-Nr.	Inhalt /VE	Preis /VE	ab 5 VE 10%
9675	1	40.10	netto



Warnschild Vermop

Artikel-Nr.	Inhalt /VE	Preis /VE	ab 5 VE 10%
8885	1	40.75	netto



Warnschild Vileda

Artikel-Nr.	Inhalt /VE	Preis /VE	ab 5 VE 10%
4675	1	36.50	netto

* auf Bestellung

Reinigungsgeräte und Utensilien | Allgemein

Warnschilder



Warnschild Banana Cones

Artikel-Nr.	Produktinfo	Inhalt /VE	Preis /VE	ab 5 VE 10%
28238	60 cm	(Pal. 120) 1	39.35	35.40
28239	90 cm	(Pal. 50) 1	50.70	45.65

Diverse Kleinartikel



Stielbürste

Körper und Besatz hitzebeständig bis 125°C, lebensmittelecht und cadmiumfrei, Polyester 0.5

Artikel-Nr.	Produktinfo	Inhalt /VE	Preis /VE	ab 5 VE 10%
4336	mit langem Stiel, weiss	1	15.15	13.65



Tatzenbürste

Körper und Besatz hitzebeständig bis 125°C, lebensmittelecht und cadmiumfrei, Polyester 0.25

Artikel-Nr.	Produktinfo	Inhalt /VE	Preis /VE	ab 5 VE 10%
4337	weiss mit blauen Borsten	1	9.70	8.70



Abwaschbürsten

assortiert

Artikel-Nr.	Inhalt /VE	Preis /VE	ab 5 VE 10%
4311	10	16.85	15.15



Abwaschbürste mit Schaber

weiss, aus PP

Artikel-Nr.	Inhalt /VE	Preis /VE	ab 5 VE 10%
4619	10	17.90	16.10



Abwaschbürsten Duo Set

Körper: PP, Besatz: Nylon

Artikel-Nr.	Produktinfo	Inhalt /VE	Preis /VE	ab 5 VE 10%
4346	blau / weiss	2	2.70	netto



Abwaschbürsten Duo Set

hellblau / weiss, Nylon, hitzebeständig bis 90°

Artikel-Nr.	Inhalt /VE	Preis /VE	ab 5 VE 10%
26565	2	2.90	netto



Fegbürste

weiss, spitz/rund, Körper und Besatz hitzebeständig bis 125°C, lebensmittelecht und cadmiumfrei, Polyester 0.5

Artikel-Nr.	Inhalt /VE	Preis /VE	ab 5 VE 10%
4338	1	10.20	9.20



Fegbürste

blau, spitz/rund, Körper und Besatz hitzebeständig bis 125°C, lebensmittelecht und cadmiumfrei, Polyester 0.5

Artikel-Nr.	Inhalt /VE	Preis /VE	ab 5 VE 10%
4338.1*	1	10.20	9.20

Reinigungsgeräte und Utensilien | Allgemein

Diverse Kleinartikel



Fegbürste

rot, spitz/rund, Körper und Besatz hitzebeständig bis 125°C, lebensmittelecht und cadmiumfrei, Polyester 0.5

Artikel-Nr.	Inhalt /VE	Preis /VE	ab 5 VE 10%
4338.2*	1	10.20	9.20



Fegbürste

grün, spitz/rund, Körper und Besatz hitzebeständig bis 125°C, lebensmittelecht und cadmiumfrei, Polyester 0.5

Artikel-Nr.	Inhalt /VE	Preis /VE	ab 5 VE 10%
4338.3*	1	10.20	9.20



Fegbürste

gelb, spitz/rund, Körper und Besatz hitzebeständig bis 125°C, lebensmittelecht und cadmiumfrei, Polyester 0.5

Artikel-Nr.	Inhalt /VE	Preis /VE	ab 5 VE 10%
4338.4*	1	10.20	9.20



Nagelbürste

weiss

Artikel-Nr.	Inhalt /VE	Preis /VE	ab 5 VE 10%
4117	5	7.60	6.85



Hahnen-Ablaufreiniger

weiss

Artikel-Nr.	Produktinfo	Inhalt /VE	Preis /VE	ab 5 VE 10%
4309	34 cm, Ø 14 mm	5	11.85	10.65



Überlaufreiniger

weiss, aus Kunststoff

Artikel-Nr.	Inhalt /VE	Preis /VE	ab 5 VE 10%
4310	1	2.40	netto



Hahnenputzer

mit Wollkopf, reine Schweineborsten hell und Baumwolle

Artikel-Nr.	Produktinfo	Inhalt /VE	Preis /VE	ab 5 VE 10%
16086	Länge 34 cm, Ø 10 mm	1	2.95	2.65
16087	Länge 34 cm, Ø 15 mm	1	3.35	3.00
16088	Länge 34 cm, Ø 20 mm	1	3.80	3.40



Hygiene Rohr- und Flaschenbürste

Körper: PP weiss, Besatz: Polyester blau

Artikel-Nr.	Produktinfo	Inhalt /VE	Preis /VE	ab 5 VE 10%
17692	50 cm	1	6.35	5.70



Flaschenputzer

blauer Plastikgriff

Artikel-Nr.	Produktinfo	Inhalt /VE	Preis /VE	ab 5 VE 10%
4307	Ø 50 mm	3	10.25	9.25

* auf Bestellung

Reinigungsgeräte und Utensilien | Allgemein

Diverse Kleinartikel



Flaschenputzer

mit Büschel, Körper: PP blau, Besatz: Nylon weiss

Artikel-Nr.	Produktinfo	Inhalt /VE	Preis /VE	
4178.1	Ø 50 mm	1	4.05	netto



Flaschenputzer mit Schaumstoff

blauer Plastikgriff

Artikel-Nr.	Produktinfo	Inhalt /VE	Preis /VE	ab 5 VE 10%
4308	Ø 50 mm	3	12.45	11.20



Reagenzputzer Nr. 1

Artikel-Nr.	Produktinfo	Inhalt /VE	Preis /VE	
10970	Ø 50 mm, Länge 62 cm / 12.5 cm	1	5.55	netto



Reagenzputzer Nr. 2

Artikel-Nr.	Produktinfo	Inhalt /VE	Preis /VE	
11318	Ø 20 mm, Länge 36 cm / 12 cm	1	4.60	netto



Reagenzputzer Nr. 3

Artikel-Nr.	Produktinfo	Inhalt /VE	Preis /VE	
11459	Ø 12 mm, Länge 28 cm / 8.5 cm	1	3.95	netto



Reagenzputzer Nr. 4

Artikel-Nr.	Produktinfo	Inhalt /VE	Preis /VE	
10395	Ø 30 mm, Länge 37 cm / 12 cm	1	3.50	netto



Reagenzputzer Nr. 5

Artikel-Nr.	Produktinfo	Inhalt /VE	Preis /VE	ab 5 VE 10%
10359	Ø 18 mm, Länge 35 cm / 10 cm	1	5.25	4.70



Reagenzputzer Nr. 6

Artikel-Nr.	Produktinfo	Inhalt /VE	Preis /VE	
10157	Ø 10 mm, Länge 49 cm / 12 cm	1	3.40	netto



Reagenzputzer Nr. 7

Artikel-Nr.	Produktinfo	Inhalt /VE	Preis /VE	ab 5 VE 10%
11460	Ø 12 mm, Länge 27 cm / 8 cm	1	5.25	4.70

Reinigungsgeräte und Utensilien | Allgemein

Diverse Kleinartikel



Reagenzputzer Nr. 8

Artikel-Nr.	Produktinfo	Inhalt /VE	Preis /VE	
10159	Ø 9 mm, Länge 25 cm / 5 cm	1	3.15	netto



Staubwedel mit Teleskopstiel

bunt

Artikel-Nr.	Produktinfo	Inhalt /VE	Preis /VE	ab 5 VE 10%
4306	85 - 125 cm	(Pal. 900) 1	11.50	10.35



Staubwedel Profi mit Teleskopstiel

blau

Artikel-Nr.	Produktinfo	Inhalt /VE	Preis /VE	ab 5 VE 10%
14669	54 cm, Stiel 113-200 cm	1	12.35	11.10



Ersatzstaubwedel Profi

blau

Artikel-Nr.	Produktinfo	Inhalt /VE	Preis /VE	ab 5 VE 10%
14670	54 cm	1	7.05	6.35



Staubwedel Deluxe mit Teleskopstiel

türkis, Lammwolle

Artikel-Nr.	Produktinfo	Inhalt /VE	Preis /VE	ab 5 VE 10%
26767	80 - 130 cm	1	18.65	16.80



Spinnenwedel mit Teleskopstiel

blau / rot, Kugelform

Artikel-Nr.	Produktinfo	Inhalt /VE	Preis /VE	
4298	75 - 133 cm	1	11.50	netto



Spinnenwedel ohne Stiel

blau / rot, Kugelform

Artikel-Nr.	Produktinfo	Inhalt /VE	Preis /VE	
24475*	für Art. 4298	1	8.60	netto



Staubbiene Profi

blau / rot, mit Teleskopstiel

Artikel-Nr.	Produktinfo	Inhalt /VE	Preis /VE	ab 5 VE 10%
14690	75 - 133 cm	1	11.90	10.75



Staubbiene Profi

blau / rot, mit Steckkonus

Artikel-Nr.	Inhalt /VE	Preis /VE	ab 5 VE 10%
14688	1	9.05	8.15

Reinigungsgeräte und Utensilien | Allgemein

Diverse Kleinartikel



Multistaubwischer

Box à 5 Wischtuch + 1 Griff

Artikel-Nr.	Inhalt /VE	Preis /VE	
13189	4	22.25	netto



Radiatorenbürste Handeinzug

Rosshaar, Buchenholz 100% FSC



Artikel-Nr.	Inhalt /VE	Preis /VE	ab 5 VE 10%
16092	1	27.55	24.80



Radiatorenbürste «U-Form»

Körper: PP blau, Besatz: Kunststoff

Artikel-Nr.	Inhalt /VE	Preis /VE	ab 5 VE 10%
4123	10	69.20	62.25



Lina Rahmen- / Leistenbürste

mit Winkelstück

Artikel-Nr.	Produktinfo	Inhalt /VE	Preis /VE	
26663	grau / weiss	(Pal. 120) 10	130.50	netto
26663.9	grau / weiss	(Pal. 1200) 1	14.50	netto



Lina Teleskopstiel

112 - 200 cm, für Art. 26663 / 26663.9

Artikel-Nr.	Produktinfo	Inhalt /VE	Preis /VE	
26693	silber / schwarz	(Pal. 1000) 1	14.50	netto



Grillbürste

Metallkratzer mit Messingdraht gross

Artikel-Nr.	Produktinfo	Inhalt /VE	Preis /VE	ab 5 VE 10%
4305	schwarz	1	9.05	8.15



Grillbürste

4-reihig, mit Metallkratzer

Artikel-Nr.	Inhalt /VE	Preis /VE	
4172	10	67.20	netto



Drahtbürste

3-reihig, mit Holzgriff

Artikel-Nr.	Inhalt /VE	Preis /VE	
4326	1	2.50	netto



Aschenbecher-Pinsel

Artikel-Nr.	Inhalt /VE	Preis /VE	ab 5 VE 10%
4325	3	22.10	19.85

Reinigungsgeräte und Utensilien | Allgemein

Diverse Kleinartikel



Tatzenbürste

aus Holz roh, Union

Artikel-Nr.	Produktinfo	Inhalt /VE	Preis /VE	ab 5 VE 10%
4174	32 cm	1	12.60	11.35



Badewannenbürste

Naturfaser, Holz roh

Artikel-Nr.	Inhalt /VE	Preis /VE	ab 5 VE 10%
4164	1	11.25	10.10



Badewannenbürste

weiss, Kunststoff

Artikel-Nr.	Inhalt /VE	Preis /VE	ab 5 VE 10%
4165	1	6.05	5.45



Sprühflasche 500 ml

leer, 2-teilig

Artikel-Nr.	Inhalt /VE	Preis /VE	
4227	1	5.45	netto



Aufhängeschiene All-Fix für Besen

weiss, rostfrei, mit 3 Aufhänger

Artikel-Nr.	Produktinfo	Inhalt /VE	Preis /VE	ab 5 VE 10%
14691*	50 cm	1	31.90	28.70



Aufhängeschiene All-Fix für Besen

blau, rostfrei, mit 3 Aufhänger

Artikel-Nr.	Produktinfo	Inhalt /VE	Preis /VE	ab 5 VE 10%
14693	50 cm	1	31.90	28.70



Plastikeimer rund

mit Metallbügel, 10 Liter

Artikel-Nr.	Produktinfo	Inhalt /VE	Preis /VE	
9731	blau	1	3.80	netto
9731.1*	weiss	1	3.80	netto
9732	gelb	1	3.85	netto
9733*	rot	1	3.80	netto



Plastikeimer rund

mit Metallbügel, 5 Liter

Artikel-Nr.	Produktinfo	Inhalt /VE	Preis /VE	
12233*	weiss	1	5.50	netto
12233.1*	gelb	(Pal. 1000) 1	5.50	netto
12233.2*	grün	(Pal. 1000) 1	5.50	netto
12233.3	blau	1	5.50	netto
12233.4*	rot	1	5.50	netto

* auf Bestellung

Reinigungsgeräte und Utensilien | Allgemein

Diverse Kleinartikel



Saugglocke Pump Max

blau / schwarz, PP

Artikel-Nr.	Inhalt /VE	Preis /VE	ab 5 VE 10%
23982*	1	9.75	8.75



Saugglocke

mit Holzstiel, rote Glocke

Artikel-Nr.	Inhalt /VE	Preis /VE	ab 5 VE 10%
27486*	1	5.00	4.50



Wanda Waschbeckenbürste

130 mm

Artikel-Nr.	Produktinfo	Inhalt /VE	Preis /VE	
26669	blau / transparent	(Pal. 120) 25	132.50	netto
26669.9	blau / transparent	(Pal. 3000) 1	5.90	netto

Fensterreinigung



Fensterreiniger Aqua-Clean

Stiel: Art. 20800

Artikel-Nr.	Produktinfo	Inhalt /VE	Preis /VE	ab 5 VE 10%
4320	25 cm	1	18.75	16.85



Teleskopstiel

88 - 210 cm, für Art. 4320

Artikel-Nr.	Produktinfo	Inhalt /VE	Preis /VE	
20800*	Aluminium	1	18.70	netto



Einwaschbezug

zu Fensterreiniger Art. 4320

Artikel-Nr.	Produktinfo	Inhalt /VE	Preis /VE	ab 5 VE 10%
4321*	25 cm	5	25.95	23.35



Fensterwischer mit Lippe

blauer Griff

Artikel-Nr.	Produktinfo	Inhalt /VE	Preis /VE	ab 5 VE 10%
4625	25 cm	1	4.85	4.40
4626	35 cm	1	5.35	4.80



Fensterreinigungsset in Nylon-Tasche (14-teilig)

inkl. Wischgriff, Schienen, Ersatzgummi, Teleskopstange, etc.

Artikel-Nr.	Inhalt /VE	Preis /VE	ab 5 VE 10%
27637*	1	201.65	181.50

Reinigungsgeräte und Utensilien | Vermop



Eimer

17 Liter

Artikel-Nr.	Produktinfo	Inhalt /VE	Preis /VE	
11302*	rot	1	26.05	netto
10963*	blau	1	26.05	netto

Reinigungsgeräte und Utensilien | Vermop



Eimer

6 Liter

Artikel-Nr.	Produktinfo	Inhalt /VE	Preis /VE	
10923*	rot	1	19.30	netto
10376*	gelb	1	19.30	netto
10922*	blau	1	19.30	netto
8717*	grün	1	19.30	netto



Eimer Equipe

8 Liter

Artikel-Nr.	Produktinfo	Inhalt /VE	Preis /VE	
27077*	blau	1	18.50	netto
27077.1*	rot	1	18.50	netto
27077.2*	gelb	1	18.50	netto



Sprint Plus Halter

inkl. Clips

Artikel-Nr.	Produktinfo	Inhalt /VE	Preis /VE	
10459	40 cm	1	50.60	netto
12667	50 cm	1	54.30	netto



Sprint Tronic Mop

getuftet

Artikel-Nr.	Produktinfo	Inhalt /VE	Preis /VE	
8701	40 cm	1	20.70	netto



Sprint Basic Mop, Einfassband blau

weiss, Schlinge / Fransen, getuftet

Artikel-Nr.	Produktinfo	Inhalt /VE	Preis /VE	
8888	40 cm	1	9.80	netto
8721	50 cm	1	10.15	netto



Sprint White Magic

Wischmopp ohne Aussenfransen

Artikel-Nr.	Produktinfo	Inhalt /VE	Preis /VE	
8891.1	40 cm	1	35.70	netto



Sprint Plus Tronic

mit Lasche, getuftet

Artikel-Nr.	Produktinfo	Inhalt /VE	Preis /VE	
11716	40 cm	1	20.70	netto



Sprint Plus Basic Mop

mit Lasche, getuftet, Baumwolle / Polyester

Artikel-Nr.	Produktinfo	Inhalt /VE	Preis /VE	
11717	40 cm	1	10.95	netto



Clipper Halter

Kunststoff

Artikel-Nr.	Produktinfo	Inhalt /VE	Preis /VE	
11763	40 cm	1	100.20	netto

Reinigungsgeräte und Utensilien | Vermop

**Clipper Basic Mop**

mit Tasche und 2 Laschen, Schlinge / Franse, getuftet

Artikel-Nr.	Produktinfo	Inhalt /VE	Preis /VE	
8711	40 cm	1	18.90	netto

**Clipper Tronic Mop**

mit Tasche/Lasche, getuftet

Artikel-Nr.	Produktinfo	Inhalt /VE	Preis /VE	
8719*	40 cm	1	31.55	netto

**Teleskopstiel**

Ø 23.5 mm

Artikel-Nr.	Produktinfo	Inhalt /VE	Preis /VE	
8702	90 - 165 cm	1	34.00	netto

**Alustiel**

eloxiert, Griff anthrazit

Artikel-Nr.	Produktinfo	Inhalt /VE	Preis /VE	
10481	140 x 2.35 cm	1	9.50	netto

**Wand- und Deckenbesen, Rundkopf**

mit Teleskopstiel

Artikel-Nr.	Inhalt /VE	Preis /VE	
11704	1	21.55	netto

**Feuchtwischhalter**

aus Edelstahl

Artikel-Nr.	Produktinfo	Inhalt /VE	Preis /VE	
12150	80 cm	1	23.55	netto

**Feuchtwischmop Basic**

mit Tasche

Artikel-Nr.	Produktinfo	Inhalt /VE	Preis /VE	
4526*	80 cm	1	19.20	netto

**Türstopper mit Stiel**

Ø Fuss 12 cm

Artikel-Nr.	Produktinfo	Inhalt /VE	Preis /VE	
24296*	97 cm	1	30.10	netto

**Aqua Nasswischwagen**

Grundgestell aus Kunststoff, mit Presse VK4, 17 Liter Eimer, ohne Deichsel

Artikel-Nr.	Inhalt /VE	Preis /VE	
14204*	1	192.05	netto

**Aqua Nasswischwagen**

Grundgestell aus Kunststoff, mit Presse VK4, 6 + 17 Liter Eimer, ohne Deichsel

Artikel-Nr.	Inhalt /VE	Preis /VE	
8723*	1	206.50	netto

Reinigungsgeräte und Utensilien | Vermop



Aqua Nasswischwagen

Grundgestell aus Kunststoff, mit Presse VK4, 2 x 17 Liter Eimer, mit Deichsel

Artikel-Nr.	Inhalt /VE	Preis /VE	
20560*	1	217.80	netto

Reinigungsgeräte und Utensilien | Vikan

Maschinen / Tische



Handfeger

35 x 4.5 x 11 cm, Polyester, weich

Artikel-Nr.	Produktinfo	Inhalt /VE	Preis /VE	
11402.3*	blau	1	13.05	netto
11402	weiss	1	13.05	netto
11402.2*	grün	1	13.05	netto
11402.4	rot	1	13.05	netto
11402.5*	gelb	1	13.05	netto



Kehrschaufel

330 x 295 x 100 mm

Artikel-Nr.	Produktinfo	Inhalt /VE	Preis /VE	
11412.3*	blau	1	16.15	netto
11412	weiss	1	16.15	netto
11412.2*	grün	1	16.15	netto
11412.4*	rot	1	16.15	netto
11412.5*	gelb	1	16.15	netto



Padhalter

23.5 x 10 x 7.5 cm, Polypropylen

Artikel-Nr.	Produktinfo	Inhalt /VE	Preis /VE	
11413.3*	blau	1	39.75	netto
11413*	weiss	1	39.75	netto
11413.2*	grün	1	39.75	netto
11413.4*	rot	1	39.75	netto
11413.5*	gelb	1	39.75	netto



Rohrbürste

blau, medium

Artikel-Nr.	Produktinfo	Inhalt /VE	Preis /VE	
11403.3*	50 x 6 x 14 cm	1	10.50	netto



Scheuerbürste

415 x 71 x 75 mm, hart

Artikel-Nr.	Produktinfo	Inhalt /VE	Preis /VE	
11441	weiss	1	15.15	netto



Nagelbürste

11.8 x 4.5 x 3.8 cm, hart

Artikel-Nr.	Produktinfo	Inhalt /VE	Preis /VE	
12251.3*	blau	1	7.10	netto
12251	weiss	1	7.10	netto
12251.4*	rot	1	7.10	netto
12251.5*	gelb	1	7.10	netto

Reinigungsgeräte und Utensilien | Vikan

Maschinen / Tische



Rohrbürste für Aussenreinigung

blau, weich

Artikel-Nr.	Produktinfo	Inhalt /VE	Preis /VE	
12271.3*	50 x 27 x 11 cm	1	48.55	netto

Fussboden



Wasserschieber

60 x 8.5 x 11.5 cm, mit schwarzem Gummi

Artikel-Nr.	Produktinfo	Inhalt /VE	Preis /VE	
11246.3	blau	1	36.40	netto

Ersatzgummi für Wasserschieber

schwarz



Artikel-Nr.	Produktinfo	Inhalt /VE	Preis /VE	
12990*	60 cm	1	19.95	netto

Ultra Hygiene Wasserschieber

60 x 8 x 9.5 cm



Artikel-Nr.	Produktinfo	Inhalt /VE	Preis /VE	
11436.3	blau	1	43.35	netto
11436*	weiss	1	43.35	netto
11436.2*	grün	1	43.35	netto
11436.4*	rot	1	43.35	netto
11436.5*	gelb	1	43.35	netto

Wasserschieber mit Drehgelenk

60 x 10 x 7.5 cm



Artikel-Nr.	Produktinfo	Inhalt /VE	Preis /VE	
12756.3*	blau	1	42.55	netto
12756	weiss	1	42.55	netto

Boden- und Wandbürste

27 x 6.5 x 10 cm, hart



Artikel-Nr.	Produktinfo	Inhalt /VE	Preis /VE	
11440.3	blau	1	27.90	netto
11440	weiss	1	27.90	netto

Bodenbesen

61 x 6.5 x 12.5 cm, Polyester, weich



Artikel-Nr.	Produktinfo	Inhalt /VE	Preis /VE	
11408.3	blau	1	47.90	netto
11408	weiss	1	47.90	netto
11408.2*	grün	1	47.90	netto
11408.4*	rot	1	47.90	netto
11408.5*	gelb	1	47.90	netto

Bodenbesen

60 x 4.5 x 13.5 cm, weich



Artikel-Nr.	Produktinfo	Inhalt /VE	Preis /VE	
12127.3*	blau	1	47.90	netto

Reinigungsgeräte und Utensilien | Vikan

Fussboden



Bodenschrubber

47 x 8 x 11.5 cm, hart

Artikel-Nr.	Produktinfo	Inhalt /VE	Preis /VE	
12991.3*	blau	1	56.70	netto
12991*	weiss	1	56.70	netto
12991.2*	grün	1	56.70	netto
12991.4*	rot	1	56.70	netto
12991.5*	gelb	1	56.70	netto



Bodenbesen

41 x 6.5 x 13 cm, weich

Artikel-Nr.	Produktinfo	Inhalt /VE	Preis /VE	
12067.3*	blau	1	30.05	netto
12067*	weiss	1	30.05	netto
12067.2*	grün	1	30.05	netto
12067.4*	rot	1	30.05	netto
12067.5*	gelb	1	30.05	netto



Bodenschrubber

30.5 x 8.5 x 11 cm, hart

Artikel-Nr.	Produktinfo	Inhalt /VE	Preis /VE	
12247.3*	blau	1	39.25	netto
12247*	weiss	1	39.25	netto
12247.2*	grün	1	39.25	netto
12247.4*	rot	1	39.25	netto
12247.5*	gelb	1	39.25	netto

Stiele



Glasfaserstiel

170 x 3.3 cm

Artikel-Nr.	Produktinfo	Inhalt /VE	Preis /VE	
11398.3	blau	1	37.70	netto



Glasfaserstiel

150 x 3.1 cm

Artikel-Nr.	Produktinfo	Inhalt /VE	Preis /VE	
11247	weiss	1	32.25	netto



Ergonomischer Stiel

151 x 3.1 cm, Alu

Artikel-Nr.	Produktinfo	Inhalt /VE	Preis /VE	
12238.3	blau	1	26.00	netto
12238	weiss	1	26.00	netto
12238.2	grün	1	26.00	netto
12238.4	rot	1	26.00	netto
12238.5	gelb	1	26.00	netto

Reinigungsgeräte und Utensilien | Vikan

Sonstige Geräte



Grosse Handschaufel

16 x 9.5 x 36 cm

Artikel-Nr.	Produktinfo	Inhalt /VE	Preis /VE	
12068.3*	blau	1	12.85	netto
12068*	weiss	1	12.85	netto
12068.2*	grün	1	12.85	netto
12068.4*	rot	1	12.85	netto
12068.5*	gelb	1	12.85	netto



Spülbürste

25 cm, medium

Artikel-Nr.	Produktinfo	Inhalt /VE	Preis /VE	
16740.3	blau	1	5.40	netto
16740*	weiss	1	5.40	netto
16740.5*	gelb	1	5.40	netto



Spülbürste mit Schaberand

28 x 6 x 5.5 cm, medium

Artikel-Nr.	Produktinfo	Inhalt /VE	Preis /VE	
16767.3*	blau	1	6.10	netto
16767	weiss	1	6.10	netto
16767.4*	rot	1	6.10	netto
16767.5*	gelb	1	6.10	netto

Zubehör



Nylon-Pad, hart

24.5 x 12.5 x 2.3 cm

Artikel-Nr.	Produktinfo	Inhalt /VE	Preis /VE	
11416*	braun	10	42.80	netto



Nylon-Pad, medium

24.5 x 12.5 x 2.3 cm

Artikel-Nr.	Produktinfo	Inhalt /VE	Preis /VE	
11417*	blau	10	42.80	netto



Nylon-Pad, weich

24.5 x 12.5 x 2.3 cm

Artikel-Nr.	Produktinfo	Inhalt /VE	Preis /VE	
11418	weiss	10	42.80	netto

Reinigungsgeräte und Utensilien | Unger

Glasreinigung



S-Wischer Ergotec

Griff und Gummi, komplett mit S-Schiene, soft

Artikel-Nr.	Produktinfo	Inhalt /VE	Preis /VE	
9657	35 cm	1	28.50	netto
9669	45 cm	1	30.65	netto

Reinigungsgeräte und Utensilien | Unger

Glasreinigung



S-Wischer

Griff und Gummi, komplett mit S-Schiene, hard

Artikel-Nr.	Produktinfo	Inhalt /VE	Preis /VE	
4617	25 cm	1	25.55	netto
9877	45 cm	1	24.95	netto



S-Schiene

komplett mit hartem Gummi

Artikel-Nr.	Produktinfo	Inhalt /VE	Preis /VE	
8858	35 cm	1	10.85	netto
28284*	45 cm	1	25.35	netto



S-Schiene

komplett mit soft-Gummi

Artikel-Nr.	Produktinfo	Inhalt /VE	Preis /VE	
12015*	35 cm	1	10.65	netto
9583*	45 cm	1	25.35	netto



S-Wischergriff ErgoTec

Artikel-Nr.	Produktinfo	Inhalt /VE	Preis /VE	
12009	25 cm	1	15.30	netto



Wischergummi

soft, in Box

Artikel-Nr.	Produktinfo	Inhalt /VE	Preis /VE	
9582*	35 cm	25	93.40	netto



Wischergummi-Ersatz

soft, im Beutel

Artikel-Nr.	Produktinfo	Inhalt /VE	Preis /VE	
9671*	35 cm	10	37.00	netto
10396	45 cm	1	4.05	netto



Wischergummi-Ersatz

hart, im Beutel

Artikel-Nr.	Produktinfo	Inhalt /VE	Preis /VE	
9875*	45 cm	10	39.95	netto
5374*	92 cm	10	71.30	netto



Teleskopstange OptiLoc

2-teilig, mit Sicherheitskonus

Artikel-Nr.	Produktinfo	Inhalt /VE	Preis /VE	
8883*	125 cm	1	29.95	netto
9887	250 cm	1	41.35	netto
9888	300 cm	1	47.50	netto
10384*	400 cm	1	59.10	netto

Reinigungsgeräte und Utensilien | Unger

Glasreinigung



Teleskopstange OptiLoc

3-teilig, mit Sicherheitskonus

Artikel-Nr.	Produktinfo	Inhalt /VE	Preis /VE	
8873	450 cm	1	82.30	netto
12040*	600 cm	1	107.85	netto
12052*	750 cm	1	138.15	netto
12019*	900 cm	1	168.55	netto



Ergotec-Trägereil

Kunststoff

Artikel-Nr.	Produktinfo	Inhalt /VE	Preis /VE	
9689	25 cm	1	12.15	netto
9688	35 cm	1	11.40	netto
9687	45 cm	1	12.15	netto



Alu-Träger

Artikel-Nr.	Produktinfo	Inhalt /VE	Preis /VE	
9883*	25 cm	1	12.95	netto
9884	35 cm	1	7.60	netto
9885*	45 cm	1	8.50	netto



Pad Strip Pac

Trägereil mit Einwascherbezug

Artikel-Nr.	Produktinfo	Inhalt /VE	Preis /VE	
9645*	35 cm	1	27.85	netto



MicroStrip Mikrofaser-Bezug

Artikel-Nr.	Produktinfo	Inhalt /VE	Preis /VE	
9949	35 cm	1	16.95	netto
9697*	45 cm	1	19.20	netto



Original Strip Standardbezug

Artikel-Nr.	Produktinfo	Inhalt /VE	Preis /VE	
9683	35 cm	1	15.85	netto
9692	45 cm	1	16.90	netto



Pad Strip - Standardbezug mit Padfläche

Mischgewebe, mit Klettverschluss

Artikel-Nr.	Produktinfo	Inhalt /VE	Preis /VE	
9878	35 cm	1	16.75	netto
9879*	45 cm	1	32.00	netto



Visa Versa

Wischer und Einwascher in Einem; komplett mit S-Schiene, Original-Bezug und Gummi

Artikel-Nr.	Produktinfo	Inhalt /VE	Preis /VE	
12013*	35 cm	1	47.30	netto
16057*	45 cm	1	71.90	netto

Reinigungsgeräte und Utensilien | Unger

Glasreinigung



Trimhalter 10 + 1

10 Klingen, 1 Halter TH100

Artikel-Nr.	Produktinfo	Inhalt /VE	Preis /VE	
9890	10 cm	1	10.50	netto



Glasschaberklingen

Etui à 25 Klingen, für Art. 9890

Artikel-Nr.	Produktinfo	Inhalt /VE	Preis /VE	
9644*	10 cm	25	12.75	netto



Sicherheitsschaber ohne Gummiüberzug

mit Klinge, aus Metall

Artikel-Nr.	Produktinfo	Inhalt /VE	Preis /VE	
4528	4 cm	1	5.25	netto

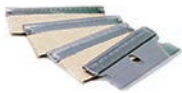

Ersatzklingen

für Art. 4528

Artikel-Nr.	Produktinfo	Inhalt /VE	Preis /VE	
5367	4 cm	100	32.25	netto



ErgoTec Schaber für Fenster

kurzer Kunststoffgriff

Artikel-Nr.	Produktinfo	Inhalt /VE	Preis /VE	
10040	10 cm	1	20.20	netto



Ersatzklingen

für Art. 10040

Artikel-Nr.	Produktinfo	Inhalt /VE	Preis /VE	
9889*	10 cm	1	9.90	netto



ErgoTec-Set

hochwertiges Glasreinigungs-Set, beinhaltet alle ErgoTec-Werkzeuge

Artikel-Nr.	Produktinfo	Inhalt /VE	Preis /VE	
4747	komplett in stabiler Nylon-Tragetasche	1	212.00	netto



ProFlatDuster 75 Staubwedel

Artikel-Nr.	Produktinfo	Inhalt /VE	Preis /VE	
13654	75 cm	1	36.85	netto



ProFlatDuster 75 Ersatzbezüge Mikrofaser

für Art. 13654

Artikel-Nr.	Produktinfo	Inhalt /VE	Preis /VE	
14131*	75 cm	5	73.30	netto

Reinigungsgeräte und Utensilien | Unger

Glasreinigung



Eimer

mit Ablagesieb für Wischer und Einwascher

Artikel-Nr.	Produktinfo	Inhalt /VE	Preis /VE	
9696*	18 Liter	1	21.55	netto



Neopren-Handschuh

mit Klettverschluss

Artikel-Nr.	Produktinfo	Inhalt /VE	Preis /VE	
10041*	Grösse L	1	56.40	netto

Wand & Decke



Teleskopstange OptiLoc

2-teilig, mit Sicherheitskonus

Artikel-Nr.	Produktinfo	Inhalt /VE	Preis /VE	
8883*	125 cm	1	29.95	netto
9887	250 cm	1	41.35	netto
9888	300 cm	1	47.50	netto
10384*	400 cm	1	59.10	netto



Teleskopstange OptiLoc

3-teilig, mit Sicherheitskonus

Artikel-Nr.	Produktinfo	Inhalt /VE	Preis /VE	
8873	450 cm	1	82.30	netto
12040*	600 cm	1	107.85	netto
12052*	750 cm	1	138.15	netto
12019*	900 cm	1	168.55	netto



ErgoTec Sicherheitskonus

verhindert das Herabfallen von Werkzeugen von der Teleskopstange

Artikel-Nr.	Inhalt /VE	Preis /VE	
13657*	1	9.30	netto



Rohrbürste rund

biegsam, passt auf Teleskopstange

Artikel-Nr.	Inhalt /VE	Preis /VE	
9891*	1	23.10	netto



Wandbürste oval

optimal zum Entstauben auf rauen Oberflächen und flachen Gegenständen, passt auf Teleskopstange

Artikel-Nr.	Inhalt /VE	Preis /VE	
9695	1	26.20	netto



StarDuster Staubwedel

aus Lammwolle, biegsam, Handgriff und auf Stange schraubbar

Artikel-Nr.	Inhalt /VE	Preis /VE	
10966	1	44.95	netto

Reinigungsgeräte und Utensilien | Unger

Bodenpflege



Nifty Nabber Pro

Allzweckgreifer

Artikel-Nr.	Produktinfo	Inhalt /VE	Preis /VE	
8877	90 cm	1	37.95	netto

Reinigungsgeräte und Utensilien | Ecolab



Rasant-Halter

40 cm, robust, einfach und schnell anwendbar; für eine optimale Produktivität bei der Unterhaltsreinigung

Artikel-Nr.	Inhalt /VE	Preis /VE	
8789	1	83.40	netto



Rasant-Halter R40

40 cm, robust, einfach und schnell anwendbar; für eine optimale Produktivität bei der Unterhaltsreinigung

Artikel-Nr.	Inhalt /VE	Preis /VE	
9932	1	89.10	netto



Alustiel

140 cm, eloxiert

Artikel-Nr.	Produktinfo	Inhalt /VE	Preis /VE	
9714	blau	1	21.80	netto



Blizzard Bezug mit Lasche R40

40 cm, mit Lasche, Schlinge / Franse

Artikel-Nr.	Inhalt /VE	Preis /VE	
9931	1	23.50	netto



Rasant-Bezug CombiteX R40

mit Lasche, Deckblatt: Schlingen getuftet, Aussenposament: Microfaserstreifen

Artikel-Nr.	Produktinfo	Inhalt /VE	Preis /VE	
5144	40 cm	1	18.10	netto



Rasant-Bezug micro R40

mit Tasche / Lasche

Artikel-Nr.	Produktinfo	Inhalt /VE	Preis /VE	
9933	40 cm	1	27.30	netto



Rasant-Bezug CombiteX

mit Tasche, Deckblatt: Schlingen getuftet, Aussenposament: Microfaserstreifen; deutlich verringerte Washkosten

Artikel-Nr.	Produktinfo	Inhalt /VE	Preis /VE	
9712	40 cm	1	16.40	netto

Reinigungsgeräte und Utensilien | Diversey



TASKI AERO 8 SEV

kompakter, leistungsstarker und ultra-leiser Kesselsauger inkl. Zubehör

Artikel-Nr.	Produktinfo	Inhalt /VE	Preis /VE	
28777	Nutzvolumen 8 Liter	(Pal. 20) 1	259.00	netto

Reinigungsgeräte und Utensilien | Diversey



TASKI AERO 8 PLUS SEV

kompakter, leistungsstarker und ultra-leiser Kesselsauger inkl. Zubehör

Artikel-Nr.	Produktinfo	Inhalt /VE	Preis /VE	
28778*	mit ergonomischer Kabelaufwicklungstrommel, ECO-Modus und Beutelfüllstandsanzeige, Nutzvolumen 8 Liter	(Pal. 16) 1	359.00	netto



TASKI AERO 15 SEV

kompakter, leistungsstarker und ultra-leiser Kesselsauger inkl. Zubehör

Artikel-Nr.	Produktinfo	Inhalt /VE	Preis /VE	
28779*	Nutzvolumen 15 Liter	(Pal. 16) 1	289.00	netto



TASKI AERO 15 PLUS SEV

kompakter, leistungsstarker und ultra-leiser Kesselsauger inkl. Zubehör

Artikel-Nr.	Produktinfo	Inhalt /VE	Preis /VE	
28780*	mit ergonomischer Kabelaufwicklungstrommel, ECO-Modus und Beutelfüllstandsanzeige, Nutzvolumen 15 Liter	(Pal. 16) 1	389.00	netto



TASKI go SEV

standard Staubsauger mit robustem und einfachem Design, hergestellt aus 75 % recyceltem Material, inkl. Zubehör

Artikel-Nr.	Inhalt /VE	Preis /VE	
27502	(Pal. 20) 1	99.00	netto

Reinigungsgeräte und Utensilien | Diverse Hersteller



Trockensauger PPR240-11 blau / schwarz Henry Plus

ausgestattet mit Hochleistungsmotor, Kabelaufrollsystem mit Schnellwechselfunktion, Parkfunktion, Behälterinhalt von 9 Liter; für alle Bodenbeläge

Artikel-Nr.	Produktinfo	Inhalt /VE	Preis /VE	
26530*	inkl. VA-Saugrohre, FloMax Saugschlauch, HiPro Kombidüse, Kleinteile-Zubehör	(Pal. 24) 1	310.00	netto



HEPA-FLO Vliesstaubbeutel NVM-1CH

10 Stück

Artikel-Nr.	Produktinfo	Inhalt /VE	Preis /VE	
26531	für Art. 26530	(Pal. 576) 10	26.25	netto

Wäschereiartikel | Wäschesäcke



Wäschesäcke

PE-light, 320/280 x 1200 mm, 0.02 mm, Rolle à 20 Säcke

Artikel-Nr.	Produktinfo	Inhalt /VE	Preis /VE	Preis ab 6 VE
6164	blau	(Pal. 70) 12	48.70	43.80
6164.1	rot	(Pal. 70) 12	48.70	43.80
6164.2	gelb	(Pal. 70) 12	48.70	43.80
6164.3	schwarz	(Pal. 48) 20	81.10	73.00
6164.4	grau	(Pal. 48) 20	81.10	73.00
6164.5	grün	(Pal. 70) 12	48.70	43.80
6164.6	weiss	(Pal. 70) 12	48.70	43.80
24900	braun	(Pal. 70) 12	48.70	43.80
24901	orange	(Pal. 70) 12	48.70	43.80
24902	violett	(Pal. 70) 12	48.70	43.80

Wäschereiartikel | Wäschesäcke



Wäschesäcke

PE-LD, 350/250 x 1200 mm, 0.037 mm, Rolle à 10 Säcke

Artikel-Nr.	Produktinfo	Inhalt /VE	Preis /VE	Preis ab 6 VE
6167	blau	(Pal. 50) 25	121.65	109.50
6167.1	rot	(Pal. 50) 25	121.65	109.50
6167.2	gelb	(Pal. 50) 25	121.65	109.50
6167.3	schwarz	(Pal. 50) 25	121.65	109.50
6167.4	grau	(Pal. 50) 25	121.65	109.50
6167.5	grün	(Pal. 50) 25	121.65	109.50
6167.6	weiss	(Pal. 50) 25	121.65	109.50
6167.7	transparent	(Pal. 50) 25	121.65	109.50



Wäschesack Premium

LD-PE, 700 x 1100 mm, 0.06 mm, Rolle à 25 Säcke

Artikel-Nr.	Produktinfo	Inhalt /VE	Preis /VE	ab 5 VE 10%
14250	gelb	(Pal. 30) 10	112.50	101.25



Wäschesack AquaFilm

wasserlöslich, transparent

Artikel-Nr.	Produktinfo	Inhalt /VE	Preis /VE	ab 5 VE 10%
18237	711 x 990 mm, 0.022 mm	100	130.65	117.60



Wäschenetz Vermop

mit Kordel und Verschluss

Artikel-Nr.	Produktinfo	Inhalt /VE	Preis /VE	
26710*	blau, 120 Liter	1	71.80	netto

Wäschereiartikel | Frischwäschebeutel



Frischwäschebeutel

transparent

Artikel-Nr.	Produktinfo	Inhalt /VE	Preis /VE	Preis ab 6 VE
7805	35 x 50 cm, 0.03 mm	(Pal. 60) 500	106.30	95.65

Wäschereiartikel | Diverse



Fusselroller Fusselfix

komplett

Artikel-Nr.	Produktinfo	Inhalt /VE	Preis /VE	
9775	10 m	1	8.15	netto



Ersatzrolle Fusselfix

für Art. 9775

Artikel-Nr.	Produktinfo	Inhalt /VE	Preis /VE	
9776	10 m	1	6.00	netto



Kleiderroller

mit schwarzem Griff

Artikel-Nr.	Produktinfo	Inhalt /VE	Preis /VE	ab 5 VE 10%
16085	Länge ca. 5 m pro Rolle	1	3.05	2.75

* auf Bestellung

Wäschereiartikel | Diverse



Ersatzrolle

für Art. 16085

Artikel-Nr.	Produktinfo	Inhalt /VE	Preis /VE	ab 5 VE 10%
27473	5 m	1	2.10	1.85

Reinigungschemie



Private Label	310
Ecolab	311
Diversey	331
Steinfels Swiss	351
van Baerle	363
Buzil	371
Dr. Schnell	376
Diverse Produzenten	384

Private Label | Geschirr-Reiniger



Geschirrspültabs SMA35 - CLEAN & CLEVER

phosphat- und chlorfrei, integrierter Kalkstopper

Artikel-Nr.	Produktinfo	Inhalt /VE	Preis /VE	
9735	60 Tabs à 18 g	(Pal. 72) 5	69.90	netto



Geschirrspülreiniger PRO120 - CLEAN & CLEVER

Artikel-Nr.	Produktinfo	Inhalt /VE	Preis /VE	
20204	12 kg	(Pal. 60) 1	57.85	netto



Klarspüler PRO123 - CLEAN & CLEVER

Artikel-Nr.	Produktinfo	Inhalt /VE	Preis /VE	ab 5 VE 10%
9652	1 Liter	(Pal. 35) 12	77.40	69.70
21918	10 Liter	(Pal. 60) 1	57.45	netto



Handspülmittel PRO11 - CLEAN & CLEVER

Artikel-Nr.	Produktinfo	Inhalt /VE	Preis /VE	
19764	1 Liter	(Pal. 80) 8	26.40	netto
13393	10 Liter	(Pal. 60) 1	27.45	netto



Geschirrwaschmittel MAGIC CLIN Active

Phosphatfrei/chlorfrei, ohne NTA, entfernt hartnäckige Kaffee- und Teerückstände und andere Verschmutzungen, für Silber geeignet (nicht geeignet für Buntmetalle und Aluminium), einsetzbar bis 35°fH, nicht schäumend.

Artikel-Nr.	Produktinfo	Inhalt /VE	Preis /VE	
19868	12 kg	(Pal. 60) 1	62.85	netto
19869	25 kg	(Pal. 24) 1	120.90	netto



Geschirrwaschmittel MAGIC CLIN Plus

Chlorhaltig, hohe Reinigungskraft, entfernt Kaffee- und Teerückstände, bis 20°fH, Korrosionsschutz.

Artikel-Nr.	Produktinfo	Inhalt /VE	Preis /VE	
19867	12 kg	(Pal. 60) 1	62.85	netto
19865	25 kg	(Pal. 24) 1	120.90	netto



Glanztrocknungsmittel MAGIC RINSE N

Flecken- und streifenfreies Trocknen, trocknet innert kürzester Zeit, materialschonend.

Artikel-Nr.	Produktinfo	Inhalt /VE	Preis /VE	
19871*	10 kg	(Pal. 60) 1	56.55	netto



Glanztrocknungsmittel MAGIC RINSE S

Nur für Geschirrwaschmaschinen mit säurebeständigem Spül- und Dosiersystem geeignet, pH sauer, erhöht die Glanzwirkung, hemmt Kalkablagerungen, hartwasserbeständig.

Artikel-Nr.	Produktinfo	Inhalt /VE	Preis /VE	
19872	10 kg	(Pal. 60) 1	88.70	netto
19873	20 kg	(Pal. 24) 1	168.00	netto

Private Label | Sanitärreiniger



Essigreiniger PRO3 - CLEAN & CLEVER

Artikel-Nr.	Produktinfo	Inhalt /VE	Preis /VE	
10029	10 Liter	(Pal. 60) 1	29.55	netto

Private Label | Textil-Waschmittel



Corso Vollwaschmittel

phosphatfrei

Artikel-Nr.	Produktinfo	Inhalt /VE	Preis /VE	
8299	10 kg	(Pal. 64) 1	32.10	netto
8298	20 kg	(Pal. 33) 1	57.40	netto

Ecolab | Geschirr-Reinigung

Blockförmige Geschirrwashmittel



Eco-Clin Tabs 88

Geschirrwash-Tabts

Artikel-Nr.	Produktinfo	Inhalt /VE	Preis /VE	
13550	4 kg	(Pal. 168) 1	51.00	netto



Solid Mega

Geschirrwashmittel für alle Geschirrwashmaschinen

Artikel-Nr.	Produktinfo	Inhalt /VE	Preis /VE	
9844	4.5 kg, blockförmig	(Pal. 36) 4	282.10	netto



Solid Protect

Geschirrwashmittel für alle Geschirrwashmaschinen

Artikel-Nr.	Produktinfo	Inhalt /VE	Preis /VE	
8586	4.5 kg, blockförmig, Foldaway pack	4	280.10	netto



Solid Hero

Geschirrwashmittel für alle Geschirrwashmaschinen

Artikel-Nr.	Produktinfo	Inhalt /VE	Preis /VE	
9833	4.5 kg, blockförmig, roter kleber	(Pal. 36) 4	313.00	netto



Solid ClearDRY Clean

Glanzmittel

Artikel-Nr.	Produktinfo	Inhalt /VE	Preis /VE	
21530	1.1 kg, blockförmig	(Pal. 264) 2	339.10	netto



ECL 215

Geschirrrreiniger

Artikel-Nr.	Produktinfo	Inhalt /VE	Preis /VE	
22010	4.5 kg, blockförmig	(Pal. 36) 4	296.80	netto



Apex Rinse N

Hochkonzentrierter Hochleistungsklarspüler

Artikel-Nr.	Produktinfo	Inhalt /VE	Preis /VE	
27105	1,1 kg	(Pal. 264) 2	321.10	netto



Apex Ultra

Hochkonzentriertes Maschinenspülmittel in Blockform, für mittlere Wasserhärte

Artikel-Nr.	Produktinfo	Inhalt /VE	Preis /VE	
22205	3.1 kg	(Pal. 56) 4	193.90	netto



Apex™
Produktlinie in Blockform für
das maschinelle Geschirreinigen



KitchenPro
Systemlösungen für die
Küchenhygiene



MAXX2
Systemlösung für die
Gebäudereinigung



AQUANOMIC
Systemlösung für die
Wäscheaufbereitung



Nexa
Systemlösung für die
Handhygiene

So individuell wie Ihre Kundschaft - so individuell ist unsere Systemlösung für Sie!

Als Komplettanbieter für professionelle Reinigung und Desinfektion bietet Ihnen Ecolab eine umfassende Produktauswahl für alle Bereiche der Hygiene - aber auch individuelle Lösungskonzepte, zugeschnitten auf die besonderen Gegebenheiten Ihres Betriebs. Vertrauen Sie auf unsere Erfahrung, bewährte Innovationskraft und die 360°-Sicherheitsarchitektur zum Schutz Ihrer Gäste und zur Maximierung Ihres Geschäftserfolges.

Ecolab | Geschirr-Reinigung

Blockförmige Geschirrwaschmittel



Solid Clean H

Geschirrwaschmittel, für hohe Wasserhärte

Artikel-Nr.	Produktinfo	Inhalt /VE	Preis /VE	
18721	4.5 kg	(Pal. 36) 4	296.00	netto



Solid Clean M

Geschirrwaschmittel, für mittlere Wasserhärte



Artikel-Nr.	Produktinfo	Inhalt /VE	Preis /VE	
18572	4.5 kg	(Pal. 36) 4	274.20	netto

Flüssige Geschirrwaschmittel



Topmatic Plus

Geschirrwaschmittel

Artikel-Nr.	Produktinfo	Inhalt /VE	Preis /VE	
10151	12 kg	(Pal. 60) 1	95.40	netto
9824	25 kg	(Pal. 24) 1	189.70	netto
5436	250 kg	(Pal. 2) 1	1'824.30	netto



Topmatic Perfekt

Phosphatfreies Geschirrwaschmittel

Artikel-Nr.	Produktinfo	Inhalt /VE	Preis /VE	
13723*	25 kg	1	188.60	netto
9552*	250 kg	(Pal. 2) 1	1'775.80	netto



Topmatic Perfect ProTec

Phosphatfreies Geschirrwaschmittel, im Container

Artikel-Nr.	Produktinfo	Inhalt /VE	Preis /VE	
19071	250 kg	1	1'890.00	netto



Trump Hydro Special

Phosphatfreies Geschirrwaschmittel

Artikel-Nr.	Produktinfo	Inhalt /VE	Preis /VE	
10152	12 kg	(Pal. 60) 1	94.10	netto
9825	25 kg	(Pal. 24) 1	184.00	netto
20988	5 Liter	(Pal. 36) 4	189.30	netto
7354*	250 kg	(Pal. 2) 1	1'764.40	netto



Topmatic Universal special

Phosphat- und chlorfreies Geschirrwaschmittel

Artikel-Nr.	Produktinfo	Inhalt /VE	Preis /VE	
12732	25 kg	(Pal. 24) 1	181.80	netto
11501	250 kg	(Pal. 2) 1	1'753.00	netto
18528	250 kg, im Container	(Pal. 1) 1	1'867.20	netto



Topmatic Hero ProTec

Chlor- und phosphathaltiges Geschirrwaschmittel, im Container

Artikel-Nr.	Produktinfo	Inhalt /VE	Preis /VE	
18531	250 kg	(Pal. 1) 1	1'858.60	netto

Ecolab | Geschirr-Reinigung

Pulverförmige Geschirrwaschmittel



Guardian Heavy Plus

Geschirrwaschmittel für alle Geschirrwaschmaschinen

Artikel-Nr.	Produktinfo	Inhalt /VE	Preis /VE	
9707	4.3 kg	(Pal. 32) 4	158.60	netto

Glanztrocknungsmittel



Clear Dry HDP Plus

Glanztrocknungsmittel, pH sauer

Artikel-Nr.	Produktinfo	Inhalt /VE	Preis /VE	
10150	5 Liter	(Pal. 60) 2	91.10	netto
9827	20 kg	(Pal. 24) 1	172.70	netto
9553	200 kg	(Pal. 2) 1	1'617.00	netto



Clear Dry Classic

Glanztrocknungsmittel

Artikel-Nr.	Produktinfo	Inhalt /VE	Preis /VE	
9847	5 Liter	(Pal. 60) 2	166.50	netto



Toprinse Clean

Glanztrocknungsmittel



Artikel-Nr.	Produktinfo	Inhalt /VE	Preis /VE	
18715	5 Liter	(Pal. 60) 2	174.90	netto



Toprinse

Glanztrocknungsmittel

Artikel-Nr.	Produktinfo	Inhalt /VE	Preis /VE	
22411	20 kg	(Pal. 24) 1	152.50	netto



Toprinse HDP ProTec

Saurer Klarspüler

Artikel-Nr.	Produktinfo	Inhalt /VE	Preis /VE	
18529	200 kg, im Container	(Pal. 1) 1	1'781.50	netto

Spezialprodukte



Dip-it-Plus

Tauchreiniger Aktiv-Sauerstoff

Artikel-Nr.	Produktinfo	Inhalt /VE	Preis /VE	
9544	2.4 kg	(Pal. 44) 6	220.70	netto



Dip-it-Catee

Tauchreiniger

Artikel-Nr.	Produktinfo	Inhalt /VE	Preis /VE	
9836	10 kg	(Pal. 55) 1	129.30	netto

Ecolab | Geschirr-Reinigung

Spezialprodukte



Guardian Blitz

Geschirr-Grundreiniger

Artikel-Nr.	Produktinfo	Inhalt /VE	Preis /VE	
5435	2.4 kg	(Pal. 44) 6	279.70	netto



X-Streamtec Shine

Hochleistungsadditiv

Artikel-Nr.	Produktinfo	Inhalt /VE	Preis /VE	
9551	25 kg	(Pal. 24) 1	300.60	netto
18530	250 kg, im Container	1	3'077.60	netto



Assure Plus

Vorreiniger für Geschirr und Besteck

Artikel-Nr.	Produktinfo	Inhalt /VE	Preis /VE	
8771	12 kg	(Pal. 60) 1	98.80	netto



Assure Powder

Pflege- und Vorweichmittel für Silbergeschirr und -besteck

Artikel-Nr.	Produktinfo	Inhalt /VE	Preis /VE	
10009*	2.4 kg	(Pal. 44) 6	126.20	netto



Apex Presoak

Blöckförmiger Besteck-Tauchreiniger

Artikel-Nr.	Produktinfo	Inhalt /VE	Preis /VE	
22750	1.8 kg	(Pal. 144) 3	148.30	netto



Aquanomic Solid Detergent

Waschmittel in Blockform, phosphatfrei

Artikel-Nr.	Produktinfo	Inhalt /VE	Preis /VE	
25624	4.08 kg	(Pal. 36) 4	458.20	netto



Aquanomic Solid Oxy

Fleckenentferner in Blockform, farbschonend

Artikel-Nr.	Produktinfo	Inhalt /VE	Preis /VE	
25623	1.36 kg	(Pal. 315) 2	78.90	netto

Manuelle Abwaschmittel



Assert Lemon

Manuelles Abwasch- und Reinigungsmittel

Artikel-Nr.	Produktinfo	Inhalt /VE	Preis /VE	
12604	1 Liter	(Pal. 63) 6	38.50	netto
9708	5 Liter	(Pal. 60) 2	57.80	netto
10131	20 kg	(Pal. 24) 1	103.50	netto



Assert Classic

Manuelles Abwasch- und Reinigungsmittel, unparfümiert

Artikel-Nr.	Produktinfo	Inhalt /VE	Preis /VE	
12725	1 Liter	(Pal. 63) 6	35.80	netto
12488	10 kg	(Pal. 60) 1	52.90	netto
9834	20 kg	(Pal. 24) 1	93.50	netto

* auf Bestellung

VOC-Abgaben werden separat verrechnet.

Ecolab | Geschirr-Reinigung

Manuelle Abwaschmittel



Apex Manual Detergent

Handspülmittel in Blockform, für manuelle Geschirr- und Utensilienreinigung

Artikel-Nr.	Produktinfo	Inhalt /VE	Preis /VE	
22747	1.36 kg	(Pal. 216) 2	116.10	netto



Dishguard 71

Handspülmittel

Artikel-Nr.	Produktinfo	Inhalt /VE	Preis /VE	
9863	1 Liter	(Pal. 96) 4	86.50	netto

Ecolab | Küchenhygiene

Entkalker



Lime-A-Way Extra

Entkalkungsmittel für Küche, Bad/Dusche und Toilette

Artikel-Nr.	Produktinfo	Inhalt /VE	Preis /VE	
19977	1 Liter	(Pal. 128) 4	62.10	netto
9364	5 Liter	(Pal. 60) 2	145.30	netto



Strip-A-Way Powder

Entkalker, pulverförmig, für Geschirr

Artikel-Nr.	Produktinfo	Inhalt /VE	Preis /VE	
9853	12 kg	(Pal. 55) 1	152.20	netto

Allzweckreiniger



Imi Orange

Kraftvoller Allzweckreiniger ohne Ammoniak

Artikel-Nr.	Produktinfo	Inhalt /VE	Preis /VE	
8187	5 Liter	(Pal. 80) 2	74.30	netto

Entfetter



Renolit Plus

Entfetter

Artikel-Nr.	Produktinfo	Inhalt /VE	Preis /VE	
9543	10 Liter	(Pal. 60) 1	109.10	netto
9826	20 kg	(Pal. 24) 1	196.10	netto



Renolit clean S

ökologischer Allzweck- und Oberflächenreiniger



Artikel-Nr.	Produktinfo	Inhalt /VE	Preis /VE	
20478	5 Liter	2	114.90	netto

Edelstahlpflege



Polish Cleaner

Reinigungs- und Pflegemittel für Chromstahlflächen

Artikel-Nr.	Produktinfo	Inhalt /VE	Preis /VE	
5111	500 ml	(Pal. 65) 12	144.60	netto

Ecolab | Küchenhygiene

Edelstahlpflege



Helios Brillant

Glaskeramikkochfeld- und Edelstahlreiniger

Artikel-Nr.	Produktinfo	Inhalt /VE	Preis /VE	
10235	500 ml	(Pal. 84) 6	74.50	netto



Chromol

Edelstahlpflege

Artikel-Nr.	Produktinfo	Inhalt /VE	Preis /VE	
9710	500 ml	(Pal. 96) 6	82.40	netto

Grill- und Ofenreiniger



Greasecutter Plus

Backofen- und Herdreiniger

Artikel-Nr.	Produktinfo	Inhalt /VE	Preis /VE	
9846	5 Liter	(Pal. 32) 4	274.80	netto



Greasecutter Fast Foam

Grillreiniger

Artikel-Nr.	Produktinfo	Inhalt /VE	Preis /VE	
14319	750 ml	(Pal. 180) 4	69.50	netto



Grease Express

Hochtemperatur-Grillreiniger

Artikel-Nr.	Produktinfo	Inhalt /VE	Preis /VE	
11990	1 Liter	(Pal. 128) 4	95.90	netto



Greaselift

Nicht ätzender Grillreiniger und Fettlöser

Artikel-Nr.	Produktinfo	Inhalt /VE	Preis /VE	
22096	750 ml, inkl. 2 Sprühköpfe	(Pal. 60) 6	101.50	netto

Desinfektion



Sirafan Speed

Schnelldesinfektionsmittel für die Küche

Artikel-Nr.	Produktinfo	Inhalt /VE	Preis /VE	
17916	750 ml	(Pal. 96) 6	69.00	netto
18877	5 Liter	(Pal. 40) 2	129.10	netto

Diverse



Ne-O-dor

Biologischer Geruchsbinder und Geruchsvernichter

Artikel-Nr.	Produktinfo	Inhalt /VE	Preis /VE	
5484	750 ml	(Pal. 104) 6	120.10	netto

Ecolab | Küchenhygiene

Diverse



Freezer Cleaner

Reiniger für Tiefkühlanlagen

Artikel-Nr.	Produktinfo	Inhalt /VE	Preis /VE	
9545	5 Liter	(Pal. 80) 2	231.10	netto



Rilan

Scheuermittel, flüssig

Artikel-Nr.	Produktinfo	Inhalt /VE	Preis /VE	
9711	750 ml	(Pal. 75) 6	45.40	netto

Ecolab | Facility Management

Grundreinigung



Maxx Forte2

Universal-Grundreiniger

Artikel-Nr.	Produktinfo	Inhalt /VE	Preis /VE	
25434	5 Liter	(Pal. 60) 2	113.70	netto

Automatenreiniger



Neomax GMS

Hochalkalischer Reiniger

Artikel-Nr.	Produktinfo	Inhalt /VE	Preis /VE	
8780	10 Liter	(Pal. 40) 1	106.90	netto



Neomax Clean

Automatenreiniger

Artikel-Nr.	Produktinfo	Inhalt /VE	Preis /VE	
17831*	10 kg	(Pal. 60) 1	84.20	netto



Neomax forte

Starker Automatenreiniger

Artikel-Nr.	Produktinfo	Inhalt /VE	Preis /VE	
9936	10 kg	(Pal. 60) 1	89.20	netto



Neomax I

Industriereiniger

Artikel-Nr.	Produktinfo	Inhalt /VE	Preis /VE	
8597	10 Liter	(Pal. 60) 1	94.00	netto



Neomax N

Universal-Automatenreiniger, neutral

Artikel-Nr.	Produktinfo	Inhalt /VE	Preis /VE	
8603	10 Liter	(Pal. 60) 1	79.70	netto

Ecolab | Facility Management

Wischpflege



Indur Top

Wischpflegemittel

Artikel-Nr.	Produktinfo	Inhalt /VE	Preis /VE	
8773	5 Liter	(Pal. 60) 2	53.80	netto



Indur XL Fresh

Wischpflegemittel

Artikel-Nr.	Produktinfo	Inhalt /VE	Preis /VE	
8836	5 Liter	(Pal. 60) 2	89.10	netto



Maxx Indur2

Ultranetzende Wischpflege

Artikel-Nr.	Produktinfo	Inhalt /VE	Preis /VE	
25438	5 Liter	(Pal. 60) 2	76.20	netto

Teppichreinigung



Carpet Spray-ex

Reiniger für Teppichsprühextraktion

Artikel-Nr.	Produktinfo	Inhalt /VE	Preis /VE	
9567	5 Liter	(Pal. 60) 2	119.00	netto



Carpet shampoo

Teppich-Shampoo

Artikel-Nr.	Produktinfo	Inhalt /VE	Preis /VE	
10105*	5 Liter	(Pal. 60) 2	145.20	netto

Glasreiniger



Spray Cleaner

Allzweckreiniger für glatte Oberflächen

Artikel-Nr.	Produktinfo	Inhalt /VE	Preis /VE	
10051	500 ml	(Pal. 65) 12	116.60	netto



Per Vetro

Glas- und Spiegelreiniger

Artikel-Nr.	Produktinfo	Inhalt /VE	Preis /VE	
6054	5 Liter	(Pal. 60) 2	57.10	netto



Maxx Brial2

Glas- und Oberflächenreiniger

Artikel-Nr.	Produktinfo	Inhalt /VE	Preis /VE	
25322	5 Liter	(Pal. 60) 2	61.10	netto



Maxx Windus C2

Glas- und Oberflächenreiniger

Artikel-Nr.	Produktinfo	Inhalt /VE	Preis /VE	
25183	750 ml	(Pal. 48) 12	88.70	netto

* auf Bestellung

Ecolab | Facility Management

Glasreiniger



TopClin Hygiene Spray-Blue

Glasreiniger

Artikel-Nr.	Produktinfo	Inhalt /VE	Preis /VE	
19875	5 Liter	(Pal. 96) 1	40.30	netto



Glasscare 40

Allzweck- und Glasreiniger

Artikel-Nr.	Produktinfo	Inhalt /VE	Preis /VE	
9866	1 Liter	(Pal. 96) 4	125.60	netto



Glasscare 40 Nachfüllflasche

leer

Artikel-Nr.	Produktinfo	Inhalt /VE	Preis /VE	
10141*	650 ml	6	20.40	netto

Allzweckreiniger



Energy Clean S

Allzweckreiniger, für manuelle und maschinelle Reinigung

Artikel-Nr.	Produktinfo	Inhalt /VE	Preis /VE	
16128	1 Liter	12	82.10	netto
22863	5 Liter	(Pal. 60) 2	64.50	netto



Maxx Magic2

Ultranetzender Universal-Reiniger

Artikel-Nr.	Produktinfo	Inhalt /VE	Preis /VE	
25539	5 Liter	(Pal. 60) 2	106.70	netto

Möbelpflege



Pro Shine Special

Möbelpolitur

Artikel-Nr.	Produktinfo	Inhalt /VE	Preis /VE	
9869	500 ml	(Pal. 96) 6	65.90	netto

Sanitärreiniger



Into Top

Sanitär-Unterhaltsreiniger

Artikel-Nr.	Produktinfo	Inhalt /VE	Preis /VE	
8776	5 Liter	(Pal. 60) 2	53.80	netto



Helotil

saurer Spezialreiniger

Artikel-Nr.	Produktinfo	Inhalt /VE	Preis /VE	
9599	1 Liter	(Pal. 63) 6	73.80	netto
9939	10 Liter	(Pal. 60) 1	116.90	netto

Ecolab | Facility Management

Sanitärreiniger



Into active gel

Gel-Sanitärreiniger

Artikel-Nr.	Produktinfo	Inhalt /VE	Preis /VE	
9575	1 Liter	(Pal. 30) 12	131.10	netto



Into forte

Periodischer Sanitärreiniger

Artikel-Nr.	Produktinfo	Inhalt /VE	Preis /VE	
9650	5 Liter	(Pal. 60) 2	108.30	netto



Into

Täglicher / Periodischer Sanitärreiniger

Artikel-Nr.	Produktinfo	Inhalt /VE	Preis /VE	
9676	1 Liter	(Pal. 30) 12	128.20	netto
9677	10 kg	(Pal. 60) 1	102.20	netto



Into cool power

Sanitär-Unterhaltsreiniger

Artikel-Nr.	Produktinfo	Inhalt /VE	Preis /VE	
12709	5 Liter	(Pal. 80) 2	102.20	netto



Kristalin bio

Bioaktiver Sanitärreiniger Konzentrat

Artikel-Nr.	Produktinfo	Inhalt /VE	Preis /VE	
14721	5 Liter	2	113.20	netto



Into WC super

WC-Reiniger

Artikel-Nr.	Produktinfo	Inhalt /VE	Preis /VE	
8837	750 ml	(Pal. 65) 12	164.60	netto



Maxx Into WC2

Sanitär- und WC-Reiniger, desodorierende Wirkung

Artikel-Nr.	Produktinfo	Inhalt /VE	Preis /VE	
25324	750 ml	(Pal. 65) 12	96.90	netto



Maxx Into2

Sanitär-Unterhaltsreiniger

Artikel-Nr.	Produktinfo	Inhalt /VE	Preis /VE	
25437	1 Liter	(Pal. 30) 12	88.80	netto
25207	5 Liter	(Pal. 60) 2	67.20	netto



Bathcare Special 61

Saurer Sanitärreiniger

Artikel-Nr.	Produktinfo	Inhalt /VE	Preis /VE	
9593	1 Liter	(Pal. 96) 4	137.20	netto

Ecolab | Facility Management

Sanitärreiniger



Bathcare Special 61 Nachfüllflasche

leer

Artikel-Nr.	Produktinfo	Inhalt /VE	Preis /VE	
9169*	650 ml	6	20.40	netto



Toiletcare 64

WC-Reiniger

Artikel-Nr.	Produktinfo	Inhalt /VE	Preis /VE	
10036	1 Liter	(Pal. 96) 4	129.70	netto

Spezialreiniger



Copper Shine Special

Buntmetall-Reiniger

Artikel-Nr.	Produktinfo	Inhalt /VE	Preis /VE	
4464	500 ml	6	54.20	netto



Mould-Ex

Schimmelentferner

Artikel-Nr.	Produktinfo	Inhalt /VE	Preis /VE	
9589	1 Liter	(Pal. 96) 4	57.70	netto



Xense Orange fresh

Duftspray

Artikel-Nr.	Produktinfo	Inhalt /VE	Preis /VE	
10156	500 ml	(Pal. 84) 6	159.70	netto

OASIS PRO System



Oasis Pro 33 Premium

Hochleistungsreiniger für Hartfussböden

Artikel-Nr.	Produktinfo	Inhalt /VE	Preis /VE	
16538	2 Liter	(Pal. 76) 2	140.30	netto



Oasis Pro 40 Premium

Allzweck- und Glasreiniger

Artikel-Nr.	Produktinfo	Inhalt /VE	Preis /VE	
9856	2 Liter	(Pal. 76) 2	155.80	netto



Oasis Clean 40 S

Glas- und Oberflächenreiniger



Artikel-Nr.	Produktinfo	Inhalt /VE	Preis /VE	
22075	2 Liter	2	142.20	netto



Oasis Pro 56 Premium

Geruchsneutralisator - Fresh Breeze

Artikel-Nr.	Produktinfo	Inhalt /VE	Preis /VE	
11791	2 Liter	(Pal. 76) 2	283.80	netto

Ecolab | Facility Management

OASIS PRO System



Oasis Pro 61 Premium

Saurer Sanitärreiniger

Artikel-Nr.	Produktinfo	Inhalt /VE	Preis /VE	
9855	2 Liter	(Pal. 76) 2	184.30	netto



Oasis Pro 64 Premium

WC-Reiniger

Artikel-Nr.	Produktinfo	Inhalt /VE	Preis /VE	
9860	2 Liter	(Pal. 76) 2	160.90	netto



Oasis Pro 62 Premium

Sanitärreiniger

Artikel-Nr.	Produktinfo	Inhalt /VE	Preis /VE	
16719	2 Liter	(Pal. 76) 2	170.70	netto



KitchenPro Manual

Hochkonzentriertes Handspülmittel, für manuelle Geschirr- und Utensilienreinigung

Artikel-Nr.	Produktinfo	Inhalt /VE	Preis /VE	
23416	2 Liter	(Pal. 76) 2	65.00	netto



KitchenPro Duo

Allzweck- und Bodenreiniger

Artikel-Nr.	Produktinfo	Inhalt /VE	Preis /VE	
23108	2 Liter	(Pal. 76) 2	50.20	netto



Greaselift

Ätzalkalifreier Grillreiniger und Fettlöser

Artikel-Nr.	Produktinfo	Inhalt /VE	Preis /VE	
23278	2 Liter	(Pal. 76) 2	243.60	netto



KitchenPro DesSpecial

Hochkonzentrierter Desinfektionsreiniger

Artikel-Nr.	Produktinfo	Inhalt /VE	Preis /VE	
23469	2 Liter	(Pal. 76) 2	53.60	netto



KitchenPro WashN Walk

Küchenbodenreiniger

Artikel-Nr.	Produktinfo	Inhalt /VE	Preis /VE	
23204	2 Liter	(Pal. 76) 2	50.20	netto



Oasis Pro Nachfüllflasche

leer

Artikel-Nr.	Produktinfo	Inhalt /VE	Preis /VE	
9966*	Oasis Pro 40 Premium, 650 ml	6	20.40	netto
5716*	Oasis Pro 64 Premium, 500 ml	6	20.40	netto

Ecolab | Facility Management

OASIS PRO System



Klappverschluss Deckel

rot

Artikel-Nr.	Produktinfo	Inhalt /VE	Preis /VE	
5698	für Art. 9966	1	1.30	netto

Ecolab | Health Care: Haut + Hände

Antiseptika



Laudamonium

Zur Fusspilzprophylaxe und zur Flächendesinfektion

Artikel-Nr.	Produktinfo	Inhalt /VE	Preis /VE	
5197	6 Liter	(Pal. 84) 1	111.60	netto



Skinman soft Protect

Alkoholisches Desinfektionsmittel für die hygienische und chirurgische Händedesinfektion. Schneller Wirkungseintritt durch sorgfältig ausgesuchte Wirkstoffe.

Artikel-Nr.	Produktinfo	Inhalt /VE	Preis /VE	
12953	farblos, 100 ml	50	182.30	netto
20327	farblos, 500 ml	24	260.80	netto

Lotionen



Manisoft

Hautfreundliche Waschlotion (pH 5.5) für schonende Reinigung (seifenfrei)

Artikel-Nr.	Produktinfo	Inhalt /VE	Preis /VE	
8602	500 ml	(Pal. 40) 24	121.20	netto
8592	Manisoft SOT20, 20 kg	(Pal. 24) 1	104.00	netto

Spender + Zubehör



Maximum 2

Wandspender für 500 ml-Gebinde

Artikel-Nr.	Produktinfo	Inhalt /VE	Preis /VE	
9870	mit Kunststoffpumpe, weiss	1	67.60	netto

Ecolab | Health Care: Desinfektionsmittel

Flächen- und Sprühdeseinfektion



Incides N Desinfektionstücher

Das Tuch für die alkoholische Schnelldesinfektion

Artikel-Nr.	Produktinfo	Inhalt /VE	Preis /VE	
8793	Dose à 90 Tücher	(Pal. 108) 6	77.40	netto



Incides N Desinfektionstücher - Nachfüllpackung

Das Tuch für alkoholische Schnelldesinfektion

Artikel-Nr.	Produktinfo	Inhalt /VE	Preis /VE	
6178	90 Tücher	(Pal. 276) 5	54.50	netto

Ecolab | Health Care: Desinfektionsmittel

Flächen- und Sprühdeseinfektion



Incidin Foam

Das gebrauchsfertige Schaumspray für die alkoholische Schnelldesinfektion.

Artikel-Nr.	Produktinfo	Inhalt /VE	Preis /VE	
8795	750 ml, inkl. Schaum-Sprühkopf	(Pal. 30) 16	243.20	netto
8796	5 Liter	(Pal. 60) 2	125.00	netto



Incidin PLUS

Flächendesinfektionsmittel für medizinisches Inventar im Sinne des Medizinproduktegesetzes (MPG). Auch für andere abwaschbare Flächen geeignet. Mit Glucoprotamin.

Artikel-Nr.	Produktinfo	Inhalt /VE	Preis /VE	
9558	6 Liter	(Pal. 84) 1	119.40	netto



Schaumsprühkopf für Incidin Foam

für 750 ml Flaschen

Artikel-Nr.	Inhalt /VE	Preis /VE	
10056	1	4.85	netto

Ecolab | Wäscherei

Pulver-Waschmittel



Taxat Color

Professionelles Buntwaschmittel

Artikel-Nr.	Produktinfo	Inhalt /VE	Preis /VE	
8591	20 kg	(Pal. 30) 1	145.20	netto



Taxat Profi / Supra

Compact - Vollwaschmittel

Artikel-Nr.	Produktinfo	Inhalt /VE	Preis /VE	
9840	20 kg	(Pal. 30) 1	152.40	netto



Taxat Joker

Fleckensalz mit 4-fach-Energie

Artikel-Nr.	Produktinfo	Inhalt /VE	Preis /VE	
10034	3 kg	(Pal. 64) 1	35.10	netto



Tryplosan

Bleich- und Fleckenentfernungsmittel auf Basis Aktivchlor

Artikel-Nr.	Produktinfo	Inhalt /VE	Preis /VE	
12149	17 kg	(Pal. 48) 1	266.05	netto



Eltra

Hygienevollwaschmittel

Artikel-Nr.	Produktinfo	Inhalt /VE	Preis /VE	
9850	20 kg	(Pal. 30) 1	164.60	netto



Bio X

Bioaktives Vor- und Waschmittel

Artikel-Nr.	Produktinfo	Inhalt /VE	Preis /VE	
9828	25 kg	(Pal. 30) 1	205.90	netto

Ecolab | Wäscherei

Pulver-Waschmittel



Perco Plus

Vor- und Waschmittel

Artikel-Nr.	Produktinfo	Inhalt /VE	Preis /VE	
9837	20 kg	(Pal. 39) 1	159.80	netto



Pursol perfect

Sauerstoffbleichmittel

Artikel-Nr.	Produktinfo	Inhalt /VE	Preis /VE	
9546	25 kg	(Pal. 30) 1	158.60	netto



Pursol Activ

Aktiviertes Bleich- und Fleckenentfernungsmittel

Artikel-Nr.	Produktinfo	Inhalt /VE	Preis /VE	
9838	20 kg	(Pal. 40) 1	216.30	netto



Taxat Clean Color

Ökologisches, hochwirksames Buntwaschmittel



Artikel-Nr.	Produktinfo	Inhalt /VE	Preis /VE	
21764	15 kg	(Pal. 33) 1	79.80	netto



Taxat Clean

Ökologisches, hochwirksames Vollwaschmittel



Artikel-Nr.	Produktinfo	Inhalt /VE	Preis /VE	
21763	15 kg	(Pal. 33) 1	79.80	netto



Taxat Super Silex

Enzymatisches Vollwaschmittel

Artikel-Nr.	Produktinfo	Inhalt /VE	Preis /VE	
24016	20 kg	(Pal. 40) 1	153.70	netto



Topwash Professional

Vollwaschmittel

Artikel-Nr.	Produktinfo	Inhalt /VE	Preis /VE	
21291	14 kg	(Pal. 24) 1	42.30	netto

Flüssige Textilwaschmittel



Sericol

Waschkraftverstärker

Artikel-Nr.	Produktinfo	Inhalt /VE	Preis /VE	
9845	20 kg	(Pal. 24) 1	227.20	netto



Turbo Saprit Style

Formspüler

Artikel-Nr.	Produktinfo	Inhalt /VE	Preis /VE	
13042	20 kg	(Pal. 24) 1	183.00	netto

Ecolab | Wäscherei

Flüssige Textilwaschmittel



Noxa liquid

Konzentrierte natürliche Flüssigstärke

Artikel-Nr.	Produktinfo	Inhalt /VE	Preis /VE	
9556	20 kg	(Pal. 24) 1	141.00	netto



Turbo Usona

Flüssiges Spezialwaschmittel

Artikel-Nr.	Produktinfo	Inhalt /VE	Preis /VE	
13040	20 kg	(Pal. 24) 1	141.90	netto



Oxybrite perfekt

Sauerstoffbleichmittel

Artikel-Nr.	Produktinfo	Inhalt /VE	Preis /VE	
10142	22 kg	(Pal. 24) 1	100.10	netto



Turbo alca

Alkaliverstärker mit Komplexbildner

Artikel-Nr.	Produktinfo	Inhalt /VE	Preis /VE	
11372	250 kg	(Pal. 2) 1	1'350.00	netto



Ozonit 40

Desinfektionsmittel mit Bleichwirkung für Textilien

Artikel-Nr.	Produktinfo	Inhalt /VE	Preis /VE	
18946	22 kg	(Pal. 24) 1	180.40	netto

Biozide vorsichtig verwenden. Vor Gebrauch stets Etikett und Produktinformationen lesen.



Taxat Angora

Flüssiges Spezial - Feinwaschmittel

Artikel-Nr.	Produktinfo	Inhalt /VE	Preis /VE	
23918	5 kg	(Pal. 36) 4	194.30	netto



Topwash Professional

Flüssiges Gel-Waschmittel

Artikel-Nr.	Produktinfo	Inhalt /VE	Preis /VE	
21290	10.8 kg	(Pal. 60) 1	42.30	netto



Dermasil Emulsion

Enzymatisches Waschmittel

Artikel-Nr.	Produktinfo	Inhalt /VE	Preis /VE	
18938	25 kg	(Pal. 24) 1	290.00	netto



Turbo Plus

Flüssiges Waschkonzentrat mit optischem Aufheller

Artikel-Nr.	Produktinfo	Inhalt /VE	Preis /VE	
16115	17 kg	1	198.90	netto

Ecolab | Wäscherei

Desinfektionswaschmittel



Eltra

Hygienevollwaschmittel - Zum desinfizierenden Waschen von Textilien nach dem Medizinproduktegesetz

Artikel-Nr.	Produktinfo	Inhalt /VE	Preis /VE	
10074*	6 kg	(Pal. 80) 1	48.05	netto



mopEltra

Desinfizierendes Spezialwaschmittel für Wischbezüge

Artikel-Nr.	Produktinfo	Inhalt /VE	Preis /VE	
5169	20 kg	(Pal. 30) 1	187.40	netto



Ozonit

Desinfektionsmittel mit Bleichwirkung für Textilien

Artikel-Nr.	Produktinfo	Inhalt /VE	Preis /VE	
19500	22 kg	(Pal. 24) 1	135.30	netto

ECOBRITE System



Ecobrite Power Color

Hochkonzentriert, neutraler Waschkraftverstärker, Fettlöser

Artikel-Nr.	Produktinfo	Inhalt /VE	Preis /VE	
9849	20 kg	(Pal. 24) 1	242.10	netto



Ecobrite Perfekt

Bleichmittel auf Sauerstoffbasis

Artikel-Nr.	Produktinfo	Inhalt /VE	Preis /VE	
9848	20 kg	(Pal. 24) 1	108.30	netto



Ecobrite Conditioner CE

Wasserenthärter

Artikel-Nr.	Produktinfo	Inhalt /VE	Preis /VE	
5433	25 kg	(Pal. 24) 1	181.80	netto



Ecobrite Destainer

Chlor-Bleichmittel

Artikel-Nr.	Produktinfo	Inhalt /VE	Preis /VE	
9859	20 kg	(Pal. 24) 1	78.80	netto



Ecobrite Blue Soft

Weichspüler

Artikel-Nr.	Produktinfo	Inhalt /VE	Preis /VE	
22087	20 kg	(Pal. 24) 1	98.10	netto



Ecobrite Magic Emulsion

Hochkonzentriertes Alleinwaschmittel

Artikel-Nr.	Produktinfo	Inhalt /VE	Preis /VE	
21994	25 kg	(Pal. 24) 1	198.40	netto

Ecolab | Wäscherei

ECOBRITE System



Ecobrite Neutraliser IT

Neutralisationsmittel

Artikel-Nr.	Produktinfo	Inhalt /VE	Preis /VE	
21762	21 kg	(Pal. 24) 1	204.10	netto



Ecobrite Super Silex Liquid

Hochkonzentriertes enzymhaltiges neutrales ONE-SHOT Alleinwaschmittel, frischer und sauberer Duft, Fettlöser

Artikel-Nr.	Produktinfo	Inhalt /VE	Preis /VE	
21761	20 kg	(Pal. 24) 1	152.00	netto

Fleckenentfernung: STAIN EX



Stain EX 1 Wäschevorbehandlung

Gegen Fett-/Öl-/Make-up-Flecken, gelb

Artikel-Nr.	Produktinfo	Inhalt /VE	Preis /VE	
14636	5 Liter	(Pal. 96) 1	64.00	netto



Stain EX 2

Gegen Tinte-/Wachs-Flecken, blau

Artikel-Nr.	Produktinfo	Inhalt /VE	Preis /VE	
10132*	500 ml	(Pal. 132) 4	83.90	netto



StainBlaster Multi Purpose

Universal-Fleckenentferner für Textilien

Artikel-Nr.	Produktinfo	Inhalt /VE	Preis /VE	
25142	500 ml	(Pal. 132) 4	84.90	netto

Diverse



Ecobrite Alca

Hochkonzentrierter Alkali-Waschkraftverstärker

Artikel-Nr.	Produktinfo	Inhalt /VE	Preis /VE	
23664	25 kg	(Pal. 24) 1	143.60	netto



Softenit Dual EXXcellence

Konzentrierter, hochwertiger Weichspüler

Artikel-Nr.	Produktinfo	Inhalt /VE	Preis /VE	
20025	20 kg	(Pal. 24) 1	116.00	netto



Triplex Energy Plus

Flüssiger Waschkraftverstärker

Artikel-Nr.	Produktinfo	Inhalt /VE	Preis /VE	
9318	20 kg	(Pal. 24) 1	271.00	netto

Ecolab | Personal- und Waschaumhygiene

Händehygiene



Epicare 1

Waschlotion, parfümiert

Artikel-Nr.	Produktinfo	Inhalt /VE	Preis /VE	
10463	500 ml	(Pal. 80) 12	69.30	netto
4496	5 Liter	(Pal. 39) 3	89.20	netto



Epicare 2

Waschlotion, ohne Parfum

Artikel-Nr.	Produktinfo	Inhalt /VE	Preis /VE	
12708	500 ml	(Pal. 80) 12	69.30	netto



Epicare 3

Antimikrobielle Waschlotion, ohne Parfum

Artikel-Nr.	Produktinfo	Inhalt /VE	Preis /VE	
4497	500 ml	(Pal. 96) 12	102.20	netto



Epicare 5C

Antimikrobielle Waschlotion, frei von Triclosan

Artikel-Nr.	Produktinfo	Inhalt /VE	Preis /VE	
27263	500 ml	(Pal. 80) 6	74.50	netto
27212	5 Liter	(Pal. 60) 2	136.80	netto



Epicare Des

Händedesinfektionsmittel

Artikel-Nr.	Produktinfo	Inhalt /VE	Preis /VE	
14492	500 ml	(Pal. 180) 6	62.00	netto



Maximum 2

Wandspender für 500 ml-Gebinde

Artikel-Nr.	Produktinfo	Inhalt /VE	Preis /VE	
9870	mit Kunststoffpumpe, weiss	1	67.60	netto

NEXA-System



Foam 1 Nexa

Schaum-Waschlotion, mit angenehm frischem Duft

Artikel-Nr.	Produktinfo	Inhalt /VE	Preis /VE	
25614	750 ml	(Pal. 60) 6	85.20	netto



Foam 2 Nexa

Schaum-Waschlotion, ohne Duftstoffe

Artikel-Nr.	Produktinfo	Inhalt /VE	Preis /VE	
26307	750 ml	(Pal. 60) 6	85.20	netto



Nexa Epicare 5C

Antimikrobielle Waschlotion

Artikel-Nr.	Produktinfo	Inhalt /VE	Preis /VE	
26077	750 ml	(Pal. 60) 6	100.60	netto

Ecolab | Personal- und Waschraumhygiene

NEXA-System



Spirigel Complete Nexa

Händedesinfektionsgel

Artikel-Nr.	Produktinfo	Inhalt /VE	Preis /VE	
25615	750 ml	(Pal. 60) 6	109.80	netto



NEXA Seifenspender

weiss, H: 236 B: 140 T: 102 mm

Artikel-Nr.	Produktinfo	Inhalt /VE	Preis /VE	
25613*	für 750 ml, berührungslos	1	72.90	netto

Ecolab | Geräte und Zubehör

Zubehör



Ausgusshahn

Artikel-Nr.	Produktinfo	Inhalt /VE	Preis /VE	
5189	10 Liter Bidon	1	6.10	netto
10185	20, 25 und 30 Liter Bidon	1	5.40	netto



Bidonöffner / Schraubenschlüssel

Artikel-Nr.	Produktinfo	Inhalt /VE	Preis /VE	
10234	für 10 Liter Bidon	1	4.60	netto
10187	für 20, 25, 30 und 60 Liter Bidon	1	4.60	netto



Sprühkopf «Canyon»

weiss

Artikel-Nr.	Inhalt /VE	Preis /VE	
5685	1	5.60	netto



Klappverschluss Deckel

blau

Artikel-Nr.	Inhalt /VE	Preis /VE	
10129	1	1.15	netto



Sprühkopf

blau

Artikel-Nr.	Produktinfo	Inhalt /VE	Preis /VE	
9566	für 650 und 750 ml Flasche	1	4.65	netto

Diversey | Gebäudereinigung

TASKI Sani Sanitärreiniger



TASKI Sani Antikalk

Farbloser, saurer Sanitärreiniger, welcher verdünnt für die Unterhaltsreinigung oder unverdünnt (gebrauchsfertig) für die Kalkentfernung und WC-/Pissoirreinigung (mit dem praktischen WC-Mopp-System) eingesetzt werden kann

Artikel-Nr.	Produktinfo	Inhalt /VE	Preis /VE	
11730	5 Liter	(Pal. 80) 2	97.50	netto

Hygiene ohne Kompromisse

Diversey[®]



**Wo Hygiene eine zentrale Rolle spielt, kann Reinigung
nicht dem Zufall überlassen werden!**

Diversey ist der globale Anbieter für Reinigungsprodukte und -systeme für die Bereiche: Gebäudereinigung, Küchenhygiene, Textilpflege, Persönliche Hygiene.

Aktuelle Informationen und Angebote finden Sie unter:
www.diversey-deals.ch

Diversey | Gebäudereinigung

TASKI Sani Sanitärreiniger



TASKI Sani Calc

Kraftvoller Kalkentferner für harte, säurefeste Oberflächen und Böden.

Artikel-Nr.	Produktinfo	Inhalt /VE	Preis /VE	
11896	1 Liter	(Pal. 120) 6	72.00	netto
11353	10 Liter	(Pal. 60) 1	107.50	netto



TASKI Sani Calc W3b Gebrauchsflasche

leer

Artikel-Nr.	Produktinfo	Inhalt /VE	Preis /VE	
11980	500 ml	(Pal. 145) 6	22.20	netto



TASKI Sani Cid

Saurer Sanitär-Unterhaltsreiniger für harte, säurefeste Oberflächen. Die spezielle Reinigungsformel sorgt für hervorragende Reinigungsergebnisse und verhindert bei täglicher Anwendung Kalkaufbau, auch in Hartwasserbereichen.

Artikel-Nr.	Produktinfo	Inhalt /VE	Preis /VE	
12777	1 Liter	(Pal. 120) 6	48.60	netto
11351	10 Liter	(Pal. 60) 1	72.00	netto



TASKI Sani Cid Gebrauchsflasche

leer

Artikel-Nr.	Produktinfo	Inhalt /VE	Preis /VE	
11714	500 ml	(Pal. 145) 6	22.20	netto



TASKI Sani Cid conc.

Hochkonzentrierter saurer Sanitär-Unterhaltsreiniger für harte, säurefeste Oberflächen. Die spezielle Reinigungsformel sorgt für hervorragende Reinigungsergebnisse und verhindert bei tägl. Anwendung Kalkaufbau, auch in Hartwasserbereichen.

Artikel-Nr.	Produktinfo	Inhalt /VE	Preis /VE	
12024	5 Liter	(Pal. 120) 1	125.75	netto



TASKI Sani Cid Sprühflasche

leer

Artikel-Nr.	Produktinfo	Inhalt /VE	Preis /VE	
11920	500 ml	(Pal. 105) 5	35.75	netto



TASKI Sani Clonet

Gebrauchsfertiger WC-Reiniger für die periodische, gründliche Entfernung von Kalkansätzen und anderen Rückständen in WC-Schüsseln und Pissoiranlagen.

Artikel-Nr.	Produktinfo	Inhalt /VE	Preis /VE	
11846	750 ml	(Pal. 130) 6	49.80	netto
11352	10 Liter	(Pal. 60) 1	98.50	netto



TASKI Sani WC Premium

Hochaktiver WC- und Pissoir-Grundreiniger für die Entfernung hartnäckiger Ablagerungen und Rost. Anzuwenden mit dem praktischen WC-Mopp System.

Artikel-Nr.	Produktinfo	Inhalt /VE	Preis /VE	
11960	5 Liter	(Pal. 48) 2	143.50	netto



TASKI Sani Antikalk Citrus

Farbloser, saurer Sanitärreiniger, welcher verdünnt für die Unterhaltsreinigung oder unverdünnt für die Kalkentfernung und WC-/Pissoirreinigung (mit dem praktischen WC-Mopp-System) eingesetzt werden kann. Mit frischem Zitrusduft.

Artikel-Nr.	Produktinfo	Inhalt /VE	Preis /VE	
12600	5 Liter	(Pal. 80) 2	98.50	netto

Diversey | Gebäudereinigung

TASKI Sani Sanitärreiniger



TASKI Sani 100

Sanitär-Unterhaltsreiniger für harte, wasserfeste Oberflächen und Böden. Geeignet für den Einsatz in Weichwasserbereichen.

Artikel-Nr.	Produktinfo	Inhalt /VE	Preis /VE	
12722	10 Liter	(Pal. 60) 1	75.00	netto

TASKI Sani Sanitärreiniger - Spezialprodukte



Diversey Cream R7

Vielseitig verwendbarer, materialschonender Creme-Reiniger für harte, wasserfeste Oberflächen.

Artikel-Nr.	Produktinfo	Inhalt /VE	Preis /VE	
11625	500 ml	(Pal. 75) 16	66.40	netto



TASKI Sani Flow

Hochaktiver, kraftvoller Rohrreiniger mit dreifacher Wirkung: Entfernt Verstopfungen, verhindert weitere Ablagerungen und beseitigt schlechte Abflussgerüche.

Artikel-Nr.	Produktinfo	Inhalt /VE	Preis /VE	
11789	1 Liter	(Pal. 120) 6	76.20	netto

TASKI Sani Sanitärreiniger - Schaumreinigung



TASKI Sani Calcafoam

Saurer Schaumreiniger für Unterhaltsreinigung und Kalkentfernung, geeignet in Wellness- und Bädereichen sowie in Sanitäranlagen



Artikel-Nr.	Produktinfo	Inhalt /VE	Preis /VE	
14771	5 Liter	(Pal. 80) 2	77.00	netto

TASKI Sprint Oberflächenreiniger



TASKI Sprint Syntonet S

Farbloser, universeller Oberflächenreiniger für die streifenfreie Reinigung von Glas-, Kunststoff- und anderen harten, wasserfesten Oberflächen.

Artikel-Nr.	Produktinfo	Inhalt /VE	Preis /VE	
11850	10 Liter	(Pal. 60) 1	76.50	netto



TASKI Sprint 200 conc.

Hochkonzentrierter Alkohol-Unterhaltsreiniger für die streifenfreie Reinigung von harten, wasserfesten Oberflächen und Böden.

Artikel-Nr.	Produktinfo	Inhalt /VE	Preis /VE	
12026	5 Liter	1	89.50	netto



TASKI Sprint 200 conc. Sprühflasche

leer

Artikel-Nr.	Produktinfo	Inhalt /VE	Preis /VE	
11715	500 ml	(Pal. 105) 5	35.75	netto



TASKI Sprint 200

Alkohol-Unterhaltsreiniger für die streifenfreie Reinigung von harten, wasserfesten Oberflächen und Böden.

Artikel-Nr.	Produktinfo	Inhalt /VE	Preis /VE	
12778	1 Liter	(Pal. 120) 6	37.20	netto
11354	10 Liter	(Pal. 60) 1	48.50	netto

Diversey | Gebäudereinigung

TASKI Sprint Oberflächenreiniger



TASKI Sprint Cristal

Aktivreiniger für die manuelle Unterhaltsreinigung von harten, wasserfesten Oberflächen und Böden.

Artikel-Nr.	Produktinfo	Inhalt /VE	Preis /VE	
11848	10 Liter	(Pal. 24) 1	73.50	netto



TASKI Sprint Glass

Glas- und Oberflächenreiniger für die streifenfreie Reinigung von Glas, Spiegeln und anderen harten, wasserfesten Oberflächen.

Artikel-Nr.	Produktinfo	Inhalt /VE	Preis /VE	
11926	750 ml	(Pal. 95) 6	40.50	netto
11959	10 Liter	(Pal. 60) 1	56.50	netto



TASKI Sprint

Kraftreiniger für die periodische Reinigung und Fleckentfernung auf harten, wasserfesten Oberflächen und Böden.

Artikel-Nr.	Produktinfo	Inhalt /VE	Preis /VE	
11925	10 Liter	(Pal. 60) 1	98.50	netto



TASKI Sprint Glass Pur-Eco

Ökologischer Glas- und Oberflächenreiniger für eine streifenfreie Reinigung



Artikel-Nr.	Produktinfo	Inhalt /VE	Preis /VE	
17201*	5 Liter	(Pal. 80) 2	60.50	netto

TASKI Sprint Oberflächenreiniger - Spezialprodukte



TASKI Sprint Performer

Hochwirksamer, gebrauchsfertiger Sprühreiniger für die Entfernung von Tinte, Filz-, Blei- und Lippenstift, schwarze Absatzspuren, Nikotinfilmern, fettige Nahrungsmittelflecken usw. von alkalibeständigen, harten Oberflächen.

Artikel-Nr.	Produktinfo	Inhalt /VE	Preis /VE	
11971	10 Liter	(Pal. 60) 1	110.00	netto



TASKI Sprint Flower

Intensiv parfümierter Unterhaltsreiniger für harte, wasserfeste Oberflächen und Böden.

Artikel-Nr.	Produktinfo	Inhalt /VE	Preis /VE	
11682	10 Liter	(Pal. 60) 1	118.00	netto



Good Sense Fresh

Sprühprodukt zum Entfernen schlechter Gerüche aus Textilien und Einrichtungsgegenständen

Artikel-Nr.	Produktinfo	Inhalt /VE	Preis /VE	
11927	750 ml	(Pal. 95) 6	70.80	netto

TASKI Jontec Fussbodenreiniger



Diversey Actival

Hochalkalischer, niedrigschäumender Fussbodenreiniger für die Entfernung pflanzlicher Öle und Fette

Artikel-Nr.	Produktinfo	Inhalt /VE	Preis /VE	
11626	10 Liter	(Pal. 60) 1	72.50	netto

Diversey | Gebäudereinigung

TASKI Jontec Fussbodenreiniger



TASKI Jontec 300

Niedrigschäumender, neutraler Fussboden-Unterhaltsreiniger für alle beschichteten und unbeschichteten Hartbeläge, geeignet für den Einsatz mit Scheuersaugmaschinen.

Artikel-Nr.	Produktinfo	Inhalt /VE	Preis /VE	
12809	1 Liter	(Pal. 120) 6	51.60	netto
11355	10 Liter	(Pal. 60) 1	79.00	netto



TASKI Jontec 300 conc.

Niedrigschäumender, neutraler Fussbodenreiniger, hochkonzentriert, für alle beschichteten und unbeschichteten wasserbeständigen Hartbeläge und Sporthallenbeläge

Artikel-Nr.	Produktinfo	Inhalt /VE	Preis /VE	
19889	1 Liter	(Pal. 56) 6	184.80	netto
12492	Cubitainer 5 Liter	(Pal. 120) 1	119.00	netto



TASKI Jontec 300 ID

Hochkonzentrierter, niedrigschäumender, neutraler Fussbodenreiniger, auch geeignet für Sporthallenbeläge

Artikel-Nr.	Produktinfo	Inhalt /VE	Preis /VE	
19886	1.5 Liter	(Pal. 192) 2	76.35	netto



TASKI Jontec Best

Neutraler, niedrigschäumender, lösemittelhaltiger Fussbodenreiniger zur Fettentfernung auf allen wasserfesten Hartbelägen, geeignet für den Einsatz mit Scheuersaugmaschinen

Artikel-Nr.	Produktinfo	Inhalt /VE	Preis /VE	
13467	10 Liter	(Pal. 60) 1	85.00	netto



TASKI Jontec Forward

Alkalischer, niedrigschäumender Fussbodenreiniger gegen Verschmutzungen und Fett, für wasserbeständige, unbeschichtete Hartbeläge, geeignet für den Einsatz mit Scheuersaugmaschinen

Artikel-Nr.	Produktinfo	Inhalt /VE	Preis /VE	
14515	10 Liter	(Pal. 60) 1	113.00	netto

TASKI Jontec Wischpflege



TASKI Jontec Tensol ID

Polierbares Bodenreinigungs- und Pflegeprodukt für beschichtete und unbeschichtete, wasserfeste Hartbodenbeläge, hochkonzentriert, niedrigschäumend, geeignet für den Einsatz mit Scheuersaugmaschinen

Artikel-Nr.	Produktinfo	Inhalt /VE	Preis /VE	
17600	1.5 Liter	(Pal. 192) 2	78.50	netto



TASKI Jontec Tensol

Polierbares Bodenreinigungs- und Pflegeprodukt ohne Schichtaufbau, ideal für die Reinigung und Pflege beschichteter und unbeschichteter wasserfester Bodenbeläge

Artikel-Nr.	Produktinfo	Inhalt /VE	Preis /VE	
11356	10 Liter	(Pal. 60) 1	76.50	netto

TASKI Jontec Sprayprodukte



TASKI Jontec Spray

Sprayreinigungs- und Pflegeemulsion für Einscheibenmaschinen bis 400 U/min.

Artikel-Nr.	Produktinfo	Inhalt /VE	Preis /VE	
11924	5 Liter	(Pal. 16) 2	138.50	netto

Diversey | Gebäudereinigung

TASKI Jontec Sprayprodukte



TASKI Jontec Omnispray

Reinigungs- und Pflegeprodukt für beschichtete und unbeschichtete Böden, ideal in Kombination mit dem TASKI omni-System

Artikel-Nr.	Produktinfo	Inhalt /VE	Preis /VE	
12733	5 Liter	(Pal. 80) 2	98.50	netto

TASKI Jontec Grundreiniger



TASKI Jontec Linosafe

Hochleistungs-Grundreiniger zur Entfernung von Beschichtungen und Pflegefilmen von Linoleum- und anderen Fußböden, Teil des LinoSecure-Systems

Artikel-Nr.	Produktinfo	Inhalt /VE	Preis /VE	
11972	10 Liter	(Pal. 60) 1	109.50	netto

TASKI Jontec Dispersionen



TASKI Jontec Linobase

Semipermanenter Versiegler für alte/schadhafte Linoleum-Böden, Teil des LinoSecure-Systems

Artikel-Nr.	Produktinfo	Inhalt /VE	Preis /VE	
11974	5 Liter	(Pal. 80) 2	163.50	netto



TASKI Jontec Matt

Matte, trittsichere Dispersion für die meisten harten, wasserfesten Hartbeläge. Besonders widerstandsfähig gegen Alkohol- und Desinfektionsprodukte.

Artikel-Nr.	Produktinfo	Inhalt /VE	Preis /VE	
11973	5 Liter	(Pal. 80) 2	140.00	netto

TASKI Jontec Steinpflege



TASKI Jontec PowerCid

Säurehaltiges Pulver für die Entfernung von Zementschleiern und Kalkablagerungen auf keramischen und anderen säurebeständigen Böden.

Artikel-Nr.	Produktinfo	Inhalt /VE	Preis /VE	
11565	5 kg	(Pal. 75) 1	79.00	netto

TASKI Tapi Teppichreiniger



TASKI Tapi Defoam

Antischaumprodukt, für den Gebrauch in Sprühextraktionsmaschinen und Nasssaugern.

Artikel-Nr.	Produktinfo	Inhalt /VE	Preis /VE	
11919	1 Liter	(Pal. 120) 6	85.50	netto



TASKI Tapi Deo

Lufterfrischer für die Beseitigung schlechter Gerüche

Artikel-Nr.	Produktinfo	Inhalt /VE	Preis /VE	
11955	40 Portionen	(Pal. 1008) 40	54.40	netto



TASKI Tapi Extract

Teppichreiniger für die Sprühextraktion von textilen Bodenbelägen und Polsterstoffen

Artikel-Nr.	Produktinfo	Inhalt /VE	Preis /VE	
11566	5 Liter	(Pal. 80) 2	110.00	netto

Diversey | Gebäudereinigung

TASKI Tapi Teppichreiniger



TASKI Tapi Gum

Kältespray für die Entfernung von Kaugummirückständen.

Artikel-Nr.	Produktinfo	Inhalt /VE	Preis /VE	
11975*	500 ml	(Pal. 155) 6	107.10	netto



TASKI Tapi Spotex 2

Wasserlöslicher Teppich-Fleckenentferner für textile Bodenbeläge und Polstermöbel. Spezielle Reinigungsformel besonders geeignet für die Entfernung wasserlöslicher Flecken wie z.B. Fruchtsaft, Kaffee, Tee, Ketchup, Wein oder Blut.

Artikel-Nr.	Produktinfo	Inhalt /VE	Preis /VE	
11956	750 ml	(Pal. 95) 6	130.20	netto

J-Flex System



TASKI Jontec 300 Micro J-Flex

Hochkonzentrierter, niedrigschäumender, neutraler Fussbodenreiniger, auch geeignet für Sporthallenbeläge

Artikel-Nr.	Produktinfo	Inhalt /VE	Preis /VE	
22573	1.5 Liter	(Pal. 175) 1	56.05	netto



TASKI Sani Cid J-Flex

Hochkonzentrierter, saurer Sanitär-Unterhaltsreiniger für harte, säurefeste Oberflächen. Die spezielle Reinigungsformel sorgt für hervorragende Reinigungsergebnisse und verhindert bei regelmäßiger Anwendung Kalkaufbau, auch in Hartwasser.

Artikel-Nr.	Produktinfo	Inhalt /VE	Preis /VE	
12598	1.5 Liter	(Pal. 175) 1	54.90	netto



TASKI Sani Cid Sprühflasche

leer

Artikel-Nr.	Produktinfo	Inhalt /VE	Preis /VE	
11920	500 ml	(Pal. 105) 5	35.75	netto



TASKI Sprint Glass J-Flex

Hochkonzentrierter Oberflächen-/Glasreiniger für die streifenfreie Reinigung von Glas, Spiegeln und anderen harten, wasserfesten Oberflächen. Formuliert für die Verwendung mit dem JohnsonDiversey J-Flex-System.

Artikel-Nr.	Produktinfo	Inhalt /VE	Preis /VE	
12599	1.5 Liter	(Pal. 175) 1	108.00	netto



TASKI Sprint 200 Pur-Eco J-Flex

Alkohol-Unterhaltsreiniger, hochkonzentriert. Für die streifenfreie Reinigung von harten, wasserfesten Oberflächen und Böden. Formuliert die Verwendung mit dem Diversey J-Flex-System.



Artikel-Nr.	Produktinfo	Inhalt /VE	Preis /VE	
16628	1.5 Liter	(Pal. 175) 1	55.20	netto



Oxivir Plus J-Flex

Desinfektionsreiniger mit breitem Anwendungsspektrum

Artikel-Nr.	Produktinfo	Inhalt /VE	Preis /VE	
23897	1.5 Liter	(Pal. 175) 1	30.30	netto



TASKI Jontec Tensol J-Flex

Hochkonzentriertes, niedrigschäumendes, polierbares Bodenreinigungs- und Pflegeprodukt für unbeschichtete, wasserfeste Hartbodenbeläge, geeignet für den Einsatz mit Scheuersaugmaschinen

Artikel-Nr.	Produktinfo	Inhalt /VE	Preis /VE	
13400	1.5 Liter	(Pal. 175) 1	58.20	netto

Diversey | Gebäudereinigung

J-Flex System



TASKI Sani Calc J-Flex

Wirkungsvoller Sanitär-Grundreiniger und Kalkentferner für säurefeste Oberflächen und Böden

Artikel-Nr.	Produktinfo	Inhalt /VE	Preis /VE	
19656	1.5 Liter	(Pal. 175) 1	79.35	netto

EXACT System



TASKI Sani Cid conc.

Hochkonzentrierter saurer Sanitär-Unterhaltsreiniger für harte, säurefeste Oberflächen. Die spezielle Reinigungsformel sorgt für hervorragende Reinigungsergebnisse und verhindert bei tägl. Anwendung Kalkaufbau, auch in Hartwasserbereichen.

Artikel-Nr.	Produktinfo	Inhalt /VE	Preis /VE	
12024	5 Liter	(Pal. 120) 1	125.75	netto



TASKI Sani Cid Sprühflasche

leer

Artikel-Nr.	Produktinfo	Inhalt /VE	Preis /VE	
11920	500 ml	(Pal. 105) 5	35.75	netto



TASKI Sprint 200 conc.

Hochkonzentrierter Alkohol-Unterhaltsreiniger für die streifenfreie Reinigung von harten, wasserfesten Oberflächen und Böden.

Artikel-Nr.	Produktinfo	Inhalt /VE	Preis /VE	
12026	5 Liter	1	89.50	netto



TASKI Sprint 200 conc. Sprühflasche

leer

Artikel-Nr.	Produktinfo	Inhalt /VE	Preis /VE	
11715	500 ml	(Pal. 105) 5	35.75	netto

NOBLA Produkte



NOBLA Allzweckreiniger

Für alles Abwaschbare auf Wänden und Böden

Artikel-Nr.	Produktinfo	Inhalt /VE	Preis /VE	
11674	10 Liter	(Pal. 60) 1	42.50	netto



NOBLA Bodenreiniger

Für die gründliche Reinigung aller wasserfesten Böden mit Reinigungsmaschinen.

Artikel-Nr.	Produktinfo	Inhalt /VE	Preis /VE	
11680*	10 Liter	(Pal. 60) 1	52.50	netto



NOBLA Duftreiniger

Reinigt und desodoriert alle abwaschbaren Oberflächen in Bädern, Wasch-, Dusch- und Toilettenräumen.

Artikel-Nr.	Produktinfo	Inhalt /VE	Preis /VE	
11675	10 Liter	(Pal. 60) 1	101.00	netto

Diversey | Gebäudereinigung

NOBLA Produkte



NOBLA WC-Reiniger

Spezialreiniger für die Grundreinigung von WC-Schüsseln und Pissoirs.

Artikel-Nr.	Produktinfo	Inhalt /VE	Preis /VE	
11678	10 Liter	(Pal. 60) 1	78.00	netto

Good Sense - Langzeit Lufterfrischer



Good Sense Spender für Lufterfrischer

kompaktes und einfach nachzufüllendes Gerät mit einstellbarem Sprühintervall

Artikel-Nr.	Produktinfo	Inhalt /VE	Preis /VE	
11694	ohne Lufterfrischerpatrone, inkl. 2 AA/LR6 Batterien	(Pal. 240) 1	70.40	netto



Good Sense Refill Summer Festival

Sommer-Lufterfrischerpatronen mit O.N.T.

Artikel-Nr.	Produktinfo	Inhalt /VE	Preis /VE	
11454	20 ml	(Pal. 737) 12	101.80	netto



Good Sense Refill Vert

Apfel-Lufterfrischerpatronen mit O.N.T.

Artikel-Nr.	Produktinfo	Inhalt /VE	Preis /VE	
11695	20 ml	(Pal. 737) 12	101.80	netto



Good Sense Refill Magnolia & Mimosa

Blüten-Lufterfrischerpatronen mit O.N.T.

Artikel-Nr.	Produktinfo	Inhalt /VE	Preis /VE	
11696	20 ml	(Pal. 737) 12	101.80	netto



Good Sense Refill Variety Pack

Assortiertes Duftpatronen-Pack à 2 Boxen. Jede Box enthält 2x die Düfte Magnolia & Mimosa, Toscaane und Summer Festival

Artikel-Nr.	Produktinfo	Inhalt /VE	Preis /VE	
11699	20 ml	(Pal. 737) 12	102.40	netto

Good Sense - Spezialprodukte



Good Sense Fresh

Sprühprodukt zum Entfernen schlechter Gerüche aus Textilien und Einrichtungsgegenständen

Artikel-Nr.	Produktinfo	Inhalt /VE	Preis /VE	
11927	750 ml	(Pal. 95) 6	70.80	netto

RoomCare System - Gebrauchsfertige Produkte



RoomCare R1

Toiletten- und Pissoirreiniger für die tägliche Reinigung. Regelmässiger Einsatz verhindert Kalkaufbau.

Artikel-Nr.	Produktinfo	Inhalt /VE	Preis /VE	
11648	750 ml	(Pal. 130) 6	33.30	netto

Diversey | Gebäudereinigung

RoomCare System - Gebrauchsfertige Produkte



RoomCare R3

Oberflächenreiniger für die Reinigung von Glas und anderen harten, wasserfesten Oberflächen. Trocknet schnell und streifenfrei.

Artikel-Nr.	Produktinfo	Inhalt /VE	Preis /VE	
11650	750 ml	(Pal. 95) 6	31.20	netto



RoomCare R4

Möbelpolitur für die schnelle und einfache Pflege von versiegeltem Holz. Reinigt, glänzt und schützt in einem Arbeitsgang.

Artikel-Nr.	Produktinfo	Inhalt /VE	Preis /VE	
11453	750 ml	(Pal. 95) 6	63.90	netto



RoomCare R5

Raumdeospray. Erfrischt und desodoriert mit einem langanhaltenden, frischen Duft.

Artikel-Nr.	Produktinfo	Inhalt /VE	Preis /VE	
11651	750 ml	(Pal. 95) 6	51.60	netto



RoomCare R6

Periodischer Toiletten- und Pissoirreiniger für die gründliche Entfernung von Kalkablagerungen, Flecken und anderen Rückständen.

Artikel-Nr.	Produktinfo	Inhalt /VE	Preis /VE	
11652	750 ml	(Pal. 130) 6	38.70	netto



Diversey Cream R7

Vielseitig verwendbarer, materialschonender Creme-Reiniger für harte, wasserfeste Oberflächen.

Artikel-Nr.	Produktinfo	Inhalt /VE	Preis /VE	
11625	500 ml	(Pal. 75) 16	66.40	netto



RoomCare R9

Saurer Sanitär- und Unterhaltsreiniger für säurefeste Oberflächen. Regelmässiger Einsatz verhindert Kalkaufbau.

Artikel-Nr.	Produktinfo	Inhalt /VE	Preis /VE	
11654	750 ml	(Pal. 95) 6	38.70	netto

RoomCare System - Divermite Hochkonzentrate



RoomCare R3-plus

Hochkonzentrierter Oberflächen- / Glasreiniger zur Dosierung über den Divermite-Produktpender.

Artikel-Nr.	Produktinfo	Inhalt /VE	Preis /VE	
11659	1.5 Liter, pH-Wert 7.0 - 7.5	(Pal. 192) 2	177.45	netto



RoomCare R9-plus

Hochkonzentrierter saurer Sanitärreiniger zur Dosierung über den Divermite-Produktpender.

Artikel-Nr.	Produktinfo	Inhalt /VE	Preis /VE	
11663	1.5 Liter, pH-Wert 1.5 - 2.0	(Pal. 192) 2	218.70	netto

Diversey | Gebäudereinigung

Wellness System



TASKI Sprint Degerm

Flüssiger Desinfektionsreiniger mit bakterizider, fungizider (Candida) und viruzider (HIV, HBV, HCV, Rotavirus) Wirkung für die Reinigung und Desinfektion von harten Flächen. DGHM-gelistet.

Artikel-Nr.	Produktinfo	Inhalt /VE	Preis /VE	
12494	10 Liter	(Pal. 60) 1	179.00	netto

Diverse



Ausgusshahn

Artikel-Nr.	Produktinfo	Inhalt /VE	Preis /VE	
11756	für 10 Liter Bidon	(Pal. 3900) 1	8.80	netto

Diversey | Küchenhygiene

Pulvergeschirrwaschmittel



Suma Active

Pulverförmiger Geschirreiniger für alle Wasserhärten.

Artikel-Nr.	Produktinfo	Inhalt /VE	Preis /VE	
11805	10 kg	(Pal. 44) 1	84.00	netto

Flüssiggeschirrwaschmittel



Suma Super L1

Geschirrwaschmittel für Weichwasser

Artikel-Nr.	Produktinfo	Inhalt /VE	Preis /VE	
11334	20 Liter	(Pal. 24) 1	196.00	netto



Suma Maxi L3.1

Geschirrwaschmittel für alle Wasserhärten

Artikel-Nr.	Produktinfo	Inhalt /VE	Preis /VE	
11456	10 Liter	(Pal. 60) 1	98.00	netto
11335	20 Liter	(Pal. 24) 1	188.00	netto



Suma Nova L6

Phosphatfreies Geschirrwaschmittel, frei von Aktivchlor, für alle Wasserhärten.

Artikel-Nr.	Produktinfo	Inhalt /VE	Preis /VE	
11604	10 Liter	(Pal. 57) 1	111.50	netto
11337.1	20 Liter	(Pal. 24) 1	166.00	netto



Suma Vario L3.8 SafePack

Chlorithaltiges Geschirrwaschmittel für alle Wasserhärten, leistungsstarke Chlorbleiche ohne lästigen Chlorgeruch

Artikel-Nr.	Produktinfo	Inhalt /VE	Preis /VE	
11602	10 Liter	(Pal. 57) 1	120.00	netto



Suma Power T57 SafePack

Alkalischer Waschkraftvertärker

Artikel-Nr.	Produktinfo	Inhalt /VE	Preis /VE	
11614	10 Liter	(Pal. 57) 1	90.00	netto

Diversey | Küchenhygiene

Flüssiggeschirrwaschmittel



Suma Nova Pur-Eco L6

Ökologisches Geschirrwaschmittel für alle Wasserhärten



Artikel-Nr.	Produktinfo	Inhalt /VE	Preis /VE	
19507	5 Liter	(Pal. 80) 2	79.00	netto
18166	10 Liter, SafePack	(Pal. 57) 1	84.00	netto
17676	20 Liter	(Pal. 24) 1	146.00	netto



Suma Star Pur-Eco D1

Ökologisches, mildes Handgeschirrpulvermittel



Artikel-Nr.	Produktinfo	Inhalt /VE	Preis /VE	
17677	5 Liter	(Pal. 80) 2	56.00	netto

Glanztrockner



Suma Rinse A5

Neutrales Glanzreinigungsmittel, schaumhemmend

Artikel-Nr.	Produktinfo	Inhalt /VE	Preis /VE	
11611	10 Liter	(Pal. 60) 1	80.50	netto
11339	20 Liter	(Pal. 24) 1	150.00	netto



Suma Crystal A8

Saures Glanzreinigungsmittel, speziell für Gläserpülmaschinen und Hartwasserbetriebe, schaumhemmend

Artikel-Nr.	Produktinfo	Inhalt /VE	Preis /VE	
11612	10 Liter, SafePack	(Pal. 57) 1	84.00	netto
8442	10 Liter	(Pal. 60) 1	83.50	netto
11341	20 Liter	(Pal. 24) 1	153.00	netto

Spezialprodukte



Suma Dip K1

Flüssiger Tauchreiniger mit Chlor zur Entfernung von Stärke-, Kaffee- und Teerückständen

Artikel-Nr.	Produktinfo	Inhalt /VE	Preis /VE	
11913	5 Liter	(Pal. 80) 2	75.50	netto



Suma Shine K2

Pulverförmiger Tauchreiniger zur Entfernung von Stärke-, Kaffee- und Teerückständen auf Sauerstoffbasis

Artikel-Nr.	Produktinfo	Inhalt /VE	Preis /VE	
11894	10 kg	(Pal. 44) 1	96.50	netto



Suma Silk K6

Pulverförmiger Tauchreiniger zur Entfernung von Stärke-, Kaffee- und Teerückständen auf Chlorbasis.

Artikel-Nr.	Produktinfo	Inhalt /VE	Preis /VE	
11343	10 kg	(Pal. 44) 1	105.00	netto

Suma RevoFlow



Suma RevoFlow Max P1

Maschineller Geschirreiniger mit Bleichwirkung

Artikel-Nr.	Produktinfo	Inhalt /VE	Preis /VE	
18647	4,5 kg	(Pal. 36) 3	207.90	netto

Diversey | Küchenhygiene

Suma RevoFlow



Suma RevoFlow Clean P5

Granuliertes, chlorhaltiges Geschirrwaschmittel für mittleres bis hartes Wasser.

Artikel-Nr.	Produktinfo	Inhalt /VE	Preis /VE	
18162	4.5 kg	(Pal. 36) 3	211.95	netto



Suma RevoFlow Clear A11

Saurer Glanzrockner, hochkonzentriert, für hohe und schwankende Wasserhärten

Artikel-Nr.	Produktinfo	Inhalt /VE	Preis /VE	
18163	4 Liter	(Pal. 33) 3	165.00	netto

Küchenreinigung



Suma Star D1

Mildes Handgeschirrspülmittel.

Artikel-Nr.	Produktinfo	Inhalt /VE	Preis /VE	
11616	5 Liter	(Pal. 80) 2	51.00	netto
11344	20 Liter	(Pal. 24) 1	98.00	netto



Suma Star D1 Gebrauchsflasche

leer

Artikel-Nr.	Produktinfo	Inhalt /VE	Preis /VE	
11627	500 ml	(Pal. 145) 6	22.50	netto



Suma Multi D2

Universalsreiniger

Artikel-Nr.	Produktinfo	Inhalt /VE	Preis /VE	
11617	5 Liter	(Pal. 80) 2	46.50	netto



Suma Break up D3.5

Fettlöser, extra stark, aluminiumsicher

Artikel-Nr.	Produktinfo	Inhalt /VE	Preis /VE	
24604	5 Liter	(Pal. 80) 2	71.00	netto
11346	20 Liter	(Pal. 24) 1	140.00	netto



Diversey Actival

Hochalkalischer, niedrigschäumender Fussbodenreiniger für die Entfernung pflanzlicher Öle und Fette

Artikel-Nr.	Produktinfo	Inhalt /VE	Preis /VE	
11626	10 Liter	(Pal. 60) 1	72.50	netto



Suma Scale D5.2

Sofort-Kalkentferner

Artikel-Nr.	Produktinfo	Inhalt /VE	Preis /VE	
11348	5 Liter	(Pal. 80) 2	75.00	netto



Suma Scale D5.2 Gebrauchsflasche

leer

Artikel-Nr.	Produktinfo	Inhalt /VE	Preis /VE	
11630	500 ml	(Pal. 145) 6	22.50	netto

Diversey | Küchenhygiene

Küchenreinigung



Suma Rapid D6

Gebrauchsfertiger Sprühreiniger für die streifenfreie Reinigung von Glas und anderen wasserfesten Oberflächen

Artikel-Nr.	Produktinfo	Inhalt /VE	Preis /VE	
11620	750 ml	(Pal. 95) 6	41.10	netto
11434	10 Liter	(Pal. 60) 1	57.00	netto



Suma Inox Classic D7

Pflegeprodukt für Chromstahlflächen auf Ölbasis

Artikel-Nr.	Produktinfo	Inhalt /VE	Preis /VE	
8443	750 ml	(Pal. 95) 6	69.00	netto



Suma Inox D7.1

Pflegeprodukt für Chromstahlflächen (Emulsion)

Artikel-Nr.	Produktinfo	Inhalt /VE	Preis /VE	
11621	750 ml	(Pal. 95) 6	69.00	netto

Diverflow mit SureLink System



Suma Multi-conc D3 conc.

Hochkonzentrierter Universalreiniger für das Diverflow mit SureLink System

Artikel-Nr.	Produktinfo	Inhalt /VE	Preis /VE	
20767	1.5 Liter	(Pal. 75) 4	198.30	netto

Ofen- und Grillreiniger



Suma Grill D9

Backofen- und Grillreiniger

Artikel-Nr.	Produktinfo	Inhalt /VE	Preis /VE	
11349	750 ml, inkl. 3 hochwertigen Sprühpistolen	(Pal. 95) 6	62.10	netto
12417	5 Liter	(Pal. 80) 2	99.50	netto

Desinfektionsprodukte



Suma Quicksan D4.3

Schnell-Desinfektionsspray, ohne Nachspülen

Artikel-Nr.	Produktinfo	Inhalt /VE	Preis /VE	
11347	750 ml	(Pal. 95) 6	62.10	netto



Suma Bac D10

Desinfektionsreiniger

Artikel-Nr.	Produktinfo	Inhalt /VE	Preis /VE	
11624	20 Liter	(Pal. 24) 1	310.00	netto



Divodes FG Spray

Flüssiges Spray-Desinfektionsmittel auf Alkoholbasis

Artikel-Nr.	Produktinfo	Inhalt /VE	Preis /VE	
16738	750 ml	6	50.65	netto

Diversey | Textilpflege

Vor- und Hauptwaschmittel - Pulver



Clax Ultima

Hochwirksames Vor- und Buntwaschmittel

Artikel-Nr.	Produktinfo	Inhalt /VE	Preis /VE	
22834	20 kg, 30 - 95 °C	(Pal. 36) 1	139.00	netto



Clax Thermo

Hochwirksames Kochwaschmittel konzentriert

Artikel-Nr.	Produktinfo	Inhalt /VE	Preis /VE	
11665	20 kg, 80 - 95 °C	(Pal. 32) 1	139.00	netto



Clax DS Desotherm

Hochwirksames Hygiene-Waschmittel, mit Wirkstoffkombination gegen Geruch, RKI-Anmeldung!

Artikel-Nr.	Produktinfo	Inhalt /VE	Preis /VE	
12946	20 kg, 40 - 95°C	(Pal. 36) 1	139.00	netto



Clax Revoflow Pro

Hochkonzentriertes Vollwaschmittel für alle Wasserhärten

Artikel-Nr.	Produktinfo	Inhalt /VE	Preis /VE	
20316	3.5 kg	(Pal. 36) 3	154.35	netto

Waschmittel-Tabs



Clax Tabs

Vor- und Buntwaschtabs

Artikel-Nr.	Produktinfo	Inhalt /VE	Preis /VE	
14543	72 Tabs à 37.5 g	(Pal. 240) 1	36.15	netto

Waschkraftverstärker



Clax 100

Niotensidhaltiger Waschkraftverstärker-Fettlöser

Artikel-Nr.	Produktinfo	Inhalt /VE	Preis /VE	
12955	10 Liter	(Pal. 60) 1	104.50	netto



Clax 200 color

Hochwirksamer, konzentrierter Waschkraftverstärker-Fettlöser

Artikel-Nr.	Produktinfo	Inhalt /VE	Preis /VE	
12996	20 Liter	(Pal. 24) 1	207.00	netto



Clax Calcsoft

Hochkonzentrierter Waschkraftverstärker mit Komplexiereigenschaften

Artikel-Nr.	Produktinfo	Inhalt /VE	Preis /VE	
22974	20 Liter	(Pal. 24) 1	177.00	netto

Diversey | Textilpflege

Flüssigwaschmittel



Clax Elegant

Enzymatisches Flüssigwaschmittel für empfindliche Textilien

Artikel-Nr.	Produktinfo	Inhalt /VE	Preis /VE	
11788	5 Liter	(Pal. 80) 2	89.50	netto
11669	20 Liter	(Pal. 24) 1	174.00	netto



Clax Delta G

Hochkonzentriertes Kombiwaschmittel

Artikel-Nr.	Produktinfo	Inhalt /VE	Preis /VE	
13412	20 Liter	(Pal. 24) 1	183.00	netto



Clax Proof Integral

Seifenhaltiges Waschmittel für Weichwasser

Artikel-Nr.	Produktinfo	Inhalt /VE	Preis /VE	
24010	20 Liter	(Pal. 24) 1	137.00	netto

Feinwaschmittel



Clax Merino

Spezialwaschmittel für Wolle und Seide

Artikel-Nr.	Produktinfo	Inhalt /VE	Preis /VE	
11670	20 Liter	(Pal. 24) 1	193.00	netto

Bleichmittel



Clax Personril

Bleichmittel auf Peressigsäurebasis

Artikel-Nr.	Produktinfo	Inhalt /VE	Preis /VE	
11672	20 Liter	(Pal. 24) 1	130.00	netto



Clax Activ conc

Pulverförmige Chlorbleiche

Artikel-Nr.	Produktinfo	Inhalt /VE	Preis /VE	
22408	10 kg	(Pal. 44) 1	91.00	netto

Weichspüler



Clax Soft Fresh

Weichspüler

Artikel-Nr.	Produktinfo	Inhalt /VE	Preis /VE	
11893	20 Liter	(Pal. 24) 1	65.00	netto



Clax Deosoft Breeze conc

Konzentrierter Finisher mit geruchsneutralisierender O.N.T.-Technologie

Artikel-Nr.	Produktinfo	Inhalt /VE	Preis /VE	
14150	20 Liter	(Pal. 24) 1	147.00	netto

Diversey | Textilpflege

Neutralisationsmittel



Clax Neutrapur

Neutralisationsmittel mit bakterizider Wirkung

Artikel-Nr.	Produktinfo	Inhalt /VE	Preis /VE	
12126	20 Liter	(Pal. 24) 1	143.00	netto

Detachiermittel



Esa Col Prof. Pro Formula

Leistungsstarker Fleckentferner zur Vorbehandlung aller Textilien vor dem Waschen

Artikel-Nr.	Produktinfo	Inhalt /VE	Preis /VE	
27953	750 ml	(Pal. 95) 6	59.10	netto

Dosierhilfen



Gebrauchsflasche

Standard, neutral, leer

Artikel-Nr.	Produktinfo	Inhalt /VE	Preis /VE	
11923	500 ml	(Pal. 145) 6	22.20	netto



Sprühflasche

weiss, leer

Artikel-Nr.	Produktinfo	Inhalt /VE	Preis /VE	
11911	500 ml	(Pal. 105) 5	35.75	netto

Diversey | Körperhygiene

Soft Care Line



Soft Care Fresh

Leicht parfümiert, Seifenlotion

Artikel-Nr.	Produktinfo	Inhalt /VE	Preis /VE	
11361	800 ml, für Spender Art. 11644	(Pal. 144) 6	57.30	netto



Soft Care Med

Händedesinfektionsgel auf Alkoholbasis

Artikel-Nr.	Produktinfo	Inhalt /VE	Preis /VE	
11360	800 ml, für Spender Art. 11644	(Pal. 144) 6	89.10	netto



Soft Care Mild

Leicht parfümiert, milde Seifenlotion

Artikel-Nr.	Produktinfo	Inhalt /VE	Preis /VE	
11647	800 ml, für Spender Art. 11644	(Pal. 144) 6	62.40	netto



Soft Care Sensisept

Nicht parfümiert, ohne Farbstoffe, milde Händedesinfektionsseife

Artikel-Nr.	Produktinfo	Inhalt /VE	Preis /VE	
11357	800 ml, für Spender Art. 11644	(Pal. 144) 6	79.20	netto

Diversey | Körperhygiene

Soft Care Line



Soft Care Lux 2 in 1

Duschgel und Haarshampoo



Artikel-Nr.	Produktinfo	Inhalt /VE	Preis /VE	
10153	800 ml, für Spender Art. 11644	(Pal. 144) 6	74.70	netto

Soft Care Line Seifenspender



Soft Care Line Seifenspender

Artikel-Nr.	Produktinfo	Inhalt /VE	Preis /VE	
11644	für Soft Care-Kartuschen Art. 11455, 11645, 11361, 11360, 11647, 11357, 11358, 10158	(Pal. 300) 1	51.00	netto

Soft Care Select



Soft Care Select Lux 2 in 1

Duschgel + Haarshampoo



Artikel-Nr.	Produktinfo	Inhalt /VE	Preis /VE	
11690	300 ml	(Pal. 60) 28	226.80	netto

Soft Care Bulk



LUX Professional

Milde Seifenlotion

Artikel-Nr.	Produktinfo	Inhalt /VE	Preis /VE	
11435	5 Liter	(Pal. 80) 2	72.50	netto



Soft Care Star

Milde Seifenlotion

Artikel-Nr.	Produktinfo	Inhalt /VE	Preis /VE	
16472	5 Liter	(Pal. 80) 2	74.50	netto

Diversey | Markenprodukte

Geschirreiniger / Küche



Cif Professional Crème

Oberflächenreiniger für hartnäckige Verschmutzungen

Artikel-Nr.	Produktinfo	Inhalt /VE	Preis /VE	
14370	5 Liter	(Pal. 80) 2	73.50	netto
11634	10 Liter	(Pal. 60) 1	67.50	netto



Cif Professional Crème Lemon

Crème-Reiniger für Küche und Bad

Artikel-Nr.	Produktinfo	Inhalt /VE	Preis /VE	
11350	10 Liter	(Pal. 60) 1	67.50	netto

Diversey | Markenprodukte

Geschirreiniger / Küche



Solo Professional

Abwasmittel mit Zitronensaft - mit verstärkter Fettlösekraft für strahlend glänzendes Geschirr

Artikel-Nr.	Produktinfo	Inhalt /VE	Preis /VE	
11635	10 Liter	(Pal. 60) 1	48.00	netto
11636	750 ml	(Pal. 80) 12	50.90	netto



Sun Professional Spülglanz

Artikel-Nr.	Produktinfo	Inhalt /VE	Preis /VE	
16209	1 Liter	(Pal. 90) 6	54.55	netto



Sun Professional Tabs

Geschirreiniger Tablets für den Einsatz in Haushaltsgeschirrspülmaschinen, für alle Wasserhärten

Artikel-Nr.	Produktinfo	Inhalt /VE	Preis /VE	
11637.1	40 Tabs	(Pal. 120) 1	79.10	netto



Sun Professional Tabs All in 1

Für den Einsatz in professionellen Short Cycle- und Haushaltsmaschinen. Enthält Regeneriersalz und Glänzer.

Artikel-Nr.	Produktinfo	Inhalt /VE	Preis /VE	
13043	200 Tabs	(Pal. 100) 1	100.80	netto



Sun Professional Tabs All in 1 - Extra Power

Extra Power Geschirreiniger Tabs so kraftvoll, dass angetrocknete Speisereste in Töpfen und Pfannen ohne Vorspülen entfernt werden. Phosphatfrei. 100% wasserlöslichen & biologisch abbaubaren Hydrofilm.

Artikel-Nr.	Produktinfo	Inhalt /VE	Preis /VE	
22608	Karton à 175 Tabs	(Pal. 100) 1	91.00	netto

Sanitärreiniger



Cif Professional Business Solutions 2in1

Badreiniger mit Ani-Kalk Wirkung löst Schmutz, Seifenreste, Kalkablagerungen etc.

Artikel-Nr.	Produktinfo	Inhalt /VE	Preis /VE	
21018	750 ml	(Pal. 95) 6	36.00	netto



Domestos Professional WC Entkalker

WC Reiniger und Entkalker

Artikel-Nr.	Produktinfo	Inhalt /VE	Preis /VE	
28698	750 ml	6	20.70	netto



Domestos Professional Fugenreiniger

Fugenreiniger für die Entfernung organischer Rückstände und Verschmutzungen aus Fugen von wasserfesten Oberflächen

Artikel-Nr.	Produktinfo	Inhalt /VE	Preis /VE	
17795	750 ml	(Pal. 96) 6	57.55	netto

Diversey | Markenprodukte

Textilpflege



Surf Professional

Vollwaschmittel mit aktiviertem Sauerstoff

Artikel-Nr.	Produktinfo	Inhalt /VE	Preis /VE	
17318	18.4 kg, 40 - 95°C	(Pal. 36) 1	92.90	netto



OMO Professional Liquid

Flüssigwaschmittel mit integrierter Dosierung

Artikel-Nr.	Produktinfo	Inhalt /VE	Preis /VE	
11540	7.5 Liter	(Pal. 76) 1	61.90	netto



OMO Professional Advance

Professionelles Pulverwaschmittel für alle Textilien und Temperaturbereiche

Artikel-Nr.	Produktinfo	Inhalt /VE	Preis /VE	
14493	14.4 kg, 150 Waschgänge	(Pal. 36) 1	85.85	netto



Comfort Professional

Gewebeveredler - für langanhaltende Frische

Artikel-Nr.	Produktinfo	Inhalt /VE	Preis /VE	
11542	10 Liter	(Pal. 60) 1	31.00	netto



Enka Professional

Sauerstoffbleichmittel für Kochwäsche

Artikel-Nr.	Produktinfo	Inhalt /VE	Preis /VE	
12926	12 kg	(Pal. 48) 1	100.80	netto



Enka 60 Spezial Prof. Pro Formula

Sauerstoffbleichmittel für alle Temperaturbereiche

Artikel-Nr.	Produktinfo	Inhalt /VE	Preis /VE	
28607	12 kg	(Pal. 60) 1	145.80	netto



Coral Professional Business Solutions

Schonendes, flüssiges Feinwaschmittel für empfindliche Gewebe

Artikel-Nr.	Produktinfo	Inhalt /VE	Preis /VE	
22837	5 Liter	(Pal. 64) 2	50.00	netto

Steinfels Swiss | Küchenhygiene

Geschirr-Reiniger



MayaEasySoft

Mildes, parfümiertes Handabwaschmittel zum manuellen Geschirrspülen und Reinigen abwaschbarer Gegenstände. Ausgezeichnetes Reinigungsvermögen für Fett, Öle, Essensresten und Schmutz. Dermatologisch geprüft, sehr gut hautverträglich.



Artikel-Nr.	Produktinfo	Inhalt /VE	Preis /VE	
18282	500 ml	(Pal. 135) 6	24.00	netto

...perfekt! Auch unsere Mitarbeiter sind
von der Effizienz der ökologischen
Produkte überzeugt!



MayaTex - das Textilwaschmittel-System für Ihren Betrieb

MayaTex ist das perfekte Flüssigwaschmittel-System im Textilwaschen, für fast alle Betriebsgrößen. Mit den effizienten und ökologischen Maya-Produkten, in Kombination mit der intelligenten Dosiertechnik, bewältigen Sie künftig Ihr gesamtes Wäschevolumen auf Knopfdruck - ohne umständliches Dosieren und mit einem sensationellen Waschergebnis, welches auch Sie überzeugen wird!



Steinfels
S W I S S

Steinfels Swiss | Küchenhygiene

Geschirr-Reiniger



DISH-LAV C

Granuliertes Universal-Geschirrwaschmittel, chlorhaltig, für alle Wasserhärten geeignet

Artikel-Nr.	Produktinfo	Inhalt /VE	Preis /VE	
16314*	8 kg	(Pal. 72) 1	70.00	netto
19520*	25 kg	(Pal. 24) 1	172.50	netto



MayaLav

Chlor- und phosphatfreies Universal-Geschirrwaschmittelkonzentrat für Wasserhärten -28° fH, nicht geeignet für Aluminium



Artikel-Nr.	Produktinfo	Inhalt /VE	Preis /VE	
19521	10 Liter	(Pal. 40) 1	92.80	netto
19526	19 Liter	(Pal. 24) 1	162.55	netto



DISH-LAV FLC

Konzentriertes Geschirrwaschmittel für Wasserhärten bis 20° fH, chlorhaltig, hervorragendes Lösungsvermögen von Stärke-, Eiweiss- Kaffee- und Teerückständen.

Artikel-Nr.	Produktinfo	Inhalt /VE	Preis /VE	
19528	20,2 Liter	(Pal. 24) 1	180.35	netto



DISH-LAV Sinfos

Chlor- und phosphatfreies Universal-Geschirrwaschmittelkonzentrat für alle Wasserhärten.

Artikel-Nr.	Produktinfo	Inhalt /VE	Preis /VE	
19530	25 kg	(Pal. 24) 1	158.75	netto



MayaBrillant

Universal-Glantzrocknerkonzentrat, neutral, für tropfen- und fleckenfreies Geschirr, schaumgebremst



Artikel-Nr.	Produktinfo	Inhalt /VE	Preis /VE	
19532	10 Liter	(Pal. 40) 1	80.80	netto
19533	20 Liter	(Pal. 24) 1	145.15	netto



MayaBrillant sauer

Glantzrocknerkonzentrat, sauer, für hartes Wasser, schaumgebremst, für tropfen- und fleckenfreies Geschirr



Artikel-Nr.	Produktinfo	Inhalt /VE	Preis /VE	
19534	10 Liter	(Pal. 40) 1	82.40	netto
19535	20 Liter	(Pal. 24) 1	146.60	netto



MayaLav Extra

Konzentriertes Spezialprodukt zur Verhinderung des Stärkeaufbaus, ist nicht geeignet für Aluminium, vor Kälte schützen



Artikel-Nr.	Produktinfo	Inhalt /VE	Preis /VE	
19536	20 Liter	(Pal. 24) 1	153.50	netto



Somat Glänzer

Für Geschirrspülmaschine. Mit dem Somat Klarspüler erzielen Sie nach dem Reinigen noch strahlenderen Glanz auf Gläser, Besteck und Geschirr.

Artikel-Nr.	Produktinfo	Inhalt /VE	Preis /VE	
21738	750 ml	(Pal. 60) 10	61.00	netto



MayaLav Basic

Chlor- und phosphatfreies Universal-Geschirrwaschmittelkonzentrat für Wasserhärten von 25°fH bis 40°fH. Nicht geeignet für Aluminium.



Artikel-Nr.	Produktinfo	Inhalt /VE	Preis /VE	
25954	12.5 kg	(Pal. 60) 1	90.65	netto
25955	25 kg	(Pal. 24) 1	158.75	netto

Steinfels Swiss | Küchenhygiene

Geschirr-Reiniger



Somat 10 Extra - ALL IN ONE Tabs

Dank der Sofort-Aktiv-Formel löst sich der Somat-Tab schneller auf als bisher und kann so von Anfang an seine starke Reinigungsleistung entfalten - in allen Spülprogrammen.

Artikel-Nr.	Produktinfo	Inhalt /VE	Preis /VE	
27542	Box à 27 Tabs	8	95.60	netto



Somat Classic

Entfernt zuverlässig selbst hartnäckige Flecken und Beläge wie z.B. Stärkereste wie Nudel- und Kartoffelreste und Eiweissrückstände

Artikel-Nr.	Produktinfo	Inhalt /VE	Preis /VE	
21737	Box à 40 Tabs	(Pal. 72) 240	71.70	netto



Steinfels Silbertauchreiniger

Flüssiges, gebrauchsfertiges Reinigungsmittelkonzentrat für angelaufenes Silber und versilberte Gegenstände.

Artikel-Nr.	Produktinfo	Inhalt /VE	Preis /VE	
16290	4.9 Liter	(Pal. 96) 1	60.20	netto



MayaSoft

Mildes, parfümiertes Handabwasmittel zum manuellen Geschirrspülen und Reinigen abwaschbarer Gegenstände. Ausgezeichnetes Reinigungsvermögen für Fette, Öle, Essensresten und Schmutz. Dermatologisch geprüft, sehr gut hautverträglich.



Artikel-Nr.	Produktinfo	Inhalt /VE	Preis /VE	
19531	9.8 Liter	(Pal. 40) 1	52.00	netto

Küchen-Reiniger



DISH-LAV TKS C

Chlorhaltiges Pulver zur Tauchreinigung, entfernt Tee-, Kaffee- und Stärkerückstände, eignet sich ebenfalls für die tägliche Rahmautomatenreinigung.

Artikel-Nr.	Produktinfo	Inhalt /VE	Preis /VE	
19538*	15 kg	(Pal. 18) 1	150.75	netto



SteinfelsEasy MIC alkalisch

Milch-, Rahm- und Glaceautomatenreiniger alkalisch: Zum täglichen Reinigen, Entfetten und Entkeimen von Milch-, Rahm- und Glaceautomaten sowie Kaffeemaschinen.

Artikel-Nr.	Produktinfo	Inhalt /VE	Preis /VE	
19540	500 ml	(Pal. 140) 6	44.70	netto



MayaUni

Unparfümierter, schaumarm konzentrierter Allzweckreiniger. Speziell geeignet für die allgemeine Küchenreinigung. Manuell und maschinell einsetzbar.



Artikel-Nr.	Produktinfo	Inhalt /VE	Preis /VE	
19542	10 Liter	(Pal. 40) 1	52.50	netto



MayaEasy Super Activ

Dickflüssiges, parfümiertes Scheuermittel, gebrauchsfertig für Pfannen, Töpfe, Küchengeräte und Chromstahlflächen. Hinterlässt keine Kratzer.



Artikel-Nr.	Produktinfo	Inhalt /VE	Preis /VE	
22920	500 g	(Pal. 140) 6	21.90	netto



Activ Forte

Konzentrierter, unparfümierter, fettlösender Reiniger für stark fettige Verschmutzungen auf Dampfzügen, Filter etc.

Artikel-Nr.	Produktinfo	Inhalt /VE	Preis /VE	
19752*	10,1 kg	(Pal. 40) 1	64.65	netto

Steinfels Swiss | Küchenhygiene

Küchen-Reiniger



MayaForte

Alkalischer, hochwirksamer Grill-, Backofenreiniger und Fettlöser zum mühelosen Entfernen von Fett-, Brat-, Back-, Grillier- und Frittierrückständen. Ist nicht geeignet für Aluminium.



Artikel-Nr.	Produktinfo	Inhalt /VE	Preis /VE	
19544	9.8 Liter	(Pal. 40) 1	67.20	netto



MayaEasy Forte

Alkalischer, hochwirksamer Grill-, Backofenreiniger und Fettlöser zum mühelosen Entfernen von Fett-, Brat-, Back-, Grillier- und Frittierrückständen. Sofort und unverdünnt einsetzbar. Ist nicht geeignet für Aluminium.



Artikel-Nr.	Produktinfo	Inhalt /VE	Preis /VE	
17889	500 ml	(Pal. 135) 6	39.30	netto

DISH-LAV EK

Pulverförmiger Entkalker für Geschirrwashmaschinen. Für maschinelle Anwendung.



Artikel-Nr.	Produktinfo	Inhalt /VE	Preis /VE	
16214*	8 kg	(Pal. 60) 1	78.00	netto

Steinfels 840 Quick-Des 70

Schnelldesinfektionsmittel, alkoholhaltig, muss nicht nachgespült werden. Sofort und unverdünnt einsatzbereit.



Artikel-Nr.	Produktinfo	Inhalt /VE	Preis /VE	
19545	9.5 Liter	(Pal. 60) 1	83.25	netto
19644	500 ml	(Pal. 108) 6	42.60	netto

Javel Tabs

Desinfiziert, desodoriert und reinigt Gegenstände wie Toiletten, Syphons, Böden, Platten, Tierkisten und Abfalleimer.



Artikel-Nr.	Produktinfo	Inhalt /VE	Preis /VE	
19546	500 g, ca. 145 Stück	(Pal. 84) 12	195.00	netto

Steinfels Easy Inox

Metallpflege im gesamten Innenbereich wie Edelstahl, Chromstahl, Aluminium, Eloxal usw., hinterlässt einen pflegenden Film ohne auszuhärten, sofort und unverdünnt einsetzbar.



Artikel-Nr.	Produktinfo	Inhalt /VE	Preis /VE	
20206	500 ml	(Pal. 135) 6	48.60	netto

MayaExpress

Hochwirksamer, umweltschonender Schnellentkalker in einem handlichen Gebinde für Geräte wie Kaffeemaschinen, Wasserkocher, Bügeleisen und Pfannen.



Artikel-Nr.	Produktinfo	Inhalt /VE	Preis /VE	
24473*	1000 ml	6	36.30	netto

Steinfels Swiss | Textilpflege

Textilwaschmittel Pulver



Maga

Enzymhaltiges Vor- und Buntwaschmittel für alle Wasserhärten, ohne Bleichmittel und ohne optische Aufheller.

Artikel-Nr.	Produktinfo	Inhalt /VE	Preis /VE	
19551	15 kg	(Pal. 40) 1	102.75	netto

Steinfels Swiss | Textilpflege

Textilwaschmittel Pulver



Florid

Hauptwaschmittel für Weisswäsche für alle Wasserhärten, mit Bleichmittel und optischem Aufheller, Bleichwirkung ab 60 °C.

Artikel-Nr.	Produktinfo	Inhalt /VE	Preis /VE	
19552	15 kg	(Pal. 40) 1	107.25	netto



Niador

Vollwaschmittel für alle Wasserhärten und Temperaturen, mit Bleichmittel und optischem Aufheller.

Artikel-Nr.	Produktinfo	Inhalt /VE	Preis /VE	
19553	15 kg	(Pal. 40) 1	107.25	netto



Atlan

Vollwaschmittel für Buntwäsche für alle Wasserhärten und Temperaturen. Ohne optische Aufheller.

Artikel-Nr.	Produktinfo	Inhalt /VE	Preis /VE	
19554	15 kg	(Pal. 40) 1	111.75	netto



Maga Color Compact

Kompaktwaschmittel gegen Flecken. Bewahrt die Leuchtkraft der Wäsche.

Artikel-Nr.	Produktinfo	Inhalt /VE	Preis /VE	
23641	990 g	4	53.00	netto



X-Tra

Universelles Waschpulver mit Anit-Fleck-Effekt für strahlende Sauberkeit und sensationell duftende Wäsche.

Artikel-Nr.	Produktinfo	Inhalt /VE	Preis /VE	
28807	5.5 kg	(Pal. 96) 1	39.90	netto

Textilwaschmittel flüssig



MayaTex 2

Hauptwaschmittelkonzentrat für Weichwasser, ohne optische Aufheller und ohne Bleichmittel, nur für die automatische Dosierung empfohlen. In Kombination mit MayaTex 6 für alle Wasserhärten geeignet. Auch für die Nassreinigung einsetzbar.



Artikel-Nr.	Produktinfo	Inhalt /VE	Preis /VE	
19560	25 kg	(Pal. 24) 1	158.00	netto



MayaTex 4

Fein- und Wollwaschmittelkonzentrat für alle Wasserhärten, bis zu einer Temperatur von 60° C, ohne Bleichmittel und ohne optische Aufheller, besonders geeignet für Feder- und Daunenwäsche, geeignet für die automatische Dosierung.



Artikel-Nr.	Produktinfo	Inhalt /VE	Preis /VE	
19562	20 kg	(Pal. 24) 1	160.00	netto



Bio Ambra

Fein- und Wollwaschmittelkonzentrat für alle Wasserhärten, bis zu einer Temperatur von 60°C, ohne Bleichmittel und ohne optische Aufheller, besonders geeignet für Feder- und Daunenwäsche, geeignet für die automatische Dosierung.

Artikel-Nr.	Produktinfo	Inhalt /VE	Preis /VE	
19666	10 kg	(Pal. 40) 1	90.00	netto
25862	20 kg	(Pal. 24) 1	163.00	netto

Steinfels Swiss | Textilpflege

Textilwaschmittel flüssig



MayaTex 1

Flüssiges, enzymhaltiges Vorwaschmittel für Weichwasser. Löst durch enzymatischen Abbau Verschmutzungen wie Blut, Eiweiss, Milch, Saucen, Schweiss, Urin etc. MayaTex 1 enthält keine optische Aufheller und auch kein Bleichmittel.



Artikel-Nr.	Produktinfo	Inhalt /VE	Preis /VE	
25860	20 kg	(Pal. 24) 1	173.00	netto
25500*	60 kg	(Pal. 6) 1	519.00	netto

Waschhilfsmittel



MayaTex 6

Hochalkalischer konzentrierter Waschkraftverstärker mit zusätzlicher Enthärtungsfunktion für alle Wasserhärten. In Kombination mit MayaTex 1 und 2 anwendbar. Nur für die automatische Dosierung empfohlen. Auch für die Nassreinigung einsetzbar.



Artikel-Nr.	Produktinfo	Inhalt /VE	Preis /VE	
19564	24 kg	(Pal. 24) 1	160.80	netto



MayaTex 5

Neutraler superkonzentrierter Fettlöser gegen speise- und mineralöhlhaltige Verschmutzungen, geeignet für die automatische oder manuelle Dosierung. Kann auch als Vorbehandlungsmittel eingesetzt werden. Auch für die Nassreinigung einsetzbar.



Artikel-Nr.	Produktinfo	Inhalt /VE	Preis /VE	
19563	20 kg	(Pal. 24) 1	208.00	netto



Bio Lipo

Konzentrierter pH-neutraler Fettlöser, auch Flecken- und Einweichhilfsmittel, besonders wirksam gegen kugelschreiber- und mineralöhlhaltige Flecken.

Artikel-Nr.	Produktinfo	Inhalt /VE	Preis /VE	
16673*	20 kg	(Pal. 24) 1	208.00	netto



Bio Prep

Alkalischer, konzentrierter Fettlöser, kann auch als Vorwaschmittel eingesetzt werden.

Artikel-Nr.	Produktinfo	Inhalt /VE	Preis /VE	
19749	10 kg	(Pal. 40) 1	112.50	netto
25347	20 kg	(Pal. 24) 1	208.00	netto



MayaTex 3

Bleichmittelkonzentrat auf Peressigsäurebasis, für den Einsatz ab 40 °C, auch für die chemothermische Desinfektion geeignet. Nur für die automatische Dosierung empfohlen. Auch für die Nassreinigung einsetzbar.



Artikel-Nr.	Produktinfo	Inhalt /VE	Preis /VE	
19561	20 kg	(Pal. 24) 1	173.00	netto



Blimit

Pulverförmiges Bleich- und Fleckenentfernungsmittel auf Sauerstoffbasis für Weiss- und Buntwäsche, ab 60° C.

Artikel-Nr.	Produktinfo	Inhalt /VE	Preis /VE	
19556	15 kg	(Pal. 48) 1	93.00	netto



Blimit spezial

Pulverförmiges Bleich- und Fleckenentfernungsmittel auf Sauerstoffbasis für Weiss- und Buntwäsche, ab 40° C.

Artikel-Nr.	Produktinfo	Inhalt /VE	Preis /VE	
19557	15 kg	(Pal. 48) 1	137.25	netto

Steinfels Swiss | Textilpflege

Waschhilfsmittel



Action 1

Gegen eiweiss- und proteinhaltige Verfleckungen wie Milch, Blut, Zucker etc.

Artikel-Nr.	Produktinfo	Inhalt /VE	Preis /VE	
19668	300 ml	6	78.60	netto



MayaAction 2

Gegen Tinten-, Filzschreiber-, Kugelschreiber- und Fettflecken.



Artikel-Nr.	Produktinfo	Inhalt /VE	Preis /VE	
19669*	300 ml	6	63.30	netto



Action 3

Gegen gerbstoff- und taninhaltige Verfleckungen wie Kaffee, Rotwein, Obst etc.

Artikel-Nr.	Produktinfo	Inhalt /VE	Preis /VE	
19670*	300 ml	6	117.00	netto



Action 4

Gegen rosthaltige Verfleckungen

Artikel-Nr.	Produktinfo	Inhalt /VE	Preis /VE	
19671*	300 ml	6	63.30	netto



Multi Finish

Bakterio- und antistatische knitterarme Ausrüstung, Geruchsverhinderer und Schutz vor Verfilzung von Wolle.

Artikel-Nr.	Produktinfo	Inhalt /VE	Preis /VE	
19314	10 kg	(Pal. 40) 1	102.00	netto
19566	20 kg	(Pal. 24) 1	187.00	netto



Mollo

Angenehm duftendes Weichspülerkonzentrat ohne Farbstoff, mit Antistatikum, macht die Wäsche weich, schmiegsam und griffig.

Artikel-Nr.	Produktinfo	Inhalt /VE	Preis /VE	
19750	10 kg	(Pal. 40) 1	46.00	netto
25863	20 kg	(Pal. 24) 1	75.00	netto



Stärke 77

Flüssiges synthetisches Appreturkonzentrat, verleiht der Wäsche einen festen Griff.

Artikel-Nr.	Produktinfo	Inhalt /VE	Preis /VE	
19973	10 kg	(Pal. 40) 1	121.00	netto



Lenisept

Für die chemo-thermische Desinfektion der Wäsche. Pulverförmiges, chlosabspaltendes Mittel, auch als Entfleckungsmittel für chlorechte Wäsche einsetzbar.

Artikel-Nr.	Produktinfo	Inhalt /VE	Preis /VE	
19558	15 kg	(Pal. 27) 1	198.75	netto



Pre Tex Forte

Fleckenentferner Konzentrat, entfernt Öl- und Fettflecken, Schmutzränder, Make-Up, Obst, Rotwein, Kaffee, Tee und viele andere Flecken.

Artikel-Nr.	Produktinfo	Inhalt /VE	Preis /VE	
19877	500 ml, Sprühflasche	(Pal. 135) 6	60.30	netto
16055	5 kg	(Pal. 96) 1	77.75	netto

Steinfels Swiss | Textilpflege

Waschhilfsmittel



pre-Wash Fleckenentferner

Flecken- und Vorbehandlungsmittel für die Entfernung von öl- und fetthaltigen Flecken.

Artikel-Nr.	Produktinfo	Inhalt /VE	Preis /VE	
17640.1	500 ml, Sprühflasche	(Pal. 90) 6	77.10	netto
19665.1	4.85 kg	(Pal. 96) 1	136.15	netto

Steinfels Swiss | Persönliche Hygiene und Sicherheitsartikel

Hände / Hair & Body



MayaHand Soap

Milde rückfettende und feuchtigkeitsspendende Handseife, dermatologisch geprüft.



Artikel-Nr.	Produktinfo	Inhalt /VE	Preis /VE	
20058	5 kg	(Pal. 96) 1	26.00	netto



Hand Desinfect E

Alkoholisches Desinfektionsmittel mit Sofort- und Langzeitwirkung

Artikel-Nr.	Produktinfo	Inhalt /VE	Preis /VE	
18699	4.28 kg	(Pal. 96) 1	40.00	netto

Steinfels Swiss | Objekt- und Gebäudereinigung

Boden- und Oberflächenreiniger



MayaMulti

Parfümierter, konzentrierter Allzweckreiniger für die allgemeine Reinigung. Manuell und maschinell einsetzbar.



Artikel-Nr.	Produktinfo	Inhalt /VE	Preis /VE	
19567	10 kg	(Pal. 40) 1	56.50	netto



MayaMulti Plus

Parfümierter, konzentrierter, stark alkalischer Allzweckreiniger für die allgemeine Reinigung. Manuell und maschinell einsetzbar.



Artikel-Nr.	Produktinfo	Inhalt /VE	Preis /VE	
19568	10 kg	(Pal. 40) 1	62.00	netto



MayaVit

Glas- und Oberflächenreiniger mit hohem Schmutzlösevermögen. Hinterlässt keine Streifen und Rückstände.



Artikel-Nr.	Produktinfo	Inhalt /VE	Preis /VE	
19569	10 kg	(Pal. 40) 1	40.00	netto



Steinfels Floor-Alconet

Hochwirksames Alkoholemhrzweck- und Bodenreinigungs-Konzentrat mit Langzeitduftnote für manuelle und maschinelle Reinigung aller wasserbeständigen, polierten oder glänzenden Bodenbelägen, Fliesen und sämtlichen abwaschbaren Oberflächen.

Artikel-Nr.	Produktinfo	Inhalt /VE	Preis /VE	
19570	10 kg	(Pal. 40) 1	51.00	netto



Steinfels Fresh

Desodorisierendes Reinigungsmittelkonzentrat für den Sanitärbereich. Hinterlässt einen angenehmen frischen Duft.

Artikel-Nr.	Produktinfo	Inhalt /VE	Preis /VE	
19674*	10 kg	(Pal. 40) 1	87.50	netto

Steinfels Swiss | Objekt- und Gebäudereinigung

Boden- und Oberflächenreiniger



MayaEasy Vit

Glas- und Oberflächenreiniger mit hohem Schmutzlösevermögen. Hinterlässt keine Steifen und Rückstände. Sofort und unverdünnt einsetzbar.



Artikel-Nr.	Produktinfo	Inhalt /VE	Preis /VE	
14814	500 ml	(Pal. 135) 6	29.40	netto

Sanitärreiniger



MayaSan

Mildes, angenehm parfümiertes Reinigungs- und Entkalkungsmittel für die tägliche Reinigung und Entkalkung im Sanitär- und Küchenbereich.



Artikel-Nr.	Produktinfo	Inhalt /VE	Preis /VE	
19571	10 kg	(Pal. 40) 1	57.00	netto



MayaEasy San

Mildes, angenehm parfümiertes Reinigungs- und Entkalkungsmittel für die tägliche Reinigung und Entkalkung im Sanitär- und Küchenbereich. Sofort und unverdünnt einsetzbar.



Artikel-Nr.	Produktinfo	Inhalt /VE	Preis /VE	
17930	500 ml	(Pal. 135) 6	29.40	netto



MayaSan Forte

Hochwirksames, angenehm parfümiertes Reinigungs- und Entkalkungsmittel für die tägliche Reinigung und Entkalkung im Sanitär- und Küchenbereich.



Artikel-Nr.	Produktinfo	Inhalt /VE	Preis /VE	
19572	10 kg	(Pal. 40) 1	61.00	netto



MayaEntkalker

Dickflüssiges entkeimendes Entkalkungsmittel und Urinsteinentferner für WC, Dusche, Lavabos usw., angenehm parfümiert. Nicht auf Armaturen und emaillierten Flächen anwenden.



Artikel-Nr.	Produktinfo	Inhalt /VE	Preis /VE	
19573	10 kg	(Pal. 40) 1	60.00	netto



Steinfels Sanex

Hochwirksames, angenehm parfümiertes Kalkentfernerkonzentrat mit reinigender Unterstützung und Korrosionsschutz. Besonders schnellwirkend. Für alle säurebeständigen Oberflächen in Küche, Sanitär- und Nassbereichen, Schwimmbädern usw.

Artikel-Nr.	Produktinfo	Inhalt /VE	Preis /VE	
19676*	10 kg	(Pal. 40) 1	83.00	netto



Piso clean and fresh - Sani clean

Piso-Duftsteine für die intensive und anhaltende Urinalhygiene, beugt Kalk- und Urinalsteinbildung vor.

Artikel-Nr.	Produktinfo	Inhalt /VE	Preis /VE	
17548	1 kg	(Pal. 504) 1	16.35	netto

Bodenreinigung und -pflege



Steinfels Floor-Net

Bodenreinigungs- und Pflege-Konzentrat mit Schmutzstopp. Verhindert das Anhaften von Kaugummi und schwarzen Absatzstrichen usw. auf der Bodenoberfläche. Kein Schichtenaufbau, polierbar und maschinentauglich. Hochkonzentrat: 25 ml / 8 l Wasser.

Artikel-Nr.	Produktinfo	Inhalt /VE	Preis /VE	
16053	10 kg	(Pal. 60) 1	70.00	netto

Steinfels Swiss | Objekt- und Gebäudereinigung

Bodenreinigung und -pflege



Steinfels Carp-Ex

Teppichwaschmittel-Konzentrat mit Schaumbremse für das Sprühextraktionsverfahren von farb- und feuchtigkeitsbeständigen textilen Bodenbelägen und Polsterstoffen.

Artikel-Nr.	Produktinfo	Inhalt /VE	Preis /VE	
4729*	10 kg	(Pal. 40) 1	77.00	netto



Steinfels Floor-Profi

Intensives Industrie- und Mehrzweckreinigungs-Konzentrat. Entfernt selbst hartnäckige, verkrustete Öl- und Fettrückstände. Idealer Reiniger für Garagen- und Industriebetriebe sowie Küchen.

Artikel-Nr.	Produktinfo	Inhalt /VE	Preis /VE	
20237*	10 kg	(Pal. 40) 1	74.00	netto

Desinfektionsmittel



Steinfels DesoClean

Reinigungs- und Desinfektionsmittel, für sämtliche, glatte Oberflächen, Gerätschaften und Einrichtungen. Reinigung mit Einscheibenmaschine, im Nasswischverfahren, wie auch bei der manuellen Reinigung. Wirksam auch gegen Norovirus.

Artikel-Nr.	Produktinfo	Inhalt /VE	Preis /VE	
19673	10 kg	(Pal. 40) 1	101.50	netto

Lufterfrischer



Airclean Lufterfrischer

200 ml, Lufterfrischer mit Sprühkopf. Beseitigt unangenehme Gerüche.

Artikel-Nr.	Produktinfo	Inhalt /VE	Preis /VE	
17557	Citro	8	56.80	netto
22118	Fleur	8	56.80	netto

Steinfels Swiss | Dosier- und Anwendungshilfen



Neutrale Dosierflasche

farblos

Artikel-Nr.	Produktinfo	Inhalt /VE	Preis /VE	
18393	500 ml	1	2.60	netto



Verschluss, gerade

für Dosierflasche 500 ml

Artikel-Nr.	Inhalt /VE	Preis /VE	
19971	1	0.75	netto

Sprühkopf

Zu Steinfels-Sprühflaschen 500 ml



Artikel-Nr.	Produktinfo	Inhalt /VE	Preis /VE	
18123	weiss	1	2.95	netto

Schaumkopf

Zu Sprühflaschen 500 ml



Artikel-Nr.	Produktinfo	Inhalt /VE	Preis /VE	
25910*	weiss	1	3.25	netto

Nachhaltige Hygiene für alle Bereiche.

GREEN
WE DARE TO CARE

Mit der ökologischen Produktlinie «GREEN» leisten wir einen aktiven Beitrag zum Schutz unserer Umwelt. GREEN steht für konsequent naturnah entwickelte Wasch- und Reinigungsmittel auf Basis nachwachsender Rohstoffe, die auch in anspruchsvollen Einsatzgebieten für fortschrittliche und effektive Reinigung und gesunde Sauberkeit sorgen.

Reinigen Sie heute schon für morgen.

Die Zukunft wird zeigen, welche Wasch- und Reinigungsmittel wir heute einsetzen. Deshalb haben wir GREEN für Sie entwickelt: nachhaltige, effiziente Wasch- und Reinigungsprodukte, mit denen Sie in jedem Anwendungsbereich dauerhafte Sauberkeit und absolute Hygiene erzielen. Dafür sorgen Öko-Rohstoffe, die heute und in Zukunft sowohl unsere Gesundheit als auch die Umwelt schonen. Erfahren Sie alles über ökologische Hygiene unter green.vanbaerle.com

Überzeugend ökologisch in allen Bereichen.

GREEN ist das Resultat dieser engagiert ökologischen Haltung.

«GREEN» steht für:

- ökologische Innovation
- nachhaltige Qualität
- naturnahe Hygiene und Kompetenz

Für die Küche:



Für das Geschirr:



Für die Wäsche:



Für den Raum:



Für die Waschräumhygiene:



vanBaerle

Better. For you.

van Baerle | Küche



Relaclean standard

Ökologischer, unparfümierter Universalreiniger. Geeignet für alle abwaschbaren Oberflächen sowie für die manuelle Geschirreinigung.



Artikel-Nr.	Produktinfo	Inhalt /VE	Preis /VE	
18740	10 kg	(Pal. 40) 1	45.50	netto



Relaclean general

Ökologischer, parfümierter Universalreiniger. Geeignet für alle abwaschbaren Oberflächen sowie für die manuelle Geschirreinigung.



Artikel-Nr.	Produktinfo	Inhalt /VE	Preis /VE	
26496*	10 kg	1	45.50	netto
17854	20 kg	(Pal. 24) 1	83.00	netto



Relaclean 200

Leicht alkalisch, gut fettlösend Allzweckreiniger für alle Oberflächen.



Artikel-Nr.	Produktinfo	Inhalt /VE	Preis /VE	
18025	10 kg	(Pal. 40) 1	59.50	netto
16868	20 kg	(Pal. 24) 1	111.00	netto



Relaclean 250

Alkalischer Bodenreiniger mit hohem Fettlösevermögen. Geeignet für die maschinelle und manuelle Anwendung.



Artikel-Nr.	Produktinfo	Inhalt /VE	Preis /VE	
17084	25 kg	(Pal. 24) 1	166.25	netto



Relaclean 400

Alkalischer Grill- und Backofenreiniger zur Entfernung eingebrannter Speisereste auf alkaliresistenten Materialien.



Artikel-Nr.	Produktinfo	Inhalt /VE	Preis /VE	
16866	10 kg	(Pal. 40) 1	91.10	netto
17043	20 kg	(Pal. 24) 1	173.40	netto



Relaclean 600

Kraftvolle und schonende Scheuercreme für Chromstahl-, Melaminharz- und Email-Oberflächen.



Artikel-Nr.	Produktinfo	Inhalt /VE	Preis /VE	
17063	10 kg	(Pal. 40) 1	66.50	netto
16869	600 g	(Pal. 52) 10	46.80	netto



Relaclean 800

Saurer Entkalker. Geeignet für die schnelle und rückstandsfreie Entfernung von Kalkablagerungen.



Artikel-Nr.	Produktinfo	Inhalt /VE	Preis /VE	
16870	10 kg	(Pal. 40) 1	61.10	netto



Relaclean 1000

Kraftvoller, alkalischer Allzweckreiniger und Entfetter für lösemittel- und alkaliresistente Oberflächen. Geeignet für die schnelle und gründliche maschinelle und manuelle Reinigung stark verschmutzter Oberflächen.



Artikel-Nr.	Produktinfo	Inhalt /VE	Preis /VE	
17558	10 kg	(Pal. 40) 1	91.00	netto
18900	20 kg	(Pal. 24) 1	180.00	netto



Citronet Geschirrspülmittel

Ökologischer Entfetter und manuelles Geschirrspülmittel. Parfümiert.



Artikel-Nr.	Produktinfo	Inhalt /VE	Preis /VE	
17144	20 kg	(Pal. 24) 1	87.20	netto

van Baerle | Küche



Relaclean decalc

Ökologischer, saurer Enkalker für Einlege- und Spülverfahren. Geeignet zur Anwendung bei säureresistenten Materialien und Geräten.



Artikel-Nr.	Produktinfo	Inhalt /VE	Preis /VE	
17559	10 kg	(Pal. 40) 1	77.50	netto
28646	500 g	(Pal. 52) 10	54.50	netto



Relaclean 350

Alkoholisches, schnellwirkendes Desinfektionsmittel. Geeignet für die Desinfektion von Geräten, Maschinenteilen und Arbeitsflächen.



Artikel-Nr.	Produktinfo	Inhalt /VE	Preis /VE	
24542	5 Liter	(Pal. 60) 1	44.75	netto
18024	500 ml	(Pal. 53) 10	72.00	netto



Relaclean multi

Ökologischer, unparfümierter, leicht alkalischer, schäumender Allzweckreiniger und Entfetter. Entfernt wirkungsvoll fettige Rückstände von allen abwaschbaren Oberflächen.



Artikel-Nr.	Produktinfo	Inhalt /VE	Preis /VE	
28623	20 kg	(Pal. 24) 1	103.00	netto



Relaclean rapid

Ökologisches, schnell wirkendes, alkoholisches Desinfektionsmittel, welches sich für die Desinfektion von geräten, Maschinenteilen und Arbeitsflächen eignet.



Artikel-Nr.	Produktinfo	Inhalt /VE	Preis /VE	
24525	5 kg	1	47.00	netto



Oven & Grill Clean

Ökologischer, effizienter, hoch alkalischer Grill-, Backofen- und Steamerreiniger zur Verwendung in Grossküchen und in der Lebensmittelindustrie.



Artikel-Nr.	Produktinfo	Inhalt /VE	Preis /VE	
22412	5 Liter	(Pal. 128) 1	40.25	netto
22295	4 x 5 Liter	4	153.00	netto



Techno Floor Forte

Ökologischer, kräftiger, leicht alkalischer Bodenreiniger. Eignet sich für die regelmässige Reinigung von mässig bis stark verschmutzten wasserfesten Fussböden.



Artikel-Nr.	Produktinfo	Inhalt /VE	Preis /VE	
17726	5 Liter	4	104.00	netto



NU-Kleen All

Neutraler, parfümierter und universell einsetzbarer biotechnologischer Kraftreiniger für alle abwaschbaren Oberflächen.



Artikel-Nr.	Produktinfo	Inhalt /VE	Preis /VE	
17249	10 Liter	1	132.00	netto



NU-Grip Plus

Neutraler, biotechnologischer Tiefenreiniger und kraftvoller Entfetter gegen rutschige und fettige Böden in Küchen und Gastronomiebereichen.



Artikel-Nr.	Produktinfo	Inhalt /VE	Preis /VE	
19998	10 Liter	1	155.00	netto

van Baerle | Küche



Nu-Kleen Floor

Biotechnologischer Bodenreiniger und Fettlöser für die maschinelle Reinigung aller abwaschbaren Böden und Oberflächen.



Artikel-Nr.	Produktinfo	Inhalt /VE	Preis /VE	
17870	10 Liter	1	155.00	netto



Relaclean acetic

Ökologischer Putzessig zur Kalkentfernung auf säureempfindlichen Oberflächen.



Artikel-Nr.	Produktinfo	Inhalt /VE	Preis /VE	
17265	10 kg	(Pal. 40) 1	48.50	netto

van Baerle | Geschirr



Relavit durac

Gut schmutztragendes Geschirrspülmittel mit Bleichzusatz und Silberschutz. Für weiches bis mittelhartes Wasser.



Artikel-Nr.	Produktinfo	Inhalt /VE	Preis /VE	
16855	12 kg	(Pal. 40) 1	91.20	netto
16856	25 kg	(Pal. 24) 1	170.00	netto



Relavit ha

Geschirrspülmittel mit erhöhter Alkalität zur effizienten Schmutzentfernung. Mit Bleichzusatz und Silberschutz.



Artikel-Nr.	Produktinfo	Inhalt /VE	Preis /VE	
16854	25 kg	(Pal. 24) 1	163.75	netto



Relavit os

Phosphat- und silikatfreies Geschirrspülmittel mit Bleichwirkung ohne Chlorgeruch für alle Wasserhärten.



Artikel-Nr.	Produktinfo	Inhalt /VE	Preis /VE	
16859	25 kg	(Pal. 24) 1	167.50	netto
16858	12 kg	(Pal. 40) 1	90.00	netto
19328	200 kg	1	1'280.00	netto



Relavit pro

Phosphatfreies Geschirrspülmittel mit Bleichwirkung ohne Chlorgeruch für alle Wasserhärten.



Artikel-Nr.	Produktinfo	Inhalt /VE	Preis /VE	
16972	25 kg	(Pal. 24) 1	170.00	netto



Relaxin es

Neutrales Glanztrocknungsmittel mit zusätzlicher Schaumbremse und Silberschutz.



Artikel-Nr.	Produktinfo	Inhalt /VE	Preis /VE	
16863	10 kg	(Pal. 40) 1	83.00	netto
16862	20 kg	(Pal. 24) 1	152.60	netto



Relaxin g11

Neutrales, entschäumendes Glanztrocknungsmittel mit Silberschutz.



Artikel-Nr.	Produktinfo	Inhalt /VE	Preis /VE	
16851	20 kg	(Pal. 24) 1	152.00	netto
21638	8 kg	1	63.60	netto



Relaxin plus

Saures Glanztrocknungsmittel mit zusätzlicher Schaumbremse und Silberschutz. Besonders geeignet bei härterem Wasser.



Artikel-Nr.	Produktinfo	Inhalt /VE	Preis /VE	
16861	20 kg	(Pal. 24) 1	166.60	netto

van Baerle | Geschirr



Relaxin sr

Saures Glanz Trocknungsmittel mit Silberschutz, besonders geeignet bei härterem Wasser.



Artikel-Nr.	Produktinfo	Inhalt /VE	Preis /VE	
16852	20 kg	(Pal. 24) 1	159.00	netto



Relavit birsa

Pulverförmiges, effizient bleichendes Geschirr-Einweichmittel für chlor- und alkaliresistente Geschirr- und Besteckteile.



Artikel-Nr.	Produktinfo	Inhalt /VE	Preis /VE	
16864	10 kg	(Pal. 33) 1	77.50	netto



Relavit Star

Ökologisches, effizientes, phosphat-, enzym- und chlorfreies Geschirrspülmittel, für gewerbliche Geschirrspülmaschinen. Geeignet für tiefe bis mittlere Wasserhärten.



Artikel-Nr.	Produktinfo	Inhalt /VE	Preis /VE	
18182	12 kg	(Pal. 40) 1	89.40	netto
17258	25 kg	(Pal. 24) 1	166.25	netto



Relaxin shine

Ökologisches, saures Glanz Trocknungsmittel für gewerbliche Geschirrspülautomaten.



Artikel-Nr.	Produktinfo	Inhalt /VE	Preis /VE	
17116	10 kg	(Pal. 40) 1	71.10	netto
17128	20 kg	(Pal. 24) 1	136.20	netto



Relasafe Drum durac

Effizient bleichendes, chlorhaltiges Geschirrspülmittel mit Silberschutz, für gewerbliche Geschirrspülmaschinen. Geeignet für weiches bis mittelhartes Wasser.



Artikel-Nr.	Produktinfo	Inhalt /VE	Preis /VE	
22926	250 kg	1	1'682.50	netto



Relasafe Drum star

Ökologisches, effizientes, phosphat-, enzym- und chlorfreies Geschirrspülmittel, für gewerbliche Geschirrspülmaschinen. Geeignet für tiefe bis mittlere Wasserhärten.



Artikel-Nr.	Produktinfo	Inhalt /VE	Preis /VE	
22525	200 kg	(Pal. 1) 1	1'340.00	netto



Relasafe Drum shine

Ökologisches, saures Glanz Trocknungsmittel für gewerbliche Geschirrspülmaschinen.



Artikel-Nr.	Produktinfo	Inhalt /VE	Preis /VE	
22526	200 kg	(Pal. 1) 1	1'384.00	netto



Relaxin extra

Effizienter Steckbeckenspüler mit schneller Trocknung und hoher Reinigungswirkung.



Artikel-Nr.	Produktinfo	Inhalt /VE	Preis /VE	
18043	5 kg	(Pal. 60) 1	36.50	netto



Relavit vitro

Phosphat- und chlorfreies, geruchsneutrales, materialschonendes Geschirrspülmittel mit Silberschutz. Geeignet für alle Wasserhärten.



Artikel-Nr.	Produktinfo	Inhalt /VE	Preis /VE	
19722	12 kg	1	93.60	netto

van Baerle | Geschirr



Relavit top

Waschkraftverstärker auf Enzymbasis. Wird in Kombination mit einem Geschirrspülmittel eingesetzt.



Artikel-Nr.	Produktinfo	Inhalt /VE	Preis /VE	
18021	20 kg	(Pal. 24) 1	254.00	netto

van Baerle | Textil



Relatex bio

Enzymhaltiges Vor- und Buntwaschmittel ohne Bleichmittel und optische Auffeller.



Artikel-Nr.	Produktinfo	Inhalt /VE	Preis /VE	
17068	25 kg, bis 95°C	(Pal. 24) 1	167.50	netto



Relatex lav

Enzymhaltiges Hauptwaschmittel mit aktiviertem Bleichsystem. Enthält optische Auffeller und eignet sich insbesondere für die weisse Wäsche.



Artikel-Nr.	Produktinfo	Inhalt /VE	Preis /VE	
17069	25 kg, bis 95°C	(Pal. 24) 1	182.50	netto



Relatex liquid

Flüssiges, enzymhaltiges Waschmittel. Besonders gut geeignet gegen Eiweiss-Verschmutzungen wie Milch-, Kakao- und Blutflecken. Ohne optische Auffeller.



Artikel-Nr.	Produktinfo	Inhalt /VE	Preis /VE	
17072	10 kg, bis 60°C	(Pal. 40) 1	85.50	netto
17442	20 kg, bis 60°C	(Pal. 24) 1	168.00	netto



Relatex lana

Fein- und Wollwaschmittel für alles Farbige und Feine aus Wolle, Seide und Synthetik.



Artikel-Nr.	Produktinfo	Inhalt /VE	Preis /VE	
17080	20 kg, bis 40°C	(Pal. 24) 1	159.00	netto



Relatex septo

Bleichmittel auf Chlorbasis. Ideal zur Fleckenentfernung in der Vorwäsche.



Artikel-Nr.	Produktinfo	Inhalt /VE	Preis /VE	
17064	10 kg, bis 60°C	(Pal. 40) 1	157.50	netto



Relatex oxiplus

Schonendes Bleich- und Fleckenentfernungsmittel auf Sauerstoffbasis



Artikel-Nr.	Produktinfo	Inhalt /VE	Preis /VE	
17061	8 kg, ab 30°C	1	78.40	netto
17081	25 kg, ab 30°C	1	228.75	netto



Relatex soft

Parfümierter, antistatisch wirkender Weichspüler.



Artikel-Nr.	Produktinfo	Inhalt /VE	Preis /VE	
17075	20 kg	(Pal. 24) 1	77.00	netto



Relatex antioil

Schaumarmer, textilschonender Öl- und Fettlöser und Waschkraftverstärker.



Artikel-Nr.	Produktinfo	Inhalt /VE	Preis /VE	
17082	10 kg	(Pal. 40) 1	92.50	netto

van Baerle | Textil



Relatex 1

Enzymhaltige, schaumarme Tensidkomponente. Für Weisswäsche.



Artikel-Nr.	Produktinfo	Inhalt /VE	Preis /VE	
17054	20 kg	(Pal. 24) 1	182.00	netto
17830	55 kg	(Pal. 6) 1	484.00	netto



Relatex 2

Alkalischer Waschkraftverstärker. Geeignet für alle Waschtemperaturen.



Artikel-Nr.	Produktinfo	Inhalt /VE	Preis /VE	
17055	25 kg	(Pal. 24) 1	113.75	netto
17561	70 kg	(Pal. 6) 1	315.00	netto



Relatex 3

Schutztrage- und Wasserenthärtungskomponente, geeignet für alle Temperaturen und Textilarten.



Artikel-Nr.	Produktinfo	Inhalt /VE	Preis /VE	
17056	20 kg	(Pal. 24) 1	130.60	netto
17562	65 kg	(Pal. 6) 1	412.10	netto



Relatex 4

Bleichmittel auf Sauerstoffbasis, zur Entfernung von bleichbaren Anschmutzungen.



Artikel-Nr.	Produktinfo	Inhalt /VE	Preis /VE	
17057	20 kg	(Pal. 24) 1	167.00	netto
17563	60 kg	(Pal. 6) 1	489.00	netto



Relatex 5

Aufhellerfreie, enzymhaltige Tensidlösung. Für Buntwäsche.



Artikel-Nr.	Produktinfo	Inhalt /VE	Preis /VE	
17058	20 kg	(Pal. 24) 1	169.00	netto
17833	55 kg	(Pal. 6) 1	446.05	netto



Relatex 8

Saures, parfümiertes Neutralisationsmittel im vanBaerle (Wasch-) Komponentensystem. Verhindert Stossflecken auf feuchter Wäsche.



Artikel-Nr.	Produktinfo	Inhalt /VE	Preis /VE	
17073	20 kg	(Pal. 24) 1	185.00	netto
14303	50 kg	1	447.50	netto



Relatex 9

Waschkraft- und Fettlösekomponente, geeignet für alle Textilarten und Waschttemperaturen.



Artikel-Nr.	Produktinfo	Inhalt /VE	Preis /VE	
17071	20 kg	(Pal. 24) 1	250.00	netto
18623	50 kg	(Pal. 6) 1	610.00	netto



Relatex k

Ökologischer Wasserenthärter und Waschkraftverstärker für automatische Dosierung, für mittelhartes bis hartes Wasser.



Artikel-Nr.	Produktinfo	Inhalt /VE	Preis /VE	
17860	25 kg	(Pal. 24) 1	177.50	netto



Relatex spray

Kraftvolles Fleckenvorbehandlungsmittel gegen Fett- und Schmutzränder. Besonders geeignet für Küchenwäsche.



Artikel-Nr.	Produktinfo	Inhalt /VE	Preis /VE	
18271	10 kg	(Pal. 40) 1	132.00	netto

van Baerle | Textil



Relatex Profi C

Konzentriertes, hochalkalisches und schaumarmes Buntwaschmittel für Weichwasser.



Artikel-Nr.	Produktinfo	Inhalt /VE	Preis /VE	
16835	70 kg, bis 95°C	(Pal. 4) 1	567.00	netto



Relatex total

Ökologisches Vor- und Buntwaschmittel, enzymhaltig, ohne Bleichmittel und optische Aufheller, für alle Wasserhärten.



Artikel-Nr.	Produktinfo	Inhalt /VE	Preis /VE	
17142	20 kg, bis 95°C	(Pal. 30) 1	158.00	netto



Relatex base

Ökologisches, parfümiertes Basiswaschmittel für die automatische Dosierung. Geeignet für alle Wäschearten, ausser Wolle und Seide.



Artikel-Nr.	Produktinfo	Inhalt /VE	Preis /VE	
17859	20 kg, bis 95°C	(Pal. 24) 1	168.00	netto



Relatex peroxy

Ökologisches Bleichmittel auf Sauerstoffbasis, entfernt oxidativ unangenehme Gerüche und Flecken aus Textilien, ist auch bei tiefen Temperaturen wirksam.



Artikel-Nr.	Produktinfo	Inhalt /VE	Preis /VE	
16728	20 kg	1	222.00	netto



Relatex merino

Ökologisches Fein- und Wollwaschmittel. Enzymhaltig, für die schonende und gründliche Reinigung empfindlicher Textilien wie Wolle, Seide usw.



Artikel-Nr.	Produktinfo	Inhalt /VE	Preis /VE	
24430	20 kg, bis 40°C	1	170.00	netto

van Baerle | Raum- und Objekthygiene



Relaroom sanitair

Parfümierter, zitronensäurer Reiniger für die manuelle Anwendung im Sanitärbereich.



Artikel-Nr.	Produktinfo	Inhalt /VE	Preis /VE	
17079	10 kg	(Pal. 40) 1	61.00	netto
19492	20 kg	(Pal. 24) 1	110.00	netto



Relaroom toilet

Parfümierter, saurer WC-Reiniger zur Entfernung von Kalk- und Urinstein.



Artikel-Nr.	Produktinfo	Inhalt /VE	Preis /VE	
18727	10 kg	1	75.50	netto
16873	20 kg	(Pal. 24) 1	135.00	netto



Relaroom glas

Parfümierter Alkoholreiniger für alle glatten Oberflächen wie Glas, Spiegel, Keramik, Kunststoff und Chromstahl.



Artikel-Nr.	Produktinfo	Inhalt /VE	Preis /VE	
16874	10 kg	(Pal. 40) 1	63.50	netto
17039	20 kg	(Pal. 24) 1	120.00	netto

van Baerle | Raum- und Objekthygiene



Relaroom sanit

Ökologischer, saurer Bad- und WC-Reiniger zur täglichen Unterhaltsreinigung aller säureresistenten Materialien im Sanitärbereich.



Artikel-Nr.	Produktinfo	Inhalt /VE	Preis /VE	
17299	10 kg	(Pal. 40) 1	63.50	netto



Swan WC Forte

Ökologischer, saurer Toilettenreiniger auf Ameisensäurebasis entfernt Kalk- und Urinstein.



Artikel-Nr.	Produktinfo	Inhalt /VE	Preis /VE	
17256	750 ml	(Pal. 36) 6	35.30	netto



Techno Floor

Neutraler Reiniger für die tägliche Reinigung von harten Fussböden mit Wischmop oder Bodenlappen.



Artikel-Nr.	Produktinfo	Inhalt /VE	Preis /VE	
17266	5 l	4	104.00	netto



Relaroom floor

Schwach schäumender Bodenreiniger. Eignet sich für die maschinelle und manuelle Reinigung.



Artikel-Nr.	Produktinfo	Inhalt /VE	Preis /VE	
18321	10 kg	(Pal. 40) 1	61.00	netto



Relaroom fresh

Raumdeo zur Beseitigung unangenehmer Gerüche.



Artikel-Nr.	Produktinfo	Inhalt /VE	Preis /VE	
17062	0.2 kg	9	61.10	netto



Relaroom Allcoclean fresh

Parfümierter alkoholischer Unterhaltsreiniger. Eignet sich sowohl zur streifenfreien Bodenreinigung wie auch zur Unterhaltsreinigung aller abwäschraren Oberflächen.



Artikel-Nr.	Produktinfo	Inhalt /VE	Preis /VE	
24704	10 Liter	1	48.50	netto



Relaroom wipe

Ökologischer, parfümierter, alkalischer Bodenreiniger, dessen schaumgebremste Formulierung sich, neben der manuellen Reinigung, ideal zur Anwendung in Reinigungsautomaten, wie Scheuersaugmaschinen eignet.



Artikel-Nr.	Produktinfo	Inhalt /VE	Preis /VE	
28624	20 kg	(Pal. 24) 1	102.00	netto



NU-Kleen Smell

Biotechnologischer Universalreiniger für den Sanitärbereich. Reinigt nachhaltig im Bereich von Toiletten und Pissoir. Eliminiert biologische Gerüche von Urin und Fäkalien.



Artikel-Nr.	Produktinfo	Inhalt /VE	Preis /VE	
17248	10 Liter	(Pal. 40) 1	132.00	netto

van Baerle | Raum- und Objekthygiene



Nu-Smell Plus

Biotechnologischer Geruchsvernichter für den Toiletten- und Urinalbereich



Artikel-Nr.	Produktinfo	Inhalt /VE	Preis /VE	
17240	5 Liter	1	54.00	netto
20263*	630 ml	12	170.10	netto

van Baerle | Hand- und Körperhygiene



Relaroom Creamsoft

Hautfreundliche Seifencreme für die schonende Händereinigung.



Artikel-Nr.	Produktinfo	Inhalt /VE	Preis /VE	
16875	10 kg	(Pal. 40) 1	63.00	netto



Flo Hand Wash

Ökologische, neutrale, hautfreundliche Handseife. Für häufiges Reinigen geeignet. Leicht parfümiert.



Artikel-Nr.	Produktinfo	Inhalt /VE	Preis /VE	
17210	5 Liter	4	122.60	netto

Buzil | Planta Edition



Planta Orange P311

Ökologischer Oberflächenunterhaltsreiniger, hochkonzentriert. Für alle wasserbeständigen Oberflächen und Bodenbeläge.



Artikel-Nr.	Produktinfo	Inhalt /VE	Preis /VE	
27033	10 Liter	(Pal. 60) 1	55.55	netto
29086	1 Liter	(Pal. 50) 12	72.85	netto



Planta Aloe P 314

Ökologisches Geschirrspülmittel, neutral. Ideal für den Einsatz im Lebensmittelbereich. Für wasserbeständige Oberflächen und Materialien wie z.B. Geschirr, Gläser, Besteck.



Artikel-Nr.	Produktinfo	Inhalt /VE	Preis /VE	
29046	10 Liter	(Pal. 60) 1	59.90	netto
29087	1 Liter	(Pal. 50) 12	80.00	netto



Planta Multi Gloss P 320

Ökologische Dispersion, glänzend. Für beschichtbare und wasserbeständige Bodenbeläge wie z.B. PVC, Linoleum und Elastomerbeläge, beschichtbare PUR-vergütete Beläge, Natur- und Kunststeine.



Artikel-Nr.	Produktinfo	Inhalt /VE	Preis /VE	
29044	5 Liter	(Pal. 96) 1	59.30	netto



Planta Multi Stripper P 321

Ökologischer Universalgrundreiniger. Für wasserbeständige und alkaliempfindliche Bodenbeläge wie z.B. Linoleum, Elastomerbeläge und PVC. Einsetzbar auf Kunst- und Natursteinbelägen.



Artikel-Nr.	Produktinfo	Inhalt /VE	Preis /VE	
29045	5 Liter	1	52.15	netto



Planta Soft P 313

Ökologischer Universalreiniger für alle wasserbeständigen, glänzenden Oberflächen und Bodenbeläge.



Artikel-Nr.	Produktinfo	Inhalt /VE	Preis /VE	
27034	10 Liter	(Pal. 60) 1	40.15	netto
29088	1 Liter	(Pal. 50) 12	56.20	netto



MIT SICHERHEIT PERFEKT SAUBER



HART ZUM SCHMUTZ, SCHONEND FÜR DIE UMWELT!



Mit den Produkten der Planta® Edition bietet Buzil ein Komplettsystem für die umweltschonende Reinigung in allen Anwendungsbereichen – von Oberflächen und Böden über Sanitäranlagen und Glas bis hin zu Handwaschlotionen. Die Produkte der Planta® Edition sind mit dem europäischen Ecolabel sowie dem österreichischen Umweltzeichen ausgezeichnet und entsprechen höchsten Ansprüchen in Sachen Umweltverträglichkeit und Reinigungsleistung. Planta®: So wird perfekte Sauberkeit garantiert nachhaltig!



EDITION PLANTA®
Ausgezeichnet mit dem Europäischen Ecolabel
und dem Österreichischen Umweltzeichen



Buzil | Planta Edition



Planta San P 312

Ökologischer Sanitärunterhaltsreiniger auf Zitronensäurebasis. Für den gesamten Sanitär- und Nassbereich.



Artikel-Nr.	Produktinfo	Inhalt /VE	Preis /VE	
26449	10 Liter	(Pal. 60) 1	49.35	netto
26455	1 Liter	(Pal. 50) 12	67.30	netto

Buzil | Oberflächen



Aktiv G 433

Materialschonender Intensivreiniger für alle wasserbeständigen Oberflächen z.B. Türen, Fenster- rahmen, Heizkörper.

Artikel-Nr.	Produktinfo	Inhalt /VE	Preis /VE	
24268	10 Liter	(Pal. 60) 1	49.45	netto
24267*	1 Liter	(Pal. 50) 12	69.15	netto



Blitz Citro G 481

Neutraler Allesreiniger, duftintensiv für alle wasserbeständigen Oberflächen, Zitronenduft.

Artikel-Nr.	Produktinfo	Inhalt /VE	Preis /VE	
17665	10 Liter	1	39.45	netto
9367	1 Liter	(Pal. 50) 12	56.45	netto



Blitz Orange G 482

Neutraler Allesreiniger, duftintensiv für alle wasserbeständigen Oberflächen, Orangenduft.

Artikel-Nr.	Produktinfo	Inhalt /VE	Preis /VE	
26446	10 Liter	(Pal. 60) 1	39.45	netto
26453*	1 Liter	(Pal. 50) 12	56.45	netto



Blitz Tropic G 483

Neutraler Allesreiniger, duftintensiv für alle wasserbeständigen Oberflächen, Tropicduft.

Artikel-Nr.	Produktinfo	Inhalt /VE	Preis /VE	
26448	10 Liter	(Pal. 60) 1	39.45	netto
26454	1 Liter	(Pal. 50) 12	56.45	netto



Profiglass G 522

Gebrauchsfertiger Glasreiniger. Verzögerte Wiederanschmutzung durch Anti-Soiling Effekt.

Artikel-Nr.	Produktinfo	Inhalt /VE	Preis /VE	
24329	10 Liter	(Pal. 60) 1	40.00	netto
27216	600 ml, mit Sprühkopf	(Pal. 60) 12	39.85	netto



Buz Windowmaster G 525

Glas- und Rahmenreinigerkonzentrat für die Reinigung von grossflächer Aussenverglasung. Verzögerte Wiederanschmutzung durch Anti-Soiling Effekt.

Artikel-Nr.	Produktinfo	Inhalt /VE	Preis /VE	
24264	10 Liter	(Pal. 60) 1	50.45	netto
24330*	1 Liter	(Pal. 50) 12	69.15	netto

Buzil | Sanitär



Buz Contracalc G 461

Flüssiger, farbloser Entkalker und Sanitärgrundreiniger auf Phosphorsäurebasis für gesamten Sanitär-, Bäder- und Lebensmittelbereich. Geräteentkalkung, Schwimmbadreinigung. Alle säurebeständigen Materialien und Oberflächen.



Artikel-Nr.	Produktinfo	Inhalt /VE	Preis /VE	
24262	10 Liter	(Pal. 60) 1	62.85	netto
24271	1 Liter	(Pal. 50) 12	82.55	netto

Buzil | Sanitär



WC CLEANER G 465

Viskoser Sanitärgrundreiniger und WC-Reiniger auf Salzsäurebasis für alle salzsäurebeständigen WC-Becken und Urinale.

Artikel-Nr.	Produktinfo	Inhalt /VE	Preis /VE	
26069	10 Liter	(Pal. 60) 1	48.80	netto
27933	1 Liter	(Pal. 50) 12	67.30	netto



BUCAL G 468

Säurefreier, materialschonender Sanitärunterhaltsreiniger, langanhaltender Frischduft, verhindert Kalkaufbau.

Artikel-Nr.	Produktinfo	Inhalt /VE	Preis /VE	
24273*	10 Liter	(Pal. 60) 1	49.05	netto
9366	1 Liter	(Pal. 50) 12	69.15	netto



O Tens G500

Tensidfreier Universalreiniger auf Citratbasis, alkalisch. Für feuchtigkeitsbeständige und farbechte Oberflächen. Feinsteinzeugfliesen, Wand- und Deckenreinigung, Polstermöbel und Textilbeläge.

Artikel-Nr.	Produktinfo	Inhalt /VE	Preis /VE	
28911*	10 Liter	1	51.20	netto
27114*	1 Liter	(Pal. 50) 12	69.15	netto



BUCASAN Trendy T 464

Sanitärunterhaltsreiniger auf Amidosulfonsäurebasis, duftintensiv. Für alle säurebeständigen Materialien. Für den gesamten Nassraum- und Sanitärbereich.

PK-Listung Keramik PK-Listung Edelstahl PK-Listung Epoxidharz

Artikel-Nr.	Produktinfo	Inhalt /VE	Preis /VE	
24344	10 Liter	(Pal. 60) 1	47.00	netto
24343	1 Liter	(Pal. 50) 12	64.95	netto

Buzil | Boden



Unibuz G 235

Wischpflege für wasserbeständige Bodenbeläge wie Granit, Marmor, Betonwerkstein.

Artikel-Nr.	Produktinfo	Inhalt /VE	Preis /VE	
24266	10 Liter	(Pal. 60) 1	42.05	netto
24265*	1 Liter	(Pal. 50) 12	59.30	netto



TOTAL G 424

Hochalkalischer Grundreiniger für alkali- und wasserbeständige Hartbodenbeläge wie PVC, Stein (unpoliert), Klinker- und Tonplatten.

Artikel-Nr.	Produktinfo	Inhalt /VE	Preis /VE	
27863*	10 Liter	(Pal. 60) 1	50.80	netto



Corridor Unic Ultra S 707

Universalgrundreiniger für wasserbeständige und alkaliempfindliche Bodenbeläge.

Artikel-Nr.	Produktinfo	Inhalt /VE	Preis /VE	
24338	10 Liter	(Pal. 60) 1	77.70	netto



Polybuz Trendy T 201

Glanzreiniger auf alkoholbasis für alle wasserbeständigen Bodenbeläge, die keine Pflege benötigen wie versiegeltes Parkett und Granit.

PK-Listung Keramik

Artikel-Nr.	Produktinfo	Inhalt /VE	Preis /VE	
24342	10 Liter	(Pal. 60) 1	54.05	netto
24341	1 Liter	(Pal. 50) 12	71.70	netto

Buzil | Boden



Buz Match Trendy T 265

Neutraler Automatenreiniger für Sportbodenbeläge in Sport-, Turn- oder Mehrzweckhallen.

Artikel-Nr.	Produktinfo	Inhalt /VE	Preis /VE	
26451	10 Liter	(Pal. 60) 1	63.95	netto

Buzil | Industrie



Perfekt G 440

Alkalischer Intensivreiniger für Industriebetriebe, Werkstattböden, Grossküchen und Gastronomie, lebensmittelverarbeitende Industrie, lösemittelempfindliche Böden.

Artikel-Nr.	Produktinfo	Inhalt /VE	Preis /VE	
17666	10 Liter	(Pal. 60) 1	51.00	netto
18723	1 Liter	(Pal. 50) 12	70.00	netto



Indumaster Protect IR 30

Maschinenreiniger mit Korrosionsschutz. Löst öl- und fetthaltige Verschmutzungen sowie Bohrröle.

Artikel-Nr.	Produktinfo	Inhalt /VE	Preis /VE	
27082	10 Liter	(Pal. 60) 1	42.90	netto



Indumaster Radical IR 40

Alkalischer Industriereiniger für alkalibeständige Böden und Oberflächen.

Artikel-Nr.	Produktinfo	Inhalt /VE	Preis /VE	
26754	10 Liter	(Pal. 60) 1	51.80	netto



Indumaster Forte IR 42

Lösungsmittelhaltiger Industrie- und Sportbodenreiniger. Lösemittelbeständige und alkaliempfindliche Böden und Oberflächen.

Artikel-Nr.	Produktinfo	Inhalt /VE	Preis /VE	
24334	10 Liter	(Pal. 60) 1	98.95	netto



Indumaster Strong IR 45

Hochalkalischer Hochleistungs-Industriereiniger. Alkalibeständige Böden und Oberflächen. Löst hartnäckigste Verschmutzungen.

Artikel-Nr.	Produktinfo	Inhalt /VE	Preis /VE	
24336*	10 Liter	(Pal. 60) 1	72.65	netto
24333*	1 Liter	(Pal. 50) 12	96.05	netto



Indumaster Universal IR 55

Ökologischer Industriereiniger für wasserbeständige Materialien, Oberflächen, Böden und Produktionsmaschinen. Angenehmer Geruch.



Artikel-Nr.	Produktinfo	Inhalt /VE	Preis /VE	
24337	10 Liter	(Pal. 60) 1	49.15	netto

Buzil | Küche



Bistro G 435

Küchenintensivreiniger für Gastronomie und Grossküchen, lebensmittelverarbeitende Industrie, alkalibeständige Oberflächen und Fussböden.

Artikel-Nr.	Produktinfo	Inhalt /VE	Preis /VE	
24270	10 Liter	(Pal. 60) 1	72.30	netto
24269*	1 Liter	(Pal. 50) 12	95.80	netto

Buzil | Küche



Buzil Dish Fix G 530

Neutrales Handgeschirrspülmittel für wasserbeständige Oberflächen und Materialien. Materialschonend.

Artikel-Nr.	Produktinfo	Inhalt /VE	Preis /VE	
24332	10 Liter	(Pal. 60) 1	42.95	netto
24331	1 Liter	(Pal. 50) 12	59.80	netto



Buzil Grillmaster G 576

Hochalkalischer Grill- und Backofenreiniger für Gastronomie und Grossküchen. Löst starke Fett-, Öl- und Eiweißverkrustungen sowie Grill-, Back- und Bratrückstände.

Artikel-Nr.	Produktinfo	Inhalt /VE	Preis /VE	
27908	600 ml	12	66.40	netto



Buzil Metasoft G 507

Gebrauchsfertiger Edelstahlreiniger für säurebeständige Oberflächen, Edelstahl und Cerankochfelder.

Artikel-Nr.	Produktinfo	Inhalt /VE	Preis /VE	
27558*	600 ml	(Pal. 60) 12	182.15	netto

Buzil | Spezial



Buzil POINT G 502

Flecklöser für textile Beläge und Oberflächen. Angenehmer Duft. Entfernt wasserunlösliche Verschmutzungen wie Kaugummi, Klebstoffe usw.

Artikel-Nr.	Produktinfo	Inhalt /VE	Preis /VE	
26093*	200 ml	(Pal. 168) 12	146.50	netto

Buzil | Zubehör



Dosierkugel

transparent, für alle Buzil 1 Liter-Flaschen

Artikel-Nr.	Produktinfo	Inhalt /VE	Preis /VE	
27939	20 ml-Dosierung	1	5.95	netto
27940	50 ml-Dosierung	1	5.95	netto



Auslaufhahn

für alle Buzil 10 Liter-Bidons

Artikel-Nr.	Inhalt /VE	Preis /VE	
27941	1	11.80	netto

Dr. Schnell | Sanitärreinigung

Sanitärraum- / Nasszellenreinigung



Milifix

saurer Grundreiniger für Industrie

HK-Listung

Artikel-Nr.	Produktinfo	Inhalt /VE	Preis /VE	
8142	10 Liter	(Pal. 60) 1	89.90	netto



Milizid Konzentrat

Sanitärreiniger und Kalklöser

EU Ecolabel
HK-Listung

Artikel-Nr.	Produktinfo	Inhalt /VE	Preis /VE	
8175	1 Liter	(Pal. 40) 12	85.05	netto
8151	10 Liter	(Pal. 60) 1	64.60	netto

Dr. Schnell | Sanitärreinigung

Sanitärraum- / Nasszellenreinigung



Milizid Citro

Sanitärreiniger und Kalklöser



Artikel-Nr.	Produktinfo	Inhalt /VE	Preis /VE	
8124	1 Liter	(Pal. 40) 12	85.05	netto
8090	10 Liter	(Pal. 60) 1	64.60	netto



Milizid Cool Breeze

Sanitärreiniger und Kalklöser



Artikel-Nr.	Produktinfo	Inhalt /VE	Preis /VE	
8123	1 Liter	(Pal. 40) 12	85.05	netto
8126	10 Liter	(Pal. 60) 1	64.60	netto



Milizid Kartusche

12 ml Kartuschen



Artikel-Nr.	Inhalt /VE	Preis /VE	
8136	(Pal. 120) 100	225.75	netto



Milizid Kraftgel

Saurer Sanitärreiniger



Artikel-Nr.	Produktinfo	Inhalt /VE	Preis /VE	
16964	1 Liter	(Pal. 40) 12	137.90	netto
16982	10 Liter	(Pal. 60) 1	104.55	netto

Reinigungsmilch



Milor

milde Reinigungsmilch, flüssig

Artikel-Nr.	Produktinfo	Inhalt /VE	Preis /VE	
8149	500 ml	(Pal. 40) 20	93.15	netto

Dr. Schnell | Oberflächenreinigung

Oberflächenreinigung



Forol Fruit Konzentrat

Universalreiniger



Artikel-Nr.	Produktinfo	Inhalt /VE	Preis /VE	
4498	1 Liter	(Pal. 40) 12	75.50	netto



Forol Konzentrat

Universalreiniger



Artikel-Nr.	Produktinfo	Inhalt /VE	Preis /VE	
8155	1 Liter	(Pal. 40) 12	74.40	netto
8075	10 Liter	(Pal. 60) 1	54.15	netto



Lemon

Duft-Neutralreiniger, parfümiert

Artikel-Nr.	Produktinfo	Inhalt /VE	Preis /VE	
8161	1 Liter	(Pal. 40) 12	63.50	netto
8170	10 Liter	(Pal. 60) 1	45.90	netto

Professionelle Reinigungsprodukte für die Gebäudereinigung, Küchen- und Textilhygiene



Massgeschneiderte Hygienelösungen
und exzellenter Service:
www.dr-schnell.com

Wir leben Hygiene

DR.SCHNELL

QUALITÄT UND SERVICE

Dr. Schnell | Oberflächenreinigung

Oberflächenreinigung



Mistral

Glanzreiniger

Artikel-Nr.	Produktinfo	Inhalt /VE	Preis /VE	
8139	10 Liter	(Pal. 60) 1	44.25	netto

Fenster-, Glas-, Spiegelreinigung



Glasfee

Glasreiniger



Artikel-Nr.	Produktinfo	Inhalt /VE	Preis /VE	
8147	500 ml, mit Sprüher	(Pal. 40) 20	93.55	netto
8219	1 Liter	(Pal. 40) 12	54.80	netto
8134	10 Liter	(Pal. 60) 1	40.90	netto



Glasan

Grossflächen-Glasreiniger, alkalisch

Artikel-Nr.	Produktinfo	Inhalt /VE	Preis /VE	
8096	1 Liter	(Pal. 40) 12	82.85	netto

Schreibtischreinigung - Graffiti in Innenräumen



Novo Pen-Off

Schreibtischplattenreiniger

Artikel-Nr.	Produktinfo	Inhalt /VE	Preis /VE	
8119	500 ml	(Pal. 136) 6	52.10	netto

Flächendesinfektion für Grossküchen



Desifor Forte AF

Reinigungs- und Desinfektionsmittel für Oberflächen



Artikel-Nr.	Produktinfo	Inhalt /VE	Preis /VE	
25349	10 Liter	(Pal. 60) 1	233.65	netto



Desifor Quick Plus

Schnell-Desinfektion



Artikel-Nr.	Produktinfo	Inhalt /VE	Preis /VE	
4467	1 Liter	(Pal. 192) 2	45.50	netto

Dr. Schnell | Floor

Wischpflegen



Floortop

Hochleistungswischpflege



Artikel-Nr.	Produktinfo	Inhalt /VE	Preis /VE	
8091	1 Liter	(Pal. 40) 12	144.20	netto
8058	10 Liter	(Pal. 60) 1	115.15	netto

Dr. Schnell | Floor

Grundreiniger



Forex

Intensivreiniger für Feinsteinzeug



Artikel-Nr.	Produktinfo	Inhalt /VE	Preis /VE	
8099	10 Liter	(Pal. 60) 1	173.95	netto



Tempoforte

Universal Grundreiniger

Artikel-Nr.	Produktinfo	Inhalt /VE	Preis /VE	
17936	10 Liter	(Pal. 60) 1	98.50	netto

Textile Bodenbeläge / Polster



Rapido Kaugummi-Ex

Kaugummi-Vereisungsspray

Artikel-Nr.	Produktinfo	Inhalt /VE	Preis /VE	
8195	500 ml	(Pal. 840) 1	14.10	netto



Vacu-Fresh

Duftgranulat für Staubsauger, 9 x 6 cm

Artikel-Nr.	Produktinfo	Inhalt /VE	Preis /VE	
8164	6 g	(Pal. 108) 10	24.70	netto

Dr. Schnell | Küche

Küchenhygiene



Gastro Pur

Öl- / Fettlöser



Artikel-Nr.	Produktinfo	Inhalt /VE	Preis /VE	
8127	1 Liter	(Pal. 40) 12	127.90	netto
8057	10 Liter	(Pal. 60) 1	101.30	netto



Hornit Handseife

10 Liter

Artikel-Nr.	Produktinfo	Inhalt /VE	Preis /VE	
8118	10 Liter	(Pal. 60) 1	69.90	netto



Perocid Konzentrat

Kalklöser für den Küchenbereich



Artikel-Nr.	Produktinfo	Inhalt /VE	Preis /VE	
8131	10 Liter	(Pal. 60) 1	68.60	netto

Handspülmittel



FOR

Handgeschirrspülmittel, pH-Wert 5.5



Artikel-Nr.	Produktinfo	Inhalt /VE	Preis /VE	
8223	1 Liter	(Pal. 40) 12	48.10	netto

Dr. Schnell | Küche

Handspülmittel



Grün & Mild

Handgeschirrspülmittel

HACCP

Artikel-Nr.	Produktinfo	Inhalt /VE	Preis /VE	
8221	1 Liter	(Pal. 40) 12	68.30	netto



Onemü 2000

Neutrales Universalreinigungs- und Spülmittel

HACCP

Artikel-Nr.	Produktinfo	Inhalt /VE	Preis /VE	
10060	1 Liter	(Pal. 40) 12	45.70	netto

Grill- und Ofenreiniger



Attila

Krustenbrecher mit Sprühpistole

HACCP

Artikel-Nr.	Produktinfo	Inhalt /VE	Preis /VE	
8145	1 Liter	(Pal. 192) 2	36.95	netto

Reiniger für Geschirrspülmaschinen



Perotex CF 3000

Phosphat- und chlorfreies Geschirrwaschmittel, für hohe Wasserhärten

HACCP

Artikel-Nr.	Produktinfo	Inhalt /VE	Preis /VE	
25350	25 kg	(Pal. 24) 1	278.85	netto



Perotex CF Evo14

Phosphat- und chlorfreies Geschirrwaschmittel, für mittlere Wasserhärten

HACCP

Artikel-Nr.	Produktinfo	Inhalt /VE	Preis /VE	
25814	25 kg	(Pal. 24) 1	261.65	netto



Perotex intensiv N

Chlorhaltiger Geschirreiniger für mittlere Wasserhärten

HACCP

Artikel-Nr.	Produktinfo	Inhalt /VE	Preis /VE	
25353	25 kg	(Pal. 24) 1	208.00	netto



Perotex Pur

Phosphat- und chlorfreies Geschirrwaschmittel, für gewerbliche Spülmaschinen, nur für sehr weiches Wasser

HACCP

Artikel-Nr.	Produktinfo	Inhalt /VE	Preis /VE	
25606	30 kg	(Pal. 24) 1	218.65	netto



Perotex Ultra

Reiniger mit Ultra-Power-Formulierung für gewerbliche Spülmaschinen

HACCP

Artikel-Nr.	Produktinfo	Inhalt /VE	Preis /VE	
25346	3 kg	(Pal. 24) 4	206.95	netto

Dr. Schnell | Küche

Klarspüler für Geschirrspülmaschinen



Mafor S

Klarspüler für Spülmaschinen, sauer



Artikel-Nr.	Produktinfo	Inhalt /VE	Preis /VE	
8059	10 kg	(Pal. 60) 1	100.25	netto
25348	20 kg	(Pal. 24) 1	191.70	netto



Mafor N

Klarspüler für Spülmaschinen



Artikel-Nr.	Produktinfo	Inhalt /VE	Preis /VE	
8130	10 kg	(Pal. 60) 1	93.05	netto
8128	20 kg	(Pal. 24) 1	186.05	netto

Dr. Schnell | Wäscherei



Dr. Schnell's Vollwaschmittel

Umweltschonendes Markenwaschmittel

Artikel-Nr.	Produktinfo	Inhalt /VE	Preis /VE	
8121	6.5 kg	(Pal. 92) 1	31.90	netto
8176	20 kg	(Pal. 33) 1	81.50	netto



Prima 40

Bunt- und Feinwaschmittel zur schonenden Reinigung empfindlicher Textilien



Artikel-Nr.	Produktinfo	Inhalt /VE	Preis /VE	
24863	20 kg	(Pal. 24) 1	243.10	netto



Prima Extent

Phosphatfreier Waschkraftverstärker

Artikel-Nr.	Produktinfo	Inhalt /VE	Preis /VE	
24846	25 kg	(Pal. 24) 1	275.05	netto



Prima Hygiene

Alleinwaschmittel für Weiss- und Buntwäsche



Artikel-Nr.	Produktinfo	Inhalt /VE	Preis /VE	
24864	20 kg	(Pal. 24) 1	192.35	netto



Prima Oxy

Flüssiges Bleich- und Desinfektionsmittelkonzentrat



Artikel-Nr.	Produktinfo	Inhalt /VE	Preis /VE	
16125	20 kg	(Pal. 24) 1	152.85	netto

Biozide vorsichtig verwenden. Vor Gebrauch stets Etikett und Produktinformationen lesen.



Prima Tex

Spezialwaschmittel für Reinigungstextilien

Artikel-Nr.	Produktinfo	Inhalt /VE	Preis /VE	
23253	20 kg	(Pal. 24) 1	245.15	netto



Rapa Plus

Phosphatfreies, desinfizierendes Pulvervollwaschmittel



Artikel-Nr.	Produktinfo	Inhalt /VE	Preis /VE	
8148	20 kg	(Pal. 32) 1	171.35	netto

Dr. Schnell | Health Care

Hautreinigung / Hautpflege / Hautschutz



CimoMed Waschgel Sensitive

Hautreinigung parfüm- und farbstofffrei

HACCP

Artikel-Nr.	Produktinfo	Inhalt /VE	Preis /VE	
8133	1 Liter	(Pal. 56) 6	82.15	netto

Dr. Schnell | Diverses

Öl- / Fettlöser, Industriereiniger



Tear Öl- und Liquid-Absorber

Artikel-Nr.	Produktinfo	Inhalt /VE	Preis /VE	
9918	20 kg	(Pal. 36) 1	61.40	netto



Super Pur

Industrie- und Werkstattreiniger

Artikel-Nr.	Produktinfo	Inhalt /VE	Preis /VE	
8153	10 Liter	(Pal. 60) 1	96.80	netto



Prima Degrease

Flüssiger phosphatfreier Fettlöser

Artikel-Nr.	Produktinfo	Inhalt /VE	Preis /VE	
24865	20 kg	(Pal. 24) 1	407.05	netto

Raumbeduftung



Duftspray Citrus

Ohne Treibgas

Artikel-Nr.	Produktinfo	Inhalt /VE	Preis /VE	
8226	500 ml	(Pal. 136) 6	76.20	netto



Fresh Orange

Duft-Spritzöl

Artikel-Nr.	Produktinfo	Inhalt /VE	Preis /VE	
9915	500 ml	6	74.95	netto

Dr. Schnell | Dosiergeräte und Zubehör



Auslaufhahn

Für 10 Liter-Bidon

Artikel-Nr.	Inhalt /VE	Preis /VE	
8229	1	12.15	netto



Dr. Schnell Kleindosierer

Für 1 Literflaschen

Artikel-Nr.	Inhalt /VE	Preis /VE	
8199	1	2.00	netto

Dr. Schnell | Dosiergeräte und Zubehör



Handsprüher

600 ml

Artikel-Nr.	Produktinfo	Inhalt /VE	Preis /VE	
8242	weiss, ohne Logo	(Pal. 32) 1	6.95	netto
8172	blau, für Forol 1%	(Pal. 384) 1	7.75	netto
8276	rot, für Milizid	(Pal. 384) 1	7.75	netto

Diverse Produzenten | Gebäudereinigung

Sanitärreiniger



Durgol forte

Starkes Entkalkungsmittel zur Entfernung besonders starker Kalkablagerungen und Ausblühungen v.a. im Sanitär- und Baubereich.

Artikel-Nr.	Produktinfo	Inhalt /VE	Preis /VE	
14285	10 Liter	(Pal. 60) 1	78.60	netto



Javel-Wasser Classic

Bleich-, Reinigungs- und Desinfektionsmittel.

Artikel-Nr.	Produktinfo	Inhalt /VE	Preis /VE	ab 5 VE 10%
27515	2000 ml	(Pal. 45) 8	22.90	20.60



SANET IVECID

Sanitär-Duftreiniger

Artikel-Nr.	Produktinfo	Inhalt /VE	Preis /VE	
10180	1 Liter	(Pal. 56) 10	85.35	netto



WC-Liquid

Flüssigreiniger

Artikel-Nr.	Produktinfo	Inhalt /VE	Preis /VE	
10138	750 ml	10	85.30	netto



WC Power Schaum

Kalkentferner und Sanitärreiniger

Artikel-Nr.	Produktinfo	Inhalt /VE	Preis /VE	
26602	2.5 kg	(Pal. 80) 1	39.90	netto

Oberflächenreiniger



Glass Cleaner

Glas- und Spiegelreiniger

Artikel-Nr.	Produktinfo	Inhalt /VE	Preis /VE	
23777	750 ml	(Pal. 48) 10	67.90	netto

Desinfektionsreiniger



Desinfektionstuch

für Hände und Oberflächen

Artikel-Nr.	Produktinfo	Inhalt /VE	Preis /VE	ab 5 VE 10%
14500	60 x 80 mm	(Pal. 56) 1000	147.50	132.75

Diverse Produzenten | Gebäudereinigung

Diverses



Streusalz

gegen Schnee- und Eisglätte

Artikel-Nr.	Produktinfo	Inhalt /VE	Preis /VE	
14813	25 kg	(Pal. 32) 1	26.65	netto



bacteriaStop sb3 surface

Streugranulat zur hygienischen und schnellen Aufnahme von Erbrochenem und anderen Flüssigkeiten

Artikel-Nr.	Produktinfo	Inhalt /VE	Preis /VE	
26567	1 Liter	1	29.90	netto



bacteriaStop xs3 special

Schimmelpilz-, Algen- und Moosentferner, Flasche mit Sprühkopf

Artikel-Nr.	Produktinfo	Inhalt /VE	Preis /VE	
24579	750 ml	1	35.90	netto

Diverse Produzenten | Küchenhygiene

Entkalker



CERAGOL Ultra Profi

Schnellentkalker

Artikel-Nr.	Produktinfo	Inhalt /VE	Preis /VE	
10283	1 Liter	(Pal. 44) 10	48.50	netto



Durgol express

Entkalker

Artikel-Nr.	Produktinfo	Inhalt /VE	Preis /VE	
11958	10 Liter	(Pal. 40) 1	75.60	netto
16520	1 Liter	(Pal. 60) 10	86.00	netto



Durgol cuisine

Küchenreiniger-Schaum, hochwirksam gegen Kalk und Fett

Artikel-Nr.	Produktinfo	Inhalt /VE	Preis /VE	
12998	600 ml	6	42.00	netto

Diverse Produzenten | Geschirr-Reinigung

Spezialprodukte



Regeneriersalz Reosal fein

Artikel-Nr.	Produktinfo	Inhalt /VE	Preis /VE	
10284	1 kg	(Pal. 80) 10	23.60	netto
17129	25 kg	(Pal. 32) 1	28.85	netto

Diverse Produzenten | Insektizid



bacteriaStop ia2

Insektizid - Ameisenpulver, in & outdoor

Artikel-Nr.	Produktinfo	Inhalt /VE	Preis /VE	
24586	250 g	1	19.90	netto

Biozide vorsichtig verwenden. Vor Gebrauch stets Etikett und Produktinformationen lesen.

Diverse Produzenten | Insektizid

**bacteriaStop ik2**

Insektizid - Insekten Spray, in & outdoor

Artikel-Nr.	Produktinfo	Inhalt /VE	Preis /VE	
24587	400 ml	1	26.50	netto

Biozide vorsichtig verwenden. Vor Gebrauch stets Etikett und Produktinformationen lesen.

Werbeartikel



Ideen,
die einfach
immer
zünden

BLEIBENDER
EINDRUCK
LASTING IMPRESSION

BY *Mank*[®]





„Individualität und Vielfalt als Schlüssel zum Erfolg“ Linclass®
 „Individuality and diversity is the key to success...“ by Mank®





Flying Flags

Grösse 2 bis 5 Meter
Mindestbestellmenge: 1 Stk.



Schlüsselanhänger

Mindestbestellmenge: 500 Stk.



Microfaser-Brillenputztücher

Mindestbestellmenge: 500 Stk.



Rucksack-Beutel

Mindestbestellmenge: 200 Stk.



Bonbon-Dosen

Mindestbestellmenge: 500 Stk.



Pizzamesser

Mindestbestellmenge: 250 Stk.



Splash Icon

Mindestbestellmenge: 100 Stk.



Regenschirme · Stockschirme
Taschenschirme · Golfschirme

Mindestbestellmenge: 48 Stk.



T-Shirts · Poloshirts · Jacken · Hoodies
Flecejacken von Hakro und
über 40 weiteren Top Labels

Mindestbestellmenge: 10 Stk.



Einkauf Chip

Mindestbestellmenge: 250 Stk.



Lanyards

Mindestbestellmenge: 100 Stk.



Baumwoll- und
Non Woven-Taschen

Mindestbestellmenge: 250 Stk.

Baseball Caps · Trucker Caps · Beanies · Mützen

Mindestbestellmenge: 100 Stk.



Trias – Charakterdarsteller mit Ecken und Kanten

42654 **Trias** express

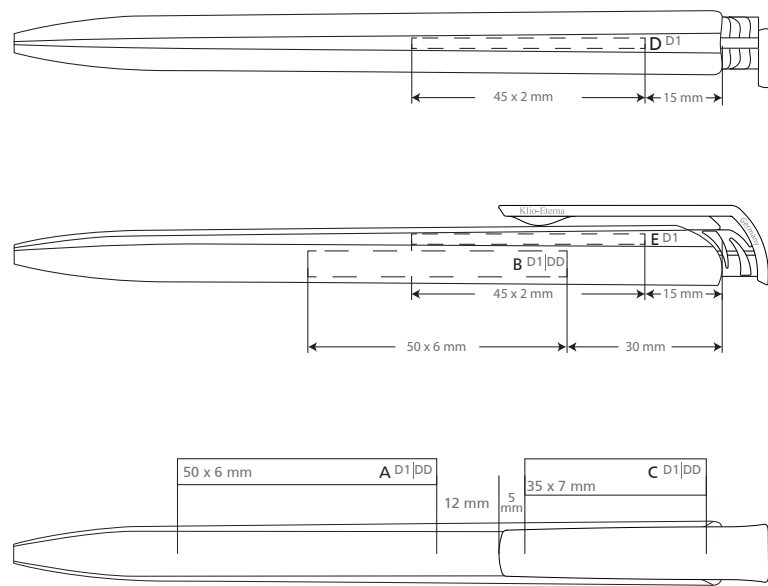

- Druckkugelschreiber in außergewöhnlichem 6-Kant-Design
- „Made in Germany“
- Besonders schnelle Lieferzeit
- Sensationelle 7 Druckflächen
- In 6 Farbkombinationen erhältlich
- Hochwertige Silktech-Mine:
Standard: S = 2000 m, Schriftfarbe Blau
- Mindestbestellmenge: 500 Stück
- Preise und weitere Modelle auf Anfrage

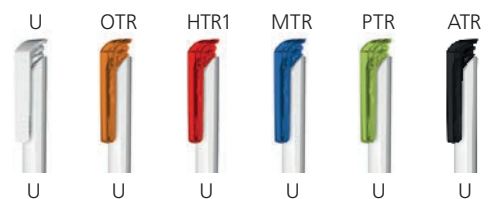

Jona – Verwandlungskünstler mit Stil

41125 **Jona** high gloss Mn



- Druckkugelschreiber in modernem Design
- „Made in Germany“
- Freigestaltbarer Sonderklipp auf Anfrage
- Große Werbeflächen
- Umfangreiche Standardfarbpalette und Sonderfarboptionen (ab 5.000 Stück)
- Mindestbestellmenge: 500 Stück
- Preise und weitere Modelle auf Anfrage

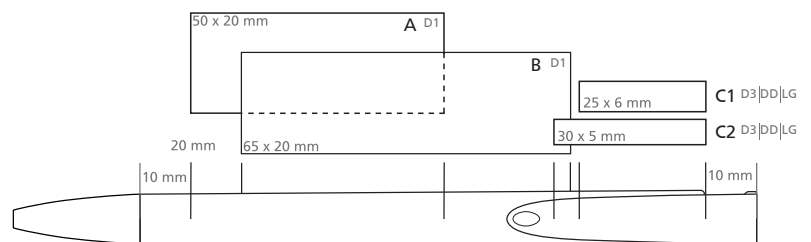



Unsere Qualität

Nur ein erstklassiges Produkt kann einen erstklassigen Eindruck bei Ihrer Zielgruppe hinterlassen. Das ist uns bewusst, das nehmen wir sehr ernst. Daher verarbeiten wir nur ausgewählte umweltfreundliche Rohstoffe. Unsere Produkte durchlaufen zahlreiche Qualitätsprüfungen innerhalb des Produktionsprozesses. Unabhängige Complianceprüfungen, Öko- und Prüfsiegel wie EN 1783, FSC, ISO 9001, ISO 9994 und GS sorgen dafür, dass Sie ein sicheres, umweltbewusstes und zuverlässiges Produkt erhalten, das es verdient Ihre Markenbotschaft zu transportieren.



Langhölzer 22C

110 x 64 x 14,5 mm, ca. 35 Hölzer



Kaminhölzer Drum M / L

Drum M 113 x Ø 39,8 mm, ca. 45 Hölzer
 Drum L 215 x Ø 51,5 mm, ca. 68 Hölzer



Bestseller:



5L, 53 x 36 x 9 mm
 ca. 24 Hölzer



BMS20, 39,5 mm x 50 x 8 mm
 20 Hölzer

BX1, 56 x 24 x 7 mm
 ca. 11 Hölzer



Cricket Feuerzeuge



A	
Abdeckhauben für Trolleys	87
Abfallbehälter	40–41, 116, 119, 210, 213, 234–238
Abfallkörbe	40–41, 116, 119, 210, 213, 234–238
Abfallsäcke	224–231, 239
Ablaufreiniger	289
Abwaschbürsten	288, 300
Abwaschmittel	310–315, 342–343, 350, 353–354, 365–366, 371, 381
ADA Hotelkosmetik	92–114
Airlaid Servietten	13–17
Allzweckbeutel	233
Allzweckreiniger	316, 319–320, 339, 344–345, 354, 359, 363–364, 370–371, 374, 377, 381
Aluminiumfolie	80–81
Alustiele	294, 296, 299, 305
Antiseptika	324
Aschenbecher / Ascher	42, 66, 240
Aschenbecher-Pinsel	292
Aufhängeschiene für Besen	293
Ausgushahn	331, 342
Automatenreiniger	318, 354, 375
B	
Babystuhl	37
Backpapier	78–79
Badematten	116
Badesalz	106
Badeschuhe	115
Badewannenbürste	293
Bar	51–54
Batterien	129–130
Be Different	101–102
Becher	59–63, 65, 115
Besen	281–284, 296, 298–299
Bestecktaschen	24–25, 37
Beutel	
Allzweck	233
Brot	85–86
Cello	85
Einlagebeutel	41, 231–234
Eiswürfel	85
Frischwäschebeutel	119, 307
Gefrier- / Frischhalte- / Koch-	84–85
Harrassen	87
Hygiene	208–209, 230
Hygienebeutel	208–209
Knotenbeutel	233, 234
Kreuzbogenbeutel	85
Papierbeutel	85–86
Pergamin	86
Polybeutel	130–131
Sandwichbeutel	87
Seitenfaltbeutel	85–86
Vakumbeutel	84
Verbandwagenbeutel	230
Wäschebeutel	92, 111, 119, 306–307
Bleichmittel	311, 325–329, 346–347, 351, 355–357, 367–369, 382
Bodenlappen	281
Bodenreiniger	323, 335–336, 338–339, 344, 359, 360–365, 370, 375
Bodenwischer	282, 287
Bodenwischpflege	318, 336, 374, 379
Bodylotion	90, 98–99, 103
Bonblöcke	48
Bonbons	36–37
Brabantia	
Abfallbehälter	236–238
Kehrichtsäcke	239
WC-Garnitur	206
Brenner	47
Brennflüssigkeit	46–47
Brennpaste	46–47
Brennpastenzubehör	47
Brotbeutel	85–86
Budelle	63
Bulkysoft	
Abfallbehälter	235
Falthandtücher	163–165
Flüssigseife	188
Kosmetiktücher	121–122
Lufterfrischer	217
Rollenhandtücher	179–180
Schaumseife	197
Spenderservietten	18, 20
Tischtuchrollen	28
Toilettenpapier	137–138, 144, 151
Wischtücher	263–265
Zellstoff-Servietten	8–13
Buntmetall-Reiniger	322
Buntwaschmittel	325–326, 346, 355–356, 367–369, 382
Bürsten	
Abwaschbürsten	288, 300
Fegbürsten	288–289
Grill	292
Haar-	111
Reinigungszubehör	284, 288–289, 292–294, 297–298, 300, 304
WC-	206–208
Zahn-	91, 115
Buzil	371–376
C	
Cello-Beutel	85
Cello-Folien	83
Chicopee-Reinigungstücher	265–266
Chromstahlpflege	316, 345, 354–355, 363, 369
Classic Hotelkosmetik	99–100
Clax Textilpflege	346–348
Clean & Clever	171, 190, 274–275, 310
Cocktail-Schirmchen	54
Cocktail-Sticks	53–54
Cocktail-Stirrer	53
Conditioner	93, 97–98, 102, 106, 108
Containersäcke	230–231
Corso Vollwaschmittel	311
Cosi-Spender	124, 184
Coupefiguren	53–54
Couponblöcke	48
D	
Dachsteller	117
Dauerfrischpapier	78
Dekanter	63–64
DermaCare	100–101
Desinfektion	
Hände	185, 198–205, 324, 330–331, 348, 359, 384
Oberflächen	204, 379, 384
Waschmittel	328
Desinfektionsreiniger	323, 338, 342, 345, 384
Desinfektionsspender	193, 199–202, 205, 211
Detachiermittel	348
Diplomatkapseln	68–69
Dispo Servietten	17–19
Diversey	219, 305, 331–351

Dosiergeräte / -hilfen	348, 361, 376, 383–384
Dr. Schnell	376–384
Dressiersäcke	74
Druckausschuss	131
Duftspender	214–222
Duftspray	215–222, 322, 337, 340, 361
Duni	7–8, 13, 15, 19, 21–28, 40
Dunilin-Servietten	13
Duschgel	90, 122, 196, 349
Duschhaube	91, 95, 98, 106, 108–110, 112

E

Eco-Clin	311
Ecobrite	328–329
Ecolab	287, 305, 311–331
Edelstahlpflege	316–317
Eierlöffel	41
Eierwärmer	35
Eimer	293–295, 304
Eimereinlagen	41, 231–234
Einlagebeutel	41, 231–234
Einmachglas	65
Einweghandschuhe	
Latex	71
Nitril	70
Polyethylen	72
Vinyl	72
Eiswürfelbeutel	85
Entfetter	316–317, 323, 328–329, 335–336, 344, 346, 350–351, 354–355, 357–359, 361, 363–365, 367–368, 375–376, 380, 383, 385
Entkalkungsmittel	
Kaffeemaschinen	78, 355
Sanitär	316, 350, 360, 373, 384
Esslätz	40

F

Falthandtücher	154–157, 159–173
Fegbürsten	288–289
Feinwaschmittel	327, 347, 351, 382
Fensterreinigungsgeräte	294
Fensterschaber	300–304
Feuchtes Toilettenpapier	154
Feuchtservietten	41
Filtertüten	77
Fingerfood-Spiesse	76
Flächendesinfektion	204, 324–325, 379
Flaschen leer	124, 184, 320, 322–323, 333, 344, 348
Flaschenöffner	92
Flaschenputzer	289–290
Flaschenrosetten	37
Fleckenentferner für Textilien	329, 348, 358–359
Fleischwickler-Rollen	78
Floorpads	280
Floraluxe	107
Flüssigseife	123, 183–190
Flüssigseifenspender	123–124, 184, 186–189, 191
Flütes	58–59
Föhn	116
Folien	
Cello	83
Frischhaltefolie	81–83
Handstretch	131
Folienrollenspender	82–83
Fondue-Brenner	47
Frischhaltebeutel	84–85

Frischhaltefolie	81–83
Frischpapier	78
Frischwäschebeutel	119, 307
Fusselrolle	307–308
Fusspilzprophylaxe	324

G

Gästepräzente	36–37
Gebäudereinigung	
Allgemein	331–342, 359–361, 384–385
Desinfektionsreiniger	323, 338, 342, 345, 384
Grundreinigung	318, 333, 337, 339–340, 371, 373–374, 376, 380
Gebrauchsflaschen leer	124, 184, 320, 322–323, 333, 344, 348
Geburtstagskerzen	44–45
Geflügelmanschetten	74
Gefrierbeutel	85
Geruchsneutralisator	215–222, 322, 337, 340, 361
Geschirreinigung	
Glanz	310–311, 314, 343–344, 350, 353, 365–366
Salz	77, 350, 385
Waschmittel	310–315, 342–343, 350, 353–354, 365–366, 371, 381
Geschirrtücher	49, 74
Geschirrwashmittel	310–315, 342–343, 350, 353–354, 365–366, 371, 381
Glanzreiniger	310–311, 314, 343–344, 350, 353, 365–366
Glanztrocknungsmittel	310–311, 314, 343–344, 350, 353, 365–366
Gläser	56–66
Gläserdeckel	41
Gläserunterlagen	34–35
Glasfaserstiele	284, 299
Glasreinigung	300–304, 319–320, 322, 338, 341, 373, 379
Glasschaber	300–304
Gojo	188, 190, 194–196
Good Sense	219, 335, 340
Graffiti-Entferner	379
GREEN	108–109
Green Culture	103–105
Greifer	305
Grillbürsten	292
Grillreiniger	317, 323, 345
Grundreiniger	318, 333, 337, 339–340, 371, 373–374, 376, 380
Gutscheine	48

H

Haarbürsten	111
Haartrockner	116
Hagleitner	
Falthandtuchspender	165
Händedesinfektion	205–206
Luffterfrischer	217–218
Rollenhandtücher	180–181
Schaumseife	198
Toilettenpapier	151–152
Hähne	124, 184, 331, 342, 376, 383
Halterungen press+wash	113
Handabwaschmittel	316, 323, 343–344, 351, 354, 363, 376, 380
Handcreme /-lotion	96, 99, 185, 190, 330
Händedesinfektion	185, 198–205, 324, 330–331, 348, 359, 384
Handgeschirrspülmittel	316, 323, 343–344, 351, 354, 363, 376, 380
Handschuhe	
Latex	71
Nitril	70
Polyethylen	72
Reinigungshandschuhe	69–72, 304
Schuhputz-Handschuhe	92, 112

Service-Handschuhe	48	Waschraumhygiene	135–137, 143–144, 150, 159–163, 175–179, 187–188, 192–194, 204–205, 212, 214–215
Vinyl	72	Wisch- / Reinigungstücher	242, 255–263
Handstretchfolie	131	Kindermalsets	37, 103
Handtuchrollen	174–183	Klarspüler	310–311, 314, 343–344, 350, 353, 365–366
Handtuchspender	157–158, 162–163, 165, 167–168, 173, 175, 178–183	Klebeband	131
Handwischer	286–287	Kleenex	
Harassenbeutel	87	Flüssigseife	187
Haushaltrollen	242–243	Handtücher	160–163
Heissgetränke-Gläser	62–63	Händedesinfektion	204
Hochstuhl	37	Kosmetiktücher	120–121
Holzbodenreinigung /-pflege	374	Rollenhandtücher	178
Holzspiesse	53, 75–76	Schaumseife	193
Holzstiele	282	Taschentücher	122
Hosenspanner	118	Toilettenpapier	135–137, 143, 150
Hot & Safe	47	Kleiderbügel	118
Hotelkosmetik & Accessoires	91–114	Knotenbeutel	233, 234
Hydro Basics	96–99	Kochbeutel	84–85
Hygienebeutel	208–209, 230	Kochmützen	72–73
Hygienebeutelspender	209–211	Kochschürzen	73
I			
Informationstafeln	126	Kofferständer	119
J			
Jungle Kids	103	Kopierpapier	128–129
K			
Kaffee-Filter	77	Körbchen	116–117
Kaffeegläser	62	Körperhygiene /-pflege	348–349, 371
Kaffeemaschinenreiniger	77–78, 354–355	Kosmetiktaschen	116–117
Kalkentferner	78, 316, 333, 339, 344, 350, 355, 360, 363, 373, 384–385	Kosmetiktücher	119–122
Kamm	91, 109, 111	Kosmetiktuchspender	121–122
Kannenhalter	35	Kreidetafeln	126–127
Karaffen	63–64	Kreuzbodenbeutel	85
Kartenhalter	39	Kristallgläser	56
Kassa-Block	48	Krüge	63–64
Kassenrollen	50	Küche / Buffet	67–88
Katrin		Küchenhygiene	316–318, 342–345, 351–355, 380–382, 385
Duschgel	122–123	Küchenpapier	242–243
Falthandtücher	165–167	Küchenrolle	242–243
Flüssigseife	189	Küchenschnüre	73
Rollenhandtücher	181–182	Küchentücher	49, 74
Schaumseife	197	Kugelschreiber	92, 129
Toilettenpapier	152	Kulturbeutel	116–117
Toilettensitzreiniger	212	Kupferlappen	280–281
Kaugummientferner	338, 376, 380	L	
Kehrgarnitur	285–287	Labortücher	262
Kehricht	223–240	Lampenöl	46
Kehrichtsäcke	224–231, 239	Lappen	
Kehrschaufel	285–287	Bodenlappen	281
Kerzen		Kupfer	280–281
Geburtstagskerzen	44–45	Putzlappen	267–271
LED	45	Latz	40, 73
Partylichter	44	Lavette	245–266
Rechaudkerzen	44	Lebensmitteltücher	75, 247
Spitzkerzen	42	LED Writing Board	126
Stabkerzen	45	LED-Kerzen	45
Stumpenkerzen	42–43	Leitsysteme	127
Kerzenhalter	44–45	Linoleumbodenreiniger	337, 371,
Kerzenmanschette	46, 74	Longdrinkbecher	59–60, 62
Kerzenzubehör	46	Lufterfrischer	215–222, 322, 337, 340, 361
Kimberly-Clark		Luftpolsterfolie	59–60, 62
Hotelkosmetik & Accessoires	120–122	M	
Kehricht	235, 238	Magic Clin	310
		Magic Rins	310
		Malhefte	37, 103
		Malstifte	37, 103
		Mank	13, 15, 23, 25–26, 28, 31, 40
		Manschetten	

Fleisch	74
Geflügel	74
Kerzenmanschetten	46, 74
manuelle Abwaschmittel	316, 323, 343–344, 351, 354, 363, 376, 380
Markenprodukte	
Reinigungschemie	349–351
Marmorreinigung /-pflege	374
Maschinen	297–306
Massageschwamm	95
Massflasche	63
Mechanikertuch	269–271
Meldescheingarnitur	129
Menükartenhalter	39
Menürahmen	126–127
Menüständer	126–127
Messer	
elektrisch für Tischtuchrolle	29
Metallreiniger	322, 355
Metallstiele	285
Microfasertücher	274–276,
Möbelreinigung	320, 338, 341, 374
Mop + Mophalter	284, 295–296
Müllsäcke	224–231, 239
Mundpflegesets	95, 97, 109–113
Mützen	72–73

N

Nagelfeilen	91, 98, 106, 108–112
Nähetui	91, 95, 98, 106, 108–112
Napperons	30
Nasswischtücher	274–276
Naturals	105–106
Necessaire	116–117
Neutralisationsmittel	322, 329, 348, 368
Numatic	306

O

Oasis Pro	322–324
Oberflächendesinfektion	204, 379, 384
Ofenreiniger	317, 355, 363, 376, 381

P

Packpapier	131
Packschnur	131
Packseidenpapier	131
Pad-Schwämme	277–278
Padhalter	297, 302
Pads	110, 278–280, 300
Palettenbeutel	234
Pantoffeln	103, 114–115
Papierbeutel	85–86
Papierkörbe	40–41, 116, 119, 210, 213, 234–238
Papiertaschentücher	122
Parkettreiniger /-pflege	374
Partylichter	44
Passiertuch	77
Patisseriekapselfen	68–69
PeakServe	157–158
Pergamentersatz	68, 78
Pergamin	68, 78, 86–87
Pergaminbeutel	86
Pfeffermühle	36
Pflanzenseife	94, 97, 105–106
Pflaster	88
Pinsel	77, 292
Aschenbecherpinsel	292

Pissoir-Sieb	212
Pissoir-Steine	212–213
Plakathalter	213
Plattenpapier	31–32
Pocket Napkins	24–25, 37
Poliertücher	253, 262
Polybeutel	130–131
Portemonnaies	49
Pralinekapselfen	68
Pumpspender	96, 99, 108
Pure Herbs	92–96
Purell	199–204
Putzeimer	293–295, 304
Putzfäden	271–272
Putzklappen	267–271
Putztuchrollen	263–265

R

Randreinigungsgerät	206–208
Rasant	305
Rasiersets	91, 95, 97, 109–113
Raumdüfte	
Duftspender	214–222
Duftspray	215–222, 322, 337, 340, 361
Geruchsneutralisator	215–222, 322, 337, 340, 361
Good Sense	219, 340
Lufterfrischer	215–222, 322, 337, 340, 361
Reagenzputzer	290–291
Receptions-glocke	128
Rechaud für Fondue	47
Rechaudkerzen	44
Rechaudzubehör	46–47
Regeneriersalz	77, 350, 385
Reiniger	
Boden	323, 335–336, 338–339, 344, 359, 360–365, 370, 375
Reinigung für Tiefkühlanlagen	318
Reinigungschemie	309–386
Reinigungsgeräte	297–306
Reinigungshandschuhe	69–72, 304
Reinigungsmaschinen	297–306
Reinigungsmilch	377
Reinigungsrollen	263–265
Reinigungstücher	241–272
Chicopee	265–266
Lavette	245–266
Reinigungswagen	296–297
Reinigungszubehör	273–308
Reisbesen	281
Rezeptions-glocke	128
Rohrbürste	297–298, 304
Rohrreiniger	334
Rollenhalter für Haushaltrollen	243
Rollenhandtücher	174–183
Rondellen für Buttertöpfe	40
RoomCar	340–341

S

Säcke	
Wäschesäcke	92, 111, 119, 306–307
SafePack	342–343
Salzmühle	36
Sandwichbeutel	87
Sanitärreiniger	310, 320–323, 331–334, 341, 350, 360, 376–377, 384
Schaber	288, 300, 303
Glasreinigung	300–304
Schaumseife	191–193, 195–198

Schaumseifenspender	191–194, 197–199	Sprühkopf	325, 331, 361
Scheuermilch	377	Stabkerzen	45
Schiefertafeln	126–127	Stahlschwämme	280
Schilder „Bitte nicht stören“	115	Stahlwatte	280
Schimmelentferner	322	Stand-Aschenbecher	240
Schlüsselanhänger	128	Ständer	126
Schnüre		Starline	
Küchenschnüre	73	Hotelkosmetik & Accessoires	90–92
Pack	131	Reinigungszubehör	274
Schreibtischreiniger	379	Tabletop	4, 17, 21, 26, 36–37, 41, 53
Schuhlöffel	92, 111	Toilette / Hygiene	140–141, 183–184, 190, 208–209
Schuhpolitur	91–92	Wisch- & Reinigungstücher	243–245
Schuhputz-Handschuhe	92, 112	Staubbeutel /-säcke	306
Schuhputzschwamm	95, 98, 109, 111–112	Staubbiene	291
Schürzen		Staubsauger	305–306
Esslatz	40	Staubwedel	291, 303–304
Kochschürzen	73	Steinoberflächenpflege	337
Latz	40, 73	Stiele	
Service	73	Alu	294, 296, 299, 305
Schwämme	276–278, 280	Glasfaser	284, 299
Schwergut-Säcke	231	Holz	282
Seidenpapier	131	Metall	285
Seife		Teleskop	284
Flüssig	123, 183–190	Streichhölzer	92
pflanzlich	94, 97, 105–106	Stühle	37
Schaum	191–193, 195–198	Stumpenkerzen	42–43
Seifenlotion	90–91, 94, 97, 100–106, 122–123, 183–199, 359, 371, 380	Suma	342–345
Seifenspender	123–124, 191–199, 205, 331, 349	Süssigkeiten	36–37
Seifenspray	186		
Seitenfaltbeutel	85–86	T	
Service-Handschuhe	48	Tablett für Gästepräsentation	117
Serviceblock	47–48	Tafeln	126
Serviceblock-Halter	47	Taschentücher	122
Serviceschürzen	73	Taski	275, 331–339, 342
Servietücher	49, 74	Tassenunterlagen	34–35
Servietten	4–19	Tatzenbürste	393
Serviettenspender	19–21	Tauchreiniger	343, 354
Serviettentaschen	24–25, 37	Teebecher	62
Shampoo	90, 92–108, 122–124, 185, 187–188, 319, 349	Teebeutel	41
Silbergeschirr / -besteckpflege	315	Teebeutelshale	41
Slippers	103, 114–115	Tela	5, 17, 21, 26–27, 34, 120, 242
Snögg	88	Teleskopstiele	284
Soft Care	348–349	Tellerunterlagen	34
Speisekartenhalter	39	Teppichreinigung	361
Spender		Textilpflege	346–348, 351, 355–359
Desinfektion	193, 199–202, 205, 211	Clax	346–348
Duft	214–222	Tiefkühlanlagen-Reinigung	318
Flüssigseife	123–124, 184, 186–189, 191	Tiefkühlbeutel	85
Folienrollen	82–83	Tiefkühlreiniger	318
Handtuch	157–158, 162–163, 165, 167–168, 173, 175, 178–183	Tischabfallbehälter	40–41, 116, 119, 210, 213, 234–238
Haushaltrollen	243	Tischdeckpapier	30
Hygienebeutel	209–211	Tischglocke	128
Kosmetiktücher	121–122	Tischläufer	26
press+wash	113	Tischreiter	40
Pumpspender	96, 99, 108	Tischset	21–24, 37
Schaumseife	191–194, 197–199	Tischsteller	39
Toilettenpapier	135, 137, 142–144, 147–154	Tischtuchrollen	26–29
Wandhalterung	153, 199, 265	Toilettenpapier	134–154
Wisch- / Reinigungstücher	245, 253–256, 264	feucht	154
Spiegel für Badezimmer	116	Toilettenpapierspender	135, 137, 142–144, 147–154
Spiesse	76	Toilettenreiniger	321–323, 331–333, 340, 350, 360, 369–371, 374, 384
Spinnenwedel	291, 304	Toilettenstauauflage	214
Spirit	124	Toilettenstreifen	212
Spitzenpapier	32–33	Topfreiniger	278
Spitzkerzen	42	Tork	
Sprühflaschen leer	333–334, 338–339, 344, 348,	Hotelkosmetik & Accessoires	119–120, 122
		Kehricht	234–235, 238–239
		Küche / Buffet	75

PeakServe	157–158	WC-Garnitur	206–208
Tabletop	6, 12, 16–20, 25, 28	WC-Reiniger	321–323, 331–333, 340, 350, 360, 369–371, 374, 384
Waschraumhygiene	134–135, 142–150, 154–158, 174–175, 184–187, 191–192, 209–211, 213, 215	WC-Stein	212–213, 360
Wisch- und Reinigungstücher	242–255	Wedel	291, 304
Traiteurschnüre	73	Weichspüler	328–329, 347, 358, 367
Trennungskordeln	127	Weingläser	56–58
Treteimer	236–238	Weinkrüge	63–64
Trinkhalme	51–52	Weinkühler	41
Trockensauger	305–306	Weintropfenfänger	41
Tücher		Wellness-Slippers	115
Chicopee - Reinigungstücher	265–266	Whiskyglas	59–61
Falthandtücher	154–157, 159–173	WHITE	110–111
Kosmetiktücher	119–122	Wickeltisch	37, 214
Küchen- / Geschirrtücher	49, 74	Wisch- / Reinigungstücherspender	245, 253–256, 264
Labortücher	262	Wischer	
Lebensmittel	75, 247	Hand-	286–287
Microfasertücher	274–276	Wischpflege	319, 336, 374, 379
Nasswischtücher	274–276	Boden	318, 336, 374, 379
Poliertücher	253, 262	Wischtücher	241–272
Rollenhandtücher	174–183	Wollwaschmittel	356, 367, 369
Wisch- / und Reinigungstücher	241–272		
Wischtücher	243–250, 256–267, 274–276		
U			
Ueberlaufreiniger	289	Zahnbecher	115
Unger	300–305	Zahnbürsten	91, 115
Universalreiniger	316, 319–320, 339, 344–345, 254, 359, 363–364, 370–371, 374, 377, 381	Zahnglasbeutel	115
		Zahnstocher	36, 76
		Zitronennetzchen	41
		Zündhölzer	92
V			
Vac-Beutel	84		
Vakuumbbeutel	84		
Van Baerle	362–371		
Vasen	66		
Verbandwagenbeutel	230		
Vermop	287, 294–297, 307		
Vikan	297–300		
Vileda	69, 274–280, 285, 287		
Vollwaschmittel	311, 325–326, 328, 346, 351, 356, 382		
Vorreiniger für Geschirr	315		
W			
Waffeltuch	49, 281		
Warnschilder „Rutschgefahr“	287–288		
Wäschebeutel /-säcke	92, 111, 119, 306–307		
Wäscherei	306–308, 325–329, 382		
Wäschestärke	327		
Waschkraftverstärker	326, 328–329, 346, 357, 367–368, 382		
Waschlotion	183–191, 324, 330		
Waschmittel			
Bleichmittel	311, 325–329, 346–347, 351, 355–357, 367–369, 382		
Buntwaschmittel	325–326, 346, 355–356, 367–369, 382		
Desinfektionswaschmittel	328		
Feinwaschmittel	327, 347, 351, 382		
Fleckenentferner	329, 348, 358–359		
Vollwaschmittel	311, 325–326, 328, 346, 351, 356, 382		
Weichspüler	328–329, 347, 358, 367		
Wollwaschmittel	356, 367, 369		
Waschraumhygiene	53–62		
Wasserenthärter	328, 368		
Wasserkocher	119		
Wasserschieber	284, 298		
Wattestäbchen	91, 110		
WC-Besen	206–208		
WC-Bürste	206–208		

66.1	76	4240	84	4341	284	4751.3	50	4966	247	5145	40	5348	31	5512	76
600	42	4242	84	4341.1	284	4766	50	4967	248	5160	47	5349	31	5515	53
602	42	4244	84	4341.2	284	4772	247	4968.2	251	5161	47	5350	30	5517	53
801	69	4245	84	4341.3	284	4779	26	4970	168	5164	47	5355	32	5524.1	75
1601	54	4248	84	4341.4	284	4783	26	4973	172	5165	47	5355.1	32	5525	75
1602	54	4253	84	4342	284	4784	26	4976	170	5169	328	5356	32	5526	75
1603	54	4254	84	4346	288	4786	26	4978	251	5186	29	5356.1	32	5529	75
1618	54	4261.2	282	4350	48	4787	26	4979	249	5189	331	5357	32	5530	75
1950	29	4268	286	4353	48	4792	232	4982.1	249	5190	29	5358	32	5531	75
3742	181	4269	287	4368	207	4794	118	4983.2	251	5191	29	5359	32	5537	41
3747.1	45	4270	286	4386	5	4795	118	4985.1	249	5192	29	5359.1	32	5541	53
3752	76	4276	285	4419	277	4802	24	4986	249	5194	29	5360	32	5542	53
3774	98	4277	285	4420	277	4803	24	4987.1	156	5195	29	5361	32	5548	53
3778	142	4282	287	4464	322	4809.1	156	4988	155	5196	29	5362	32	5558	53
3797	96	4288	287	4467	379	4824	84	4989	154	5197	324	5363	32	5569	42
3798	96	4290	283	4490.1	35	4826.2	134	4990.2	252	5205	23	5364	32	5570	42
3799	113	4291	283	4492	35	4828	172	4991	245	5208	23	5365	32	5571	42
4030.2	4	4292	206	4493	35	4828.1	172	4992	242	5220	21	5367	303	5572	42
4031.2	4	4298	291	4496	330	4829	170	4993	249	5221	21	5370	34	5573	42
4032.2	4	4299	284	4497	330	4829.2	170	4994.2	251	5222	21	5370.1	34	5574	42
4034.2	4	4300	281	4498	377	4830	171	4995	243	5224	21	5374	301	5577	42
4035.2	4	4305	292	4500	77	4832	242	4996.2	251	5225	21	5377	32	5578	42
4037.2	4	4306	291	4501	74	4839	169	4997.1	156	5227	21	5380	32	5579	42
4043.1	4	4307	289	4503	49	4844	157	4998	169	5232	21	5381	32	5582	42
4050.2	4	4308	290	4504	74	4858.2	138	5001	5	5236	77	5382	32	5620	44
4051.2	4	4309	289	4504.1	74	4859	134	5002	5	5268	24	5383	32	5621	44
4052.2	4	4310	289	4504.2	74	4860.1	134	5003.1	5	5270	24	5384	32	5623	44
4054.2	4	4311	288	4507	49	4860.2	134	5005	16	5276	30	5385	32	5627	44
4055.2	4	4312	206	4508	49	4860.3	134	5006	16	5277	30	5386	32	5629	44
4057.2	4	4314	206	4510	73	4863	139	5008	12	5280	30	5387	32	5640	46
4062.2	4	4315	208	4514	73	4870.2	134	5019	15	5281	30	5388	32	5643	46
4070.2	4	4316	207	4520	49	4872	154	5020	12	5283	30	5389	32	5645	46
4071.2	4	4317	208	4526	296	4873	152	5021.1	6	5284	30	5390	32	5646	46
4072.2	4	4319	207	4528	303	4878	139	5025.1	6	5285	30	5392	32	5647	47
4074.2	4	4320	294	4535	85	4886	140	5030	5	5287	30	5394	32	5648	46
4075.2	4	4321	294	4536.1	85	4886.2	140	5031	5	5288	30	5395	32	5649	46
4077.2	4	4325	292	4537.1	85	4889	142	5032	5	5300	30	5403	32	5651.1	77
4082.2	4	4326	292	4548.1	86	4891	75	5034	5	5301	30	5404	32	5653.1	77
4117	289	4330	283	4549.1	86	4892	75	5035	5	5302	30	5412	206	5654	77
4123	292	4330.1	283	4551	86	4893	142	5037	5	5303	30	5420	33	5655	77
4144	281	4330.2	283	4552	86	4896.1	168	5042	5	5304	30	5422	33	5660	77
4149	282	4330.3	283	4588	140	4902	250	5047	26	5305	30	5424	33	5666	46
4151	281	4330.4	283	4595	162	4904	171	5050	5	5306	30	5425	33	5674	44
4155	282	4331	283	4597	179	4904.1	171	5058	17	5307	30	5426	33	5679	278
4159	282	4331.1	283	4617	301	4904.3	171	5070	5	5308	30	5427	33	5680	73
4164	293	4331.2	283	4619	288	4905	122	5071	5	5309	30	5428	33	5685	331
4165	293	4331.3	283	4621	286	4907	242	5072	5	5310	30	5429	33	5687	131
4166	282	4331.4	283	4622	286	4913	168	5074	5	5311	26	5430.1	33	5688	131
4172	292	4332	283	4623	286	4914	170	5075	5	5312	26	5433	328	5689	245
4174	293	4332.1	283	4624	284	4917	168	5077	5	5313	26	5435	315	5691	74
4178.1	290	4332.2	283	4625	294	4918.1	167	5090	16	5314	26	5436	313	5692	74
4184	282	4332.3	283	4626	294	4920	165	5091	16	5315	26	5439	33	5693	74
4185	282	4332.4	283	4628	284	4921	174	5092	16	5318	30	5441	32	5694	74
4194	281	4333	283	4628.1	284	4932	154	5094	16	5339	31	5446	33	5696	37
4195	281	4333.1	283	4628.2	284	4934	25	5101	34	5340	31	5455	33	5697	37
4197	281	4333.2	283	4628.3	284	4937.1	155	5104	34	5340.1	31	5456	33	5698	324
4198	282	4333.3	283	4628.4	284	4939	173	5110	34	5341	31	5479	34	5699	37
4199	282	4333.4	283	4639	284	4953	174	5111	316	5341.1	31	5480	34	5702	47
4222	212	4334	286	4675	287	4954	174	5115	34	5342	31	5482.1	35	5705	47
4223	212	4336	288	4690	266	4956	253	5116	34	5343	31	5482.2	34	5706	278
4224	212	4337	288	4712	86	4958.2	251	5118	34	5343.1	31	5483	34	5708	47
4227	293	4338	288	4727	8	4959.1	250	5119	34	5344	31	5484	317	5710	48
4233	84	4338.1	288	4728	8	4960.2	253	5132	41	5344.1	31	5490.1	35	5711	48
4234	84	4338.2	289	4729	361	4962	250	5133	41	5345	31	5501	35	5712	48
4236	84	4338.3	289	4730.1	248	4963.2	252	5134	41	5346	31	5507	35	5714.1	48
4237	84	4338.4	289	4745	279	4964	250	5142	41	5347	31	5508	35	5715	48
4239	84	4340	284	4747	303	4965	250	5144	305	5347.1	31	5510	35	5716	323

5731	183	5930	72	6044	23	6168	92	6344	124	7023	222	7292	233	7449	257
5732	85	5931	72	6045	208	6170	92	6344	184	7024	222	7293	233	7452	261
5733	85	5934	73	6047	209	6172	91	6345	124	7026	236	7300	161	7463	177
5739	48	5935	73	6049	208	6173	91	6345	184	7032	222	7301	161	7475	12
5750	244	5936.1	71	6054	319	6174	92	6346	95	7033	222	7305	161	7476	12
5754	87	5938.1	71	6055	210	6178	324	6347	94	7039	222	7306	160	7477.1	12
5755	85	5939.1	71	6068	7	6181	91	6354	96	7044	218	7307.1	161	7479	12
5756	85	5943	247	6080	7	6185	91	6355	96	7050	199	7311.1	139	7487	12
5757	85	5944	245	6084	7	6193	91	6356	96	7056	157	7312	39	7488	244
5758	85	5945	245	6085	36	6194	91	6357	97	7058	157	7313	39	7489	12
5759	85	5946	245	6086	7	6195	115	6358	97	7060	157	7315	138	7490	187
5760	85	5947	245	6087	7	6198	115	6359	97	7069	175	7342	279	7491	187
5761	85	5948	243	6088	12	6199	115	6366	97	7070	219	7346	260	7493	187
5763	85	5949	243	6089	7	6204	116	6367	98	7071	219	7347	260	7494	187
5764	85	5950	242	6093	21	6205	116	6368	98	7072	219	7354	313	7501	18
5766	86	5952	242	6096	116	6208	116	6369	97	7073	219	7356	72	7502	19
5767.1	86	5960	280	6100	8	6214	116	6370	98	7079	185	7357	72	7503.1	19
5768	87	5961	280	6101	13	6218	99	6373	93	7082	5	7358	72	7504	18
5769	86	5964	281	6104	13	6227	99	6374	94	7086	17	7359	72	7506	72
5773	86	5965	280	6105	13	6228	124	6375	114	7087	17	7360	239	7508	72
5777	83	5965.9	280	6107	13	6228	184	6441	265	7096	17	7361	239	7509	20
5787	85	5966	244	6108	13	6235	99	6442	265	7118.4	147	7362	239	7510.1	6
5788	85	5967	244	6110	90	6236	100	6443	265	7119	147	7363	239	7511	17
5789	85	5970	276	6111	7	6237	100	6444	265	7121	186	7364	239	7514	12
5790	85	5971	277	6113	28	6238	99	6446	265	7123	186	7365	239	7520.1	6
5791	86	5971.1	277	6115	13	6239	99	6450	265	7134	184	7370.2	4	7523.1	6
5800	85	5973	245	6116	7	6241	118	6451	265	7135	185	7371.2	4	7530.1	6
5801	85	5974	281	6117	28	6244	118	6452	265	7136	186	7372.2	4	7531.1	12
5806	231	5975	278	6118	91	6245	118	6453	265	7137	185	7374.2	4	7536	19
5809	232	5976	278	6120	28	6246	118	6454	265	7138.3	254	7375.2	4	7540.1	6
5810.2	84	5977	234	6121	13	6247	118	6461	266	7139	185	7377.2	4	7556	87
5811	84	5978	278	6123	28	6253	99	6467	98	7142	215	7382.1	36	7561	144
5812	84	5979	276	6125	90	6289	114	6470	43	7143	215	7383.2	4	7563	130
5814	84	5985	69	6126	90	6294	113	6478	43	7144	215	7385	36	7563.1	130
5815	84	5986	69	6127	124	6295	113	6485	43	7147	215	7387	36	7574	226
5816	84	5987	69	6127	184	6297	93	6492	45	7152	215	7389	87	7576	193
5817	84	5989	69	6130	90	6299	93	6493	45	7153	135	7392	70	7578	193
5822	84	5991	190	6142	28	6303	123	6544.1	24	7154.3	253	7393	70	7580	28
5824	84	5992	190	6144	28	6303	184	6634	119	7155.1	21	7394	70	7581	27
5829	68	5993	190	6146	90	6304	123	6635	119	7156.1	21	7395	70	7582	27
5830	68	5997	190	6147	90	6304	184	6665	177	7157.1	21	7396	70	7585	29
5836	68	5998	212	6148.1	21	6306	122	6668	177	7158.1	21	7397	70	7590	34
5837	278	6000	116	6149	28	6307	122	6708	114	7159.1	21	7398	70	7590.1	34
5838	68	6001	173	6150	91	6309	123	6709	110	7160.1	21	7399	70	7591	34
5839	68	6003	234	6152.1	21	6309	183	6726	111	7162.1	21	7400	159	7591.1	34
5840	68	6007	7	6153	7	6310	123	6727	111	7168.1	21	7401	175	7592	34
5841	68	6009	211	6155	91	6310	183	6729	97	7169	235	7402	161	7596	30
5844	69	6010	211	6157	92	6312	122	6730	97	7170	235	7404	159	7597	30
5849	68	6013	117	6158	92	6313	122	6731	117	7171	186	7405	159	7598	30
5850	68	6016	41	6159	92	6315	123	6736	97	7171	211	7407	159	7600.1	30
5852	77	6019	115	6161	92	6315	184	6765	178	7173	187	7408	161	7603	30
5854	74	6020	115	6164	306	6316	123	6835	41	7173	211	7409	161	7607	231
5858	84	6021	117	6164.1	306	6316	184	6865	111	7174.3	143	7410	162	7611	225
5884	247	6022	117	6164.2	306	6327	124	6866	111	7176	143	7411	162	7612	225
5885	249	6024	120	6164.3	306	6327	184	6869	111	7178	238	7412	159	7617	52
5887	182	6028	120	6164.4	306	6328	124	6870	15	7179	234	7413	159	7618	52
5898	75	6029	120	6164.5	306	6328	184	6871	113	7180	231	7414	178	7620	52
5898	249	6030	119	6164.6	306	6338	93	6872	110	7181	249	7415	175	7621	52
5900	242	6032	119	6165	114	6339	94	6873	110	7182	185	7416	161	7622	52
5912	78	6033	120	6167	307	6340	124	6876	111	7183	185	7433	255	7623	51
5916	40	6034.1	120	6167.1	307	6340	184	6886	98	7257	128	7437	262	7624	52
5917	79	6035	121	6167.2	307	6341	124	6887	98	7264	128	7438	262	7626	52
5917.1	79	6037	121	6167.3	307	6341	184	6901	113	7274.1	129	7439	262	7627	51
5918.1	78	6038	121	6167.4	307	6342	124	6929	71	7283	131	7441	258	7628.1	52
5919	79	6039	23	6167.5	307	6342	184	6953	95	7288	243	7442	258	7630	51
5922	78	6041	208	6167.6	307	6343	124	7018.3	158	7290	132	7443	258	7631	51
5926	131	6042	23	6167.7	307	6343	184	7022	222	7291	132	7444	258	7633	51

7636	233	7725	81	7853	153	8121	382	8547	277	8815.1	261	9545	318	9846	317
7638	232	7728	131	7854	145	8123	377	8550	277	8816.1	261	9546	326	9847	314
7639	234	7729	209	7855	153	8124	377	8552	277	8817.1	261	9551	315	9848	328
7640	130	7730	81	7856	145	8126	377	8560	277	8818.1	261	9552	313	9849	328
7641	130	7731	25	7857	209	8127	380	8562	279	8820	260	9553	314	9850	325
7641.1	130	7734	228	7858.2	134	8128	382	8565	280	8824.1	261	9556	327	9853	316
7642	130	7735	228	7859	154	8130	382	8565.1	280	8826	259	9558	325	9855	323
7642.1	130	7736	228	7861	73	8131	380	8573	275	8827	260	9565	276	9856	322
7643	130	7737.1	229	7862	72	8133	383	8573	285	8829	261	9566	331	9859	328
7644	130	7738.1	229	7863	119	8134	379	8578	279	8830	259	9567	319	9860	323
7644.1	130	7739.1	230	7864	41	8136	377	8580	276	8831.1	261	9575	321	9863	316
7645	130	7740	81	7865	275	8139	379	8586	311	8833	260	9579	287	9866	320
7645.1	130	7741	82	7865.1	275	8142	376	8591	325	8835	260	9582	301	9869	320
7646	130	7744	229	7865.2	275	8145	381	8592	324	8836	319	9583	301	9870	324
7647	130	7745	81	7865.3	275	8147	379	8597	318	8837	321	9589	322	9870	330
7650	130	7748.1	81	7865.4	275	8148	382	8602	324	8840	262	9593	321	9875	301
7651	130	7750	81	7866	255	8149	377	8603	318	8841	262	9599	320	9877	301
7652	130	7755	81	7871	140	8151	376	8608	280	8842	262	9635	213	9878	302
7653	130	7760	81	7876	244	8153	383	8609	279	8844	262	9644	303	9879	302
7654	234	7761	82	7878	244	8155	377	8611	280	8850	262	9645	302	9883	302
7655	234	7763	230	7881	243	8161	377	8613	280	8858	301	9650	321	9884	302
7656	234	7765	81	7883	75	8164	380	8614	276	8860	263	9652	310	9885	302
7658	234	7766	82	7884	75	8170	377	8615	276	8863	256	9657	300	9887	301
7659	234	7767	81	7885	75	8172	384	8616	280	8864	261	9669	300	9887	304
7660.1	232	7769.1	232	7887	244	8175	376	8618.1	280	8869	256	9671	301	9888	301
7662	233	7770.1	225	7890	266	8176	382	8626	279	8872	255	9675	287	9888	304
7663	233	7771	82	7893	136	8187	316	8628	276	8873	302	9676	321	9889	303
7664	233	7772	226	7894	140	8195	380	8629	275	8873	304	9677	321	9890	303
7666	68	7774	80	7897.2	140	8199	383	8630	277	8877	305	9683	302	9891	304
7667	68	7777	80	7903	19	8219	379	8631	280	8883	301	9687	302	9915	383
7668	226	7777.9	80	7904	19	8221	381	8632	280	8883	304	9688	302	9918	383
7669	231	7778	80	7906.1	71	8223	380	8633	71	8885	287	9689	302	9931	305
7670.1	234	7778.2	80	7908	19	8226	383	8634	71	8888	295	9692	302	9932	305
7675.1	225	7778.9	80	7913	19	8229	383	8635	71	8891.1	295	9695	304	9933	305
7680	87	7779	80	7916	78	8242	384	8637	70	8896	69	9696	304	9936	318
7681	231	7781	83	7926	154	8276	384	8639	70	8897	285	9697	302	9939	320
7688	224	7782	83	7938	71	8291	275	8646	70	8898	69	9699	208	9949	302
7689	224	7786	83	7939	71	8298	311	8656	245	8899	69	9707	314	9966	323
7690	224	7789	83	7940	73	8299	311	8661.1	168	8913	280	9708	315	10002	279
7691	230	7801	41	7957	71	8370	258	8662.1	156	8915	276	9710	317	10009	315
7692	231	7805	119	7957.1	71	8373	256	8663	248	8916	280	9711	318	10029	310
7693	231	7805	307	7957.2	71	8374	256	8665.3	158	8932	226	9712	305	10034	325
7694	231	7806	82	7958	71	8375	257	8678	207	8954	77	9714	305	10036	322
7695	233	7809	233	7964	71	8376	258	8694	233	8979	198	9721	69	10040	303
7702	228	7811	233	7964.1	71	8377	256	8701	295	8990	270	9721.1	69	10041	304
7703	228	7812	233	7970	244	8380	258	8702	296	8991	268	9725	69	10048	18
7704	232	7813	233	7972	245	8383	257	8711	296	8992	270	9725.1	69	10051	319
7705.1	228	7814	233	7973	145	8384	257	8717	295	8993	269	9731	293	10056	325
7706.1	228	7815	233	7980	48	8400	257	8719	296	8994	270	9731.1	293	10057	92
7707.1	228	7816	233	7980.1	48	8402	257	8721	295	8995	268	9732	293	10058	92
7708	230	7817	233	7985	69	8404	257	8723	296	8995.1	268	9733	293	10060	381
7709	87	7818	233	7986	69	8405	258	8771	315	8996	268	9735	310	10063	276
7711	232	7819	233	7987	69	8406	258	8773	319	8997	271	9775	307	10074	328
7713	232	7819.1	233	7989	69	8407	258	8776	320	8999	271	9776	307	10087	207
7714	227	7820	233	7993	190	8442	343	8780	318	9021	131	9824	313	10099	234
7715	229	7821	233	7994.2	134	8443	345	8789	305	9025	131	9825	313	10100	171
7715.1	229	7822	233	8057	380	8511	150	8793	324	9169	322	9826	316	10105	319
7716	227	7826	141	8058	379	8515	150	8795	325	9305	189	9827	314	10120	276
7717	229	7830	142	8059	382	8523	275	8796	325	9306	189	9828	325	10122	279
7717.1	229	7832	173	8064	124	8530	277	8800	259	9307	190	9833	311	10129	331
7718	227	7836	173	8075	377	8531	275	8801	258	9308	190	9834	315	10131	315
7719	229	7844	244	8090	377	8531	285	8802	259	9318	329	9836	314	10132	329
7719.1	229	7845	244	8091	379	8532	277	8803	259	9364	316	9837	326	10138	384
7721	80	7846	209	8096	379	8538	277	8804	259	9366	374	9838	326	10141	320
7721.1	81	7847	209	8099	380	8543	277	8809	259	9367	373	9840	325	10142	327
7722	230	7848	140	8118	380	8544	276	8810	259	9543	316	9844	311	10150	314
7723	232	7849	144	8119	379	8545	276	8811	260	9544	314	9845	326	10151	313

10152	313	10838	46	11353	333	11603	250	11805	342	12086	85	12603	109	12991	299
10153	349	10839	33	11354	334	11604	342	11846	333	12093	210	12604	315	12991.2	299
10156	322	10884.1	222	11355	336	11611	343	11848	335	12098	247	12607	23	12991.3	299
10157	290	10887	222	11356	336	11612	343	11850	334	12105	209	12645	265	12991.4	299
10159	291	10893	222	11357	348	11614	342	11865	78	12107	258	12652	26	12991.5	299
10180	384	10895	222	11360	348	11616	344	11885	119	12119	226	12660	236	12992	169
10184	285	10922	295	11361	348	11617	344	11886	248	12120	147	12666	78	12992.1	169
10185	331	10923	295	11364	42	11620	345	11893	347	12122	147	12667	295	12996	346
10187	331	10930	27	11372	327	11621	345	11894	343	12126	348	12687	8	12998	385
10194	254	10931	27	11398.3	299	11624	345	11896	333	12127.3	298	12689	21	13000	43
10226	243	10932	27	11402	297	11625	334	11900	231	12139	266	12690	26	13006.1	145
10234	331	10963	294	11402.2	297	11625	341	11904	225	12149	325	12708	330	13010	95
10235	317	10964	278	11402.3	297	11626	335	11905	234	12150	296	12709	321	13021	250
10267	113	10965	278	11402.4	297	11626	344	11911	348	12174	230	12722	334	13022	95
10268	251	10966	304	11402.5	297	11627	344	11913	343	12214	277	12725	315	13040	327
10273	281	10970	290	11403.3	297	11630	344	11914	141	12215	277	12732	313	13042	326
10274	111	10972.1	129	11408	298	11634	349	11919	337	12225	275	12733	337	13043	350
10278	121	10978	24	11408.2	298	11635	350	11920	333	12225.1	275	12750	95	13045	143
10281	260	10984	248	11408.3	298	11636	350	11920	338	12225.2	275	12755	160	13059	250
10283	385	10990	53	11408.4	298	11637.1	350	11920	339	12225.3	275	12756	298	13062	56
10284	77	11015	15	11408.5	298	11644	349	11923	348	12233	293	12756.3	298	13063	56
10284	385	11017	48	11412	297	11647	348	11924	336	12233.1	293	12773	274	13064	56
10359	290	11018	48	11412.2	297	11648	340	11925	335	12233.2	293	12774	274	13065	56
10360	37	11019	48	11412.3	297	11650	341	11926	335	12233.3	293	12775	274	13066	56
10370	279	11020	48	11412.4	297	11651	341	11927	335	12233.4	293	12776	274	13067	56
10372	21	11027	84	11412.5	297	11652	341	11927	340	12238	299	12777	333	13068	56
10376	295	11030	47	11413	297	11654	341	11955	337	12238.2	299	12778	334	13069	56
10378.1	156	11036	51	11413.2	297	11659	341	11956	338	12238.3	299	12779	252	13070	58
10384	301	11048	279	11413.3	297	11663	341	11958	385	12238.4	299	12780	252	13071	58
10384	304	11049	47	11413.4	297	11665	346	11959	335	12238.5	299	12781	252	13072	58
10386	155	11050	47	11413.5	297	11669	347	11960	333	12241	69	12782	252	13073	58
10395	290	11051	47	11416	300	11670	347	11971	335	12242	115	12809	336	13074	58
10396	301	11090	40	11417	300	11672	347	11972	337	12247	299	12811.1	156	13075	58
10398	155	11093	40	11418	300	11674	339	11973	337	12247.2	299	12835	252	13076	58
10454	232	11100	73	11434	345	11675	339	11974	337	12247.3	299	12836	252	13077	58
10459	295	11102	29	11435	349	11678	340	11975	338	12247.4	299	12837	215	13078	58
10463	330	11243	185	11436	298	11680	339	11980	333	12247.5	299	12838	215	13079	58
10478.1	170	11246.3	298	11436.2	298	11682	335	11990	317	12251	297	12842	13	13080	61
10481	296	11247	299	11436.3	298	11683	46	11992.1	137	12251.3	297	12847	159	13081	61
10666	178	11281	84	11436.4	298	11690	349	12009	301	12251.4	297	12848	274	13082	61
10673	30	11283	42	11436.5	298	11694	219	12013	302	12251.5	297	12849	274	13083	61
10677	30	11284	156	11440	298	11694	340	12015	301	12271.3	298	12850	274	13085	61
10679	30	11286	145	11440.3	298	11695	219	12019	302	12291	266	12851	274	13086	61
10680	30	11287	148	11441	297	11695	340	12019	304	12299	226	12852	41	13088	93
10681	30	11288	191	11453	341	11696	219	12024	333	12301	226	12852	236	13100	56
10683	29	11300	21	11454	219	11696	340	12024	339	12302	226	12863	236	13101	56
10684	30	11302	294	11454	340	11699	340	12026	334	12305	226	12886	140	13102	56
10686	79	11305	174	11456	342	11704	296	12026	339	12307	226	12897	25	13103	56
10691	30	11314	84	11459	290	11714	333	12032	94	12325	279	12898	25	13104	56
10696	30	11315	84	11460	290	11715	334	12033	94	12417	345	12902	119	13105	56
10697	110	11316	84	11496.1	6	11715	339	12040	302	12425	84	12919	79	13106	56
10702	24	11317	84	11500	97	11716	295	12040	304	12439	99	12920	79	13107	56
10708	225	11318	290	11501	313	11717	295	12052	302	12456	86	12925	253	13108	56
10711	24	11334	342	11513	207	11730	331	12052	304	12464	84	12926	351	13109	56
10713	24	11335	342	11521	95	11752	131	12061	267	12488	315	12939	93	13115	57
10718	87	11337.1	342	11540	351	11756	342	12067	299	12492	336	12940	93	13116	57
10719	87	11339	343	11542	351	11763	295	12067.2	299	12494	342	12946	346	13117	57
10720	84	11341	343	11543	103	11765	131	12067.3	299	12503	23	12953	324	13119	65
10721	84	11343	343	11543	115	11771	167	12067.4	299	12509	130	12955	346	13123	242
10722	84	11344	344	11544	39	11777	191	12067.5	299	12511	33	12964	117	13125	59
10723	84	11346	344	11565	337	11788	347	12068	300	12512	32	12970	87	13126	59
10753	69	11347	345	11566	337	11789	334	12068.2	300	12514	32	12971.1	78	13127	59
10754	40	11348	344	11581	130	11791	322	12068.3	300	12575	236	12972	257	13128	59
10756	27	11349	345	11594	207	11799	85	12068.4	300	12598	338	12976	155	13129	59
10766	78	11350	349	11595	207	11800	85	12068.5	300	12599	338	12977	155	13130	59
10806	138	11351	333	11598	130	11801	85	12071	114	12600	333	12984	131	13131	59
10833	230	11352	333	11602	342	11803	85	12085.1	137	12602	109	12990	298	13132	59

13133	60	13563	158	14431	159	14680	27	16130	59	16458	253	16998	15	17318	351
13134	60	13564	158	14475	201	14681	27	16131	59	16459	79	17001	25	17341	248
13135	60	13565	235	14477	203	14682	27	16132	62	16472	349	17002	25	17344	127
13136	60	13565.5	235	14481	203	14683	284	16133	62	16474	116	17003	25	17345	127
13137	60	13566	235	14482	201	14684	285	16134	63	16520	385	17005	15	17346	127
13138	60	13566.5	235	14483	203	14686	27	16136	63	16538	322	17013	15	17347	127
13139	60	13567	150	14484	203	14687	27	16137	63	16574	195	17015	25	17368	103
13140	60	13572.1	18	14492	330	14688	291	16138	63	16628	338	17019	15	17369	103
13141	60	13573.1	18	14493	351	14689	27	16139	63	16638	210	17024	13	17370	103
13142	60	13654	303	14500	384	14690	291	16151	284	16644	44	17025	13	17384	94
13149	62	13657	304	14501	159	14691	293	16156	249	16652	160	17033	63	17402	107
13151	62	13723	313	14502	159	14692	27	16163	275	16671	8	17034	63	17403	107
13153	63	13744	12	14512	195	14693	293	16173	201	16673	357	17037	63	17405	107
13154	63	13760	127	14513	195	14696	27	16178	196	16714	71	17039	369	17407	107
13155	63	13767	13	14515	336	14697	287	16179	202	16715	71	17041	248	17408	107
13156	63	13773	126	14516	199	14698	27	16209	350	16716	71	17043	363	17409	107
13157	63	13774	126	14532	90	14699	27	16214	355	16717	71	17045	79	17422	117
13158	63	13782	126	14533	90	14700	27	16218	74	16719	323	17054	368	17423	117
13159	63	13790	126	14542	173	14704	26	16238	207	16728	369	17055	368	17426	115
13161	63	13791	126	14543	346	14711	188	16247	186	16738	345	17056	368	17428	25
13162	66	13792	39	14546	240	14712	110	16259	267	16740	300	17057	368	17430	99
13163	66	13793	39	14548	263	14718	117	16262	206	16740.3	300	17058	368	17431	96
13178	58	13794	39	14553	135	14719	155	16263.2	252	16740.5	300	17061	367	17433	105
13189	292	13795	39	14557	222	14721	321	16264	155	16767	300	17062	370	17435	105
13208	119	13798	39	14564	266	14731	23	16266	174	16767.3	300	17063	363	17436	105
13251	127	13836	39	14567	173	14732	260	16272	220	16767.4	300	17064	367	17437	108
13252	127	13837	39	14572	87	14768	203	16273	220	16767.5	300	17068	367	17438	109
13253	127	13852	49	14577	194	14771	334	16274	220	16799	26	17069	367	17439	109
13259	127	13862	37	14577	199	14790	196	16280	84	16814	123	17071	368	17440	109
13269	127	13957	12	14579	5	14792	196	16288	254	16814	184	17072	367	17442	367
13282	147	14018	87	14588	194	14813	385	16289	247	16833	96	17073	368	17505	213
13289	143	14022	142	14588	199	14814	360	16290	354	16835	369	17075	367	17506	213
13335	248	14024	13	14592	173	14820	25	16292	105	16839	79	17079	369	17519	115
13342	266	14053	208	14600	142	14834	103	16314	353	16846	6	17080	367	17548	360
13346	94	14082	7	14600.1	142	14835	103	16355	254	16851	365	17081	367	17557	221
13358	94	14083	257	14608	192	14842	213	16356	254	16852	366	17082	367	17557	361
13360.2	252	14084	94	14610	148	14906	120	16357	255	16854	365	17084	363	17558	363
13382	268	14085	95	14611	254	14918	45	16358	255	16855	365	17116	366	17559	364
13383	268	14086	95	14614	174	14936	232	16389	16	16856	365	17128	366	17561	368
13393	310	14087	95	14615	145	14940	213	16390	16	16858	365	17129	385	17562	368
13394	268	14130.2	251	14617	148	14944	172	16391	23	16859	365	17142	369	17563	368
13400	338	14131	303	14618	145	14945.1	21	16392	23	16861	365	17144	363	17590	213
13402	130	14141	120	14619	247	14952	99	16393	23	16862	365	17155	45	17591	213
13411	105	14150	347	14622	186	14962	220	16394	23	16863	365	17156	45	17594	239
13412	347	14167	257	14627	155	14963	220	16395	23	16864	366	17201	335	17595	239
13413	150	14172	66	14629	174	15624	274	16396	23	16866	363	17202	195	17600	336
13421	271	14176	240	14636	329	15644	230	16397	23	16868	363	17206	202	17636	60
13423	106	14204	296	14647	262	15856	160	16398	23	16869	363	17207	202	17640.1	359
13433	18	14206	236	14649	287	16049	186	16399	23	16870	363	17208	28	17643	41
13434	106	14234	149	14650	282	16050	211	16402	68	16873	369	17210	371	17653	15
13440	250	14250	307	14656	5	16051	185	16406	178	16874	369	17218	23	17665	373
13459	268	14285	384	14657	49	16053	360	16408	193	16875	371	17236	63	17666	375
13460.1	154	14303	368	14659	17	16055	358	16408	205	16898	202	17240	371	17676	343
13462	209	14304	262	14660	17	16057	302	16409	74	16900	188	17248	370	17677	343
13467	336	14319	317	14661	17	16074	247	16410.1	193	16901	188	17249	364	17685	59
13474	160	14325	126	14663	17	16080	59	16433.2	251	16959	195	17256	370	17687	61
13479	103	14334	153	14664	17	16084	286	16436.2	252	16962	280	17258	366	17688	61
13487	114	14359	13	14666	21	16085	307	16442	74	16964	377	17265	365	17692	289
13492	222	14370	349	14668	232	16086	289	16443	74	16969	280	17266	370	17694	249
13502	39	14371	21	14669	291	16087	289	16444	74	16972	365	17267	28	17697	26
13528	7	14372	21	14670	291	16088	289	16451	254	16973	69	17268	105	17700	26
13550	311	14373	21	14672	34	16090	208	16452	254	16974	69	17269	106	17704	40
13558	135	14416	199	14674	34	16092	292	16453	255	16975	69	17270	106	17718	26
13559	147	14418	35	14675	34	16115	327	16454	255	16976	69	17283	253	17720	150
13560	147	14425	199	14676	34	16121	40	16455	253	16982	377	17289	72	17726	364
13561	175	14427	194	14677	27	16125	382	16456	253	16995	15	17299	370	17755	62
13562	157	14429	194	14679	27	16128	320	16457	253	16996	15	17314	198	17756	62

17757	215	18271	368	19063	269	19676	360	20790	114	21442	109	21700	8	22087	328
17767	263	18273	139	19071	313	19695	148	20791	113	21443	109	21701	8	22089	190
17785	215	18282	351	19082	58	19703	247	20793	137	21444	96	21702	8	22096	317
17794	135	18315	141	19084	65	19722	366	20800	294	21445	96	21703	8	22118	221
17795	350	18321	370	19301	186	19749	357	20887	203	21446	93	21704	8	22118	361
17815	42	18331	62	19314	358	19750	358	20902	12	21447	93	21705	28	22120	51
17816	42	18334	23	19328	365	19752	354	20948	81	21500	49	21706	28	22127	220
17821	30	18340	23	19329	169	19763	261	20969	235	21504	39	21707	28	22128	220
17830	368	18341	23	19330	169	19764	310	20984	73	21504	127	21708	28	22136	210
17831	318	18344	23	19331	153	19776	25	20988	313	21505	39	21727	7	22137	210
17833	368	18354	119	19332	138	19795	28	20991	192	21505	127	21737	354	22167	74
17854	363	18379	256	19334	243	19845	127	20992	192	21506	126	21738	353	22205	311
17859	369	18382	167	19346	82	19853	230	21001	274	21507	126	21742	173	22236	274
17860	368	18384	154	19441	210	19865	310	21001.1	274	21508	126	21744	154	22236.1	274
17870	365	18393	361	19487	220	19867	310	21001.2	274	21509	39	21746	191	22236.2	274
17876	80	18394	252	19488	220	19868	310	21001.3	274	21509	127	21761	329	22236.3	274
17887	82	18430	63	19489	220	19869	310	21018	350	21510	39	21762	329	22240	212
17888	82	18440	136	19492	369	19871	310	21073	181	21510	127	21763	326	22241	212
17889	355	18441	135	19500	328	19872	310	21138	187	21511	39	21764	326	22284	52
17891	83	18442	136	19507	343	19873	310	21139	174	21511	127	21788	13	22287	263
17892	82	18454	136	19520	353	19875	320	21140	13	21512	39	21789	13	22295	364
17895	238	18476	230	19521	353	19877	358	21147	13	21512	127	21790	8	22320	118
17896	57	18508	143	19526	353	19886	336	21168	16	21513	127	21791	8	22321	118
17897	57	18509	143	19528	353	19889	336	21169	16	21514	127	21792	8	22323	144
17898	57	18518	135	19530	353	19971	361	21170	16	21515	39	21793	8	22324	162
17899	56	18519	136	19531	354	19973	358	21171	16	21517	39	21794	8	22326	238
17916	317	18528	313	19532	353	19977	316	21172	16	21525	40	21795	8	22330	64
17930	360	18529	314	19533	353	19978	129	21173	16	21526	40	21796	8	22331	64
17936	380	18530	315	19534	353	19987	15	21174	16	21530	311	21798	9	22332	64
17972	51	18531	313	19535	353	19998	364	21175	16	21531	40	21800	9	22333	64
17977	21	18532	76	19536	353	19999	162	21176	16	21532	128	21801	9	22348	120
17984	51	18540.1	6	19538	354	20001	143	21179	16	21533	128	21802	9	22356	64
17985	51	18541	201	19540	354	20025	329	21180	16	21534	49	21803	9	22387	26
18012	26	18542	202	19542	354	20058	359	21181	16	21535	49	21804	9	22399	254
18021	367	18568	252	19544	355	20161	165	21209	30	21536	49	21805	9	22406	84
18024	364	18572	313	19545	355	20178	31	21222	56	21569	16	21806	9	22408	347
18025	363	18593	122	19546	355	20197	64	21223	25	21570	16	21807	9	22410	196
18026	28	18605	231	19551	355	20198	64	21227	28	21571	16	21808	9	22411	314
18043	366	18609	187	19552	356	20199	64	21283	106	21572	16	21809	11	22412	364
18061	114	18609	194	19553	356	20200	64	21284	106	21573	16	21810	11	22414	43
18062	43	18623	368	19554	356	20204	310	21286	106	21574	16	21811	11	22428	17
18067	28	18643	26	19556	357	20206	355	21287	106	21575	16	21812	11	22429	17
18075	247	18644	175	19557	357	20227	116	21290	327	21586	37	21813	11	22430	17
18080	145	18645	175	19558	358	20237	361	21291	326	21588	129	21814	11	22431	17
18081	239	18647	343	19560	356	20243	51	21304	111	21591	129	21815	11	22433	17
18098	139	18699	359	19561	357	20256	44	21305	112	21594	50	21816	11	22434	17
18102	135	18701	106	19562	356	20257	44	21306	112	21603	48	21818	11	22435	17
18116	191	18715	314	19563	357	20258	44	21307	112	21604	48	21819	18	22436	17
18117	192	18721	313	19564	357	20263	371	21309	112	21605	48	21820	18	22437	17
18123	361	18723	375	19566	358	20296	42	21310	112	21606	48	21821	20	22438	17
18128	43	18725	51	19567	359	20316	346	21368	26	21634	37	21822	20	22439	17
18131	191	18727	369	19568	359	20324	178	21418	126	21638	365	21865	79	22440	17
18132	191	18740	363	19569	359	20327	324	21419	126	21640.1	137	21897	25	22441	17
18133	191	18812	194	19570	359	20356	65	21420	126	21649	37	21915	221	22442	17
18162	344	18813	192	19571	360	20367	266	21421	126	21666	70	21916	221	22443	17
18163	344	18837	120	19572	360	20454	179	21427	107	21669	70	21918	310	22444	17
18166	343	18877	317	19573	360	20455	180	21428	108	21670	70	21922	157	22491	231
18167	126	18900	363	19644	355	20463	28	21429	108	21671	70	21923	158	22492	231
18173	43	18938	327	19656	339	20478	316	21430	108	21672	70	21953	150	22493	231
18182	366	18946	327	19665.1	359	20527	178	21431	108	21692	13	21991	7	22494	231
18198	8	18955	195	19666	356	20528	188	21432	108	21693	13	21992	7	22525	366
18221	135	18956	201	19668	358	20528	194	21433	108	21694	13	21994	328	22526	366
18231	145	18999	193	19669	358	20560	297	21434	107	21695	13	22010	311	22533	238
18232	149	18999	205	19670	358	20565	162	21435	107	21696	13	22015	171	22560	108
18234	149	19000	194	19671	358	20580	12	21436	105	21697	13	22019	141	22568	279
18237	307	19000	205	19673	361	20581	236	21437	105	21698	13	22047	256	22569	221
18239	231	19060	209	19674	359	20767	345	21438	103	21699	8	22075	322	22571	248

22573	338	23204	323	23976	276	24343	374	24799	213	25080	138	25434	318	25984	11
22587	113	23208	225	23982	294	24344	374	24800	213	25081	141	25437	321	25985	11
22588	112	23223	177	23990	70	24396	274	24801	213	25083	139	25438	319	25986	11
22589	112	23253	382	23991	70	24397	173	24802	213	25086	171	25442	62	25987	11
22590	112	23275	224	23992	70	24398	219	24803	213	25087	172	25445	65	25988	11
22591	112	23276	224	23993	70	24399	219	24804	37	25088	169	25447	59	25989	11
22601	100	23277	224	23994	70	24422	43	24805	37	25089	170	25454	163	25990	11
22602	100	23278	323	23995	70	24430	369	24806	170	25091	243	25477	269	25991	11
22603	100	23304	103	23996	70	24432	198	24807	214	25092	243	25500	357	25992	11
22604	100	23306	105	23997	70	24433	195	24808	214	25093	142	25535	211	25993	11
22605	100	23326	101	24010	347	24434	195	24810	136	25107	267	25537	211	25997	141
22606	101	23333	113	24016	326	24435	196	24846	382	25108	267	25539	320	26023	116
22607	101	23334	113	24108	64	24436	196	24863	382	25109	267	25588	171	26024	148
22608	350	23386	169	24113	64	24437	201	24864	382	25110	267	25599	136	26025	148
22627	19	23387	168	24174	196	24438	196	24865	383	25114	267	25606	381	26026	149
22628	19	23416	323	24177	196	24439	195	24900	306	25115	267	25613	331	26027	149
22629	19	23431	53	24178	50	24440	196	24901	306	25121	86	25614	330	26028	149
22630	19	23469	323	24179	50	24441	195	24902	306	25142	329	25615	331	26029	149
22631	19	23481	88	24180	50	24442	196	24905	151	25147	213	25623	315	26037	164
22632	19	23518	267	24181	128	24445	195	24906	168	25157	220	25624	315	26038	164
22633	20	23528	221	24182	128	24446	196	24908	170	25161	175	25628	181	26042	165
22634	20	23536	73	24183	130	24447	202	24909	170	25162	157	25629	152	26043	165
22635	20	23537	207	24184	128	24455	48	24912	152	25163	158	25717	44	26052	45
22646	24	23631	230	24186	128	24473	355	24913	180	25164	147	25766	13	26069	374
22647	24	23641	356	24203	53	24475	291	24916	151	25165	192	25769	163	26077	330
22648	24	23660	227	24206	76	24497	28	24918	198	25166	192	25814	381	26082	8
22649	24	23661	227	24207	76	24520	121	24922	172	25167	238	25843	11	26084	235
22650	24	23662	227	24208	76	24525	364	24928	181	25168	238	25844	11	26086	236
22680	211	23663	221	24209	76	24542	364	24930	198	25169	122	25845	11	26088	239
22690	236	23664	329	24210	76	24546	201	24933	217	25182	127	25846	11	26093	376
22691	286	23666	77	24213	53	24547	201	24942	218	25183	319	25848	11	26134	163
22747	316	23670	28	24214	53	24548	201	24947	218	25193	141	25851	11	26136	264
22750	315	23671	24	24228	65	24549	201	24950	205	25194	269	25854	28	26137	179
22752	50	23680	26	24229	65	24579	385	24952	218	25195	269	25859	8	26141	226
22753	50	23684	13	24230	64	24586	385	24953	152	25196	269	25860	357	26144	151
22754	50	23687	28	24232	36	24587	386	24955	217	25198	269	25862	356	26158	257
22757	215	23689	28	24233	36	24591	207	24956	218	25200	268	25863	358	26159	257
22758	215	23692	26	24234	36	24604	344	24962	198	25207	321	25864	80	26161	257
22759	215	23766	225	24236	36	24617.2	251	24966	44	25322	319	25865	9	26162	257
22760	215	23767	225	24237	36	24618	160	24969	217	25324	321	25866	9	26166	42
22761	215	23768	226	24238	36	24619	160	24994	217	25326	128	25867	9	26167	42
22762	215	23774	215	24239	36	24620	160	24995	218	25335	220	25869	9	26188	64
22763	214	23777	384	24240	36	24621	160	25010	180	25336	221	25870	9	26189	64
22783	98	23799	224	24241	36	24635	177	25032	183	25337	221	25871	9	26191	65
22831	177	23820	224	24249	181	24637	256	25033	182	25338	31	25872	9	26192	65
22834	346	23821	224	24262	373	24638	177	25034	183	25339	31	25873	9	26194	65
22837	351	23852	220	24264	373	24640	26	25035	183	25340	31	25874	9	26195	65
22859	98	23853	220	24265	374	24646	204	25036	183	25341	31	25875	9	26200	151
22862	171	23854	220	24266	374	24647	204	25037	182	25346	381	25876	9	26215	151
22863	320	23855	220	24267	373	24648	204	25038	182	25347	357	25877	9	26216	151
22920	354	23856	220	24268	373	24649	204	25039	153	25348	382	25878	9	26217	138
22926	366	23857	220	24269	375	24652	172	25040	153	25349	379	25879	9	26219	137
22960	43	23858	220	24270	375	24653	20	25041	183	25350	381	25910	361	26220	144
22974	346	23859	220	24271	373	24668	101	25042	183	25353	381	25913	17	26221	164
22987	13	23860	220	24273	374	24695	101	25044	199	25361	88	25914	65	26222	164
22988	13	23861	220	24296	296	24696	102	25046	199	25376	45	25919	242	26223	164
22996	35	23862	220	24329	373	24697	101	25047	144	25377	45	25920	242	26224	164
23066	45	23863	220	24330	373	24698	101	25049	183	25402	209	25922	64	26225	164
23067	45	23897	338	24331	376	24699	102	25052	153	25405	210	25923	64	26226	165
23074	11	23918	327	24332	376	24700	102	25053	198	25407	205	25924	64	26227	164
23084	210	23920	65	24333	375	24704	370	25057	183	25411	211	25935	63	26228	163
23098	210	23948	23	24334	375	24708	101	25059	153	25424	213	25954	353	26229	163
23108	323	23959	20	24336	375	24709	101	25060	182	25425	205	25955	353	26230	163
23132	248	23960	20	24337	375	24711	102	25061	183	25426	205	25967	90	26231	163
23133	172	23961	20	24338	374	24771	190	25062	199	25427	205	25968	111	26232	163
23141	31	23962	20	24341	374	24772	190	25077	139	25432	165	25969	114	26233	180
23202	271	23963	18	24342	374	24783	190	25078	138	25433	181	25981	108	26234	180

26236	199	26557	202	26862	11	27152	16	27389	268	28233	178	28495	24	29088	371
26238	199	26558	203	26864	11	27153	16	27390	268	28235	177	28496	24	29100	43
26239	179	26559	203	26865	11	27154	16	27393	76	28236	177	28497	24	29101	43
26240	195	26560	203	26866	11	27155	16	27463	213	28237	177	28498	24	29116	187
26241	179	26564	208	26867	11	27156	16	27467	80	28238	288	28499	24	29116	192
26242	195	26565	288	26875	137	27157	16	27473	308	28239	288	28539	220	29119	134
26243	195	26567	385	26878	17	27158	16	27481	286	28243	150	28540	220	29120	156
26244	195	26602	384	26881	17	27159	16	27486	294	28264	255	28541	220	29188	206
26246	199	26608	221	26883	17	27160	16	27488	272	28284	301	28553	219	29203	109
26251	121	26609	221	26889	76	27161	16	27490	272	28298	129	28607	351	29204	109
26252	121	26610	221	26900	76	27183	178	27502	306	28300	129	28623	364	29205	110
26253	121	26611	221	26918	162	27184	214	27515	384	28324	130	28624	370	29206	110
26254	263	26612	221	26919	144	27191	180	27516	266	28326	129	28646	364	29207	110
26255	263	26624	193	26920	188	27192	180	27520	169	28333	130	28689	76	29208	110
26256	263	26626	193	26920	194	27212	330	27521	172	28341	76	28692	76		
26257	264	26627	193	26921	150	27213	227	27526	153	28342	76	28698	350		
26258	264	26645	204	26922	179	27214	227	27527	274	28353	285	28777	305		
26259	264	26647	203	26923	137	27215	227	27527.1	274	28354	285	28778	306		
26260	265	26663	292	26925	161	27216	373	27527.2	274	28357	16	28779	306		
26261	264	26663.9	292	26931	141	27218	218	27527.3	274	28358	16	28780	306		
26262	264	26669	294	26936	155	27219	218	27536	162	28366	259	28797	198		
26263	264	26669.9	294	26938	30	27221	138	27542	354	28372	263	28801	44		
26264	18	26677	84	26950	188	27223	134	27558	376	28373	263	28802	139		
26265	11	26693	292	26951	191	27224	252	27570	282	28375	181	28803	139		
26266	11	26710	307	26955	261	27263	330	27583	72	28377	182	28807	356		
26267	151	26715	136	26983	61	27284	206	27584	72	28378	182	28829	57		
26269	151	26716	136	26984	61	27290	34	27585	72	28379	182	28830	57		
26270	180	26726	214	26985	61	27308	282	27586	72	28382	167	28831	57		
26271	144	26727	214	26986	61	27336	267	27587	71	28383	167	28832	60		
26272	197	26731	278	26994	62	27337	267	27588	71	28384	168	28833	60		
26273	188	26732	278	27033	371	27338	267	27589	71	28385	168	28838	137		
26274	217	26734	278	27034	371	27339	269	27590	71	28386	152	28869	232		
26275	122	26735	277	27037	12	27340	269	27637	294	28387	152	28871	157		
26276	210	26754	375	27042	206	27341	269	27643	195	28388	152	28872	158		
26277	214	26767	291	27042.9	206	27342	268	27644	195	28389	152	28873	158		
26278	235	26824	8	27043	221	27343	268	27645	196	28390	123	28901	282		
26279	264	26825	8	27045	221	27344	268	27646	195	28390	189	28911	374		
26281	264	26826	8	27046	221	27345	269	27647	195	28390	197	28917	100		
26282	265	26827	8	27047	221	27346	269	27648	196	28390	212	28918	100		
26284	265	26829	8	27048	221	27347	269	27819	62	28391	123	28969	81		
26285	265	26831	8	27049	221	27349	269	27840	121	28391	189	28983	15		
26307	330	26832	8	27055	206	27350	269	27849	201	28391	197	28985	15		
26312	209	26833	8	27055.9	206	27351	269	27862	206	28391	212	28988	15		
26313	214	26834	8	27057	237	27352	269	27862.9	206	28392	123	28989	15		
26314	217	26835	8	27058	237	27353	269	27863	374	28392	189	28996	15		
26315	217	26837	8	27059	237	27355	270	27870	23	28392	197	28999	148		
26316	217	26838	8	27060	237	27356	270	27879	81	28393	123	29000	148		
26317	217	26839	8	27061	237	27358	270	27882	37	28393	189	29004	114		
26318	217	26840	8	27064	237	27359	270	27897	88	28393	197	29005	114		
26320	188	26841	8	27066	236	27360	270	27908	376	28398	167	29009	204		
26321	197	26842	9	27067	237	27361	270	27933	374	28400	165	29010	204		
26446	373	26845	9	27068	238	27362	270	27939	376	28401	236	29011	204		
26448	373	26846	9	27069	237	27364	270	27940	376	28402	167	29023	84		
26449	373	26847	9	27070	237	27365	270	27941	376	28403	167	29026	102		
26451	375	26849	9	27071	238	27367	271	27953	348	28419	189	29027	102		
26453	373	26850	9	27072	237	27368	271	27954	44	28420	122	29028	102		
26454	373	26851	9	27073	238	27370	271	27955	44	28421	189	29029	102		
26455	373	26852	9	27077	295	27371	271	28027	37	28422	122	29030	102		
26487	37	26853	9	27077.1	295	27373	270	28125	129	28423	197	29040	65		
26488	36	26854	9	27077.2	295	27374	270	28158	279	28424	197	29041	65		
26496	363	26855	9	27082	375	27375	272	28188	280	28425	212	29044	371		
26530	306	26856	9	27092	261	27376	272	28191	185	28441	217	29045	371		
26531	306	26857	11	27100	45	27377	272	28228	179	28443	217	29046	371		
26544	77	26858	11	27105	311	27379	271	28229	179	28444	217	29056	282		
26547	76	26859	11	27114	374	27380	271	28230	179	28448	262	29073	117		
26548	76	26860	11	27150	16	27383	271	28231	179	28491	206	29086	371		
26556	202	26861	11	27151	16	27384	271	28232	177	28494	24	29087	371		

PREISE

Alle Preise in Schweizer Franken (CHF), zuzüglich MWST und LSVA. Preisänderungen bleiben vorbehalten.

KONDITIONEN

Zahlbar netto innert 30 Tagen; plus MWST und LSVA. Bestellungen mit ungültigen Preisangaben werden ohne Rückfrage zu den gültigen Tagespreisen ausgeliefert.

RABATTE

Verlangen Sie die Spezialofferte für grössere Mengen oder für Jahresabschlüsse.

LIEFERUNG

Frankolieferungen ab CHF 500.— (ausgenommen Bergbahnen).

Bei Sendungen unter CHF 50.— beträgt der Versandkostenanteil CHF 10.—;

CHF 50.— bis 100.— = CHF 20.—;

CHF 100.— bis 350.— = CHF 30.—;

CHF 350.— bis 500.— = CHF 40.—.

Expresszuschläge werden zusätzlich verrechnet.

TERMINLIEFERUNGEN

Lieferungen bis 10.00 Uhr, sowie Sendungen, die innerhalb eines Zeitfensters von 2 Stunden (z.B. 9-11 Uhr) ausgeliefert werden müssen, werden zusätzlich mit CHF 50.— belastet.

LIEFERFRIST

Alle in der Preisliste aufgeführten Artikel sind in der Regel in ausreichenden Mengen sofort ab Lager lieferbar und innerhalb von 24 Stunden beim Kunden. Ausnahmen: Bei Artikeln mit dem Vermerk „Auf Bestellung“ ist mit einer Lieferfrist zu rechnen.

ABLAD

Kundenwünsche erfüllen wir so weit als möglich gerne. Bei besonders aufwendigem Ablad, bei extremen Zufahrtsverhältnissen oder Wartezeiten muss ein Kostenanteil verrechnet werden.

PALETTEN-TAUSCH

Tausch-Paletten können nur in gutem Zustand gemäss SBB-Norm zurückgenommen werden. Nicht getauschte Paletten fakturieren wir zum Selbstkostenpreis.

Wir bitten um Ihr Verständnis, dass sich Abholfahrten für leere Paletten aus Kosten-, aber auch aus ökologischen Gründen nicht verantworten lassen.

REKLAMATIONEN

Beanstandungen können nur innert 8 Tagen nach Erhalt der Ware berücksichtigt werden. Beschwerden über Transportschäden sind direkt bei Empfang dem Transporteur (Bahn, Paketdienst, Camionneur) zu melden.

RETOUREN

Bei Retouren bis halber Palette werden CHF 50.— für Handling/Transport verrechnet, grössere Retouren nach Aufwand. Artikel mit dem Vermerk „auf Bestellung“ und Sonderanfertigungen können nicht zurückgenommen werden.

