

**INDEX**

0675 Series Parts - North American.....	8-42	6 Series Parts - North American..	8-20, 8-21, 8-22, 8-23
1 FR Series - Cross Kit .....	8-45	6/55 Series Drivelines - CV 80.....	8-118
1 Series Parts - Metric.....	8-55, 8-56, 8-57	6/55 Series Parts - CV 80.....	8-117, 8-118
10 Series Parts - Metric.....	8-81, 8-82	7N Series Parts - Metric.....	8-73, 8-74, 8-75
1000 Series - Cross Reference .....	8-14	8 Series Parts - Metric.....	8-76, 8-77, 8-78
1000 Series Parts - North American.....	8-43, 8-44	9 Series Parts - Metric.....	8-79, 8-80
12 Series Parts - North American.....	8-24, 8-25, 8-26	AB1 Series Parts - Metric.....	8-55, 8-56, 8-57
14 Series - Cross Kit.....	8-45	AB2 Series Parts - Metric.....	8-58, 8-59, 8-60
14 Series Parts - North American.....	8-27, 8-28, 8-29	AB3 Series Parts - Metric.....	8-61, 8-62, 8-63
1800 Series - Cross Kit.....	8-45	AB4 Series Parts - Metric.....	8-64, 8-65, 8-66
2 Series Parts - Metric.....	8-58, 8-59, 8-60	AB5 Series Parts - Metric.....	8-67, 8-68, 8-69
2100/100 Series Parts - Metric.....	8-83, 8-84	AB6 Series Parts - Metric.....	8-70, 8-71, 8-72
220/720 Series Parts - Metric.....	8-91, 8-92	AB7N Series Parts - Metric.....	8-73, 8-74, 8-75
2200/200 Series Parts - Metric.....	8-85, 8-86	AB8N Series Parts - Metric.....	8-76, 8-77, 8-78
2300/210 Series Parts - Metric.....	8-89, 8-90	AB9 Series Parts - Metric.....	8-79, 8-80
2380 CV Parts - Metric.....	8-121, 8-122	Adaptors - PTO.....	8-153, 8-154
2400 Series Parts - Metric.....	8-93, 8-94	Adaptors - Pump Drive.....	8-163, 8-164
2480 CV Drivelines - Metric.....	8-124	Adaptors - Weld On.....	8-162
2480 CV Parts - Metric.....	8-123, 8-124	Assembly - Cross Kit.....	8-7
2500 Series Parts - Metric.....	8-95, 8-96	Assembly - U-Joint.....	8-7
2580 CV Drivelines - Metric.....	8-126	AW10 Series Parts - Metric .....	8-83, 8-84
2580 CV Parts - Metric.....	8-124, 8-125	AW11 Series Parts - Metric .....	8-87, 8-88
2600 Series Parts - Metric.....	8-46, 8-95, 8-96	AW12 Series Parts - Metric .....	8-99, 8-100
3 DR Series - Cross Kit.....	8-45	AW20 Series Parts - Metric .....	8-85, 8-86
3 Series Parts - Metric.....	8-61, 8-62, 8-63	AW21 Series Parts - Metric .....	8-89, 8-90
3/14 Series Parts - CV 80.....	8-111, 8-112	AW22 Series Parts - Metric .....	8-91, 8-92
35 Series - Cross Kit.....	8-45	AW26 Series Parts - Metric .....	8-97, 8-98
35 Series Parts - North American... 8-30, 8-31, 8-32, 8-33		AW35 Series Parts - Metric .....	8-93, 8-94
4 Series Parts - Metric.....	8-64, 8-65, 8-66	AW36 Series Parts - Metric .....	8-95, 8-96
4/35 Series Drivelines - CV 80.....	8-114	Baler Drivelines - CV 80 .....	8-108, 8-130
4/35 Series Parts - CV 80.....	8-113	Bearing Kits - Easy Lock.....	8-10, 8-11, 8-12
44 Series Parts - North American.....	8-34, 8-35, 8-36	Bearing Kits - Old Style .....	8-13
5 Series Parts - Metric.....	8-67, 8-68, 8-69	Bondioli - Cross Kit.....	8-52
5/35/44 Series Drivelines - CV 80.....	8-116	Bondioli Tube - Dimensions .....	8-102
5/35/44 Series Parts - CV 80.....	8-115, 8-116	Clutch - Friction.....	8-144, 8-146
55 Series Parts - North American.....	8-37, 8-38, 8-39	Clutch - Overrunning .....	8-145
6 Series Parts - Metric.....	8-70, 8-71, 8-72	Clutch - Shearbolt .....	8-145

# INDEX

Clutch - Starter Kits .....	8-131	CV 80 - 6/55 Series Parts .....	8-117, 8-118
Clutch - Torquemaster .....	8-133	CV 80 - Baler Drivelines .....	8-108, 8-130
Clutch - Torquemaster Assy .....	8-135	CV 80 - Driveline Baler.....	8-108
Clutch - Torquemaster Features .....	8-134	CV 80 - Information .....	8-109
Clutch Parts - Torquemaster ..8-41, 8-142, 8-143, 8-144		CV 80 Sizes - Driveline .....	8-110
Combine - Driveline .....	8-50	CV Joints - Wide Angle.....	8-147
Complete - Universal Joints .....	8-50	Decals - Safety .....	8-1
Cones - Safety.....	8-108	Dimensions - Bondioli Tube .....	8-102
Couplers - Overrunning .....	8-158	Dimensions - Cross Kit .....	8-6, 8-52
Couplers - Splined .....	8-160	Dimensions - Lemon Tube .....	8-102
Coupling - Spider.....	8-47	Dimensions - Spline .....	8-15
Cross & Bearing - E-Kits.....	8-16	Dimensions - Star Tube.....	8-102
Cross Kit - 1 FR Series .....	8-45	Dimensions - Triangle Tube.....	8-102
Cross Kit - 14 Series .....	8-45	Dimensions - Walterscheid Tube .....	8-102
Cross Kit - 1800 Series .....	8-45	Disc - Flexible.....	8-47
Cross Kit - 3 DR Series.....	8-45	Display - E-Kits.....	8-16, 8-149
Cross Kit - 35 Series .....	8-45	Display - Metric .....	8-152
Cross Kit - Assembly.....	8-7	Display - North American .....	8-150, 8-151
Cross Kit - Bondioli.....	8-52	Driveline - Combine .....	8-50
Cross Kit - Cross Over Chart.....	8-5	Driveline - Cross Over Chart .....	8-54
Cross Kit - Dimensions .....	8-6, 8-52	Driveline - CV 80 Sizes .....	8-110
Cross Kit - Grease .....	8-4	Driveline - Equivalent Chart.....	8-54
Cross Kit - Horsepower.....	8-6	Driveline - Flex Wing Cutters .....	8-129
Cross Kit - Quick Reference .....	8-6	Driveline Baler - CV 80.....	8-108
Cross Kit - Replacement.....	8-7	Driveline Parts - CV 50 .....	8-119, 8-120
Cross Kit - Vehicular .....	8-45	Easy Lock - Bearing Kits.....	8-10, 8-11, 8-12
Cross Kit - Walterscheid.....	8-52	Easy Lock - Guards.....	8-10, 8-11
Cross Over Chart - Cross Kit.....	8-5	Easy Lock - Safety.....	8-2
Cross Over Chart - Driveline .....	8-54	E-Kits - Cross & Bearing.....	8-16
Cross Reference - 1000 Series .....	8-14	E-Kits - Display.....	8-16, 8-149
CV 50 - Driveline Parts.....	8-119, 8-120	E-Kits - Metric .....	8-16
CV 80 - 3/14 Series Parts.....	8-111, 8-112	E-Kits - North American.....	8-16
CV 80 - 4/35 Series Drivelines.....	8-114	Equivalent Chart - Driveline.....	8-54
CV 80 - 4/35 Series Parts.....	8-113	Explanation Inch - Part Number .....	8-18
CV 80 - 5/35/44 Series Drivelines.....	8-116	Explanation Metric - Part Number .....	8-54
CV 80 - 5/35/44 Series Parts.....	8-115, 8-116	Flex Wing Cutters - Driveline .....	8-129
CV 80 - 6/55 Series Drivelines.....	8-118	Flexible - Disc.....	8-47

**INDEX**

Friction - Clutch.....	8-144, 8-146	Metric - 2580 CV Drivelines.....	8-126
Friction Clutch Parts - Metric.....	8-107	Metric - 2580 CV Parts .....	8-124, 8-125
Gear Boxes - Hub City.....	8-165	Metric - 2600 Series Parts.....	8-46
German - Shafting .....	8-9	Metric - 2600 Series Parts.....	8-97, 8-98
Grease - Cross Kit .....	8-4	Metric - 3 Series Parts.....	8-61, 8-62, 8-63
Grease - Interval .....	8-3, 8-4	Metric - 4 Series Parts.....	64, 65, 66
Grease - Safety .....	8-3	Metric - 5 Series Parts.....	8-67, 8-68, 8-69
Guards - Easy Lock.....	8-10, 8-11	Metric - 6 Series Parts.....	8-70, 8-71, 8-72
Guards - Metric.....	8-11	Metric - 7N Series Parts .....	8-73, 8-74, 8-75
Guards - North American.....	8-10	Metric - 8 Series Parts.....	8-76, 8-77, 8-78
Horsepower - Cross Kit.....	8-6	Metric - 9 Series Parts.....	8-79, 8-80
Hub City - Gear Boxes.....	8-165	Metric - AB1 Series Parts.....	8-55, 8-56, 8-57
Hub City - PTO.....	8-155 to 8-164	Metric - AB2 Series Parts.....	8-58, 8-59, 8-60
I Series Parts - Metric.....	8-87, 8-88	Metric - AB3 Series Parts.....	8-61, 8-62, 8-63
II Series Parts - Metric.....	8-99, 8-100	Metric - AB4 Series Parts.....	8-64, 8-65, 8-66
Identification - Transparency Inch .....	8-19	Metric - AB5 Series Parts.....	8-67, 8-68, 8-69
Identification - Transparency Metric .....	8-53	Metric - AB6 Series Parts.....	8-70, 8-71, 8-72
Information - CV 80 .....	8-109	Metric - AB7N Series Parts .....	8-73, 8-74, 8-75
Interchange - Metric.....	8-51	Metric - AB8N Series Parts .....	8-76, 8-77, 8-78
Interval - Grease .....	8-3, 8-4	Metric - AB9 Series Parts.....	8-79, 8-80
Italian - Shafting .....	8-9	Metric - AW10 Series Parts .....	8-83, 8-84
Lemon Tube - Dimensions .....	8-102	Metric - AW11 Series Parts .....	8-87, 8-88
Locking Device - Pins.....	8-153	Metric - AW12 Series Parts .....	8-99, 8-100
Locking Device - Repair Kit .....	8-17, 8-106	Metric - AW20 Series Parts .....	8-85, 8-86
Manual - Safety.....	8-1	Metric - AW21 Series Parts .....	8-89, 8-90
Metric - 1 Series Parts.....	8-55, 8-56, 8-57	Metric - AW22 Series Parts .....	8-91, 8-92
Metric - 10 Series Parts.....	8-81, 8-82	Metric - AW26 Series Parts .....	8-97, 8-98
Metric - 2 Series Parts.....	8-58, 8-59, 8-60	Metric - AW35 Series Parts .....	8-93, 8-94
Metric - 2100/100 Series Parts .....	8-83, 8-84	Metric - AW36 Series Parts .....	8-95, 8-96
Metric - 220/720 Series Parts .....	8-91, 8-92	Metric - Display.....	8-152
Metric - 2200/200 Series Parts .....	8-85, 8-86	Metric - E-Kits .....	8-16
Metric - 2300/210 Series Parts .....	8-89, 8-90	Metric - Friction Clutch Parts .....	8-107
Metric - 2380 CV Parts .....	8-121, 8-122	Metric - Guards.....	8-11
Metric - 2400 Series Parts.....	8-93, 8-94	Metric - I Series Parts.....	8-87, 8-88
Metric - 2480 CV Drivelines.....	8-124	Metric - II Series Parts.....	8-99, 8-100
Metric - 2480 CV Parts .....	8-123, 8-124	Metric - Interchange.....	8-51
Metric - 2500 Series Parts.....	8-95, 8-96	Metric - Profile Shafting .....	8-9

# INDEX

Metric - Profile Tubing.....	8-9	Repair Kit - Locking Device .....	8-17, 8-106
Metric - Replacement CV Driveline.....	8-128	Repair Kit - Nylon Bearings.....	8-48
Metric - Replacement Driveline .....	8-103, 8-104	Repair Kit - QD Metric .....	8-106
Metric Profile - Shafting and Tubing .....	8-101	Repair Kit - Quick Disconnect .....	8-17
North American - 0675 Series Parts.....	8-42	Replacement - Cross Kit.....	8-7
North American - 1000 Series Parts.....	8-43, 8-44	Replacement - U-Joint.....	8-7
North American - 12 Series Parts.....	8-24, 8-25, 8-26	Replacement CV Driveline - Metric.....	8-128
North American - 14 Series Parts.....	8-27, 8-28, 8-29	Replacement CV Driveline - North American.....	8-127
North American - 35 Series Parts..	8-30, 8-31, 8-32, 8-33	Replacement Drivelines - Metric.....	8-103, 8-104
North American - 44 Series Parts.....	8-34, 8-35, 8-36	Safety - Cones.....	8-108
North American - 55 Series Parts.....	8-37, 8-38, 8-39	Safety - Decals .....	8-1
North American - 6 Series Parts. 8-20,	8-21, 8-22, 8-23	Safety - Easy Lock.....	8-2
North American - Display .....	8-150, 8-151	Safety - Grease .....	8-3
North American - E-Kits.....	8-16	Safety - Manual.....	8-1
North American - Guards.....	8-10	Safety - Section .....	8-1
North American - Replacement CV Driveline.....	8-127	Section - Safety .....	8-1
North American - Shafting and Tubing.....	8-47	Selection Guide - Torquemaster.....	8-136, 8-137
North American - Shafts.....	8-8	Shafting - German .....	8-9
North American - Tubing .....	8-8	Shafting - Italian .....	8-9
North American - W Series Parts.....	8-40, 8-41	Shafting and Tubing - Metric Profile .....	8-101
Nylon Bearings - Repair Kit.....	8-48	Shafting and Tubing - North American.....	8-47
Old Style - Bearing Kits .....	8-13	Shafts - North American .....	8-8
Overrunning - Clutch .....	8-145	Shafts - Splined.....	8-161
Overrunning - Couplers .....	8-158	Shearbolt - Clutch .....	8-145
Part Number - Explanation Inch.....	8-18	Sleeves - PTO.....	8-155
Part Number - Explanation Metric.....	8-54	Spider - Coupling.....	8-47
Pins - Locking Device.....	8-153	Spiral - Pins.....	8-108
Pins - Spiral.....	8-108	Spline - Dimensions .....	8-15
Profile Shafting - Metric .....	8-9	Splined - Couplers .....	8-160
Profile Tubing - Metric.....	8-9	Splined - Shafts.....	8-161
PTO - Adaptors .....	8-153, 8-154	Star Tube - Dimensions.....	8-102
PTO - Hub City.....	8-155 to 8-164	Starter Kits - Clutch .....	8-131
PTO - Sleeves.....	8-155	Torquemaster - Clutch .....	8-133
Pump Drive - Adaptors .....	8-163, 8-164	Torquemaster - Clutch Parts.....	8-138 to 8-144
QD Metric - Repair Kit .....	8-106	Torquemaster - Selection Guide.....	8-136, 8-137
Quick Disconnect - Repair Kit .....	8-17	Torquemaster Assy - Clutch .....	8-135
Quick Reference - Cross Kit .....	8-6	Torquemaster Features - Clutch .....	8-134

## INDEX

Transparency Inch - Identification .....	8-19
Transparency Metric - Identification .....	8-53
Triangle Tube - Dimensions.....	8-102
Tubing - North American .....	8-8
U-Joint - Assembly .....	8-7
U-Joint - Replacement.....	8-7
Universal Joints - Complete .....	8-50
Vehicular - Cross Kit.....	8-45
W Series Parts - North American.....	8-40, 8-41
Walterscheid - Cross Kit.....	8-52
Walterscheid Tube - Dimensions .....	8-102
Weld On - Adaptors .....	8-162
Wide Angle - CV Joints.....	8-147

## DRIVELINE SAFETY

THE SAFETY OF THE END USER DEPENDS UPON PROPER USE AND MAINTENANCE OF THE IMPLEMENT TRACTOR, AND DRIVELINE, PLUS ALL RELATED SAFETY SHIELDING. INFORMATION REGARDING CORRECT DRIVELINE USAGE IS INCLUDED ON THE SAFETY LABEL.



Use the implement only with a driveline which is compatible in length, power capacity, torque limiters or overrunning clutches, and shielding. The driveline and its torque limiter or overrunning clutch should only be used for their intended purposes.

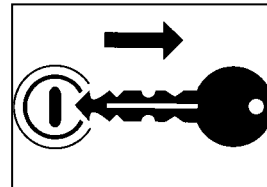

Disengage the PTO, turn off the tractor engine and remove key before approaching the implement or performing maintenance work.

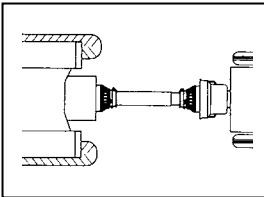

Ensure that all driveline, tractor and implement shields are functional and in place before operation. Damages or missing components must be replaced with spare parts, correctly installed, before using the driveline.

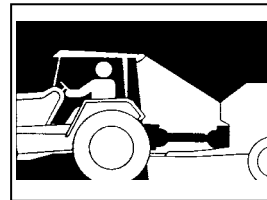

When used at night or in poor visibility, illuminate the driveline operating area during installation.

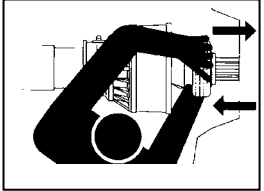

Ensure that the driveline is securely attached to the tractor and the implement before operating.

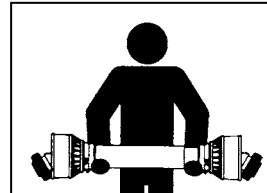

Keep the driveline horizontal during handling to prevent the halves from sliding apart, which could cause injury or damage the shielding.

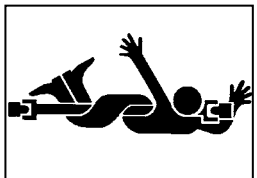

Do not wear loose clothing, jewelry, hair, or anything which could get caught in the machine. **Contact with rotating parts could cause serious injury or death.**

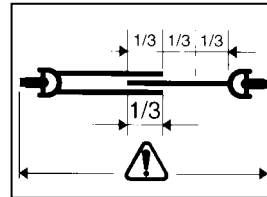

Always hitch the tractor to **STATIONARY MACHINERY** (pumps, elevators, generators, driers, etc.) so that the telescoping tubes overlap by at least  $\frac{1}{3}$  of their length.

## WORKING CONDITIONS

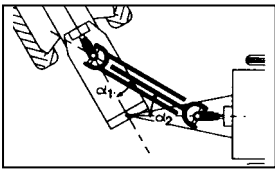

When operating, ensure that joining angles are equal. Disengage the PTO when the angle of the joints exceeds 35°.

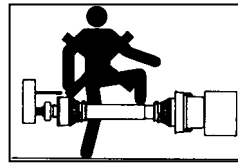

Do not stand on the driveline. Do not step over, or go under the driveline. Contact with a rotating driveline could cause serious injury or death.

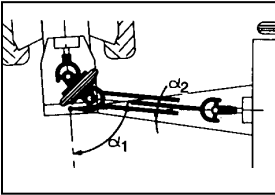

**CONSTANT VELOCITY JOINTS** may operate at angles up to 70-80° depending upon type, but only for brief periods (for example during turns) and never continuously.

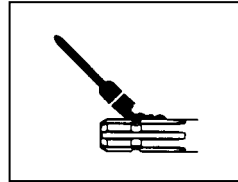

Installing the Driveline: Clean and grease the tractor PTO and implement shaft before installing the driveline.

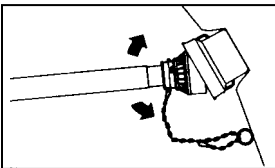

Attach the safety chains, allowing sufficient slack for the driveline during turns, operation, and transport.

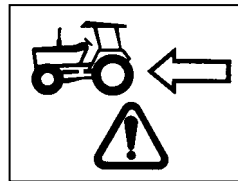

The tractor printed on the shield indicated the tractor end of the driveline. Any torque limiter or overrunning clutch must be installed on the implement end.

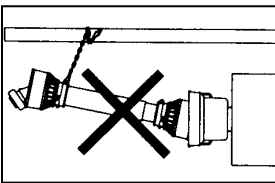

Never use the safety chains to support the driveline for storage. Always use the support on the implement.

**SAFETY SECTION**

**WARNING!**

- Be certain to disengage PTO shaft and to turn off the tractor before making any operational maintenance inspections or repairs. Keep clear of the machine until all parts have stopped moving.
- NEVER operate an implement with driveline guards missing or in a damaged condition.
- Guards must rotate freely on the yokes.

**SAFETY DECALS**



PART NO.  
PTO 1310022

**IMPORTANT**

- CHECK THAT *GUARD MISSING DECAL* ON STEEL TUBE UNDER INNER GUARD AND *ROTATING DRIVELINE DECAL* ON OUTER GUARD ARE FIRMLY AFFIXED, UNDAMAGED AND READABLE - IF NOT, REPLACE.
- GUARDS MUST ROTATE FREELY ON YOKES.



PART NO.  
PTO 1310021

**FOR USE ON  
IMPLEMENT END  
ONLY**



**ALL CLUTCHES MUST BE USED  
ON THE IMPLEMENT END ONLY.**  
Yellow decal is provided on clutch.

**SAFETY MANUAL**

The Agriculture Driveline Manufacturers Association (ADMA) has printed a Safety Manual for owners and operators of agricultural machinery.

PART NO.  
PTO 5615123

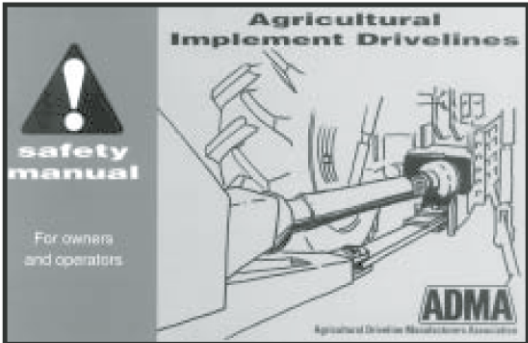



## EASY LOCK GUARD SYSTEM

SAFETY  
SECTION

## Instructions for Removal and Installation of Easy Lock Guards

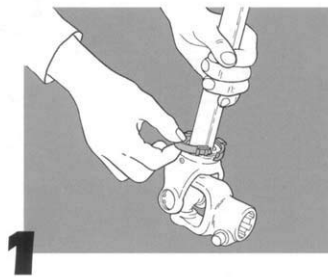
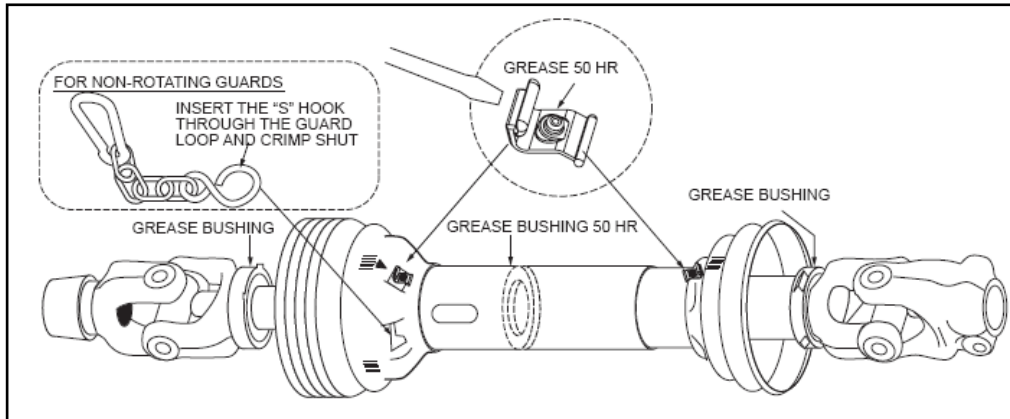

Clean and grease bearing raceway before the nylon bearing is placed in the groove. Grease any remaining nylon bearings in guard.

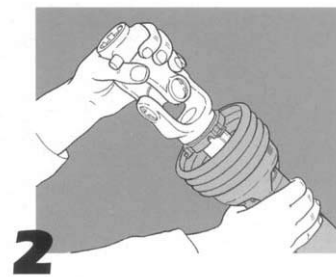

Slide guard half over driveline and insert nylon bearing tabs into the openings in the guard.

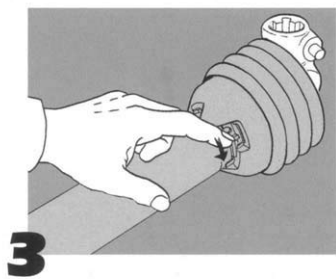

Turn the nylon bearing until it engages into the guard.

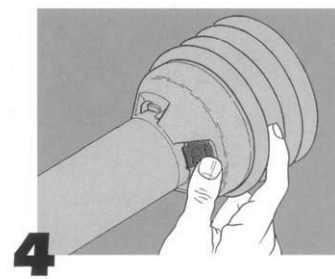

Push Easy Lock clip into position. The nylon bearing and guard are now secure. **Guards must rotate freely on yokes.**

**5 To Remove Guard** - Use screwdriver to release Easy Lock clip. Turn the nylon bearings to disengage from the guard and remove guard.

**GREASING RECOMMENDATIONS**

**SAFETY SECTION**

**Telescoping Drivelines**

Be certain to follow greasing instructions as identified below:

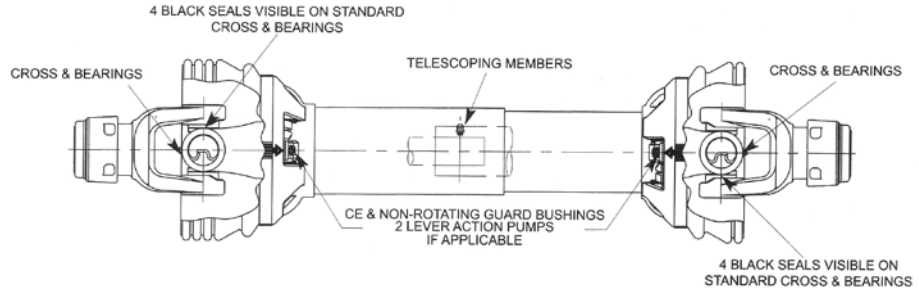

Lubricate all fittings with a good quality lithium soap compatible E.P. grease meeting the N.L.G.I. #2 specifications and containing no more than 1% molybdenum disulfide.

An E.P. grease meeting the N.L.G.I. #2 specifications and containing 3% molybdenum disulfide may be substituted in the telescoping members only.

LUBE RECOMMENDATIONS		
INTERVAL	LOCATION	AMOUNT
50 HRS	Extended lube cross & bearing (orange seals not visible)	2-3 Lever action pumps
8 HRS*	Standard cross & bearings (black seals)	2-3 Lever action pumps
8 HRS	Telescoping members (50 hrs. hardened spline)	8-10 Lever action pumps
50 HRS**	CE & non-rotating guard bushings (1000 RPM max.)	2 Lever action pumps

- Constant angle applications may require a lube interval of 4 hours.
- High speed may require a lube interval of 8 hours.

**CAUTION!! REPLACEMENT PARTS ARE NOT LUBRICATED.**

**80° Constant Velocity Drivelines**

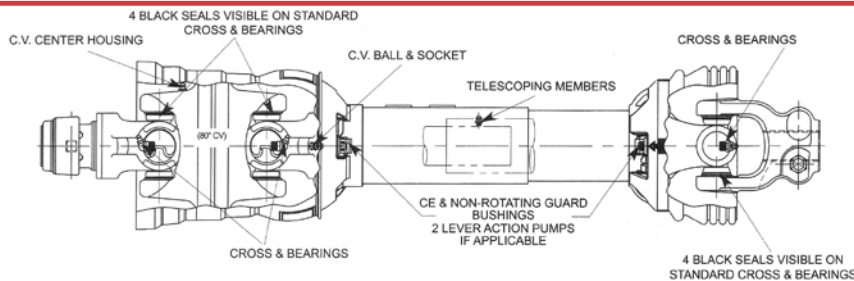

Lubricate all fittings with a good quality lithium soap compatible E.P. grease meeting the N.L.G.I. #2 specifications and containing no more than 1% molybdenum disulfide.

An E.P. grease meeting the N.L.G.I. #2 specifications and containing 3% molybdenum disulfide may be substituted in the telescoping members only.

LUBE RECOMMENDATIONS		
INTERVAL	LOCATION	AMOUNT
50 HRS	Extended lube cross & bearings (orange seals not visible)	2-3 Lever action pumps
8 HRS*	Standard cross & bearings (black seals)	2-3 Lever action pumps
8 HRS	Telescoping members (50 hrs hardened spline)	8-10 Lever action pumps
8 HRS*	CV ball & socket	4-6 Lever action pumps
24 HRS	CV center housing	12-15 Lever action pumps
50 HRS**	CE & non-rotating guard bushings (1000 RPM max.)	2 Lever action pumps**

- Constant angle applications may require a lube interval of 4 hours.
- High speed may require a lube interval of 8 hours.

**CAUTION!! REPLACEMENT PARTS ARE NOT LUBRICATED.**

## GREASING RECOMMENDATIONS

SAFETY  
SECTION

## 50° Constant Velocity Drivelines

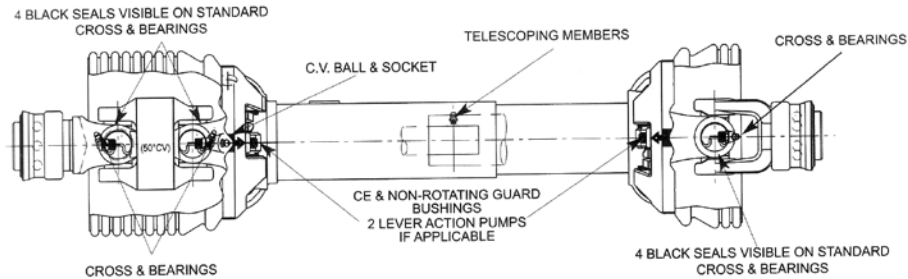

Lubricate all fittings with a good quality lithium soap compatible E.P. grease meeting the N.L.G.I. #2 specifications and containing no more than 1% molybdenum disulfide.

An E.P. grease meeting the N.L.G.I. #2 specifications and containing 3% molybdenum disulfide may be substituted in the telescoping members only.

LUBE RECOMMENDATIONS		
INTERVAL	LOCATION	AMOUNT
50 HRS	Extended lube cross & bearings (orange seals not visible)	2-3 Lever action pumps
8 HRS*	Standard cross & bearings (black seals)	2-3 Lever action pumps
8 HRS	Telescoping members (50 hrs hardened spline)	8-10 Lever action pumps
8 HRS*	CV ball & socket	4-6 Lever action pumps
50 HRS**	CE & non-rotating guard bushings (1000 RPM max)	2 Lever action pumps**

- Constant angle applications may require a lube interval of 4 hours.
- High speed may require a lube interval of 8 hours.

**CAUTION!! REPLACEMENT PARTS ARE NOT LUBRICATED.**

**REPLACEMENT PARTS MUST BE LUBRICATED AT TIME OF ASSEMBLY AND DURING USE PER THE LUBE RECOMMENDATIONS.**

## Greasing Recommendations for Cross &amp; Bearing Kits

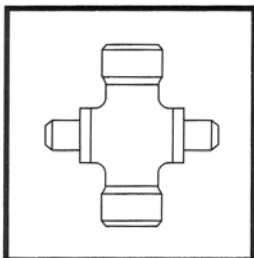

Standard Cross & Bearing Kits (R-Kits) = 8 Hours.  
Extended Lubrication Cross & Bearing Kits (E-Kits) = 50 - 250 Hours.

**CROSS REFERENCE CHART**

**QUICK REFERENCE SECTION**

**North American Components**

CROSS & BRG KIT PART NO.	WEASLER AFTMKT. U-JOINT SERIES	WEASLER U-JOINT SERIES	APC/WESCO U-JOINT SERIES	CHAINBELT U-JOINT SERIES	G&G U-JOINT SERIES	NEAPCO U-JOINT SERIES	ROCKWELL U-JOINT SERIES	SPICER U-JOINT SERIES
PTO 2000100	-	-	-	-	-	-	1FR	-
PTO 2000300	-	-	-	-	-	-	3DR	-
PTO 2000600	6	L6W/6RW	6N 6R	-	6N	L600	L6N	-
PTO 2000675	-	-	-	-	-	0675	-	-
PTO 2000700	-	W	-	-	-	-	-	-
PTO 2001000	-	-	-	-	-	-	-	1000
PTO 2001200	12	12RW 12R	12N	R12N R31N/120	12N	1200	L12N	1140
PTO 2001400	14	14R/GN 14NW	14N	R14N/140	14N	2000	L14N	1240
PTO 2001875	-	-	-	-	-	1800	-	-
PTO 2002600	-	-	-	-	-	2600	-	1480
PTO 2003500	35	35RW/35R DN/35NW	35N	R35N/350	35N	2200	35N	1340
PTO 2004400	44	44R	44N	440	14R	44R	44R	1440
PTO 2005500	55	L55/55NW 55R	-	-	55N	-	55N	-

**Metric Components**

CROSS & BEARING R-KIT PART NO.	CROSS & BEARING E-KIT PART NO.	INTERCHANGES WITH BONDIOLI & PAVESI SERIES	INTERCHANGES WITH WALTERSCHEID SERIES
PTO 2006154	PTO 2016154	1	N/A
PTO 2006580	PTO 2016580	5	N/A
PTO 2006794	PTO 2016794	7N	N/A
PTO 2006806	PTO 2016806	8	N/A
PTO 2006908	PTO 2016908	9	N/A
PTO 2007004	PTO 2017004	N/A	2600
PTO 2007155	PTO 2017155	N/A	2100
PTO 2007676	PTO 2017676	N/A	2400
PTO 2007890	N/A	11	N/A
PTO 2007989	PTO 2017989	N/A	2500
PTO 2008261	PTO 2018261	2	2200
PTO 2008370	PTO 2018370	3	1
PTO 2008474	PTO 2018474	4	2300
PTO 2008692	PTO 2018692	6	220
PTO 2008706	PTO 2018706	7 (Old Series)	230
PTO 2007276	PTO 2017276	N/A	2280
PTO 2007491	PTO 2017491	N/A	2380
PTO 2007694	PTO 2017694	N/A	2480
PTO 2007906	PTO 2017906	N/A	2580

## QUICK REFERENCE FOR CROSS &amp; BEARING KITS

## QUICK REFERENCE SECTION

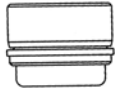

**A** Snap Ring located in the bushing (internal)



**B** Snap Ring located in the yoke (external)



**R** = Regular Cross & Bearing Kit

**E** = Extended Lube Cross & Bearing Kit

## North American

(R) PART NO.	(E) PART NO.	SERIES	(R) KIT RATED H/P @ 540 RPM	(E) KIT RATED H/P @ 540 RPM	(R) KIT RATED H/P @ 1000 RPM	(E) KIT RATED H/P @ 1000 RPM	BEARING DIAMETER	CAP TO CAP OVERALL LENGTH	SNAP RING TYPE	PG. NO.
PTO 2000100	N/A	Rockwell 1FR	N/A	N/A	N/A	N/A	7/8"	2 15/16"	B	56
PTO 2000300	N/A	Rockwell 3DR	N/A	N/A	N/A	N/A	1"	3 15/16"	B	56
PTO 2000600	PTO 2010600	6	14	19	21	29	31/32"	2 5/16"	A	22
PTO 2000675	N/A	0675	16	N/A	24	N/A	15/16"	2 5/16"	A	52
PTO 2000700	N/A	W	N/A	N/A	N/A	N/A	9/16"	1 1/2"	Pin & Block	50
PTO 2001000	N/A	1000	15	N/A	24	N/A	15/16"	2 9/32"	A	53
PTO 2001200	PTO 2011200	12	19	26	29	40	1 1/16"	2 1/2"	A	27
PTO 2001400	PTO 2011400	14	28	38	44	58	1 1/8"	2 5/8"	B	32
PTO 2001875	N/A	1800	30	N/A	48	N/A	1"	3 7/16"	A	56
PTO 2002600	N/A	2600	100	N/A	144	N/A	1 3/8"	4 3/16"	B	57
PTO 2003500	PTO 2013500	35	51	70	79	108	1 1/4"	3 7/32"	B	36
PTO 2004400	PTO 2014400	44	77	103	119	158	1 5/16"	4"	A	42
PTO 2005500	PTO 2015500	55	106	137	164	211	1 17/32"	4 5/16"	B	47

## Italian Series

(R) PART NO.	(E) PART NO.	SERIES	(R) KIT RATED H/P @ 540 RPM	(E) KIT RATED H/P @ 540 RPM	(R) KIT RATED H/P @ 1000 RPM	(E) KIT RATED H/P @ 1000 RPM	BEARING DIAMETER	CAP TO CAP OVERALL LENGTH	SNAP RING TYPE	PG. NO.
PTO 2006154	PTO 2016154	1	15	19	23	29	22.0 mm	54.0 mm	B	66
PTO 2008261	PTO 2018261	2	21	25	33	38	23.8 mm	61.2 mm	B	69
PTO 2008370	PTO 2018370	3	29	38	44	58	27.0 mm	70.0 mm	B	72
PTO 2008474	PTO 2018474	4	36	45	56	70	27.0 mm	74.6 mm	B	75
PTO 2006580	PTO 2016580	5	52	65	81	100	30.2 mm	79.6 mm	B	78
PTO 2008692	PTO 2018692	6	64	79	99	122	30.2 mm	92.0 mm	B	82
PTO 2006794	PTO 2016794	7N	79	94	122	145	34.9 mm	94.0 mm	B	84
PTO 2006806	PTO 2016806	8	100	120	154	185	34.9 mm	106.5 mm	B	87
PTO 2006908	PTO 2016908	9	120	151	185	232	41.0 mm	108.0 mm	B	90

## German Series

(R) PART NO.	(E) PART NO.	SERIES	(R) KIT RATED H/P @ 540 RPM	(E) KIT RATED H/P @ 540 RPM	(R) KIT RATED H/P @ 1000 RPM	(E) KIT RATED H/P @ 1000 RPM	BEARING DIAMETER	CAP TO CAP OVERALL LENGTH	SNAP RING TYPE	PG. NO.
PTO 2007155	PTO 2017155	2100	16	19	23	29	22.0 mm	54.8 mm	B	93
PTO 2008261	PTO 2018261	2200	26	25	33	38	23.8 mm	61.2 mm	B	95
PTO 2008370	PTO 2018370	1	30	38	44	58	27.0 mm	70.0 mm	B	97
PTO 2008474	PTO 2018474	2300	37	45	56	70	27.0 mm	74.6 mm	B	99
PTO 2008692	PTO 2018692	220	64	79	99	122	30.2 mm	92.0 mm	B	102
PTO 2007676	PTO 2017676	2400	53	66	80	102	32.0 mm	76.0 mm	B	104
PTO 2007989	PTO 2017989	2500	90	94	124	144	36.0 mm	88.8 mm	B	107
PTO 2007004	PTO 2017004	2600	108	149	175	230	42.0 mm	104.0 mm	B	110

**UNIVERSAL JOINT REPLACEMENT**

**QUICK REFERENCE SECTION**

**To Disassemble Universal Joint**

1. Remove all snap rings.

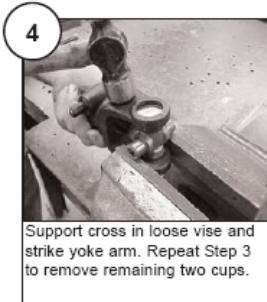
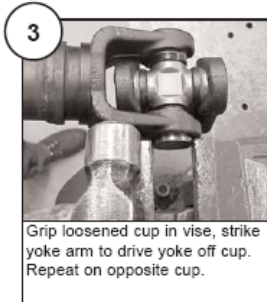
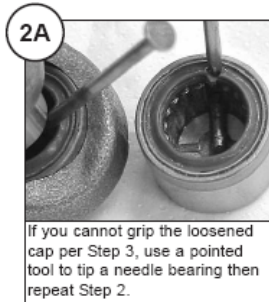
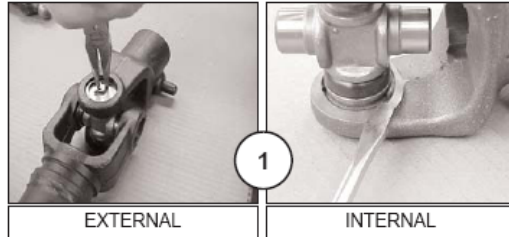

**To Reassemble Universal Joint**

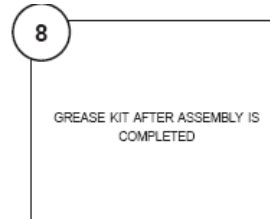
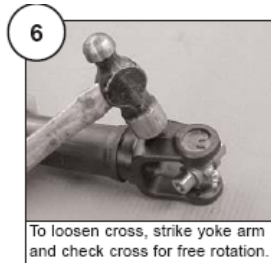
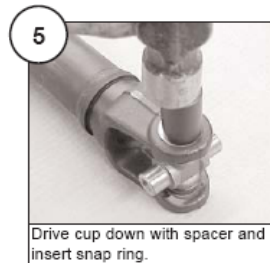
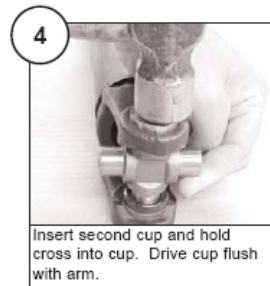
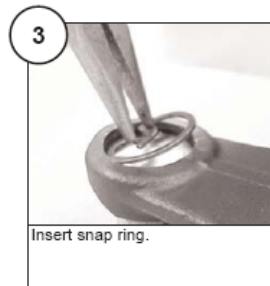
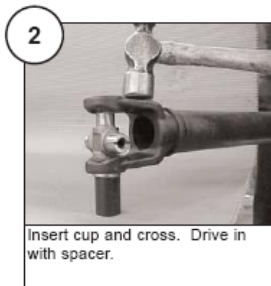

## NORTH AMERICAN SHAFTING AND TUBING

QUICK REFERENCE  
SECTION

## North American Shaft



PART NO.	SIZE	LENGTH
PTO 4000012	3/4" Sq.	6'
PTO 4000014	7/8" Sq.	6'
PTO 4000015	15/16" Sq.	6'
PTO 4000016	1" Sq.	6'
PTO 4000019	1 3/16" Sq.	6'
PTO 4000020	1 1/4" Sq.	6'
PTO 4000021	1 5/16" Sq.	6'
PTO 4001214	3/4" x 7/8" Rect.	6'
PTO 4001618	1" x 1 1/8" Rect.	6'
PTO 4010019	1 3/16" Sq.	10'
PTO 4010021	1 5/16" Sq.	10'
PTO 4011214	3/4" x 7/8" Rect.	10'
PTO 4011618	1" x 1 1/8" Rect.	10'
PTO 4020014	7/8" Hex	6'
PTO 4020016	1" Hex	6'
PTO 4020018	1 1/8" Hex	6'
PTO 4040019	1 3/16" Sq.	3'
PTO 4020020	1 1/4" Hex	6'
PTO 4040021	1 5/16" Sq.	3'
PTO 4041214	3/4" x 7/8" Rect.	3'
PTO 4041615H	1" x 15 Spl.	3'
PTO 4041618	1" x 1 1/8" Rect.	3'
PTO 4042120	1 5/16" x 20 Spl.	3'
PTO 4042720	1 11/16" x 20 Spl.	3'

## North American Tube



PART NO.	SIZE	LENGTH
PTO 6000012	1" Sq.	6'
PTO 6000015	1 1/4" Sq. (.120 wall)	6'
PTO 6000016	1 1/4" Sq. (.109 wall)	6'
PTO 6000020	1 5/8" Sq.	6'
PTO 6001618	3/4" x 7/8" Rect.	6'
PTO 6002022	1 1/4" x 1 3/8" Rect.	6'
PTO 6011618	3/4" x 7/8" Rect.	10'
PTO 6012022	1 1/4" x 1 3/8" Rect.	10'
PTO 6020600	1 1/2" Rd.	6'
PTO 6021400	2" Rd. (.083 wall)	6'
PTO 6022600	2 3/4" Rd. (.109 wall)	6'
PTO 6023500	2 1/8" Rd. (.120 wall)	6'
PTO 6023501	2 1/8" Rd. (.083 wall)	6'
PTO 6024400	2 1/2" Rd. (.120 wall)	6'
PTO 6031400	2" Rd. (.083 wall)	10'
PTO 6033500	2 1/8" Rd. (.120 wall)	10'
PTO 6034400	2 1/2" Rd. (.120 wall)	10'
PTO 6040600	1 1/2" Rd.	3'
PTO 6041618	3/4" x 7/8" Rect.	3'
PTO 6042022	1 1/4" x 1 3/8" Rect.	3'
PTO 6043500	2 1/8" Rd. (.120 wall)	3'
PTO 6044400	2 1/2" Rd. (.120 wall)	3'

**METRIC PROFILE SHAFTING AND TUBING**

**QUICK REFERENCE SECTION**

SERIES	PART NO.	METERS	INCHES	USE AS
ByPy 1	PTO 4006126	1.5	59 1/16"	Inner
ByPy 1	PTO 4016126	3.0	118 5/16"	Inner
ByPy 1	PTO 4046126	1.0	39 3/8"	Inner
ByPy 1	PTO 6006133	1.5	59 1/16"	Outer
ByPy 1	PTO 6016133	3.0	118 5/16"	Outer
ByPy 1	PTO 6046133	1.0	39 3/8"	Outer
ByPy 2	PTO 4006229	1.5	59 1/16"	Inner
ByPy 2	PTO 4016229	3.0	118 5/16"	Inner
ByPy 2	PTO 4046229	1.0	39 3/8"	Inner
ByPy 2	PTO 6006236	1.5	59 1/16"	Outer
ByPy 2	PTO 6016236	3.0	118 5/16"	Outer
ByPy 2	PTO 6046236	1.0	39 3/8"	Outer
ByPy 3	PTO 6006236	1.5	59 1/16"	Inner
ByPy 3	PTO 6016236	3.0	118 5/16"	Inner
ByPy 3	PTO 6046236	1.0	39 3/8"	Inner
ByPy 3 & 4	PTO 6006343	1.5	59 1/16"	Outer
ByPy 3 & 4	PTO 6016343	3.0	118 5/16"	Outer
ByPy 3 & 4	PTO 6046343	1.0	39 3/8"	Outer
ByPy 4	PTO 4006436	1.5	59 1/16"	Inner
ByPy 4	PTO 4016436	3.0	118 5/16"	Inner
ByPy 4	PTO 4046436	1.0	39 3/8"	Inner
ByPy 5 & 6	PTO 4006545	1.5	59 1/16"	Inner
ByPy 5 & 6	PTO 4016545	3.0	118 5/16"	Inner
ByPy 5 & 6	PTO 4046545	1.0	39 3/8"	Inner
ByPy 5	PTO 6006552	1.5	59 1/16"	Outer
ByPy 5	PTO 6016552	3.0	118 5/16"	Outer
ByPy 5	PTO 6046552	1.0	39 3/8"	Outer
ByPy 6, 7N & 8	PTO 6006654	1.5	59 1/16"	Outer
ByPy 6, 7N & 8	PTO 6016654	3.0	118 5/16"	Outer
ByPy 6, 7N & 8	PTO 6046654	1.0	39 3/8"	Outer
ByPy 7N	PTO 4006745	1.5	59 1/16"	Inner
ByPy 7N	PTO 4016745	3.0	118 5/16"	Inner
ByPy 7N	PTO 4046745	1.0	39 3/8"	Inner
ByPy 9	PTO 4006954	1.5	59 1/16"	Inner
ByPy 9	PTO 4016954	3.0	118 5/16"	Inner
ByPy 9	PTO 4046954	1.0	39 3/8"	Inner
ByPy 8 & 9	PTO 6006863	1.5	59 1/16"	Outer
ByPy 8 & 9	PTO 6016863	3.0	118 5/16"	Outer
ByPy 8 & 9	PTO 6046863	1.0	39 3/8"	Outer
W/S 2100	PTO 4007123	1.5	59 1/16"	Inner
W/S 2100	PTO 4017123	3.0	118 5/16"	Inner
W/S 2100	PTO 4047123	1.0	39 3/8"	Inner
W/S 2100	PTO 6007130	1.5	59 1/16"	Outer
W/S 2100	PTO 6017130	3.0	118 5/16"	Outer
W/S 2100	PTO 6047130	1.0	39 3/8"	Outer
W/S I & 2200	PTO 4007234	1.5	59 1/16"	Inner
W/S I & 2200	PTO 4017234	3.0	118 5/16"	Inner
W/S I & 2200	PTO 4047234	1.0	39 3/8"	Inner
W/S I & 2200	PTO 6007241	1.5	59 1/16"	Outer

SERIES	PART NO.	METERS	INCHES	USE AS
W/S I & 2200	PTO 6017241	3.0	118 5/16"	Outer
W/S I & 2200	PTO 6047241	1.0	39 3/8"	Outer
W/S 2400 (lemon)	PTO 4007539	1.5	59 1/16"	Inner
W/S 2400 (lemon)	PTO 4017539	3.0	118 5/16"	Inner
W/S 2400 (lemon)	PTO 4047539	1.0	39 3/8"	Inner
W/S 2400 (lemon)	PTO 6007548	1.5	59 1/16"	Outer
W/S 2400 (lemon)	PTO 6017548	3.0	118 5/16"	Outer
W/S 2400 (lemon)	PTO 6047548	1.0	39 3/8"	Outer
W/S 2400 & 2500 (star)	PTO 4007651	1.5	59 1/16"	Inner
W/S 2400 & 2500 (star)	PTO 4017651	3.0	118 5/16"	Inner
W/S 2400 & 2500 (star)	PTO 4047651	1.0	39 3/8"	Inner
AW36 (star)	PTO 6007961	1.5	59 1/16"	Outer
AW36 (star)	PTO 6017961	3.0	118 5/16"	Outer
AW36 (star)	PTO 6047961	1.0	39 3/8"	Outer
AW26 (star)	PTO 4007961	1.5	59 1/16"	Inner
AW26 (star)	PTO 4017961	3.0	118 5/16"	Inner
AW26 (star)	PTO 4047961	1.0	39 3/8"	Inner
AW26 (star)	PTO 6007071	1.5	59 1/16"	Outer
AW26 (star)	PTO 6017071	3.0	118 5/16"	Outer
AW26 (star)	PTO 6047071	1.0	39 3/8"	Outer

**German-Style Shafting & Tubing**

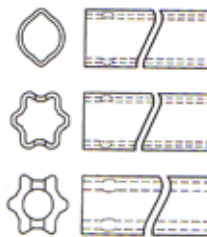

Lemon & Star Profile

**Italian-Style Shafting & Tubing**



Tri-Lobe Profile



## EASY LOCK GUARDING SYSTEM

QUICK REFERENCE  
SECTION

North American



SERIES	OLD GUARDS PART NO.	OLD NYLON BEARING KITS	NEW GUARDS PART NO.	NEW NYLON BEARING KITS
6	PTO 9000648	PTO 9200600/ PTO 9204P15	PTO 9002548	PTO 9210600
	PTO 9000660	PTO 9200600/ PTO 9204P15	PTO 9002560	PTO 9210600
W	PTO 9000748	PTO 9200141	PTO 9002548	PTO 9215170
12	PTO 9001248	PTO 9201200/ PTO 9204P16	PTO 9002548	PTO 9211200
	PTO 9001260	PTO 9201200/ PTO 9204P16	PTO 9002560	PTO 9211200
14	PTO 9001248	PTO 9201200/ PTO 9205071	PTO 9002548	PTO 9211200
	PTO 9001260	PTO 9201200/ PTO 9205071	PTO 9002560	PTO 9211200
35	PTO 9003548	PTO 9203500/ PTO 9205084	PTO 9002548	PTO 9211200
	PTO 9003560	PTO 9203500/ PTO 9205084	PTO 9002560	PTO 9211200
44	PTO 9004448	PTO 9204400	PTO 9023548	PTO 9214400
	PTO 9004460	PTO 9204400	PTO 9023560	PTO 9214400
55	PTO 9004448	PTO 9204400	PTO 9023548	PTO 9214400
	PTO 9004460	PTO 9204400	PTO 9023560	PTO 9214400

**PLEASE NOTE!**

- Not all guard and nylon bearing systems are interchangeable. When purchasing shaft weld and tube weld yokes or guards, make certain there is a proper fit between nylon bearing raceway in yoke and guard. Make sure guard rotates freely on the yokes.
- The nylon bearings provided are the most popular in the replacement market. If the nylon bearing provided is not a proper fit, it is essential that the proper nylon bearing is identified to insure proper performance and safety. To assist in ordering the proper nylon bearing, listed in this brochure are stock numbers and dimensions for nylon bearings.
- All Series North American guards are provided without nylon bearings. To help assure the proper set of nylon bearings are installed, one nylon bearing set will be exactly the same (nylon bearing raceway dimensions) as has always been provided in our aftermarket guards. The other set will be dimensioned to retrofit the Weasler OEM raceway. Assembly instructions included with these nylon bearing kits.
- **ALL GUARDS ARE PROVIDED WITHOUT NYLON BEARINGS - ORDER NYLON BEARINGS SEPARATELY.**

**EASY LOCK GUARDING SYSTEM**
**QUICK REFERENCE SECTION**

INTERCHANGES WITH SERIES	OLD GUARDS PART NO.	OLD NYLON BEARING KITS	NEW GUARDS PART NO.	NEW NYLON BEARING KITS
ByPy 1	PTO 9008134	PTO 9600101	PTO 9002548	PTO 9615029
	PTO 9008148	PTO 9600101	PTO 9002548	PTO 9615029
	PTO 9008154	PTO 9600101	PTO 9002560	PTO 9615029
ByPy 2	PTO 9008234	PTO 9600202	PTO 9002548	PTO 9612502
	PTO 9008248	PTO 9600202	PTO 9002548	PTO 9612502
	PTO 9008254	PTO 9600202	PTO 9002560	PTO 9612502
ByPy 3 & 4	PTO 9008234	PTO 9600234	PTO 9002548	PTO 9612534
	PTO 9008248	PTO 9600234	PTO 9002548	PTO 9612534
	PTO 9008254	PTO 9600234	PTO 9002560	PTO 9612534
ByPy 5	PTO 9008534	PTO 9600305	PTO 9023548	PTO 9613505
	PTO 9008548	PTO 9600305	PTO 9023548	PTO 9613505
	PTO 9008554	PTO 9600305	PTO 9023560	PTO 9613505
ByPy 6	PTO 9008634	PTO 9600467	PTO 9023548	PTO 9613567
	PTO 9008648	PTO 9600467	PTO 9023548	PTO 9613567
	PTO 9008654	PTO 9600467	PTO 9023560	PTO 9613567
ByPy 7	PTO 9008634	PTO 9600467	PTO 9023548	PTO 9613567
	PTO 9008648	PTO 9600467	PTO 9023548	PTO 9613567
	PTO 9008654	PTO 9600467	PTO 9023560	PTO 9613567
ByPy 8 & 9	PTO 9006934	PTO 9600489	PTO 9004548	PTO 9614589
	PTO 9006948	PTO 9600489	PTO 9004548	PTO 9614589
	PTO 9006954	PTO 9600489	PTO 9004560	PTO 9614589
W/S 2100 (AW10)	PTO 9008134	PTO 9600105	PTO 9002548	PTO 9615005
	PTO 9008148	PTO 9600105	PTO 9002548	PTO 9615005
	PTO 9008154	PTO 9600105	PTO 9002560	PTO 9615005
W/S 2200 (AW20) & W/S I (AWII)	PTO 9008234	PTO 9600215	PTO 9002548	PTO 9610251
	PTO 9008248	PTO 9600215	PTO 9002548	PTO 9610251
	PTO 9008254	PTO 9600215	PTO 9002560	PTO 9610251
W/S 2300 (AW21)	PTO 9008234	PTO 9600215	PTO 9002548	PTO 9610251
	PTO 9008248	PTO 9600215	PTO 9002548	PTO 9610251
	PTO 9008254	PTO 9600215	PTO 9002560	PTO 9610251
W/S 220 (AW22), W/S 2400 (AW35) & W/S 2500 (AW36)	PTO 9008534	PTO 9600325	PTO 9023548	PTO 9613525
	PTO 9008548	PTO 9600325	PTO 9023548	PTO 9613525
	PTO 9008554	PTO 9600325	PTO 9023560	PTO 9613525
W/S 2600 (AW26)	PTO 9008634	PTO 9600435	PTO 9004548	PTO 9614535
	PTO 9008648	PTO 9600435	PTO 9004548	PTO 9614535
	PTO 9008654	PTO 9600435	PTO 9004560	PTO 9614535

**EASY LOCK GUARDING SYSTEM**

**QUICK REFERENCE SECTION**

**Nylon Bearing Repair Kits**

**TYPE A - FITS 250 GUARDS**

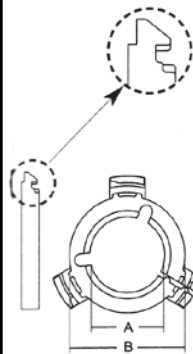

NORTH AMERICAN SERIES						
PART NO.	SERIES	GUARD TYPE	DIM A INNER BRG ID	DIM B INNER BRG OD	DIM A OUTER BRG ID	DIM B OUTER BRG OD
PTO 9210600	6	250	46.4 mm (1.83")	71.4 mm (2.81")	46.4 mm (1.83")	71.4 mm (2.81")
PTO 9211200	12, 14 & 35	250	52.8 mm (2.08")	71.4 mm (2.81")	52.8 mm (2.08")	71.4 mm (2.81")
PTO 9215170	W	250	41.8 mm (1.65")	71.4 mm (2.81")	41.8 mm (1.65")	71.4 mm (2.81")
METRIC SERIES						
PART NO.	SERIES	GUARD TYPE	DIM A INNER BRG ID	DIM B INNER BRG OD	DIM A OUTER BRG ID	DIM A2 OUTER BRG OD
PTO 9615029	ByPy 1	250	34.5 mm (1.36")	71.4 mm (2.81")	40.4 mm (1.59")	71.4 mm (2.81")
PTO 9612502	ByPy 2	250	40.4 mm (1.59")	71.4 mm (2.81")	47.4 mm (1.87")	71.4 mm (2.81")
PTO 9612534	ByPy 3 & 4	250	47.4 mm (1.87")	71.4 mm (2.81")	53.4 mm (2.10")	71.4 mm (2.81")
PTO 9615005	W/S 2100	250	41.4 mm (1.63")	71.4 mm (2.81")	41.4 mm (1.63")	71.4 mm (2.81")
PTO 9610251	W/S 2200, W/S 1 & W/S 2300	250	50.8 mm (2.00")	71.4 mm (2.81")	50.8 mm (2.00")	71.4 mm (2.81")

**TYPE B - FITS 350/450 GUARDS**

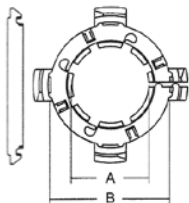

NORTH AMERICAN SERIES						
PART NO.	SERIES	GUARD TYPE	DIM A INNER BRG ID	DIM B INNER BRG OD	DIM A OUTER BRG ID	DIM B OUTER BRG OD
PTO 9214400	44 & 55	350	67.2 mm (2.65")	83.6 mm (3.29")	67.2 mm (2.65")	83.6 mm (3.29")
METRIC SERIES						
PART NO.	SERIES	GUARD TYPE	DIM A INNER BRG ID	DIM B INNER BRG OD	DIM A OUTER BRG ID	DIM B OUTER BRG OD
PTO 9613505	ByPy 5	350	53.5 mm (2.11")	83.6 mm (3.29")	62.7 mm (2.47")	83.6 mm (3.29")
PTO 9613567	ByPy 6 & 7	350	59.4 mm (2.34")	83.6 mm (3.29")	68.4 mm (2.69")	83.6 mm (3.29")
PTO 9614589	ByPy 8 & 9	450	68.4 mm (2.69")	103 mm (4.06")	80.4 mm (3.17")	103 mm (4.06")
PTO 9613525	W/S 220, W/S 2400 & W/S 2500	350	62.5 mm (2.46")	83 mm (3.27")	62.5 mm (2.46")	83 mm (3.27")
PTO 9614535	W/S 2600	450	82.8 mm (3.26")	103 mm (4.05")	82.8 mm (3.26")	103 mm (4.05")

**TYPE C**

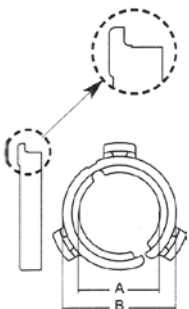

PREVIOUS-STYLE METRIC NYLON BEARING KIT						
PART NO.	SERIES	DIM A INNER BRG ID	DIM B INNER BRG OD	DIM A OUTER BRG ID	DIM B OUTER BRG OD	
PTO 9600101	ByPy 1	34.8 mm (1.37")	57 mm (2.24")	40.8 mm (1.61")	57 mm (2.24")	
PTO 9600202	ByPy 2	40.4 mm (1.59")	71.4 mm (2.81")	47.4 mm (1.87")	71.4 mm (2.81")	
PTO 9600234	ByPy 3 & 4	47.4 mm (1.87")	71.4 mm (2.81")	53.4 mm (2.10")	71.4 mm (2.81")	
PTO 9600305	ByPy 5	53.4 mm (2.10")	81.7 mm (3.22")	62.7 mm (2.47")	81.7 mm (3.22")	
PTO 9600467	ByPy 6 & 7	59.4 mm (2.34")	98.8 mm (3.89")	68.4 mm (2.69")	98.8 mm (3.89")	
PTO 9600489	ByPy 8 & 9	68.4 mm (2.69")	98.8 mm (3.89")	80.4 mm (3.17")	98.8 mm (3.89")	
PTO 9600105	W/S 2100	41.4 mm (1.63")	57 mm (2.24")	41.4 mm (1.63")	57 mm (2.24")	
PTO 9600215	W/S 2200, AW11 & W/S 2300	50.8 mm (2.00")	71.4 mm (2.81")	50.8 mm (2.00")	71.4 mm (2.81")	
PTO 9600325	W/S 220, W/S 2400 & W/S 2500	62.7 mm (2.47")	81.7 mm (3.22")	62.7 mm (2.47")	81.7 mm (3.22")	
PTO 9600435	W/S 2600	82.8 mm (3.26")	98.8 mm (3.89")	82.8 mm (3.26")	98.8 mm (3.89")	

**EASY LOCK GUARDING SYSTEM**

**QUICK REFERENCE SECTION**

**Previous-Style North American Nylon Bearing Kit**

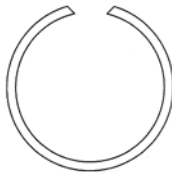
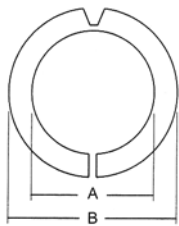
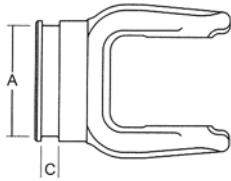

METAL RETAINING RING

PART NO.	DIM A YOKE RACEWAY O.D. NYLON BEARING I.D.	DIM B NYLON BEARING O.D.	DIM C YOKE RACEWAY WIDTH NYLON BEARING WIDTH
PTO 9200017	2.15" (2 5/32")	2.76" (2 3/4")	.36" (23/64")
PTO 9200069	1.77" (1 49/64")	2.76" (2 3/4")	.36" (23/64")
PTO 9200085	2.02" (2 1/64")	2.76" (2 3/4")	.36" (23/64")
PTO 9200102	1.41" (1 13/32")	2.02" (2 1/64")	.30" (19/64")
PTO 9200141	1.65" (1 21/32")	2.76" (2 3/4")	.36" (23/64")
PTO 9200165	2.15" (2 5/32")	3.26" (3 17/64")	.36" (23/64")
PTO 9200195	1.78" (1 25/32")	2.52" (2 33/64")	.37" (3/8")
PTO 9200254	1.64" (1 41/64")	2.25" (2 1/4")	.29" (19/64")
PTO 9200259	2.03" (2 1/32")	3.26" (3 17/64")	.36" (23/64")
PTO 9200260	1.39" (1 25/64")	2.77" (2 49/64")	.36" (23/64")
PTO 9200600	1.83" (1 53/64")	2.76" (2 3/4")	.25" (1/4")
PTO 9201200	2.09" (2 3/32")	2.77" (2 49/64")	.32" (21/64")
PTO 9202600	2.86" (2 55/64")	3.56" (3 9/16")	.34" (11/32")
PTO 9203500	2.08" (2 5/64")	2.76" (2 3/4")	.32" (21/64")
PTO 9204400	2.65" (2 21/32")	3.26" (3 17/64")	.36" (23/64")
PTO 9204P15	1.65" (1 21/32")	2.76" (2 3/4")	.30" (19/64")
PTO 9204P16	1.77" (1 49/64")	2.76" (2 3/4")	.36" (23/64")
PTO 9205071	2.02" (2 1/64")	2.76" (2 3/4")	.36" (23/64")
PTO 9205084	2.15" (2 5/32")	2.76" (2 3/4")	.36" (23/64")

(Kit includes nylon bearing and metal retaining ring)

**REPRESENTATIVE DRIVELINE SHOWING OVERALL LENGTH**

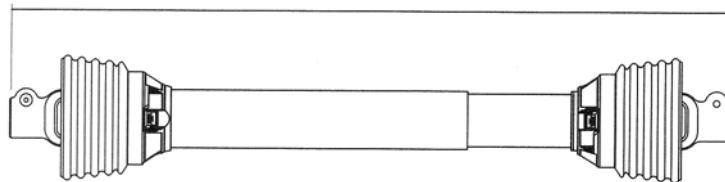

**REPRESENTATIVE DRIVELINE SHOWING CENTERLINE TO CENTERLINE**

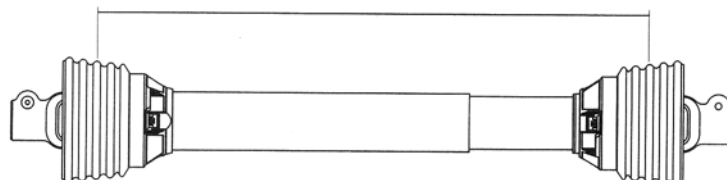

# 1000 SERIES CROSS REFERENCE

## QUICK REFERENCE SECTION

NEAPCO PART NO.	WESTWARD PART NO.
-	PTO 8021015
-	PTO 8021016
-	PTO 100011036
1-0170	PTO 2001000
10-0322	PTO 100011014
10-0333	PTO 100011012
10-0383	PTO 100011007
10-0411	PTO 8011018
10-0412	PTO 8041014
10-0413	PTO 100011045
10-0422	PTO 8041012
10-0423	PTO 100011056
10-0452	PTO 8041016
10-0463 or 10-4453	PTO 100011049
10-0473	PTO 8001015
10-0483	PTO 8001016
10-0493	PTO 100011051
10-1532	PTO 100011034
10-1557	PTO 100011037
10-1574	PTO 8061019
10-1702	PTO 100011039
10-1703	PTO 100011040
10-1705	PTO 100011041
10-1707	PTO 100011043
10-1708	PTO 100011044
10-1765	PTO 8121020
10-3122	PTO 100011015
10-3163	PTO 100011013
10-3183	PTO 100011062
10-4123	PTO 100011055
10-4139	PTO 1021006
10-4143	PTO 100011053
10-4153	PTO 8001019
10-4163	PTO 8001017
10-4173	PTO 8001013
10-4183	PTO 100011058
10-4193	PTO 100011054
10-4293	PTO 100011060
10-4363	PTO 8021020
10-4373	PTO 8001010
10-4443	PTO 100011059
10-4473	PTO 100011052
10-4481	PTO 8011013
10-4573 or 10-4493	PTO 100011033
10-4693	PTO 100011038
10-4943	PTO 100011057
10-5113	PTO 100011048
10-5129	PTO 3001000
10-5131	PTO 7001000
10-5149	PTO 100011035
10-5216	PTO 100011061
10-5313	PTO 8061013
10-5354	PTO 100011042

SPICER PART NO.	WESTWARD PART NO.
-	PTO 3001000
-	PTO 7001000
-	PTO100011044
-	PTO 8021016
-	PTO 8021020
-	PTO 100011034
-	PTO 100011042
-	PTO 100011043
-	PTO 100011037
-	PTO 100011035
-	PTO 100011036
-	PTO 8061013
-	PTO 100011061
-	PTO 8061019
10-3-122X	PTO 100011015
10-3-163X	PTO 100011013
10-3-183X	PTO 100011062
10-3-22X	PTO 100011014
10-3-33X	PTO 100011012
10-3-51X	PTO 8121020
10-3-83X	PTO 100011007
10-4-110X	PTO 1021006
10-4-103	PTO 100011053
10-4-11	PTO 8011018
10-4-113	PTO 100011052
10-4-12	PTO 8041014
10-4-123	PTO 100011054
10-4-13 or 10-4-133	PTO 100011045
10-4-153	PTO 8001019
10-4-163	PTO 8001017
10-4-183	PTO 100011058
10-4-193	PTO 100011055
10-4-22	PTO 8041012
10-4-23	PTO 100011056
10-4-293	PTO 100011060
10-4-373	PTO 8001010
10-4-43	PTO 8001013
10-4-443	PTO 100011059
10-4-453 or 10-4-253	PTO 100011049
10-4-481	PTO 8011013
10-4-52	PTO 8041016
10-4-53	PTO 100011057
10-4-573	PTO 100011051
10-4-63	PTO 100011048
10-4-643	PTO 8021015
10-4-693	PTO 100011038
10-4-703	PTO 100011040
10-4-713	PTO 100011039
10-4-723	PTO 100011041
10-4-73	PTO 8001015
10-4-83	PTO 8001016
10-4-93	PTO 100011033
HM170	PTO 2001000

**STANDARD SPLINES FOR AGRICULTURE**

**1" X 15**

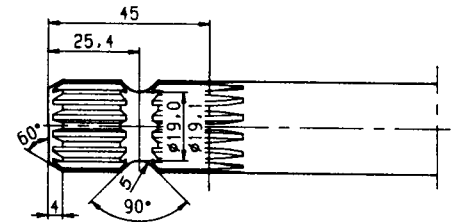
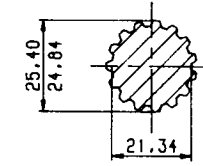
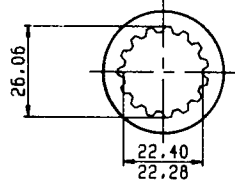

**1 1/8" X 6**

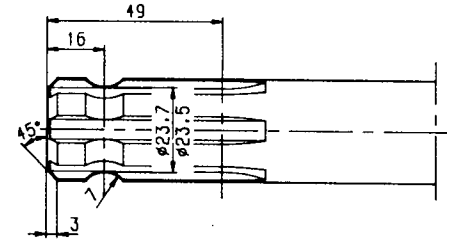
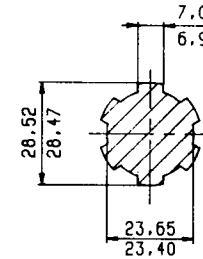
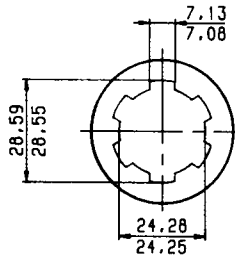

**TYPE 1  
1 3/8" X 6**

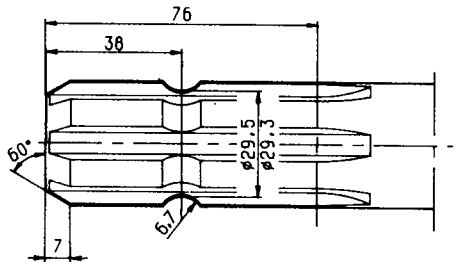
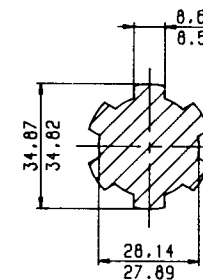
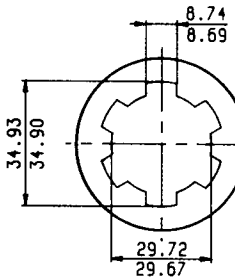

**TYPE 2  
1 3/8" X 21**

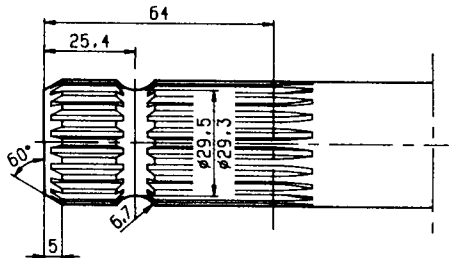
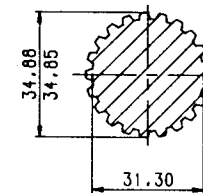
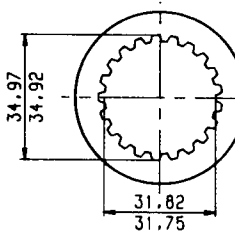

**1 3/4" X 6**

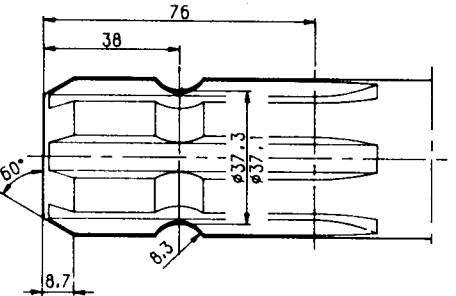
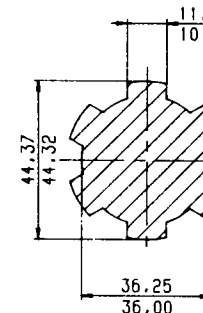
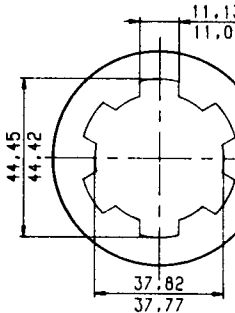

**TYPE 3  
1 3/4" X 20**

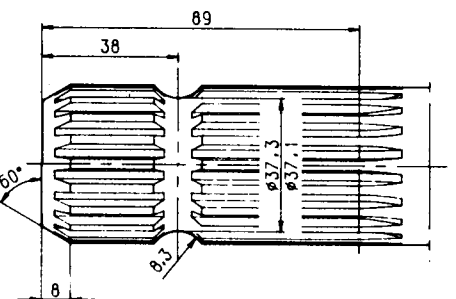
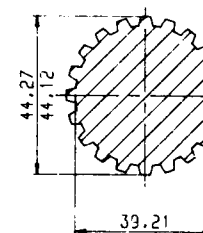
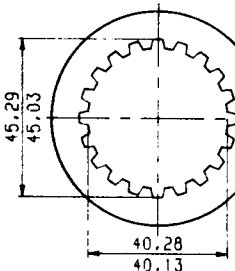

## PTO CROSS & BEARING "E" KITS

### E EXTENDED LUBRICATION

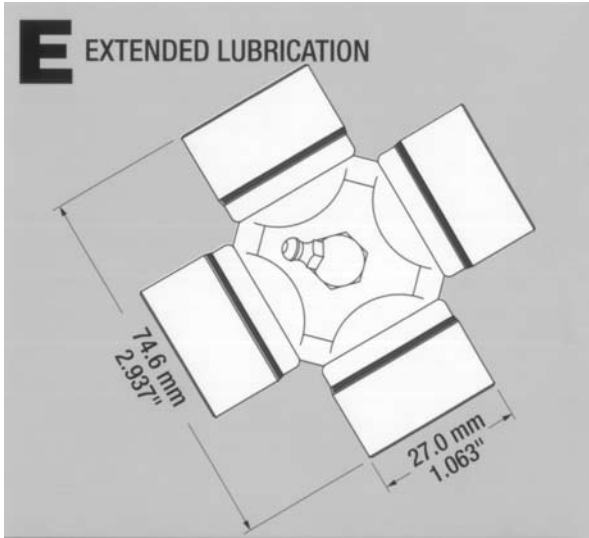

### ENOUGH LUBE FOR THE ENTIRE SEASON!

- Higher torque capacity
- Interchangeable with standard kit
- More production between lube cycles
- Reduced downtime on drivelines
- Larger roller bearings
- Superior performance!
- Improved orange triple lipped seal for longer life

#### PTO 12002400 North American Point of Purchase Display

Includes:

4 of PTO 2010600	10 of PTO 2013500
6 of PTO 2011200	2 of PTO 2014400
6 of PRO 2011400	2 of PTO 2015500

#### PTO 12008400 Metric Point of Purchase Display

Includes:

4 of PTO 2016154	2 of PTO 2017989
2 of PTO 2016580	2 of PTO 2018261
2 of PTO 2016806	2 of PTO 2018370
2 of PTO 2017155	8 of PTO 2018474
2 of PTO 2017676	2 of PTO 2018692

PART NO.	DESCRIPTION
NORTH AMERICAN E-KITS	
PTO 2010600	$3^{1/32}$ " to $2^{5/16}$ "
PTO 2011200	$1^{1/16}$ " to $2^{9/16}$ "
PTO 2011400	$1^{1/8}$ " to $2^{5/8}$ "
PTO 2013500	$1^{1/4}$ " to $3^{7/32}$ "
PTO 2014400	$1^{5/16}$ " to 4"
PTO 2015500	$1^{17/32}$ " x $4^{5/16}$ "
METRIC E-KITS	
PTO 2016154	22 x 54 mm
PTO 2016580	30.2 x 80 mm
PTO 2016794	35 x 94 mm
PTO 2016806	35 x 106.5 mm
PTO 2016908	41 x 108 mm
PTO 2017004	42 x 104 mm
PTO 2017155	22 x 55 mm
PTO 2017276	-

PART NO.	DESCRIPTION
METRIC E-KITS	
PTO 2017491	-
PTO 2017676	32 x 76 mm
PTO 2017694	-
PTO 2017906	-
PTO 2017989	36 x 89 mm
PTO 2018261	23.8 x 61.3 mm
PTO 2018370	27 x 70 mm
PTO 2018474	27 x 74.6 mm
PTO 2018692	30.2 x 92 mm
PTO 2018706	30.2 x 106.5 mm
NORTH AMERICAN POINT OF PURCHASE DISPLAY	
PTO 12002400	Standard Display
METRIC POINT OF PURCHASE DISPLAY	
PTO 12008400	Metric Display

**LOCKING DEVICE**

**QUICK REFERENCE SECTION**



**Safety Slide Lock**

An exclusive Weasler replacement component, the Safety Slide Lock\* yoke is locked in place by two hardened pawls with compound radii that conform to the groove in the shaft for full contact. The device is particularly applicable where there is appreciable end thrust.

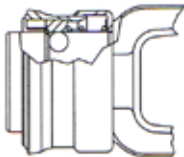

**Spring-Lok**

The collar is spring loaded for ease of installation and positive locking to tractor shaft.

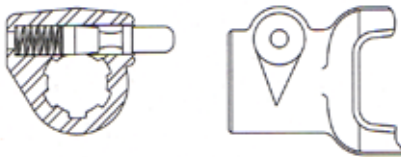

**Quick Disconnect**

A smooth plunger eliminates sharp projections such as x-washers. Trails rather than leads rotation.

**LOCKING DEVICE REPAIR KIT**

**\*Auto-Lok/Safety Slide Lock**



PART NO.	DESCRIPTION
PTO 13004000	Repair Kit for Weasler Auto-Lok and Safety Slide Lock 6 Spline & 21 Spline
PTO 13004020	Repair Kit for Weasler Auto-Lok and Safety Slide Lock 20 Spline
PTO 13004015	Repair Kit for 1" x 15 Spline

*\*This repair kit contains both balls & pawls. When repairing the "Safety Slide Lock" use the pawls only and discard the balls. When repairing the "Auto-Lok" use both the balls and the pawls.*

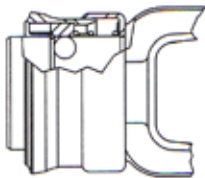

**Spring-Lok**

PART NO.	DESCRIPTION
PTO 13003100	Repair Kit for Weasler Spring-Lok, 6 Spline & 21 Spline
PTO 13003115	1" x 15 Spline

**Quick Disconnect**

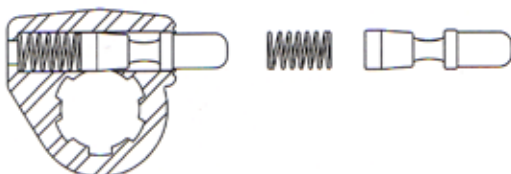

PART NO.	DESCRIPTION
PTO 13002006	Repair Kit for Weasler and Rockwell 6 Spline
PTO 13002806	Repair Kit for 1 3/4" x 6 Spl.
PTO 13002021	Weasler 21 Spline and Hex Quick Disconnect
PTO 13002020	Weasler 20 Spline

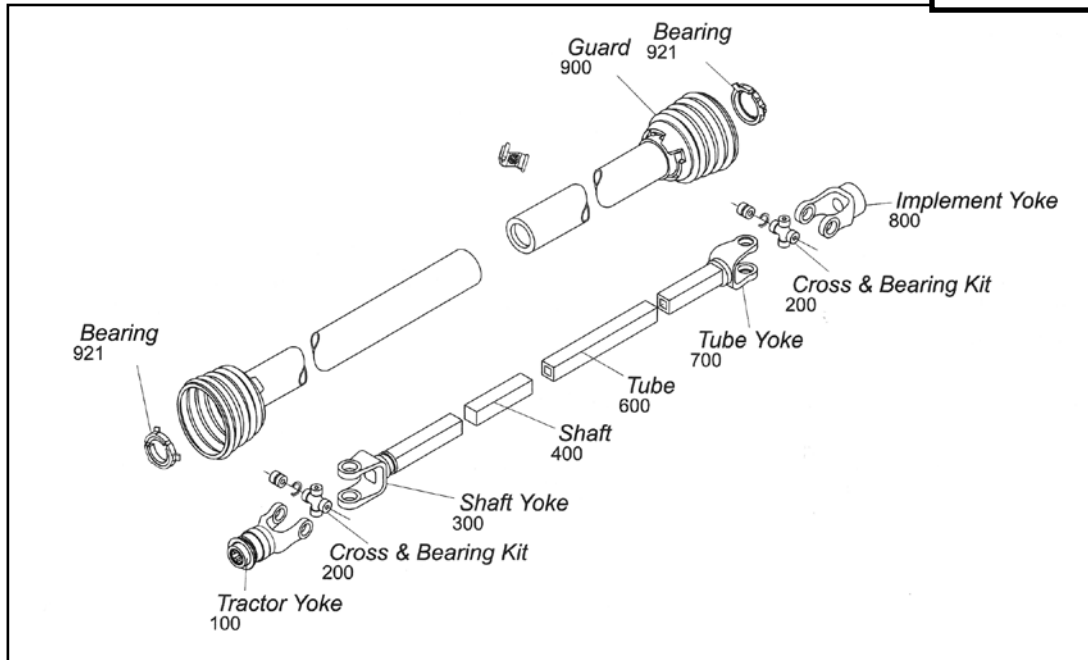

## PART NUMBER EXPLANATION

DRIVELINE  
COMPONENTS

Each series has an exploded view for identification purposes. The drawing illustrates the components in the same sequence as an implement input driveline transmitting power from tractor to implement. Each component of the exploded view is identified by an eight digit stock number to insure correct identification of each component.

Example: 100 prefix denotes a Spring-Lok Tractor Yoke on the exploded view. (When ordering a tractor yoke, be sure the stock number begins with 100.)

Number Identification Examples:

102-06 06  
 6 Spline  
 6 Series  
 QD Yoke  
 Tractor Yoke

200-06 00  
 6 Series  
 Cross & Bearing Kit

300-12 00  
 12 Series  
 Shaft Weld Yoke

400-16 18  
 \*1 1/8"  
 \*1"  
 Shaft

500-35 00  
 35 Series  
 Slip Sleeve

602-44 00  
 44 Series  
 Tube

701-44 00  
 44 Series  
 Tube Weld Yoke

800-35 24  
 \*1 1/2" Round Bore  
 35 Series  
 Implement Yoke

900-45 48  
 For 48" O.A. Driveline  
 Guard Type  
 Plastic Guard

(\*Expressed in 1/16 inches.)

**TRANSPARENCY IDENTIFICATION SYSTEM**

**DRIVELINE COMPONENTS**

**For Driveline Components**

The individual transparency cards will allow the user to easily identify driveline components. Cross and Bearing Kits may be identified by the bearing cap outside diameter and the width of the cross. Yokes may be identified by the hole in the ear and profile. Tubes and shafts may be identified by the end sections.

How to use the Transparency Identification System:

1. Match the part to be replaced with the corresponding transparency card for identification.
2. Select the proper stock number for the replacement part.

PART NO.
PTO 12002500

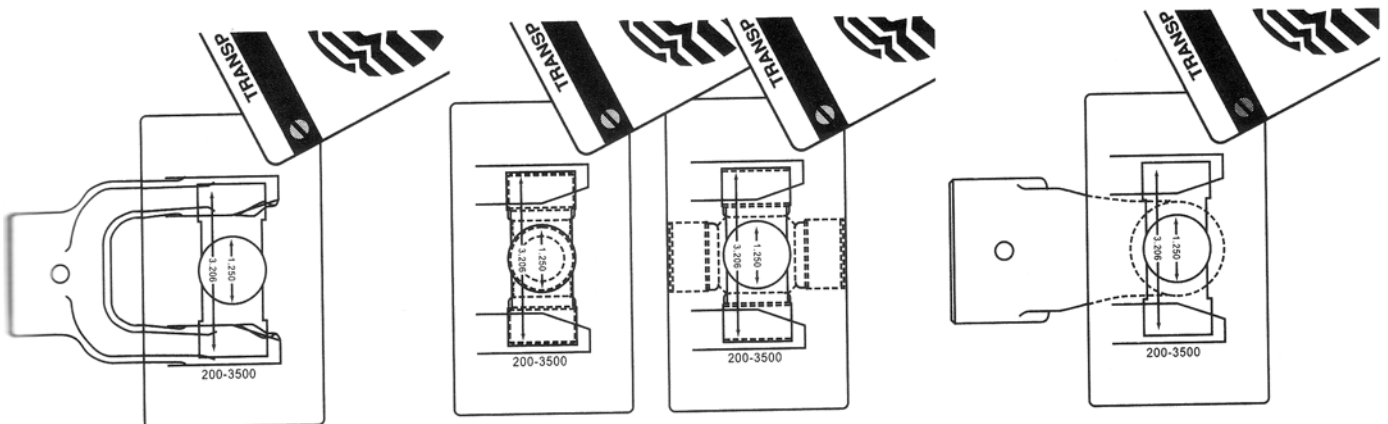
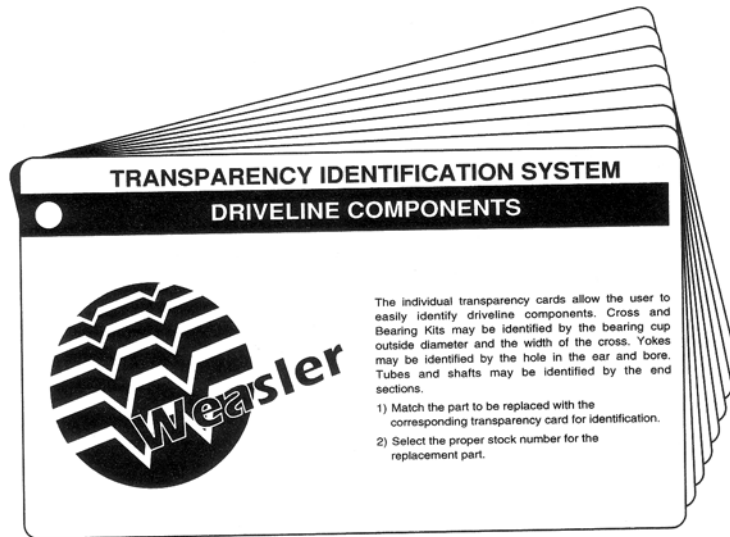

6 SERIES

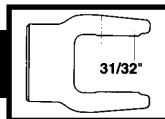

DRIVELINE COMPONENTS

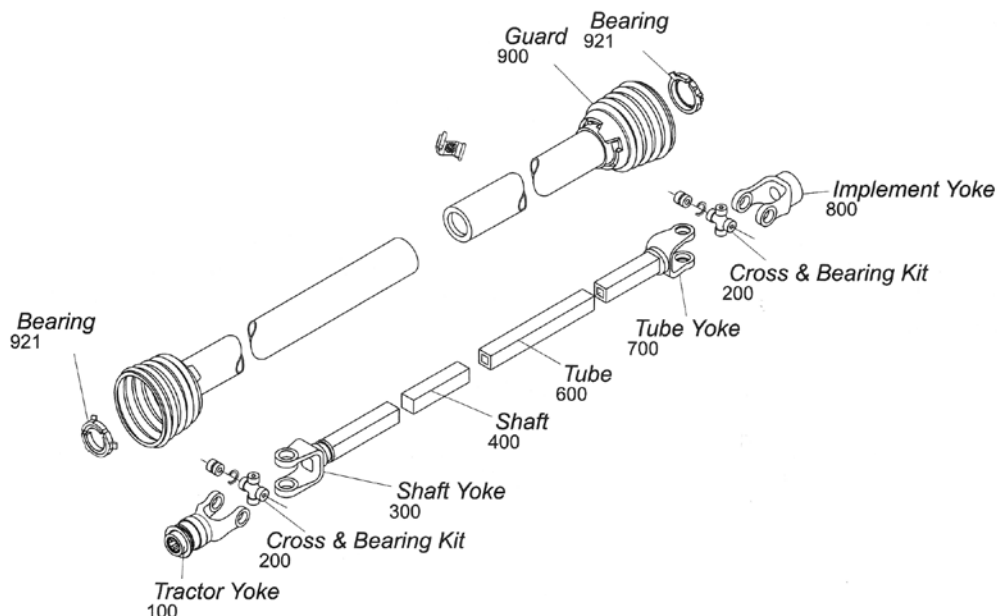

Tractor Yoke

Spring-Lok

Repair Kit - Page 49

PART NO.	DIM. "A" BORE
PTO 1000606	1 3/8" x 6 Spl.
PTO 1000621	1 3/8" x 21 Spl.

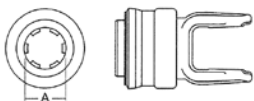

Auto-Lok

Repair Kit - Page 49

PART NO.	DIM. "A" BORE
PTO 1010610	.981" x 10 Spl.
PTO 1010615	1" x 15 Spl.



Quick Disconnect

Repair Kit - Page 49

PART NO.	DIM. "A" BORE
PTO 1020606	1 3/8" x 6 Spl.
PTO 1020621	1 3/8" x 21 Spl.



Spring-Lok (metal collar)

Lawn & Garden

Repair Kit - Page 49

PART NO.	DIM. "A" BORE
PTO 1050610 (Auto-Lok)	.98" x 10 Spl.
PTO 1050615 (Spring-Lok)	1" x 15 Spl.

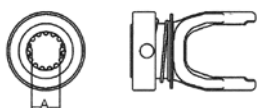

Male Spline

Lawn & Garden

PART NO.	DIM. "A"	DIM. "B"
PTO 1060615	1" x 15 Spl.	5.38

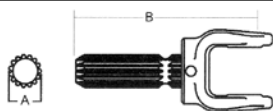

Cross & Bearing Kit (R-Kit)

Snap Ring Located in Bushing

PART NO.	DIM. "A"	DIM. "B"
PTO 2000600	31/32"	2 9/32"

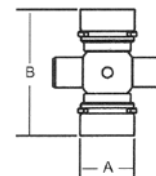

Extended Lubrication Cross & Bearing Kit (E-Kit)

Snap Ring Located in Bushing

PART NO.	DIM. "A"	DIM. "B"
PTO 2010600	31/32"	2 9/32"

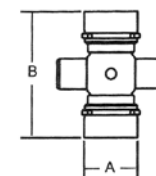

Shaft Weld Yoke

With Bearing Groove  
(Guard must rotate freely on yoke)

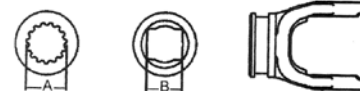

PART NO.	DIM. "A" BORE	DIM. "B" BORE
PTO 3000600	-	3/4" x 7/8"
PTO 3020600	1" x 15 Spl.	-
PTO 3030600	-	3/4" x 7/8"

Without Bearing Groove

PART NO.	DIM. "A" BORE
PTO 3010600	1" x 15 Spl.



**6 SERIES**

**DRIVELINE COMPONENTS**

**Shaft**

3/4" x 7/8"  
Rectangular

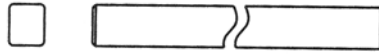

PART NO.	LENGTH
PTO 4001214	6'
PTO 4011214	10'
PTO 4041214	3'

1" x 15 Spline  
(Induction Hardened)



PART NO.	LENGTH
PTO 4041615H	3'

**Slip Sleeve**

With Grease Groove

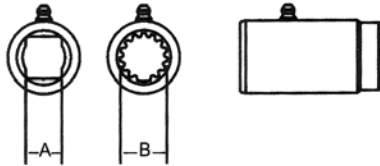

PART NO.	LENGTH	DIM "A" BORE	DIM "B" BORE	FITS TUBE SIZE
PTO 5100600	4"	3/4" x 7/8" Rect.	-	1 1/2" (.065 Wall)
PTO 5100615	3"	-	1" x 15 Spl.	1 1/2" (.065 Wall)

**Tube**

1" x 1 1/8"  
Rectangular O.D.



PART NO.	LENGTH	FITS SHAFT
PTO 6001618	6'	3/4" x 7/8"
PTO 6011618	10'	3/4" x 7/8"
PTO 6041618	3'	3/4" x 7/8"

1 1/2" Round (.065 Wall) O.D.

PART NO.	LENGTH
PTO 6020600	6'
PTO 6040600	3'



**Tube Weld Yoke**

With Bearing Groove  
(Guard must rotate freely on yoke)



PART NO.	DIM. "A" BORE	FITS TUBE SIZE
PTO 7000600	1" x 1 1/8"	-
PTO 7010600	-	1 1/2" (.065 Wall)

(Guard must rotate freely on yoke)

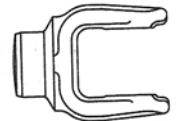

PART NO.	FITS TUBE SIZE
PTO 7020600 (without Bearing Groove)	1 1/2" (.065 Wall)
PTO 7030600 (with Groove)	1 1/2" (.065 Wall)

**Implement Yoke**

Round Bore  
With Keyway & Set Screw



PART NO.	DIM "A" BORE	STANDARD KEYWAY
PTO 8000610	5/8"	3/16"
PTO 8000612	3/4"	3/16"
PTO 8000613	13/16"	3/16"
PTO 8000614	7/8"	3/16"
PTO 8000615	15/16"	1/4"
PTO 8000616	1"	1/4"
PTO 8000618	1 1/8"	1/4"
PTO 8000619	1 3/16"	1/4"
PTO 8000620	1 1/4"	1/4"

**Spline Bore**

With 1/4" Pin Hole

PART NO.	DIM "A" BORE
PTO 8010606	1 3/8" x 6 Spl.
PTO 8010618	1 1/8" x 6 Spl.

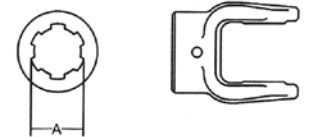

**Shear Pin**

With 1/4" Pin Hole

PART NO.	DIM "A" BORE
PTO 8020616	1"
PTO 8020618	1 1/8"
PTO 8020620	1 1/4"
PTO 8020614	7/8"

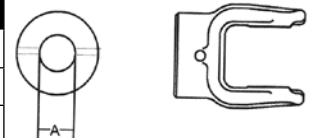

6 SERIES

DRIVELINE COMPONENTS

Implement Yoke (cont'd)

Square Bore  
With Set Screw

PART NO.	DIM "A" BORE
PTO 8040612	3/4"
PTO 8040614	7/8"
PTO 8040616	1"
PTO 8040618	1 1/8"
PTO 8040620	1 1/4"

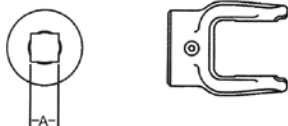

Round Bore  
Double Keyway & Set Screw

PART NO.	DIM "A" BORE	DOUBLE KEYWAY
PTO 8060610	5/8"	3/16" & 1/8"
PTO 8060612	3/4"	3/16" & 1/4"
PTO 8060613	13/16"	3/16" & 1/4"
PTO 8060614	7/8"	3/16" & 1/4"
PTO 8060616	1"	3/16" & 1/4"
PTO 8060618	1 1/8"	1/4" & 5/16"
PTO 8060619	1 3/16"	1/4" & 5/16"
PTO 8060620	1 1/4"	1/4" & 5/16"

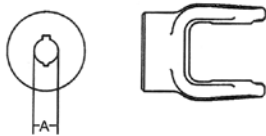

Clamp Yoke  
With Bolt Hole & Set Screw

PART NO.	DIM "A" BORE	DIM "B" BORE	KEYWAY
PTO 8070614	7/8"	-	3/16"
PTO 8070615	-	1" x 15 Spl.	-
PTO 8070616	1"	-	1/4"

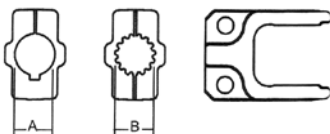

Stock Bore  
With Hub O.D. Turned

PART NO.	DIM "A" BORE
PTO 8090608	1/2"

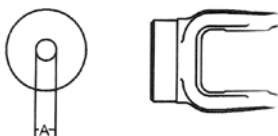

Slip Sleeve Yoke

PART NO.	DIM "A" BORE	DIM "B" BORE	DIM "C" BORE	DIM "D" LENGTH
PTO 8080612	3/4" Sq.	-	-	5 1/2"
PTO 8080614	7/8" Sq.	-	-	5 1/2"
PTO 8120615	-	1" x 15 Spl.	-	5 1/2"
PTO 8130600	-	-	3/4" x 7/8" Rect.	5 1/2"



Yoke & Shaft Assembly

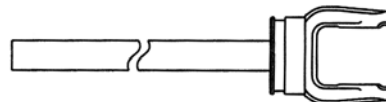

PART NO.	SHAFT SIZE	CENTERLINE TO END OF SHAFT DIMENSION
PTO 10000610	1" x 15 Spl.	12.50"
PTO 10000648	3/4" x 7/8"	38.75"

Yoke & Tube Assembly

1" x 1 1/8" Tube

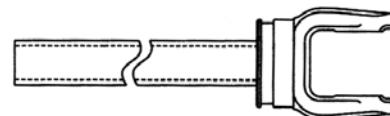

PART NO.	FITS SHAFT	CENTERLINE TO END OF TUBE DIMENSION
PTO 11000648	3/4" x 7/8"	38.75"

Guard

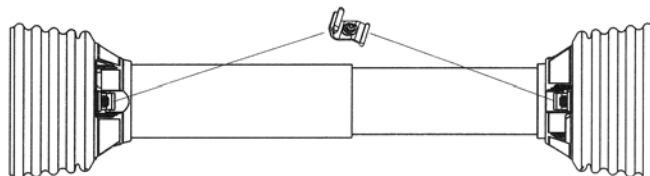

Order bearings as required.

PART NO.	OVERALL DRIVELINE LENGTH	BEARING KIT (2 PER KIT)
PTO 9002548	48"	PTO 9210600
PTO 9002560	60"	PTO 9210600

Assembly instructions included with guard.

Note: When installing Guards, observe the following:

- 1) Install proper nylon bearing (see page 10).
- 2) Guards must rotate freely on yokes.

Easy Lock™ Replacement Kit

PART NO.
PTO 13005000 (4 per kit)



**6 SERIES**

**DRIVELINE COMPONENTS**

**Universal Joints**

**Round to Round**

Furnished with Keyway & Set Screw

PART NO.	DIM "A" BORE
PTO 15120612	3/4"
PTO 15160616	1"



**Drivelines**

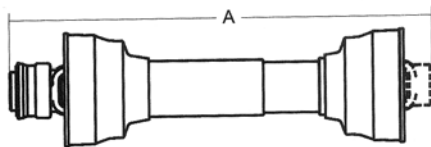

Drivelines are furnished without Cross & Bearing Kit and Implement Yoke. Select kit and Implement Yoke as required. When Cross & Bearing Kit and Implement Yoke are assembled, the overall compressed length of the driveline will be 48".

PART NO.	TRACTOR YOKE	OVERALL COMPRESSED LENGTH DIM "A"
PTO 14000648	1 3/8" x 6 Spl. Spring Lok	48"

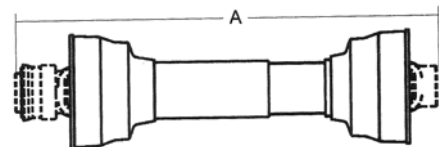

Drivelines are furnished without Cross & Bearing Kit and Outboard Yokes. Select kit and Outboard Yokes as required. When Cross & Bearing Kit and Outboard Yokes are assembled, the overall compressed length of the driveline will be 48".

PART NO.	OVERALL COMPRESSED LENGTH DIM "A"
PTO 14010648	48"

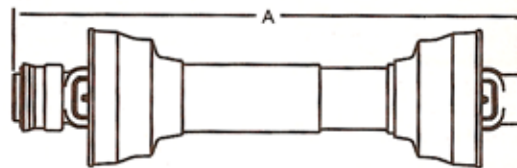

PART NO.	TRACTOR YOKE	IMPLEMENT YOKE	OVERALL COMPRESSED LENGTH DIM "A"	APPLICATION
PTO 14000600	1 3/8" x 6 Spl. Spring Lok	1" Round with 1/2" Pin Hole	39"	Finishing Mower
PTO 14000605	1 3/8" x 6 Spl. Spring Lok	1" Round with 5/16" Pin Hole	32 1/2"	All Purpose
PTO 14000616	1 3/8" x 6 Spl. Spring Lok	1" Round 1/4" Keyway	48"	Auger
PTO 14000620	1 3/8" x 6 Spl. Spring Lok	1 3/8" x 6 Spl. Spring Lok	27 1/4"	Fertilizer Spreader
PTO 14000638	1 3/8" x 6 Spl. Q.D.	1" Round with Pinhole	38"	All Purpose

12 SERIES

DRIVELINE COMPONENTS

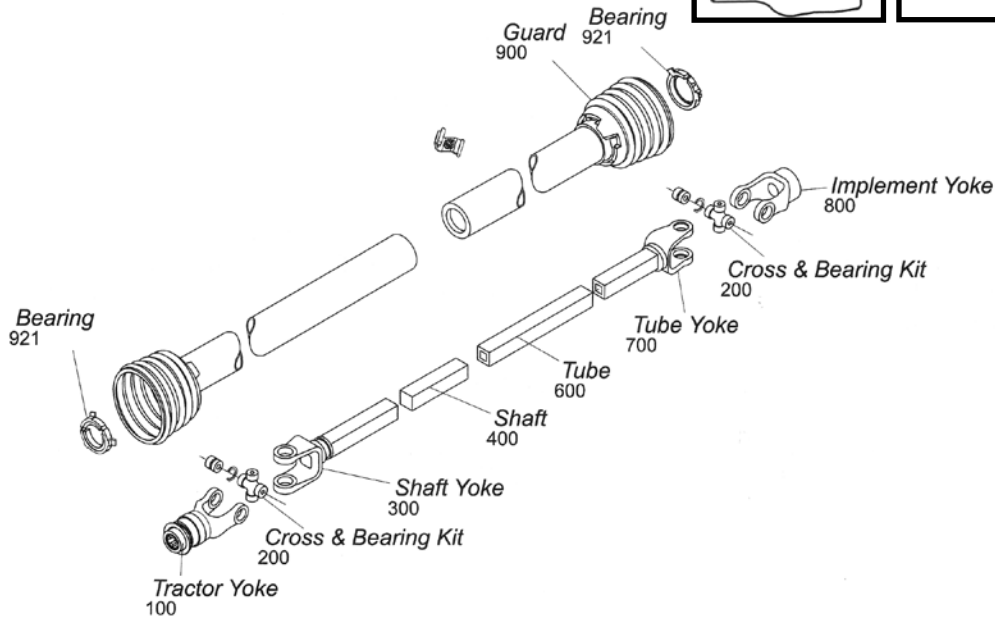

Tractor Yoke

Spring-Lok Repair Kit - Page 49

PART NO.	DIM "A" BORE
PTO 1001206	1 3/8" x 6 Spl.
PTO 1001221	1 3/8" x 21 Spl.

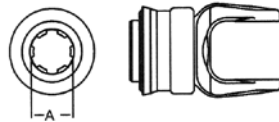

Quick Disconnect Repair Kit - Page 49

PART NO.	DIM "A" BORE
PTO 1021206	1 3/8" x 6 Spl.
PTO 1021221	1 3/8" x 21 Spl.

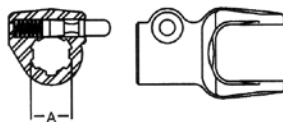

Ball Shear Device With Spring-Lok Repair Kit - Page 49

PART NO.	DIM "A" BORE	SHEAR BOLT
PTO 1041206	1 3/8" x 6 Spl.	5/16" - 18 Gr. 5
PTO 1041221	1 3/8" x 21 Spl.	5/16" - 18 Gr. 5

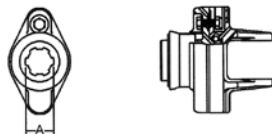

Cross & Bearing Kit (R-Kit)

Snap Ring Located in Bushing

PART NO.	DIM "A"	DIM "B"
PTO 2001200	1 1/16"	2 1/2"

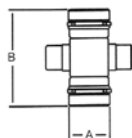

Extended Lubrication Cross & Bearing Kit (E-Kit)

Snap Ring Located in Bushing

PART NO.	DIM "A"	DIM "B"
PTO 2011200	1 1/16"	2 1/2"

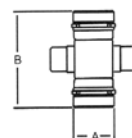

Shaft Weld Yoke

With Bearing Groove (Guard must rotate freely on yoke)

PART NO.	DIM "A" BORE
PTO 3001200	1" x 1 1/8"
PTO 3011200	1 5/16" Sq.

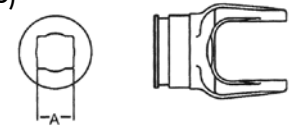

Shaft

1" x 1 1/8" Rectangular

PART NO.	LENGTH
PTO 4001618	6'
PTO 4011618	10'
PTO 4041618	3'



Slip Sleeve

With Grease Groove

PART NO.	DIM "A" BORE	DIM "B" BORE	LENGTH	FITS TUBE SIZE
PTO 5001400	1" x 1 1/8" Rect.	-	5"	2" (.083 Wall)
PTO 5011400	-	1 5/16" x 20 Spl.	8"	2" (.083 Wall)



Tube

1 1/4" x 1 3/8" Rectangular O.D.

PART NO.	LENGTH	FITS SHAFT
PTO 6002022	6'	1" x 1 1/8"
PTO 6012022	10'	1" x 1 1/8"
PTO 6042022	3'	1" x 1 1/8"



**12 SERIES**

**DRIVELINE COMPONENTS**

**Tube (cont'd)**

**2" (.083 Wall)**

PART NO.	LENGTH
PTO 6021400	6'
PTO 6031400	10'
PTO 6041400	3'



**Tube Weld Yoke**

With Bearing Groove  
(Guard must rotate freely on yoke)

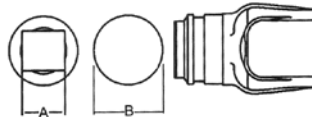

PART NO.	DIM "A" BORE	DIM "B" FITS TUBE SIZE
PTO 7001200	1 1/4" x 1 3/8"	
PTO 7011200	-	2" (.083 Wall)
PTO 7021200	1 1/4" Sq.	

**Implement Yoke**

**Round Bore**

With Keyway & Set Screw

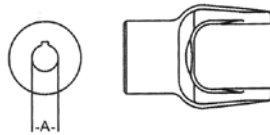

PART NO.	DIM "A" BORE	STANDARD KEYWAY
PTO 8001212	3/4"	3/16"
PTO 8001214	7/8"	3/16"
PTO 8001215	15/16"	1/4"
PTO 8001216	1"	1/4"
PTO 8001218	1 1/8"	1/4"
PTO 8001219	1 3/16"	1/4"
PTO 8001220	1 1/4"	1/4"
PTO 8001222	1 3/8"	5/16"
PTO 8001224	1 1/2"	3/8"

**Spline Bore**

With 21/64" Pin Hole

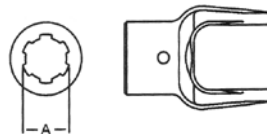

PART NO.	DIM "A" BORE
PTO 8011206	1 3/8" x 6 Spl.
PTO 8011210*	1 3/16" x 10 Spl.
PTO 8011213	.90" x 13 Spl. w/Set Screw
PTO 8011218	1 1/8" x 6 Spl.
PTO 8011221	1 3/8" x 21 Spl.

\*No pin hole

**Implement Yoke (cont'd)**

**Shear Pin**

With 1/4" Pin Hole

PART NO.	DIM "A" BORE
PTO 8021216	1"
PTO 8021218	1 1/8"
PTO 8021220	1 1/4"
PTO 8021222	1 3/8"

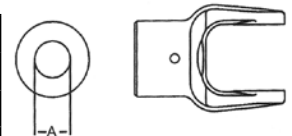

**Square Bore**

With Set Screw

PART NO.	DIM "A" BORE
PTO 8041214	7/8"
PTO 8041216	1"
PTO 8041218	1 1/8"
PTO 8041220	1 1/4"

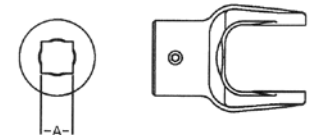

**Hexagon Bore**

With Set Screw

PART NO.	DIM "A" BORE
PTO 8051218	1 1/8"
PTO 8051220	1 1/4"

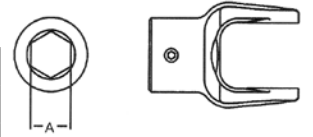

**Round Bore**

Double Keyway & Set Screw

PART NO.	DIM "A" BORE	DOUBLE KEYWAY
PTO 8061216	1"	1/4" & 3/16"
PTO 8061218	1 1/8"	1/4" & 5/16"
PTO 8061220	1 1/4"	1/4" & 5/16"

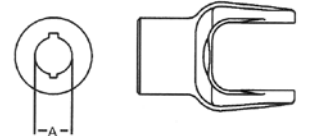

**Stock Bore**

With Hub O.D. Turned

PART NO.	DIM "A" BORE
PTO 8091208	1/2"

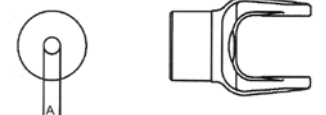

**Slip Yoke**

PART NO.	DIM "A" BORE
PTO 8081216	1" Sq.
PTO 8101216	1" Rd. with 1/4" Keyway
PTO 8101218	1 1/8" Rd. with 5/16" Keyway
PTO 8120615	1" x 15 Spl.
PTO 8111218	1 1/8" Hex

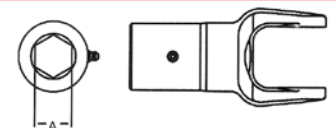



12 SERIES

DRIVELINE COMPONENTS

Yoke & Shaft Assembly

1" x 1 1/8" Shaft

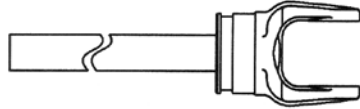

PART NO.	CENTERLINE TO END OF SHAFT DIMENSION
PTO 10001248	37.38"
PTO 10001260	49.38"

Yoke & Tube Assembly

1 1/4" x 1 3/8" Tube

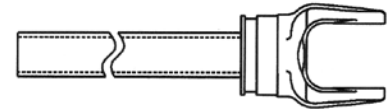

PART NO.	FITS SHAFT	CENTERLINE TO END OF TUBE DIMENSION
PTO 11001248	1" x 1 1/8"	37.38"
PTO 11001260	1" x 1 1/8"	49.38"

Guard

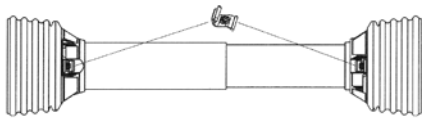

Order Bearings as required

PART NO.	OVERALL DRIVELINE LENGTH	BEARING KIT (2 PER KIT)
PTO 9002548	48"	PTO 9210600
PTO 9002560	60"	PTO 9210600

Assembly instructions included with guard.

Note: When installing Guards observe the following:

- 1) Install proper nylon bearing (See Page 10)
- 2) Guards must rotate freely on yokes.

Easy Lock™ Replacement Kit

PART NO.
PTO 13005000 (4 per kit)



Universal Joint

Spring Lok to Shaft Weld Yoke Repair Kit - Page 49



PART NO.	DIM "A" BORE	DIM "B" BORE
PTO 15061200	1 3/8" x 6 Spl.	1" x 1 1/8" Rect.

Drivelines

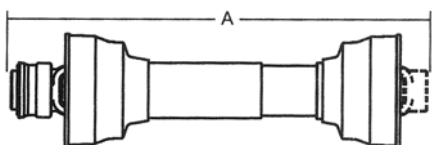

Drivelines are furnished without Cross & Bearing Kit and Implement Yoke. Select kit and Implement Yoke as required. When Cross & Bearing Kit and Implement Yoke are assembled, the overall compressed length of the driveline will be 48" or 60".

PART NO.	TRACTOR YOKE	OVERALL COMPRESSED LENGTH DIM "A"
PTO 14001248	1 3/8" x 6 Spl. Spring Lok	48"
PTO 14001260	1 3/8" x 6 Spl. Spring Lok	60"

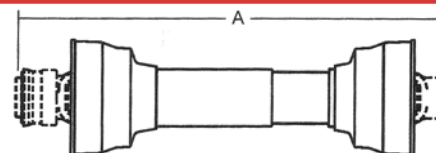

Drivelines are furnished without Cross & Bearing Kit and Outboard Yokes. Select kit and Outboard Yokes as required. When Cross & Bearing Kit and Outboard Yokes are assembled, the overall compressed length of the driveline will be 48" or 60".

PART NO.	OVERALL COMPRESSED LENGTH DIM "A"
PTO 14011248	48"
PTO 14011260	60"
PTO 12021248 (with crosses installed)	48"
PTO 14031248 (with 15/16" Sq. Shaft)	48"

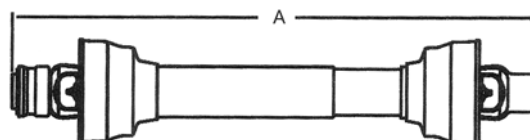

PART NO.	TRACTOR YOKE	IMPLEMENT YOKE	OVERALL COMPRESSED LENGTH DIM "A"	APPLICATION
PTO 14001200	1 3/8" x 6 Spl. Q.D.	1 1/4" Rd with 1/4" Keyway	48"	Post Hole Digger
PTO 14001220	1 3/8" x 6 Spl. Spring Lok	1 1/4" Rd with 1/4" Keyway	48"	Augers

**14 SERIES**

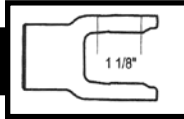

**DRIVELINE COMPONENTS**

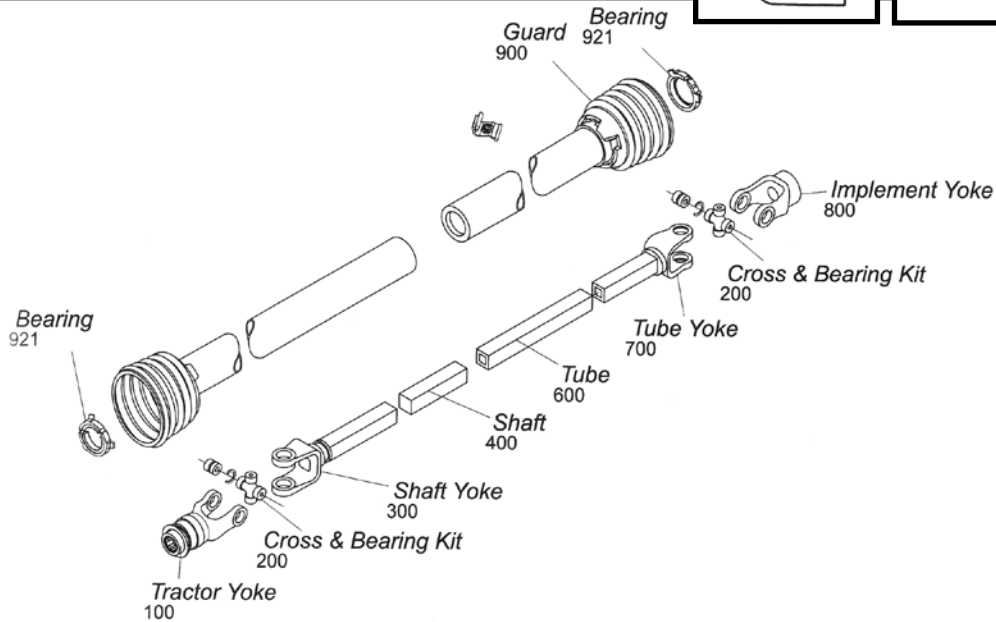

**Tractor Yoke**

**Spring-Lok**

Repair Kit - Page 49

PART NO.	DIM "A" BORE
PTO 1001406	1 3/8" x 6 Spl.
PTO 1001421	1 3/8" x 21 Spl.

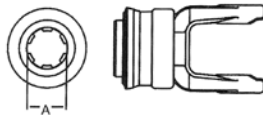

**Safety Slide Lock**

Repair Kit - Page 49

PART NO.	DIM "A" BORE
PTO 1011420	1 3/4" x 20 Spl.

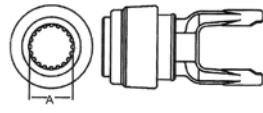

**Quick Disconnect**

Repair Kit - Page 49

PART NO.	DIM "A" BORE	DIM "B" BORE
PTO 1021406	1 3/8" x 6 Spl.	-
PTO 1021418	-	1 1/8" Hex
PTO 1021421	1 3/8" x 21 Spl.	-

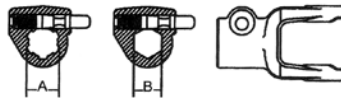

**Ball Shear Device**

With Spring-Lok

Repair Kit - Page 49

PART NO.	DIM "A" BORE	SHEAR BOLT
PTO 1041406	1 3/8" x 6 Spl.	5/16" - 18 Gr. 5
PTO 1041421	1 3/8" x 21 Spl.	5/16" - 18 Gr. 5

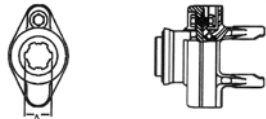

**Cross & Bearing Kit (R-Kit)**

Snap Ring Located in Yoke

PART NO.	DIM "A"	DIM "B"
PTO 2001400	1 1/8"	2 5/8"

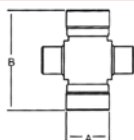

**Extended Lubrication Cross & Bearing Kit (E-Kit)**

Snap Ring Located in Yoke

PART NO.	DIM "A"	DIM "B"
PTO 2011400	1 1/8"	2 5/8"

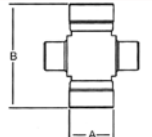

**Shaft Weld Yoke**

With Bearing Groove

(Guard must rotate freely on yoke)

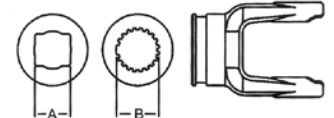

PART NO.	DIM "A" BORE	DIM "B" BORE
PTO 3001400	1" x 1 1/8"	-
PTO 3011400	-	1 5/16" x 20 Spl.

**Shaft**

**1" x 1 1/8" Rectangular**

PART NO.	LENGTH
PTO 4001618	6'
PTO 4011618	10'
PTO 4041618	3'



**1 5/16" x 20 Spline**

Induction Hardened

PART NO.	LENGTH
PTO 4042120	3'



**Slip Sleeve**

1" x 1 1/8" Rectangular  
With Grease Groove

PART NO.	LENGTH	FITS TUBE SIZE
PTO 5001400	5"	2" (.083 Wall)



14 SERIES

DRIVELINE COMPONENTS

Slip Sleeve (cont'd)

1 5/16" x 20 Spline  
With Grease Reservoir

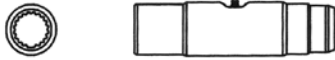

PART NO.	LENGTH	FITS TUBE SIZE
PTO 5011400	8"	2" (.083 Wall)

Tube

1 1/4" x 1 3/8"  
Rectangular O.D.

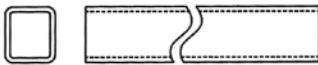

PART NO.	LENGTH	FITS SHAFT
PTO 6002022	6'	1" x 1 1/8"
PTO 6012022	10'	1" x 1 1/8"
PTO 6042022	3'	1" x 1 1/8"

2" Round (.083 Wall)



PART NO.	LENGTH
PTO 6021400	6'
PTO 6031400	10'
PTO 6041400	3'

Tube Weld Yoke

With Bearing Groove  
(Guard must rotate  
freely on yoke)

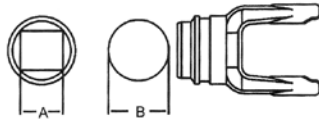

PART NO.	DIM "A" BORE	DIM "B" FITS TUBE SIZE
PTO 7001400	1 1/4" x 1 3/8"	-
PTO 7011400	-	2" (.083 Wall)

Implement Yoke

Round Bore  
With Keyway & Set Screw

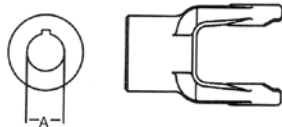

PART NO.	DIM "A" BORE	STANDARD KEYWAY
PTO 8001416	1"	1/4"
PTO 8001418	1 1/8"	1/4"
PTO 8001419	1 3/16"	1/4"
PTO 8001420	1 1/4"	1/4"
PTO 8001422	1 3/8"	5/16"
PTO 8001423	1 7/16"	3/8"
PTO 8001424	1 1/2"	3/8"

Implement Yoke (cont'd)

Spline Bore  
With 21/64" Pin Hole

PART NO.	DIM "A" BORE
PTO 8011406	1 3/8" x 6 Spl.
PTO 8011418	1 1/8" x 6 Spl.
PTO 8011420	1 1/4" x 6 Spl.
PTO 8011421	1 3/8" x 21 Spl.

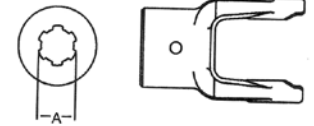

Shear Pin  
With 1/4" Pin Hole

PART NO.	DIM "A" BORE
PTO 8021418	1 1/8"
PTO 8021420	1 1/4"
PTO 8021422*	1 3/8"
PTO 8021424	1 1/2"

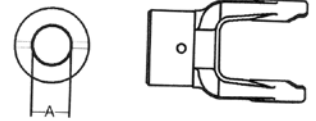

\*With 1/4" and 1/2" pin hole.

Torque Limiter Flange  
(Interchanges with Great Lakes Clutch)

PART NO.
PTO 8031400

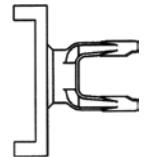

Square Bore  
With Set Screw

PART NO.	DIM "A" BORE
PTO 8041414	7/8"
PTO 8041416	1"
PTO 8041418	1 1/8"
PTO 8041419	1 3/16"
PTO 8041420	1 1/4"

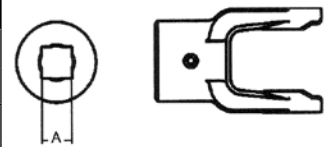

Hexagon Bore  
With Set Screw

PART NO.	DIM "A" BORE
PTO 8051418	1 1/8"
PTO 8051420	1 1/4"

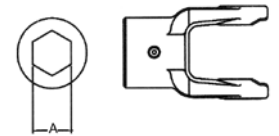

Round Bore  
Double Keyway & Set Screw

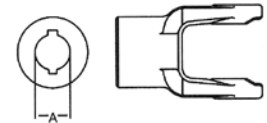

PART NO.	DIM "A" BORE	DOUBLE KEYWAY
PTO 8061418	1 1/8"	1/4" & 5/16"
PTO 8061419	1 3/16"	1/4" & 5/16"
PTO 8061420	1 1/4"	1/4" & 5/16"

Stock Bore  
With Hub O.D. Turned

PART NO.	DIM "A" BORE
PTO 8091412	3/4"

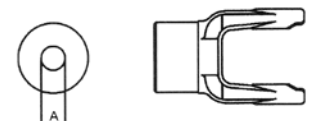

### 14 SERIES

### DRIVELINE COMPONENTS

#### Guard

Order Bearings as required

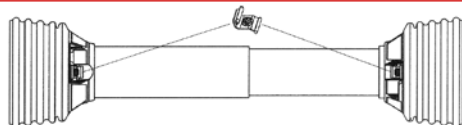

PART NO.	OVERALL DRIVELINE LENGTH	BEARING KIT (2 PER KIT)
PTO 9002548	48"	PTO 9211200
PTO 9002560	60"	PTO 9211200

Assembly instructions included with guard.

Note: When installing Guards observe the following:

- 1) Install proper nylon bearing (See Page 10)
- 2) Guards must rotate freely on yokes.

#### Yoke & Shaft Assembly

1" x 1 1/8" Shaft

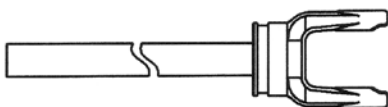

PART NO.	CENTERLINE TO END OF SHAFT DIMENSION
PTO 10001438	26.12"
PTO 10001448	35.62"
PTO 10001460	47.62"

#### Easy Lock™ Replacement Kit

PART NO.

PTO 13005000 (4 per kit)



#### Yoke, Tube & Sleeve Assembly

1" x 1 1/8"

Rectangular



PART NO.	CENTERLINE TO END OF TUBE DIMENSION
PTO 11001438	26.12"
PTO 11001448	35.12"
PTO 11001460	48.12"

#### Universal Joints

Spring-Lok to Shaft Weld Yoke Repair Kit - Page 61



PART NO.	DIM "A" BORE	DIM "B" BORE
PTO 15061400	1 3/8" x 6 Spl.	1" x 1 1/8" Rect.

#### Drivelines

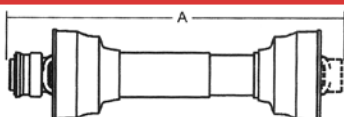

Drivelines are furnished without Cross & Bearing Kit and Implement Yoke. Select kit and Implement Yoke as required. When Cross & Bearing Kit and Implement Yoke are assembled, the overall compressed length of the driveline will be 48" or 60".

PART NO.	TRACTOR YOKE	OVERALL COMPRESSED LENGTH DIM "A"
PTO 14001448	1 3/8" x 6 Spl. Spring Lok	48"
PTO 14001460	1 3/8" x 6 Spl. Spring Lok	60"

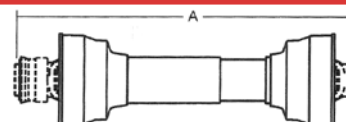

Drivelines are furnished without Cross & Bearing Kit and Outboard Yokes. Select kit and Outboard Yokes as required. When Cross & Bearing Kit and Outboard Yokes are assembled, the overall compressed length of the driveline will be 48" or 60".

PART NO.	OVERALL COMPRESSED LENGTH DIM "A"
PTO 14011448	48"
PTO 14011460	60"
PTO 14021448 (with crosses installed)	48"

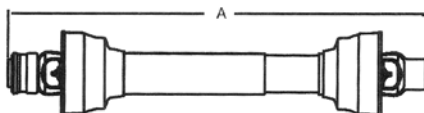

PART NO.	TRACTOR YOKE	IMPLEMENT YOKE	OVERALL COMPRESSED LENGTH DIM "A"	APPLICATION
PTO 14001404	1 3/8" x 6 Spl. Spring Lok	1 3/8" Round with 1/2" Shear Pin Hole	30 3/16"	4 ft. Lift Type Rotary Cutter
PTO 14001405	1 3/8" x 6 Spl. Spring Lok	1 3/8" Round with 1/2" Shear Pin Hole	37 3/16"	5 ft. Lift Type Rotary Cutter
PTO 14001406	1 3/8" x 6 Spl. Spring Lok	1 3/8" Round with 1/2" Shear Pin Hole	56 3/16"	5 & 6 ft. Pull Type Rotary Cutter
PTO 14001420	1 3/8" x 6 Spl. Spring Lok	1 1/4" Round with 1/4" Keyway	48"	Auger

35 SERIES

DRIVELINE COMPONENTS

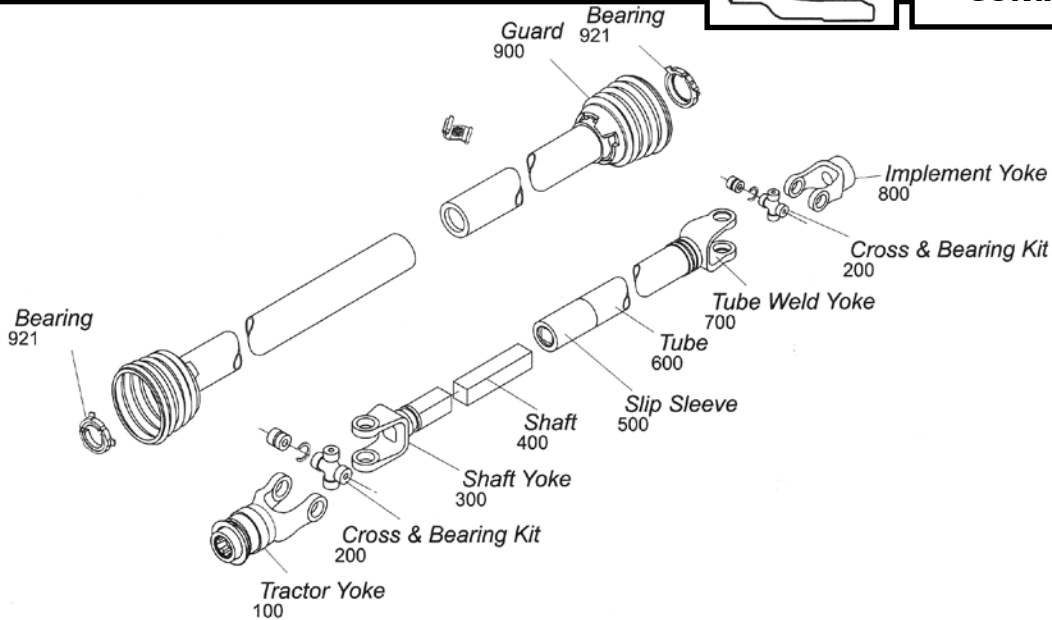

Tractor Yoke

Safety Slide Lock  
Repair Kit - Page 49

PART NO.	DIM "A" BORE
PTO 1013506	1 3/8" x 6 Spl.
PTO 1013520	1 3/4" x 20 Spl.
PTO 1013521	1 3/8" x 21 Spl.

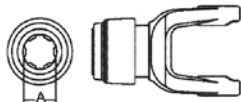

Quick Disconnect  
Repair Kit - Page 49

PART NO.	DIM "A" BORE	DIM "B" BORE
PTO 1023505	-	1 1/4" Hex
PTO 1023506	1 3/8" x 6 Spl.	-
PTO 1023518	-	1 1/8" Hex
PTO 1023520	1 3/4" x 20 Spl.	-
PTO 1023521	1 3/8" x 21 Spl.	-
PTO 1023528	1 3/4" x 6 Spl.	-

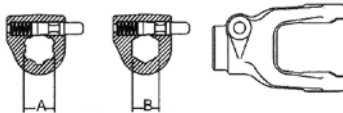

Ball Shear Device  
With Safety Slide Lock  
Repair Kit - Page 49

PART NO.	DIM "A" BORE	SHEAR BOLT
PTO 1043506	1 3/8" x 6 Spl.	(2) 3/8" - 16 Gr. 5
PTO 1043520	1 3/4" x 20 Spl.	(2) 3/8" - 16 Gr. 5
PTO 1043521	1 3/8" x 21 Spl.	(2) 3/8" - 16 Gr. 5

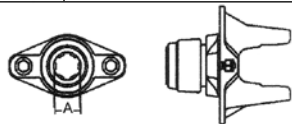

Auto-Lok  
Repair Kit - Page 49

PART NO.	DIM "A" BORE
PTO 1103506	1 3/8" x 6 Spl.
PTO 1103520	1 3/4" x 20 Spl.
PTO 1103521	1 3/8" x 21 Spl.

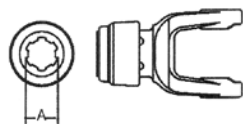

Cross & Bearing Kit (R-Kit)

Snap Ring Located in Yoke

PART NO.	DIM "A"	DIM "B"
PTO 2003500	1 1/4"	3 7/32"

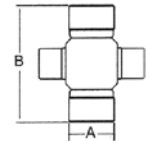

Extended Lubrication Cross & Bearing Kit (E-Kit)

Snap Ring Located in Yoke

PART NO.	DIM "A"	DIM "B"
PTO 2013500	1 1/4"	3 7/32"

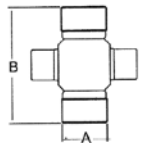

Shaft Weld Yoke

With Bearing Groove  
(Guard must rotate  
freely on yoke)

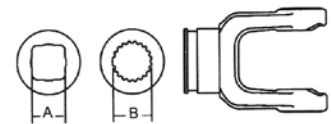

PART NO.	DIM "A" BORE	DIM "B" BORE
PTO 3003500	1 3/16" Sq.	-
PTO 3013500	-	1 5/16" x 20 Spl.
PTO 3023500	-	1 11/16" x 20 Spl.

Shaft

1 3/16" Square

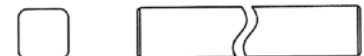

PART NO.	LENGTH
PTO 4000019	6'
PTO 4010019	10'
PTO 4040019	3'

### 35 SERIES

### DRIVELINE COMPONENTS

#### Shaft

**Spline Shaft**  
Induction Hardened



PART NO.	DIM "A" SIZE	LENGTH
PTO 4042120	1 5/16" x 20 Spl.	3'
PTO 4042720	1 11/16" x 20 Spl.	3'

#### Slip Sleeve

With Grease Groove

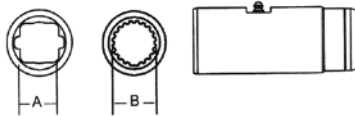

PART NO.	LENGTH	DIM "A" BORE	DIM "B" BORE	FITS TUBE SIZE
PTO 5003500	5"	1 3/16" Sq.	-	2 1/8" (.120 Wall)
PTO 5013500	5"	1 3/16" Sq.	-	2 1/8" (.083 Wall) & 2 1/4" (.120 Wall)
PTO 5043500	8"	1 5/16" Sq.	-	2 1/2" (.120 Wall)
PTO 5053500	5"	-	1 11/16" x 20 Spl.	2 1/2" (.120 Wall)

**Spline Sleeve**  
With Grease Reservoir



PART NO.	LENGTH	DIM "A" BORE	FITS TUBE SIZE
PTO 5023500	8"	1 5/16" x 20 Spl.	2 1/8" (.120 Wall)
PTO 5033500	8"	1 11/16" x 20 Spl.	2 1/2" (.120 Wall)

#### Tube



PART NO.	DIM "A" SIZE	LENGTH
PTO 6023500	2 1/8" (.120 Wall)	6'
PTO 6023501	2 1/8" (.083 Wall)	6'
PTO 6033500	2 1/8" (.120 Wall)	10'
PTO 6043500	2 1/8" (.120 Wall)	3'

#### Tube Weld Yoke

With Bearing Groove  
(Guard must rotate freely on yoke)



PART NO.	FITS TUBE SIZE
PTO 7013500	2 1/8" (.120 Wall)
PTO 7023500	2 1/8" (.083 Wall)
PTO 7033500 with Bore**	2 1/4" (.120 Wall)
PTO 7043500 with Bore**	2 1/2" (.120 Wall)
PTO 7053500 with Bore**	2 1/8" (.120 Wall)

\*\*Bore through for telescoping shaft.

#### Implement Yoke

**Round Bore**  
With Keyway & Set Screw



PART NO.	DIM "A" BORE	STANDARD KEYWAY
PTO 8003516	1"	1/4"
PTO 8003518	1 1/8"	1/4"
PTO 8003519	1 3/16"	1/4"
PTO 8003520	1 1/4"	1/4"
PTO 8003522	1 3/8"	5/16"
PTO 8003523	1 7/16"	3/8"
PTO 8003524	1 1/2"	3/8"
PTO 8003524H	1 1/2"	3/8" with Pin hole
PTO 8003526	1 5/8"	3/8"
PTO 8003528	1 3/4"	3/8"

#### Spline Bore

With 21/64" Pin Hole

PART NO.	DIM "A" BORE
PTO 8013506	1 3/8" x 6 Spl.
PTO 8013521	1 3/8" x 21 Spl.



#### Shear Pin

With 1/4" Pin Hole

PART NO.	DIM "A" BORE
PTO 8023520	1 1/4"
PTO 8023522*	1 3/8"
PTO 8023524	1 1/2"

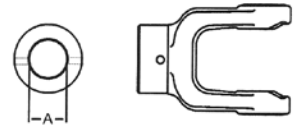

\*With 1/2" Pin Hole

#### Torque Limiter Flange

(Interchanges with Great Lakes Clutch)

PART NO.
PTO 8033500

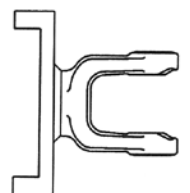

#### Square Bore

With Set Screw

PART NO.	DIM "A" BORE
PTO 8043516	1"
PTO 8043518	1 1/8"
PTO 8043519	1 3/16"
PTO 8043520	1 1/4"
PTO 8043524	1 1/2"
PTO 8043526	1 5/8"

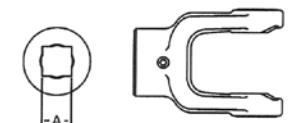

**35 SERIES**

**DRIVELINE COMPONENTS**

**Implement Yoke**

Round Bore  
With Double Keyway & Set Screw



PART NO.	DIM "A" BORE	DOUBLE KEYWAY
PTO 8063519	1 3/16"	1/4" & 5/16"
PTO 8063520	1 1/4"	1/4" & 5/16"
PTO 8063522	1 3/8"	5/16" & 3/8"

**Clamp Yoke**

PART NO.	DIM "A" BORE
PTO 8073520	1 3/4" x 20 Spl.
PTO 8073521	1 3/8" x 21 Spl.
PTO 8073527	1 3/4" x 27 Spl.

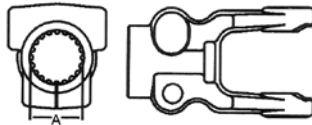

**Stock Bore**

With Hub O.D. Turned

PART NO.	DIM "A" BORE
PTO 8093516	1"



**Guard**

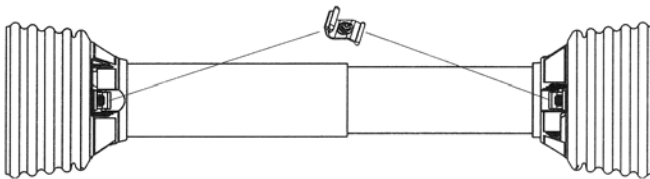

Order Bearings as required

PART NO.	OVERALL DRIVELINE LENGTH	BEARING KIT (2 PER KIT)
PTO 9002548	48"	PTO 9211200
PTO 9002560	60"	PTO 9211200

Assembly instructions included with guard.

Note: When installing Guards observe the following:

- 1) Install proper nylon bearing (See Page 10)
- 2) Guards must rotate freely on yokes.

**Easy Lock™ Replacement Kit**

PART NO.
PTO 13005000 (4 per kit)



**Yoke & Shaft Assembly**

1 3/16" Square Shaft

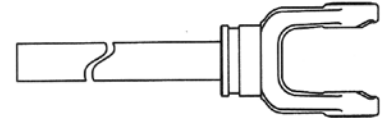

PART NO.	CENTERLINE TO END OF SHAFT DIMENSION
PTO 10003531	17.69"
PTO 10003535	21.69"
PTO 10003542	28.69"
PTO 10003548	33.19"
PTO 10003560	44.94"

**Yoke, Tube & Sleeve Assembly**

1 3/16" Square

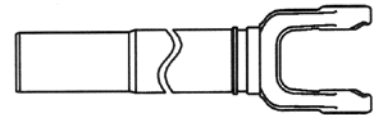

PART NO.	CENTERLINE TO END OF TUBE DIMENSION
PTO 11003531	17.69"
PTO 11003535	21.69"
PTO 11003543	29.69"
PTO 11003548	34.69"
PTO 11003560	46.69"

**Universal Joints**

Quick Disconnect to Shaft Weld Yoke

Repair Kit - Page 46



PART NO.	DIM "A" BORE	DIM "B" BORE
PTO 15063500	1 3/8" x 6 Spl.	1 3/16" Sq.

**35 SERIES**

**DRIVELINE COMPONENTS**

**Drivelines**

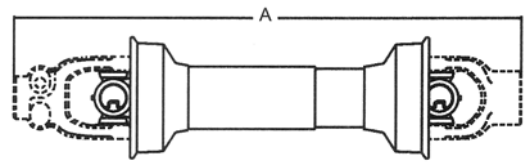
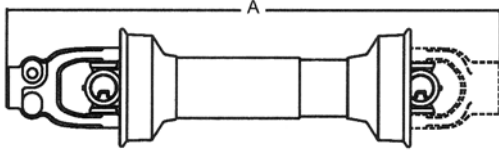

Drivelines are furnished without Cross & Bearing Kit and Implement Yoke. Select kit and Implement Yoke as required. When Cross & Bearing Kit and Implement Yoke are assembled, the overall compressed length of the driveline will be 31", 35", 48" or 60".

Drivelines are furnished without Cross & Bearing Kit and Outboard Yokes. Select kit and Outboard Yokes as required. When Cross & Bearing Kit and Outboard Yokes are assembled, the overall compressed length of the driveline will be 39", 48" or 60".

PART NO.	TRACTOR YOKE	OVERALL COMPRESSED LENGTH DIM "A"
PTO 14003531	1 3/8" x 6 Spl. Q.D.	31"
PTO 14003535	1 3/8" x 6 Spl. Q.D.	35"
PTO 14003548	1 3/8" x 6 Spl. Q.D.	48"
PTO 14003560	1 3/8" x 6 Spl. Q.D.	60"

PART NO.	OVERALL COMPRESSED LENGTH DIM "A"
PTO 14013548	48"
PTO 14013560	60"
PTO 14023539 (with crosses installed)	39"
PTO 14023548 (with crosses installed)	48"

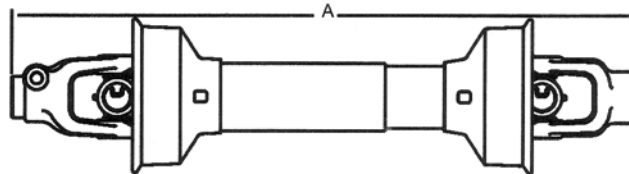

PART NO.	TRACTOR YOKE	IMPLEMENT YOKE	OVERALL COMPRESSED LENGTH DIM "A"	APPLICATION
PTO 14003507	1 3/8" x 6 Spl. Q.D.	1 3/8" Round with 1/2" Shear Pin Hole	64 7/8"	7 ft. Pull Type Rotary Cutter
PTO 14003524	1 3/8" x 6 Spl. Q.D.	1 1/2" Round with 3/8" Keyway	48"	Pumps
PTO 14003536	1 3/8" x 6 Spl. Safety Slide Lock	1 3/8" 6 Spl. Safety Slide Lock	36"	All Purpose



44 SERIES

DRIVELINE COMPONENTS

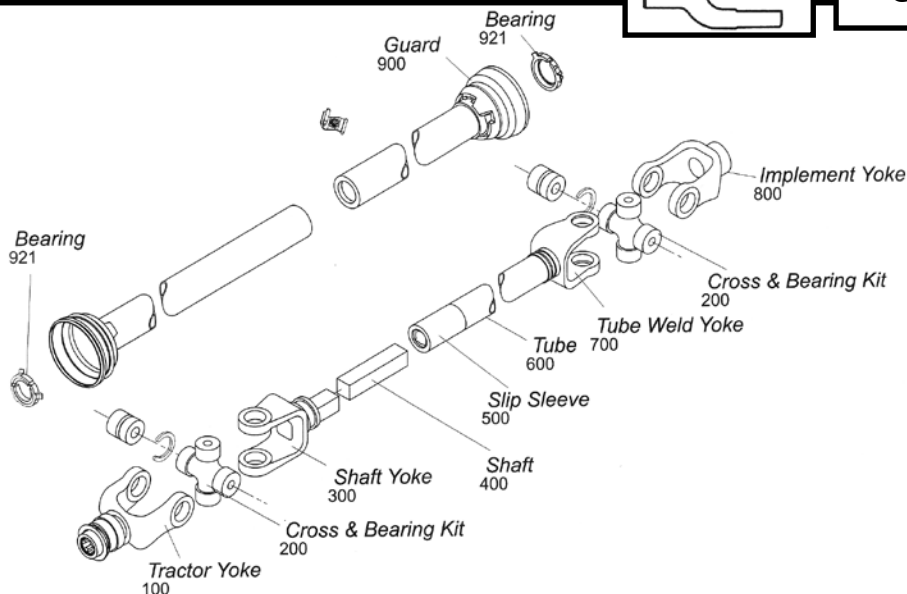

Tractor Yoke

Safety Slide Lock  
Repair Kit - Page 49

PART NO.	DIM "A" BORE
PTO 1014406	1 3/8" x 6 Spl.
PTO 1014420	1 3/4" x 20 Spl.
PTO 1014421	1 3/8" x 21 Spl.

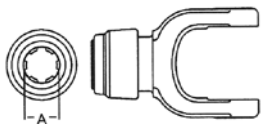

Quick Disconnect  
Repair Kit - Page 49

PART NO.	DIM "A" BORE
PTO 1024406	1 3/8" x 6 Spl.
PTO 1024420	1 3/4" x 20 Spl.
PTO 1024421	1 3/8" x 21 Spl.

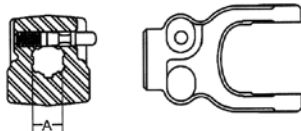

Ball Shear Device  
With Safety Slide Lock  
Repair Kit - Page 49

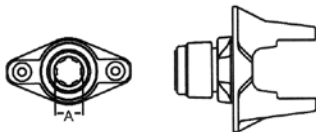

PART NO.	DIM "A" BORE	SHEAR BOLT
PTO 1044406	1 3/8" x 6 Spl.	(2) 3/8" - 16 Gr. 5
PTO 1044420	1 3/4" x 20 Spl.	(2) 3/8" - 16 Gr. 5
PTO 1044421	1 3/8" x 21 Spl.	(2) 3/8" - 16 Gr. 5

Auto-Lok  
Repair Kit - Page 49

PART NO.	DIM "A" BORE
PTO 1104406	1 3/8" x 6 Spl.
PTO 1104420	1 3/4" x 20 Spl.
PTO 1104421	1 3/8" x 21 Spl.

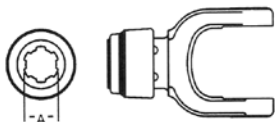

Cross & Bearing Kit (R-Kit)

Snap Ring Located in Bushing

PART NO.	DIM "A"	DIM "B"
PTO 2004400	1 5/16"	4"

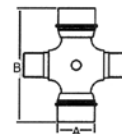

Extended Lubrication Cross & Bearing Kit (E-Kit)

Snap Ring Located in Bushing

PART NO.	DIM "A"	DIM "B"
PTO 2014400	1 5/16"	4"

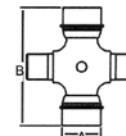

Shaft Weld Yoke

With Bearing Groove  
(Guard must rotate  
freely on yoke)

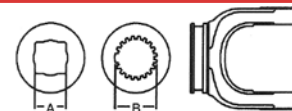

PART NO.	DIM "A" BORE	DIM "B" BORE
PTO 3004400	1 5/16" Sq.	-
PTO 3024400	-	1 11/16" x 20 Spl.

Shaft

1 5/16" Square

PART NO.	LENGTH
PTO 4000021	6'
PTO 4010021	10'
PTO 4040021	3'

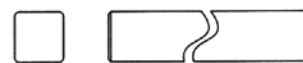

Induction Hardened



PART NO.	DIM "A"	LENGTH
PTO 4042120	1 5/16" x 20 Spl.	3'
PTO 4042720	1 11/16" x 20 Spl.	3'

**44 SERIES**

**DRIVELINE COMPONENTS**

**Slip Sleeve**

With Grease Groove

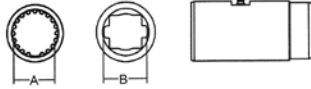

PART NO.	LENGTH	DIM "A"	DIM "B"	FITS TUBE SIZE
PTO 5004400	5"	-	1 5/16" Sq.	2 1/2" (.120 Wall)
PTO 5053500	5"	1 11/16" x 20 Spl.		2 1/2" (.120 Wall)

With Grease Reservoir

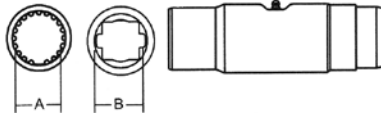

PART NO.	DIM "A"	DIM "B"	LENGTH	FITS TUBE SIZE
PTO 5023500	1 5/16" x 20 Spl.	-	8"	2 1/2" (.120 Wall)
PTO 5033500	1 11/16" x 20 Spl.	-	8"	2 1/2" (.120 Wall)
PTO 5043500	-	1 5/16" Sq.	8"	2 1/2" (.120 Wall)

**Tube**

2 1/2" (.120 Wall)

PART NO.	LENGTH
PTO 6024400	6'
PTO 6034400	10'
PTO 6044400	3'



**Tube Weld Yoke**

With Bearing Groove  
(Guard must rotate freely on yoke)

PART NO.	FITS TUBE SIZE
PTO 7014400	2 1/2" (.120 Wall)
*PTO 7024400 (with bore)	2 1/2" (.120 Wall)

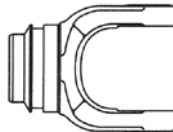

\*Bore through for telescoping.

**Implement Yoke**

Round Bore

With Keyway & Set Screw



PART NO.	DIM "A" BORE	STANDARD KEYWAY
PTO 8004420	1 1/4"	1/4"
PTO 8004422	1 3/8"	5/16"
PTO 8004423	1 7/16"	3/8"
PTO 8004424	1 1/2"	3/8"
PTO 8004426	1 5/8"	3/8"
PTO 8004428	1 3/4"	3/8"
PTO 8004432	2"	1/2"

**Implement Yoke**

Spline Bore

With 21/64" Pin Hole

PART NO.	DIM "A" BORE
PTO 8014406	1 3/8" x 6 Spl.
PTO 8014421	1 3/8" x 21 Spl.

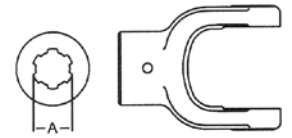

Torque Limiter Flange

(Interchanges with Great Lakes Clutch)

PART NO.
PTO 8034400

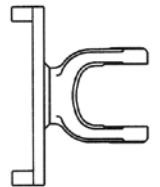

Square Bore

With Set Screw

PART NO.	DIM "A" BORE
PTO 8044418	1 1/8"

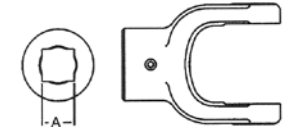

Round Bore

With Double Keyway & Set Screw

PART NO.	DIM "A" BORE	DOUBLE KEYWAY
PTO 8064420	1 1/4"	5/16" & 1/4"
PTO 8064422	1 3/8"	5/16" & 1/4"
PTO 8064424	1 1/2"	5/16" & 3/8"



Clamp Yoke

PART NO.	DIM "A" BORE
PTO 8074406	1 3/8" x 6 Spl.
PTO 8074420	1 3/4" x 20 Spl.
PTO 8074421	1 3/8" x 21 Spl.
PTO 8074427	1 3/4" x 27 Spl.

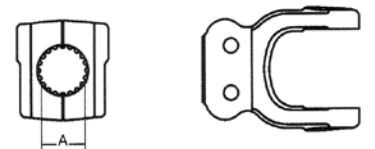

Stock Bore

With Hub O.D. Turned

PART NO.	DIM "A" BORE
PTO 8094416	1"

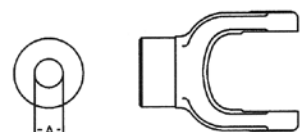

## 44 SERIES

DRIVELINE  
COMPONENTS

## Guard

Order Bearings as required

PART NO.	OVERALL DRIVELINE LENGTH	BEARING KIT (2 PER KIT)
PTO 9023548	48"	PTO 9214400
PTO 9023560	60"	PTO 9214400

Assembly instructions included with guard.

Note: When installing Guards observe the following:

- 1) Install proper nylon bearing (See Page 10)
- 2) Guards must rotate freely on yokes.

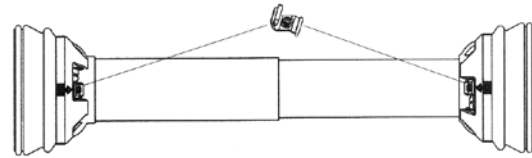

## Easy Lock™ Replacement Kit

PART NO.

PTO 13005000 (4 per kit)



## Yoke &amp; Shaft Assembly

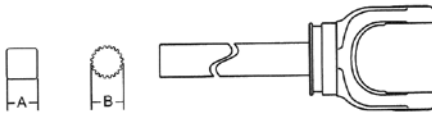

PART NO.	DIM "A"	DIM "B"	CENTERLINE TO END OF SHAFT DIMENSION
PTO 10004448	1 5/16" Sq.	-	33.12"
PTO 10004460	1 5/16" Sq.	-	45.12"
PTO 10014448	-	1 11/16" x 20 Spl.	33.12"

## Yoke, Tube &amp; Sleeve Assembly

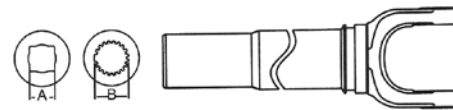

PART NO.	DIM "A" BORE	DIM "B" BORE	CENTERLINE TO END OF TUBE DIMENSION
PTO 11004448	1 5/16" Sq.	-	35.62"
PTO 11004460	1 5/16" Sq.	-	45.62"
PTO 11014448	-	1 11/16" x 20 Spl.	35.62"

## Drivelines

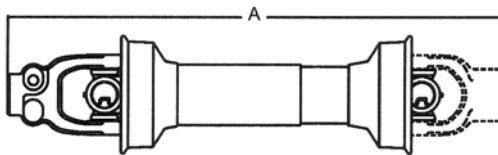

Drivelines are furnished without Cross & Bearing Kit and Implement Yoke. Select kit and Implement Yoke as required. When Cross & Bearing Kit and Implement Yoke are assembled, the overall compressed length of the driveline will be 48" or 60".

PART NO.	SHAFT SIZE	TRACTOR YOKE	OVERALL COMPRESSED LENGTH DIM "A"
PTO 14004448	1 5/16"	1 3/8" x 6 Spl. Q.D.	48"
PTO 14004460	1 5/16"	1 3/8" x 6 Spl. Q.D.	60"
PTO 14044448	1 11/16" x 20 Spl.	1 3/8" x 6 Spl. Q.D.	48"

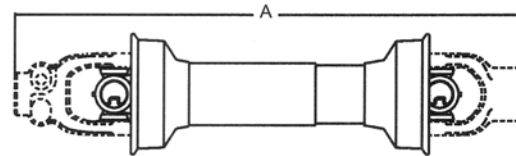

Drivelines are furnished without Cross & Bearing Kit and Outboard Yokes. Select kit and Outboard Yokes as required. When Cross & Bearing Kit and Outboard Yokes are assembled, the overall compressed length of the driveline will be 48" or 60".

PART NO.	SHAFT SIZE	OVERALL COMPRESSED LENGTH DIM "A"
PTO 14014448	1 5/16"	48"
PTO 14014460	1 5/16"	60"
PTO 14054448	1 11/16" x 20 Spl.	48"

### 55 SERIES

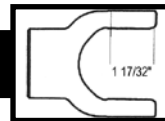

### DRIVELINE COMPONENTS

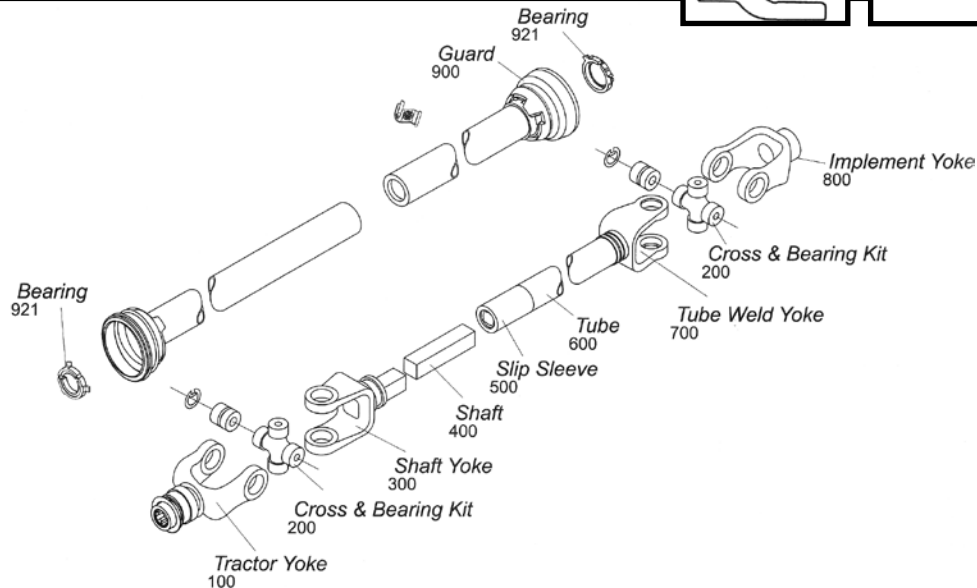

#### Tractor Yoke

##### Safety Slide Lock Repair Kit - Page 49

PART NO.	DIM "A" BORE
PTO 1015506	1 3/8" x 6 Spl.
PTO 1015520	1 3/4" x 20 Spl.
PTO 1015521	1 3/8" x 21 Spl.

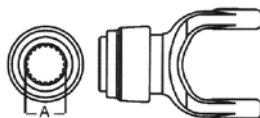

##### Quick Disconnect Repair Kit - Page 49

PART NO.	DIM "A" BORE
PTO 1025506	1 3/8" x 6 Spl.
PTO 1025521	1 3/8" x 21 Spl.
PTO 1025520	1 3/4" x 20 Spl.
PTO 1025528	1 3/4" x 6 Spl.

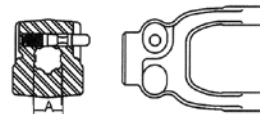

##### Ball Shear Device With Safety Slide Lock Repair Kit - Page 49

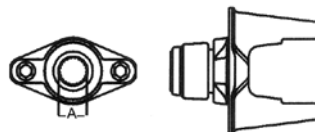

PART NO.	DIM "A" BORE	SHEAR BOLT
PTO 1045506	1 3/8" x 6 Spl.	(2) 3/8" - 16 Gr. 5
PTO 1045520	1 3/4" x 20 Spl.	(2) 3/8" - 16 Gr. 5
PTO 1045521	1 3/8" x 21 Spl.	(2) 3/8" - 16 Gr. 5

##### Auto-Lok Repair Kit - Page 49

PART NO.	DIM "A" BORE
PTO 1105506	1 3/8" x 6 Spl.
PTO 1105520	1 3/4" x 20 Spl.
PTO 1105521	1 3/8" x 21 Spl.



#### Cross & Bearing Kit (R-Kit)

Snap Ring Located in Yoke

PART NO.	DIM "A"	DIM "B"
PTO 2005500	1 17/32"	4 5/16"

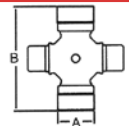

#### Extended Lubrication Cross & Bearing Kit (E-Kit)

Snap Ring Located in Yoke

PART NO.	DIM "A"	DIM "B"
PTO 2015500	1 17/32"	4 5/16"

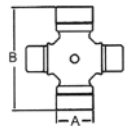

#### Shaft Weld Yoke

With Bearing Groove (Guard must rotate freely on yoke)



PART NO.	DIM "A" BORE	DIM "B" BORE
PTO 3005500	1 5/16" Sq.	-
PTO 3015500	1 3/16" Sq.	-
PTO 3025500	-	1 11/16" x 20 Spl.

#### Shaft

##### 1 5/16" Square

PART NO.	LENGTH
PTO 4000021	6'
PTO 4010021	10'
PTO 4040021	3'



##### 1 11/16" x 20 Spline Induction Hardened

PART NO.	DIM "A"	LENGTH
PTO 4042120	1 5/16" x 20 Spl.	3'
PTO 4042720	1 11/16" x 20 Spl.	3'



55 SERIES

DRIVELINE COMPONENTS

Slip Sleeve

With Grease Groove

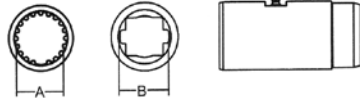

PART NO.	LENGTH	DIM "A" BORE	DIM "B" BORE	FITS TUBE SIZE
PTO 5004400	5"	-	1 5/16" Sq.	2 1/2" (.120 Wall)
PTO 5053500	5"	1 11/16" x 20 Spl.		2 1/2" (.120 Wall)

With Grease Reservoir

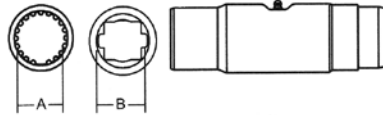

PART NO.	DIM "A" BORE	DIM "B" BORE	LENGTH	FITS TUBE SIZE
PTO 5023500	1 5/16" x 20 Spl.	-	8"	2 1/2" (.120 Wall)
PTO 5033500	1 11/16" x 20 Spl.	-	8"	2 1/2" (.120 Wall)
PTO 5043500	-	1 5/16" Sq.	8"	2 1/2" (.120 Wall)

Tube

2 1/2" (.120 Wall)

PART NO.	LENGTH
PTO 6024400	6'
PTO 6034400	10'
PTO 6044400	3'



Tube Weld Yoke

With Bearing Groove  
(Guard must rotate freely on yoke)



PART NO.	FITS TUBE SIZE
PTO 7015500	2 1/2" (.120 Wall)
*PTO 7045500 (with bore)	2 1/2" (.120 Wall)

\*Bore through for telescoping.

Implement Yoke

Round Bore

With Keyway & Set Screw



PART NO.	DIM "A" BORE	STANDARD KEYWAY
PTO 8005522	1 3/8"	5/16"
PTO 8005524	1 1/2"	3/8"
PTO 8005526	1 5/8"	3/8"
PTO 8005528	1 3/4"	3/8"
PTO 8005532	2"	1/2"

Implement Yoke

Spline Bore

With 21/64" Pin Hole

PART NO.	DIM "A" BORE
PTO 8015506	1 3/8" x 6 Spl.
PTO 8015521	1 3/8" x 21 Spl.

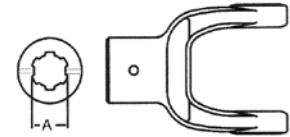

Clamp Yoke



PART NO.	DIM "A" BORE
PTO 8075506	1 3/8" x 6 Spl.
PTO 8075520	1 3/4" x 20 Spl.
PTO 8075521	1 3/8" x 21 Spl.
PTO 8075527	1 3/4" x 27 Spl.

Stock Bore

With Hub O.D. Turned

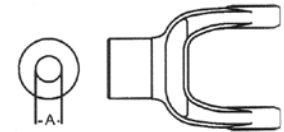

PART NO.	DIM "A" BORE
PTO 8095516	1"

Guard

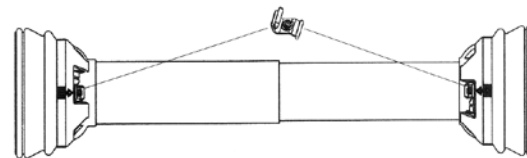

Order Bearings as required

PART NO.	OVERALL DRIVELINE LENGTH	BEARING KIT (2 PER KIT)
PTO 9023548	48"	PTO 9214400
PTO 9023560	60"	PTO 9214400

Assembly instructions included with guard.

Note: When installing Guards observe the following:

- 1) Install proper nylon bearing (See Page 10)
- 2) Guards must rotate freely on yokes.

Easy Lock™ Replacement Kit

PART NO.
PTO 13005000 (4 per kit)



**55 SERIES**

**DRIVELINE COMPONENTS**

**Yoke & Shaft Assembly**

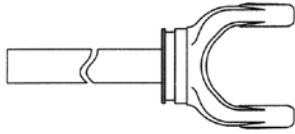

PART NO.	SHAFT SIZE	CENTERLINE TO END OF SHAFT DIMENSION
PTO 10005548	1 5/16"	32.75"
PTO 10005560	1 5/16"	44.88"
PTO 10015548	1 11/16" x 20 Spl.	32.75"

**Yoke, Tube & Sleeve Assembly**

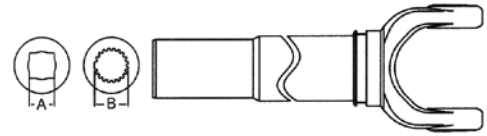

PART NO.	DIM "A" BORE	DIM "B" BORE	CENTERLINE TO END OF TUBE DIMENSION
PTO 11005548	1 5/16" Sq.	-	33.38"
PTO 11005560	1 5/16" Sq.	-	45.38"
PTO 11015548	-	1 11/16" x 20 Spl.	33.38"

**Drivelines**

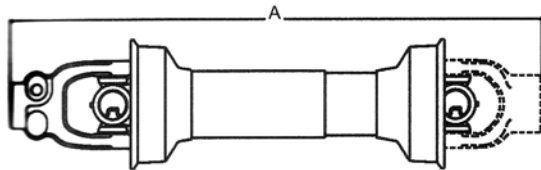

Drivelines are furnished without Cross & Bearing Kit and Implement Yoke. Select kit and Implement Yoke as required. When Cross & Bearing Kit and Implement Yoke are assembled, the overall compressed length of the driveline will be 48" or 60".

PART NO.	SHAFT SIZE	TRACTOR YOKE	OVERALL COMPRESSED LENGTH DIM "A"
PTO 14005548	1 5/16"	1 3/8" x 6 Spl. Q.D.	48"
PTO 14005560	1 5/16"	1 3/8" x 6 Spl. Q.D.	60"
PTO 14045548	1 11/16" x 20 Spl.	1 3/8" x 6 Spl. Q.D.	48"

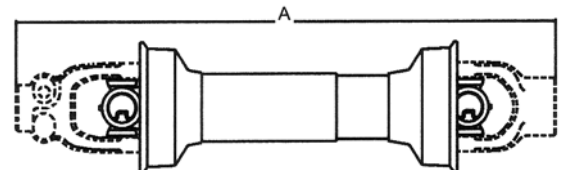

Drivelines are furnished without Cross & Bearing Kit and Outboard Yokes. Select kit and Outboard Yokes as required. When Cross & Bearing Kit and Outboard Yokes are assembled, the overall compressed length of the driveline will be 48", 58" or 60".

PART NO.	SHAFT SIZE	OVERALL COMPRESSED LENGTH DIM "A"
PTO 14015548	1 5/16" Sq.	48"
PTO 14015560	1 5/16" Sq.	60"
PTO 14055548	1 11/16" x 20 Spl.	48"
PTO 14055558	1 11/16" x 20 Spl.	58"

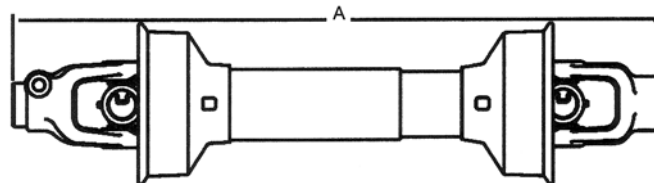

PART NO.	TRACTOR YOKE	IMPLEMENT YOKE	OVERALL COMPRESSED LENGTH DIM "A"	APPLICATION	SHAFT SIZE
PTO 14005537	1 3/8" x 6 Spl. Safety Slide Lock	1 3/8" x 6 Spl. Safety Slide Lock	37"	All Purpose	1 5/16" Sq.
PTO 14005546	1 3/4" x 20 Spl. Safety Slide Lock	1 3/8" Rd. w/ Keyway and (2) Set Screws	46"	All Purpose	1 11/16" x 20 Spl.

W SERIES

DRIVELINE COMPONENTS

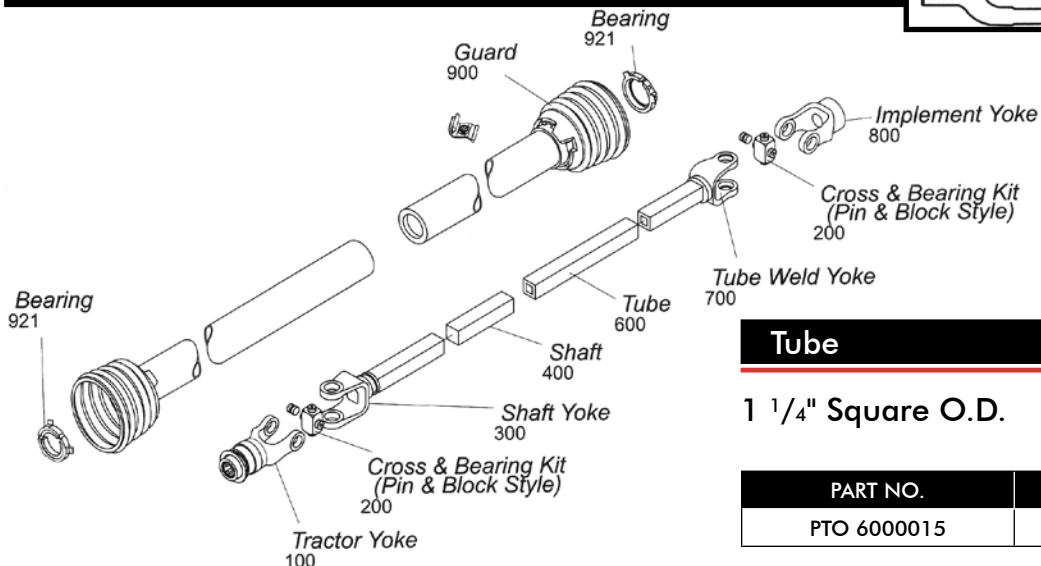

Tractor Yoke

Spring-Lok Repair Kit - Page 49

PART NO.	DIM "A" BORE
PTO 1000721	1 3/8" x 21 Spl.
PTO 1000706	1 3/8" x 6 Spl.

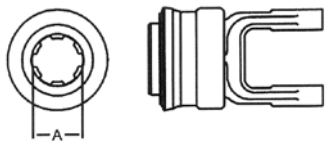

Quick Disconnect Repair Kit - Page 49

PART NO.	DIM "A" BORE
PTO 1020706	1 3/8" x 6 Spl.

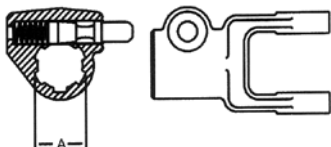

Cross & Bearing Kit

(Pin & Block Style)  
Zerk Located in Block

PART NO.	DIM "A"	DIM "B"
PTO 2000700	9/16"	1 1/2"

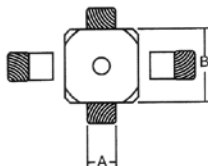

Shaft Weld Yoke

With Bearing Groove  
(Guard must rotate freely on yoke)

PART NO.	DIM "A" BORE
PTO 3000700	1 5/16" Sq.



Shaft

1 5/16" Square

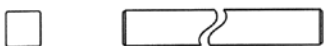

PART NO.	LENGTH	FITS TUBE
PTO 4000015	6'	1 1/4" Sq.

Tube

1 1/4" Square O.D.



PART NO.	LENGTH	FITS SHAFT
PTO 6000015	6'	1 5/16" Sq.

Tube Weld Yoke

With Bearing Groove  
(Guard must rotate freely on yoke)

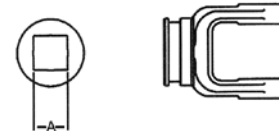

PART NO.	DIM "A" BORE	FITS TUBE SIZE
PTO 7000700	1 5/16" Sq.	1 1/4"

Guard

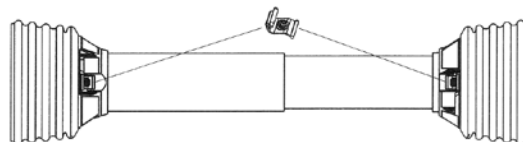

Order Bearings as required

PART NO.	OVERALL DRIVELINE LENGTH	BEARING KIT (2 PER KIT)
PTO 9002548	48"	PTO 9215170

Assembly instructions included with guard.

Note: When installing Guards observe the following:

- 1) Install proper nylon bearing (See Page 10)
- 2) Guards must rotate freely on yokes.

Easy Lock™ Replacement Kit

PART NO.
PTO 13005000 (4 per kit)



Drivelines

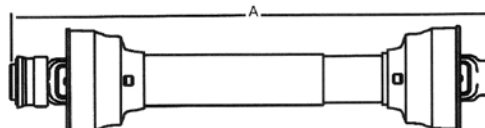

Use 12 Series driveline for all "W" Series replacement drivelines. See 12 Series (Page 26) for drivelines.

**W SERIES - DOMESTIC DRIVELINE COMPONENTS**

**Implement Yoke**

**ROUND BORE**  
with Keyway & Set Screw

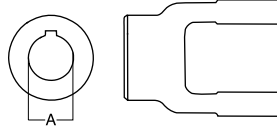

PART NO.	"A" BORE	STANDARD KEYWAY
PTO 8000710	5/8"	3/16"
PTO 8000712	3/4"	3/16"
PTO 8000713	13/16"	3/16"
PTO 8000714	7/8"	3/16"
PTO 8000715	15/16"	1/4"
PTO 8000716	1"	1/4"
PTO 8000718	1 1/8"	1/4"
PTO 8000719	1 3/16"	1/4"
PTO 8000720	1 1/4"	1/4"

**Driveline**

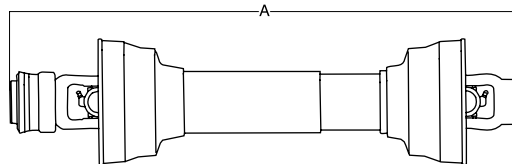

PART NO.	TRACTOR YOKE	IMPLEMENT YOKE	OVERALL COMPRESSED LENGTH "A"	APPLICATION
PTO 14000700	1 3/8" x 6 Spring-Lok	1 1/4" Round 1/4" Keyway	48"	Post Hole Digger



**0675 SERIES**

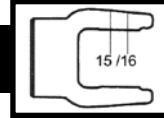

**DRIVELINE COMPONENTS**

**Tractor Yoke**

**Spring-Lok  
Repair Kit - Page 49**

PART NO.	DIM "A" BORE
PTO 1000506	1 3/8" x 6 Spl.

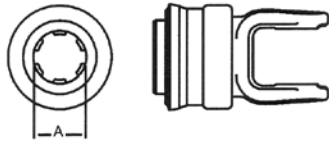

**Quick Disconnect  
Repair Kit - Page 49**

PART NO.	DIM "A" BORE
PTO 1020506	1 3/8" x 6 Spl.

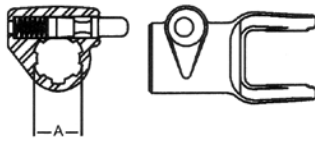

**Cross & Bearing Kit**

**Snap Ring Located in Bushing**

PART NO.	DIM "A"	DIM "B"
PTO 2000675	15/16"	2 5/16"

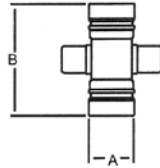

**Shaft Weld Yoke**

**With Bearing Groove  
(Guard must rotate  
freely on yoke)**

PART NO.	DIM "A" BORE
PTO 3000500	3/4" x 7/8"



**Tube Weld Yoke**

**With Bearing Groove  
(Guard must rotate  
freely on yoke)**

PART NO.	DIM "A" BORE
PTO 7000500	1" x 1 1/8"

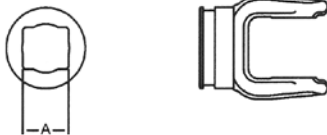

**Implement Yoke**

**Round Bore  
With Keyway & Set Screw**

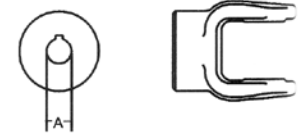

PART NO.	DIM "A" BORE	STANDARD KEYWAY
PTO 8000510	5/8"	3/16"
PTO 8000512	3/4"	3/16"

**Spline Bore  
With 21/64" Pin Hole**

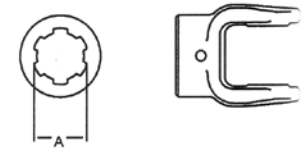

PART NO.	DIM "A" BORE
PTO 8010506	1 3/8" x 6 Spl.

**Square Bore  
With Set Screw**



PART NO.	DIM "A" BORE
PTO 8040512	3/4"
PTO 8040514	7/8"
PTO 8040516	1"

**Round Bore  
With Double Keyway  
& Set Screw**

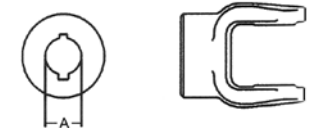

PART NO.	DIM "A" BORE	DOUBLE KEYWAY
PTO 8060514	7/8"	3/16" x 1/4"
PTO 8060516	1"	3/16" x 1/4"
PTO 8060518	1 1/8"	1/4" x 5/16"
PTO 8060520	1 1/4"	1/4" x 5/16"

### 1000 SERIES

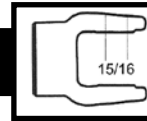

### DRIVELINE COMPONENTS

#### Tractor Yoke

Quick Disconnect  
Repair Kit - Page 49

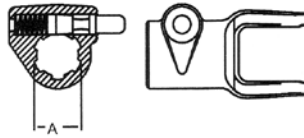

PART NO.	DIM "A" BORE
PTO 1021006	1 3/8" x 6 Spl.

#### Cross & Bearing Kit

Snap Ring Located in Bushing

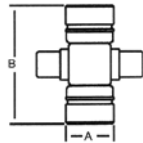

PART NO.	DIM "A"	DIM "B"
PTO 2001000	15/16"	2 19/64"

#### Shaft Weld Yoke

With Bearing Groove  
(Guard must rotate  
freely on yoke)

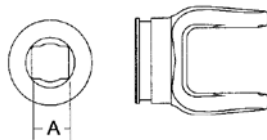

PART NO.	DIM "A" BORE
PTO 3001000	3/4" x 7/8" Rect.

#### Tube Weld Yoke

With Bearing Groove  
(Guard must rotate  
freely on yoke)



PART NO.	DIM "A" BORE
PTO 7001000	1" x 1 1/8"

#### Implement Yoke

Spline Bore  
With Set Screw

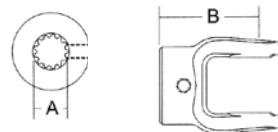

PART NO.	DIM "A" BORE	DIM "B" CENTERLINE
PTO 8011013	.901" x 13 Spl.	2 1/2" (2.50)
PTO 8011018	1 1/8" x 6 Spl.	2 1/2" (2.50)

#### Shear Pin

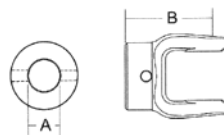

PART NO.	DIM "A" BORE	DIM "B" CENTERLINE	PINHOLE SIZE
PTO 8021015	15/16"	2 1/2" (2.50)	11/32" (.34)
PTO 8021016	1"	2 1/2" (2.50)	1/4" (.25)
PTO 100011059	1"	2 1/2" (2.50)	3/8" (.38)
PTO 8021020	1 1/4"	2 1/2" (2.50)	5/16" (.31)
PTO 8021024	1 1/2"	2 1/2" (2.50)	9/32" (.28)
PTO 100011034	1 1/2"	2 1/2" (2.50)	17/64" (.27)

#### Implement Yoke

Round Bore  
With Keyway & Set Screw

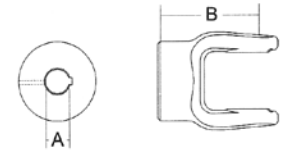

PART NO.	DIM "A" BORE	KEYWAY	DIM "B" CENTERLINE
PTO 8001010	5/8"	3/16" (.19)	2 1/2" (2.50)
PTO 100011044	5/8"	3/16" (.19)	1 11/16" (1.69)
PTO 100011045	3/4"	3/16" (.19)	2 1/2" (2.50)
PTO 100011038	3/4"	3/16" (.19)	1 11/16" (1.69)
PTO 100011056	3/4"	1/4" (.25)	2 1/2" (2.50)
PTO 8001013	13/16"	1/4" (.25)	2 1/2" (2.50)
PTO 100011039	13/16"	1/4" (.25)	1 11/16" (1.69)
PTO 100011057	7/8"	3/16" (.19)	2 1/2" (2.50)
PTO 100011049	7/8"	1/4" (.25)	2 1/2" (2.50)
PTO 100011048	7/8"	1/4" (.25)	2 1/2" (2.50)
PTO 100011040	7/8"	1/4" (.25)	1 11/16" (1.69)
PTO 8001015	15/16"	1/4" (.25)	2 1/2" (2.50)
PTO 8001016	1"	3/16" (.19)	2 1/2" (2.50)
PTO 100011051	1"	1/4" (.25)	2 1/2" (2.50)
PTO 100011033	1"	1/4" (.25)	2 1/2" (2.50)
PTO 100011041	1"	1/4" (.25)	1 11/16" (1.69)
PTO 8001017	1 1/16"	1/4" (.25)	2 1/2" (2.50)
PTO 100011053	1 1/8"	1/4" (.25)	2 1/2" (2.50)
PTO 100011052	1 1/8"	5/16" (.31)	2 1/2" (2.50)
PTO 8001019	1 3/16"	5/16" (.31)	2 1/2" (2.50)
PTO 100011058	1 1/4"	1/4" (.25)	2 1/2" (2.50)
PTO 100011055	1 1/4"	5/16" (.31)	2 1/2" (2.50)
PTO 100011054	1 1/4"	5/16" (.31)	2 1/2" (2.50)
PTO 100011060	1 3/8"	5/16" (.31)	2 1/2" (2.50)
PTO 8001022	1 3/8"	3/8"	2 1/2" (2.50)

Square Bore  
With Set Screw

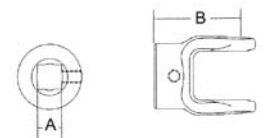

PART NO.	DIM "A" BORE	DIM "B" CENTERLINE
PTO 8041012	3/4"	2 1/2" (2.50)
PTO 100011042	3/4"	1 11/16" (1.69)
PTO 8041014	7/8"	2 1/2" (2.50)
PTO 100011043	7/8"	1 11/16" (1.69)
PTO 8041016	1"	2 1/2" (2.50)
PTO 8041018	1 1/8"	2 1/2" (2.50)
PTO 100011037	1 1/8"	2 1/2" (2.50)

1000 SERIES

DRIVELINE COMPONENTS

Implement Yoke

Square Bore  
With Pin Hole

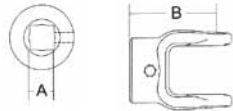

PART NO.	DIM "A" BORE	DIM "B" CENTERLINE	PINHOLE SIZE
PTO 100011035	3/4"	2 1/2" (2.50)	5/16" (.312)
PTO 100011036	1"	2 1/2" (2.50)	3/8" (3.75)

Round Bore  
Double Keyway & Set Screw

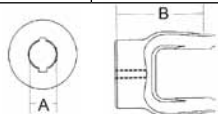

PART NO.	DIM "A" BORE	DOUBLE KEYWAY	DIM "B" CENTERLINE
PTO 8061012	3/4"	3/16" & 1/4"	2 1/2" (2.50)
PTO 8061013	13/16"	3/16" & 1/4"	2 1/2" (2.50)
PTO 8061014	7/8"	3/16" & 1/4"	2 1/2" (2.50)
PTO 8061016	1"	3/16" & 1/4"	2 1/2" (2.50)
PTO 8061018	1 1/8"	3/16" & 1/4"	2 1/2" (2.50)
PTO 100011061	1 1/8"	1/4" & 5/16"	2 1/2" (2.50)
PTO 8061020	1 1/4"	1/4" & 5/16"	2 1/2" (2.50)
PTO 8061019	1 13/16"	1/4" & 5/16"	2 1/2" (2.50)

Hexagon Bore

With Set Screw

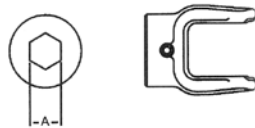

PART NO.	DIM "A" BORE
PTO 8051014	7/8"
PTO 8051018	1 1/8"

Slip Sleeve Yoke

Square

PART NO.	DIM "A" BORE
PTO 8081012	3/4"
PTO 8081014	7/8"
PTO 8081016	1"

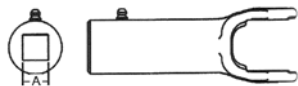

Round

PART NO.	DIM "A" BORE	KEYWAY	DIM "B" CENTERLINE
PTO 8101012	3/4"	3/16"	5 1/2" (5.50)
PTO 8101014	7/8"	1/4"	5 1/2" (5.50)
PTO 8101013	13/16"	1/4"	5 1/2" (5.50)
PTO 8101016	1"	1/4"	5 1/2" (5.50)
PTO 100011007	1"	1/4"	5 1/2" (5.50)
PTO 8101018	1 1/8"	1/4"	5 1/2" (5.50)
PTO 100011062	1 1/8"	5/16"	5 1/2" (5.50)
PTO 8101020	1 1/4"	1/4"	5 1/2" (5.50)
PTO 100011013	1 1/4"	5/16"	5 1/2" (5.50)
PTO 100011066	1 1/8"	1/4"	5 1/2" (5.50)

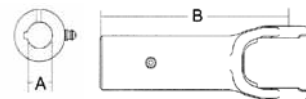

Slip Sleeve Yoke

Hex

PART NO.	DIM "A" BORE
PTO 8111014	7/8"
PTO 8111018	1 1/8"

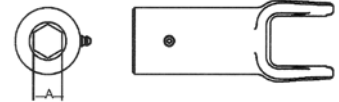

Spline

PART NO.	DIM "A" BORE	DIM "B" CENTERLINE
PTO 8121018	1 1/8" x 10 Spl.	5 1/2" (5.50)
PTO 8121020	1 1/4" x 6 Spl.	5 1/2" (5.50)

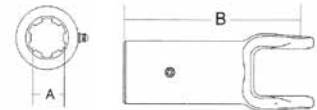

PART NO.	DIM "A" BORE	DIM "B" CENTERLINE
PTO 8131012	3/4" x 7/8"	5 1/2" (5.50)
PTO 100011014	7/8"	5 1/2" (5.50)
PTO 100011015	1"	5 1/2" (5.50)

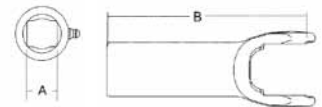

Guard

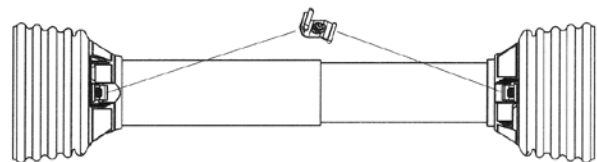

Order Bearings as required

PART NO.	OVERALL DRIVELINE LENGTH	BEARING KIT (2 PER KIT)
PTO 9002548	48"	PTO 9210600
PTO 9002560	60"	PTO 9210600

Assembly instructions included with guard.

Note: When installing Guards observe the following:

- 1) Install proper nylon bearing (See Page 10)
- 2) Guards must rotate freely on yokes.

Easy Lock™ Replacement Kit

PART NO.
PTO 13005000 (4 per kit)



**1800 SERIES**

**DRIVELINE COMPONENTS**

Interchanges with Neapco

**Cross & Bearing Kit**

Snap Ring Located in Bushing

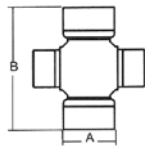

PART NO.	DIM "A"	DIM "B"
PTO 2001875	1"	3 1/4"

**VEHICULAR CROSS & BEARING KIT**

Interchanges with Spicer

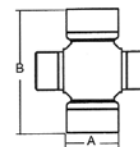

PART NO.	SPICER U-JOINT SERIES	DIM "A"	DIM "B"
PTO 2000310	1310	1 1/16"	3 7/32"
PTO 2000350	1350	1 3/16"	3 5/8"
PTO 2000410	1410	1 3/16"	4 3/16"

**1 FR SERIES**

**Cross & Bearing Kit**

Snap Ring Located in Yoke

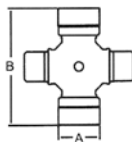

PART NO.	DIM "A"	DIM "B"
PTO 2000100	7/8"	2 15/16"

**14 SERIES**

Interchanges with Howse

**Cross & Bearing Kit**

Snap Ring Located in Bushing

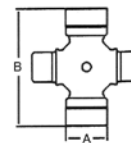

PART NO.	DIM "A"	DIM "B"
PTO 2001401	1 1/8"	2 5/8"

**3 DR SERIES**

**Cross & Bearing Kit**

Snap Ring Located in Yoke

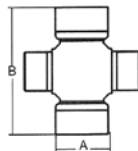

PART NO.	DIM "A"	DIM "B"
PTO 2000300	1"	3 15/16"

**35 SERIES**

Interchanges with Howse

**Cross & Bearing Kit**

Snap Ring Located in Bushing

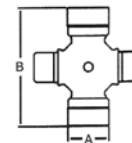

PART NO.	DIM "A"	DIM "B"
PTO 2003501	1 1/4"	3 7/32"

# 2600 SERIES

Interchanges with Neapco & Walterscheid 1480

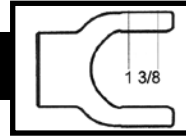

## DRIVELINE COMPONENTS

### Tractor Yoke

Quick Disconnect  
Repair Kit - Page 49

PART NO.	DIM "A" BORE
PTO 1022606	1 3/8" x 6 Spl.
PTO 1022620	1 3/4" x 20 Spl.
PTO 1022621	1 3/8" x 21 Spl.

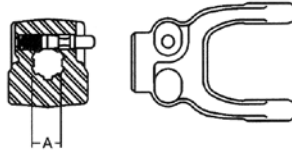

### Cross & Bearing Kit

Snap Ring Located in Yoke

PART NO.	DIM "A"	DIM "B"
PTO 2002600	1 3/8"	4 3/16"

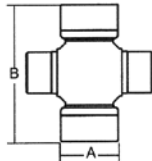

### Shaft Weld Yoke

With Bearing Groove  
(Guard must rotate freely on yoke)

PART NO.	DIM "A" BORE
PTO 3002600	1 5/16" Sq.



### Shaft

1 5/16" Square

PART NO.	LENGTH
PTO 4000021	6'
PTO 4010021	10'
PTO 4040021	3'



### Slip Sleeve

1 5/16" Square  
With Grease Groove

PART NO.	LENGTH	FITS TUBE SIZE
PTO 5002600	5"	2 3/4" (.109 Wall)



### Tube

2 3/4" (.109 Wall)

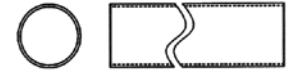

PART NO.	LENGTH
PTO 6022600	6'

### Tube Weld Yoke

With Bearing Groove  
(Guards must rotate freely on the yoke)

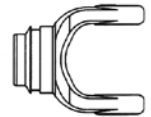

PART NO.	FITS TUBE SIZE
PTO 7012600	2 3/4" (.109 Wall)

### Implement Yoke

Round Bore  
With Keyway & Set Screw



PART NO.	DIM "A" BORE	STANDARD KEYWAY
PTO 8002622	1 3/8"	5/16"
PTO 8002624	1 1/2"	3/8"
PTO 8002628	1 3/4"	3/8"

### Guard

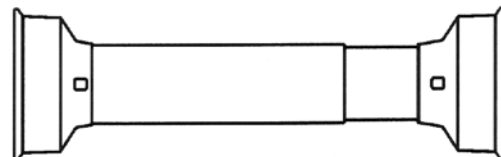

With Bearings (920-2600)

PART NO.	OVERALL DRIVELINE LENGTH
PTO 9002648	48"

Assembly instructions included with guard.

Note: When installing Guards observe the following:

- 1) Install proper nylon bearing and retainer (See Page 10)
- 2) Guards must rotate freely on yokes.

**SHAFTING & TUBING**

**DRIVELINE COMPONENTS**

**Shafting**



PART NO.	SIZE	LENGTH
PTO 4000012	3/4" Sq.	6'
PTO 4000014	7/8" Sq.	6'
PTO 4000015	15/16" Sq.	6'
PTO 4000016	1" Sq.	6'
PTO 4000019	1 3/16" Sq.	6'
PTO 4000020	1 1/4" Sq.	6'
PTO 4000021	1 5/16" Sq.	6'
PTO 4001214	3/4" x 7/8" Rect.	6'
PTO 4001618	1" x 1 1/8" Rect.	6'
PTO 4010019	1 3/16" Sq.	10'
PTO 4010021	1 5/16" Sq.	10'
PTO 4011214	3/4" x 7/8" Rect.	10'
PTO 4011618	1" x 1 1/8" Rect.	10'
PTO 4020014	7/8" Hex	6'
PTO 4020016	1" Hex	6'
PTO4020018	1 1/8" Hex	6'
PTO 4020020	1 1/4" Hex	6'
PTO 4040019	1 3/16" Sq.	3'
PTO 4040021	1 5/16" Sq.	3'
PTO 4041214	3/4" x 7/8" Rect.	3'
PTO 4041615H	1" x 15 Spl. (Induction Hardened)	3'
PTO 4041618	1" x 1 1/8" Rect.	3'
PTO 4042120	1 5/16" x 20 Spl. (Induction Hardened)	3'
PTO 4042720	1 11/16" x 20 Spl. (Induction Hardened)	3'

**Tubing**



PART NO.	SIZE	LENGTH
PTO 6000012	1" Sq.	6'
PTO 6000015	1 1/4" Sq. (.120 Wall)	6'
PTO 6000016	1 1/4" Sq. (.109 Wall)	6'
PTO 6000020	1 5/8" Sq.	6'
PTO 6001618	3/4" x 7/8" Rect.	6'
PTO 6002022	1 1/4" x 1 3/8" Rect.	6'
PTO 6011618	3/4" x 7/8" Rect.	10'
PTO 6012022	1 1/4" x 1 3/8" Rect.	10'
PTO 6020600	1 1/2" Rd.	6'
PTO 6021400	2" Rd. (.083 Wall)	6'
PTO 6022600	2 3/4" Rd. (.109 Wall)	6'
PTO 6023500	2 1/8" Rd. (.120 Wall)	6'
PTO 6023501	2 1/8" Rd. (.083 Wall)	6'
PTO 6024400	2 1/2" Rd. (.120 Wall)	6'
PTO 6031400	2" Rd. (.083 Wall)	10'
PTO 6033500	2 1/8" Rd. (.120 Wall)	10'
PTO 6034400	2 1/2" Rd. (.120 Wall)	10'
PTO 6040600	1 1/2" Rd.	3'
PTO 6041400	2" Rd. (.083 Wall)	3'
PTO 6041618	3/4" x 7/8" Rect.	3'
PTO 6042022	1 1/4" x 1 3/8" Rect.	3'
PTO 6043500	2 1/8" Rd. (.120 Wall)	3'
PTO 6044400	2 1/2" Rd. (.120 Wall)	3'

**Shock Absorbing Flexible Coupling Disc**

6" O.D.

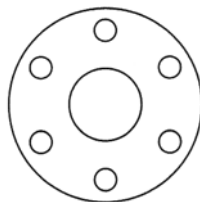

PART NO.	DESCRIPTION
PTO 9702110	Disc only w/ 5/8" holes
PTO 9702108	Disc only w/ 1/2" holes

**Spider**

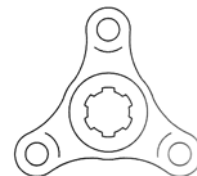

PART NO.	DESCRIPTION
PTO 810111016	1 3/8" x 6 Spl. with 5/8" bolt hole
PTO 810111053	1 3/8" x 6 Spl. with 21/64" pinholes & 5/8" bolt hole
PTO 810211097	1 3/4" Rd. with 3/8" keyway & 5/8" bolt hole

# NYLON BEARING REPAIR KIT

## DRIVELINE COMPONENTS

(Kit includes nylon bearing and retainer)

### NOTE!

Not all guard and bearing systems are interchangeable. When purchasing shaft weld and tube weld yokes or guards, make certain there is a proper fit between nylon bearing raceway in yoke and guard.

It is essential that the proper nylon bearing is identified and installed to insure proper performance and safety.

To assist in ordering the proper nylon bearing, listed below are part numbers and dimensions for our standard after-market and OEM nylon bearings.

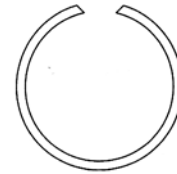
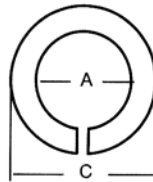
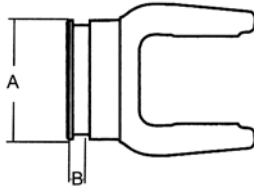

PART NO.	DIM "A" YOKE RACEWAY O.D. NYLON BEARING I.D.	DIM "B" YOKE RACEWAY WIDTH NYLON BEARING WIDTH	DIM "C" NYLON BEARING O.D.
PTO 9200017	2 1/8" (2.125")	3/8" (.375")	2 3/4" (2.75")
PTO 9200069	1 3/4" (1.75")	3/8" (.375")	2 3/4" (2.75")
PTO 9200085	2" (2.0")	3/8" (.375")	2 3/4" (2.75")
PTO 9200102	1 3/8" (1.375")	11/32" (.343")	2" (2.0")
PTO 9200141	1 5/8" (1.625")	11/32" (.343")	2 3/4" (2.75")
PTO 9200165	2 1/8" (2.125")	3/8" (.375")	3 1/4" (3.25")
PTO 9200195	1 3/4" (1.75")	3/8" (.375")	2 1/2" (2.50")
PTO 9200254	1 5/8" (1.625")	11/32" (.343")	2 1/4" (2.25")
PTO 9200259	2" (2.0")	3/8" (.375")	3 1/4" (3.25")
PTO 9200260	2 17/32" (2.530")	33/64" (.358")	2 49/64" (2.770")
PTO 9200600	1 13/16" (1.825")	9/32" (.2812")	2 3/4" (2.75")
PTO 9201200	2 1/16" (2.0625")	11/32" (.343")	2 3/4" (2.75")
PTO 9202600	2 7/8" (2.875")	11/32" (.343")	3 9/16" (3.5625")
PTO 9203500	2 1/16" (2.0625")	11/32" (.343")	2 3/4" (2.75")
PTO 9204400	2 5/8" (2.625")	3/8" (.375")	3 1/4" (3.25")
PTO 9204P15	1 21/32" (1.646")	11/32" (.358")	2 3/4" (2.76")
PTO 9204P16	1 25/32" (1.770")	11/32" (.358")	2 3/4" (2.76")
PTO 9205071	2 1/32" (2.021")	11/32" (.358")	2 3/4" (2.76")
PTO 9205084	2 5/32" (2.146")	11/32" (.358")	2 3/4" (2.76")
PTO 9204N15	1 61/64" (1.947")	9/32" (.291")	2 1/4" (2.25")
PTO 9204N16	2 1/8" (2.125")	21/64" (.341")	2 1/2" (2.50")

### NOTE!

All Series North American guards are provided without nylon bearings. To help assure the proper set of nylon bearings are installed, one nylon bearing set will be exactly the same (nylon bearing raceway dimensions) as has always been provided in our aftermarket guards. The other set will be dimensioned to retrofit the Weasler OEM raceway. Assembly instructions included with these nylon bearing kits.

**DRIVELINE COMPONENTS**

**LOCKING DEVICE**



**Safety Slide Lock**

An exclusive Weasler replacement component, the Safety Slide Lock\* yoke is locked in place by two hardened pawls with compound radii that conform to the groove in the shaft for full contact. The device is particularly applicable where there is appreciable end thrust.

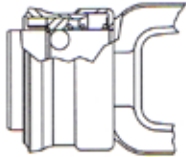

**Spring-Lok**

The collar is spring loaded for ease of installation and positive locking to tractor shaft.

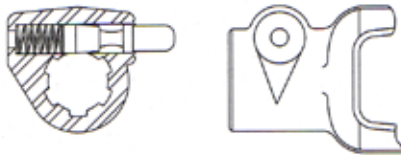

**Quick Disconnect**

A smooth plunger eliminates sharp projections such as x-washers. Trails rather than leads rotation.

**LOCKING DEVICE REPAIR KIT**

**\*Auto-Lok/Safety Slide Lock**



PART NO.	DESCRIPTION
PTO 13004000	Repair Kit for Weasler Auto-Lok and Safety Slide Lock 6 Spline & 21 Spline
PTO 13004020	Repair Kit for Weasler Auto-Lok and Safety Slide Lock 20 Spline
PTO 13004015	Repair Kit for 1" x 15 Spline

*\*This repair kit contains both balls & pawls. When repairing the "Safety Slide Lock" use the pawls only and discard the balls. When repairing the "Auto-Lok" use both the balls and the pawls.*

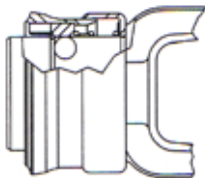

**Spring-Lok**

PART NO.	DESCRIPTION
PTO 13003100	Repair Kit for Weasler Spring-Lok, 6 Spline & 21 Spline
PTO 13003115	1" x 15 Spline

**Quick Disconnect**

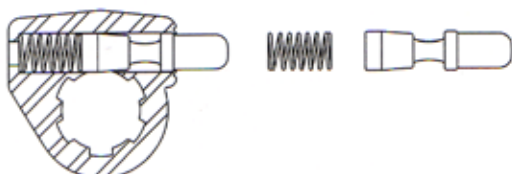

PART NO.	DESCRIPTION
PTO 13002006	Repair Kit for Weasler and Rockwell 6 Spline
PTO 13002806	Repair Kit for 1 3/4" x 6 Spl.
PTO 13002021	Weasler 21 Spline and Hex Quick Disconnect
PTO 13002020	Weasler 20 Spline



## COMPLETE UNIVERSAL JOINTS

### Round to Round

PART NO.	SERIES NO.	BORE A	BORE A-1	WEIGHT LBS.
PTO 1930416	4P	1 Round	1 Round	2.26
PTO 1930612	6N	3/4 Round	3/4 Round	2.56
PTO 1930616	6N	1 Round	1 Round	3.13

Round bore yokes are furnished with standard keyway and setscrew.

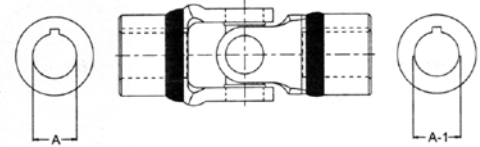

### Round to Tube Weld

PART NO.	SERIES NO.	BORE A	BORE A-1	WEIGHT LBS.
PTO 1900616	6N	1 round	1 x 1 1/8 Rect.	2.94

Round bore yokes are furnished with standard keyway and setscrew.

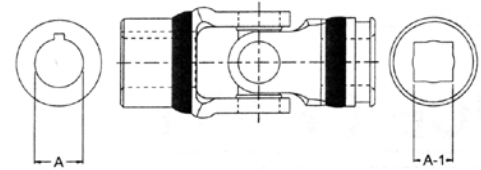

## COMBINE HEADER DRIVELINES

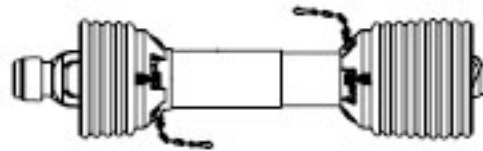

### Metric

PART NO.	SERIES	COMBINE HOOK-UP	HEADER HOOK-UP	OAL COMPRESSED	FITS
PTO 14007631	2400	1 3/8" x 21 Spline Slide Collar	1 1/8" Hex Clamp	31"	<u>Cutting Platform Series:</u> 90, 600 & 900 Models: 615, 618, 620, 622, 625, 630, 918 & 920 <u>Draper Platform Series:</u> 90 - 25', 30', 36' Models: 606C, 608C & 612C (New)
PTO 14007661	2400	1 3/8" x 21 Spline Slide Collar	1 1/8" Hex Clamp	61"	635 Flex Platform (2008 Models)
PTO 14007633	2400	1 1/8" Hex Slide Collar	1 1/8" Hex Clamp	33"	<u>Case-IH Combine</u> Models: 1420, 1440, 1460, 1470, 1480, 1482, 1620, 1640, 1644, 1660, 1666, 1670, 1680, 1682, 1688, 2144, 2166, 2188, 2344, 2366, 2377, 2388 <u>John Deere Combine</u> Models: 1253A, 453A, 454A, 653A, 654A, 655A, 853A, 854A

### North American

PART NO.	SERIES	COMBINE HOOK-UP	HEADER HOOK-UP	OAL COMPRESSED	FITS
PTO 14013531	35	1 3/8" x 21 Spline Slide Collar	1 1/8" Hex Clamp	31"	<u>Cutting Platform Series:</u> 90, 600 & 900 Models: 615, 618, 620, 622, 625, 630, 918 & 920 <u>Draper Platform Series:</u> 90 - 25', 30', 36' Models: 606C, 608C & 612C (New)
PTO 14003561	35	1 3/8" x 21 Spline Slide Collar	1 1/8" Hex Clamp	61"	635 Flex Platform (2008 Models)

## COMPETITOR INTERCHANGEABILITY

	FM/TRW	NEAPCO	BONDIOLI & PAVESI	AGDRIVE	WALTERSCHEID	WEASLER
Series Kit	1 20425	1 1-0121	1 1.41	AB1 AP100		2006154
Series Kit	2100 20430	2100 1-1001		AW10 AP10	2100 10.01.00	2007155
Series Kit	2 20426	2 1-0221	2 2.41	AB2 AP220		2008261
Series Kit	2200 20426	2200 1-0221		AW20 AP220	2200 20.00.00	2008261
Series Kit	3 20330	3 1-0321	3 3.41	AB3 AP311		2008370
Series Kit	1 20330	1 1-0321		AW11 AP311	1 11.03.00	2008370
Series Kit	2300 20331	2300 1-0421		AW21 AP421	2300 21.00.00	2008474
Series Kit	4 20331	4 1-0421	4 4.41	AB4 AP421		2008474
Series Kit	5 20427	5 2-0521	5 5.41	AB5 AP500		2006580
Series Kit	2400 20428	2400 2-2421		AW35 AP35	2400 35.00.00	2007676
Series Kit	6 20429	6 3-0621	6 6.41	AB6 AP622		2008692
Series Kit	2500 20434	2500 3-2521		AW36 AP36	2500 36.00.00	2007989
Series Kit	7 20432	7 3-0721	7 7.81	AB7N AP7N		2006794
Series Kit	8 20431	8 3-0821	8 8.41	AB8 AP824		2006806
Series Kit	9 20433	9 3-0921	9 9.81	AB9 AP900		
Series Kit	10 20439	10 3-1021	10 41210			

## METRIC PTO DRIVELINES, COMPONENTS & ACCESSORIES





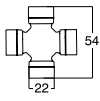
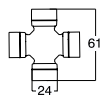
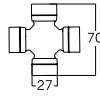
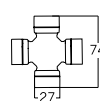
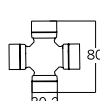
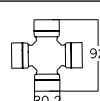
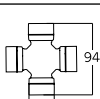
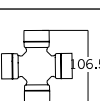
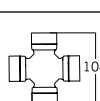

NOW AVAILABLE - a complete line of European drivelines and accessories for replacement of complete drivelines in the field. Plus a complete inventory of reasonably priced replacement parts to fit existing Bondioli & Pavesi and Walterscheid drivelines.

### Bondioli & Pavesi Drivelines Covered

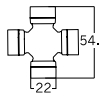
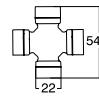
B&P SERIES	CROSS SIZE	AG-DRIVE SERIES	HP		IN. LB. TORQUE	
			540 RPM	1,000 RPM	540 RPM	1,000 RPM
1		AB1	16	25	1,850	1,500
2		AB2	21	31	2,400	1,950
3		AB3	30	47	3,450	2,900
4		AB4	35	55	4,050	3,350
5		AB5	47	74	5,500	4,600
6		AB6	64	100	7,350	6,259
7		AB7N	75	118	8,600	7,350
8		AB8	95	150	10,950	9,300
9		AB9	120	190	13,800	11,850

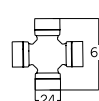
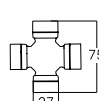
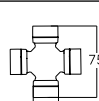
**Important Notice:** These drivelines, accessories and replacement parts are of quality European engineering and manufactured by a recognized OEM supplier and are not an imported copy from east bloc or pacific rim countries.

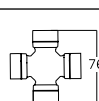
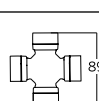
### Walterscheid Drivelines Covered

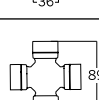
WALTER-SCHIED SERIES	CROSS SIZE	AGDRIVE SERIES	HP		IN. LB. TORQUE	
			540 RPM	1,000 RPM	540 RPM	1,000 RPM
2100		AW10	16	24	1,860	1,550
		AW10S	27	42	3,140	2,600
2200		AW20	27	42	3,140	2,600
		AW20S	16	24	1,860	1,530
2300		AW21	38	60	4,420	3,675
		AW21S	53	83	6,150	5,130
2400		AW35	53	83	6,150	5,130
		AW35S	90	139	10,400	8,630
2500		AW36	120	190	13,800	11,850
		AW36S	98	145	16,580	13,800
		AW26	107	166	12,390	10,310

**TRANSPARENCY IDENTIFICATION SYSTEM**

**METRIC DRIVELINES & COMPONENTS**

**For Metric Driveline Components**

The individual transparency cards will allow the user to easily identify driveline components. Cross and Bearing Kits may be identified by the bearing cap outside diameter and the width of the cross. Yokes may be identified by the hole in the ear and profile. Tubes and shafts may be identified by the end sections.

How to use the Transparency Identification System:

1. Match the part to be replaced with the corresponding transparency card for identification.
2. Select the proper stock number for the replacement part.

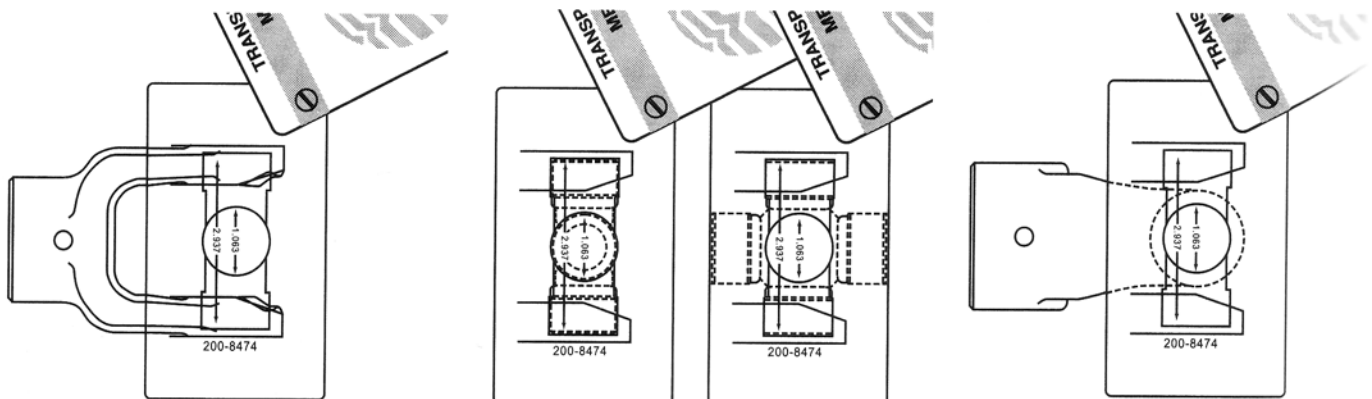
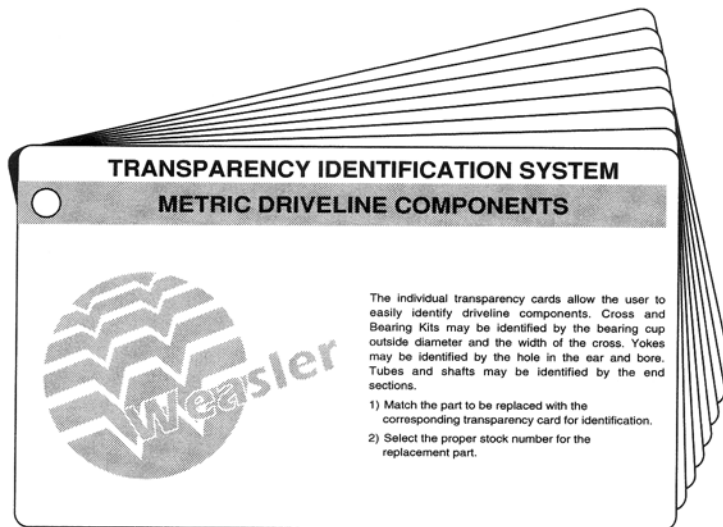

**METRIC DRIVELINES & COMPONENTS**

**PART NUMBER EXPLANATION**

Each series has an exploded view for identification purposes. The drawing illustrates the components in the same sequence as an implement input driveline transmitting power from tractor to implement. Each component of the exploded view is identified by an eight-digit stock number to insure correct identification of each component.

Example: For metric components the 102 prefix denotes a Quick Disconnect Tractor Yoke on the exploded view.

When ordering any component in the exploded view (for any series), be sure the part number begins with the appropriate three-digit prefix.

The digit immediately following the dash (-) will be a 6, 7 or 8.

- A 6 indicates the item is interchangeable with Bondioli & Pavesi ONLY.
- A 7 indicates the item is interchangeable with Walterscheid ONLY.
- An 8 indicates the item is interchangeable with BOTH Bondioli & Pavesi AND Walterscheid.

This interchangeability designation is used for all components EXCEPT roll pins, guards and guard bearings.

The following chart lists the approximate size replacement for Metric Drivelines. These are not an exact interchange, and should be used as a general replacement guide only.

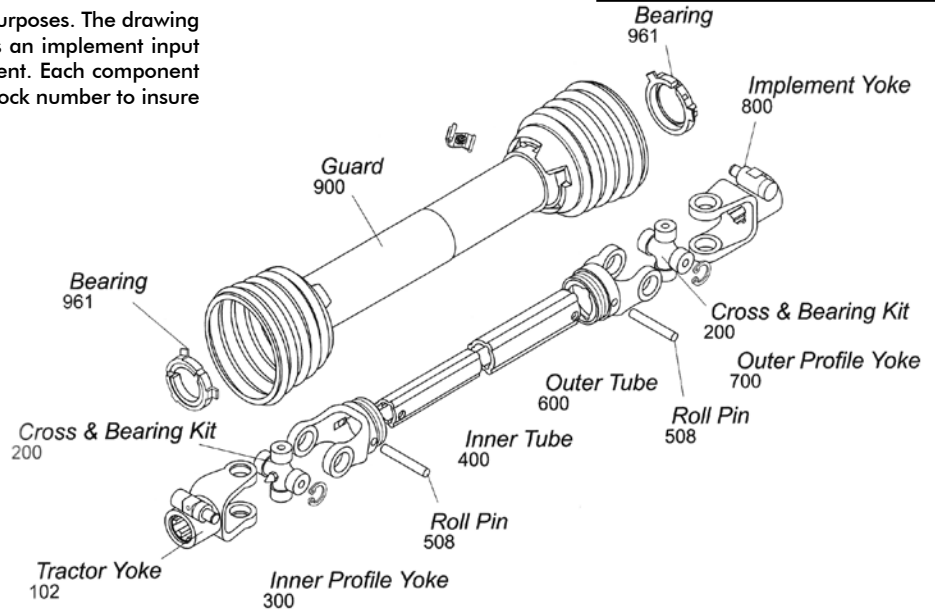

**Cross & Bearing Kit Cross Reference Chart for Metric Components**

CROSS & BEARING R-KIT PART NO.	CROSS & BEARING E-KIT PART NO.	INTERCHANGES WITH BONDIOLI & PAVESI SERIES	INTERCHANGES WITH WALTERSCHEID SERIES
PTO 2006154	PTO 2016154	1	N/A
PTO 2006580	PTO 2016580	5	N/A
PTO 2006794	PTO 2016794	7N	N/A
PTO 2006806	PTO 2016806	8	N/A
PTO 2006908	PTO 2016908	9	N/A
PTO 2007004	PTO 2017004	N/A	2600
PTO 2007155	PTO 2017155	N/A	2100
PTO 2007676	PTO 2017676	N/A	2400
PTO 2007890	N/A	11	N/A
PTO 2007989	PTO 2017989	N/A	2500
PTO 2008261	PTO 2018261	2	2200
PTO 2008370	PTO 2018370	3	I
PTO 2008474	PTO 2018474	4	2300
PTO 2008692	PTO 2018692	6	220
PTO 2008706	PTO 2018706	7 (Old Series)	230
PTO 2007276	PTO 2017276	N/A	2280
PTO 2007491	PTO 2017491	N/A	2380
PTO 2007694	PTO 2017694	N/A	2480
PTO 2007906	PTO 2017906	N/A	2580

**Driveline Replacement Chart**

WEASLER SERIES	REPLACEMENT FOR:	WEASLER SERIES	REPLACEMENT FOR:
6	Bondioli & Pavesi 1 & 2 Series Walterscheid 2100 & 2200 Series	35	Bondioli & Pavesi 5 Series Walterscheid 220 & 2400 Series
12	Bondioli & Pavesi 3 Series Walterscheid I Series	44	Bondioli & Pavesi 6 & 7 Series Walterscheid II Series
14	Bondioli & Pavesi 4 Series Walterscheid 2300 Series	55	Bondioli & Pavesi 8 & 9 Series Walterscheid 2500 & 2600 Series

**1 SERIES**

Interchanges with Bondioli & Pavesi

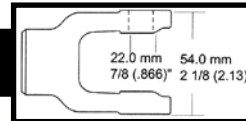

**METRIC DRIVELINES & COMPONENTS**

**AB1**

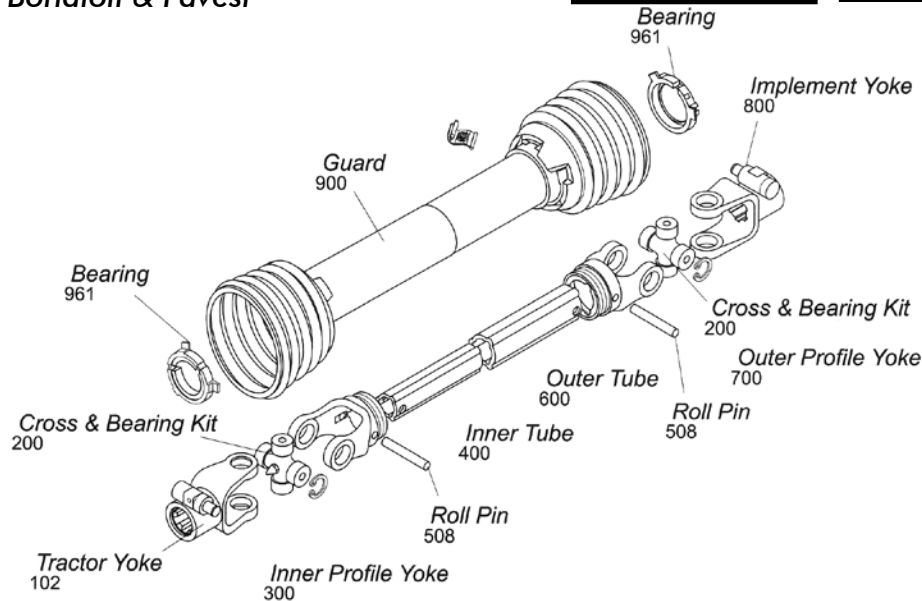

**Tractor Yoke**

**Safety Slide Lock  
Repair Kit - Page 106**

PART NO.	DIM "A" BORE
PTO 1016106	1 3/8" x 6 Spl.
PTO 1016121	1 3/8" x 21 Spl.

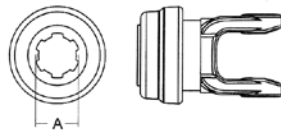

**Quick Disconnect  
Repair Kit - Page 106**

PART NO.	DIM "A" BORE
PTO 1026118	1 1/8" x 6 Spl.
PTO 1026106	1 3/8" x 6 Spl.
PTO 1026121	1 3/8" x 21 Spl.

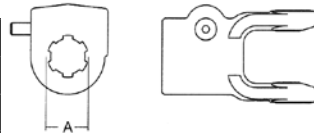

**Cross & Bearing Kit (R-Kit)**

Snap Ring Located in Yoke

PART NO.	DIM "A"		DIM "B"	
	mm	inches	mm	inches
PTO 2006154	22.0	7/8" (.87)	54.0	2 1/8" (2.13)

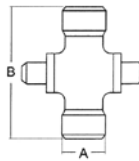

**Extended Lubrication Cross & Bearing Kit (E-Kit)**

Snap Ring Located in Yoke

PART NO.	DIM "A"		DIM "B"	
	mm	inches	mm	inches
PTO 2016154	22.0	7/8" (.87)	54.0	2 1/8" (2.13)

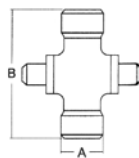

**Inner Profile Yoke**

With Bearing Groove  
(Guard must rotate  
freely on yoke)

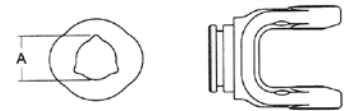

PART NO.	DIM "A" BORE	
	mm	inches
PTO 3006126	27.5	1 5/64" (1.08)

**Inner Tube**

26.5 (3.4 Wall) mm  
1.024" (.138" Wall)



PART NO.	LENGTH	
	m	inches
PTO 4006126	1.5	59 1/16" (59.06)
PTO 4016126	3.0	118 1/8" (118.11)
PTO 4046126	1.0	39 3/8" (39.37)

**Roll Pin**

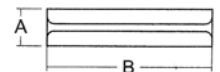

PART NO.	DIM "A"		DIM "B"	
	mm	inches	mm	inches
PTO 5080850	8.0	5/16" (.31)	50.0	1 31/32" (1.97)

1 SERIES

METRIC DRIVELINES & COMPONENTS

Outer Tube

32.5 (2.6 Wall) mm  
1.299" (.102" Wall)

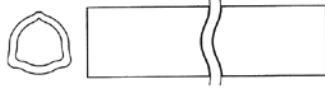

PART NO.	LENGTH	
	m	inches
PTO 6006133	1.5	59 1/16" (59.06)
PTO 6016133	3.0	118 1/8" (118.11)
PTO 6046133	1.0	39 3/8" (39.37)

Outer Profile Yoke

With Bearing Groove  
(Guard must rotate freely on yoke)



PART NO.	DIM "A" BORE	
	mm	inches
PTO 7006133	33.0	1 5/16" (1.30)

Implement Yoke

Round Bore  
With Keyway & Set Screw

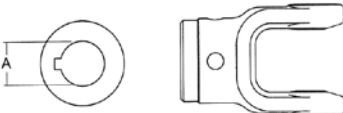

PART NO.	DIM "A"		STANDARD KEYWAY	
	mm	inches	mm	inches
AE 100322	22.22	7/8" (.875)	10.0	3/16" (.1875)
PTO 8006108	25.4	1" (1.0)	6.35	1/4" (.25)
PTO 8006110	31.75	1 1/4" (1.25)	6.35	1/4" (.25)
PTO 8006130	30.0	1 3/16" (1.18)	10.0	25/64" (.39)

Drivelines

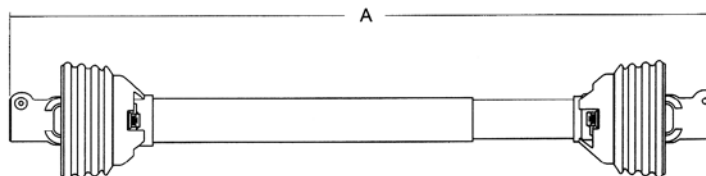

PART NO.	OVERALL COMP. LENGTH DIM "A"	TRACTOR YOKE	IMPLEMENT YOKE
PTO 14006127	27"	1 3/8" x 6 Spl. QD	1 3/8" x 6 Spl. QD
PTO 14006135	35"	1 3/8" x 6 Spl. QD	1 3/8" x 6 Spl. QD
PTO 14006137	37"	1 3/8" x 6 Spl. QD	1 3/8" x 6 Spl. QD
PTO 14046148	48"	1 3/8" x 6 Spl. QD	*

\*Drivelines are furnished without Cross & Bearing Kit and Implement Yoke. Select kit and yoke as required.

Implement Yoke

Shear Pin  
With Pin Hole

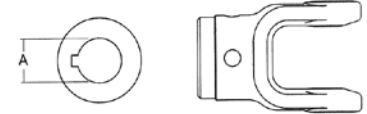

PART NO.	DIM "A"	
	mm	inches
PTO 8026110	31.75	1 1/4" (1.25)
PTO AE100022	22.22	7/8"
PTO AE100028	28.57	1 1/8"

Guard

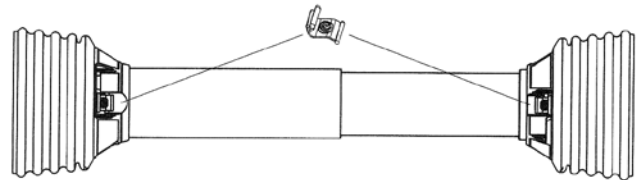

Order Bearings as required

PART NO.	OVERALL DRIVELINE LENGTH	BEARING KIT (2 PER KIT)
PTO 9002548	48"	PTO 9615029
PTO 9002560	60"	PTO 9615029

Assembly instructions included with guard.

Note: When installing Guards observe the following:

- 1) Install proper nylon bearing (See Page 11)
- 2) Guards must rotate freely on yokes.

Easy Lock™ Replacement Kit

PART NO.
PTO 13005000 (4 per kit)



# 1 SERIES

## Clamp Yokes

### Round Bore

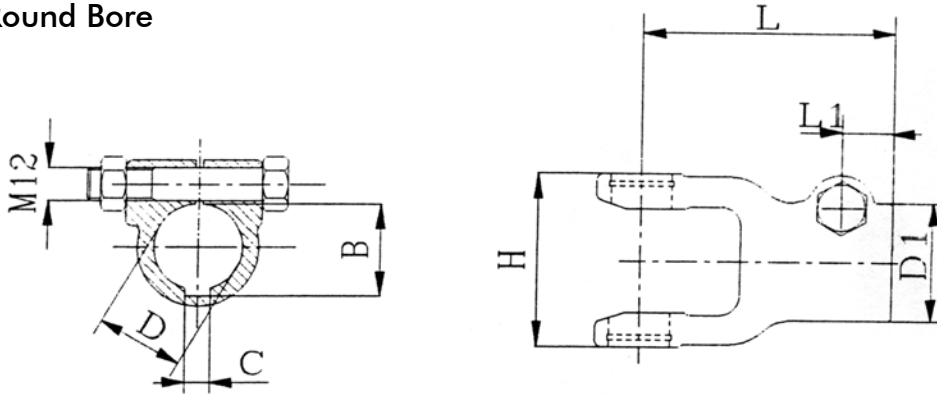

PART NO.	SIZE (MM)			SERIES AB1			
	D	C	B	L	L1	D1	H
PTO AP100520	20	6	22.8	92	16	46	63
PTO AP100530	30	8	33.3	92	16	46	63

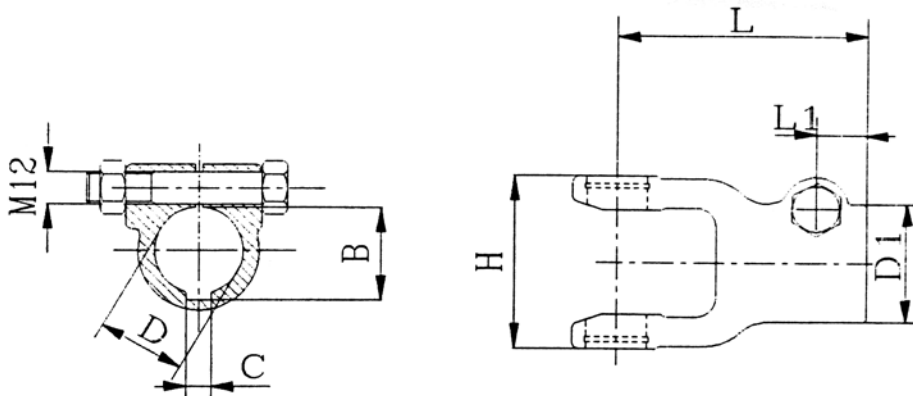

PART NO.	SIZE			SERIES AB1			
	D	C	B	L	L1	D1	H
PTO AE100531	1 1/4"	1/4" (5/16")	35.1 (36.72)	92	16	46	63



2 SERIES

Interchanges with Bondioli & Pavesi

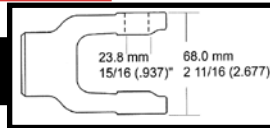

METRIC DRIVELINES & COMPONENTS

AB2

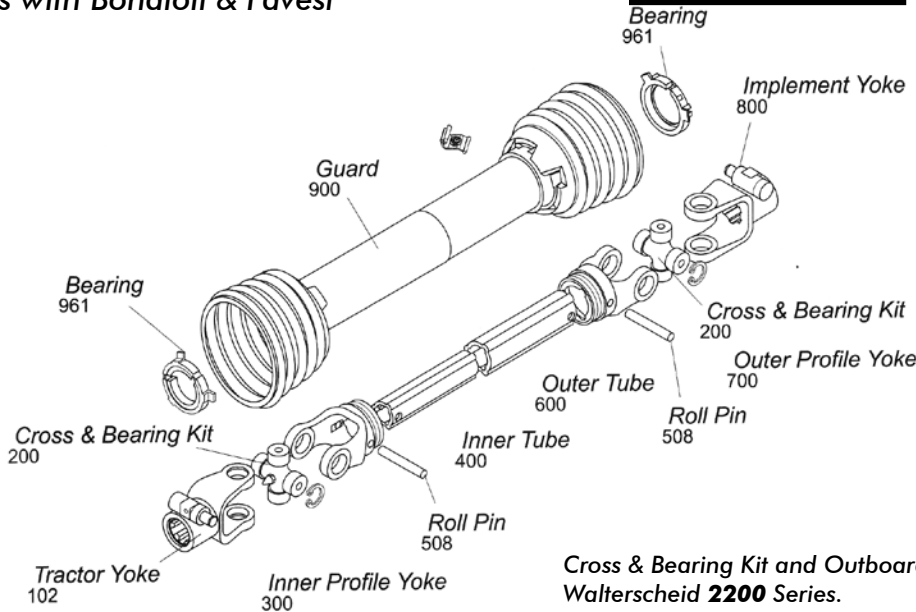

Cross & Bearing Kit and Outboard Yokes interchange with Walterscheid 2200 Series.

Tractor Yoke

Safety Slide Lock Repair Kit - Page 88

PART NO.	DIM "A" BORE
PTO 1018206	1 3/8" x 6 Spl.
PTO 1018221	1 3/8" x 21 Spl.

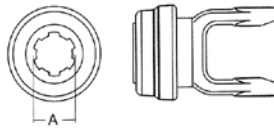

Inner Profile Yoke

With Bearing Groove (Guard must rotate freely on yoke)

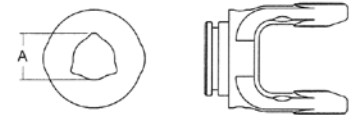

PART NO.	DIM "A" BORE	
	mm	inches
PTO 3006229	29.8	1 11/64" (1.17)

Quick Disconnect Repair Kit - Page 88

PART NO.	DIM "A" BORE
PTO 1028218	1 1/8" x 6 Spl.
PTO 1028206	1 3/8" x 6 Spl.
PTO 1028221	1 3/8" x 21 Spl.

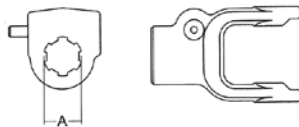

Inner Tube

29.0 (4.1 Wall) mm  
1.142" (.134" Wall)



PART NO.	LENGTH	
	m	inches
PTO 4006229	1.5	59 1/16" (59.06)
PTO 4016229	3.0	118 1/8" (118.11)
PTO 4046229	1.0	39 3/8" (39.37)

Cross & Bearing Kit (R-Kit)

Snap Ring Located in Yoke

PART NO.	DIM "A"		DIM "B"	
	mm	inches	mm	inches
PTO 2008261	23.8	15/16" (.94)	61.2	2 13/32" (2.41)

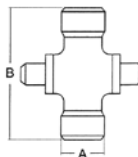

Extended Lubrication Cross & Bearing Kit (E-Kit)

Snap Ring Located in Yoke

PART NO.	DIM "A"		DIM "B"	
	mm	inches	mm	inches
PTO 2018261	23.8	15/16" (.94)	61.2	2 13/32" (2.41)

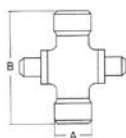

Roll Pin

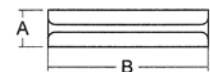

PART NO.	DIM "A"		DIM "B"	
	mm	inches	mm	inches
PTO 5080860	8.0	5/16" (.31)	60.0	2 23/64" (2.36)

**2 SERIES**

**METRIC DRIVELINES & COMPONENTS**

**Outer Tube**

36.0 (3.2 Wall) mm  
1.417" (.134" Wall)



PART NO.	LENGTH	
	m	inches
PTO 6006236	1.5	59 1/16" (59.06)
PTO 6016236	3.0	118 1/8" (118.11)
PTO 6046236	1.0	39 3/8" (39.37)

**Outer Profile Yoke**

With Bearing Groove  
(Guard must rotate freely on yoke)

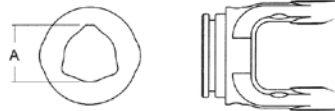

PART NO.	DIM "A" BORE	
	mm	inches
PTO 7006236	36.8	1 29/64" (1.45)

**Implement Yoke**

Round Bore  
With Keyway & Set Screw



PART NO.	DIM "A"		STANDARD KEYWAY	
	mm	inches	mm	inches
PTO AE220319	19.05	3/4"	-	-
PTO 8008225	25.0	63/64" (.98)	8.0	5/16" (.31)
PTO 8008208	25.0	1" (1.0)	8.0	1/4" (.25)
PTO 8008218	28.6	1 1/8" (1.13)	8.0	1/4" (.25)
PTO 8008230	30.0	1 3/16" (1.18)	8.0	5/16" (.31)
PTO 8008210	31.8	1 1/4" (1.25)	6.4	1/4" (.25)
PTO 8008211	34.9	1 3/8" (1.38)	8.0	5/16" (.31)

**Drivelines**

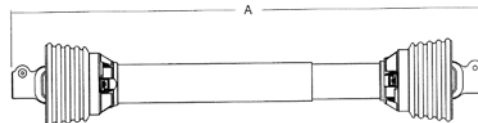

PART NO.	OVERALL COMP. LENGTH DIM "A"	TRACTOR YOKE	IMPLEMENT YOKE
PTO 14006247	47"	1 3/8" x 6 Spl. QD	1 3/8" x 6 Spl. QD
PTO 14006251	51"	1 3/8" x 6 Spl. QD	1 3/8" Rd. w/Pinhole
PTO 14006252	52"	1 3/8" x 6 Spl. QD	1 1/4" Rd. w/Pinhole
PTO 14046248	48"	1 3/8" x 6 Spl. QD	*
PTO 14046260	60"	1 3/8" x 6 Spl. QD	*
PTO 14106233	33"	1 3/8" x 6 Spl. QD	1 3/8" x 6 Spl. w/Friction Clutch
PTO 14206252	52"	1 3/8" x 6 Spl. QD	1 3/8" x 6 Spl. w/Radial Pin Clutch

\*Drivelines are furnished without Cross & Bearing Kit and Implement Yoke. Select kit and yoke as required.

**Shear Pin Yoke**

With Pin Hole

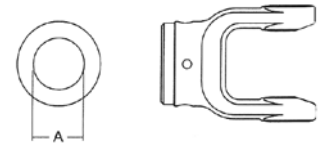

PART NO.	DIM "A" BORE	
	mm	inches
PTO 8028220	31.8	1 1/4" Rd. (1.25)
PTO 8028222	34.9	1 3/8" Rd. (1.38)
PTO AE220019	19.05	3/4"
PTO AE220025	25.40	1"
PTO AP220025	25.0	-
PTO AP220030	30.0	-

**Guard**

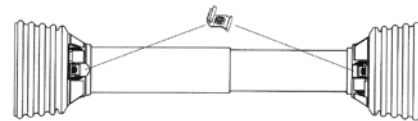

Order Bearings as required

PART NO.	OVERALL DRIVELINE LENGTH	BEARING KIT (2 PER KIT)
PTO 9002548	48"	PTO 9612502
PTO 9002560	60"	PTO 9612502

Assembly instructions included with guard.  
Note: When installing Guards observe the following:  
1) Install proper nylon bearing (See Page 11)  
2) Guards must rotate freely on yokes.

**Easy Lock™ Replacement Kit**

PART NO.
PTO 13005000 (4 per kit)



**2 SERIES**

**METRIC DRIVELINES  
& COMPONENTS**

**Clamp Yokes**

**Round Bore**

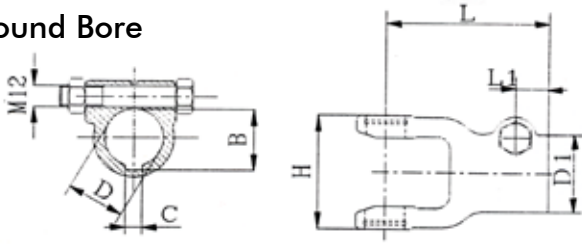

PART NO.	SIZE			SERIES AB2/AW20			
	D	C	B	L	L1	D1	H
PTO AE220522	22.22 (7/8")	3/16"	24.75	98	20	48	70

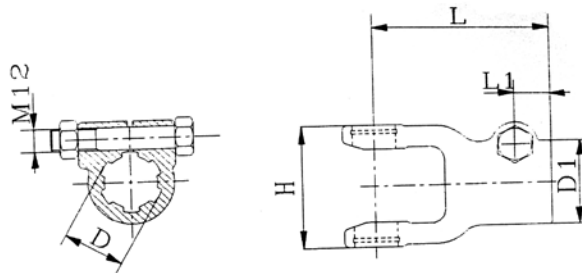

PART NO.	SIZE		SERIES AB2/AW20			
	D	Spline	L	L1	D1	H
PTO AP2205138	1 3/8"	6	98	20	48	70

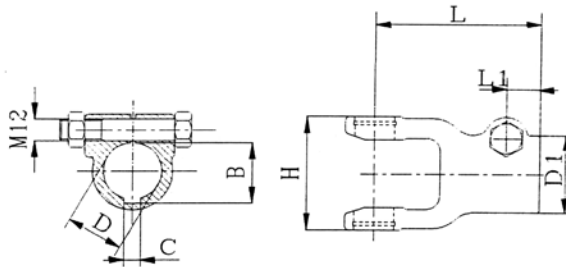

PART NO.	SIZE (MM)			SERIES AB2/AW20			
	D	C	B	L	L1	D1	H
PTO AP220525	25	8	28.3	98	20	48	70
PTO AP220530	30	8	33.3	98	20	48	70

**3 SERIES**

Interchanges with Bondioli & Pavesi

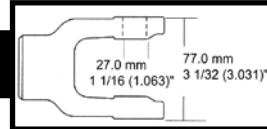

**METRIC DRIVELINES & COMPONENTS**

**AB3**

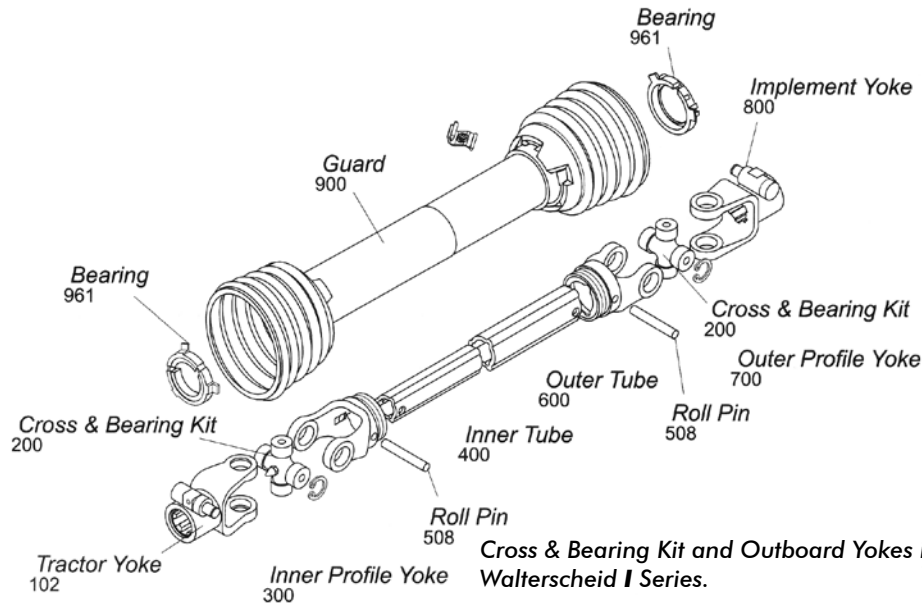

Cross & Bearing Kit and Outboard Yokes interchange with Walterscheid I Series.

**Tractor Yoke**

**Safety Slide Lock Repair Kit - Page 106**

PART NO.	DIM "A" BORE
PTO 1018306	1 3/8" x 6 Spl.
PTO 1018321	1 3/8" x 21 Spl.

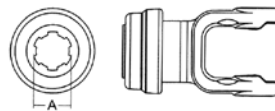

**Quick Disconnect Repair Kit - Page 106**

PART NO.	DIM "A" BORE
PTO 1028306	1 3/8" x 6 Spl.
PTO 1028321	1 3/8" x 21 Spl.

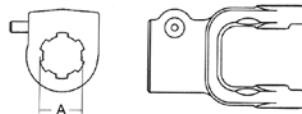

**Cross & Bearing Kit (R-Kit)**

Snap Ring Located in Yoke

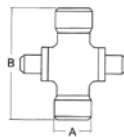

PART NO.	DIM "A"		DIM "B"	
	mm	inches	mm	inches
PTO 2008370	27.0	1 1/16" (1.06)	70.0	2 3/4" (2.76)

**Extended Lubrication Cross & Bearing Kit (E-Kit)**

Snap Ring Located in Yoke

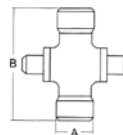

PART NO.	DIM "A"		DIM "B"	
	mm	inches	mm	inches
PTO 2018370	27.0	1 1/16" (1.06)	70.0	2 3/4" (2.76)

**Inner Profile Yoke**

With Bearing Groove (Guard must rotate freely on yoke)



PART NO.	DIM "A" BORE	
	mm	inches
PTO 3006336	36.8	1 29/64" (1.45)

**Inner Tube**

36.0 (3.2 Wall) mm  
1.417" (1.134" Wall)

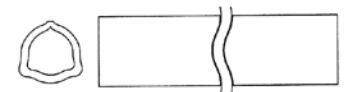

PART NO.	LENGTH	
	m	inches
PTO 6006236	1.5	59 1/16" (59.06)
PTO 6016236	3.0	118 1/8" (118.11)
PTO 6046236	1.0	39 3/8" (39.37)

**Roll Pin**

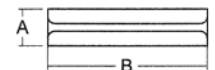

PART NO.	DIM "A"		DIM "B"	
	mm	inches	mm	inches
PTO 5080860	8.0	5/16" (.31)	60.0	2 23/64" (2.36)

3 SERIES

METRIC DRIVELINES & COMPONENTS

Outer Tube

43.5 (3.4 Wall) mm  
1.693" (.118" Wall)



PART NO.	LENGTH	
	m	inches
PTO 6006343	1.5	59 1/16" (59.06)
PTO 6016343	3.0	118 1/8" (118.11)
PTO 6046343	1.0	39 3/8" (39.37)

Outer Profile Yoke

With Bearing Groove  
(Guard must rotate freely on yoke)



PART NO.	DIM "A" BORE	
	mm	inches
PTO 7006343	44.0	1 47/64" (1.73)

Implement Yoke

Round Bore  
With Keyway & Set Screw

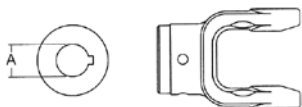

PART NO.	DIM "A"		STANDARD KEYWAY	
	mm	inches	mm	inches
PTO 8008325	25.0	63/64" (.98)	8.0	5/16" (.31)
PTO AE311325	25.40	1"	-	-
PTO 8008330	30.0	1 3/16" (1.18)	8.0	5/16" (.31)
PTO 8008310	31.8	1 1/4" (1.25)	6.4	1/4" (.25)
PTO 8008311	34.9	1 3/8" (1.38)	8.0	5/16" (.31)

Implement Yoke

Shear Pin  
With Pin Hole

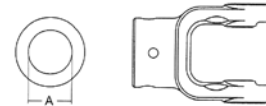

PART NO.	DIM "A" BORE	
	mm	inches
PTO AE311025	25.40	1"
PTO AP311025	25.0	Bore
PTO 8028310	31.8	1 1/4" (1.25)
PTO 8028325	25.0	63/64" (.98)
PTO 8028330	30.0	1 3/16" (1.18)
PTO 8028335	35.0	-

Guard

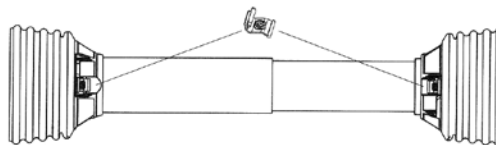

Order Bearings as required

PART NO.	OVERALL DRIVELINE LENGTH	BEARING KIT (2 PER KIT)
PTO 9002548	48"	PTO 9612534
PTO 9002560	60"	PTO 9612534

Assembly instructions included with guard.

Note: When installing Guards observe the following:

- 1) Install proper nylon bearing (See Page 11)
- 2) Guards must rotate freely on yokes.

Easy Lock™ Replacement Kit

PART NO.
PTO 13005000 (4 per kit)



Drivelines

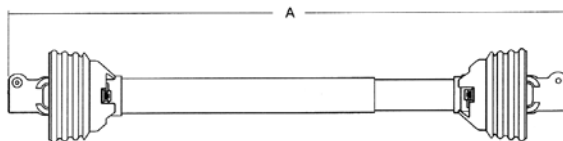

PART NO.	OVERALL COMP. LENGTH DIM "A"	TRACTOR YOKE	IMPLEMENT YOKE
PTO 14006340	40"	1 3/8" x 6 Spl. QD	1 3/8" x 6 Spl. QD
PTO 14046348	48"	1 3/8" x 6 Spl. QD	*
PTO 14046360	60"	1 3/8" x 6 Spl. QD	*

\*Drivelines are furnished without Cross & Bearing Kit and Implement Yoke. Select kit and yoke as required.

**3 SERIES**

**METRIC DRIVELINES & COMPONENTS**

**Clamp Yokes**

**Round Bore**

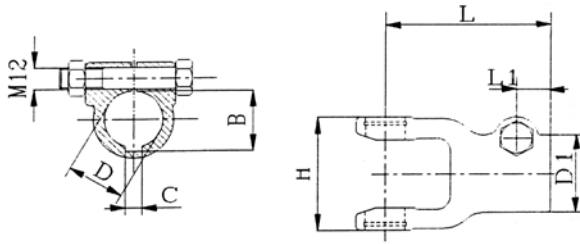

PART NO.	SIZE (MM)			SERIES AB3/AW11			
	D	C	B	L	L1	D1	H
PTO AP311525	25	8	28.3	102	20	50	80
PTO AP311530	30	8	33.3	102	20	50	80
PTO AP311535	35	10	38.3	102	20	50	80

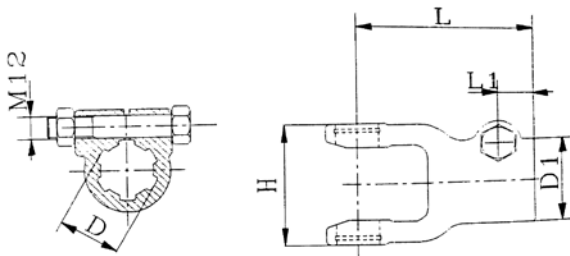

PART NO.	SIZE (MM)		SERIES AB3/AW11			
	D	SPLINE	L	L1	D1	H
PTO AP3115121	1 3/8"	21	102	20	50	80

4 SERIES

Interchanges with Bondioli & Pavesi

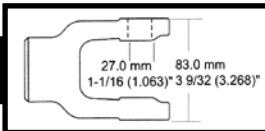

METRIC DRIVELINES & COMPONENTS

AB4

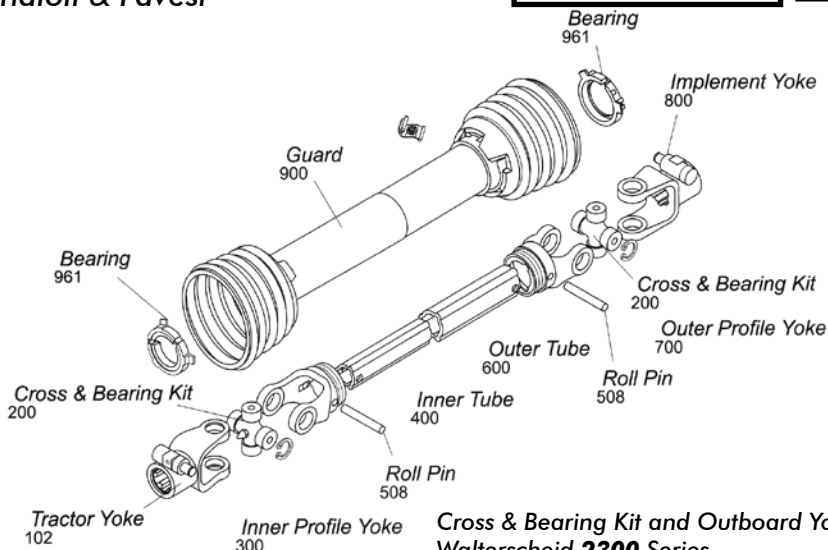

Cross & Bearing Kit and Outboard Yokes interchange with Walterscheid 2300 Series.

Tractor Yoke

Safety Slide Lock

Repair Kit - Page 106

PART NO.	DIM "A" BORE
PTO 1018406	1 3/8" x 6 Spl.
PTO 1018421	1 3/8" x 21 Spl.

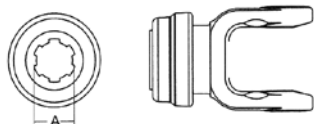

Quick Disconnect

Repair Kit - Page 106

PART NO.	DIM "A" BORE
PTO 1028406	1 3/8" x 6 Spl.
PTO 1028418	1 1/8" Hex
PTO 1028421	1 3/8" x 21 Spl.
PTO AP421120	1 3/4" x 20 Spl.
PTO AP421134	1 3/4" x 6 Spl.

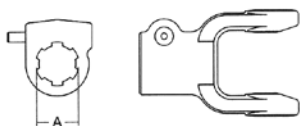

Ball Shear

PART NO.	DIM "A" BORE
PTO 1048406	1 3/8" x 6 Spl.
PTO 1048420	1 3/4" x 20 Spl.
PTO 1048421	1 3/8" x 21 Spl.

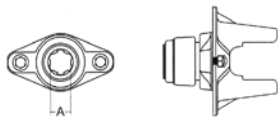

Cross & Bearing Kit (R-Kit)

Snap Ring Located in Yoke

PART NO.	DIM "A"		DIM "B"	
	mm	inches	mm	inches
PTO 2008474	27.0	1 1/16" (1.06)	74.6	2 15/16" (2.94)

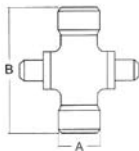

Extended Lubrication Cross & Bearing Kit (E-Kit)

Snap Ring Located in Yoke

PART NO.	DIM "A"		DIM "B"	
	mm	inches	mm	inches
PTO 2018474	27.0	1 1/16" (1.06)	74.6	2 15/16" (2.94)

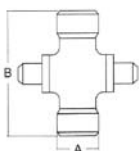

Inner Profile Yoke

With Bearing Groove

(Guard must rotate freely on yoke)

PART NO.	DIM "A" BORE	
	mm	inches
PTO 3006436	36.8	1 29/64" (1.45)



Inner Tube

36.0 (3.9 Wall) mm  
1.417" (.157" Wall)



PART NO.	LENGTH	
	m	inches
PTO 4006436	1.5	59 1/16" (59.06)
PTO 4016436	3.0	118 1/8" (118.11)
PTO 4046436	1.0	39 3/8" (39.37)

Roll Pin

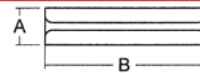

PART NO.	DIM "A"		DIM "B"	
	mm	inches	mm	inches
PTO 5080860	8.0	5/16" (.31)	60.0	2 3/8" (2.36)

Outer Tube

43.5 (3.4 Wall) mm  
1.713" (.138" Wall)



PART NO.	LENGTH	
	m	inches
PTO 6006343	1.5	59 1/16" (59.06)
PTO 6016343	3.0	118 1/8" (118.11)
PTO 6046343	1.0	39 3/8" (39.37)

**4 SERIES**

**METRIC DRIVELINES & COMPONENTS**

**Outer Profile Yoke**

With Bearing Groove  
(Guard must rotate freely on yoke)



PART NO.	DIM "A" BORE	
	mm	inches
PTO 7006443	44.0	1 47/64" (1.73)

**Implement Yoke**

Round Bore  
With Keyway & Set Screw



PART NO.	DIM "A"		STANDARD KEYWAY	
	mm	inches	mm	inches
PTO 8008430	30.0	1 3/16" (1.18)	8.0	5/16" (.31)
PTO 8008410	31.8	1 1/4" (1.25)	6.4	1/4" (.25)
PTO 8008411	34.9	1 3/8" (1.38)	8.0	5/16" (.31)
PTO 8008424	38.1	1 1/2" (1.50)	9.5	3/8" (.38)
PTO 8008435	35.0	1 3/8" (1.38)	10.0	25/64" (.39)

Shear Pin  
With Pin Hole

PART NO.	DIM "A" BORE	
	mm	inches
PTO AE421028	28.57	1 1/8" (1.125)
PTO 8028410	31.8	1 1/4" (1.25)
PTO 8028430	30.0	1 3/16" (1.18)
PTO 8028435	35.0	1 3/8" (1.38)

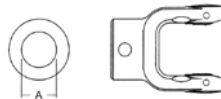

**Implement Yoke**

Hex Bore

PART NO.	DIM "A" BORE	
	mm	inches
PTO 8058418	28.9	1 9/64" (1.14)



Clamp Yoke

PART NO.	DIM "A" BORE
PTO 8078406	1 3/8" x 6 Spl.
PTO 8078420	1 1/4" Rd.



**Guard**

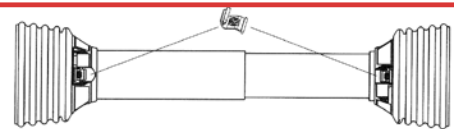

Order Bearings as required

PART NO.	OVERALL DRIVELINE LENGTH	BEARING KIT (2 PER KIT)
PTO 9002548	48"	PTO 9612534
PTO 9002560	60"	PTO 9612534

Assembly instructions included with guard.

Note: When installing Guards observe the following:

- 1) Install proper nylon bearing (See Page 11)
- 2) Guards must rotate freely on yokes.

**Easy Lock™ Replacement Kit**

PART NO.
PTO 13005000 (4 per kit)



**Clamp Yokes**

Round Bore

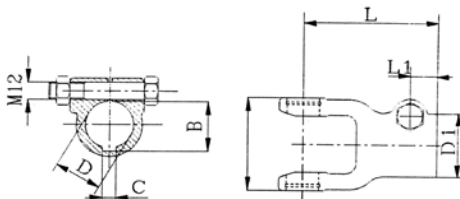

PART NO.	SIZE			SERIES AB4/AW21			
	D	C	B	L	L1	D1	H
PTO AP421535	1 3/8" (34.92 mm)	5/16"	39.9	107	20	50	84
PTO AE421528	1 1/8" (28.57 mm)	1/4"	31.9	107	20	50	84



## 4 SERIES

METRIC DRIVELINES  
& COMPONENTS

## Drivelines

PART NO.	OVERALL COMP. LENGTH DIM "A"	TRACTOR YOKE	IMPLEMENT YOKE
PTO 14006424	48"	1 3/8" x 6 Spl. QD	1 1/2" Rd.
PTO 14006430	30"	1 3/8" x 6 Spl. QD	1 3/8" Rd.
PTO 14006432	32"	1 3/8" x 6 Spl. QD	1 3/8" Rd. w/Pinhole
PTO 14006436	36"	1 3/8" x 6 Spl. QD	1 3/8" Rd. w/Pinhole
PTO 14006437	37"	1 3/8" x 6 Spl. QD	1 3/8" Rd.
PTO 14006438	38"	1 3/8" x 6 Spl. QD	1 3/8" x 6 Spl. QD
PTO 14006442	42"	1 3/8" x 6 Spl. QD	1 3/8" Rd. w/Pinhole
PTO 14006446	46"	1 3/8" x 6 Spl. QD	1 3/8" x 6 Spl. QD
PTO 14006448	48"	1 3/8" x 6 Spl. QD	1 3/8" x 6 Spl. QD
PTO 14006451	51"	1 3/8" x 6 Spl. QD	1 3/8" Rd. w/Pinhole
PTO 14006453	53"	1 3/8" x 6 Spl. QD	1 1/4" Rd. w/Pinhole
PTO 14006455	55"	1 3/8" x 6 Spl. QD	1 3/8" x 6 Spl. QD
PTO 14046448	48"	1 3/8" x 6 Spl. QD	*
PTO 14046460	60"	1 3/8" x 6 Spl. QD	*
PTO 14106436	36"	1 3/8" x 6 Spl. QD	1 3/8" x 6 Spl. w/Friction Clutch
PTO 14106438	38"	1 3/8" x 6 Spl. QD	1 3/8" x 6 Spl. w/Friction Clutch
PTO 14206454	54"	1 3/8" x 6 Spl. QD	1 3/8" x 6 Spl. w/Radial Pin Clutch

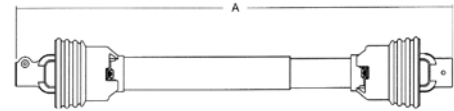

\*Drivelines are furnished without Cross & Bearing Kit and Implement Yoke. Select kit and yoke as required.

### 5 SERIES

Interchanges with Bondioli & Pavesi

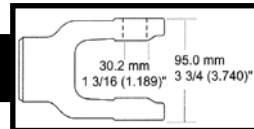

### METRIC DRIVELINES & COMPONENTS

### AB5

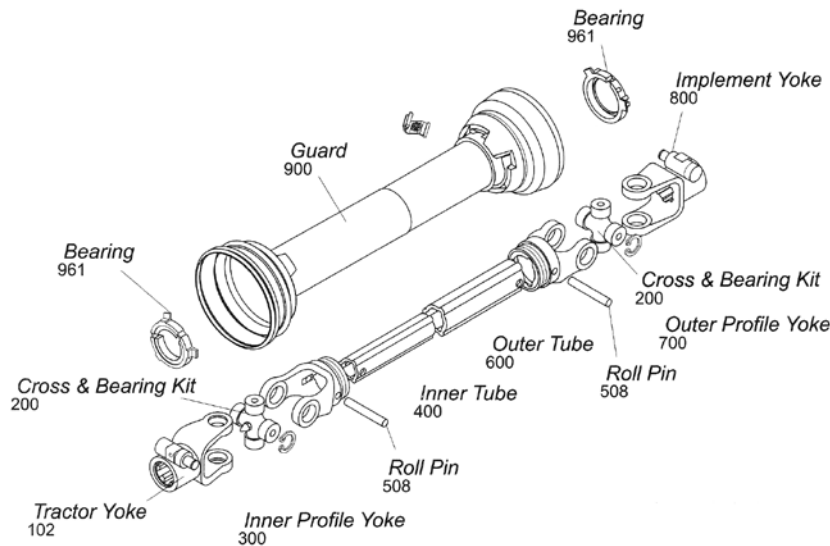

#### Tractor Yoke

Safety Slide Lock  
Repair Kit - Page 106

PART NO.	DIM "A" BORE
PTO 1016506	1 3/8" x 6 Spl.
PTO 1016521	1 3/8" x 21 Spl.

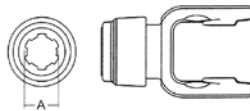

Quick Disconnect  
Repair Kit - Page 106

PART NO.	DIM "A" BORE
PTO 1026506	1 3/8" x 6 Spl.
PTO 1026520	1 3/4" x 20 Spl.
PTO 1026521	1 3/8" x 21 Spl.
PTO AP500134	1 3/4" x 6 Spl.

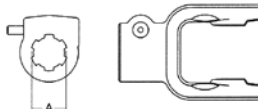

#### Ball Shear

PART NO.	DIM "A" BORE
PTO 1046506	1 3/8" x 6 Spl.
PTO 1046520	1 3/4" x 20 Spl.
PTO 1046521	1 3/8" x 21 Spl.

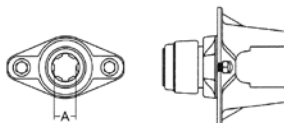

#### Cross & Bearing Kit (R-Kit)

Snap Ring Located in Yoke

PART NO.	DIM "A"		DIM "B"	
	mm	inches	mm	inches
PTO 2006580	30.2	1 3/16" (1.19)	79.4	3 1/8" (3.13)

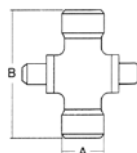

#### Extended Lubrication Cross & Bearing Kit (E-Kit)

Snap Ring Located in Yoke

PART NO.	DIM "A"		DIM "B"	
	mm	inches	mm	inches
PTO 2016580	30.2	1 3/16" (1.19)	79.4	3 1/8" (3.13)

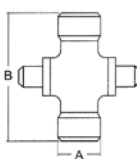

#### Inner Profile Yoke

With Bearing Groove  
(Guard must rotate freely on yoke)

PART NO.	DIM "A" BORE	
	mm	inches
PTO 3006545	45.2	1 25/32" (1.78)

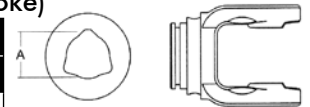

#### Inner Tube

45.0 (3.9 Wall) mm  
1.77" (.15" Wall)



PART NO.	LENGTH	
	m	inches
PTO 4006545	1.5	59 1/16" (59.06)
PTO 4016545	3.0	118 1/8" (118.11)
PTO 4046545	1.0	39 3/8" (39.37)

#### Roll Pin

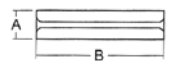

PART NO.	DIM "A"		DIM "B"	
	mm	inches	mm	inches
PTO 5081075	10.0	25/64" (.394)	75.0	2 61/64" (2.95)

#### Outer Tube

51.5 (3.0 Wall) mm  
2.03" (.12" Wall)

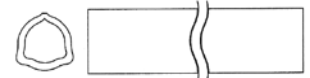

PART NO.	LENGTH	
	m	inches
PTO 6006552	1.5	59 1/16" (59.06)
PTO 6016552	3.0	118 1/8" (118.11)
PTO 6046552	1.0	39 3/8" (39.37)

5 SERIES

METRIC DRIVELINES & COMPONENTS

Outer Profile Yoke

With Bearing Groove  
(Guard must rotate freely on yoke)

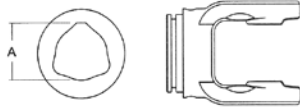

PART NO.	DIM "A" BORE	
	mm	inches
PTO 7006552	51.7	2 3/64" (2.04)

Implement Yoke

Clamp Yoke

PART NO.	DIM "A" BORE
PTO 8076521	1 3/8" x 21 Spl. (1.38)



Guard

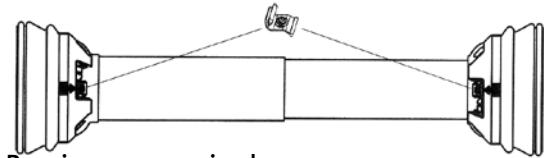

Order Bearings as required

PART NO.	OVERALL DRIVELINE LENGTH	BEARING KIT (2 PER KIT)
PTO 9023548	48"	PTO 9613505
PTO 9023560	60"	PTO 9613505

Assembly instructions included with guard.

Note: When installing Guards observe the following:

- 1) Install proper nylon bearing (See Page 11)
- 2) Guards must rotate freely on yokes.

Easy Lock™ Replacement Kit

PART NO.
PTO 13005000 (4 per kit)



Implement Yoke

Round Bore  
With Keyway & Set Screw

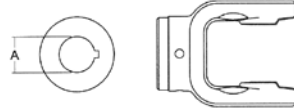

PART NO.	DIM "A"		STANDARD KEYWAY	
	mm	inches	mm	inches
PTO AP500330	30.0	-	-	-
PTO 8006510	31.8	1 1/4" (1.25)	6.4	1/4" (.25)
PTO 8006511	34.9	1 3/8" (1.38)	8.0	5/16" (.31)
PTO 8006522	35.0	1 3/8" (1.38)	13.0	33/64" (.51)
PTO 8006524	38.1	1 1/2" (1.50)	9.5	3/8" (.38)
PTO 8006535	35.0	1 3/8" (1.378)	8.0	5/16" (.31)

Shear Pin  
With Pin Hole

PART NO.	DIM "A" BORE	
	mm	inches
PTO 8026535	34.9	1 3/8" (1.38)

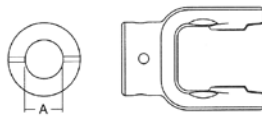

Clamp Yokes

Round Bore

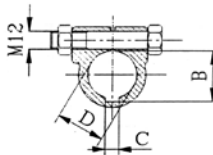

PART NO.	SIZE		
	D	C	B
PTO AP500530	30	8	33.3

**5 SERIES**

**METRIC DRIVELINES & COMPONENTS**

**Drivelines**

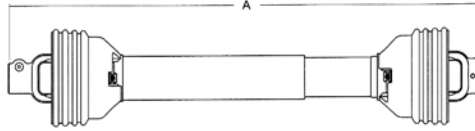

PART NO.	OVERALL COMP. LENGTH DIM "A"	TRACTOR YOKE	IMPLEMENT YOKE
PTO 14006524	48"	1 3/8" x 6 Spl. QD	1 1/2" Rd.
PTO 14006542	42"	1 3/8" x 6 Spl. QD	1 3/8" Rd. w/Pinhole
PTO 14006543	43"	1 3/8" x 6 Spl. QD	1 3/8" x 6 Spl. QD
PTO 14006546	46"	1 3/8" x 6 Spl. QD	1 3/8" Rd.
PTO 14006551	51"	1 3/8" x 6 Spl. QD	1 3/8" Rd.
PTO 14006555	55"	1 3/8" x 6 Spl. QD	1 3/8" x 6 Spl. QD
PTO 14016524	48"	1 3/8" x 21 Spl. QD	1 1/2" Rd.
PTO 14016536	36"	1 3/8" x 6 Spl. QD	1 3/8" x 6 Spl. QD
PTO 14016542	42"	1 3/8" x 6 Spl. QD	1 3/8" x 6 Spl. QD
PTO 14046548	48"	1 3/8" x 6 Spl. QD	*
PTO 14046560	60"	1 3/8" x 6 Spl. QD	*
PTO 14106546	46"	1 3/8" x 6 Spl. QD	1 3/8" x 6 Spl. w/Friction Clutch
PTO 14306538	38"	1 3/8" x 6 Spl. QD	1 3/8" x 6 Spl. w/Overrunning Clutch

\*Drivelines are furnished without Cross & Bearing Kit and Implement Yoke. Select kit and yoke as required.

# 6 SERIES

Interchanges with Bondioli & Pavesi

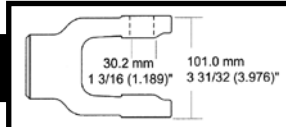

## METRIC DRIVELINES & COMPONENTS

Cross & Bearing Kit and Outboard Yokes interchange with Walterscheid 220 Series.

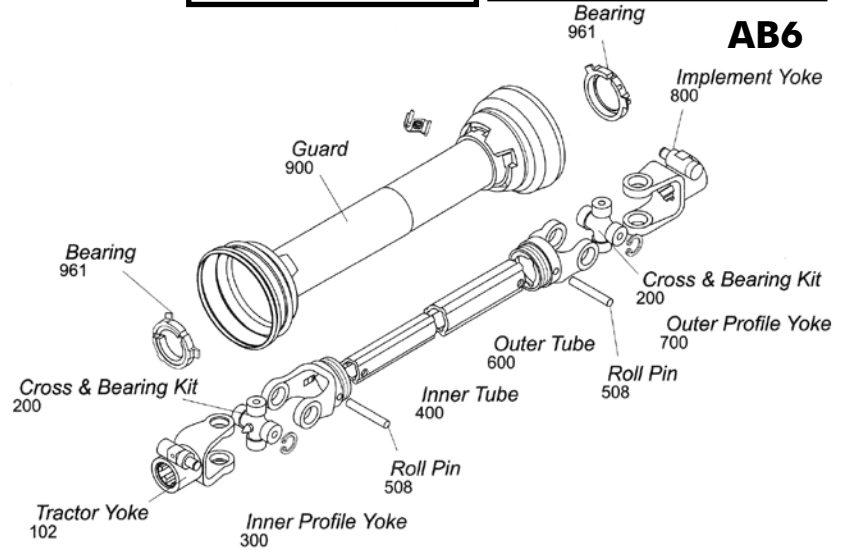

### AB6

### Tractor Yoke

#### Safety Slide Lock

Repair Kit - Page 106

PART NO.	DIM "A" BORE
PTO 1018606	1 3/8" x 6 Spl.
PTO 1018620	1 3/4" x 20 Spl.
PTO 1018621	1 3/8" x 21 Spl.

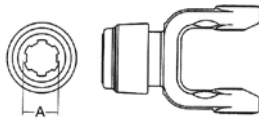

#### Quick Disconnect

Repair Kit - Page 106

PART NO.	DIM "A" BORE
PTO 1028606	1 3/8" x 6 Spl.
PTO 1028621	1 3/8" x 21 Spl.
PTO 1028618	1 1/8" x Hex
PTO 1028620	1 3/4" x 20 Spl.
PTO AP622134	1 3/4" x 6 Spl.

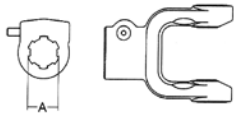

#### Ball Shear

PART NO.	DIM "A" BORE
PTO 1048606	1 3/8" x 6 Spl.
PTO 1048620	1 3/4" x 20 Spl.
PTO 1048621	1 3/8" x 21 Spl.

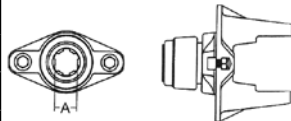

#### Auto-Lok

Repair Kit - Page 106

PART NO.	DIM "A" BORE
PTO 1108606	1 3/8" x 6 Spl.

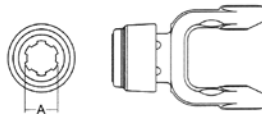

### Cross & Bearing Kit (R-Kit)

Snap Ring Located in Yoke

PART NO.	DIM "A"		DIM "B"	
	mm	inches	mm	inches
PTO 2008692	30.2	1 3/16" (1.19)	92.0	3 5/8" (3.62)

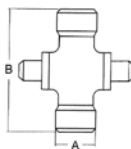

### Extended Lubrication Cross & Bearing Kit (E-Kit)

Snap Ring Located in Yoke

PART NO.	DIM "A"		DIM "B"	
	mm	inches	mm	inches
PTO 2018692	30.2	1 3/16" (1.19)	92.0	3 5/8" (3.62)

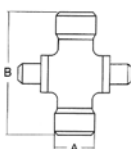

### Inner Profile Yoke

With Bearing Groove

(Guard must rotate freely on yoke)

PART NO.	DIM "A" BORE	
	mm	inches
PTO 3006645	45.2	1 25/32" (1.78)



### Inner Tube

45.0 (3.9 Wall) mm  
1.77" (.154" Wall)

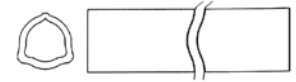

PART NO.	LENGTH	
	m	inches
PTO 4006545	1.5	59 1/16" (59.06)
PTO 4016545	3.0	118 1/8" (118.11)
PTO 4046545	1.0	39 3/8" (39.37)

### Roll Pin

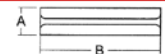

PART NO.	DIM "A"		DIM "B"	
	mm	inches	mm	inches
PTO 5081080	10.0	25/64" (.39)	80.0	3 5/32" (3.15)

### Outer Tube

54.0 (4.5 Wall) mm  
2.13" (.18" Wall)



PART NO.	LENGTH	
	m	inches
PTO 6006654	1.5	59 1/16" (59.06)
PTO 6016654	3.0	118 1/8" (118.11)
PTO 6046654	1.0	39 3/8" (39.37)

**6 SERIES**

**METRIC DRIVELINES & COMPONENTS**

**Outer Profile Yoke**

With Bearing Groove  
(Guard must rotate freely on yoke)



PART NO.	DIM "A" BORE	
	mm	inches
PTO 7006654	54.2	2 1/8" (2.13)

**Implement Yoke**

Round Bore  
With Keyway & Set Screw



PART NO.	DIM "A"		STANDARD KEYWAY	
	mm	inches	mm	inches
PTO 8008610	31.8	1 1/4" (1.25)	6.4	1/4" (.25)
PTO 8008611	34.9	1 3/8" (1.38)	8.0	5/16" (.31)
PTO 8008624	38.1	1 1/2" (1.50)	9.5	3/8" (.38)
PTO 8008628	44.5	1 3/4" (1.75)	9.5	3/8" (.38)
PTO 8008635	35.0	1 3/8" (1.38)	10.0	25/64" (.39)
PTO 8008640	40.0	1 37/64" (1.57)	12.0	15/32" (.47)
PTO AE622341	41.27	1 5/8" (1.625)	-	-

Shear Pin  
With Pin Hole

PART NO.	DIM "A" BORE	
	mm	inches
PTO 8028611	34.9	1 3/8" (1.38)
PTO 8028620	31.8	1 1/4" (1.25)

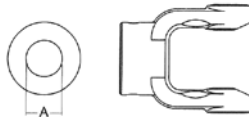

**Implement Yoke**

Hex Bore

PART NO.	DIM "A" BORE
PTO 8058618	1 9/64" Hex (1.14), 28.9 mm

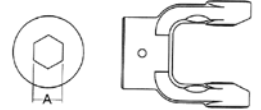

Clamp Yoke

PART NO.	DIM "A" BORE
PTO 8078606	1 3/8" x 6 Spl.
PTO 8078620	1 3/4" x 20 Spl.
PTO 8078621	1 3/8" x 21 Spl.
PTO AE622528	1 1/8" Rd & Kw
PTO AE622531	1 1/4" Rd & Kw
PTO AE622535	1 3/8" Rd & Kw



**Guard**

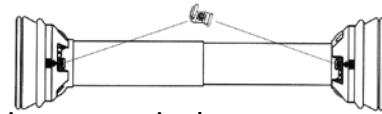

Order Bearings as required

PART NO.	OVERALL DRIVELINE LENGTH	BEARING KIT (2 PER KIT)
PTO 9023548	48"	PTO 9613567
PTO 9023560	60"	PTO 9613567

Assembly instructions included with guard.

Note: When installing Guards observe the following:

- 1) Install proper nylon bearing (See Page 11)
- 2) Guards must rotate freely on yokes.

**Easy Lock™ Replacement Kit**

PART NO.
PTO 13005000 (4 per kit)



**Clamp Yokes**

Round Bore

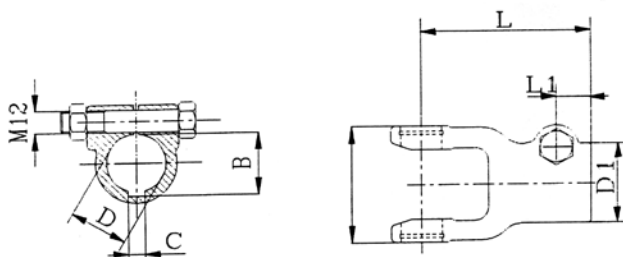

PART NO.	SIZE		
	D	C	B
PTO AP622330	30	12	43.3
PTO AP622340	40	12	43.3
PTO AP622530	30	8	33.3

\*Drivelines are furnished without Cross & Bearing Kit and Implement Yoke. Select kit and yoke as required.

## 6 SERIES

METRIC DRIVELINES  
& COMPONENTS

## Drivelines

PART NO.	OVERALL COMP. LENGTH DIM "A"	TRACTOR YOKE	IMPLEMENT YOKE
PTO 14006624	48"	1 3/8" x 6 Spl. QD	1 1/2" Rd.
PTO 14006628	48"	1 3/8" x 6 Spl. QD	1 3/4" Rd.
PTO 14006637	37"	1 3/8" x 6 Spl. QD	1 3/8" x 6 Spl. QD
PTO 14006642	42"	1 3/8" x 6 Spl. QD	1 3/8" x 6 Spl. QD
PTO 14006644	44"	1 3/8" x 6 Spl. QD	1 3/8" x 6 Spl. QD
PTO 14006652	52"	1 3/8" x 6 Spl. QD	1 3/8" Rd. w/Pinhole
PTO 14006655	55"	1 3/8" x 6 Spl. QD	1 3/8" x 6 Spl. QD
PTO 14006657	57"	1 3/8" x 6 Spl. QD	1 3/8" x 6 Spl. QD
PTO 14016624	48"	1 3/8" x 21 Spl. QD	1 1/2" Rd.
PTO 14016666	66"	1 3/8" x 21 Spl. QD	1 1/2" Rd.
PTO 14046648	48"	1 3/8" x 6 Spl. QD	*
PTO 14046660	60"	1 3/8" x 6 Spl. QD	*
PTO 14066644	44"	1 3/8" x 21 Spl. QD	1 3/8" x 21 Spl. QD
PTO 14106654	54"	1 3/8" x 6 Spl. QD	1 3/8" x 6 Spl. w/Friction Clutch
PTO 14106660	60"	1 3/8" x 6 Spl. QD	1 3/4" x 20 Spl. w/Friction Clutch
PTO 14106661	61"	1 3/4" x 20 Spl. QD	1 3/4" x 20 Spl. w/Friction Clutch
PTO 14306639	39"	1 3/8" x 6 Spl. QD	1 3/8" x 6 Spl. w/Overrunning Clutch

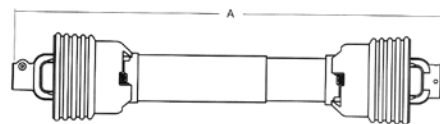

\*Drivelines are furnished without Cross & Bearing Kit and Implement Yoke. Select kit and yoke as required.

**7N SERIES**

Interchanges with Bondioli & Pavesi

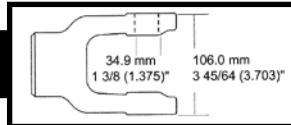

**METRIC DRIVELINES & COMPONENTS**

**AB7N**

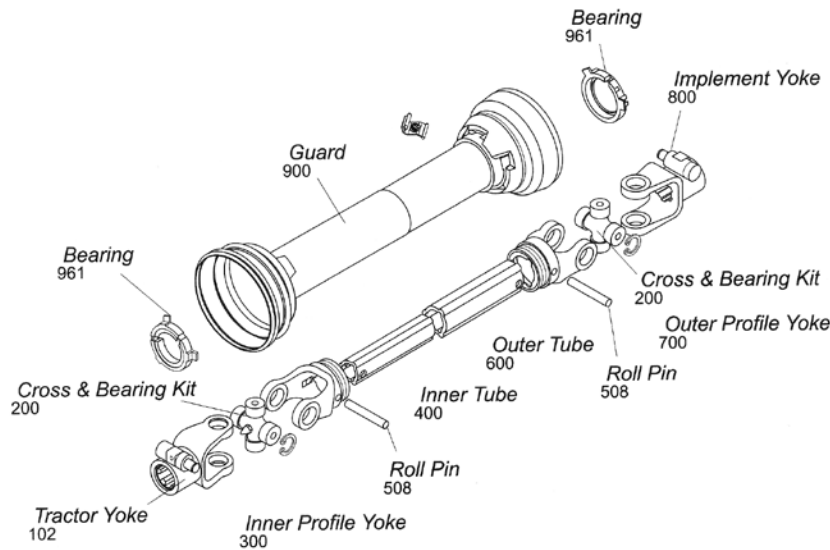

**Tractor Yoke**

**Safety Slide Lock**  
Repair Kit - Page 106

PART NO.	DIM "A" BORE
PTO 1016706	1 3/8" x 6 Spl.
PTO 1016720	1 3/4" x 20 Spl.
PTO 1016721	1 3/8" x 21 Spl.

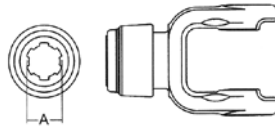

**Extended Lubrication Cross & Bearing Kit (E-Kit)**

Snap Ring Located in Yoke

PART NO.	DIM "A"		DIM "B"	
	mm	inches	mm	inches
PTO 2016794	34.9	1 3/8" (1.37)	94.0	3 45/64" (3.70)

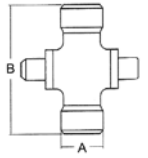

**Quick Disconnect**  
Repair Kit - Page 106

PART NO.	DIM "A" BORE
PTO 1026706	1 3/8" x 6 Spl.
PTO 1026720	1 3/4" x 20 Spl.
PTO 1026721	1 3/8" x 21 Spl.
PTO 1026728	1 3/4" x 6 Spl.



**AB7\***

PART NO.	DIM "A"		DIM "B"	
	mm	inches	mm	inches
PTO 2008706	30.2	1 3/16" (1.19)	106.5	4 3/16" (4.19)
PTO 2018706	30.2	1 3/16" (1.19)	106.5	4 3/16" (4.19)

\*Old Bondioli & Pavesi 7 Series is interchangeable with Walterscheid 230 Series. Original part identification begins with 23.

**Ball Shear**

PART NO.	DIM "A" BORE
PTO 1046706	1 3/8" x 6 Spl.
PTO 1046721	1 3/8" x 21 Spl.

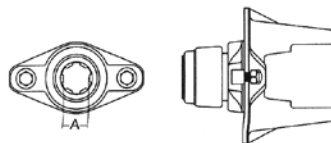

**Inner Profile Yoke**

With Bearing Groove  
(Guard must rotate freely on yoke)

PART NO.	DIM "A" BORE	
	mm	inches
PTO 3006745	45.2	1 25/32" (1.78)

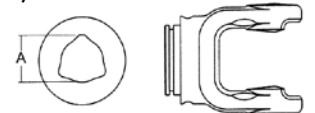

**Cross & Bearing Kit (R-Kit)**

Snap Ring Located in Yoke

PART NO.	DIM "A"		DIM "B"	
	mm	inches	mm	inches
PTO 2006794	34.9	1 3/8" (1.37)	94.0	3 45/64" (3.70)

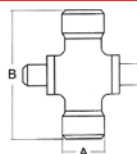

**Inner Tube**

45.0 (5.4 Wall) mm  
1.77" (.21" Wall)



PART NO.	LENGTH	
	m	inches
PTO 4006745	1.5	59 1/16" (59.06)
PTO 4016745	3.0	118 1/8" (118.11)
PTO 4046745	1.0	39 3/8" (39.37)



7N SERIES

METRIC DRIVELINES & COMPONENTS

Roll Pin

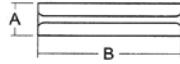

PART NO.	DIM "A"		DIM "B"	
	mm	inches	mm	inches
PTO 5081080	10.0	13/32" (.39)	80.0	3 5/32" (3.15)

Outer Tube

54.0 (4.5 Wall) mm  
2.13" (.18" Wall)

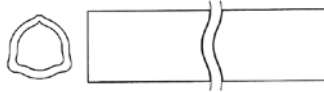

PART NO.	LENGTH	
	m	inches
PTO 6006654	1.5	59 1/16" (59.06)
PTO 6016654	3.0	118 1/8" (118.11)
PTO 6046654	1.0	39 3/8" (39.37)

Outer Profile Yoke

With Bearing Groove  
(Guard must rotate  
freely on yoke)



PART NO.	DIM "A" BORE	
	mm	inches
PTO 7006754	54.2	2 1/8" (2.13)

Clamp Yokes

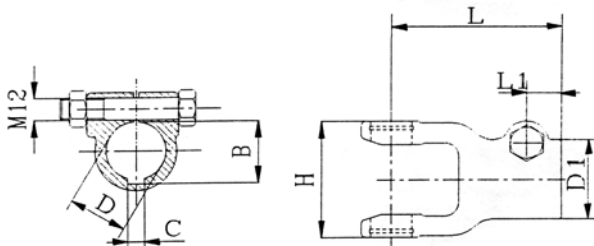

PART NO.	SIZE		
	D	C	B
PTO AP7N535	35	10	38.3

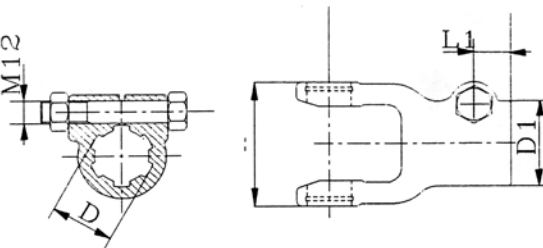

PART NO.	SIZE	
	D	SPLINE
PTO AP7N5138	1 3/8"	6

Implement Yoke

Round Bore  
With Keyway & Set Screw

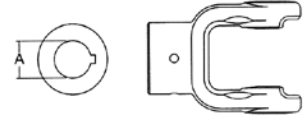

PART NO.	DIM "A"		STANDARD KEYWAY	
	mm	inches	mm	inches
PTO 8006722	35.0	1 3/8" (1.38)	8.0	5/16" (.31)
PTO 8006728	44.5	1 3/4" (1.75)	9.5	3/8" (.38)
PTO 8006740	40.0	1 37/64" (1.57)	12.7	1/2" (.50)

Guard

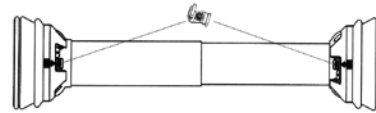

Order Bearings as required

PART NO.	OVERALL DRIVELINE LENGTH	BEARING KIT (2 PER KIT)
PTO 9023548	48"	PTO 9613567
PTO 9023560	60"	PTO 9613567

Assembly instructions included with guard.

Note: When installing Guards observe the following:

- 1) Install proper nylon bearing (See Page 11)
- 2) Guards must rotate freely on yokes.

Easy Lock™ Replacement Kit

PART NO.
PTO 13005000 (4 per kit)



**7N SERIES**

**METRIC DRIVELINES & COMPONENTS**

**Drivelines**

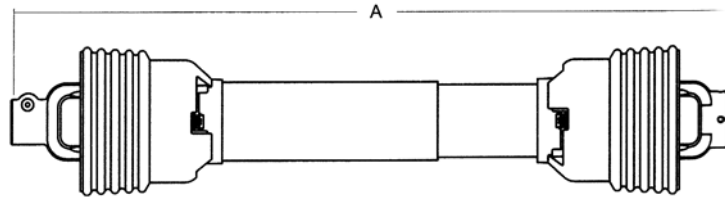

PART NO.	OVERALL COMP. LENGTH DIM "A"	TRACTOR YOKE	IMPLEMENT YOKE
PTO 14006748	48"	1 3/8" x 6 Spl. QD	1 3/4" Rd.
PTO 14046748	48"	1 3/8" x 6 Spl. QD	*
PTO 14046760	60"	1 3/8" x 6 Spl. QD	*

\*Drivelines are furnished without Cross & Bearing Kit and Implement Yoke. Select kit and yoke as required.

For a selection of  
3 point hitch parts,  
see Section 22  
of this catalogue.

8 SERIES

Interchanges with Bondioli & Pavesi

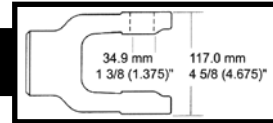

METRIC DRIVELINES & COMPONENTS

AB8

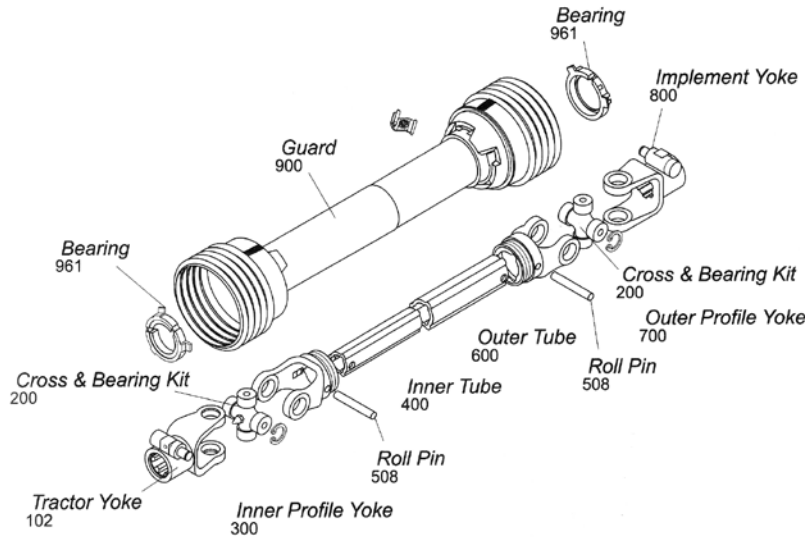

Tractor Yoke

Safety Slide Lock  
Repair Kit - Page 106

PART NO.	DIM "A" BORE
PTO 1016806	1 3/8" x 6 Spl.
PTO 1016820	1 3/4" x 20 Spl.
PTO 1016821	1 3/8" x 21 Spl.

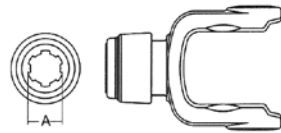

Quick Disconnect  
Repair Kit - Page 106

PART NO.	DIM "A" BORE
PTO 1026806	1 3/8" x 6 Spl.
PTO 1026820	1 3/4" x 20 Spl.
PTO 1026821	1 3/8" x 21 Spl.
PTO 1026828	1 3/4" x 6 Spl.

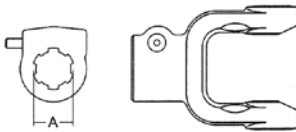

Ball Shear

PART NO.	DIM "A" BORE
PTO 1046806	1 3/8" x 6 Spl.
PTO 1046820	1 3/4" x 20 Spl.
PTO 1046821	1 3/8" x 21 Spl.

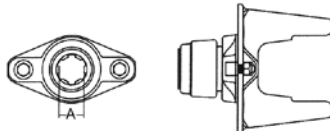

Auto-Lok

Repair Kit - Page 88

PART NO.	DIM "A" BORE
PTO 1106806	1 3/8" x 6 Spl.

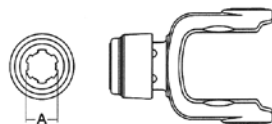

Cross & Bearing Kit (R-Kit)

Snap Ring Located in Yoke

PART NO.	DIM "A"		DIM "B"	
	mm	inches	mm	inches
PTO 2006806	34.9	1 3/8" (1.38)	106.5	4 3/16" (4.19)

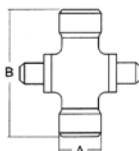

Extended Lubrication Cross & Bearing Kit (E-Kit)

Snap Ring Located in Yoke

PART NO.	DIM "A"		DIM "B"	
	mm	inches	mm	inches
PTO 2016806	34.9	1 3/8" (1.38)	106.5	4 3/16" (4.19)

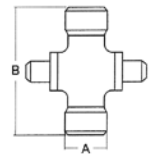

Inner Profile Yoke

With Bearing Groove  
(Guard must rotate freely on yoke)

PART NO.	DIM "A" BORE	
	mm	inches
PTO 3006845 (Old Series 8)	45.2	1 25/32" (1.78)
PTO 3006854	54.2	2 1/8" (2.13)

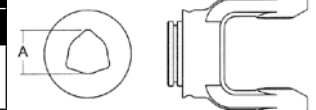

Inner Tube

54.0 (4.5 Wall) mm  
2.13" (.177" Wall)



PART NO.	LENGTH	
	m	inches
PTO 6006854	1.5	59 1/16" (59.06)
PTO 6016854	3.0	118 1/8" (118.11)
PTO 6046854	1.0	39 3/8" (39.37)

Roll Pin

PART NO.	DIM "A"		DIM "B"	
	mm	inches	mm	inches
PTO 5080880	8.0	5/16" (.31)	80.0	3 5/32" (3.15)
PTO 5081280	12.0	15/32" (.47)	80.0	3 5/32" (3.15)

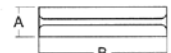

**8 SERIES**

**METRIC DRIVELINES & COMPONENTS**

**Outer Tube**

63.0 (4.1 Wall) mm  
2.48" (.161" Wall)



PART NO.	LENGTH	
	m	inches
PTO 6006863	1.5	59 1/16" (59.06)
PTO 6016863	3.0	118 1/8" (118.11)
PTO 6046863	1.0	39 3/8" (39.37)

**Outer Profile Yoke**

With Bearing Groove  
(Guard must rotate  
freely on yoke)



PART NO.	DIM "A" BORE	
	mm	inches
PTO 7006863	63.0	2 31/64" (2.48)

**Implement Yoke**

Round Bore  
With Keyway & Set Screw



PART NO.	DIM "A"		STANDARD KEYWAY	
	mm	inches	mm	inches
PTO 8006822	35.0	1 3/8" (1.38)	8.0	5/16" (.31)
PTO 8006824	38.1	1 1/2" (1.50)	8.0	5/16" (.31)
PTO 8006828	44.5	1 3/4" (1.75)	9.5	3/8" (.38)
PTO 8006832	50.8	2" (2.00)	12.7	1/2" (.50)
PTO AP824340	40	-	-	-
PTO AE824341	41.27	1 5/8" (1.625)	-	-

Spline Bore  
With Pinhole

PART NO.	DIM "A" BORE
PTO 8016806	1 3/8" x 6 Spl.

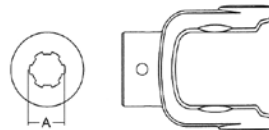

**Clamp Yokes**

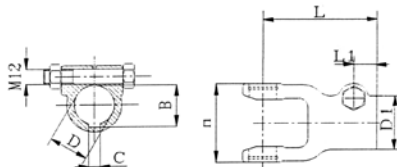

PART NO.	SIZE		
	D	C	B
PTO AP824535	35	10	38.3

**Implement Yoke**

**Clamp Yoke**

PART NO.	DIM "A" BORE
PTO 8076806	1 3/8" x 6 Spl.
PTO 8076820	1 3/4" x 20 Spl.
PTO 8076821	1 3/8" x 21 Spl.
PTO AP824534	1 3/4" x 6 Spl.
PTO 509080455	1 3/4" x 6 Spl. (Bondioli)



**Guard**

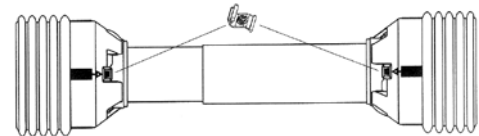

Order Bearings as required

PART NO.	OVERALL DRIVELINE LENGTH	BEARING KIT (2 PER KIT)
PTO 9004548	48"	PTO 9614589
PTO 9004560	60"	PTO 9614589

Assembly instructions included with guard.

Note: When installing Guards observe the following:

- 1) Install proper nylon bearing (See Page 11)
- 2) Guards must rotate freely on yokes.

**Easy Lock™ Replacement Kit**

PART NO.
PTO 13005000 (4 per kit)



**Hub Yokes**

With Spring Pin Hole

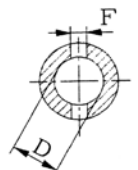

PART NO.	SIZE	
	D	F
PTO AP824040	40	13

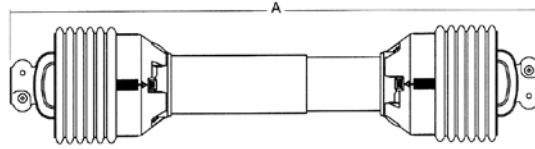
**8 SERIES****METRIC DRIVELINES  
& COMPONENTS****Drivelines**

PART NO.	OVERALL COMP. LENGTH DIM "A"	TRACTOR YOKE	IMPLEMENT YOKE
PTO 14006828	57"	1 <sup>3</sup> / <sub>8</sub> " x 6 Spl. QD	1 <sup>3</sup> / <sub>4</sub> " Rd.
PTO 14006846	46"	1 <sup>3</sup> / <sub>8</sub> " x 6 Spl. QD	1 <sup>3</sup> / <sub>8</sub> " x 6 Spl. QD
PTO 14006857	57"	1 <sup>3</sup> / <sub>8</sub> " x 6 Spl. QD	1 <sup>3</sup> / <sub>8</sub> " x 6 Spl. QD
PTO 14046848	48"	1 <sup>3</sup> / <sub>8</sub> " x 6 Spl. QD	*
PTO 14046860	60"	1 <sup>3</sup> / <sub>8</sub> " x 6 Spl. QD	*
PTO 14066846	46"	1 <sup>3</sup> / <sub>8</sub> " x 21 Spl. QD	1 <sup>3</sup> / <sub>8</sub> " x 21 Spl. QD

\*Drivelines are furnished without Cross & Bearing Kit and Implement Yoke. Select kit and yoke as required.

For a wide selection  
of combine repair parts,  
visit Section 16.

**9 SERIES**

Interchanges with Bondioli & Pavesi

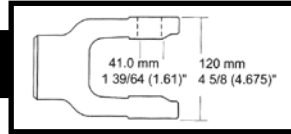

**METRIC DRIVELINES & COMPONENTS**

**AB9**

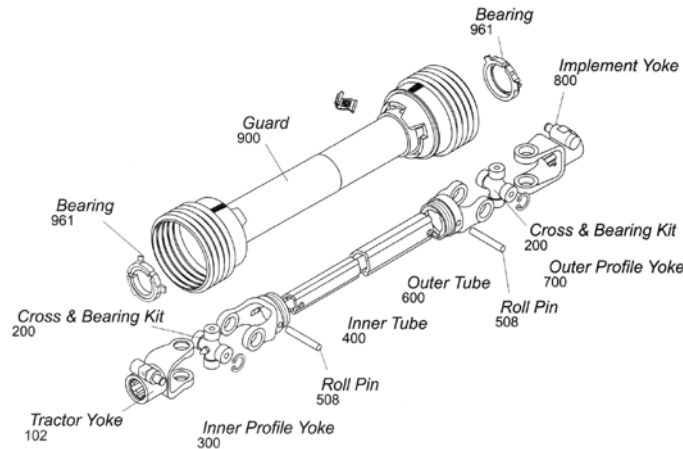

**Tractor Yoke**

Safety Slide Lock  
Repair Kit - Page 106

PART NO.	DIM "A" BORE
PTO 1016906	1 3/8" x 6 Spl.
PTO 1016920	1 3/4" x 20 Spl.
PTO 1016921	1 3/8" x 21 Spl.

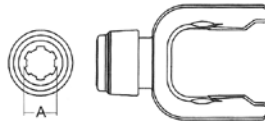

Quick Disconnect  
Repair Kit - Page 106

PART NO.	DIM "A" BORE
PTO 1026906	1 3/8" x 6 Spl.
PTO 1026920	1 3/4" x 20 Spl.
PTO 1026921	1 3/8" x 21 Spl.
PTO AP900134	1 3/4" x 6 Spl.

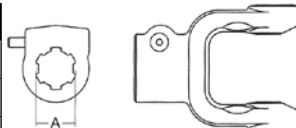

**Inner Profile Yoke**

With Bearing Groove  
(Guard must rotate freely on yoke)

PART NO.	DIM "A" BORE	
	mm	inches
PTO 3006954	54.2	2 1/8" (2.13)



**Inner Profile Tube**

54.0 (4.9 Wall) mm  
2.13" (.19" Wall)



**Cross & Bearing Kit (R-Kit)**

Snap Ring Located in Yoke

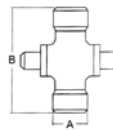

PART NO.	DIM "A"		DIM "B"	
	mm	inches	mm	inches
PTO 2006908	41.0	1 39/64" (1.61)	108	4 1/4" (4.25)

**Extended Lubrication Cross & Bearing Kit (E-Kit)**

Snap Ring Located in Yoke

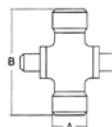

PART NO.	DIM "A"		DIM "B"	
	mm	inches	mm	inches
PTO 2016908	41.0	1 39/64" (1.61)	108	4 1/4" (4.25)

**Roll Pin**

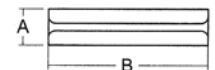

PART NO.	DIM "A"		DIM "B"	
	mm	inches	mm	inches
PTO 5081080	10.0	25/64" (.39)	80.0	3 5/32" (3.15)
PTO 5081280	12.0	15/32" (.47)	80.0	3 5/32" (3.15)

## 9 SERIES

METRIC DRIVELINES  
& COMPONENTS

## Outer Tube

63.0 (4.1 Wall) mm  
2.48" (.16" Wall)



PART NO.	LENGTH	
	m	inches
PTO 6006863	1.5	59 1/16" (59.06)
PTO 6016863	3.0	118 1/8" (118.11)
PTO 6046863	1.0	39 3/8" (39.37)

## Outer Profile Yoke

With Bearing Groove  
(Guard must rotate  
freely on yoke)



PART NO.	DIM "A" BORE	
	mm	inches
PTO 7006963	63.0	2 31/64" (2.48)

## Implement Yoke

Round Bore  
With Keyway & Set Screw

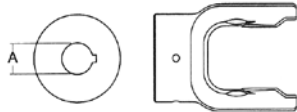

PART NO.	DIM "A" BORE	STANDARD KEYWAY
PTO 8006922	1 3/8" (1.38)	5/16" (.31)
PTO 8006924	1 1/2" (1.50)	3/8" (.38)

## Guard

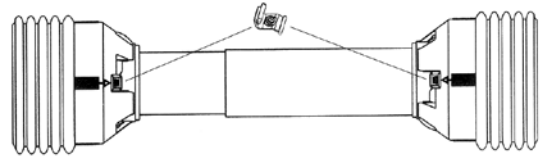

Order Bearings as required

PART NO.	OVERALL DRIVELINE LENGTH	BEARING KIT (2 PER KIT)
PTO 9004548	48"	PTO 9614589
PTO 9004560	60"	PTO 9614589

Assembly instructions included with guard.

Note: When installing Guards observe the following:

- 1) Install proper nylon bearing (See Page 11)
- 2) Guards must rotate freely on yokes.

## Easy Lock™ Replacement Kit

PART NO.

PTO 13005000 (4 per kit)



## Drivelines

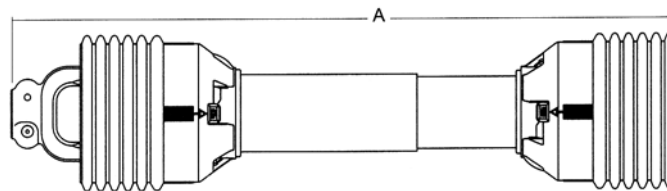

PART NO.	OVERALL COMP. LENGTH DIM "A"	TRACTOR YOKE	IMPLEMENT YOKE
PTO 14046948	48"	1 3/8" x 6 Spl. QD	*
PTO 14046960	60"	1 3/8" x 6 Spl. QD	*

\*Drivelines are furnished without Cross & Bearing Kit and Implement Yoke. Select kit and yoke as required.

**10 SERIES - METRIC DRIVELINE COMPONENTS**

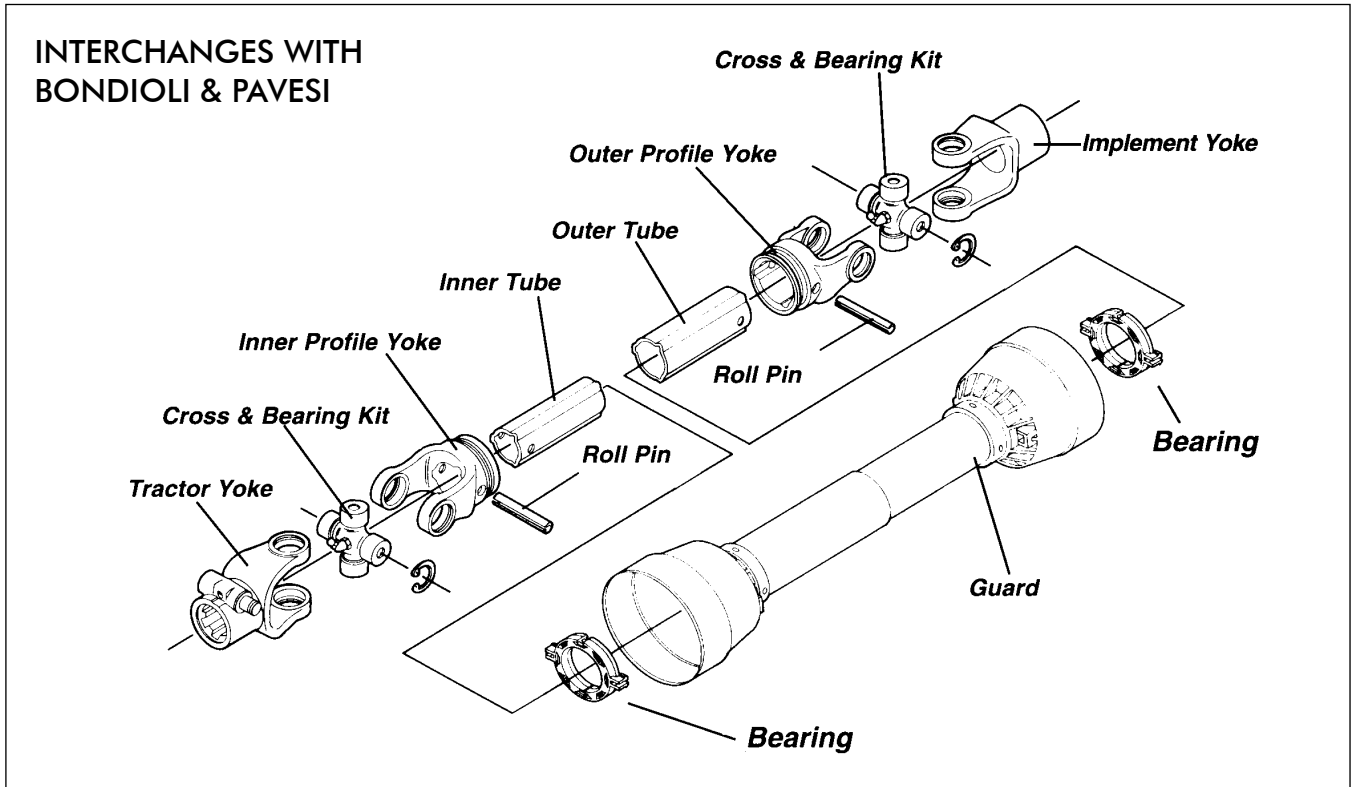

**Tractor Yoke**

**QUICK DISCONNECT**

PART NO.	DIM. "A" BORE
PTO 572100351	1 3/8" x 6 spline
PTO 572100451	1 3/4" x 6 spline
PTO 572103851	1 3/4" x 20 spline
PTO 572103751	1 3/8" x 21 spline

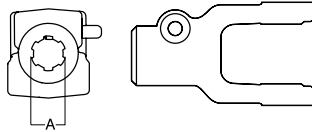

**Roll Pin**



PART NO.	DIM. "A"	DIM. "B"
PTO 5081280	12 mm	80 mm

**Cross & Bearing Kit**

Snap Ring Located in Yoke

PART NO.	DIM. "A" BORE	DIM. "B" BORE
PTO 41210	41 mm	118 mm

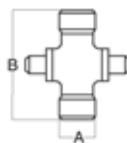

**Outer Tube**

63.0 mm (4.0 wall)

PART NO.	LENGTH
PTO 125151500	1500 mm

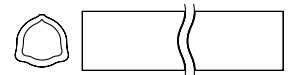

**Inner Profile Yoke**

PART NO.	DIM. "A" BORE
PTO 204106852	54 mm

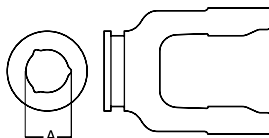

**Outer Profile Yoke**

With Bearing Groove

PART NO.	DIM. "A" BORE
PTO 204106851	66 mm

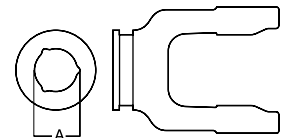

**Inner Tube**

54.0 mm (6.0 wall)

PART NO.	LENGTH
PTO 125141500	1500 mm

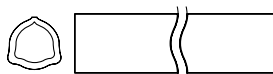

**Plastic Guard**

Without Bearings

PART NO.	OVERALL DRIVELINE LENGTH	BEARINGS
PTO 9004548	1210 mm (48")	CALL

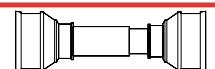



## 10 SERIES - METRIC DRIVELINE COMPONENTS

### Implement Yoke

**ROUND BORE**  
With Keyway & Pin Hole

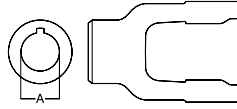

PART NO.	DIM "A" BORE	PIN HOLE SIZE
PTO 211106751	1 1/2"	3/8"
PTO 211108851	1 3/4"	3/8"
PTO 211106752	1 15/16"	1/2"
PTO 211106753	2"	1/2"

**ROUND BORE**  
With Keyway & Set Screw

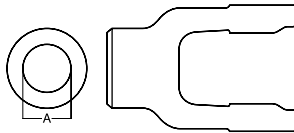

PART NO.	BORE	STD. KEYWAY
PTO 212108751	1 3/8"	5/16"

### Clamp Yoke

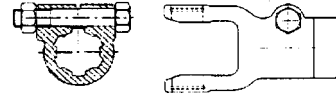

PART NO.	DESCRIPTION
PTO 509100455	1 3/4" x 6 spline
PTO 509103853	1 3/4" x 20 spline

## SHEAVES!!!

Westward Parts has available a full line of both QD and taper lok style sheaves.

Contact your nearest branch  
for price & availability.

**2100/100 SERIES**

Interchanges with Walterscheid

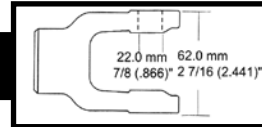

**METRIC DRIVELINES & COMPONENTS**

**AW10**

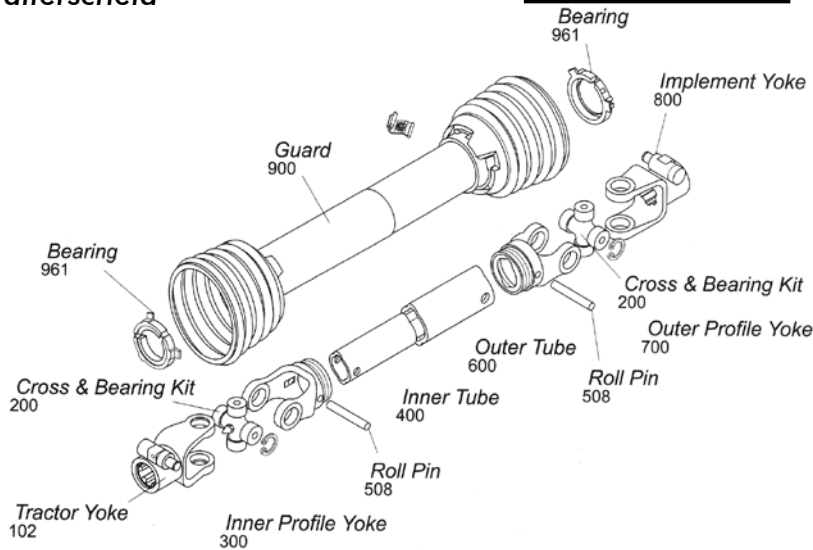

**Tractor Yoke**

Safety Slide Lock  
Repair Kit - Page 106

PART NO.	DIM "A" BORE
PTO 1017106	1 3/8" x 6 Spl.
PTO 1017121	1 3/8" x 21 Spl.

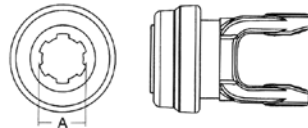

Quick Disconnect  
Repair Kit - Page 106

PART NO.	DIM "A" BORE
PTO 1027106	1 3/8" x 6 Spl.
PTO 1027121	1 3/8" x 21 Spl.

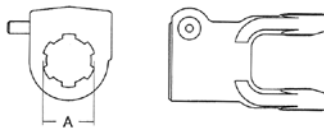

**Cross & Bearing Kit (R-Kit)**

Snap Ring Located in Yoke

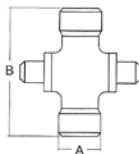

PART NO.	DIM "A"		DIM "B"	
	mm	inches	mm	inches
PTO 2007155	22.0	7/8" (.87)	55.2	2 11/64" (2.17)

**Extended Lubrication Cross & Bearing Kit (E-Kit)**

Snap Ring Located in Yoke

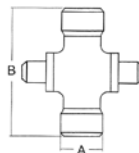

PART NO.	DIM "A"		DIM "B"	
	mm	inches	mm	inches
PTO 2017155	22.0	7/8" (.87)	55.2	2 11/64" (2.17)

**Inner Profile Yoke**

With Bearing Groove  
(Guard must rotate freely on yoke)

PART NO.	DIM "A" BORE	
	mm	inches
PTO 3007123	23.8	15/16" (.94)

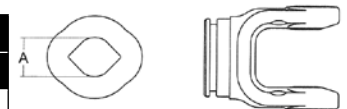

**Inner Tube (Solid)**

23.5 mm  
.93"



PART NO.	LENGTH	
	m	inches
PTO 4007123	1.5	59 1/16" (59.06)
PTO 4017123	3.0	118 1/8" (118.11)
PTO 4047123	1.0	39 3/8" (39.37)

**Roll Pin**

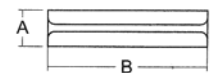

PART NO.	DIM "A"		DIM "B"	
	mm	inches	mm	inches
PTO 5080850	8.0	5/16" (.31)	50.0	1 31/32" (1.97)

2100/100 SERIES

METRIC DRIVELINES & COMPONENTS

Outer Tube

30.0 (2.9 Wall) mm  
1 3/16" (1.19" Wall)



PART NO.	LENGTH	
	m	inches
PTO 6007130	1.5	59 1/16" (59.06)
PTO 6017130	3.0	118 1/8" (118.11)
PTO 6047130	1.0	39 3/8" (39.37)

Outer Profile Yoke

With Bearing Groove  
(Guard must rotate freely on yoke)

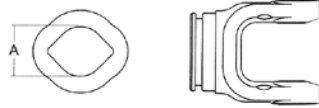

PART NO.	DIM "A" BORE	
	mm	inches
PTO 7007130	30.0	1 3/16" (1.18)

Implement Yoke

Round Bore  
With Keyway & Set Screw



PART NO.	DIM "A" BORE		STANDARD KEYWAY	
	mm	inches	mm	inches
PTO 8007125	25.0	63/64" (.98)	8.0	5/16" (.31)
PTO 8007130	30.0	1 3/16" (1.18)	8.0	5/16" (.31)
PTO AE110328	28.57	1 1/8" (1.125)	8.0	5/16" (.31)

Implement Yoke

Shear Pin  
With Pin Hole

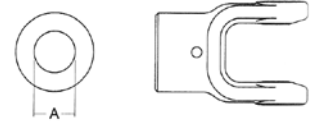

PART NO.	DIM "A" BORE	
	mm	inches
PTO 8027108	25.4	1" (1.0)
PTO 8027110	31.8	1 1/4" (1.25)
PTO 8027125	25.0	63/64" (.98)
PTO 8027130	30.0	1 3/16" (1.18)
PTO AE110019	19.05	3/4" (.75)

Guard

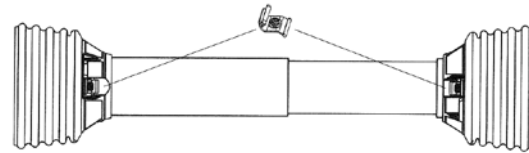

Order Bearings as required

PART NO.	OVERALL DRIVELINE LENGTH	BEARING KIT (2 PER KIT)
PTO 9002548	48"	PTO 9615005
PTO 9002560	60"	PTO 9615005

Assembly instructions included with guard.

Note: When installing Guards observe the following:

- 1) Install proper nylon bearing (See Page 11)
- 2) Guards must rotate freely on yokes.

Easy Lock™ Replacement Kit

PART NO.
PTO 13005000 (4 per kit)



**2200/200 SERIES**

Interchanges with Walterscheid

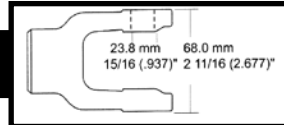

**METRIC DRIVELINES & COMPONENTS**

**AW20**

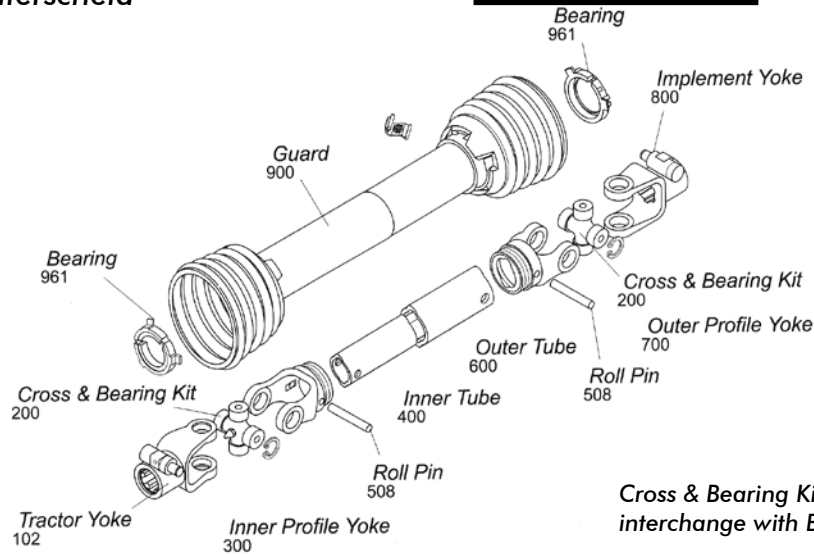

Cross & Bearing Kit and Outboard Yokes interchange with Bondioli 2 Series.

**Tractor Yoke**

Safety Slide Lock  
Repair Kit - Page 106

PART NO.	DIM "A" BORE
PTO 1018206	1 3/8" x 6 Spl.
PTO 1018221	1 3/8" x 21 Spl.

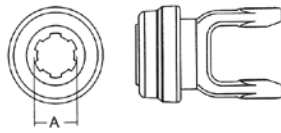

Quick Disconnect  
Repair Kit - Page 106

PART NO.	DIM "A" BORE
PTO 1028206	1 3/8" x 6 Spl.
PTO 1028218	1 1/8" x 6 Spl.
PTO 1028221	1 3/8" x 21 Spl.

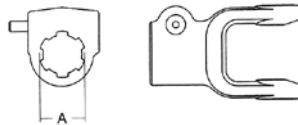

**Cross & Bearing Kit (R-Kit)**

Snap Ring Located in Yoke

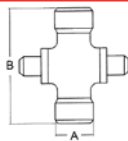

PART NO.	DIM "A"		DIM "B"	
	mm	inches	mm	inches
PTO 2008261	23.8	15/16" (.94)	61.2	2 13/32" (2.41)

**Extended Lubrication Cross & Bearing Kit (E-Kit)**

Snap Ring Located in Yoke

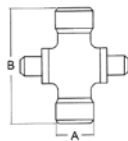

PART NO.	DIM "A"		DIM "B"	
	mm	inches	mm	inches
PTO 2018261	23.8	15/16" (.94)	61.2	2 13/32" (2.41)

**Inner Profile Yoke**

With Bearing Groove  
(Guard must rotate freely on yoke)

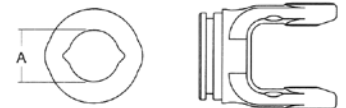

PART NO.	DIM "A" BORE	
	mm	inches
PTO 3007234	34.5	1 23/64" (1.36)

**Inner Tube**

34.5 (4.0 Wall) mm  
1.36" (.16 Wall)



PART NO.	LENGTH	
	m	inches
PTO 4007234	1.5	59 1/16" (59.06)
PTO 4017234	3.0	118 1/8" (118.11)
PTO 4047234	1.0	39 3/8" (39.37)

**Roll Pin**

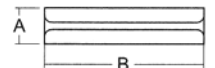

PART NO.	DIM "A"		DIM "B"	
	mm	inches	mm	inches
PTO 5081060	10.0	25/64" (.39)	60.0	2 23/64" (2.36)

**2200/200 SERIES**

**METRIC DRIVELINES & COMPONENTS**

**Clamp Yokes**

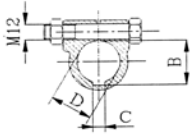

PART NO.	SIZE			
	D		C	B
	inches	mm		
PTO AE110525	1"	25.4mm	¼"	28.70
PTO AE110531	1¼"	31.75mm	¼"(5/16")	35.1

**Outer Tube**

41.0 (2.9 Wall) mm  
1.61" (.11" Wall)  
With Bearing Groove  
(Guard must rotate  
freely on yoke)



PART NO.	LENGTH	
	m	inches
PTO 6007241	1.5	59 1/16" (59.06)
PTO 6017241	3.0	118 1/8" (118.11)
PTO 6047241	1.0	39 3/8" (39.37)

**Outer Profile Yoke**

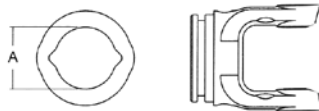

PART NO.	DIM "A" BORE	
	mm	inches
PTO 7007241	41.3	1 5/8" (1.63)

**Implement Yoke**

Round Bore  
With Keyway & Set Screw



PART NO.	DIM "A" BORE		STANDARD KEYWAY	
	mm	inches	mm	inches
PTO 8008225	25.0	63/64" (.98)	8.0	5/16" (.31)
PTO 8008208	25.4	1" (1.0)	6.4	1/4" (.25)
PTO 8008230	30.0	1 3/16" (1.18)	8.0	5/16" (.31)
PTO 8008210	31.8	1 1/4" (1.25)	6.4	1/4" (.25)
PTO 8008211	34.9	1 3/8" (1.38)	8.0	5/16" (.31)
PTO 8008218	28.6	1 1/8" (1.13)	6.4	1/4" (.25)
PTO 8008220	31.8	1 1/4" (1.25)	8.0	5/16" (.31)

**Profile Yokes**

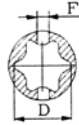

PART NO.	SIZE		
	D	B	F
PTO AP20223	23.5	47	8
PTO AP20230	30.0	47	8

**Implement Yoke**

**Shear Pin**

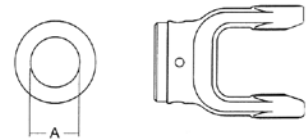

PART NO.	DIM "A" BORE	
	mm	inches
PTO 8028220 (with 3/8" Pinhole)	31.8	1 1/4" (1.25)
PTO 8028222 (with 1/2" Pinhole)	35.0	1 3/8" (1.38)
PTO 8028225 (with 5/16" Pinhole)	25.0	63/64" (.98)
PTO 8028230 (with 25/64" Pinhole)	30.0	1 3/16" (1.18)

**Guard**

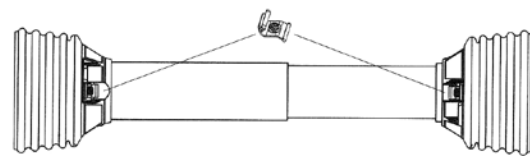

**Order Bearings as required**

PART NO.	OVERALL DRIVELINE LENGTH	BEARING KIT (2 PER KIT)
PTO 9002548	48"	PTO 9610251
PTO 9002560	60"	PTO 9610251

Assembly instructions included with guard.

Note: When installing Guards observe the following:

- 1) Install proper nylon bearing (See Page 11)
- 2) Guards must rotate freely on yokes.

**Easy Lock™ Replacement Kit**

PART NO.
PTO 13005000 (4 per kit)



**I SERIES**

Interchanges with Walterscheid

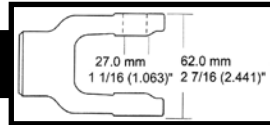

**METRIC DRIVELINES & COMPONENTS**

**AW11**

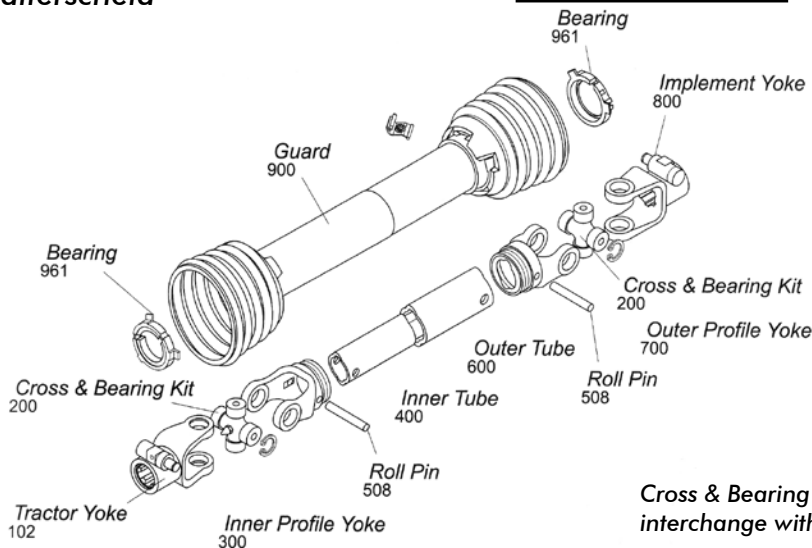

Cross & Bearing Kit and Outboard Yokes interchange with Bondioli 3 Series.

**Tractor Yoke**

Safety Slide Lock  
Repair Kit - Page 106

PART NO.	DIM "A" BORE
PTO 1018306	1 3/8" x 6 Spl.
PTO 1018321	1 3/8" x 21 Spl.

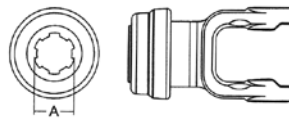

Quick Disconnect  
Repair Kit - Page 106

PART NO.	DIM "A" BORE
PTO 1028306	1 3/8" x 6 Spl.
PTO 1028321	1 3/8" x 21 Spl.

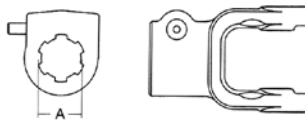

**Cross & Bearing Kit (R-Kit)**

Snap Ring Located in Yoke

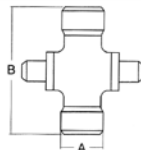

PART NO.	DIM "A"		DIM "B"	
	mm	inches	mm	inches
PTO 2008370	27.0	1 1/16" (1.06)	70.0	2 3/4" (2.76)

**Extended Lubrication Cross & Bearing Kit (E-Kit)**

Snap Ring Located in Yoke

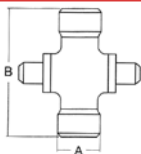

PART NO.	DIM "A"		DIM "B"	
	mm	inches	mm	inches
PTO 2018370	27.0	1 1/16" (1.06)	70.0	2 3/4" (2.76)

**Inner Profile Yoke**

With Bearing Groove  
(Guard must rotate freely on yoke)

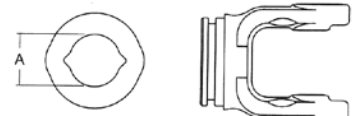

PART NO.	DIM "A" BORE	
	mm	inches
PTO 3007334	34.5	1 23/64" (1.36)

**Inner Tube**

34.5 (4.0 Wall) mm  
1.36" (.16 Wall)



PART NO.	LENGTH	
	m	inches
PTO 4007234	1.5	59 1/16" (59.06)
PTO 4017234	3.0	118 1/8" (118.11)
PTO 4047234	1.0	39 3/8" (39.37)

**Roll Pin**

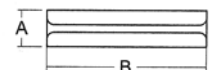

PART NO.	DIM "A"		DIM "B"	
	mm	inches	mm	inches
PTO 5081065	10.0	25/64" (.39)	65.0	2 9/16" (2.56)

I SERIES

METRIC DRIVELINES & COMPONENTS

Outer Tube

41.0 (2.9 Wall) mm  
1.61" (.11" Wall)



PART NO.	LENGTH	
	m	inches
PTO 6007241	1.5	59 1/16" (59.06)
PTO 6017241	3.0	118 1/8" (118.11)
PTO 6047241	1.0	39 3/8" (39.37)

Outer Profile Yoke

With Bearing Groove  
(Guard must rotate freely on yoke)

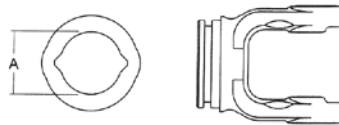

PART NO.	DIM "A" BORE	
	mm	inches
PTO 7007341	41.3	1 5/8" (1.63)

Implement Yoke

Round Bore  
With Keyway & Set Screw

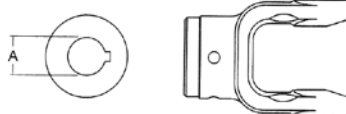

PART NO.	DIM "A" BORE		STANDARD KEYWAY	
	mm	inches	mm	inches
PTO 8008325	25.0	63/64" (.98)	8.0	5/16" (.31)
PTO 8008330	30.0	1 3/16" (1.18)	8.0	5/16" (.31)
PTO 8008310	31.8	1 1/4" (1.25)	6.4	1/4" (.25)
PTO 8008311	34.9	1 3/8" (1.37)	8.0	5/16" (.31)

Implement Yoke

Shear Pin  
With Pin Hole

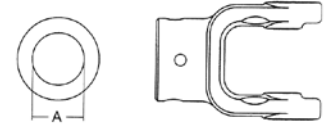

PART NO.	DIM "A" BORE	
	mm	inches
PTO 8028310	31.8	1 1/4" (1.25)
PTO 8028325	25.0	63/64" (.98)
PTO 8028330	30.0	1 3/16" (1.18)
PTO 8028335	35.0	1 3/8" (1.38)

Guard

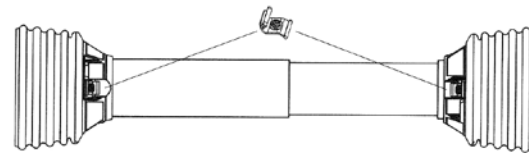

Order Bearings as required

PART NO.	OVERALL DRIVELINE LENGTH	BEARING KIT (2 PER KIT)
PTO 9002548	48"	PTO 9610251
PTO 9002560	60"	PTO 9610251

Assembly instructions included with guard.

Note: When installing Guards observe the following:

- 1) Install proper nylon bearing (See Page 11)
- 2) Guards must rotate freely on yokes.

Easy Lock™ Replacement Kit

PART NO.
PTO 13005000 (4 per kit)



**2300/210 SERIES**

Interchanges with Walterscheid

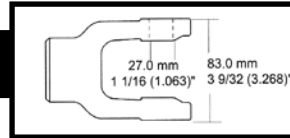

**METRIC DRIVELINES & COMPONENTS**

**AW21**

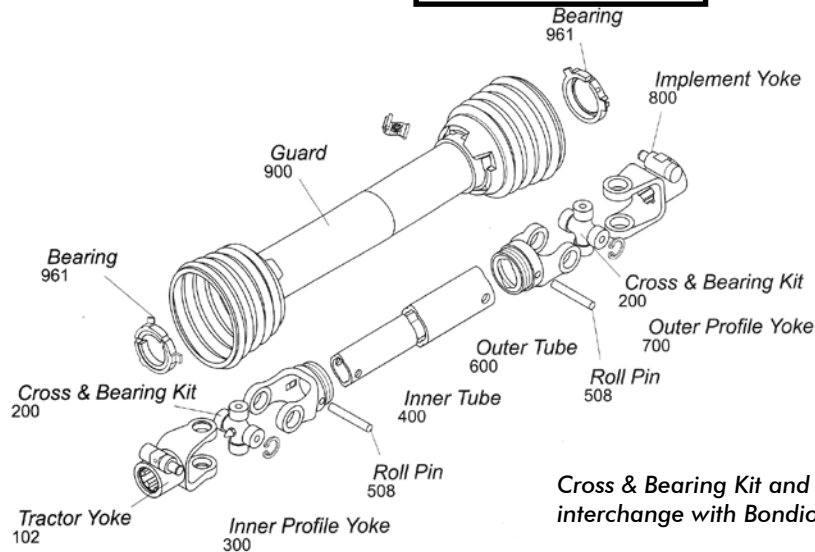

Cross & Bearing Kit and Outboard Yokes interchange with Bondioli 4 Series.

**Tractor Yoke**

Safety Slide Lock  
Repair Kit - Page 106

PART NO.	DIM "A" BORE
PTO 1018406	1 3/8" x 6 Spl.
PTO 1018421	1 3/8" x 21 Spl.

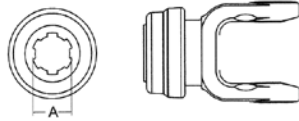

Quick Disconnect  
Repair Kit - Page 106

PART NO.	DIM "A" BORE
PTO 1028406	1 3/8" x 6 Spl.
PTO 1028418	1 1/8" Hex
PTO 1028421	1 3/8" x 21 Spl.

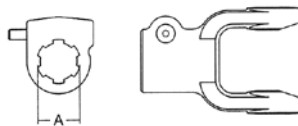

**Ball Shear**

PART NO.	DIM "A" BORE
PTO 1048406	1 3/8" x 6 Spl.
PTO 1048420	1 3/4" x 20 Spl.
PTO 1048421	1 3/8" x 21 Spl.

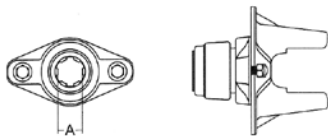

**Cross & Bearing Kit (R-Kit)**

Snap Ring Located in Yoke

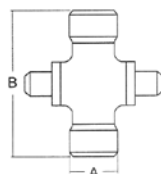

PART NO.	DIM "A"		DIM "B"	
	mm	inches	mm	inches
PTO 2008474	27.0	1 1/16" (1.06)	74.6	2 15/16" (2.94)

**Extended Lubrication Cross & Bearing Kit (E-Kit)**

Snap Ring Located in Yoke

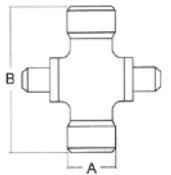

PART NO.	DIM "A"		DIM "B"	
	mm	inches	mm	inches
PTO 2018474	27.0	1 1/16" (1.06)	74.6	2 15/16" (2.94)

**Inner Profile Yoke**

With Bearing Groove  
(Guard must rotate freely on yoke)



PART NO.	DIM "A" BORE	
	mm	inches
PTO 3007434	34.5	1 11/32" (1.36)
PTO 3017439	39.5	1 9/16" (1.56)

**Inner Tube**

34.5 (4.0 Wall) mm  
1.36" (.16 Wall)



PART NO.	LENGTH	
	m	inches
PTO 4007234	1.5	59 1/16" (59.06)
PTO 4017234	3.0	118 1/8" (118.11)
PTO 4047234	1.0	39 3/8" (39.37)



2300/210 SERIES

METRIC DRIVELINES & COMPONENTS

Roll Pin

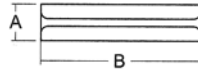

PART NO.	DIM "A"		DIM "B"	
	mm	inches	mm	inches
PTO 5081065	10.0	25/64" (.39)	65.0	2 9/16" (2.56)

Outer Tube

41.0 (2.9 Wall) mm  
1.61" (.11" Wall)



PART NO.	DIM "A"		LENGTH	
	mm	m	inches	
PTO 6007241	41.0 (3.0 Wall)	1.5	59 1/16" (59.06)	
PTO 6017241	41.0 (3.0 Wall)	3.0	118 1/8" (118.11)	
PTO 6047241	41.0 (3.0 Wall)	1.0	39 3/8" (39.37)	

Outer Profile Yoke

With Bearing Groove  
(Guard must rotate  
freely on yoke)

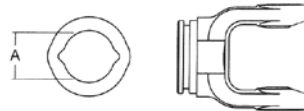

PART NO.	DIM "A" BORE	
	mm	inches
PTO 7007441	41.3	1 5/8" (1.63)
PTO 7017448	48.0	1 57/64" (1.89)

Implement Yoke

Round Bore  
With Keyway & Set Screw

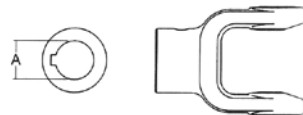

PART NO.	DIM "A" BORE		STANDARD KEYWAY	
	mm	inches	mm	inches
PTO 8008430	30.0	1 3/16" (1.18)	8.0	5/16" (.31)
PTO 8008410	31.8	1 1/4" (1.25)	6.4	1/4" (.25)
PTO 8008411	34.9	1 3/8" (1.38)	8.0	5/16" (.31)
PTO 8008424	38.1	1 1/2" (1.50)	9.5	3/8" (.38)
PTO 8008435	35.0	1 3/8" (1.38)	10.0	25/64" (.39)

Implement Yoke

Shear Pin  
With Pin Hole

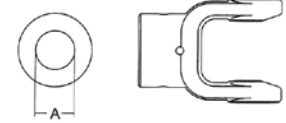

PART NO.	DIM "A" BORE	
	mm	inches
PTO 8028420	31.8	1 1/4" (1.25)
PTO 8028430	30.0	1 3/16" (1.18)
PTO 8028435	35.0	1 3/8" (1.38)

Guard

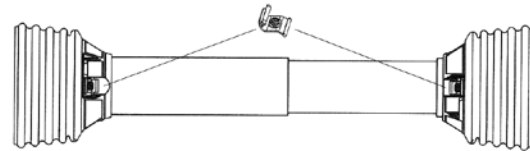

Order Bearings as required

PART NO.	OVERALL DRIVELINE LENGTH	BEARING KIT (2 PER KIT)
PTO 9023548	48"	PTO 9610251
PTO 9023560	60"	PTO 9610251

Assembly instructions included with guard.

Note: When installing Guards observe the following:

- 1) Install proper nylon bearing (See Page 11)
- 2) Guards must rotate freely on yokes.

Easy Lock™ Replacement Kit

PART NO.
PTO 13005000 (4 per kit)



**220/720 SERIES**

Interchanges with Walterscheid

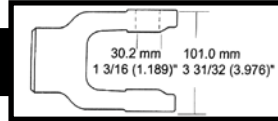

**METRIC DRIVELINES & COMPONENTS**

**AW22**

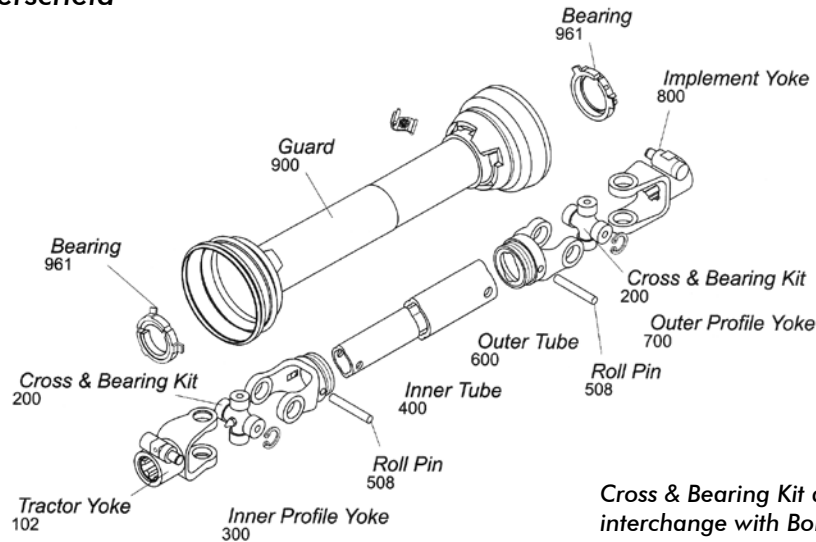

Cross & Bearing Kit and Outboard Yokes interchange with Bondioli 6 Series.

**Tractor Yoke**

Safety Slide Lock  
Repair Kit - Page 106

PART NO.	DIM "A" BORE
PTO 1018606	1 3/8" x 6 Spl.
PTO 1018620	1 3/4" x 20 Spl.
PTO 1018621	1 3/8" x 21 Spl.

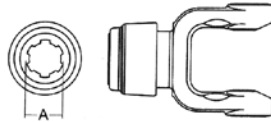

Quick Disconnect  
Repair Kit - Page 88106

PART NO.	DIM "A" BORE
PTO 1028606	1 3/8" x 6 Spl.
PTO 1028618	1 1/8" Hex
PTO 1028620	1 3/4" x 20 Spl.
PTO 1028621	1 3/8" x 21 Spl.
PTO AP35134	1 3/4" x 6 Spl. Bore

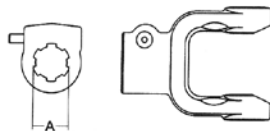

**Ball Shear**

PART NO.	DIM "A" BORE
PTO 1048606	1 3/8" x 6 Spl.
PTO 1048620	1 3/4" x 20 Spl.
PTO 1048621	1 3/8" x 21 Spl.

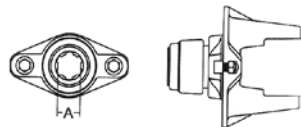

**Cross & Bearing Kit (R-Kit)**

Snap Ring Located in Yoke

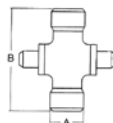

PART NO.	DIM "A"		DIM "B"	
	mm	inches	mm	inches
PTO 2008692	30.2	1 3/16" (1.19)	92.0	3 5/8" (3.62)

**Extended Lubrication Cross & Bearing Kit (E-Kit)**

Snap Ring Located in Yoke

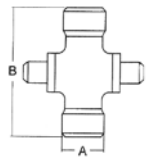

PART NO.	DIM "A"		DIM "B"	
	mm	inches	mm	inches
PTO 2018692	30.2	1 3/16" (1.19)	92.0	3 5/8" (3.62)

**Inner Profile Yoke**

With Bearing Groove  
(Guard must rotate freely on yoke)

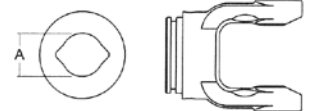

PART NO.	DIM "A" BORE	
	mm	inches
PTO 3007539	39.5	1 9/16" (1.56)

**Inner Tube**

39.5 (4.5 Wall) mm  
1.56" (.18 Wall)



PART NO.	LENGTH	
	m	inches
PTO 4007539	1.5	59 1/16" (59.06)
PTO 4017539	3.0	118 1/8" (118.11)
PTO 4047539	1.0	39 3/8" (39.37)

220/720 SERIES

METRIC DRIVELINES & COMPONENTS

Roll Pin

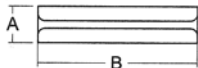

PART NO.	DIM "A"		DIM "B"	
	mm	inches	mm	inches
PTO 5081080	10.0	25/64" (.39)	80.0	3 5/32" (3.10)

Outer Tube

48.0 (3.8 Wall) mm  
1.89" (.15" Wall)



PART NO.	LENGTH	
	m	inches
PTO 6007248	1.5	59 1/16" (59.06)
PTO 6017248	3.0	118 1/8" (118.11)
PTO 6047248	1.0	39 3/8" (39.37)

Outer Profile Yoke

With Bearing Groove  
(Guard must rotate freely on yoke)

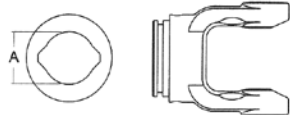

PART NO.	DIM "A" BORE	
	mm	inches
PTO 7007548	48.0	1 57/64" (1.89)

Implement Yoke

Round Bore  
With Keyway & Set Screw

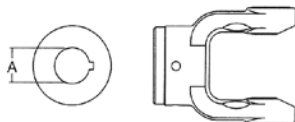

PART NO.	DIM "A" BORE		STANDARD KEYWAY	
	mm	inches	mm	inches
PTO 8008610	31.8	1 1/4" (1.25)	6.4	1/4" (.25)
PTO 8008611	34.9	1 3/8" (1.38)	8.0	5/16" (.31)
PTO 8008624	38.1	1 1/2" (1.50)	9.5	3/8" (.38)
PTO 8008628	44.5	1 3/4" (1.75)	9.5	3/8" (.38)
PTO 8008635	35.0	1 3/8" (1.38)	10.0	25/64" (.39)
PTO 8008640	40.0	1 37/64" (1.57)	12.0	15/32" (.47)

Implement Yoke

Shear Pin  
With Pin Hole



PART NO.	DIM "A" BORE	
	mm	inches
PTO 8028611	35.0	1 3/8" (1.38)
PTO 8028620	31.8	1 1/4" (1.25)

Guard

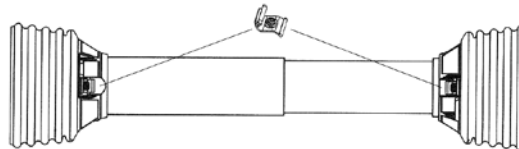

Order Bearings as required

PART NO.	OVERALL DRIVELINE LENGTH	BEARING KIT (2 PER KIT)
PTO 9023548	48"	PTO 9613525
PTO 9023560	60"	PTO 9613525

Assembly instructions included with guard.

Note: When installing Guards observe the following:

- 1) Install proper nylon bearing (See Page 11)
- 2) Guards must rotate freely on yokes.

Easy Lock™ Replacement Kit

PART NO.
PTO 13005000 (4 per kit)



**2400 SERIES**

Interchanges with Walterscheid

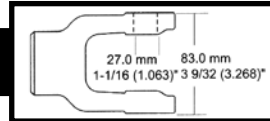

**METRIC DRIVELINES & COMPONENTS**

**AW35**

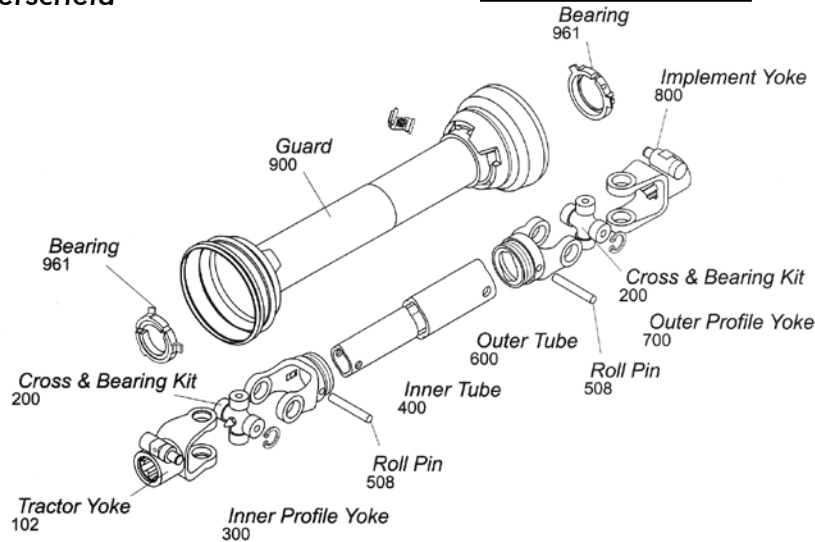

**Tractor Yoke**

Safety Slide Lock  
Repair Kit - Page 106

PART NO.	DIM "A" BORE
PTO 1017606	1 3/8" x 6 Spl.
PTO 1017620	1 3/4" x 20 Spl.
PTO 1017621	1 3/8" x 21 Spl.

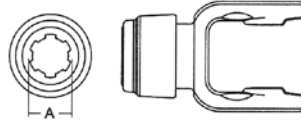

**Inner Profile Yoke**



PART NO.	DIM "A" PROFILE		DIM "B" PROFILE	
	mm	inches	mm	inches
PTO 3007639 (Lemon)	39.5	1 9/16" (1.56)	-	-
PTO 3017651 (Star)	-	-	51.4	2 1/64" (2.02)

Quick Disconnect  
Repair Kit - Page 106

PART NO.	DIM "A" BORE
PTO 1027606	1 3/8" x 6 Spl.
PTO 1027620	1 3/4" x 20 Spl.
PTO 1027621	1 3/8" x 21 Spl.
PTO AP35134	1 3/4" x 6 Spl.

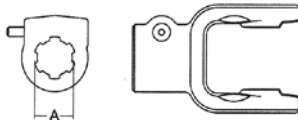

**Inner Tube**



**Ball Shear**

PART NO.	DIM "A" BORE
PTO 1047606	1 3/8" x 6 Spl.
PTO 1047620	1 3/4" x 20 Spl.
PTO 1047621	1 3/8" x 21 Spl.

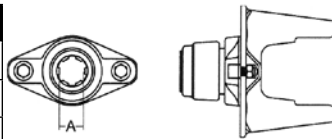

PART NO.	DIM "A"	DIM "B"	LENGTH	
			m	inches
PTO 4007539	39.5 (4.5 wall)	-	1.5	59 1/16" (59.06)
PTO 4007651	-	51.0 (6.0 wall)	1.5	59 1/16" (59.06)
PTO 4017539	39.5 (4.5 wall)	-	3.0	118 1/8" (118.11)
PTO 4017651	-	51.0 (6.0 wall)	3.0	118 1/8" (118.11)
PTO 4047539	39.5 (4.5 wall)	-	1.0	39 3/8" (39.37)
PTO 4047651	-	51.0 (6.0 wall)	1.0	39 3/8" (39.37)

**Cross & Bearing Kit (R-Kit)**

Snap Ring Located in Yoke

PART NO.	DIM "A"		DIM "B"	
	mm	inches	mm	inches
PTO 2007676	32.0	1 1/4" (1.26)	76.0	3" (3.00)

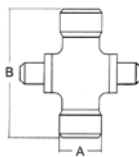

**Extended Lubrication Cross & Bearing Kit (E-Kit)**

Snap Ring Located in Yoke

PART NO.	DIM "A"		DIM "B"	
	mm	inches	mm	inches
PTO 2017676	32.0	1 1/4" (1.26)	76.0	3" (3.00)

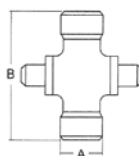

**Roll Pin**

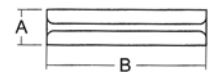

PART NO.	DIM "A"		DIM "B"	
	mm	inches	mm	inches
PTO 5081075	10.0	25/64" (.39)	75.0	2 61/64" (2.95)

2400 SERIES

METRIC DRIVELINES & COMPONENTS

Outer Tube

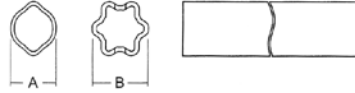

PART NO.	DIM "A"	DIM "B"	LENGTH	
			m	inches
PTO 6007548	48.0 (4.0 Wall)	-	1.5	59 1/16" (59.06)
PTO 6007661	-	61.0 (4.0 Wall)	1.5	59 1/16" (59.06)
PTO 6017548	48.0 (4.0 Wall)	-	3.0	118 1/8" (118.11)
PTO 6017661	-	61.0 (4.0 Wall)	3.0	118 1/8" (118.11)
PTO 6047548	48.0 (4.0 Wall)	-	1.0	39 3/8" (39.37)
PTO 6047661	-	61.0 (4.0 Wall)	1.0	39 3/8" (39.37)

Outer Profile Yoke

With Bearing Groove  
(Guard must rotate freely on yoke)

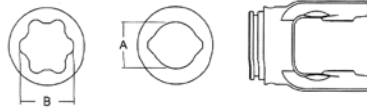

PART NO.	DIM "A" BORE		DIM "B" BORE	
	mm	inches	mm	inches
PTO 7007648	48.0	1 7/8" (1.89)	-	-
PTO 7007661	-	-	61.0	2 13/32" (2.40)

Implement Yoke

Round Bore  
With Keyway & Set Screw

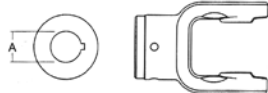

PART NO.	DIM "A" BORE		STANDARD KEYWAY	
	mm	inches	mm	inches
PTO AP35330	30.0	-	-	-
PTO 8007610	31.8	1 1/4" (1.25)	6.4	1/4" (.25)
PTO 8007611	34.9	1 3/8" (1.38)	8.0	5/16" (.31)
PTO 8007635	35.0	1 3/8" (1.38)	10.0	25/64" (.39)
PTO 8007640	40.0	1 37/64" (1.57)	12.0	15/32" (.47)
PTO AP35342	42.0	-	-	-

Drivelines



PART NO.	OVERALL COMP. LENGTH DIM "A"	TRACTOR YOKE	IMPLEMENT YOKE
PTO 14007640	40"	1 3/8" x 6 Spl.	1 3/8" x 6 Spl.
PTO 14307645	45"	1 3/8" x 6 Spl. QD	1 3/8" x 6 Spl. with Overrunning Clutch

Implement Yoke

Shear Pin  
With Pin Hole



PART NO.	DIM "A" BORE	
	mm	inches
PTO AP35030	30.0	
PTO AE35031	31.75	1 1/4"
PTO 8027611	35.0	1 3/8" (1.38)
PTO 8027622	35.0	1 3/8" (1.38)
PTO 8027630 (with 13 mm Pin Hole)	35.0	1 3/8" (1.38)
PTO 8027640 (with 13 mm Pin Hole)	40.0	1 37/64" (1.57)
PTO AP35040	40.0	

Clamp Yoke



PART NO.	DIM "A" BORE
PTO 8077620	1 3/4" x 20 Spl. (1.75)
PTO 8077621	1 3/8" x 21 Spl. (1.38)
PTO 8077622	1 3/8" x 6 Spl. (1.38)
PTO AP110525	25mm -Rd. & Kw
PTO AP110530	30mm -Rd. & Kw

Guard

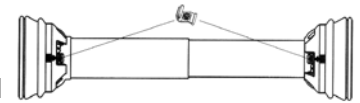

Order Bearings as required

PART NO.	OVERALL DRIVELINE LENGTH	BEARING KIT (2 PER KIT)
PTO 9023548	48"	PTO 9613525
PTO 9023560	60"	PTO 9613525

Assembly instructions included with guard.

Note: When installing Guards observe the following:

- 1) Install proper nylon bearing (See Page 11)
- 2) Guards must rotate freely on yokes.

Easy Lock™ Replacement Kit

PART NO.
PTO 13005000 (4 per kit)



**2500 SERIES**

Interchanges with Walterscheid

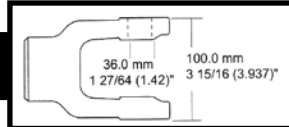

**METRIC DRIVELINES & COMPONENTS**

**AW36**

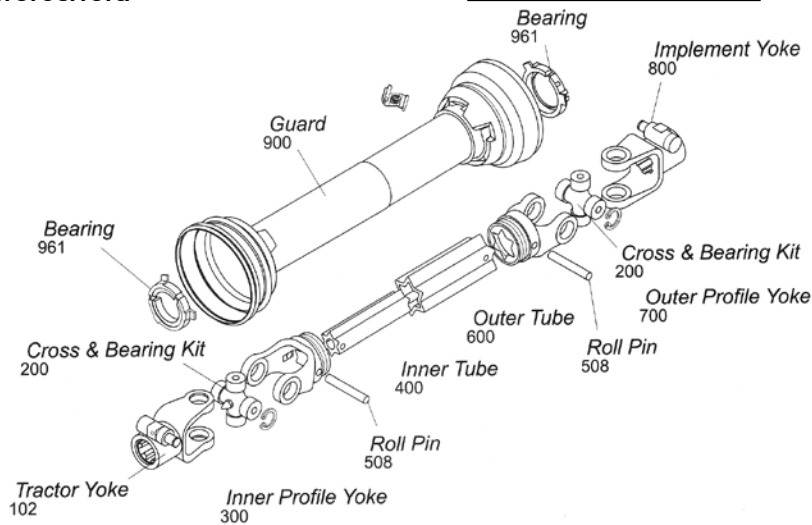

**Tractor Yoke**

Safety Slide Lock  
Repair Kit - Page 106

PART NO.	DIM "A" BORE
PTO 1017906	1 3/8" x 6 Spl.
PTO 1017920	1 3/4" x 20 Spl.
PTO 1017921	1 3/8" x 21 Spl.

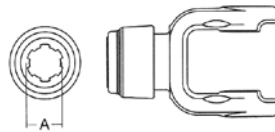

**Auto-Lok Tractor Yoke**

Auto-Lok  
Repair Kit - Page 106

PART NO.	DIM "A" BORE
PTO 1107906	1 3/8" x 6 Spl.

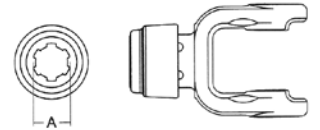

Quick Disconnect  
Repair Kit - Page 106

PART NO.	DIM "A" BORE
PTO 1027906	1 3/8" x 6 Spl.
PTO 1027920	1 3/4" x 20 Spl.
PTO 1027921	1 3/8" x 21 Spl.



**Inner Profile Yoke**

With Bearing Groove  
(Guard must rotate  
freely on yoke)

PART NO.	DIM "A" BORE	
	mm	inches
PTO 3007951	51.4	2 1/64" (2.02)

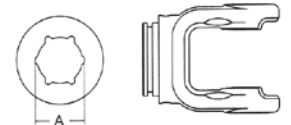

**Cross & Bearing Kit (R-Kit)**

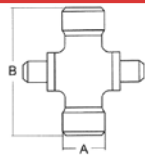

Snap Ring Located in Yoke

PART NO.	DIM "A"		DIM "B"	
	mm	inches	mm	inches
PTO 2007989	36.0	1 27/64" (1.42)	88.8	3 1/2" (3.50)

**Extended Lubrication Cross & Bearing Kit (E-Kit)**

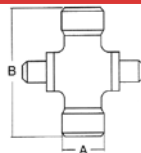

Snap Ring Located in Yoke

PART NO.	DIM "A"		DIM "B"	
	mm	inches	mm	inches
PTO 2017989	36.0	1 27/64" (1.42)	88.8	3 1/2" (3.50)

**Inner Tube**

51.0 mm (6.0 Wall) mm  
2.00" (.24" Wall)



PART NO.	LENGTH	
	m	inches
PTO 4007651	1.5	59 1/16" (59.06)
PTO 4017651	3.0	118 1/8" (118.11)
PTO 4047651	1.0	39 3/8" (39.37)

**Roll Pin**

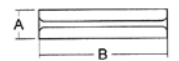

PART NO.	DIM "A"		DIM "B"	
	mm	inches	mm	inches
PTO 5081090	10.0	25/64" (.39)	90.00	3 35/64" (3.54)

2500 SERIES

METRIC DRIVELINES & COMPONENTS

Outer Tube

61.0 (4.3 Wall) mm  
2.40" (.17" Wall)



PART NO.	LENGTH	
	m	inches
PTO 6007961	1.5	59 1/16" (59.06)
PTO 6017961	3.0	118 1/8" (118.11)
PTO 6047961	1.0	39 3/8" (39.37)

Outer Profile Yoke

With Bearing Groove  
(Guard must rotate freely on yoke)

PART NO.	DIM "A" BORE	
	mm	inches
PTO 7007961	61.0	2 13/32" (2.40)

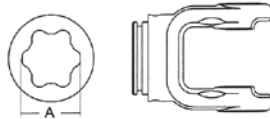

Implement Yoke

Round Bore  
With Keyway & Set Screw

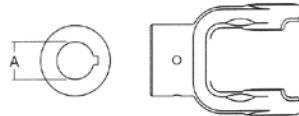

PART NO.	DIM "A" BORE		STANDARD KEYWAY	
	mm	inches	mm	inches
PTO 8007922	35.0	1 3/8" (1.38)	8.0	5/16" (.31)
PTO 8007924	38.1	1 1/2" (1.50)	9.5	3/8" (.37)
PTO 8007935	35.0	1 3/8" (1.38)	10.0	25/64" (.39)

Spline Bore  
With Pin Hole

PART NO.	DIM "A" BORE
PTO 8017921	1 3/8" x 21 Spl.

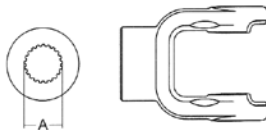

Drivelines

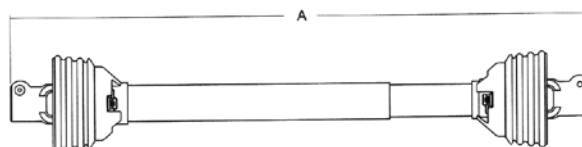

PART NO.	OVERALL COMP. LENGTH DIM "A"	TRACTOR YOKE	IMPLEMENT YOKE
PTO 14007955 (Star Tubing)	55"	1 3/8" x 6 Spl. QD	1 3/8" x 21 Spl. with Pinhole
PTO 14207939	30"	1 3/4" x 20 Spl. QD	1 3/8" x 21 Spl. with Friction Clutch
PTO 14217939	39"	1 3/8" x 21 Spl.	1 3/8" x 6 Spl. with Friction Clutch

Implement Yoke

Shear Pin  
With Pin Hole

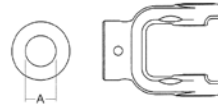

PART NO.	DIM "A" BORE	
	mm	inches
PTO 8027922	35.0	1 3/8" (1.38)
PTO 8027924	38.1	1 1/2" (1.50)
PTO AP36040	40.0	
PTO AP36045	45.0	

Clamp Yoke

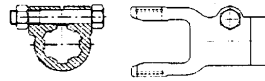

PART NO.	DIM "A" BORE
PTO 8077906	1 3/8" x 6 Spl.
PTO 8077918	1 3/4" x 6 Spl.
PTO 8077920	1 3/4" x 20 Spl.
PTO 8077921	1 3/8" x 21 Spl.
PTO AP36535	35 mm Bore

Guard

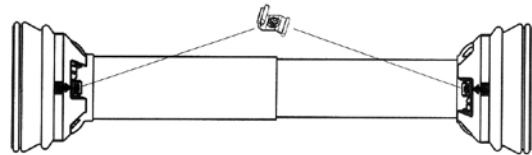

Order Bearings as required

PART NO.	OVERALL DRIVELINE LENGTH	BEARING KIT (2 PER KIT)
PTO 9023548	48"	PTO 9613525
PTO 9023560	60"	PTO 9613525

Assembly instructions included with guard.

Note: When installing Guards observe the following:

- 1) Install proper nylon bearing (See Page 11)
- 2) Guards must rotate freely on yokes.

Easy Lock™ Replacement Kit

PART NO.
PTO 13005000 (4 per kit)



**METRIC DRIVELINES  
& COMPONENTS**

**2600 SERIES**

Interchanges with Walterscheid

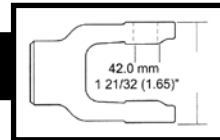

**AW26**

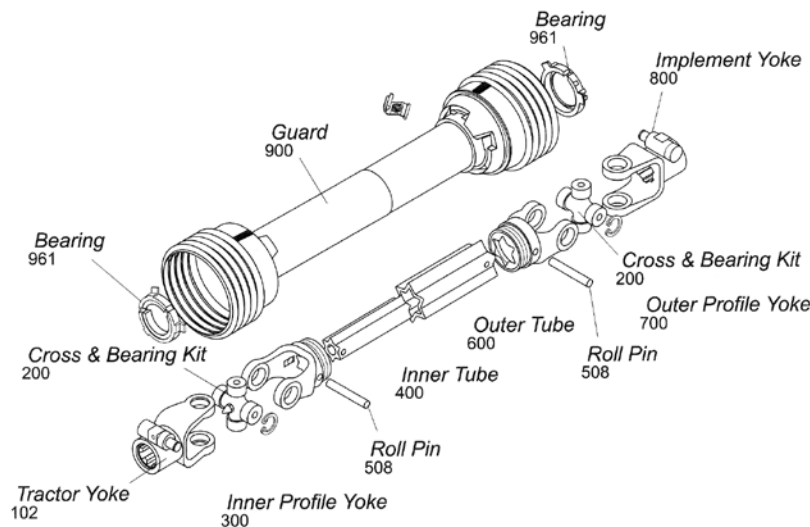

**Tractor Yoke**

Safety Slide Lock  
Repair Kit - Page 106

PART NO.	DIM "A" BORE
PTO 1017006	1 3/8" x 6 Spl.
PTO 1017020	1 3/4" x 20 Spl.
PTO 1017021	1 3/8" x 21 Spl.

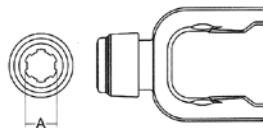

**Inner Profile Yoke**

With Bearing Groove  
(Guard must rotate  
freely on yoke)



Quick Disconnect  
Repair Kit - Page 106

PART NO.	DIM "A" BORE
PTO 1027006	1 3/8" x 6 Spl.
PTO 1027020	1 3/4" x 20 Spl.
PTO 1027021	1 3/8" x 21 Spl.



PART NO.	DIM "A" PROFILE	
	mm	inches
PTO 3007061	61.0	2 13/32" (2.40)

**Cross & Bearing Kit (R-Kit)**

Snap Ring Located in Yoke

PART NO.	DIM "A"		DIM "B"	
	mm	inches	mm	inches
PTO 2007004	42.0	1 21/32" (1.65)	104.0	4 3/32" (4.09)

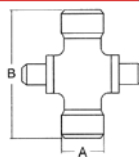

**Inner Tube**

61.0 mm (4.3 Wall) mm  
2.40" (.17" Wall)



PART NO.	LENGTH	
	m	inches
PTO 6007961	1.5	59 1/16" (59.06)
PTO 6017961	3.0	118 1/8" (118.11)
PTO 6047961	1.0	39 3/8" (39.37)

**Extended Lubrication Cross & Bearing Kit (E-Kit)**

Snap Ring Located in Yoke

PART NO.	DIM "A"		DIM "B"	
	mm	inches	mm	inches
PTO 2017004	42.0	1 21/32" (1.65)	104.0	4 3/32" (4.09)

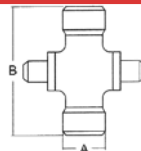

**Roll Pin**

PART NO.	DIM "A"		DIM "B"	
	mm	inches	mm	inches
PTO 5081090	10.0	25/64" (.39)	90.00	3 35/64" (3.54)

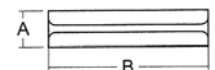



2600 SERIES

METRIC DRIVELINES & COMPONENTS

Outer Tube

71.5 (4.9 Wall) mm  
2.81" (.19" Wall)



PART NO.	LENGTH	
	m	inches
PTO 6007071	1.5	59 1/16" (59.06)
PTO 6017071	3.0	118 1/8" (118.11)
PTO 6047071	1.0	39 3/8" (39.37)

Outer Profile Yoke

With Bearing Groove  
(Guard must rotate freely on yoke)



PART NO.	DIM "A" BORE	
	mm	inches
PTO 7007071	71.7	2 53/64" (2.82)

Implement Yoke

Round Bore  
With Keyway & Set Screw

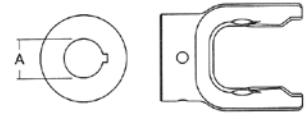

PART NO.	DIM "A" BORE		STANDARD KEYWAY	
	mm	inches	mm	inches
PTO 8007024	38.1	1 1/2" (1.50)	9.5	3/8" (.37)
PTO 8007026	41.3	1 5/8" (1.63)	9.5	3/8" (.37)
PTO 8007028	44.5	1 3/4" (1.75)	9.5	3/8" (.37)
PTO 8007032	50.8	2" (2.00)	12.7	1/2" (.50)

Easy Lock™ Replacement Kit

PART NO.
PTO 13005000 (4 per kit)



Guard

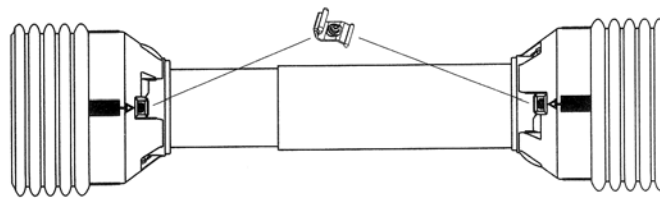

Order Bearings as required

PART NO.	OVERALL DRIVELINE LENGTH	BEARING KIT (2 PER KIT)
PTO 9004548	48"	PTO 9614535
PTO 9004560	60"	PTO 9614535

Assembly instructions included with guard.

Note: When installing Guards observe the following:

- 1) Install proper nylon bearing (See Page 11)
- 2) Guards must rotate freely on yokes.

**II SERIES**

Interchanges with Walterscheid

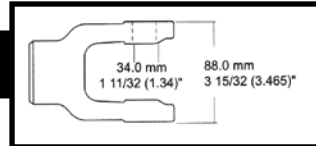

**METRIC DRIVELINES & COMPONENTS**

**AW12**

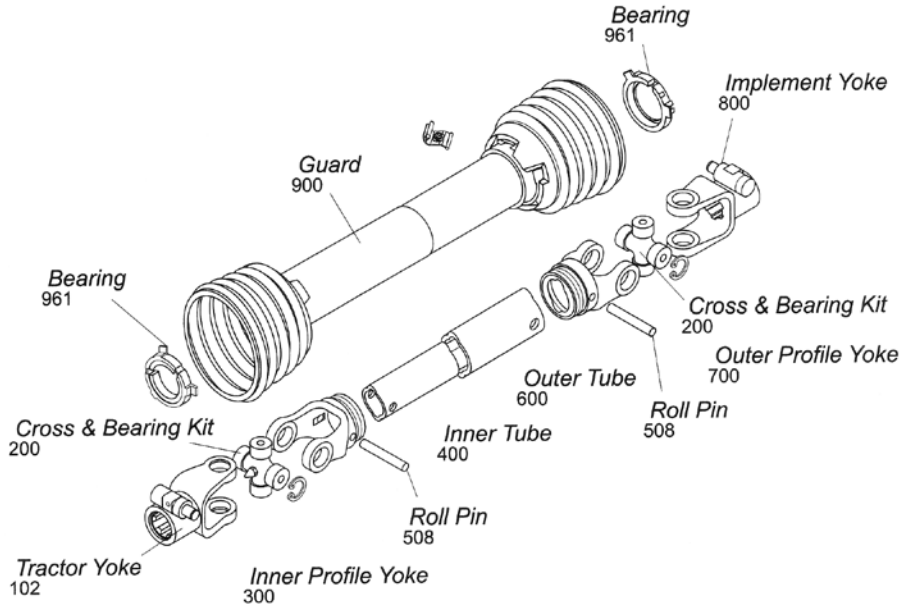

**Tractor Yoke**

Quick Disconnect  
Repair Kit - Page 106

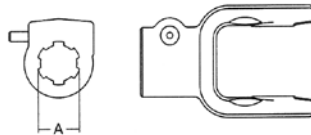

PART NO.	DIM "A" BORE
PTO 1027806	1 3/8" x 6 Spl.
PTO 1027821	1 3/8" x 21 Spl.
PTO AP12134	1 3/4" x 6 Spl.
PTO AP12120	1 3/4" x 20 Spl.

**Cross & Bearing Kit**

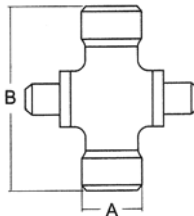

Snap Ring Located in Bushing

PART NO.	DIM "A"		DIM "B"	
	mm	inches	mm	inches
PTO 2007890	34.0	1 11/32" (1.34)	90.2	3 35/64" (3.55)

**Inner Profile Yoke**

With Bearing Groove  
(Guard must rotate  
freely on yoke)

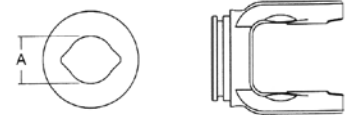

PART NO.	DIM "A" PROFILE	
	mm	inches
PTO 3007839	39.5	1 9/16" (1.56)

**Outer Profile Yoke**

With Bearing Groove  
(Guard must rotate  
freely on yoke)

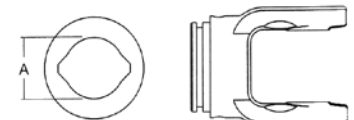

PART NO.	DIM "A" PROFILE	
	mm	inches
PTO 7007848	48.0	1 7/8" (1.89)

**II SERIES**

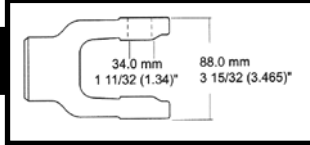

**METRIC DRIVELINES & COMPONENTS**

**Clamp Yokes**

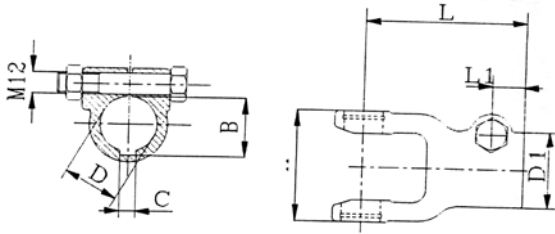

PART NO.	SIZE		
	D	C	B
PTO AP12535	35	10	38.3
PTO AP12538	40	12	43.3

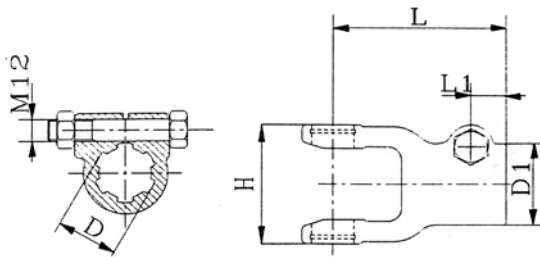

PART NO.	SIZE	
	D	SPLINE
PTO AP125121	1 3/8"	21

**Hub Yokes**

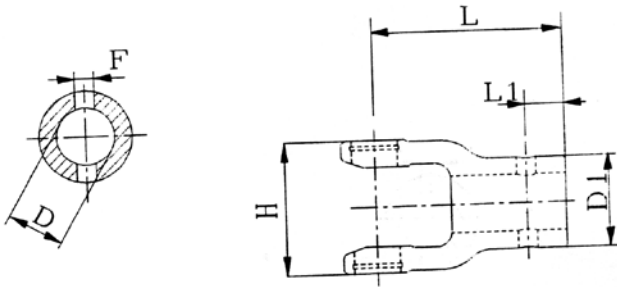

PART NO.	SIZE	
	D	F
PTO AP12035	35	13

**PROFILE SHAFTING AND TUBING**

**METRIC DRIVELINES & COMPONENTS**

SERIES	PART NO.	METERS	INCHES	USE AS
ByPy 1	PTO 4006126	1.5	59 1/16"	Inner
ByPy 1	PTO 4016126	3.0	118 5/16"	Inner
ByPy 1	PTO 4046126	1.0	39 3/8"	Inner
ByPy 1	PTO 6006133	1.5	59 1/16"	Outer
ByPy 1	PTO 6016133	3.0	118 5/16"	Outer
ByPy 1	PTO 6046133	1.0	39 3/8"	Outer
ByPy 2	PTO 4006229	1.5	59 1/16"	Inner
ByPy 2	PTO 4016229	3.0	118 5/16"	Inner
ByPy 2	PTO 4046229	1.0	39 3/8"	Inner
ByPy 2	PTO 6006236	1.5	59 1/16"	Outer
ByPy 2	PTO 6016236	3.0	118 5/16"	Outer
ByPy 2	PTO 6046236	1.0	39 3/8"	Outer
ByPy 3	PTO 6006236	1.5	59 1/16"	Inner
ByPy 3	PTO 6016236	3.0	118 5/16"	Inner
ByPy 3	PTO 6046236	1.0	39 3/8"	Inner
ByPy 3 & 4	PTO 6006343	1.5	59 1/16"	Outer
ByPy 3 & 4	PTO 6016343	3.0	118 5/16"	Outer
ByPy 3 & 4	PTO 6046343	1.0	39 3/8"	Outer
ByPy 4	PTO 4006436	1.5	59 1/16"	Inner
ByPy 4	PTO 4016436	3.0	118 5/16"	Inner
ByPy 4	PTO 4046436	1.0	39 3/8"	Inner
ByPy 5 & 6	PTO 4006545	1.5	59 1/16"	Inner
ByPy 5 & 6	PTO 4016545	3.0	118 5/16"	Inner
ByPy 5 & 6	PTO 4046545	1.0	39 3/8"	Inner
ByPy 5	PTO 6006552	1.5	59 1/16"	Outer
ByPy 5	PTO 6016552	3.0	118 5/16"	Outer
ByPy 5	PTO 6046552	1.0	39 3/8"	Outer
ByPy 6, 7N & 8	PTO 6006654	1.5	59 1/16"	Outer
ByPy 6, 7N & 8	PTO 6016654	3.0	118 5/16"	Outer
ByPy 6, 7N & 8	PTO 6046654	1.0	39 3/8"	Outer
ByPy 7N	PTO 4006745	1.5	59 1/16"	Inner
ByPy 7N	PTO 4016745	3.0	118 5/16"	Inner
ByPy 7N	PTO 4046745	1.0	39 3/8"	Inner
ByPy 9	PTO 4006954	1.5	59 1/16"	Inner
ByPy 9	PTO 4016954	3.0	118 5/16"	Inner
ByPy 9	PTO 4046954	1.0	39 3/8"	Inner
ByPy 8 & 9	PTO 6006863	1.5	59 1/16"	Outer
ByPy 8 & 9	PTO 6016863	3.0	118 5/16"	Outer
ByPy 8 & 9	PTO 6046863	1.0	39 3/8"	Outer
AW10	PTO 4007123	1.5	59 1/16"	Inner
AW10	PTO 4017123	3.0	118 5/16"	Inner
AW10	PTO 4047123	1.0	39 3/8"	Inner
AW10	PTO 6007130	1.5	59 1/16"	Outer
AW10	PTO 6017130	3.0	118 5/16"	Outer
AW10	PTO 6047130	1.0	39 3/8"	Outer
AW11 & 21	PTO 4007234	1.5	59 1/16"	Inner
AW11 & 21	PTO 4017234	3.0	118 5/16"	Inner
AW11 & 21	PTO 4047234	1.0	39 3/8"	Inner
AW11 & 21	PTO 6007241	1.5	59 1/16"	Outer

SERIES	PART NO.	METERS	INCHES	USE AS
AW11 & 21	PTO 6017241	3.0	118 5/16"	Outer
AW11 & 21	PTO 6047241	1.0	39 3/8"	Outer
AW35 (Lemon)	PTO 4007539	1.5	59 1/16"	Inner
AW35 (Lemon)	PTO 4017539	3.0	118 5/16"	Inner
AW35 (Lemon)	PTO 4047539	1.0	39 3/8"	Inner
AW35 (Lemon)	PTO 6007548	1.5	59 1/16"	Outer
AW35 (Lemon)	PTO 6017548	3.0	118 5/16"	Outer
AW35 (Lemon)	PTO 6047548	1.0	39 3/8"	Outer
AW35 & 36 (Star)	PTO 4007651	1.5	59 1/16"	Inner
AW35 & 36 (Star)	PTO 4017651	3.0	118 5/16"	Inner
AW35 & 36 (Star)	PTO 4047651	1.0	39 3/8"	Inner
AW36 (Star)	PTO 6007961	1.5	59 1/16"	Outer
AW36 (Star)	PTO 6017961	3.0	118 5/16"	Outer
AW36 (Star)	PTO 6047961	1.0	39 3/8"	Outer
AW26	PTO 4007961	1.5	59 1/16"	Inner
AW26	PTO 4017961	3.0	118 5/16"	Inner
AW26	PTO 4047961	1.0	39 3/8"	Inner
AW26	PTO 6007071	1.5	59 1/16"	Outer
AW26	PTO 6017071	3.0	118 5/16"	Outer
AW26	PTO 6047071	1.0	39 3/8"	Outer

**German-Style Shafting & Tubing**

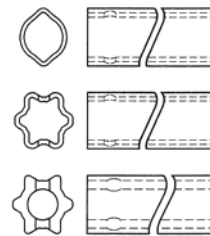

Lemon & Star Profile

**Italian-Style Shafting & Tubing**



Tri-Lobe Profile

## LEMON TUBES (Fits Walterscheid & Agdrive)

All tubes are 150 cm long.

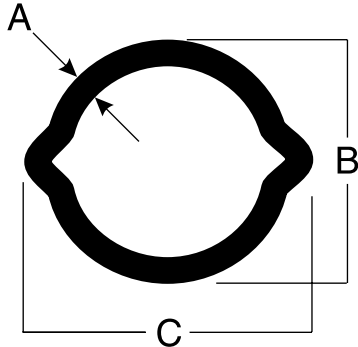

PART NO.	A	B	C
PTO AP230150	Solid	23.5 mm	31 mm
PTO 4007123	4	23.5 mm	31 mm
PTO 6007130	2.8	30 mm	39 mm
PTO 4007234	4	34.5 mm	40 mm
PTO 6007241	3	41 mm	48 mm
PTO 4007539	4.5	39.5 mm	49 mm
PTO 6007548	4	48 mm	57.5 mm

## STAR PROFILE TUBES

All tubes are 150 cm long.

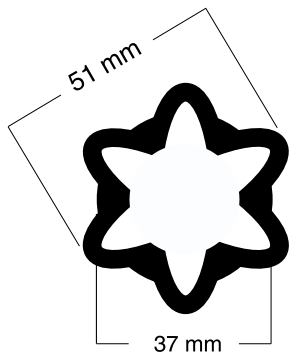

PART NO.
PTO 4007951

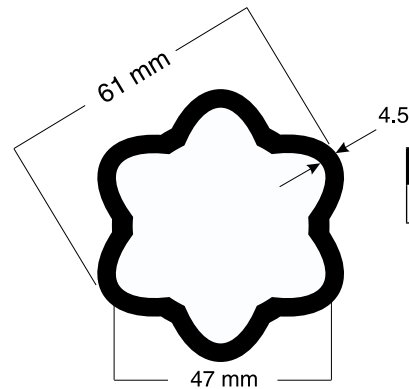

PART NO.
PTO 6007961

## TRIANGLE TUBES (Fits Bondioli & Pavesi)

All tubes are 150 cm long.

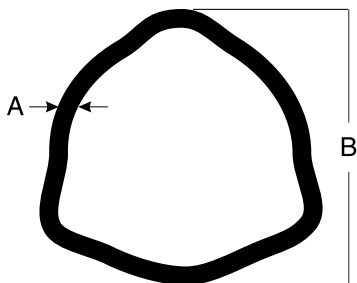

PART NO.	A	B
PTO 4006126	3.5	26 mm
PTO 6006133	2.6	33 mm
PTO 4006229	4	29 mm
PTO 4006336	3.4	36 mm
PTO 6006343	3	43 mm
PTO 4006436	4	36 mm
PTO 6006343	3	43 mm
PTO 4006545	4	45 mm
PTO 6006552	3	52 mm

PART NO.	A	B
PTO 4006745	5	45 mm
PTO 6006654	4.5	54 mm
PTO 6006863	4	63 mm
PTO 4000954	5	54 mm
PTO 6006863	4	63 mm
PTO 666150	6	66 mm

**METRIC REPLACEMENT DRIVELINES**

**METRIC DRIVELINES & COMPONENTS**

*Interchanges with Bondioli & Pavesi and Walterscheid*

**Fertilizer Spreader**

PART NO.	SERIES	OVERALL COMP. LENGTH DIM "A"	TRACTOR YOKE	IMPLEMENT YOKE
PTO 14006127	ByPy 1	27"	1 3/8" x 6 Spl. QD	1 3/8" x 6 Spl. QD
PTO 14006135	ByPy 1	35"	1 3/8" x 6 Spl. QD	1 3/8" x 6 Spl. QD

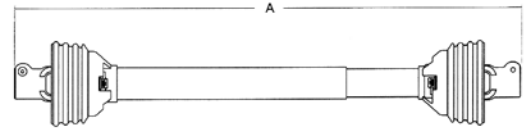

**Post Hole Digger**

PART NO.	SERIES	OVERALL COMP. LENGTH DIM "A"	TRACTOR YOKE	IMPLEMENT YOKE
PTO 14006252	ByPy 2 (Light Duty)	52"	1 3/8" x 6 Spl. QD	1 1/4" Rd. with Pinhole
PTO 14006453	ByPy 4 (Heavy Duty)	53"	1 3/8" x 6 Spl. QD	1 1/4" Rd. with Pinhole

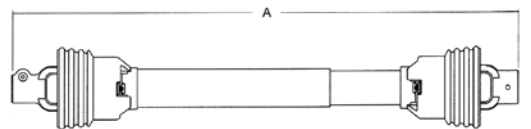

**Finishing Mower**

PART NO.	SERIES	OVERALL COMP. LENGTH DIM "A"	TRACTOR YOKE	IMPLEMENT YOKE
PTO 14006340	ByPy 3	40"	1 3/8" x 6 Spl. QD	1 3/8" x 6 Spl. QD
PTO 14006446	ByPy 4	46"	1 3/8" x 6 Spl. QD	1 3/8" x 6 Spl. QD
PTO 14006637	ByPy 6	37"	1 3/8" x 6 Spl. QD	1 3/8" x 6 Spl. QD

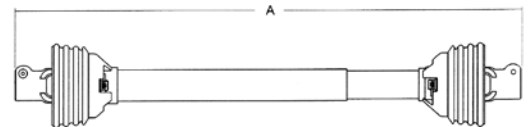

**Catfish Pond Driveline**

PART NO.	SERIES	OVERALL COMP. LENGTH DIM "A"	TRACTOR YOKE	IMPLEMENT YOKE
PTO 14006424	ByPy 4	48"	1 3/8" x 6 Spl. QD	1 1/2" Rd.
PTO 14006524	ByPy 5	48"	1 3/8" x 6 Spl. QD	1 1/2" Rd.
PTO 14006624	ByPy 6	48"	1 3/8" x 6 Spl. QD	1 1/2" Rd.
PTO 14016524	ByPy 5	48"	1 3/8" x 21 Spl. QD	1 1/2" Rd.
PTO 14016624	ByPy 6	48"	1 3/8" x 21 Spl. QD	1 1/2" Rd.

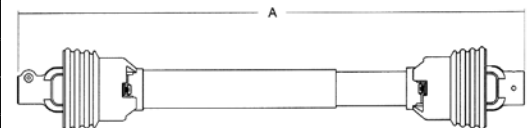

**Hammer Mill**

PART NO.	SERIES	OVERALL COMP. LENGTH DIM "A"	TRACTOR YOKE	IMPLEMENT YOKE
PTO 14006628	ByPy 6	48"	1 3/8" x 6 Spl. QD	1 3/4" Rd.
PTO 14006748	ByPy 7	48"	1 3/8" x 6 Spl. QD	1 3/4" Rd.

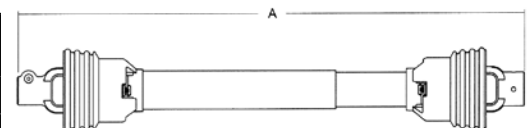

## METRIC REPLACEMENT DRIVELINES

METRIC DRIVELINES  
& COMPONENTS

Interchanges with Bondioli &amp; Pavesi and Walterscheid

## All Purpose Drivelines

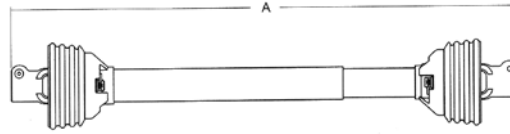

PART NO.	SERIES	OVERALL COMP. LENGTH DIM "A"	TRACTOR YOKE	IMPLEMENT YOKE
PTO 14006137	ByPy 1	37"	1 3/8" x 6 Spl. QD	1 3/8" x 6 Spl. QD
PTO 14006247	ByPy 2	47"	1 3/8" x 6 Spl. QD	1 3/8" x 6 Spl. QD
PTO 14006438	ByPy 4	38"	1 3/8" x 6 Spl. QD	1 3/8" x 6 Spl. QD
PTO 14006455	ByPy 4	55"	1 3/8" x 6 Spl. QD	1 3/8" x 6 Spl. QD
PTO 14006448	ByPy 4	48"	1 3/8" x 6 Spl. QD	1 3/8" x 6 Spl. QD
PTO 14006543	ByPy 5	43"	1 3/8" x 6 Spl. QD	1 3/8" x 6 Spl. QD
PTO 14006555	ByPy 5	55"	1 3/8" x 6 Spl. QD	1 3/8" x 6 Spl. QD
PTO 14006642	ByPy 6	42"	1 3/8" x 6 Spl. QD	1 3/8" x 6 Spl. QD
PTO 14006644	ByPy 6	44"	1 3/8" x 6 Spl. QD	1 3/8" x 6 Spl. QD
PTO 14006655	ByPy 6	55"	1 3/8" x 6 Spl. QD	1 3/8" x 6 Spl. QD
PTO 14006657	ByPy 6	57"	1 3/8" x 6 Spl. QD	1 3/8" x 6 Spl. QD
PTO 14006846	ByPy 8	46"	1 3/8" x 6 Spl. QD	1 3/8" x 6 Spl. QD
PTO 14006857	ByPy 8	57"	1 3/8" x 6 Spl. QD	1 3/8" x 6 Spl. QD
PTO 14016542	ByPy 5	42"	1 3/8" x 6 Spl. QD	1 3/8" x 6 Spl. QD
PTO 14016666	ByPy 6	66"	1 3/8" x 21 Spl. QD	1 1/2" Rd.
PTO 14046148	ByPy 1	48"	1 3/8" x 6 Spl. QD	*
PTO 14046248	ByPy 2	48"	1 3/8" x 6 Spl. QD	*
PTO 14046260	ByPy 2	60"	1 3/8" x 6 Spl. QD	*
PTO 14046348	ByPy 3	48"	1 3/8" x 6 Spl. QD	*
PTO 14046360	ByPy 3	60"	1 3/8" x 6 Spl. QD	*
PTO 14046448	ByPy 4	48"	1 3/8" x 6 Spl. QD	*
PTO 14046460	ByPy 4	60"	1 3/8" x 6 Spl. QD	*
PTO 14046548	ByPy 5	48"	1 3/8" x 6 Spl. QD	*
PTO 14046560	ByPy 5	60"	1 3/8" x 6 Spl. QD	*
PTO 14046648	ByPy 6	48"	1 3/8" x 6 Spl. QD	*
PTO 14046660	ByPy 6	60"	1 3/8" x 6 Spl. QD	*
PTO 14046748	ByPy 7	48"	1 3/8" x 6 Spl. QD	*
PTO 14046760	ByPy 7	60"	1 3/8" x 6 Spl. QD	*
PTO 14046848	ByPy 8	48"	1 3/8" x 6 Spl. QD	*
PTO 14046860	ByPy 8	60"	1 3/8" x 6 Spl. QD	*
PTO 14046948	ByPy 9	48"	1 3/8" x 6 Spl. QD	*
PTO 14046960	ByPy 9	60"	1 3/8" x 6 Spl. QD	*
PTO 14066644	ByPy 6	44"	1 3/8" x 21 Spl. QD	1 3/8" x 21 Spl. QD
PTO 14066846	ByPy 8	46"	1 3/8" x 21 Spl. QD	1 3/8" x 21 Spl. QD
PTO 14107155	W/S 2100	55"	1 3/8" x 6 Spl. QD	30-mm Friction Clutch
PTO 14217939	W/S 2500	39"	1 3/8" x 6 Spl. QD	30-mm Friction Clutch

\*Drivelines are furnished without Cross &amp; Bearing Kit and Implement Yoke. Select kit and yoke as required.

## Peanut Harvester Non-CV

PART NO.	SERIES	OVERALL COMP. LENGTH DIM "A"	TRACTOR YOKE	IMPLEMENT YOKE
PTO 14007955 (Star)	W/S 2500	55"	1 3/4" x 20 Spl. QD	1 3/8" x 21 Spl. QD

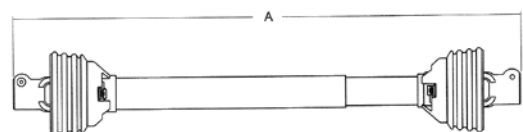

**METRIC REPLACEMENT DRIVELINES**

**METRIC DRIVELINES & COMPONENTS**

*Interchanges with Bondioli & Pavesi and Walterscheid*

**Rotary Cutter**

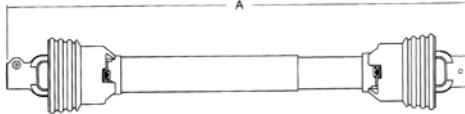

PART NO.	SERIES	TYPE	OVERALL COMP. LENGTH DIM "A"	TRACTOR YOKE	IMPLEMENT YOKE
PTO 14006251	ByPy 2	Pull (Towed)	51"	1 3/8" x 6 Spl. QD	1 3/8" Rd. w/Pinhole
PTO 14006432	ByPy 4	4 ft. Lift (3-pt Hitch)	32"	1 3/8" x 6 Spl. QD	1 3/8" Rd. w/Pinhole
PTO 14006436	ByPy 4	5 ft. Lift (3-pt Hitch)	36"	1 3/8" x 6 Spl. QD	1 3/8" Rd. w/Pinhole
PTO 14006442	ByPy 4	6 ft. Lift (3-pt Hitch)	42"	1 3/8" x 6 Spl. QD	1 3/8" Rd. w/Pinhole
PTO 14006451	ByPy 4	Pull (Towed)	51"	1 3/8" x 6 Spl. QD	1 3/8" Rd. w/Pinhole
PTO 14006542	ByPy 5	6 ft. Lift (3-pt Hitch)	42"	1 3/8" x 6 Spl. QD	1 3/8" Rd. w/Pinhole
PTO 14006546	ByPy 5	6 ft. Heavy Duty	46"	1 3/8" x 6 Spl. QD	1 3/8" x 6 Spl. QD
PTO 14006551	ByPy 5	6 ft. Lift (3-pt Hitch)	51"	1 3/8" x 6 Spl. QD	1 3/8" Rd.
PTO 14006652	ByPy 6	7 ft. Lift (3-pt Hitch)	52"	1 3/8" x 6 Spl. QD	1 3/8" Rd. w/Pinhole

**Rotary Cutter/Tiller**

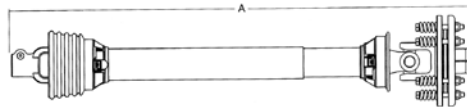

PART NO.	SERIES	TYPE	OVERALL COMP. LENGTH DIM "A"	TRACTOR YOKE	IMPLEMENT YOKE
PTO 14106438	ByPy 4	Pull (Towed)	38"	1 3/8" x 6 Spl. QD	1 3/8" x 6 Spl. w/Friction Clutch
PTO 14106546	ByPy 5	Pull (Towed)	46"	1 3/8" x 6 Spl. QD	1 3/8" x 6 Spl. w/Friction Clutch
PTO 14106654	ByPy 6	7 ft. Lift (3-pt Hitch)	54"	1 3/8" x 6 Spl. QD	1 3/8" x 6 Spl. w/Friction Clutch
PTO 14106233	ByPy 2	Pull (Towed)	33"	1 3/8" x 6 Spl. QD	1 3/8" x 6 Spl. w/Friction Clutch
PTO 14106436	ByPy 4	Pull (Towed)	36"	1 3/8" x 6 Spl. QD	1 3/8" x 6 Spl. w/Friction Clutch
PTO 14106660	ByPy 6	7 ft. Lift (3-pt Hitch)	60"	1 3/8" x 6 Spl. QD	1 3/4" x 20 Spl. w/Friction Clutch
PTO 14106661	ByPy 6	7 ft. Lift (3-pt Hitch)	61"	1 3/8" x 6 Spl. QD	1 3/4" x 20 Spl. w/Friction Clutch

**Hay Tedder**

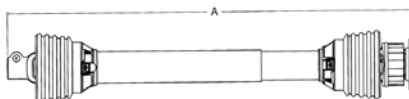

PART NO.	SERIES	TYPE	OVERALL COMP. LENGTH DIM "A"	TRACTOR YOKE	IMPLEMENT YOKE
PTO 14206252	ByPy 2*	2-Rotor	52"	1 3/8" x 6 Spl. QD	1 3/8" x 6 Spl. Radial Pin Clutch
PTO 14206454	ByPy 4**	4-Rotor	54"	1 3/8" x 6 Spl. QD	1 3/8" x 6 Spl. Radial Pin Clutch
PTO 14207939	W/S 2500	-	39"	1 3/4" x 20 Spl. QD	1 3/4" x 21 Spl. QD Radial Pin Clutch

**Disc Mower**

PART NO.	SERIES	OVERALL COMP. LENGTH DIM "A"	TRACTOR YOKE	IMPLEMENT YOKE
PTO 14306538	ByPy 5	38"	1 3/8" x 6 Spl. QD	1 3/8" x 6 Spl. QD w/Overrunning Clutch
PTO 14306639	ByPy 6	39"	1 3/8" x 6 Spl. QD	1 3/8" x 6 Spl. QD w/Overrunning Clutch
PTO 14307645	W/S 2400	45"	1 3/8" x 6 Spl. QD	1 3/8" x 6 Spl. QD w/Overrunning Clutch





## Q.D. REPAIR KIT

### METRIC DRIVELINES & COMPONENTS

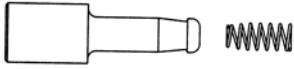

PART NO.	DESCRIPTION
PTO 13006121	Repair kit for 1 3/8" x 6 Spl. & 1 3/8" x 21 Spl. Bondioli & Pavesi Series 1, 2, 3, 4, 5, 6, 7N, 8 and 9

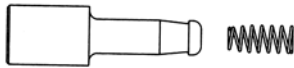

PART NO.	DESCRIPTION
PTO 13006720	Repair kit for 7N Series
PTO 13006721	1 3/4" x 20 Spl.



PART NO.	DESCRIPTION
PTO 13007120	Repair kit for 1 3/4" x 20 Spl. All Walterscheid Series Spring Internal to Yoke



PART NO.	DESCRIPTION
PTO 13007138	Repair kit for 1 3/8" x 6 Spl. & 1 3/8" x 21 Spl. All Walterscheid Series

## LOCKING DEVICE REPAIR KIT

### \*Auto-Lok/Safety Slide Lock



PART NO.	DESCRIPTION
PTO 13004000	Repair Kit for Weasler Auto-Lok and Safety Slide Lock 6 Spline & 21 Spline

*\*This repair kit contains both balls & pawls. When repairing the "Safety Slide Lock" use the pawls only and discard the balls. When repairing the "Auto-Lok" use both the balls and the pawls.*

**PARTS FOR FRICTION CLUTCHES**

CLUTCH PART NO.	DISC. DIA. (MM)	DISC PART NO.	QTY REQ.	SPRING PART NO.	QTY REQ.
PTO AK421075	140	PTO AB2004140	2	PTO AB20116	8
PTO AK622090	140	PTO AB2004140	2	PTO AB20117	8
PTO AK500090	140	PTO AB2004140	2	PTO AB20117	8
PTO AK723125	160	PTO AB2004160	2	PTO AB20117	8
PTO AK35125	160	PTO AB2004160	2	PTO AB20117	8
PTO AK7N200	160	PTO AB2004160	4	PTO AB20117	8
PTO AK824125	160	PTO AB2004160	2	PTO AB20117	8
PTO AK36200	160	PTO AB2004160	4	PTO AB20117	8
PTO AK13875	140	PTO AB2004140	2	PTO AB20116	8
PTO AK13890	140	PTO AB2004140	2	PTO AB20117	8
PTO AK138125	160	PTO AB2004160	2	PTO AB20117	8

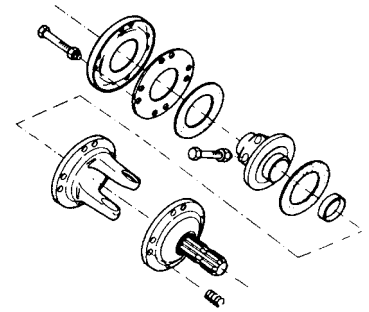

**FLANGE YOKES FOR FRICTION CLUTCHES**

Item #8 in diagram

PART NO.	SERIES	DESCRIPTION
PTO AB200814	AB4/AW21	8 holes
PTO AB200815	AB5	8 holes
PTO AB200816	AB6/AW22	8 holes

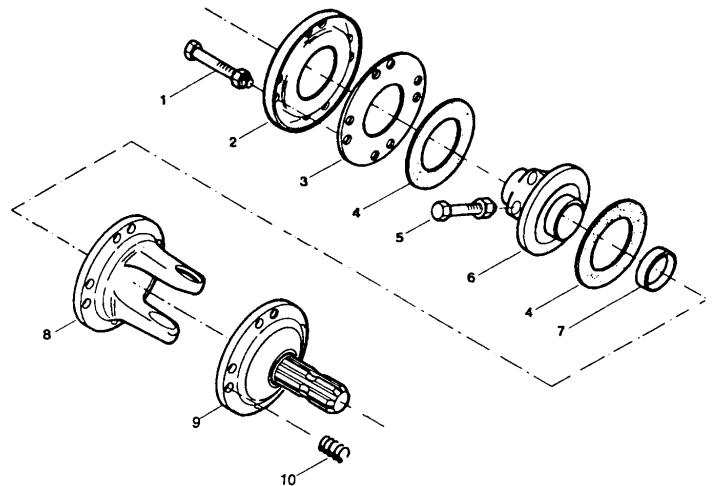

## SAFETY CONES

Replace that bent metal shield for complete safety!

PART NO.	L	D	D1	MACHINE SIZE (MM)
PTO AS22286	195	294	210	166
PTO AS1515190	150	208		150
PTO AS8209	150	257	200	
PTO AS3180L190	190	220		160

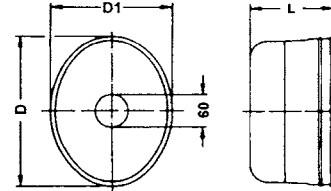

## COMPLETE DRIVE LINES

- Units are complete with 1 3/8" - 6 spline tractor QD yoke but do not include implement yoke.
- Shielding is included.
- Units are Waltersheld (lemon tube) style of profiles.

PART NO.	HP @ 540 RPM	FOR IMPLEMENT YOKES SEE PAGE #
PTO AW10121	16	68
PTO AB1051	16	-

\*This unit is 28" overall length collapsed and is complete with 1 3/8 - 6 spline yoke on both ends.  
Unit is well suited for fertilizer spreader.

## SPIRAL PINS

- Bulk - sold in quantities of 10
- See Section 4 for pricing.

PART NO.	A x B	PART NO.	A x B
HAR 2788	1/8" x 1"	HAR 2796	5/16" x 2 3/4"
HAR 2789	3/16" x 1"	HAR 2797	3/8" x 1 1/2"
HAR 2790	3/16" x 2"	HAR 2798	3/8" x 2"
HAR 2791	1/4" x 1"	HAR 2799	3/8" x 3"
HAR 2792	1/4" x 1 1/2"	HAR 2800	7/16" x 1 1/2"
HAR 2793	1/4" x 2"	HAR 2801	7/16" x 2"
HAR 2794	5/16" x 1 1/2"	HAR 2802	7/16" x 3"
HAR 2795	5/16" x 2"	HAR 2803	1/2" x 2"
		HAR 2804	1/2" x 3"

PART NO.
HAR 2805

Package contains:

10 of 1/8" x 1"	10 of 3/16" x 1"
10 of 3/16" x 2"	10 of 1/4" x 1"
10 of 1/4" x 1 1/2"	10 of 1/4" x 2"
9 of 5/16" x 1 1/2"	6 of 5/16" x 2"
5 of 5/16" x 2 3/4"	7 of 3/8" x 1 1/2"
5 of 3/8" x 2"	5 of 3/8" x 3"
5 of 7/16" x 1 1/2"	5 of 7/16" x 2"
5 of 7/16" x 3"	4 of 1/4" x 2"

## 80° C.V. ROUND BALER DRIVELINES

### Driveline Tractor Shaft Half Assembly



PART NO.	SERIES	TRACTOR YOKE	SHAFT HALF	FITS
PTO 19503506	35R	1 3/8" x 6 Spline	1 11/16" x 21 Spline	Gehl, John Deere, Case, Vermeer, Hesston and others

### C.V. Female Tractor Half

Produced 2005 - 2007 for John Deere Round Balers.

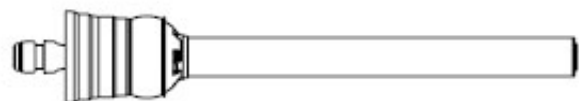

PART NO.	SERIES	TRACTOR YOKE	TUBE HALF
PTO 9214503559	35R	1 3/8" x 6 Spline	2 1/2" O.D.
PTO 9214603559	35R	1 3/8" x 21 Spline	2 1/2" O.D.

## 80° CONSTANT VELOCITY DRIVELINE

### CONSTANT VELOCITY

*With innovative and patented features exclusive to Weasler for North American-style Drivelines.*

#### Features

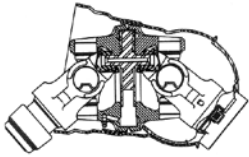

##### ARTICULATED GUARD SYSTEM

CV center housing accommodates a bell that fits within minimum ASAE tractor master shield. Bell is articulated to allow a full 80°. The plastic guard over the CV joint is supported by a bearing that rides on the center housing.

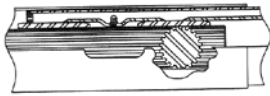

##### TELESCOPING DRIVELINE

The Weasler CV driveline utilizes shafts that telescope into a hardened sleeve with a large grease reservoir. Reduced friction means low thrust, for minimal wear throughout CV life. Tested in contaminated environments.

##### LONG LIFE

Compact, heavy duty center housing has a large capacity grease cavity and unique lubrication system. Patented grease system insures positive one shot lubrication of hardened and ground centering balls and sockets. Unique center slider support plates greatly increases life by retaining lubrication and sealing out contaminants. Full surface contact means reduced wear on all components, minimizing vibration.

##### HIGH TORSIONAL STRENGTH

The exclusive ball and socket of the Weasler CV is integral with the yoke. Trunnions on the center plate are supported directly in the yoke by the ball and socket, providing strength for heavy-duty applications. Forged yokes and center housing are engineered for high torque.

#### Benefits

Constant Velocity Drivelines allow turns at high angles under full power without damaging the driveline or other components. When using conventional drivelines, the vibrations increase as the angle increases. A CV driveline will substantially reduce vibrations due to its operating at a constant speed. The reduction in vibration will result in fewer breakdowns and lower cost of implement maintenance.

#### Applications

Listed are some applications of 80° CV drivelines that Weasler currently produces for Original Equipment Manufacturers.

Round Balers  
Square Balers  
Orchard Sprayers  
Flexwing Mowers  
Manure Pumps  
Beet Toppers

Rock Pickers  
Stalk Choppers  
Box-type Manure Spreaders  
Tank-type Manure Spreaders  
Mower Conditioners  
Peanut Harvesters

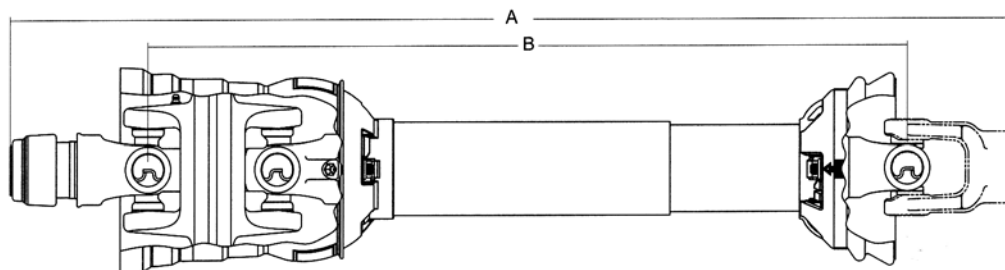
**80° CONSTANT VELOCITY DRIVELINE****CONSTANT  
VELOCITY**

A = Overall Length

B = Centerline Length

**Constant Velocity Driveline Replacement Chart**

ASAE CATEGORY	WEASLER SERIES	REPLACEMENT FOR
3	14	Bondioli & Pavesi 4 Series Walterscheid 2380 Series
4	35	Bondioli & Pavesi 5 Series
5	35/44	Bondioli & Pavesi 6 Series Walterscheid 2480 Series
6	55	Bondioli & Pavesi 8 Series Walterscheid 2580 Series & 2680 Series

The above chart lists the approximate size replacement for Constant Velocity Drivelines. These are not an exact interchange, and should be used as a general replacement guide only.

*NOTE: 35/44 refers to CV Series. When CV is assembled with 44 Series tube end driveline becomes a 44 Series. When CV is assembled with a 35 Series tube end driveline is a 35 Series.*

**Instructions for Ordering a CV Driveline**

To determine the series of a Weasler driveline, reference the dimension of the Cross & Bearing as illustrated on page 5. To determine the series as a replacement for a competitive driveline, reference the above chart.

Determine the overall length of the driveline in a closed position (DIM "A") in the illustration. Next, select the part number which closely corresponds with the appropriate series and length.

- Some drivelines are furnished without Cross & Bearing Kit and Implement Yoke. For implement yoke selection, refer to the appropriate Weasler Aftermarket Driveline Component section.
- **GUARDS MUST ROTATE FREELY ON YOKES.**

# NORTH AMERICAN SECTION

## 80° CV CATEGORY 3/14 SERIES

### NORTH AMERICAN CONSTANT VELOCITY

#### Tractor Yoke

**Safety Slide Lock**  
Repair Kit - Page 49

PART NO.	DIM "A" BORE
PTO 1071406	1 3/8" x 6 Spl.
PTO 1071420	1 3/4" x 20 Spl.
PTO 1071421	1 3/8" x 21 Spl.

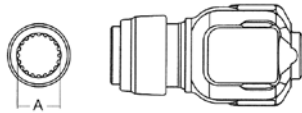

#### Center Housing

PART NO.
PTO 5501430

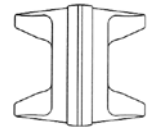

#### Spring-Lok

Repair Kit - Page 49

PART NO.	DIM "A" BORE
PTO 1081406	1 3/8" x 6 Spl.
PTO 1081421	1 3/8" x 21 Spl.

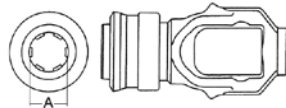

#### Yoke & Shaft

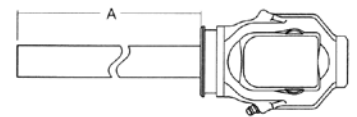

PART NO.	SHAFT SIZE	DIM "A" SHAFT LENGTH
PTO 10101400	1" x 1 1/8" Rect.	27 1/4"

#### Auto-Lok

Repair Kit - Page 49

PART NO.	DIM "A" BORE
PTO 1111406	1 3/8" x 6 Spl.
PTO 1111420	1 3/4" x 20 Spl.
PTO 1111421	1 3/8" x 21 Spl.

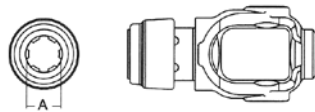

#### Yoke, Tube & Sleeve Assembly

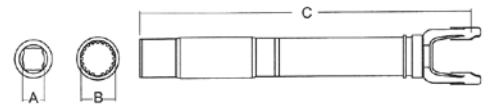

PART NO.	DIM "A" BORE	DIM "B" BORE	OVERALL DRIVELINE LENGTH	DIM "C" CL TO END OF SLEEVE
PTO 11101448	1" x 1 1/8" Rect.	N/A	48"	31.62"
PTO 11101458	1" x 1 1/8" Rect.	N/A	58"	41.62"
PTO 11101467	1" x 1 1/8" Rect.	N/A	67"	50.62"

#### Cross & Bearing Kit (R-Kit)

PART NO.	DIM "A"	DIM "B"	DIM "C"	DIM "D"
PTO 2001430	1 1/8"	2 5/8"	4 1/4"	1 1/8"

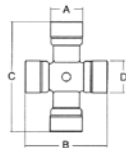

#### Extended Lubrication Cross & Bearing Kit (E-Kit)

PART NO.	DIM "A"	DIM "B"	DIM "C"	DIM "D"
PTO 2011430	1 1/8"	2 5/8"	4 1/4"	1 1/8"

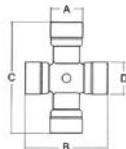

#### Yoke, Tube & Sleeve Assembly w/Guard

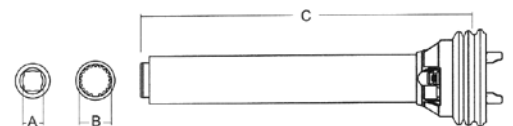

PART NO.	DIM "A" BORE	DIM "B" BORE	OVERALL DRIVELINE LENGTH	DIM "C" CL TO END OF SLEEVE
PTO 17501448	1" x 1 1/8" Rect.	N/A	48"	31.62"
PTO 17501458	1" x 1 1/8" Rect.	N/A	58"	41.62"
PTO 17501467	1" x 1 1/8" Rect.	N/A	67"	50.62"

#### Shaft

1" x 1 1/8" Rectangular



PART NO.	LENGTH
PTO 4001618	6'
PTO 4011618	10'
PTO 4041618	3'

## 80° CV CATEGORY 3/14 SERIES

NORTH AMERICAN  
CONSTANT VELOCITY

## Joint &amp; Shaft

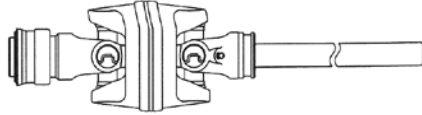

PART NO.	SHAFT SIZE	SHAFT LENGTH	TRACTOR YOKE
PTO 15501406	1" x 1 1/8" Rect.	27 1/4"	1 3/8" x 6 Spl.
PTO 15601421	1" x 1 1/8" Rect.	27 1/4"	1 3/8" x 21 Spl.

## Joint &amp; Shaft w/Guard

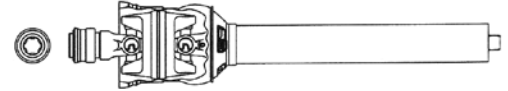

PART NO.	SHAFT SIZE	SHAFT LENGTH	TRACTOR YOKE
PTO 19501406	1" x 1 1/8" Rect.	27 1/4"	1 3/8" x 6 Spl.
PTO 19601421	1" x 1 1/8" Rect.	27 1/4"	1 3/8" x 21 Spl.

## Guard

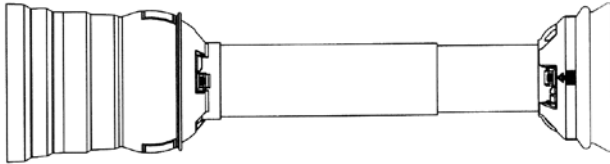

Assembly instructions included with guard.

Note: When installing Guards observe the following:

- 1) Install proper nylon bearing (See Page 10)
- 2) Guards must rotate freely on yokes.

PART NO.	OVERALL DRIVELINE LENGTH	BEARING KIT (2 PER KIT)
PTO 9121448	48"	PTO 9211400
PTO 9121458	58"	PTO 9211400
PTO 9121467	67"	PTO 9211400

## Easy Lock™ Replacement Kit

PART NO.

PTO 13005000 (4 per kit)



## Drivelines

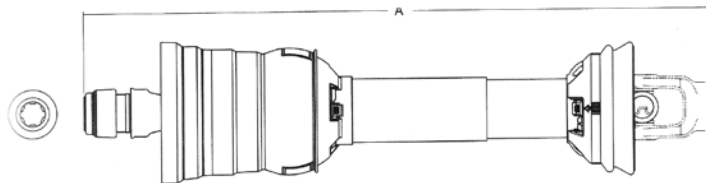

PART NO.	SHAFT SIZE	DIM "A" OVERALL COMPRESSED LENGTH	MAXIMUM OVERALL EXTENDED OPERATING LENGTH	TRACTOR YOKE
PTO 14501448	1" x 1 1/8"	48"	67"	1 3/8" x 6 Spl.
PTO 14601448	1" x 1 1/8"	48"	67"	1 3/8" x 21 Spl.
PTO 14501458	1" x 1 1/8"	58"	77"	1 3/8" x 6 Spl.
PTO 14601458	1" x 1 1/8"	58"	77"	1 3/8" x 21 Spl.
PTO 14501467	1" x 1 1/8"	67"	86"	1 3/8" x 6 Spl.
PTO 14601467	1" x 1 1/8"	67"	86"	1 3/8" x 21 Spl.

(Order implement yoke and cross & bearing kit separately as required.)

### 80° CV CATEGORY 4/35 SERIES

### NORTH AMERICAN CONSTANT VELOCITY

#### Tractor Yoke

**Safety Slide Lock**  
Repair Kit - Page 49

PART NO.	DIM "A" BORE
PTO 1123506	1 3/8" x 6 Spl.
PTO 1123520	1 3/4" x 20 Spl.
PTO 1123521	1 3/8" x 21 Spl.

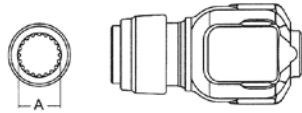

**Auto-Lok**  
Repair Kit - Page 49

PART NO.	DIM "A" BORE
PTO 1133506	1 3/8" x 6 Spl.
PTO 1133520	1 3/4" x 20 Spl.
PTO 1133521	1 3/8" x 21 Spl.

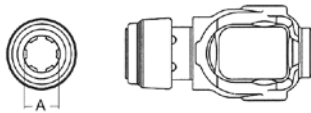

#### Cross & Bearing Kit (R-Kit)

PART NO.	DIM "A"	DIM "B"	DIM "C"	DIM "D"
PTO 2003540	1 1/8"	3 7/32"	4 1/4"	1 1/4"

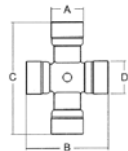

#### Extended Lubrication Cross & Bearing Kit (E-Kit)

PART NO.	DIM "A"	DIM "B"	DIM "C"	DIM "D"
PTO 2013540	1 1/8"	3 7/32"	4 1/4"	1 1/4"

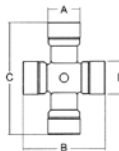

#### Shaft

**1 5/16" x 20 Spline**  
Induction Hardened



PART NO.	LENGTH
PTO 4042120	3'

#### Center Housing

PART NO.
PTO 5503540

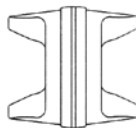

#### Yoke & Shaft

PART NO.	SHAFT SIZE	DIM "A" SHAFT LENGTH
PTO 10103501	1 5/16" x 20 Spl.	27"

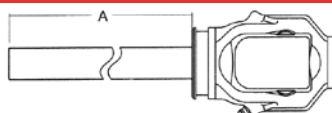

#### Yoke, Tube & Sleeve Assembly

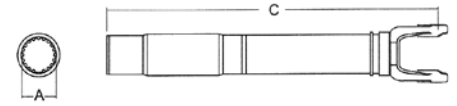

PART NO.	DIM "A" BORE	OVERALL DRIVELINE LENGTH	DIM "C" CL* TO END OF SLEEVE
PTO 11113548	1 5/16" x 20 Spl.	48"	29.25"
PTO 11113558	1 5/16" x 20 Spl.	58"	39.38"
PTO 11113567	1 5/16" x 20 Spl.	67"	48.25"

\*CL=Centerline

#### Yoke, Tube & Sleeve Assembly w/Guard

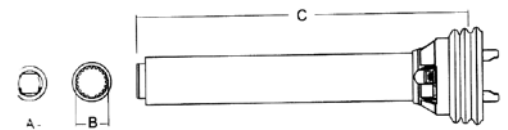

PART NO.	DIM "A" BORE	DIM "B" BORE	OVERALL DRIVELINE LENGTH	DIM "C" CL* TO END OF SLEEVE
PTO 17513548	N/A	1 5/16" x 20 Spl.	48"	29.25"
PTO 17513558	N/A	1 5/16" x 20 Spl.	58"	39.37"
PTO 17513567	N/A	1 5/16" x 20 Spl.	67"	48.25"
PTO 17513573	N/A	1 5/16" x 20 Spl.	73"	54.37"
PTO 17513579	N/A	1 5/16" x 20 Spl.	79"	58.25"

\*CL=Centerline

#### Joint & Shaft

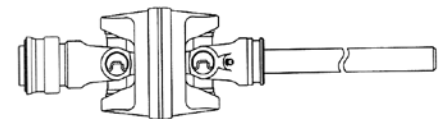

PART NO.	SHAFT SIZE	SHAFT LENGTH	TRACTOR YOKE
PTO 15503540	1 5/16" x 20 Spl.	27"	1 3/8" x 6 Spl.
PTO 15603540	1 5/16" x 20 Spl.	27"	1 3/8" x 21 Spl.
PTO 15703540	1 5/16" x 20 Spl.	27"	1 3/4" x 20 Spl.

#### Joint & Shaft w/Guard

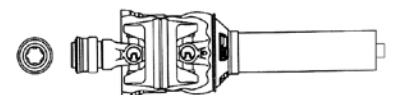

PART NO.	SHAFT SIZE	SHAFT LENGTH	TRACTOR YOKE
PTO 19503540	1 5/16" x 20 Spl.	27"	1 3/8" x 6 Spl.
PTO 19603540	1 5/16" x 20 Spl.	27"	1 3/8" x 21 Spl.
PTO 19703540	1 5/16" x 20 Spl.	27"	1 3/4" x 20 Spl.



## 80° CV CATEGORY 4/35 SERIES

NORTH AMERICAN  
CONSTANT VELOCITY

## Guard

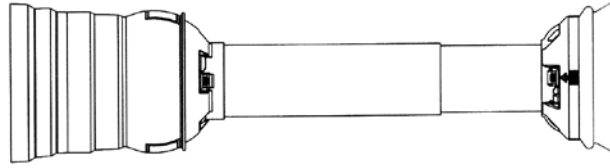

PART NO.	OVERALL DRIVELINE LENGTH	BEARING SET
PTO 9121448	48"	PTO 9211400
PTO 9121458	58"	PTO 9211400
PTO 9121467	67"	PTO 9211400

Assembly instructions included with guard.

NOTE: When installing Guards observe the following:

- 1) Install proper nylon bearing (See page 10).
- 2) Guards must rotate freely on yokes.

## Easy Lock™ Replacement Kit

PART NO.

PTO 13005000 (4 per kit)



## Drivelines

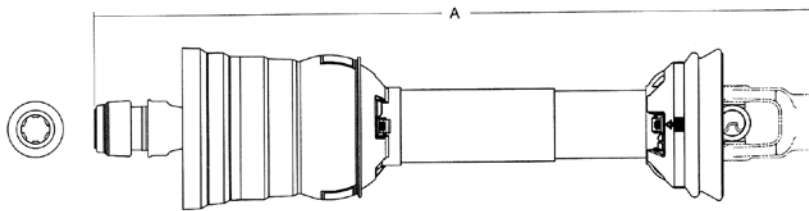

PART NO.	SHAFT SIZE	DIM "A" OVERALL COMPRESSED LENGTH	EXTENDED OPERATING LENGTH	TRACTOR YOKE
PTO 14513548*	1 5/16" x 20 Spl.	48"	67"	1 3/8" x 6 Spl.
PTO 14613548*	1 5/16" x 20 Spl.	48"	67"	1 3/8" x 21 Spl.
PTO 14713548*	1 5/16" x 20 Spl.	48"	67"	1 3/4" x 20 Spl.
PTO 14513558*	1 5/16" x 20 Spl.	58"	77"	1 3/8" x 6 Spl.
PTO 14613558*	1 5/16" x 20 Spl.	58"	77"	1 3/8" x 21 Spl.
PTO 14713558*	1 5/16" x 20 Spl.	58"	77"	1 3/4" x 20 Spl.
PTO 14513567*	1 5/16" x 20 Spl.	67"	84"	1 3/8" x 6 Spl.
PTO 14613567*	1 5/16" x 20 Spl.	67"	84"	1 3/8" x 21 Spl.
PTO 14713567*	1 5/16" x 20 Spl.	67"	84"	1 3/4" x 20 Spl.
PTO 14513573*	1 5/16" x 20 Spl.	73"	92"	1 3/8" x 6 Spl.
PTO 14613573*	1 5/16" x 20 Spl.	73"	92"	1 3/8" x 21 Spl.
PTO 14713573*	1 5/16" x 20 Spl.	73"	92"	1 3/4" x 20 Spl.

\*(Order implement yoke and cross & bearing kit separately as required.)

### 80° CV CATEGORY 5/35/44 SERIES

### NORTH AMERICAN CONSTANT VELOCITY

#### Tractor Yoke

Safety Slide Lock  
Repair Kit - Page 49

PART NO.	DIM "A" BORE
PTO 1073506	1 3/8" x 6 Spl.
PTO 1073520	1 3/4" x 20 Spl.
PTO 1073521	1 3/8" x 21 Spl.

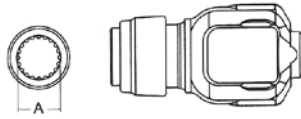

#### Auto-Lok

Repair Kit - Page 49

PART NO.	DIM "A" BORE
PTO 1113506	1 3/8" x 6 Spl.
PTO 1113520	1 3/4" x 20 Spl.
PTO 1113521	1 3/8" x 21 Spl.

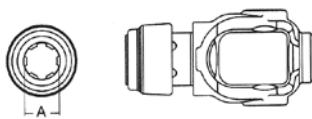

#### Cross & Bearing Kit (R-Kit)

PART NO.	DIM "A"	DIM "B"	DIM "C"	DIM "D"
PTO 2003545	1 1/4"	3 7/32"	4 5/16"	1 1/4"

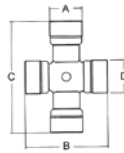

#### Extended Lubrication Cross & Bearing Kit (E-Kit)

PART NO.	DIM "A"	DIM "B"	DIM "C"	DIM "D"
PTO 2013545	1 1/4"	3 7/32"	4 5/16"	1 1/4"

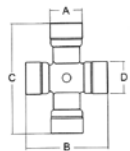

#### Shaft

1 11/16" x 20 Spline  
Induction Hardened



PART NO.	LENGTH
PTO 4042720	3'

#### Center Housing

PART NO.
PTO 5503545

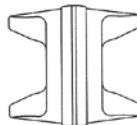

#### Yoke & Shaft

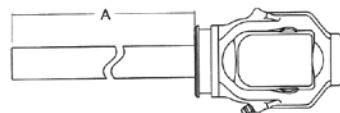

PART NO.	SHAFT SIZE	DIM "A" SHAFT LENGTH
PTO 10103500	1 11/16" x 20 Spl.	27"

#### Yoke, Tube & Sleeve Assembly

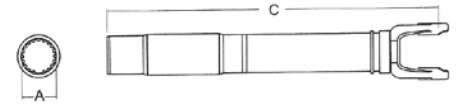

PART NO.	DIM "A" BORE	OVERALL DRIVELINE LENGTH	DIM "B" CL* TO END OF SLEEVE
PTO 11103548	1 11/16" x 20 Spl.	48"	29.25"
PTO 11103558	1 11/16" x 20 Spl.	58"	39.38"
PTO 11103567	1 11/16" x 20 Spl.	67"	48.25"
PTO 11103573	1 11/16" x 20 Spl.	73"	54.38"
PTO 11103579	1 11/16" x 20 Spl.	79"	58.25"
PTO 11104448	1 11/16" x 20 Spl.	48"	29.88"
PTO 11104458	1 11/16" x 20 Spl.	58"	38.88"
PTO 11104467	1 11/16" x 20 Spl.	67"	47.88"
PTO 11104473	1 11/16" x 20 Spl.	73"	53.88"
PTO 11104479	1 11/16" x 20 Spl.	79"	59.88"

\*CL=Centerline

#### Yoke, Tube & Sleeve Assembly w/Guard

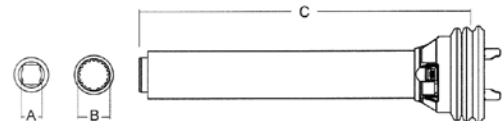

PART NO.	DIM "A" BORE	DIM "B" BORE	OVERALL DRIVELINE LENGTH	DIM "C" CL* TO END OF SLEEVE
PTO 17503548	N/A	1 11/16" x 20 Spl.	48"	29.25"
PTO 17503558	N/A	1 11/16" x 20 Spl.	58"	39.37"
PTO 17503567	N/A	1 11/16" x 20 Spl.	67"	48.25"
PTO 17503573	N/A	1 11/16" x 20 Spl.	73"	54.37"
PTO 17503579	N/A	1 11/16" x 20 Spl.	79"	58.25"
PTO 17503548	N/A	1 11/16" x 20 Spl.	48"	28.87"
PTO 17504458	N/A	1 11/16" x 20 Spl.	58"	38.87"
PTO 17504467	N/A	1 11/16" x 20 Spl.	67"	47.87"
PTO 17504473	N/A	1 11/16" x 20 Spl.	73"	53.87"
PTO 17504479	N/A	1 11/16" x 20 Spl.	79"	59.87"

\*CL=Centerline

#### Joint & Shaft

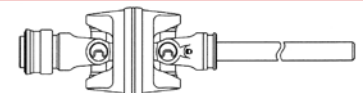

PART NO.	SHAFT SIZE	SHAFT LENGTH	TRACTOR YOKE
PTO 15503506	1 11/16" x 20 Spl.	27"	1 3/8" x 6 Spl.
PTO 15603521	1 11/16" x 20 Spl.	27"	1 3/8" x 21 Spl.
PTO 15703520	1 11/16" x 20 Spl.	27"	1 3/4" x 20 Spl.

**80° CV CATEGORY 5/35/44 SERIES**

**NORTH AMERICAN  
CONSTANT VELOCITY**

**Joint & Shaft w/Guard**

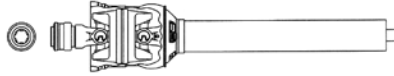

PART NO.	SHAFT SIZE	SHAFT LENGTH	TRACTOR YOKE
PTO 19503506	1 11/16" x 20 Spl.	27 1/4"	1 3/8" x 6 Spl.
PTO 19603521	1 11/16" x 20 Spl.	27 1/4"	1 3/8" x 21 Spl.
PTO 19703520	1 11/16" x 20 Spl.	27 1/4"	1 3/4" x 20 Spl.

**Easy Lock™ Replacement Kit**

PART NO.

PTO 13005000 (4 per kit)



**Guard**

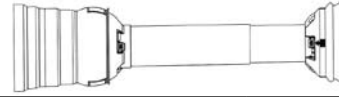

PART NO.	OVERALL DRIVELINE LENGTH	BEARING SET (2 PER KIT)
PTO 9123548	48"	PTO 9213500
PTO 9123558	58"	PTO 9213500
PTO 9123567	67"	PTO 9213500
PTO 9123573	73"	PTO 9213500
PTO 9123579	79"	PTO 9213500

Assembly instructions included with guard.

NOTE: When installing Guards observe the following:

- 1) Install proper nylon bearing (See page 10).
- 2) Guards must rotate freely on yokes.

**Drivelines**

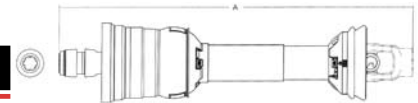

PART NO.	SHAFT SIZE	DIM "A" OVERALL COMPRESSED LENGTH	MAX. OVERALL EXTENDED OPERATING LENGTH	TRACTOR YOKE	IMPLEMENT YOKE
PTO 14503500	1 11/16" x 20 Spl.	58"	79"	1 3/8" x 6 Spl.	1 3/8" x 6 Spl. w/Friction Clutch
PTO 14503501	1 11/16" x 20 Spl.	67"	88"	1 3/8" x 6 Spl.	1 3/8" x 21 Spl. w/Friction Clutch
PTO 14603500	1 11/16" x 20 Spl.	58"	79"	1 3/8" x 21 Spl.	1 3/8" x 6 Spl. w/Friction Clutch
PTO 14503502	1 11/16" x 20 Spl.	58"	79"	1 3/8" x 20 Spl.	1 3/8" x 6 Spl. w/Friction Clutch
PTO 14503548	1 11/16" x 20 Spl.	48"	67"	1 3/8" x 6 Spl.	N/A*
PTO 14603548	1 11/16" x 20 Spl.	48"	67"	1 3/8" x 21 Spl.	N/A*
PTO 14703548	1 11/16" x 20 Spl.	48"	67"	1 3/4" x 20 Spl.	N/A*
PTO 14503558	1 11/16" x 20 Spl.	58"	77"	1 3/8" x 6 Spl.	N/A*
PTO 14603558	1 11/16" x 20 Spl.	58"	77"	1 3/8" x 21 Spl.	N/A*
PTO 14703558	1 11/16" x 20 Spl.	58"	77"	1 3/4" x 20 Spl.	N/A*
PTO 14503567	1 11/16" x 20 Spl.	67"	84"	1 3/8" x 6 Spl.	N/A*
PTO 14603567	1 11/16" x 20 Spl.	67"	84"	1 3/8" x 21 Spl.	N/A*
PTO 14703567	1 11/16" x 20 Spl.	67"	84"	1 3/4" x 20 Spl.	N/A*
PTO 14503573	1 11/16" x 20 Spl.	73"	92"	1 3/8" x 6 Spl.	N/A*
PTO 14603573	1 11/16" x 20 Spl.	73"	92"	1 3/8" x 21 Spl.	N/A*
PTO 14703573	1 11/16" x 20 Spl.	73"	92"	1 3/4" x 20 Spl.	N/A*
PTO 14503579	1 11/16" x 20 Spl.	79"	96"	1 3/8" x 6 Spl.	N/A*
PTO 14603579	1 11/16" x 20 Spl.	79"	96"	1 3/8" x 21 Spl.	N/A*
PTO 14703579	1 11/16" x 20 Spl.	79"	96"	1 3/4" x 20 Spl.	N/A*
PTO 14504448	1 11/16" x 20 Spl.	48"	67"	1 3/8" x 6 Spl.	N/A*
PTO 14604448	1 11/16" x 20 Spl.	48"	67"	1 3/8" x 21 Spl.	N/A*
PTO 14704448	1 11/16" x 20 Spl.	48"	67"	1 3/4" x 20 Spl.	N/A*
PTO 14504458	1 11/16" x 20 Spl.	58"	77"	1 3/8" x 6 Spl.	N/A*
PTO 14604458	1 11/16" x 20 Spl.	58"	77"	1 3/8" x 21 Spl.	N/A*
PTO 14704458	1 11/16" x 20 Spl.	58"	77"	1 3/4" x 20 Spl.	N/A*
PTO 14504467	1 11/16" x 20 Spl.	67"	84"	1 3/8" x 6 Spl.	N/A*
PTO 14604467	1 11/16" x 20 Spl.	67"	84"	1 3/8" x 21 Spl.	N/A*
PTO 14704467	1 11/16" x 20 Spl.	67"	84"	1 3/4" x 20 Spl.	N/A*
PTO 14504473	1 11/16" x 20 Spl.	73"	92"	1 3/8" x 6 Spl.	N/A*
PTO 14604473	1 11/16" x 20 Spl.	73"	92"	1 3/8" x 21 Spl.	N/A*
PTO 14704473	1 11/16" x 20 Spl.	73"	92"	1 3/4" x 20 Spl.	N/A*
PTO 14504479	1 11/16" x 20 Spl.	79"	96"	1 3/8" x 6 Spl.	N/A*
PTO 14604479	1 11/16" x 20 Spl.	79"	96"	1 3/8" x 21 Spl.	N/A*
PTO 14704479	1 11/16" x 20 Spl.	79"	96"	1 3/4" x 20 Spl.	N/A*

\*(Order implement yoke and cross & bearing kit separately as required.)

### 80° CV CATEGORY 6/55 SERIES

### NORTH AMERICAN CONSTANT VELOCITY

#### Tractor Yoke

Safety Slide Lock  
Repair Kit - Page 49

PART NO.	DIM "A" BORE
PTO 1075506	1 3/8" x 6 Spl.
PTO 1075520	1 3/4" x 20 Spl.
PTO 1075521	1 3/8" x 21 Spl.

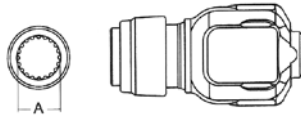

#### Auto-Lok

Repair Kit - Page 49

PART NO.	DIM "A" BORE
PTO 1115506	1 3/8" x 6 Spl.
PTO 1115520	1 3/4" x 20 Spl.
PTO 1115521	1 3/8" x 21 Spl.

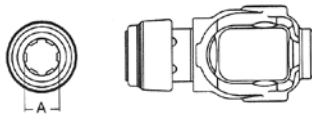

#### Cross & Bearing Kit (R-Kit)

PART NO.	DIM "A"	DIM "B"	DIM "C"	DIM "D"
PTO 2005556	1 5/16"	3 23/32"	4 5/16"	1 17/32"

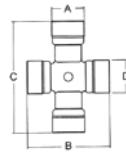

#### Extended Lubrication Cross & Bearing Kit (E-Kit)

PART NO.	DIM "A"	DIM "B"	DIM "C"	DIM "D"
PTO 2015556	1 5/16"	3 23/32"	4 5/16"	1 17/32"

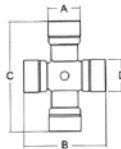

#### Shaft

1 11/16" x 20 Spline  
Induction Hardened



PART NO.	LENGTH
PTO 4042720	3'

#### Center Housing

PART NO.
PTO 5505556

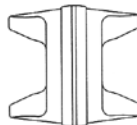

#### Yoke & Shaft

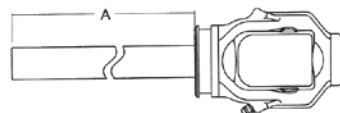

PART NO.	SHAFT SIZE	DIM "A" SHAFT LENGTH
PTO 10105500	1 11/16" x 20 Spl.	27"

#### Yoke, Tube & Sleeve Assembly

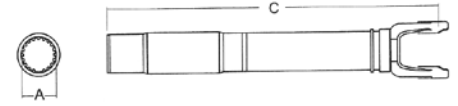

PART NO.	DIM "A" BORE	OVERALL DRIVELINE LENGTH	DIM "C" CL* TO END OF SLEEVE
PTO 11105548	1 11/16" x 20 Spl.	48"	28.88"
PTO 11105558	1 11/16" x 20 Spl.	58"	38.88"
PTO 11105567	1 11/16" x 20 Spl.	67"	47.88"
PTO 11105573	1 11/16" x 20 Spl.	73"	53.88"
PTO 11105579	1 11/16" x 20 Spl.	79"	59.88"

\*CL=Centerline

#### Yoke, Tube & Sleeve Assembly w/Guard

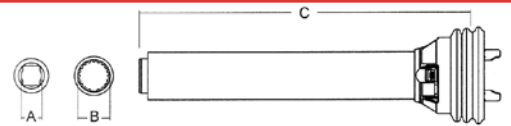

PART NO.	DIM "A" BORE	DIM "B" BORE	OVERALL DRIVELINE LENGTH	DIM "C" CL* TO END OF SLEEVE	IMPLEMENT YOKE
PTO 17505548	N/A	1 11/16" x 20 Spl.	48"	29.25"	-
PTO 17505558	N/A	1 11/16" x 20 Spl.	58"	39.37"	-
PTO 17505567	N/A	1 11/16" x 20 Spl.	67"	48.25"	-
PTO 17505573	N/A	1 11/16" x 20 Spl.	73"	54.37"	-
PTO 17505579	N/A	1 11/16" x 20 Spl.	79"	58.25"	-
PTO 9214505551	N/A	1 11/16" x 20 Spl.	51"	28.87"	1 3/4" x 20 Spl.
PTO 9214505555	N/A	1 11/16" x 20 Spl.	55"	38.87"	1 3/8" x 6 Spl.
PTO 9214515555	N/A	1 11/16" x 20 Spl.	55"	47.87"	1 3/4" x 20 Spl.

\*CL=Centerline

#### Joint & Shaft w/Guard

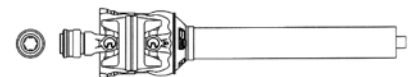

PART NO.	SHAFT SIZE	SHAFT LENGTH	TRACTOR YOKE
PTO 19505506	1 11/16" x 20 Spl.	27 1/4"	1 3/8" x 6 Spl.
PTO 19605521	1 11/16" x 20 Spl.	27 1/4"	1 3/8" x 21 Spl.
PTO 19705520	1 11/16" x 20 Spl.	27 1/4"	1 3/4" x 20 Spl.
PTO 9314505555	1 11/16" x 20 Spl.	27 1/4"	1 3/8" x 6 Spl.
PTO 9314605555	1 11/16" x 20 Spl.	27 1/4"	1 3/8" x 21 Spl.
PTO 9314705555	1 11/16" x 20 Spl.	27 1/4"	1 3/4" x 20 Spl.

## 80° CV CATEGORY 6/55 SERIES

NORTH AMERICAN  
CONSTANT VELOCITY

## Joint &amp; Shaft

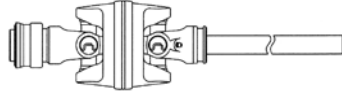

PART NO.	SHAFT SIZE	SHAFT LENGTH	TRACTOR YOKE
PTO 15505506	1 11/16" x 20 Spl.	27"	1 3/8" x 6 Spl.
PTO 15605521	1 11/16" x 20 Spl.	27"	1 3/8" x 21 Spl.
PTO 15705520	1 11/16" x 20 Spl.	27"	1 3/4" x 20 Spl.

## Easy Lock™ Replacement Kit

PART NO.

PTO 13005000 (4 per kit)



## Guard

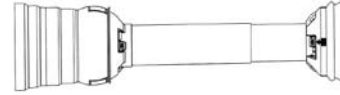

PART NO.	OVERALL DRIVELINE LENGTH	BEARING SET (2 PER KIT)
PTO 9125548	48"	PTO 9215500
PTO 9125558	58"	PTO 9215500
PTO 9125567	67"	PTO 9215500
PTO 9125573	73"	PTO 9215500
PTO 9125579	79"	PTO 9215500

Assembly instructions included with guard.

NOTE: When installing Guards observe the following:

- 1) Install proper nylon bearing (See page 10).
- 2) Guards must rotate freely on yokes.

## Drivelines

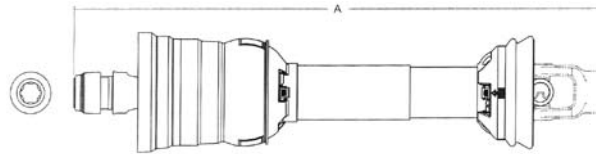

PART NO.	SHAFT SIZE	DIM "A" OVERALL COMPRESSED LENGTH	EXTENDED OPERATING LENGTH	TRACTOR YOKE	IMPLEMENT YOKE
PTO 14505548	1 11/16" x 20 Spl.	48"	67"	1 3/8" x 6 Spl.	*
PTO 14505551	1 11/16" x 20 Spl.	51"	68"	1 3/8" x 6 Spl.	1 3/4" x 20 Spl. w/Clamp
PTO 14505555	1 11/16" x 20 Spl.	55"	77"	1 3/8" x 6 Spl.	1 3/8" x 6 Spl. w/Clamp
PTO 14505558	1 11/16" x 20 Spl.	58"	80"	1 3/8" x 6 Spl.	*
PTO 14505567	1 11/16" x 20 Spl.	67"	84"	1 3/8" x 6 Spl.	*
PTO 14505573	1 11/16" x 20 Spl.	73"	92"	1 3/8" x 6 Spl.	*
PTO 14505579	1 11/16" x 20 Spl.	79"	96"	1 3/8" x 6 Spl.	*
PTO 14515555	1 11/16" x 20 Spl.	55"	77"	1 3/8" x 6 Spl.	1 3/4" x 20 Spl. w/Clamp
PTO 14605548	1 11/16" x 20 Spl.	48"	67"	1 3/8" x 21 Spl.	*
PTO 14605551	1 11/16" x 20 Spl.	51"	68"	1 3/8" x 21 Spl.	1 3/4" x 20 Spl. w/Clamp
PTO 14605555	1 11/16" x 20 Spl.	55"	77"	1 3/8" x 21 Spl.	1 3/8" x 6 Spl. w/Clamp
PTO 14605558	1 11/16" x 20 Spl.	58"	80"	1 3/8" x 21 Spl.	*
PTO 14605567	1 11/16" x 20 Spl.	67"	84"	1 3/8" x 21 Spl.	*
PTO 14605573	1 11/16" x 20 Spl.	73"	92"	1 3/8" x 21 Spl.	*
PTO 14605579	1 11/16" x 20 Spl.	79"	96"	1 3/8" x 21 Spl.	*
PTO 14615555	1 11/16" x 20 Spl.	55"	77"	1 3/8" x 21 Spl.	1 3/4" x 20 Spl. w/Clamp
PTO 14625555	1 11/16" x 20 Spl.	55"	77"	1 3/8" x 21 Spl.	1 3/8" x 21 Spl. w/Clamp
PTO 14635555	1 11/16" x 20 Spl.	55"	77"	1 3/8" x 21 Spl.	1 3/8" x 21 Spl. w/Pinhole
PTO 14705548	1 11/16" x 20 Spl.	48"	67"	1 3/4" x 20 Spl.	*
PTO 14705551	1 11/16" x 20 Spl.	51"	68"	1 3/4" x 20 Spl.	1 3/4" x 20 Spl. w/Clamp
PTO 14705555	1 11/16" x 20 Spl.	55"	77"	1 3/4" x 20 Spl.	1 3/8" x 6 Spl. w/Clamp
PTO 14705558	1 11/16" x 20 Spl.	58"	80"	1 3/4" x 20 Spl.	*
PTO 14705567	1 11/16" x 20 Spl.	67"	84"	1 3/4" x 20 Spl.	*
PTO 14705573	1 11/16" x 20 Spl.	73"	92"	1 3/4" x 20 Spl.	*
PTO 14705579	1 11/16" x 20 Spl.	79"	96"	1 3/4" x 20 Spl.	*
PTO 14715555	1 11/16" x 20 Spl.	55"	77"	1 3/4" x 20 Spl.	1 3/4" x 20 Spl. w/Clamp
PTO 14725555	1 11/16" x 20 Spl.	55"	77"	1 3/4" x 20 Spl.	1 3/8" x 21 Spl. w/Clamp
PTO 14735555	1 11/16" x 20 Spl.	55"	77"	1 3/4" x 20 Spl.	1 3/8" x 21 Spl. w/Pinhole

\*(Order implement yoke and cross &amp; bearing kit separately as required.)

**NORTH AMERICAN  
CONSTANT VELOCITY**

**50° CV DRIVELINE COMPONENTS**

**Tractor Yoke**

Repair Kit - Page 49

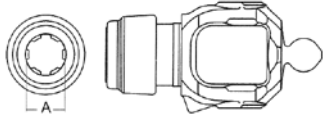

PART NO.	SERIES	DIM "A" BORE
PTO 1501406	14	1 3/8" x 6 Spl.
PTO 1501421	14	1 3/8" x 21 Spl.
PTO 1513506	35	1 3/8" x 6 Spl.
PTO 1513521	35	1 3/8" x 21 Spl.

**Shaft Weld Yoke**

(Guard must rotate freely on the yoke.)

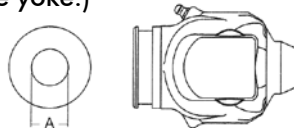

PART NO.	SERIES	DIM "A" BORE
PTO 3501400	14	1" Rd.

**Center Housing**

PART NO.	SERIES
PTO 5551400	14
PTO 5553500	35

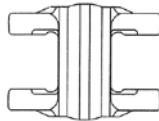

**Tube Yoke**

(Guard must rotate freely on the yoke.)

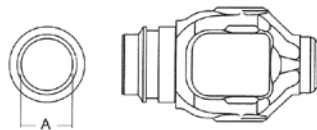

PART NO.	SERIES	DIM "A" BORE
PTO 7503500	35	1 5/8"

**Implement Yoke**

Round Bore  
With Keyway & Pinhole

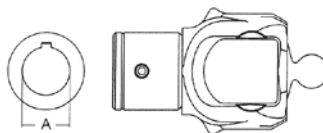

PART NO.	SERIES	DIM "A" BORE
PTO 8501420	14 (w/ 1/4" keyway & 2 set screws)	1 1/4"
PTO 8511420	14 (w/ 1/4" keyway & 3/8" pinhole)	1 1/4"
PTO 8501422	14 (w/ 5/16" keyway & 1/4" pinhole)	1 3/8"
PTO 8503522	35 (w/ 5/16" keyway & 1/4" pinhole)	1 3/8"

**Clamp Yoke**

With Keyway



PART NO.	SERIES	DIM "A" BORE
PTO 8571420	14	1 1/4"
PTO 8573520	35	1 1/4"
PTO 8573524	35	1 1/2"

**Stock Bore**

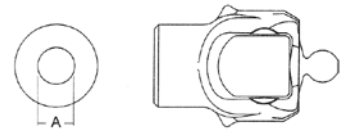

PART NO.	SERIES	DIM "A" BORE
PTO 8591400	14	1"
PTO 8593500	35	1"

**Guard**

PART NO.
PTO 9501430

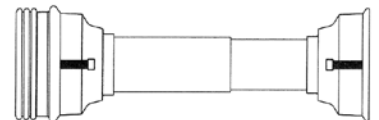

(Guard must rotate freely on yokes.)

NOTE:

\*Outer Guard is larger in order to shield CV half of the driveline.  
\*50° CV joint and shaft half most commonly connects to the implement... ie. grain auger. Also, ball shear connects to the tractor PTO, which is the tube half.

**Yoke & Shaft**

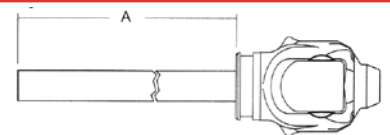

PART NO.	SERIES	SHAFT SIZE	DIM "A"
PTO 10501400	14	1" x 1 1/8" Rect.	29.38"

**Yoke & Tube**

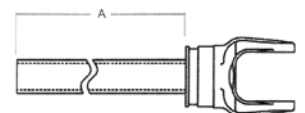

PART NO.	SERIES	SHAFT SIZE	DIM "A"
PTO 11501400	14	1 1/4" x 1 3/8" Rect.	34"

## 50° CV DRIVELINE COMPONENTS

NORTH AMERICAN  
CONSTANT VELOCITY

## Joint &amp; Shaft Half with Guard

With Keyway, (2) Set Screws &amp; Pinhole

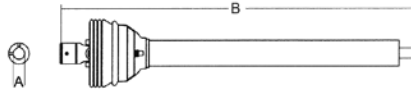

PART NO.	SERIES	DIM "A" BORE	DIM "B"
PTO 19501420	14	1 1/4" Rd.	39.63"

## Ball Shear Device

With Spring-Lok

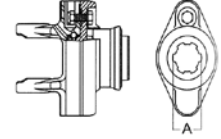

PART NO.	DIM "A" BORE	SHEAR BOLT
PTO 1041406	1 3/8" x 6 Spl.	(1) 5/16" - 18 Gr. 5

## Constant Velocity Joint

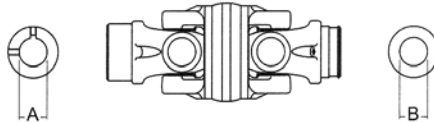

PART NO.	SERIES	DIM "A" BORE	DIM "B" BORE
PTO 18501420	14	1 1/4" Rd. *	1"
PTO 18511420	14	1 1/4" Rd. **	1"

\*(with 1/4" keyway &amp; 2 set screws)

\*\*(with keyway and pinhole)

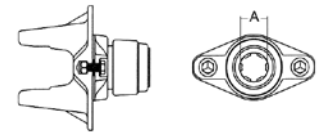

PART NO.	DIM "A" BORE	SHEAR BOLT
PTO 1043506	1 3/8" x 6 Spl.	(2) 3/8" - 16 Gr. 5

## Applications of 50° CV

Grain Augers  
Compost Turners  
Front-Mount Riding Mowers

Mower Conditioners  
Potato Harvesters  
Tub Grinders

# METRIC SECTION

**METRIC  
CONSTANT VELOCITY**

## 2380 SERIES

Interchanges with Walterscheid (AW21)

### Cross & Bearing Kit (R-Kit)

Snap Ring Located in Yoke

PART NO.	DIM "A"		DIM "B"		DIM "C"		DIM "D"	
	mm	inches	mm	inches	mm	inches	mm	inches
PTO 2007491	74.6	2 15/16 (2.93)	91.0	3 37/64 (3.58)	23.8	15/16 (.93)	27.0	1 1/16 (1.06)

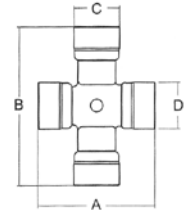

### Cross & Bearing Kit (E-Kit)

PART NO.	DIM "A"		DIM "B"		DIM "C"		DIM "D"	
	mm	inches	mm	inches	mm	inches	mm	inches
PTO 2017491	74.6	2 15/16 (2.93)	91.0	3 37/64 (3.58)	23.8	15/16 (.93)	27.0	1 1/16 (1.06)

### Tractor Yoke

Safety Slide Lock  
Repair Kit - Page 106  
Ring Groove

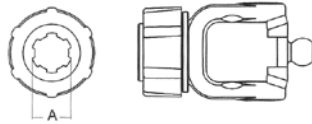

PART NO.	DIM "A" BORE
PTO 1078406	1 3/8" x 6 Spl.
PTO 1078421	1 3/8" x 21 Spl.

### Inner Tube

34.5 (4.0 Wall)  
1.358 (.158 Wall)"  
Rilsan Coating



PART NO.	LENGTH	
	mm	inches
PTO 4067234	1000	39 3/8 (39.37)

### Roll Pin

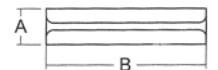

PART NO.	DIM "A"		DIM "B"	
	mm	inches	mm	inches
PTO 5081065	10.0	25/64 (.393)	65.0	2 9/16 (2.56)

Quick Disconnect  
Repair Kit - Page 106



PART NO.	DIM "A" BORE
PTO 1098406	1 3/8" x 6 Spl.

### Inner Profile Yoke

With Bearing Groove  
(Guard must rotate freely on yoke.)

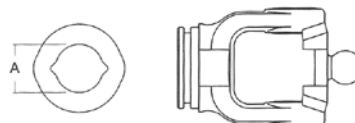

PART NO.	DIM "A" BORE	
	mm	inches
PTO 3017434	34.5	1 23/64 (1.36)

### Center Housing

PART NO.
PTO 5507400

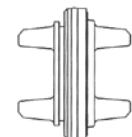

### Outer Tube

41.0 (3.0 Wall)  
Special



PART NO.	LENGTH	
	mm	inches
PTO 6067241	1000	39 3/8 (39.37)



**2380 SERIES**

**METRIC  
CONSTANT VELOCITY**

**Outer Profile Yoke**

**80° C.V. Joint**

With Bearing Groove  
(Guard must rotate freely on yoke.)

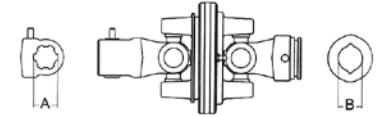
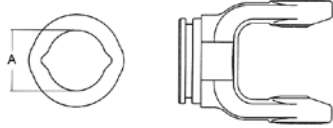

PART NO.	DIM "A" BORE	
	mm	inches
PTO 7007441	41.0	1.614

PART NO.	DIM "A" BORE	DIM "B" BORE
PTO 15507406	1 3/8" x 6 Spl.	34.5 mm (1.358")

**Guard**

Order bearings as required.

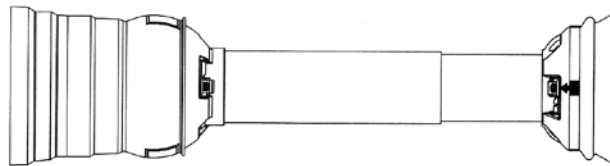

PART NO.	OVERALL DRIVELINE LENGTH	BEARING SET (2 PER KIT)
PTO 9127448	48"	PTO 9610021

Assembly instructions included with guard.  
NOTE: When installing Guards observe the following:  
1) Install proper nylon bearing (See page 11).  
2) Guards must rotate freely on yokes.

**Easy Lock™ Replacement Kit**

PART NO.
PTO 13005000 (4 per kit)



**2480 SERIES**

Interchanges with Walterscheid (AW35)

**METRIC  
CONSTANT VELOCITY**

**Cross & Bearing Kit (R-Kit)**

Snap Ring Located in Yoke

PART NO.	DIM "A"		DIM "B"		DIM "C"		DIM "D"	
	mm	inches	mm	inches	mm	inches	mm	inches
PTO 2007694	76	2 <sup>63</sup> / <sub>64</sub> (2.99)	94.0	3 <sup>45</sup> / <sub>64</sub> (3.70)	27	1 <sup>1</sup> / <sub>16</sub> (1.06)	32.0	1 <sup>7</sup> / <sub>64</sub> (1.26)

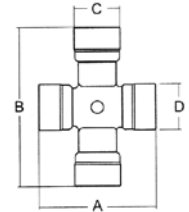

**Cross & Bearing Kit (E-Kit)**

PART NO.	DIM "A"		DIM "B"		DIM "C"		DIM "D"	
	mm	inches	mm	inches	mm	inches	mm	inches
PTO 2017694	76	2 <sup>63</sup> / <sub>64</sub> (2.99)	94.0	3 <sup>45</sup> / <sub>64</sub> (3.70)	27	1 <sup>1</sup> / <sub>16</sub> (1.06)	32.0	1 <sup>7</sup> / <sub>64</sub> (1.26)

**Tractor Yoke**

**Safety Slide Lock**  
Repair Kit - Page 106

PART NO.	DIM "A" BORE
PTO 1077606	1 <sup>3</sup> / <sub>8</sub> " x 6 Spl.
PTO 1077620	1 <sup>3</sup> / <sub>4</sub> " x 20 Spl.
PTO 1077621	1 <sup>3</sup> / <sub>8</sub> " x 21 Spl.

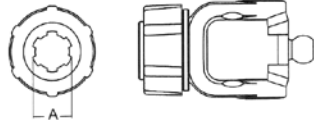

**Inner Tube**

40.0 (4.8 Wall)  
Rilsan Coating



PART NO.	DIM "A"		LENGTH	
	mm	inches	mm	inches
PTO 4027639	40.0	1 <sup>9</sup> / <sub>16</sub> (1.56)	1000	39 <sup>3</sup> / <sub>8</sub> (39.37)

**Quick Disconnect**  
Repair Kit - Page 106

PART NO.	DIM "A" BORE
PTO 1097606	1 <sup>3</sup> / <sub>8</sub> " x 6 Spl.
PTO 1097620	1 <sup>3</sup> / <sub>4</sub> " x 20 Spl.
PTO 1097621	1 <sup>3</sup> / <sub>8</sub> " x 21 Spl.

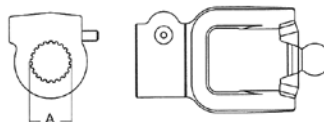

**Roll Pin**

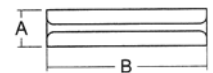

PART NO.	DIM "A"		DIM "B"	
	mm	inches	mm	inches
PTO 5081080	10.0	<sup>13</sup> / <sub>32</sub> (.406)	80.0	3 <sup>5</sup> / <sub>32</sub> (3.156)

**Inner Profile Yoke**

With Bearing Groove  
(Guard must rotate  
freely on yoke.)

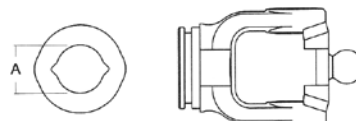

PART NO.	DIM "A" BORE	
	mm	inches
PTO 3017639	40.0	1 <sup>9</sup> / <sub>16</sub> (1.56)

**Center Housing**

PART NO.
PTO 5507600

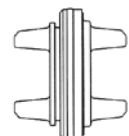

**2480 SERIES**

**METRIC  
CONSTANT VELOCITY**

**Outer Tube**

48.0 (4.0 Wall)  
4.0 Wall (Special)



PART NO.	LENGTH	
	mm	inches
PTO 6067648	1000	39 3/8 (39.37)

**80° C.V. Joint**

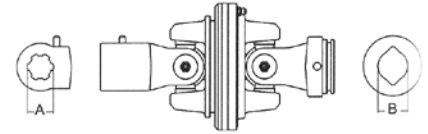

PART NO.	DIM "A" BORE	DIM "B" BORE
PTO 15507640	1 3/8" x 6 Spl.	40.0 mm (1.562")

**Outer Profile Yoke**

With Bearing Groove  
(Guard must rotate  
freely on yoke.)

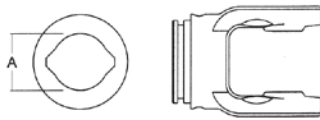

PART NO.	DIM "A" BORE	
	mm	inches
PTO 7007648	48.0	1 7/8 (1.890)

**Easy Lock™ Replacement Kit**

PART NO.
PTO 13005000 (4 per kit)



**Guard**

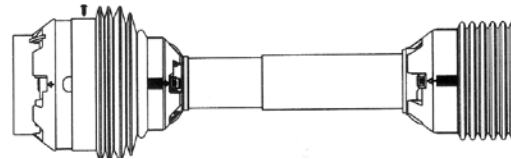

PART NO.	OVERALL DRIVELINE LENGTH	BEARING SET (2 PER KIT)
PTO 9127648	48"	PTO 9610035
PTO 9127660	60"	PTO 9610035

Assembly instructions included with guard.

NOTE: When installing Guards observe the following:

- 1) Install proper nylon bearing (See page 11).
- 2) Guards must rotate freely on yokes.

**Drivelines**

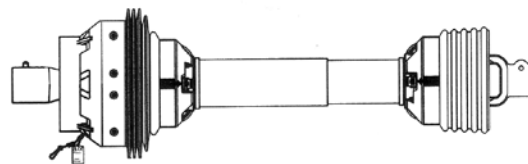

PART NO.	TRACTOR YOKE	IMPLEMENT YOKE	OVERALL DRIVELINE LENGTH
PTO 14507648	1 3/8" x 6 Spl.	1 3/8" x 6 Spl.	48"
PTO 14507660	1 3/8" x 6 Spl.	1 3/8" x 6 Spl.	60"
PTO 14607648	1 3/8" x 21 Spl.	1 3/8" x 6 Spl.	48"
PTO 14607660	1 3/8" x 21 Spl.	1 3/8" x 6 Spl.	60"
PTO 14517660	1 3/8" x 6 Spl.	1 3/8" x 6 Spl.	60"
PTO 14617660	1 3/8" x 21 Spl.	1 3/8" x 6 Spl.	60"
PTO 14717660	1 3/4" x 20 Spl.	1 3/8" x 6 Spl.	60"

(Order implement yoke and cross & bearing kit separately as required.)

**2580 SERIES**  
*Interchanges with Walterscheid (AW36)*

**METRIC  
CONSTANT VELOCITY**

**Cross & Bearing Kit (R-Kit)**

Snap Ring Located in Yoke

PART NO.	DIM "A"		DIM "B"		DIM "C"		DIM "D"	
	mm	inches	mm	inches	mm	inches	mm	inches
PTO 2007906	88.8	3.49	106.0	4.17	32.0	1.26	36.0	1.42

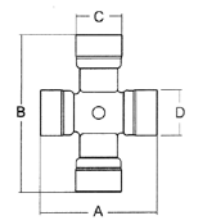

**Cross & Bearing Kit (E-Kit)**

PART NO.	DIM "A"		DIM "B"		DIM "C"		DIM "D"	
	mm	inches	mm	inches	mm	inches	mm	inches
PTO 2017906	88.8	3.49	106.0	4.17	32.0	1.26	36.0	1.42

**Tractor Yoke**

Safety Slide Lock  
Repair Kit - Page 106

PART NO.	DIM "A" BORE
PTO 1077906	1 3/8" x 6 Spl.
PTO 1077920	1 3/4" x 20 Spl.
PTO 1077921	1 3/8" x 21 Spl.

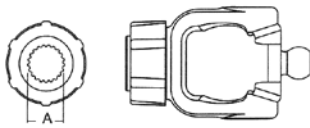

**Outer Tube**

61.0 x 4.0  
(Special)



PART NO.	LENGTH	
	mm	inches
PTO 6007961	1500	59 1/16 (59.0)
PTO 6047961	1500	59 1/16 (59.0)

**Inner Profile Yoke**

With Bearing Groove  
(Guard must rotate  
freely on yoke.)



PART NO.	DIM "A" BORE	
	mm	inches
PTO 3027951	51.0	2

**Center Housing**

PART NO.
PTO 5507900

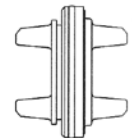

**Outer Profile Yoke**

With Bearing Groove  
(Guard must rotate  
freely on yoke.)

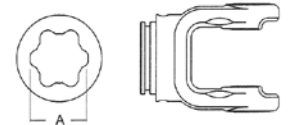

PART NO.	DIM "A" BORE	
	mm	inches
PTO 7007961	61.0	2 3/8 (2.402)

**Inner Tube**

Rilsan Coating



PART NO.	DIM "A"		LENGTH	
	mm	inches	mm	inches
PTO 4067951	51.0	2.01	1000	39 3/8 (39.37)

**80° C.V. Joint**

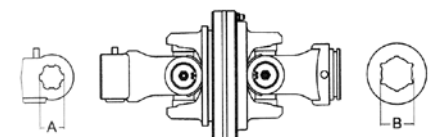

**Roll Pin**

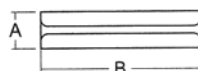

PART NO.	DIM "A"		DIM "B"	
	mm	inches	mm	inches
PTO 5081090	10.0	13/32 (.406)	90.0	3 1/2 (3.54)

PART NO.	DIM "A" BORE	DIM "B" BORE
PTO 15507951	1 3/8" x 6 Spl.	51.0 mm (2.000")
PTO 15607951	1 3/8" x 21 Spl.	51.0 mm (2.000")
PTO 15707951	1 3/4" x 20 Spl.	51.0 mm (2.000")

## 2580 SERIES

**METRIC**  
CONSTANT VELOCITY

## Yoke, Tube &amp; Sleeve Assembly with Guard

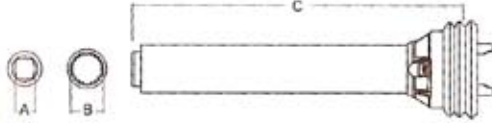

PART NO.	FITS PROFILE TUBE	IMPLEMENT YOKE
PTO 9214507951	51.0 (Star)	1 3/4" x 20 Spl. w/Clamp
PTO 9214507955	51.0 (Star)	1 3/8" x 6 Spl. w/Clamp
PTO 9214517955	51.0 (Star)	1 3/4" x 20 Spl. w/Clamp
PTO 9214627955	51.0 (Star)	1 3/8" x 21 Spl. w/Clamp
PTO 9214637955	51.0 (Star)	1 3/8" x 21 Spl. w/Pinhole

## Joint &amp; Shaft with Guard

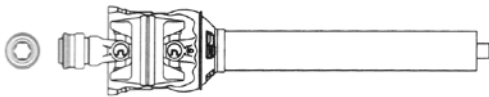

PART NO.	FITS PROFILE TUBE	IMPLEMENT YOKE
PTO 9314517955	51.0 (Star)	1 3/8" x 6 Spl.
PTO 9314717955	51.0 (Star)	1 3/4" x 20 Spl.
PTO 9314507951	51.0 (Star)	1 3/8" x 6 Spl.
PTO 9314607951	51.0 (Star)	1 3/8" x 6 Spl.
PTO 9314707951	51.0 (Star)	1 3/8" x 21 Spl.

## Guard

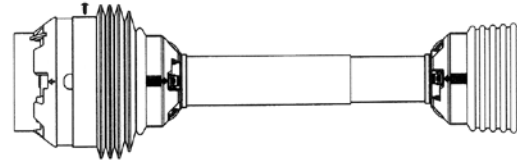

PART NO.	OVERALL DRIVELINE LENGTH	BEARING SET (2 PER KIT)
PTO 9127948	48"	PTO 9610036
PTO 9127960	60"	PTO 9610036

Assembly instructions included with guard.

NOTE: When installing Guards observe the following:

- 1) Install proper nylon bearing (See page 11).
- 2) Guards must rotate freely on yokes.

## Easy Lock™ Replacement Kit

PART NO.
PTO 13005000 (4 per kit)



## Drivelines

PART NO.	TRACTOR YOKE	IMPLEMENT YOKE	OVERALL DRIVELINE LENGTH
PTO 14507948	1 3/8" x 6 Spl.	1 3/8" x 6 Spl.	48"
PTO 14507951	1 3/8" x 6 Spl.	1 3/4" x 20 Spl.w/Clamp	51"
PTO 14507955	1 3/8" x 6 Spl.	1 3/8" x 6 Spl. w/Clamp	55"
PTO 14507960	1 3/8" x 6 Spl.	1 3/8" x 6 Spl.	60"
PTO 14517955	1 3/8" x 6 Spl.	1 3/4" x 20 Spl.w/Clamp	55"
PTO 14607948	1 3/8" x 21 Spl.	1 3/8" x 6 Spl.	48"
PTO 14607951	1 3/8" x 21 Spl.	1 3/4" x 20 Spl.w/Clamp	51"
PTO 14607955	1 3/8" x 21 Spl.	1 3/8" x 6 Spl. w/Clamp	55"
PTO 14607960	1 3/8" x 21 Spl.	1 3/8" x 21 Spl.	60"
PTO 14617955	1 3/8" x 21 Spl.	1 3/4" x 20 Spl.w/Clamp	55"
PTO 14627955	1 3/8" x 21 Spl.	1 3/8" x 21 Spl.w/Clamp	55"
PTO 14637955	1 3/8" x 21 Spl.	1 3/8" x 21 Spl.w/Pinhole	55"
PTO 14707951	1 3/4" x 20 Spl.	1 3/4" x 20 Spl.w/Clamp	51"
PTO 14707955	1 3/4" x 20 Spl.	1 3/4" x 6 Spl.w/Clamp	55"
PTO 14717955	1 3/4" x 20 Spl.	1 3/4" x 20 Spl.w/Clamp	55"
PTO 14727955	1 3/4" x 20 Spl.	1 3/8" x 21 Spl.w/Clamp	55"
PTO 14737955	1 3/4" x 20 Spl.	1 3/4" x 21 Spl.w/Pinhole	55"

(Order implement yoke and cross & bearing kit separately as required.)

# APPLICATIONS

**CONSTANT  
VELOCITY**

## NORTH AMERICAN REPLACEMENT DRIVELINES

### Flexwing Mower Replacement Drivelines

PART NO.	SERIES	CATEGORY	TRACTOR YOKE	CLAMP-STYLE IMPLEMENT YOKE	OVERALL COMPRESSED DRIVELINE LENGTH
PTO 14505551	55	6	1 3/8" x 6 Spl.	1 3/4" x 20 Spl.	51"
PTO 14605551	55	6	1 3/8" x 21 Spl.	1 3/4" x 20 Spl.	51"
PTO 14705551	55	6	1 3/4" x 20 Spl.	1 3/4" x 20 Spl.	51"
PTO 14505555	55	6	1 3/8" x 6 Spl.	1 3/8" x 6 Spl.	55"
PTO 14605555	55	6	1 3/8" x 21 Spl.	1 3/8" x 6 Spl.	55"
PTO 14705555	55	6	1 3/4" x 20 Spl.	1 3/8" x 6 Spl.	55"
PTO 14515555	55	6	1 3/8" x 6 Spl.	1 3/4" x 20 Spl.	55"
PTO 14615555	55	6	1 3/8" x 21 Spl.	1 3/4" x 20 Spl.	55"
PTO 14715555	55	6	1 3/4" x 20 Spl.	1 3/4" x 20 Spl.	55"

### Round Baler Drivelines

PART NO.	SERIES	CATEGORY	TRACTOR YOKE	IMPLEMENT YOKE	OVERALL COMPRESSED DRIVELINE LENGTH
PTO 14503500	35	5	1 3/8" x 6 Spl.	1 3/8" x 6 Spl. with 18,000 in-lb. Friction Clutch	58"
PTO 14603500	35	5	1 3/8" x 21 Spl.	1 3/8" x 6 Spl. with 10,000 in-lb. Friction Clutch	58"
PTO 14503501	35	5	1 3/8" x 6 Spl.	1 3/8" x 21 Spl. with 15,000 in-lb. Friction Clutch	67"
PTO 14503502	35	5	1 3/8" x 6 Spl.	1 3/8" x 6 Spl. with 15,000 in-lb. Friction Clutch	58"

### Peanut Harvester Replacement Drivelines

PART NO.	SERIES	CATEGORY	TRACTOR YOKE	CLAMP-STYLE IMPLEMENT YOKE	OVERALL COMPRESSED DRIVELINE LENGTH
PTO 14625555	55	6	1 3/8" x 21 Spl.	1 3/8" x 21 Spl.	55"
PTO 14725555	55	6	1 3/4" x 20 Spl.	1 3/8" x 21 Spl.	55"
PTO 14635555	55	6	1 3/8" x 21 Spl.	1 3/8" x 21 Spl.	55"
PTO 14735555	55	6	1 3/4" x 20 Spl.	1 3/8" x 21 Spl.	55"

## METRIC REPLACEMENT DRIVELINES

**CONSTANT  
VELOCITY**

### Flexwing Mower Replacement Drivelines

PART NO.	SERIES	TRACTOR YOKE	CLAMP-STYLE IMPLEMENT YOKE	OVERALL COMPRESSED DRIVELINE LENGTH
PTO 14507951	2580	1 3/8" x 6 Spl.	1 3/4" x 20 Spl.	51"
PTO 14607951	2580	1 3/8" x 21 Spl.	1 3/4" x 20 Spl.	51"
PTO 14707951	2580	1 3/4" x 20 Spl.	1 3/4" x 20 Spl.	51"
PTO 14507955	2580	1 3/8" x 6 Spl.	1 3/8" x 6 Spl.	55"
PTO 14607955	2580	1 3/8" x 21 Spl.	1 3/8" x 6 Spl.	55"
PTO 14707955	2580	1 3/4" x 20 Spl.	1 3/8" x 6 Spl.	55"
PTO 14517955	2580	1 3/8" x 6 Spl.	1 3/4" x 20 Spl.	55"
PTO 14617955	2580	1 3/8" x 21 Spl.	1 3/4" x 20 Spl.	55"
PTO 14717955	2580	1 3/4" x 20 Spl.	1 3/4" x 20 Spl.	55"

### Peanut Harvesters

PART NO.	SERIES	TRACTOR YOKE	CLAMP-STYLE IMPLEMENT YOKE	OVERALL COMPRESSED DRIVELINE LENGTH
PTO 14627955	2580	1 3/8" x 21 Spl.	1 3/8" x 21 Spl.	55"
PTO 14727955	2580	1 3/4" x 20 Spl.	1 3/8" x 21 Spl.	55"
PTO 14637955	2580	1 3/8" x 21 Spl.	1 3/8" x 21 Spl.	55"
PTO 14737955	2580	1 3/4" x 20 Spl.	1 3/8" x 21 Spl.	55"

**80° CV'S FOR FLEX-WING CUTTERS - DOMESTIC & METRIC**

**CONSTANT VELOCITY**

**Interchanges with BUSH HOG® - Model #: 2615, 3615**



Also fits other competitive models.

	CV PART NO.	OVERALL TRACTOR YOKE	IMPLEMENT COMPRESSED LENGTH	CLAMP YOKE	SERIES
DOMESTIC	PTO 14505555	1 3/8" x 6 Spline	55"	1 3/8" x 6 Spline	55
	PTO 14605555	1 3/8" x 21 Spline	55"	1 3/8" x 6 Spline	55
	PTO 14705555	1 3/4" x 20 Spline	55"	1 3/8" x 6 Spline	55
METRIC	PTO 14507955	1 3/8" x 6 Spline	55"	1 3/8" x 6 Spline	BP 8/WS 2580
	PTO 14607955	1 3/8" x 21 Spline	55"	1 3/8" x 6 Spline	BP 8/WS 2580
	PTO 14707955	1 3/4" x 20 Spline	55"	1 3/8" x 6 Spline	BP 8/WS 2580

**Interchanges with RHINO® - Model #: SR-15, SE-15**

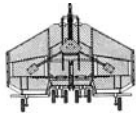

	CV PART NO.	OVERALL TRACTOR YOKE	IMPLEMENT COMPRESSED LENGTH	CLAMP YOKE	SERIES
DOMESTIC	PTO 14505551	1 3/8" x 6 Spline	51"	1 3/4" x 20 Spline	55
	PTO 14605551	1 3/8" x 21 Spline	51"	1 3/4" x 20 Spline	55
	PTO 14705551	1 3/4" x 20 Spline	51"	1 3/4" x 20 Spline	55
METRIC	PTO 14507951	1 3/8" x 6 Spline	51"	1 3/4" x 20 Spline	BP 8/WS 2580
	PTO 14607951	1 3/8" x 21 Spline	51"	1 3/4" x 20 Spline	BP 8/WS 2580
	PTO 14707951	1 3/4" x 20 Spline	51"	1 3/4" x 20 Spline	BP 8/WS 2580

**Interchanges with DEERE® - Model #: 1517, 1518, 2018**

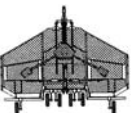

Also fits other competitive models.

	CV PART NO.	OVERALL TRACTOR YOKE	IMPLEMENT COMPRESSED LENGTH	CLAMP YOKE	SERIES
DOMESTIC	PTO 14515555	1 3/8" x 6 Spline	55"	1 3/4" x 20 Spline	55
	PTO 14615555	1 3/8" x 21 Spline	55"	1 3/4" x 20 Spline	55
	PTO 14715555	1 3/4" x 20 Spline	55"	1 3/4" x 20 Spline	55
METRIC	PTO 14517955	1 3/8" x 6 Spline	55"	1 3/4" x 20 Spline	BP 8/WS 2580
	PTO 14617955	1 3/8" x 21 Spline	55"	1 3/4" x 20 Spline	BP 8/WS 2580
	PTO 14717955	1 3/4" x 20 Spline	55"	1 3/4" x 20 Spline	BP 8/WS 2580



## WING DRIVE FRICTION CLUTCH

The Wing Drive Friction Clutch is indispensable in certain agricultural implement applications. The friction clutch is the only torque limiter to continuously transmit power while overloaded. This is valuable during start up of high inertia machines, as well as for leveling out torsional fluctuations due to high cyclic loads. During overload the clutch limits transmitted power. The patented design dissipates heat quickly, improving durability while protecting the machine.

### Performance Benefits

- Implement overload protection.
- Dissipates heat minimizing downtime for higher productivity.
- Corrosion resistant friction discs.
- Optimized design affords more reliable torque setting.
- Minimal maintenance.
- Smooth operation, no damaging torque spikes.
- Torque transmission while slipping aids in dislodging plugs for increased productivity

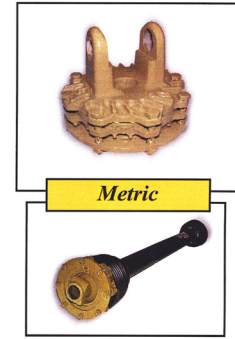

## REPLACEMENT WING DRIVE SHAFTS

### Machine Specific Shafts for:

Schulte, Woods, John Deere, Bush Hog, Rhino/M&W, Kodiak, Land Pride, Bush-Whacker

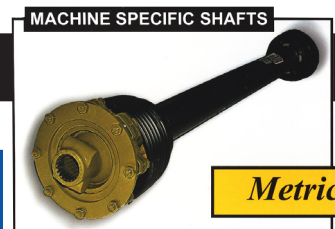

### MACHINE SPECIFIC SHAFTS -INTERCHANGES WITH BONDIOLI & PAVESI

PART NO.	SERIES	DESCRIPTION	TORQUE RATING	COMP. OAL	APPLICATION
PTO 14106656	ByPy 6	1 3/4" x 20 Clamp x 1 3/4" x 20 Clamp Fric. Cl.	15,000 in•lbs.	56.11"	M&W-A415; AGI 15 ft. Flexwing; Rhino - FR15, SR15 15 ft. Rotary Cutter; Landpride - RC5515, RC6515 15 ft. Mower; Woods - BW180 Flexwing
PTO 14106664	ByPy 6	1 3/4" x 20 Clamp x 1 3/4" x 20 Clamp Fric. Cl.	15,000 in•lbs	64.11"	Schulte - XH1500 Flexwing; Bush Hog - 2515, 2720 Flexwing; Deere - HX15; Kodiak - Ol' Grizz 15 ft
PTO 14116664	ByPy 6	1 3/8" x 21 Clamp x 1 3/8" x 21 Clamp Fric. Cl.	15,000 in•lbs	64.11"	Schulte - FX26; Deere - 1518, 2018
PTO 14126664	ByPy 6	1 3/4" x 20 Clamp x 1 3/8" x 6 Clamp Fric. Cl.	15,000 in•lbs	64.11"	Bush-Whacker -T-180

For inner profile tube replacement for all of the above order PTO 4006745 - 45.0mm (5.4 Wall) mm

### REPLACEMENT FRICTION CLUTCH

PART NO.	USED ON DRIVELINE
PTO 5668620	14106656
PTO 5668620	14106664
PTO 5668621	14116664
PTO 5668606	14126664
FRICTION CLUTCH REPLACEMENT PARTS	
PTO 98715000	Spring
PTO 9701700	Disc

High Performance Friction Clutch specially developed for demanding field conditions for wing drives on flex wing and multiple disc mowers.



## REPLACEMENT WING DRIVE SHAFTS

ALL PURPOSE SHAFTS



- Check outboard yokes for correct hook-up.
- Verify overall compressed length.
- Utilizes standard open spring friction clutch.



### ALL PURPOSE SHAFTS –INTERCHANGES WITH BONDIOLI & PAVESI

PART NO.	SERIES	DESCRIPTION	TORQUE RATING	COMP. OAL	APPLICATION
PTO 14106660	ByPy 6	1 3/8" x 6 Q.D. x 1 3/4" x 20 Clamp Fric. Cl.	13,200 in•lbs	61.15"	Bush Hog - Various Models
PTO 14106661	ByPy 6	1 3/4" x 20 Q.D. x 1 3/4" x 20 Clamp Fric. Cl.	13,200 in•lbs	63.18"	Bush Hog - Various Models
PTO 14116660	ByPy 6	1 3/8" x 6 Q.D. x 1 3/8" x 21 Clamp Fric. Cl.	13,200 in•lbs	61.15"	Bush Hog - Various Models

NOTE: Replacement shafts may differ from original equipment shafts.  
15,000 in•lbs = 1700 Nm & 13,200 in•lb = 1500 Nm

#### REPLACEMENT SPRING FRICTION CLUTCH

PART NO.	USED ON DRIVELINE
PTO 5608620	14106660
PTO 5608620	14106661
PTO 5608621	14116660
REPLACEMENT PART AVAILABILITY:	
PTO 9704160	Disc

## REPLACEMENT WING DRIVE SHAFTS

MACHINE SPECIFIC SHAFTS



North American

Machine Specific Shafts for:  
Shulte, Woods, John Deere, Bush Hog,  
Rhino/M&W, Kodiak, Land Pride, Bush-Whacker

### ALL PURPOSE SHAFTS –INTERCHANGES WITH BONDIOLI & PAVESI

PART NO.	SERIES	DESCRIPTION	TORQUE RATING	COMP. OAL	APPLICATION
PTO 14104456	44	1 3/4" x 20 Clamp x 1 3/4" x 20 Clamp Fric. Cl.	15,000 in•lbs.	56.11"	M&W -A415, AGI 15 ft. Flexwing; Rhino - FR15, SR15 15 ft. Rotary Cutter; Landpride RC5515, RC6515 15 ft. Mower; Woods -BW180 Flexwing
PTO 14104464	44	1 3/4" x 20 Clamp x 1 3/4" x 20 Clamp Fric. Cl.	15,000 in•lbs	64.11"	Schulte - XH1500 Flexwing; Bush Hog - 2515, 2726 Flexwing; Deere - HX15; Kodiak - Ol' Grizz 15 ft
PTO 14114464	44	1 3/8" x 21 Clamp x 1 3/8" x 21 Clamp Fric. Cl.	15,000 in•lbs	64.11"	Schulte - FX26; Deere - 1518, 2018
PTO 14124464	44	1 3/4" x 20 Clamp x 1 3/8" x 6 Clamp Fric. Cl.	15,000 in•lbs.	64.11"	Bush-Whacker - T-180

NOTE: Replacement shafts may differ from original equipment shafts.  
15,000 in•lbs = 1700 Nm & 13,200 in•lb = 1500 Nm

#### REPLACEMENT FRICTION CLUTCH

PART NO.	USED ON DRIVELINE
PTO 5664420	14104456
PTO 5664420	14104464
PTO 5664421	14114464
PTO 5664406	14124464
FRICTION CLUTCH REPLACEMENT PARTS	
PTO 98715000	Spring
PTO 9701700	Disc

High Performance Friction Clutch  
specially developed for  
demanding field conditions for  
wing drives on flex wing and  
multiple disc mowers.



**80° CV ROUND BALER DRIVELINES**

**CONSTANT VELOCITY**



**Gehl Deluxe - Model # 2880**

- PTO 14503567 - 80° CV D/L 1-3/8 x 6 Tractor Yoke
- PTO 57015000 - 7" Clutch Pak
- PTO 8173521 - 1-3/8 x 21 Clutch Yoke
- PTO 2003500 - 35 Series Cross Kit



**COMPLETE D/L PART NO.**

PTO 14503501

**Deere - Model # 467 & 466**

- PTO 14503558 - 80° CV D/L 1-3/8 x 6 Tractor Yoke
- PTO 59018000 - 9" Clutch Pak
- PTO 8173506 - 1-3/8 x 6 Clutch Yoke
- PTO 2003500 - 35 Series Cross Kit



**COMPLETE D/L PART NO.**

PTO 14503500

**Deere - Model # 567 & 566 (1000 RPM)**

- PTO 14603558 - 80° CV D/L 1-3/8 x 21 Tractor Yoke
- PTO 59010000 - 9" Clutch Pak
- PTO 8173506 - 1-3/8 x 6 Clutch Yoke
- PTO 2003500 - 35 Series Cross Kit

**COMPLETE D/L PART NO.**

PTO 14603500

**PARTS FOR TORQMASTER CLUTCH**

**SPRING**

7" CLUTCH PART NO.	9" CLUTCH PART NO.
PTO 9879000	PTO 98910000
PTO 98712000	PTO 98915000
PTO 98715000	PTO 98918000
PTO 98718000	

**SEPARATOR PLATE**

7" CLUTCH PART NO.	9" CLUTCH PART NO.
PTO 9907000	PTO 9909000

**DISC**

7" CLUTCH PART NO.	9" CLUTCH PART NO.
PTO 9707000	PTO 9709000

**Case - Model # 8455S & 8455T - (540 RPM)**

**(1000 RPM)**

- PTO 14503558 - 80° CV D/L 1-3/8 x 6 Tractor Yoke
- PTO 57015000 - 7" Clutch Pak
- PTO 8173506 - 1-3/8 x 6 Clutch Yoke
- PTO 2003500 - 35 Series Cross Kit



**COMPLETE D/L PART NO.**

PTO 14503502

- PTO 14603558 - 80° CV D/L 1-3/8 x 21 Tractor Yoke
- PTO 57015000 - 7" Clutch Pak
- PTO 8173506 - 1-3/8 x 6 Clutch Yoke
- PTO 2003500 - 35 Series Cross Kit

**COMPLETE D/L PART NO.**

PTO 14603502

**Vermeer - Model # 604K - (540 RPM)**

**(1000 RPM)**

- PTO 14503558 - 80° CV D/L 1-3/8 x 6 Tractor Yoke
- PTO 57015000 - 7" Clutch Pak
- PTO 8173506 - 1-3/8 x 6 Clutch Yoke
- PTO 2003500 - 35 Series Cross Kit



**COMPLETE D/L PART NO.**

PTO 14503502

- PTO 14603558 - 80° CV D/L 1-3/8 x 21 Tractor Yoke
- PTO 57015000 - 7" Clutch Pak
- PTO 8173506 - 1-3/8 x 6 Clutch Yoke
- PTO 2003500 - 35 Series Cross Kit

**COMPLETE D/L PART NO.**

PTO 14603502

**Hesston - Model # 555S & 555T - (540 RPM)**

**(1000 RPM)**

- PTO 14503558 - 80° CV D/L 1-3/8 x 6 Tractor Yoke
- PTO 57015000 - 7" Clutch Pak
- PTO 8173506 - 1-3/8 x 6 Clutch Yoke
- PTO 2003500 - 35 Series Cross Kit



**COMPLETE D/L PART NO.**

PTO 14503502

- PTO 14603558 - 80° CV D/L 1-3/8 x 21 Tractor Yoke
- PTO 57015000 - 7" Clutch Pak
- PTO 8173506 - 1-3/8 x 6 Clutch Yoke
- PTO 2003500 - 35 Series Cross Kit

**COMPLETE D/L PART NO.**

PTO 14603502

**DEALER STARTER KITS**

**North American Starter Kit**

PART NO.
PTO 12006000

Contains 1 of each of the following:

PART NO.	DESCRIPTION
PTO 5506000	Domestic 5" Clutch Pak (6,000 in. lbs.)
PTO 5709000	Domestic 7" Clutch Pak (9,000 in. lbs.)
PTO 57012000	Domestic 7" Clutch Pak (12,000 in. lbs.)
PTO 8173506	Domestic 35 Series 1 3/8" x 6 Spl. Clamp Yoke
PTO 8171406	Domestic 14 Series 1 1/8" x 6 Spl. Clamp Yoke
PTO 8253522	Domestic 35 Series 1 3/8" Round with keyway & 2 setscrews
	TORQMASTER Promotional Poster

**North American & Metric Starter Kit**

PART NO.
PTO 12006100

Contains 1 of each of the following:

PART NO.	DESCRIPTION
PTO 5506000	Domestic 5" Clutch Pak (6,000 in. lbs.)
PTO 5709000	Domestic 7" Clutch Pak (9,000 in. lbs.)
PTO 57012000	Domestic 7" Clutch Pak (12,000 in. lbs.)
PTO 8173506	Domestic 35 Series 1 3/8" x 6 Spl. Clamp Yoke
PTO 8171406	Domestic 14 Series 1 1/8" x 6 Spl. Clamp Yoke
PTO 8253522	Domestic 35 Series 1 3/8" Round with keyway & 2 setscrews
PTO 8178406	Metric ByPy 4 Series/Walterscheid 2300 Series 1 3/8" x 6 Spline Clamp Yoke
PTO 8256522	Metric ByPy 5 Series 1 3/8" Round with keyway & 2 setscrews
	TORQMASTER Promotional Poster



## 80° CONSTANT VELOCITY DRIVELINE

with innovative and patented features exclusive to Weasler...

### Features

#### ARTICULATED GUARD SYSTEM

CV centre housing accommodates a bell that fits within minimum ASAE tractor master shield. Bell is articulated to allow a full 80°. The plastic guard over the CV joint is supported by a bearing that rides on the centre housing. The steel guard incorporates a field proven bearing system that significantly reduces wear and increases the life of guard components.

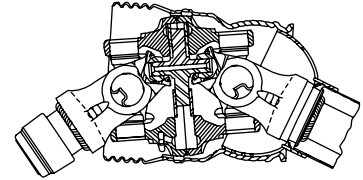

#### TELESCOPING DRIVELINE

The Weasler CV driveline utilizes shafts that telescope into a hardened sleeve with a large grease reservoir. Reduced friction means low thrust, for minimal wear throughout CV life. Tested in contaminated environments.

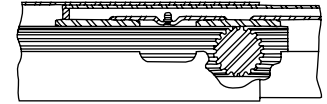

#### LONG LIFE

Compact, heavy duty centre housing has a large capacity grease cavity and unique lubrication system. Patented grease system ensures positive one shot lubrication of hardened and ground centering balls and sockets. Unique centre slider support plates greatly increase life by retaining lubrication and sealing out contaminants. Full surface contact means reduced wear on all components, minimizing vibration.

#### HIGH TORSIONAL STRENGTH

The exclusive ball and socket of the Weasler CV is integral with the yoke. Trunnions on the centre plate are supported directly in the yoke by the ball and socket, providing strength for heavy-duty applications. Forged yokes and centre housing are engineered for high torque.

### Benefits

Constant Velocity Drivelines allow turns at high angles under full power without damaging the driveline or other components. When using conventional drivelines, the vibrations increase as the angle increases. A CV driveline will substantially reduce vibrations due to its operating at a constant speed. The reduction in vibration will result in fewer breakdowns and lower cost of implement maintenance.

### Applications

Listed are some applications of CV drivelines:

- Round Balers
- Batwing Mowers
- Rock Pickers
- Tank-type Manure Spreaders
- Square Balers
- Manure Pumps
- Stalk Choppers
- Mower Conditioners
- Orchard Sprayers
- Beet Toppers
- Box-type Manure Spreaders

**TORQMASTER CLUTCHES**

**CLUTCHES**

**NORTH AMERICAN**

Weasler 14, 35, 44, 55  
Interchanges with:  
Neapco 2600 Series and  
Walterscheid 1480 Series

**METRIC**

Interchanges with:  
Bondioli and Pavesi 4, 5, 6  
and 8 Series and Walterscheid  
2300, 2400 and 2500 Series

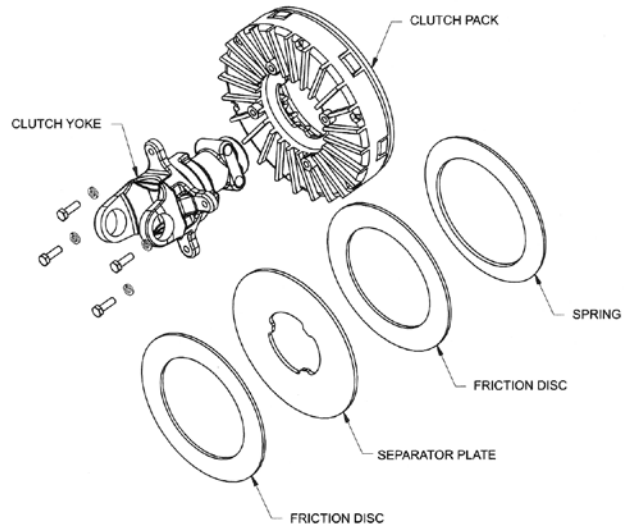

*(For use on implement end of driveline only)*

The drawing illustrates the components of the TORQMASTER. Each component of the exploded view is identified by an eight-digit stock number to ensure identification.

Number Identification Examples:

570-9000

— Torque in •lbs  
— Diameter of Clutch Pak

821-1406

— 6 Spline  
— 14 Series  
— Auto-Lok for Overrunning Clutch  
— Implement Yoke

817-3506

— 6 Spline  
— 35 Series  
— Clamp Yoke for Friction Clutch  
— Implement Yoke

818-8406

— 6 Spline  
— ByPy 4 Series and W/S 2300 Series  
— Interchanges with both ByPy and W/S  
— Clamp Yoke for Overrunning Clutch  
— Implement Yoke

825-4422

— 1 3/8" Round Bore\*  
— 44 Series  
— Round Bore for Friction Clutch  
— Implement Yoke

970-7000

— Diameter of Clutch Pak  
— Friction Disc

990-7000

— Diameter of Clutch Pak  
— Separator Plate

\*1/16th increments.

**NOTE: Overrunning Clutch Paks must be mated with Overrunning Yokes.**

## TORQMASTER - FEATURES AND BENEFITS

### CLUTCHES

- Superior performance.
- Long life.
- Isolates/dissipates heat.
- "User Friendly" - easy to service.
- Free motion - ease of hook-up.
- Minimum adjustment required.
- Auto-Lok available.
- Replacement clutch for most farm implements.\*
- Torque setting from 9,000 in•lbs to 21,000 in•lbs.
- Overrunning feature also available.
- Modular construction covers a wide variety of applications.
- Applications for the TorQmaster Modular Clutch:
 

Spreaders	Mixers
Mower Conditioners	Rotary Cutters
Flail Shredders	Grain Carts
Balers	Snowblowers
- For use on implement end of driveline only.

# TORQMASTER

## INSTRUCTIONS FOR ORDERING THE **TORQMASTER** CLUTCH

- Determine the driveline series using Transparency Identification System for either North American or Metric applications (See Pages 19 and 53).
- Identify the connecting shaft size and the method of attachment (ex: clamp, bolt, keyway).
- Obtain torque setting from owner/operator manual - if available.
- If torque setting is not available, use the following Clutch Pak Selection Guide (Pages 136 and 137) as a guideline for selecting the proper clutch pak.
  - Order clutch yoke and clutch pak separately by stock number.
  - For installation, attach lutch yoke to the driveline first, then mount the clutch pak to the clutch yoke.
  - Use the modular clutch on the implement end of the driveline only.
  - If the implement input connection guard is removed for service, re-install the guard before using the machine.
  - Some implements (ex: mower conditioner, flail shredder) require an overrunning feature incorporated into the clutch. If the replacement clutch requires this feature, order the appropriate overrunning modular clutch and overrunning clutch yoke.

**ASSEMBLY INSTRUCTIONS**

**CLUTCHES**

FOR **TORQMASTER** MODULAR CLUTCH

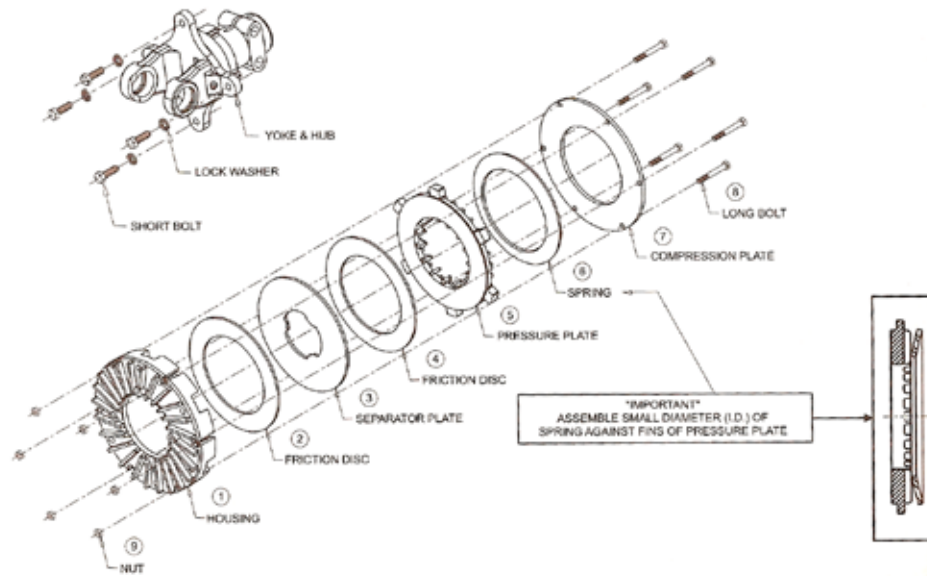

**RUN-IN OF THE TORQMASTER MODULAR CLUTCH (Instructions)**

If the clutch has not been operated for (1) season we recommend the following:

**TOOLS REQUIRED:**

(1) 1/2" box wrench or socket.

1. Make sure the tractor is off and the PTO is disengaged.
2. Disconnect the driveline from the tractor.
3. Locate the bolts on the O.D. of the clutch pak. Loosen the bolts until all are finger tight, then tighten each one half a turn.
4. Attach the implement to the tractor at the hitch pin, and the driveline to the tractor PTO.
5. Turn the tractor on. Engage the PTO clutch and run for a few seconds, or until the clutch visibly smokes.
6. Disengage the tractor PTO and shut off the tractor. Keep clear of the machine until all parts stop moving.
7. Disconnect the driveline from the tractor.
8. Tighten the bolts on the O.D. of the clutch pak until the compression plate is in full contact with the housing.
9. If the clutch contains an integral overrunning clutch, make sure the clutch spins freely in one direction.



## TORQMASTER CLUTCH PAK SELECTION GUIDE

## CLUTCHES

## Spreader

FRICION CLUTCH PART NO.	OVERRUNNING CLUTCH PART NO.	540 RPM IN•LB•TORQUE	1000 RPM IN•LB•TORQUE
CAPACITY: Less than 240 Bushels or 150 cu.ft.			
PTO 57012000	PTO 57112000	12000	-
CAPACITY: Between 241-400 Bushels or 151-250 cu.ft.			
PTO 57012000	PTO 57112000	-	12000
PTO 57015000	PTO 57115000	15000	-
CAPACITY: Between 401-560 Bushels or 251-350 cu.ft.			
PTO 57015000	PTO 57115000	-	15000
PTO 57018000	PTO 57118000	18000	-
CAPACITY: Greater than 560 Bushels or 350 cu.ft.			
PTO 57018000	PTO 57118000	-	18000
PTO 57018000	PTO 57118000	18000	-

## Mixer

FRICION CLUTCH PART NO.	OVERRUNNING CLUTCH PART NO.	540 RPM IN•LB•TORQUE	1000 RPM IN•LB•TORQUE
CAPACITY: Less than 240 Bushels or 150 cu.ft.			
PTO 57012000	PTO 57112000	12000	-
CAPACITY: Between 241-400 Bushels or 151-250 cu.ft.			
PTO 57012000	PTO 57112000	-	12000
PTO 57015000	PTO 57115000	15000	-
CAPACITY: Between 401-560 Bushels or 251-350 cu.ft.			
PTO 57015000	PTO 57115000	-	15000
PTO 57018000	PTO 57118000	18000	-
CAPACITY: Greater than 560 Bushels or 350 cu.ft.			
PTO 57018000	PTO 57118000	-	18000
PTO 57018000	PTO 57118000	18000	-

## Snowblowers

FRICION CLUTCH PART NO.	540 RPM IN•LB•TORQUE	1000 RPM IN•LB•TORQUE
WIDTH OF CUT: Less than 60"		
PTO 57012000	-	12000
PTO 57015000	15000	-
WIDTH OF CUT: 61" - 70"		
PTO 57015000	-	15000
PTO 57018000	18000	-
WIDTH OF CUT: 71" - 80"		
PTO 57018000	-	18000
PTO 57018000	18000	-
WIDTH OF CUT: 81" - 90"		
PTO 57018000	N/A	18000
WIDTH OF CUT: Greater than 90"		
PTO 57018000	N/A	18000

## Mower Conditioner

FRICION CLUTCH PART NO.	OVERRUNNING CLUTCH PART NO.	540 RPM IN•LB•TORQUE	1000 RPM IN•LB•TORQUE
SICKLE BAR: Less than 10 feet			
PTO 57012000	PTO 57112000	12000	-
SICKLE BAR: 10 - 13 feet			
PTO 57012000	PTO 57112000	-	12000
PTO 57015000	PTO 57115000	15000	-
SICKLE BAR: 14 - 17 feet			
PTO 57015000	PTO 57115000	-	15000
PTO 57018000	PTO 57118000	18000	-

FRICION CLUTCH PART NO.	OVERRUNNING CLUTCH PART NO.	540 RPM IN•LB•TORQUE	1000 RPM IN•LB•TORQUE
ROTARY DISC: Less than 10 feet			
PTO 57012000	PTO 57112000	-	12000
ROTARY DISC: 11 - 13 feet			
PTO 57015000	PTO 57115000	-	15000
ROTARY DISC: 14 - 17 feet			
PTO 57018000	PTO 57118000	-	18000

## Rotary Cutter

## 1 Clutch/Machine

FRICION CLUTCH PART NO.	OVERRUNNING CLUTCH PART NO.	540 RPM IN•LB•TORQUE	1000 RPM IN•LB•TORQUE
DECK WIDTH: 4 - 7 feet			
PTO 5709000	PTO 5719000	-	9000
PTO 57012000	PTO 57112000	12000	-
DECK WIDTH: 8 - 13 feet			
PTO 57012000	PTO 57112000	-	12000
PTO 57015000	PTO 57115000	15000	-
DECK WIDTH: 14 - 16 feet			
PTO 57015000	PTO 57115000	-	15000
PTO 57018000	PTO 57118000	18000	-
DECK WIDTH: 17 - 20 feet			
PTO 57018000	PTO 57118000	-	18000
PTO 57018000	PTO 57118000	18000	-
DECK WIDTH: Larger than 20 feet			
PTO 57018000	PTO 57118000	-	18000
SECTION WIDTH: 4 - 6 feet			
PTO 5709000	PTO 5709000	-	9000
PTO 57012000	PTO 57112000	12000	-
SECTION WIDTH: Greater than 6 feet			
PTO 57012000	PTO 57112000	-	12000
PTO 57015000	PTO 57115000	15000	-

**TORQMASTER CLUTCH PAK SELECTION GUIDE**

**CLUTCHES**

**Flail Shredder**

FRICION CLUTCH PART NO.	OVERRUNNING CLUTCH PART NO.	540 RPM IN•LB•TORQUE	1000 RPM IN•LB•TORQUE
Less than 10 feet			
PTO 57015000	PTO 57115000	-	15000
PTO 57018000	PTO 57118000	18000	-
10 - 15 feet			
PTO 57018000	PTO 57118000	-	18000
PTO 57018000	PTO 57118000	18000	-
Greater than 15 feet			
PTO 57018000	-	-	18000

**Round Baler**

FRICION CLUTCH PART NO.	OVERRUNNING CLUTCH PART NO.	540 RPM IN•LB•TORQUE	1000 RPM IN•LB•TORQUE
BALE WEIGHT: Less than 600 lbs.			
PTO 57012000	PTO 57112000	12000	-
BALE WEIGHT: 600 - 1500 lbs.			
PTO 57012000	PTO 57112000	-	12000
PTO 57015000	PTO 57115000	15000	-
BALE WEIGHT - 1501-2500 lbs.			
PTO 57012000	PTO 57112000	-	12000
PTO 57018000	PTO 57118000	18000	-

**Grain Cart**

FRICION CLUTCH PART NO.	OVERRUNNING CLUTCH PART NO.	540 RPM IN•LB•TORQUE	1000 RPM IN•LB•TORQUE
PTO 57012000	PTO 57112000	12000	-
Up to 750 Bushels			
PTO 57015000	PTO 57115000	15000	-
Above 750 Bushels			
PTO 57018000	PTO 57118000	18000	-

\*If you have an implement that does NOT appear in the above Clutch Pak Selection Guide, use the following chart as a general guideline for selecting the proper Clutch Pak.

NORTH AMERICAN	METRIC	PART NO.
14 Series	Bondioli & Pavesi 4 Series Walterscheid 2300 Series	PTO 57012000
35 Series	Bondioli & Pavesi 5 Series Walterscheid 2400 Series	PTO 57015000
44 Series	Bondioli & Pavesi 6 & 7 Series Walterscheid II Series	PTO 57018000
55 Series	Bondioli & Pavesi 8 Series Walterscheid 2500 & 2600 Series	PTO 57018000

\*See Page 134 for Clutch Pak ordering information.

**Clutch Pak Product Information**

**Adjustment detail - 7" and 9" Clutch Paks**

- No spring adjustment required.
- Tighten bolts to 30 ft-lbs (max).

You will find some overlap within an implement category in the Clutch Pak Selection Guide. The operator will generally know if he has a heavy duty or light duty application. If in doubt, always protect the driveline...refer to the "general guideline for selecting proper clutch pak" on this page.

# NORTH AMERICAN SECTION

## CLUTCH COMPONENTS

### CLUTCHES

#### TorQmaster Clutch Paks 7" & 9"

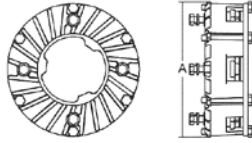

CLUTCH PAK PART NO.	OVERRUNNING CLUTCH PART NO.	in • lbs	DIM "A"
PTO 5709000	PTO 5719000	9000	7"
PTO 57012000	PTO 57112000	12000	7"
PTO 57015000	PTO 57115000	15000	7"
PTO 57018000	PTO 57118000	18000	7"
PTO 59010000	PTO 59110000	10000	9.36"
PTO 59015000	PTO 59115000	15000	9.36"
PTO 59018000	PTO 59118000	18000	9.36"
PTO 59021000	PTO 59121000	21000	9.36"

NOTE: Torqmaster clutch paks must be used with mating Torqmaster yoke that has same flange configuration only.

#### 14 Series

##### Clamp Yoke

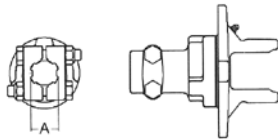

CLAMP YOKE PART NO.	OVERRUNNING CLAMP YOKE PART NO.	DIM "A" BORE
PTO 8171406	PTO 8181406	1 3/8" x 6 Spl.
PTO 8171421	PTO 8181421	1 3/8" x 21 Spl.

##### Clamp Yoke

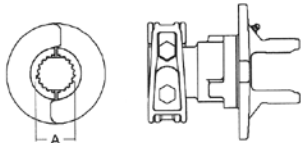

CLAMP YOKE PART NO.	OVERRUNNING CLAMP YOKE PART NO.	DIM "A" BORE
PTO 8171420	PTO 8181420	1 3/4" x 20 Spl.

##### Auto-Lok Yoke

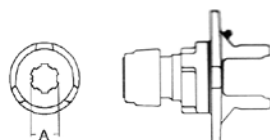

AUTO-LOK YOKE PART NO.	OVERRUNNING AUTO-LOK YOKE PART NO.	DIM "A" BORE
PTO 8201406	PTO 8211406	1 3/8" x 6 Spl.
PTO 8201420	PTO 8211420	1 3/4" x 20 Spl.
PTO 8201421	PTO 8211421	1 3/8" x 21 Spl.

#### 14 Series (Cont'd)

##### Round Bore Yoke

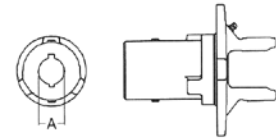

ROUND BORE YOKE PART NO.	OVERRUNNING ROUND BORE YOKE PART NO.	DIM "A" BORE W/ KEYWAY & SETSCREW
PTO 8251420	PTO 8261420	1 1/4" Rd.
PTO 8251422	PTO 8261422	1 3/8" Rd.

#### 35 Series

##### Clamp Yoke

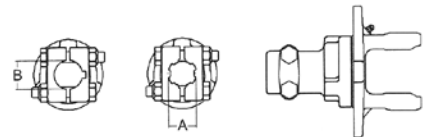

CLAMP YOKE PART NO.	OVERRUNNING CLAMP YOKE PART NO.	DIM "A" BORE	DIM "B" BORE W/ KEYWAY
PTO 8173506	PTO 8183506	1 3/8" x 6 Spl.	-
PTO 8173521	PTO 8183521	1 3/8" x 21 Spl.	-
PTO 8173524	PTO 8183524	-	1 1/2" Rd.

##### Clamp Yoke

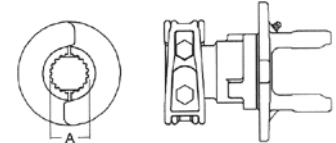

CLAMP YOKE PART NO.	OVERRUNNING CLAMP YOKE PART NO.	DIM "A" BORE
PTO 8173520	PTO 8183520	1 3/4" x 20 Spl.

##### Auto-Lok Yoke

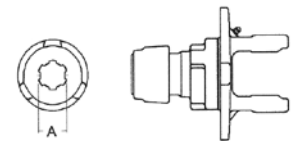

AUTO-LOK YOKE PART NO.	OVERRUNNING AUTO-LOK YOKE PART NO.	DIM "A" BORE
PTO 8203506	PTO 8213506	1 3/8" x 6 Spl.
PTO 8203520	PTO 8213520	1 3/4" x 20 Spl.
PTO 8203521	PTO 8213521	1 3/8" x 21 Spl.

**CLUTCH COMPONENTS**

**CLUTCHES**

**14 Series (Cont'd)**

**Round Bore Yoke**

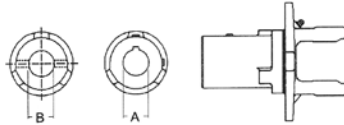

ROUND BORE YOKE PART NO.	OVERRUNNING ROUND BORE YOKE PART NO.	DIM "A" BORE W/ KEYWAY & SETSCREW	DIM "B" BORE W/ 3/8" PINHOLE
PTO 8253520	PTO 8263520	1 1/4" Rd. Dbl. KW	-
PTO 8253522	PTO 8263522	1 3/8" Rd.	-
PTO 8253524	PTO 8263524	1 1/2" Rd.	-
PTO 8273528	PTO 8263528	-	1 3/4" Rd.

**44 Series**

**Clamp Yoke**

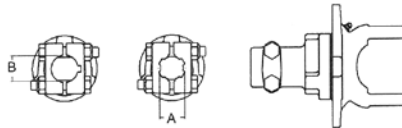

CLAMP YOKE PART NO.	OVERRUNNING CLAMP YOKE PART NO.	DIM "A"	DIM "B" W/KEYWAY
PTO 8174406	PTO 8184406	1 3/8" x 6 Spl.	-
PTO 8174421	PTO 8184421	1 3/8" x 21 Spl.	-
PTO 8174424	PTO 8184424	-	1 1/2" Rd.

**Clamp Yoke**

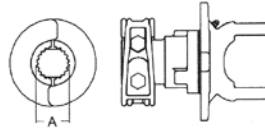

CLAMP YOKE PART NO.	OVERRUNNING CLAMP YOKE PART NO.	DIM "A" BORE
PTO 8174420	PTO 8184420	1 3/4" x 20 Spl.

**Auto-Lok Yoke**

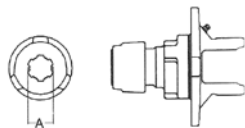

AUTO-LOK YOKE PART NO.	OVERRUNNING AUTO-LOK YOKE PART NO.	DIM "A" BORE
PTO 8204406	PTO 8214406	1 3/8" x 6 Spl.
PTO 8204420	PTO 8214420	1 3/4" x 20 Spl.
PTO 8204421	PTO 8214421	1 3/8" x 21 Spl.

**Round Bore Yoke**

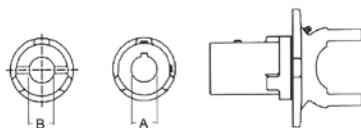

ROUND BORE YOKE PART NO.	OVERRUNNING ROUND BORE YOKE PART NO.	DIM "A" BORE W/ KEYWAY & SETSCREW	DIM "B" BORE W/ 3/8" PINHOLE
PTO 8254420	PTO 8264420	1 1/4" Rd.	-
PTO 8254422	PTO 8264422	1 3/8" Rd.	-
PTO 8274432	N/A	-	2" Rd.

**55 Series**

**Clamp Yoke**

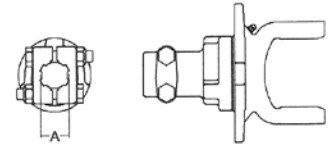

CLAMP YOKE PART NO.	OVERRUNNING CLAMP YOKE PART NO.	DIM "A" BORE
PTO 8175506	PTO 8185506	1 3/8" x 6 Spl.
PTO 8175521	PTO 8185521	1 3/8" x 21 Spl.

**Clamp Yoke**

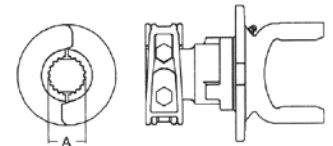

CLAMP YOKE PART NO.	OVERRUNNING CLAMP YOKE PART NO.	DIM "A" BORE
PTO 8175520	PTO 8185520	1 3/4" x 20 Spl.
PTO 8175527	PTO 8185527	1 3/4" x 27 Spl.

**Auto-Lok Yoke**

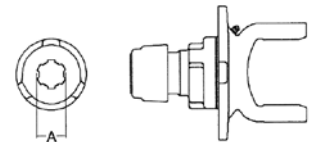

AUTO-LOK YOKE PART NO.	OVERRUNNING AUTO-LOK YOKE PART NO.	DIM "A" BORE
PTO 8205506	PTO 8215506	1 3/8" x 6 Spl.
PTO 8205520	PTO 8215520	1 3/4" x 20 Spl.
PTO 8205521	PTO 8215521	1 3/8" x 21 Spl.

**Round Bore Yoke**

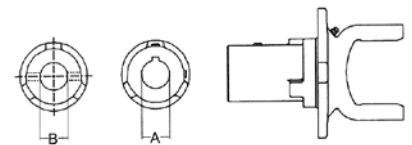

ROUND BORE YOKE PART NO.	OVERRUNNING ROUND BORE YOKE PART NO.	DIM "A" BORE W/ KEYWAY & SETSCREW	DIM "B" BORE W/ 3/8" PINHOLE
PTO 8255522	PTO 8265522	1 3/8" Rd.	-
PTO 8255528	PTO 8265528	1 3/4" Rd.	-
PTO 8275532	N/A	-	2" Rd.

# METRIC SECTION

## CLUTCHES

### CLUTCH COMPONENTS

#### TorQmaster Clutch Paks 7" & 9"

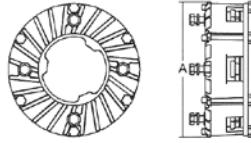

CLUTCH PAK PART NO.	OVERRUNNING CLUTCH PART NO.	in • lbs	DIM "A"
PTO 5709000	PTO 5719000	9000	7"
PTO 57012000	PTO 57112000	12000	7"
PTO 57015000	PTO 57115000	15000	7"
PTO 57018000	PTO 57118000	18000	7"
PTO 59010000	PTO 59110000	10000	9.36"
PTO 59015000	PTO 59115000	15000	9.36"
PTO 59018000	PTO 59118000	18000	9.36"
PTO 59021000	PTO 59121000	21000	9.36"

NOTE: Torqmaster clutch paks must be used with mating Torqmaster yoke that has same flange configuration only.

Interchanges with:  
Walterscheid 1480 Series Neapco 2600 Series

#### Clamp Yoke

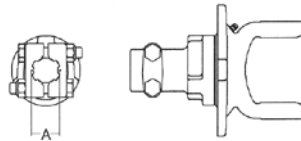

CLAMP YOKE PART NO.	OVERRUNNING CLAMP YOKE PART NO.	DIM "A" BORE
PTO 8172606	PTO 8182606	1 3/8" x 6 Spl.
PTO 8172621	PTO 8182621	1 3/8" x 21 Spl.

#### Clamp Yoke

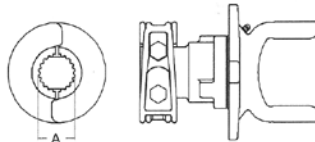

CLAMP YOKE PART NO.	OVERRUNNING CLAMP YOKE PART NO.	DIM "A" BORE
PTO 8172620	PTO 8182620	1 3/4" x 20 Spl.

Interchanges with:  
Walterscheid 1480 Series Neapco 2600 Series

#### Round Bore Yoke



ROUND BORE YOKE PART NO.	OVERRUNNING ROUND BORE YOKE PART NO.	DIM "A" BORE W/ KEYWAY & SET SCREW
PTO 8252622	PTO 8262622	1 3/8" Rd.

Interchanges with:  
Bondioli & Pavesi 2 Series, Walterscheid 2200 Series

#### Ratchet Clutch

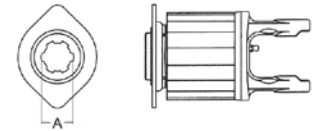

PART NO.	TYPE	DIM "A" BORE W/KEYWAY & CLUTCH SETTING	SET SCREW
PTO 5708206	Spring Lock	2600 in-lbs.	1 3/8" x 6 Spl.

Interchanges with:  
Bondioli & Pavesi 3 Series, Walterscheid I Series

#### Ratchet Clutch

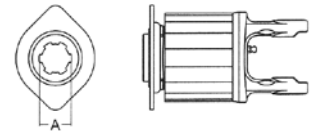

PART NO.	TYPE	CLUTCH SETTING	DIM "A" BORE W/KEYWAY & SET SCREW
PTO 5706306	Spring Lock	5300 in-lbs.	1 3/8" x 6 Spl.

Interchanges with:  
Bondioli & Pavesi 4 Series, Walterscheid 2300 Series

#### Clamp Yoke

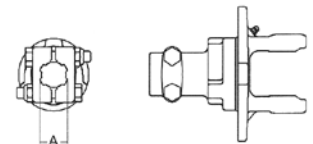

CLAMP YOKE PART NO.	OVERRUNNING CLAMP YOKE PART NO.	DIM "A" BORE W/KEYWAY & SET SCREW
PTO 8178406	PTO 8188406	1 3/8" x 6 Spl.
PTO 8178420	PTO 8188420	1 3/4" x 20 Spl.
PTO 8178421	PTO 8188421	1 3/8" x 21 Spl.

Interchanges with:  
Bondioli & Pavesi 4 Series, Walterscheid 2300 Series

#### Auto-Lok Yoke

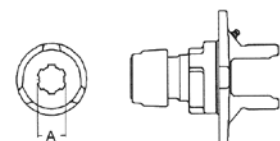

AUTO-LOK YOKE PART NO.	OVERRUNNING AUTO-LOK YOKE PART NO.	DIM "A" BORE
PTO 8208406	N/A	1 3/8" x 6 Spl.

**CLUTCH COMPONENTS**

**CLUTCHES**

*Interchanges with:*  
**Bondioli & Pavesi 4 Series, Walterscheid 2300 Series**

**Round Bore Yoke**

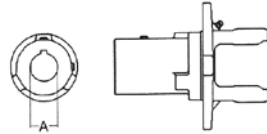

ROUND BORE YOKE PART NO.	OVERRUNNING ROUND BORE YOKE PART NO.	DIM "A" BORE W/ KEYWAY & SET SCREW
PTO 8258422	PTO 8268422	1 3/8" Rd.

*Interchanges with:*  
**Bondioli & Pavesi 4 Series, Walterscheid 2300 Series**

**Friction Clutch**

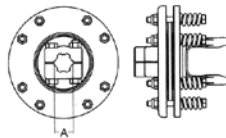

PART NO.	TYPE	CLUTCH SETTING	DIM "A" BORE
PTO 5608406	Dbl. Clamp	8000 in-lbs.	1 3/8" x 6 Spl.

*Interchanges with:*  
**Bondioli & Pavesi 4 Series, Walterscheid 2300 Series**

**Ratchet Clutch**

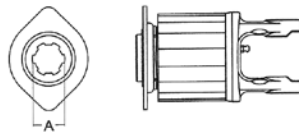

PART NO.	TYPE	CLUTCH SETTING	DIM "A" BORE
PTO 5708406	Spring Lock	8000 in-lbs.	1 3/8" x 6 Spl.

*Interchanges with:*  
**Bondioli & Pavesi 4 Series, Walterscheid 2300 Series**

**OVERRUNNING Clutch  
(Free-Wheel Clockwise)**

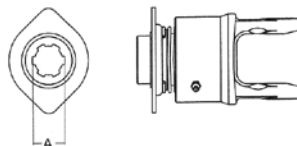

PART NO.	TYPE	CLUTCH SETTING	DIM "A" BORE
PTO 5808406	Spring Lock	N/A	1 3/8" x 6 Spl.

*Interchanges with:*  
**Bondioli & Pavesi 5 Series**

**Clamp Yoke**

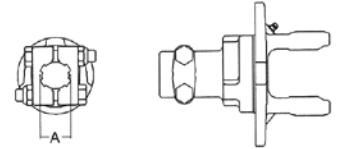

CLAMP YOKE PART NO.	OVERRUNNING CLAMP YOKE PART NO.	DIM "A" BORE
PTO 8176506	PTO 8186506	1 3/8" x 6 Spl.
PTO 8176520*	PTO 8186520	1 3/4" x 20 Spl.
PTO 8176521	PTO 8186521	1 3/8" x 21 Spl.

*\*For correct picture please refer to Walterscheid 1480 Series PTO 8172620*

*Interchanges with:*  
**Bondioli & Pavesi 5 Series**

**Round Bore Yoke**

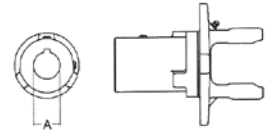

ROUND BORE YOKE PART NO.	OVERRUNNING ROUND BORE YOKE PART NO.	DIM "A" BORE W/ KEYWAY & SET SCREW
PTO 8256522	PTO 8266522	1 3/8" Rd.
PTO 8256524	PTO 8266524	1 1/2" Rd.

*Interchanges with:*  
**Bondioli & Pavesi 5 Series**

**Friction Clutch**

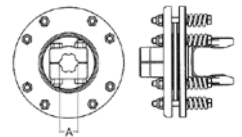

PART NO.	TYPE	CLUTCH SETTING	DIM "A" BORE
PTO 5606506	Dbl. Clamp	8000 in-lbs.	1 3/8" x 6 Spl.

*Interchanges with:*  
**Bondioli & Pavesi 5 Series**

**Ratchet Clutch  
(3 & 4 Row)**

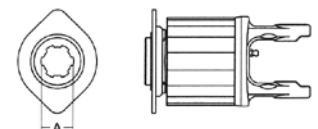

PART NO.	TYPE	CLUTCH SETTING	DIM "A" BORE
PTO 5706506	Spring Lock	8000 in-lbs.	1 3/8" x 6 Spl.

**CLUTCH COMPONENTS**

**CLUTCHES**

*Interchanges with:*  
Bondioli & Pavesi 6 Series, Walterscheid 220 Series

**Clamp Yoke**

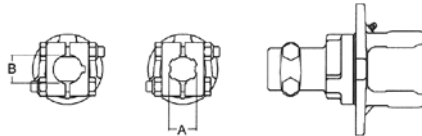

CLAMP YOKE PART NO.	OVERRUNNING CLAMP YOKE PART NO.	DIM "A" BORE	DIM "B" BORE W/KEYWAY & SET SCREW
PTO 8178606	PTO 8188606	1 3/8" x 6 Spl.	-
PTO 8178620*	PTO 8188620	1 3/4" x 20 Spl.	-
PTO 8178621	PTO 8188621	1 3/8" x 21 Spl.	-
PTO 8178624	PTO 8188624	-	1 1/2" Rd.
PTO 8178628	PTO 8188628	1 3/4" x 6 Spl.	-

\*For correct picture please refer to Walterscheid 2400 Series PTO 8177620.

*Interchanges with:*  
Bondioli & Pavesi 6 Series, Walterscheid 220 Series

**Round Bore Yoke**

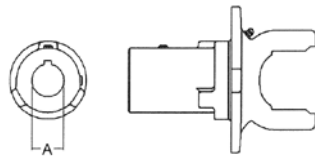

ROUND BORE YOKE PART NO.	OVERRUNNING ROUND BORE YOKE PART NO.	DIM "A" BORE W/ KEYWAY & SET SCREW
PTO 8258622	PTO 8268622	1 3/8" Rd.
PTO 8258624	PTO 8268624	1 1/2" Rd.

*Interchanges with:*  
Bondioli & Pavesi 6 Series, Walterscheid 220 Series

**Friction Clutch**

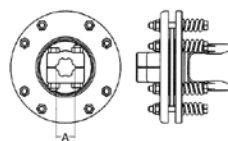

PART NO.	TYPE	CLUTCH SETTING	DIM "A" BORE
PTO 5608606	DbL. Clamp	11,125 in.-lbs.	1 3/8" x 6 Spl.

*Interchanges with:*  
Bondioli & Pavesi 6 Series, Walterscheid 220 Series

**Overrunning Clutch (Free-Wheel Clockwise)**

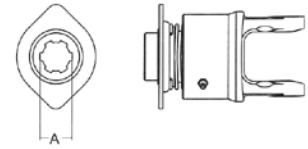

PART NO.	TYPE	CLUTCH SETTING	DIM "A" BORE
PTO 5808606	Spring Lock	N/A	1 3/8" x 6 Spl.

*Interchanges with:*  
Bondioli & Pavesi 8 Series

**Clamp Yoke**

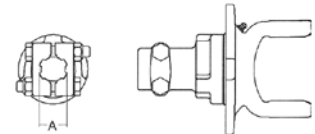

CLAMP YOKE PART NO.	OVERRUNNING CLAMP YOKE PART NO.	DIM "A" BORE W/KEYWAY & SET SCREW
PTO 8176806	PTO 8186806	1 3/8" x 6 Spl.
PTO 8176821	PTO 8186821	1 3/8" x 21 Spl.

*Interchanges with:*  
Bondioli & Pavesi 8 Series

**Clamp Yoke**

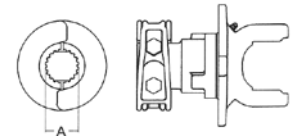

CLAMP YOKE PART NO.	OVERRUNNING CLAMP YOKE PART NO.	DIM "A" BORE
PTO 8176820	PTO 8186820	1 3/4" x 20 Spl.
PTO 8176828	PTO 8186828	1 3/4" x 6 Spl.

*Interchanges with:*  
Bondioli & Pavesi 8 Series

**Round Bore Yoke**

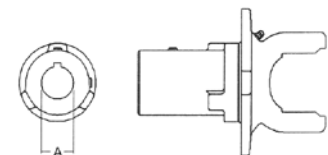

ROUND BORE YOKE PART NO.	OVERRUNNING ROUND BORE YOKE PART NO.	DIM "A" BORE W/KEYWAY & SET SCREW
PTO 8256822	PTO 8266822	1 3/8" Rd.

**CLUTCH COMPONENTS**

**CLUTCHES**

*Interchanges with:*  
**Walterscheid 2400 Series**

**Round Bore Yoke**

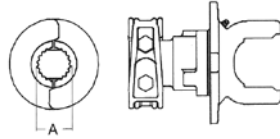

ROUND BORE YOKE PART NO.	OVERRUNNING ROUND BORE YOKE PART NO.	DIM "A" BORE W/KEYWAY & SET SCREW
PTO 8257622	PTO 8267622	1 3/8" Rd.
PTO 8257628	PTO 8267628	1 3/4" Rd.

*Interchanges with:*  
**Walterscheid 2500 Series**

**Clamp Yoke**

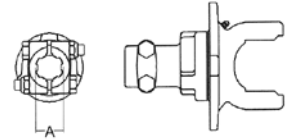

CLAMP YOKE PART NO.	OVERRUNNING CLAMP YOKE PART NO.	DIM "A" BORE
PTO 8177906	PTO 8187906	1 3/8" x 6 Spl.
PTO 8177921	PTO 8187921	1 3/8" x 21 Spl.

*Interchanges with:*  
**Walterscheid 2400 Series**

**Clamp Yoke**

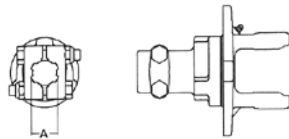

CLAMP YOKE PART NO.	OVERRUNNING CLAMP YOKE PART NO.	DIM "A" BORE
PTO 8177606	PTO 8187606	1 3/8" x 6 Spl.
PTO 8177621	PTO 8187621	1 3/8" x 21 Spl.

*Interchanges with:*  
**Walterscheid 2500 Series**

**Clamp Yoke**

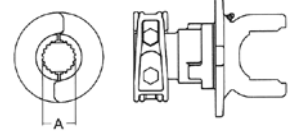

CLAMP YOKE PART NO.	OVERRUNNING CLAMP YOKE PART NO.	DIM "A" BORE
PTO 8177920	PTO 8187920	1 3/4" x 20 Spl.

*Interchanges with:*  
**Walterscheid 2400 Series**

**Clamp Yoke**

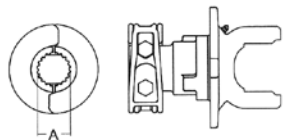

CLAMP YOKE PART NO.	OVERRUNNING CLAMP YOKE PART NO.	DIM "A" BORE
PTO 8177620	PTO 8187620	1 3/4" x 20 Spl.

*Interchanges with:*  
**Walterscheid 2500 Series**

**Round Bore Yoke**

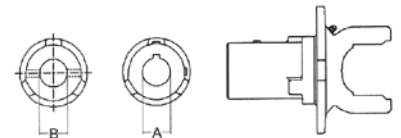

ROUND BORE YOKE PART NO.	OVERRUNNING ROUND BORE YOKE PART NO.	DIM "A" BORE W/KEYWAY & SET SCREW	DIM "B" BORE WITH 3/8" PINHOLE
PTO 8257922	PTO 8267922	1 3/8" Rd.	-
PTO 8257928	PTO 8267928	1 3/4" Rd.	-
PTO 8277932	N/A	-	2" Rd.

*Interchanges with:*  
**Walterscheid 2400 Series**

**Overrunning Clutch**  
(Free-Wheel Clockwise)

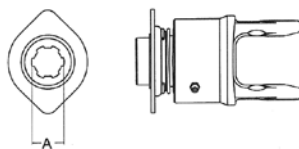

PART NO.	TYPE	CLUTCH SETTING	DIM "A" BORE
PTO 5807606	Spring Lock	N/A	1 3/8" x 6 Spl.



**CLUTCH COMPONENTS**

**CLUTCHES**

**Universal Friction Clutch**

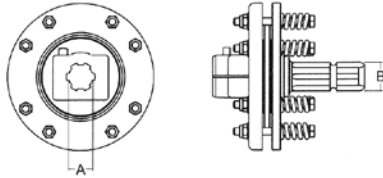

PART NO.	DIM "A"	CLUTCH SETTING	DIM "B" BORE
PTO 5606006	1 3/8" x 6 Spl.	8000 in-lbs.	1 3/8" x 6 Spl.
PTO 5606020	1 1/4" Rd.	8000 in-lbs.	1 3/8" x 6 Spl.
PTO 5606022	1 3/8" Rd.	8000 in-lbs.	1 3/8" Rd.
PTO 5606606	1 3/8" x 6 Spl.	6675 in-lbs.	1 3/8" x 6 Spl.
PTO 5600622	1 3/8" Rd.	8000 in-lbs.	1 3/8" x 6 Spl.

**Friction Disc**

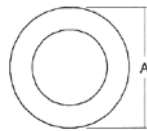

PART NO.	DIM "A" O.D.
PTO 9707000	6.20"
PTO 9709000	7.95"
PTO 9700153	6.02"
PTO 9704140	5.12"
PTO 9704160	6.30"
PTO 9706000	5.25"

**Spring 7" and 9"**

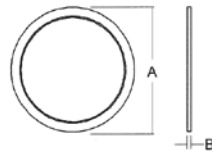

PART NO.	DIM "A" O.D.	DIM "B" THICKNESS
PTO 9879000	6.188"	.138"
PTO 98712000	6.188"	.158"
PTO 98715000	6.188"	.169"
PTO 98718000	6.188"	.189"
PTO 98910000	8.00"	.158"
PTO 98915000	7.81"	.169"
PTO 98918000	7.87"	.189"
PTO 98921000	7.75"	.89"

**Separator Plate 7" and 9"**

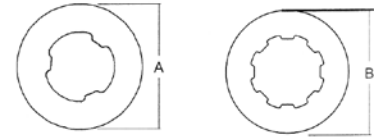

SEPARATOR PLATE PART NO.	OVERRUNNING SEPARATOR PLATE PART NO.	DIM "A" OD	DIM "B" OD
PTO 9907000	-	6.20"	-
-	PTO 9917000	-	6.20"
PTO 9909000	-	8.07"	-
-	PTO 9919000	-	8.07"
PTO 5600622	1 3/8" Rd.	8000 in-lbs.	1 3/8" x 6 Spl.

**Overrunning Clutch Repair Kit 7" and 9"**

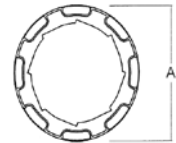

PART NO.	DIM "A" O.D.
PTO 9807000	(1) Overrunning Collar (2) Dogs (2) Leaf Springs (1) Wave Spring (1) Washer (1) Retaining Ring (1) Assembly/Disassembly Instructions

## SHEARBOLT CLUTCHES

Economical protection of equipment drivelines & gearboxes. Retrofit to existing drivelines. 1 3/8" 6 spline female.

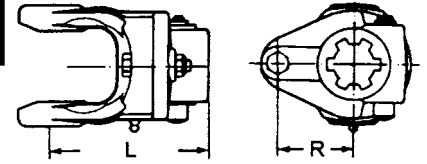

### To Fit Walterscheid

AGDRIVE SERIES	PART NO.	L	R	BOLT SIZE	TORQUE	WILL ADAPT TO
AW20	PTO AK2200426	123 mm	42 mm	M6	6,800 lbs.	Walterscheid 2200 Series
AW21	PTO AK4210487	133 mm	48 mm	M7	10,600 lbs.	Walterscheid 2300 Series
AW35	PTO AK3500487	136 mm	48 mm	M7	10,600 lbs.	Walterscheid 2400 Series
AW35	PTO AK3500568	136 mm	56 mm	M8	16,200 lbs.	Walterscheid 2400 Series
AW23	PTO AK7230561	143 mm	56 mm	M10	25,500 lbs.	
AW24	PTO AK8240561	143 mm	56 mm	M10	25,500 lbs.	
AW36	PTO AK3600561	143 mm	56 mm	M10	25,500 lbs.	

### To Fit Bondioli & Pavesi

AGDRIVE SERIES	PART NO.	L	R	BOLT SIZE	TORQUE	WILL ADAPT TO
AB2	PTO AK2200426	123 mm	42 mm	M6	6,800 lbs.	Bondioli & Pavesi Series 1
AB4	PTO AK4210487	133 mm	48 mm	M7	10,600 lbs.	Bondioli & Pavesi Series 4
AB5	PTO 1046506	136 mm	56 mm	M10	25,500 lbs.	Bondioli & Pavesi Series 5
AB7N	PTO AK7230561	143 mm	56 mm	M10	25,500 lbs.	Bondioli & Pavesi Series 7
AB8	PTO AK8240561	143 mm	56 mm	M10	25,500 lbs.	Bondioli & Pavesi Series 8

## FREEWHEEL (OVERRUNNING) CLUTCHES

- Allows equipment to coast to a stop reducing shock loads on belts, chains, bearings & drivelines.
- Lengthens gearbox life & reduces strain on tractor PTO shaft & braking system.
- Works especially well on equipment utilizing flywheels for centrifugal drive maintenance.
- 1 3/8" x 6 spline female quick detach standard on both units.

### Standard

SHAFT SERIES	PART NO.	L	HP	WILL ADAPT TO
AB4	PTO 5808406	149 mm	28	Bondioli & Pavesi Series 4
AW21	PTO 5808406	149 mm	28	Walterscheid Series 2300
AW22	PTO AK22005	157 mm	65	
AB6	PTO AK22005	157 mm	65	Bondioli & Pavesi Series 6
AB5	PTO AK50005	157 mm	35	Bondioli & Pavesi Series 5

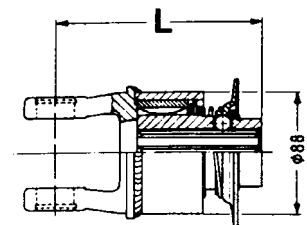

Standard

# FRICTION CLUTCHES

- Provide low maintenance protection for drivelines & gearboxes.
- Protection to roto tiller rotors & post hole digger augers etc.
- Two sizes of friction discs fit all models.
- 8 bolt configuration prevents disc warping & lengthens friction disc life.
- 1 3/8" x 6 spline female coupling is standard.

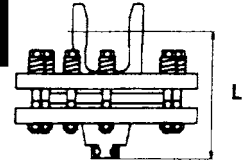

STANDARD CLAMP BOLT CONNECTION

## Standard Clamp Bolt Connection

SHAFT SERIES	PART NO.	L	TORQUE	HP	WILL ADAPT TO
AW23/AB7	PTO AK723125	154	11,000 lbs.		
AW35	PTO AK35125	159	11,000 lbs.	53	Walterscheid Series 2400
AB7N	PTO AK7N200	175	17,600 lbs.	75	Bondioli & Pavesi Series 7
AB5	PTO AK500125	147	7,920 lbs.	47	Bondioli & Pavesi Series 5

## Standard QR Connection

SHAFT SERIES	PART NO.	L	TORQUE	HP	WILL ADAPT TO
AB4	PTO AK210Q90	136	7,920 lbs.	35	Bondioli & Pavesi Series 4

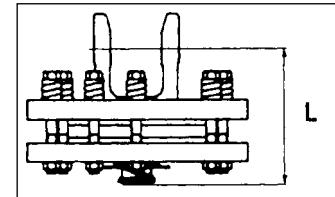

# MAK-A-KEY STEP KEY STOCK

Cold finished. Oversize keystock ground down to A, B-D & C dimensions per tolerances listed below. Use for couplings, gears, sheaves, sprockets, pulleys - anything that keys to a shaft. Available in 12' lengths. Material 1018.

PART NO.	TYPE	DIMENSIONS				WEIGHT lbs./BAR
		A	B	C	D	
HAR 31001	1	3/16"	3/32"	1/8"	1/16"	.088
HAR 31003	2	3/16"	3/32"	1/4"	1/8"	.166
HAR 31004	2	1/4"	1/8"	5/16"	1/8"	.241
HAR 31006	2	1/4"	1/8"	3/8"	3/16"	.347
HAR 31008	1	3/8"	3/16"	5/16"	5/32"	.406
HAR 31011	2	3/8"	3/16"	1/2"	1/4"	.680
HAR 31015	2	1/2"	1/4"	5/8"	5/16"	1.090

See section 4 for pricing.

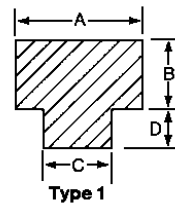

Type 1

### TYPE 1

#### Tolerances

A & C dimensions -.000/+ .002

B/D dimensions -.003/+ .003

B & D dimensions -.004/+ .004

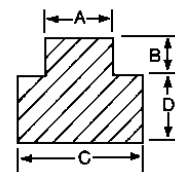

Type 2

### TYPE 2

#### Tolerances

C & A dimensions -.000/+ .002

B/D dimensions -.005/+ .005

B & D dimensions -.005/+ .005

## WIDE ANGLE (CV) JOINTS

- Convert existing equipment to smooth running CV joints.
- Replace worn CV's with complete balanced units.
- Not recommended for 1,000 rpm applications.
- 1 3/8" 6 spline female.

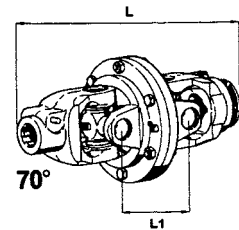
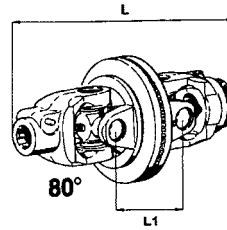

AGDRIVE SERIES	PART NO.	L	L1	TUBE	WILL ADAPT TO
AG21N	PTO AG21002	187	95	AP413	Walterscheid 2300 Outer Profile Tube
AG35	PTO AG35002	315	104	AP484	Walterscheid 2400 Outer Profile Tube

### Parts for Wide Angle CV Joints

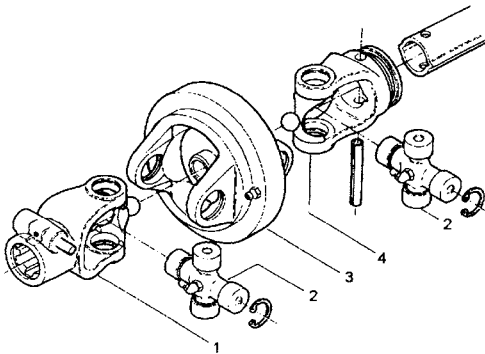

ITEM	PART NO.	SHAFT SERIES	REMARKS
1	PTO AG356138	AG35	1 3/8" (6) Q.D.
2	PTO 2007941	AG21N	27x75x24x91
2	PTO 2007694	AG35	32x76x27x94
4	PTO AG356239	AG35	Fits AP385 tube

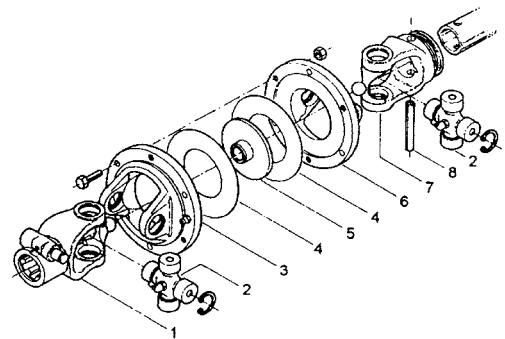

ITEM	PART NO.	SHAFT SERIES	REMARKS
2	PTO 2008474	AG21	27x75
3	PTO AG216900	AG21	145 mm O.D.
4	PTO AG216100	AG21	118 mm O.D.
6	PTO AG216901	AG21	145 mm O.D.
7	PTO AG216241	AG21	Fits AP413 tube
8	PTO 5081065	AP1065	10x65

## REPLACEMENT CLUTCHES

### CLUTCHES

#### BALL SHEAR



**APPLICATIONS:** Spreaders, Rotary Cutters, Balers, Grain Carts, Grain Augers, Snowblowers, Forage Blowers

**BENEFITS:** Minimal maintenance; No damaging heat generation for higher productivity; Repeatable overload setting; Smooth disengaged operation - No damaging torque spikes; Can be applied on implement or tractor shaft in North America.

#### RATCHET



**APPLICATIONS:** Hay Tedders, Round Balers

**BENEFITS:** Repeatable overload setting; Torque pulses while slipping aids in dislodging plugs for increased productivity; Minimal maintenance; Audible operator notification; Compact 4" (102 mm) design.

#### UNIVERSAL/FRICTION



**APPLICATIONS:** Mower Conditioners, Rotary Cutters, Balers, Shredders, Snowblowers, Spreaders, Grain Carts, Mixers

**BENEFITS:** Corrosion resistant friction discs; Minimal maintenance; Smooth operation - No damaging torque spikes; Torque carrying capability while slipping aids in dislodging plugs for increased productivity.

#### OVERRUNNING



**APPLICATIONS:** Grain Carts, Spreaders, Mixers, Shredders, Mower Conditioners, Rotary Cutters

**BENEFITS:** Low-Maintenance; Allows inertia from implement to dissipate without putting load back through the tractor or system.

#### TORQMASTER



**APPLICATIONS:** Spreaders, Rotary Cutters, Shredders, Balers, Grain Carts, Snowblowers, Mower Conditioners, Mixers

**BENEFITS:** Implement overload protection; Minimal maintenance; Isolates and dissipates heat - minimizing downtime for higher productivity; Repeatable overload setting; Corrosion resistant friction discs; Torque carrying capability while slipping aids in dislodging plugs for increased productivity.

**NORTH AMERICAN & METRIC E-KIT DISPLAY**

**MERCHANDISERS**



**North American P-O-P List of Contents**

<u>PART NO.</u>	<u>QTY.</u>	<u>PART NO.</u>	<u>QTY.</u>	<u>PART NO.</u>
PTO 12002400	4	PTO 2010600	10	PTO 2013500
	6	PTO 2011200	2	PTO 2014400
	6	PTO 2011400	2	PTO 2015500

**Metric P-O-P List of Contents**

<u>PART NO.</u>	<u>QTY.</u>	<u>PART NO.</u>	<u>QTY.</u>	<u>PART NO.</u>
PTO 12008400	4	PTO 2016154	2	PTO 2017989
	2	PTO 2016580	2	PTO 2018261
	2	PTO 2016806	2	PTO 2018370
	2	PTO 2017155	8	PTO 2018474
	2	PTO 2017676	2	PTO 2018692

**NORTH AMERICAN DRIVELINE COMPONENT DISPLAY MERCHANDISERS**

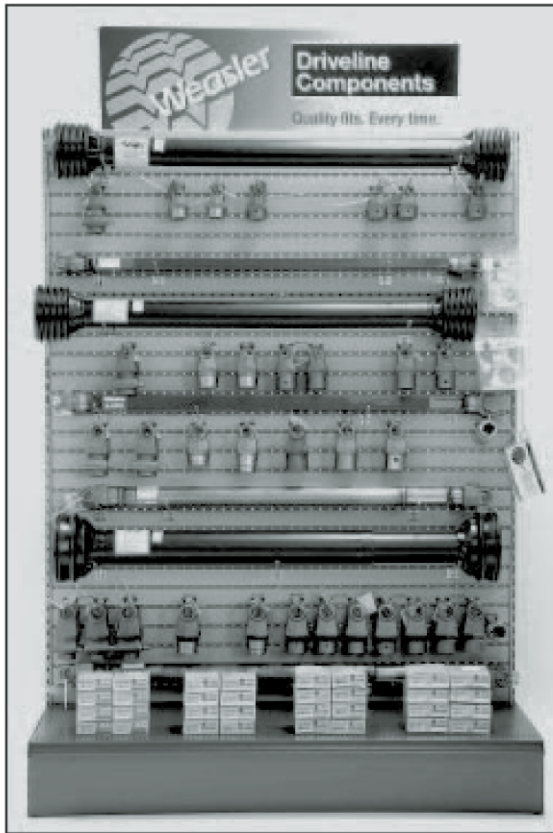

**6 Series**

QTY.	PART NO.
2	PTO 1020606
8	PTO 2000600
2	PTO 3000600
2	PTO 7000600
1	PTO 8000612
4	PTO 8000616
2	PTO 8000620
1	PTO 9002548
1	PTO 9210600
1	PTO 10000648
1	PTO 11000648

**12 Series**

QTY.	PART NO.
2	PTO 1021206
8	PTO 2001200
2	PTO 3001200
2	PTO 7001200
4	PTO 8001216
1	PTO 8001222
2	PTO 8061220
1	PTO 9002548
1	PTO 9211200
1	PTO 10001248
1	PTO 11001248

**14 Series**

QTY.	PART NO.
2	PTO 1001421
2	PTO 1021406
8	PTO 2001400
2	PTO 3001400
1	PTO 5001400
2	PTO 7011400
2	PTO 8001420
2	PTO 8001422
1	PTO 8021422
1	PTO 10001448
1	PTO 11001448

**35 Series**

QTY.	PART NO.
2	PTO 1023506
1	PTO 1023521
8	PTO 2003500
1	PTO 3003500
1	PTO 5003500
1	PTO 7013500
2	PTO 8003520
2	PTO 8003522
2	PTO 8003524
1	PTO 8013506
1	PTO 9002548
1	PTO 9211200
1	PTO 10003548
1	PTO 11003548

PART NO.	DESCRIPTION
PTO 12001000	DISPLAY CENTER

The Weasler Display Center is a dealer merchandiser that makes selling easy. Most parts are on display for convenient visual inventory control as well as quick self-service for the customer.

The 48" x 66" floor fixture contains an inventory of driveline components in the most popular sizes.

Equivalents are available for most competitive brands.

PART NO.	DESCRIPTION
PTO 12002000	DISPLAY CENTER

Includes the same product as No. 12001000, plus an assortment of tubing and shafting in 6' lengths.

QTY.	PART NO.
2	PTO 4001214
2	PTO 4001618
1	PTO 4000019
2	PTO 6001618
2	PTO 6002022
1	PTO 6021400
1	PTO 6023500

**Transparency ID System**

QTY.	PART NO.
1	PTO 12002500

**Header Board w/Hardware**

QTY.	PART NO.
1	PTO 12000001H

**NORTH AMERICAN DRIVELINE COMPONENT DISPLAY  
44/55 SERIES**

**MERCHANDISERS**



PART NO.	DESCRIPTION
PTO 12004000	DISPLAY CENTER

The Weasler Display Center is a dealer merchandiser that makes selling easy. Most parts are on display for convenient visual inventory control as well as quick self-service for the customer.

The 48" x 56" floor fixture contains an inventory of high horsepower driveline components in the most popular sizes. Equivalent parts are available for most competitive brands.

**44 Series**

QTY.	PART NO.
1	PTO 1024406
1	PTO 1024420
1	PTO 1024421
8	PTO 2004400
2	PTO 3004400
2	PTO 5004400
1	PTO 7014400
1	PTO 8004422
2	PTO 8004424
1	PTO 8004428
1	PTO 8014406
2	PTO 9023548
2	PTO 9214400

**55 Series**

QTY.	PART NO.
2	PTO 1025506
1	PTO 1025520
1	PTO 1025521
4	PTO 2005500
2	PTO 3005500
1	PTO 3025500
1	PTO 7015500
1	PTO 8005522
1	PTO 8005524
2	PTO 8005528
1	PTO 8005532

**Locking Repair Kits**

QTY.	PART NO.
1	PTO 13002006
1	PTO 13002020
1	PTO 13002021

**Shafting**

QTY.	PART NO.
1	PTO 4040021
1	PTO 4042720
1	PTO 6044400

**Transparency ID System**

QTY.	PART NO.
1	PTO 12004500

**Header Board w/Hardware**

QTY.	PART NO.
1	PTO 12000004H



**METRIC DRIVELINE COMPONENT DISPLAY**

**MERCHANDISERS**

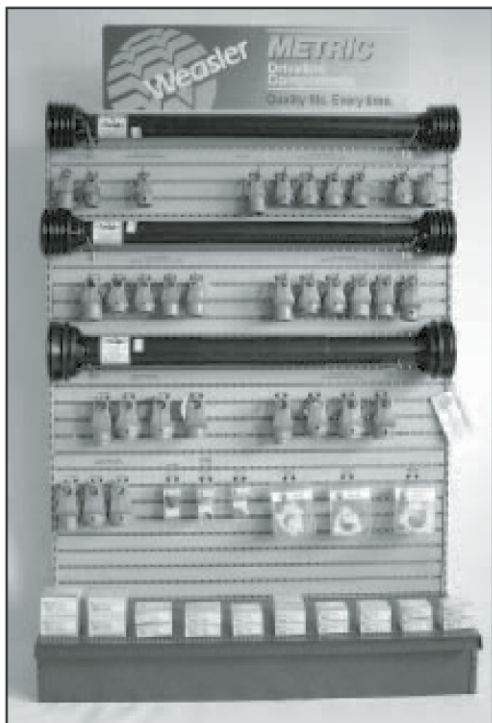

PART NO.	DESCRIPTION
PTO 12008000	DISPLAY CENTER

The Weasler Display Center is a dealer merchandiser that makes selling easy. Most parts are on display for convenient visual inventory control as well as quick self-service for the customer.

The 48" x 66" floor fixture contains an inventory of the most popular sizes, including inner and outer profile tubes.

PART NO.	DESCRIPTION
PTO 12008100	DISPLAY CENTER

The display board includes the items depicted by the display photo above. It does NOT include an assortment of inner and outer profile tubes.

<b>Tractor Yoke</b>	
QTY.	PART NO.
1	PTO 1026106
1	PTO 1026506
1	PTO 1027606
1	PTO 1028206
1	PTO 1028306
1	PTO 1028406
1	PTO 1028606

<b>Lock Yoke Repair Kit</b>	
QTY.	PART NO.
1	PTO 13006121
1	PTO 13007138

<b>Cross &amp; Bearing Kit</b>	
QTY.	PART NO.
2	PTO 2006154
2	PTO 2006580
2	PTO 2006806
2	PTO 2007155
2	PTO 2007676
2	PTO 2007989
2	PTO 2008261
2	PTO 2008370
4	PTO 2008474
2	PTO 2008692

<b>Inner Profile Yoke</b>	
QTY.	PART NO.
1	PTO 3006126
1	PTO 3006229
1	PTO 3006336
1	PTO 3006436
1	PTO 3006545
1	PTO 3006645
1	PTO 3007234
1	PTO 3007639

<b>Roll Pin</b>	
QTY.	PART NO.
1	PTO 5080850
1	PTO 5080860
1	PTO 5080880
1	PTO 5081060
1	PTO 5081065
1	PTO 5081075
1	PTO 5081080
1	PTO 5081090

<b>Outer Profile Yoke</b>	
QTY.	PART NO.
1	PTO 7006236
1	PTO 7006343
1	PTO 7006443
1	PTO 7006552
1	PTO 7006654
1	PTO 7007241
1	PTO 7007648

<b>Implement Yoke</b>	
QTY.	PART NO.
1	PTO 8006510
1	PTO 8008208
1	PTO 8008210
1	PTO 8008310
1	PTO 8008410
1	PTO 8008411
1	PTO 8027110
1	PTO 8027611
1	PTO 8028435

<b>Guard</b>	
QTY.	PART NO.
2	PTO 9002548
1	PTO 9023548

<b>Bearing Kit (2 per kit)</b>	
QTY.	PART NO.
1	PTO 9615005
1	PTO 9615029
1	PTO 9612502
1	PTO 9612534
1	PTO 9613525
1	PTO 9613567

<b>Transparency ID System</b>	
QTY.	PART NO.
1	PTO 12008500

**PTO LOCKING PINS**

PART NO.	DESCRIPTION
PTO 2266	Westward Agri-Pak containing 2 - 5/16" shaft locking pins
PTO 2273	Westward Agri-Pak containing 2 - 3/8" shaft locking pins

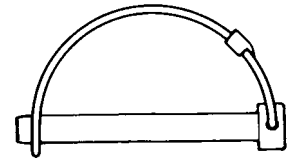

**PTO ADAPTORS**

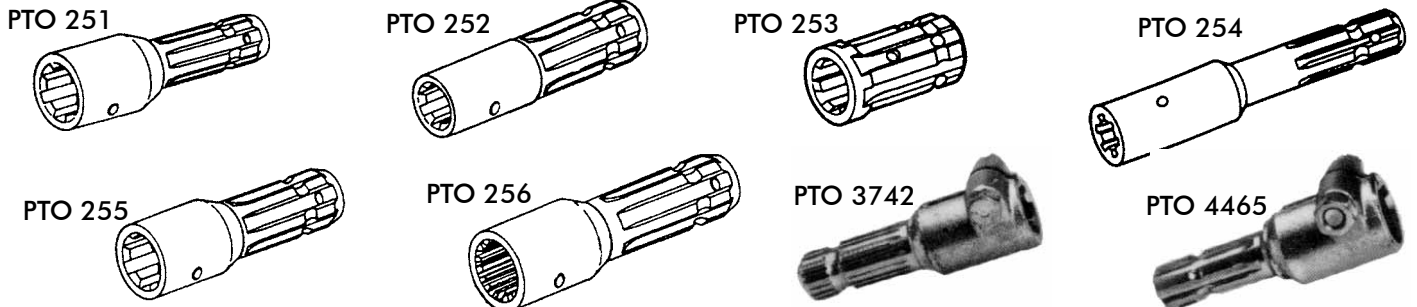

PART NO.	ADAPTOR TYPE	FEMALE SPLINE Ø F	MALE SPLINE Ø M	INCREASES PTO SHAFT LENGTH BY	OVERALL LENGTH	WEIGHT (KG)
PTO 251	Universal Reducer	1 3/8" x 6	1 1/8" x 6	2 7/8" 73 mm	5 3/8" 136 mm	0.76
PTO 252	Long Increaser	1 1/8" x 6	1 3/8" x 6	2 3/4" 70 mm	4 3/4" 121 mm	0.64
PTO 253	Short Increaser	1 1/8" x 6	1 3/8" x 6	1 11/32" 34 mm	3 3/16" 81 mm	0.27
PTO 254	Ext. Adaptors	1 3/8" x 6	1 3/8" x 6	7" 178 mm	9 7/16" 240 mm	1.6
PTO 255	Extension Adaptor	1 3/8" x 6	1 3/8" x 6	4" 102 mm	5 3/4" 146 mm	0.93
PTO 256	21 Spline Adaptor	1 3/8" x 21	1 3/8" x 6	3 1/2" 89 mm	6 1/8" 156 mm	0.94
PTO 3742	Bolt Type	1 3/8" x 6	1 3/8" x 21	4 3/4" 121 mm	6 1/2" 165 mm	1.45
PTO 4465	Bolt Type	1 3/4" x 6	1 3/8" x 6	5" 127 mm	7 7/8" 200 mm	2.85

**NOTE: THERE IS NO WARRANTY ON PTO ADAPTORS.**

**Special PTO Adaptor**

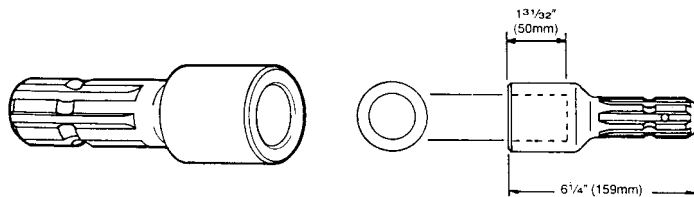

PART NO.	DESCRIPTION
PTO 4895	1" Round with 540 rpm (6 spline)
PTO 4896	1 1/8" Round with 540 rpm (6 spline)
PTO 4897	1 1/4" Round with 540 rpm (6 spline)
PTO 4898	1 3/8" Round with 540 rpm (6 spline)
PTO 4899	1 1/2" Round with 540 rpm (6 spline)

**Quick Release Adaptor**

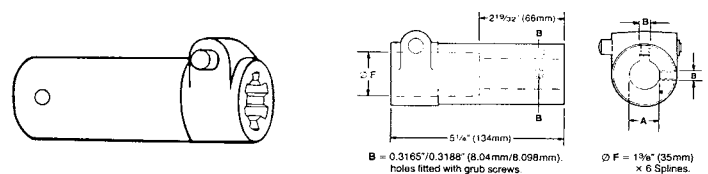

PART NO.	DESCRIPTION
PTO 4900	7/8" Round (A) with 540 rpm (6 spline)
PTO 4901	1" Round (A) with 540 rpm (6 spline)

**NOTE: THERE IS NO WARRANTY ON PTO ADAPTORS.**

# PTO ADAPTORS

## General Purpose Pump Adaptor

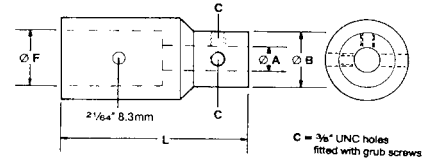
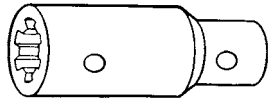

PART NO.	DESCRIPTION	FEMALE SPLINE Ø F			Ø A		Ø B		OVERALL LENGTH		WEIGHT (KG)
PTO 4981	5/8" Round with 540 rpm (6 spline)	1 3/8"	35	6	5/8"	16 mm	1 3/8"	35 mm	4 5/8"	117.5 mm	0.82
PTO 4982	3/4" Round with 540 rpm (6 spline)	1 3/8"	35	6	3/4"	19 mm	1 3/8"	35 mm	4 5/8"	117.5 mm	0.78
PTO 4983	7/8" Round with 540 rpm (6 spline)	1 3/8"	35	6	7/8"	22 mm	1 3/8"	35 mm	4 5/8"	117.5 mm	0.74
PTO 4984	1" Round with 540 rpm (6 spline)	1 3/8"	35	6	1"	25 mm	1 1/2"	38 mm	4 5/8"	117.5 mm	0.66

**NOTE: THERE IS NO WARRANTY ON PTO ADAPTORS.**

# HEAVY DUTY PTO ADAPTORS

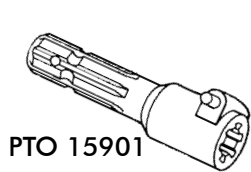

PTO 15901

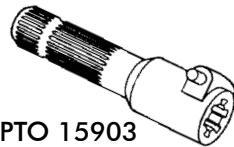

PTO 15903

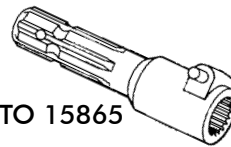

PTO 15865

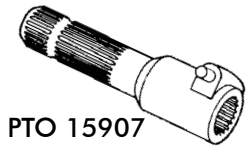

PTO 15907

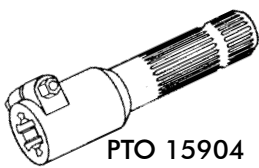

PTO 15904

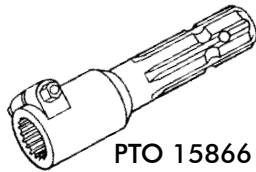

PTO 15866

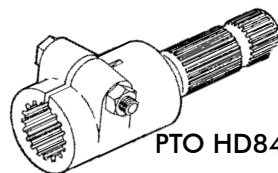

PTO HD8441

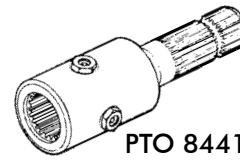

PTO 8441

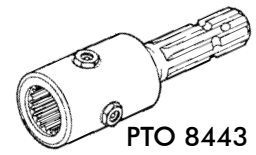

PTO 8443

FEMALE SPLINE Ø F		MALE SPLINE Ø M		QUICK RELEASE	BOLT TYPE	SET SCREW	INCREASES PTO SHAFT LENGTH BY		OVERALL LENGTH		WEIGHT (KG)
1 3/8"	x 6	1 3/8"	x 6	PTO 15901	PTO 15902		4 5/16"	110 mm	6 1/2"	165 mm	1.40
1 3/8"	x 6	1 3/8"	x 21	PTO 15903	PTO 15904		4 3/4"	121 mm	6 1/2"	165 mm	1.45
1 3/8"	x 21	1 3/8"	x 6	PTO 15865	PTO 15866		4 5/16"	110 mm	6 1/2"	165 mm	1.45
1 3/8"	x 21	1 3/8"	x 21	PTO 15907			4 3/4"	121 mm	6 1/2"	165 mm	1.50
1 3/4"	x 20	1 3/8"	x 6			PTO 8443*	5"	127 mm	7 3/8" ØC=2 9/16"	187 mm ØC=65 mm	1.61
1 3/4"	x 20	1 3/8"	x 21			PTO 8441*	5"	127 mm	7 3/8" ØC=2 9/16"	187 mm ØC=65 mm	1.80
1 3/4"	x 20	1 3/8"	x 21		PTO HD8441		5 1/2"	140 mm	7 7/8"	200 mm	3.01
1 3/4"	x 20	1 3/8"	x 6		PTO HD8443		5"	127 mm	7 7/8"	200 mm	2.95

\*Supplied with 2 grub screws & locknuts.

**NOTE: THERE IS NO WARRANTY ON PTO ADAPTORS.**

**PTO ADAPTERS**

**Sleeve Increasers**

PART NO.	FEMALE SPLINE Ø F	MALE SPLINE Ø M	OVERALL LENGTH (A)		WEIGHT (KG)
PTO 249	1 1/8 x 6	1 3/8 x 6	2 3/16"	56 mm	0.10
PTO 250	1 1/8 x 6	1 3/8 x 6	1 7/8"	48 mm	0.08

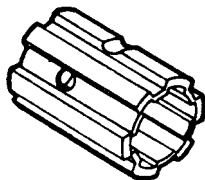

PTO 249

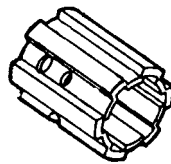

PTO 250

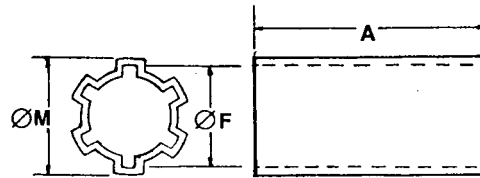

**NOTE: THERE IS NO WARRANTY ON PTO ADAPTORS.**

**Splined Adaptors - To 75 H.P.**

PART NO.	FEMALE SPLINE	MALE SPLINE	LENGTH	EXTENDS PTO	SECURED BY
PTO 0332-00084	25 mm - 18	1 3/8 - 6	4 5/8"	3 1/4"	Cross Pin
PTO 0332-03531*	1 1/8 - 6	1 3/8 - 6	5 1/2"	3 9/16"	Cross Pin
PTO 0332-01354+	1 1/8 - 6	1 3/8 - 6	5 9/16"	4 1/8"	Cross Pin
PTO 0332-00375*	1 1/8 - 6	1 3/8 - 6	10 1/2"	8 13/16"	Cross Pin
PTO 0332-00377*	1 1/8 - 6	1 1/8 - 6	5 1/2"	3 3/4"	Cross Pin
PTO 0332-00400*	1 3/8 - 6	1 1/8 - 6	6 1/2"	4 9/16"	Cross Pin
PTO 0332-00420*	1 3/8 - 6	1 1/8 - 6	5 1/8"	2 13/16"	Cross Pin
PTO 0332-00371*	1 3/8 - 6	1 3/8 - 6	6 1/2"	4 9/16"	Cross Pin
PTO 0332-00378*	1 3/8 - 6	1 3/8 - 6	5 1/8"	2 15/16"	Cross Pin
PTO 0332-00373	1 3/8 - 21	1 3/8 - 6	6 1/2"	4 1/2"	Setscrew
PTO 0332-00070	1 3/8 - 21	1 3/4 - 20	7"	5"	Setscrew
PTO 0332-00401	1 3/4 - 6	1 3/8 - 6	6 1/2"	4 3/4"	Cross Pin
PTO 0332-00406	1 1/8 - 6	1 1/8 - 6	6 1/2"	4 3/4"	Cross Pin

- Capacity to operate on tractors rated to 75 PTO HP.
- Provide a means of connecting two dissimilar splines.
- Welded steel construction for added strength.
- PARCO-LUBRICATED rust preventative finish.
- Cross pins or setscrews furnished.



PTO 0332-03531

\*\*Fits John Deere Model 400, Ariens (New Holland) Model S16 and Bollens Models HT-18 and HT-20.

+Split Hub for Bolt Clamping.

\*Includes PTO Pins.

**NOTE: THERE IS NO WARRANTY ON PTO ADAPTORS.**

## PTO ADAPTERS

### Splined Adaptors - To 125 H.P.

- Capacity to operate on tractors rated to 125 PTO HP.
- Developed for long and rugged use.
- Alloy steel, heat treated for extra strength.
- Withstands high shock loads from tractor or implement.
- PARCO-LUBRICATED rust preventative finish.

PART NO.	FEMALE SPLINE	MALE SPLINE	LENGTH	EXTENDS PTO	SECURED BY
PTO 0332-00001	1 3/8 - 21	1 3/8 - 21	6 7/8"	4 13/16"	Setscrew
PTO 0332-00002	1 3/8 - 21	1 3/8 - 6	6 7/8"	4 13/16"	Setscrew
PTO 0332-00004	1 3/8 - 6	1 3/8 - 21	6 7/8"	4 13/16"	Setscrew
PTO 0332-00005	1 3/8 - 6	1 3/8 - 6	6 7/8"	4 13/16"	Setscrew



PTO 0332-00001

### Kwik-D-Tach Spline Adaptors - To 75 H.P.



PTO 0332-00010

PART NO.	FEMALE SPLINE	MALE SPLINE	LENGTH	EXTENDS PTO
PTO 0332-00010	1 3/8 - 6	1 3/8 - 6	6 1/2"	4 5/16"
PTO 0332-00013	1 3/8 - 6	1 3/8 - 21	6 1/2"	4 5/16"
PTO 0332-00015	1 3/8 - 6	1 1/8 - 6	6 1/2"	4 5/16"
PTO 0332-01373	1 3/8 - 21	1 3/8 - 6	6 1/2"	4 5/16"
PTO 0332-02121	1 3/8 - 21	1 3/8 - 21	6 1/2"	4 5/16"
PTO 0332-00086	Repair Kit			

- Capacity to operate on tractors rated to 75 PTO H.P.
- Patented Quick Release device.
- New PTO Quick Release concept - Spring Loaded - rotates about 30° by hand for quick release.
- Dependable operation - no sticking pins - always easily operated.
- No sharp edges, protrusions, pins or other interferences to injure operators.

### Splined Adaptors - To 75 H.P.

FOR TRACTORS WITH 1 3/4 - 20 SPLINE PTO

PART NO.	FEMALE SPLINE	MALE SPLINE	LENGTH	EXTENDS PTO
PTO 0332-00020	1 3/4 - 20	1 3/8 - 6	8 3/16"	Setscrew
PTO 0332-01476	1 3/4 - 20	1 3/8 - 6	8 3/16"	Clamp
PTO 0332-01477	1 3/4 - 20	1 3/8 - 21	8 3/16"	Clamp



PTO 0332-00020

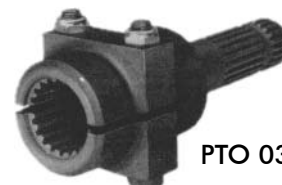

PTO 0332-00077

\*For applications using our standard 0332-00020 and 0332-00021 adaptors where heavy overhung load is a factor such as PTO mounted pumps, etc.

**NOTE: THERE IS NO WARRANTY ON PTO ADAPTORS.**

## PTO ADAPTERS

### Forged PTO Adaptors - To 125 H.P.

FOR TRACTORS WITH 1 3/4 - 20 SPLINE PTO

PART NO.	FEMALE SPLINE	MALE SPLINE	LENGTH	EXTENDS PTO
PTO 0332-01490	1 3/4 - 20	1 3/8 - 6	8 3/16"	Clamp Type
PTO 0332-01491	1 3/4 - 20	1 3/8 - 21	8 3/16"	Clamp Type



\*For applications using our standard 0332-00088 and 0332-00089 adaptors where heavy overhung load is a factor such as PTO mounted pumps, etc.

### Forged PTO Adaptors - To 75 H.P.

- "Forged" internal spline.
- Universal quick-detach slot and bolt holes - can be used with any American, British or European PTO system.
- Furnished with 5/16 x 1 1/16" spring pin for direct connection to PTO.

PART NO.	FEMALE SPLINE	MALE SPLINE	LENGTH	EXTENDS PTO
PTO 0332-00018	1 1/8 - 6	1 3/8 - 6	3"	1 1/8"

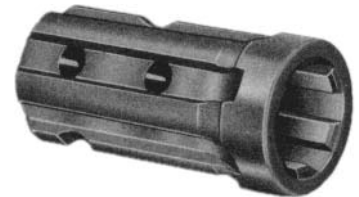

### Push-Pin Type PTO Adaptors - to 75 H.P.

#### QUICK RELEASE EXTENSION ADAPTOR

PART NO.	FEMALE SPLINE	MALE SPLINE	LENGTH	EXTENDS PTO
PTO 0332-00092	1 3/8 - 6	1 3/8 - 21	7 5/16"	5 5/16"
PTO 0332-01375	1 3/8 - 21	1 3/8 - 6	7 5/16"	5 1/8"
PTO 0335-90120	Repair Kit			



### Round Shaft Adaptors - To 75 H.P.

PART NO.	FEMALE ROUND	KEYWAY	MALE SPLINE	LENGTH	EXTENDS SHAFT
PTO 0332-00376	1"	1/4"	1 3/8" - 6	5 11/16"	3 1/4"
PTO 0332-00430	1 1/8"	1/4"	1 3/8" - 6	5 11/16"	3 3/16"
PTO 0332-00431	1 1/4"	1/4"	1 3/8" - 6	5 11/16"	3 3/16"
PTO 0332-00432	1 3/8"	5/16"	1 3/8" - 6	5 11/16"	3 3/16"
PTO 0332-00433	1 1/2"	3/8"	1 3/8" - 6	6 9/32"	4"



PTO 0332-00376

**NOTE: THERE IS NO WARRANTY ON PTO ADAPTORS.**

## PTO ADAPTERS

### Clamp Type PTO Adaptors - To 75 H.P.

PART NO.	FEMALE SPLINE	MALE SPLINE	LENGTH	EXTENDS PTO
PTO 0332-01354	1 1/8 - 6	1 3/8 - 6	7 5/16"	4 5/8"
PTO 0332-00057	1 3/8 - 6	1 3/8 - 6	7 5/16"	4 5/8"
PTO 0332-01374*	1 3/8 - 6	1 3/8 - 6	13 1/4"	10 9/16"
PTO 0332-00087	1 3/8 - 21	1 3/8 - 6	7 5/16"	5 5/16"



PTO 0332-00057

\*For tractor mounted pumps with spline bore.

### Sleeve Type Splined Adaptors - To 75 H.P.

PART NO.	FEMALE SPLINE	MALE SPLINE	LENGTH	SPECIAL APPLICATIONS
PTO 0332-00355	31/32 - 10	1 3/8 - 6	2 1/4"	IHC Cub & Kubota
PTO 0332-00352	1 1/8 - 6	1 3/8 - 6	2 1/4"	
PTO 0332-00363	1 1/8 - 6	1 3/8 - 6	2"	Replaces Ford 231082
PTO 0332-00403	1 3/8 - 6	1 3/4 - 6	2 1/2"	

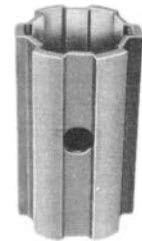

PTO 0332-00352

## OVER-RUNNING COUPLERS

Hub City over-running couplers provide a safe way to protect operators and machinery where inertia of driven units (ie. rotary mowers, balers, hay conditioners, etc.) can over-run driving source. They take the push out of the driven machine and eliminate the chance of broken or twisted PTO shafts. Over-running couplers drive solidly from tractor to driven implement, but over-run smoothly when implement exceeds PTO speeds.

### Kwik-D-Tach Tractor Models - To 125 H.P.

- Capacity to operate on tractors to 125 PTO H.P.
- New PTO quick release concept - spring loaded - rotates about 30° by hand for quick release.
- Designed to operate with 1,000 rpm PTO's.
- Installation and lubrication instruction enclosed with each coupler.
- Patent pending.

PART NO.	FEMALE SPLINE	MALE SPLINE	LENGTH	EXTENDS PTO
PTO 0331-00010	1 3/8 - 6	1 3/8 - 6	7 5/16"	4 13/16"
PTO 0331-00011	1 3/8 - 6	1 3/8 - 21	7 3/16"	4 11/16"
PTO 0331-00012	1 3/8 - 21	1 3/8 - 6	7 5/16"	5 5/16"
PTO 0331-00013	1 3/8 - 21	1 3/8 - 21	7 3/16"	5 3/16"
PTO 0337-00126	Repair Kit			



**NOTE: THERE IS NO WARRANTY ON PTO ADAPTORS.**

**PTO ADAPTERS**

**Tractor Models - to 75 HP**

Over-Running Couplers covered by Patent No. 3,233,471 - Canadian Patent No. 727-982

- All steel welded housing
- Heat treated alloy steel inner sleeve.
- Hardened steel keys, spring loaded.
- Snap ring construction for quick, easy disassembly for cleaning and service.
- Spring roll pin for quick mounting to tractor.
- Convenient grease fitting for gun lubrication.
- Designed to operate with 1,000 RPM P.T.O.'s.
- Shipping weight 6 lbs.



PART NUMBER	FEMALE SPLINE	MALE SPLINE	LENGTH	EXTENDS TRACTOR P.T.O.		FITS TRACTOR
				SHAFT END	SHAFT RETAINING GROOVE	
PTO 0331-00690	1 1/8 - 6	1 1/8 - 6	6 21/32"	4 5/32	4 1/32	All with Cross Pin Hole Including Ford
PTO 0331-00670	1 1/8 - 6	1 1/8 - 6	6 21/32"	4 5/32	4 1/32	All with Cross Pin Hole Including Ford
PTO 0331-00680	1 1/8 - 6	1 1/8 - 6	6 21/32"	4 5/32	4 1/32	All with Cross Pin Hole Including Ford
PTO 0331-00660	1 1/8 - 6	1 1/8 - 6	6 21/32"	4 5/32	4 1/32	All with Cross Pin Hole Including Ford
PTO 0337-00076	Repair Kit					

Installation and lubrication instructions enclosed with each coupler.

**Utility Models - to 75 HP**

- Same construction as Standard-Duty Tractor Models.
- For those applications other than tractor P.T.O. shafts, where the driven shaft overruns the driver occasionally or where one shaft must override or idle part of the time.
- Operating speed to 1,000 RPM.
- Shipping weight 6 lbs.

FEMALE SPLINE	MALE EXTENSION	PART NO.
1 1/4 Rd., 1/4 KW	1 1/4 Rd., 1/4 KW	PTO 0331-00615
Repair Kit	PTO 0337-00076	



Installation and lubrication instructions enclosed with each coupler.

**NOTE: THERE IS NO WARRANTY ON PTO ADAPTORS.**



## PTO ADAPTERS

### Universal Models - To 75 H.P.

- Same construction as Standard-Duty Tractor Models.
- Universal flange for mounting sheave or sprocket, has six  $\frac{3}{8}$  holes equally spaced on  $4\frac{1}{2}$  Bolt Circle. Flange O.D. 5 - Hub O.D.  $2\frac{3}{4}$
- Operating speed to 1,000 RPM.
- Shipping Weight 6 lbs.



FEMALE SLEEVE		PART NO.
I.D.	TYPE	
1 $\frac{1}{4}$ "	Round w/ $\frac{1}{4}$ keyway	PTO 0331-00600
1 $\frac{3}{8}$ "	Round w/ $\frac{5}{16}$ keyway	PTO 0331-00607
Repair Kit		PTO 0337-00082

## SPLINED COUPLINGS

### Splined Couplings

PART NO.	SPLINED SIZE	O.D.	LENGTH
PTO 0332-00336	$\frac{3}{4}$ - 6	1 $\frac{3}{8}$ "	2 $\frac{1}{2}$ "
PTO 0332-00337	$\frac{7}{8}$ - 6	1 $\frac{3}{8}$ "	2 $\frac{1}{2}$ "
PTO 0332-00340*	$\frac{31}{32}$ - 10	1 $\frac{3}{8}$ "	2 $\frac{3}{4}$ "
PTO 0332-00338	1 - 10	1 $\frac{3}{8}$ "	2 $\frac{1}{2}$ "
PTO 0332-00341	1 - 6	1 $\frac{3}{8}$ "	2 $\frac{3}{4}$ "
PTO 0332-00344	1 $\frac{1}{8}$ - 6	1 $\frac{9}{16}$ "	2 $\frac{3}{4}$ "
PTO 0332-00342	1 $\frac{1}{4}$ - 6	1 $\frac{7}{8}$ "	3 $\frac{1}{4}$ "
PTO 0332-00348	1 $\frac{1}{4}$ - 10	1 $\frac{3}{4}$ "	3 $\frac{3}{4}$ "
PTO 0332-00345	1 $\frac{3}{8}$ - 6	1 $\frac{3}{4}$ "	3 $\frac{3}{4}$ "
PTO 0332-00365	1 $\frac{3}{8}$ - 10	1 $\frac{3}{4}$ "	3"
PTO 0332-00349	1 $\frac{5}{8}$ - 6	2	3 $\frac{3}{4}$ "
PTO 0332-00347	1 $\frac{1}{2}$ - 6	1 $\frac{7}{8}$ "	3 $\frac{3}{4}$ "
PTO 0332-00367	1 $\frac{1}{2}$ - 10	1 $\frac{7}{8}$ "	3"
PTO 0332-00346	1 $\frac{3}{4}$ - 6	2 $\frac{1}{4}$ "	3 $\frac{3}{4}$ "

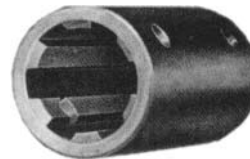

PTO 0332-00345

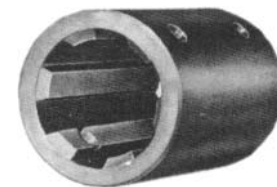

PTO 0332-00346

**NOTE: THERE IS NO WARRANTY ON PTO ADAPTORS.**

# PTO ADAPTERS

## Involute Splined Couplings

PART NO.	NO. OF SPLINES	SPLINE DESCRIPTION	SPLINE O.D.	COUPLING O.D.	COUPLING LENGTH
PTO 0332-00027	9	16/32 DP 30° PT	0.625"	1 3/8"	2"
PTO 0332-00066	11	16/32 DP 30° PT	0.750"	1 3/8"	2"
PTO 0332-00028	13	16/32 DP 30° PT	0.875"	1 3/8"	3"
PTO 0332-00043	15	16/32 DP 30° PT	1.000"	1 1/2"	3"
PTO 0332-00029	14	12/24 DP 30° PT	1.250"	1 3/4"	3"
PTO 0332-00350	21	16/32 DP 30° PT	1.375"	1 3/4"	3"
PTO 0332-00320	20	12/24 DP 30° PT	1.750"	2 1/4"	3 3/4"
PTO 0332-00030	13	8/16 DP 30° PT	1.750"	2 1/4"	3 3/4"
PTO 0332-00351	27	16/32 DP 30° PT	1.750"	2 1/4"	3"



## Splined Shafts



PART NO.	SIZE	SPLINE	LENGTH
PTO 0332-00390	1"	6	10"
PTO 0332-00391	1 1/8"	6	10"
PTO 0332-00392	1 1/4"	6	10"
PTO 0332-00393	1 1/4"	10	10"
PTO 0332-00394	1 3/8"	6	10"
PTO 0332-00396	1 1/2"	6	10"
PTO 0332-00397	1 5/8"	6	10"
PTO 0332-00398	1 3/4"	6	10"

## Extension Shafts



PART NO.	SIZE	SPLINE	LENGTH
PTO 0332-00356	1 3/8" - 6	1 3/8" - 6	9"
PTO 0332-00357	1 3/8" - 6	1 1/8" - 6	9"

## Involute Splined Shafts

PART NO.	NO OF SPLINES	SPLINE DESCRIPTION	SPLINE O.D.	SHAFT LENGTH
PTO 0332-00023	9	16/32 DP 30° PA	0.625"	6"
PTO 0332-00024	13	16/32 DP 30° PA	0.875"	6"
PTO 0332-00044	15	16/32 DP 30° PA	1.000"	8"
PTO 0332-00025	14	12/24 DP 30° PA	1.250"	10"
PTO 0332-00395	21	16/32 DP 30° PA	1.375"	10"
PTO 0332-00038	16	10/20 DP 30° PA	1.7000"	10"
PTO 0332-00026	13	8/16 DP 30° PA	1.750"	10"
PTO 0332-00399	27	16/32 DP 30° PA	1.750"	10"
PTO 0332-00039	16	8/16 DP 30° PA	2.125"	10"



**NOTE: THERE IS NO WARRANTY ON PTO ADAPTORS.**

## SPLINED SHAFTS

### Splined Shafts



PART NO.	DESCRIPTION
PTO 0332-00358	1 1/8 - 6 Spline, 5 1/4" Long
PTO 0332-00359	1 3/8 - 6 Spline, 5 1/2" Long
PTO 0332-00019	1 3/8 - 21 Spline, 5 1/2" Long

## WELD-ON ADAPTORS

### Quick Release Weld-Ons



PART NO.	DESCRIPTION
PTO 0332-01350	1 3/8 - 21 Spline, 3 5/16" Long
PTO 0332-01345	1 3/8 - 6 Spline, 3 5/16" Long

### Square Bushing Weld-Ons



PART NO.	I.D.	O.D.	LENGTH
PTO 0332-00360	7/8 & 1" Square	1 3/4"	2 1/4"
PTO 0332-00362	1 1/8" Square	2"	2 1/2"
PTO 0332-00364	1 1/4" Square	2 1/4"	2 1/2"

## COUPLINGS & SPLINED HUBS

### Round Bore Couplings

PART NO.	BORE SIZE	KEYWAY	O.D.	LENGTH
PTO 0332-00380	3/4"	3/16"	1 1/2"	2 3/4"
PTO 0332-00381	7/8"	3/16"	1 1/2"	2 3/4"
PTO 0332-00382	1"	1/4"	1 3/4"	2 3/4"
PTO 0332-00383	1 1/16"	1/4"	1 3/4"	2 3/4"
PTO 0332-00384	1 1/8"	1/4"	2"	3"
PTO 0332-00385	1 3/16"	1/4"	2"	3"
PTO 0332-00386	1 1/4"	1/4"	2"	3"
PTO 0332-00387	1 5/16"	5/16"	2"	3"
PTO 0332-00388	1 3/8"	5/16"	2 1/8"	3"
PTO 0332-00389	1 7/16"	3/8"	2 1/8"	3"
PTO 0332-00379	1 1/2"	3/8"	2 1/4"	3"



- Use to join two shafts.
- Repair pulleys, gears, sprockets, etc.
- O.D. and I.D. concentricity not held to close limits - If precision O.D. and I.D. concentricity is required,
- Not drilled for setscrews.

## COUPLINGS & SPLINED HUBS

### Spline Bore Couplings

PART NO.	NO. OF SPLINES	SPLINE DESCRIPTION		SPLINE O.D.	HUB O.D.	LENGTH
PTO 0332-00031	6	6B	Str. Side	1.000"	2.001/2.000"	1 3/4"
PTO 0332-00085	18	1.25 Module	20° PA	0.984"	1.751/1.750"	1 3/4"
PTO 0332-00032	9	16/32 DP	30° PA	0.625"	1.251/1.250"	1 1/4"
PTO 0332-00071	11	16/32 DP	30° PA	0.750"	1.501/1.500"	1 1/2"
PTO 0332-00033	13	16/32 DP	30° PA	0.875"	1.501/1.500"	1 1/2"
PTO 0332-00072	15	16/32 DP	30° PA	1.000"	1.751/1.750"	1 3/4"
PTO 0332-00035	21	16/32 DP	30° PA	1.375"	2.251/2.250"	2 1/8"
PTO 0332-00073	23	16/32 DP	30° PA	1.500"	2.251/2.250"	2 1/8"
PTO 0332-00075	27	16/32 DP	30° PA	1.750"	3.001/3.000"	2 1/4"
PTO 0332-00034	14	12/24 DP	30° PA	1.250"	2.251/2.250"	2"
PTO 0332-00036	16	10/20 DP	30° PA	1.700"	2.751/2.750"	2 1/4"
PTO 0332-00074	13	8/16 DP	30° PA	1.750"	3.001/3.000"	2 1/4"
PTO 0332-00037	16	8/16 DP	30° PA	2.125"	3.501/3.500"	2 31/32"
PTO 0332-00093	17	12/24 DP	30° PA	1.500"	2.251/2.250"	2 1/4"

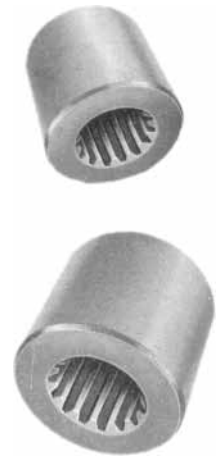

## PTO PUMP DRIVE ADAPTORS

### Kwik-D-Tach Splined Pump Drive Adaptors

Same safe, dependable fast action release as Kwik-D-Tach Splined Adaptors

PART NO.	FEMALE SPLINE	FEMALE ROUND*	KEYWAY	LENGTH
PTO 0332-00012	1 3/8 - 6	0.625"	3/16 x 3/32"	4 13/32"
PTO 0332-00014	1 3/8 - 6	0.750"	3/16 x 3/32"	4 13/32"
PTO 0332-00011	1 3/8 - 6	0.875"	3/16 x 3/32"	4 13/32"
PTO 0332-00040	1 3/8 - 6	0.937"	1/4 x 1/8"	4 13/32"
PTO 0332-00016	1 3/8 - 6	1.000"	1/4 x 1/8"	4 13/32"
PTO 0332-00017	1 3/8 - 6	1.125"	1/4 x 1/8"	4 13/32"

\*Nominal +0.002

PTO 0332-00014



**NOTE: THERE IS NO WARRANTY ON PTO ADAPTORS.**

## PTO PUMP DRIVE ADAPTORS

### Splined Pump Drive Adaptors

PTO Pin included with all 1 <sup>3</sup>/<sub>8</sub> - 6 Spline and 1 <sup>3</sup>/<sub>8</sub> - 6 Spline Pump Drives  
 1 <sup>3</sup>/<sub>8</sub> - 21 Spline and 1 <sup>3</sup>/<sub>4</sub> - 27 Spline Pump drives are supplied with Setscrews.

PART NO.	FEMALE SPLINE	FEMALE ROUND*	KEYWAY	LENGTH
PTO 0332-00412	1 <sup>3</sup> / <sub>8</sub> - 6	1.000"	1/4 x 1/8"	3 <sup>1</sup> / <sub>8</sub> "
PTO 0332-00407	1 <sup>3</sup> / <sub>8</sub> - 6	0.625"	3/16 x 3/32"	4 <sup>11</sup> / <sub>32</sub> "
PTO 0332-00408	1 <sup>3</sup> / <sub>8</sub> - 6	0.750"	3/16 x 3/32"	4 <sup>11</sup> / <sub>32</sub> "
PTO 0332-00409	1 <sup>3</sup> / <sub>8</sub> - 6	0.875"	3/16 x 3/32"	4 <sup>11</sup> / <sub>32</sub> "
PTO 0332-00413	1 <sup>3</sup> / <sub>8</sub> - 6	0.937"	1/4 x 1/8"	4 <sup>11</sup> / <sub>32</sub> "
PTO 0332-00410	1 <sup>3</sup> / <sub>8</sub> - 6	1.000"	1/4 x 1/8"	4 <sup>11</sup> / <sub>32</sub> "
PTO 0332-00411	1 <sup>3</sup> / <sub>8</sub> - 6	1.125"	1/4 x 1/8"	4 <sup>11</sup> / <sub>32</sub> "
PTO 0332-00607	1 <sup>3</sup> / <sub>8</sub> - 21	0.625"	3/16 x 3/32"	4 <sup>3</sup> / <sub>8</sub> "
PTO 0332-00608	1 <sup>3</sup> / <sub>8</sub> - 21	0.750"	3/16 x 3/32"	4 <sup>3</sup> / <sub>8</sub> "
PTO 0332-00609	1 <sup>3</sup> / <sub>8</sub> - 21	0.875"	3/16 x 3/32"	4 <sup>3</sup> / <sub>8</sub> "
PTO 0332-00612	1 <sup>3</sup> / <sub>8</sub> - 21	0.937"	1/4 x 1/8"	4 <sup>3</sup> / <sub>8</sub> "
PTO 0332-00610	1 <sup>3</sup> / <sub>8</sub> - 21	1.000"	1/4 x 1/8"	4 <sup>3</sup> / <sub>8</sub> "

\*Nominal +0.002



PTO 0332-00408

**NOTE: THERE IS NO WARRANTY ON PTO ADAPTORS.**

# AGRI-HUB BEVEL GEAR DRIVES

## Dimensions

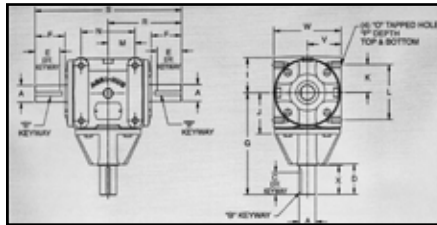

PART NO.	A	B	C	D	E	F	G	H	I	J
PTO AG30AB	.750 .749	$3/16 \times 3/32$ KW	1.29*	1.50	1.29	1.50	5.19	7.10	1.91	2.31
PTO AG40AB	1.000 .999	$1/4 \times 1/8$ KW	1.53	2.00	1.53	2.00	5.72	8.19	2.47	2.84
PTO AG60AB	1.375 1.374	$5/16 \times 5/32$ KW	1.81	2.50	1.81	2.50	8.41	11.26	2.85	3.38
PTO AG80AB	1.375 1.374	$5/16 \times 5/32$ KW	2.31	3.06	2.31	3.00	10.88	14.73	3.85	4.54
PTO AG100AB	1.750 1.749	$3/8 \times 3/16$ KW	2.25	3.00	2.25	3.00	13.00	17.61	4.61	5.26

\*1.25 effective keyway on AG30, 2/1 straight bevel ratio.

PART NO.	K	L	M	N	O	P	R	S	V	W	X
PTO AG30AB	1.438	2.875	1.563	3.125	$5/16$ -18UNC-2B	0.63	3.97	7.94	1.813	3.625	1.44
PTO AG40AB	2.125	4.250	2.125	4.250	$3/8$ -16UNC-2B	0.69	5.09	10.18	2.063	4.125	N/A
PTO AG60AB	2.250	4.500	2.250	4.500	$1/2$ -13UNC-2B	0.81	6.13	12.25	2.814	5.628	N/A
PTO AG80AB	3.250	6.500	3.250	6.500	$1/2$ -13UNC-2B	1.00	7.91	15.82	4.094	8.188	N/A
PTO AG100AB	4.000	8.000	4.000	8.000	$1/2$ -13UNC-2B	0.75	9.14	18.28	4.750	9.500	N/A

Dimensions subject to change without notice.

NOTE: Specify ratio when ordering: i.e. 1-1, 1.5-1, 2-1

## Standard Styles Available:

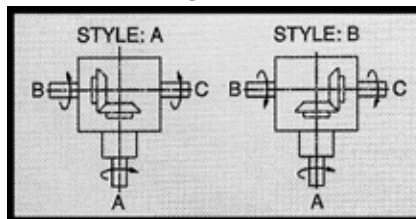

### 1-1 Ratio

#### Maximum Input Horsepower

MODEL	INPUT (PINION) RPM			
	100	540	1000	1750
AG30	2.52	9.92	18.07	30.05
AG40	3.50	16.00	26.50	40.00
AG60	5.25	29.25	50.00	78.00
AG80	16.25	70.00	120.00	175.00
AG100	25.56	100.00	162.75	248.00

### 1.5-1 Ratio

#### Maximum Input Horsepower

MODEL	INPUT (PINION) RPM			
	100	540	1000	1750
AG30	1.16	4.75	7.25	11.25
AG40	1.85	6.75	11.25	16.75
AG60	3.25	13.25	22.75	38.50
AG80	9.27	39.30	68.50	112.00
AG100	21.83	91.68	151.98	237.91

### 2-1 Ratio

#### Maximum Input Horsepower

MODEL	INPUT (PINION) RPM			
	100	540	1000	1750
AG30	0.80	3.32	5.88	9.50
AG40	1.25	5.50	9.25	14.75
AG60	2.50	11.75	19.75	31.00
AG80	5.75	25.75	45.00	71.00
AG100	12.00	50.00	85.00	130.00

**PART NUMBER INDEX**

HAR 2788	108	PTO 0332-00033	163	PTO 0332-00388	162	PTO 100011039	14, 43
HAR 2789	108	PTO 0332-00034	163	PTO 0332-00389	162	PTO 100011040	14, 43
HAR 2790	108	PTO 0332-00035	163	PTO 0332-00390	161	PTO 100011041	14, 43
HAR 2791	108	PTO 0332-00036	163	PTO 0332-00391	161	PTO 100011042	14, 43
HAR 2792	108	PTO 0332-00037	163	PTO 0332-00392	161	PTO 100011043	14, 43
HAR 2793	108	PTO 0332-00038	161	PTO 0332-00393	161	PTO 100011044	14, 43
HAR 2794	108	PTO 0332-00039	161	PTO 0332-00394	161	PTO 100011045	14, 43
HAR 2795	108	PTO 0332-00040	163	PTO 0332-00395	161	PTO 100011048	14, 43
HAR 2796	108	PTO 0332-00043	161	PTO 0332-00396	161	PTO 100011049	14, 43
HAR 2797	108	PTO 0332-00044	161	PTO 0332-00397	161	PTO 100011051	14, 43
HAR 2798	108	PTO 0332-00057	158	PTO 0332-00398	161	PTO 100011052	14, 43
HAR 2800	108	PTO 0332-00066	161	PTO 0332-00399	161	PTO 100011053	14, 43
HAR 2801	108	PTO 0332-00070	155	PTO 0332-00400	155	PTO 100011054	14, 43
HAR 2802	108	PTO 0332-00071	163	PTO 0332-00401	155	PTO 100011055	14, 43
HAR 2803	108	PTO 0332-00072	163	PTO 0332-00406	155	PTO 100011056	14, 43
HAR 2804	108	PTO 0332-00073	163	PTO 0332-00407	164	PTO 100011057	14, 43
HAR 2805	108	PTO 0332-00074	163	PTO 0332-00408	164	PTO 100011058	14, 43
HAR 299	108	PTO 0332-00075	163	PTO 0332-00409	164	PTO 100011059	14, 43
HAR 31001	146	PTO 0332-00084	155	PTO 0332-00410	164	PTO 100011060	14, 43
HAR 31003	146	PTO 0332-00085	163	PTO 0332-00411	164	PTO 100011061	14, 44
HAR 31004	146	PTO 0332-00086	156	PTO 0332-00412	164	PTO 100011062	14, 44
HAR 31006	146	PTO 0332-00087	158	PTO 0332-00413	164	PTO 100011066	44
HAR 31008	146	PTO 0332-00092	157	PTO 0332-00420	155	PTO 10001248	26
HAR 31011	146	PTO 0332-00093	163	PTO 0332-00430	157	PTO 10001260	26
HAR 31015	146	PTO 0332-00320	161	PTO 0332-00431	157	PTO 10001438	29
PTO 0331-00010	158	PTO 0332-00336	160	PTO 0332-00432	157	PTO 10001448	29
PTO 0331-00011	158	PTO 0332-00337	160	PTO 0332-00433	157	PTO 10001460	29
PTO 0331-00012	158	PTO 0332-00338	160	PTO 0332-00607	164	PTO 10003531	32
PTO 0331-00013	158	PTO 0332-00340	160	PTO 0332-00608	164	PTO 10003535	32
PTO 0331-00600	160	PTO 0332-00341	160	PTO 0332-00609	164	PTO 10003542	32
PTO 0331-00607	160	PTO 0332-00342	160	PTO 0332-00610	164	PTO 10003548	32
PTO 0331-00615	159	PTO 0332-00344	160	PTO 0332-00612	164	PTO 10003560	32
PTO 0331-00660	159	PTO 0332-00345	160	PTO 0332-01345	162	PTO 10004448	36
PTO 0331-00670	159	PTO 0332-00346	160	PTO 0332-01350	162	PTO 10004460	36
PTO 0331-00680	159	PTO 0332-00347	160	PTO 0332-01354	155, 158	PTO 1000506	42
PTO 0331-00690	159	PTO 0332-00348	160	PTO 0332-01373	156	PTO 10005548	39
PTO 0332-00001	156	PTO 0332-00349	160	PTO 0332-01374	158	PTO 10005560	39
PTO 0332-00002	156	PTO 0332-00350	161	PTO 0332-01375	157	PTO 1000606	20
PTO 0332-00004	156	PTO 0332-00351	161	PTO 0332-01476	156	PTO 1000621	20
PTO 0332-00005	156	PTO 0332-00356	161	PTO 0332-01477	156	PTO 1000706	40
PTO 0332-00010	156	PTO 0332-00358	161, 162	PTO 0332-01490	157	PTO 1000721	40
PTO 0332-00011	163	PTO 0332-00359	162	PTO 0332-01491	157	PTO 1001206	24
PTO 0332-00012	163	PTO 0332-00360	162	PTO 0332-02120	156	PTO 1001221	24
PTO 0332-00013	156	PTO 0332-00362	162	PTO 0332-03531	155	PTO 1001406	27
PTO 0332-00014	163	PTO 0332-00364	162	PTO 0335-90120	157	PTO 1001421	27
PTO 0332-00015	156	PTO 0332-00365	160	PTO 0337-00076	159	PTO 10014448	36
PTO 0332-00016	163	PTO 0332-00367	160	PTO 0337-00082	160	PTO 10015548	39
PTO 0332-00017	163	PTO 0332-00371	155	PTO 0337-00126	158	PTO 10101400	111
PTO 0332-00018	157	PTO 0332-00373	155	PTO 10000610	22	PTO 10103501	113
PTO 0332-00019	162	PTO 0332-00375	155	PTO 10000648	22	PTO 10105500	117
PTO 0332-00020	156	PTO 0332-00376	157	PTO 100011007	14, 44	PTO 1010610	20
PTO 0332-00023	161	PTO 0332-00378	155	PTO 100011012	14	PTO 1010615	20
PTO 0332-00024	161	PTO 0332-00379	162	PTO 100011013	14, 44	PTO 1011420	27
PTO 0332-00025	161	PTO 0332-00380	162	PTO 100011014	14, 44	PTO 1013500	115
PTO 0332-00026	161	PTO 0332-00381	162	PTO 100011015	14, 44	PTO 1013506	30
PTO 0332-00027	161	PTO 0332-00382	162	PTO 100011033	14, 43	PTO 1013520	30
PTO 0332-00028	161	PTO 0332-00383	162	PTO 100011034	14, 43	PTO 1013521	30
PTO 0332-00029	161	PTO 0332-00384	162	PTO 100011035	14, 44	PTO 1014406	34
PTO 0332-00030	161	PTO 0332-00385	162	PTO 100011036	14, 44	PTO 1014420	34
PTO 0332-00031	163	PTO 0332-00386	162	PTO 100011037	14, 43	PTO 1014421	34
PTO 0332-00032	163	PTO 0332-00387	162	PTO 100011038	14, 43	PTO 1015506	37

**PART NUMBER INDEX**

PTO 1015520 ..... 37	PTO 1026121 ..... 55	PTO 1047620 ..... 93	PTO 1111420 ..... 111
PTO 1015521 ..... 37	PTO 1026506 ..... 67	PTO 1047621 ..... 93	PTO 1111421 ..... 111
PTO 1016106 ..... 55	PTO 1026520 ..... 67	PTO 1048406 ..... 64, 89	PTO 1113506 ..... 115
PTO 1016121 ..... 55	PTO 1026520 ..... 67	PTO 1048420 ..... 64, 89	PTO 1113520 ..... 115
PTO 1016506 ..... 67	PTO 1026521 ..... 67	PTO 1048421 ..... 64, 89	PTO 1115506 ..... 117
PTO 1016521 ..... 67	PTO 1026706 ..... 73	PTO 1048606 ..... 70, 91	PTO 1115520 ..... 117
PTO 1016706 ..... 73	PTO 1026720 ..... 73	PTO 1048620 ..... 70, 91	PTO 1115521 ..... 117
PTO 1016720 ..... 73	PTO 1026721 ..... 73	PTO 1048621 ..... 70, 91	PTO 1123506 ..... 113
PTO 1016721 ..... 73	PTO 1026728 ..... 73	PTO 10501400 ..... 119	PTO 1123520 ..... 113
PTO 1016806 ..... 76	PTO 1026806 ..... 76	PTO 1050610 ..... 20	PTO 1123521 ..... 113
PTO 1016820 ..... 76	PTO 1026820 ..... 76	PTO 1050615 ..... 20	PTO 1133506 ..... 113
PTO 1016821 ..... 76	PTO 1026821 ..... 76	PTO 1060615 ..... 20	PTO 1133520 ..... 113
PTO 1016906 ..... 79	PTO 1026828 ..... 76	PTO 1071406 ..... 111	PTO 1133521 ..... 113
PTO 1016920 ..... 79	PTO 1026906 ..... 79	PTO 1071420 ..... 111	PTO 125141500 ..... 81
PTO 1016921 ..... 79	PTO 1026920 ..... 79	PTO 1071421 ..... 111	PTO 125151500 ..... 81
PTO 1017006 ..... 97	PTO 1026921 ..... 79	PTO 1073506 ..... 115	PTO 1310021 ..... 1
PTO 1017020 ..... 97	PTO 1027106 ..... 83	PTO 1073520 ..... 115	PTO 1310022 ..... 1
PTO 1017021 ..... 97	PTO 1027121 ..... 83	PTO 1073521 ..... 115	PTO 14000600 ..... 23
PTO 1017606 ..... 93	PTO 1027606 ..... 83	PTO 1075506 ..... 117	PTO 14000605 ..... 23
PTO 1017620 ..... 93	PTO 1027620 ..... 93	PTO 1075520 ..... 117	PTO 14000616 ..... 23
PTO 1017621 ..... 93	PTO 1027620 ..... 93	PTO 1075521 ..... 117	PTO 14000620 ..... 23
PTO 1017906 ..... 95	PTO 1027621 ..... 93	PTO 1077606 ..... 123	PTO 14000638 ..... 23
PTO 1017920 ..... 95	PTO 1027806 ..... 99	PTO 1077620 ..... 123	PTO 14000648 ..... 23
PTO 1017921 ..... 95	PTO 1027821 ..... 99	PTO 1077621 ..... 123	PTO 14000700 ..... 41
PTO 1018206 ..... 58, 85	PTO 1027906 ..... 95	PTO 1077906 ..... 125	PTO 14001200 ..... 26
PTO 1018221 ..... 58, 85	PTO 1027920 ..... 95	PTO 1077920 ..... 125	PTO 14001220 ..... 26
PTO 1018306 ..... 61, 87	PTO 1027921 ..... 95	PTO 1077921 ..... 125	PTO 14001248 ..... 26
PTO 1018321 ..... 61, 87	PTO 1028206 ..... 58, 85	PTO 1078406 ..... 121	PTO 14001260 ..... 26
PTO 1018406 ..... 64, 89	PTO 1028218 ..... 58, 85	PTO 1078421 ..... 121	PTO 14001404 ..... 29
PTO 1018421 ..... 64, 89	PTO 1028221 ..... 58, 85	PTO 1081406 ..... 111	PTO 14001405 ..... 29
PTO 1018606 ..... 70, 91	PTO 1028306 ..... 61, 87	PTO 1081421 ..... 111	PTO 14001406 ..... 29
PTO 1018620 ..... 70, 91	PTO 1028321 ..... 61, 87	PTO 1097606 ..... 123	PTO 14001420 ..... 29
PTO 1018621 ..... 70, 91	PTO 1028406 ..... 64, 89	PTO 1097620 ..... 123	PTO 14001448 ..... 29
PTO 1020506 ..... 42	PTO 1028418 ..... 64, 89	PTO 1097621 ..... 123	PTO 14001460 ..... 29
PTO 1020606 ..... 20	PTO 1028421 ..... 64, 89	PTO 1098406 ..... 121	PTO 14003507 ..... 33
PTO 1020621 ..... 20	PTO 1028606 ..... 70, 91	PTO 11000648 ..... 22	PTO 14003524 ..... 33
PTO 1020706 ..... 40	PTO 1028618 ..... 70, 91	PTO 11001248 ..... 26	PTO 14003531 ..... 33
PTO 1021006 ..... 14, 43	PTO 1028620 ..... 70, 91	PTO 11001260 ..... 26	PTO 14003535 ..... 33
PTO 1021206 ..... 24	PTO 1028621 ..... 70, 91	PTO 11001438 ..... 29	PTO 14003536 ..... 33
PTO 1021221 ..... 24	PTO 1041206 ..... 24	PTO 11001448 ..... 29	PTO 14003548 ..... 33
PTO 1021406 ..... 27	PTO 1041221 ..... 24	PTO 11001460 ..... 29	PTO 14003560 ..... 33
PTO 1021418 ..... 27	PTO 1041406 ..... 27, 120	PTO 11003531 ..... 32	PTO 14003561 ..... 50
PTO 1021421 ..... 27	PTO 1041421 ..... 27	PTO 11003535 ..... 32	PTO 14004448 ..... 36
PTO 1022606 ..... 46	PTO 1043506 ..... 30, 120	PTO 11003543 ..... 32	PTO 14004460 ..... 36
PTO 1022620 ..... 46	PTO 1043520 ..... 30	PTO 11003548 ..... 32	PTO 14005537 ..... 39
PTO 1022621 ..... 46	PTO 1043521 ..... 30	PTO 11003560 ..... 32	PTO 14005546 ..... 39
PTO 1023505 ..... 30	PTO 1044406 ..... 34	PTO 11004448 ..... 36	PTO 14005548 ..... 39
PTO 1023506 ..... 30	PTO 1044420 ..... 34	PTO 11004460 ..... 36	PTO 14005560 ..... 39
PTO 1023518 ..... 30	PTO 1044421 ..... 34	PTO 1103506 ..... 30	PTO 14006127 ..... 56, 103
PTO 1023520 ..... 30	PTO 1045506 ..... 37	PTO 1103520 ..... 30	PTO 14006135 ..... 56, 103
PTO 1023521 ..... 30	PTO 1045520 ..... 37	PTO 1103521 ..... 30	PTO 14006137 ..... 56, 104
PTO 1023528 ..... 30	PTO 1045521 ..... 37	PTO 1104406 ..... 34	PTO 14006247 ..... 59, 104
PTO 1024406 ..... 34	PTO 1046506 ..... 67	PTO 1104420 ..... 34	PTO 14006251 ..... 59, 105
PTO 1024420 ..... 34	PTO 1046520 ..... 67	PTO 1104421 ..... 34	PTO 14006252 ..... 59, 103
PTO 1024421 ..... 34	PTO 1046521 ..... 67	PTO 1105506 ..... 37	PTO 14006340 ..... 62, 103
PTO 1025506 ..... 37	PTO 1046706 ..... 73	PTO 1105520 ..... 37	PTO 14006424 ..... 66, 103
PTO 1025520 ..... 37	PTO 1046721 ..... 73	PTO 1105521 ..... 37	PTO 14006430 ..... 66
PTO 1025521 ..... 37	PTO 1046806 ..... 76	PTO 1106806 ..... 76	PTO 14006432 ..... 66, 105
PTO 1025528 ..... 37	PTO 1046820 ..... 76	PTO 1107906 ..... 95	PTO 14006436 ..... 66, 105
PTO 1026106 ..... 55	PTO 1046821 ..... 76	PTO 1108606 ..... 70	PTO 14006437 ..... 66
PTO 1026118 ..... 55	PTO 1047606 ..... 93	PTO 1111406 ..... 111	PTO 14006438 ..... 66, 104



**PART NUMBER INDEX**

PTO 14006442	66, 105	PTO 14046660	72, 104	PTO 14705567	118	PTO 17513548	113
PTO 14006446	66, 103	PTO 14046748	75, 104	PTO 14705573	118	PTO 17513558	113
PTO 14006448	66, 104	PTO 14046760	75, 104	PTO 14705579	118	PTO 17513567	113
PTO 14006451	66, 105	PTO 14046848	78, 104	PTO 14707951	126, 128, 129	PTO 17513573	113
PTO 14006453	66, 103	PTO 14046860	78, 104	PTO 14707955	126, 128, 129	PTO 17513579	113
PTO 14006455	66, 104	PTO 145055573	118	PTO 14713548	114	PTO 18501420	120
PTO 14006524	69, 103	PTO 14517660	124	PTO 14713558	114	PTO 18511420	120
PTO 14006542	69, 105	PTO 14517955	126, 128, 129	PTO 14713567	114	PTO 1900616	50
PTO 14006543	69, 104	PTO 14601448	112	PTO 14713573	114	PTO 1930416	50
PTO 14006546	69, 105	PTO 14601458	112	PTO 14715555	118, 127, 129	PTO 1930612	50
PTO 14006551	69, 105	PTO 14601467	112	PTO 14717660	124, 126, 128, 129	PTO 1930616	50
PTO 14006555	69, 104	PTO 14603500	116, 127	PTO 14725555	118, 127	PTO 19501406	112
PTO 14006624	72, 103	PTO 14603502	130	PTO 14727955	126, 128	PTO 19501420	120
PTO 14006628	72, 103	PTO 14603548	116	PTO 14735555	118, 127	PTO 19503506	108, 116
PTO 14006637	72, 103	PTO 14603558	116	PTO 14737955	126, 128	PTO 19503540	113
PTO 14006642	72, 104	PTO 14603567	116	PTO 1501406	119	PTO 19505506	117
PTO 14006644	72, 104	PTO 14603573	116	PTO 1501421	119	PTO 19601421	112
PTO 14006652	72, 105	PTO 14603579	116	PTO 1503506	119	PTO 19603521	116
PTO 14006655	72, 104	PTO 14604448	116	PTO 15061200	26	PTO 19603540	113
PTO 14006657	72, 104	PTO 14604458	116	PTO 15061400	29	PTO 19605521	117
PTO 14006748	75, 103	PTO 14604467	116	PTO 15063500	32	PTO 19703520	116
PTO 14006828	78	PTO 14604473	116	PTO 15120612	23	PTO 19703540	113
PTO 14006846	78, 104	PTO 14604479	116	PTO 1513521	119	PTO 19705520	117
PTO 14006857	78, 104	PTO 14605548	118	PTO 15160616	23	PTO 2000100	5, 6, 45
PTO 14007631	50	PTO 14605551	118, 127, 129	PTO 15501406	112	PTO 2000300	5, 6, 45
PTO 14007633	50	PTO 14605555	118, 127, 129	PTO 15503506	115	PTO 2000310	45
PTO 14007640	94	PTO 14605558	118	PTO 15503540	113	PTO 2000350	45
PTO 14007661	50	PTO 14605567	118	PTO 15507406	122	PTO 2000410	45
PTO 14007955	96, 104	PTO 14605573	118	PTO 15507640	124	PTO 2000600	5, 6, 20
PTO 14010648	23	PTO 14605579	118	PTO 15507951	125	PTO 2000675	5, 6, 42
PTO 14011248	26	PTO 14607648	124	PTO 15601421	112	PTO 2000700	5, 6, 40
PTO 14011260	26	PTO 14607660	124	PTO 15603521	115	PTO 2001000	5, 6, 14, 43
PTO 14011448	29	PTO 14607948	126	PTO 15603540	113	PTO 2001200	5, 6, 24
PTO 14011460	29	PTO 14607951	126, 128, 129	PTO 15607951	125	PTO 2001400	5, 6, 27
PTO 14013531	50	PTO 14607955	126, 128, 129	PTO 15703520	115	PTO 2001401	45
PTO 14013548	33	PTO 14607960	126	PTO 15703540	113	PTO 2001430	111
PTO 14013560	33	PTO 14613548	114	PTO 15707951	125	PTO 2001875	5, 6, 45
PTO 14014448	36	PTO 14613558	114	PTO 15865	154	PTO 2002600	5, 6, 46
PTO 14014460	36	PTO 14613567	114	PTO 15866	154	PTO 2003500	5, 6, 30
PTO 14015548	39	PTO 14613573	114	PTO 15901	154	PTO 2003501	45
PTO 14015560	39	PTO 14615555	118, 127, 129	PTO 15902	154	PTO 2003540	113
PTO 14016524	69, 103	PTO 14617660	124	PTO 15903	154	PTO 2003545	115
PTO 14016536	69	PTO 14617955	126, 128, 129	PTO 15904	154	PTO 2004400	5, 6, 34
PTO 14016542	69, 104	PTO 14625555	118, 127	PTO 15907	154	PTO 2005500	5, 6, 37
PTO 14016624	72, 103	PTO 14627955	126, 128	PTO 17501448	111	PTO 2005556	117
PTO 14016666	72, 104	PTO 14635555	118, 127	PTO 17501458	111	PTO 2006154	5, 6, 54, 55
PTO 14023539	33	PTO 14637955	126, 128	PTO 17501467	111	PTO 2006580	5, 6, 54, 67
PTO 14023548	33	PTO 14703548	116	PTO 17503548	115	PTO 2006794	5, 6, 54, 73
PTO 14031248	26	PTO 14703558	116	PTO 17503558	115	PTO 2006806	5, 6, 54, 76
PTO 14044448	36	PTO 14703567	116	PTO 17503567	115	PTO 2006908	5, 6, 54, 79
PTO 14045548	39	PTO 14703573	116	PTO 17503573	115	PTO 2007004	5, 6, 54, 97
PTO 14046148	56, 104	PTO 14703579	116	PTO 17503579	115	PTO 2007155	5, 6, 54, 83
PTO 14046248	59, 104	PTO 14704448	116	PTO 17504458	115	PTO 2007276	5, 54
PTO 14046260	59, 104	PTO 14704458	116	PTO 17504467	115	PTO 2007491	5, 54, 121
PTO 14046348	62, 104	PTO 14704467	116	PTO 17504473	115	PTO 2007676	5, 6, 54, 93
PTO 14046360	62, 104	PTO 14704473	116	PTO 17504479	115	PTO 2007694	5, 54, 123, 147
PTO 14046448	66, 104	PTO 14704479	116	PTO 17505548	117	PTO 2007890	5, 54, 99
PTO 14046460	66, 104	PTO 14705548	118	PTO 17505558	117	PTO 2007906	5, 54, 125
PTO 14046548	69, 104	PTO 14705551	118, 127, 129	PTO 17505567	117	PTO 2007941	147
PTO 14046560	69, 104	PTO 14705555	118, 127, 129	PTO 17505573	117	PTO 2007989	5, 6, 54, 95
PTO 14046648	72, 104	PTO 14705558	118	PTO 17505579	117	PTO 2008261	5, 6, 54, 58, 85

**PART NUMBER INDEX**

PTO 2008370 . . . . .5, 6, 54, 61, 87	PTO 3006336 . . . . .61	PTO 4011618 . . . . .8, 24, 27, 47, 111	PTO 5053500 . . . . .31, 35, 38
PTO 2008474 . . . . .5, 6, 54, 64, 89, 147	PTO 3006436 . . . . .64	PTO 4016126 . . . . .9, 55, 101	PTO 5080850 . . . . .55, 83
PTO 2008692 . . . . .5, 6, 54, 70, 91	PTO 3006545 . . . . .67	PTO 4016229 . . . . .9, 58, 101	PTO 5080860 . . . . .58, 61, 64
PTO 2008706 . . . . .5, 54, 73	PTO 3006645 . . . . .70	PTO 4016436 . . . . .9, 64, 101	PTO 5080880 . . . . .76
PTO 2010600 . . . . .6, 16, 20	PTO 3006745 . . . . .73	PTO 4016545 . . . . .9, 67, 70, 101	PTO 5081060 . . . . .85
PTO 2011200 . . . . .6, 16, 24	PTO 3006845 . . . . .76	PTO 4016745 . . . . .9, 73, 101	PTO 5081065 . . . . .87, 90, 121, 147
PTO 2011400 . . . . .6, 16, 27	PTO 3006854 . . . . .76	PTO 4016954 . . . . .9, 79, 101	PTO 5081075 . . . . .67, 93
PTO 2011430 . . . . .111	PTO 3006954 . . . . .79	PTO 4017123 . . . . .9, 83, 101	PTO 5081080 . . . . .70, 74, 79, 92, 123
PTO 2013500 . . . . .6, 16, 30	PTO 3007061 . . . . .97	PTO 4017234 . . . . .9, 85, 87, 89, 101	PTO 5081090 . . . . .95, 97, 125
PTO 2013540 . . . . .113	PTO 3007123 . . . . .83	PTO 4017539 . . . . .9, 91, 93, 101	PTO 5081280 . . . . .76, 79, 81
PTO 2013545 . . . . .115	PTO 3007234 . . . . .85	PTO 4017651 . . . . .9, 93, 95, 101	PTO 509080455 . . . . .77
PTO 2014400 . . . . .6, 16, 34	PTO 3007334 . . . . .87	PTO 4017961 . . . . .9, 101	PTO 509100455 . . . . .82
PTO 2015500 . . . . .6, 16, 37	PTO 3007434 . . . . .89	PTO 4020014 . . . . .8, 47	PTO 509103853 . . . . .82
PTO 2015556 . . . . .117	PTO 3007539 . . . . .91	PTO 4020016 . . . . .8, 47	PTO 5100600 . . . . .21
PTO 2016154 . . . . .5, 6, 16, 54, 55	PTO 3007639 . . . . .93	PTO 4020018 . . . . .8, 47	PTO 5100615 . . . . .21
PTO 2016580 . . . . .5, 6, 16, 54, 67	PTO 3007839 . . . . .99	PTO 4020020 . . . . .8, 47	PTO 5501430 . . . . .111
PTO 2016794 . . . . .5, 6, 16, 54, 73	PTO 3007951 . . . . .95	PTO 4027639 . . . . .123	PTO 5503540 . . . . .113
PTO 2016806 . . . . .5, 6, 16, 54, 76	PTO 3010600 . . . . .20	PTO 4040019 . . . . .8, 30, 47	PTO 5503545 . . . . .115
PTO 2016908 . . . . .5, 6, 16, 54, 79	PTO 3011200 . . . . .24	PTO 4040021 . . . . .8, 34, 37, 46, 47	PTO 5505556 . . . . .117
PTO 2017004 . . . . .5, 6, 16, 54, 97	PTO 3011400 . . . . .27	PTO 4041214 . . . . .8, 21, 47	PTO 5506000 . . . . .131
PTO 2017155 . . . . .5, 6, 16, 54, 83	PTO 3013500 . . . . .30	PTO 4041615H . . . . .8, 21, 47	PTO 5507400 . . . . .121
PTO 2017276 . . . . .5, 16, 54	PTO 3015500 . . . . .37	PTO 4041618 . . . . .8, 24, 27, 47, 111	PTO 5507600 . . . . .123
PTO 2017491 . . . . .5, 16, 54, 121	PTO 3017434 . . . . .121	PTO 4042120 . . . . .8, 27, 31, 34, 37, 47, 113	PTO 5507900 . . . . .125
PTO 2017676 . . . . .5, 6, 16, 54, 93	PTO 3017439 . . . . .89	PTO 4042720 . . . . .8, 31, 34, 37, 47, 115, 117	PTO 5551400 . . . . .119
PTO 2017694 . . . . .5, 16, 54, 123	PTO 3017639 . . . . .123	PTO 4046126 . . . . .9, 55, 101	PTO 5553500 . . . . .119
PTO 2017906 . . . . .5, 16, 54, 125	PTO 3017651 . . . . .93	PTO 4046229 . . . . .9, 58, 101	PTO 5600622 . . . . .144
PTO 2017989 . . . . .5, 6, 16, 54, 95	PTO 3020600 . . . . .20	PTO 4046436 . . . . .9, 64, 101	PTO 5606006 . . . . .144
PTO 2018261 . . . . .5, 6, 16, 54, 58, 85	PTO 3023500 . . . . .30	PTO 4046545 . . . . .9, 67, 70, 101	PTO 5606020 . . . . .144
PTO 2018370 . . . . .5, 6, 16, 54, 61, 87	PTO 3024400 . . . . .34	PTO 4046745 . . . . .9, 73, 101	PTO 5606022 . . . . .144
PTO 2018474 . . . . .5, 6, 16, 54, 64, 89	PTO 3025500 . . . . .37	PTO 4046954 . . . . .9, 79, 101	PTO 5606506 . . . . .141
PTO 2018692 . . . . .5, 6, 54, 70, 91	PTO 3017951 . . . . .125	PTO 4047123 . . . . .9, 83, 101	PTO 5606606 . . . . .144
PTO 2018706 . . . . .5, 16, 54, 73	PTO 3030600 . . . . .20	PTO 4047234 . . . . .9, 85, 87, 89, 101	PTO 5608406 . . . . .141
PTO 204106851 . . . . .81	PTO 3501400 . . . . .119	PTO 4047539 . . . . .9, 91, 93, 101	PTO 5608606 . . . . .142
PTO 204106852 . . . . .81	PTO 3742 . . . . .153	PTO 4047651 . . . . .9, 93, 95, 101	PTO 5615123 . . . . .1
PTO 211106751 . . . . .82	PTO 4000012 . . . . .8, 47	PTO 4047961 . . . . .9, 101	PTO 5706306 . . . . .140
PTO 211106752 . . . . .82	PTO 4000014 . . . . .8, 47	PTO 4067234 . . . . .121	PTO 5706506 . . . . .141
PTO 211106753 . . . . .82	PTO 4000015 . . . . .8, 40, 47	PTO 4067951 . . . . .125	PTO 5708206 . . . . .140
PTO 211108851 . . . . .82	PTO 4000016 . . . . .8, 47	PTO 41210 . . . . .81	PTO 57012000 . . . . .131, 136, 137, 138, 140
PTO 212108751 . . . . .82	PTO 4000019 . . . . .8, 30, 47	PTO 4465 . . . . .153	PTO 57015000 . . . . .136, 137, 138
PTO 2266 . . . . .153	PTO 4000020 . . . . .8, 47	PTO 4895 . . . . .153	PTO 57018000 . . . . .136, 137, 138, 140
PTO 2273 . . . . .153	PTO 4000021 . . . . .8, 34, 37, 46, 47	PTO 4896 . . . . .153	PTO 57112000 . . . . .136, 137, 138, 140
PTO 249 . . . . .155	PTO 4000954 . . . . .102	PTO 4897 . . . . .153	PTO 57115000 . . . . .136, 137, 138, 140
PTO 250 . . . . .155	PTO 4001214 . . . . .8, 21, 47	PTO 4898 . . . . .153	PTO 572100351 . . . . .81
PTO 251 . . . . .153	PTO 4001618 . . . . .8, 24, 27, 47, 111	PTO 4899 . . . . .153	PTO 572100451 . . . . .81
PTO 252 . . . . .153	PTO 4006126 . . . . .9, 55, 101, 102	PTO 4900 . . . . .153	PTO 572103751 . . . . .81
PTO 253 . . . . .153	PTO 4006229 . . . . .9, 58, 101, 102	PTO 4901 . . . . .153	PTO 572103851 . . . . .81
PTO 254 . . . . .153	PTO 4006336 . . . . .102	PTO 4981 . . . . .154	PTO 57118000 . . . . .136, 137, 138, 140
PTO 255 . . . . .153	PTO 4006436 . . . . .9, 64, 101, 102	PTO 4982 . . . . .154	PTO 59010000 . . . . .138, 140
PTO 256 . . . . .153	PTO 4006545 . . . . .9, 67, 70, 101, 102	PTO 4983 . . . . .154	PTO 59015000 . . . . .138, 140
PTO 3000500 . . . . .42	PTO 4006745 . . . . .9, 73, 101, 102	PTO 4984 . . . . .154	PTO 59018000 . . . . .138, 140
PTO 3000600 . . . . .20	PTO 4006954 . . . . .9, 79, 101	PTO 5001400 . . . . .24, 27	PTO 59021000 . . . . .138, 140
PTO 3000700 . . . . .40	PTO 4007123 . . . . .9, 89, 101, 102	PTO 5002600 . . . . .46	PTO 59110000 . . . . .138, 140
PTO 3001000 . . . . .14, 43	PTO 4007234 . . . . .9, 85, 87, 89, 101, 102	PTO 5003500 . . . . .31	PTO 59115000 . . . . .138, 140
PTO 3001200 . . . . .24	PTO 4007539 . . . . .9, 91, 93, 101, 102	PTO 5004400 . . . . .35, 38	PTO 59118000 . . . . .138, 140
PTO 3001400 . . . . .27	PTO 4007651 . . . . .9, 93, 95, 101, 102	PTO 5011400 . . . . .24, 28	PTO 59121000 . . . . .138, 140
PTO 3002600 . . . . .46	PTO 4007951 . . . . .102	PTO 5013500 . . . . .31	PTO 6043500 . . . . .8, 31, 47
PTO 3003500 . . . . .30	PTO 4007961 . . . . .9, 101	PTO 5023500 . . . . .31, 35, 38	PTO 6044400 . . . . .8, 35, 38, 47
PTO 3004400 . . . . .34	PTO 4010019 . . . . .8, 30, 47	PTO 5033500 . . . . .31, 35, 38	PTO 6046133 . . . . .9, 56, 101
PTO 3005500 . . . . .37	PTO 4010021 . . . . .8, 34, 37, 46, 47	PTO 5043500 . . . . .31, 35, 38	PTO 6046236 . . . . .9, 59, 61, 101
PTO 3006126 . . . . .55	PTO 4011214 . . . . .8, 21, 47		PTO 6046343 . . . . .9, 62, 64, 101
PTO 3006229 . . . . .58			

**PART NUMBER INDEX**

PTO 6046552 . . . . .9, 67, 101	PTO 8000614 . . . . .21	PTO 8005528 . . . . .38	PTO 8011213 . . . . .25
PTO 6046654 . . . . .9, 70, 74, 101	PTO 8000615 . . . . .21	PTO 8005532 . . . . .38	PTO 8011218 . . . . .25
PTO 6046854 . . . . .76	PTO 8000616 . . . . .21	PTO 8006108 . . . . .56	PTO 8011221 . . . . .25
PTO 6046863 . . . . .9, 77, 80, 101	PTO 8000618 . . . . .21	PTO 8006110 . . . . .56	PTO 8011406 . . . . .28
PTO 6047071 . . . . .9, 98, 101	PTO 8000619 . . . . .21	PTO 8006130 . . . . .56	PTO 8011418 . . . . .28
PTO 6047130 . . . . .9, 84, 101	PTO 8000620 . . . . .21	PTO 8006510 . . . . .68	PTO 8011420 . . . . .28
PTO 6047241 . . . . .9, 86, 88, 90, 101	PTO 8000710 . . . . .41	PTO 8006511 . . . . .68	PTO 8011421 . . . . .28
PTO 6047248 . . . . .92	PTO 8000712 . . . . .41	PTO 8006522 . . . . .68	PTO 8013506 . . . . .31
PTO 6047548 . . . . .9, 94, 101	PTO 8000713 . . . . .41	PTO 8006524 . . . . .68	PTO 8013521 . . . . .31
PTO 6047661 . . . . .94	PTO 8000714 . . . . .41	PTO 8006535 . . . . .68	PTO 8014406 . . . . .35
PTO 6047960 . . . . .125	PTO 8000715 . . . . .41	PTO 8006722 . . . . .74	PTO 8014421 . . . . .35
PTO 6047961 . . . . .9, 96, 97, 101	PTO 8000716 . . . . .41	PTO 8006728 . . . . .74	PTO 8015506 . . . . .38
PTO 6067241 . . . . .121	PTO 8000718 . . . . .41	PTO 8006740 . . . . .74	PTO 8015521 . . . . .38
PTO 6067648 . . . . .124	PTO 8000719 . . . . .41	PTO 8006822 . . . . .77	PTO 8016806 . . . . .77
PTO 666150 . . . . .102	PTO 8000720 . . . . .41	PTO 8006824 . . . . .77	PTO 8017921 . . . . .96
PTO 7000500 . . . . .42	PTO 8001010 . . . . .14, 43	PTO 8006828 . . . . .77	PTO 8020614 . . . . .21
PTO 7000600 . . . . .21	PTO 8001013 . . . . .14, 43	PTO 8006832 . . . . .77	PTO 8020616 . . . . .21
PTO 7000700 . . . . .40	PTO 8001015 . . . . .14, 43	PTO 8006922 . . . . .80	PTO 8020618 . . . . .21
PTO 7001000 . . . . .14, 43	PTO 8001016 . . . . .14, 43	PTO 8006924 . . . . .80	PTO 8020620 . . . . .21
PTO 7001200 . . . . .25	PTO 8001017 . . . . .14, 43	PTO 8007024 . . . . .98	PTO 8021015 . . . . .14, 43
PTO 7001400 . . . . .28	PTO 8001019 . . . . .14, 43	PTO 8007026 . . . . .98	PTO 8021016 . . . . .14, 43
PTO 7006133 . . . . .56	PTO 8001022 . . . . .43	PTO 8007028 . . . . .98	PTO 8021020 . . . . .14, 43
PTO 7006236 . . . . .59	PTO 8001212 . . . . .25	PTO 8007032 . . . . .98	PTO 8021024 . . . . .43
PTO 7006343 . . . . .62	PTO 8001214 . . . . .25	PTO 8007125 . . . . .84	PTO 8021216 . . . . .25
PTO 7006443 . . . . .65	PTO 8001215 . . . . .25	PTO 8007130 . . . . .84	PTO 8021218 . . . . .25
PTO 7006552 . . . . .68	PTO 8001216 . . . . .25	PTO 8007610 . . . . .94	PTO 8021220 . . . . .25
PTO 7006654 . . . . .71	PTO 8001218 . . . . .25	PTO 8007611 . . . . .94	PTO 8021222 . . . . .25
PTO 7006754 . . . . .74	PTO 8001219 . . . . .25	PTO 8007635 . . . . .94	PTO 8021418 . . . . .28
PTO 7006863 . . . . .77	PTO 8001220 . . . . .25	PTO 8007640 . . . . .94	PTO 8021420 . . . . .28
PTO 7006963 . . . . .80	PTO 8001222 . . . . .25	PTO 8007922 . . . . .96	PTO 8021422 . . . . .28
PTO 7007071 . . . . .98	PTO 8001224 . . . . .25	PTO 8007924 . . . . .96	PTO 8021424 . . . . .28
PTO 7007130 . . . . .84	PTO 8001416 . . . . .28	PTO 8007935 . . . . .96	PTO 8023520 . . . . .31
PTO 7007241 . . . . .86	PTO 8001418 . . . . .28	PTO 8008208 . . . . .59, 86	PTO 8023522 . . . . .31
PTO 7007341 . . . . .88	PTO 8001419 . . . . .28	PTO 8008210 . . . . .59, 86	PTO 8043520 . . . . .31
PTO 7007441 . . . . .90, 122	PTO 8001420 . . . . .28	PTO 8008211 . . . . .59, 86	PTO 8043524 . . . . .31
PTO 7007548 . . . . .92	PTO 8001422 . . . . .28	PTO 8008218 . . . . .59, 86	PTO 8043526 . . . . .31
PTO 7007648 . . . . .94, 124	PTO 8001423 . . . . .28	PTO 8008220 . . . . .86	PTO 8044418 . . . . .35
PTO 7007661 . . . . .94	PTO 8001424 . . . . .28	PTO 8008225 . . . . .59, 86	PTO 8051014 . . . . .44
PTO 7007848 . . . . .99	PTO 8002622 . . . . .46	PTO 8008230 . . . . .59, 86	PTO 8051018 . . . . .44
PTO 7007961 . . . . .96, 125	PTO 8002624 . . . . .46	PTO 8008310 . . . . .62, 88	PTO 8051218 . . . . .25
PTO 7010600 . . . . .21	PTO 8002628 . . . . .46	PTO 8008311 . . . . .62, 88	PTO 8051220 . . . . .25
PTO 7011200 . . . . .25	PTO 8003516 . . . . .31	PTO 8008325 . . . . .62, 88	PTO 8051418 . . . . .28
PTO 7011400 . . . . .28	PTO 8003518 . . . . .31	PTO 8008330 . . . . .62, 88	PTO 8051420 . . . . .28
PTO 7012600 . . . . .46	PTO 8003519 . . . . .31	PTO 8008410 . . . . .65, 90	PTO 8058418 . . . . .65
PTO 7013500 . . . . .31	PTO 8003520 . . . . .31	PTO 8008411 . . . . .65, 90	PTO 8058618 . . . . .71
PTO 7014400 . . . . .35	PTO 8003522 . . . . .31	PTO 8008424 . . . . .65, 90	PTO 8060514 . . . . .42
PTO 7015500 . . . . .38	PTO 8003523 . . . . .31	PTO 8008430 . . . . .65, 90	PTO 8060516 . . . . .42
PTO 7017448 . . . . .90	PTO 8003524 . . . . .31	PTO 8008435 . . . . .65, 90	PTO 8060518 . . . . .42
PTO 7020600 . . . . .21	PTO 8003524H . . . . .31	PTO 8008610 . . . . .71, 92	PTO 8060520 . . . . .42
PTO 7021200 . . . . .25	PTO 8003526 . . . . .31	PTO 8008611 . . . . .71, 92	PTO 8060610 . . . . .22
PTO 7023500 . . . . .31	PTO 8003528 . . . . .31	PTO 8008624 . . . . .71, 92	PTO 8060612 . . . . .22
PTO 7024400 . . . . .35	PTO 8004420 . . . . .35	PTO 8008628 . . . . .71, 92	PTO 8060613 . . . . .22
PTO 7030600 . . . . .21	PTO 8004422 . . . . .35	PTO 8008635 . . . . .71	PTO 8060614 . . . . .22
PTO 7043500 . . . . .31	PTO 8004423 . . . . .35	PTO 8008640 . . . . .71, 92	PTO 8060616 . . . . .22
PTO 7045500 . . . . .38	PTO 8004424 . . . . .35	PTO 8010506 . . . . .42	PTO 8060618 . . . . .22
PTO 7053500 . . . . .31	PTO 8004426 . . . . .35	PTO 8010606 . . . . .21	PTO 8060619 . . . . .22
PTO 7503500 . . . . .119	PTO 8004428 . . . . .35	PTO 8010618 . . . . .21	PTO 8060620 . . . . .22
PTO 8000510 . . . . .42	PTO 8004432 . . . . .35	PTO 8011013 . . . . .14, 43	PTO 8061012 . . . . .44
PTO 8000512 . . . . .42	PTO 8005522 . . . . .38	PTO 8011018 . . . . .14, 43	PTO 8061013 . . . . .14, 44
PTO 8000612 . . . . .21	PTO 8005524 . . . . .38	PTO 8011206 . . . . .25	PTO 8061014 . . . . .44
PTO 8000613 . . . . .21	PTO 8005526 . . . . .38	PTO 8011210 . . . . .25	PTO 8061016 . . . . .44

**PART NUMBER INDEX**

PTO 8061018	44	PTO 8101016	44	PTO 8183521	138	PTO 8256522	131, 141
PTO 8061019	14, 44	PTO 8101018	44	PTO 8183524	138	PTO 8256524	141
PTO 8061020	44	PTO 8101020	44	PTO 8184406	139	PTO 8256822	142
PTO 8061216	25	PTO 810111016	47	PTO 8184420	139	PTO 8257622	143
PTO 8061218	25	PTO 810111053	47	PTO 8184421	139	PTO 8257628	143
PTO 8061220	25	PTO 8101216	25	PTO 8184424	139	PTO 8257922	143
PTO 8061418	28	PTO 8101218	25	PTO 8185506	139	PTO 8257928	143
PTO 8061419	28	PTO 810211097	47	PTO 8185520	139	PTO 8258422	141
PTO 8061420	28	PTO 8111014	44	PTO 8185521	139	PTO 8258622	142
PTO 8063519	32	PTO 8111018	44	PTO 8185527	139	PTO 8258624	142
PTO 8063520	32	PTO 8111218	25	PTO 8186506	141	PTO 8261420	138
PTO 8063522	32	PTO 8120615	22	PTO 8186520	141	PTO 8261422	138
PTO 8064420	35	PTO 8121018	44	PTO 8186521	141	PTO 8262622	140
PTO 8064422	35	PTO 8121020	14, 44	PTO 8186820	142	PTO 8263520	139
PTO 8070614	22	PTO 8130600	22	PTO 8186828	142	PTO 8263522	139
PTO 8070615	22	PTO 8131012	44	PTO 8187606	143	PTO 8263524	139
PTO 8070616	22	PTO 8171406	131, 138	PTO 8187620	143	PTO 8263528	139
PTO 8071406	131	PTO 8171420	138	PTO 8187621	143	PTO 8264420	139
PTO 8073520	32	PTO 8171421	138	PTO 8187906	143	PTO 8264422	139
PTO 8073521	32	PTO 8172606	140	PTO 8187920	143	PTO 8265522	139
PTO 8073527	32	PTO 8172620	140	PTO 8187921	143	PTO 8265528	139
PTO 8074406	35	PTO 8172621	140	PTO 8188606	142	PTO 8266522	141
PTO 8074420	35	PTO 8173506	131, 138	PTO 8188620	142	PTO 8266524	141
PTO 8074421	35	PTO 8173520	138	PTO 8188621	142	PTO 8266822	142
PTO 8074427	35	PTO 8173521	138	PTO 8188624	142	PTO 8267622	143
PTO 8075506	38	PTO 8173524	138	PTO 8188628	142	PTO 8267628	143
PTO 8075520	38	PTO 8174406	139	PTO 8201406	138	PTO 8267922	143
PTO 8075521	38	PTO 8174420	139	PTO 8201420	138	PTO 8267928	143
PTO 8075527	38	PTO 8174421	139	PTO 8201421	138	PTO 8268422	141
PTO 8076521	68	PTO 8174424	139	PTO 8203506	138	PTO 8268622	142
PTO 8076806	77	PTO 8175506	139	PTO 8203520	138	PTO 8268624	142
PTO 8076820	77	PTO 8175520	139	PTO 8203521	138	PTO 8273527	139
PTO 8076821	77	PTO 8175521	139	PTO 8204406	139	PTO 8274432	139
PTO 8077620	94	PTO 8175527	139	PTO 8204420	139	PTO 8275532	139
PTO 8077621	94	PTO 8176506	141	PTO 8204421	139	PTO 8276828	142
PTO 8077622	94	PTO 8176520	141	PTO 8205506	139	PTO 8277606	143
PTO 8077906	96	PTO 8176521	141	PTO 8205520	139	PTO 8277932	143
PTO 8077918	96	PTO 8176806	142	PTO 8205521	139	PTO 8286806	142
PTO 8077920	96	PTO 8176820	142	PTO 8208406	140	PTO 8286821	142
PTO 8077921	96	PTO 8176821	142	PTO 8211406	138	PTO 8441	154
PTO 8078406	65	PTO 8177620	143	PTO 8211420	138	PTO 8443	154
PTO 8078420	65	PTO 8177621	143	PTO 8211421	138	PTO 8501420	119
PTO 8078606	71	PTO 8177906	143	PTO 8213506	138	PTO 8501422	119
PTO 8078620	71	PTO 8177920	143	PTO 8213520	138	PTO 8503522	119
PTO 8078621	71	PTO 8177921	143	PTO 8213521	138	PTO 8511420	119
PTO 8080612	22	PTO 8178406	131, 140	PTO 8214406	139	PTO 8571420	119
PTO 8080614	22	PTO 8178420	140	PTO 8214420	139	PTO 8573520	119
PTO 8080635	92	PTO 8178421	140	PTO 8214421	139	PTO 8573524	119
PTO 8081012	44	PTO 8178606	142	PTO 8215506	139	PTO 8591400	119
PTO 8081014	44	PTO 8178620	142	PTO 8215520	139	PTO 8593500	119
PTO 8081016	44	PTO 8178621	142	PTO 8215521	139	PTO 8708406	141
PTO 8081216	25	PTO 8178624	142	PTO 8251420	138	PTO 87015000	140
PTO 8090608	22	PTO 8178628	142	PTO 8251422	138	PTO 9002548	10, 11, 22, 26, 29, 32, 40, 44, 56, 59, 62, 65, 84, 86, 88
PTO 8091208	25	PTO 8181406	138	PTO 8252622	140	PTO 9002560	10, 11, 22, 26, 29, 32, 44, 56, 59, 62, 65, 84, 86, 88
PTO 8091412	28	PTO 8181420	138	PTO 8253520	139	PTO 9002648	46
PTO 8093516	32	PTO 8181421	138	PTO 8253522	131, 139	PTO 9004548	11, 77, 80, 81, 98
PTO 8094416	35	PTO 8182606	140	PTO 8253524	139	PTO 9004560	11, 77, 80, 98
PTO 8095516	38	PTO 8182620	140	PTO 8254420	139		
PTO 8101012	44	PTO 8182621	140	PTO 8254422	139		
PTO 8101013	44	PTO 8183506	138	PTO 8255522	139		
PTO 8101014	44	PTO 8183520	138	PTO 8255528	139		

**PART NUMBER INDEX**

PTO 9023548 . . . 10, 11, 36, 68, 71, 74, 90, 92, 94, 96	PTO 9610035 . . . . .124	PTO AE110525 . . . . .86	PTO AP110525 . . . . .94
PTO 9023560 . . . 10, 11, 36, 38, 68, 71, 74, 90, 92, 94, 96	PTO 9610036 . . . . .126	PTO AE110531 . . . . .86	PTO AP110530 . . . . .94
PTO 9121448 . . . . .112, 114	PTO 9610251 . . . . .11, 12	PTO AE220019 . . . . .59	PTO AP12035 . . . . .100
PTO 9121458 . . . . .112, 114	PTO 9612502 . . . . .11, 12	PTO AE220025 . . . . .59	PTO AP12120 . . . . .99
PTO 9121467 . . . . .112, 114	PTO 9612534 . . . . .11, 12	PTO AE220319 . . . . .59	PTO AP12134 . . . . .99
PTO 9123548 . . . . .116	PTO 9613505 . . . . .11, 12	PTO AE220522 . . . . .60	PTO AP125121 . . . . .100
PTO 9123558 . . . . .116	PTO 9613525 . . . . .11, 12	PTO AE311025 . . . . .62	PTO AP12535 . . . . .100
PTO 9123567 . . . . .116	PTO 9613567 . . . . .11, 12	PTO AE311325 . . . . .62	PTO AP12538 . . . . .100
PTO 9123573 . . . . .116	PTO 9614535 . . . . .11, 12	PTO AE35031 . . . . .94	PTO AP20223 . . . . .86
PTO 9123579 . . . . .116	PTO 9614589 . . . . .11, 12	PTO AE421028 . . . . .65	PTO AP20230 . . . . .86
PTO 9125548 . . . . .118	PTO 9615005 . . . . .11, 12	PTO AE421528 . . . . .65	PTO AP220030 . . . . .59
PTO 9125558 . . . . .118	PTO 9615029 . . . . .11, 12	PTO AE622341 . . . . .71	PTO AP22025 . . . . .59
PTO 9125567 . . . . .118	PTO 9700153 . . . . .144	PTO AE622528 . . . . .71	PTO AP2202525 . . . . .60
PTO 9125573 . . . . .118	PTO 9702108 . . . . .47	PTO AE622531 . . . . .71	PTO AP2205138 . . . . .60
PTO 9125579 . . . . .118	PTO 9702110 . . . . .47	PTO AE622535 . . . . .71	PTO AP220530 . . . . .60
PTO 9127448 . . . . .122	PTO 9704140 . . . . .144	PTO AE824341 . . . . .77	PTO AP230150 . . . . .102
PTO 9127648 . . . . .124	PTO 9704160 . . . . .144	PTO AG100 . . . . .165	PTO AP311025 . . . . .62
PTO 9127660 . . . . .124	PTO 9706000 . . . . .144	PTO AG100AB . . . . .165	PTO AP3115121 . . . . .63
PTO 9127948 . . . . .126	PTO 9707000 . . . . .130, 144	PTO AG21002 . . . . .147	PTO AP311525 . . . . .63
PTO 9127960 . . . . .126	PTO 9709000 . . . . .130, 144	PTO AG216100 . . . . .147	PTO AP311530 . . . . .63
PTO 9200017 . . . . .13, 48	PTO 9807000 . . . . .144	PTO AG216241 . . . . .147	PTO AP311535 . . . . .63
PTO 9200069 . . . . .13, 48	PTO 9879000 . . . . .130, 144	PTO AG216900 . . . . .147	PTO AP35030 . . . . .94
PTO 9200085 . . . . .13, 48	PTO 9907000 . . . . .130, 144	PTO AG216901 . . . . .147	PTO AP35040 . . . . .94
PTO 9200102 . . . . .13, 48	PTO 9909000 . . . . .130, 144	PTO AG30 . . . . .165	PTO AP35134 . . . . .91, 93
PTO 9200141 . . . . .13, 48	PTO 9917000 . . . . .144	PTO AG30AB . . . . .165	PTO AP35330 . . . . .94
PTO 9200165 . . . . .13, 48	PTO 9919000 . . . . .144	PTO AG35002 . . . . .147	PTO AP35342 . . . . .94
PTO 9200195 . . . . .13, 48	PTO 98712000 . . . . .130, 144	PTO AG356138 . . . . .147	PTO AP36040 . . . . .96
PTO 9200254 . . . . .13, 48	PTO 98715000 . . . . .130, 144	PTO AG356239 . . . . .147	PTO AP36045 . . . . .96
PTO 9200259 . . . . .13, 48	PTO 98718000 . . . . .130, 144	PTO AG40 . . . . .165	PTO AP36535 . . . . .96
PTO 9200260 . . . . .13, 48	PTO 98910000 . . . . .130, 144	PTO AG40AB . . . . .165	PTO AP421120 . . . . .64
PTO 9200600 . . . . .13, 48	PTO 98915000 . . . . .130, 144	PTO AG60 . . . . .165	PTO AP421134 . . . . .64
PTO 9201200 . . . . .48	PTO 98918000 . . . . .130, 144	PTO AG60AB . . . . .165	PTO AP421535 . . . . .65
PTO 9202600 . . . . .13, 48	PTO 98921000 . . . . .144	PTO AG80 . . . . .165	PTO AP500134 . . . . .67
PTO 9203500 . . . . .13, 48	PTO 9214503559 . . . . .108	PTO AG80AB . . . . .165	PTO AP500330 . . . . .68
PTO 9204400 . . . . .13, 48	PTO 9214505551 . . . . .117	PTO AK1046506 . . . . .145	PTO AP500530 . . . . .68
PTO 9204N15 . . . . .48	PTO 9214505555 . . . . .117	PTO AK138125 . . . . .107	PTO AP622134 . . . . .70
PTO 9204N16 . . . . .48	PTO 9214507951 . . . . .126	PTO AK13875 . . . . .107	PTO AP622330 . . . . .71
PTO 9204P15 . . . . .13	PTO 9214507955 . . . . .126	PTO AK13890 . . . . .107	PTO AP622340 . . . . .71
PTO 9204P15 . . . . .48	PTO 9214515555 . . . . .117	PTO AK210Q90 . . . . .146	PTO AP622530 . . . . .71
PTO 9204P16 . . . . .13, 48	PTO 9214517955 . . . . .126	PTO AK2200426 . . . . .145	PTO AP7N5138 . . . . .74
PTO 9205071 . . . . .13, 48	PTO 9214603559 . . . . .108	PTO AK22005 . . . . .145	PTO AP7N535 . . . . .74
PTO 9205084 . . . . .13, 48	PTO 9214627955 . . . . .126	PTO AK3500487 . . . . .145	PTO AP824040 . . . . .77
PTO 9210600 . . . . .10, 12	PTO 9214637955 . . . . .126	PTO AK3500568 . . . . .145	PTO AP824340 . . . . .77
PTO 9211200 . . . . .10, 12	PTO 9314505555 . . . . .117	PTO AK35125 . . . . .107, 146	PTO AP824534 . . . . .77
PTO 9211400 . . . . .112, 114	PTO 9314507951 . . . . .126	PTO AK3600561 . . . . .145	PTO AP900134 . . . . .79
PTO 9214400 . . . . .10, 12	PTO 9314517955 . . . . .126	PTO AK36200 . . . . .107	PTO AS1515190 . . . . .108
PTO 9215170 . . . . .10, 12	PTO 9314605555 . . . . .117	PTO AK4210487 . . . . .145	PTO AS22286 . . . . .108
PTO 9215500 . . . . .118	PTO 9314607951 . . . . .126	PTO AK421075 . . . . .107	PTO AS3180L190 . . . . .108
PTO 9501430 . . . . .119	PTO 9314705555 . . . . .117	PTO AK50005 . . . . .145	PTO AS8209 . . . . .108
PTO 9600101 . . . . .12	PTO 9314707951 . . . . .126	PTO AK500090 . . . . .107	PTO AW10121 . . . . .108
PTO 9600105 . . . . .12	PTO 9314717955 . . . . .126	PTO AK500125 . . . . .146	PTO HD8441 . . . . .154
PTO 9600202 . . . . .12	PTO AB1051 . . . . .108	PTO AK622090 . . . . .107	PTO HD8443 . . . . .154
PTO 9600215 . . . . .12	PTO AB200814 . . . . .107	PTO AK7230561 . . . . .145	
PTO 9600234 . . . . .12	PTO AB200815 . . . . .107	PTO AK723125 . . . . .107, 146	
PTO 9600305 . . . . .12	PTO AB200816 . . . . .107	PTO AK7N200 . . . . .107	
PTO 9600435 . . . . .12	PTO AE1000022 . . . . .56	PTO AK7N200 . . . . .146	
PTO 9600467 . . . . .12	PTO AE1000028 . . . . .56	PTO AK8240561 . . . . .145	
PTO 9600489 . . . . .12	PTO AE100322 . . . . .56	PTO AK8240561 . . . . .145	
PTO 9601200 . . . . .13	PTO AE100531 . . . . .57	PTO AK824125 . . . . .107	
	PTO AE110019 . . . . .84	PTO AP100520 . . . . .57	
	PTO AE110328 . . . . .84	PTO AP100530 . . . . .57	