

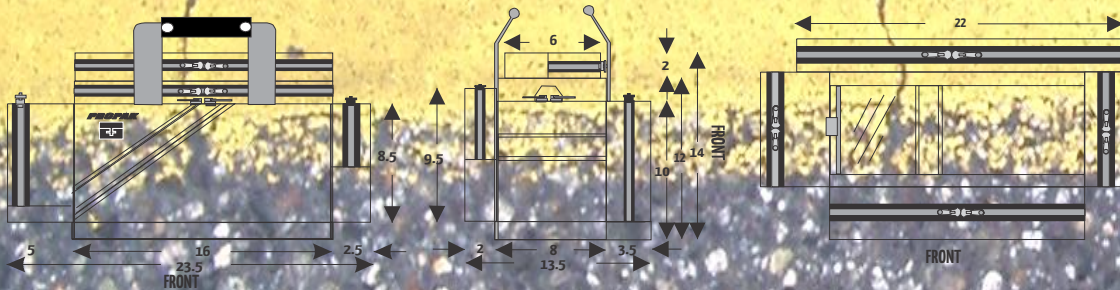

PROPAK

MANUFACTURING Inc.

Manufacturing Excellence



PROPAK
MANUFACTURING Inc.

Ph 250-861-8998 toll free 888-338-8838 www.propak.net

MD:00 MEDICATION MODULES

MD:01 Compact medication module

The MD:01 Pullout Medication Module organizes and displays all or your injectable medications. The RX:01 and RX:02 medication cassettes add great protection to those fragile ampules and vials. The MD:01 has two sliders with loops for a lock or seal. Constructed of 500 denier cordura it is designed for trouble free service. Its compact size make it fit well into several bag designs making it a very versatile addition to your organizational needs. Supplied with two RX:01 and two RX:02 medication cassettes.

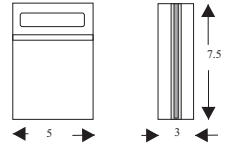

MD:02 Medication Module

The MD:02 Pullout Medication Module organizes and displays all or your advanced medication supplies. The internal divider dramatically increases display area, while the left side has windowed pockets to and displays miscellaneous supplies, Made of 500 denier cordura and is supplied with two sliders with interlocking loops for an additional lock or seal including drawing blood. The MD:02 is supplied with 4 RX:01 and 4 RX:02 medication cassettes

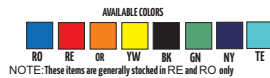

MD:03 lid Mount Medication Module

The MD:03 is a module design to fit on the inside lid of a trauma bag. Containing 4 RX:01 and 4 RX:02 medication cassettes. Constructed with 500 denier cordura, and YKK self repairing zipper.

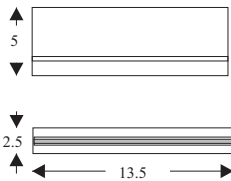

PSS7 Medication Module

The PSS7 medication module features foam with a 1/4" die cut grid so the module can be customized to your personal needs

PSS7F Replacement foam comes in set of two



Rx:01 / 02: Medication Cassette

The RX:01 /02 are closed celled foam blocks inserted in a plastic case the RX:01 is a 1/2" foam block die cut to securely fit ampules the RX:02 is a 1" foam block die cut to hold vials. Both sizes have hook fastener on the back so they are removable.

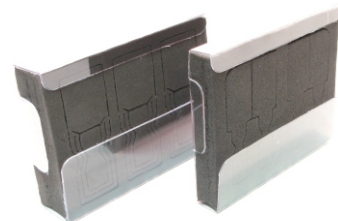

Contents not included

ME:00 INTUBATION MODULES

ME:01 Intubation Module c/w Pockets for blades

The ME:01 Pullout Intubation Module organizes and displays all or your advanced airway management supplies. The removable center card dramatically increases display area, with a windowed pocket on one side and airway loops on the other. The ME:01 features individual pockets to hold your blades. There are also pockets for organizing ET tubes. And ample elastic loops for the rest of your needs. The front of the case is padded for extra protection.



ME:02 Intubation Module c/w Lg internal Pouch

The ME:02 Pullout Intubation Module organizes and displays all or your advanced airway management supplies. The removable center card dramatically increases display area, while the large windowed pouch stores and displays miscellaneous supplies, including child or pediatric B.V.M.



ME:03 Compact Intubation Module

The ME:03 is a comprehensive module for the size and weight discerning. Constructed with 500 denier cordura, nylon webbing, heavy woven elastic and YKK self repairing zipper.



PSS4 Intubation Module

The PSS4 Intubation module features cloth pockets to hold the blades, and numerous elastic loops for all you intubation needs



MI/MT IV / TRAUMA MODULES

MI:01 IV Administration Module

The **MD:01** Pullout IV Administration Module organizes and displays all your IV supplies so every thing you need to start an intravenous line is at your finger tips. This module works well in conjunction with the MD:02, Constructed of 500 denier cordura nylon. The MI:01 comes with sliders that have interlocking loops, so a seal or lock can be added and a clear top pocket for identification and posting expiry dates for quick referral. Using modules has many benefits, including time savings. by not having to search through you kit, what you need is at your finger tips. They speed up replenishing your supplies after a call out. Modules increase the efficiency of more than one person working out of the same main bag. Use one red for dextrose and one blue for saline

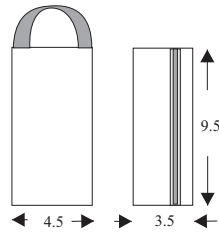

PSS00 IV Module

The **PSS6** Pullout IV Module is more developed than the MI:01 and includes additional elastic loops for organizing blood drawing supplies. Also constructed of 500 denier cordura. For trouble free service.

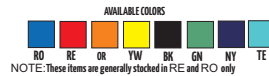
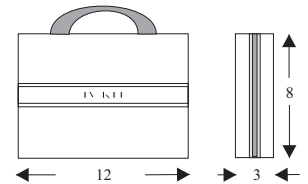

MT:02 Trauma Module

The **MT:02** Trauma module is a module developed to organize your trauma supplies. In a visual and logical format The use of a module makes it much easier for two attendants to work out of one main turn out bag. The trauma module is set up so the contents are off set to keep the bag in more of a rectangular shape.

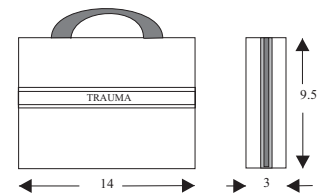

Contents not included

SA:00 OXYGEN CARRY BAGS

OXYGEN CYLINDER SLEEVE

- SA:01 D Oxygen Cylinder Sleeve D
- SA:01 JD Oxygen Cylinder Sleeve Jumbo D
- SA:01 E Oxygen Cylinder Sleeve E

The SA:01 Oxygen carry sleeve is a simple unpadded protective cover for your O2 cylinder. It features a large side pocket, comfortable handle, and a vinyl bottom. Made from 1000D cordura for added abrasion resistance. Comes in three sizes for D, Jumbo D, E cylinders.

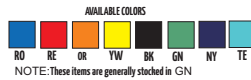

OXYGEN CARRY BAG

- SA:02 Oxygen Carry Bag D Cylinder
- SA:03 Oxygen Carry Bag E cylinder
- SA:04 Oxygen Carry Bag Jumbo D cylinder
- SA:05 Oxygen Carry C / M9 cylinder

The SA:02 SA:03 SA:04 SA:05 feature a regulator access compartment with airway loops and an elasticized pocket. The removable pouch can carry airway accessories. The bag is padded to protect the cylinder and regulator

Specs:

- 1000 denier cordura
- # 10 self repairing zippers
- nylon webbing and bindings
- 200 denier oxford liner
- heavy woven elastics
- welded steel hardware
- closed celled foam
- reflexite brand reflective tape

Features:

- removable pouch
- airway loops inside cylinder opening
- left or right suspending hook mounts
- optional cot hooks
- optional heavy adjustable shoulder strap
- available in fluid resistant materials

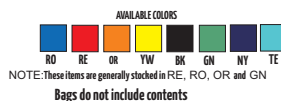
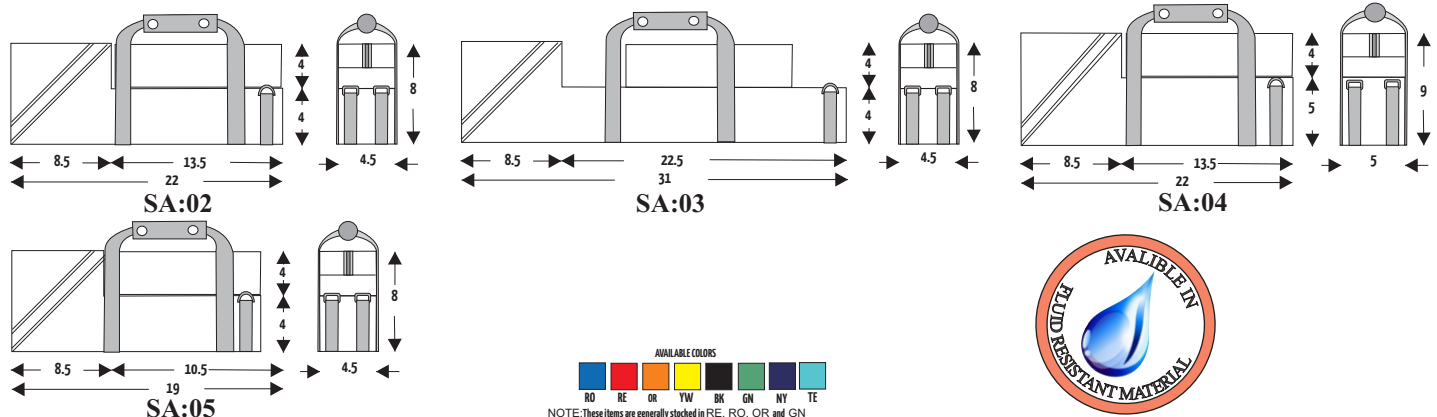

DC:01 TRAUMA / OXYGEN

DC:01 TRAUMA / OXYGEN DEPLOYMENT KIT C/W CARD COLLAR BACK POCKET

Fits a D cylinder, Jumbo D available on request



The DC:01 is a premium, semi-rigid deployment system that organizes your oxygen, airway, hard collars and trauma supplies into one space-efficient, user friendly kit. The DC:01 is constructed from the highest quality fabrics and hardware. The thoughtfully laid out interior features many things including a clear windowed pocket on the lid and a supported shelf which will not drop down impeding the removal and replacement of the O2 cylinder. Combine this with access from the interior to the O2 pocket make this product well suited for a ventilator.

Various elastic looping and a generous amount of pockets / pouches make organizing your medical supplies easy and logical. The robust materials, and impeccable construction is designed for years of trouble free service.

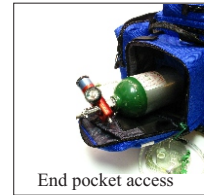

Specs:

- 1000 denier cordura
- # 10 self repairing zippers
- nylon webbing / binding
- 200 denier oxford nylon liner
- heavy woven elastic
- welded steel hardware
- closed celled foam
- reflexite brand reflective tape

Features:

- Replaceable bottom
- ergonomic design
- color coded sliders
- reflective tape on 5 sides
- Plastic insert to protect end pocket
- Oxygen access through the end pocket
- Shelf over cylinder c/w support
- one internal clear windowed pocket
- front pocket developed with elastic loops
- pouch / pocket for organization
- adjustable shoulder strap (SP:01)
- available in fluid resistant Materials

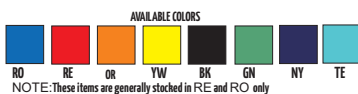
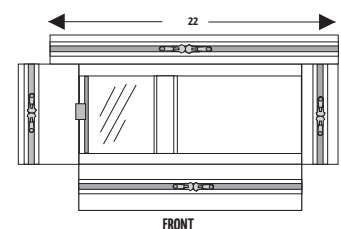
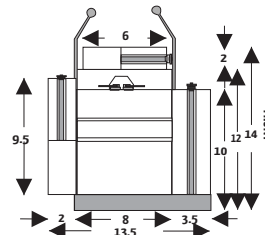
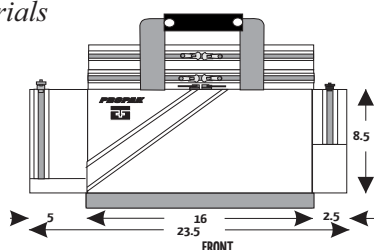

DC Trauma/Oxygen deployment system

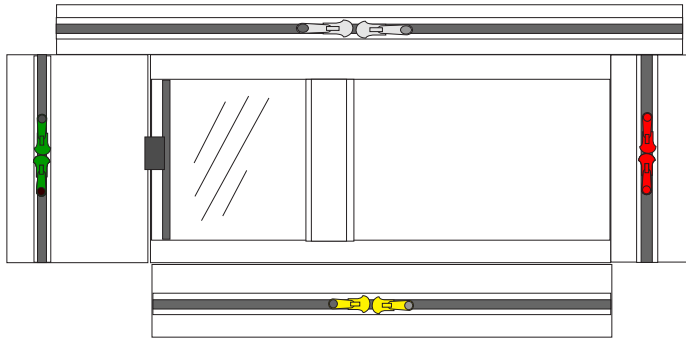

DC:01

Hard collar back pocket
deluxe organized front pocket

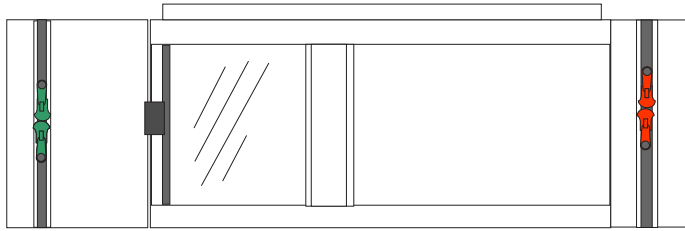

DC:02

Hideaway back pack straps
no front pocket

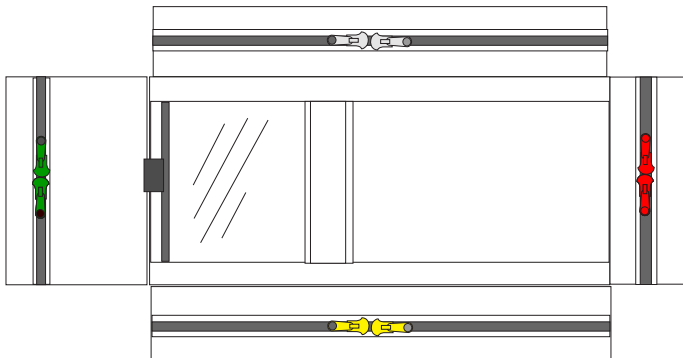

DC:03

Pocket to fit module on back
deluxe organized front pocket

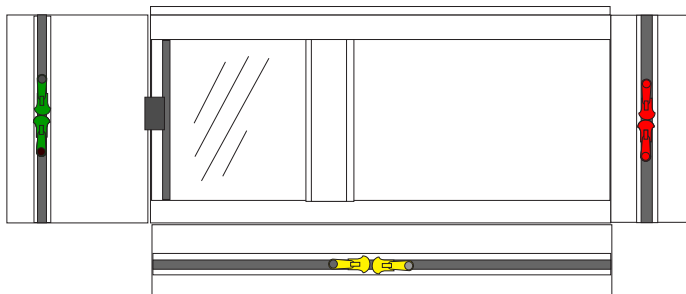

DC:04

Hideaway back pack straps in back
deluxe organized front pocket

TOP VIEW

DC:02 TRAUMA / OXYGEN

DC:02 OXYGEN / AIRWAY MANAGEMENT C/W CONCEALED PACK STRAPS

Fits a D cylinder, Jumbo D available on request

The DC:02 is a premium, semi-rigid deployment system that organizes your oxygen and airway supplies into one space-efficient, user friendly kit. The DC:01 is constructed from the highest quality fabrics and hardware. The thoughtfully laid out interior features many things including a clear windowed pocket on the lid and a supported shelf which will not drop down impeding the removal and replacement of the O2 cylinder. Combine this with access from the interior to the O2 pocket make this product well suited for a ventilator.

The interior provides room for a pullout module such as intubation or trauma. The robust materials, and impeccable construction is designed for years of trouble free service.

Specs:

1000 denier cordura
10 self repairing zippers
nylon webbing / binding
200 denier oxford nylon liner
heavy woven elastic
welded steel hardware
closed celled foam
reflectite brand reflective tape

Features:

Replaceable bottom
ergonomic design
color coded sliders
reflective tape on 5 sides
Plastic insert to protect end pocket
Oxygen access through the end pocket
Shelf over cylinder c/w support
one internal clear windowed pocket
adjustable shoulder strap (SP:01)
zip out foam for laundering
available in fluid resistant Materials

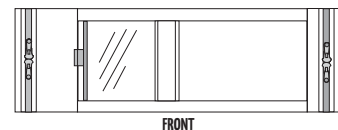
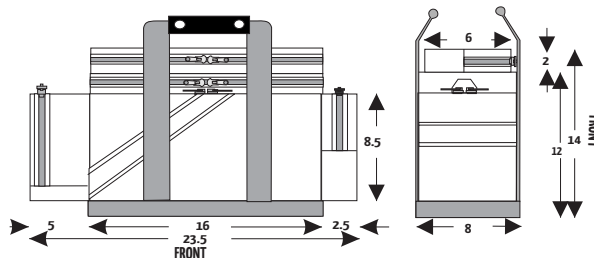
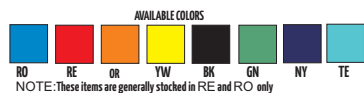

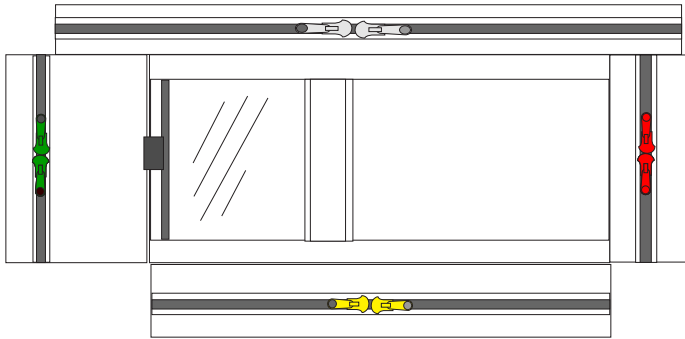

DC:01

Hard collar back pocket
deluxe organized front pocket

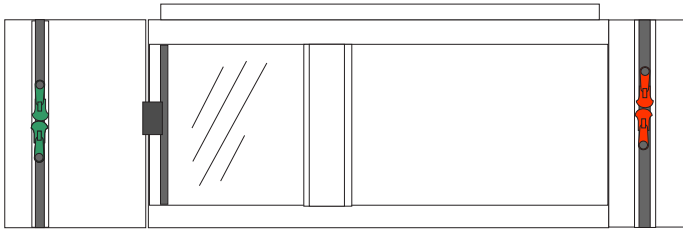

DC:02

Hideaway back pack straps
no front pocket

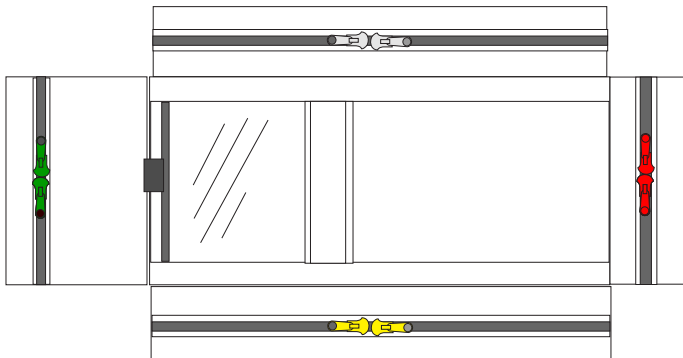

DC:03

Pocket to fit module on back
deluxe organized front pocket

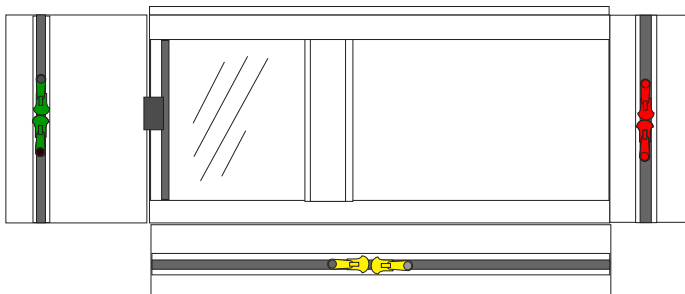

DC:04

Hideaway back pack straps in back
deluxe organized front pocket

TOP VIEW

DC:03 TRAUMA / OXYGEN

DC:03 TRAUMA / OXYGEN DEPLOYMENT KIT C/W MODULE BACK POCKET

Fits a D cylinder, Jumbo D available on request

The DC:03 is a premium, semi-rigid deployment system that organizes your oxygen, airway, trauma supplies into one space-efficient, user friendly kit. The DC:03 is constructed from the highest quality fabrics and hardware. The thoughtfully laid out interior features many things including a clear windowed pocket on the lid and a supported shelf which will not drop down impeding the removal and replacement of the O2 cylinder. Combine this with access from the interior to the O2 pocket make this product well suited for a ventilator. Various elastic looping and a generous amount of pockets / pouches make organizing your medical supplies easy and logical. The robust materials, and impeccable construction is designed for years of trouble free service.

Specs:

1000 denier cordura
10 self repairing zippers
nylon webbing / binding
200 denier oxford nylon liner
heavy woven elastic
welded steel hardware
closed celled foam
reflexite brand reflective tape

Features:

Replaceable bottom
ergonomic design
color coded sliders
reflective tape on 5 sides
Plastic insert to protect end pocket
Oxygen access through the end pocket
Shelf over cylinder c/w support
one internal clear windowed pocket
front pocket developed with elastic loops and pouches / pocket for organization
adjustable shoulder strap (SP:01)
zip out foam for laundering
available in fluid resistant Materials

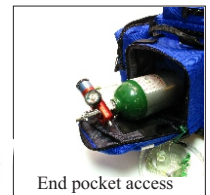
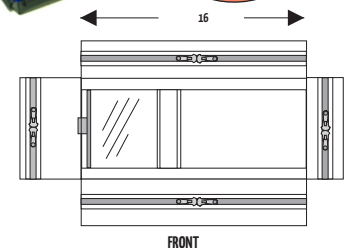
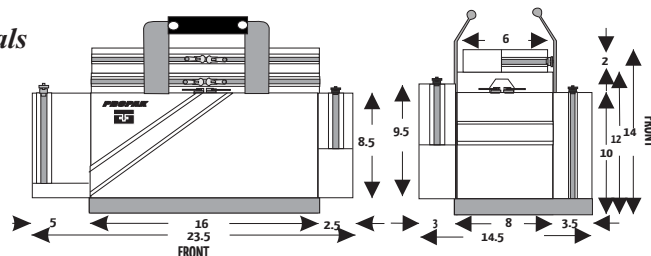
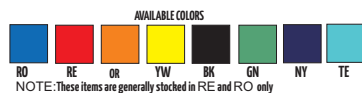

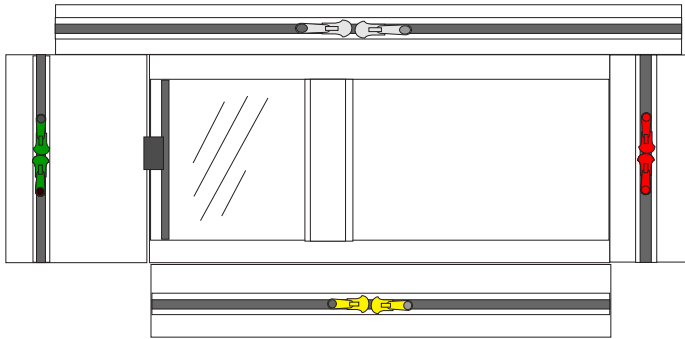

DC:01

Hard collar back pocket
deluxe organized front pocket

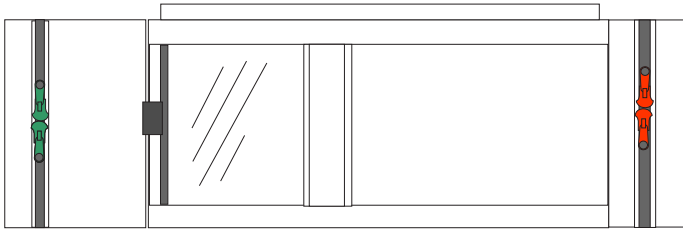

DC:02

Hideaway back pack straps
no front pocket

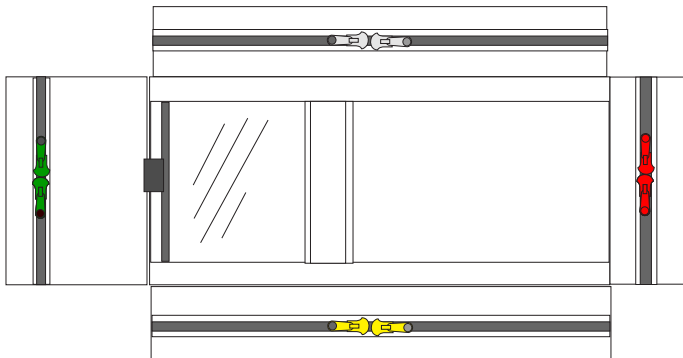

DC:03

Pocket to fit module on back
deluxe organized front pocket

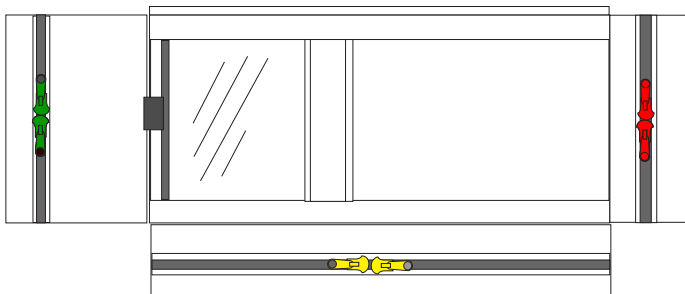

DC:04

Hideaway back pack straps in back
deluxe organized front pocket

TOP VIEW

DC:04 TRAUMA / OXYGEN

DC:04 TRAUMA / OXYGEN DEPLOYMENT KIT C/W CONCEALED PACK STRAPS AND DELUXE FRONT POCKET

Fits a D cylinder, Jumbo D available on request

The DC:04 is a premium, semi-rigid deployment system that organizes your oxygen, airway, trauma supplies into one space-efficient, user friendly kit. The DC:04 is constructed from the highest quality fabrics and hardware. The thoughtfully laid out interior features many things including a clear windowed pocket on the lid and a supported shelf which will not drop down impeding the removal and replacement of the O2 cylinder. Combine this with access from the interior to the O2 pocket make this product well suited for a ventilator. Various elastic looping and a generous amount of pockets / pouches make organizing your medical supplies easy and logical. The robust materials, and impeccable construction is designed for years of trouble free service.

Specs:

1000 denier cordura
10 self repairing zippers
nylon webbing / binding
200 denier oxford nylon liner
heavy woven elastic
welded steel hardware
closed celled foam
reflexite brand reflective tape

Features:

Replaceable bottom
ergonomic design
color coded sliders
reflective tape on 5 sides
Plastic insert to protect end pocket
Oxygen access through the end pocket
Shelf over cylinder c/w support
one internal clear windowed pocket
front pocket developed with elastic loops and pouches / pocket for organization
adjustable shoulder strap (SP:01)
zip out foam for laundering
available in fluid resistant Materials

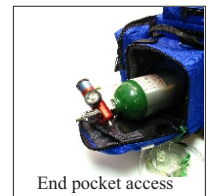
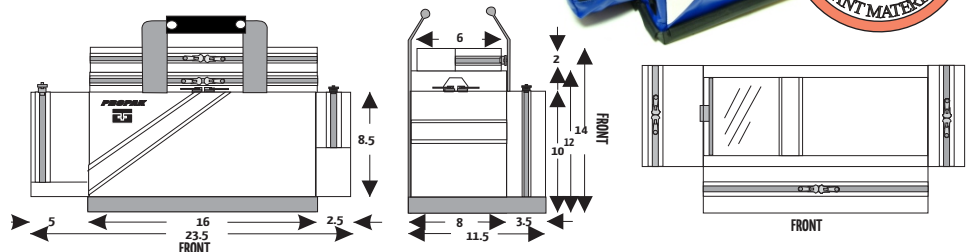

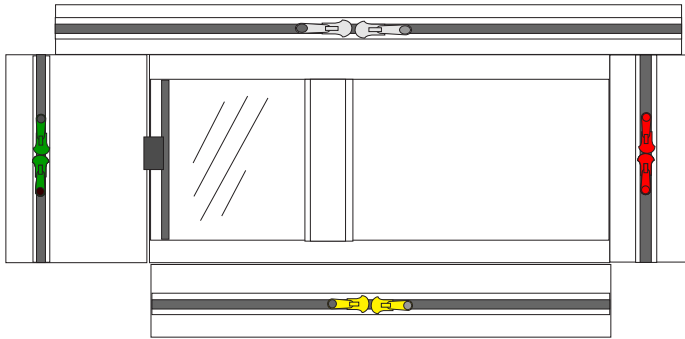

DC:01

Hard collar back pocket
deluxe organized front pocket

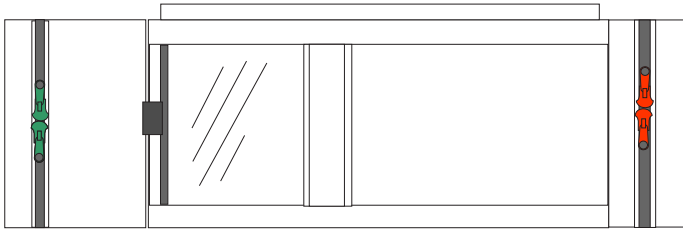

DC:02

Hideaway back pack straps
no front pocket

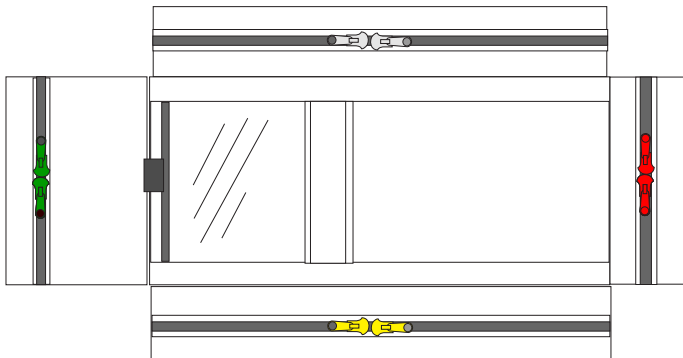

DC:03

Pocket to fit module on back
deluxe organized front pocket

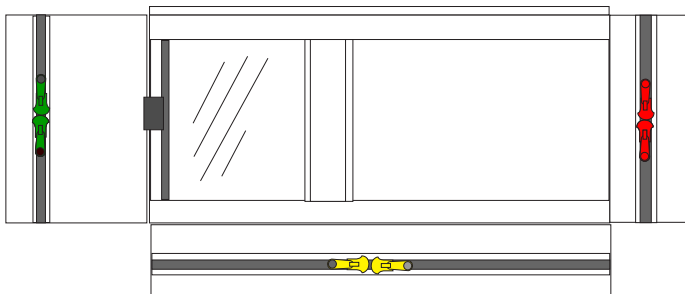

DC:04

Hideaway back pack straps in back
deluxe organized front pocket

TOP VIEW

DE:01 SEMI-RIGID TRAUMA

DE:01 SEMI-RIGID TRAUMA DEPLOYMENT SYSTEM

The DE:01 is a premium, semi-rigid deployment system that organizes your airway, trauma and diagnostic supplies into one space-efficient, user friendly kit. The DE:01 is constructed from the highest quality fabrics and hardware. The thoughtfully laid out interior features many things including a clear windowed pocket on the lid various elastic looping and a generous amount of pockets / pouches, and removable dividers, which makes organizing you medical supplies easy and logical. The versatility extends beyond it's fundamental organization and storage capacity, by accepting any of our pullout modules to satisfy your specific response needs. The robust materials, and impeccable construction is designed for years of trouble free service.

Specs:

Reflexite brand reflective tape
 1000 denier cordura outer
 200 denier oxford liner
 #10 self repairing zippers
 nylon webbing / binding
 heavy woven elastic
 welded steel hardware
 closed celled foam



Features:

Replaceable bottom
 ergonomic design
 color coded sliders
 reflective tape on 5 sides
 adjustable shoulder strap
 hidden padded pack straps
 one internal clear windowed pocket
 front pocket developed with elastic loops
 pouch / pocket for organization
 available in fluid resistant Materials

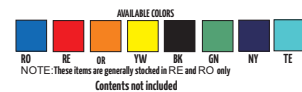
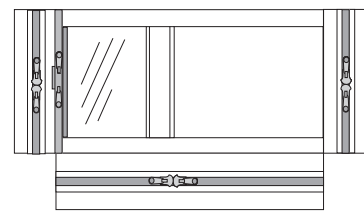
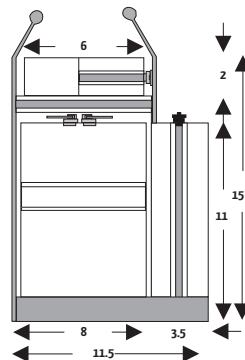
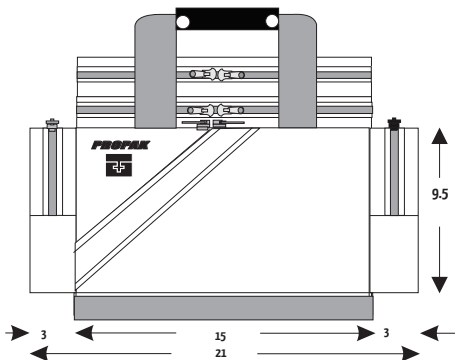

DE:01A SEMI-RIGID TRAUMA ALS

DE:01A SEMI-RIGID TRAUMA DEPLOYMENT SYSTEM ADVANCED LIFE SUPPORT

The DE:01A is a premium, semi-rigid deployment system that organizes your airway, trauma, diagnostic, medications, and IV administration supplies into one space-efficient, user friendly kit. The DE:01A is constructed from the highest quality fabrics and hardware. The thoughtfully laid out interior features many things including a clear windowed pocket on the interior lid with a double elastics system that holds stacked boxes of preload meds. letting you remove one leaving the other secure. Various elastic looping and a generous amount of pockets / pouches, and removable dividers, makes organizing you medical supplies easy and logical. The versatility extends beyond it's fundamental organization and storage capacity, by the addition of our pullout modules. ME:02 Intubation, MD:02 Medication, and Two IV administration The robust materials, and impeccable construction is designed for years of trouble free service.

Specs:

reflexite brand reflective tape
1000 denier cordura outer
200 denier oxford liner
#10 self repairing zippers
nylon webbing / binding
heavy woven elastic
welded steel hardware
closed celled foam



Features:

Four modules
Ergonomic design
replaceable bottom
color coded sliders
reflective tape on 5 sides
adjustable shoulder strap
hidden padded pack straps
one internal clear windowed pocket
front pocket developed with elastic loops
pouch / pocket for organization
available in fluid resistant Materials

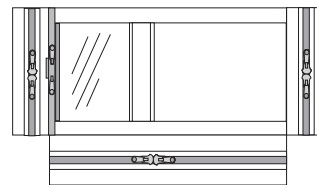
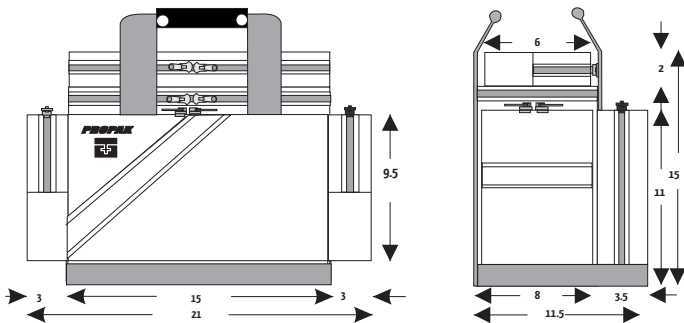

AVAILABLE COLORS
RD RE OR YW BK GN NY TE
NOTE: these items are generally checked in F/E and P/O only
Contents not included



DE:01A Semi-Rigid Trauma Deployment System Advanced Life Support

FI:01, 03 MULTI-PURPOSE KITS

The FI:00 series of trauma bags

The FI:00 Series of semi rigid compact trauma bags. They come in several sizes. the main body of the bags are all the same, the volume changes by adding pockets to the outside. All models have a deluxe front pocket developed with internal pouches and elastic loops for holding all your trauma needs. These bags have many uses from a first in trauma bag, a sports medicine bag, a pediatric case, and a nurses bag among many. All models are constructed to Propak Manufacturing's extremely high standards.

FI:01 Multi- Purpose kit the FI:01 is constructed of 1000 Denier cordura nylon with a 200 denier oxford liner, nylon webbing, nickel plated steel hardware, large # 10 YKK self repairing zippers. Make for a very high quality bag good for years of service in even the highest call out services. The FI:01 features a developed front pocket, an external lid pocket and an internal lid pocket. The shape is maintained with removable closed celled evazote foam. Reflexite brand reflective tape make you seen at night.

Specs:

- 1000 denier cordura
- # 10 self repairing zippers
- nylon webbing / binding
- 200 denier oxford nylon liner
- heavy woven elastic
- welded steel hardware
- closed celled foam
- reflexite brand reflective tape

Features:

- ergonomic design
- reflective tape on 2 sides
- two external pockets
- one internal clear windowed pocket
- front pocket developed with elastic loops
- pouch / pocket for organization
- compact size
- optional shoulder strap (SP:01)
- available in fluid resistant Materials

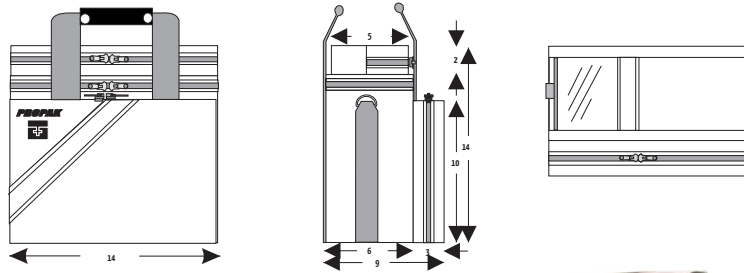

Optional shoulder strap



Bags do not include contents

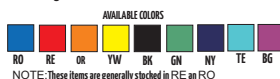

NOTE: These items are generally stocked in RE or RO

FI:03 Budget multi- Purpose Kit. This kit is still constructed to Propak's very high standards but with material of a lesser cost. For use in areas where the kit sits for long periods. Such as a Burn kit, or a disaster bag. It is constructed out of 400 or 500 denier outer cloth with the same 200 denier oxford liner, smaller webbing, and only # 8 self repairing coil..

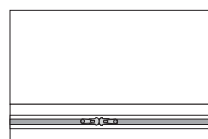
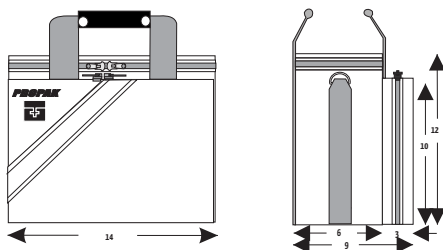

Bags do not include contents



NOTE: These items are generally stocked in RE or RO



FI:04, 05 MULTI-PURPOSE KITS

FI:04 Deluxe Multi-Purpose Kit

FI:04 Has in addition to the FI:01 two end pockets, a replaceable bottom, and color coded sliders.

FI:04, 05 Specs:

1000 denier cordura
 # 10 self repairing zippers
 nylon webbing / binding
 200 denier oxford nylon liner
 heavy woven elastic
 welded steel hardware
 closed celled foam
 reflexite brand reflective tape

Features:

Replaceable bottom
 ergonomic design FI:04
 color coded sliders
 reflective tape on 5 sides
 four external pockets FI:04
 five external pockets FI:05
 one internal clear windowed pocket
 front pocket developed with elastic loops
 pouch / pocket for organization
 compact size
 lockable zipper sliders to secure or seal
 drug pockets
 available in fluid resistant Materials

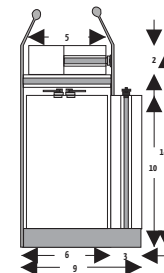
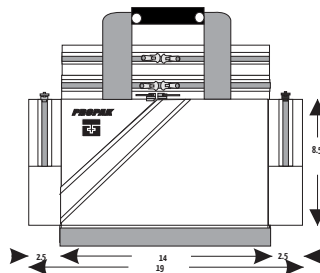
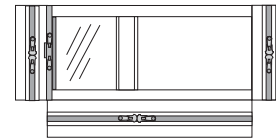

Bags do not include contents



NOTE: These items are generally stashed in RE or RO

FI:05 Deluxe Multi-Purpose Kit C/W Back pocket

It is the same as the FI:04 with the addition of a back pocket

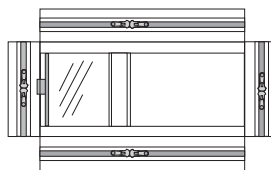
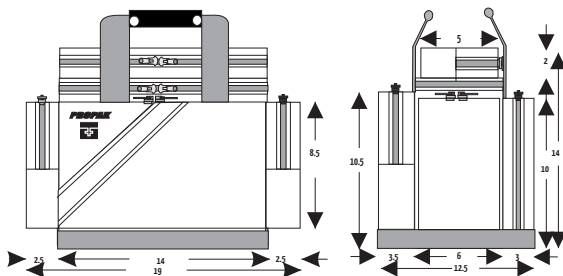

Bags do not include contents



NOTE: These items are generally stashed in RE or RO

The Ultimate in Comprehensive Kits

This is the **FI:04 Compact Trauma Bag**, enhanced with several modules, to make up a comprehensive advanced life support system. This is the bag to go in the door with. Strong, light weight and ergonomically designed to maximize resources. It organizes intubation, IV administration, ampule, vial and preload meds. Throw a B.V.M. in the the main compartment. Trauma and misc. in the front pocket, diagnostic in the top pocket, sharps in the left hand side pocket. You should have all you need for patient care until you are back to the unit. If more is needed the large trauma bag can be called for. An option is for your service to acquire extra modules, so you can replenish the jump kit with stocked modules reducing down time between calls. Then restocking, checking for expiry dates and cleaning of the modules can be done when time permits.

Specs:

- 1000 denier cordura
- # 10 self repairing zippers
- nylon webbing / binding
- 200 denier oxford nylon liner
- heavy woven elastic
- welded steel hardware
- closed celled foam
- reflexite brand reflective tape

Features:

- Replaceable bottom
- ergonomic design
- color coded sliders
- reflective tape on 5 sides
- four external pockets
- one internal clear windowed pocket
- front pocket developed with elastic loops
- pouch / pocket for organization
- compact size
- lockable zipper sliders to secure or seal
- drug pockets
- adjustable shoulder strap (SP:01)
- three modules (MI:01, ME03, MD:01)
- available in fluid resistant Materials



MI:01



ME:03



MD:01



SP:01

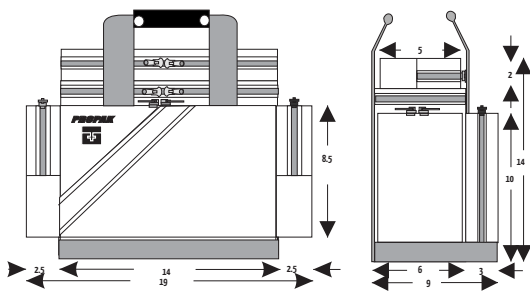
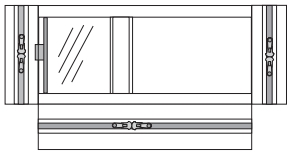

Bags do not include contents

AVAILABLE COLORS



NOTE: These items are generally stocked in RE or RO



Replaceable bottom



Ergonomic design

PK:08 PK:09

TRAUMA MEDICAL PACK

PK:08 Trauma Medical Pack

PK:09 Trauma Medical Pack with Side pockets

The PK:08 and PK:09 are a back pack style response tool designed and manufactured to the high standards Propak Manufacturing has come to be recognized for. This commercial grade back pack is versatile and able to be configured in several different ways, making it migrate seamlessly into your deployment needs. If you wish to carry oxygen the pack is equipped with both vertical and horizontal mounting hardware. The large list of options dramatically expands the range of functions accessible with this system. The PK:09 features extra side pockets and oxygen outlet through side pocket. Both designs come with a very comfortable fully adjustable pack system which can be hidden away to keep the straps from interfering in calls where a pack is not required. Both the PK:08 and PK:09 can be ordered with an aluminum stayed heavy duty pack system. For use in services who find themselves requiring greater comfort when carrying for prolonged periods.

Features

- The pack comes with several sizes of clear windowed pouches for color coding and organizing your supplies for quick response
- O2 tank strap and two mounts for vertical or horizontal mounting
- Very comfortable adjustable pack system which can be hidden away
- Optional aluminum stayed heavy duty pack harness
- High visibility
- Wide range of colors
- Extra zipper protection
- Large list of options
- Non ferrous metals for use near highly magnetic diagnostic equipment
- Hard collar pocket
- PK:09 side pockets with O2 outlet
- Hydration system compatible,
- Protective bottom
- Carrying handle that does not stress the main zipper
- Contoured styling
- 6 external pockets PK:09
- 3 external pockets PK:08
- external hard collar pocket

PK:08



Construction

- 1000 denier nylon outer
- # 10 YKK zippers
- Nylon webbing
- 200 denier nylon liner
- Evazote closed celled foam
- Genuine leather parts
- Reflexite brand reflective tape



Hard collar pocket

PK:09



Dimensions

PK:08 23" tall x 14" wide x 13" deep 58cm x 36cm x 33cm

PK:09 23" tall x 21" wide x 13" deep 58cm x 53cm x 33cm

Colors

Packs are available in several colors including: red, royal, orange, teal, grey, black, green, high vis green, high vis lime, olive, yellow but generally stocked in red and royal

Warranty

5 year workmanship and materials

Options

- | | | | | |
|-------------------------------|------------------|-----------------|----------------------------|----------------------|
| - Aluminum stayed pack system | - Divider system | - RX:01 | - Pouch #1 12.5 x 10 x 1.5 | - Pouch #5 6 x 5 x 4 |
| - Rain cover | - Shelf system | - RX:02 | - Pouch #2 10 x 10 x 1.5 | - Pouch #6 4 x 5 x 4 |
| - Hydration system | - Tank strap | - S700 foam | - Pouch #3 13 x 5 x 6 | |
| - Cargo mesh with pocket | - Lash Straps | - Jumbo D strap | - Pouch #4 13 x 5 x 4 | |



PSO:200 / 300 / 400

O2 Carry Bag Oxygen carry bag O:200 "D" cylinder O:300 "E" cylinder O:400 jumbo "D" Bag comes with a detachable pouch on top, covered regulator for protection, webbing pockets to fit optional aluminum hooks to hang the unit on a stretcher. Also includes "D" rings to attach optional shoulder strap **COLOR green, red, royal, orange, teal.**

PSO:200 22L X 4.5W X 8H PSO:300 31L X 4.5W X 8H PSO:400 22L X 5W X 8H



PSS:400

Intubation Module Intubation module with cloth pockets to hold blades
COLOR red, royal, orange, teal. 14L X 3W X 9.5H



PSS:600

IV Administration Module Module to hold all your supplies to start an IV
COLOR red, royal, orange, teal. 12L X 3W X 8H



PSS:700 / PSS:7foam

Ampoule Module Drug kit to hold meds. in fragile containers. Kit features die cut foam which can be custom configured. PSS:7foam is the replacement foam for this module
COLOR red, royal, orange, teal. 12.5L X 5W X 3H



PSS:800

Trauma Module Module to hold all your trauma supplies. Can be ordered with optional waist strap
COLOR red, royal, orange, teal. 13L X 3W X 9.5H



PST:100

O2 Trauma Kit Semi rigid trauma bag featuring full opening main compartment, developed lid pockets, interior dividers, foam for support, and replaceable bottom.

COLOR red, royal, orange, teal. 23.5L X 9.5W X 9H



PSV:100

Rescue Vest Vest comes with flapped bottom pockets, five front pockets, one back pocket, webbing for side adjustments and adjustable radio harness
Sizes Sm/Med, Med/L, L/XL

COLOR red, royal, orange, teal.



PSV:200

Rescue Vest Vest comes with zipped bottom pockets, five front pockets, one back pocket, webbing for side adjustments and adjustable radio harness
Sizes Sm/Med, Med/L, L/XL

COLOR red, royal, orange, teal.



PSV:300

Rescue Vest Vest comes with flapped bottom pockets, five front pockets, webbing for side adjustment, adjustable radio harness and mesh body
Sizes: Sm/Med, Med/L, L/XL

COLOR red, royal, orange, teal.



PSA3/5P

Lid mounted pouch to fit PSA:300 and PSA:500 COLOR red 13L X 5W X 2.5H



PSA:200

Soft pack Kit (large) Trauma Bag comes with developed front pocket and replaceable bottom
Same dimensions as PSA:300 COLOR red, royal, orange, teal. 22L X 14W X 12H



PSA:300 / PSA:300D

Trauma Kit (large) Semi rigid Trauma Bag comes with developed front pocket.
Interior liner with dividers, foam for support, Lid pouch and replaceable bottom
Same dimensions as PSA:200 PSA:300D comes with PSS:400, PSS:600 and
PSS:700 replaces lid pouch COLOR red, royal, orange, teal 22L X 14W X 12H.



PSA:400

Soft pack kit (small) Trauma Bag comes with developed front pocket and replaceable bottom
Same dimensions as PSA:500 COLOR red, royal, orange, teal. 18L X 14W X 12H.



PSA:500 / PSA:500D

Trauma Kit (Small) Semi rigid Trauma Bag comes with developed front pocket.
Interior liner with dividers, foam support. Lid pouch and replaceable bottom
Same dimensions as PSA:400. PSA:500D comes with PSS:600 and PSS:700
replaces lid pouch. COLOR red, royal, orange, teal. 18L X 14W X 12H



PSA:600

Comprehensive trauma kit Semi rigid Trauma / oxygen Bag comes with two
developed front pockets. Interior liner with dividers, foam for support large rear
collar pocket and replaceable bottom. COLOR red, royal, orange, teal.
27L X 15W X 12H



PSA:700

First responder kit Semi Rigid Trauma Bag comes with attached shoulder strap,
liner with dividers, foam support, and developed inside lid pocket
COLOR red, royal, orange, teal. 14L X 13W X 6H



PSA:900

Deluxe first responder kit Semi Rigid Trauma Bag comes with exterior pocket,
attached shoulder strap, liner with dividers, foam support, and developed inside
lid pocket. COLOR red, royal, orange, teal. 14L X 13W X 8H



PSA:1000

Modular medical O2 kit Trauma / oxygen Bag comes with hideaway back pack
straps. Interior liner with dividers, foam for support, large front pocket, three
windowed pouches, O2 access hole in front pocket and replaceable bottom
COLOR red, royal, orange, teal. 22L X 12W X 10.5W



PSA:1100

Multi pocket medical kit Utility bag comes with four interlocking pouches, two
having mesh fronts for viewing contents, liner with foam support, "D" rings to
attach an optional shoulder strap COLOR red, royal, orange, teal.
12L X 6W X 11H



SA:06, 7, 9 OXYGEN / VENTILATOR CARRY BAG

SA:06 oxygen/ventilator carry bag D cylinder

SA:07 oxygen/ventilator carry bag E cylinder

SA:09 oxygen/ventilator carry bag jumbo D cylinder

The SA:06, SA:07 and SA:09 are part of the SA series of oxygen deployment bags. These three models are quite unique in their shape and function. The body of the bag has two access zippers, the end zipper giving access to the oxygen cylinder regulator and facilitates removal and replacement of the cylinder. The second zipper situated at the top of the bag gives access to the shelf over the cylinder and opens up to the regulator. This is well suited to adjuncts which are required to be continually attached to the O2 supply such as a ventilator or suction unit, but this storage area is not limited to only that use and also works well for storage of all your generic O2 supplies. The vertical design makes carrying the bag close to the centerline of the attendant, helping to reduce joint stress. The removable aluminum hooks are designed to hang the bag on the side of a patient cot, reducing the number of items the attendant is required to carry. The bottom of the hooks also support the bag in the vertical position and with rubber feet elevates the bag off of the ground away from wear and soiling from accident site fluids.

Features:

- Ergonomic design. Lowers muscle and joint stress
- Cylinder access through end of bag
- Access to regulator from main compartment. So equipment can remain attached to O2 supply
- Comes with heavy duty adjustable shoulder strap
- Aluminum hooks to suspend the bag on patient cot
- Rubber feet to elevate bag off the ground
- Available in three cylinder sizes
- Closed celled foam for content protection
- Internal shelf to support contents over cylinder



Construction:

- Outer 1000 denier cordura nylon and also available in 18oz fluid resistant material
- Liner 200 denier oxford nylon
- Large # 10 self-repairing coil zippers
- Heavy nylon webbings
- Welded steel hardware
- Evazote closed celled foam
- Reflexite brand reflective tape
- Aircraft grade aluminum



Accessories

The SA:06, SA:07 and SA:09 come standard with our SP:01 heavy-duty adjustable shoulder strap. They also come with two aircraft grade aluminum supports, which are hooks to suspend the bag as well as attachment for the rubber feet

Colors

available in several colors but generally only stocked in green

Dimensions

SA:06 is dimensioned to fit a D cylinder

22 long X 4.75 wide X 11.5 tall

SA:07 is dimensioned to fit an E cylinder

31 long X 4.75 wide X 11.5 tall

SA:09 is dimensioned to fit a jumbo D cylinder

22 long X 5.25 wide X 12 tall



Note: If you require the bag to be constructed with non-ferrous components for magnetic areas such as MRI proximity, please contact the office

